



MET Laboratories, Inc. *Safety Certification - EMI - Telecom Environmental Simulation*
33439 WESTERN AVENUE • UNION CITY, CALIFORNIA 94587-3201 • PHONE (510) 489-6300 • FAX (510) 489-6372

Electromagnetic Compatibility Criteria Test Report

for the

**Firetide
HotPort 3500-5001**

Verified under
the FCC Certification Rules
contained in
Title 47 of the CFR, Part 15.407 and 15.247
for Intentional Radiators

MET Report: EMCS18793A-FCC407

January 5, 2006

Prepared For:

**Firetide
16795 Lark Ave.
Los Gatos, CA 95032**

Prepared By:
MET Laboratories, Inc.
33439 Western Ave.
Union City, California 94587



Electromagnetic Compatibility Criteria Test Report

for the

**Firetide
HotPort 3500-5001**

Tested Under

the FCC Certification Rules
contained in
Title 47 of the CFR, Part 15.407 and 15.247
for Intentional Radiators

Shawn McMillen, Project Engineer
Electromagnetic Compatibility Lab

Cheryl Anicete
Documentation Department

Engineering Statement: The measurements shown in this report were made in accordance with the procedures indicated, and the emissions from this equipment were found to be within the limits applicable. I assume full responsibility for the accuracy and completeness of these measurements, and for the qualifications of all persons taking them. It is further stated that upon the basis of the measurements made, the equipment tested is capable of operation in accordance with the requirements of Parts 15.407 and 15.247, of the FCC Rules under normal use and maintenance.

Tony Permsombut, Manager
Electromagnetic Compatibility Lab



Firetide
HotPort 3500-5001

Electromagnetic Compatibility
Equipment Configuration
CFR Title 47, Part 15, Subpart E

Report Status Sheet

Revision	Report Date	Reason for Revision
Ø	January 5, 2006	Initial Issue.
1	February 13. 2006	Revision 1



Table of Contents

I.	Executive Summary	1
	A. Purpose of Test	2
	B. Executive Summary	3
II.	Equipment Configuration	4
	A. Overview	5
	B. References	6
	C. Test Site	6
	D. Description of Test Sample	6
	E. Equipment Configuration	9
	F. Support Equipment	9
	G. Ports and Cabling Information	10
	H. Mode of Operation	10
	I. Method of Monitoring EUT Operation	10
	J. Modifications	10
	a) Modifications to EUT	10
	b) Modifications to Test Standard	10
	K. Disposition of EUT	10
III.	Electromagnetic Compatibility Criteria for Intentional Radiators	11
	§ 15.203 Antenna Requirement	12
	§ 15.207 Conducted Emissions Limits	13
	§ 15.209 Radiated Emissions Limits	17
	§ 15.403 26dB Bandwidth	20
	§ 15.407 RF Power Output	24
	§ 15.407 Peak Power Spectral Density	28
	§ 15.407 Peak Excursion Ratio	32
	§ 15.407 Undesirable Emissions	36
IV.	Test Equipment	43
V.	Certification & User's Manual Information	45
	A. Certification Information	46
	B. Label and User's Manual Information	50
VI.	Exhibits	52



List of Tables

Table 1 Executive Summary of EMC Part 15.407 and 15.247 Compliance Testing.....	3
Table 2. Equipment Configuration	9
Table 3. Support Equipment.....	9
Table 4. Ports and Cabling Information	10
Table 5. Conducted Limits for Intentional Radiators from FCC Part 15 § 15.207(a)	13
Table 6. Conducted Emissions - Voltage, AC Power, Phase Line (120 VAC, 60 Hz).....	14
Table 7. Conducted Emissions - Voltage, AC Power, Neutral Line (120 VAC, 60 Hz).....	14
Table 8. Radiated Emissions Limits Calculated from FCC Part 15, § 15.209 (a).....	17
Table 9. Output Power Requirements from §15.407 and §15.247.	24
Table 10. Restricted Bands of Operation.....	37

List of Figures

Figure 1. Block Diagram of Test Configuration (Radiated Emissions).....	7
Figure 2. Block Diagram of Test Configuration (Conducted Measurement)	8

List of Photographs

Photograph 1. Conducted Emissions Test Setup	16
Photograph 2. Radiated Emission Test Setup < 1 GHz	19
Photograph 3. Test Equipment and setup for various Radiated Measurements.....	42



List of Terms and Abbreviations

AC	Alternating Current
ACF	Antenna Correction Factor
Cal	Calibration
<i>d</i>	Measurement Distance
dB	Decibels
dB μ A	Decibels above one microamp
dB μ V	Decibels above one microvolt
dB μ A/m	Decibels above one microamp per meter
dB μ V/m	Decibels above one microvolt per meter
DC	Direct Current μ
E	Electric Field
DSL	Digital Subscriber Line
ESD	Electrostatic Discharge
EUT	Equipment Under Test
<i>f</i>	Frequency
FCC	Federal Communications Commission
GR-1089-CORE	(<i>GR</i>) General Requirement(s) imposed by the NEBS standard, (<i>CORE</i>) Central Office Recovery Express (AT&T), (<i>1089</i>) specifies various parts of the General Requirements under Bellcore Technical Standard, Requirements for Electromagnetic Compatibility and Electrical Safety - Generic Criteria for Network Telecommunications Equipment
GRP	Ground Reference Plane
H	Magnetic Field
HCP	Horizontal Coupling Plane
Hz	Hertz
IEC	International Electrotechnical Commission
kHz	kilohertz
kPa	kilopascal
kV	kilovolt
LISN	Line Impedance Stabilization Network
MHz	Megahertz
μ H	microhenry
μ	microfarad
μ s	microseconds
NEBS	Network Equipment-Building System
PRF	Pulse Repetition Frequency
RF	Radio Frequency
RMS	Root-Mean-Square
TWT	Traveling Wave Tube
V/m	Volts per meter
VCP	Vertical Coupling Plane



I. Executive Summary



A. Purpose of Test

An EMC evaluation was performed to determine compliance of the Firetide, HotPort 3500-5001, with the requirements of Part 15, §15.407. All references are to the most current version of Title 47 of the Code of Federal Regulations in effect. In accordance with §2.1033, the following data is presented in support of the Certification of the HotPort 3500-5001. Firetide should retain a copy of this document which should be kept on file for at least two years after the manufacturing of the HotPort 3500-5001, has been **permanently** discontinued.



B. Executive Summary

The following tests were conducted on a sample of the equipment for the purpose of demonstrating compliance with Part 15, §15.407 and 15.247, in accordance with Firetide, purchase order number PO-1362. All tests were conducted using measurement procedure ANSI C63.4-2003.

Reference	Description	Results
15.403 (c)	26dB Occupied Bandwidth	Compliant, refer to FCC ID: SWX-SR5 for UNII High Band data.
15.407 (a)(1), (2), (3)	Conducted Transmitter Output Power	Compliant
15.407 (a)(1), (2), (3), (5)	Power Spectral Density	Compliant, refer to FCC ID: SWX-SR5 for UNII High Band data.
15.407 (a)(6)	Peak Excursion	Compliant, refer to FCC ID: SWX-SR5 for UNII High Band data.
15.407 (b)(1), (2), (5), (6)	Undesirable Emissions	Compliant
15.205/15.209	General Field Strength Limits (Restricted Bands and Radiated Emission Limits)	Compliant
15.207	AC Conducted Emissions 150kHz – 30MHz	Compliant
Title 47 of the CFR, Part 15, Subpart C, §15.207	AC Power Line Conducted Emissions	Compliant
Title 47 of the CFR, Part 15, Subpart C, §15.203/15.247(b)(c)	Antenna Requirement	Compliant
Title 47 of the CFR, Part 15, Subpart C, §15.205(d)	Band Edge Emissions	Compliant
Title 47 of the CFR, Part 15, Subpart C, §15.247(a)(2)	6dB Occupied Bandwidth	Compliant, refer to FCC ID: SWX-SR5.
Title 47 of the CFR, Part 15, Subpart C, §15.247(b)(3)	Maximum Peak Conducted Output Power	Compliant
Title 47 of the CFR, Part 15, Subpart C, §15.247(d)	Spurious Radiated Emissions	Compliant
Title 47 of the CFR, Part 15, Subpart C, §15.247(e)	Peak Power Spectral Density	Compliant, refer to FCC ID: SWX-SR5.

Table 1 Executive Summary of EMC Part 15.407 and 15.247 Compliance Testing.



II. Equipment Configuration



A. Overview

MET Laboratories, Inc. was contracted by Firetide to perform testing on the HotPort 3500-5001, under Firetide’s purchase order number PO-1362.

This document describes the test setups, test methods, required test equipment, and the test limit criteria used to perform compliance testing of the Firetide, HotPort 3500-5001.

The results obtained relate only to the item(s) tested.

Model(s) Tested:	HotPort 3500-5001	
Model(s) Covered:	HotPort 3500-5001	
EUT Specifications:	Primary Power: 120V 60Hz	
	FCC ID: REP-3500-3	
	Type of Modulations:	Orthogonal Frequency Division Multiplexing(OFDM)
	Emission Designators:	UNII Low Band 802.11/a - 19M9D7D
		UNII Mid Band 802.11/a - 19M2D7D
		DTS High Band 802.11/a - 16M6D7D
	Equipment Code:	DTS
	Peak RF Output Power:	UNII Low Band 802.11/a – 15.99dBm
		UNII Mid Band 802.11/a – 22.01dBm
		DTS High Band 802.11/a – 24.97dBm
EUT Frequency Ranges:	5150 - 5250MHz	
	5250 - 5350MHz	
	5725 - 5825MHz	
Analysis:	The results obtained relate only to the item(s) tested.	
Environmental Test Conditions:	Temperature (15-35° C): 21° C	
	Relative Humidity (30-60%): 47%	
	Barometric Pressure (860-1060 mbar): 1009 mbar	
Evaluated by:	Shawn McMillen	
Date(s):	January 5, 2006	



B. References

CFR 47, Part 15, Subpart C	Federal Communication Commission, Code of Federal Regulations, Title 47, Part 15: General Rules and Regulations, Allocation, Assignment, and Use of Radio Frequencies
CFR 47, Part 15, Subpart B	Electromagnetic Compatibility: Criteria for Radio Frequency Devices
CFR 47, Part 15, Subpart E	Unlicensed National Information Infrastructure Devices
ANSI C63.4:2003	Methods and Measurements of Radio-Noise Emissions from Low-Voltage Electrical And Electronic Equipment in the Range of 9 kHz to 40 GHz
ANSI/NCSL Z540-1-1994	Calibration Laboratories and Measuring and Test Equipment - General Requirements
ANSI/ISO/IEC 17025:2000	General Requirements for the Competence of Testing and Calibration Laboratories

C. Test Site

All testing was performed at MET Laboratories, Inc., 4855 Patrick Henry Drive, Building 6, Santa Clara, California 95054. All equipment used in making physical determinations is accurate and bears recent traceability to the National Institute of Standards and Technology.

Radiated Emissions measurements were performed in a 10 meter semi-anechoic chamber (equivalent to an Open Area Test Site). In accordance with §2.948(a)(3), a complete site description is contained at MET Laboratories. In accordance with §2.948(d), MET Laboratories has been accredited by the National Voluntary Laboratory Accreditation Program (Lab Code: 100273-0).

D. Description of Test Sample

The HotPort 3500-5001, is equipped with a ubiquiti 802.11a/b/g card. It is a wireless communications system operating in the Low and Mid UNII bands at 5180-5240MHz and 5260-5320MHz as well as 5725-5825MHz DTS.

Radiated Emission

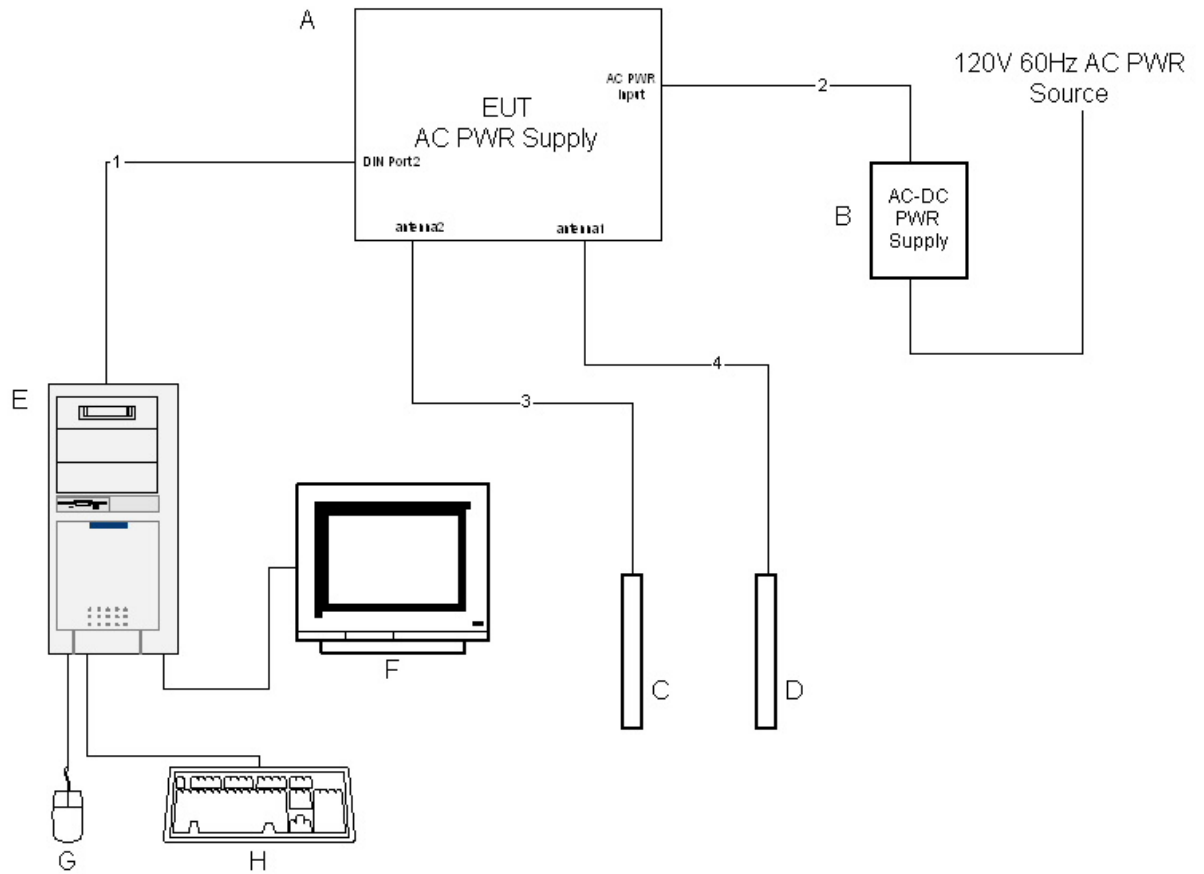

Figure 1. Block Diagram of Test Configuration (Radiated Emissions)

Conducted Measurement

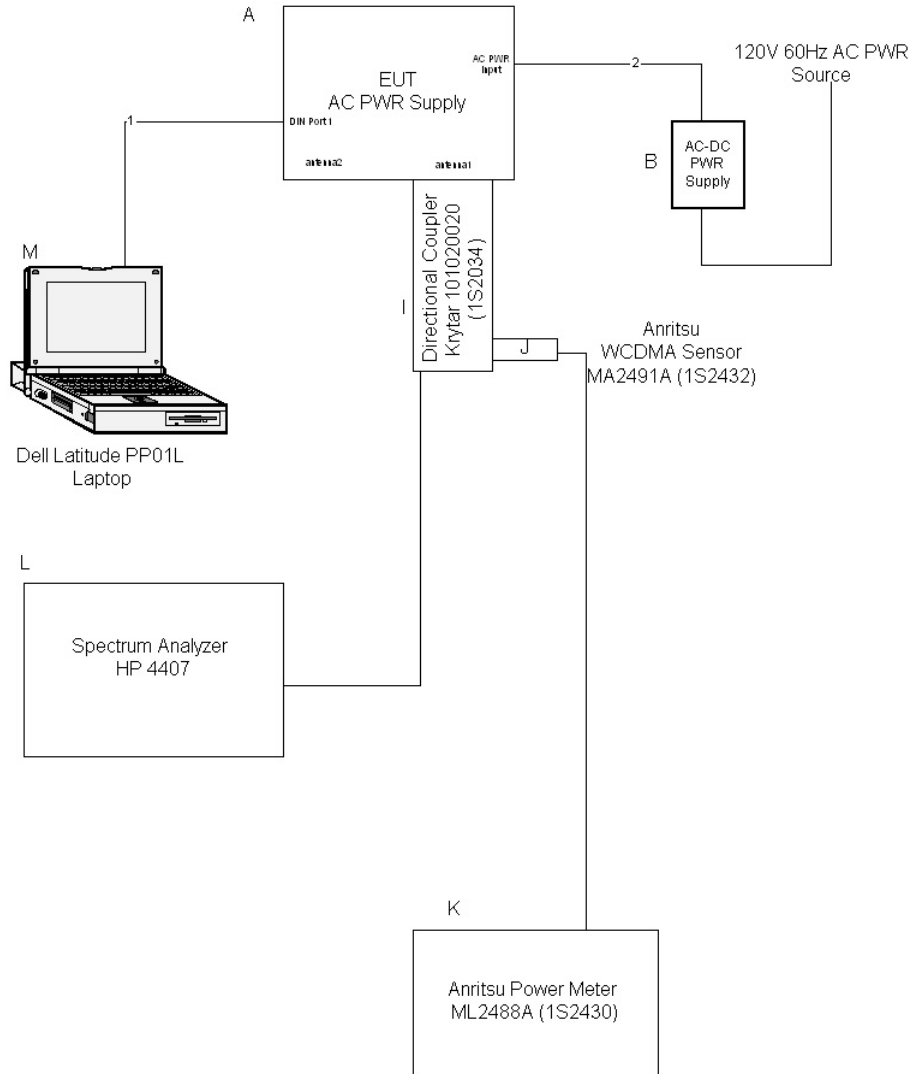

Figure 2. Block Diagram of Test Configuration (Conducted Measurement)



E. Equipment Configuration

The EUT was set up as outlined in Figure 1 and Figure 2, Block Diagram of Test Setup. All cards, racks, etc., incorporated as part of the EUT is included in the following list.

Ref. ID	Name / Description	Model Number	Part Number	Serial Number	Rev. #
A	Wireless Hub	HotPort 3500-5001	N/A	N/A	N/A
B	AC-DC Adaptor (Hon-Kwang)	HK-A512-A05	N/A	K0000000679	N/A
C	5 GHz Antenna	N/A	N/A	N/A	N/A
D	5 GHz Antenna	N/A	N/A	N/A	N/A

Table 2. Equipment Configuration

F. Support Equipment

HotPort 3500-5001 supplied support equipment necessary for the operation and testing of the HotPort 3500-5001. All support equipment supplied is listed in the following Support Equipment List.

Ref. ID	Name / Description	Manufacturer	Model Number	*Customer Supplied Calibration Data
E	Ethernet Hub	Net Gear	DS104	N/A
F	PC	Dell	Dimension M233A	N/A
G	Mouse	Logitech	Mouse Man	N/A
H	Keyboard	Compaq	N/A	N/A
I	Serial Modem	Webramp	Webramp 200	N/A
J	Printer	Canon	BJC-200	N/A
K	Monitor	Toshiba	TekBright	N/A
L	Directional Coupler	Krytar	101020020	N/A
M	WCDMA Sensor	Anritsu	MA2491	N/A
N	Power Meter	Anritsu	ML2488A	N/A
O	Spectrum Analyzer	Agilent	E4407A	N/A
P	Laptop	Dell	Latitude PP01L	N/A

Table 3. Support Equipment

* The 'Customer Supplied Calibration Data' column will be marked as either not applicable, not available, or will contain the calibration date supplied by the customer.

** The AC/DC Adapter was use to power the EUT for testing purpose only, will not be sold with radio.



G. Ports and Cabling Information

Ref. ID	Port name on EUT	Cable Description or reason for no cable	Qty.	Length (m)	Shielded (Yes/No)	Termination Box ID & Port ID
Conducted Measurement						
1	A, LAN Port 4	RJ45	1	15	No	P
2	A, PWR Input	DC PWR Cord	1	1.5	No	B
N/A	A, Antenna Port 1	N/A (directly connect)	N/A	N/A	N/A	L
N/A	A, Antenna Port 2	N/A	N/A	N/A	N/A	Unterminated
Radiated Emission						
1	A, LAN Port 1	RJ45	1	15	Yes	E, port 1
2	A, LAN Port 2	RJ45	1	15	Yes	E, port 2
3	A, LAN Port 3	RJ45	1	15	Yes	E, port 3
4	A, LAN Port 4	RJ45	1	15	Yes	F
5	A, PWR Input	DC PWR Cord	1	1.5	No	B
N/A	A, Antenna Port 1	N/A (directly connect)	N/A	N/A	N/A	C
N/A	A, Antenna Port 2	N/A (directly connect)	N/A	N/A	N/A	D

Table 4. Ports and Cabling Information

H. Mode of Operation

The EUT was operated in the following manner:
Telnet was used to access the radio in order to change the channel frequency, bit rate and to turn on/off the transmitter. The power output was set to a fixed value which could not vary the output power.

I. Method of Monitoring EUT Operation

Performance of the EUT was monitored in the following manner:
A Spectrum Analyzer and a Power Meter were used to monitor the EUT's transmitter channel and power output.

J. Modifications

a) Modifications to EUT

No modifications were made to the EUT.

b) Modifications to Test Standard

No modifications were made to the test standard.

K. Disposition of EUT

The test sample including all support equipment submitted to the Electro-Magnetic Compatibility Lab for testing was returned to Firetide upon completion of testing.



III. Electromagnetic Compatibility Criteria for Intentional Radiators



Electromagnetic Compatibility Criteria for Intentional Radiators

§ 15.203 Antenna Requirement

Test Requirement: § 15.203: An intentional radiator shall be designed to ensure that no antenna other than that furnished by the responsible party shall be used with the device. The use of a permanently attached antenna or of an antenna that uses a unique coupling to the intentional radiator shall be considered sufficient to comply with the provisions of this section. The manufacturer may design the unit so that a broken antenna can be replaced by the user, but the use of a standard antenna jack or electrical connector is prohibited.

The structure and application of the EUT were analyzed to determine compliance with Section 15.203 of the Rules. Section 15.203 states that the subject device must meet at least one of the following criteria:

- a.) Antenna must be permanently attached to the unit.
- b.) Antenna must use a unique type of connector to attach to the EUT.
- c.) Unit must be professionally installed. Installer shall be responsible for verifying that the correct antenna is employed with the unit.

Results: The EUT as tested meets the criteria of this rule by virtue of having professionally installed. The EUT is therefore compliant with §15.203.

Antenna	
Model No. / Gain	C037-510585 / 5.0 dBi
Vendor	Firetide

Test Engineer(s): Shawn McMillen

Test Date(s): December 5, 2005



Electromagnetic Compatibility Criteria for Intentional Radiators

§ 15.207 Conducted Emissions Limits

Test Requirement(s): § 15.207 (a): For an intentional radiator that is designed to be connected to the public utility (AC) power line, the radio frequency voltage that is conducted back onto the AC power line on any frequency or frequencies, within the band 150 kHz to 30MHz, shall not exceed the limits in the following table, as measured using a 50 μ H/50 Ω line impedance stabilization network (LISN). Compliance with the provisions of this paragraph shall be based on the measurement of the radio frequency voltage between each power line and ground at the power terminal. The lower limit applies at the boundary between the frequency ranges.

Frequency range (MHz)	§ 15.207(a), Conducted Limit (dB μ V)	
	Quasi-Peak	Average
* 0.15- 0.45	66 - 56	56 - 46
0.45 - 0.5	56	46
0.5 - 30	60	50

Table 5. Conducted Limits for Intentional Radiators from FCC Part 15 § 15.207(a)

Test Procedure: The EUT was placed on a 0.8 m-high wooden table inside a semi-anechoic chamber. The EUT was situated such that the back of the EUT was 0.4 m from one wall of the vertical ground plane, and the remaining sides of the EUT were no closer than 0.8 m from any other conductive surface. The EUT was powered from a 50 Ω /50 μ H Line Impedance Stabilization Network (LISN). The EMC receiver scanned the frequency range from 150 kHz to 30 MHz. Conducted Emissions measurements were made in accordance with *ANSI C63.4-1992 "Methods and Measurements of Radio-Noise Emissions from Low-Voltage Electrical and Electronic Equipment in the Range of 9kHz to 40 GHz"*. The measurements were performed over the frequency range of 0.15 MHz to 30 MHz using a 50 Ω /50 μ H LISN as the input transducer to an EMC/field intensity meter.

Test Results: The EUT was found compliant with the Conducted Emission limits of §15.207(a) for Intentional Radiators. See following pages for detailed test results

Test Engineer(s): Tony Permsombut

Test Date(s): December 10, 2005



Electromagnetic Compatibility Criteria for Intentional Radiators

§ 15.207 Conducted Emissions Limits

FREQ. (MHz)	Corrected Amplitude (dBuV) QP	Limit (dBuV) QP	Pass/Fail QP	Margin (dB) QP	Corrected Amplitude (dBuV) AVG	Limit (dBuV) AVG	Pass/Fail AVG	Margin (dB) AVG
0.2438	42.86	61.97	PASS	-19.11	35.06	51.97	PASS	-16.91
0.4885	44.04	56.19	PASS	-12.15	40.66	46.19	PASS	-5.53
1.6231	40.92	56	PASS	-15.08	27.77	46	PASS	-18.23
2.115	43.96	56	PASS	-12.04	29.22	46	PASS	-16.78
6.889	43.11	60	PASS	-16.89	25.55	50	PASS	-24.45

Table 6. Conducted Emissions - Voltage, AC Power, Phase Line (120 VAC, 60 Hz)

FREQ. (MHz)	Corrected Amplitude (dBuV) QP	Limit (dBuV) QP	Pass/Fail QP	Margin (dB) QP	Corrected Amplitude (dBuV) AVG	Limit (dBuV) AVG	Pass/Fail AVG	Margin (dB) AVG
0.2536	42.85	61.64	PASS	-18.79	35.79	51.64	PASS	-15.85
0.507	44.38	56	PASS	-11.62	38.24	46	PASS	-7.76
1.6015	41.55	56	PASS	-14.45	27.24	46	PASS	-18.76
2.1151	44.14	56	PASS	-11.86	29.61	46	PASS	-16.39

Table 7. Conducted Emissions - Voltage, AC Power, Neutral Line (120 VAC, 60 Hz)



Electromagnetic Compatibility Criteria for Intentional Radiators

§ 15.207 Conducted Emissions Limits

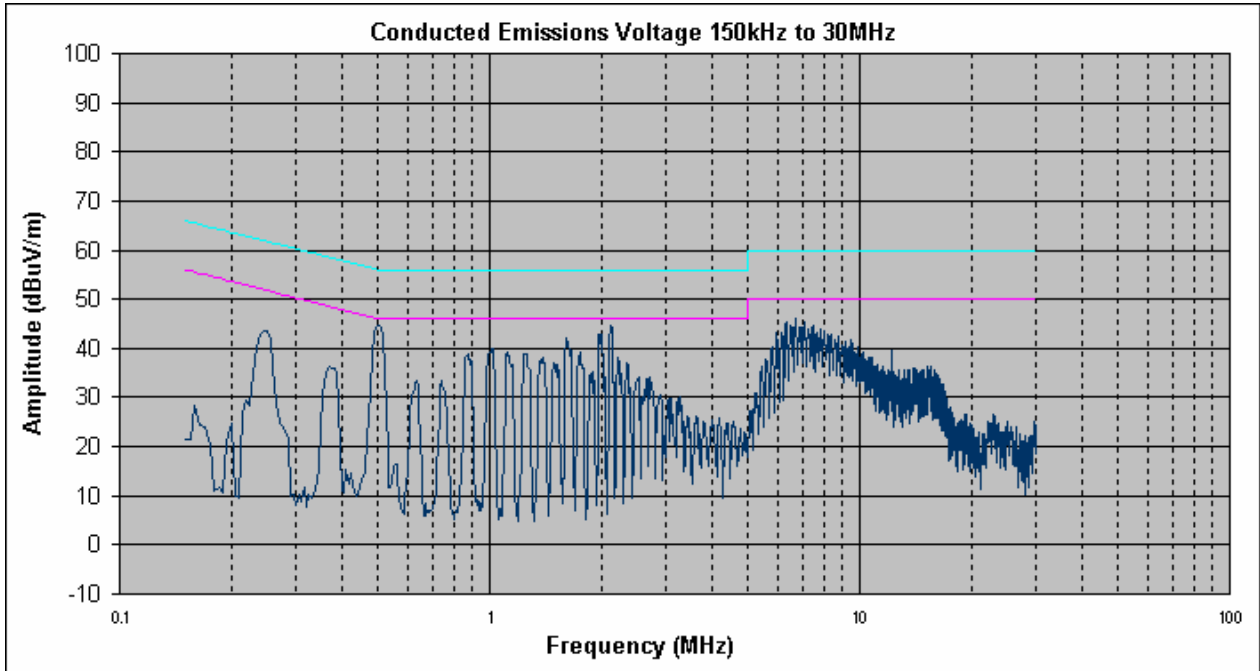

Conducted Emission, Phase Line Plots

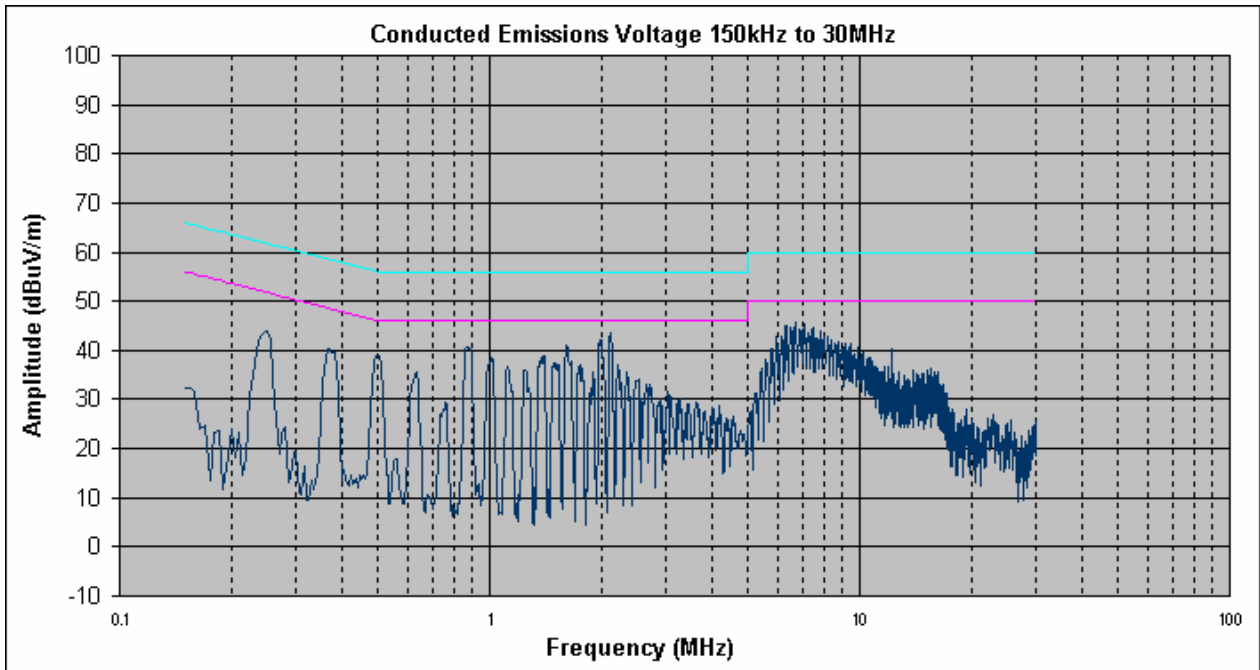

Conducted Emission, Neutral Plots



Conducted Emission Limits Test Setup



Photograph 1. Conducted Emissions Test Setup



Electromagnetic Compatibility Criteria for Intentional Radiators

§ 15.209 Radiated Emissions Limits

Test Requirement(s): § 15.209 (a): Except as provided elsewhere in this subpart, the emissions from an intentional radiator shall not exceed the field strength levels specified in Table 8.

Frequency (MHz)	§ 15.209(a), Radiated Emission Limits (dBµV) @ 3m
30 - 88	40.00
88 - 216	43.50
216 - 960	46.00
Above 960	54.00

Table 8. Radiated Emissions Limits Calculated from FCC Part 15, § 15.209 (a)

Test Procedure: The transmitter was set to the mid channel at the highest output power and placed on a 0.8 m high wooden table inside in a semi-anechoic chamber. Measurements were performed with the EUT rotated 360 degrees and varying the adjustable antenna mast with 1 m to 4 m height to determine worst case orientation for maximum emissions. Measurement were repeated the measurement at the low and highest channels.

For frequencies from 30 MHz to 1 GHz, measurements were made using a quasi-peak detector with a 120 kHz bandwidth.

For intentional radiators with a digital device portion which operates below 10 GHz, the spectrum was investigated as per §15.33(a)(1) and §15.33(a)(4); i.e., the lowest RF signal generated or used in the device up to the 10th harmonic of the highest fundamental frequency or to 40 GHz, whichever is lower.

In accordance with §15.35(b) the limit on the radio frequency emissions as measured using instrumentation with a peak detector function shall be 20 dB above the maximum permitted average limit for the frequency being investigated unless a different peak emission limit is otherwise specified in the rules.

EUT Field Strength Final Amplitude = Raw Amplitude – Preamp gain + Antenna Factor + Cable Loss – Distance Correction Factor (1 meter)

Test Results: The EUT was found compliant with the Radiated Emission limits of §15.209(a) for Intentional Radiators. See following pages for detailed test results.

Test Engineer(s): Elijah Garcia

Test Date(s): December 19, 2005



Electromagnetic Compatibility Criteria for Intentional Radiators

§ 15.209 Radiated Emissions Limits

802.11a Radiated Emissions from 30 MHz – 1 GHz

Quasi-Peak Results

Frequency (MHz)	Antenna Polarity (H/V)	EUT Azimuth (Degrees)	Antenna Height (m)	Uncorrected Amplitude (dBuv)	Antenna Correction Factor (dB/m) (+)	Pre Amp Gain (dB) (-)	Cable Loss (dB) (+)	Corrected Amplitude (dBuV/m)	Limit (dBuV/m)	Margin (dB)
288.68	V	263	1	11.07	13.31	0.00	2.85	27.23	46.00	-18.77
509.64	H	57	1	10.97	18.55	0.00	4.08	33.61	46.00	-12.39
531.76	H	47	1	13.73	18.63	0.00	4.21	36.56	46.00	-9.44
-531.88	V	298	1	21.49	18.49	0.00	4.21	44.19	46.00	-1.81
598.32	V	1.88	1	16.16	19.50	0.00	4.58	40.24	46.00	-5.76
666.68	V	350	1	12.38	19.84	0.00	4.86	37.08	46.00	-8.92

Note: When transmit mode or receive mode were activated, there are no differences to emissions. For above 1 GHz measurement up to 5th harmonic of the highest operating frequency, emissions are noise floor during receive mode.

* - At this frequency, the measured electric-field strength exhibits a margin of compliance that is less than 3 dB below the specification limit. We recommend that every emission measured, have at least a 3 dB margin to allow for deviations in the emission characteristics that may occur during the production process.

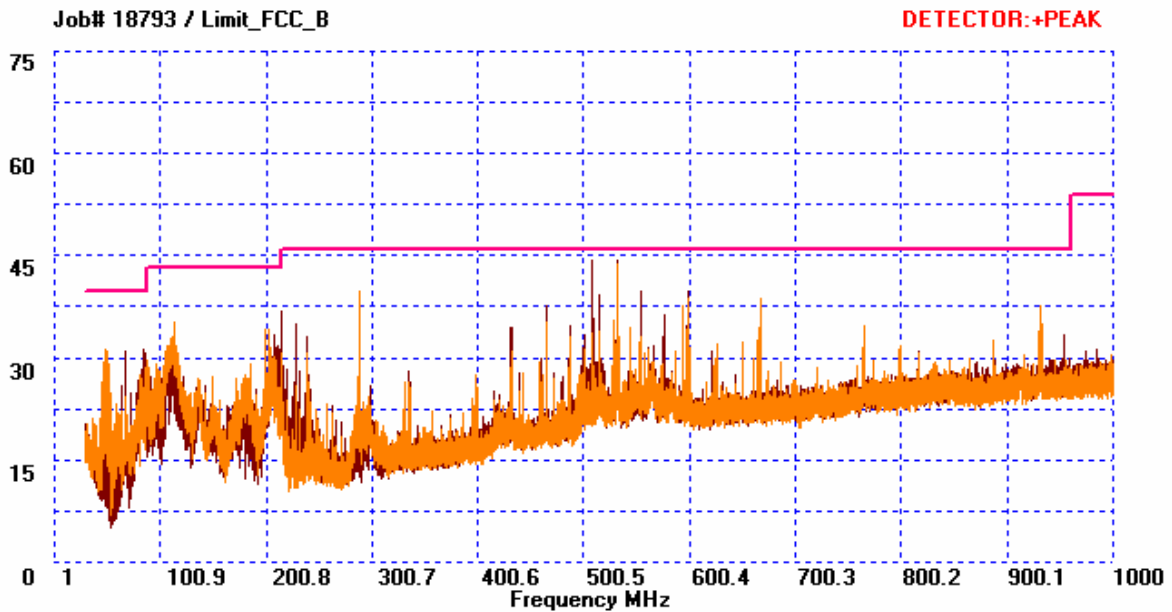

= Vertical Polarization
 = Horizontal Polarization



Electromagnetic Compatibility Criteria for Intentional Radiators

§ 15.209 Radiated Emissions Limits

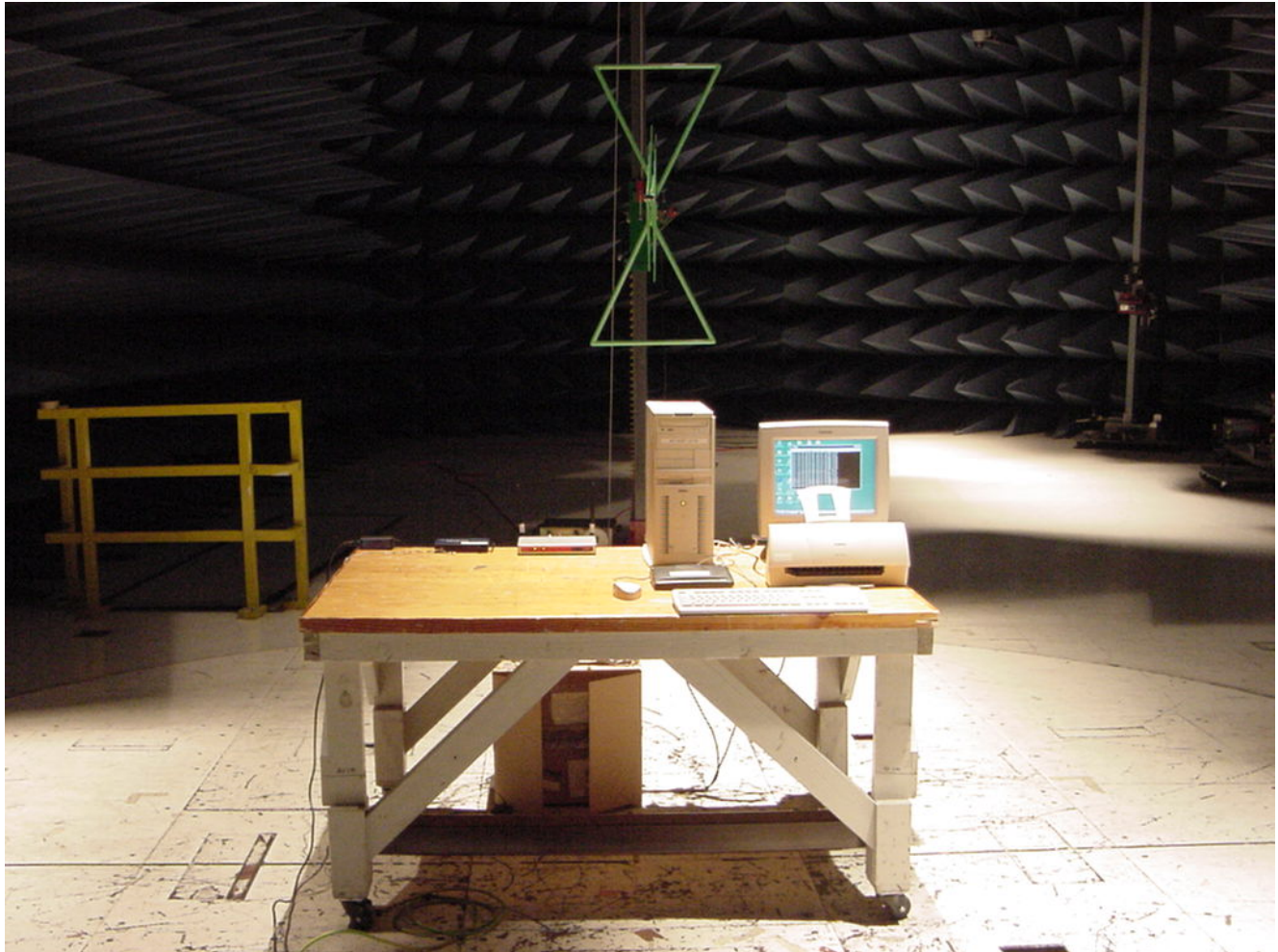

Photograph 2. Radiated Emission Test Setup < 1 GHz



Electromagnetic Compatibility Criteria for Intentional Radiators

§ 15. 403(c) 26dB Bandwidth

Test Requirements: § 15.403 (c): Operation under the provisions of this section is limited to frequency hopping and digitally modulated intentional radiators that comply with the following provisions:

Test Procedure: The transmitter was set to the mid channel at the highest output power and connected to the spectrum analyzer through an attenuator. The bandwidth of the fundamental frequency was measured with the spectrum analyzer using a RBW approximately equal to 1% of the total emission bandwidth, VBW > RBW. The 26 dB Bandwidth was measured and recorded. The measurements were repeated at the low and high channels.

Test Results Equipment complies with § 15.407 (c). The 26 dB Bandwidth was determined from the plots on the following pages.

802.11a mode Low Band		
Carrier Channel	Frequency (MHz)	Measured 26 dB Bandwidth (MHz)
Low	5180	19.121
Mid	5200	19.959
High	5240	19.706

802.11a mode Mid Band		
Carrier Channel	Frequency (MHz)	Measured 26 dB Bandwidth (MHz)
Low	5260	19.159
Mid	5280	19.271
High	5320	18.812

Note: For band 5725-5825MHz refer to modularly approved FCC ID: SWX-SR5 for measurement of occupied bandwidth and compliance with § 15.247.

Test Engineer: Shawn McMillen

Test Date: December 5, 2005



Electromagnetic Compatibility Criteria for Intentional Radiators

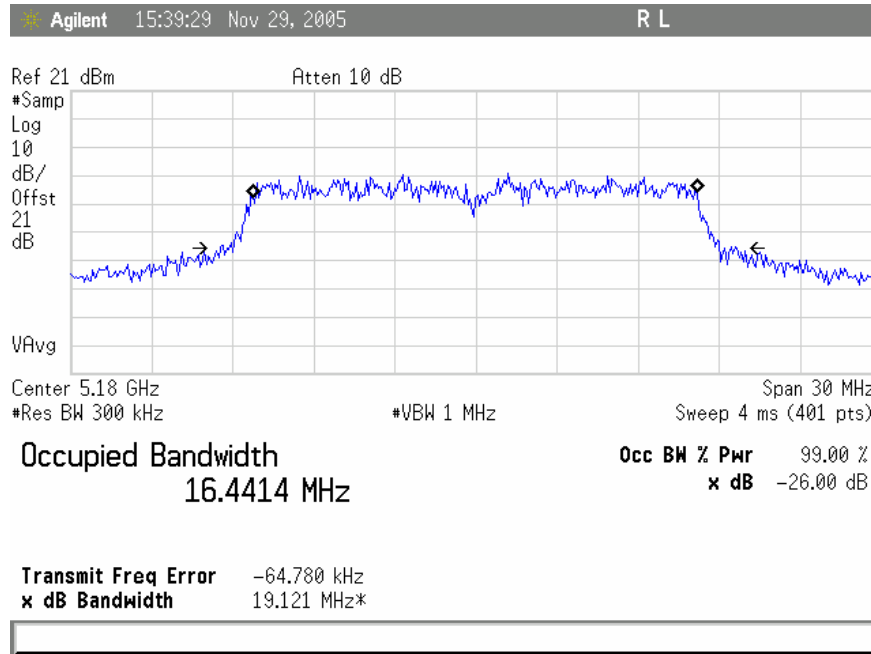

Plot 1. 802.11/a Low Band Low Ch Occupied Band Width

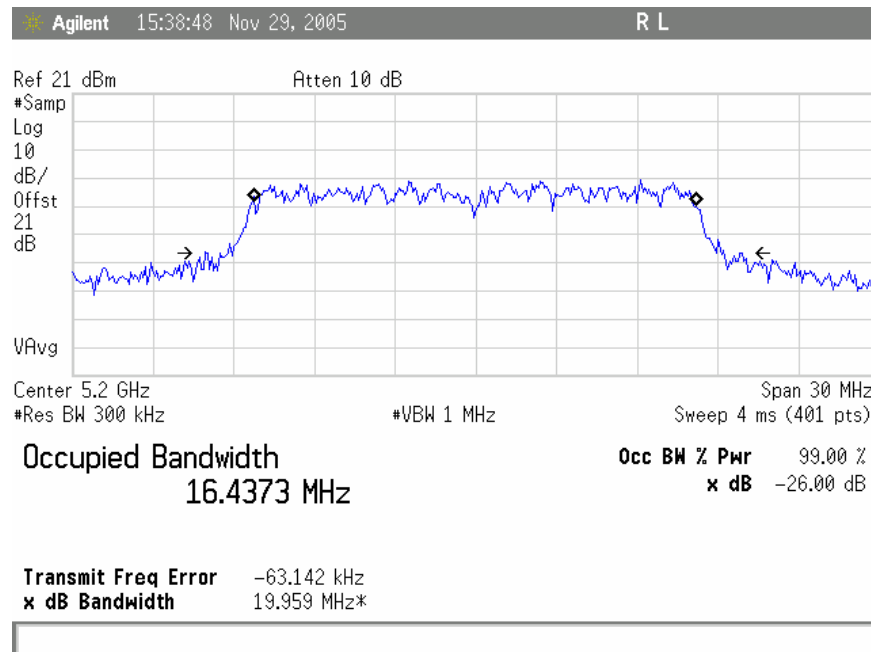

Plot 2. 802.11/a Low Band Mid Ch Occupied Band Width

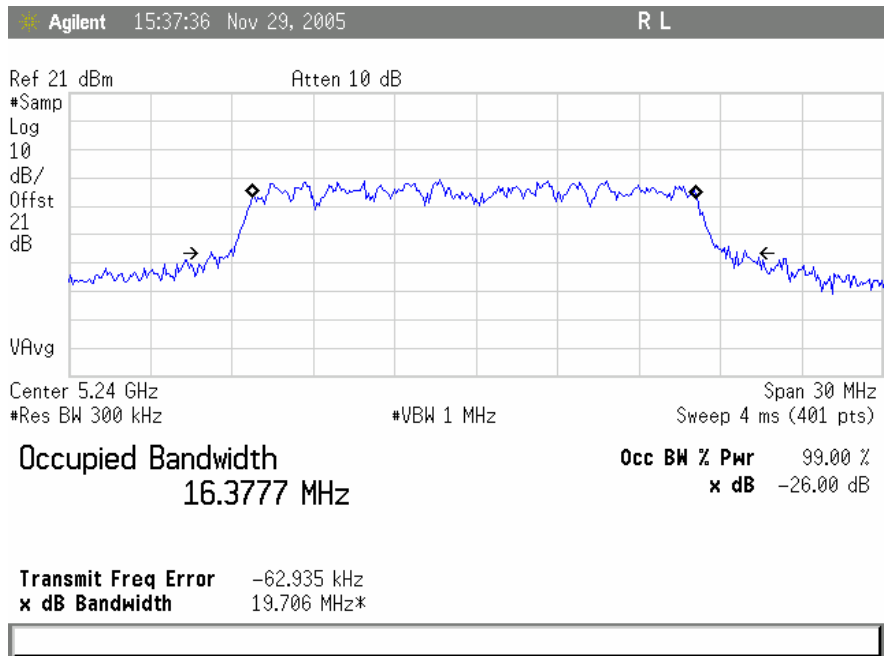

Plot 3. 802.11/a Low Band High Ch Occupied Band Width

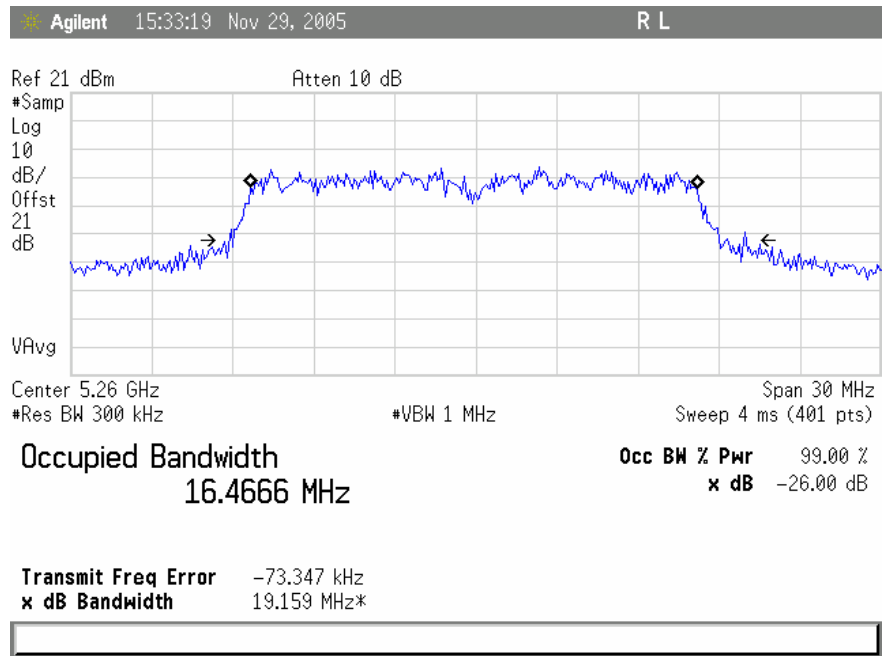

Plot 4. 802.11/a Mid Band Low Ch Occupied Band Width

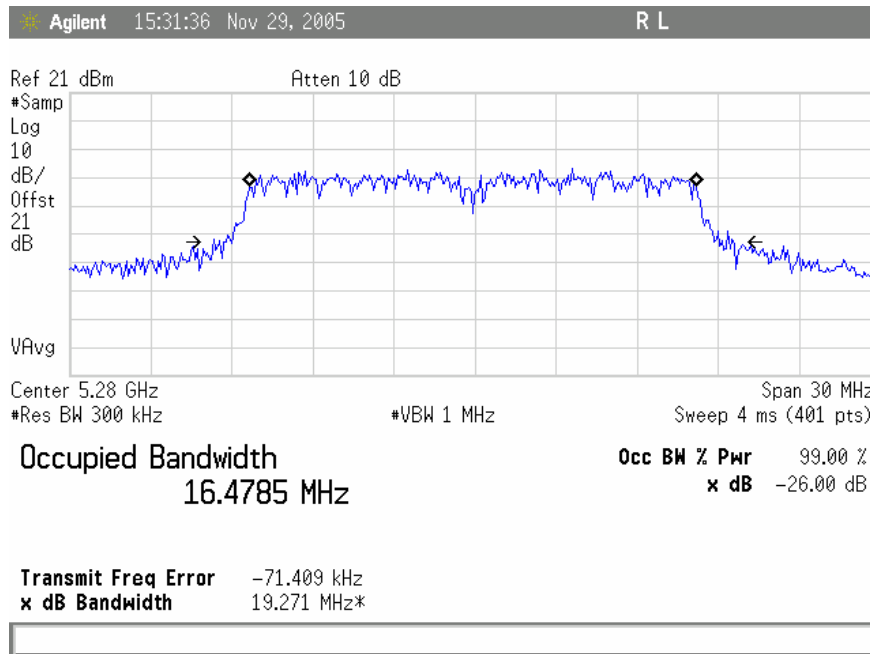

Plot 5. 802.11/a Mid Band Mid Ch Occupied Band Width

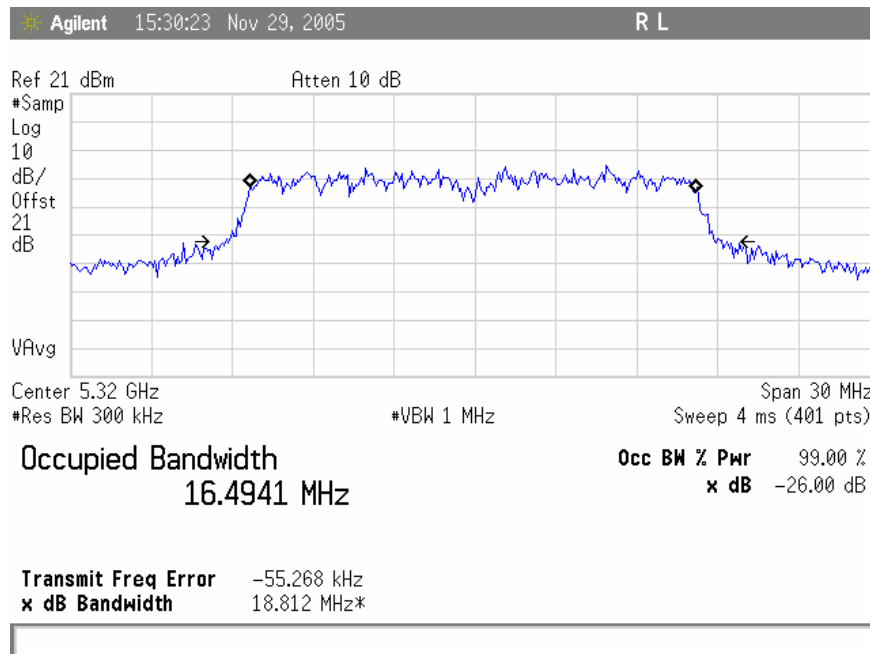

Plot 6. 802.11/a Mid Band High Ch Occupied Band Width



Electromagnetic Compatibility Criteria for Intentional Radiators

§ 15. 407(a) (1), (2) and §15.247(c): RF Power Output

Test Requirements: §15.407(a) (1), (2) and §15.247: The maximum output power of the intentional radiator shall not exceed the following:

Digital Transmission Systems (MHz)	Output Limit (mW)
5150-5250	50
5250-5350	250
5725-5825	1000

Table 9. Output Power Requirements from §15.407 and §15.247.

§15.407(a) (1): For the band 5.15-5.25 GHz the peak transmit power over the frequency band of operation shall not exceed the lesser 50mW or 4dBm + 10logB, where B is the 26-dB emission bandwidth in MHz.

§15.407(a) (2): For the band 5.25-5.35GHz the peak transmit power over the frequency band of operation shall not exceed the lesser of 250mW or 11dBm + 10logB, where B is the 26-dB emission bandwidth in MHz.

§15.247(c): Systems operating in the 5725 – 5850 MHz band the power over the frequency band of operation shall not exceed 30dBm or 1000mW.

Test Procedure: The transmitter was connected to a calibrated Power Meter. The EUT was measured at the low, mid and high channels of each band at all available data rates.

Test Engineer: Shawn McMillen

Test Date: December 5, 2005



802.11a Low Band			
Frequency (MHz)	Data Rate (MB/s)	Measured Average Output Power (dBm)	Measured Peak Output Power (dBm)
5180	6	11.44	15.66
	9	11.80	15.99
	12	11.77	15.97
	18	11.77	15.97
	24	11.77	15.97
	36	11.77	15.97
	48	11.77	15.97
	54	11.77	15.97
	5200	6	11.40
9		11.74	15.72
12		11.70	15.72
18		11.70	15.72
24		11.70	15.72
36		11.70	15.72
48		11.70	15.72
54		11.70	15.72
5240	6	11.48	15.93
	9	11.90	15.96
	12	11.90	15.90
	18	11.90	15.90
	24	11.90	15.90
	36	11.90	15.90
	48	11.90	15.90
	54	11.90	15.90



802.11a Mid Band			
Frequency (MHz)	Data Rate (Mbps)	Measured Average Output Power (dBm)	Measured Peak Output Power (dBm)
5260	6	12.77	21.20
	9	13.92	22.00
	12	13.85	22.01
	18	13.81	22.00
	24	13.81	22.00
	36	13.81	22.00
	48	13.81	22.00
	54	13.81	22.00
5280	6	13.58	21.80
	9	13.90	22.00
	12	13.80	22.00
	18	13.80	22.00
	24	13.80	22.00
	36	13.80	22.00
	48	13.80	22.00
	54	13.80	22.00
5320	6	13.56	21.85
	9	13.36	21.70
	12	13.41	21.70
	18	13.41	21.70
	24	13.41	21.70
	36	13.41	21.70
	48	13.41	21.70
	54	13.41	21.70



802.11a High Band			
Frequency (MHz)	Data Rate (Mbps)	Measured Average Output Power (dBm)	Measured Peak Output Power (dBm)
5745	6	21.66	24.97
	9	21.68	24.97
	12	21.67	24.97
	18	21.67	24.97
	24	21.67	24.97
	36	21.67	24.97
	48	21.67	24.97
	54	21.67	24.97
	5765	6	21.27
9		21.63	24.93
12		21.62	24.92
18		21.62	24.92
24		21.62	24.92
36		21.62	24.92
48		21.62	24.92
54		21.62	24.92
5805	6	22.22	24.83
	9	22.15	24.82
	12	22.10	24.81
	18	22.10	24.81
	24	22.10	24.81
	36	22.10	24.81
	48	22.10	24.81
	54	22.10	24.81



Electromagnetic Compatibility Criteria for Intentional Radiators

§ 15.407(a)(1), (a)(2) Peak Power Spectral Density

Test Requirements: § 15.407(a)(1), (a)(2): For digitally modulated systems, the conducted peak power spectral density from the intentional radiator to the antenna shall not be greater than 4dBm/MHz in the frequency band 5.15-5.25 GHz and 11dBm/MHz in the frequency band 5.25-5.35GHz.

Test Procedure: The transmitter was connected directly to a Spectrum Analyzer through a directional coupler. The power was monitored at the coupler port with a Power Meter capable of measuring peak and average RF power. The power level was set to the maximum level on the EUT. The RBW was set to 1MHz and the VBW was set to 3MHz. The method of measurement #2 from the FCC Public Notice CA 02-2138 was used.

Test Results: Equipment complies with the peak power spectral density limits of § 15.407(a)(1), (a)(2). The peak power spectral density was determined from plots on the following page(s).

802.11a Low Band				
Carrier Channel	Frequency (MHz)	Measured PPSD (dBm)	Limit (dBm)	Margin (dB)
Low	5180	-2.242	4	6.242
Mid	5200	-2.055	4	6.055
High	5240	-1.463	4	5.463

802.11a Mid Band				
Carrier Channel	Frequency (MHz)	Measured PPSD (dBm)	Limit (dBm)	Margin (dB)
Low	5260	1.979	11	9.021
Mid	5280	1.765	11	9.235
High	5320	1.588	11	9.412

Note: For band 5725-5825MHz refer to modularly approved FCC ID: SWX-SR5 for the measurement of Peak Power Spectral Density and compliance with § 15.247.

Test Engineer: Shawn McMillen

Test Date: December 5, 2005



Electromagnetic Compatibility Criteria for Intentional Radiators

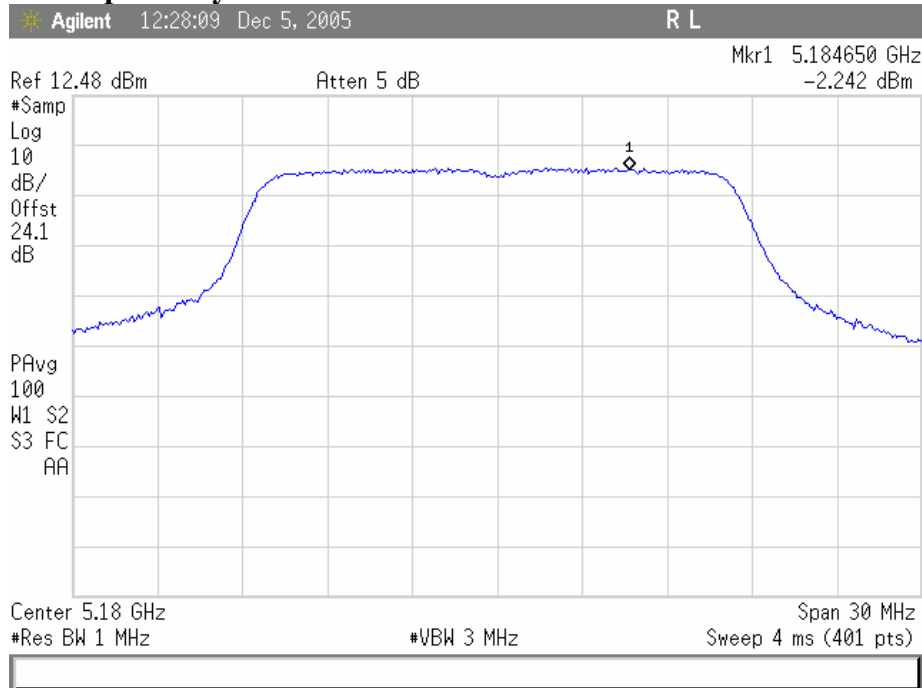

Plot 7. 802.11/a- Low Band Low Ch Peak Power Spectral Density

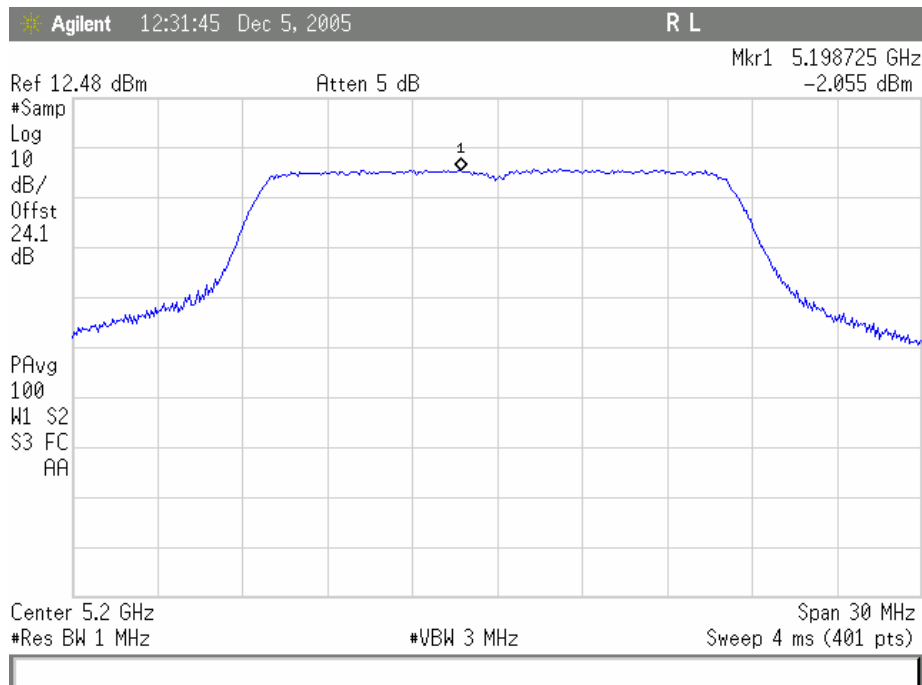

Plot 8. 802.11/a - Low Band Mid Ch Peak Power Spectral Density

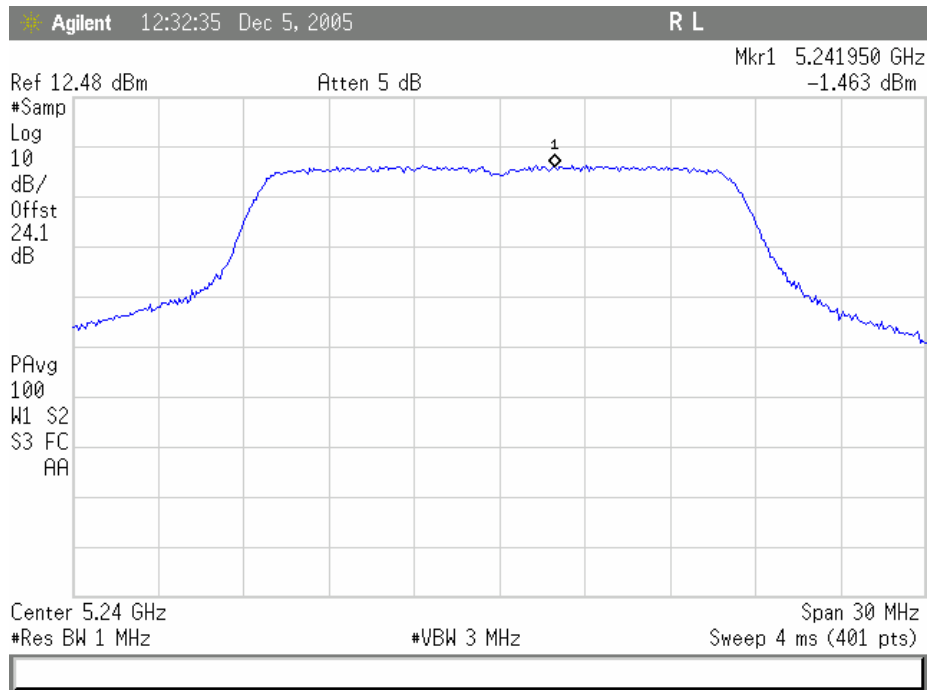

Plot 9. 802.11/a – Low Band High Ch Peak Power Spectral Density

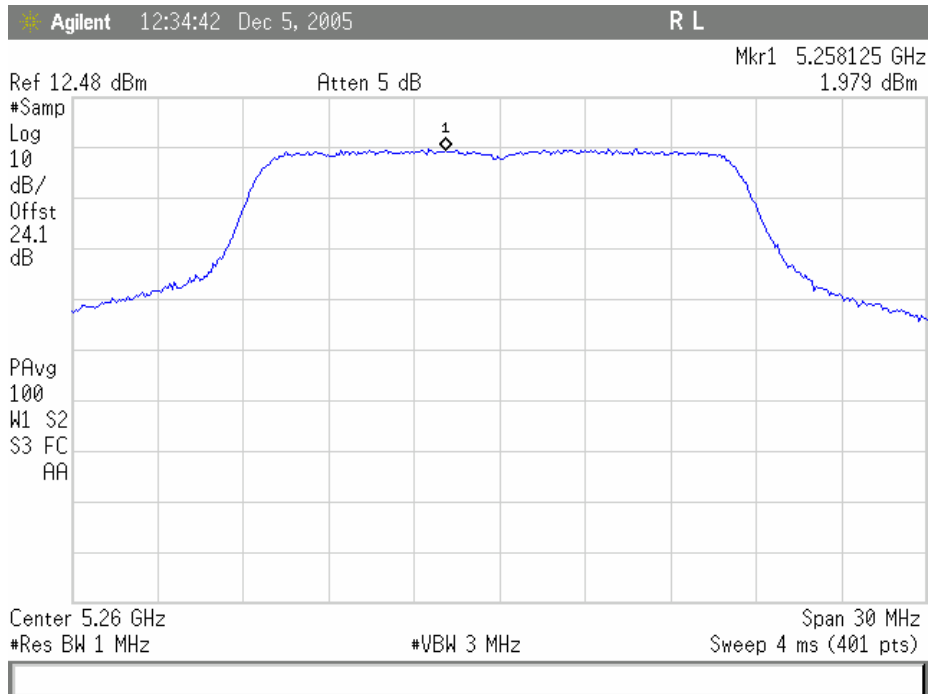

Plot 10. 802.11/a – Mid Band Low Ch Peak Power Spectral Density

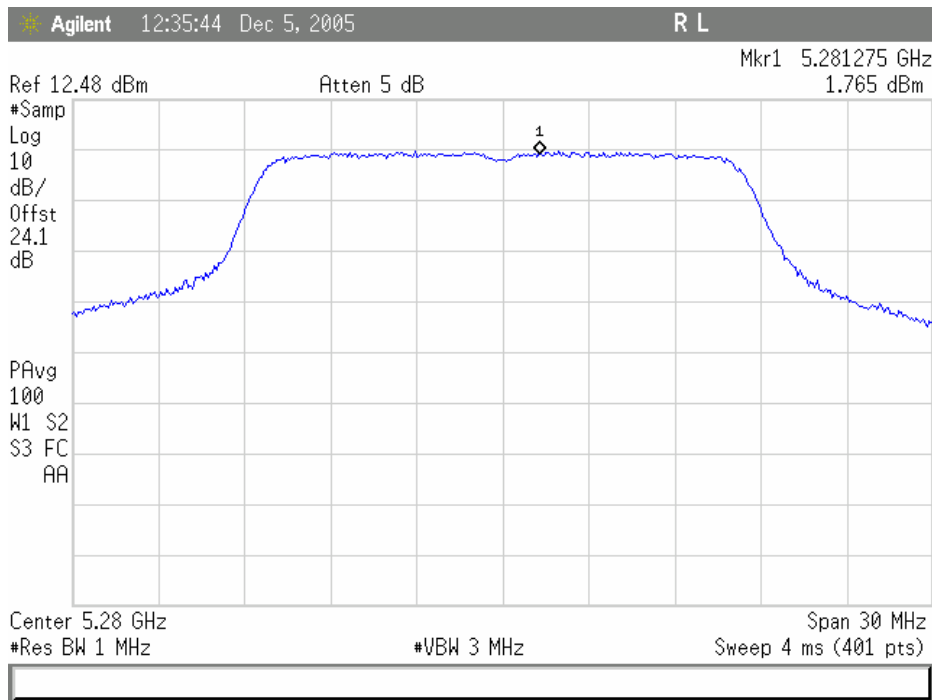

Plot 11. 802.11/a – Mid Band Mid Ch Peak Power Spectral Density

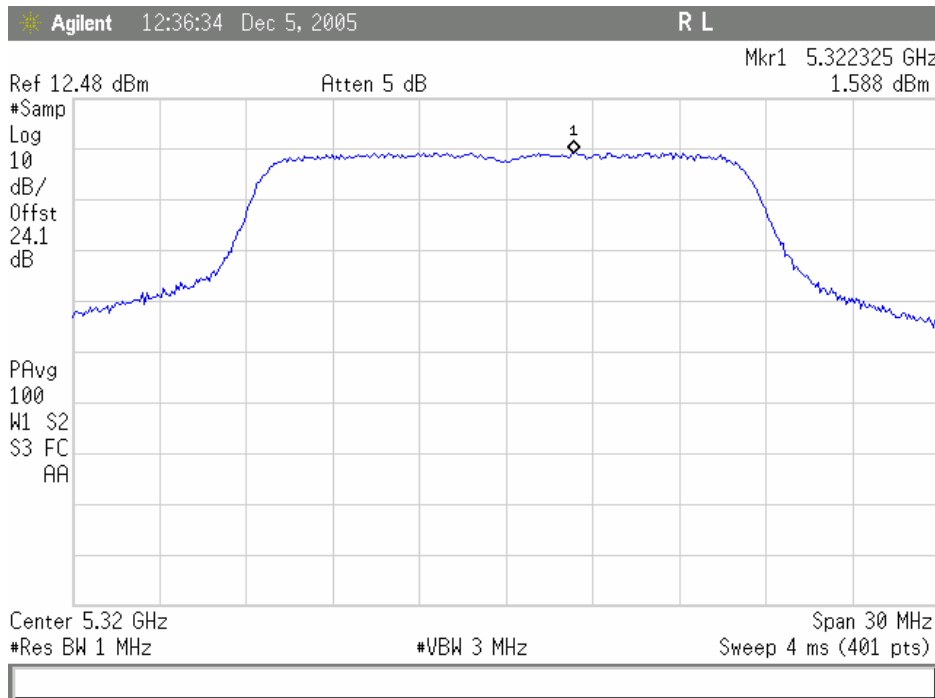

Plot 12. 802.11/a – Mid Band High Ch Peak Power Spectral Density



Electromagnetic Compatibility Criteria for Intentional Radiators

§ 15.407(a)(6) Peak Excursion Ratio

Test Requirements: § 15.407(a)(6): For digitally modulated systems, the peak excursion of the modulation envelope to the peak transmit power shall not exceed 13dB across any 1MHz bandwidth of the emission bandwidth whichever is less.

Test Procedure: The method of measurement #2 from the FCC Public Notice CA 02-2138 was used. The EUT was connected directly to the spectrum analyzer through cabling and attenuation. The 1st trace on the spectrum analyzer was set to RBW=1MHz, VBW=3MHz. The peak detector mode was used and the trace max held. The 2nd trace on the spectrum analyzer was set to a RBW=1MHz, VBW=30 KHz. The detector mode was set to sample detector.

The Peak Excursion Ratio was determined from the difference between the maximum found in each trace.

Test Results: Equipment complies with the peak excursion ratio limits of § 15.407(a)(6). The peak excursion ratio was determined from plots on the following page(s).

802.11a Low Band				
Carrier Channel	Frequency (MHz)	Excursion Ratio (dBm)	Limit (dBm)	Margin (dB)
Low	5180	10.573	13	2.427
Mid	5200	11.190	13	1.810
High	5240	9.306	13	3.694

802.11a Mid Band				
Carrier Channel	Frequency (MHz)	Excursion Ratio (dBm)	Limit (dBm)	Margin (dB)
Low	5260	11.104	13	1.896
Mid	5280	10.456	13	2.544
High	5320	10.337	13	2.663

Test Engineer: Shawn McMillen

Test Date: December 5, 2005

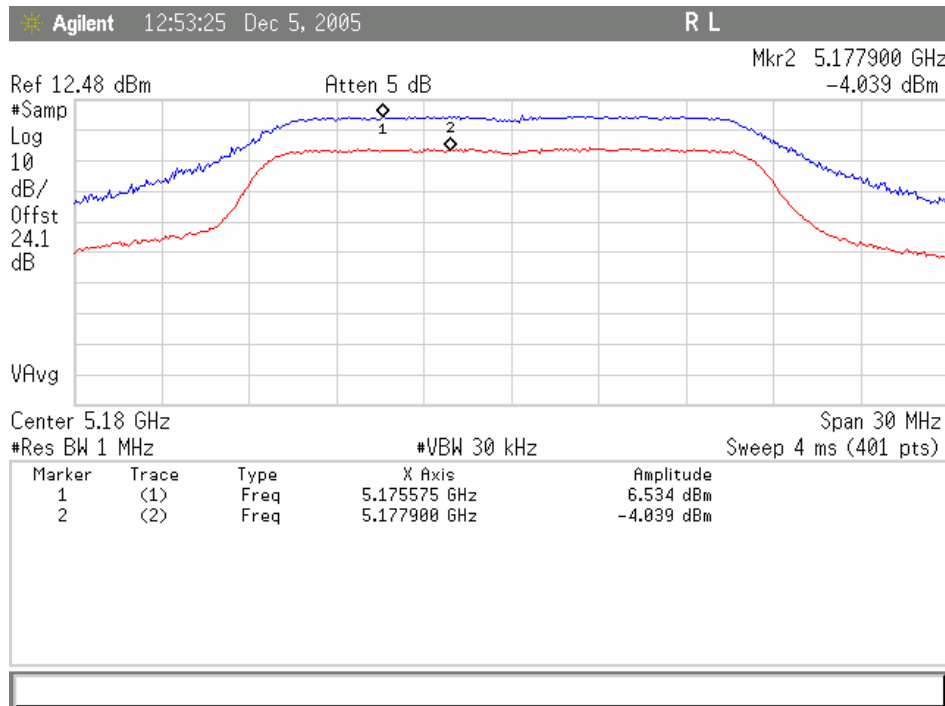

Plot 13. Peak Excursion Ratio for Low Band Low Ch

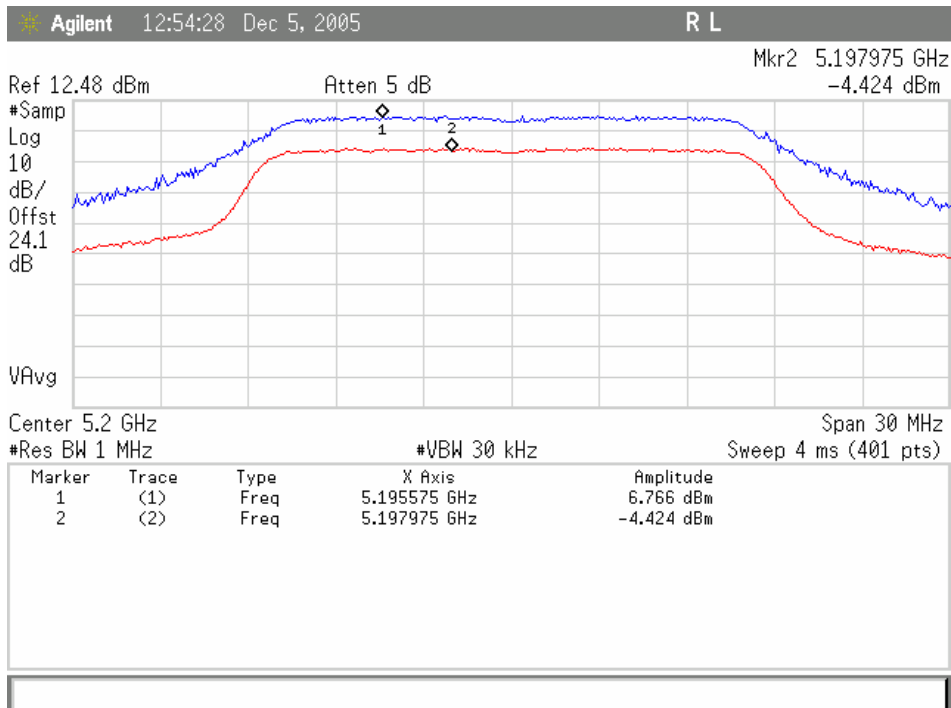

Plot 14. Peak Excursion Ratio for Low Band Mid Ch

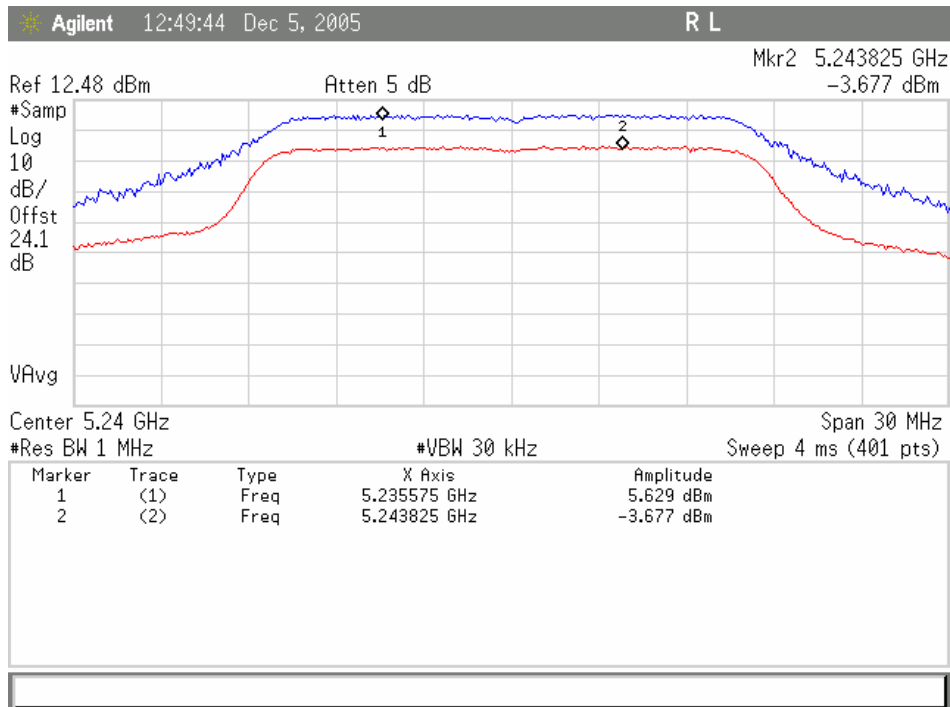

Plot 15. Peak Excursion Ratio for Low Band High Ch

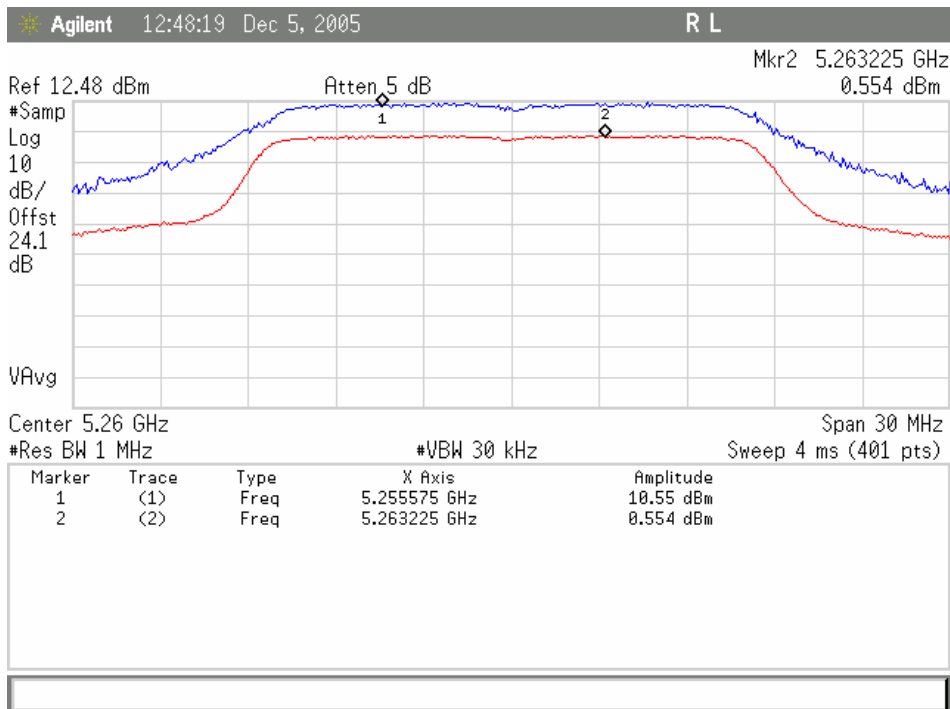

Plot 16. Peak Excursion Ratio for Mid Band Low Ch

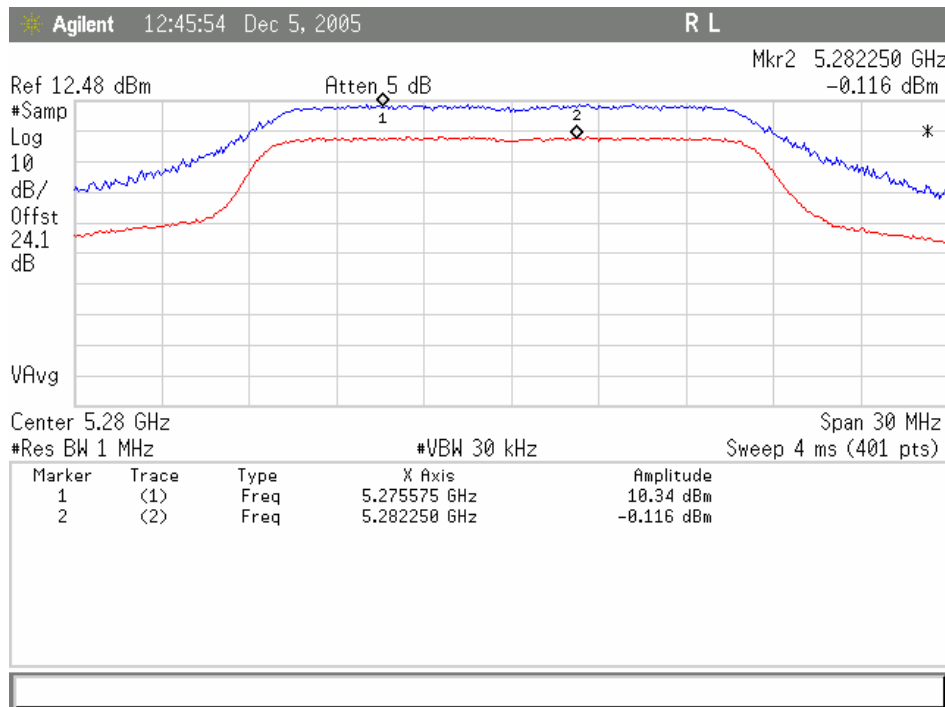

Plot 17. Peak Excursion Ratio for Mid Band Mid Ch

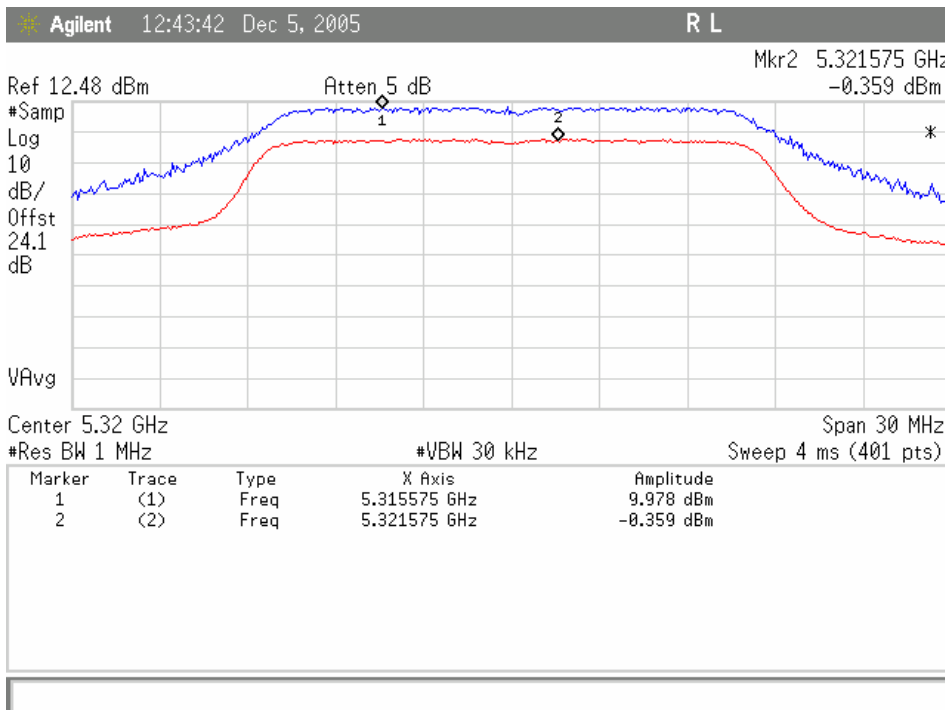

Plot 18. Peak Excursion Ratio for Mid Band High Ch



Electromagnetic Compatibility Criteria for Intentional Radiators

§ 15.407(b)(1),(2), (5), (6) and §15.247(c): Undesirable Emissions

Test Requirements: § 15.407(b)(1),(2), (5), (6); § 15.209 (a) §15.205: Emissions outside the frequency band.

§ 15.407(b)(1): In any 1MHz bandwidth outside the frequency band 5.15-5.25GHz in which the spread spectrum or digitally modulated intentional radiator is operating, the radio frequency power shall not exceed -27dBm/MHz EIRP.

§ 15.407(b)(2): In any 1MHz bandwidth outside the frequency band 5.25-5.35GHz in which the spread spectrum or digitally modulated intentional radiator is operating, the radio frequency power shall not exceed -27dBm/MHz EIRP.

§ 15.407(b)(4): In any 1MHz bandwidth outside the frequency band 5.725-5.825GHz in which the spread spectrum or digitally modulated intentional radiator is operating, the radio frequency power shall not exceed -27dBm/MHz EIRP.

§ 15.407(b)(6): Radiated emissions which fall in the restricted bands, as defined in § 15.205(a), must also comply with the radiated emission limits specified in § 15.209(a).

§15.205(a): Except as shown in paragraph (d) of this section, only spurious emissions are permitted in any of the frequency bands listed below:

§15.247(c): In any 100 kHz bandwidth outside the frequency band in which the spread spectrum or digitally modulated intentional radiator is operating, the radio frequency power that is produced by the intentional radiator shall be at least 20 dB below that in the 100 kHz bandwidth within the band that contains the highest level of the desired power, based on either an RF conducted or a radiated measurement. Attenuation below the general limits specified in § 15.209(a) is not required. In addition, radiated emissions which fall in the restricted bands, as defined in § 15.205(a), must also comply with the radiated emission limits specified in § 15.209(a).

Note: Both antenna types, directional or Omni-directional, which can be used with the EUT were tested for compliance. However, only the configuration which produced the highest emission levels was reported.

Test Engineer: Shawn McMillen

Test Date: December 5, 2005



MHz	MHz	MHz	GHz
0.090–0.110-----	16.42–16.423	399.9–410	4.5–5.15
¹ 0.495–0.505-----	16.69475–16.69525	608–614	5.35–5.46
2.1735–2.1905-----	16.80425–16.80475	960–1240	7.25–7.75
4.125–4.128-----	25.5–25.67	1300–1427	8.025–8.5
4.17725–4.17775-----	37.5–38.25	1435–1626.5	9.0–9.2
4.20725–4.20775-----	73–74.6	1645.5–1646.5	9.3–9.5
6.215–6.218-----	74.8–75.2	1660–1710	10.6–12.7
6.26775–6.26825-----	108–121.94	1718.8–1722.2	13.25–13.4
6.31175–6.31225-----	123–138	2200–2300	14.47–14.5
8.291–8.294-----	149.9–150.05	2310–2390	15.35–16.2
8.362–8.366-----	156.52475–156.52525	2483.5–2500	17.7–21.4
8.37625–8.38675-----	156.7–156.9	2655–2900	22.01–23.12
8.41425–8.41475-----	162.0125–167.17	3260–3267	23.6–24.0
12.29–12.293-----	167.72–173.2	3332–3339	31.2–31.8
12.51975–12.52025-----	240–285	3345.8–3358 36.	43–36.5
12.57675–12.57725-----	322–335.4	3600–4400	(²)

Table 10. Restricted Bands of Operation



Electromagnetic Compatibility Criteria for Intentional Radiators

§ 15.407(b)(1): Harmonic Emissions Requirements – Radiated (802.11a)

UNII Low Band 5.15-5.25GHz

Frequency (MHz)	Receive Antenna Polarity (H/V)	Uncorrected Field strength (dBµV)@ 3m	Preamp (dB)	Antenna Factor (dB)	Cable Loss (dB)	Distance Correction Factor (dB)	Corrected Field Strength @ 3m (dBµV)	Limit @ 3m (dBµV)	EIRP dBm	Measurement Type
10360	V	43.6	34.7	40.5	5.2	0	54.6	74	-52.4	Peak
15540	V	45.2	34.7	40.5	5.2	0	56.2	74	-50.8	Peak
15540	V	31.4	33.0	44.5	6.5	0	49.4	54	-57.6	Average
Low Channel 5180MHz										
Frequency (MHz)	Receive Antenna Polarity (H/V)	Uncorrected Field strength (dBµV)@ 3m	Preamp (dB)	Antenna Factor (dB)	Cable Loss (dB)	Distance Correction Factor (dB)	Corrected Field Strength @ 3m (dBµV)	Limit @ 3m (dBµV)	EIRP dBm	Measurement Type
10400	V	41.7	34.7	40.5	5.2	0	52.7	74	-54.3	Peak
15600	V	42.5	34.7	40.5	5.2	0	53.5	74	-53.5	Peak
15600	V	30.8	33.0	44.5	6.5	0	48.8	54	-58.2	Average
Mid Channel 5200MHz										
Frequency (MHz)	Receive Antenna Polarity (H/V)	Uncorrected Field strength (dBµV)@ 3m	Preamp (dB)	Antenna Factor (dB)	Cable Loss (dB)	Distance Correction Factor (dB)	Corrected Field Strength @ 3m (dBµV)	Limit @ 3m (dBµV)	EIRP dBm	Measurement Type
10480	V	41.5	34.7	40.5	5.2	0	52.5	74	-54.5	Peak
15720	V	40.7	34.7	40.5	5.2	0	51.7	74	-55.3	Peak
15720	V	30.6	33.0	44.5	6.5	0	48.6	54	-58.4	Average
High Channel 5240MHz										

Note: All other emissions were measured at the noise floor of the spectrum analyzer.
EIRP = dBµV + 107.

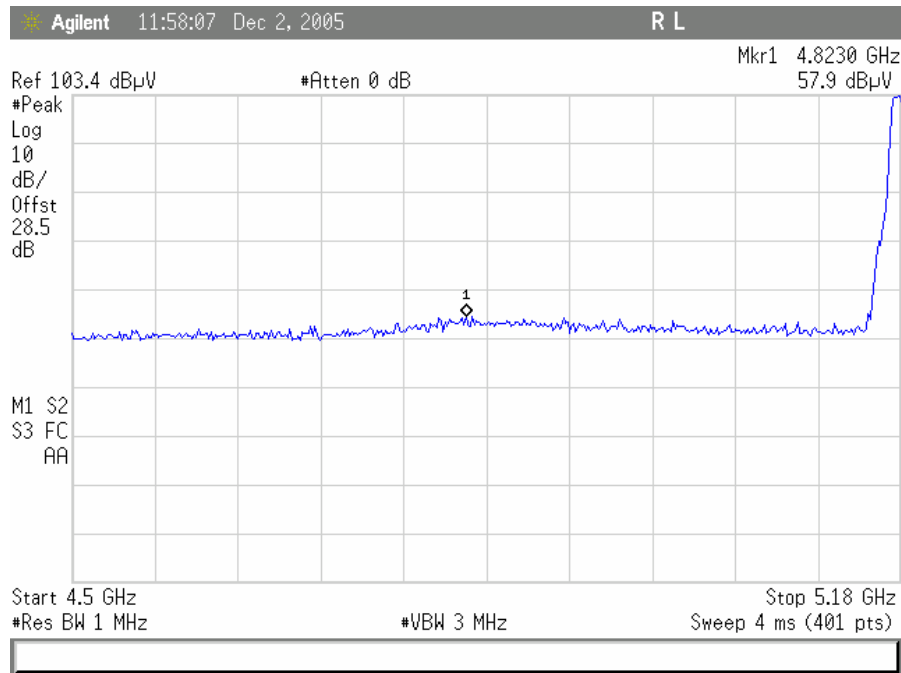

Plot 19. 802.11/a Low Band Restricted band 4.5-5.15GHz Peak

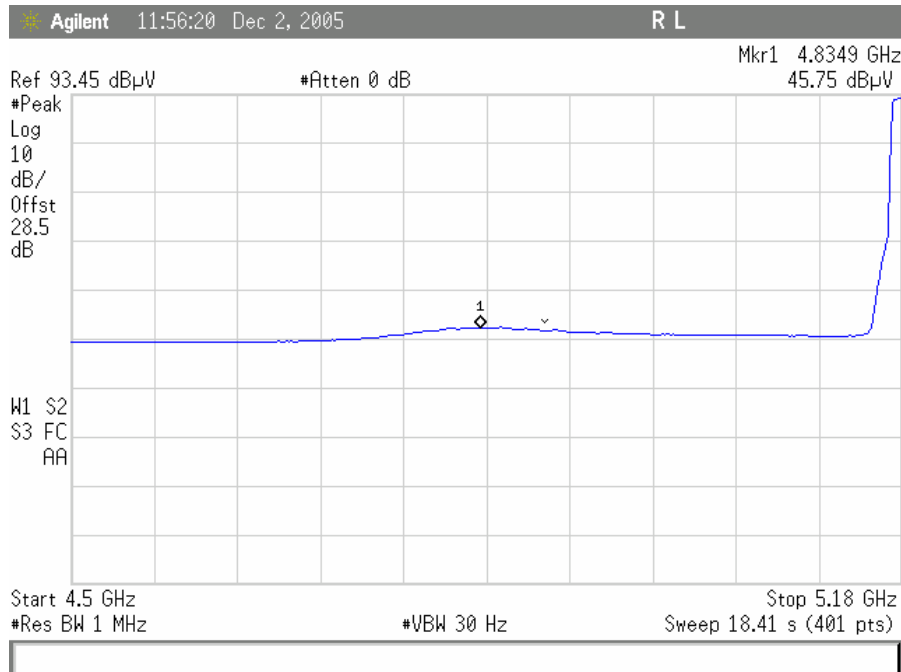

Plot 20. 802.11/a Low Band Restricted band 4.5-5.15GHz Avg



Electromagnetic Compatibility Criteria for Intentional Radiators

§ 15.407(b)(2): Harmonic Emissions Requirements – Radiated (802.11a)

UNII Mid Band 5.25-5.35GHz

Frequency (MHz)	Receive Antenna Polarity (H/V)	Uncorrected Field strength (dBµV)@ 3m	Preamp (dB)	Antenna Factor (dB)	Cable Loss (dB)	Distance Correction Factor (dB)	Corrected Field Strength @ 3m (dBµV)	Limit @ 3m (dBµV)	EIRP dBm	Measurement Type
10520	V	41.1	35.2	38.1	6.7	0	50.7	74	-56.3	Peak
15780	V	40.5	34.3	38.3	7.8	0	52.3	74	-54.7	Peak
15780	V	29.1	34.3	38.3	7.8	0	40.9	54	-66.1	Average
Low Channel 5260MHz										
Frequency (MHz)	Receive Antenna Polarity (H/V)	Uncorrected Field strength (dBµV)@ 3m	Preamp (dB)	Antenna Factor (dB)	Cable Loss (dB)	Distance Correction Factor (dB)	Corrected Field Strength @ 3m (dBµV)	Limit @ 3m (dBµV)	EIRP dBm	Measurement Type
10560	V	40.9	35.2	38.1	6.7	0	50.5	74	-56.5	Peak
15840	V	41.7	34.3	38.3	7.8	0	53.5	74	-53.5	Peak
15840	V	29.4	34.3	38.3	7.8	0	41.2	54	-65.8	Average
Mid Channel 5280MHz										
Frequency (MHz)	Receive Antenna Polarity (H/V)	Uncorrected Field strength (dBµV)@ 3m	Preamp (dB)	Antenna Factor (dB)	Cable Loss (dB)	Distance Correction Factor (dB)	Corrected Field Strength @ 3m (dBµV)	Limit @ 3m (dBµV)	EIRP dBm	Measurement Type
10640	V	40.7	35.2	38.1	6.7	0	50.3	74	-56.7	Peak
10640	V	29.3	35.2	38.1	6.7	0	38.9	54	-68.1	Average
15960	V	42.2	34.3	38.3	7.8	0	54.0	74	-53.0	Peak
15960	V	30.1	34.3	38.3	7.8	0	41.9	54	-65.1	Average
High Channel 5320MHz										

**Note: All other emissions were measured at the noise floor of the spectrum analyzer.
EIRP = dBµV + 107.**



Electromagnetic Compatibility Criteria for Intentional Radiators

§ 15.247(d): Harmonic Emissions Requirements – Radiated (802.11a)

5.725-5.825GHz Band

Frequency (MHz)	Receive Antenna Polarity (H/V)	Uncorrected Field strength (dBµV)@ 3m	Preamp (dB)	Antenna Factor (dB)	Cable Loss (dB)	Distance Correction Factor (dB)	Corrected Field Strength @ 3m (dBµV)	Limit @ 3m (dBµV)	EIRP dBm	Measurement Type
11490	V	44	34.7	39.0	9.4	0	57.7	74	-49.3	Peak
11490	V	31.4	34.7	39.0	9.4	0	45.1	54	-61.9	Average
17235	V	43.8	33.0	44.5	11.8	0	67.1	74	-39.9	Peak
Low Channel 5745MHz										
Frequency (MHz)	Receive Antenna Polarity (H/V)	Uncorrected Field strength (dBµV)@ 3m	Preamp (dB)	Antenna Factor (dB)	Cable Loss (dB)	Distance Correction Factor (dB)	Corrected Field Strength @ 3m (dBµV)	Limit @ 3m (dBµV)	EIRP dBm	Measurement Type
11530	V	43.7	34.7	39.0	9.4	0	57.4	74	-49.6	Peak
11530	V	32.1	34.7	39.0	9.4	0	45.8	54	-61.2	Average
17295	V	44.6	33.0	44.5	11.8	0	67.9	74	-39.1	Peak
Mid Channel 5765MHz										
Frequency (MHz)	Receive Antenna Polarity (H/V)	Uncorrected Field strength (dBµV)@ 3m	Preamp (dB)	Antenna Factor (dB)	Cable Loss (dB)	Distance Correction Factor (dB)	Corrected Field Strength @ 3m (dBµV)	Limit @ 3m (dBµV)	EIRP dBm	Measurement Type
11610	V	44.4	34.7	39.0	9.4	0	58.1	74	-48.9	Peak
11610	V	32	34.7	39.0	9.4	0	45.7	54	-61.3	Average
17415	V	42.3	33.0	44.5	11.8	0	65.6	74	-41.4	Peak
High Channel 5805MHz										

**Note: All other emissions were measured at the noise floor of the spectrum analyzer.
EIRP = dBµV + 107.**

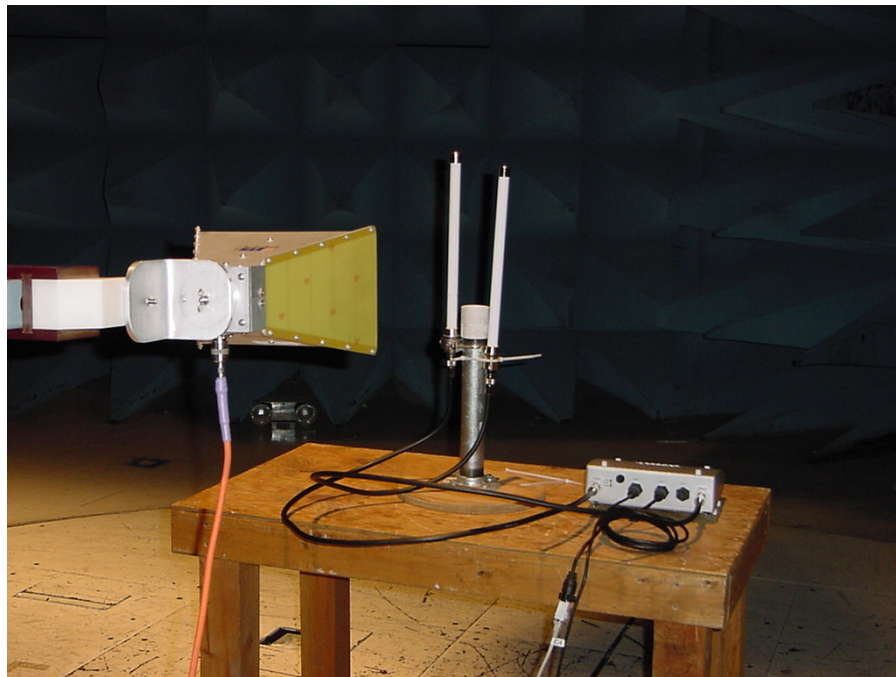
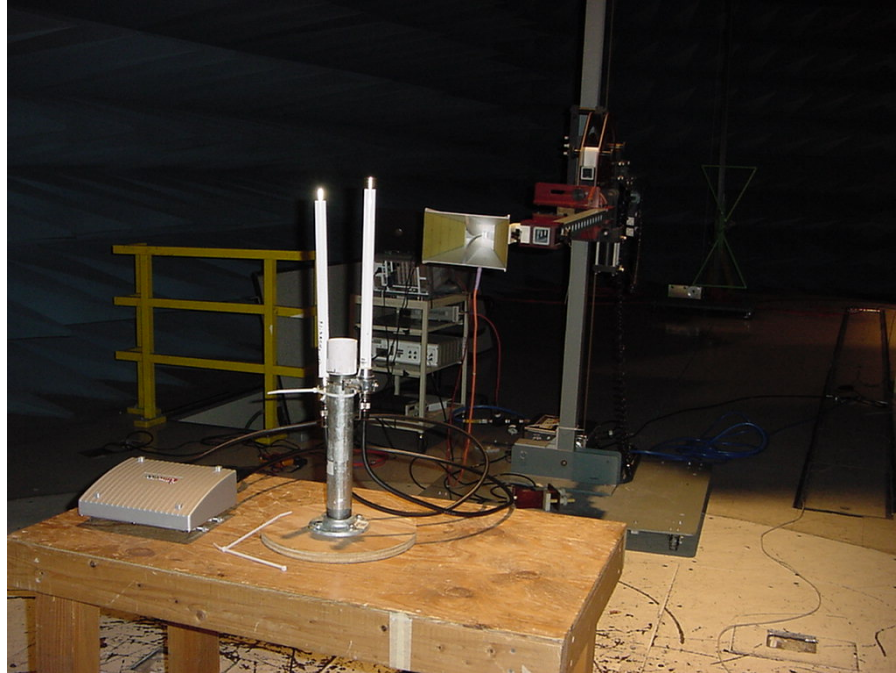

Photograph 3. Test Equipment and setup for various Radiated Measurements



IV. Test Equipment



Test Equipment

Calibrated test equipment utilized during testing was maintained in a current state of calibration per the requirements of ANSI/NCSL Z540-1-1994 and ANSI/ISO/IEC 17025:2000.

MET Asset #	Equipment	Manufacturer	Model	Last Cal Date	Cal Due Date
1S2421	EMI RECEIVER	ROHDE&SCHWARZ	ESIB 7	2/9/2005	2/9/2006
1S2184	BILOG ANTENNA	CHASE	CBL6112A	1/12/2005	1/12/2006
1S2121	PRE-AMPLIFIER	HEWLETT PACKARD	8449B	10/14/2005	10/14/2006
1S2198	ANTENNA, HORN	EMCO	3115	7/14/2005	7/14/2006
1S2202	ANTENNA, HORN, 1 METER	EMCO	3116	3/23/2005	3/23/2007
N/A	HIGH PASS FILTER	MICRO-TRONICS	HPM13146	SEE NOTE	
1S2263	CHAMBER, 10 METER	RANTEC	N2-14	7/25/2005	7/25/2006
1S2430	WIDEBAND POWER METER	ANRITSU COMPANY	ML2488A	1/12/2005	1/12/2006
1S2432	WIDEBAND POWER SENSOR	ANRITSU COMPANY	MA2491A	1/12/2005	1/12/2006
1S2034	COUPLER, DIRECTIONAL 1-20 GHz	KRYTAR	101020020	SEE NOTE	
1S2041	COUPLER, BI DIRECTIONAL COAXIAL	NARDA	N/A	SEE NOTE	
1S2460	Analyzer, Spectrum 9 kHz-40GHz	Agilent	E4407B	07/06/2005	07/06/2008
1S2430	WIDEBAND POWER METER	ANRITSU COMPANY	ML2488A	1/12/2005	1/12/2006
1S2432	WIDEBAND POWER SENSOR	ANRITSU COMPANY	MA2491A	1/12/2005	1/12/2006
1S2034	COUPLER, DIRECTIONAL 1-20 GHz	KRYTAR	101020020	SEE NOTE	
1S2041	COUPLER, BI DIRECTIONAL COAXIAL	NARDA	N/A	SEE NOTE	
1S2128	Harmonic Mixer	Hewlett Packard	11970A	N/A	3/10/2006
1S2129	Harmonic Mixer	Hewlett Packard	11970K	N/A	3/10/2006

Note: Functionally tested equipment is verified using calibrated instrumentation at the time of testing.



V. Certification & User's Manual Information



Certification & User's Manual Information

A. Certification Information

The following is extracted from Title 47 of the Code of Federal Regulations, Part 2, Subpart I — Marketing of Radio frequency devices:

§ 2.801 Radio-frequency device defined.

As used in this part, a radio-frequency device is any device which in its operation is capable of Emitting radio-frequency energy by radiation, conduction, or other means. Radio- frequency devices include, but are not limited to:

- (a) The various types of radio communication transmitting devices described throughout this chapter.
- (b) *The incidental, unintentional and intentional radiators defined in Part 15 of this chapter.*
- (c) The industrial, scientific, and medical equipment described in Part 18 of this chapter.
- (d) Any part or component thereof which in use emits radio-frequency energy by radiation, conduction, or other means.

§ 2.803 Marketing of radio frequency devices prior to equipment authorization.

- (a) Except as provided elsewhere in this chapter, no person shall sell or lease, or offer for sale or lease (including advertising for sale or lease), or import, ship or distribute for the purpose of selling or leasing or offering for sale or lease, any radio frequency device unless:
 - (1) In the case of a device subject to certification, such device has been authorized by the Commission in accordance with the rules in this chapter and is properly identified and labeled as required by §2.925 and other relevant sections in this chapter; or
 - (2) In the case of a device that is not required to have a grant of equipment authorization issued by the Commission, but which must comply with the specified technical standards prior to use, such device also complies with all applicable administrative (including verification of the equipment or authorization under a Declaration of Conformity, where required), technical, labeling and identification requirements specified in this chapter.
- (d) Notwithstanding the provisions of paragraph (a) of this section, the offer for sale solely to business, commercial, industrial, scientific or medical users (but not an offer for sale to other parties or to end users located in a residential environment) of a radio frequency device that is in the conceptual, developmental, design or pre-production stage is permitted prior to equipment authorization or, for devices not subject to the equipment authorization requirements, prior to a determination of compliance with the applicable technical requirements *provided* that the prospective buyer is advised in writing at the time of the offer for sale that the equipment is subject to the FCC rules and that the equipment will comply with the appropriate rules before delivery to the buyer or to centers of distribution.



- (e)(1) Notwithstanding the provisions of paragraph (a) of this section, prior to equipment authorization or determination of compliance with the applicable technical requirements any radio frequency device may be operated, but not marketed, for the following purposes and under the following conditions:
- (i) *Compliance testing;*
 - (ii) Demonstrations at a trade show provided the notice contained in paragraph (c) of this section is displayed in a conspicuous location on, or immediately adjacent to, the device;
 - (iii) Demonstrations at an exhibition conducted at a business, commercial, industrial, scientific or medical location, but excluding locations in a residential environment, provided the notice contained in paragraphs (c) or (d) of this section, as appropriate, is displayed in a conspicuous location on, or immediately adjacent to, the device;
 - (iv) Evaluation of product performance and determination of customer acceptability, provided such operation takes place at the manufacturer's facilities during developmental, design or pre-production states; or
 - (v) Evaluation of product performance and determination of customer acceptability where customer acceptability of a radio frequency device cannot be determined at the manufacturer's facilities because of size or unique capability of the device, provided the device is operated at a business, commercial, industrial, scientific or medical user's site, but not at a residential site, during the development, design or pre-production stages.
- (e)(2) For the purpose of paragraphs (e)(1)(iv) and (e)(1)(v) of this section, the term *manufacturer's facilities* includes the facilities of the party responsible for compliance with the regulations and the manufacturer's premises, as well as the facilities of other entities working under the authorization of the responsible party in connection with the development and manufacture, but not the marketing, of the equipment.
- (f) For radio frequency devices subject to verification and sold solely to business, commercial, industrial, scientific and medical users (excluding products sold to other parties or for operation in a residential environment), parties responsible for verification of the devices shall have the option of ensuring compliance with the applicable technical specifications of this chapter at each end user's location after installation, provided that the purchase or lease agreement includes a proviso that such a determination of compliance be made and is the responsibility of the party responsible for verification of the equipment.



Certification & User's Manual Information

The following is extracted from Title 47 of the Code of Federal Regulations, Part 2, Subpart J — Equipment Authorization Procedures:

§ 2.901 Basis and Purpose

- (a) In order to carry out its responsibilities under the Communications Act and the various treaties and international regulations, and in order to promote efficient use of the radio spectrum, the Commission has developed technical standards for radio frequency equipment and parts or components thereof. The technical standards applicable to individual types of equipment are found in that part of the rules governing the service wherein the equipment is to be operated.¹ *In addition to the technical standards provided, the rules governing the service may require that such equipment be verified by the manufacturer or importer, be authorized under a Declaration of Conformity, or receive an equipment authorization from the Commission by one of the following procedures: certification or registration.*
- (b) The following sections describe the verification procedure, the procedure for a Declaration of Conformity, and the procedures to be followed in obtaining certification from the Commission and the conditions attendant to such a grant.

§ 2.907 Certification.

- (a) Certification is an equipment authorization issued by the Commission, based on representation and test data submitted by the applicant.
- (b) Certification attaches to all units subsequently marketed by the grantee which are identical (see Section 2.908) to the sample tested except for permissive changes or other variations authorized by the Commission pursuant to Section 2.1043.

¹ In this case, the equipment is subject to the rules of Part 15. More specifically, the equipment falls under Subpart B (of Part 15), which deals with unintentional radiators.



Certification & User's Manual Information

§ 2.948 Description of measurement facilities.

- (a) Each party making measurements of equipment that is subject to an equipment authorization under Part 15 or Part 18 of this chapter, regardless of whether the measurements are filed with the Commission or kept on file by the party responsible for compliance of equipment marketed within the U.S. or its possessions, shall compile a description of the measurement facilities employed.
- (1) If the measured equipment is subject to the verification procedure, the description of the measurement facilities shall be retained by the party responsible for verification of the equipment.
- (i) *If the equipment is verified through measurements performed by an independent laboratory, it is acceptable for the party responsible for verification of the equipment to rely upon the description of the measurement facilities retained by or placed on file with the Commission by that laboratory. In this situation, the party responsible for the verification of the equipment is not required to retain a duplicate copy of the description of the measurement facilities.*
- (ii) If the equipment is verified based on measurements performed at the installation site of the equipment, no specific site calibration data is required. It is acceptable to retain the description of the measurement facilities at the site at which the measurements were performed.
- (2) If the equipment is to be authorized by the Commission under the certification procedure, the description of the measurement facilities shall be filed with the Commission's Laboratory in Columbia, Maryland. The data describing the measurement facilities need only be filed once but must be updated as changes are made to the measurement facilities or as otherwise described in this section. At least every three years, the organization responsible for filing the data with the Commission shall certify that the data on file is current.



Certification & User's Manual Information

Label and User's Manual Information

The following is extracted from Title 47 of the Code of Federal Regulations, Part 15, Subpart A — General:

§ 15.19 Labeling requirements.

(a) *In addition to the requirements in Part 2 of this chapter, a device subject to certification or verification shall be labeled as follows:*

- (1) Receivers associated with the operation of a licensed radio service, e.g., FM broadcast under Part 73 of this chapter, land mobile operation under Part 90, etc., shall bear the following statement in a conspicuous location on the device:

This device complies with Part 15 of the FCC Rules. Operation is subject to the condition that this device does not cause harmful interference.

- (2) A stand-alone cable input selector switch, shall bear the following statement in a conspicuous location on the device:

This device is verified to comply with Part 15 of the FCC Rules for use with cable television service.

- (3) All other devices shall bear the following statement in a conspicuous location on the device:

This device complies with Part 15 of the FCC Rules. Operation is subject to the following two conditions: (1) This device may not cause harmful interference, and (2) this device must accept any interference received, including interference that may cause undesired operation.

- (4) Where a device is constructed in two or more sections connected by wires and marketed together, the statement specified under paragraph (a) of this section is required to be affixed only to the main control unit.

- (5) When the device is so small or for such use that it is not practicable to place the statement specified under paragraph (a) of this section on it, the information required by this paragraph shall be placed in a prominent location in the instruction manual or pamphlet supplied to the user or, alternatively, shall be placed on the container in which the device is marketed. However, the FCC identifier or the unique identifier, as appropriate, must be displayed on the device.

§ 15.21 Information to user.

The users manual or instruction manual for an intentional or unintentional radiator shall caution the user that changes or modifications not expressly approved by the party responsible for compliance could void the user's authority to operate the equipment.



Verification & User's Manual Information

The following is extracted from Title 47 of the Code of Federal Regulations, Part 15, Subpart B — Unintentional Radiators:

§ 15.105 Information to the user.

- (a) For a Class B digital device or peripheral, the instructions furnished the user shall include the following or similar statement, placed in a prominent location in the text of the manual:

Note: This equipment has been tested and found to comply with the limits for a Class B digital device, pursuant to Part 15 of the FCC Rules. These limits are designed to provide reasonable protection against harmful interference when the equipment is operated in a residential environment. This equipment generates, uses, and can radiate radio frequency energy and, if not installed and used in accordance with the instruction manual, may cause harmful interference to radio communications. However, there is no guarantee that interference will not occur in a particular installation. If this equipment does cause harmful interference to radio or television reception, which can be determined by turning the equipment off and on, the user is encouraged to try to correct the interference by one or more of the following measures:

- Reorient or relocate the receiving antenna.
- Increase the separation between the equipment and receiver.
- Connect the equipment into an outlet on a circuit different from that to which the receiver is connected.
- Consult the dealer or an experienced radio/TV technician for help.



VI. Exhibits



Exhibit A, Hopping Capability Requirements



Exhibit B, Non-Coordination Requirements



End of Report