

HotPort™

HIGH PERFORMANCE MESH NETWORK

Wireless Mesh Node User Guide

HotPort 3100 Series & 3500 Series Indoor Mesh Nodes



HotPort 3101
HotPort 3103
HotPort 3100/PS
HotPort 3500-2401
HotPort 3500-5001
HotPort 3500-2403
HotPort 3500-5003 (shown)

 **firetide™**
instant mesh networks™

Wireless Mesh Node User Guide

HotPort 3100 Series & 3500 Series Indoor Mesh Nodes

January 2006



© 2005, 2006 Firetide, Inc. All rights reserved. 011006a

Firetide, the Firetide logo, Instant Mesh Networks, HotPort, and HotView are trademarks of Firetide, Inc. All other trademarks are the property of their respective owners.

Caution



Do not open the HotPort mesh node enclosure. This may damage the components inside and affect proper operation. Opening your HotPort mesh node or peeling the tamper evident labeling will invalidate your warranty.

- No serviceable parts inside.
- Refer to qualified service personnel.
- Unit must be disconnected from power prior to servicing.
- Unit has tamper-evident labeling that indicates when cover has been removed.

Indoor Manual Contents

Introduction.....	1
Firetide HotPort Wireless Mesh Nodes	1
The Firetide HotPort Mesh Network.....	3
HotPort Mesh Network Features and Benefits.....	3
HotPort Mesh Network Applications.....	6
HotPort Product Description	7
Front Panel LED Indicators.....	7
Rear Panel Connectors	8
Transmit Power Control	9
Creating a Firetide Mesh Network.....	10
Planning Your Network.....	10
Understanding HotPort Antenna Patterns.....	10
Easy Installation	12
Unpacking.....	12
Connections	12
Using the Optional Mounting Hardware.....	13
Getting Started	15
Connecting the HotView Workstation to the Mesh Network.....	15
Getting Started with HotView Mesh Management Software.....	16
Restoring Default Settings	17
HotPort Factory Default Settings	17
Appendix A—Contacting Firetide	18
Appendix B—Specifications	19
Appendix C—Countries of Operation	21
Appendix D—Regulatory Notices.....	22
USA	22
Canadian Compliance Statement.....	23
European Community.....	24

Introduction

Firetide HotPort Wireless Mesh Nodes

The Firetide™ HotPort™ High-Performance Mesh Network provides a high-capacity, self-healing wireless mesh backbone for indoor and outdoor networks. The HotPort system enables multiple network services and standard Ethernet devices to operate on the wireless backbone, creating secure and reliable wireless networks for video surveillance, voice, and data.

HotPort 3100 series mesh nodes provide fast and easy indoor network deployment. They connect wirelessly to other indoor and outdoor HotPort nodes to form a high-performance wireless mesh network. Ethernet packets are automatically switched across the mesh, in a manner analogous to an Ethernet switch, using AutoMesh™, a proprietary protocol developed by Firetide. AutoMesh has been optimized for efficiency in wireless mesh environments.

HotPort nodes are plenum-rated and feature a built-in four-port 10/100 Ethernet switch for connecting networking devices at any indoor location to a fully wireless mesh backbone. Models are available for operation at 2.4 GHz for high capacity and maximum range or at 5 GHz for high capacity and minimal interference from 2.4 GHz devices. For use on US Public Safety bands, a 4.9 GHz unit is available. This frequency may only be used by FCC-licensed Public Safety agencies.

Nodes can be mounted securely to a wall, ceiling, or countertop using an optional mounting bracket. Each HotPort indoor node includes antennas.

The high throughput of the HotPort mesh ensures higher link performance over longer distances and enables networking services to operate on a wireless backbone rather than a costly wired network. A Firetide mesh is also completely portable, so relocating your entire network is as easy as taking your HotPort nodes with you to your new site, leaving no wires behind.

The HotPort Family

HotPort nodes are available in both indoor and outdoor models, and with a range of single-band and multiple-band radios.

HotPort 3101 and 3103 Models

The HotPort 3101 indoor mesh node provides 10 Mbps throughput for high performance, low cost Wi-Fi HotZone applications. The HotPort 3103 provides 25 Mbps throughput plus traffic prioritization for optimal video, voice, and data networking. Both are dual-band units.

The HotPort 3100/PS provides similar functionality for Public Safety band use in the US.

HotPort 3500 Series Models

The HotPort 3500 Series feature band-specific high-power radios, but are otherwise identical to the 3100 Series Models.

Outdoor Nodes

In addition to the indoor models, Firetide offers a range of HotPorts for outdoor use. These are described in the HotPort 3200/3600 Series User Guide.

The full model range is shown in this table:

Model & SKU	Use	Band	RF Output Power	Data Rate	Default Channel
3101	Indoor	2.4, 5 GHz	standard	10 Mbps	2.462 GHz DSSS, Ch 11
3103	Indoor	2.4, 5 GHz	standard	25 Mbps	2.462 GHz DSSS, Ch 11
3100/PS	Indoor, Public Safety	2.4, 4.9, 5 GHz	standard	25 Mbps	4.962 GHz DSSS, Ch 5
3500-2401	Indoor	2.4 GHz	high	10 Mbps	2.462 GHz DSSS, Ch 11
3500-5001	Indoor	5 GHz	high	10 Mbps	5.805 GHz OFDM, Ch 161
3500-2403	Indoor	2.4 GHz	high	25 Mbps	2.462 GHz DSSS, Ch 11
3500-5003	Indoor	5 GHz	high	25 Mbps	5.805 GHz OFDM, Ch 161
3203	Outdoor	2.4, 5 GHz	standard	25 Mbps	2.462 GHz DSSS, Ch 11
3200PS	Outdoor, Public Safety	2.4, 4.9, 5 GHz	standard	25 Mbps	2.462 GHz DSSS, Ch 11
3600-2400	Outdoor	2.4 GHz	high	25 Mbps	2.462 GHz DSSS, Ch 11
3600-5000	Outdoor	5 GHz	high	25 Mbps	5.805 GHz OFDM, Ch 161

Data rates are typical for a single hop operation.

The Firetide HotPort Mesh Network

The HotPort™ High Performance Mesh Network is the third generation of mesh networking products from Firetide, a leading developer of wireless mesh networks. The HotPort system is a multi-function mesh network that enables standard Ethernet devices such as access points, surveillance cameras, IP telephones, network servers, and printers to deliver networking services over the wireless mesh backbone.

Mesh networking can be compared to the Internet, where data can be re-routed onto other paths if one path becomes disabled or congested. Losing one or two nodes or links won't bring down the entire mesh network. Unlike other WLAN technologies, a mesh network's reliability and scalability can

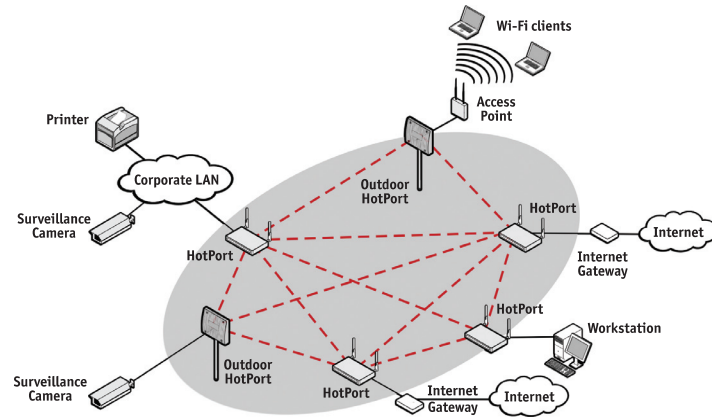

Firetide Mesh Network with Indoor and Outdoor Wireless Mesh Nodes

actually be improved by adding more nodes and enriching the density of the mesh. More redundant paths mean the network in aggregate can handle far more data traffic, and is therefore quite scalable. Mesh networks are ideal whenever the network must be reliable, scalable, and flexible. They are very portable and can adapt to many different physical environments.

HotPort Mesh Network Features and Benefits

Provide Ethernet Anywhere

The HotPort mesh network delivers live Ethernet service virtually anywhere, indoors or outdoors, without a wired backbone. This makes the mesh ideal for any location where network cabling is too difficult, invasive, or expensive to install, such as in historic buildings, outdoor locations, temporary venues such as conferences and festivals, or office space that changes frequently. The HotPort mesh provides conventional Ethernet functionality, so Ethernet devices do not require any additional software, drivers, or setup to operate on the mesh.

Easy to Deploy and Manage

After basic configuration and startup, HotPort nodes automatically find each other to form the wireless mesh. The network automatically heals itself if a node goes down or if a path between nodes is blocked. Minimal network management is required to deploy the network. Network management is provided with an intuitive graphical interface on a workstation that can be connected either directly to the mesh or remotely via the Internet.

High Capacity and Scalability

The HotPort mesh network provides exceptional performance and scalability and is designed especially for high-bandwidth/low-latency applications, such as real-time video, voice, and large Wi-Fi HotZones. A highly scalable architecture allows expansion of the network from just a few nodes to many. To add more nodes, you can simply copy the configuration from an existing node to the new nodes and then power up the new nodes. Multiple mesh networks operating on different radio spectrums or IP addresses can be physically connected to each other to expand the overall network, while still retaining their separate mesh identities.

Reliable

The self-healing architecture of the HotPort mesh network and its redundant paths between nodes makes it very reliable and fault tolerant. Mesh traffic will reroute over a different path automatically if a path becomes obstructed or if a node is taken out of service or moved to another location.

Indoor and Outdoor High-Performance Nodes

Each node on the HotPort mesh features hardware optimized for maximum speed on the mesh and at each location. In addition to providing fast transport between hops, each node also features an integrated high speed Ethernet switch for local line-rate switching up to 100 Mbps per port. These service ports support virtually any Ethernet device, including access points,

HotPort indoor and outdoor mesh network nodes are fully compatible with each other for seamless network connectivity between indoor and outdoor locations. All HotPort indoor mesh nodes provide four 10/100 Ethernet ports. HotPort outdoor mesh nodes feature weatherproof NEMA 4X enclosures, high-gain antennas for extended range, and two 10/100 Mbps Ethernet ports. HotPort outdoor mesh nodes also support 802.3af-compliant Power over Ethernet (PoE). Only one connection is needed to provide power for an outdoor mesh node and up to two connected devices.

Excellent Price/Performance

Wireless mesh networks can significantly reduce the labor costs and lead times of network installation by eliminating a significant amount of backhaul cabling. HotPort mesh nodes provide excellent wireless connectivity for maximum coverage at each location, and no auxiliary servers or additional devices are required to support larger node populations.

2.4 GHz, 4.9 GHz, and 5 GHz Spectrums

HotPort mesh networks have the flexibility to operate in 2.4 GHz or 5 GHz spectrums. Each spectrum supports high capacity 25 Mbps operation, with 2.4 GHz operation providing the longest range and 5 GHz operation offering a shorter range but minimal interference in environments that are saturated with 2.4 GHz wireless traffic.

For US Public Safety use only, the HotPort 3100/PS operates on the 4.9 GHz US Public Safety band.

Security

The HotPort mesh network includes several layers of security, including 40 and 104 bit WEP key and 128 and 256 AES key encryption. The mesh also provides packet filtering, based on MAC addresses, to limit access to the mesh. For additional security, a proprietary mesh protocol prevents non-HotPort devices from participating on the mesh. Client computers can connect directly to the mesh nodes via a short cable to take advantage of the wireless backbone in locations that otherwise prohibit the use of wireless access points and Wi-Fi clients for security reasons.

VLANs

The HotPort mesh network includes support for virtual local area networks (VLANs) to enable traffic to be separated into smaller groups and application-specific LANs. VLANs allow small groups of users to operate within their own private space on the mesh, and they can also improve mesh perfor-

mance by directing traffic onto specific VLAN routes. The HotPort mesh supports 802.1q VLAN tagging of packets entering and exiting the mesh.

You can assign mesh node Ethernet ports to different VLANs. Only ports belonging to the same VLAN can switch traffic among themselves. You can define up to 4096 VLAN IDs and create up to 16 multiple, logically separated VLAN networks within a single mesh. The HotPort mesh also supports VLAN trunks.

Traffic Prioritization (class of service)

Note: Traffic prioritization is not available on HotPort 3101, 3500-2401, or 3500-5001 models.

The HotPort system provides three traffic prioritization levels (Low, Medium, or High) to prioritize traffic on the mesh. This helps ensure that certain types of traffic requiring high throughput or continuous service, such as voice, take precedence over other forms of traffic. Every port on every node on the mesh can be set to any of these three priority levels.

Network Gateway Servers

The HotPort Mesh network allows up to 16 mesh portals for efficient access to external network services such as the Internet. This capability enables high throughput and redundancy for external services and optimizes the transport of traffic through the mesh. HotPort mesh nodes can be assigned to specific portal groups (called "Gateway Groups") to further increase the efficiency of each portal. You configure portals by defining Network Gateway Groups.

The Network Gateway feature provides both load balancing and redundancy when accessing various network services. This helps provide better wire-

less mesh data throughput because it allows packets to enter and exit the wireless mesh at the entry/exit point closest to the packet's destination, thereby conserving wireless bandwidth and reducing the number of hops required to reach the desired destination.

Intuitive Network Mesh Management with HotView™ Software

HotView™ mesh management software provides live monitoring and management of Firetide HotPort wireless mesh networks. The software features an intuitive graphical user interface and provides complete access to all mesh and individual node settings, including security, VLAN, class of service, radio power controls, and network gateway interconnects. Live monitoring features include mesh and node statistics and a graphical view that uses node icons to indicate active connections. Users can also import graphics of floor plans or maps and place the icons for each node for a real world view of the mesh network.

HotView Pro extends the management features of HotView across multiple meshes. Thus, an enterprise can manage all of its HotPort meshes worldwide from anywhere.

HotView and HotView Pro operate on virtually any workstation or server that is connected to the mesh, either directly or remotely via WAN connection or the Internet.

HotPort Mesh Network Applications

Wi-Fi Networks

Providing a wireless backbone for Wi-Fi networks and HotSpots is one of the most prominent applications of a wireless mesh network. Because it supports access points of any brand, price, size, and features, the Firetide mesh provides more flexibility for Wi-Fi deployment than other mesh solutions. Each HotPort node also supports multiple access points, so higher density Wi-Fi networks can be deployed at a lower cost than using mesh nodes that are limited to a single integrated access point.

Multiple Services over the Mesh

The HotPort mesh network provides a high-performance wireless infrastructure to support multiple, simultaneous applications and services, including those that require extra capacity and fast throughput. Typical applications that benefit from this level of performance are video surveillance networks, voice over IP services, and metro-scale Wi-Fi HotZones. In addition to ample bandwidth, the HotPort mesh also provides VLAN and class of service traffic prioritization functionality to segment and prioritize traffic on the mesh for maximum efficiency and throughput.

Video

The high capacity and sustained throughput of the HotPort network makes it ideal for IP video networks and video surveillance applications, especially those requiring multiple cameras or faster frame rates. Wi-Fi cameras are not needed because any camera with an Ethernet interface can connect directly to a HotPort mesh node. HotPort outdoor mesh nodes also support Power over Ethernet, allowing the use of a single power connection to power both the node and the camera.

Voice over IP

The HotPort mesh network enables clear VoIP traffic over the wireless backbone. In addition to benefiting from the very high sustained throughput of the mesh, the class-of-service traffic prioritization capability enables you to assign the highest priority to voice traffic to ensure the best quality voice transmission.

Data

The HotPort mesh network is not limited to Wi-Fi applications. It also provides direct connectivity for computers and servers via a short cable to the Ethernet ports provided on each node. These direct connections simplify connectivity and enhance performance by eliminating the overhead and complexity of using access points and wireless clients to connect to the mesh.

Printing

With the HotPort mesh network, any network printer can now operate over the wireless mesh backbone without any additional setup, drivers, or software. The printer simply connects to one of the Ethernet ports on a HotPort mesh node the same way it would connect to a wired network. This wireless capability allows network printers to operate virtually anywhere, including mobile carts and in temporary settings.

Radio Settings

HotPort wireless mesh supports 2.4 GHz OFDM and DSSS radio modes, as well as 5 GHz OFDM. 3100 Series nodes are multi-band; 3500 Series are single-band. The selected radio mode is applied to the entire wireless mesh. You can use the HotView management software to display and modify the radio transmit (Tx) power level for each node.

HotPort Product Description

Front Panel LED Indicators

Indoor HotPort nodes have eight indicator LEDs on the front panel. Upon power up, all eight LEDs will illuminate continuously for several seconds until the startup sequence is complete. The post startup functions of the LEDs are described below.

Power LED

This indicator remains continuously on to indicate that HotPort node is receiving power.

Fault LED

After start up, this indicator color will change from YELLOW to OFF to indicate normal conditions. If the indicator remains on or comes back on, this indicates a fault condition.

1, 2, 3, 4 Port LEDs

These four indicators are numbered to correspond to the four rear panel Ethernet ports.

- Continuously on = link but no activity
- Flashing = link and activity
- Indicator off = no link

Mesh LED

This LED illuminates when the HotPort node connects wirelessly to one or more HotPort nodes. If this LED is off, the node is not connected to any other nodes.

Status LED

This indicator will indicate the node status as follows:

- LED on = node is operating OK
- LED off = this node is disabled

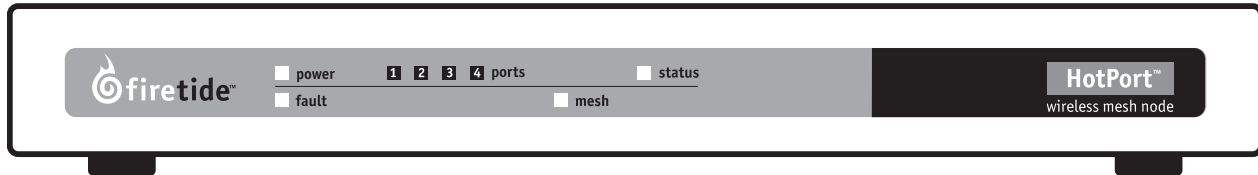

HotPort 3103 Front Panel with Indicators

Rear Panel Connectors

10/100 Ethernet Connectors

You can use the HotPort node's Ethernet ports to connect up to four Ethernet-capable client devices to the mesh. The HotPort wireless mesh network acts as a single virtual switch allowing traffic to be switched between any client devices connected to any HotPort nodes on the mesh.

You can configure each Ethernet port for 10 or 100 Mbps speed or for automatic speed negotiation. Network traffic between a HotPort node and devices connected to its Ethernet ports travels up to full wire rate (10 or 100 Mbps). Each port can also be configured for full- or half-duplex operation. In addition, you can enable and disable individual ports. The Ethernet ports support auto MDIX, which allows you to use either straight-through or crossover cables to connect the HotPort node to other devices.

Antenna Connectors

HotPort indoor mesh nodes have two Reverse Polarity SMA antenna connectors. Dual antennas provide path diversity and eliminate multi-path problems. The antenna connected to "Antenna 1" is the primary transmit/receive antenna. The antenna connected to "Antenna 2" is for diversity and will be used as a receive-only antenna. Multi-band HotPort nodes can be set to operate in the 2.4 GHz or 5 GHz spectrums, so each node includes one pair of 2.4 GHz antennas and one pair of 5 GHz antennas. The 5GHz antennas can be used for 49 GHz public safety nodes as well.

Power Connector

The power connector is for the external AC power transformer. The HotPort input power is 5 VDC and consumption is 8 to 10 watts. Use only the power adapter provided with your unit.

Reset Switch

Pressing the Reset switch restores the HotPort node to its factory default settings. This switch is recessed to prevent accidental resetting.

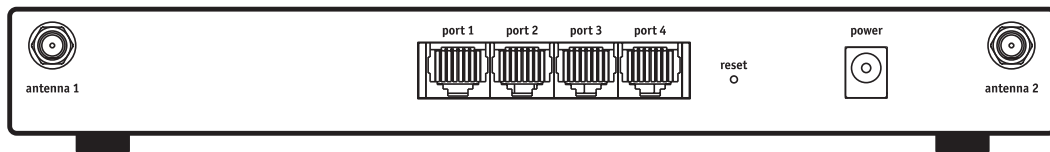

HotPort Rear Panel with Connectors and Reset Switch

Transmit Power Control

You can display and modify the radio Tx power level on a per node basis utilizing the HotView™ management software. The maximum power (i.e., 100%) is a factory-configured value that is unique to each country of operation, each channel of operation, and each antenna configuration and has been determined to be within an authorized limit. This value cannot be changed. However, using the HotView software, a mesh administrator can set any node to operate at a reduced percentage of this maximum power (e.g. 75%, 50%, or 25%). The administrator can restore the HotPort node to its approved maximum power by setting the power level back to 100%.

Note: You can only adjust the output power in the following increments: 25%, 50%, 75%, and 100%. These adjustments affect the node radio, so care must be exercised when adjusting on an existing network as the lowered power level may cause the node to lose connectivity with other mesh nodes.

For example, if the maximum FCC-allowed power output for a certain country, channel, and antenna is 17dBm the settings would be:

100% = 17dBm
75% = 16dBm
50% = 14dBm
25% = 11dBm

Note: Adjusting the power incorrectly could have an adverse effect on proper mesh operations. If you are not sure what the power should be adjusted to, it is best to leave it at its default configuration. If you need additional technical assistance, please contact your Firetide dealer.

Creating a Firetide Mesh Network

Installing, expanding, or even relocating a Firetide mesh network is easy and fast. Simply place a HotPort node wherever you need Ethernet ports and connect it to an AC power source. You then use HotView to configure the new node to match existing nodes, or to re-configure a complete network. Adhering to a few simple guidelines will help ensure that your network performs reliably and gives you the full benefits and performance that mesh networking has to offer.

Planning Your Network

Before implementing a wireless mesh network, perform the following preliminary steps:

- Survey your site and make a simple sketch of where you'll place the HotPort nodes.
- Make sure that uninterrupted AC power is available at each node location. Do not select a location where it is easy for people to unplug the power transformer. Do not connect the power transformer to a power strip that is easy to shut off.
- Select a location that is within radio range of other HotPort nodes. You can increase the working distance of your indoor, wireless mesh by avoiding obstacles between nodes. For best performance, ensure that there is a clear line of sight between each adjacent HotPort node.
- To ensure security, do not mount the mesh node in publicly accessible areas where it would be easy to steal or damage the unit or gain unauthorized access to the network using the rear panel Ethernet ports.
- See the following sections for additional site-planning information.

Understanding HotPort Antenna Patterns

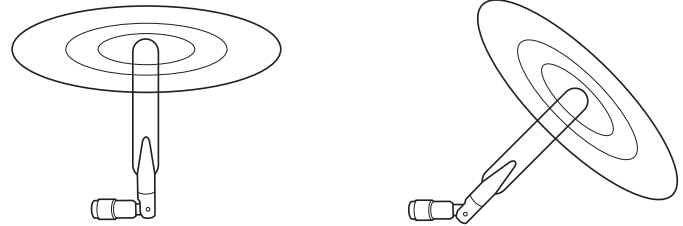

Typical Omnidirectional Antenna Patterns

Omni-directional antennas are usually the best overall choice for most HotPort mesh node installations. Omni-directional antennas radiate in a broad circular pattern perpendicular to the antenna shaft. If all nodes are on the same floor or elevation, orienting the antennas in your mesh network vertically (perpendicular to the ground) will provide optimal coverage. Covering different elevations, such as a multi-story building, may require some experimentation with antenna angles. Coverage of the RF spectrum is different in the various spectrum bands so proper orientation of the antennas will enhance your coverage area.

When other types of antennas are used, care should be taken to insure correct mutual alignment of the antennas. Consult your Firetide dealer or Firetide for further information on antenna choices and patterns.

Line-of-Sight Improves Operating Distance

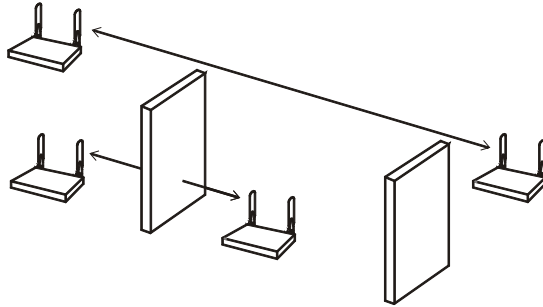

Although HotPort wireless mesh nodes can communicate between walls and buildings, you can increase the working distance of your indoor mesh node by avoiding obstacles made of dense materials, such as concrete, metal, or wood. Positioning the HotPort units so the space between them provides an unobstructed, line-of-sight view, will greatly increase the effective range and reliability of transmission. They should be located high enough above obstacles to prevent interference.

Creating a Mesh Topology for Maximum Performance and Reliability

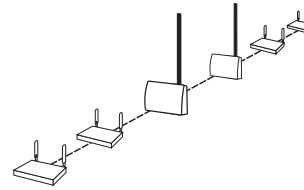

*Linear or Point-to-Point
Topology (incorrect)*

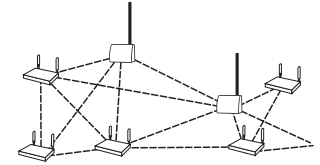

*Multipoint to Multipoint
Mesh Topology (correct)*

Unlike simple point-to-point bridging, Firetide provides true mesh networking with flexible and redundant paths. This proprietary technology was developed by Firetide specifically for efficient mesh networking. It improves overall performance, allows the network to be extended over long distances, and reduces the chance of single point failures. To fully benefit from the self-forming and self-healing properties of the mesh, place each HotPort node within direct range of two or more HotPort nodes. Avoid installing your HotPort network in a linear, point-to-point configuration. The Firetide network protocol is optimized for two and three dimensional topologies.

Easy Installation

Unpacking

Your HotPort indoor mesh node package contains the following items:

- HotPort indoor mesh node
- AC power transformer. US-only units will include a US cord; all other units will include three different cords.
- Antennas. Single-band units will have one pair; dual-band units will have two pair.
- CD containing user documentation and HotView network management software
- Wireless Mesh Node User Guide (this document)
- End user license agreement
- Product warranty card

Note: The HotPort 3100 series and 3500 series mesh nodes are indoor-only products. Any modification to the hardware or software or enhancement of this product for use outdoors is strictly prohibited and will void your warranty.

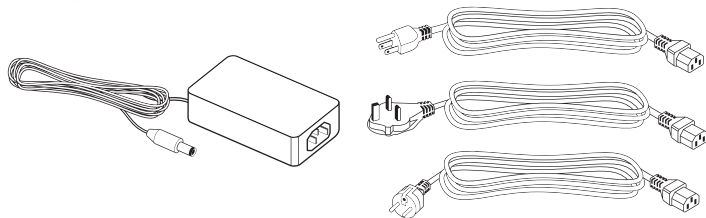

AC power transformer and line cord selection

Connections

Attach antennas

Select the proper pair of antennas for the spectrum to be used by your mesh (2.4 GHz or 5 GHz) and attach them to the threaded connectors on the rear of the HotPort enclosure. Tighten firmly by hand to ensure a good connection and to prevent the antennas from coming loose. Use only antennas provided by Firetide. Do not use one 2.4 GHz and one 5 GHz antenna. Use of other antennas not endorsed by Firetide for use with your unit is prohibited.

Connect Ethernet devices

Plug up to four Ethernet devices into the rear ports on the HotPort enclosure. If you need additional ports, you can connect a small switch to the HotPort node. However, keep in mind that all devices connected to the switch will share the wireless bandwidth of the HotPort node.

Note: By default, all ports are enabled for use with any device on the mesh. However, the port function and the VLAN access of each port can be changed using the HotView mesh management software. Keep this in mind when selecting a port for each device.

Add power

1. Connect the appropriate country-specific power cord to the HotPort power transformer and plug the other end into an AC power source.
2. Plug the small power cord from the power transformer into the HotPort node 'power' connector. All of the front panel LEDs will illuminate momentarily before switching to their normal function. For a description of the LED functions, see page 6.
3. Start up all the Ethernet devices if they are not already on.

Using the Optional Mounting Hardware

You can use the optional mounting hardware to attach a HotPort node to a wall or hang it from a stable support, such as a office cubicle wall, for example. A security slot is provided for locking the HotPort node to the bracket. Contact your Firetide dealer to order mounting hardware.

Note: The mounting hardware consists of a main mounting bracket and auxiliary bracket. The brackets are attached together for shipment. Prior to mounting, disassemble the brackets by removing the four screws holding them together. Retain the screws for later reassembly.

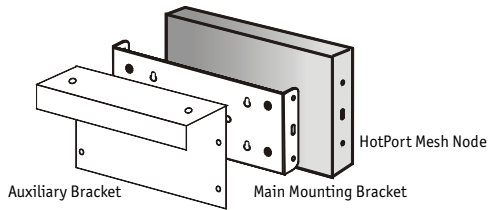

Wall Mounting

To mount a HotPort node to a wall:

1. Hold the main mounting bracket against the wall at the desired location and use a pencil to trace the screw hole locations onto the walls. Use the four keyholes if you want to be able to easily remove the bracket later with the mesh node attached. Use the two round holes if you want to secure the bracket and mesh node with a lock.
2. Drill pilot holes and use appropriate anchors when attaching to masonry, wallboard or other materials.
3. Screw the main mounting bracket to the wall.

4. If you intend to run the power cord and any Ethernet cables below the bracket, connect them to the rear panel of the mesh node before attaching it to the bracket.
5. Insert the HotPort node into the main mounting bracket and secure it with the four screws provided. The bracket provides a .25 inch (6 mm) clearance for running cords between the bracket and the back of the HotPort node.

Ceiling or Countertop Mounting

1. Attach the auxiliary bracket to the rear of the main mounting bracket as shown using the four screws provided.
2. Hold the end of auxiliary bracket against the ceiling or countertop at the desired location and use a pencil to trace the two screw hole locations onto the ceiling or countertop.
3. Drill pilot holes and use appropriate anchors when attaching to masonry, wallboard or other materials.
4. Screw the mounting bracket to the ceiling or countertop.
5. Place the bottom of the HotPort node against the main mounting bracket. The HotPort rear panel must face away from the ceiling or countertop to provide clearance for the antennas and the power and Ethernet cables.
6. Insert the the HotPort node into the main mounting bracket and secure it with the four screws provided. The bracket provides a .25 inch (6 mm) clearance for running cords between the bracket and the back of the HotPort node.

Cubicle Mounting

1. Attach the auxiliary bracket to the rear of the main mounting bracket as shown using the four screws provided.
2. If you intend to run the power cord and any Ethernet cables below the bracket, connect them to the rear panel of the mesh node before attaching it to the bracket.
3. Insert the the HotPort node into the main mounting bracket and secure it with the four screws provided. The bracket provides a .25 inch (6 mm) clearance for running cords between the bracket and the back of the HotPort node.
4. Hang the auxiliary bracket and mesh node over the top edge of a cubicle wall or other vertical.

Securing the HotPort to the Bracket (optional)

Attach a Kensington® type lock or scissor lock to the security slot on the side of the HotPort mesh node. If you are using the mounting bracket, insert the lock through the slots in both the bracket and the mesh node.

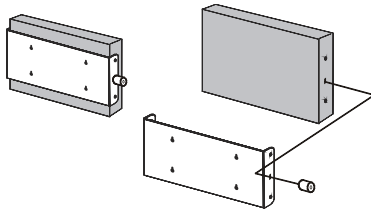

Getting Started

To configure a new mesh network, it is recommended to first install all of the nodes with the factory default configuration and then change them to the desired settings, using the included HotView software. You may wish to do the initial setup in a staging area, where you can easily see all of the nodes at the same time. The HotView (and HotView Pro) software lets you change the settings (ESSID, channel, encryption, IP address, and so on) on all nodes in one batch operation, rather than changing one node at a time. This will save you time and ensure that every mesh node is configured the same way.

HotView mesh management software provides a convenient interface for setting up HotPort mesh nodes and monitoring the mesh network. Because wireless connections between HotPort nodes are invisible, this software lets you “see” which units are within direct range of each other. HotView also provides additional security and optional configuration features. HotView is a Java-based application compatible with most Internet browsers and personal computer platforms, including Windows, Macintosh, and Linux. Registered users can download HotView software updates and documentation from the Firetide web site: www.firetide.com.

This manual provides basic configuration instructions to allow you to set up and check your mesh network as quickly as possible using HotView. Refer to the HotView user documentation included on your HotPort CD for complete instructions on using this powerful software tool.

Connecting the HotView Workstation to the Mesh Network

HotView must be installed and running on a computer or workstation connected to the mesh network. Refer to the HotView documentation for workstation specifications and requirements. The recommended way to connect to workstation to the mesh is shown in the diagram below.

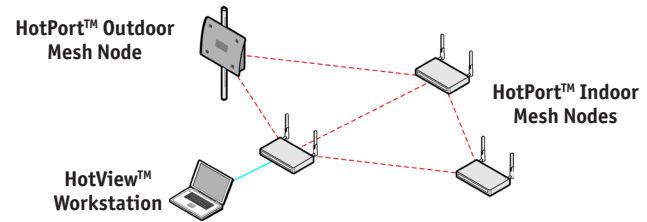

Connecting a Workstation Running HotView Mesh Management Software

1. Be sure all of your HotPort nodes are installed and powered.
2. Connect your workstation’s network adapter directly to any one of the HotPort nodes using an Ethernet cable.
3. Turn on your workstation and configure your TCP/IP settings to:
 - IP address: 192.168.224.100
 - Subnet mask: 255.255.255.0
 - Gateway is not used
4. Refer to your operating system documentation if you need assistance in setting the static IP address specified in step 3.

Getting Started with HotView Mesh Management Software

You are now ready to check your mesh configuration using the HotView mesh management software. For complete information on HotView mesh management features and more detailed instructions on its operation, install the software from the CD provided in the HotPort package. The latest HotView software and user documentation is also available for registered users at www.firetide.com.

The steps below describe how to launch the HotView software under Windows. If you are using a different operating system, refer to your operating system's documentation for instructions on how to launch applications.

1. Install the HotView mesh management software as described in the HotView User Guide.
2. From the Windows Desktop, click on the Start button.
3. Click on All Programs and select HotView software. The Login screen will appear.
4. Enter the following information to log into the mesh network:
 - Mesh IP address: 192.168.224.150
 - Username: admin
 - Password: firetide
5. Click on Login.
6. Wait for your computer to connect to the mesh. This may take a few seconds to several minutes, depending on how many nodes are in the mesh. You should see a screen with a list of all of the HotPort units on the mesh.

If this screen does not appear, or if one or more HotPort mesh nodes appear to be missing from the list, refer to the HotView User Guide for additional instructions.

Inventory	Performance	Current Faults:(3 Major Errors)(1 Warning)							
Hotport Name	Serial Number	Status	Location Sting	Software Version	Model	Ethernet MAC Address	Radio MAC Address		
Bo's Office		✓	Bo's Office at the north corner of the 1st buil...						
Mohan's Office		✓	Mohan's Office on the second floor						
Mike's cube		✓	Mike's cube that is in building no 7566 on 3...						
Siva's cube		✓	Siva's cube that is near the front door in the...						
Sai's cube		✓	Sai's cube, the cube where the candle is sti...						
Sachin's cube		✓	Sachin's cube is the easiest to find						
Ike's Office		✓	Ike's Office at the North east corner of the b...						
Murali's cube		✓	Murali's cube next to Naresh's cube						
Steve's cube		✓	Steve's cube near Mohan's office						
Outdoor Newell Ave & Newell Ct		✓	At 230 Newell Ave, it is hidden inside a box						
Outdoor Newell & Elena Way		✓	At 880 Elena Way, on the tree next to the ele...						
Outdoor Lark & Chester Oaks Dr		✓	At 2200 Chester Oaks Dr, behind star buck...						

HotView screen showing active mesh nodes

Restoring Default Settings

You can reset your HotPort node back to the factory default settings listed here. To do this, carefully insert a narrow tool, such as the end of a bent paper clip, into the Reset hole on the rear panel of the HotPort node and depress the switch located behind the hole.

HotPort Factory Default Settings

- AES encryption: Disabled
- WEP encryption: Disabled
- Mesh IP address: 192.168.224.150
- Ethernet ports: All ports enabled
- HotView username: admin
- HotView password: firetide
- 802.11 operation for multi-band units:
- Power = 17 dBm (75% of maximum)
- ESSID = HOTPORT_MESH

Frequency settings will be as specified in the table on page 2.

Appendix A—Contacting Firetide

As a Firetide customer, you are entitled to receive free support services on our web site and from your authorized Firetide dealer.

Register Now to Access our Support Web Site

Registering as a customer on our web site entitles you to free information and materials to help you get the most from your Firetide mesh network. Visit <http://www.firetide.com/support> for information on becoming a registered customer and for access to our support materials.

Dealer Provided Technical Support and Warranty Services

If you need additional technical assistance that is not available on our web site, please contact your Firetide dealer directly. All authorized Firetide dealers are trained and authorized to provide technical support and warranty services for our products and have qualified technical staff available to help you build and maintain your Firetide mesh network.

Product Returns

Please contact your Firetide dealer for instructions on returning defective or damaged products for repair or replacement. Do not return products to Firetide, Inc. Please keep all original packaging materials in the event they are needed to return the product for servicing.

Sales Assistance

If you need additional HotPort wireless mesh nodes or accessories, please contact your Firetide dealer directly. If you do not know your dealer's name, simply email sales@firetide.com and we will send you the dealer information you need. To help us provide the best service possible, be sure to include your phone number, address, and the serial numbers of the HotPort nodes at your location.

Appendix B—Specifications

This table describes the technical limits of the nodes. Various country restriction may limit available choices.

Model	Use	Bands	Data Rate	CoS
3101	Indoor	2.4, 5 GHz	10 Mbps	No
3103	Indoor	2.4, 5 GHz	25 Mbps	Yes
3100/PS	Indoor, Public Safety	2.4, 4.9, 5 GHz	25 Mbps	Yes
3500-2401	Indoor	2.4 GHz	10 Mbps	No
3500-5001	Indoor	5 GHz	10 Mbps	No
3500-2403	Indoor	2.4 GHz	25 Mbps	Yes
3500-5003	Indoor	5 GHz	25 Mbps	Yes

Model	Bands (GHz)	Max Tx Power	Sensitivity, dBm
3101 3103	2.400-2.497 DSSS 2.400-2.497 OFDM 4.900-5.000 (J) 5.150-5.250 5.250-5.350 5.725-5.850	100 mW 100 mW 100 mW 50 mW 100 mW 100 mW	1 Mbps: -96; 11 Mbps: -89 6 Mbps: -93; 54 Mbps: -75 6 Mbps: -92; 54 Mbps: -72 6 Mbps: -92; 54 Mbps: -72 6 Mbps: -92; 54 Mbps: -72 6 Mbps: -92; 54 Mbps: -72 6 Mbps: -92; 54 Mbps: -72
3100/PS	2.400-2.484 DSSS 2.400-2.484 OFDM 4.9 (US PS) 5.150-5.250 5.250-5.350 5.725-5.850	100 mW 100 mW 100 mW 50 mW 100 mW 100 mW	1 Mbps: -96; 11 Mbps: -89 6 Mbps: -93; 54 Mbps: -75 6 Mbps: -92; 54 Mbps: -72 6 Mbps: -92; 54 Mbps: -72 6 Mbps: -92; 54 Mbps: -72 6 Mbps: -92; 54 Mbps: -72 6 Mbps: -92; 54 Mbps: -72
3500-2401 3500-2403	2.400-2.484 DSSS 2.400-2.484 OFDM	400 mW	1 Mbps: -96; 11 Mbps: -90 6 Mbps: -93; 54 Mbps: -74
3500-5001 3500-5003	5.150-5.250 5.250-5.350 5.725-5.850	50 mW 200 mW 400 mW	6 Mbps: -92; 54 Mbps: -72 6 Mbps: -92; 54 Mbps: -72 6 Mbps: -92; 54 Mbps: -72

Mesh Protocol

Firetide AutoMesh Protocol

Encryption

- 40 bit, 104 bit WEP keys
- 128 bit, 256 bit AES keys

Wireless Interface

Channels available for use subject to country-specific regulatory approvals.

- Dynamic Frequency Selection (DFS)
- Transmit Power Control (TPC)

Network Ports

- Four 10/100 Base-Tx (RJ-45)
- IEEE 802.3, 802.3u compliant
- CSMA/CD 10/100 auto-sense
- Auto MDIX allows connections via straight or crossover Ethernet cable

Enclosure

- Two antenna connectors (SMA reverse polarity)
- One power connector
- Four Ethernet data connectors (RJ-45)
- System indicator LEDs (power, status, mesh, fault)
- Ethernet indicator LEDs (link status)
- Security slot for physically locking device
- Reset button (recessed)
- Weight: 2.1 lbs (.95 Kg) without external transformer
- Dimensions: W = 5.8" (14.8cm), H = 1.1" (2.7 cm), L = 9" (22.9 cm)

Power

- Input power: 5 VDC, 2 A
- External transformer: 100-240 VAC, 50/60 Hz (transformer voltages may vary depending on country of operation)
- Power consumption: 8 – 10 W

5 GHz Antennas

- Two detachable 5 GHz omnidirectional antennas
- Spectrum: For 4.9 and 5 GHz operation only
- Connectors: SMA reverse polarity
- Length: 6.25 in. (15.5 cm)
- Gain: up to 5 dBi peak

2.4 GHz Antennas

- Two detachable 2.4 GHz omnidirectional antennas
- Spectrum: For 2.4 GHz operation only
- Connectors: SMA reverse polarity
- Length: 6.81 in. (17.3 cm)
- Gain: up to 5 dBi (peak)

System Specifications

- Intel IXP425, 266 MHz processor (HotPort 3101, 3500-2401, 3500-5001)
- Intel IXP425, 533 MHz processor (HotPort 3103, 3100/PS, 3500-2403, 3500-5003)

Regulatory Agency Certifications

See Appendix C and D for countries of operation and regulatory agency information

Environmental Specifications

- Operating temperature: 0° C to +50° C
- Storage temperature: -20° C to +70° C

- Humidity (non-condensing) 10% to 90%
- Storage Humidity (non-condensing): 10% to 90%
- Plenum-rated

Warranty

One year limited warranty (see warranty card for details)

Public Safety Band

Pursuant to Part 90.1215, use of antennas with gain greater than 9 dBi and up to 26 dBi in the 4.940 – 4.990 GHz Public Safety band is permissible without reduction of Tx output power. The antenna shall have a directional gain pattern in order to meet the requirement of point to point and point to multi-point operation.

Accessories

- Mounting kit available for secure wall, ceiling, tabletop, or cubicle installation (not included)

Additional tested and approved antennas

Please refer to Firetide's Antenna Guide for a list of tested and approved antennas.

Mesh management software

- HotView™ mesh management software (bundled)
- HotView Pro™ mesh management software (optional)

Appendix C—Countries of Operation

USA - All models

- Approved for operation in the 2.400-2.484 GHz band in DSSS and OFDM modes.
- Approved for operation in the 4.9 GHz band by licensed Public Safety agencies, per FCC regulations.
- Approved for operation on the 5.150-5.250 GHz, 5.250-5.350 GHz, and 5.725-5.825 GHz bands in OFDM mode.

Canada - 3101 and 3103 only

- Approved for operation in the 2.400-2.484 GHz band in DSSS and OFDM modes.
- Approved for operation on the 5.150-5.250 GHz, 5.250-5.350 GHz, and 5.725-5.825 GHz bands in OFDM mode.

Japan - 3101 and 3103 only

- Approved for operation in the 2.400-2.497 GHz band in DSSS and OFDM modes.
- Approved for operation in the 5.150-5.250 GHz band in OFDM mode.

Korea - 3101 and 3103 only

- Approved for operation in the 2.400-2.483 GHz band in DSSS and OFDM modes.
- Approved for operation in the 5.150-5.250 GHz, 5.250-5.350 GHz, and 5.725-5.825 GHz bands in OFDM mode.

New Zealand - 3101 and 3103 only

- Approved for operation in the 2.400-2.484 GHz band in DSSS and OFDM modes.
- Approved for operation in 5.150-5.250 GHz, 5.250-5.350 GHz, and 5.725-5.825 GHz bands in OFDM mode.

Australia - 3101 and 3103 only

- Approved for operation in the 2.400-2.484 GHz band in DSSS and OFDM modes.
- Approved for operation in 5.150-5.250 GHz, 5.250-5.350 GHz, and 5.725-5.850 GHz bands in OFDM mode.

Singapore - 3101 and 3103 only

- Approved for operation in the 2.400-2.484 GHz band in DSSS and OFDM modes.
- Approved for operation in 5.150-5.250 GHz, 5.250-5.350 GHz, and 5.725-5.850 GHz bands in OFDM mode.

China - 3101 and 3103 only

- Approved for operation in the 2.400-2.484 GHz band in DSSS and OFDM modes.
- Approved for operation in 5.725-5.850 GHz band in OFDM mode.

Hong Kong - 3101 and 3103 only

- Approved for operation in the 2.400-2.484 GHz band in DSSS and OFDM modes.
- Approved for operation in 5.150-5.250 GHz, 5.250-5.350 GHz, and 5.725-5.850 GHz bands in OFDM mode.

India - 3101 and 3103 only

- Approved for operation in the 2.400-2.484 GHz band in DSSS and OFDM modes.
- Approved for operation in 5.150-5.250 GHz, 5.250-5.350 GHz, and 5.725-5.850 GHz bands in OFDM mode.

UK - 3101 and 3103 only

- Approved for operation in the 2.400-2.4835 GHz band in DSSS and OFDM modes.
- Approved for operation in 5.150-5.250 GHz, 5.250-5.350, and 5.400-5.700 GHz bands in OFDM mode.

France - 3101 and 3103 only

- Approved for operation in the 2.400-2.4835 GHz band in DSSS and OFDM modes.
- Approved for operation in 5.150-5.250 GHz and 5.250-5.350 GHz bands in OFDM mode.

Germany - 3101 and 3103 only

- Approved for operation in the 2.400-2.4835 GHz band in DSSS and OFDM modes.
- Approved for operation in 5.150-5.250 GHz, 5.250-5.350, and 5.400-5.700 GHz bands in OFDM mode.

Appendix D—Regulatory Notices

USA

FCC Class B Notice

Model	FCC ID Number
3101	REP-3100-2
3103	REP-3100-2
3100/PS	REP-3100-2
3500-2401	REP-3500-1
3500-5001	REP-3500-3
3500-2403	REP-3500-2
3500-5003	REP-3500-4

These devices comply with Part 15 of the FCC Rules. Operation is subject to the following two conditions:

1. This device may not cause harmful interference.
2. This device must accept any interference received, including interference that may cause undesired operation.

FCC Part 15 Note

This equipment has been tested and found to comply with the limits for a Class B digital device, pursuant to Part 15 of the FCC Rules. These limits are designed to provide reasonable protection against harmful interference in a residential installation. This equipment generates, uses and can radiate radio frequency energy and, if not installed and used in accordance with

the instructions, may cause harmful interference to radio communications. However, there is no guarantee that interference will not occur in a particular installation. If this equipment does cause harmful interference to radio or television reception, which can be determined by turning the equipment off and on, the user is encouraged to try to correct the interference by one or more of the following measures:

- Reorient or relocate the receiving antenna.
- Increase the separation between the equipment and receiver.
- Connect the equipment into an outlet on a circuit different from that to which the receiver is connected.
- Consult the dealer or an experienced radio/television technician for help.

FCC Part 90 Note

This equipment has been tested pursuant to FCC Part 90, DSRC-C mask certification, and is approved for use in the US on Public Safety bands by licensed Public Safety agencies.

Modifications

Any modifications made to this device that are not approved by Firetide, Inc. may void the authority granted to the user by the FCC to operate this equipment.

FCC Radiation Exposure Statement

The antenna used for this transmitter must be installed to provide a separation distance of at least 35 cm from all persons and must not be co-located or operated in conjunction with any other antenna or transmitter. OEM Integrators, end-users and installers must be provided with antenna installation instructions and transmitter operating conditions for satisfying RF exposure compliance.

Canadian Compliance Statement

This Class B Digital apparatus meets all the requirements of the Canadian Interference-Causing Equipment Regulations. Cet appareil numérique de la classe B respecte les exigences du Règlement sur le matériel brouilleur du Canada. This device complies with Class B Limits of Industry Canada. Operation is subject to the following two conditions:

1. This device may not cause harmful interference, and
2. This device must accept any interference received, including interference that may cause undesired operation.

Firetide HotPort 3100 family wireless mesh nodes are certified to the requirements of RSS-210 for 2.4-GHz spread spectrum devices, and certified to the requirements of RSS-210 for 5-GHz spread spectrum devices. The use of this device in a system operating either partially or completely outdoors may require the user to obtain a license for the system according to the Canadian regulations. For further information, contact your local Industry Canada office.

Note that the 3500 Series is NOT approved for use in Canada.

European Community

Declaration of Conformity for 3100 series only, with regard to the R&TTE Directive 1999/5/EC

English: This equipment is in compliance with the essential requirements and other relevant provisions of Directive 1999/5/EC.

Deutsch: Dieses Gerät entspricht den grundlegenden Anforderungen und den weiteren entsprechenden Vorgaben der Richtlinie 1999/5/EU.

Dansk: Dette udstyr er i overensstemmelse med de væsentlige krav og andre relevante bestemmelser i Direktiv 1999/5/EF.

Español: Este equipo cumple con los requisitos esenciales así como con otras disposiciones de la Directiva 1999/5/EC.

Français: Cet appareil est conforme aux exigences essentielles et aux autres dispositions pertinentes de la Directive 1999/5/EC.

Italiano: Questo apparato è conforme ai requisiti essenziali ed agli altri principi sanciti dalla Direttiva 1999/5/EC.

Nederlands: Deze apparatuur voldoet aan de belangrijkste eisen en andere voorzieningen van richtlijn 1999/5/EC.

Norsk: Dette utstyret er i samsvar med de grunnleggende krav og andre relevante bestemmelser i EU-direktiv 1999/5/EC.

Português: Este equipamento satisfaz os requisitos essenciais e outras provisões da Directiva 1999/5/EC.

Svenska: Denna utrustning är i överensstämmelse med de väsentliga kraven och andra relevanta bestämmelser i Direktiv 1999/5/EC.

For 2.4 GHz radios, the following standards were applied:

- Radio: EN 300.328-1, EN 300.328-2
- EMC: EN 301.489-1, EN 301.489-17

The following CE mark is affixed to wireless devices with a 2.4 GHz radio:



Note: This equipment is intended to be used in all EU and EFTA countries. Outdoor use may be restricted to certain frequencies and/or may require a license for operation. For more details, contact Firetide.

Note: Combinations of power levels and antennas resulting in a radiated power level above 100 mW equivalent isotropic radiated power (EIRP) are considered as not compliant with the above mentioned directive and are not allowed for use within the European community and other countries that have adopted the European R&TTE directive 1999/5/EC or the CEPT recommendation Rec 70.03 or both.

For 54 Mbps, 5 GHz wireless devices, the following standards were applied:

- Radio: EN 301.893
- EMC: EN 301.489-1, EN 301.489-17

The following CE mark is affixed to the 54 Mbps, 5 GHz devices:



The 3100/PS and 3500 series are not approved for use in Europe.

Hotport 3100 Series & 3500 Series
Indoor Mesh Nodes

