



Electromagnetic Compatibility Criteria Test Report

for the

**Firetide
HotPort 3500-2403**

Verified under
the FCC Certification Rules
contained in
Title 47 of the CFR, Part 15.247, Subpart C
for Intentional Radiators

MET Report: EMCS18793B-FCC247

January 5, 2006

Prepared For:

**Firetide
16795 Lark Ave.
Los Gatos, CA 95032**

Prepared By:
MET Laboratories, Inc.
33439 Western Ave.
Union City, California 94587



Electromagnetic Compatibility Criteria Test Report

for the

**Firetide
HotPort 3500-2403**

Tested Under

the FCC Certification Rules
contained in
Title 47 of the CFR, Part 15.247, Subpart C
for Intentional Radiators

Shawn McMillen, Project Engineer
Electromagnetic Compatibility Lab

Cheryl Anicete
Documentation Department

Engineering Statement: The measurements shown in this report were made in accordance with the procedures indicated, and the emissions from this equipment were found to be within the limits applicable. I assume full responsibility for the accuracy and completeness of these measurements, and for the qualifications of all persons taking them. It is further stated that upon the basis of the measurements made, the equipment tested is capable of operation in accordance with the requirements of Part 15.407, of the FCC Rules under normal use and maintenance.

Tony Permsombut, Manager
Electromagnetic Compatibility Lab



Report Status Sheet

| Revision | Report Date | Reason for Revision |
|----------|-----------------|---------------------|
| Ø | January 5, 2006 | Initial Issue. |



Table of Contents

| | | |
|-------------|---|-----------|
| I. | Executive Summary | 1 |
| | A. Purpose of Test | 2 |
| | B. Executive Summary | 2 |
| II. | Equipment Configuration | 3 |
| | A. Overview | 4 |
| | B. References | 5 |
| | C. Test Site | 5 |
| | D. Description of Test Sample | 5 |
| | E. Equipment Configuration | 8 |
| | F. Support Equipment | 8 |
| | G. Ports and Cabling Information | 9 |
| | H. Mode of Operation | 9 |
| | I. Method of Monitoring EUT Operation | 9 |
| | J. Modifications | 9 |
| | a) Modifications to EUT | 9 |
| | b) Modifications to Test Standard | 9 |
| | K. Disposition of EUT | 9 |
| III. | Electromagnetic Compatibility Criteria for Intentional Radiators | 10 |
| | § 15.203 Antenna Requirement | 11 |
| | § 15.207(a) Conducted Emissions Limits | 12 |
| | § 15.207(a) Radiated Emissions Limits | 16 |
| | § 15.247(a) 6 dB and 99% Bandwidth | 19 |
| | § 15.247(b) Peak Power Output and RF Exposure | 20 |
| | § 15.247(c) Spurious Emissions Requirements – Radiated and RF Conducted | 24 |
| | § 15.247(d) Peak Power Spectral Density | 32 |
| IV. | Test Equipment | 33 |
| V. | Certification & User’s Manual Information | 35 |
| | A. Certification Information | 36 |
| | B. Label and User’s Manual Information | 40 |
| VI. | Exhibits | 42 |



List of Tables

| | |
|--|----|
| Table 1. Executive Summary of EMC Part 15.247 Compliance Testing | 2 |
| Table 2. Frequency Allocation for 802.11/b/g | 5 |
| Table 3. Equipment Configuration | 8 |
| Table 4. Support Equipment..... | 8 |
| Table 5. Ports and Cabling Information | 9 |
| Table 6. Conducted Limits for Intentional Radiators from FCC Part 15 § 15.207(a) | 12 |
| Table 7. Conducted Emissions - Voltage, AC Power, Phase Line (120 VAC, 60 Hz)..... | 13 |
| Table 8. Conducted Emissions - Voltage, AC Power, Neutral Line (120 VAC, 60 Hz)..... | 13 |
| Table 9. Radiated Emissions Limits Calculated from FCC Part 15, § 15.209 (a) | 16 |
| Table 10. Output Power Requirements from §15.247 | 20 |
| Table 11. Restricted Bands of Operation..... | 24 |

List of Figures

| | |
|---|---|
| Figure 1. Block Diagram of Test Configuration (Radiated Emissions)..... | 6 |
| Figure 2. Block Diagram of Test Configuration (Conducted Measurement) | 7 |

List of Photographs

| | |
|---|----|
| Photograph 1. Conducted Emissions Test Setup | 15 |
| Photograph 2. Radiated Emission Test Setup..... | 18 |
| Photograph 3. Test Equipment and setup for various Radiated Measurements..... | 31 |



List of Terms and Abbreviations

| | |
|--------------|---|
| AC | Alternating Current |
| ACF | Antenna Correction Factor |
| Cal | Calibration |
| <i>d</i> | Measurement Distance |
| dB | Decibels |
| dB μ A | Decibels above one microamp |
| dB μ V | Decibels above one microvolt |
| dB μ A/m | Decibels above one microamp per meter |
| dB μ V/m | Decibels above one microvolt per meter |
| DC | Direct Current μ |
| E | Electric Field |
| DSL | Digital Subscriber Line |
| ESD | Electrostatic Discharge |
| EUT | Equipment Under Test |
| <i>f</i> | Frequency |
| FCC | Federal Communications Commission |
| GR-1089-CORE | (GR) General Requirement(s) imposed by the NEBS standard, (CORE) Central Office Recovery Express (AT&T), (1089) specifies various parts of the General Requirements under Bellcore Technical Standard, Requirements for Electromagnetic Compatibility and Electrical Safety - Generic Criteria for Network Telecommunications Equipment |
| GRP | Ground Reference Plane |
| H | Magnetic Field |
| HCP | Horizontal Coupling Plane |
| Hz | Hertz |
| IEC | International Electrotechnical Commission |
| kHz | kilohertz |
| kPa | kilopascal |
| kV | kilovolt |
| LISN | Line Impedance Stabilization Network |
| MHz | Megahertz |
| μ H | microhenry |
| μ | microfarad |
| μ s | microseconds |
| NEBS | Network Equipment-Building System |
| PRF | Pulse Repetition Frequency |
| RF | Radio Frequency |
| RMS | Root-Mean-Square |
| TWT | Traveling Wave Tube |
| V/m | Volts per meter |
| VCP | Vertical Coupling Plane |



I. Executive Summary



A. Purpose of Test

An EMC evaluation was performed to determine compliance of the Firetide, HotPort 3500-2403, with the requirements of Part 15, §15.247. All references are to the most current version of Title 47 of the Code of Federal Regulations in effect. In accordance with §2.1033, the following data is presented in support of the Certification of the HotPort 3500-2403. Firetide should retain a copy of this document which should be kept on file for at least two years after the manufacturing of the HotPort 3500-2403, has been **permanently** discontinued

B. Executive Summary

The following tests were conducted on a sample of the equipment for the purpose of demonstrating compliance with Part 15, §15.247, in accordance with Firetide, purchase order number PO-1362. All tests were conducted using measurement procedure ANSI C63.4-2003.

| Reference | Description | Results |
|---|-------------------------------------|--------------------------------------|
| Title 47 of the CFR, Part 15, Subpart C, §15.207 | AC Power Line Conducted Emissions | Compliant |
| Title 47 of the CFR, Part 15, Subpart C, §15.203/15.247(b)(c) | Antenna Requirement | Compliant |
| Title 47 of the CFR, Part 15, Subpart C, §15.205(d) | Band Edge Emissions | Compliant |
| Title 47 of the CFR, Part 15, Subpart C, §15.247(a)(2) | 6dB Occupied Bandwidth | Compliant, refer to FCC ID: SWX-SR2. |
| Title 47 of the CFR, Part 15, Subpart C, §15.247(b)(3) | Maximum Peak Conducted Output Power | Compliant |
| Title 47 of the CFR, Part 15, Subpart C, §15.247(d) | Spurious Radiated Emissions | Compliant |
| Title 47 of the CFR, Part 15, Subpart C, §15.247(e) | Peak Power Spectral Density | Compliant, refer to FCC ID: SWX-SR2. |

Table 1 Executive Summary of EMC Part 15.247 Compliance Testing



II. Equipment Configuration



A. Overview

MET Laboratories, Inc. was contracted by Firetide to perform testing on the HotPort 3500-2403, under Firetide’s purchase order number PO-1362.

This document describes the test setups, test methods, required test equipment, and the test limit criteria used to perform compliance testing of the Firetide, HotPort 3500-2403.

The results obtained relate only to the item(s) tested.

| | | |
|---------------------------------------|---|--|
| Model(s) Tested: | HotPort 3500-2403 | |
| Model(s) Covered: | HotPort 3500-2403 | |
| EUT Specifications: | Primary Power: 120V 60Hz | |
| | FCC ID: REP-3500-2 | |
| | Type of Modulations: | Direct Sequence Spread Spectrum (DSSS) and Orthogonal Frequency Division Multiplexing (OFDM) |
| | Emission Designators: | 802.11/b - 12M1D7D |
| | | 802.11/g - 16M2D7D |
| | Equipment Code: | DTS |
| | Peak RF Output Power: | 802.11/b – 25.4dBm |
| | | 802.11/g – 25.1dBm |
| EUT TX Frequency Ranges: | 802.11/b/g - 2400 – 2483.5MHz | |
| Analysis: | The results obtained relate only to the item(s) tested. | |
| Environmental Test Conditions: | Temperature (15-35° C): 21° C | |
| | Relative Humidity (30-60%): 47% | |
| | Barometric Pressure (860-1060 mbar): 1009 mbar | |
| Evaluated by: | Shawn McMillen | |
| Date(s): | January 5, 2006 | |



| Channel Number | Frequency (MHz) |
|----------------|-----------------|
| 1 | 2412 |
| 2 | 2417 |
| 3 | 2422 |
| 4 | 2427 |
| 5 | 2432 |
| 6 | 2437 |
| 7 | 2442 |
| 8 | 2447 |
| 9 | 2452 |
| 10 | 2457 |
| 11 | 2462 |

Table 2. Frequency Allocation for 802.11/b/g

B. References

| | |
|-----------------------------------|---|
| CFR 47, Part 15, Subpart C | Federal Communication Commission, Code of Federal Regulations, Title 47, Part 15: General Rules and Regulations, Allocation, Assignment, and Use of Radio Frequencies |
| CFR 47, Part 15, Subpart B | Electromagnetic Compatibility: Criteria for Radio Frequency Devices |
| ANSI C63.4:2003 | Methods and Measurements of Radio-Noise Emissions from Low-Voltage Electrical And Electronic Equipment in the Range of 9 kHz to 40 GHz |
| ANSI/NCSL Z540-1-1994 | Calibration Laboratories and Measuring and Test Equipment - General Requirements |
| ANSI/ISO/IEC 17025:2000 | General Requirements for the Competence of Testing and Calibration Laboratories |

C. Test Site

All testing was performed at MET Laboratories, Inc., 4855 Patrick Henry Drive, Building 6, Santa Clara, California 95054. All equipment used in making physical determinations is accurate and bears recent traceability to the National Institute of Standards and Technology.

Radiated Emissions measurements were performed in a 10 meter semi-anechoic chamber (equivalent to an Open Area Test Site). In accordance with §2.948(a)(3), a complete site description is contained at MET Laboratories. In accordance with §2.948(d), MET Laboratories has been accredited by the National Voluntary Laboratory Accreditation Program (Lab Code: 100273-0).

D. Description of Test Sample

The Firetide, HotPort 3500-2401, is equipped with a Ubiquiti 802.11 b/g card.

Radiated Emission

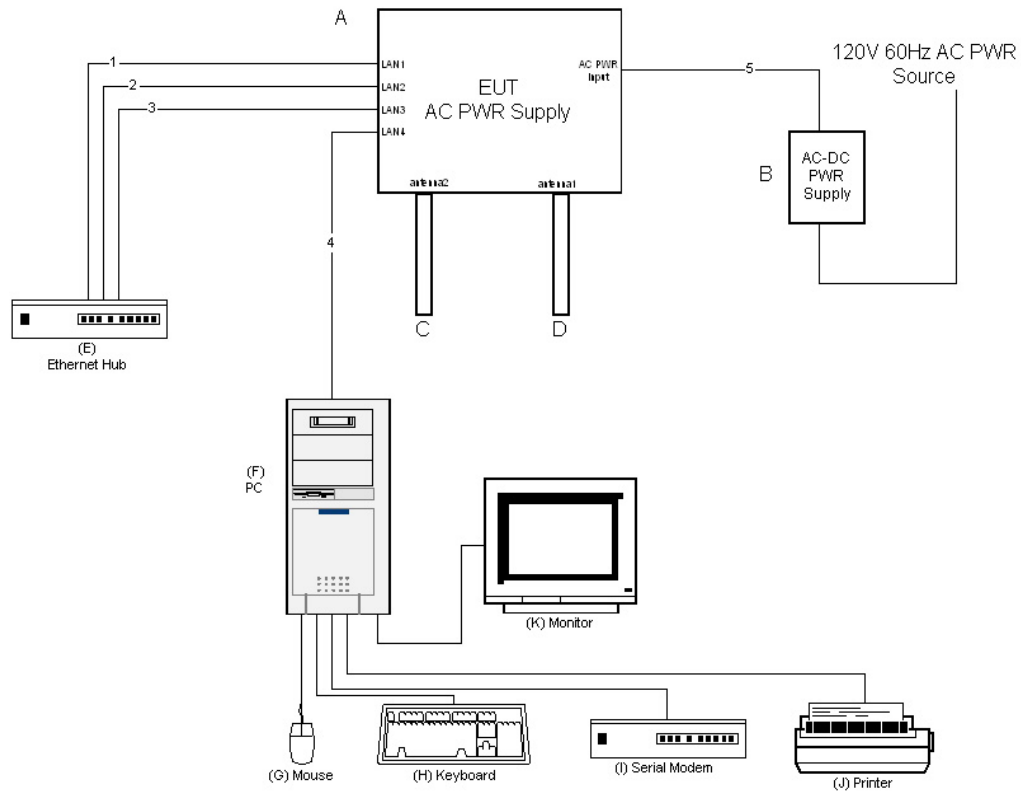

Figure 1. Block Diagram of Test Configuration (Radiated Emissions)

Conducted Measurement

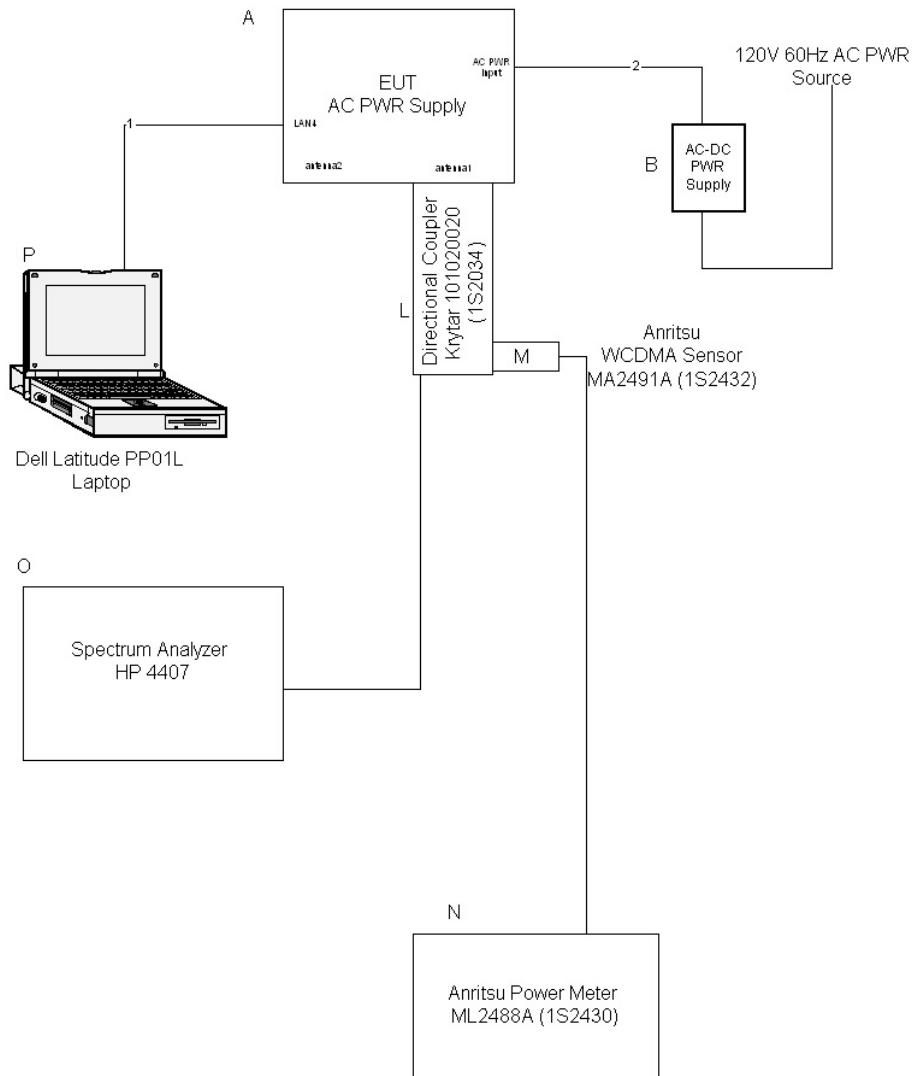

Figure 2. Block Diagram of Test Configuration (Conducted Measurement)



E. Equipment Configuration

The EUT was set up as outlined in Figure 1 and Figure 2, Block Diagram of Test Setup. All cards, racks, etc., incorporated as part of the EUT is included in the following list.

| Ref. ID | Name / Description | Model Number | Part Number | Serial Number | Rev. # |
|---------|------------------------------|-------------------|-------------|---------------|--------|
| A | Wireless Hub | HotPort 3500-2403 | N/A | N/A | N/A |
| B | AC-DC Adaptor (Hon-Kwang) | HK-A512-A05 | N/A | K0000000679 | N/A |
| C | 2.4GHz Antenna | N/A | N/A | N/A | N/A |
| D | 2.4GHz Antenna | N/A | N/A | N/A | N/A |

Table 3. Equipment Configuration

F. Support Equipment

Firetide supplied support equipment necessary for the operation and testing of the HotPort 3500-2403. All support equipment supplied is listed in the following Support Equipment List.

| Ref. ID | Name / Description | Manufacturer | Model Number | *Customer Supplied Calibration Data |
|---------|---------------------|--------------|-----------------|-------------------------------------|
| E | Ethernet Hub | Net Gear | DS104 | N/A |
| F | PC | Dell | Dimension M233A | N/A |
| G | Mouse | Logitech | Mouse Man | N/A |
| H | Keyboard | Compaq | N/A | N/A |
| I | Serial Modem | Webramp | Webramp 200 | N/A |
| J | Printer | Canon | BJC-200 | N/A |
| K | Monitor | Toshiba | TekBright | N/A |
| L | Directional Coupler | Krytar | 101020020 | N/A |
| M | WCDMA Sensor | Anritsu | MA2491 | N/A |
| N | Power Meter | Anritsu | ML2488A | N/A |
| O | Spectrum Analyzer | Agilent | E4407A | N/A |
| P | Laptop | Dell | Latitude PP01L | N/A |

Table 4. Support Equipment

* The 'Customer Supplied Calibration Data' column will be marked as either not applicable, not available, or will contain the calibration date supplied by the customer.

** The AC/DC Adapter was use to power the EUT for testing purpose only, will not be sold with radio.



G. Ports and Cabling Information

| Ref. ID | Port name on EUT | Cable Description or reason for no cable | Qty. | Length (m) | Shielded (Yes/No) | Termination Box ID & Port ID |
|------------------------------|-------------------|--|------|------------|-------------------|------------------------------|
| Conducted Measurement | | | | | | |
| 1 | A, LAN Port 4 | RJ45 | 1 | 15 | No | P |
| 2 | A, PWR Input | DC PWR Cord | 1 | 1.5 | No | B |
| N/A | A, Antenna Port 1 | N/A (directly connect) | N/A | N/A | N/A | L |
| N/A | A, Antenna Port 2 | N/A | N/A | N/A | N/A | Unterminated |
| Radiated Emission | | | | | | |
| 1 | A, LAN Port 1 | RJ45 | 1 | 15 | Yes | E, port 1 |
| 2 | A, LAN Port 2 | RJ45 | 1 | 15 | Yes | E, port 2 |
| 3 | A, LAN Port 3 | RJ45 | 1 | 15 | Yes | E, port 3 |
| 4 | A, LAN Port 4 | RJ45 | 1 | 15 | Yes | F |
| 5 | A, PWR Input | DC PWR Cord | 1 | 1.5 | No | B |
| N/A | A, Antenna Port 1 | N/A (directly connect) | N/A | N/A | N/A | C |
| N/A | A, Antenna Port 2 | N/A (directly connect) | N/A | N/A | N/A | D |

Table 5. Ports and Cabling Information

H. Mode of Operation

The EUT was operated in the following manner:
Telnet was use to access the radio in order to change the channel frequency, bit rate and to turn on/off the transmitter. The power output was set to a fixed value which could not vary the output power.

I. Method of Monitoring EUT Operation

Performance of the EUT was monitored in the following manner:
A Spectrum Analyzer and a Power Meter was use to monitor the EUT’s transmitter channel and power output.

J. Modifications

a) Modifications to EUT

No modifications were made to the EUT.

b) Modifications to Test Standard

No modifications were made to the test standard.

K. Disposition of EUT

The test sample including all support equipment submitted to the Electro-Magnetic Compatibility Lab for testing was returned to Firetide upon completion of testing.



III. Electromagnetic Compatibility Criteria for Intentional Radiators



Electromagnetic Compatibility Criteria for Intentional Radiators

§ 15.203 Antenna Requirement

Test Requirement: § 15.203: An intentional radiator shall be designed to ensure that no antenna other than that furnished by the responsible party shall be used with the device. The use of a permanently attached antenna or of an antenna that uses a unique coupling to the intentional radiator shall be considered sufficient to comply with the provisions of this section. The manufacturer may design the unit so that a broken antenna can be replaced by the user, but the use of a standard antenna jack or electrical connector is prohibited.

The structure and application of the EUT were analyzed to determine compliance with Section 15.203 of the Rules. Section 15.203 states that the subject device must meet at least one of the following criteria:

- a.) Antenna must be permanently attached to the unit.
- b.) Antenna must use a unique type of connector to attach to the EUT.
- c.) Unit must be professionally installed. Installer shall be responsible for verifying that the correct antenna is employed with the unit.

Results: The EUT as tested meets the criteria of this rule by virtue of having professionally installed. The EUT is therefore compliant with §15.203.

| Antenna | |
|------------------|------------------------|
| Model No. / Gain | C812-5100010 / 5.0 dBi |
| Vendor | Firetide |

Test Engineer(s): Shawn McMillen

Test Date(s): December 5, 2005



Electromagnetic Compatibility Criteria for Intentional Radiators

§ 15.207 Conducted Emissions Limits

Test Requirement(s): § 15.207 (a): For an intentional radiator that is designed to be connected to the public utility (AC) power line, the radio frequency voltage that is conducted back onto the AC power line on any frequency or frequencies, within the band 150 kHz to 30MHz, shall not exceed the limits in the following table, as measured using a 50 μ H/50 Ω line impedance stabilization network (LISN). Compliance with the provisions of this paragraph shall be based on the measurement of the radio frequency voltage between each power line and ground at the power terminal. The lower limit applies at the boundary between the frequency ranges.

| Frequency range (MHz) | § 15.207(a), Conducted Limit (dB μ V) | |
|-----------------------|---|---------|
| | Quasi-Peak | Average |
| * 0.15- 0.45 | 66 - 56 | 56 - 46 |
| 0.45 - 0.5 | 56 | 46 |
| 0.5 - 30 | 60 | 50 |

Table 6. Conducted Limits for Intentional Radiators from FCC Part 15 § 15.207(a)

Test Procedure: The EUT was placed on a 0.8 m-high wooden table inside a semi-anechoic chamber. The EUT was situated such that the back of the EUT was 0.4 m from one wall of the vertical ground plane, and the remaining sides of the EUT were no closer than 0.8 m from any other conductive surface. The EUT was powered from a 50 Ω /50 μ H Line Impedance Stabilization Network (LISN). The EMC receiver scanned the frequency range from 150 kHz to 30 MHz. Conducted Emissions measurements were made in accordance with ANSI C63.4-1992 "Methods and Measurements of Radio-Noise Emissions from Low-Voltage Electrical and Electronic Equipment in the Range of 9kHz to 40 GHz". The measurements were performed over the frequency range of 0.15 MHz to 30 MHz using a 50 Ω /50 μ H LISN as the input transducer to an EMC/field intensity meter. The tests were conducted in a RF-shielded enclosure.

Test Results: The EUT was found compliant with the Conducted Emission limits of §15.207(a) for Intentional Radiators. See following pages for detailed test results

Test Engineer(s): Shawn McMillen

Test Date(s): December 10, 2005



Electromagnetic Compatibility Criteria for Intentional Radiators

§ 15.207 Conducted Emissions Limits

| FREQ. (MHz) | Corrected Amplitude (dBuV) QP | Limit (dBuV) QP | Pass/Fail QP | Margin (dB) QP | Corrected Amplitude (dBuV) AVG | Limit (dBuV) AVG | Pass/Fail AVG | Margin (dB) AVG |
|-------------|-------------------------------|-----------------|--------------|----------------|--------------------------------|------------------|---------------|-----------------|
| 0.2438 | 43.1 | 61.97 | PASS | -18.87 | 38.28 | 51.97 | PASS | -13.69 |
| 0.4885 | 40.78 | 56.19 | PASS | -15.41 | 36.25 | 46.19 | PASS | -9.94 |
| 1.5593 | 41.8 | 56 | PASS | -14.2 | 28.58 | 46 | PASS | -17.42 |
| 2.0623 | 42.09 | 56 | PASS | -13.91 | 23.12 | 46 | PASS | -22.88 |
| 6.935 | 44.41 | 60 | PASS | -15.59 | 28.57 | 50 | PASS | -21.43 |

Table 7. Conducted Emissions - Voltage, AC Power, Phase Line (120 VAC, 60 Hz)

| FREQ. (MHz) | Corrected Amplitude (dBuV) QP | Limit (dBuV) QP | Pass/Fail QP | Margin (dB) QP | Corrected Amplitude (dBuV) AVG | Limit (dBuV) AVG | Pass/Fail AVG | Margin (dB) AVG |
|-------------|-------------------------------|-----------------|--------------|----------------|--------------------------------|------------------|---------------|-----------------|
| 0.2478 | 42.76 | 61.83 | PASS | -19.07 | 32.42 | 51.83 | PASS | -19.41 |
| 0.487 | 44.45 | 56.22 | PASS | -11.77 | 37.5 | 46.22 | PASS | -8.72 |
| 1.5593 | 41.39 | 56 | PASS | -14.61 | 24.43 | 46 | PASS | -21.57 |
| 2.0623 | 42.84 | 56 | PASS | -13.16 | 24.11 | 46 | PASS | -21.89 |
| 6.93 | 44.23 | 60 | PASS | -15.77 | 28.52 | 50 | PASS | -21.48 |

Table 8. Conducted Emissions - Voltage, AC Power, Neutral Line (120 VAC, 60 Hz)



Electromagnetic Compatibility Criteria for Intentional Radiators

§ 15.207 Conducted Emissions Limits

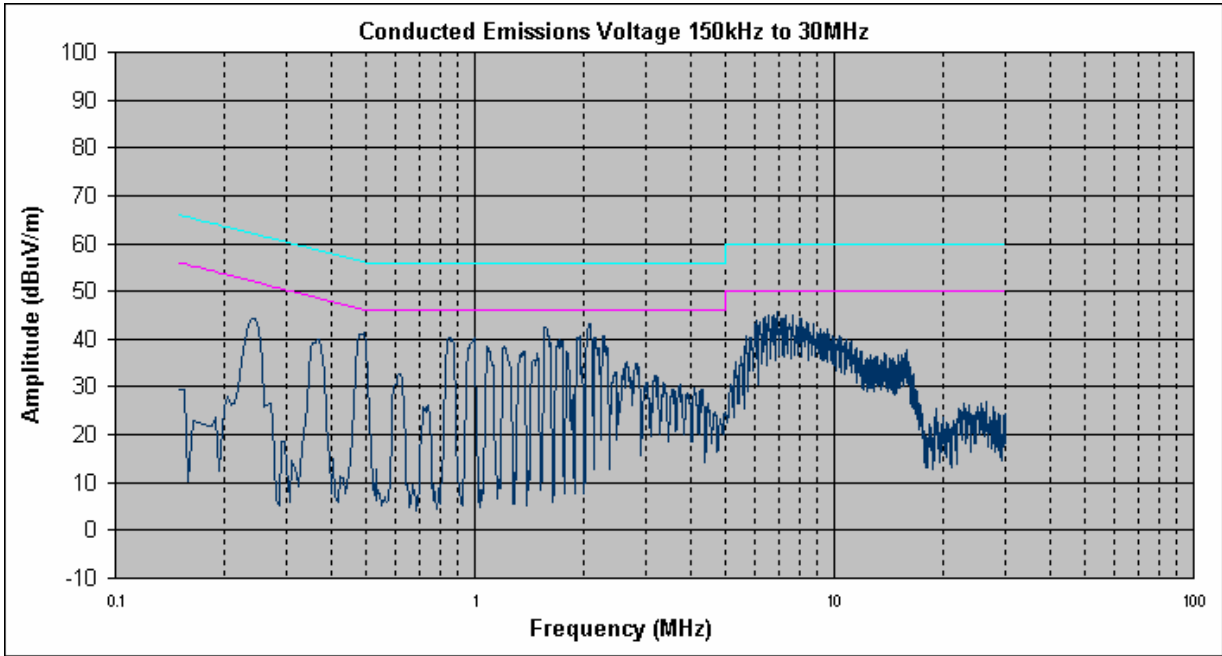

Conducted Emission, Phase Line Plots

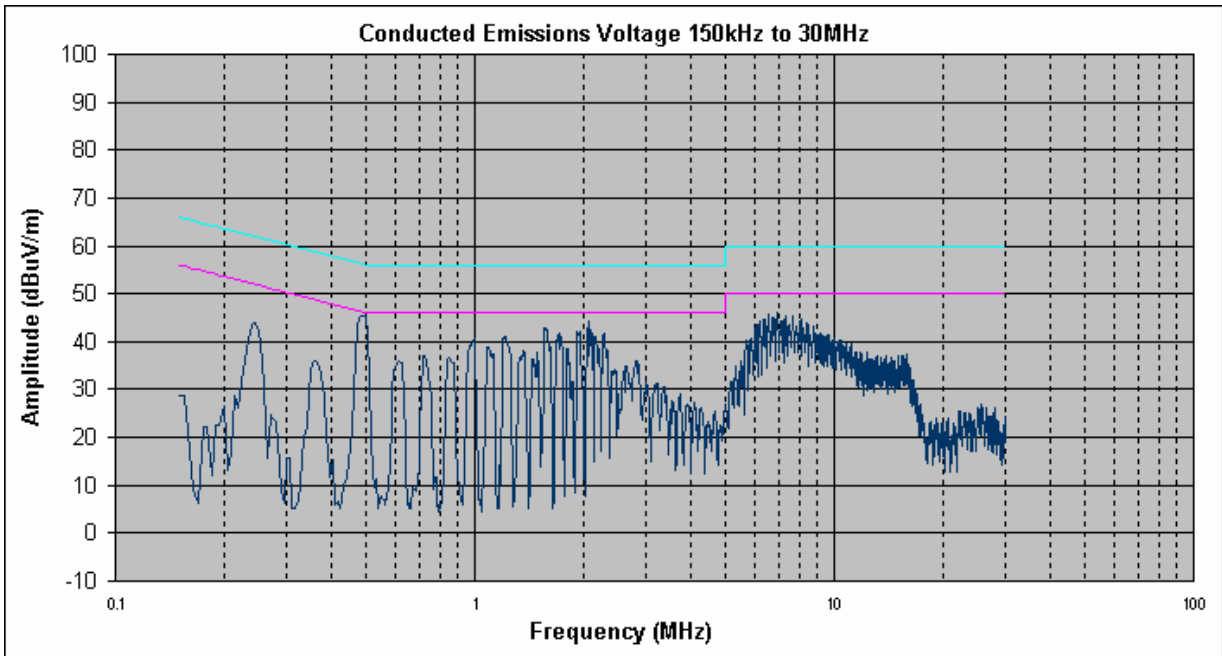

Conducted Emission, Neutral Plots



Conducted Emission Limits Test Setup



Photograph 1. Conducted Emissions Test Setup



Electromagnetic Compatibility Criteria for Intentional Radiators

§ 15.209 Radiated Emissions Limits

Test Requirement(s): § 15.209 (a): Except as provided elsewhere in this subpart, the emissions from an intentional radiator shall not exceed the field strength levels specified in Table 9.

| Frequency (MHz) | § 15.209(a), Radiated Emission Limits (dBµV) @ 3m |
|-----------------|---|
| 30 - 88 | 40.00 |
| 88 - 216 | 43.50 |
| 216 - 960 | 46.00 |
| Above 960 | 54.00 |

Table 9. Radiated Emissions Limits Calculated from FCC Part 15, § 15.209 (a)

Test Procedure: The transmitter was set to the mid channel at the highest output power and placed on a 0.8 m high wooden table inside in a semi-anechoic chamber. Measurements were performed with the EUT rotated 360 degrees and varying the adjustable antenna mast with 1 m to 4 m height to determine worst case orientation for maximum emissions. Measurement were repeated the measurement at the low and highest channels.

For frequencies from 30 MHz to 1 GHz, measurements were made using a quasi-peak detector with a 120 kHz bandwidth.

For intentional radiators with a digital device portion which operates below 10 GHz, the spectrum was investigated as per §15.33(a)(1) and §15.33(a)(4); i.e., the lowest RF signal generated or used in the device up to the 10th harmonic of the highest fundamental frequency or to 40 GHz, whichever is lower.

In accordance with §15.35(b) the limit on the radio frequency emissions as measured using instrumentation with a peak detector function shall be 20 dB above the maximum permitted average limit for the frequency being investigated unless a different peak emission limit is otherwise specified in the rules.

EUT Field Strength Final Amplitude = Raw Amplitude – Preamp gain + Antenna Factor + Cable Loss – Distance Correction Factor (1 meter)

Test Results: The EUT was found compliant with the Radiated Emission limits of §15.209(a) for Intentional Radiators. See following pages for detailed test results.

Test Engineer(s): Shawn McMillen

Test Date(s): December 9, 2005



Electromagnetic Compatibility Criteria for Intentional Radiators

§ 15.209 Radiated Emissions Limits

802.11a Radiated Emissions from 30 MHz – 1 GHz

Quasi-Peak Results

| Frequency (MHz) | Antenna Polarity (H/V) | EUT Azimuth (Degrees) | Antenna Height (m) | Uncorrected Amplitude (dBuV) | Antenna Correction Factor (dB/m) (+) | Pre Amp Gain (dB) (-) | Cable Loss (dB) (+) | Corrected Amplitude (dBuV/m) | Limit (dBuV/m) | Margin (dB) |
|-----------------|------------------------|-----------------------|--------------------|------------------------------|--------------------------------------|-----------------------|---------------------|------------------------------|----------------|--------------|
| 114.56 | V | 269 | 1 | 16.35 | 12.88 | 0.00 | 1.89 | 31.11 | 43.50 | -12.39 |
| 288.12 | V | 222 | 1 | 10.31 | 13.29 | 0.00 | 2.85 | 26.45 | 46.00 | -19.55 |
| *531.76 | V | 300 | 1 | 21.13 | 18.49 | 0.00 | 4.21 | 43.83 | 46.00 | -2.18 |
| 598.28 | V | 240 | 1 | 15.72 | 19.50 | 0.00 | 4.58 | 39.80 | 46.00 | -6.20 |
| 666.68 | V | 175 | 1 | 15.92 | 19.84 | 0.00 | 4.86 | 40.62 | 46.00 | -5.38 |
| 800 | V | 182 | 1.26 | 8.38 | 20.54 | 0.00 | 5.45 | 34.37 | 46.00 | -11.64 |

Note: When transmit mode or receive mode were activated, there are no differences to emissions. For above 1 GHz measurement up to 5th harmonic of the highest operating frequency, emissions are noise floor during receive mode.

* - At this frequency, the measured electric-field strength exhibits a margin of compliance that is less than 3 dB below the specification limit. We recommend that every emission measured, have at least a 3 dB margin to allow for deviations in the emission characteristics that may occur during the production process.

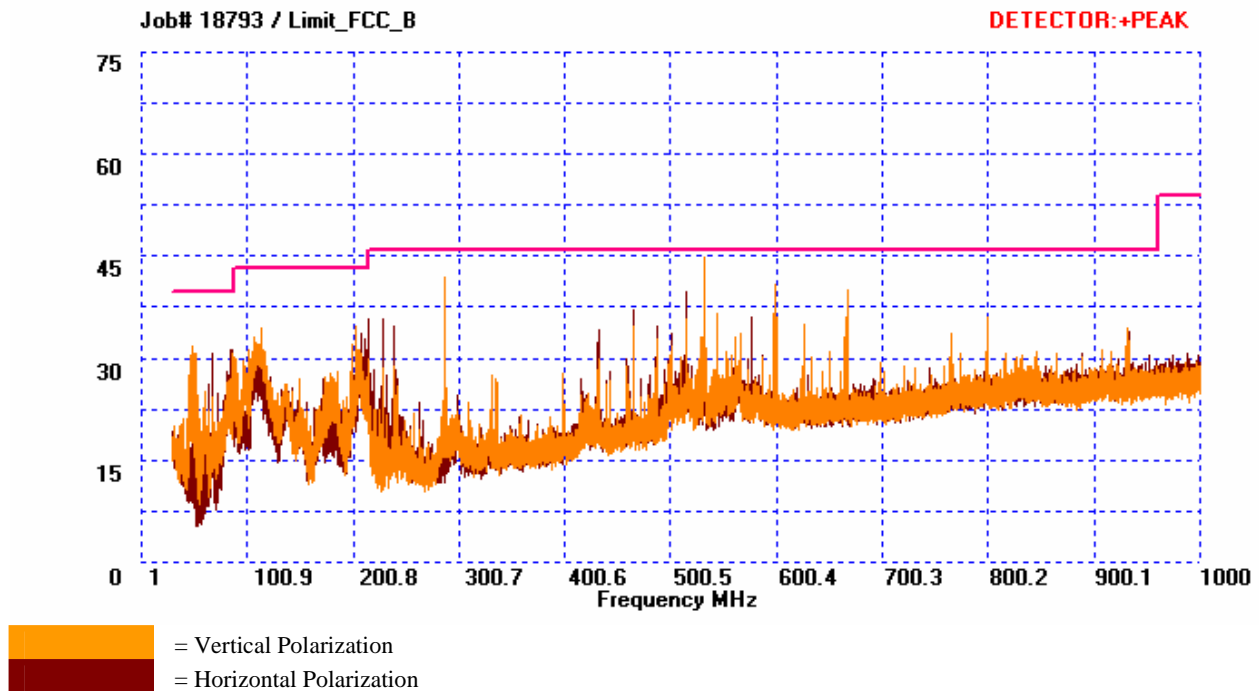

Electromagnetic Compatibility Criteria for Intentional Radiators

§ 15.209 Radiated Emissions Limits

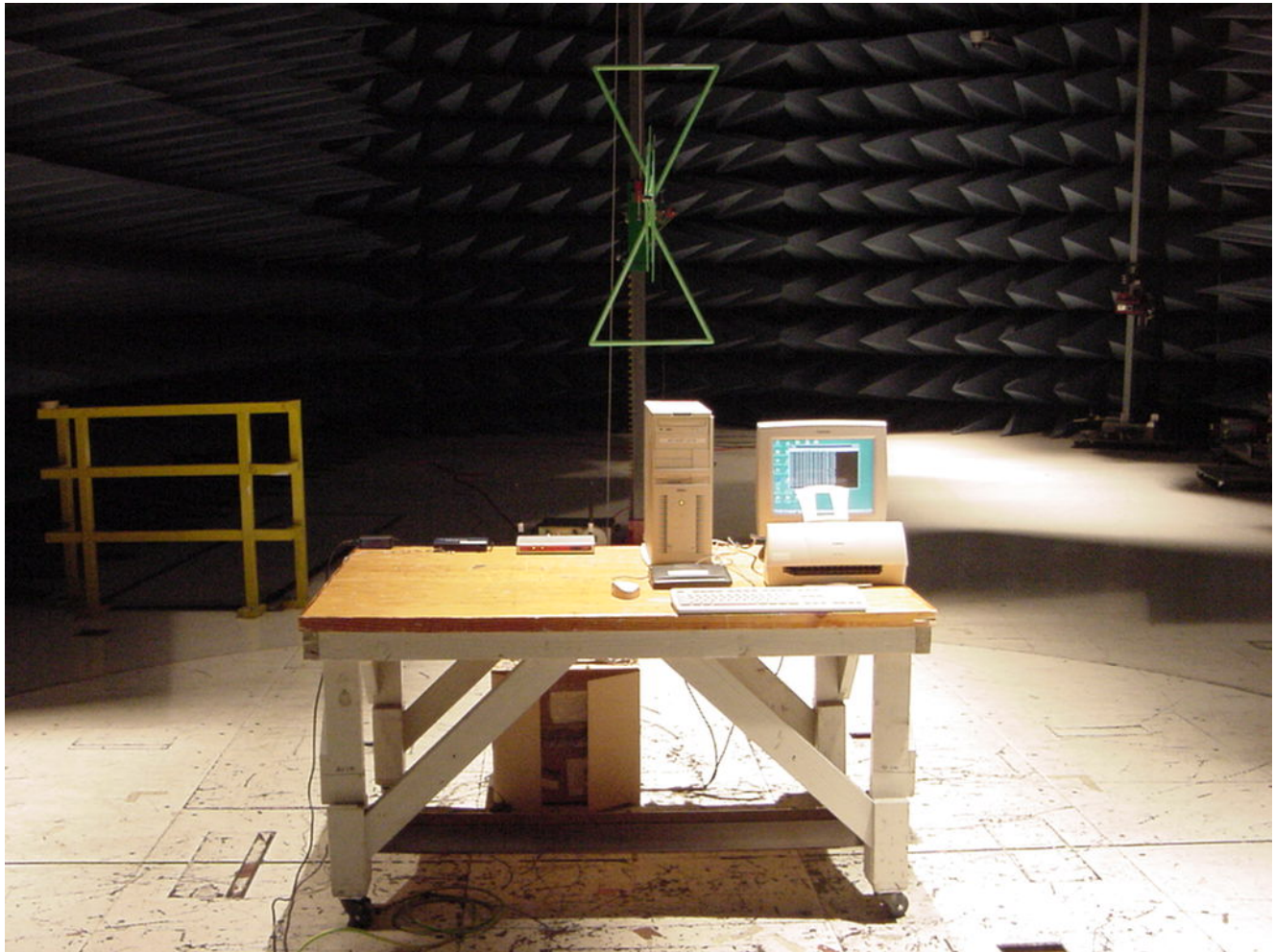

Photograph 2. Radiated Emission Test Setup



Electromagnetic Compatibility Criteria for Intentional Radiators

§ 15.247(a) 6 dB and 99% Bandwidth

- Test Requirements:** § 15.247(a): Operation under the provisions of this section is limited to frequency hopping and digitally modulated intentional radiators that comply with the following provisions:
For systems using digital modulation techniques, the EUT may operate in the 902-928 MHz, 2400-2483.5 MHz and 5725-5850 MHz bands. The minimum 6dB bandwidth shall be at least 500 kHz.
- Test Procedure:** The transmitter was set to the mid channel at the highest output power and connected to the spectrum analyzer through an attenuator. The bandwidth of the fundamental frequency was measured with the spectrum analyzer using a RBW approximately equal to 1% of the total emission bandwidth, VBW > RBW. The 6 dB Bandwidth was measured and recorded. The measurements were repeated at the low and high channels.
- Test Results** Equipment complies with § 15.247 (a). The 6 dB and 99% Bandwidth was determined from the plots on the following pages.
- Note:** Refer to modularly approved FCC ID: SWX-SR2 for measurement of occupied bandwidth.



Electromagnetic Compatibility Criteria for Intentional Radiators

§ 15.247(b) Peak Power Output and RF Exposure

Test Requirements: §15.247(b): The maximum peak output power of the intentional radiator shall not exceed the following:

| Digital Transmission Systems (MHz) | Output Limit (Watts) |
|------------------------------------|----------------------|
| 902-928 | 1.000 |
| 2400-2483.5 | 1.000 |
| 5725- 5850 | 1.000 |

Table 10. Output Power Requirements from §15.247

§15.247(c): if transmitting antennas of directional gain greater than 6 dBi are used the peak output power from the intentional radiator shall be reduced below the stated values in the Table 10, as appropriate, by the amount in dB that the directional gain of the antenna exceeds 6 dBi.

Systems operating in the 2400 – 2483.5 MHz band may employ transmitting antennas with directional gain greater than 6 dBi provided the maximum peak output power of the intentional radiator is reduced by 1 dB for every 3 dB that the directional gain of the antenna exceeds 6 dBi.

Systems operating in the 5725 – 5850 MHz band that are used exclusively for fixed, point-to-point operations may employ transmitting antennas with directional gain greater than 6 dBi without any corresponding reduction in transmitter peak output power.

Fixed, point-to-point operation excludes the use of point-to-multipoint systems, omnidirectional applications, and multiple co-located intentional radiators transmitting the same information. The operator of the spread spectrum intentional radiator or, if the equipment is professionally installed, the installer is responsible for ensuring that the system is used exclusively for fixed, point-to-point operations. The instruction manual furnished with the intentional radiator shall contain language in the installation instructions informing the operator and the installer of this responsibility.



Electromagnetic Compatibility Criteria for Intentional Radiators

§ 15.247(b) Peak Power Output and RF Exposure

Test Procedure: The transmitter was connected to a calibrated Peak Power Meter. The EUT was measured at the low, mid and high channels of each band at a data rate which gave the maximum power level.

Test Results: Equipment complies with the Peak Power Output limits of § 15.247(b).

| 802.11/b Mode | | | |
|-----------------|------------------|-------------------------------------|----------------------------------|
| Frequency (MHz) | Data Rate (MB/s) | Measured Average Output Power (dBm) | Measured Peak Output Power (dBm) |
| 2412 | 1 | 21.8 | 24.5 |
| | 2 | 22.4 | 25.4 |
| | 5.5 | 22.4 | 25.4 |
| | 11 | 22.4 | 25.4 |
| 2437 | 1 | 21.9 | 24.8 |
| | 2 | 21.9 | 24.8 |
| | 5.5 | 21.8 | 24.8 |
| | 11 | 21.9 | 24.8 |
| 2462 | 1 | 21.1 | 23.5 |
| | 2 | 21.1 | 23.5 |
| | 5.5 | 21.1 | 23.5 |
| | 11 | 21.1 | 23.5 |



| 802.11/g Mode | | | |
|-----------------|------------------|-------------------------------------|----------------------------------|
| Frequency (MHz) | Data Rate (MB/s) | Measured Average Output Power (dBm) | Measured Peak Output Power (dBm) |
| 2412 | 6 | 15.4 | 24.9 |
| | 9 | 15.5 | 25.0 |
| | 12 | 15.5 | 25.0 |
| | 18 | 15.5 | 25.0 |
| | 24 | 15.5 | 25.0 |
| | 36 | 15.5 | 25.0 |
| | 48 | 15.5 | 25.0 |
| | 54 | 15.5 | 25.0 |
| | 2437 | 6 | 14.8 |
| 9 | | 14.8 | 24.5 |
| 12 | | 14.7 | 24.5 |
| 18 | | 14.7 | 24.5 |
| 24 | | 14.7 | 24.5 |
| 36 | | 14.7 | 24.5 |
| 48 | | 14.7 | 24.5 |
| 54 | | 14.7 | 24.5 |
| 2462 | 6 | 15.4 | 25.0 |
| | 9 | 15.4 | 25.0 |
| | 12 | 15.4 | 25.1 |
| | 18 | 15.4 | 25.1 |
| | 24 | 15.4 | 25.1 |
| | 36 | 15.4 | 25.1 |
| | 48 | 15.4 | 25.1 |
| | 54 | 15.4 | 25.1 |

Test Engineer(s): Shawn McMillen

Test Date(s): December 5, 2005

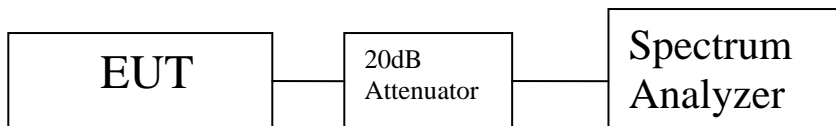

Block Diagram 1. Peak Power Output Test Setup



Electromagnetic Compatibility Criteria for Intentional Radiators

§ 15.247(b) Peak Power Output and RF Exposure

RF Exposure Requirements: §1.1307(b)(1) and §1.1307(b)(2): Systems operating under the provisions of this section shall be operated in a manner that ensures that the public is not exposed to radio frequency energy levels in excess of the Commission's guidelines.

RF Radiation Exposure Limit: §1.1310: As specified in this section, the Maximum Permissible Exposure (MPE) Limit shall be used to evaluate the environmental impact of human exposure to radiofrequency (RF) radiation as specified in Sec. 1.1307(b), except in the case of portable devices which shall be evaluated according to the provisions of Sec. 2.1093 of this chapter.

MPE Limit Calculation: EUT's operating frequencies @ 2400-2483.5 MHz; highest conducted power = 25.4dBm (peak) therefore, **Limit for Uncontrolled exposure: 1 mW/cm² or 10 W/m²**

EUT maximum antenna gain = 5 dBi.

Equation from page 18 of OET 65, Edition 97-01

$$S = PG / 4\pi R^2 \quad \text{or} \quad R = \sqrt{PG / 4\pi S}$$

where, S = Power Density (1 mW/cm²)
P = Power Input to antenna (346.7mW)
G = Antenna Gain (3.16 numeric)

$$R = (346.7 * 3.16 / 4 * 3.14 * 1.0)^{1/2} = (1095.5 / 12.56)^{1/2} = 9.3 \text{ cm}$$



Electromagnetic Compatibility Criteria for Intentional Radiators

§ 15.247(d) Harmonic Emissions – Radiated and Conducted

Test Requirements: §15.247(c); § 15.209 (a); §15.205: Emissions outside the frequency band.

§15.247(c): In any 100 kHz bandwidth outside the frequency band in which the spread spectrum or digitally modulated intentional radiator is operating, the radio frequency power that is produced by the intentional radiator shall be at least 20 dB below that in the 100 kHz bandwidth within the band that contains the highest level of the desired power, based on either an RF conducted or a radiated measurement. Attenuation below the general limits specified in § 15.209(a) is not required. In addition, radiated emissions which fall in the restricted bands, as defined in § 15.205(a), must also comply with the radiated emission limits specified in § 15.209(a).

§15.205(a): Except as shown in paragraph (d) of this section, only spurious emissions are permitted in any of the frequency bands listed below:

| MHz | MHz | MHz | GHz |
|-------------------------------|---------------------|----------------|------------------|
| 0.090–0.110----- | 16.42–16.423 | 399.9–410 | 4.5–5.15 |
| ¹ 0.495–0.505----- | 16.69475–16.69525 | 608–614 | 5.35–5.46 |
| 2.1735–2.1905----- | 16.80425–16.80475 | 960–1240 | 7.25–7.75 |
| 4.125–4.128----- | 25.5–25.67 | 1300–1427 | 8.025–8.5 |
| 4.17725–4.17775----- | 37.5–38.25 | 1435–1626.5 | 9.0–9.2 |
| 4.20725–4.20775----- | 73–74.6 | 1645.5–1646.5 | 9.3–9.5 |
| 6.215–6.218----- | 74.8–75.2 | 1660–1710 | 10.6–12.7 |
| 6.26775–6.26825----- | 108–121.94 | 1718.8–1722.2 | 13.25–13.4 |
| 6.31175–6.31225----- | 123–138 | 2200–2300 | 14.47–14.5 |
| 8.291–8.294----- | 149.9–150.05 | 2310–2390 | 15.35–16.2 |
| 8.362–8.366----- | 156.52475–156.52525 | 2483.5–2500 | 17.7–21.4 |
| 8.37625–8.38675----- | 156.7–156.9 | 2655–2900 | 22.01–23.12 |
| 8.41425–8.41475----- | 162.0125–167.17 | 3260–3267 | 23.6–24.0 |
| 12.29–12.293----- | 167.72–173.2 | 3332–3339 | 31.2–31.8 |
| 12.51975–12.52025----- | 240–285 | 3345.8–3358.36 | 43–36.5 |
| 12.57675–12.57725----- | 322–335.4 | 3600–4400 | (²) |

Table 11. Restricted Bands of Operation

¹ Until February 1, 1999, this restricted band shall be 0.490 – 0.510 MHz.

² Above 38.6



Electromagnetic Compatibility Criteria for Intentional Radiators

§ 15.247(d) Harmonic Emissions Requirements – Radiated (802.11b)

| Frequency (MHz) | Receive Antenna Polarity (H/V) | Uncorrected Field strength (dBµV)@ 3m | Preamp (dB) | Antenna Factor (dB) | Cable Loss (dB) | Distance Correction Factor (dB) | Corrected Field Strength @ 3m (dBµV) | Limit @ 3m (dBµV) | Margin (dB) | Measurement Type |
|-----------------------------|--------------------------------|---------------------------------------|-------------|---------------------|-----------------|---------------------------------|--------------------------------------|-------------------|-------------|------------------|
| 4824.0 | V | 51.6 | 35.1 | 33.5 | 5.2 | 0.0 | 55.2 | 74.0 | 18.8 | Peak |
| 4824.0 | V | 48.2 | 35.1 | 33.5 | 5.2 | 0.0 | 51.8 | 54.0 | 2.2 | Average |
| 7236.0 | V | 42.7 | 35.1 | 37.0 | 6.5 | 0.0 | 51.1 | 74.0 | 22.9 | Peak |
| 7236.0 | V | 34.6 | 35.1 | 37.0 | 6.5 | 0.0 | 43.0 | 54.0 | 11.0 | Average |
| 9648.0 | V | 44.3 | 35.6 | 38.5 | 7.8 | 0.0 | 55.0 | 74.0 | 19.0 | Peak |
| Low Channel 2412MHz | | | | | | | | | | |
| Frequency (MHz) | Receive Antenna Polarity (H/V) | Uncorrected Field strength (dBµV)@ 3m | Preamp (dB) | Antenna Factor (dB) | Cable Loss (dB) | Distance Correction Factor (dB) | Corrected Field Strength @ 3m (dBµV) | Limit @ 3m (dBµV) | Margin (dB) | Measurement Type |
| 4874.0 | V | 53.4 | 35.1 | 33.5 | 5.2 | 0.0 | 57.0 | 74.0 | 17.0 | Peak |
| 4874.0 | V | 48.8 | 35.1 | 33.5 | 5.2 | 0.0 | 52.4 | 54.0 | 1.6 | Average |
| 7311.0 | V | 43.3 | 35.1 | 37.0 | 6.5 | 0.0 | 51.7 | 74.0 | 22.3 | Peak |
| 7311.0 | V | 34.0 | 35.1 | 37.0 | 6.5 | 0.0 | 42.4 | 54.0 | 11.6 | Average |
| 9748.0 | V | 44.1 | 35.6 | 38.5 | 7.8 | 0.0 | 54.8 | 74.0 | 19.2 | Peak |
| Mid Channel 2437MHz | | | | | | | | | | |
| Frequency (MHz) | Receive Antenna Polarity (H/V) | Uncorrected Field strength (dBµV)@ 3m | Preamp (dB) | Antenna Factor (dB) | Cable Loss (dB) | Distance Correction Factor (dB) | Corrected Field Strength @ 3m (dBµV) | Limit @ 3m (dBµV) | Margin (dB) | Measurement Type |
| 4924.0 | V | 52.1 | 35.1 | 33.5 | 5.2 | 0.0 | 55.7 | 74.0 | 18.3 | Peak |
| 4924.0 | V | 48.1 | 35.1 | 33.5 | 5.2 | 0.0 | 51.7 | 54.0 | 2.3 | Average |
| 7386.0 | V | 44.7 | 35.1 | 37.0 | 6.5 | 0.0 | 53.1 | 74.0 | 20.9 | Peak |
| 7386.0 | V | 36.6 | 35.1 | 37.0 | 6.5 | 0.0 | 45.0 | 54.0 | 9.0 | Average |
| 9848.0 | V | 49.2 | 35.6 | 38.5 | 7.8 | 0.0 | 59.9 | 74.0 | 14.1 | Peak |
| High Channel 2462MHz | | | | | | | | | | |

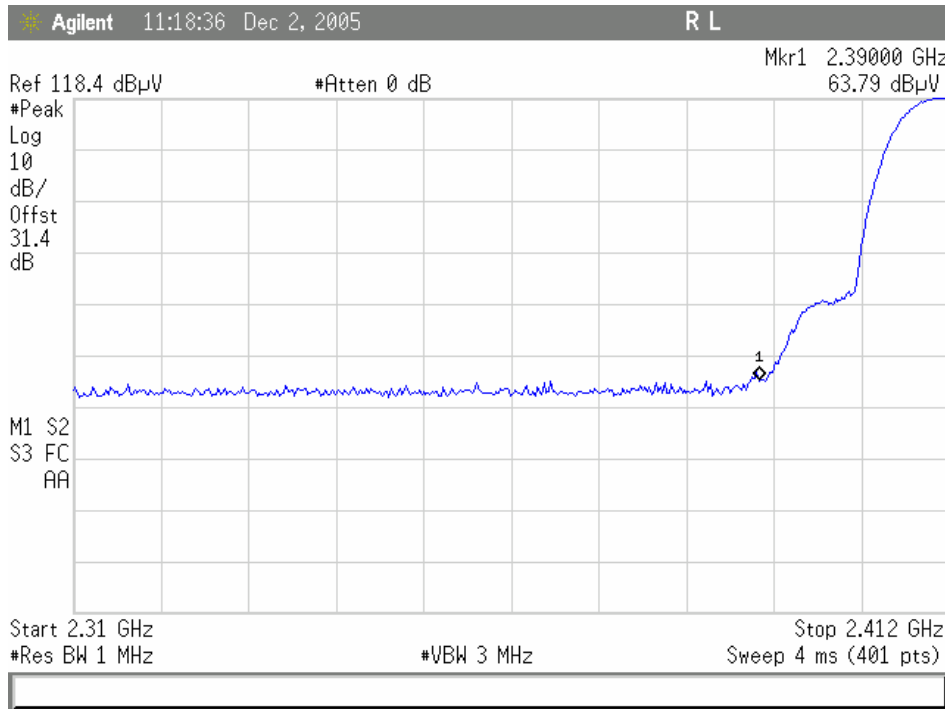

Plot 1. 802.11/b radiated restricted band 2310- 2390 MHz Peak

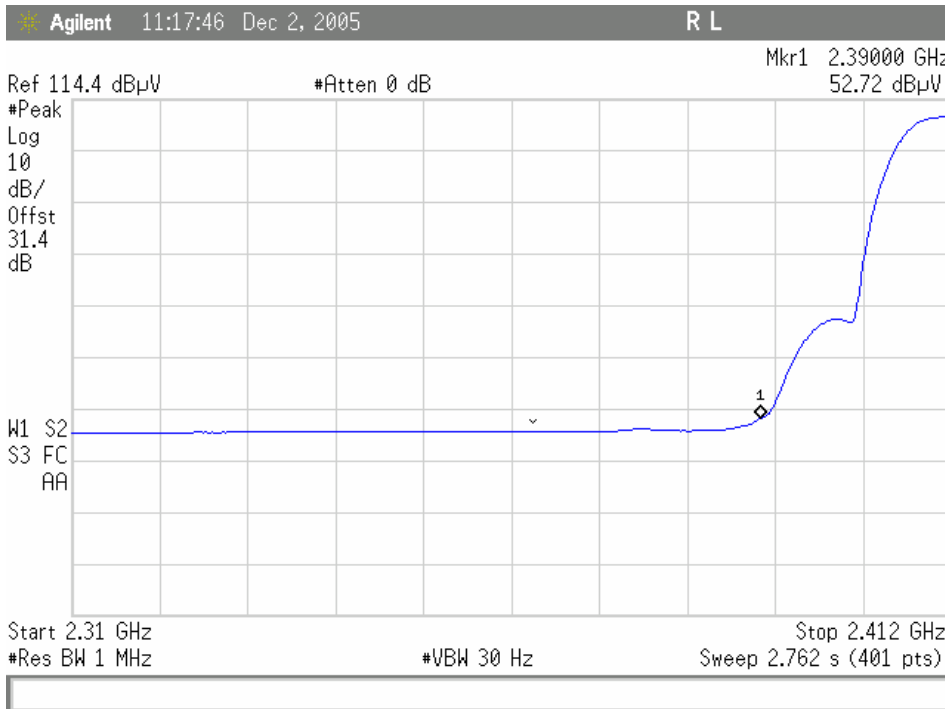

Plot 2. 802.11/b radiated restricted band 2310- 2390 MHz Avg

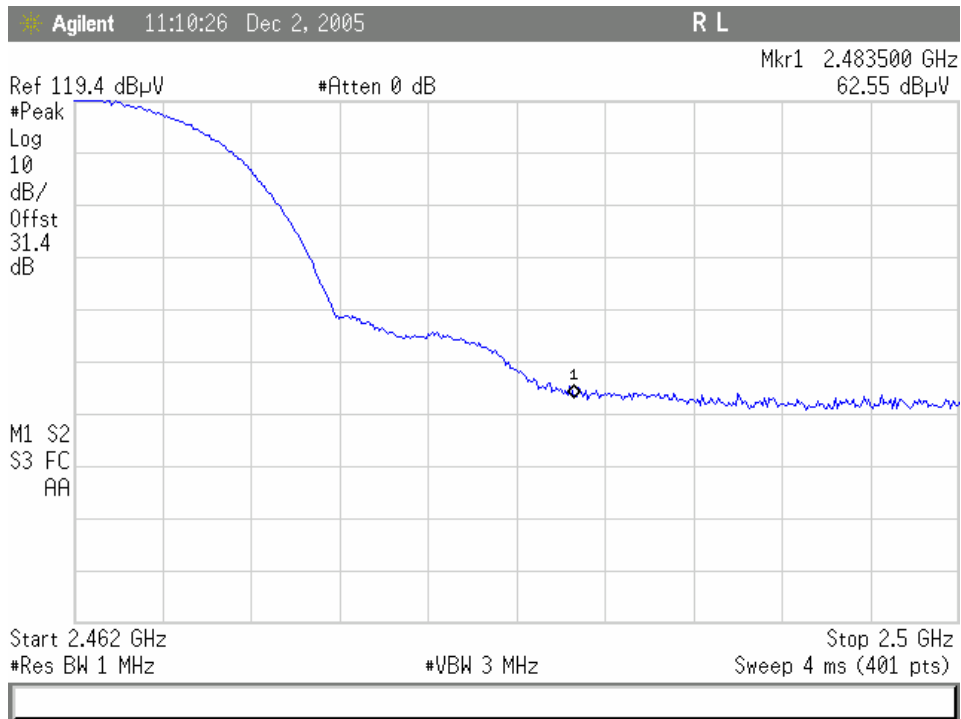

Plot 3. 802.11/b radiated restricted band 2483.5 – 2500MHz Peak

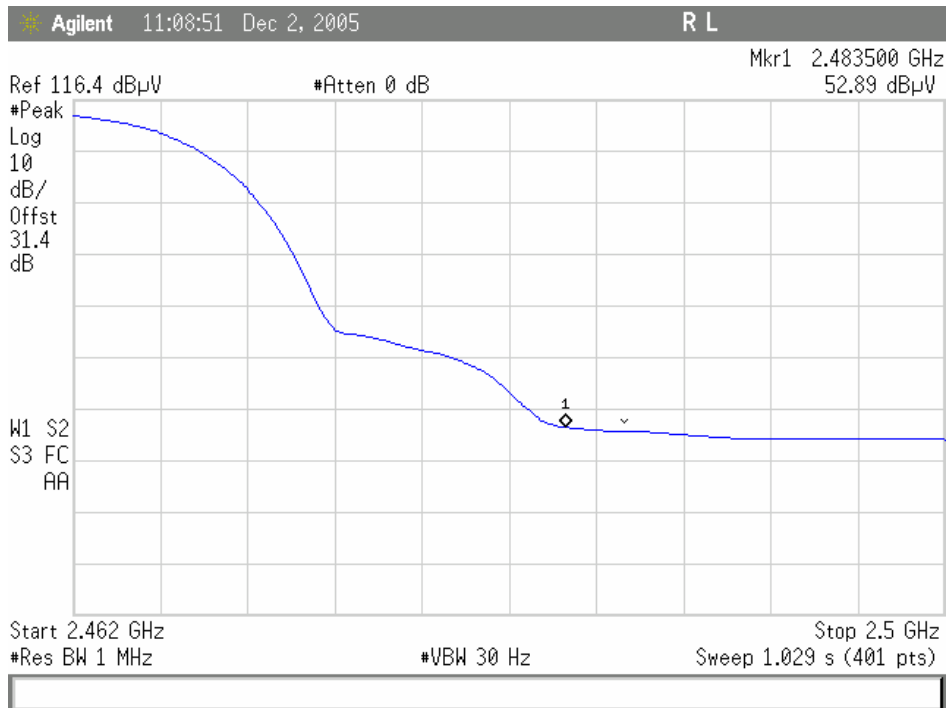

Plot 4. 802.11/b radiated restricted band 2483.5 – 2500MHz Avg



§ 15.247(d) Harmonic Emissions Requirements – Radiated (802.11g)

| Frequency (MHz) | Receive Antenna Polarity (H/V) | Uncorrected Field strength (dBµV)@ 3m | Preamp (dB) | Antenna Factor (dB) | Cable Loss (dB) | Distance Correction Factor (dB) | Corrected Field Strength @ 3m (dBµV) | Limit @ 3m (dBµV) | Margin (dB) | Measurement Type |
|-----------------------------|--------------------------------|---------------------------------------|-------------|---------------------|-----------------|---------------------------------|--------------------------------------|-------------------|-------------|------------------|
| 4824.0 | V | 49.8 | 35.1 | 33.5 | 5.2 | 0.0 | 53.4 | 74.0 | 20.6 | Peak |
| 4824.0 | V | 34.4 | 35.1 | 33.5 | 5.2 | 0.0 | 38.0 | 54.0 | 16.0 | Average |
| 7236.0 | V | 63.5 | 35.1 | 37.0 | 6.5 | 0.0 | 71.9 | 74.0 | 2.1 | Peak |
| 7236.0 | V | 33.3 | 35.1 | 37.0 | 6.5 | 0.0 | 41.7 | 54.0 | 12.3 | Average |
| 9648.0 | V | 40.0 | 35.6 | 38.5 | 7.8 | 0.0 | 50.7 | 74.0 | 23.3 | Peak |
| Low Channel 2412MHz | | | | | | | | | | |
| Frequency (MHz) | Receive Antenna Polarity (H/V) | Uncorrected Field strength (dBµV)@ 3m | Preamp (dB) | Antenna Factor (dB) | Cable Loss (dB) | Distance Correction Factor (dB) | Corrected Field Strength @ 3m (dBµV) | Limit @ 3m (dBµV) | Margin (dB) | Measurement Type |
| 4874.0 | V | 50.8 | 35.1 | 33.5 | 5.2 | 0.0 | 54.4 | 74.0 | 19.6 | Peak |
| 4874.0 | V | 34.5 | 35.1 | 33.5 | 5.2 | 0.0 | 38.1 | 54.0 | 15.9 | Average |
| 7311.0 | V | 59.8 | 35.1 | 37.0 | 6.5 | 0.0 | 68.2 | 74.0 | 5.8 | Peak |
| 7311.0 | V | 32.4 | 35.1 | 37.0 | 6.5 | 0.0 | 40.8 | 54.0 | 13.2 | Average |
| 9748.0 | V | 44.3 | 35.6 | 38.5 | 7.8 | 0.0 | 55.0 | 74.0 | 19.0 | Peak |
| Mid Channel 2437MHz | | | | | | | | | | |
| Frequency (MHz) | Receive Antenna Polarity (H/V) | Uncorrected Field strength (dBµV)@ 3m | Preamp (dB) | Antenna Factor (dB) | Cable Loss (dB) | Distance Correction Factor (dB) | Corrected Field Strength @ 3m (dBµV) | Limit @ 3m (dBµV) | Margin (dB) | Measurement Type |
| 4924.0 | V | 49.2 | 35.1 | 33.5 | 5.2 | 0.0 | 52.8 | 74.0 | 21.2 | Peak |
| 4924.0 | V | 34.4 | 35.1 | 33.5 | 5.2 | 0.0 | 38.0 | 54.0 | 16.0 | Average |
| 7386.0 | V | 60.6 | 35.1 | 37.0 | 6.5 | 0.0 | 69.0 | 74.0 | 5.0 | Peak |
| 7386.0 | V | 32.2 | 35.1 | 37.0 | 6.5 | 0.0 | 40.6 | 54.0 | 13.4 | Average |
| 9848.0 | V | 42.6 | 35.6 | 38.5 | 7.8 | 0.0 | 53.3 | 74.0 | 20.7 | Peak |
| High Channel 2462MHz | | | | | | | | | | |

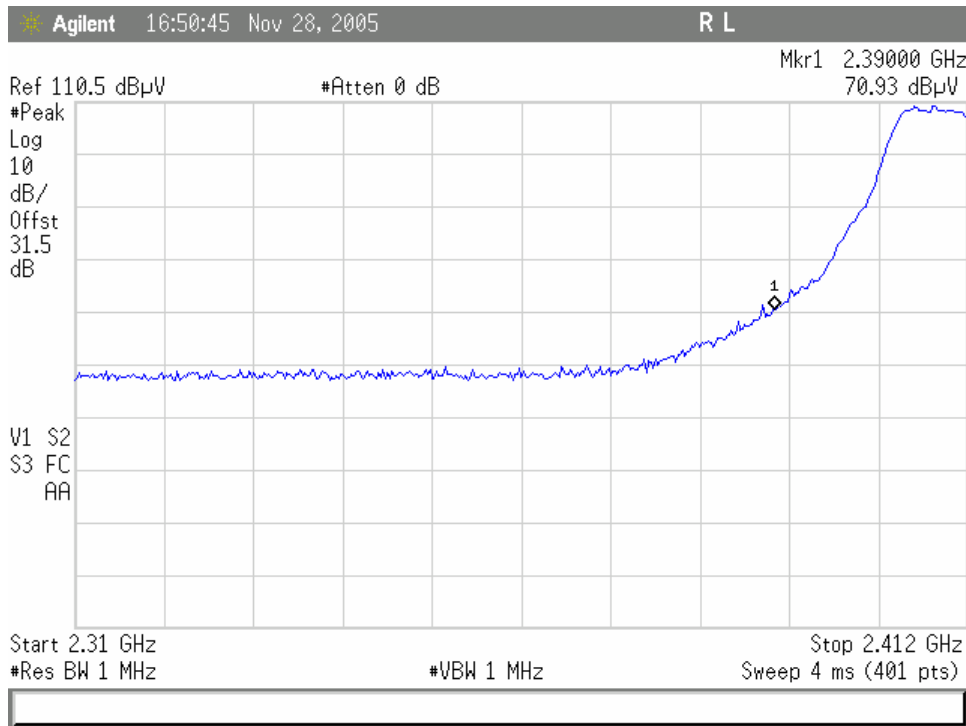

Plot 5. 802.11/g radiated restricted band 2310- 2390 MHz Peak

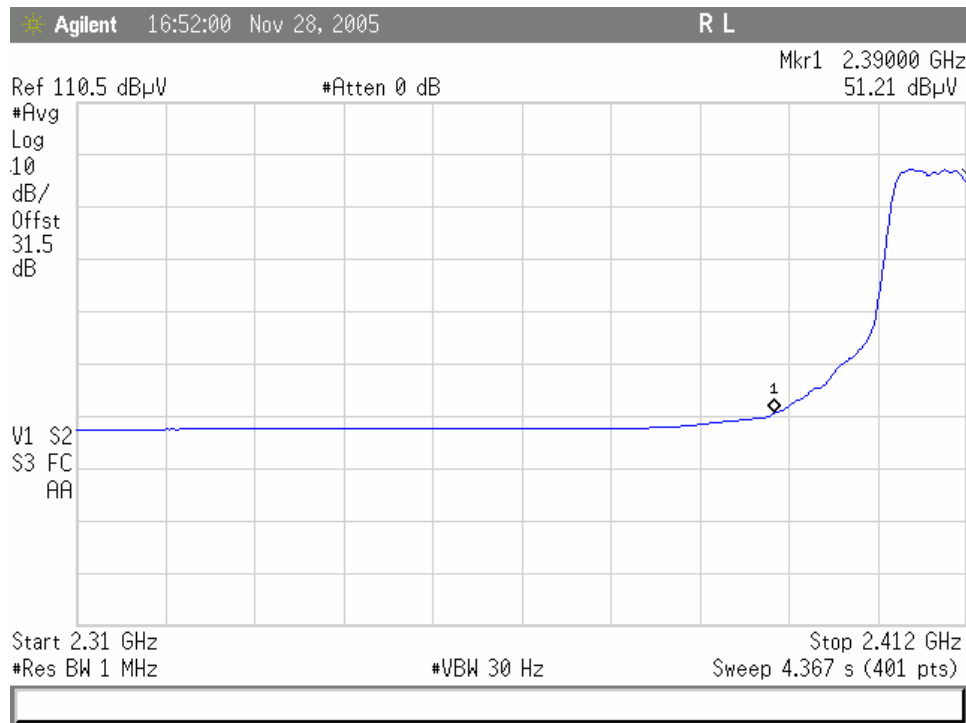

Plot 6. 802.11/g radiated restricted band 2310- 2390 MHz Avg

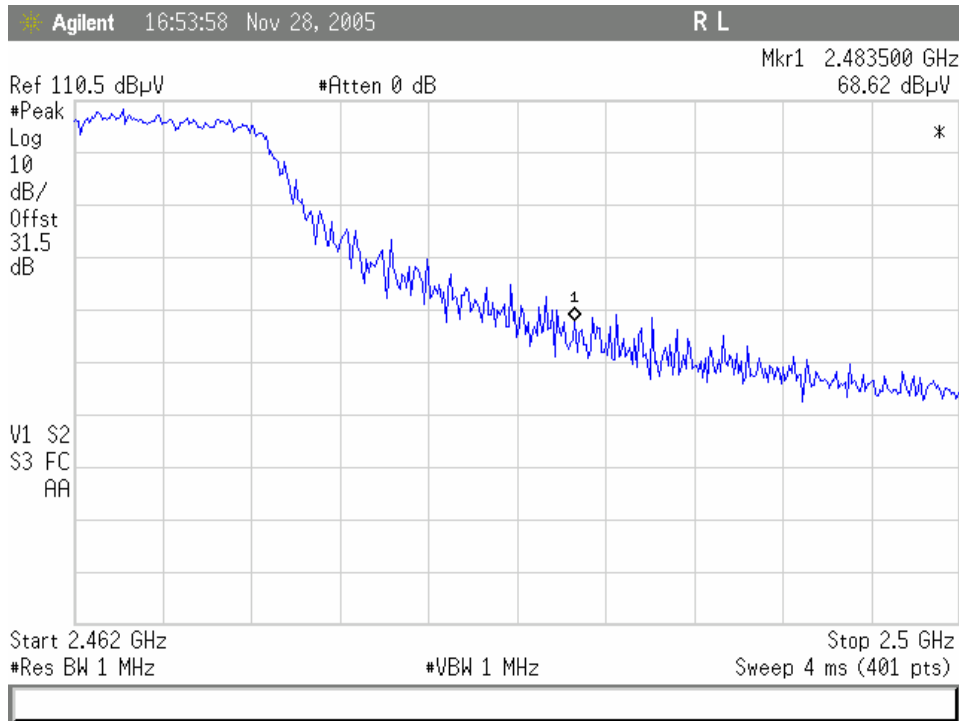

Plot 7. 802.11/g radiated restricted band 2483.5 – 2500MHz Peak

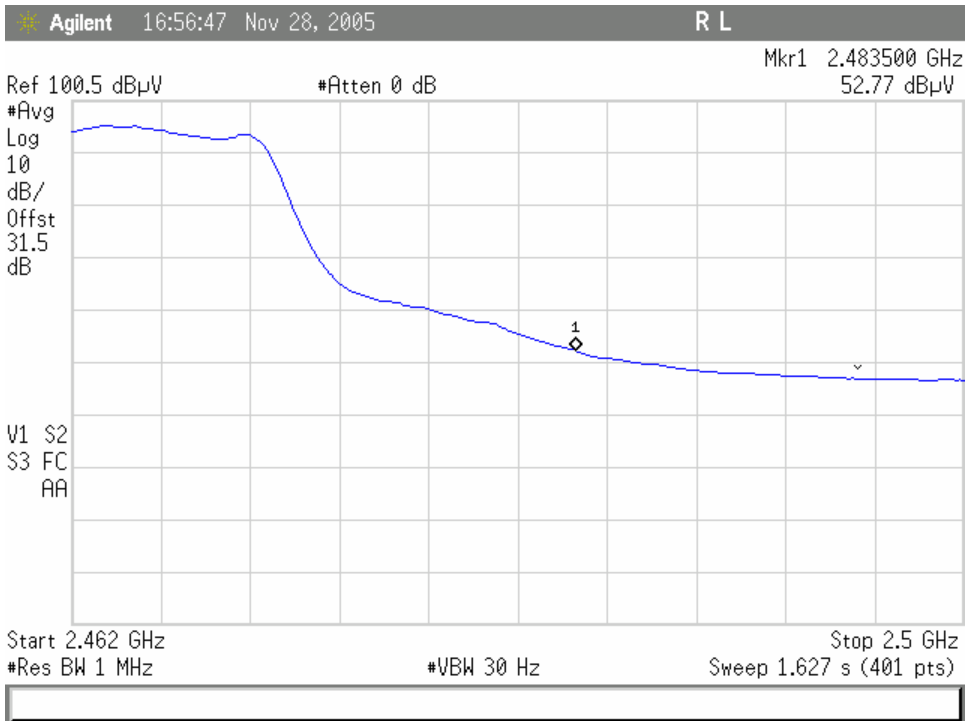

Plot 8. 802.11/g radiated restricted band 2483.5 – 2500MHz Avg

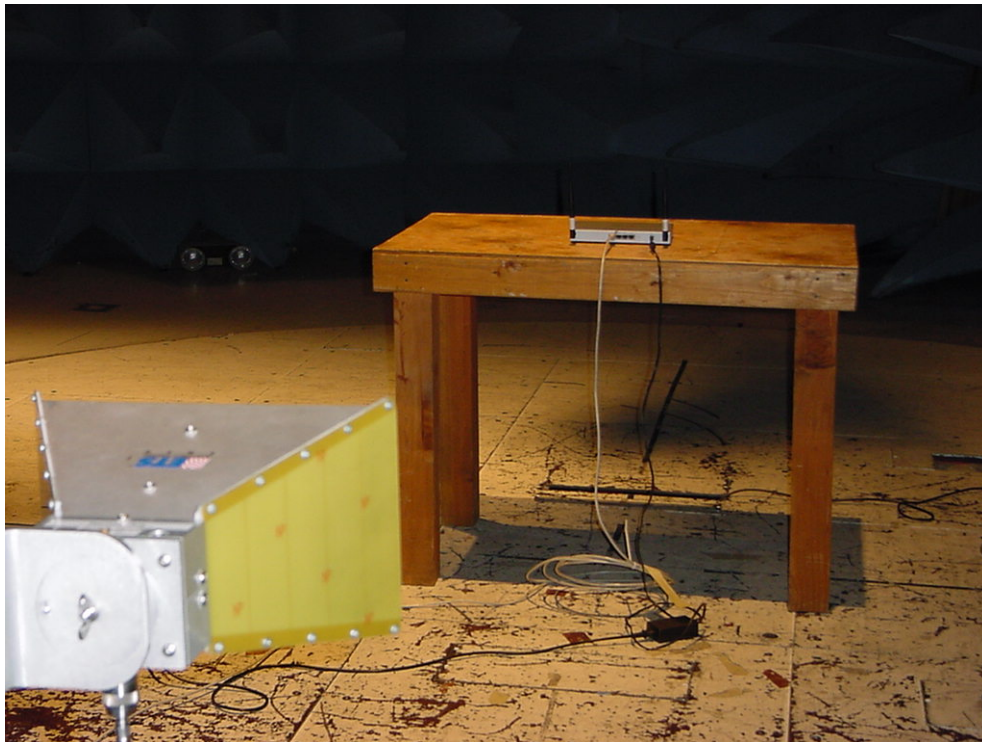
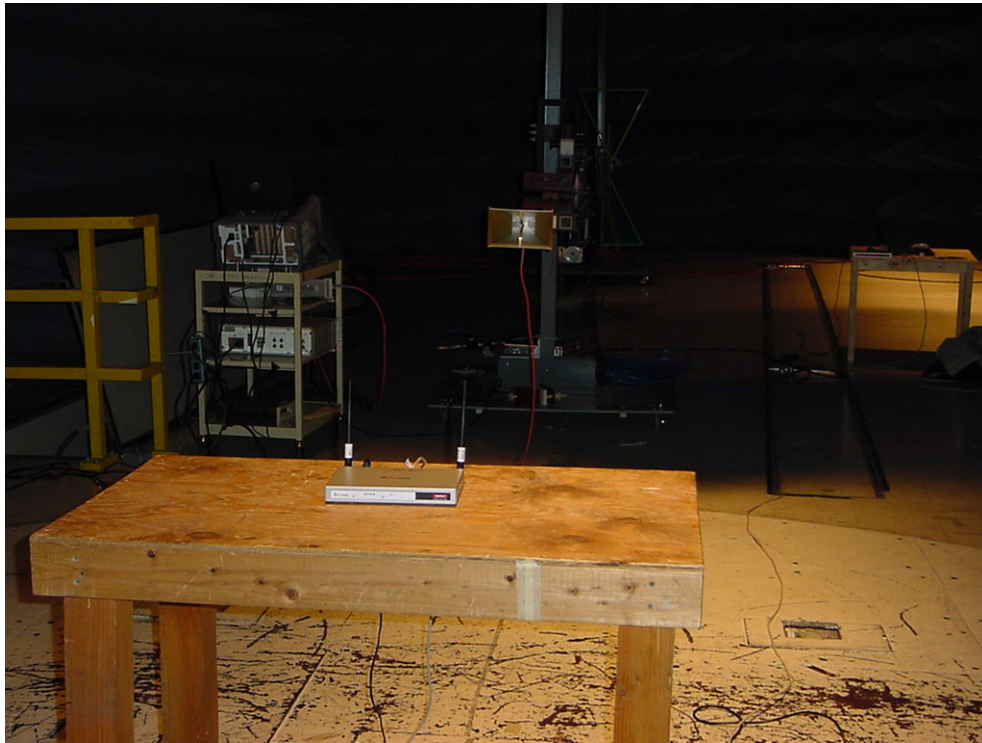

Photograph 3. Test Equipment and setup for various Radiated Measurements



Electromagnetic Compatibility Criteria for Intentional Radiators

§ 15.247(d) Peak Power Spectral Density

Test Requirements: §15.247(d): For digitally modulated systems, the peak power spectral density conducted from the intentional radiator to the antenna shall not be greater than 8dBm in any 3 kHz band during any time interval of continuous transmission.

Test Procedure: The transmitter was connected directly to a Spectrum Analyzer through a directional couple. The power was monitored at the coupler port with a Peak Power Meter. The power level was set to the maximum level. The RBW and VBW were set to 3 kHz and a SPAN of 3.0 MHz with a 100 second sweep to the Spectrum Analyzer. Measurements were carried out at the low, mid and high channels.

Test Results: Equipment complies with the peak power spectral density limits of § 15.247 (d). The peak power spectral density was determined from plots on the following page(s).

Note: Refer to modularly approved FCC ID: SWX-SR2 for measurement of Peak Power Spectral Density.



IV. Test Equipment



Test Equipment

Calibrated test equipment utilized during testing was maintained in a current state of calibration per the requirements of ANSI/NCSL Z540-1-1994 and ANSI/ISO/IEC 17025:2000.

| MET Asset # | Equipment | Manufacturer | Model | Last Cal Date | Cal Due Date |
|-------------|---------------------------------|-----------------|-----------|---------------|--------------|
| 1S2421 | EMI RECEIVER | ROHDE&SCHWARZ | ESIB 7 | 2/9/2005 | 2/9/2006 |
| 1S2184 | BILOG ANTENNA | CHASE | CBL6112A | 1/12/2005 | 1/12/2006 |
| 1S2121 | PRE-AMPLIFIER | HEWLETT PACKARD | 8449B | 10/14/2005 | 10/14/2006 |
| 1S2198 | ANTENNA, HORN | EMCO | 3115 | 7/14/2005 | 7/14/2006 |
| 1S2202 | ANTENNA, HORN, 1 METER | EMCO | 3116 | 3/23/2004 | 3/23/2007 |
| N/A | HIGH PASS FILTER | MICRO-TRONICS | HPM13146 | SEE NOTE | |
| 1S2263 | CHAMBER, 10 METER | RANTEC | N2-14 | 7/25/2005 | 7/25/2006 |
| 1S2430 | WIDEBAND POWER METER | ANRITSU COMPANY | ML2488A | 1/12/2005 | 1/12/2006 |
| 1S2432 | WIDEBAND POWER SENSOR | ANRITSU COMPANY | MA2491A | 1/12/2005 | 1/12/2006 |
| 1S2034 | COUPLER, DIRECTIONAL 1-20 GHz | KRYTAR | 101020020 | SEE NOTE | |
| 1S2041 | COUPLER, BI DIRECTIONAL COAXIAL | NARDA | N/A | SEE NOTE | |
| 1S2460 | Analyzer, Spectrum 9 kHz-40GHz | Agilent | E4407B | 07/06/2005 | 07/06/2008 |
| 1S2430 | WIDEBAND POWER METER | ANRITSU COMPANY | ML2488A | 1/12/2005 | 1/12/2006 |
| 1S2432 | WIDEBAND POWER SENSOR | ANRITSU COMPANY | MA2491A | 1/12/2005 | 1/12/2006 |
| 1S2034 | COUPLER, DIRECTIONAL 1-20 GHz | KRYTAR | 101020020 | SEE NOTE | |
| 1S2041 | COUPLER, BI DIRECTIONAL COAXIAL | NARDA | N/A | SEE NOTE | |
| 1S2128 | Harmonic Mixer | Hewlett Packard | 11970A | N/A | 3/10/2006 |
| 1S2129 | Harmonic Mixer | Hewlett Packard | 11970K | N/A | 3/10/2006 |

Note: Functionally tested equipment is verified using calibrated instrumentation at the time of testing.



V. Certification & User's Manual Information



Certification & User's Manual Information

A. Certification Information

The following is extracted from Title 47 of the Code of Federal Regulations, Part 2, Subpart I — Marketing of Radio frequency devices:

§ 2.801 Radio-frequency device defined.

As used in this part, a radio-frequency device is any device which in its operation is capable of Emitting radio-frequency energy by radiation, conduction, or other means. Radio- frequency devices include, but are not limited to:

- (a) The various types of radio communication transmitting devices described throughout this chapter.
- (b) *The incidental, unintentional and intentional radiators defined in Part 15 of this chapter.*
- (c) The industrial, scientific, and medical equipment described in Part 18 of this chapter.
- (d) Any part or component thereof which in use emits radio-frequency energy by radiation, conduction, or other means.

§ 2.803 Marketing of radio frequency devices prior to equipment authorization.

- (a) Except as provided elsewhere in this chapter, no person shall sell or lease, or offer for sale or lease (including advertising for sale or lease), or import, ship or distribute for the purpose of selling or leasing or offering for sale or lease, any radio frequency device unless:
 - (1) In the case of a device subject to certification, such device has been authorized by the Commission in accordance with the rules in this chapter and is properly identified and labeled as required by §2.925 and other relevant sections in this chapter; or
 - (2) In the case of a device that is not required to have a grant of equipment authorization issued by the Commission, but which must comply with the specified technical standards prior to use, such device also complies with all applicable administrative (including verification of the equipment or authorization under a Declaration of Conformity, where required), technical, labeling and identification requirements specified in this chapter.
- (d) Notwithstanding the provisions of paragraph (a) of this section, the offer for sale solely to business, commercial, industrial, scientific or medical users (but not an offer for sale to other parties or to end users located in a residential environment) of a radio frequency device that is in the conceptual, developmental, design or pre-production stage is permitted prior to equipment authorization or, for devices not subject to the equipment authorization requirements, prior to a determination of compliance with the applicable technical requirements *provided* that the prospective buyer is advised in writing at the time of the offer for sale that the equipment is subject to the FCC rules and that the equipment will comply with the appropriate rules before delivery to the buyer or to centers of distribution.



- (e)(1) Notwithstanding the provisions of paragraph (a) of this section, prior to equipment authorization or determination of compliance with the applicable technical requirements any radio frequency device may be operated, but not marketed, for the following purposes and under the following conditions:
- (i) *Compliance testing;*
 - (ii) Demonstrations at a trade show provided the notice contained in paragraph (c) of this section is displayed in a conspicuous location on, or immediately adjacent to, the device;
 - (iii) Demonstrations at an exhibition conducted at a business, commercial, industrial, scientific or medical location, but excluding locations in a residential environment, provided the notice contained in paragraphs (c) or (d) of this section, as appropriate, is displayed in a conspicuous location on, or immediately adjacent to, the device;
 - (iv) Evaluation of product performance and determination of customer acceptability, provided such operation takes place at the manufacturer's facilities during developmental, design or pre-production states; or
 - (v) Evaluation of product performance and determination of customer acceptability where customer acceptability of a radio frequency device cannot be determined at the manufacturer's facilities because of size or unique capability of the device, provided the device is operated at a business, commercial, industrial, scientific or medical user's site, but not at a residential site, during the development, design or pre-production stages.
- (e)(2) For the purpose of paragraphs (e)(1)(iv) and (e)(1)(v) of this section, the term *manufacturer's facilities* includes the facilities of the party responsible for compliance with the regulations and the manufacturer's premises, as well as the facilities of other entities working under the authorization of the responsible party in connection with the development and manufacture, but not the marketing, of the equipment.
- (f) For radio frequency devices subject to verification and sold solely to business, commercial, industrial, scientific and medical users (excluding products sold to other parties or for operation in a residential environment), parties responsible for verification of the devices shall have the option of ensuring compliance with the applicable technical specifications of this chapter at each end user's location after installation, provided that the purchase or lease agreement includes a proviso that such a determination of compliance be made and is the responsibility of the party responsible for verification of the equipment.



Certification & User's Manual Information

The following is extracted from Title 47 of the Code of Federal Regulations, Part 2, Subpart J — Equipment Authorization Procedures:

§ 2.901 Basis and Purpose

- (a) In order to carry out its responsibilities under the Communications Act and the various treaties and international regulations, and in order to promote efficient use of the radio spectrum, the Commission has developed technical standards for radio frequency equipment and parts or components thereof. The technical standards applicable to individual types of equipment are found in that part of the rules governing the service wherein the equipment is to be operated.¹ *In addition to the technical standards provided, the rules governing the service may require that such equipment be verified by the manufacturer or importer, be authorized under a Declaration of Conformity, or receive an equipment authorization from the Commission by one of the following procedures: certification or registration.*
- (b) The following sections describe the verification procedure, the procedure for a Declaration of Conformity, and the procedures to be followed in obtaining certification from the Commission and the conditions attendant to such a grant.

§ 2.907 Certification.

- (a) Certification is an equipment authorization issued by the Commission, based on representation and test data submitted by the applicant.
- (b) Certification attaches to all units subsequently marketed by the grantee which are identical (see Section 2.908) to the sample tested except for permissive changes or other variations authorized by the Commission pursuant to Section 2.1043.

¹ In this case, the equipment is subject to the rules of Part 15. More specifically, the equipment falls under Subpart B (of Part 15), which deals with unintentional radiators.



Certification & User's Manual Information

§ 2.948 Description of measurement facilities.

- (a) Each party making measurements of equipment that is subject to an equipment authorization under Part 15 or Part 18 of this chapter, regardless of whether the measurements are filed with the Commission or kept on file by the party responsible for compliance of equipment marketed within the U.S. or its possessions, shall compile a description of the measurement facilities employed.
- (1) If the measured equipment is subject to the verification procedure, the description of the measurement facilities shall be retained by the party responsible for verification of the equipment.
- (i) *If the equipment is verified through measurements performed by an independent laboratory, it is acceptable for the party responsible for verification of the equipment to rely upon the description of the measurement facilities retained by or placed on file with the Commission by that laboratory. In this situation, the party responsible for the verification of the equipment is not required to retain a duplicate copy of the description of the measurement facilities.*
- (ii) If the equipment is verified based on measurements performed at the installation site of the equipment, no specific site calibration data is required. It is acceptable to retain the description of the measurement facilities at the site at which the measurements were performed.
- (2) If the equipment is to be authorized by the Commission under the certification procedure, the description of the measurement facilities shall be filed with the Commission's Laboratory in Columbia, Maryland. The data describing the measurement facilities need only be filed once but must be updated as changes are made to the measurement facilities or as otherwise described in this section. At least every three years, the organization responsible for filing the data with the Commission shall certify that the data on file is current.



Certification & User's Manual Information

Label and User's Manual Information

The following is extracted from Title 47 of the Code of Federal Regulations, Part 15, Subpart A — General:

§ 15.19 Labeling requirements.

(a) *In addition to the requirements in Part 2 of this chapter, a device subject to certification or verification shall be labeled as follows:*

- (1) Receivers associated with the operation of a licensed radio service, e.g., FM broadcast under Part 73 of this chapter, land mobile operation under Part 90, etc., shall bear the following statement in a conspicuous location on the device:

This device complies with Part 15 of the FCC Rules. Operation is subject to the condition that this device does not cause harmful interference.

- (2) A stand-alone cable input selector switch, shall bear the following statement in a conspicuous location on the device:

This device is verified to comply with Part 15 of the FCC Rules for use with cable television service.

- (3) All other devices shall bear the following statement in a conspicuous location on the device:

This device complies with Part 15 of the FCC Rules. Operation is subject to the following two conditions: (1) This device may not cause harmful interference, and (2) this device must accept any interference received, including interference that may cause undesired operation.

- (4) Where a device is constructed in two or more sections connected by wires and marketed together, the statement specified under paragraph (a) of this section is required to be affixed only to the main control unit.

- (5) When the device is so small or for such use that it is not practicable to place the statement specified under paragraph (a) of this section on it, the information required by this paragraph shall be placed in a prominent location in the instruction manual or pamphlet supplied to the user or, alternatively, shall be placed on the container in which the device is marketed. However, the FCC identifier or the unique identifier, as appropriate, must be displayed on the device.

§ 15.21 Information to user.

The users manual or instruction manual for an intentional or unintentional radiator shall caution the user that changes or modifications not expressly approved by the party responsible for compliance could void the user's authority to operate the equipment.



Verification & User's Manual Information

The following is extracted from Title 47 of the Code of Federal Regulations, Part 15, Subpart B — Unintentional Radiators:

§ 15.105 Information to the user.

- (a) For a Class B digital device or peripheral, the instructions furnished the user shall include the following or similar statement, placed in a prominent location in the text of the manual:

Note: This equipment has been tested and found to comply with the limits for a Class B digital device, pursuant to Part 15 of the FCC Rules. These limits are designed to provide reasonable protection against harmful interference when the equipment is operated in a residential environment. This equipment generates, uses, and can radiate radio frequency energy and, if not installed and used in accordance with the instruction manual, may cause harmful interference to radio communications. However, there is no guarantee that interference will not occur in a particular installation. If this equipment does cause harmful interference to radio or television reception, which can be determined by turning the equipment off and on, the user is encouraged to try to correct the interference by one or more of the following measures:

- Reorient or relocate the receiving antenna.
- Increase the separation between the equipment and receiver.
- Connect the equipment into an outlet on a circuit different from that to which the receiver is connected.
- Consult the dealer or an experienced radio/TV technician for help.



VI. Exhibits



Exhibit A, Hopping Capability Requirements



Exhibit B, Non-Coordination Requirements



End of Report