



MET Laboratories, Inc. *Safety Certification - EMI - Telecom Environmental Simulation*
33439 WESTERN AVENUE • UNION CITY, CALIFORNIA 94587 • PHONE (510) 489-6300 • FAX (510) 489-6372

**Electromagnetic Compatibility Criteria
Test Report**

For the

**Firetide
Hotport Wireless Mesh Node Router, Model 3203**

Tested under

**The FCC Verification Rules
Contained in Title 47 of the CFR, Part 90, Subpart Y
for Private Land Mobile Radio Services**

MET Report: EMCS18301B-FCC90

September 15, 2005

Prepared For:

**Firetide
16795 Lark Ave.
Los Gatos CA 95032**

**Prepared By:
MET Laboratories, Inc.
33439 Western Ave.
Union City, California 94587**



Electromagnetic Compatibility Criteria Test Report

For the

Firetide
Hotport Wireless Mesh Node Router, Model 3203

Tested under

The FCC Verification Rules
Contained in Title 47 of the CFR, Part 90, Subpart Y
for Private Land Mobile Radio Services

MET Report: EMCS18301B-FCC90

Shawn McMillen
Electromagnetic Compatibility Lab

Cheryl Anicete
Documentation Department

Engineering Statement: The measurements shown in this report were made in accordance with the procedures indicated, and the emissions from this equipment were found to be within the limits applicable. I assume full responsibility for the accuracy and completeness of these measurements, and for the qualifications of all persons taking them. It is further stated that upon the basis of the measurements made, the equipment tested is / is not capable of operation in accordance with the requirements of Part 90, Subpart Y of the FCC Rules under normal use and maintenance.

Tony Permsombut, Manager
Electromagnetic Compatibility Lab



Firetide
Hotport Wireless Mesh Node Router, Model 3203

Electromagnetic Compatibility
Report Status Sheet
CFR Title 47, Part 90, Subpart Y

Report Status Sheet

Revision	Report Date	Reason for Revision
Ø	September 15, 2005	Initial Issue.



Table of Contents

1. Testing Summary	1
2. Equipment Configuration.....	2
2.1. Overview	2
2.2. Test Site	2
2.3. Description of Test Sample	2
2.4. Equipment Configuration.....	3
2.5. Support Equipment	3
2.6. Ports and Cabling Information	4
2.7. Mode of Operation	7
2.8. Method of Monitoring EUT Operation	7
2.9. Modifications	7
2.9.1. Modifications to EUT	7
2.9.2. Modifications to Test Standard	7
2.10. Disposition of EUT	7
3. Electromagnetic Compatibility RF Power Output Requirements.....	8
3.1. Peak Power Output.....	8
3.2. Peak Power Spectral Density	9
4. Electromagnetic Compatibility Modulation Characteristics Requirements.....	13
4.1. Modulation Characteristics	13
5. Electromagnetic Compatibility Occupied Bandwidth Requirements.....	14
5.1. Occupied Bandwidth (Emission Masks)	14
6. Electromagnetic Compatibility Spurious Emissions at Antenna Terminal Requirements	18
6.1. Spurious Emissions at Antenna Terminals.....	18
7. Electromagnetic Compatibility Radiated Emissions Requirements	25
7.1. Radiated Emissions (Substitution Method).....	25
8. Electromagnetic Compatibility Radiated Emissions Requirements	28
8.1. Frequency Stability	28
9. Electromagnetic Compatibility Transient Frequency Behavior Requirements	30
9.1. Transient Frequency Behavior	30
10. Test Equipment	31
11. RF Exposure Requirements	33
12. Certification Label & User's Manual Information	34
12.1. Verification Information	34
12.2. Label and User's Manual Information	38

All references to section numbers are taken directly from the standard/specification used. Only sections requiring testing or evaluation are included.



List of Tables

Table 1. Equipment Configuration	3
Table 2. Support Equipment.....	3
Table 3. Ports and Cabling Information	4
Table 4. Temperature Vs. Frequency Test Results.....	29
Table 5. Frequency Vs. Voltage Test Results	29

List of Figures

Figure 1. Block Diagram of Test Configuration (Conducted Measurements).....	5
Figure 2. Block Diagram of Test Configuration (Radiated Emissions).....	6

List of Photographs

Photograph 1. RF Power Output Test Setup.....	12
Photograph 2. Occupied Bandwidth (Emission Mask) Test Setup.....	17
Photograph 3. Spurious Emissions at Antenna Terminals Test Setup.....	24
Photograph 4. Radiated Emission Spurious Test Setup.....	27



List of Terms and Abbreviations

AC	Alternating Current
ACF	Antenna Correction Factor
Cal	Calibration
d	Measurement Distance
dB	Deci Bels
dBm	Deci-Bels relative to one milli watt
dBμV	Deci-Bels above one micro Volt
dBμV/m	Deci-Bels above one micro Volt per meter
DC	Direct Current
DCF	Distance Correction Factor
E	Electric Field
DSL	Digital Subscriber Line
ESD	Electrostatic Discharge
EUT	Equipment Under Test
f	Frequency
FCC	Federal Communications Commission
H	Magnetic Field
GHz	Giga Hertz
Hz	Hertz
ICES	Interference-Causing Equipment Standard
kHz	kilohertz
kPa	kilopascal
kV	kilo Volt
LISN	Line Impedance Stabilization Network
MHz	MegaHertz
μH	micro Henry
μF	micro Farad
μs	micro seconds
RF	Radio Frequency
RMS	Root-Mean-Square



1. Testing Summary

These tests were conducted on a sample of the equipment for the purpose of demonstrating compliance with Part 90, Subpart Y. All tests were conducted using measurement procedure ANSI TIA/EIA-603-A-2004.

Type of Submission/ Rule Part:	Certification / Part 90 Subpart Y
EUT:	Hotport Wireless Mesh Node Router
FCC ID:	REP-3200-2
Equipment Code:	TNB
Type of Modulation:	OFDM
Emission Designator:	4M17G7D, 8M28G7D, 16M4G7D
Power Limit:	For High Power Device only
RF Power Output:	Conducted Output Power in Peak: 22.67dBm (185milliwatt)
EUT Operating Frequency Range (MHz):	4950 - 4980

Title 47 of the CFR, Part 90, Subpart Y, and FCC 04-265 Reference and Test Description	Conformance			Comments
	Yes	No	N/A	
	<i>Yes - Equipment complies with the Requirement</i> <i>No - Equipment does not comply with the Requirement</i> <i>N/A - Not applicable to the equipment under tests</i>			
2.1046; 90.1215(a) Peak Power Output	✓			Measured emissions below applicable limits.
2.1046; 90.1215(a) Peak Power Spectral Density	✓			Measured emissions below applicable limits.
2.1047(a) Modulation Characteristics			✓	EUT is non-voice, data only.
2.1049; 90.210(L) Occupied Bandwidth (Emission Mask)	✓			Measured emissions below applicable limits.
2.1051; 90.210(L) Spurious Emissions at Antenna Terminals	✓			Measured emissions below applicable limits.
2.1053; 90.210(L) Radiated Spurious Emissions	✓			Measured emissions below applicable limits.
2.1055(a) (1); 90.213 Frequency Stability over Temperature Variations	✓			Measured emissions below applicable limits.
2.1055(d) (2) Frequency Stability over Voltage Variations	✓			Measured emissions below applicable limits.
90.214 Transient Frequency Behavior			✓	EUT operating frequency is at 4.9 GHz.



2. Equipment Configuration

2.1. Overview

MET Laboratories, Inc. was contracted by Firetide to perform testing on the Hotport Wireless Mesh Node Router, under Firetide purchase order number PAG238GW.

This document describes the test setups, test methods, required test equipment, and the test limit criteria used to perform compliance testing of the Firetide, Hotport Wireless Mesh Node Router.

An EMC evaluation to determine compliance of the Firetide with the requirements of Part 90, Subpart Y, was conducted. (All references are to the most current version of Title 47 of the Code of Federal Regulations in effect). In accordance with §2.1033, the following data is presented in support of the Certification of the Hotport Wireless Mesh Node Router. Firetide should retain a copy of this document and it should be kept on file for at least five years after the manufacturing of the EUT has been **permanently** discontinued.

The results obtained relate only to the item(s) tested.

Model(s) Tested:	Hotport Wireless Mesh Node Router
Model(s) Covered:	3203
EUT Specifications:	Primary Power: 120 VAC, 60 Hz
	Secondary Power: N/A
	Highest Clock Frequency: 4980 MHz
Evaluated by:	Shawn McMillen
Date(s):	Sept 13-14, 2005

2.2. Test Site

All testing was performed at MET Laboratories, Inc., 4855 Patrick Henry Drive, Building 6, Santa Clara, California 95054. All equipment used in making physical determinations is accurate and bears recent traceability to the National Institute of Standards and Technology.

Radiated Emissions measurements were performed in a 10 meter semi-anechoic chamber (equivalent to an Open Area Test Site). In accordance with §2.948(a)(3), a complete site description is contained at MET Laboratories. In accordance with §2.948(d), MET Laboratories has been accredited by the National Voluntary Laboratory Accreditation Program (Lab Code: 100273-0).

2.3. Description of Test Sample

The Hotport Wireless Mesh Node Router, Model 3203, Equipment Under Test (EUT) for the remainder of this document, is a wireless communications system operating in the 4940 to 4990 GHz spectrum.



2.4. Equipment Configuration

The EUT was set up as outlined in Figure 1, Block Diagram of Test Setup. All cards, racks, etc., incorporated as part of the EUT is included in the following list.

Ref. ID	Name / Description	Model Number	Part Number	Serial Numbers	Rev. #
A	Hotport Wireless Mesh Node Router	3203	N/A	A06080501000713	N/A
B	Indoor Power Supply Unit	HK-D532-A16 (Hong Kwang)	N/A	K000000100	N/A

Table 1. Equipment Configuration

2.5. Support Equipment

Firetide supplied support equipment necessary for the operation and testing of the Hotport Wireless Mesh Node Router. All support equipment supplied is listed in the following Support Equipment List.

Ref. ID	Name / Description	Manufacturer	Model Number	*Customer Supplied Calibration Data
C	Laptop	Dell	Latitude	N/A
D	Spectrum Analyzer	Agilent	E4407B	N/A
E	Directional coupler (for Conducted Measurement)	Krytar	101020020	N/A
F	Power Sensor (for Conducted Measurement)	Anritsu	MA2491A	N/A
G	Power Meter (for Conducted Measurement)	Anritsu	ML2488A	N/A

Table 2. Support Equipment

* - The 'Customer Supplied Calibration Data' column will be marked as either not applicable, not available, or will contain the calibration date supplied by the customer.



2.6. Ports and Cabling Information

Ref. ID	Port name on EUT	Cable Description or reason for no cable	Qty.	Length (m)	Shielded (Yes/No)	Termination Box ID & Port ID
Conducted Measurement						
1	A, Din Port 1	RJ45 / DIN	1	1.5	Yes	C
2	A, PWR Input	DIN PWR Cord	1	3	No	B
N/A	A, Antenna Port 1	N/A (directly connect)	N/A	N/A	Yes	E
N/A	A, Antenna Port 1	N/A	N/A	N/A	N/A	Unterminated
Radiated Emissions						
1	A, Din Port 1	RJ45 / DIN	1	1.5	Yes	C
2	A, PWR Input	DIN PWR Cord	1	3	No	B
N/A	A, Antenna Port 1	N/A	N/A	N/A	N/A	Unterminated
N/A	A, Antenna Port 1	N/A	N/A	N/A	N/A	Unterminated

Table 3. Ports and Cabling Information

Conducted Measurement

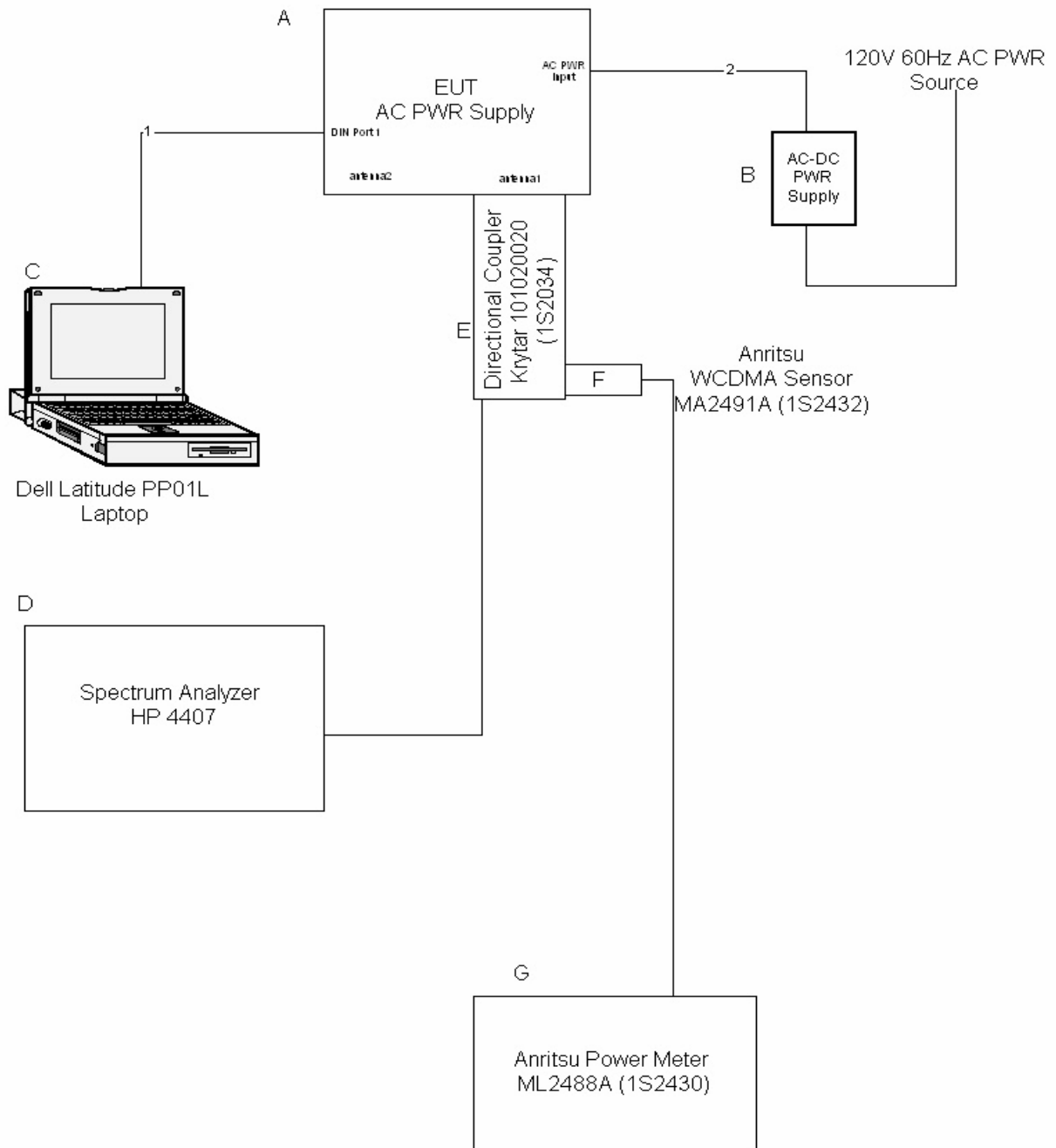

Figure 1. Block Diagram of Test Configuration (Conducted Measurements)

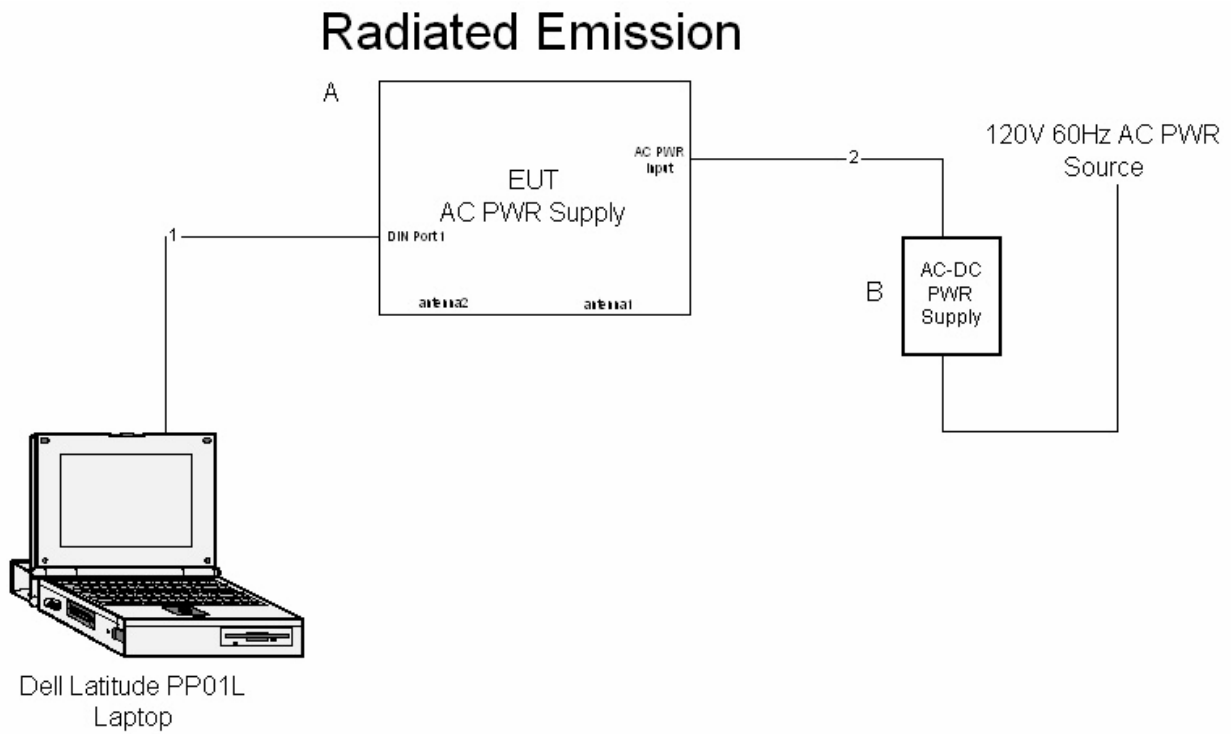

Figure 2. Block Diagram of Test Configuration (Radiated Emissions)



2.7. Mode of Operation

Telnet was used to access the radio in order to change the channel frequency, bit rate and to turn on/off the transmitter. The power output was set to a fixed value which could not vary the output power.

2.8. Method of Monitoring EUT Operation

A Spectrum Analyzer and a Power Meter were used to monitor the EUT's transmitter channel and power output.

2.9. Modifications

2.9.1. Modifications to EUT

No modifications were made to the EUT.

2.9.2. Modifications to Test Standard

No modifications were made to the test standard.

2.10. Disposition of EUT

The test sample including all support equipment submitted to the Electro-Magnetic Compatibility Lab for testing was returned to Firetide upon completion of testing.



3. Electromagnetic Compatibility RF Power Output Requirements

3.1. Peak Power Output

Test Requirement(s): §2.1046 and §90.1215(a) with FCC 04-265 (High Power Devices)

Test Procedures: As required by 47 CFR 2.1046, *RF power output measurements* were made at the RF output terminals using a Directional Coupler through a Spectrum Analyzer and Power Meter.

A laptop was connected to EUT to control the RF power output and frequency channel. The EUT was connected through a Directional Coupler to a Spectrum Analyzer to monitor the frequency and to a Power Meter to measure the Peak and Average power. The EUT power was adjusted enough to produce maximum output power as specified in the owner's manual. The output power was then recorded with peak and average reading. Measurements were made at the center channel with band widths of 5, 10 and 20MHz.

Test Results: Equipment complies with 47CFR 2.1046 and 90.1215(a) with FCC 04-265 (High Power Devices). The EUT does not exceed 33dBm at the carrier frequency.

All RF Power output measurements were direct connection to RF output Terminal of EUT from a Power Meter.

RF Power Output			
Frequency (MHz)	EUT Channel Bandwidth (MHz)	Measured Peak Power (dBm)	Measured Average Power (dBm)
4965	5	22.67	16.52
4965	10	22.65	16.53
4965	20	22.60	16.51

Test Engineer(s): Shawn McMillen

Test Date(s): 09/14/2005



3.2. Peak Power Spectral Density

Test Requirement(s): §90.1215(a) with FCC 04-265 (High Power Devices)

Test Procedures: As required by 47 CFR 2.1046, *RF power output measurements* were made at the RF output terminals using a Directional Coupler through a Spectrum Analyzer and Power Meter.

A laptop was connected to EUT to control the RF power output and frequency channel. The EUT was connected to a Spectrum Analyzer in order to measure the Peak Power. The Spectrum Analyzer was set to a RBW = VBW = 1 MHz. The EUT power was adjusted at the maximum output power level. The max hold key from the Spectrum Analyzer was activated capturing the modulated envelope of the EUT. The Peak Power Spectral Density was then recorded. Measurements were made at the center channel with band widths of 5, 10 and 20MHz.

Test Results: Equipment complies with 47 CFR 2.1046 and 90.1215(a) with FCC 04-265 (High Power devices). The EUT does not exceed 21dBm/MHz at the carrier frequency.

The following pages show measurements of Peak Power Spectral Density plots which is recorded below:

Peak Power Spectral Density				
Plot #	Frequency (MHz)	EUT Channel Bandwidth (MHz)	Measured Power Spectral Density (dBm)	Limit (dBm)
1	4965	5	19.44	21
2	4965	10	16.50	21
3	4965	20	13.89	21

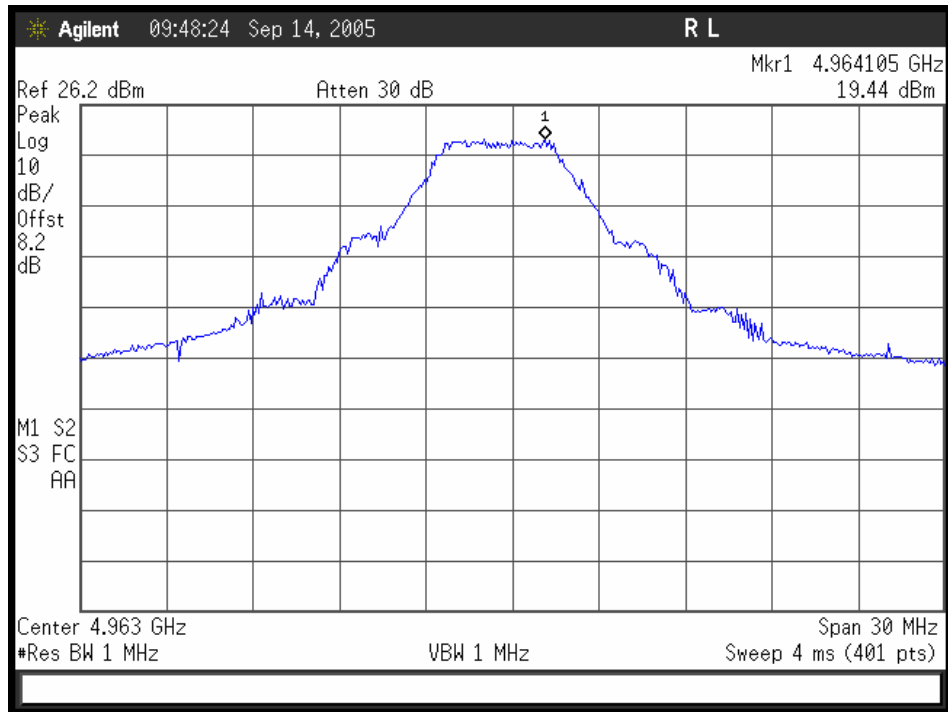

Plot 1. PPSD Mid Ch 5MHz BW

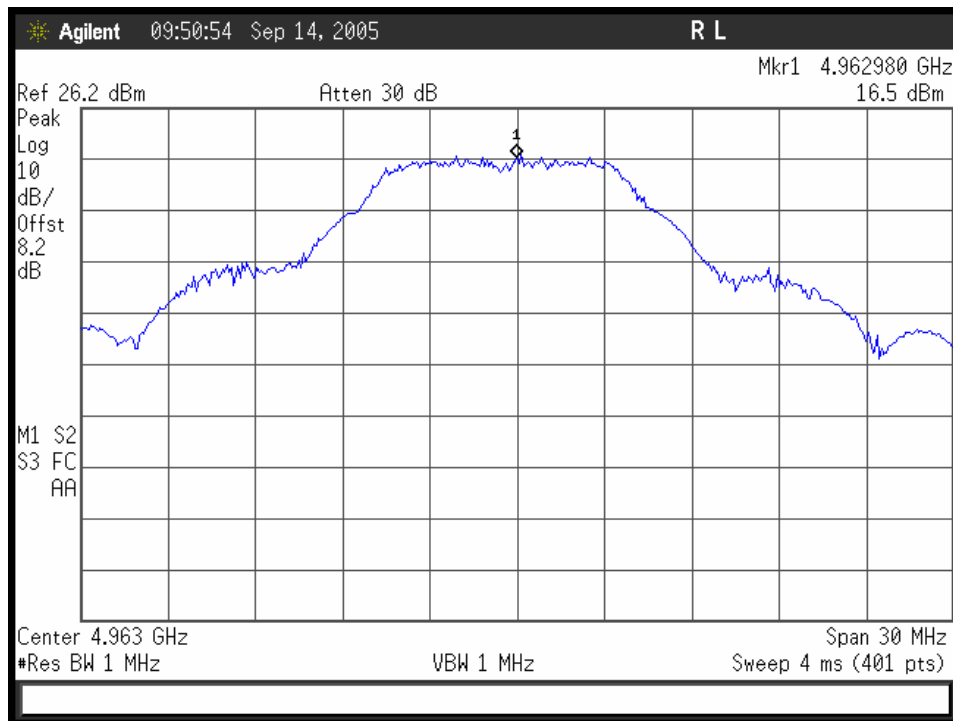

Plot 2. PPSD Mid Ch 10MHz BW

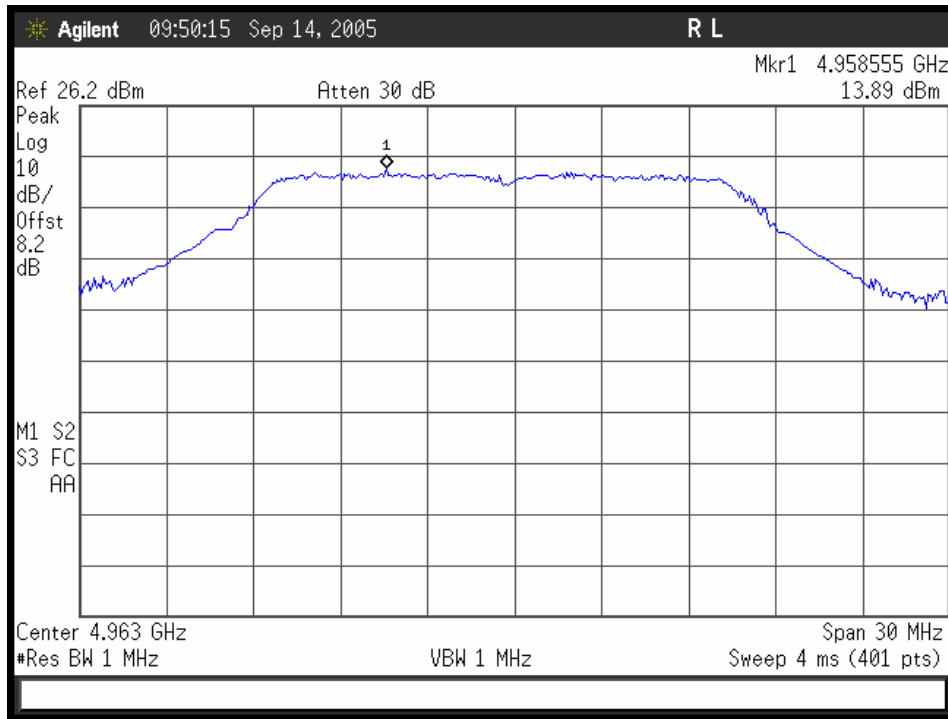

Plot 3. PPSD Mid Ch 20MHz BW

RF Power Output Test Setup

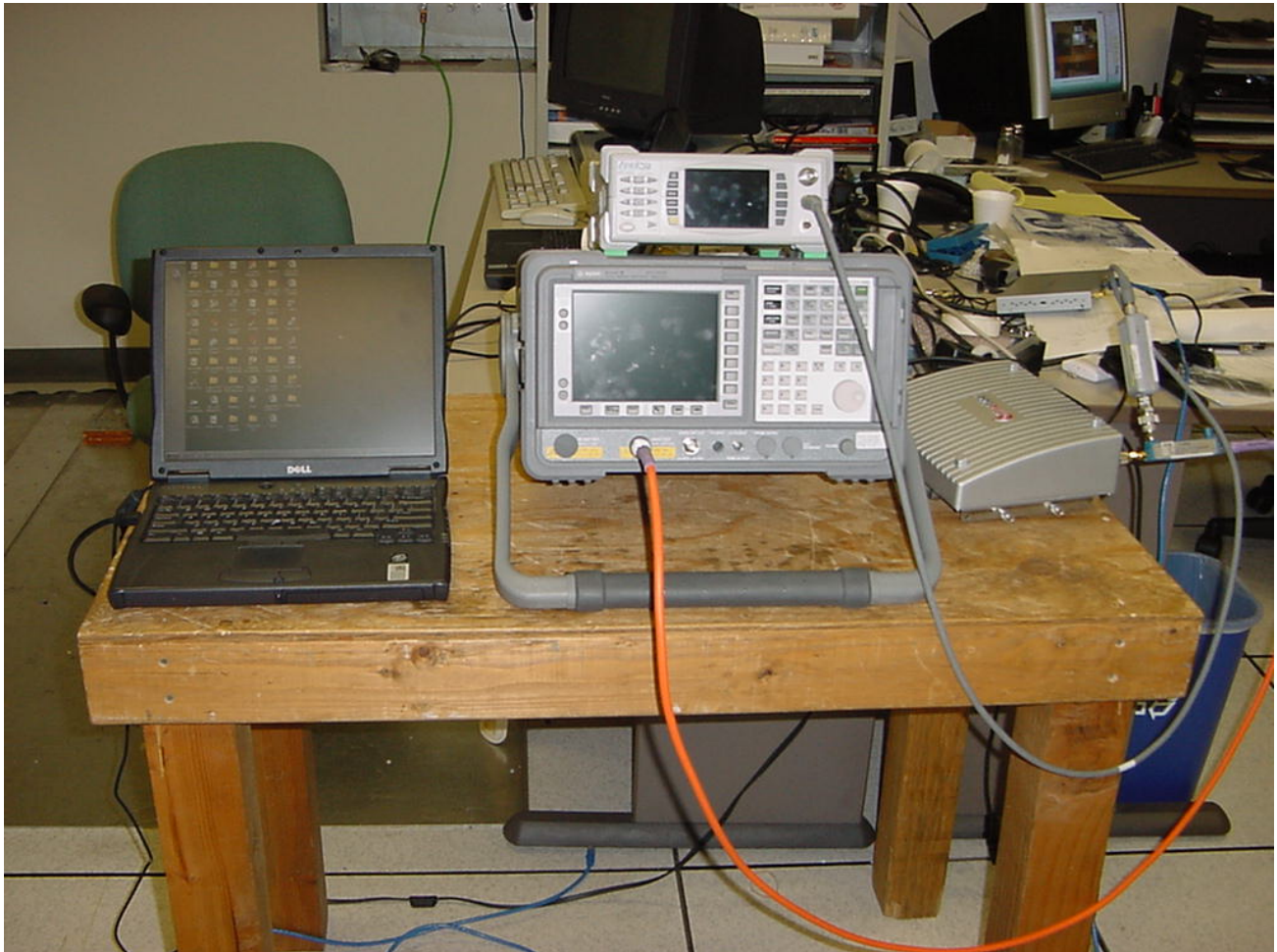

Photograph 1. RF Power Output Test Setup



4. Electromagnetic Compatibility Modulation Characteristics Requirements

4.1. Modulation Characteristics

Test Requirement(s): §2.1047

Test Procedures: As required by 47 CFR 2.1047, *Modulation Characteristics measurements* were made at the RF output terminals.

Test Results: EUT is not required for this test.
The EUT contain no analog voice circuitry.



5. Electromagnetic Compatibility Occupied Bandwidth Requirements

5.1. Occupied Bandwidth (Emission Mask)

Test Requirement(s): §2.1049 and §90.210 (L) with FCC 04-265 (Emissions Mask M)

Test Procedures: As required by 47 CFR 2.1049, *occupied bandwidth measurements* were made at the RF output terminals using a Directional Coupler through an Spectrum Analyzer and Power Meter monitoring the power output level.

A laptop was connected to EUT to control the RF power output and frequency channel. The EUT was connected to a Spectrum Analyzer and a Power Meter to monitor the output power level. The measured highest Average Power was set relative to zero dB reference. The RBW of the Spectrum Analyzer was set to at least 1% of the channel bandwidth at 5, 10 and 20MHz with a VBW set to 30 kHz. The EUT was set to transmit in the lowest of the operating frequency range. The EUT power was adjusted at the maximum output power level. The max hold key from the Spectrum Analyzer was activated capturing the modulated envelope of the EUT. The Emission Mask limit was set to the proper channel bandwidth then plotted the graph. Measurements were made at the center channel with band widths of 5, 10 and 20MHz.

Test Results: Equipment complies with Section 2.1049 and 90.210(L) with FCC 04-265 (Emission Mask M). The EUT does not exceed the Emission Masks limit.

The following pages show measurements of Emission Mask plots which is recorded below:

Emission Mask		
Plot #	Frequency (MHz)	Channel Bandwidth (MHz)
4	4965	5
5	4965	10
6	4965	20

Test Engineer(s): Shawn McMillen

Test Date(s): 09/14/2005

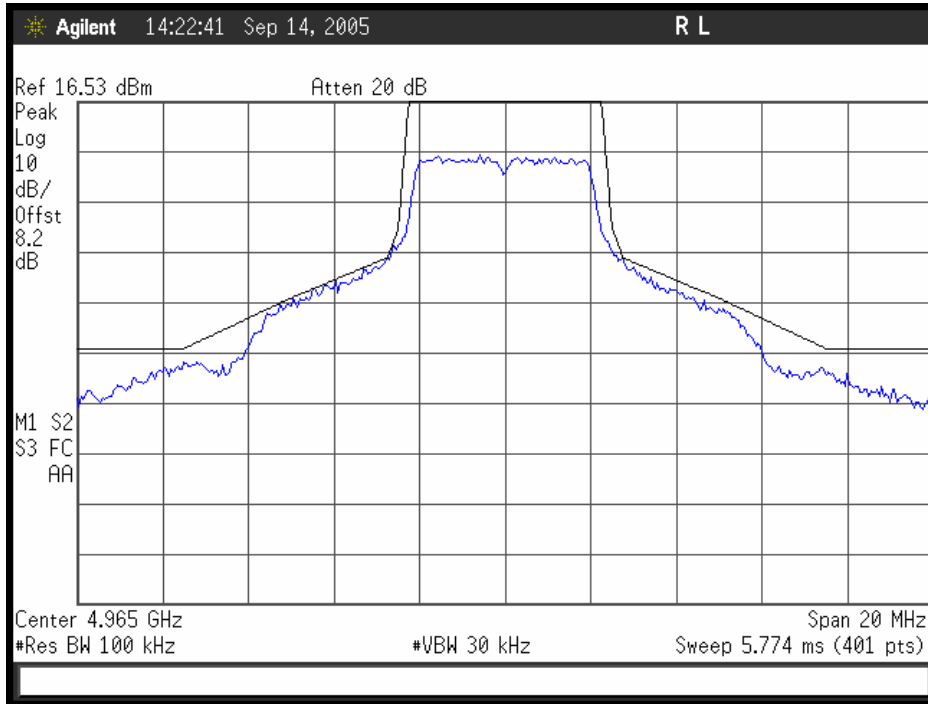

Plot 4. Emission Mask Mid Ch 5MHz BW

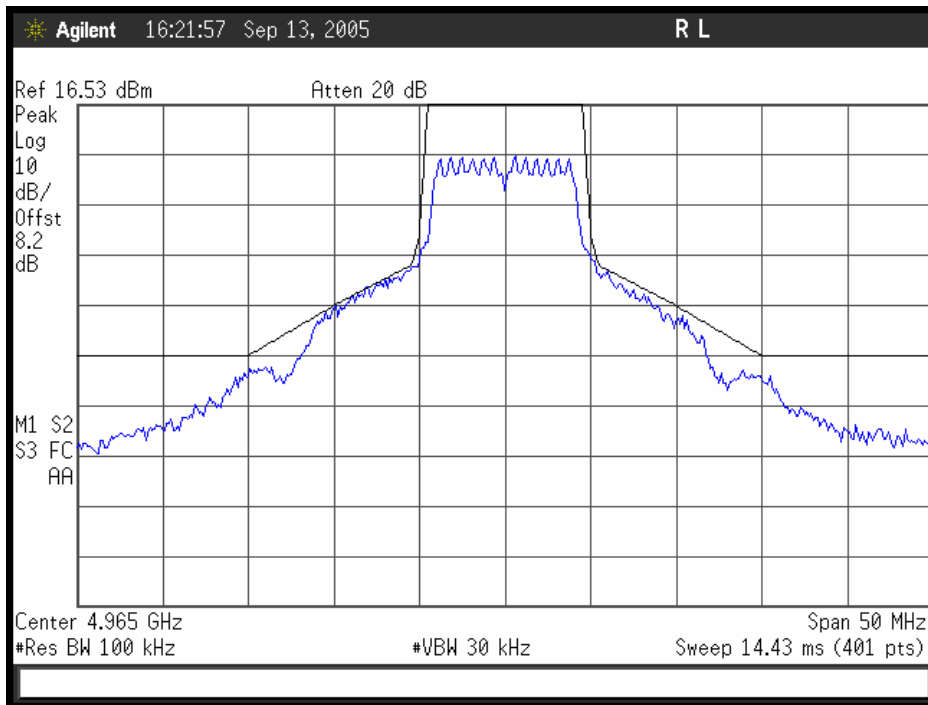

Plot 5. Emission Mask Mid Ch 10MHz BW

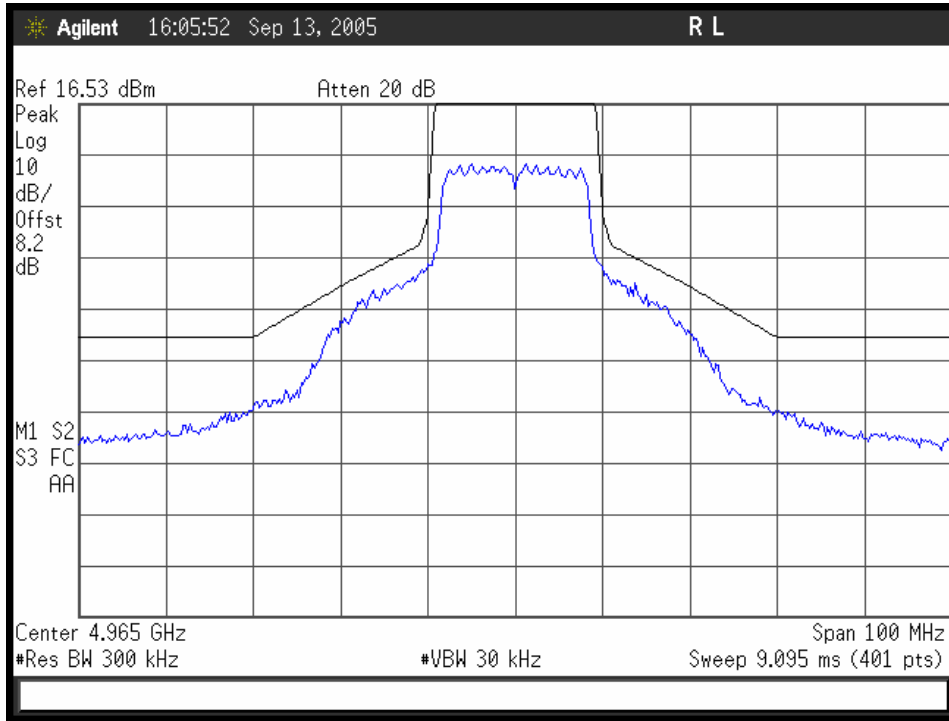

Plot 6. Emission Mask Mid Ch 20MHz BW

Occupied Bandwidth (Emission Masks) Test Setup

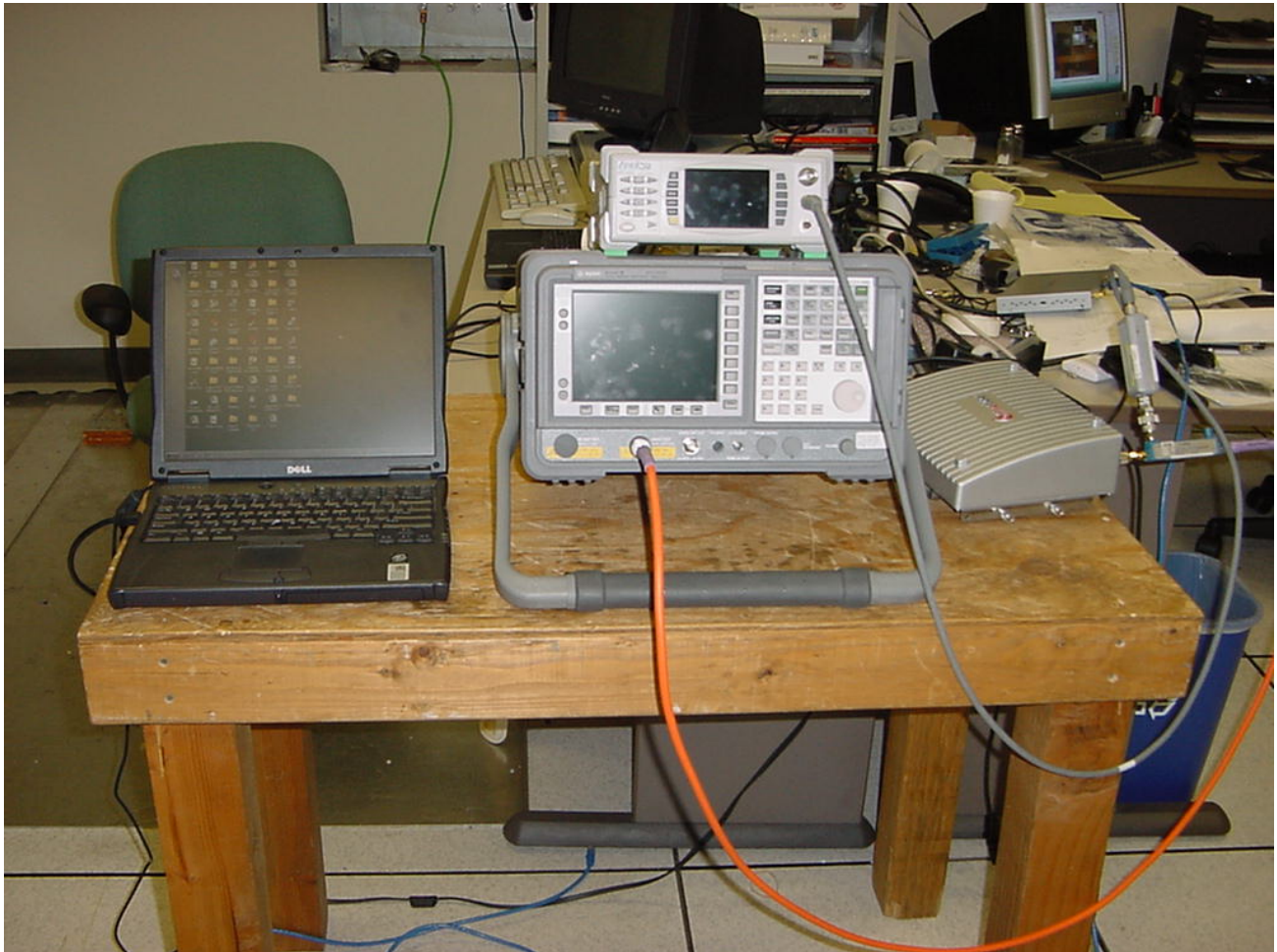

Photograph 2. Occupied Bandwidth (Emission Mask) Test Setup



6. Electromagnetic Compatibility Spurious Emissions at Antenna Terminal Requirements

6.1. Spurious Emissions at Antenna Terminals

Test Requirement(s): §2.1051 and §90.210(L) with FCC 04-265 (Emission Mask M)

Test Procedures: As required by 47 CFR 2.1051, *spurious emissions at antenna terminal measurements* were made at the RF output terminals using a Directional Coupler through a Spectrum Analyzer and Power Meter.

A laptop was connected to EUT to control the RF power output and frequency channel. The EUT was connected to a Spectrum Analyzer and a Power Meter to monitor the output power level. The Spectrum Analyzer was set to a RBW = at least 1% of the channel bandwidth and VBW of 30kHz. The Spectrum Analyzer was set to sweep 30 MHz and up to 10th harmonic of the fundamental or 40GHz which ever is the lesser. Measurements were made at the center channel with band widths of 5, 10 and 20MHz.

The Conducted Spurious Emissions *Limit* is obtained by the following:

Measured Average Power Output of EUT: 16.53dBm

Spur limit = 16.53dBm – 50 dB = – 33.47dBm

Test Results: Equipment complies with Section 2.1051 and 90.210(L) with FCC 04-265 (Emission Mask M). The following pages show measurements of Spurious Emission plots which is recorded below:

Conducted Spurious Emissions			
Plot #	Channel	Channel Frequency(MHz)	Remark:
7	Mid	4965	Frequency swept: 30MHz – 12GHz
8	Mid	4965	Frequency swept: 12 – 2625GHz
9	Mid	4965	Frequency swept: 26.5 – 40 GHz
10	Mid	4965	Frequency swept: 30MHz – 12GHz
11	Mid	4965	Frequency swept: 12 – 2625GHz
12	Mid	4965	Frequency swept: 26.5 – 40 GHz
13	Mid	4965	Frequency swept: 30MHz – 12GHz
14	Mid	4965	Frequency swept: 12 – 2625GHz
15	Mid	4965	Frequency swept: 26.5 – 40 GHz

Test Engineer(s): Shawn McMillen

Test Date(s): 6/7/05

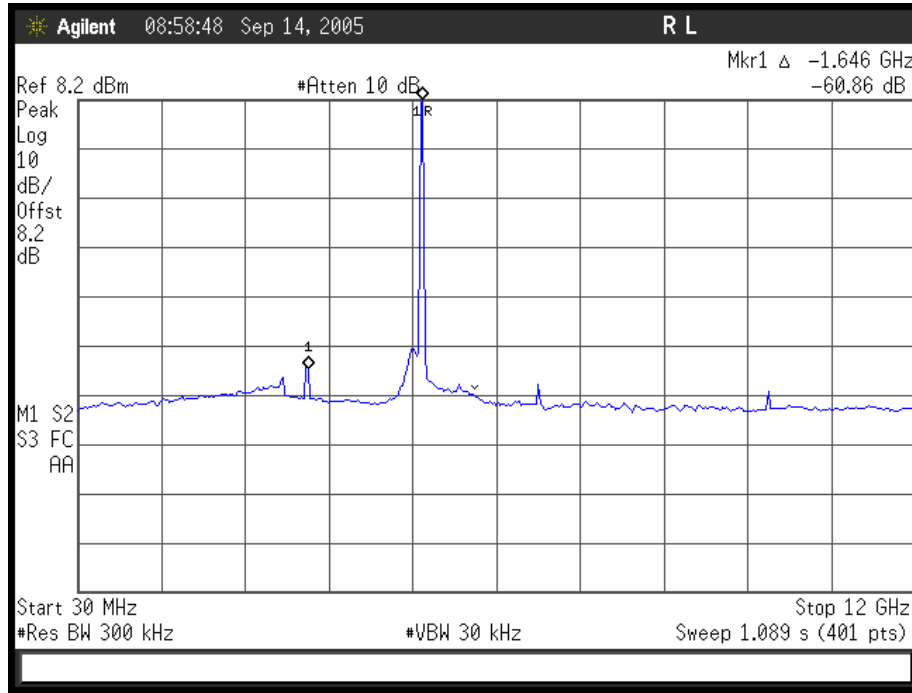

Plot 7. Conducted Spurious Emissions Mid Ch 5MHz BW (30MHz – 12GHz)

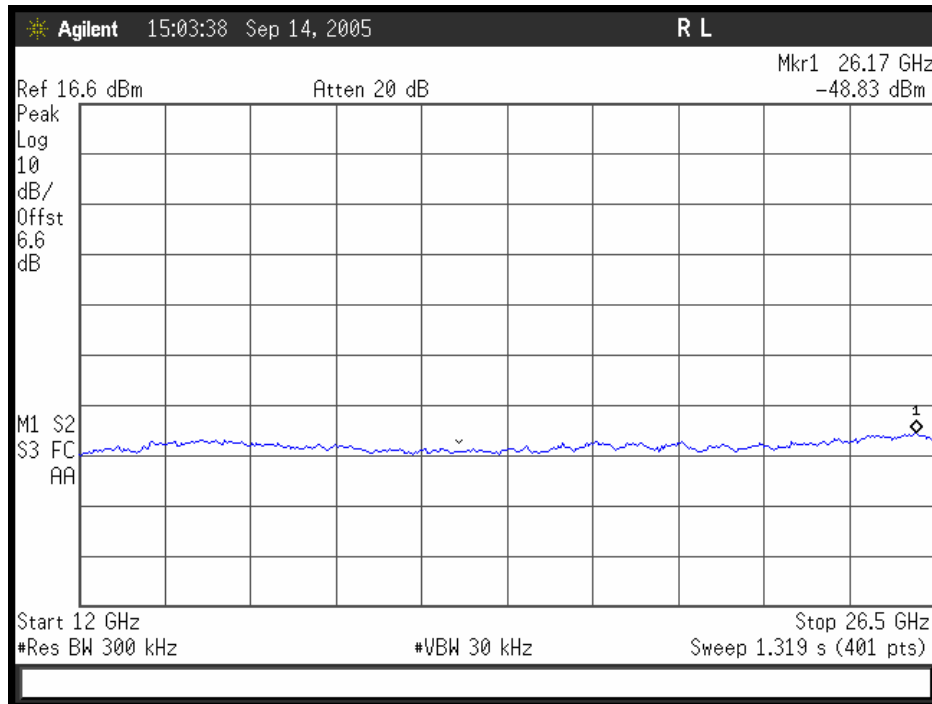

Plot 8. Conducted Spurious Emissions Mid Ch 5MHz BW (12GHz – 26.5GHz)

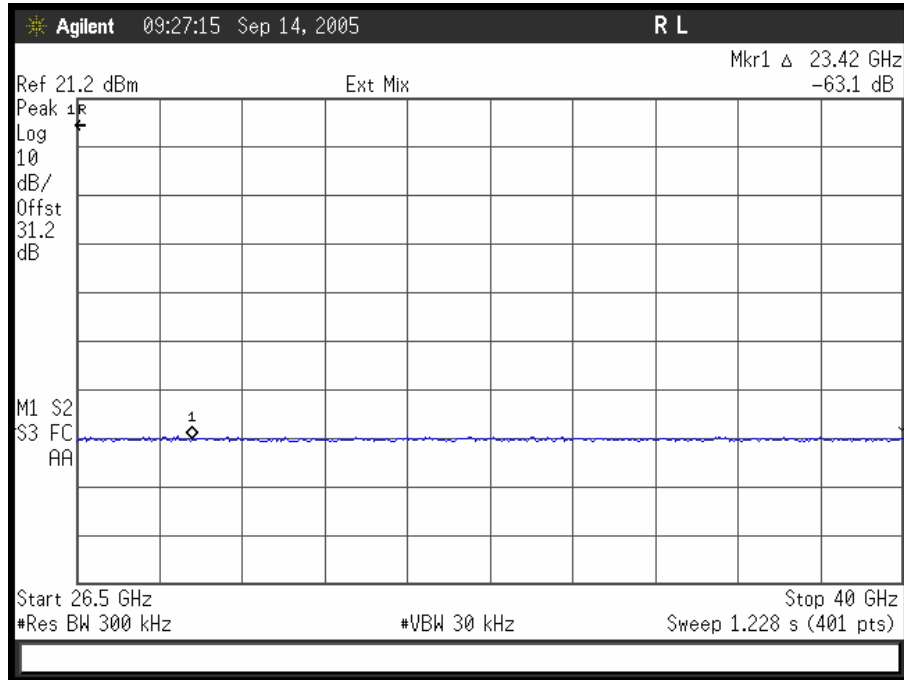

Plot 9. Conducted Spurious Emissions Mid Ch 5MHz BW (26.5GHz – 40GHz)

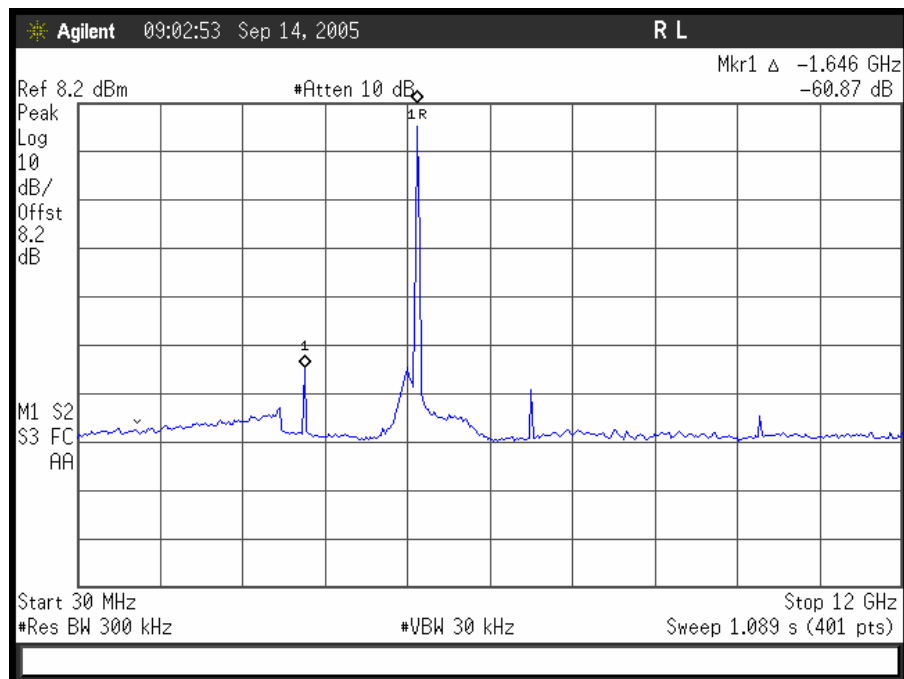

Plot 10. Conducted Spurious Emissions Mid Ch 10MHz BW (30MHz – 12GHz)

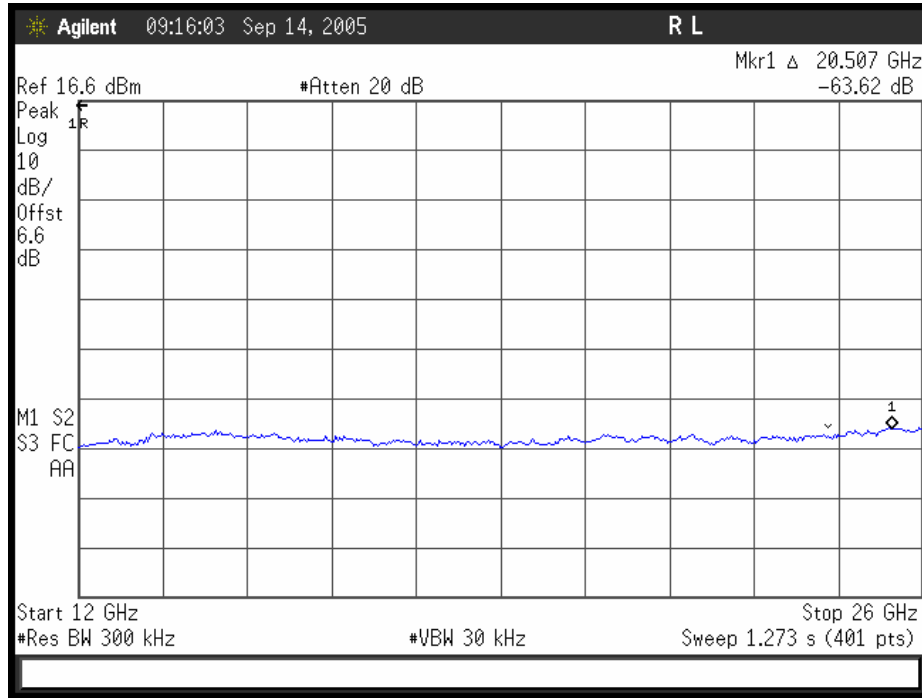

Plot 11. Conducted Spurious Emissions Mid Ch 10MHz BW (12GHz – 26.5GHz)

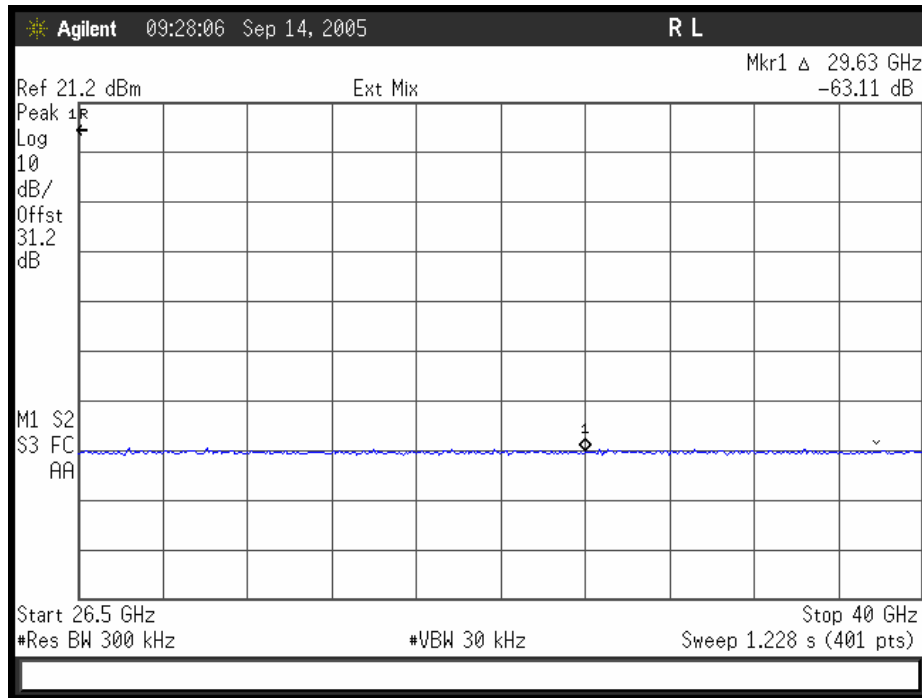

Plot 12. Conducted Spurious Emissions Mid Ch 10MHz BW (26.5GHz – 40GHz)

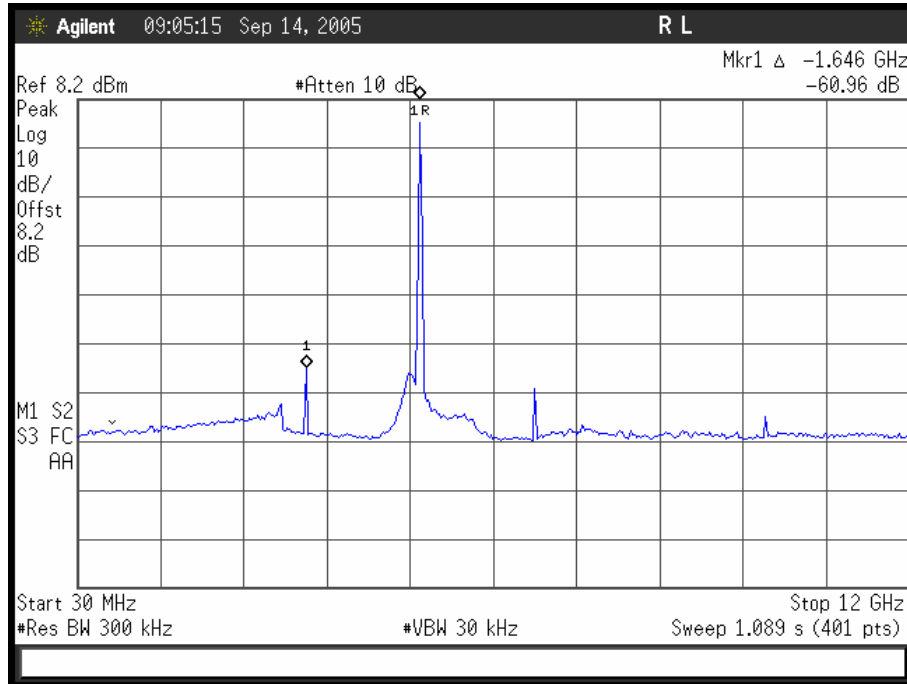

Plot 13. Conducted Spurious Emissions Mid Ch 20MHz BW (30MHz – 12GHz)

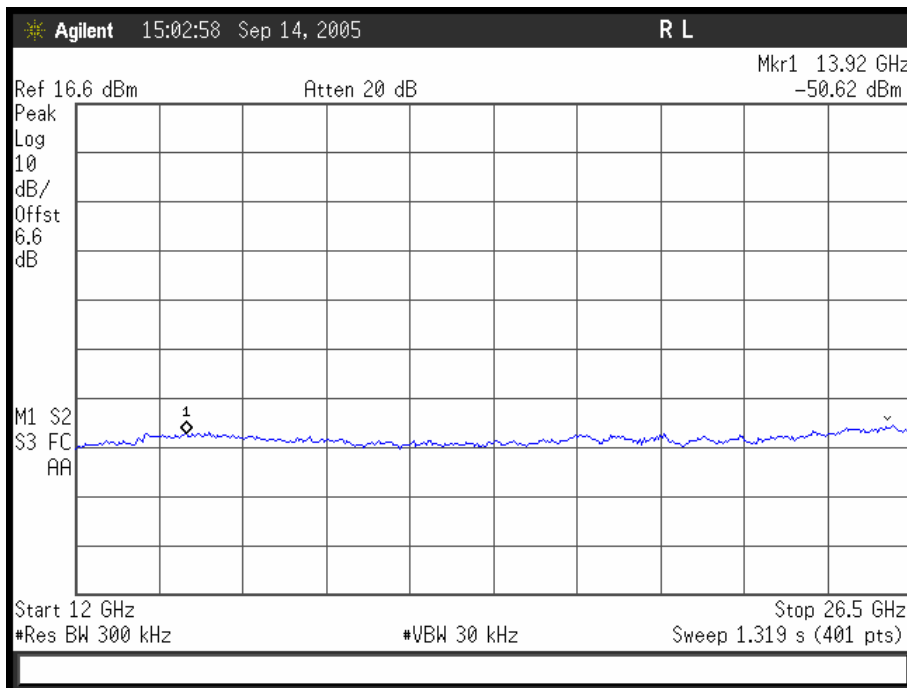

Plot 14. Conducted Spurious Emissions Mid Ch 20MHz BW (12GHz – 26.5GHz)

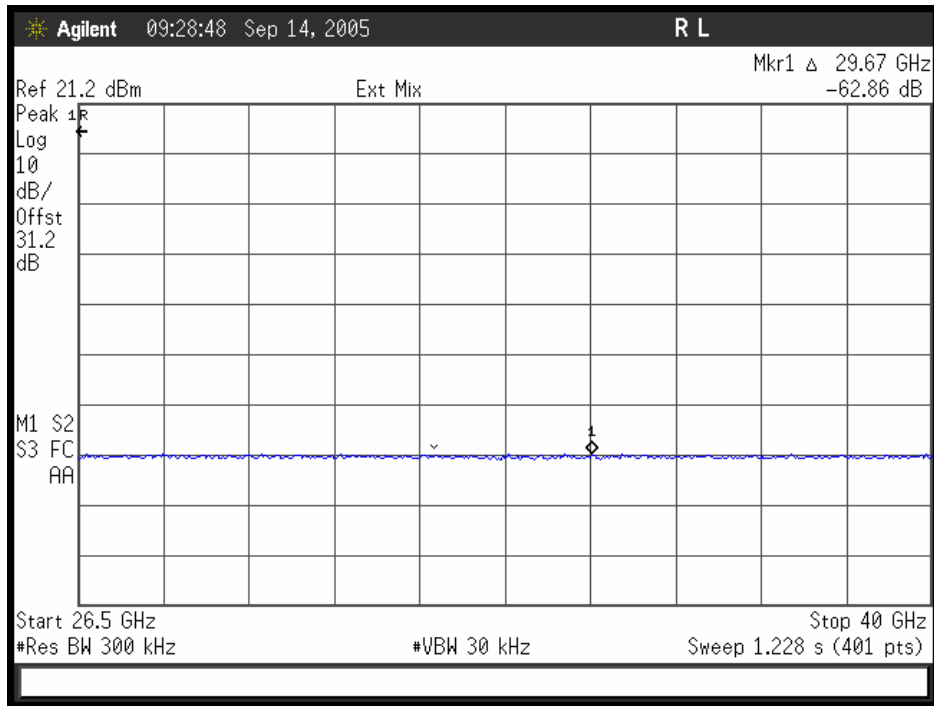

Plot 15. Conducted Spurious Emissions Mid Ch 20MHz BW (26.5GHz – 40 GHz)

Spurious Emissions at Antenna Terminals Test Setup

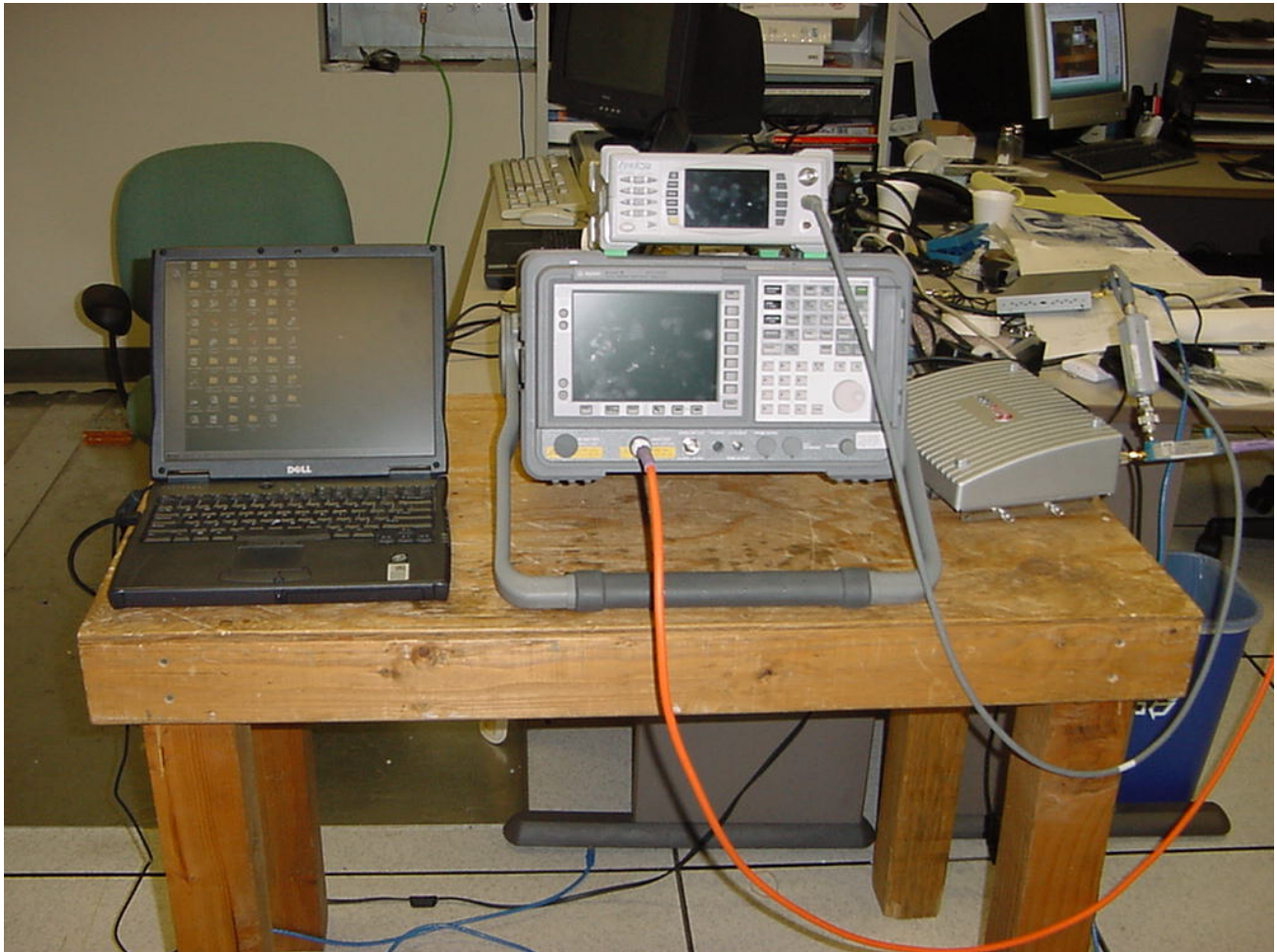

Photograph 3. Spurious Emissions at Antenna Terminals Test Setup



7. Electromagnetic Compatibility Radiated Emissions Requirements

7.1. Radiated Emissions (Substitution Method)

Test Requirement(s): §2.1053 and §90.210(L) with FCC 04-265 (Emission Mask M)

Test Procedures: As required by 47 CFR 2.1053, *field strength of radiated spurious measurements* were made in accordance with the procedures of TIA/EIA-603-A-2001 "Land Mobile FM or PM Communications Equipment Measurement and Performance Standards".

Radiated emission measurements were performed inside a 10 meter semi-anechoic chamber. The EUT was set at a distance of 3m from the receiving antenna. The EUT's RF ports were terminated to 50ohm load. The EUT was set to transmit in the middle of the operating frequency range at its maximum power level. The EUT was rotated about 360⁰ and the receiving antenna scanned from 1-4m in order to capture the maximum emission. A calibrated antenna source was positioned in place of the EUT and the previously recorded signal was duplicated. The maximum EIRP of the emission was calculated by adding the forward power to the calibrated source plus its appropriate gain value. These steps were carried out with the receiving antenna in both vertical and horizontal polarization. Harmonic emissions up to the 10th or 40GHz, which ever was the lesser, were investigated.

The Radiated Spurious Emissions *Limit* is obtained by the following:

Measured Average Power Output of EUT: 16.53dBm

Spur limit = 16.53dBm – 50 dB = – 33.47dBm

Test Results: Equipment complies with Section 2.1053 and 90.210(L) with FCC 04-265 (Emission Mask M). The following pages show measurements of emissions data sheet which is recorded in the following pages:

Test Engineer(s): Shawn McMillen

Test Date(s): 06/15/2005



Radiated Emissions (Substitution Method) Test Results

f_o = 4965 MHz

Frequency (MHz)	Polarization V/H or SNF	Spectrum Analyzer (dBuV)	Signal Generator (dBm)	Cable Loss (dB)	Tx Ant. Gain (dBi)	EIRP (dBm)	Limit (dBm)	Margin (dB)
9390	V and H	SNF	-	-	-	-	-33.47	-
14085	V and H	SNF	-	-	-	-	-33.47	-
18780	V and H	SNF	-	-	-	-	-33.47	-
23475	V and H	SNF	-	-	-	-	-33.47	-
28170	V and H	SNF	-	-	-	-	-33.47	-
32865	V and H	SNF	-	-	-	-	-33.47	-
37560	V and H	SNF	-	-	-	-	-33.47	-

Notes:

SNF = Spectrum Analyzer Noise Floor, **H** = horizontal and **V** = vertical

EIRP = SG reading - CL + Gain (dBi)

Margin = EIRP - Limit

Radiated Emissions Spurious Test Setup

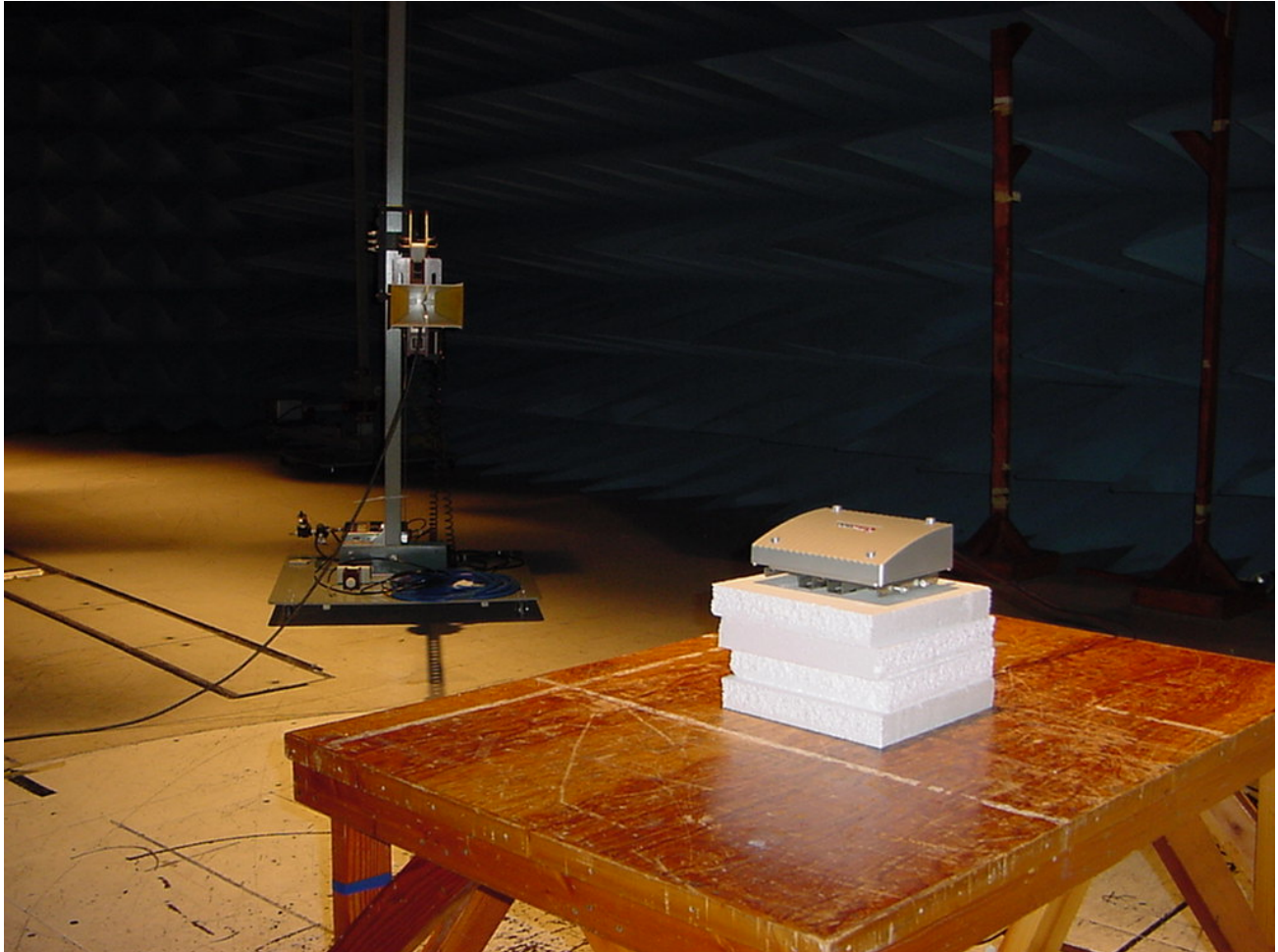

Photograph 4. Radiated Emission Spurious Test Setup



8. Electromagnetic Compatibility Frequency Stability Requirements

8.1. Frequency Stability

Test Requirement(s): §2.1055 and §90.213

Test Procedures: As required by 47 CFR 2.1055, *Frequency Stability measurements* were made at the RF output terminals using a Directional Coupler through a Spectrum Analyzer and Power Meter.

The EUT was placed in the Environmental Chamber and support equipments are outside the chamber on a table. The EUT was set to transmitter at a data rate corresponding to 5MHz BW. The frequency counter option on the Spectrum Analyzer was used to measure frequency deviations. The frequency drift was investigated for every 10^C increment until the unit is stabilized then recorded the reading in tabular format with the temperature range of -30 to 50^C.

Voltage supplied to EUT is 120 VAC reference temperature was done at 20^C. The voltage was varied by ± 15 % of nominal

Test Results: Equipment complies with Section 2.1055 and 90.213. The following pages show measurements of 99% Occupied Bandwidth plot and Frequency Drift data sheet which is recorded below:

Test Engineer(s): Shawn McMillen

Test Date(s): 06/09/2005



Frequency Stability Test Results

Reference Freq.: 4967.770010 MHz at 20°C

Temperature (Celsius)	Measured Freq (MHz)	Drift ppm
50	4967.772635	0.53
40	4967.777273	1.46
30	4967.772601	0.52
20	Reference	
10	4967.775118	1.03
0	4967.771145	0.23
-10	4967.774187	0.84
-20	4967.772190	0.44
-30	4967.770881	0.18

Table 4. Temperature Vs. Frequency Test Results

Reference: 120Vac at 20°C Freq. = 4967.770010 MHz at 20°C

Measured Voltage(dc) +/-15% of nominal	Measured Freq (MHz)	Drift (Hz)
102	4967.770209	0.04
138	4967.776155	1.24

Table 5. Frequency Vs. Voltage Test Results



9. Electromagnetic Compatibility Transient Frequency Behavior Requirements

9.1. Transient Frequency Behavior

Test Requirement(s): §90.214

Test Procedures: As required by 47 CFR 90.214, *Transient Frequency Behavior measurements* were made at the ON/OFF switch terminal.

Test Results: EUT is not required for this test.
The EUT operating frequency is at 4.9 GHz.



10. Test Equipment

Calibrated test equipment utilized during testing was maintained in a current state of calibration per the requirements of ANSI/NCSL Z540-1-1994 and ANSI/ISO/IEC 17025:2000.

Test Name: RF Power Output, PPSD & Emission Masks			Test Date(s): 09/14/2005		
MET Asset #	Nomenclature	Manufacturer	Model	Last Cal Date	Cal Due Date
1S2430	Power Meter	Anritsu Company	ML2488A	01/12/2005	01/12/2006
1S2432	Power Sensor	Anritsu Company	MA2491A	01/12/2005	01/12/2006
1S2460	Analyzer, Spectrum 9 kHz-40GHz	Agilent	E4407B	07/06/2005	07/06/2008
1S2001	DC Power Supply	Hewlett Packard	6236B	See Note	
N/A	10 dB Attenuator	Weinschel Corporation	33-10-34	See Note	
1S2034	Coupler, Directional 1-20 GHz	KRYTAR	101020020	See Note	
Test Name: Spurious Emissions at Antenna Terminals			Test Date(s): 6/7/05		
MET Asset #	Nomenclature	Manufacturer	Model	Last Cal Date	Cal Due Date
1S2430	Power Meter	Anritsu Company	ML2488A	01/12/2005	01/12/2006
1S2432	Power Sensor	Anritsu Company	MA2491A	01/12/2005	01/12/2006
1S2460	Analyzer, Spectrum 9 kHz-40GHz	Agilent	E4407B	07/06/2005	07/06/2008
N/A	10 dB Attenuator	Weinschel Corporation	33-10-34	See Note	
1S2041	Coupler, Bi Directional Coaxial	NARDA	N/A	See Note	
1S2034	Coupler, Directional 1-20 GHz	KRYTAR	101020020	See Note	
1S2001	DC Power Supply	Hewlett Packard	6236B	See Note	
Test Name: Frequency Stability			Test Date(s): 6/9/05		
MET Asset #	Nomenclature	Manufacturer	Model	Last Cal Date	Cal Due Date
1S2430	Power Meter	Anritsu Company	ML2488A	01/12/2005	01/12/2006
1S2432	Power Sensor	Anritsu Company	MA2491A	01/12/2005	01/12/2006
1S2460	Analyzer, Spectrum 9 kHz-40GHz	Agilent	E4407B	07/06/2005	07/06/2008
N/A	10 dB Attenuator	Weinschel Corporation	33-10-34	See Note	
1S2034	Coupler, Directional 1-20 GHz	KRYTAR	101020020	See Note	
1S2001	DC Power Supply	Hewlett Packard	6236B	See Note	
1S22100	Digital Multi Meter	Fluke	77 Series II	09/22/2004	09/22/2005
1S2229	Chamber, Temperature	Tenny Engineering	T63C	10/21/2004	10/21/2005



Firetide
Hotport Wireless Mesh Node Router, Model 3203

Electromagnetic Compatibility
Test Equipment
CFR Title 47, Part 90, Subpart Y

Test Name: Radiated Emissions (Substitution Method)			Test Date(s): 6/15/05		
MET Asset #	Nomenclature	Manufacturer	Model	Last Cal Date	Cal Due Date
1S2263	Chamber, 10 Meter	Rantec	N2-14	07/25/2005	07/25/2006
1S2460	Analyzer, Spectrum 9 kHz-40GHz	Agilent	E4407B	07/06/2005	07/06/2008
1S2278	Generator, Swept Signal	Hewlett Packard	83650B	06/11/2004	06/11/2005
1U7	Antenna, Horn	EMCO	3115	02/23/2005	02/23/2006
1S2198	Antenna, Horn	EMCO	3115	06/22/2004	06/22/2005
1S2129	Mixer, Harmonic	Hewlett Packard	11970K	03/10/2003	03/10/2006
1S2128	Mixer, Harmonic	Hewlett Packard	11970A	03/10/2003	03/10/2006
1S2121	Pre-Amplifier	Hewlett Packard	8449B	10/14/2004	10/14/2005
N/A	7 GHz High Pass Filter	Micro-Tronics	HPM13147	See Note	

Note: Functionally tested equipment is verified using calibrated instrumentation at the time of testing.



11. RF Exposure Requirements

RF Exposure Requirements: §90.1217, §1.1307(b)(1) and §1.1307(b)(2): Systems operating under the provisions of this section shall be operated in a manner that ensures that the public is not exposed to radio frequency energy levels in excess of the Commission's guidelines.

RF Radiation Exposure Limit: §1.1310: As specified in this section, the Maximum Permissible Exposure (MPE) Limit shall be used to evaluate the environmental impact of human exposure to radiofrequency (RF) radiation as specified in Sec. 1.1307(b), except in the case of portable devices which shall be evaluated according to the provisions of Sec. 2.1093 of this chapter.

MPE Limit Calculation: EUT's operating frequencies @ 4950 - 4980 MHz;
conducted power = 22.67dBm (peak) with maximum antenna gain of 18dBi.
Therefore, **Limit for Uncontrolled exposure: 1 mW/cm² or 10 W/m²**

Equation from page 18 of OET 65, Edition 97-01

$$S = PG / 4\pi R^2 \quad \text{or} \quad R = \sqrt{PG} / 4\pi S$$

where, S = Power Density (10 W/m²)
P = Power Input to antenna (0.185 Watts)
G = Antenna Gain (63 numeric)
R = distance to the center of radiation of the antenna (in meter)

$$R = \sqrt{0.185W * 63dB} / 4 * 3.14 * (10 W/m^2) = 0.305m$$

The distance between the human and the RF antenna should not be less than 0.305m.



12. Certification Label & User's Manual Information

12.1. Certification Information

The following is extracted from Title 47 of the Code of Federal Regulations, Part 2, Subpart I — Marketing of Radio frequency devices:

§ 2.801 Radio-frequency device defined.

As used in this part, a radio-frequency device is any device which in its operation is capable of Emitting radio-frequency energy by radiation, conduction, or other means. Radio- frequency devices include, but are not limited to:

- (a) The various types of radio communication transmitting devices described throughout this chapter.
- (b) *The incidental, unintentional and intentional radiators defined in Part 15 of this chapter.*
- (c) The industrial, scientific, and medical equipment described in Part 18 of this chapter.
- (d) Any part or component thereof which in use emits radio-frequency energy by radiation, conduction, or other means.

§ 2.803 Marketing of radio frequency devices prior to equipment authorization.

- (a) Except as provided elsewhere in this chapter, no person shall sell or lease, or offer for sale or lease (including advertising for sale or lease), or import, ship or distribute for the purpose of selling or leasing or offering for sale or lease, any radio frequency device unless:
 - (1) In the case of a device subject to certification, such device has been authorized by the Commission in accordance with the rules in this chapter and is properly identified and labeled as required by §2.925 and other relevant sections in this chapter; or
 - (2) In the case of a device that is not required to have a grant of equipment authorization issued by the Commission, but which must comply with the specified technical standards prior to use, such device also complies with all applicable administrative (including verification of the equipment or authorization under a Declaration of Conformity, where required), technical, labeling and identification requirements specified in this chapter.
- (d) Notwithstanding the provisions of paragraph (a) of this section, the offer for sale solely to business, commercial, industrial, scientific or medical users (but not an offer for sale to other parties or to end users located in a residential environment) of a radio frequency device that is in the conceptual, developmental, design or pre-production stage is permitted prior to equipment authorization or, for devices not subject to the equipment authorization requirements, prior to a determination of compliance with the applicable technical requirements *provided* that the prospective buyer is advised in writing at the time of the offer for sale that the equipment is subject to the FCC rules and that the equipment will comply with the appropriate rules before delivery to the buyer or to centers of distribution.



- (e)(1) Notwithstanding the provisions of paragraph (a) of this section, prior to equipment authorization or determination of compliance with the applicable technical requirements any radio frequency device may be operated, but not marketed, for the following purposes and under the following conditions:
- (i) *Compliance testing;*
 - (ii) Demonstrations at a trade show provided the notice contained in paragraph (c) of this section is displayed in a conspicuous location on, or immediately adjacent to, the device;
 - (iii) Demonstrations at an exhibition conducted at a business, commercial, industrial, scientific or medical location, but excluding locations in a residential environment, provided the notice contained in paragraphs (c) or (d) of this section, as appropriate, is displayed in a conspicuous location on, or immediately adjacent to, the device;
 - (iv) Evaluation of product performance and determination of customer acceptability, provided such operation takes place at the manufacturer's facilities during developmental, design or pre-production states; or
 - (v) Evaluation of product performance and determination of customer acceptability where customer acceptability of a radio frequency device cannot be determined at the manufacturer's facilities because of size or unique capability of the device, provided the device is operated at a business, commercial, industrial, scientific or medical user's site, but not at a residential site, during the development, design or pre-production stages.
- (e)(2) For the purpose of paragraphs (e)(1)(iv) and (e)(1)(v) of this section, the term *manufacturer's facilities* includes the facilities of the party responsible for compliance with the regulations and the manufacturer's premises, as well as the facilities of other entities working under the authorization of the responsible party in connection with the development and manufacture, but not the marketing, of the equipment.
- (f) For radio frequency devices subject to verification and sold solely to business, commercial, industrial, scientific and medical users (excluding products sold to other parties or for operation in a residential environment), parties responsible for verification of the devices shall have the option of ensuring compliance with the applicable technical specifications of this chapter at each end user's location after installation, provided that the purchase or lease agreement includes a provision that such a determination of compliance be made and is the responsibility of the party responsible for verification of the equipment.



The following is extracted from Title 47 of the Code of Federal Regulations, Part 2, Subpart Y — Equipment Authorization Procedures:

§ 2.901 Basis and Purpose

- (a) In order to carry out its responsibilities under the Communications Act and the various treaties and international regulations, and in order to promote efficient use of the radio spectrum, the Commission has developed technical standards for radio frequency equipment and parts or components thereof. The technical standards applicable to individual types of equipment are found in that part of the rules governing the service wherein the equipment is to be operated.¹ *In addition to the technical standards provided, the rules governing the service may require that such equipment be verified by the manufacturer or importer, be authorized under a Declaration of Conformity, or receive an equipment authorization from the Commission by one of the following procedures: certification or registration.*

- (b) The following sections describe the verification procedure, the procedure for a Declaration of Conformity, and the procedures to be followed in obtaining certification from the Commission and the conditions attendant to such a grant, whichever is applicable.

§ 2.902 Certification.

- (a) Certification is an equipment authorization issued by the Commission, based on representation and test data submitted by the applicant.

- (b) Certification attaches to all units subsequently marketed by the grantee which are identical (see Section 2.908) to the sample tested except for permissive changes or other variations authorized by the Commission pursuant to Section 2.1043.

¹ In this case, the equipment is subject to the rules of Part 15. More specifically, the equipment falls under Subpart B (of Part 15), which deals with unintentional radiators.



§ 2.948 Description of measurement facilities.

- (a) Each party making measurements of equipment that is subject to an equipment authorization under Part 15 or Part 18 of this chapter, regardless of whether the measurements are filed with the Commission or kept on file by the party responsible for compliance of equipment marketed within the U.S. or its possessions, shall compile a description of the measurement facilities employed.
- (1) If the measured equipment is subject to the verification procedure, the description of the measurement facilities shall be retained by the party responsible for verification of the equipment.
- (i) *If the equipment is verified through measurements performed by an independent laboratory, it is acceptable for the party responsible for verification of the equipment to rely upon the description of the measurement facilities retained by or placed on file with the Commission by that laboratory. In this situation, the party responsible for the verification of the equipment is not required to retain a duplicate copy of the description of the measurement facilities.*
- (ii) If the equipment is verified based on measurements performed at the installation site of the equipment, no specific site calibration data is required. It is acceptable to retain the description of the measurement facilities at the site at which the measurements were performed.
- (2) If the equipment is to be authorized by the Commission under the certification procedure, the description of the measurement facilities shall be filed with the Commission's Laboratory in Columbia, Maryland. The data describing the measurement facilities need only be filed once but must be updated as changes are made to the measurement facilities or as otherwise described in this section. At least every three years, the organization responsible for filing the data with the Commission shall certify that the data on file is current.



12.2. Label and User's Manual Information

The following is extracted from Title 47 of the Code of Federal Regulations, Part 15, Subpart A — General:

§ 15.19 Labeling requirements.

(a) *In addition to the requirements in Part 2 of this chapter, a device subject to certification or verification shall be labeled as follows:*

- (1) Receivers associated with the operation of a licensed radio service, e.g., FM broadcast under Part 73 of this chapter, land mobile operation under Part 90, etc., shall bear the following statement in a conspicuous location on the device:

This device complies with Part 15 of the FCC Rules. Operation is subject to the condition that this device does not cause harmful interference.

- (2) A stand-alone cable input selector switch, shall bear the following statement in a conspicuous location on the device:

This device is verified to comply with Part 15 of the FCC Rules for use with cable television service.

- (3) All other devices shall bear the following statement in a conspicuous location on the device:

This device complies with Part 15 of the FCC Rules. Operation is subject to the following two conditions: (1) This device may not cause harmful interference, and (2) this device must accept any interference received, including interference that may cause undesired operation.

- (4) Where a device is constructed in two or more sections connected by wires and marketed together, the statement specified under paragraph (a) of this section is required to be affixed only to the main control unit.

- (5) When the device is so small or for such use that it is not practicable to place the statement specified under paragraph (a) of this section on it, the information required by this paragraph shall be placed in a prominent location in the instruction manual or pamphlet supplied to the user or, alternatively, shall be placed on the container in which the device is marketed. However, the FCC identifier or the unique identifier, as appropriate, must be displayed on the device.



§ 15.21 Information to user.

The users manual or instruction manual for an intentional or unintentional radiator shall caution the user that changes or modifications not expressly approved by the party responsible for compliance could void the user's authority to operate the equipment.

The following is extracted from Title 47 of the Code of Federal Regulations, Part 15, Subpart B — Unintentional Radiators:

§ 15.105 Information to the user.

- (a) For a Class B digital device or peripheral, the instructions furnished the user shall include the following or similar statement, placed in a prominent location in the text of the manual:

Note: This equipment has been tested and found to comply with the limits for a Class B digital device, pursuant to Part 15 of the FCC Rules. These limits are designed to provide reasonable protection against harmful interference when the equipment is operated in a residential environment. This equipment generates, uses, and can radiate radio frequency energy and, if not installed and used in accordance with the instruction manual, may cause harmful interference to radio communications. However, there is no guarantee that interference will not occur in a particular installation. If this equipment does cause harmful interference to radio or television reception, which can be determined by turning the equipment off and on, the user is encouraged to try to correct the interference by one or more of the following measures:

- Reorient or relocate the receiving antenna.
- Increase the separation between the equipment and receiver.
- Connect the equipment into an outlet on a circuit different from that to which the receiver is connected.
- Consult the dealer or an experienced radio/TV technician for help.



**Firetide
Hotport Wireless Mesh Node Router, Model 3203**

**Electromagnetic Compatibility
Certification Label & User's Manual Information
CFR Title 47, Part 90, Subpart Y**

End of Report