

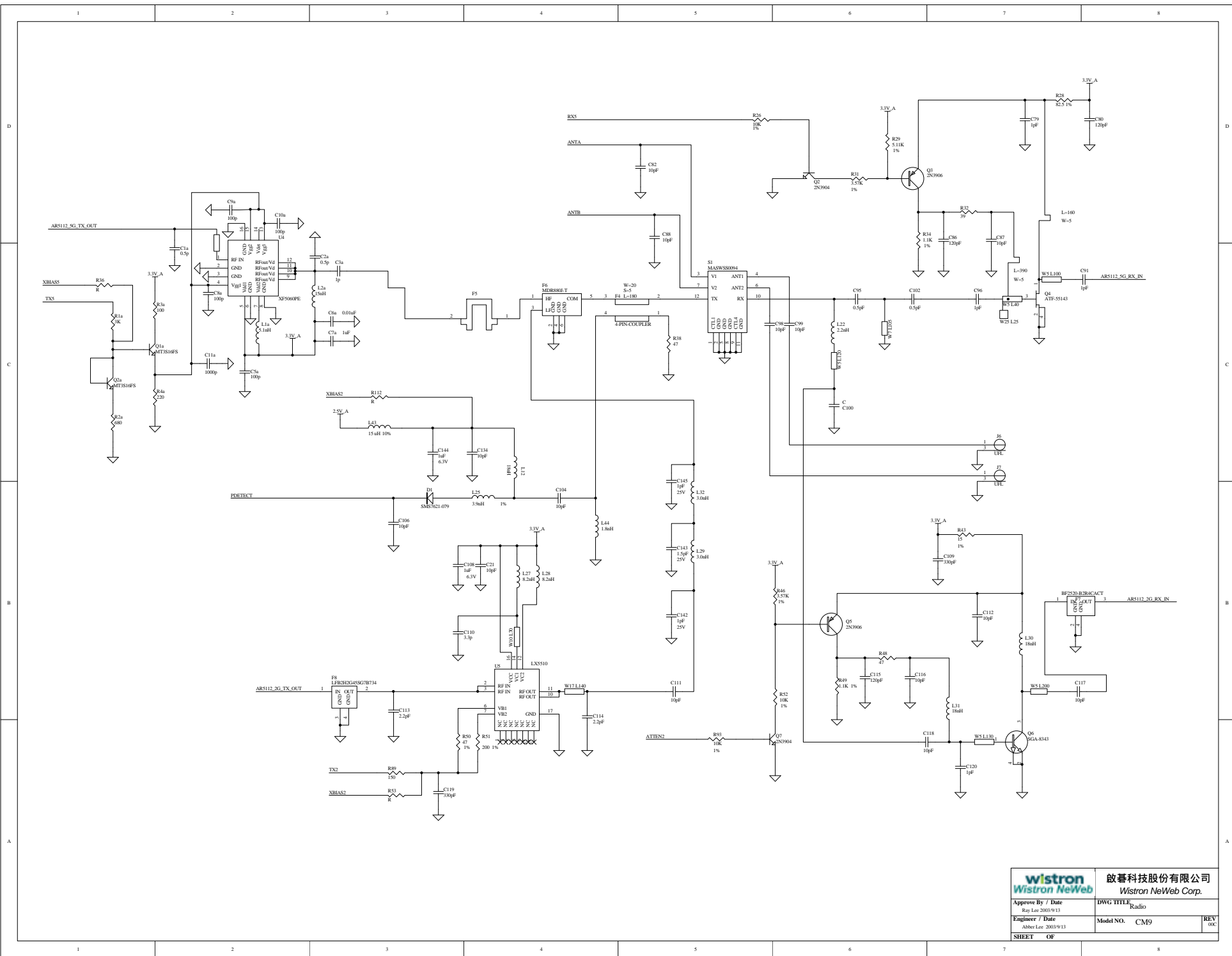

		啟碁科技股份有限公司 Wistron NeWeb Corp.	
Approve By / Date Ray.lee 11/12.2003	DWG TITLE AR5112		
Engineer / Date Abbr Lee 11/12.2003	Model NO. CM9	REV 00C	
SHEET 2 OF 4			



		<b>啟碁科技股份有限公司</b> Wistron NeWeb Corp.	
Approve By / Date Ray Lee 2003/9/13	DWG TITLE Radio		
Engineer / Date Amber Lee 2003/9/13	Model NO. CM9	REV 00	
SHEET OF			

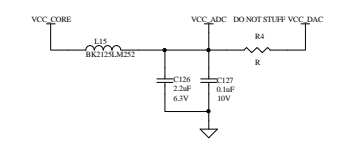
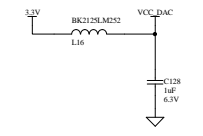
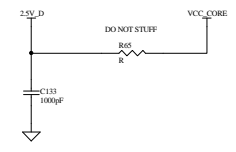
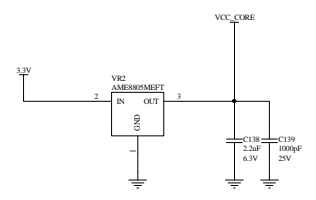
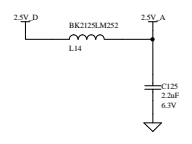
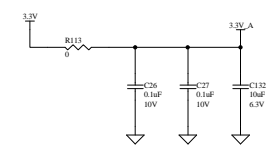
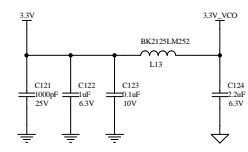
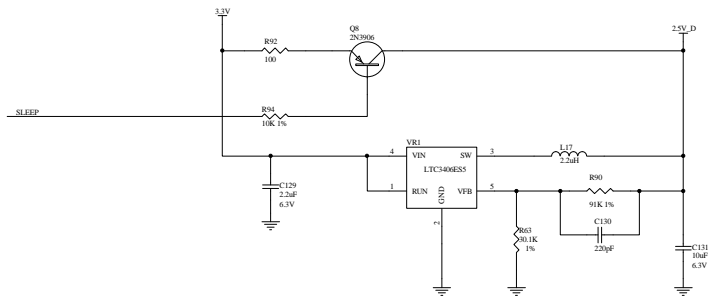

		啟碁科技股份有限公司 Wistron NeWeb Corp.	
Approve By / Date Ray Lee 12/12/2003	DWG TITLE Power and Miscellaneous		
Engineer / Date Ryan Lee 12/12/2003	Model NO. CM9	REV 001	REV 001
SHEET 1 OF 4			