

*Electromagnetic Emissions Test Report  
and  
Application for Grant of Equipment Authorization  
Class II Permissive Change  
pursuant to  
Industry Canada RSS-Gen Issue 2 / RSS 210 Issue 7  
FCC Part 15, Subpart E  
on the  
Meru Networks  
Transmitter  
Model: RS-4000*

UPN: 6749A-RS4000  
FCC ID: RE7-RS4000

GRANTEE: Meru Networks  
1309 S. Mary Ave  
Sunnyvale, CA 94087

TEST SITE: Elliott Laboratories, Inc.  
684 W. Maude Ave  
Sunnyvale, CA 94086

REPORT DATE: January 2, 2007

FINAL TEST DATE: October 16, October 17, November 29  
and December 7, 2007

AUTHORIZED SIGNATORY:



Mark E. Hill  
Staff Engineer



2016-01

Elliott Laboratories, Inc. is accredited by the A2LA, certificate number 2016-01, to perform the test(s) listed in this report. This report shall not be reproduced, except in its entirety, without the written approval of Elliott Laboratories, Inc.

**REVISION HISTORY**

Revision #	Date	Comments	Modified By
1	January 10, 2008	Initial Release	David Guidotti

**TABLE OF CONTENTS**

**COVER PAGE.....1**

**REVISION HISTORY .....2**

**TABLE OF CONTENTS .....3**

**SCOPE.....5**

**OBJECTIVE .....6**

**STATEMENT OF COMPLIANCE.....6**

**TEST RESULTS SUMMARY .....7**

    UNII / LELAN DEVICES .....7

    GENERAL REQUIREMENTS APPLICABLE TO ALL BANDS .....8

**MEASUREMENT UNCERTAINTIES .....8**

**EQUIPMENT UNDER TEST (EUT) DETAILS .....9**

    GENERAL.....9

    ANTENNA SYSTEM .....9

    ENCLOSURE.....9

    MODIFICATIONS.....9

    SUPPORT EQUIPMENT.....9

    EUT INTERFACE PORTS .....10

    EUT OPERATION .....10

**PROPOSED MODIFICATION DETAILS.....10**

    GENERAL.....10

**TEST SITE.....11**

    GENERAL INFORMATION.....11

    RADIATED EMISSIONS CONSIDERATIONS .....11

**MEASUREMENT INSTRUMENTATION .....12**

    RECEIVER SYSTEM .....12

    INSTRUMENT CONTROL COMPUTER.....12

    FILTERS/ATTENUATORS .....13

    ANTENNAS.....13

    ANTENNA MAST AND EQUIPMENT TURNTABLE.....13

    INSTRUMENT CALIBRATION.....13

**TEST PROCEDURES .....14**

    EUT AND CABLE PLACEMENT .....14

    RADIATED EMISSIONS.....14

    RADIATED EMISSIONS.....15

    BANDWIDTH MEASUREMENTS .....17

    SPECIFICATION LIMITS AND SAMPLE CALCULATIONS.....18

    GENERAL TRANSMITTER RADIATED EMISSIONS SPECIFICATION LIMITS .....18

    FCC 15.407 (A) OUTPUT POWER LIMITS.....19

    OUTPUT POWER AND SPURIOUS LIMITS –UNII DEVICES .....19

    SAMPLE CALCULATIONS - RADIATED EMISSIONS .....20

    SAMPLE CALCULATIONS - FIELD STRENGTH TO EIRP CONVERSION .....21

---

**TABLE OF CONTENTS (Continued)**

*EXHIBIT 1: Test Equipment Calibration Data..... 1*  
*EXHIBIT 2: Test Measurement Data..... 2*  
*EXHIBIT 3: Photographs of Test Configurations..... 3*  
*EXHIBIT 4: Proposed FCC ID Label & Label Location ..... 4*  
*EXHIBIT 5: Detailed Photographs..... 5*  
*EXHIBIT 6: Operator's Manual ..... 6*  
*EXHIBIT 7: Block Diagram..... 7*  
*EXHIBIT 8: Schematic Diagrams..... 8*  
*EXHIBIT 9: Theory of Operation ..... 9*  
*EXHIBIT 10: Advertising Literature..... 10*  
*EXHIBIT 11: RF Exposure Information ..... 11*

---

**SCOPE**

An electromagnetic emissions test has been performed on the Meru Networks model RS-4000 pursuant to the following rules:

Industry Canada RSS-Gen Issue 2  
RSS 210 Issue 7 “Low-power Licence-exempt Radiocommunication Devices (All Frequency Bands): Category I Equipment”  
CC Part 15, Subpart E requirements for UNII Devices

Conducted and radiated emissions data has been collected, reduced, and analyzed within this report in accordance with measurement guidelines set forth in the following reference standards and as outlined in Elliott Laboratories test procedures:

The intentional radiator above has been tested in a simulated typical installation to demonstrate compliance with the relevant Industry Canada performance and procedural standards.

Final system data was gathered in a mode that tended to maximize emissions by varying orientation of EUT, orientation of power and I/O cabling, antenna search height, and antenna polarization.

Every practical effort was made to perform an impartial test using appropriate test equipment of known calibration. All pertinent factors have been applied to reach the determination of compliance.

The test results recorded herein are based on a single type test of the Meru Networks model RS-4000 and therefore apply only to the tested sample. The sample was selected and prepared by John Dorsey of Meru Networks.

## **OBJECTIVE**

The primary objective of the manufacturer is compliance with the regulations outlined in the previous section.

Prior to marketing in the USA, all unlicensed transmitters and transceivers require certification. Receive-only devices operating between 30 MHz and 960 MHz are subject to either certification or a manufacturer's declaration of conformity, with all other receive-only devices exempt from the technical requirements.

Prior to marketing in Canada, Class I transmitters, receivers and transceivers require certification. Class II devices are required to meet the appropriate technical requirements but are exempt from certification requirements.

Certification is a procedure where the manufacturer submits test data and technical information to a certification body and receives a certificate or grant of equipment authorization upon successful completion of the certification body's review of the submitted documents. Once the equipment authorization has been obtained, the label indicating compliance must be attached to all identical units, which are subsequently manufactured.

Maintenance of compliance is the responsibility of the manufacturer. Any modification of the product which may result in increased emissions should be checked to ensure compliance has been maintained (i.e., printed circuit board layout changes, different line filter, different power supply, harnessing or I/O cable changes, etc.).

## **STATEMENT OF COMPLIANCE**

The tested sample of Meru Networks model RS-4000 complied with the requirements of the following regulations:

RSS 210 Issue 7 "Low-power Licence-exempt Radiocommunication Devices (All Frequency Bands): Category I Equipment"  
CC Part 15, Subpart E requirements for UNII Devices

Maintenance of compliance is the responsibility of the manufacturer. Any modification of the product which may result in increased emissions should be checked to ensure compliance has been maintained (i.e., printed circuit board layout changes, different line filter, different power supply, harnessing or I/O cable changes, etc.).

**TEST RESULTS SUMMARY****UNII / LELAN DEVICES****Operation in the 5.25 – 5.35 GHz Band**

FCC Rule Part	RSS Rule Part	Description	Measured Value / Comments	Limit / Requirement	Result (margin)
15.407(a)(2)		26dB Bandwidth	26.0 MHz		N/A
15.407(a)(2)	A9.2(2)	Output Power	11.6 dBm ( 0.014 W)	250mW or 10Log (26dB BW)	Complies
15.407(a)(2)	A9.2(2)	Power Spectral Density	-1.24 dBm/MHz	11 dBm/MHz	Complies
	A9.5b	Peak Spectral Density	-1.24 dBm/MHz	Shall not exceed the average value by more than 3dB	Complies
15.407(a)(2)	A9.4	Dynamic frequency selection / Transmit power control	Refer to separate test report		Complies

**Operation in the 5.47 – 5.725 GHz Band**

FCC Rule Part	RSS Rule Part	Description	Measured Value / Comments	Limit / Requirement	Result (margin)
15.407(a)(2)		26dB Bandwidth	26.2 MHz		N/A
15.407(a)(2)	A9.2(2)	Output Power	12.4 dBm ( 0.017 W)	250mW or 10Log (26dB BW)	Complies
15.407(a)(2)	A9.2(2)	Power Spectral Density	-0.28 dBm/MHz	11 dBm/MHz	Complies
	A9.5b	Peak Spectral Density	-0.28 dBm/MHz	Shall not exceed the average value by more than 3dB	Complies
15.407(a)(2)	A9.4	Dynamic frequency selection / Transmit power control	Refer to separate test report		Complies

**General requirements for all bands**

FCC Rule Part	RSS Rule Part	Description	Measured Value / Comments	Limit / Requirement	Result
	A9.5a	Modulation	OFDM is used	Digital modulation is required	Complies
	RSP 100	99% bandwidth	17.3 MHz		
15.407(b)(5) / 15.209	A9.3	Spurious Emissions below 1GHz	No radio emissions detected below 1 GHz		Complies
15.407(b)(2)	A9.3	Spurious Emissions above 1GHz	51.2dB $\mu$ V/m (363.1 $\mu$ V/m) @ 5350.0MHz		Complies (- 2.8 dB)
15.407(a)(6)	-	Peak Excursion Ratio	12.53 dB	< 13dB	Complies (- 0.47 dB)
	A9.5c	Channel Selection	The device was tested at the highest, lowest and center channels in each operating range.	Device shall be tested on the top, bottom and center channels in each band	N/A
15.407 (c)	A9.5d	Operation in the absence of information to	Operation is discontinued in the absence of	Device shall automatically discontinue	Complies

FCC Rule Part	RSS Rule Part	Description	Measured Value / Comments	Limit / Requirement	Result
		transmit	information	operation in the absence of information to transmit	
15.407 (g)	A9.5e	Frequency Stability	Frequency stability is better than 18ppm (Operational Description)		Complies
	A9.7	User Manual information	Refer to Exhibit 6 for details		Complies

**GENERAL REQUIREMENTS APPLICABLE TO ALL BANDS**

FCC Rule Part	RSS Rule part	Description	Measured Value / Comments	Limit / Requirement	Result (margin)
15.203	-	RF Connector	EUT uses a unique connector type		Complies
15.109	RSS GEN 7.2.3 Table 1	Receiver spurious emissions	49.3dB $\mu$ V/m (291.7 $\mu$ V/m) @ 2645.2MHz		Complies (- 4.7 dB)
15.207	RSS GEN Table 2	AC Conducted Emissions		Refer to standard	Note 1
15.247 (b) (5) 15.407 (f)	RSS 102	RF Exposure Requirements	Refer to MPE calculations, RSS 102 declaration and User Manual statements	Refer to OET 65, FCC Part 1 and RSS 102	Complies
	RSP 100 RSS GEN 7.1.5	User Manual		Statement required regarding non-interference	Complies
	RSP 100 RSS GEN 7.1.5	User Manual		Statement required regarding detachable antenna	Complies

Note 1 – Testing not required for this permissive change.

**MEASUREMENT UNCERTAINTIES**

ISO/IEC 17025 requires that an estimate of the measurement uncertainties associated with the emissions test results be included in the report. The measurement uncertainties given below are based on a 95% confidence level and were calculated in accordance with UKAS document LAB 34.

Measurement Type	Frequency Range (MHz)	Calculated Uncertainty (dB)
Conducted Emissions	0.15 to 30	$\pm 2.4$
Radiated Emissions	0.015 to 30	$\pm 3.0$
Radiated Emissions	30 to 1000	$\pm 3.6$
Radiated Emissions	1000 to 40000	$\pm 6.0$



**EQUIPMENT UNDER TEST (EUT) DETAILS****GENERAL**

The Meru Networks model RS-4000 is a Dual Radio WLAN Access Point that is designed to provide wireless access. Since the EUT would be placed on a table top during operation, the EUT was treated as table-top equipment during testing to simulate the end-user environment. The electrical rating of the EUT is POE.

The sample was received on October 16, 2007 and tested on October 16 and October 17, 2007. The EUT consisted of the following component(s):

Manufacturer	Model	Description	Serial Number	FCC ID
Meru Networks	RS 4000	Access Point	1506RS400000 CE600A085	RE7-RS4000

**ANTENNA SYSTEM**

The EUT antenna is a Omni with 5dBi gain. The antenna connects to the EUT via a non-standard reverse gender SMA antenna connector, thereby meeting the requirements of FCC 15.203.

**ENCLOSURE**

The EUT enclosure is primarily constructed of sheet metal. It measures approximately 18 cm wide by 22 cm deep by 10 cm high.

**MODIFICATIONS**

The EUT did not require modifications during testing in order to comply with emissions specifications.

**SUPPORT EQUIPMENT**

The following equipment was used as local support equipment for emissions testing:

Manufacturer	Model	Description	Serial Number	FCC ID
Acer	TravelMate 2300	Laptop	tlxt56053645080 22acem13	MCLT60N871
Netgear	5 Port 10/100/1000M Switch GS605 v2	Switch	1FE1715X00471	-
3com	PW130	I.T.E Power supply	P/N# 61-0127- 001	-

No remote support equipment was used during emissions testing.

**EUT INTERFACE PORTS**

The I/O cabling configuration during emissions testing was as follows:

Port	Connected To	Cable(s)		
		Description	Shielded or Unshielded	Length(m)
EUT/Console	Laptop	Serial	Shielded	2.0
EUT/ETH2	3Com/POE	RJ-45	Unshielded	2.0
EUT/ETH1	Not Loaded	-	-	-
Switch/Ethernet	Laptop	RJ-45	Unshielded	2.0
3Com/Ethernet	Switch	RJ-45	Unshielded	2.0
3Com PW130	AC Mains	2Wire	Unshielded	1.5
Laptop	AC Mains	3Wire	Unshielded	1.5
Switch	AC Mains	2Wire	Unshielded	1.5

Note: The 5V DC port was not connected during testing. The manufacturer stated that they have the option of using POE, therefore, POE was used throughout all tests.

**EUT OPERATION**

During emissions testing the EUT was transmitting in the specified operating channels. The EUT was also tested for receive mode in the specified operating channels .

**PROPOSED MODIFICATION DETAILS****GENERAL**

This section details the modifications to the Meru Networks model RS-4000 being proposed. All performance and construction deviations from the characteristics originally reported to the FCC are addressed

## *TEST SITE*

### *GENERAL INFORMATION*

Final test measurements were taken on October 16 and October 17, 2007 at the Elliott Laboratories Open Area Test Site #1 located at 684 West Maude Avenue, Sunnyvale, California Pursuant to section 2.948 of the FCC's Rules and section 3.3 of RSP-100, construction, calibration, and equipment data has been filed with the Commission.

ANSI C63.4:2003 recommends that ambient noise at the test site be at least 6 dB below the allowable limits. Ambient levels are below this requirement with the exception of predictable local TV, radio, and mobile communications traffic. The test site contains separate areas for radiated and conducted emissions testing. Considerable engineering effort has been expended to ensure that the facilities conform to all pertinent requirements of ANSI C63.4:2003.

### *RADIATED EMISSIONS CONSIDERATIONS*

The FCC has determined that radiation measurements made in a shielded enclosure are not suitable for determining levels of radiated emissions. Radiated measurements are performed in an open field environment or in a semi-anechoic chamber. The test sites are maintained free of conductive objects within the CISPR defined elliptical area incorporated in ANSI C63.4:2003 guidelines and meet the Normalized Site Attenuation (NSA) requirements of ANSI C63.4:2003.

---

**MEASUREMENT INSTRUMENTATION****RECEIVER SYSTEM**

An EMI receiver as specified in CISPR 16-1 is used for emissions measurements. The receivers used can measure over the frequency range of 9 kHz up to 2000 MHz. These receivers allow both ease of measurement and high accuracy to be achieved. The receivers have Peak, Average, and CISPR (Quasi-peak) detectors built into their design so no external adapters are necessary. The receiver automatically sets the required bandwidth for the CISPR detector used during measurements. If the repetition frequency of the signal being measured is below 20Hz, peak measurements are made in lieu of Quasi-Peak measurements.

For measurements above the frequency range of the receivers, a spectrum analyzer is utilized because it provides visibility of the entire spectrum along with the precision and versatility required to support engineering analysis. Average measurements above 1000MHz are performed on the spectrum analyzer using the linear-average method with a resolution bandwidth of 1 MHz and a video bandwidth of 10 Hz, unless the signal is pulsed in which case the average (or video) bandwidth of the measuring instrument is reduced to onset of pulse desensitization and then increased.

**INSTRUMENT CONTROL COMPUTER**

The receivers utilize either a Rohde & Schwarz EZM Spectrum Monitor/Controller or contain an internal Spectrum Monitor/Controller to view and convert the receiver measurements to the field strength at an antenna or voltage developed at the LISN measurement port, which is then compared directly with the appropriate specification limit. This provides faster, more accurate readings by performing the conversions described under Sample Calculations within the Test Procedures section of this report. Results are printed in a graphic and/or tabular format, as appropriate. A personal computer is used to record all measurements made with the receivers.

The Spectrum Monitor provides a visual display of the signal being measured. In addition, the controller or a personal computer run automated data collection programs which control the receivers. This provides added accuracy since all site correction factors, such as cable loss and antenna factors are added automatically.

---

**FILTERS/ATTENUATORS**

External filters and precision attenuators are often connected between the receiving antenna or LISN and the receiver. This eliminates saturation effects and non-linear operation due to high amplitude transient events.

**ANTENNAS**

A loop antenna is used below 30 MHz. For the measurement range 30 MHz to 1000 MHz either a combination of a biconical antenna and a log periodic or a bi-log antenna is used. Above 1000 MHz, horn antennas are used. The antenna calibration factors to convert the received voltage to an electric field strength are included with appropriate cable loss and amplifier gain factors to determine an overall site factor, which is then programmed into the test receivers or incorporated into the test software.

**ANTENNA MAST AND EQUIPMENT TURNTABLE**

The antennas used to measure the radiated electric field strength are mounted on a non-conductive antenna mast equipped with a motor-drive to vary the antenna height. Measurements below 30 MHz are made with the loop antenna at a fixed height of 1m above the ground plane.

ANSI C63.4:2003 specifies that the test height above ground for table mounted devices shall be 80 centimeters. Floor mounted equipment shall be placed on the ground plane if the device is normally used on a conductive floor or separated from the ground plane by insulating material from 3 to 12 mm if the device is normally used on a non-conductive floor. During radiated measurements, the EUT is positioned on a motorized turntable in conformance with this requirement.

**INSTRUMENT CALIBRATION**

All test equipment is regularly checked to ensure that performance is maintained in accordance with the manufacturer's specifications. All antennas are calibrated at regular intervals with respect to tuned half-wave dipoles. An exhibit of this report contains the list of test equipment used and calibration information.

## TEST PROCEDURES

### EUT AND CABLE PLACEMENT

The regulations require that interconnecting cables be connected to the available ports of the unit and that the placement of the unit and the attached cables simulate the worst case orientation that can be expected from a typical installation, so far as practicable. To this end, the position of the unit and associated cabling is varied within the guidelines of ANSI C63.4:2003, and the worst-case orientation is used for final measurements.

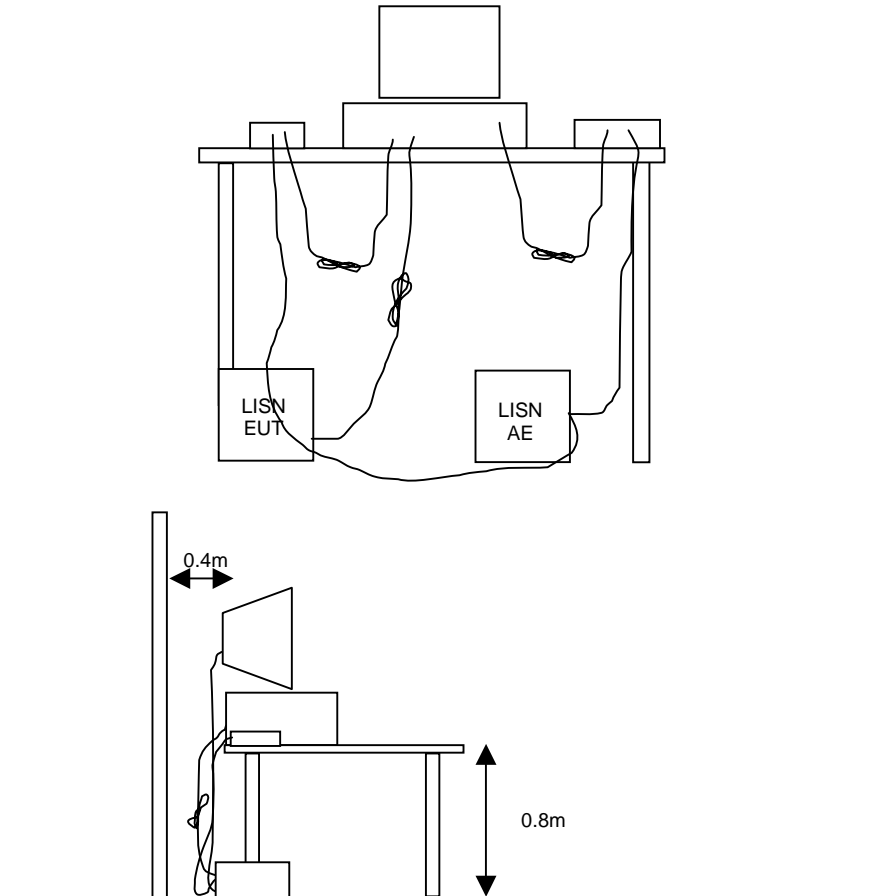

---

**RADIATED EMISSIONS**

A preliminary scan of the radiated emissions is performed in which all significant EUT frequencies are identified with the system in a nominal configuration. At least two scans are performed, one scan for each antenna polarization (horizontal and vertical; loop parallel and perpendicular to the EUT). During the preliminary scans, the EUT is rotated through 360°, the antenna height is varied (for measurements above 30 MHz) and cable positions are varied to determine the highest emission relative to the limit. Preliminary scans may be performed in a fully anechoic chamber for the purposes of identifying the frequencies of the highest emissions from the EUT.

A speaker is provided in the receiver to aid in discriminating between EUT and ambient emissions. Other methods used during the preliminary scan for EUT emissions involve scanning with near field magnetic loops, monitoring I/O cables with RF current clamps, and cycling power to the EUT.

Final maximization is a phase in which the highest amplitude emissions identified in the spectral search are viewed while the EUT azimuth angle is varied from 0 to 360 degrees relative to the receiving antenna. The azimuth, which results in the highest emission is then maintained while varying the antenna height from one to four meters (for measurements above 30 MHz, measurements below 30 MHz are made with the loop antenna at a fixed height of 1m). The result is the identification of the highest amplitude for each of the highest peaks. Each recorded level is corrected in the receiver using appropriate factors for cables, connectors, antennas, and preamplifier gain.

When testing above 18 GHz, the receive antenna is located at 1meter from the EUT and the antenna height is restricted to a maximum of 2.5 meters.

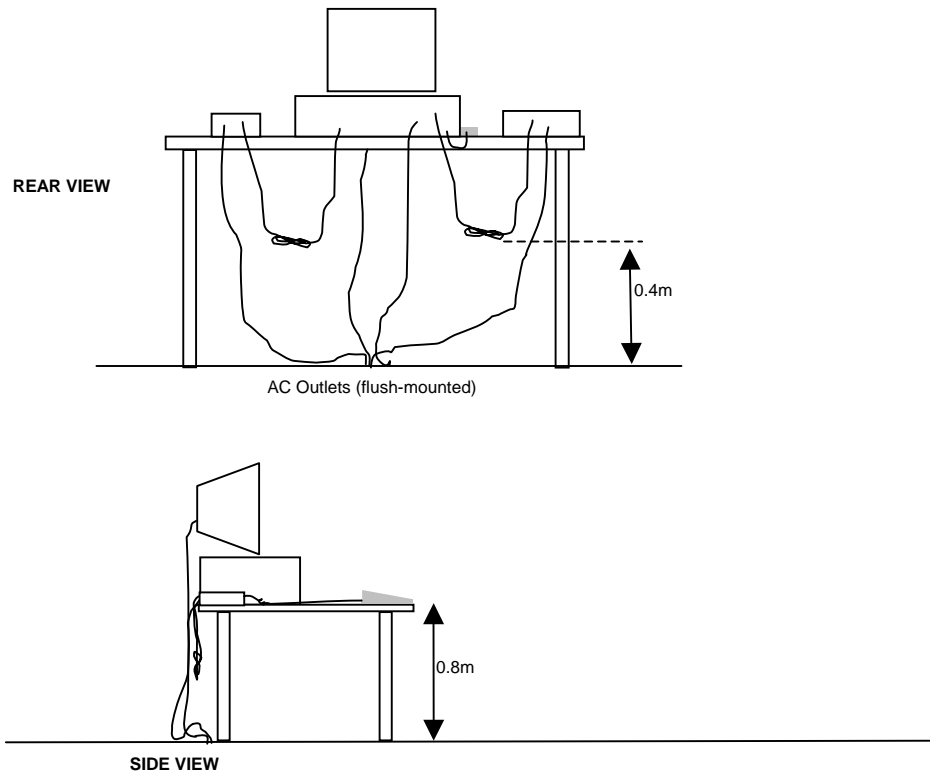

Typical Test Configuration for Radiated Field Strength Measurements



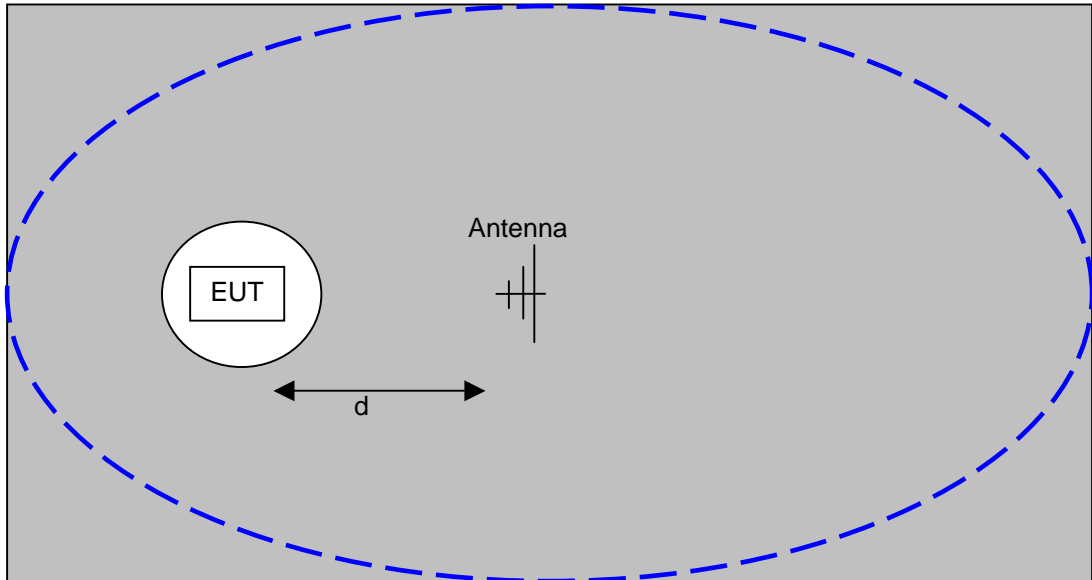

The ground plane extends beyond the ellipse defined in CISPR 16 / CISPR 22 / ANSI C63.4 and is large enough to accommodate test distances (d) of 3m and 10m. Refer to the test data tables for the actual measurement distance.

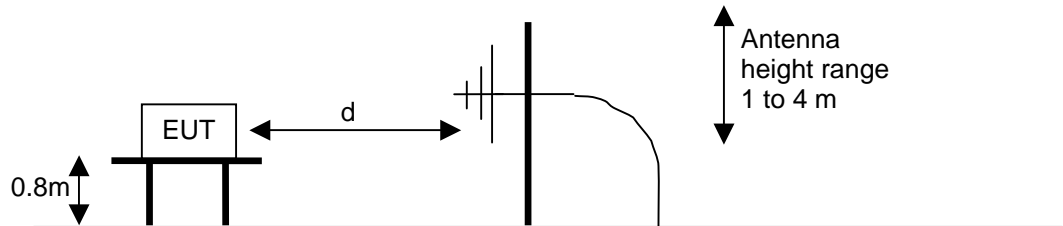

Test Configuration for Radiated Field Strength Measurements  
OATS- Plan and Side Views

**BANDWIDTH MEASUREMENTS**

The 6dB, 20dB and/or 26dB signal bandwidth is measured in using the bandwidths recommended by ANSI C63.4. When required, the 99% bandwidth is measured using the methods detailed in RSS GEN.

**SPECIFICATION LIMITS AND SAMPLE CALCULATIONS**

The limits for conducted emissions are given in units of microvolts, and the limits for radiated emissions are given in units of microvolts per meter at a specified test distance. Data is measured in the logarithmic form of decibels relative to one microvolt, or dB microvolts (dBuV). For radiated emissions, the measured data is converted to the field strength at the antenna in dB microvolts per meter (dBuV/m). The results are then converted to the linear forms of uV and uV/m for comparison to published specifications.

For reference, converting the specification limits from linear to decibel form is accomplished by taking the base ten logarithm, then multiplying by 20. These limits in both linear and logarithmic form are as follows:

**GENERAL TRANSMITTER RADIATED EMISSIONS SPECIFICATION LIMITS**

The table below shows the limits for the spurious emissions from transmitters that fall in restricted bands<sup>1</sup> (with the exception of transmitters operating under FCC Part 15 Subpart D and RSS 210 Annex 9), the limits for all emissions from a low power device operating under the general rules of RSS 310 (tables 3 and 4), RSS 210 (table 2) and FCC Part 15 Subpart C section 15.209.

Frequency Range (MHz)	Limit (uV/m)	Limit (dBuV/m @ 3m)
0.009-0.490	$2400/F_{\text{KHz}} @ 300\text{m}$	$67.6-20*\log_{10}(F_{\text{KHz}}) @ 300\text{m}$
0.490-1.705	$24000/F_{\text{KHz}} @ 30\text{m}$	$87.6-20*\log_{10}(F_{\text{KHz}}) @ 30\text{m}$
1.705 to 30	30 @ 30m	29.5 @ 30m
30 to 88	100 @ 3m	40 @ 3m
88 to 216	150 @ 3m	43.5 @ 3m
216 to 960	200 @ 3m	46.0 @ 3m
Above 960	500 @ 3m	54.0 @ 3m

<sup>1</sup> The restricted bands are detailed in FCC 15.203, RSS 210 Table 1 and RSS 310 Table 2

*FCC 15.407 (a) OUTPUT POWER LIMITS*

The table below shows the limits for output power and output power density. Where the signal bandwidth is less than 20 MHz the maximum output power is reduced to the power spectral density limit plus 10 times the log of the bandwidth (in MHz).

Operating Frequency (MHz)	Output Power	Power Spectral Density
5150 - 5250	50mW (17 dBm)	4 dBm/MHz
5250 - 5350	250 mW (24 dBm)	11 dBm/MHz
5725 – 5825	1 Watts (30 dBm)	17 dBm/MHz

For system using antennas with gains exceeding 6dBi, the output power and power spectral density limits are reduced by 1dB for every dB the antenna gain exceeds 6dBi. Fixed point-to-point applications using the 5725 – 5825 MHz band may use antennas with gains of up to 23dBi without this limitation. If the gain exceeds 23dBi then the output power limit of 1 Watt is reduced by 1dB for every dB the gain exceeds 23dBi.

*OUTPUT POWER AND SPURIOUS LIMITS –UNII DEVICES*

The table below shows the limits for output power and output power density defined by FCC Part 15 Subpart E. Where the signal bandwidth is less than 20 MHz the maximum output power is reduced to the power spectral density limit plus 10 times the log of the bandwidth (in MHz).

Operating Frequency (MHz)	Output Power	Power Spectral Density
5150 - 5250	50mW (17 dBm)	10 dBm/MHz
5250 - 5350	250 mW (24 dBm)	11 dBm/MHz
5470 - 5725	250 mW (24 dBm)	11 dBm/MHz
5725 – 5825	1 Watts (30 dBm)	17 dBm/MHz

The peak excursion envelope is limited to 13dB.

For system using antennas with gains exceeding 6dBi, the output power and power spectral density limits are reduced by 1dB for every dB the antenna gain exceeds 6dBi. Fixed point-to-point applications using the 5725 – 5825 MHz band may use antennas with gains of up to 23dBi without this limitation. If the gain exceeds 23dBi then the output power limit of 1 Watt is reduced by 1dB for every dB the gain exceeds 23dBi.

---

**SAMPLE CALCULATIONS - RADIATED EMISSIONS**

Receiver readings are compared directly to the specification limit (decibel form). The receiver internally corrects for cable loss, preamplifier gain, and antenna factor. The calculations are in the reverse direction of the actual signal flow, thus cable loss is added and the amplifier gain is subtracted. The Antenna Factor converts the voltage at the antenna coaxial connector to the field strength at the antenna elements.

A distance factor, when used for electric field measurements above 30MHz, is calculated by using the following formula:

$$F_d = 20 * \text{LOG}_{10} (D_m/D_s)$$

where:

$F_d$  = Distance Factor in dB

$D_m$  = Measurement Distance in meters

$D_s$  = Specification Distance in meters

For electric field measurements below 30MHz the extrapolation factor is either determined by making measurements at multiple distances or a theoretical value is calculated using the formula:

$$F_d = 40 * \text{LOG}_{10} (D_m/D_s)$$

Measurement Distance is the distance at which the measurements were taken and Specification Distance is the distance at which the specification limits are based. The antenna factor converts the voltage at the antenna coaxial connector to the field strength at the antenna elements.

---

The margin of a given emission peak relative to the limit is calculated as follows:

$$R_c = R_r + F_d$$

and

$$M = R_c - L_s$$

where:

$$R_r = \text{Receiver Reading in dBuV/m}$$

$$F_d = \text{Distance Factor in dB}$$

$$R_c = \text{Corrected Reading in dBuV/m}$$

$$L_s = \text{Specification Limit in dBuV/m}$$

$$M = \text{Margin in dB Relative to Spec}$$

#### *SAMPLE CALCULATIONS - FIELD STRENGTH TO EIRP CONVERSION*

Where the radiated electric field strength is expressed in terms of the equivalent isotropic radiated power (eirp), or where a field strength measurement of output power is made in lieu of a direct measurement, the following formula is used to convert between eirp and field strength at a distance of 3m from the equipment under test:

$$E = \frac{1000000 \sqrt{30 P}}{3} \quad \text{microvolts per meter}$$

where P is the eirp (Watts)

***EXHIBIT 1: Test Equipment Calibration Data***

1 Page

**Radiated Emissions, 30 - 40,000 MHz, 17-Oct-07****Engineer: Rafael Varelas**

<u>Manufacturer</u>	<u>Description</u>	<u>Model #</u>	<u>Asset #</u>	<u>Cal Due</u>
Hewlett Packard	Microwave Preamplifier, 1-26.5GHz	8449B	870	15-Nov-07
EMCO	Antenna, Horn, 1-18 GHz (SA40-Red)	3115	1142	07-Jun-08
Hewlett Packard	High Pass filter, 8.2 GHz (Blu System)	P/N 84300-80039 (84125C)	1392	29-May-08
Hewlett Packard	SpecAn 9 kHz - 40 GHz, FMT (SA40) Blue	8564E (84125C)	1393	17-Jan-08

**Radio Spurious Emissions, 29-Nov-07****Engineer: skhushzad**

<u>Manufacturer</u>	<u>Description</u>	<u>Model #</u>	<u>Asset #</u>	<u>Cal Due</u>
EMCO	Antenna, Horn, 1-18 GHz	3115	487	24-May-08
Hewlett Packard	Microwave Preamplifier, 1-26.5GHz	8449B	870	08-Nov-08
Hewlett Packard	SpecAn 30 Hz -40 GHz, SV (SA40) Red	8564E (84125C)	1148	24-Aug-08

**Radiated Emissions, 30 - 18,000 MHz, 30-Nov-07****Engineer: Rafael Varelas**

<u>Manufacturer</u>	<u>Description</u>	<u>Model #</u>	<u>Asset #</u>	<u>Cal Due</u>
EMCO	Antenna, Horn, 1-18 GHz	3115	487	24-May-08
Hewlett Packard	Microwave Preamplifier, 1-26.5GHz	8449B	870	08-Nov-08
Hewlett Packard	SpecAn 30 Hz -40 GHz, SV (SA40) Red	8564E (84125C)	1148	24-Aug-08
Hewlett Packard	High Pass filter, 8.2 GHz (Red System)	P/N 84300-80039 (84125C)	1152	15-Oct-08
Rohde & Schwarz	Test Receiver, 0.009-2750 MHz	ESN	1332	21-Dec-07
EMCO	Log Periodic Antenna, 0.2-2 GHz	3148	1404	30-Mar-08
EMCO	Biconical Antenna, 30-300 MHz	3110B	1497	03-Jul-08

---

***EXHIBIT 2: Test Measurement Data***

71 Pages





*EMC Test Data*

Client:	Meru Networks	Job Number:	J69452
Model:	RS 4000	T-Log Number:	T69548
		Account Manager:	Richard Gencev
Contact:	John Dorsey		
Emissions Standard(s):	FCC Part 15.247/RSS-210	Class:	-
Immunity Standard(s):	-	Environment:	-

**EMC Test Data**

For The

**Meru Networks**

Model

RS 4000

Date of Last Test: 1/10/2008



## EMC Test Data

Client:	Meru Networks	Job Number:	J69452
Model:	RS 4000	T-Log Number:	T69548
Contact:	John Dorsey	Account Manger:	Richard Gencev
Emissions Standard(s):	FCC Part 15.247/RSS-210	Class:	-
Immunity Standard(s):	-	Environment:	-

### EUT INFORMATION

*The following information was collected during the test session(s).*

#### General Description

The EUT is a Dual Radio WLAN Access Point that is designed to provide wireless access. Since the EUT would be placed on a table top during operation, the EUT was treated as table-top equipment during testing to simulate the end-user environment. The electrical rating of the EUT is POE.

#### Equipment Under Test

Manufacturer	Model	Description	Serial Number	FCC ID
Meru Networks	RS 4000	Access Point	1506RS400000CE600A08 5	RE7-RS4000

#### EUT Antenna (Intentional Radiators Only)

The EUT antenna is a Omni with 3dBi gain.

The antenna connects to the EUT via a non-standard reverse gender SMA antenna connector, thereby meeting the requirements of FCC 15.203.

#### EUT Enclosure

The EUT enclosure is primarily constructed of sheet metal. It measures approximately 18 cm wide by 22 cm deep by 10 cm high.



*EMC Test Data*

Client:	Meru Networks	Job Number:	J69452
Model:	RS 4000	T-Log Number:	T69548
Contact:	John Dorsey	Account Manger:	Richard Gencev
Emissions Standard(s):	FCC Part 15.247/RSS-210	Class:	-
Immunity Standard(s):	-	Environment:	-

**Modification History**

Mod. #	Test	Date	Modification
1			
2			
3			

Modifications applied are assumed to be used on subsequent tests unless otherwise stated as a further modification.



## EMC Test Data

Client:	Meru Networks	Job Number:	J69452
Model:	RS 4000	T-Log Number:	T69548
Contact:	John Dorsey	Account Manger:	Richard Gencev
Emissions Standard(s):	FCC Part 15.247/RSS-210	Class:	-
Immunity Standard(s):	-	Environment:	-

### Test Configuration #1

The following information was collected during the test session(s).

#### Local Support Equipment

Manufacturer	Model	Description	Serial Number	FCC ID
Acer	TravelMate 2300	Laptop	tlxt5605364508022acem1 3	MCLT60N871
Netgear	5 Port 10/100/1000M Switch GS605 v2	Switch	1FE1715X00471	-
3com	PW130	I.T.E Power supply	P/N# 61-0127-001	-

#### Remote Support Equipment

Manufacturer	Model	Description	Serial Number	FCC ID
None	-	-	-	-

#### Cabling and Ports

Port	Connected To	Cable(s)		
		Description	Shielded or Unshielded	Length(m)
EUT/Console	Laptop	Serial	Shielded	2.0
EUT/ETH2	3Com/POE	RJ-45	Unshielded	2.0
EUT/ETH1	Not Loaded	-	-	-
Switch/Ethernet	Laptop	RJ-45	Unshielded	2.0
3Com/Ethernet	Switch	RJ-45	Unshielded	2.0
3Com PW130	AC Mains	2Wire	Unshielded	1.5
Laptop	AC Mains	3Wire	Unshielded	1.5
Switch	AC Mains	2Wire	Unshielded	1.5

Note: The 5V DC port was not connected during testing. The manufacturer stated that they have the option of using POE, therefore, POE was used throughout all tests.

#### EUT Operation During Emissions Tests

During emissions testing the EUT was transmitting in the specified operating channels. The EUT was also tested for receive mode in the specified operating channels .

Client:	Meru Networks	Job Number:	J69452
Model:	RS 4000	T-Log Number:	T69548
		Account Manager:	Richard Gencev
Contact:	John Dorsey		
Standard:	FCC Part 15.247/RSS-210	Class:	N/A

### FCC Part 15 Subpart E Tests

#### Test Specific Details

Objective: The objective of this test session is to perform final qualification testing of the EUT with respect to the specification listed above.

Date of Test: 12/7/2007	Config. Used: 1
Test Engineer: Mehran Birgani	Config Change: None
Test Location: SVOATS #2	EUT Voltage: POE

#### General Test Configuration

When measuring the conducted emissions from the EUT's antenna port, the antenna port of the EUT was connected to the spectrum analyzer or power meter via a suitable attenuator to prevent overloading the measurement system. All measurements are corrected to allow for the external attenuators and cables used.

Ambient Conditions:            Temperature:            12 °C  
    Rel. Humidity:            68 %

#### Summary of Results

Run #	Test Performed	Limit	Pass / Fail	Result / Margin
1	Power, 5250 - 5350MHz	15.407(a) (2) RSS 210 A9.2(2)	Pass	11.6dBm
1	Power, 5470 - 5725MHz	15.407(a) (2) RSS 210 A9.2(2)	Pass	12.4dBm
1	PSD, 5250 - 5350MHz	15.407(a) (2) RSS 210 A9.2(2)	Pass	-1.24dBm/MHz
1	PSD, 5470 - 5725MHz	15.407(a) (2) RSS 210 A9.2(2)	Pass	-0.28dBm/MHz
1	26dB Bandwidth	15.407	Pass	> 20 MHz
1	99% Bandwidth	RSS 210	Pass	17.6MHz
2	Peak Excursion Envelope	15.407(a) (6)	Pass	12.53dBm
3	Antenna Conducted Out of Band Spurious	15.407(b)	Pass	All emissions below the -27dBm/MHz limit

#### Modifications Made During Testing

No modifications were made to the EUT during testing

#### Deviations From The Standard

No deviations were made from the requirements of the standard.

Client:	Meru Networks	Job Number:	J69452
Model:	RS 4000	T-Log Number:	T69548
		Account Manager:	Richard Gencev
Contact:	John Dorsey		
Standard:	FCC Part 15.247/RSS-210	Class:	N/A

**Run #1: Bandwidth, Output Power and Power spectral Density**

 Antenna Gain: 5.5 dBi

Frequency (MHz)	Software Setting	Bandwidth		Output Power <sup>1</sup> dBm		Power (Watts)	PSD <sup>2</sup> dBm/MHz			Result
		26dB	99% <sup>4</sup>	Measured	Limit		Measured	FCC Limit	RSS Limit <sup>3</sup>	
5260	19.0	26.0	17.5	9.9	24.0	0.010	-2.84	11.0	11.0	Pass
5300	19.0	26.5	17.5	11.6	24.0	0.014	-1.29	11.0	11.0	Pass
5320	19.0	26.0	17.5	11.5	24.0	0.014	-1.24	11.0	11.0	Pass
5500	19.0	26.8	17.3	11.9	24.0	0.015	-0.99	11.0	11.0	Pass
5600	19.0	26.2	17.5	12.4	24.0	0.017	-0.28	11.0	11.0	Pass
5700	19.0	31.5	17.6	12.0	24.0	0.016	-0.84	11.0	11.0	Pass

Note 1:	Output power measured using a spectrum analyzer (see plots below): RBW=1MHz, VB=3 MHz, sample detector, power averaging on (transmitted signal was continuous) and power integration over 100 MHz
Note 2:	Measured using the same analyzer settings used for output power.
Note 3:	For RSS210 the measured value of the PSD (see note 3) must not exceed the average value (calculated from the measured power divided by the measured 99% bandwidth) by more than 3dB.
Note 4:	99% Bandwidth measured in accordance with RSS GEN - RB > 1% of span and VB >=3xRB

Client: Meru Networks	Job Number: J69452
Model: RS 4000	T-Log Number: T69548
Contact: John Dorsey	Account Manager: Richard Gencev
Standard: FCC Part 15.247/RSS-210	Class: N/A

Run #1: Continued

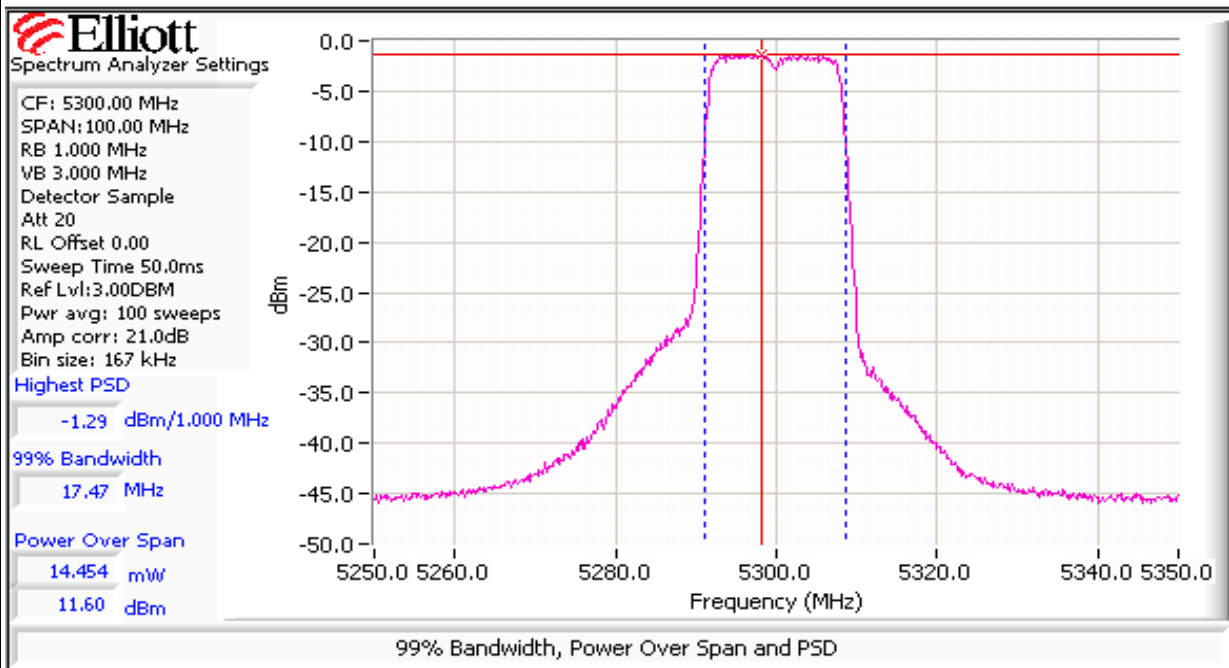
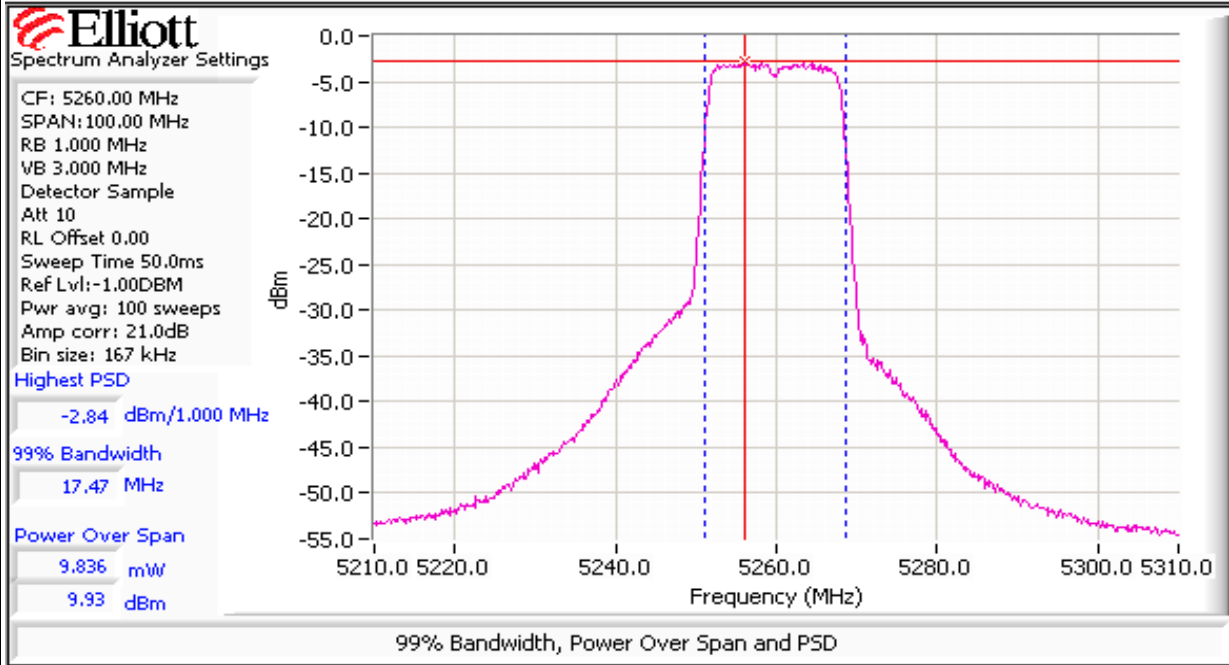

Client: Meru Networks	Job Number: J69452
Model: RS 4000	T-Log Number: T69548
Contact: John Dorsey	Account Manager: Richard Gencev
Standard: FCC Part 15.247/RSS-210	Class: N/A

Run #1: Continued

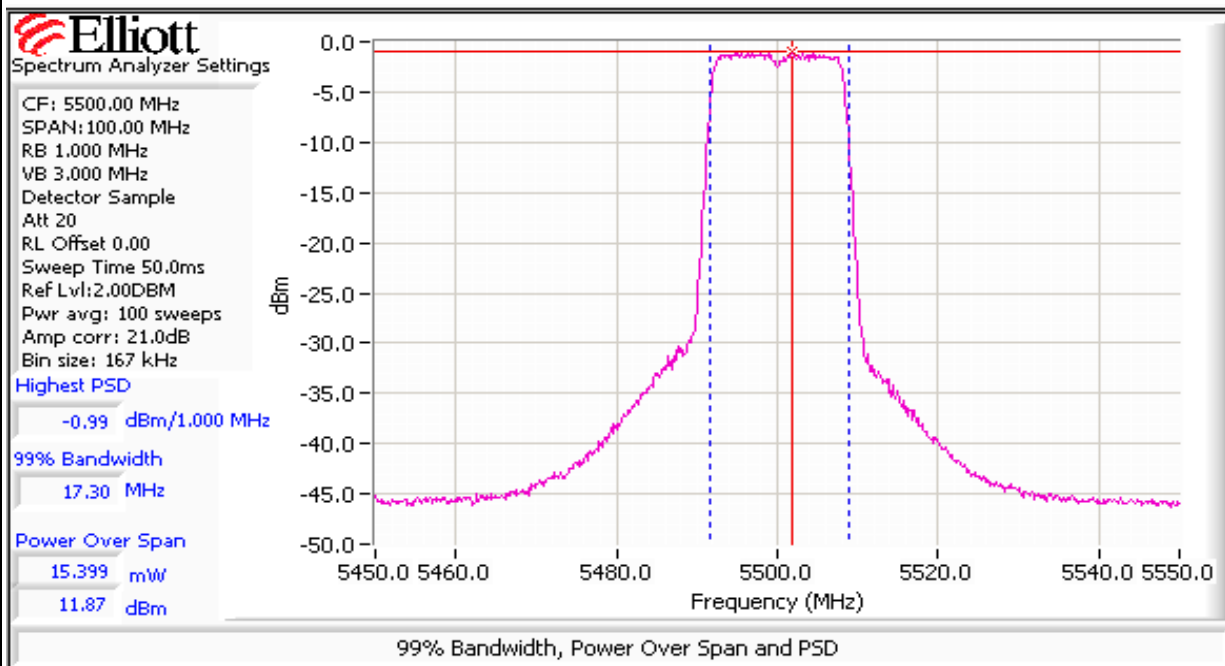
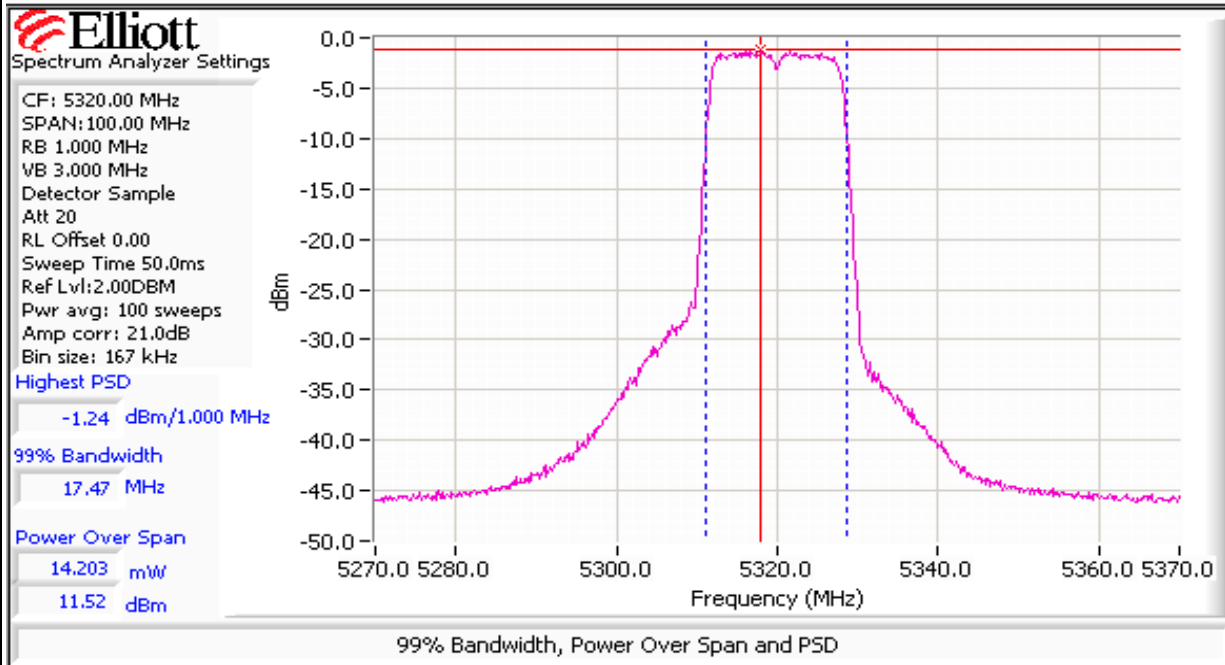



Client: Meru Networks	Job Number: J69452
Model: RS 4000	T-Log Number: T69548
Contact: John Dorsey	Account Manager: Richard Gencev
Standard: FCC Part 15.247/RSS-210	Class: N/A

Run #1: Continued

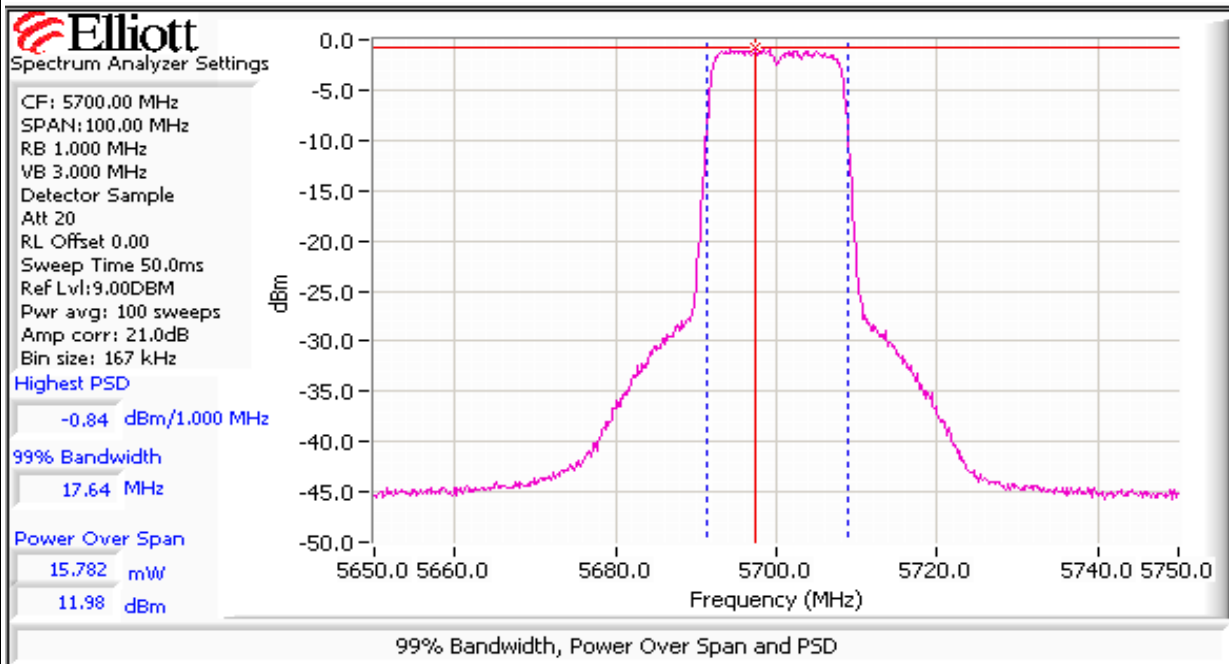
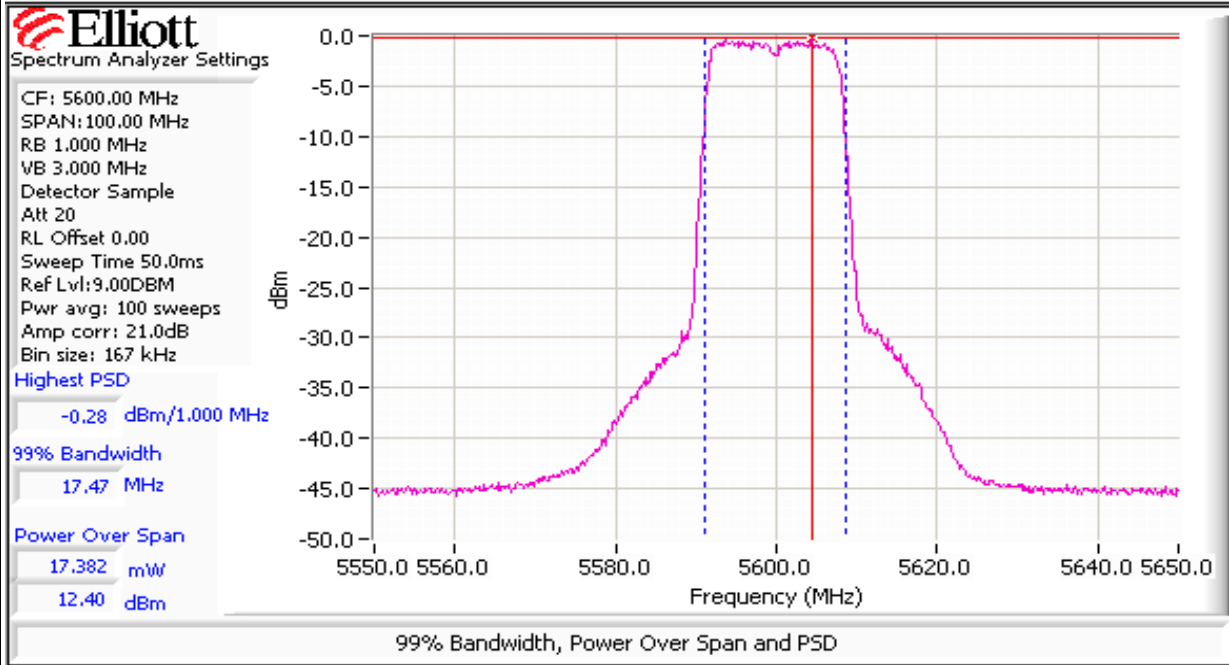

Client: Meru Networks	Job Number: J69452
Model: RS 4000	T-Log Number: T69548
Contact: John Dorsey	Account Manager: Richard Gencev
Standard: FCC Part 15.247/RSS-210	Class: N/A

Run #1: Continued

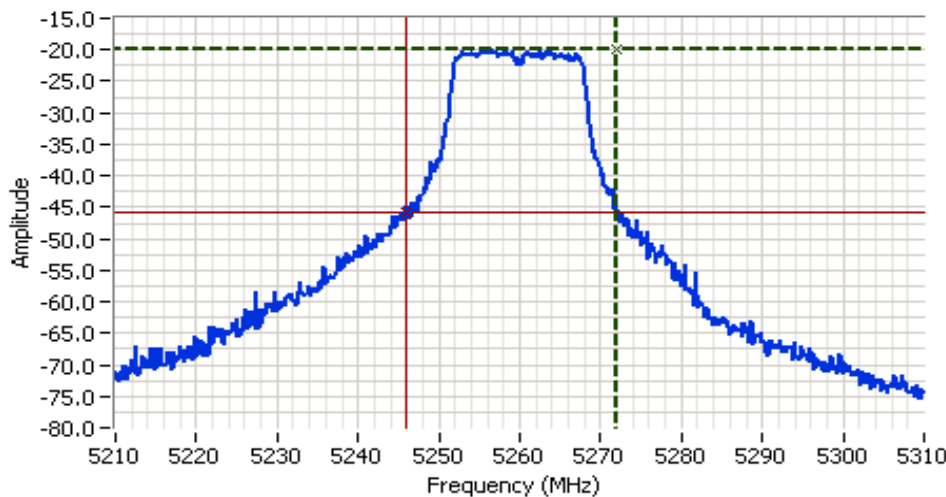

**Analyzer Settings**

HP8564E  
 CF: 5260.00 MHz  
 SPAN: 100.00 MHz  
 RB 300 kHz  
 VB 1.000 MHz  
 Detector POS  
 Att 0  
 RL Offset 0.00  
 Sweep Time 50.0ms  
 Ref Lvl: -12.00DBM

**Comments**

5260 MHz  
 26dB Bandwidth

Cursor 1	5272.00	-19.83	
Cursor 2	5246.00	-45.83	

Delta Freq. 26.00  
 Delta Amplitude 26.00

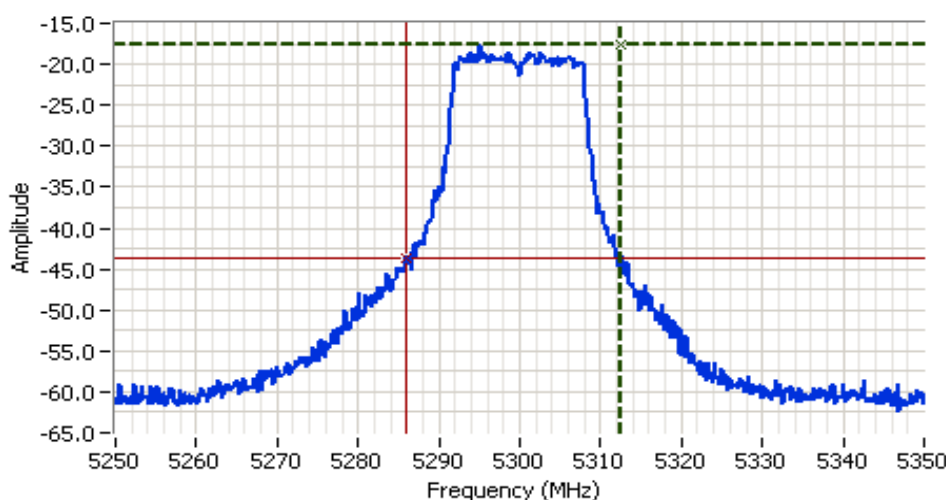

**Analyzer Settings**

HP8564E  
 CF: 5300.00 MHz  
 SPAN: 100.00 MHz  
 RB 300 kHz  
 VB 1.000 MHz  
 Detector POS  
 Att 20  
 RL Offset 0.00  
 Sweep Time 50.0ms  
 Ref Lvl: 3.00DBM

**Comments**

5300 MHz  
 26dB Bandwidth

Cursor 1	5312.50	-17.67	
Cursor 2	5286.00	-43.67	

Delta Freq. 26.50  
 Delta Amplitude 26.00



Client: Meru Networks	Job Number: J69452
Model: RS 4000	T-Log Number: T69548
Contact: John Dorsey	Account Manager: Richard Gencev
Standard: FCC Part 15.247/RSS-210	Class: N/A

Run #1: Continued

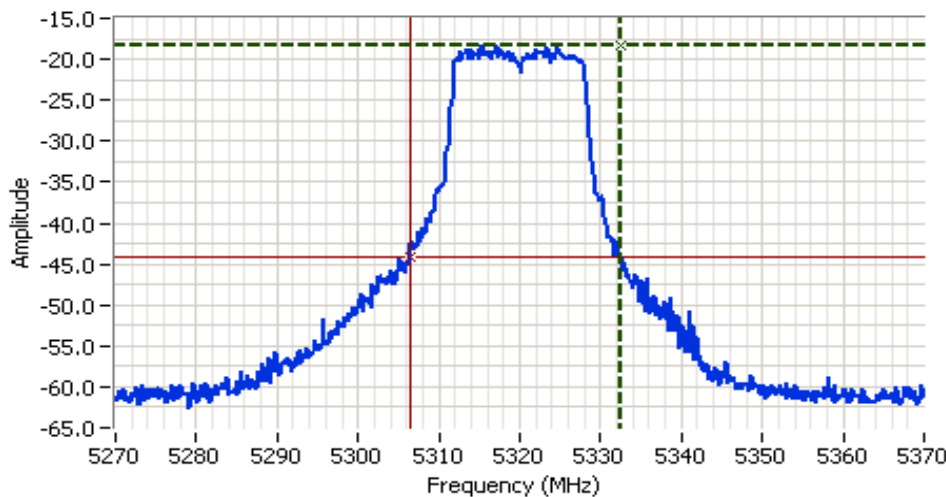

**Analyzer Settings**

HP8564E  
 CF: 5320.00 MHz  
 SPAN: 100.00 MHz  
 RB 300 kHz  
 VB 1.000 MHz  
 Detector POS  
 Att 20  
 RL Offset 0.00  
 Sweep Time 50.0ms  
 Ref Lvl: 1.80DBM

**Comments**

5320 MHz  
 26dB Bandwidth

Cursor 1	5332.50	-18.20	
Cursor 2	5306.50	-44.20	

Delta Freq. 26.00  
 Delta Amplitude 26.00

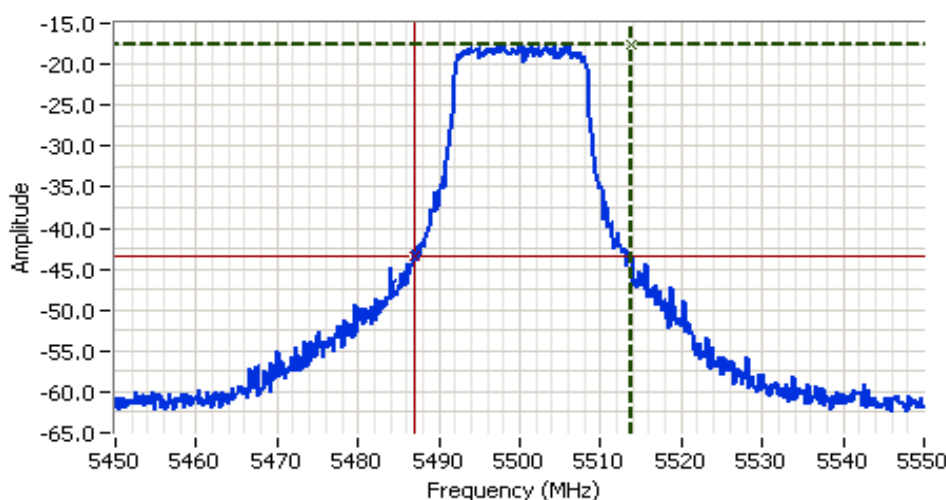

**Analyzer Settings**

HP8564E  
 CF: 5500.00 MHz  
 SPAN: 100.00 MHz  
 RB 300 kHz  
 VB 1.000 MHz  
 Detector POS  
 Att 20  
 RL Offset 0.00  
 Sweep Time 50.0ms  
 Ref Lvl: 2.00DBM

**Comments**

5500 MHz  
 26dB Bandwidth

Cursor 1	5513.83	-17.50	
Cursor 2	5487.00	-43.50	

Delta Freq. 26.83  
 Delta Amplitude 26.00



Client: Meru Networks	Job Number: J69452
Model: RS 4000	T-Log Number: T69548
Contact: John Dorsey	Account Manager: Richard Gencev
Standard: FCC Part 15.247/RSS-210	Class: N/A

Run #1: Continued

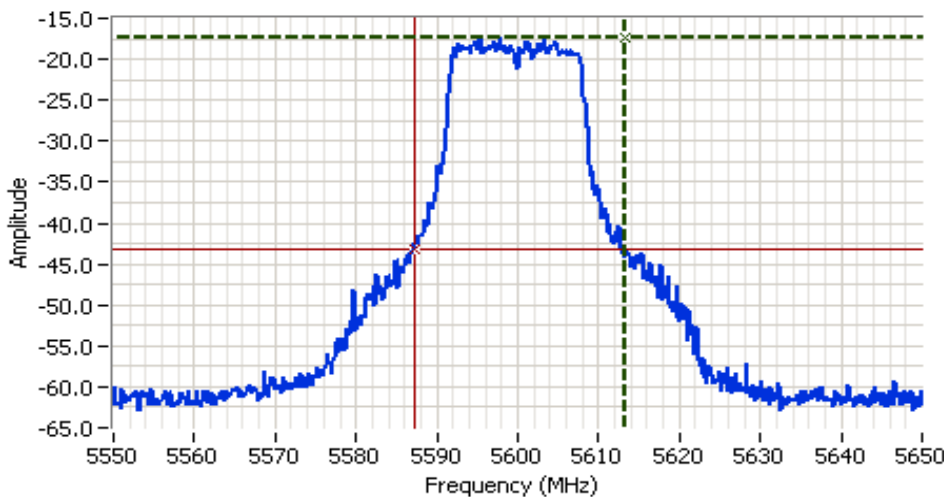

**Analyzer Settings**

HP8564E  
 CF: 5600.00 MHz  
 SPAN: 100.00 MHz  
 RB 300 kHz  
 VB 1.000 MHz  
 Detector POS  
 Att 20  
 RL Offset 0.00  
 Sweep Time 50.0ms  
 Ref Lvl: 1.90DBM

**Comments**

5600 MHz  
 26dB Bandwidth

Cursor 1	5613.33	-17.27	
Cursor 2	5587.16	-43.27	

Delta Freq. 26.17  
 Delta Amplitude 26.00

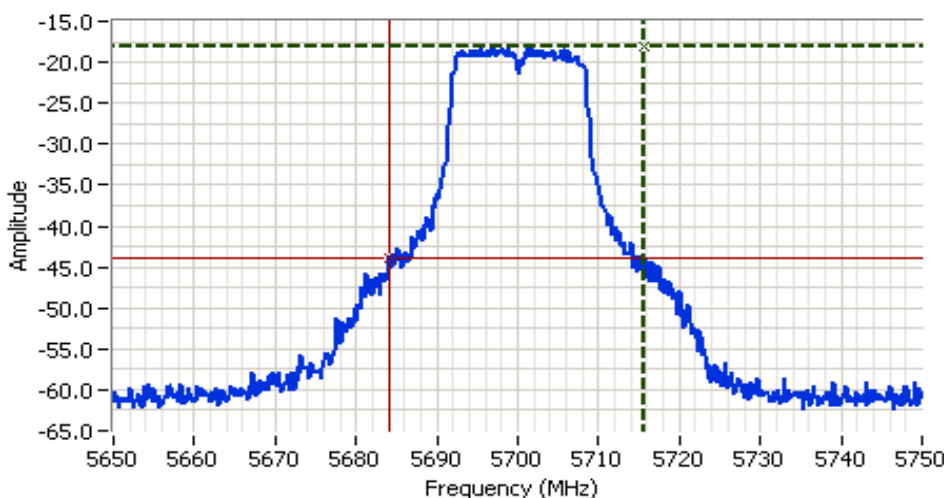

**Analyzer Settings**

HP8564E  
 CF: 5700.00 MHz  
 SPAN: 100.00 MHz  
 RB 300 kHz  
 VB 1.000 MHz  
 Detector POS  
 Att 20  
 RL Offset 0.00  
 Sweep Time 50.0ms  
 Ref Lvl: 9.00DBM

**Comments**

5700 MHz  
 26dB Bandwidth

Cursor 1	5715.66	-18.00	
Cursor 2	5684.16	-44.00	

Delta Freq. 31.50  
 Delta Amplitude 26.00



Client: Meru Networks	Job Number: J69452
Model: RS 4000	T-Log Number: T69548
Contact: John Dorsey	Account Manager: Richard Gencev
Standard: FCC Part 15.247/RSS-210	Class: N/A

### Run #2: Peak Excursion Measurement

#### Plots Showing Peak Excursion

Trace A: RBW = VBW = 1MHz

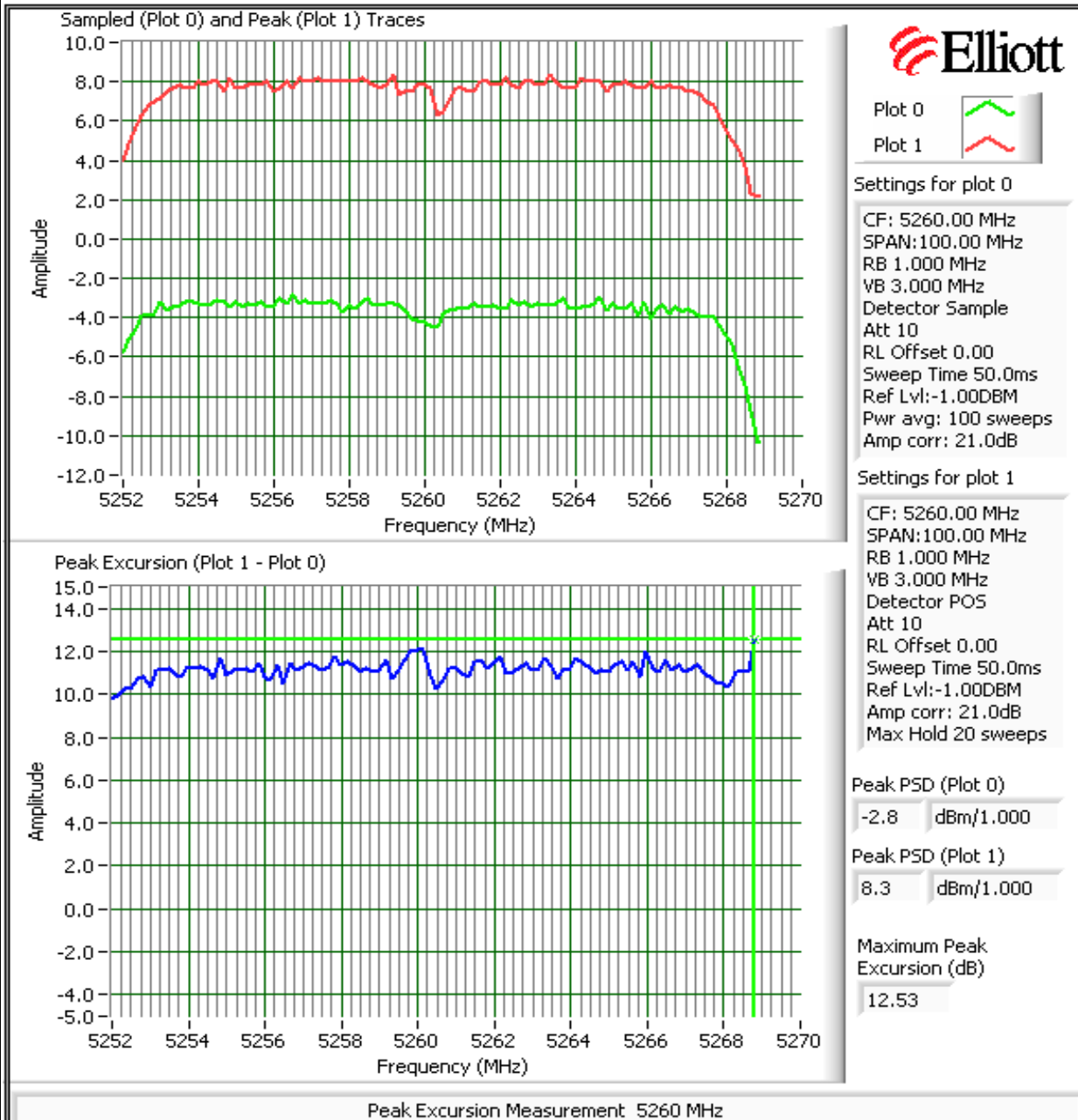

Client: Meru Networks	Job Number: J69452
Model: RS 4000	T-Log Number: T69548
Contact: John Dorsey	Account Manager: Richard Gencev
Standard: FCC Part 15.247/RSS-210	Class: N/A

Run #2: Continued

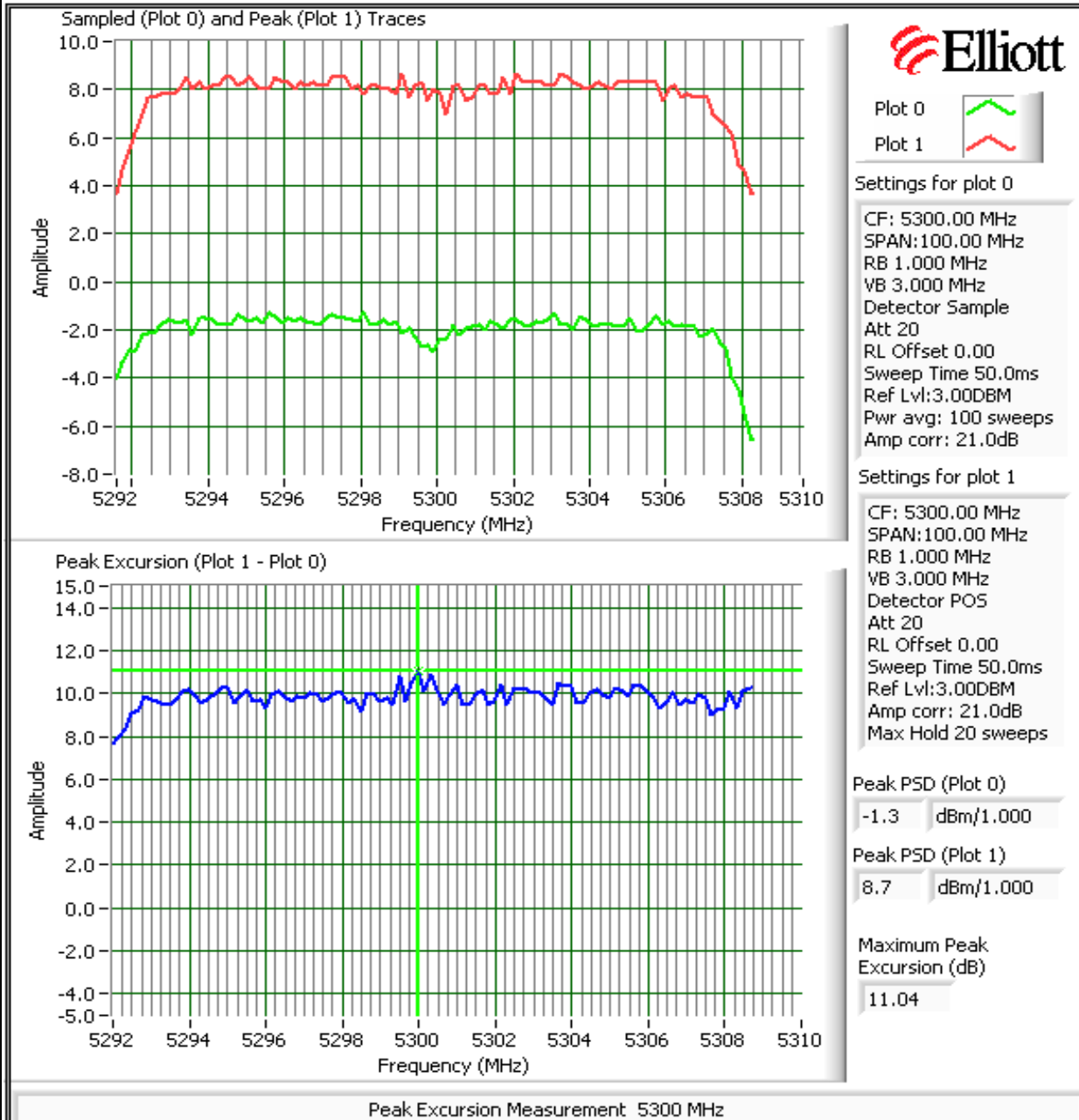

Client: Meru Networks	Job Number: J69452
Model: RS 4000	T-Log Number: T69548
Contact: John Dorsey	Account Manager: Richard Gencev
Standard: FCC Part 15.247/RSS-210	Class: N/A

Run #2: Continued

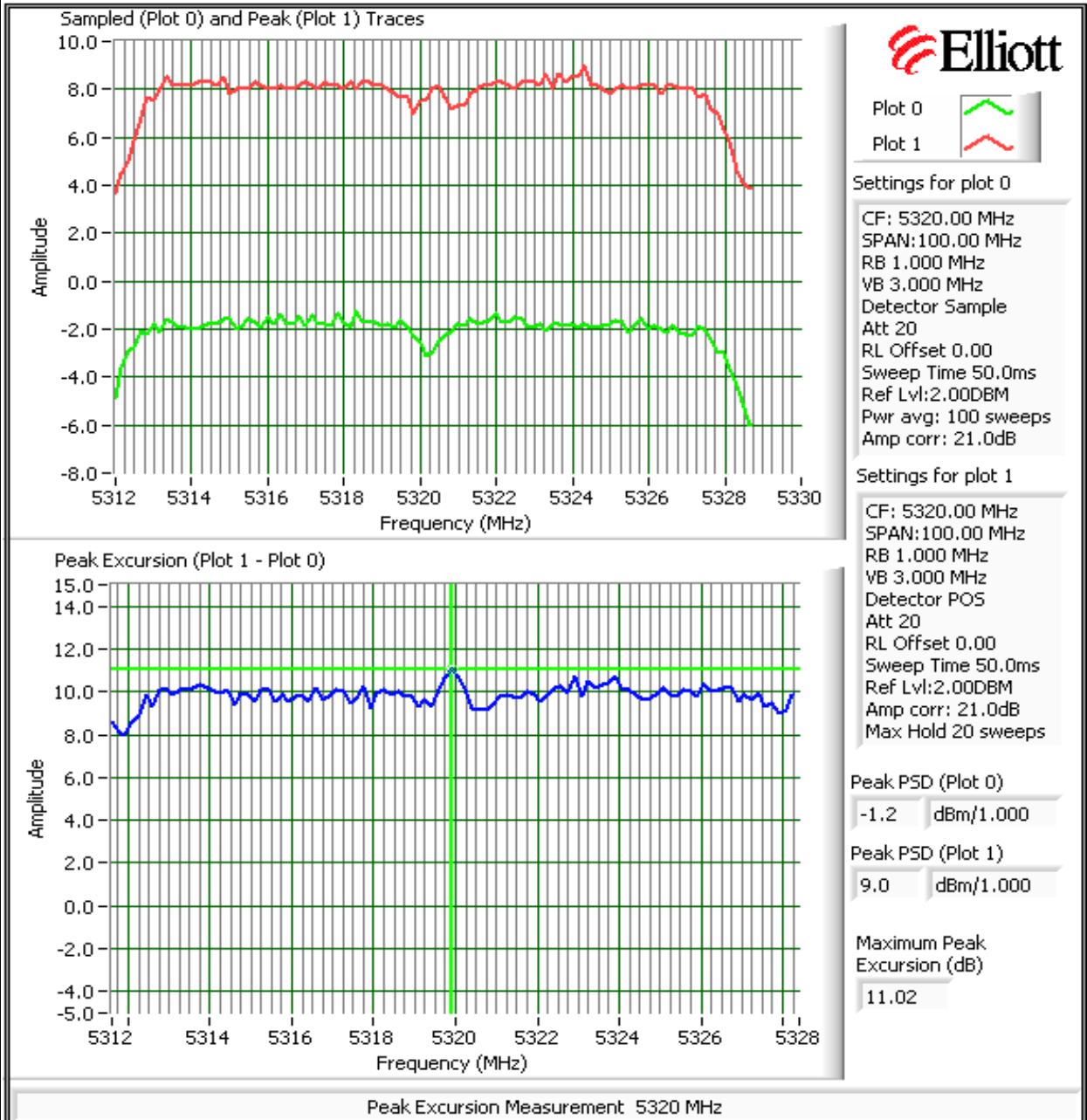

Client: Meru Networks	Job Number: J69452
Model: RS 4000	T-Log Number: T69548
Contact: John Dorsey	Account Manager: Richard Gencev
Standard: FCC Part 15.247/RSS-210	Class: N/A

Run #2: Continued

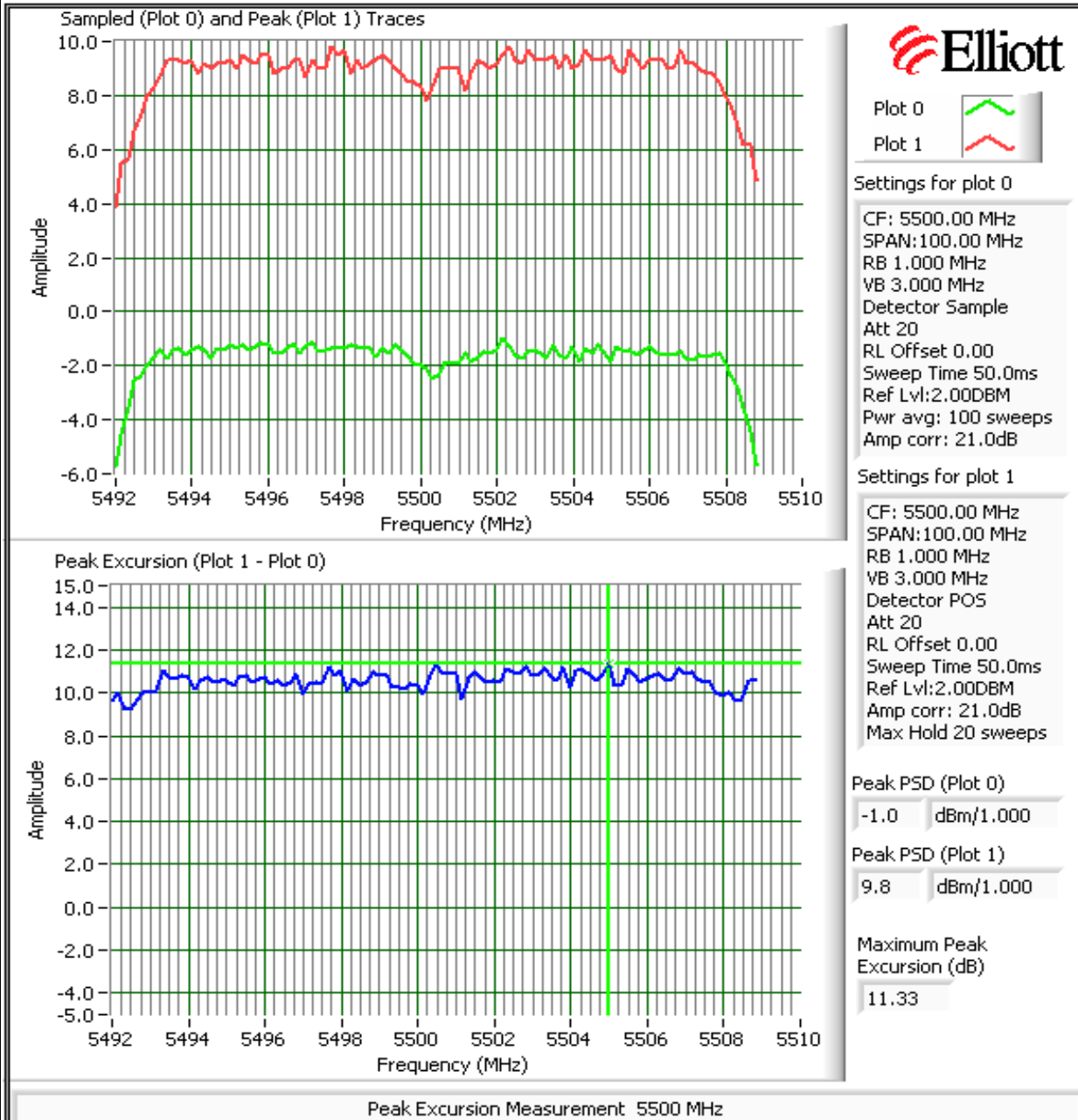



Client: Meru Networks	Job Number: J69452
Model: RS 4000	T-Log Number: T69548
Contact: John Dorsey	Account Manager: Richard Gencev
Standard: FCC Part 15.247/RSS-210	Class: N/A

Run #2: Continued

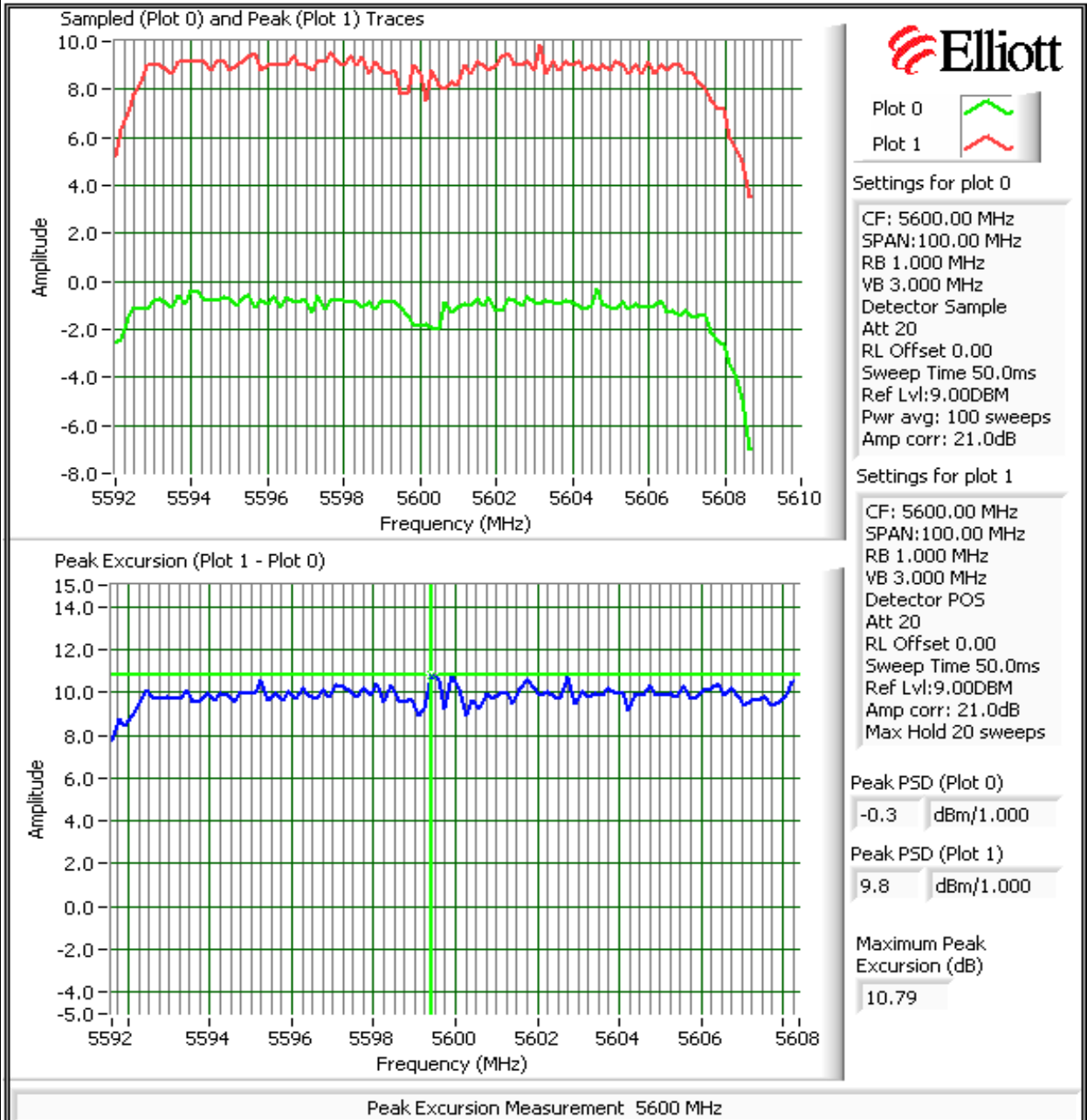

Client: Meru Networks	Job Number: J69452
Model: RS 4000	T-Log Number: T69548
Contact: John Dorsey	Account Manager: Richard Gencev
Standard: FCC Part 15.247/RSS-210	Class: N/A

Run #2: Continued

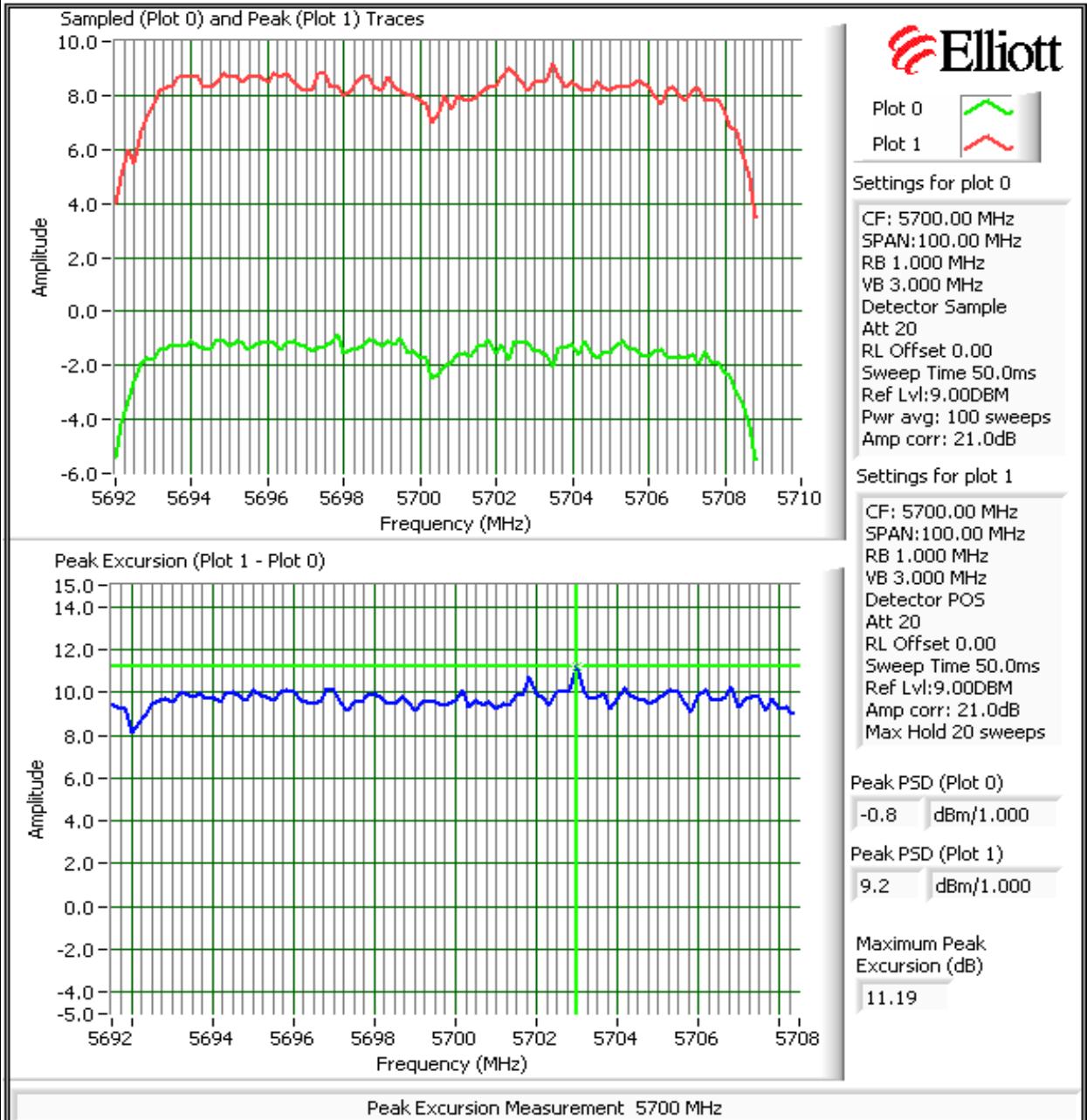

Client: Meru Networks	Job Number: J69452
Model: RS 4000	T-Log Number: T69548
Contact: John Dorsey	Account Manager: Richard Gencev
Standard: FCC Part 15.247/RSS-210	Class: N/A

Run #3: Out Of Band Spurious Emissions - Antenna Conducted

Maximum Antenna Gain: 5.5 dBi  
 Spurious Limit: -27 dBm/MHz eirp  
 Limit Used On Plots <sup>Note 1</sup>: -32.5 dBm/MHz

- Note 1: The -27dBm/MHz limit is an eirp limit. The limit for antenna port conducted measurements is adjusted to take into consideration the maximum antenna gain (limit = -27dBm - antenna gain). Radiated field strength measurements for signals more than 50MHz from the bands and that are close to the limit are made to determine compliance as the antenna gain is not known at these frequencies.
- Note 2: All spurious signals below 1GHz are measured during digital device radiated emissions test.
- Note 3: Signals within 10MHz of the 5.725 or 5.825 Band edge are subject to a limit of -17dBm EIRP
- Note 4: If the device is for outdoor use then the -27dBm eirp limit also applies in the 5150 - 5250 MHz band.
- Note 5: Signals that fall in the restricted bands of 15.205 are subject to the limit of 15.209.

Plots Showing Out-Of-Band Emissions (RBW=VBW=1MHz)

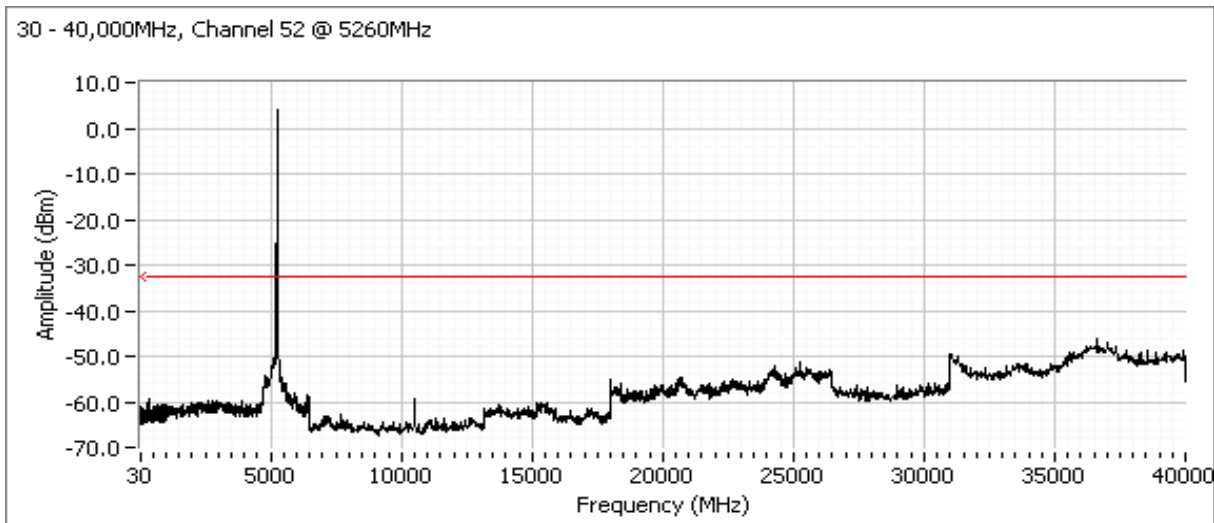

Client: Meru Networks	Job Number: J69452
Model: RS 4000	T-Log Number: T69548
Contact: John Dorsey	Account Manager: Richard Gencev
Standard: FCC Part 15.247/RSS-210	Class: N/A

Run #3: Continued

30 - 40,000MHz, Channel 60 @ 5300MHz

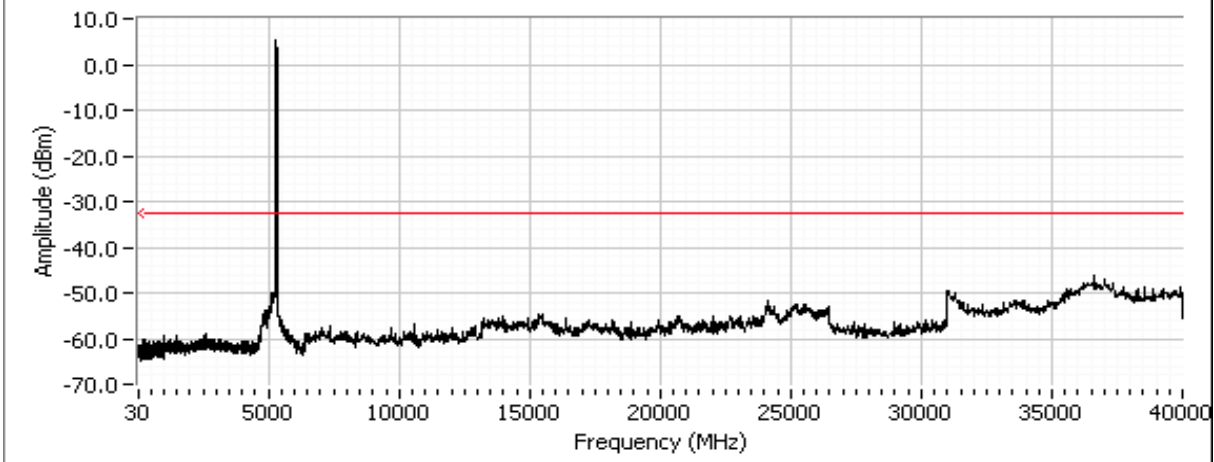

30 - 40,000MHz, Channel 64 @ 5320MHz

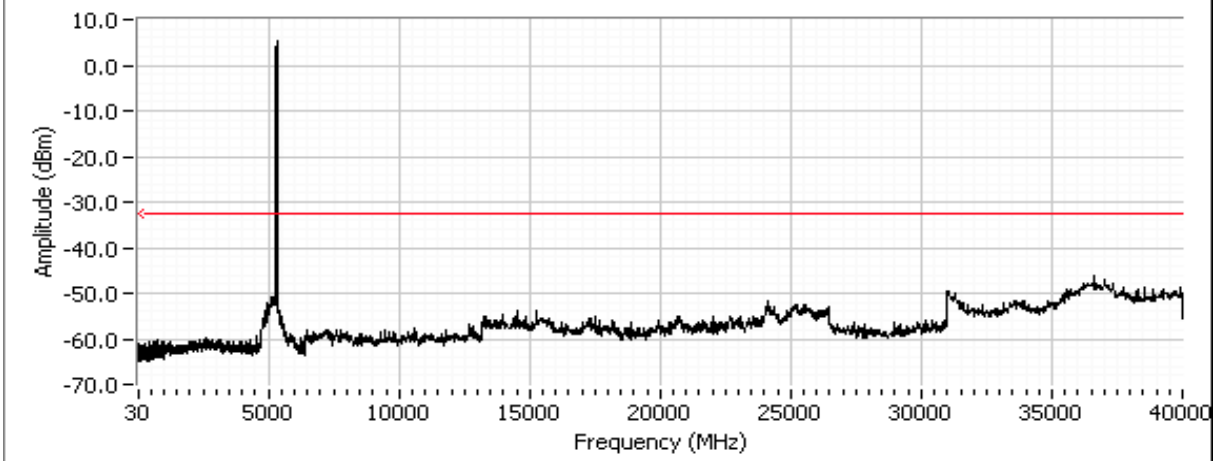

Client: Meru Networks	Job Number: J69452
Model: RS 4000	T-Log Number: T69548
Contact: John Dorsey	Account Manager: Richard Gencev
Standard: FCC Part 15.247/RSS-210	Class: N/A

Run #3: Continued

Channel 64 @ 5320MHz (-27dBm closeup)

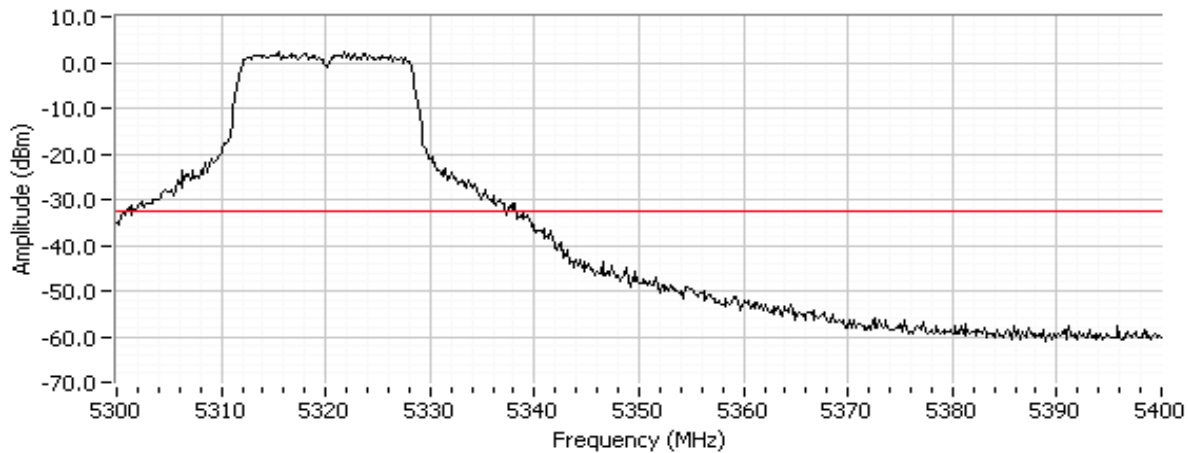

Channel 100 @ 5500MHz (-27dBm closeup)

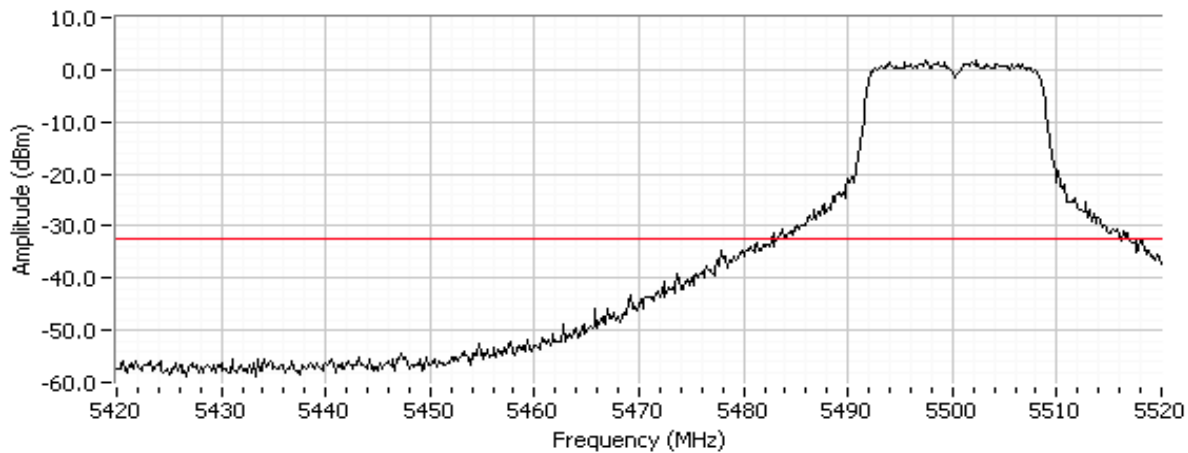

Client: Meru Networks	Job Number: J69452
Model: RS 4000	T-Log Number: T69548
Contact: John Dorsey	Account Manager: Richard Gencev
Standard: FCC Part 15.247/RSS-210	Class: N/A

Run #3: Continued

30 - 40,000MHz, Channel 100 @ 5500MHz

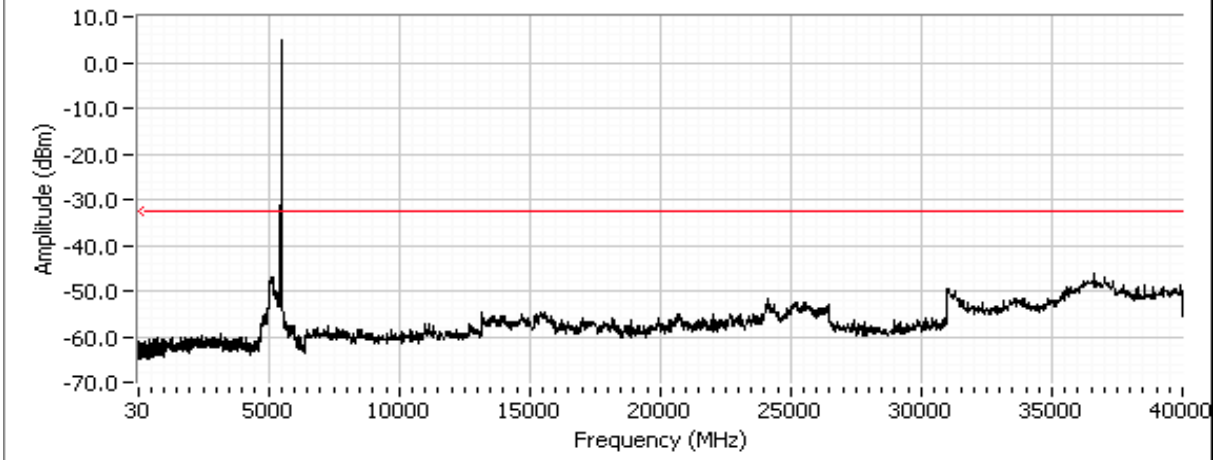

30 - 40,000MHz, Channel 120 @ 5600MHz

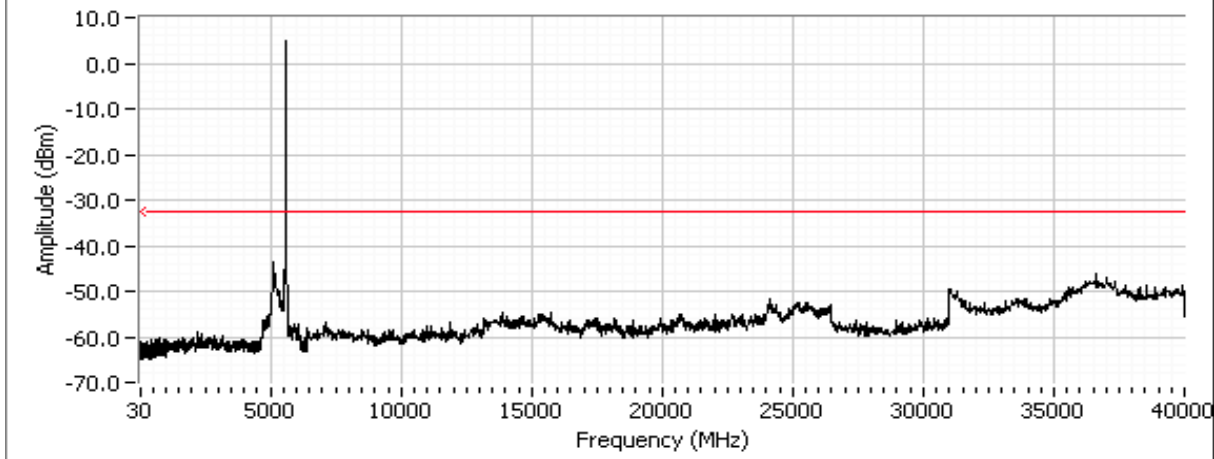

Client: Meru Networks	Job Number: J69452
Model: RS 4000	T-Log Number: T69548
Contact: John Dorsey	Account Manager: Richard Gencev
Standard: FCC Part 15.247/RSS-210	Class: N/A

Run #3: Continued

30 - 40,000MHz, Channel 140 @ 5700MHz

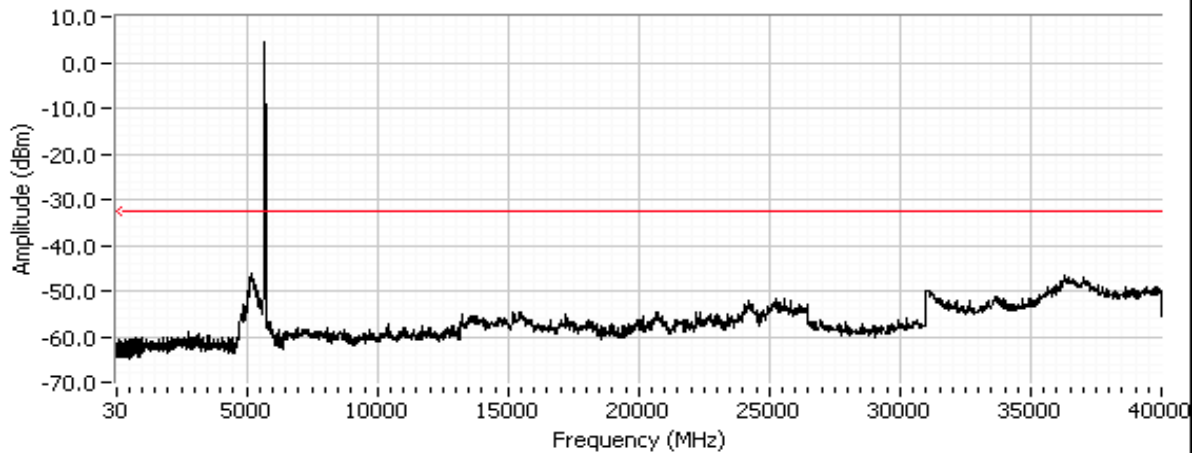

Channel 140 @ 5700MHz (-27dBm closeup)

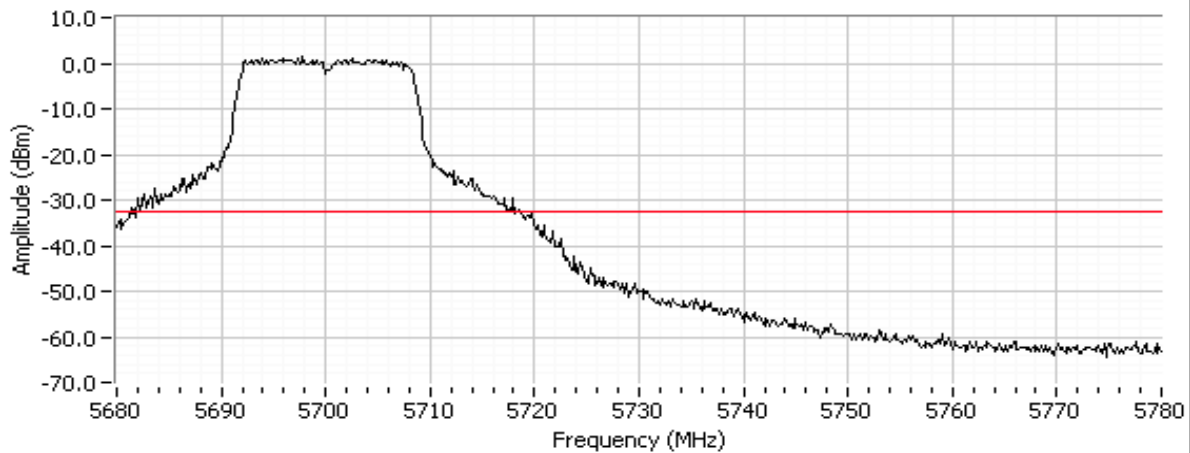

Client:	Meru Networks	Job Number:	J69452
Model:	RS 4000	T-Log Number:	T69548
		Account Manager:	Richard Gencev
Contact:	John Dorsey		
Standard:	FCC Part 15.247/RSS-210	Class:	N/A

## Antenna Port Tests - FCC Part 15.E and RSS-210 A9

### Test Specific Details

Objective: The objective of this test session is to perform final qualification testing of the EUT with respect to the specification listed above.

Date of Test: 10/17/2007 0:00	Config. Used: 1
Test Engineer: Rafael Varelas	Config Change: None
Test Location: SVOATS #1	EUT Voltage: POE

### General Test Configuration

When measuring the conducted emissions from the EUT's antenna port, the antenna port of the EUT was connected to the spectrum analyzer or power meter via a suitable attenuator to prevent overloading the measurement system. All measurements are corrected to allow for the external attenuators and cables used.

**Ambient Conditions:**

Temperature:	12 °C
Rel. Humidity:	74 %

### Summary of Results

Run #	Test Performed	Limit	Pass / Fail	Result / Margin
1	Power, 5250 - 5350MHz	15.407(a) (2) RSS 210 A9.2(2)	Pass	11.6dBm
1	Power, 5470 - 5725MHz	15.407(a) (2) RSS 210 A9.2(2)	Pass	12.4dBm
1	PSD, 5250 - 5350MHz	15.407(a) (2) RSS 210 A9.2(2)	Pass	-1.24dBm/MHz
1	PSD, 5470 - 5725MHz	15.407(a) (2) RSS 210 A9.2(2)	Pass	-0.28dBm/MHz
1	26dB Bandwidth	15.407	Pass	> 20 MHz
1	99% Bandwidth	RSS 210	Pass	17.6MHz
2	Peak Excursion Envelope	15.407(a) (6)	Pass	12.53dBm
3	Antenna Conducted - Out of Band Spurious	15.407(b)	Pass	All emissions below the -27dBm/MHz limit

### Modifications Made During Testing

No modifications were made to the EUT during testing

### Deviations From The Standard

No deviations were made from the requirements of the standard.





# EMC Test Data

Client:	Meru Networks	Job Number:	J69452
Model:	RS 4000	T-Log Number:	T69548
Contact:	John Dorsey	Account Manager:	Richard Gencev
Standard:	FCC Part 15.247/RSS-210	Class:	N/A

**Run #1: Bandwidth, Output Power and Power spectral Density**

Antenna Gain: 7 dBi

Frequency (MHz)	Software Setting	Bandwidth		Output Power <sup>1</sup> dBm		Power (Watts)	PSD <sup>2</sup> dBm/MHz			Result
		26dB	99% <sup>4</sup>	Measured	Limit		Measured	FCC Limit	RSS Limit <sup>3</sup>	
5260	19.0	26.0	17.5	9.9	23.0	0.010	-2.84	10.0	11.0	Pass
5300	19.0	26.5	17.5	11.6	23.0	0.014	-1.29	10.0	11.0	Pass
5320	19.0	26.0	17.5	11.5	23.0	0.014	-1.24	10.0	11.0	Pass
5500	19.0	26.8	17.3	11.9	23.0	0.015	-0.99	10.0	11.0	Pass
5600	19.0	26.2	17.5	12.4	23.0	0.017	-0.28	10.0	11.0	Pass
5700	19.0	31.5	17.6	12.0	23.0	0.016	-0.84	10.0	11.0	Pass

- Note 1: Output power measured using a spectrum analyzer (see plots below):  
RBW=1MHz, VB=3 MHz, sample detector, power averaging on (transmitted signal was continuous) and power integration over 100 MHz
- Note 2: Measured using the same analyzer settings used for output power.
- Note 3: For RSS210 the measured value of the PSD (see note 3) must not exceed the average value (calculated from the measured power divided by the measured 99% bandwidth) by more than 3dB.
- Note 4: 99% Bandwidth measured in accordance with RSS GEN - RB > 1% of span and VB >=3xRB

Client: Meru Networks	Job Number: J69452
Model: RS 4000	T-Log Number: T69548
Contact: John Dorsey	Account Manager: Richard Gencev
Standard: FCC Part 15.247/RSS-210	Class: N/A

Run #1: Continued

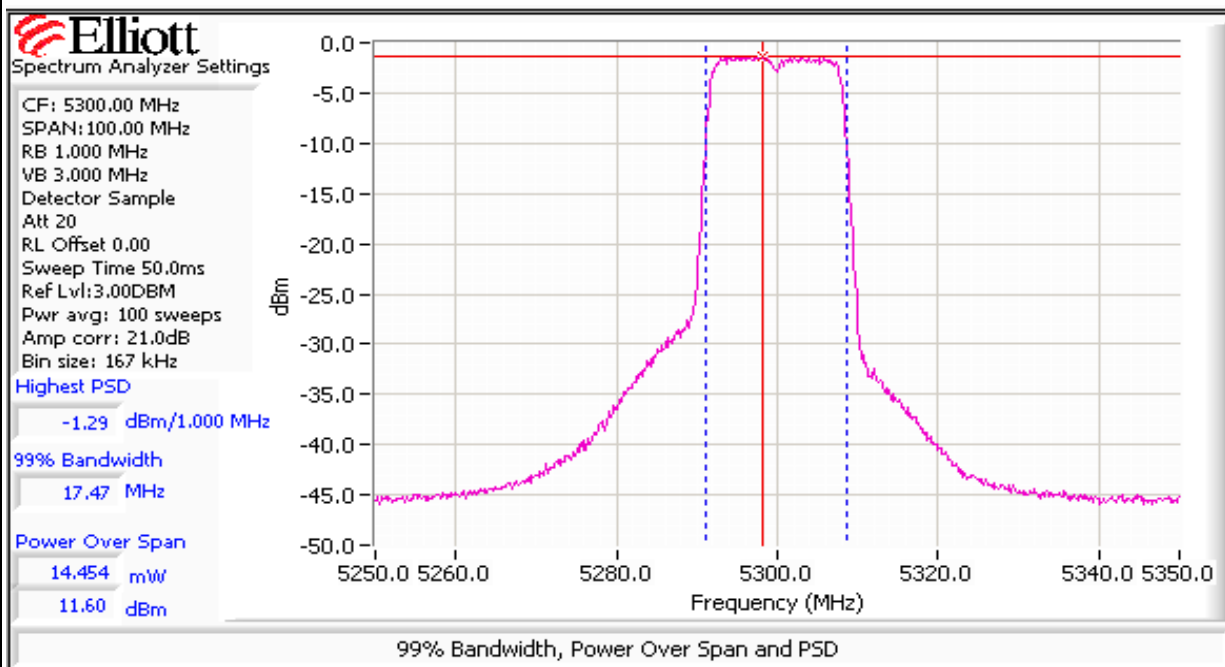
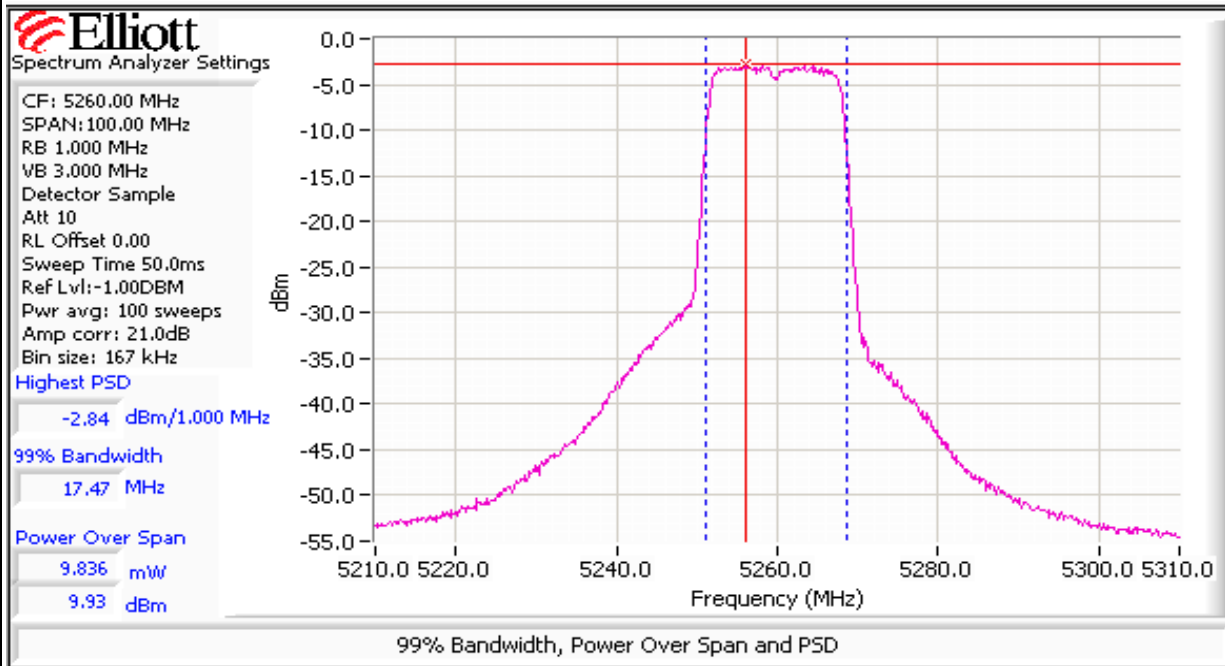

Client: Meru Networks	Job Number: J69452
Model: RS 4000	T-Log Number: T69548
Contact: John Dorsey	Account Manager: Richard Gencev
Standard: FCC Part 15.247/RSS-210	Class: N/A

Run #1: Continued

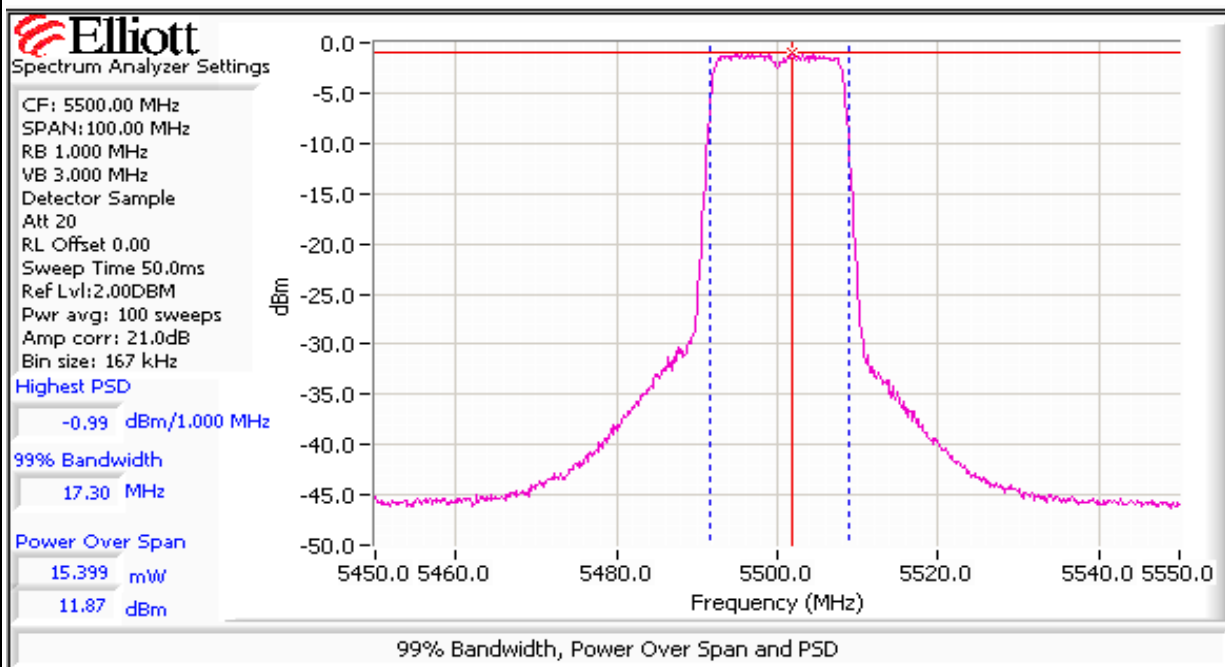
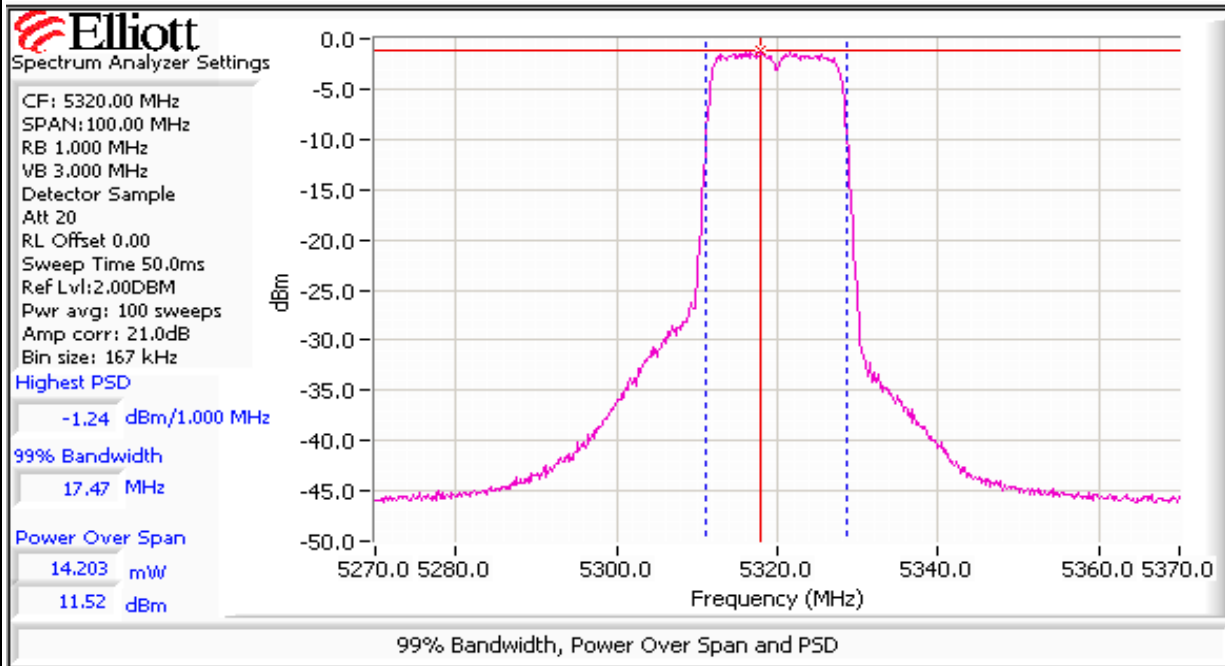

Client: Meru Networks	Job Number: J69452
Model: RS 4000	T-Log Number: T69548
Contact: John Dorsey	Account Manager: Richard Gencev
Standard: FCC Part 15.247/RSS-210	Class: N/A

Run #1: Continued

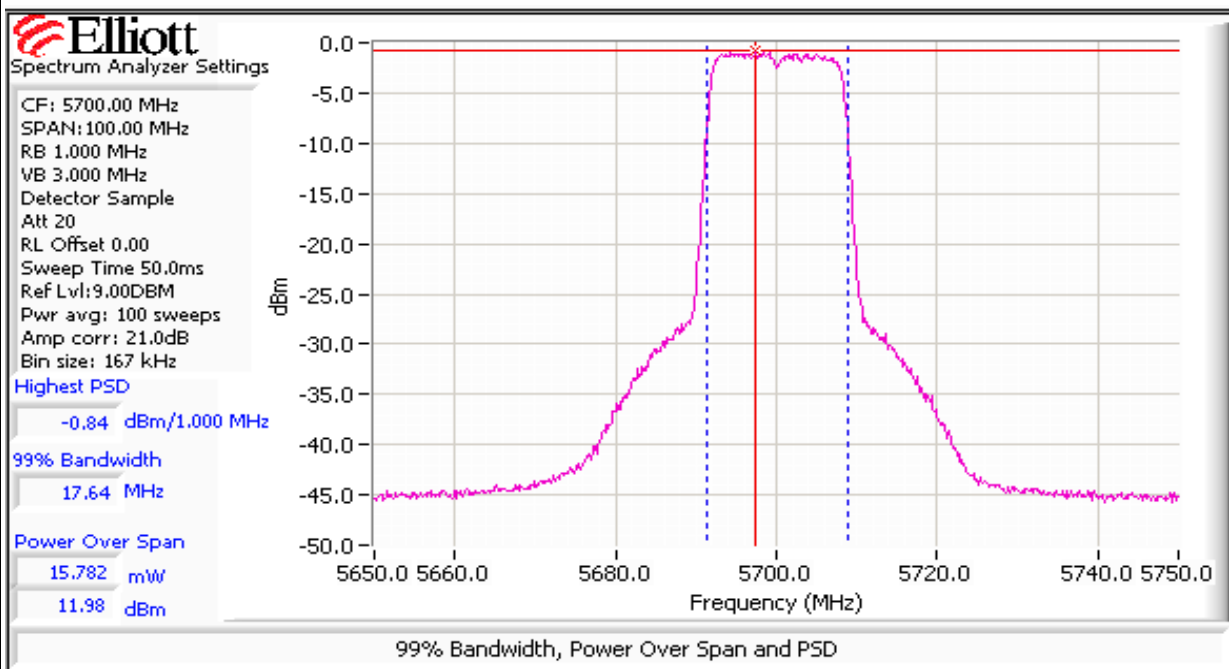
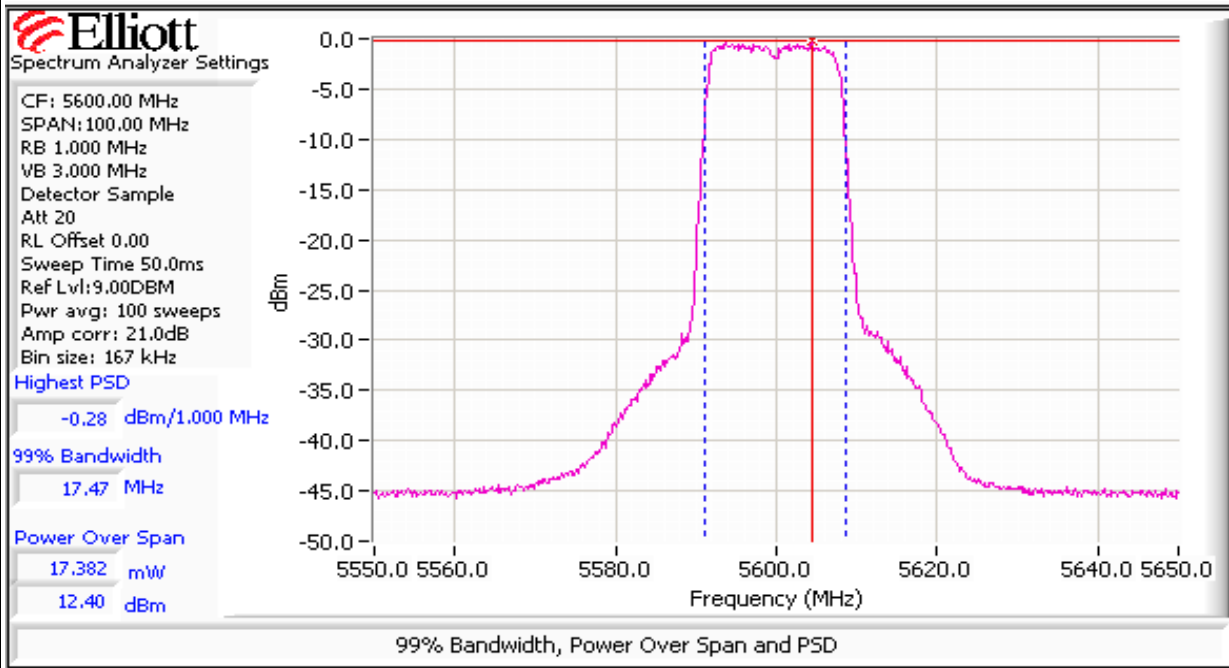

Client: Meru Networks	Job Number: J69452
Model: RS 4000	T-Log Number: T69548
Contact: John Dorsey	Account Manager: Richard Gencev
Standard: FCC Part 15.247/RSS-210	Class: N/A

Run #1: Continued

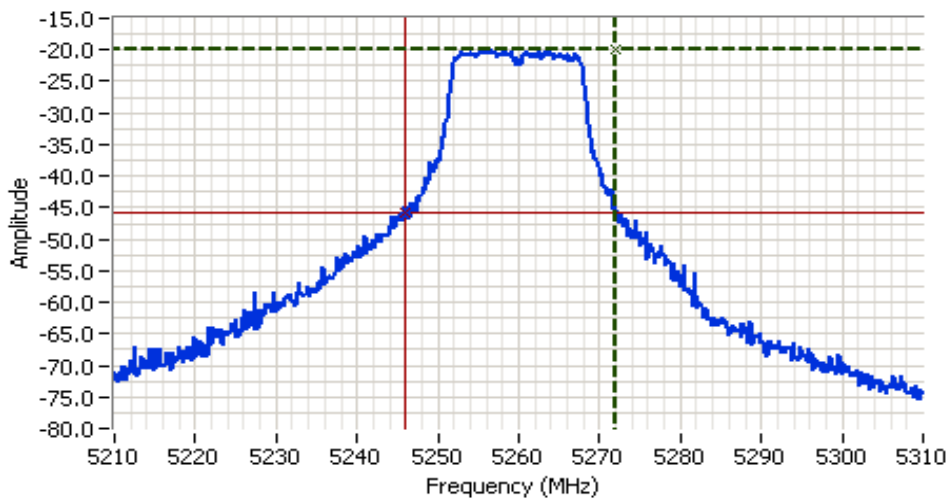

**Analyzer Settings**

HP8564E  
 CF: 5260.00 MHz  
 SPAN: 100.00 MHz  
 RB 300 kHz  
 VB 1.000 MHz  
 Detector POS  
 Att 0  
 RL Offset 0.00  
 Sweep Time 50.0ms  
 Ref Lvl: -12.00DBM

**Comments**

5260 MHz  
 26dB Bandwidth

Cursor 1 5272.00(-19.83)    Delta Freq. 26.00

Cursor 2 5246.00(-45.83)    Delta Amplitude 26.00

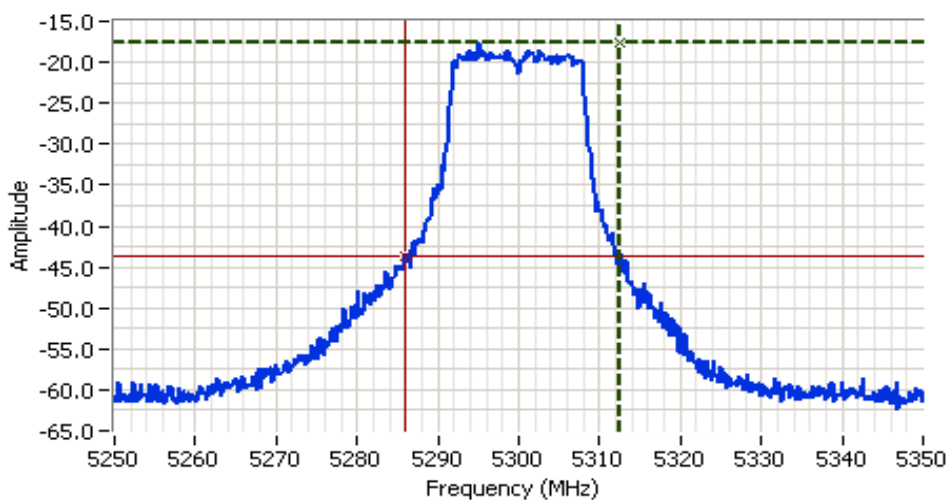

**Analyzer Settings**

HP8564E  
 CF: 5300.00 MHz  
 SPAN: 100.00 MHz  
 RB 300 kHz  
 VB 1.000 MHz  
 Detector POS  
 Att 20  
 RL Offset 0.00  
 Sweep Time 50.0ms  
 Ref Lvl: 3.00DBM

**Comments**

5300 MHz  
 26dB Bandwidth

Cursor 1 5312.50(-17.67)    Delta Freq. 26.50

Cursor 2 5286.00(-43.67)    Delta Amplitude 26.00



Client: Meru Networks	Job Number: J69452
Model: RS 4000	T-Log Number: T69548
Contact: John Dorsey	Account Manager: Richard Gencev
Standard: FCC Part 15.247/RSS-210	Class: N/A

Run #1: Continued

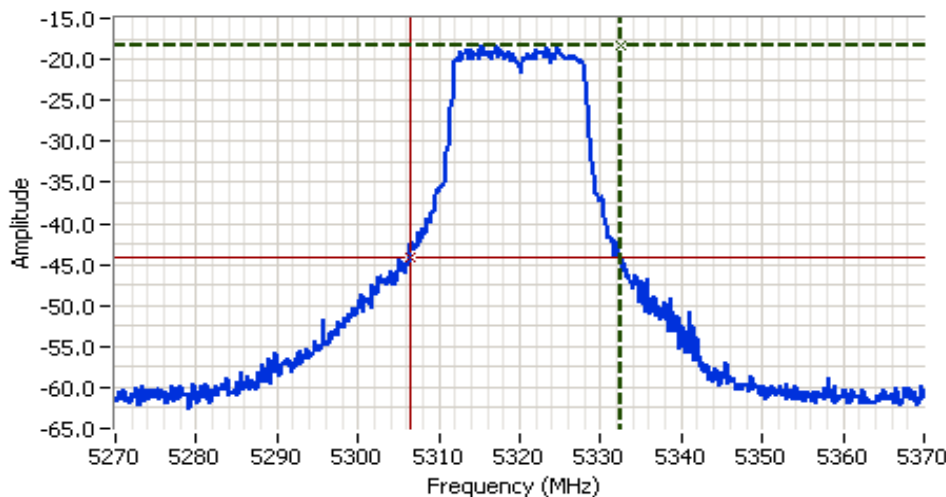

Analyzer Settings

HP8564E  
 CF: 5320.00 MHz  
 SPAN: 100.00 MHz  
 RB 300 kHz  
 VB 1.000 MHz  
 Detector POS  
 Att 20  
 RL Offset 0.00  
 Sweep Time 50.0ms  
 Ref Lvl: 1.80DBM

Comments

5320 MHz  
 26dB Bandwidth

Cursor 1	5332.50	-18.20	
Cursor 2	5306.50	-44.20	

Delta Freq. 26.00

Delta Amplitude 26.00

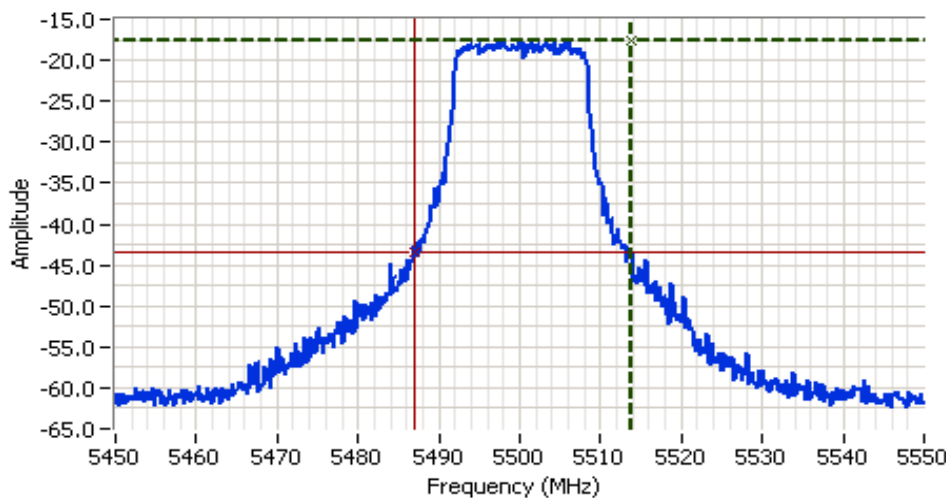

Analyzer Settings

HP8564E  
 CF: 5500.00 MHz  
 SPAN: 100.00 MHz  
 RB 300 kHz  
 VB 1.000 MHz  
 Detector POS  
 Att 20  
 RL Offset 0.00  
 Sweep Time 50.0ms  
 Ref Lvl: 2.00DBM

Comments

5500 MHz  
 26dB Bandwidth

Cursor 1	5513.83	-17.50	
Cursor 2	5487.00	-43.50	

Delta Freq. 26.83

Delta Amplitude 26.00



Client: Meru Networks	Job Number: J69452
Model: RS 4000	T-Log Number: T69548
Contact: John Dorsey	Account Manager: Richard Gencev
Standard: FCC Part 15.247/RSS-210	Class: N/A

Run #1: Continued

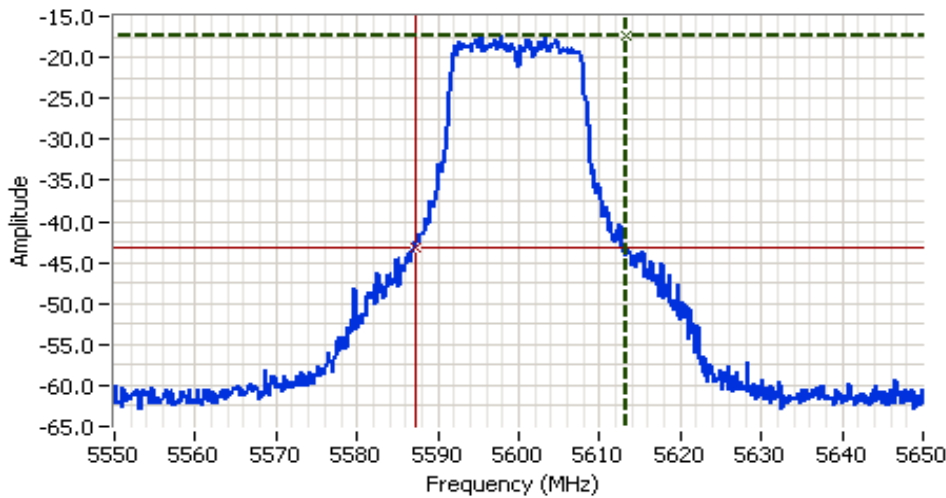

Analyzer Settings

HP8564E  
 CF: 5600.00 MHz  
 SPAN: 100.00 MHz  
 RB 300 kHz  
 VB 1.000 MHz  
 Detector POS  
 Att 20  
 RL Offset 0.00  
 Sweep Time 50.0ms  
 Ref Lvl: 1.90DBM

Comments

5600 MHz  
 26dB Bandwidth

Cursor 1	5613.33	-17.27	
Cursor 2	5587.16	-43.27	

Delta Freq. 26.17  
 Delta Amplitude 26.00

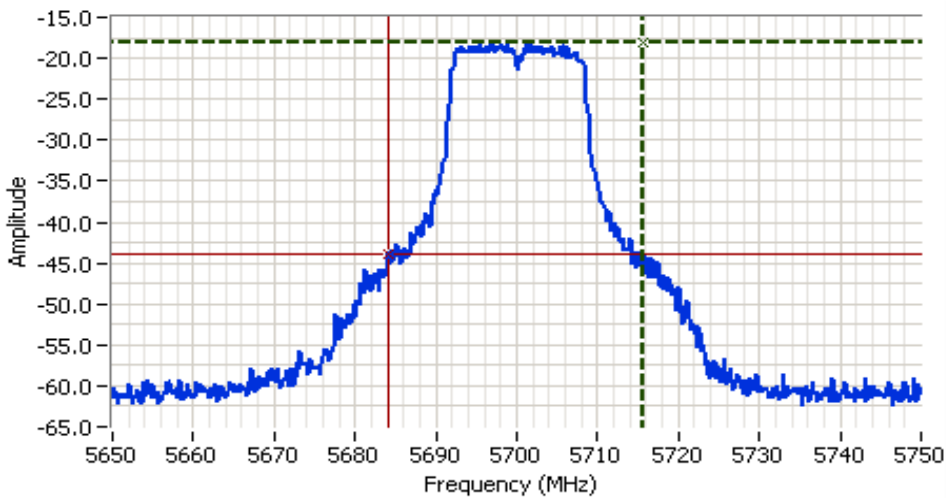

Analyzer Settings

HP8564E  
 CF: 5700.00 MHz  
 SPAN: 100.00 MHz  
 RB 300 kHz  
 VB 1.000 MHz  
 Detector POS  
 Att 20  
 RL Offset 0.00  
 Sweep Time 50.0ms  
 Ref Lvl: 9.00DBM

Comments

5700 MHz  
 26dB Bandwidth

Cursor 1	5715.66	-18.00	
Cursor 2	5684.16	-44.00	

Delta Freq. 31.50  
 Delta Amplitude 26.00



Client: Meru Networks	Job Number: J69452
Model: RS 4000	T-Log Number: T69548
Contact: John Dorsey	Account Manager: Richard Gencev
Standard: FCC Part 15.247/RSS-210	Class: N/A

### Run #2: Peak Excursion Measurement

#### Plots Showing Peak Excursion

Trace A: RBW = VBW = 1MHz

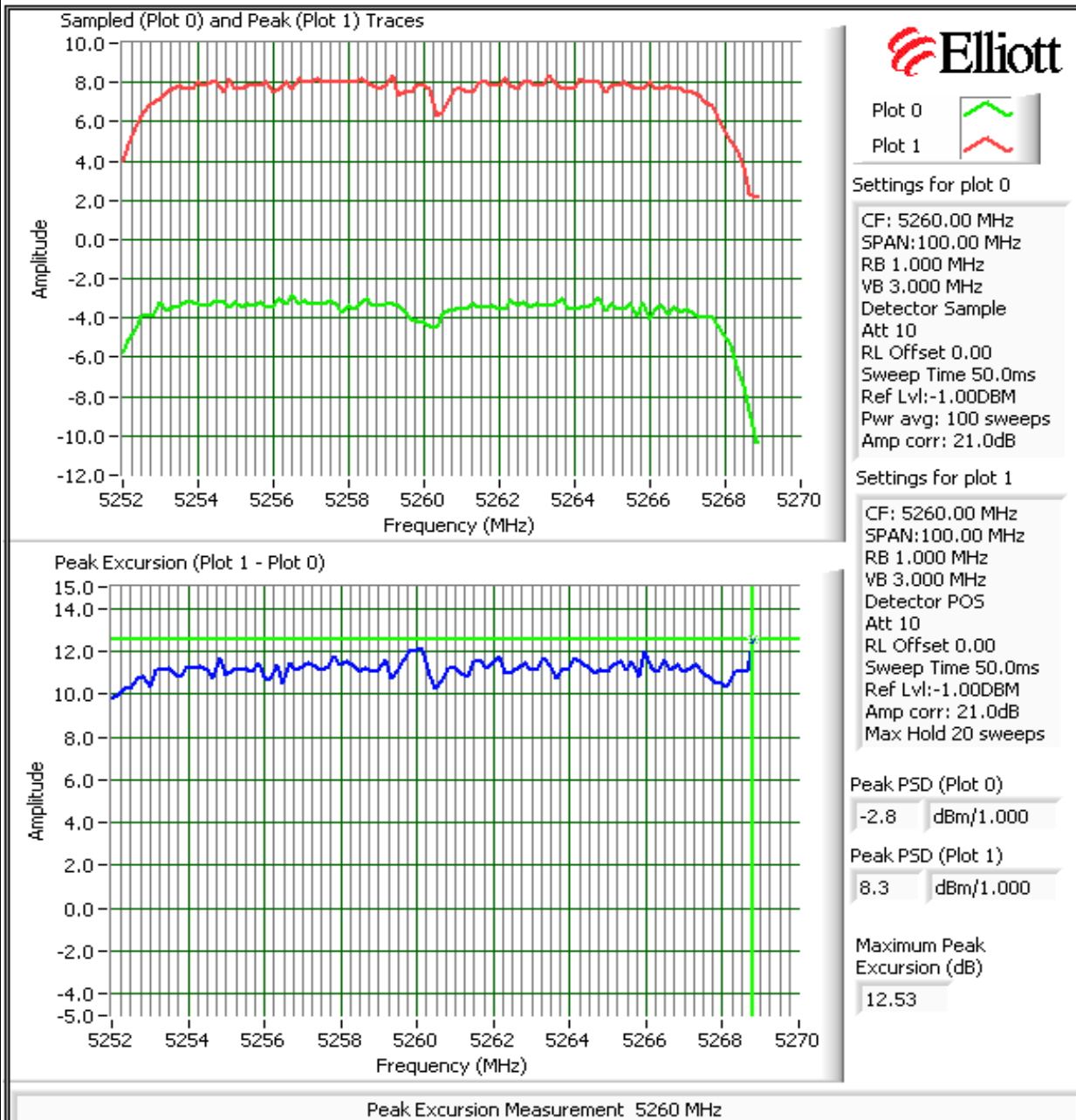



Client: Meru Networks	Job Number: J69452
Model: RS 4000	T-Log Number: T69548
Contact: John Dorsey	Account Manager: Richard Gencev
Standard: FCC Part 15.247/RSS-210	Class: N/A

Run #2: Continued

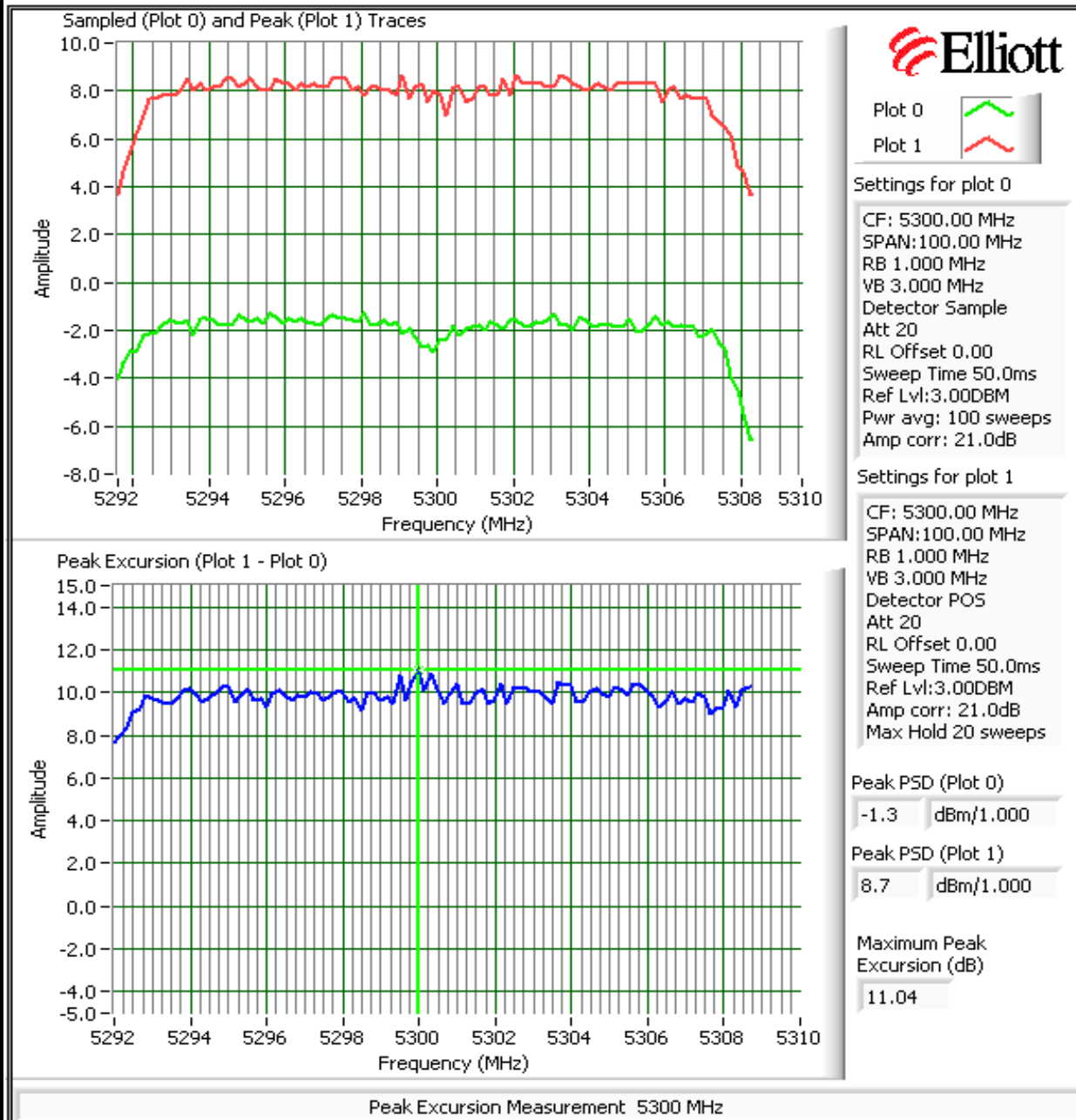

Client: Meru Networks	Job Number: J69452
Model: RS 4000	T-Log Number: T69548
Contact: John Dorsey	Account Manager: Richard Gencev
Standard: FCC Part 15.247/RSS-210	Class: N/A

Run #2: Continued

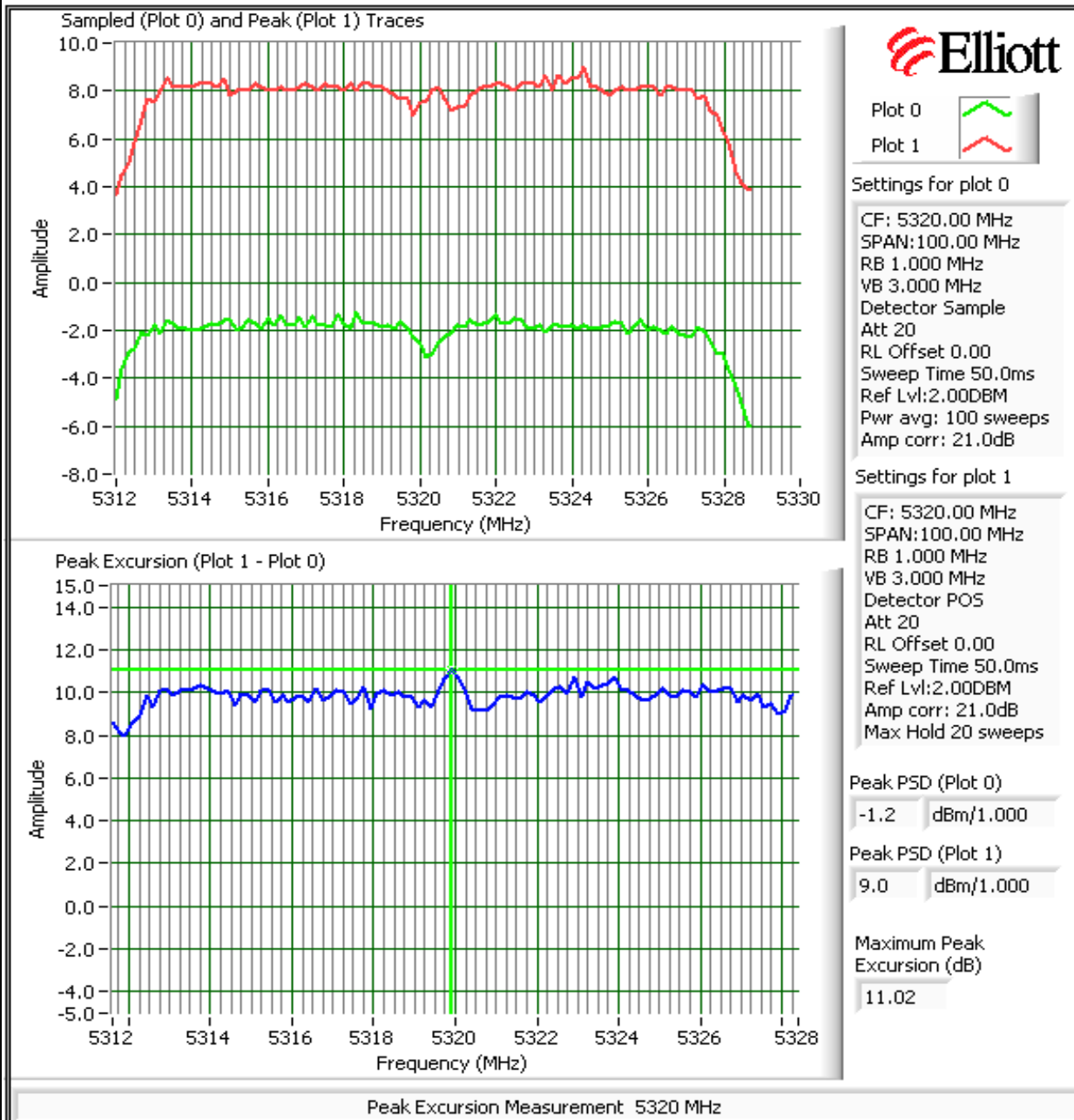

Client: Meru Networks	Job Number: J69452
Model: RS 4000	T-Log Number: T69548
Contact: John Dorsey	Account Manager: Richard Gencev
Standard: FCC Part 15.247/RSS-210	Class: N/A

Run #2: Continued

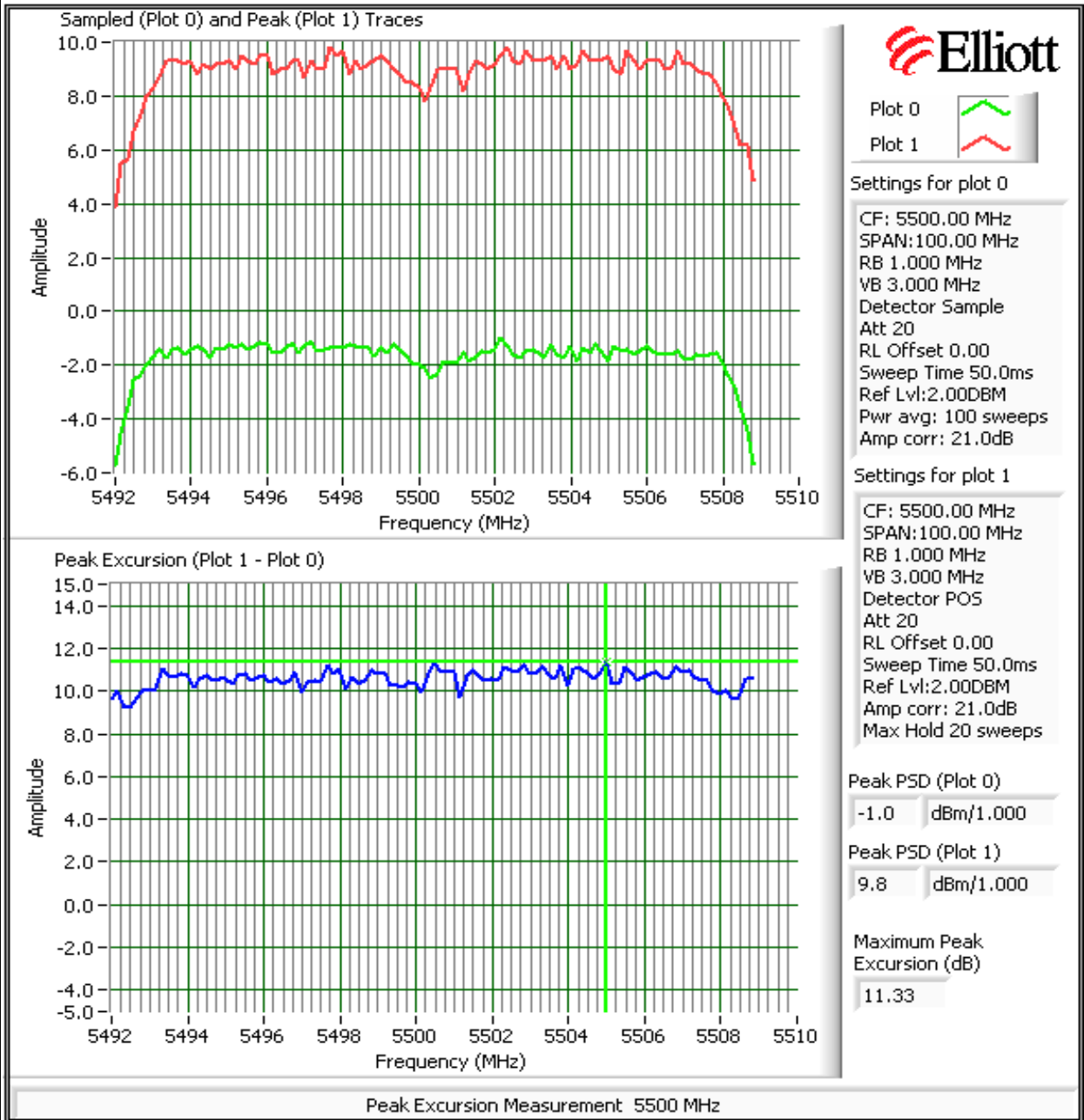

Client: Meru Networks	Job Number: J69452
Model: RS 4000	T-Log Number: T69548
Contact: John Dorsey	Account Manager: Richard Gencev
Standard: FCC Part 15.247/RSS-210	Class: N/A

Run #2: Continued

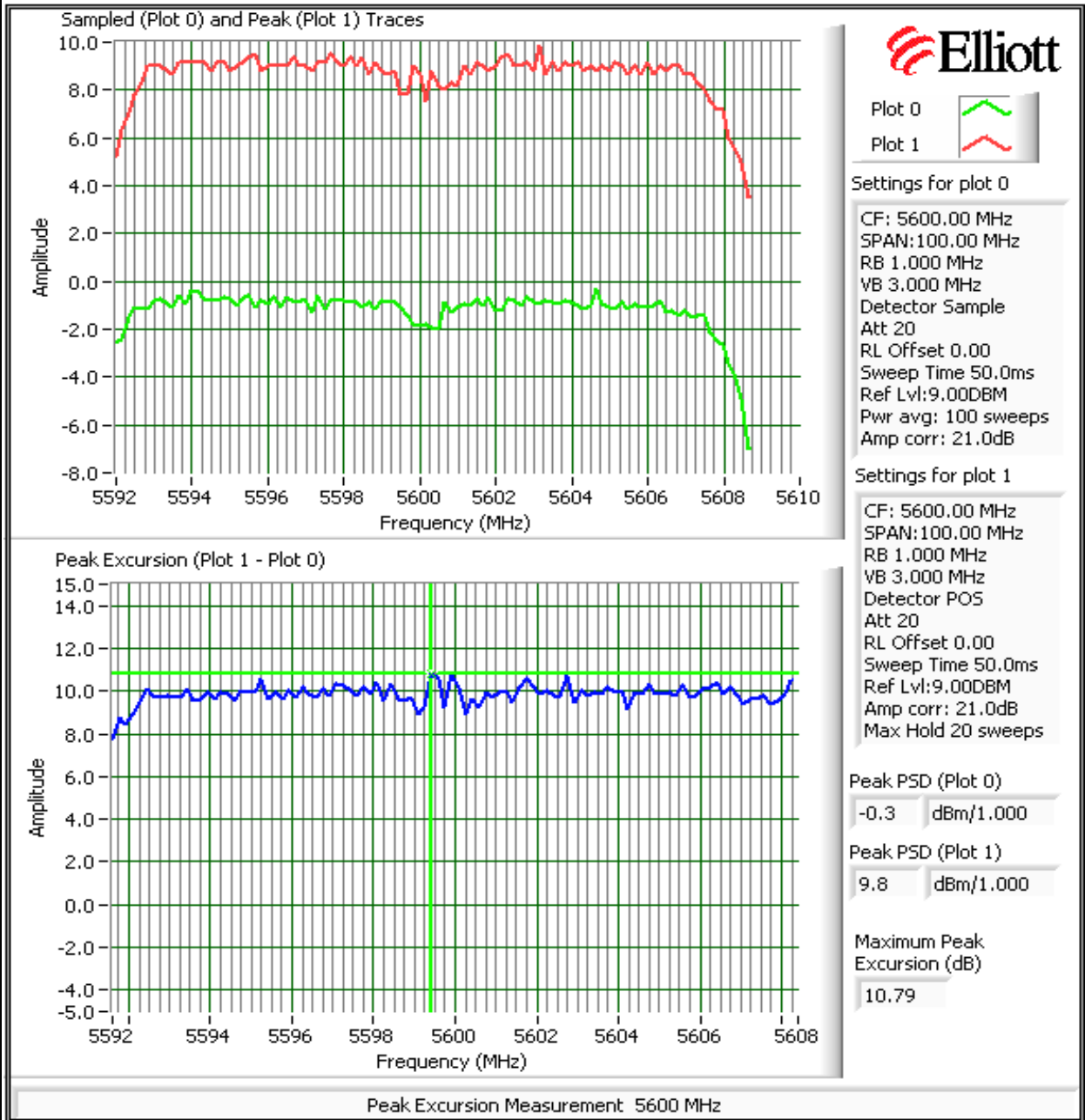

Client: Meru Networks	Job Number: J69452
Model: RS 4000	T-Log Number: T69548
Contact: John Dorsey	Account Manager: Richard Gencev
Standard: FCC Part 15.247/RSS-210	Class: N/A

Run #2: Continued

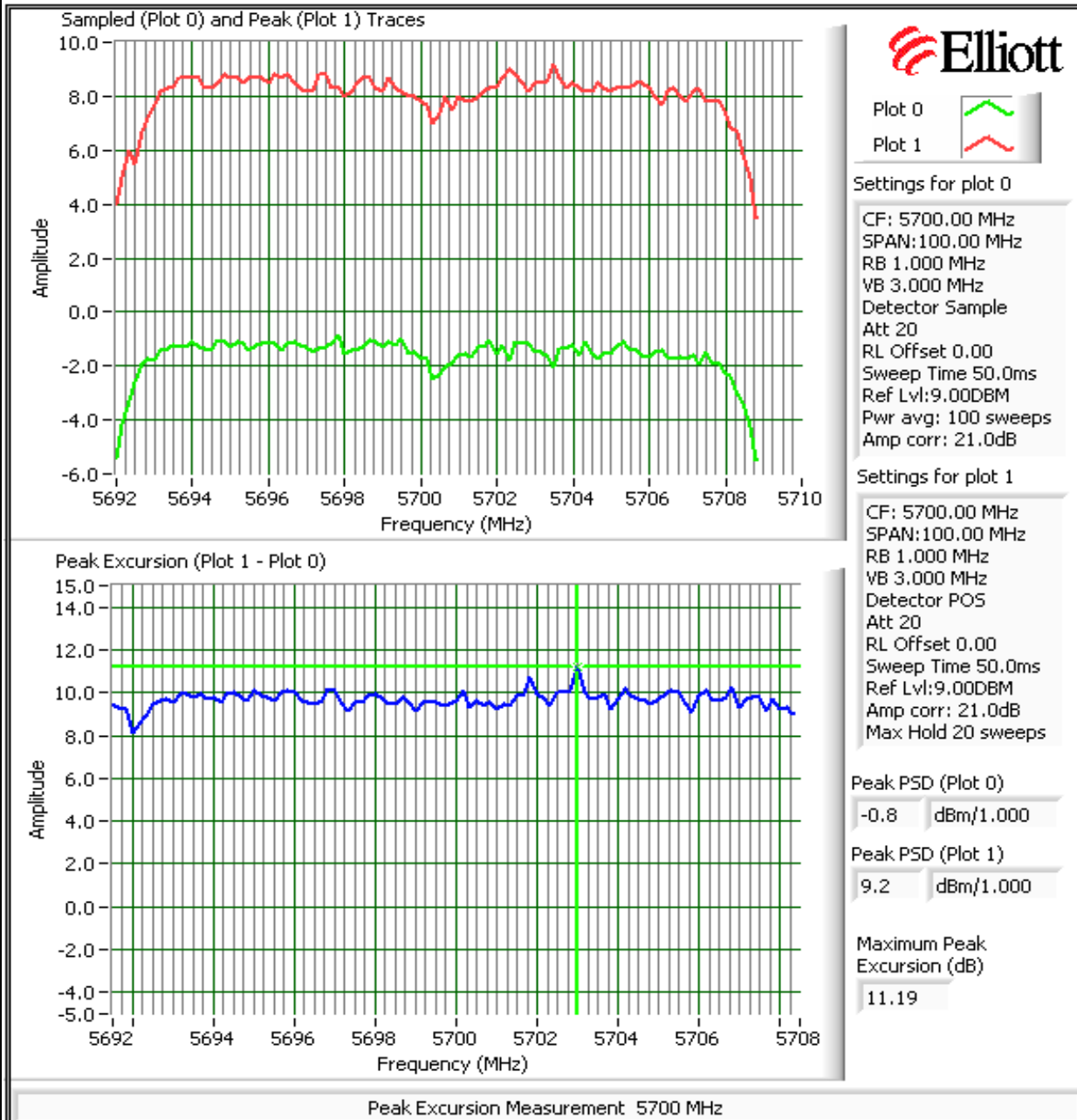

Client: Meru Networks	Job Number: J69452
Model: RS 4000	T-Log Number: T69548
Contact: John Dorsey	Account Manager: Richard Gencev
Standard: FCC Part 15.247/RSS-210	Class: N/A

### Run #3: Out Of Band Spurious Emissions - Antenna Conducted

Maximum Antenna Gain: 7 dBi  
 Spurious Limit: -27 dBm/MHz eirp  
 Limit Used On Plots <sup>Note 1</sup>: -34 dBm/MHz

Note 1: The -27dBm/MHz limit is an eirp limit. The limit for antenna port conducted measurements is adjusted to take into consideration the maximum antenna gain (limit = -27dBm - antenna gain). Radiated field strength measurements for signals more than 50MHz from the bands and that are close to the limit are made to determine compliance as the antenna gain is not known at these frequencies.

Note 2: All spurious signals below 1GHz are measured during digital device radiated emissions test.

Note 3: Signals within 10MHz of the 5.725 or 5.825 Band edge are subject to a limit of -17dBm EIRP

Note 4: If the device is for outdoor use then the -27dBm eirp limit also applies in the 5150 - 5250 MHz band.

Note 5: Signals that fall in the restricted bands of 15.205 are subject to the limit of 15.209.

### Plots Showing Out-Of-Band Emissions (RBW=VBW=1MHz)

30 - 40,000MHz, Channel 52 @ 5260MHz

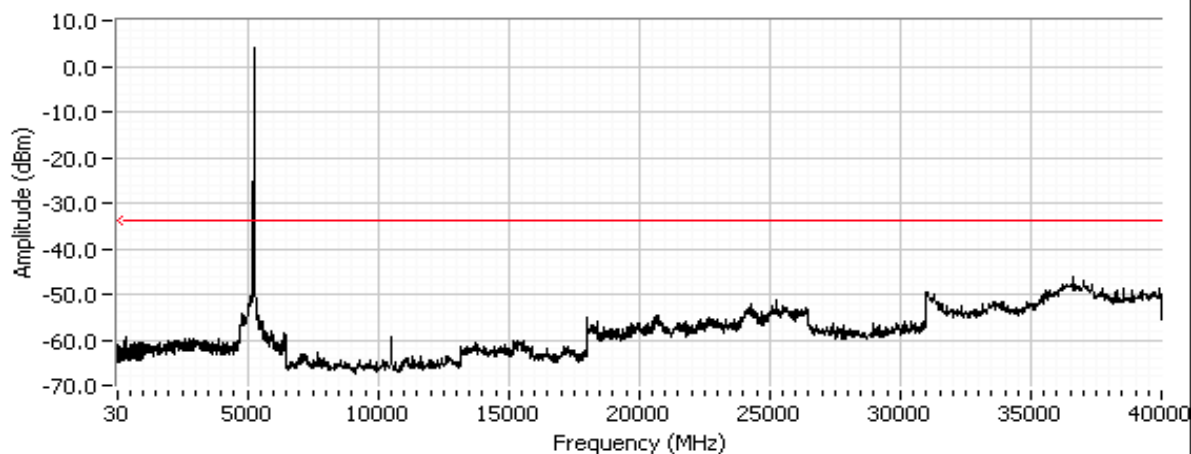

Client: Meru Networks	Job Number: J69452
Model: RS 4000	T-Log Number: T69548
Contact: John Dorsey	Account Manager: Richard Gencev
Standard: FCC Part 15.247/RSS-210	Class: N/A

### Run #3: Continued

30 - 40,000MHz, Channel 60 @ 5300MHz

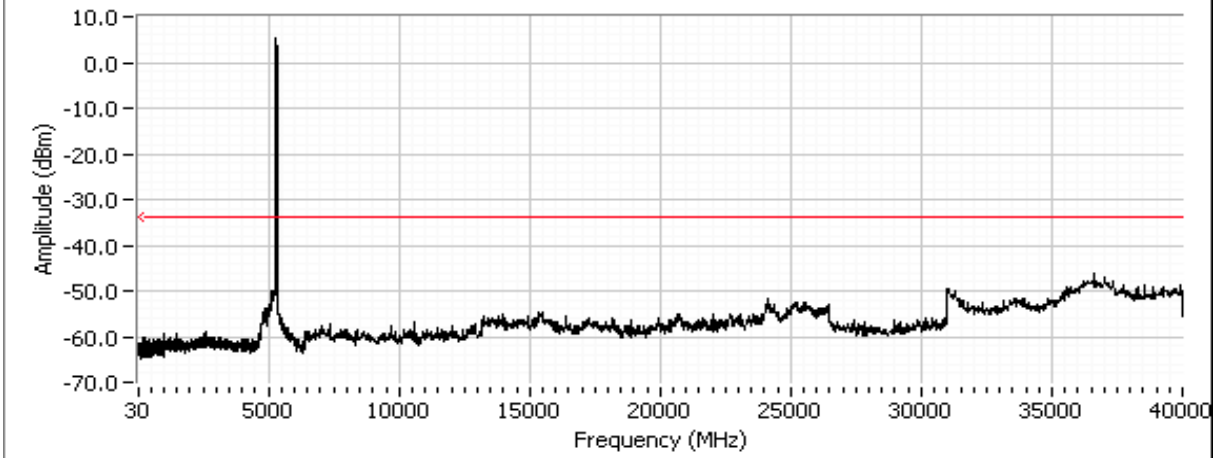

30 - 40,000MHz, Channel 64 @ 5320MHz

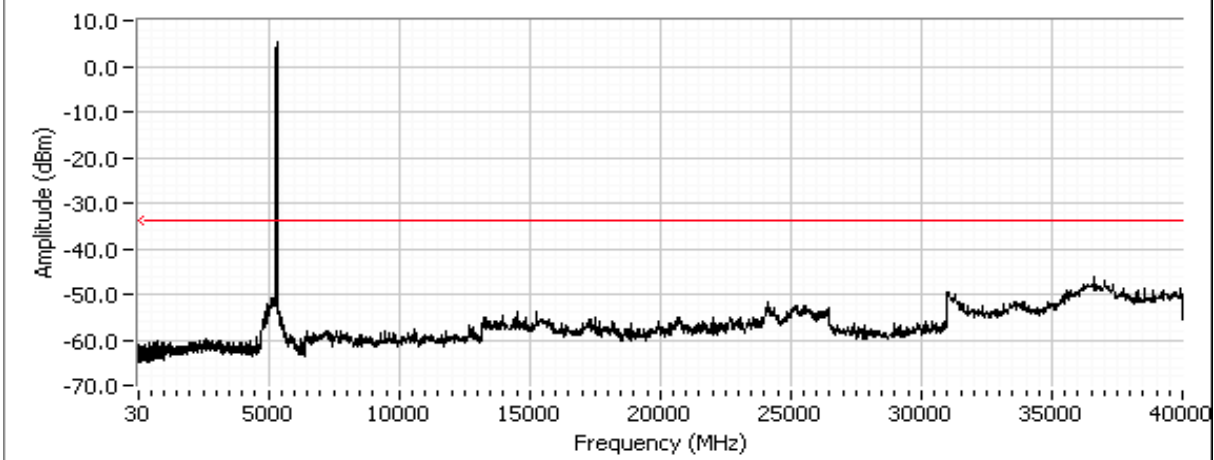

Client: Meru Networks	Job Number: J69452
Model: RS 4000	T-Log Number: T69548
Contact: John Dorsey	Account Manager: Richard Gencev
Standard: FCC Part 15.247/RSS-210	Class: N/A

Run #3: Continued

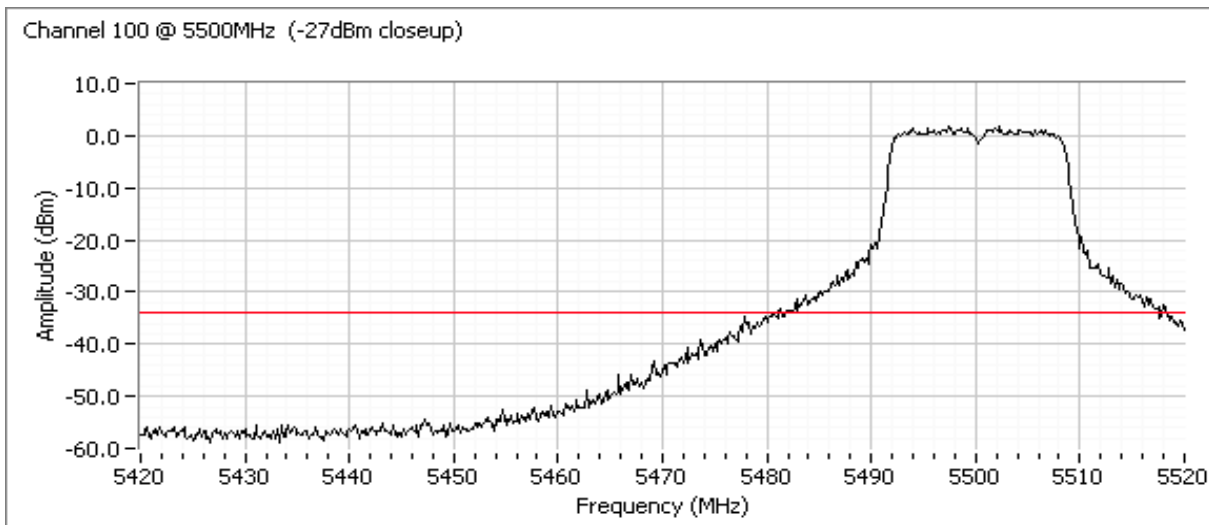
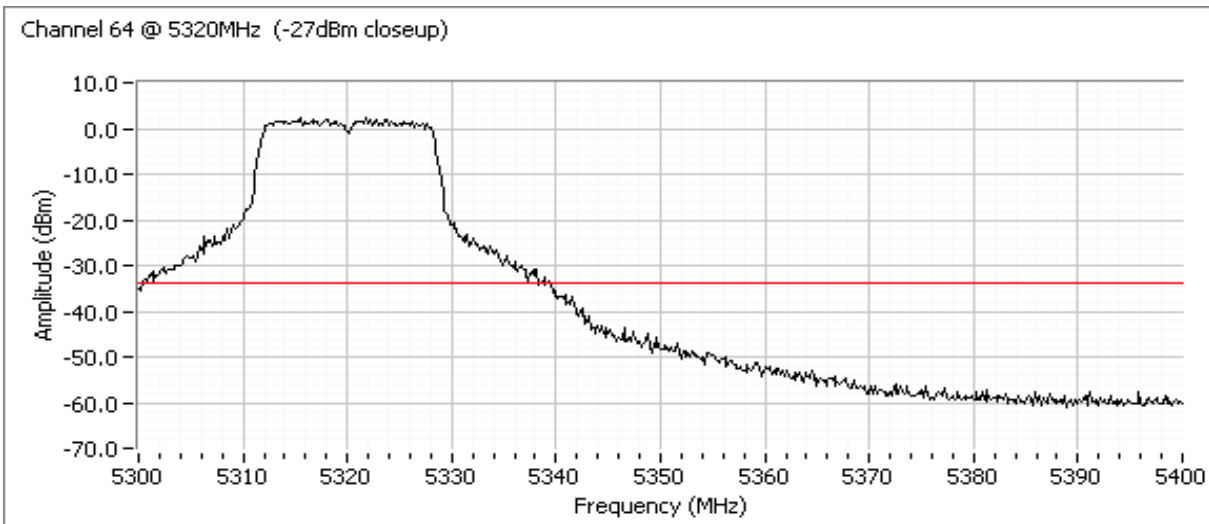



Client: Meru Networks	Job Number: J69452
Model: RS 4000	T-Log Number: T69548
Contact: John Dorsey	Account Manager: Richard Gencev
Standard: FCC Part 15.247/RSS-210	Class: N/A

Run #3: Continued

30 - 40,000MHz, Channel 100 @ 5500MHz

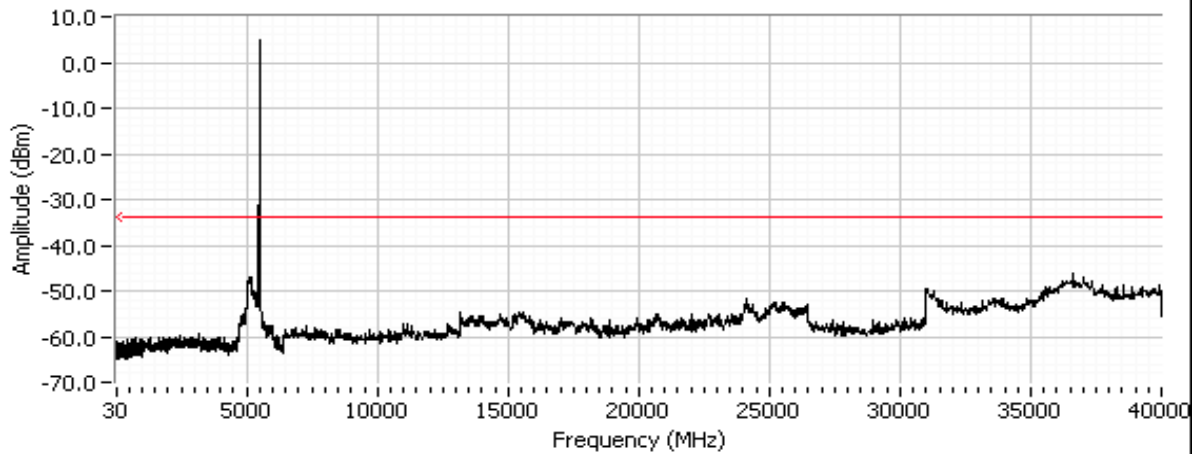

30 - 40,000MHz, Channel 120 @ 5600MHz

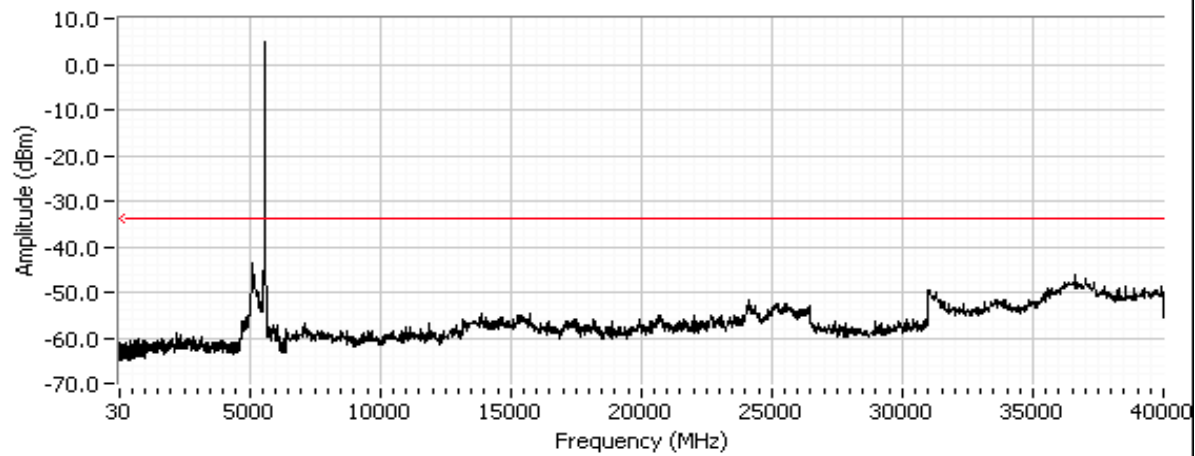

Client: Meru Networks	Job Number: J69452
Model: RS 4000	T-Log Number: T69548
Contact: John Dorsey	Account Manager: Richard Gencev
Standard: FCC Part 15.247/RSS-210	Class: N/A

Run #3: Continued

30 - 40,000MHz, Channel 140 @ 5700MHz

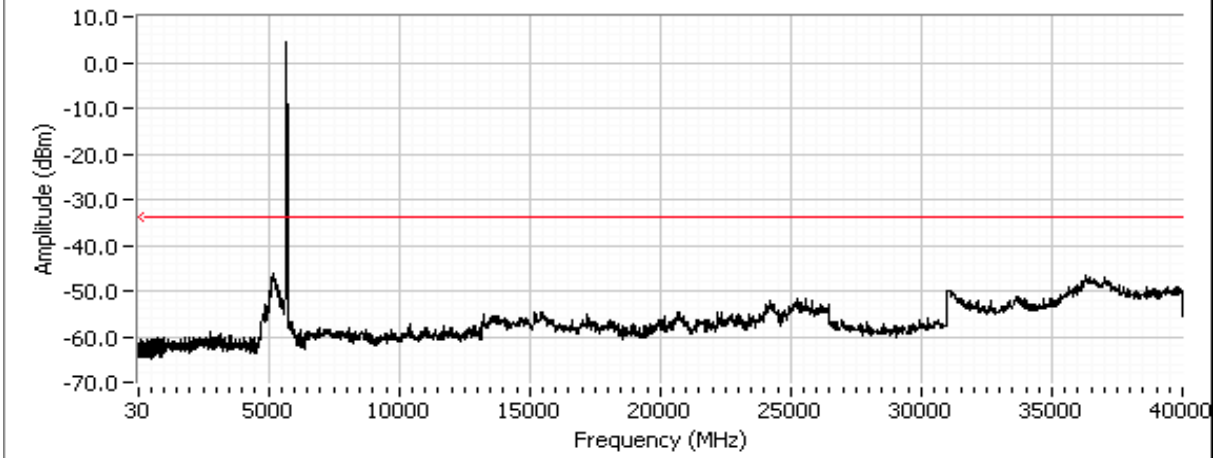

Channel 140 @ 5700MHz (-27dBm closeup)

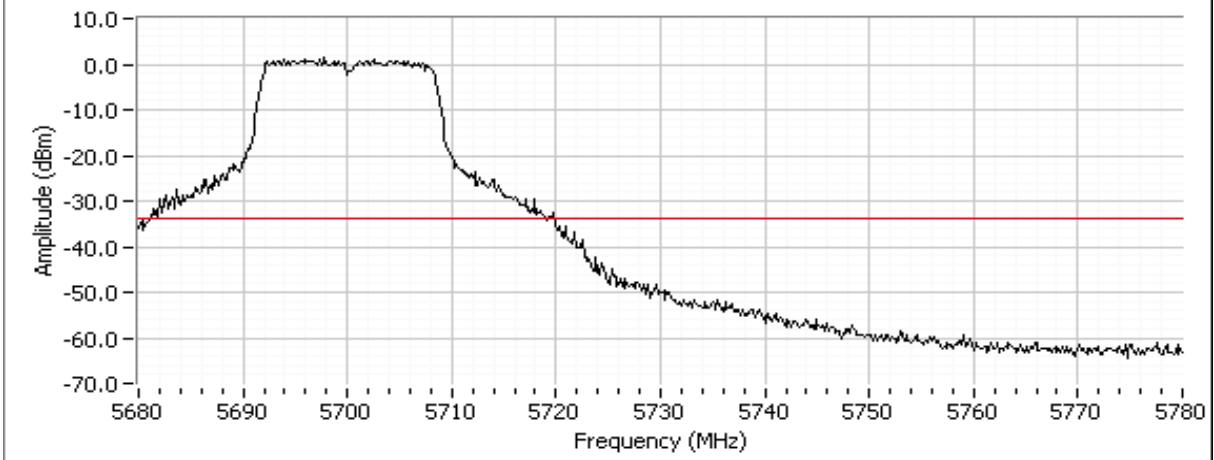

Client:	Meru Networks	Job Number:	J69452
Model:	RS 4000	T-Log Number:	T69548
Contact:	John Dorsey	Account Manager:	Richard Gencev
Standard:	FCC Part 15.247/RSS-210	Class:	N/A

## Radiated Spurious Emissions - FCC Part 15.E and RSS-210 A9

### Test Specific Details

Objective: The objective of this test session is to perform final qualification testing of the EUT with respect to the specification listed above.

### General Test Configuration

The EUT and all local support equipment were located on the turntable for radiated spurious emissions testing.

For radiated emissions testing the measurement antenna was located 3 meters from the EUT.

### Summary of Results

Run #	Freq MHz	Mode	Antenna	Power Setting	Limit	Margin/Result
1	5260	a	Omni Directional with 5.5dBi Gain	19	15.209/15.407(b)/ RSS-210 A9 and 2.6	84.2dB $\mu$ V/m @ 10527.0MHz (-4.1dB)
1	5300	a	Omni Directional with 5.5dBi Gain	19	15.209/15.407(b)/ RSS-210 A9 and 2.6	42.7dB $\mu$ V/m @ 10595.2MHz (-11.3dB)
1	5320	a	Omni Directional with 5.5dBi Gain	19	15.209/15.407(b)/ RSS-210 A9 and 2.6	52.6dB $\mu$ V/m @ 5350.3MHz <b>(-1.4dB)</b>
2	5500	a	Omni Directional with 5.5dBi Gain	19	15.209/15.407(b)/ RSS-210 A9 and 2.6	51.3dB $\mu$ V/m (367.3 $\mu$ V/m) @ 5457.9MHz (-2.7dB)
2	5600	a	Omni Directional with 5.5dBi Gain	19	15.209/15.407(b)/ RSS-210 A9 and 2.6	40.952.5 (110.9.5) @ 16799.711199.3 (-13.1dB)
2	5700	a	Omni Directional with 5.5dBi Gain	19	15.209/15.407(b)/ RSS-210 A9 and 2.6	42.549.9 (133.4.9) @ 17098.611398.6 (-11.5dB)
3	5300	RX	Omni Directional with 5.5dBi Gain	-	RSS-GEN 4.10	41.7dB $\mu$ V/m (121.6 $\mu$ V/m) @ 125.018MHz (-1.8dB)
3	5500	RX	Omni Directional with 5.5dBi Gain	-	RSS-GEN 4.10	41.7dB $\mu$ V/m (121.6 $\mu$ V/m) @ 125.018MHz (-1.8dB)

### Modifications Made During Testing

No modifications were made to the EUT during testing

### Deviations From The Standard

No deviations were made from the requirements of the standard.



Client:	Meru Networks	Job Number:	J69452
Model:	RS 4000	T-Log Number:	T69548
Contact:	John Dorsey	Account Manager:	Richard Gencev
Standard:	FCC Part 15.247/RSS-210	Class:	N/A

Run #1c: TX Radiated Spurious Emissions, 30 - 40000 MHz. High Channel @ 5320 MHz

Power Setting: 19

Antenna: Omni Directional with 5.5dBi Gain

**Fundamental Radiated Field Strength**

Frequency MHz	Level dB $\mu$ V/m	Pol v/h	15.209 / 15.247		Detector Pk/QP/Avg	Azimuth degrees	Height meters	Comments
			Limit	Margin				
5313.080	91.1	V	-	-	AVG	96	1.0	Fundamental
5313.080	99.4	V	-	-	PK	96	1.0	Fundamental
5315.080	101.1	H	-	-	AVG	263	1.2	Fundamental
5315.080	109.8	H	-	-	PK	263	1.2	Fundamental

**Other Spurious Radiated Emissions:**

Frequency MHz	Level dB $\mu$ V/m	Pol v/h	15.209 / 15.247		Detector Pk/QP/Avg	Azimuth degrees	Height meters	Comments
			Limit	Margin				
10645.17	40.1	V	54.0	-13.9	AVG	56	1.0	
10641.00	40.0	H	54.0	-14.0	AVG	64	1.0	
15995.67	38.7	V	54.0	-15.3	AVG	13	1.0	
15931.67	38.5	H	54.0	-15.5	AVG	139	1.0	
10645.17	52.1	V	74.0	-21.9	PK	56	1.0	
10641.00	52.0	H	74.0	-22.0	PK	64	1.0	
15995.67	50.5	V	74.0	-23.5	PK	13	1.0	
15931.67	50.2	H	74.0	-23.8	PK	139	1.0	

**Band Edge Signal Radiated Field Strength**

Frequency MHz	Level dB $\mu$ V/m	Pol v/h	15.209 / 15E		Detector Pk/QP/Avg	Azimuth degrees	Height meters	Comments
			Limit	Margin				
5350.330	52.6	H	54.0	-1.4	AVG	263	1.2	
5350.330	65.5	H	74.0	-8.5	PK	263	1.2	
5352.220	49.8	V	54.0	-4.2	AVG	96	1.0	
5352.220	61.6	V	74.0	-12.4	PK	96	1.0	

Note 1:

For emissions in restricted bands, the limit of 15.209 was used. For all other emissions, the limit was set to -27dBm/MHz (-68dBuV/m).

Client: Meru Networks	Job Number: J69452
Model: RS 4000	T-Log Number: T69548
Contact: John Dorsey	Account Manager: Richard Gencev
Standard: FCC Part 15.247/RSS-210	Class: N/A

Run #1c: TX Radiated Spurious Emissions, 30 - 40000 MHz. High Channel @ 5320 MHz  
 Power Setting: 19  
 Antenna: Omni Directional with 5.5dBi Gain

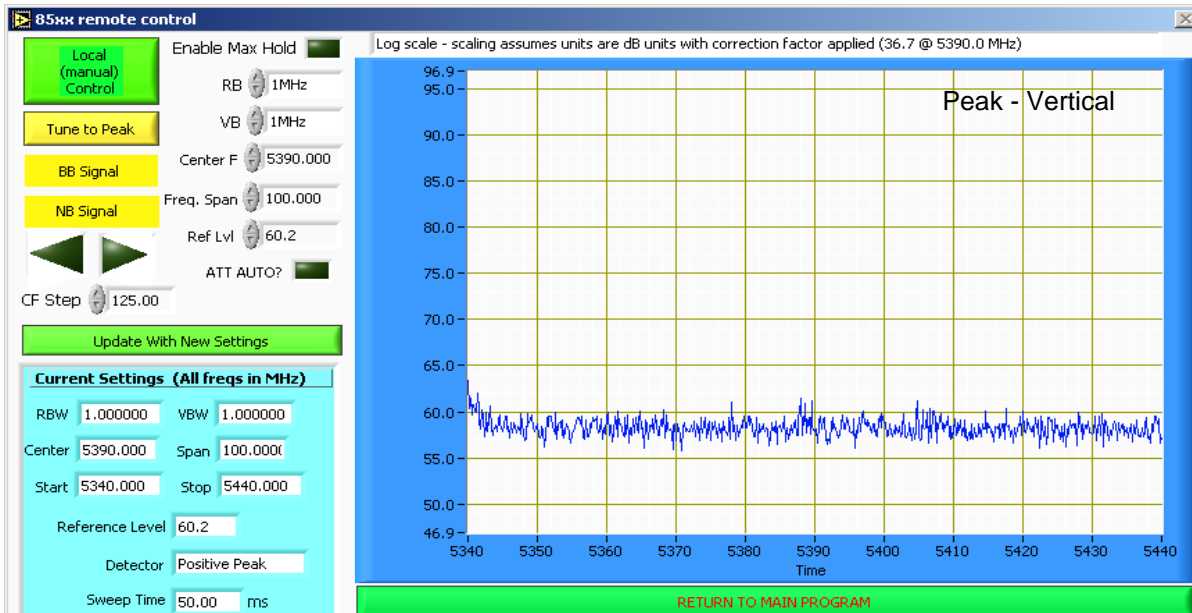

Note - final measurements made using a 3MHz span - if you want to avoid measuring a signal within 1.5MHz of the highest signal in the screen above you will need to utilize "USE CURRENT" as the detector. Remember to set RB and VB for the measurement.

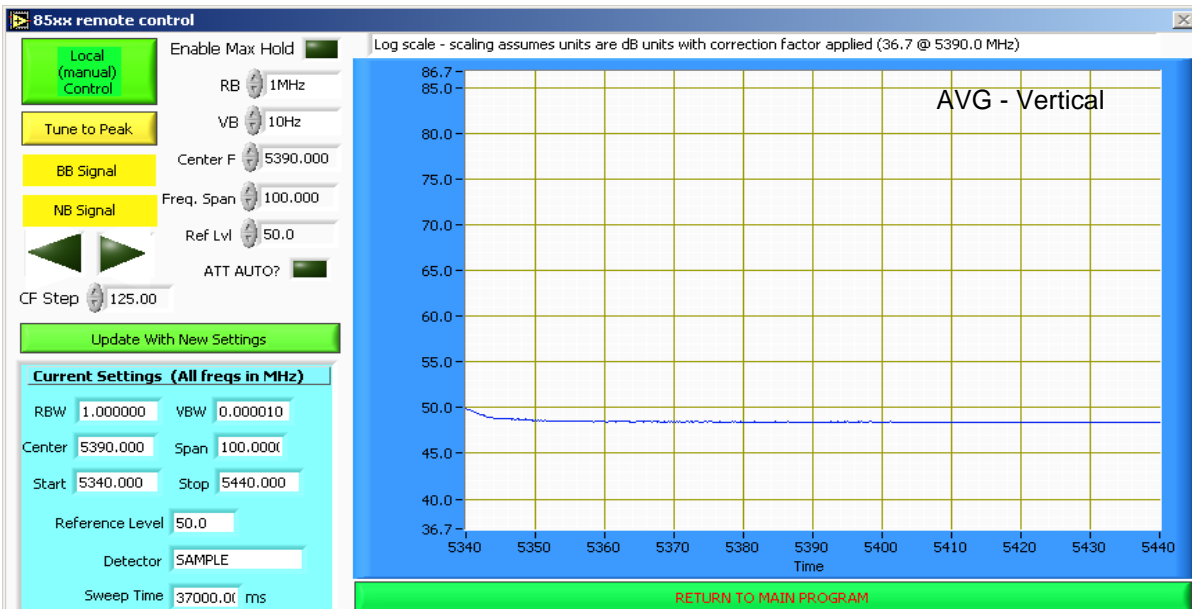

Note - final measurements made using a 3MHz span - if you want to avoid measuring a signal within 1.5MHz of the highest signal in the screen above you will need to utilize "USE CURRENT" as the detector. Remember to set RB and VB for the measurement.

Client: Meru Networks	Job Number: J69452
Model: RS 4000	T-Log Number: T69548
Contact: John Dorsey	Account Manager: Richard Gencev
Standard: FCC Part 15.247/RSS-210	Class: N/A

Run #1c: TX Radiated Spurious Emissions, 30 - 40000 MHz. High Channel @ 5320 MHz  
 Power Setting: 19  
 Antenna: Omni Directional with 5.5dBi Gain

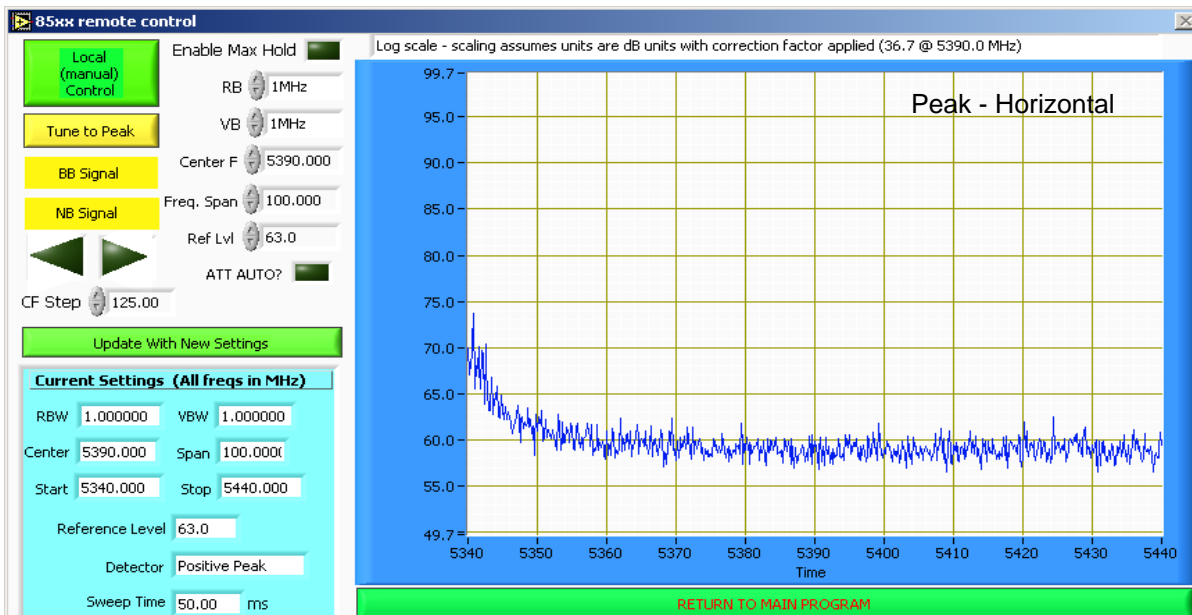

Note - final measurements made using a 3MHz span - if you want to avoid measuring a signal within 1.5MHz of the highest signal in the screen above you will need to utilize "USE CURRENT" as the detector. Remember to set RB and VB for the measurement.

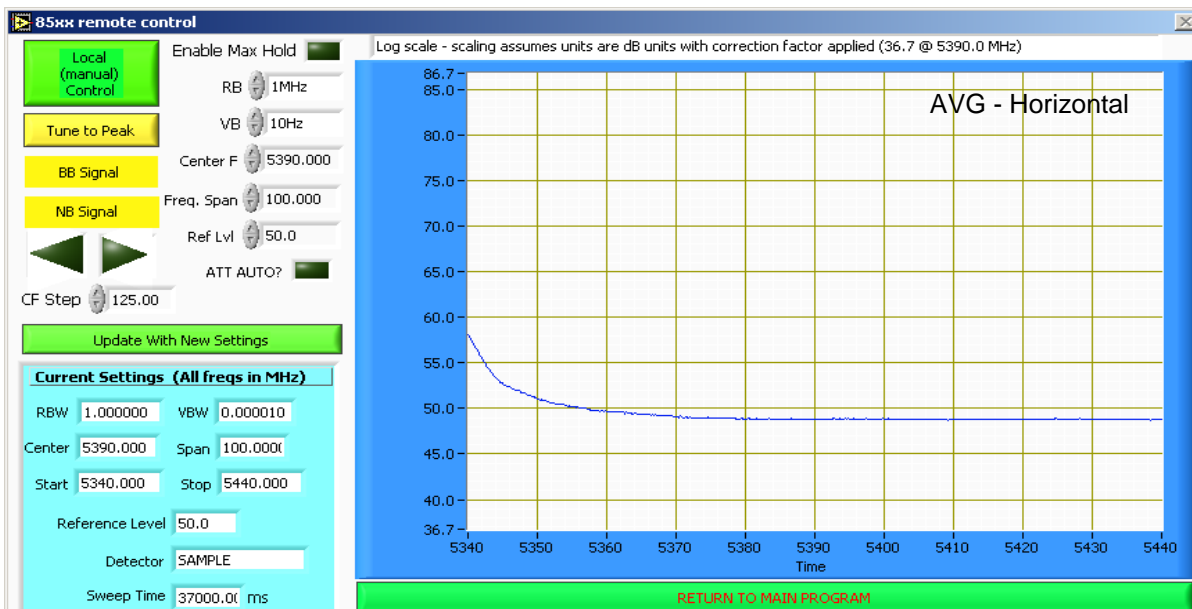

Note - final measurements made using a 3MHz span - if you want to avoid measuring a signal within 1.5MHz of the highest signal in the screen above you will need to utilize "USE CURRENT" as the detector. Remember to set RB and VB for the measurement.





Client: Meru Networks	Job Number: J69452
Model: RS 4000	T-Log Number: T69548
Contact: John Dorsey	Account Manager: Richard Gencev
Standard: FCC Part 15.247/RSS-210	Class: N/A

Run #2a: TX Radiated Spurious Emissions, 30 - 40000 MHz. Low Channel @ 5500 MHz  
 Power Setting: 19  
 Antenna: Omni Directional with 5.5dBi Gain

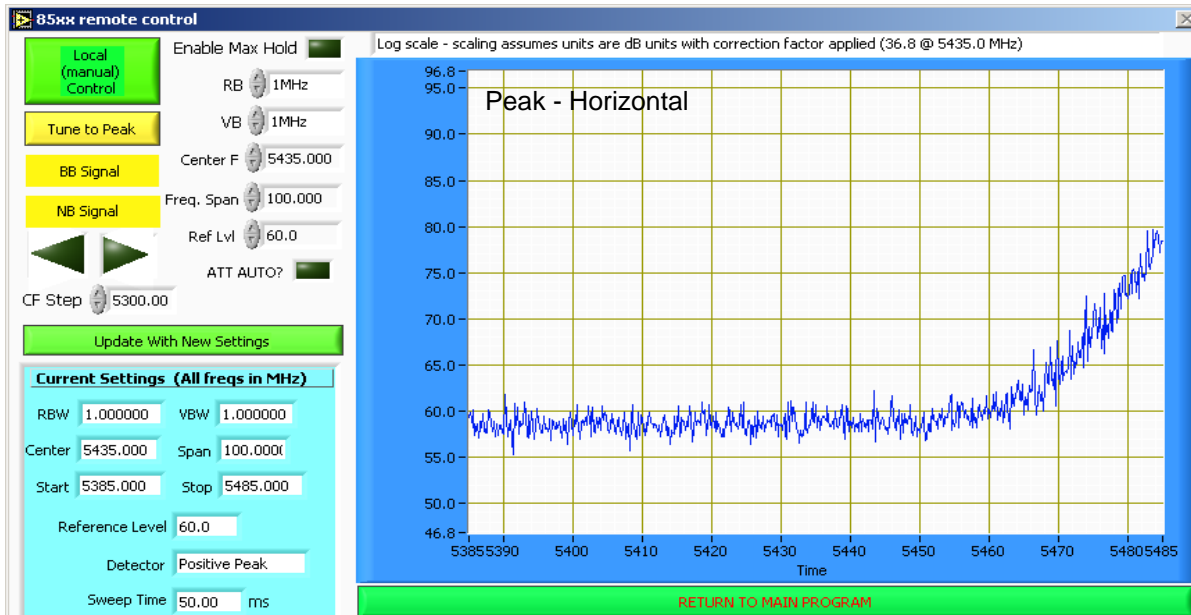

Note - final measurements made using a 3MHz span - if you want to avoid measuring a signal within 1.5MHz of the highest signal in the screen above you will need to utilize "USE CURRENT" as the detector. Remember to set RB and VB for the measurement.

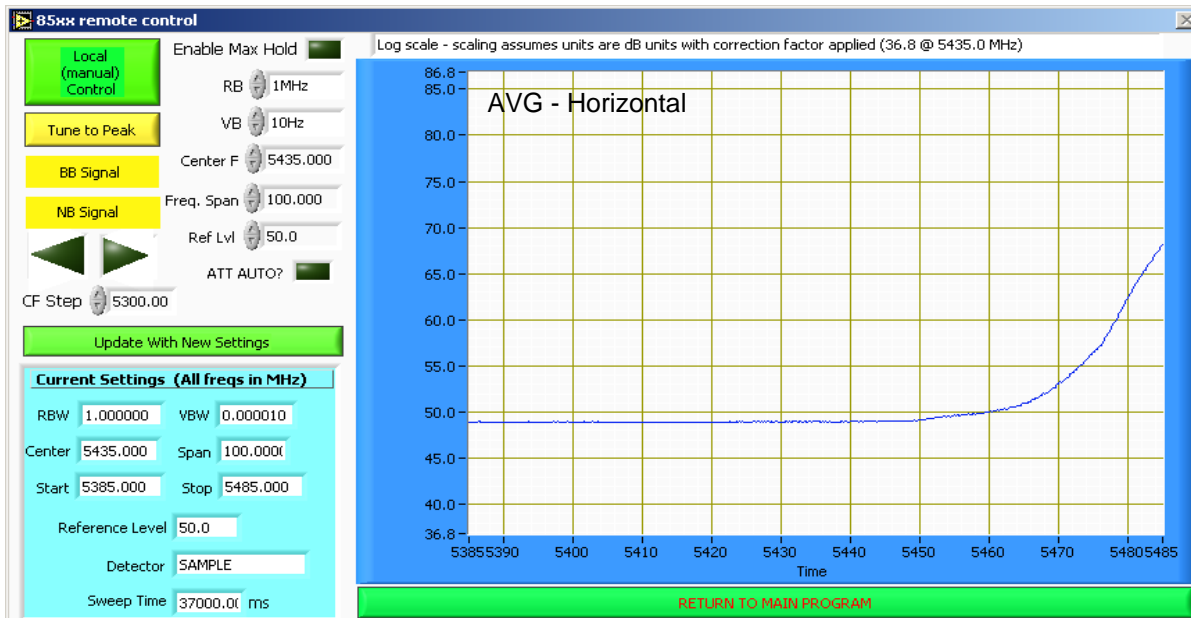

Note - final measurements made using a 3MHz span - if you want to avoid measuring a signal within 1.5MHz of the highest signal in the screen above you will need to utilize "USE CURRENT" as the detector. Remember to set RB and VB for the measurement.

Client: Meru Networks	Job Number: J69452
Model: RS 4000	T-Log Number: T69548
Contact: John Dorsey	Account Manager: Richard Gencev
Standard: FCC Part 15.247/RSS-210	Class: N/A

Run #2a: TX Radiated Spurious Emissions, 30 - 40000 MHz. Low Channel @ 5500 MHz  
 Power Setting: 19  
 Antenna: Omni Directional with 5.5dBi Gain

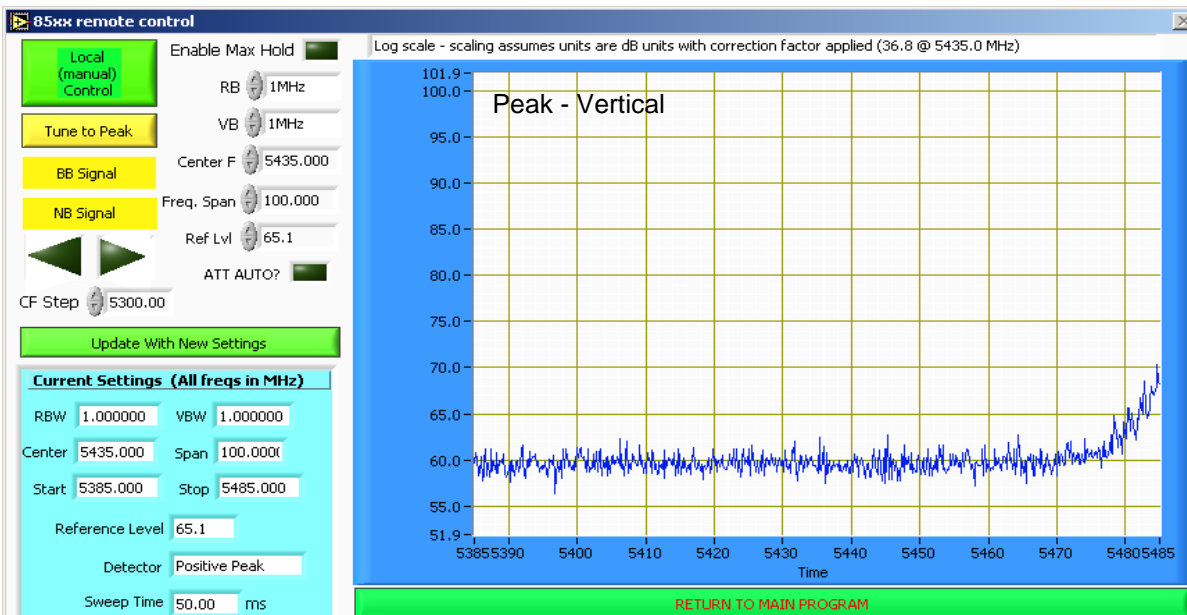

Note - final measurements made using a 3MHz span - if you want to avoid measuring a signal within 1.5MHz of the highest signal in the screen above you will need to utilize "USE CURRENT" as the detector. Remember to set RB and VB for the measurement. [Return to main program](#)

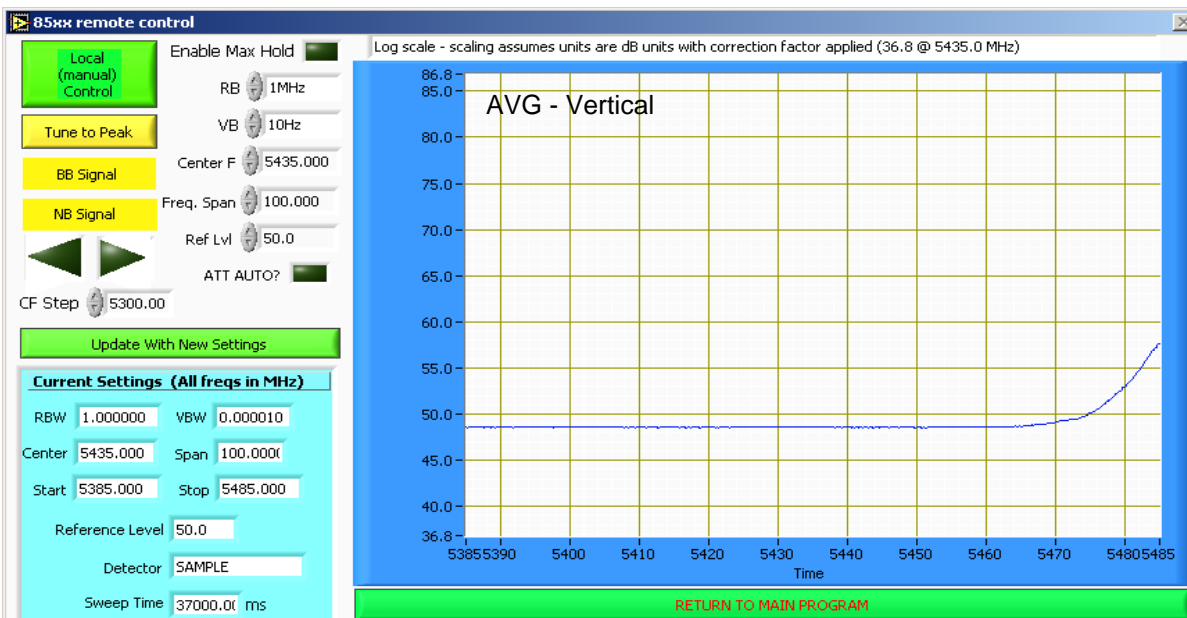

Note - final measurements made using a 3MHz span - if you want to avoid measuring a signal within 1.5MHz of the highest signal in the screen above you will need to utilize "USE CURRENT" as the detector. Remember to set RB and VB for the measurement.



*EMC Test Data*

Client:	Meru Networks	Job Number:	J69452
Model:	RS 4000	T-Log Number:	T69548
Contact:	John Dorsey	Account Manager:	Richard Gencev
Standard:	FCC Part 15.247/RSS-210	Class:	N/A

**Run #2a: TX Radiated Spurious Emissions, 30 - 40000 MHz. Low Channel @ 5500 MHz**  
**Power Setting: 19**  
**Antenna: Omni Directional with 5.5dBi Gain**

Other Spurious Radiated Emissions:

Frequency	Level	Pol	15.209 / 15.247		Detector	Azimuth	Height	Comments
MHz	dB $\mu$ V/m	v/h	Limit	Margin	Pk/QP/Avg	degrees	meters	
11000.78	42.4	H	54.0	-11.6	AVG	352	1.0	
11000.78	54.4	H	74.0	-19.6	PK	352	1.0	
16499.69	40.4	H	54.0	-13.6	AVG	155	1.0	
16499.69	52.2	H	74.0	-21.8	PK	155	1.0	
10999.12	41.6	V	54.0	-12.4	AVG	86	1.0	
10999.12	52.9	V	74.0	-21.1	PK	86	1.0	
16499.05	40.4	V	54.0	-13.6	AVG	170	1.0	
16499.05	52.2	V	74.0	-21.8	PK	170	1.0	

**Run #2b: TX Radiated Spurious Emissions, 30 - 40000 MHz. Center Channel @ 5600 MHz**  
**Power Setting: 19**  
**Antenna: Omni Directional with 5.5dBi Gain**

Other Spurious Radiated Emissions:

Frequency	Level	Pol	15.209 / 15.247		Detector	Azimuth	Height	Comments
MHz	dB $\mu$ V/m	v/h	Limit	Margin	Pk/QP/Avg	degrees	meters	
11200.53	40.1	V	54.0	-13.9	AVG	79	1.0	
11200.53	52.3	V	74.0	-21.7	PK	79	1.0	
16799.46	40.1	V	54.0	-13.9	AVG	0	1.0	
16799.46	51.4	V	74.0	-22.6	PK	0	1.0	
11199.30	40.7	H	54.0	-13.3	AVG	175	1.0	
11199.30	52.5	H	74.0	-21.5	PK	175	1.0	
16799.72	40.9	H	54.0	-13.1	AVG	136	1.0	
16799.72	52.5	H	74.0	-21.5	PK	136	1.0	

Note 1: For emissions in restricted bands, the limit of 15.209 was used. For all other emissions, the limit was set to -27dBm/MHz (~68dBuV/m).

Client: Meru Networks	Job Number: J69452
Model: RS 4000	T-Log Number: T69548
Contact: John Dorsey	Account Manager: Richard Gencev
Standard: FCC Part 15.247/RSS-210	Class: N/A

Run #2c: TX Radiated Spurious Emissions, 30 - 40000 MHz. High Channel @ 5700 MHz

Power Setting: 19

Antenna: Omni Directional with 5.5dBi Gain

Frequency	Level	Pol	15.209 / 15.247		Detector	Azimuth	Height	Comments
MHz	dB $\mu$ V/m	v/h	Limit	Margin	Pk/QP/Avg	degrees	meters	
5698.870	93.4	V	-	-	AVG	156	1.0	Fundamental
5698.870	101.7	V	-	-	PK	156	1.0	Fundamental
5700.940	97.4	H	-	-	AVG	190	1.4	Fundamental
5700.940	106.9	H	-	-	PK	190	1.4	Fundamental

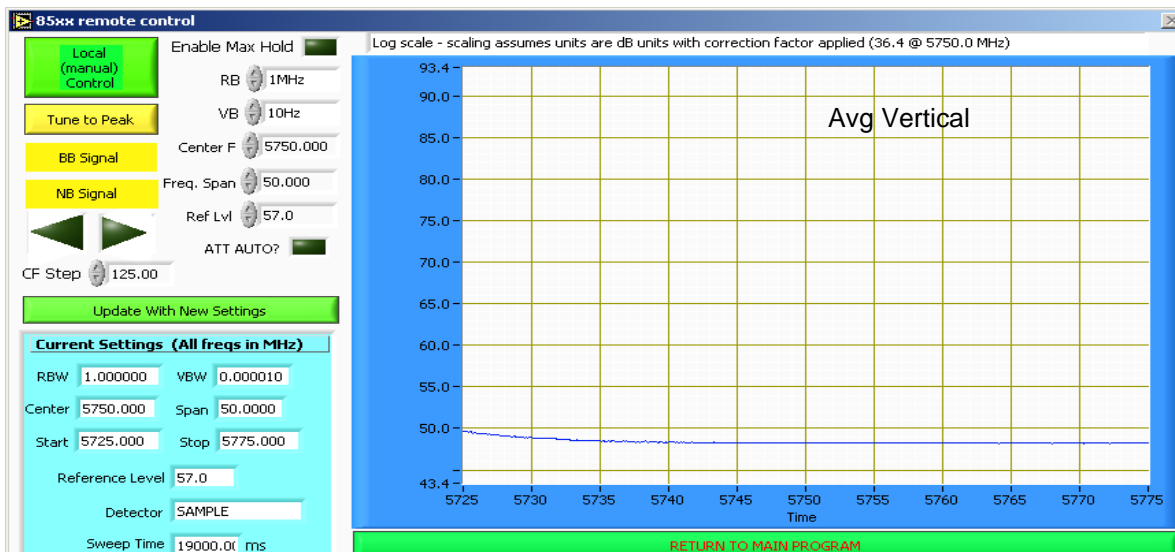

Note - final measurements made using a 3MHz span - if you want to avoid measuring a signal within 1.5MHz of the highest signal in the screen above you will need to utilize "USE CURRENT" as the detector. Remember to set RB and VB for the measurement.

Client: Meru Networks	Job Number: J69452
Model: RS 4000	T-Log Number: T69548
Contact: John Dorsey	Account Manager: Richard Gencev
Standard: FCC Part 15.247/RSS-210	Class: N/A

### Run #2c: Continued

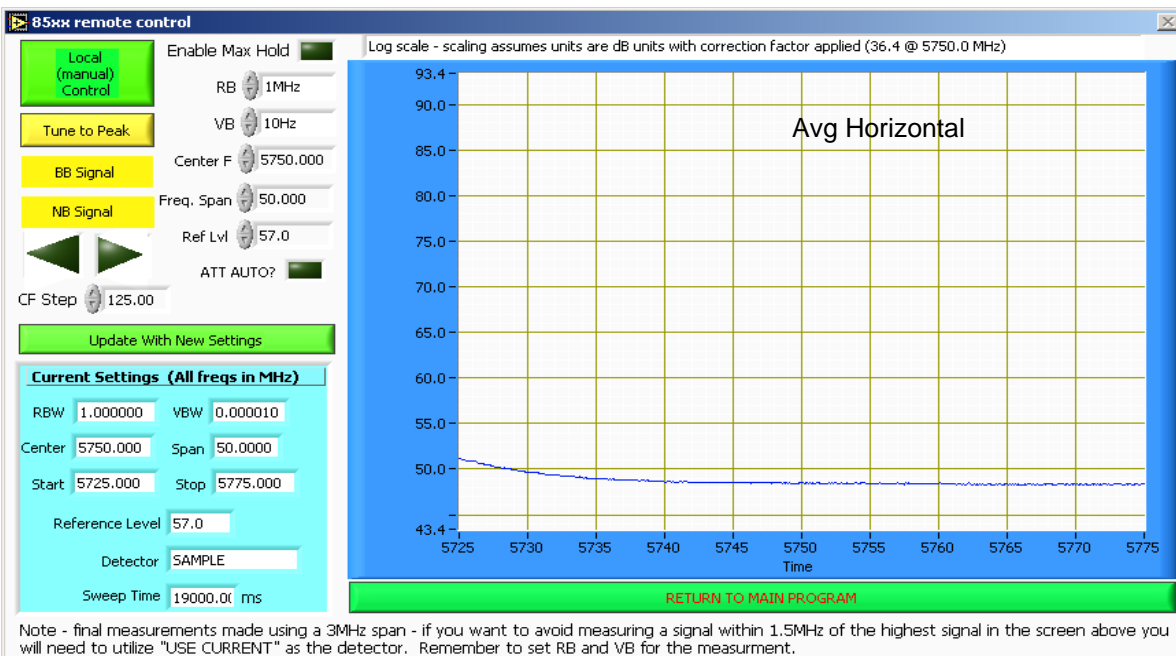
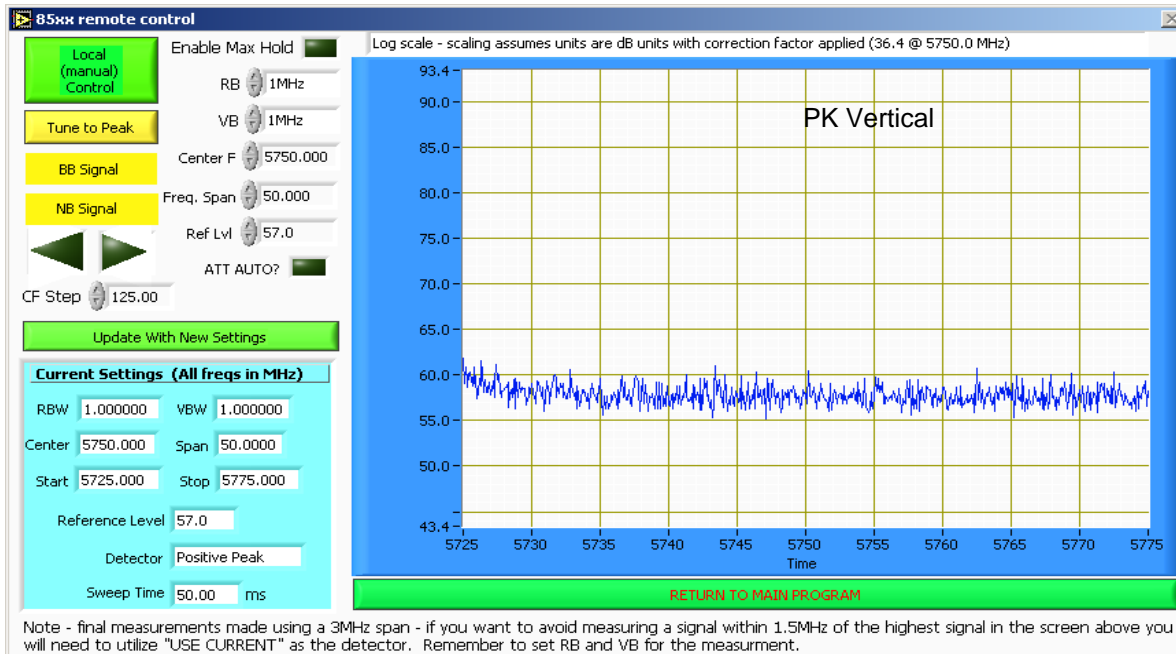

Client: Meru Networks	Job Number: J69452
Model: RS 4000	T-Log Number: T69548
Contact: John Dorsey	Account Manager: Richard Gencev
Standard: FCC Part 15.247/RSS-210	Class: N/A

Run #2c: Continued

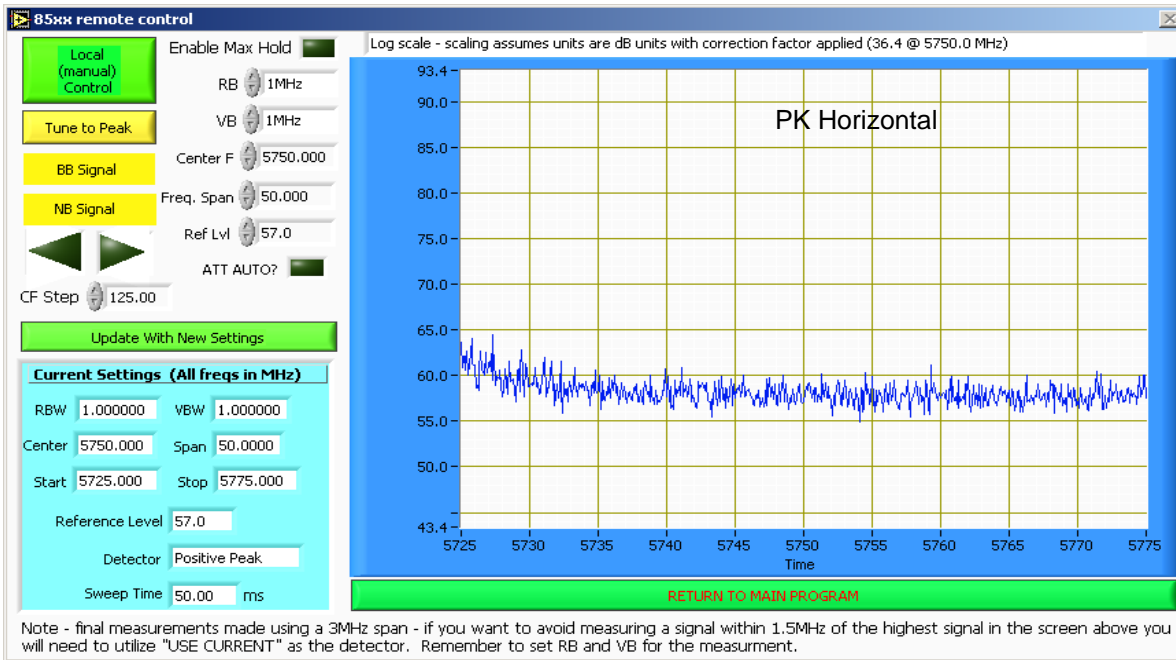

Band Edge Signal Radiated Field Strength - 27dBm/MHz at 5725 MHz

Frequency	Level	Pol	15.209 / 15E		Detector	Azimuth	Height	Comments
MHz	dBμV/m	v/h	Limit	Margin	Pk/QP/Avg	degrees	meters	
5726.090	51.0	V	68.3	-17.3	AVG	156	1.0	Note 1
5726.090	64.1	V	88.3	-24.2	PK	156	1.0	Note 1
5725.120	53.8	H	68.3	-14.5	AVG	190	1.4	Note 1
5725.120	69.7	H	88.3	-18.6	PK	190	1.4	Note 1

Other Spurious Radiated Emissions:

Frequency	Level	Pol	15.209 / 15.247		Detector	Azimuth	Height	Comments
MHz	dBμV/m	v/h	Limit	Margin	Pk/QP/Avg	degrees	meters	
11398.74	37.7	H	54.0	-16.3	AVG	292	1.9	
11398.74	49.0	H	74.0	-25.0	PK	292	1.9	
17098.94	41.9	H	54.0	-12.1	AVG	287	1.0	
17098.94	53.2	H	74.0	-20.8	PK	287	1.0	
11398.60	37.9	V	54.0	-16.1	AVG	88	1.0	
11398.60	49.9	V	74.0	-24.1	PK	88	1.0	
17098.62	42.5	V	54.0	-11.5	AVG	152	1.0	
17098.62	54.4	V	74.0	-19.6	PK	152	1.0	

Note 1: For emissions in restricted bands, the limit of 15.209 was used. For all other emissions, the limit was set to -27dBm/MHz (~68dBuV/m).



*EMC Test Data*

Client: Meru Networks	Job Number: J69452
Model: RS 4000	T-Log Number: T69548
	Account Manager: Richard Gencev
Contact: John Dorsey	
Standard: FCC Part 15.247/RSS-210	Class: N/A

**Run #3: RX Radiated Spurious Emissions, 30 - 18000 MHz**

Antenna: Omni Directional with 5.5dBi Gain

Date of Test: 11/29/2007	Config. Used: 1
Test Engineer: Rafael Varelas	Config Change: None
Test Location: SVOATS #2	EUT Voltage: POE

**Ambient Conditions:**            Temperature:        6 °C  
    Rel. Humidity:        73 %

**Run #3a: RX Radiated Spurious Emissions, 30 - 18000 MHz. Center Channel @ 5300 MHz**

Frequency MHz	Level dBµV/m	Pol v/h	RSS-GEN		Detector Pk/QP/Avg	Azimuth degrees	Height meters	Comments
			Limit	Margin				
125.02	41.7	V	43.5	-1.8	QP	76	1.3	
907.41	43.9	H	46.0	-2.1	QP	114	1.0	
85.61	36.8	V	40.0	-3.2	QP	242	1.0	
750.07	42.6	H	46.0	-3.4	QP	60	1.0	
36.16	35.6	V	40.0	-4.4	QP	178	1.0	
2500.150	48.7	H	54.0	-5.3	AVG	213	1.0	
2624.580	48.2	H	54.0	-5.8	AVG	299	1.0	
453.29	40.1	H	46.0	-5.9	QP	171	1.9	
110.02	37.6	V	43.5	-5.9	QP	333	1.0	
777.22	39.5	H	46.0	-6.5	QP	95	1.0	Signal Sub.
2624.580	65.4	H	74.0	-8.6	PK	299	1.0	
550.00	37.3	H	46.0	-8.7	QP	100	1.0	Signal Sub.
250.02	36.0	H	46.0	-10.0	QP	143	1.2	
2375.090	40.8	H	54.0	-13.2	AVG	108	1.0	
1039.208	57.3	H	74.0	-16.7	PK	300	1.0	
1039.208	35.0	H	54.0	-19.0	AVG	300	1.0	
2500.150	52.1	H	74.0	-21.9	PK	213	1.0	
2375.090	47.2	H	74.0	-26.8	PK	108	1.0	
1361.600	24.3	V	54.0	-29.7	AVG	3	1.0	
1361.600	36.7	V	74.0	-37.3	PK	3	1.0	



*EMC Test Data*

Client:	Meru Networks	Job Number:	J69452
Model:	RS 4000	T-Log Number:	T69548
Contact:	John Dorsey	Account Manager:	Richard Gencev
Standard:	FCC Part 15.247/RSS-210	Class:	N/A

**Run #3b: RX Radiated Spurious Emissions, 30 - 18000 MHz. Center Channel @ 5600 MHz**

Frequency MHz	Level dB $\mu$ V/m	Pol v/h	RSS-GEN		Detector Pk/QP/Avg	Azimuth degrees	Height meters	Comments
			Limit	Margin				
125.02	41.7	V	43.5	-1.8	QP	76	1.3	
907.41	43.9	H	46.0	-2.1	QP	114	1.0	
85.61	36.8	V	40.0	-3.2	QP	242	1.0	
750.07	42.6	H	46.0	-3.4	QP	60	1.0	
36.16	35.6	V	40.0	-4.4	QP	178	1.0	
2617.560	49.1	H	54.0	-4.9	AVG	302	1.0	
453.29	40.1	H	46.0	-5.9	QP	171	1.9	
110.02	37.6	V	43.5	-5.9	QP	333	1.0	
777.22	39.5	H	46.0	-6.5	QP	95	1.0	Signal Sub.
550.00	37.3	H	46.0	-8.7	QP	100	1.0	Signal Sub.
250.02	36.0	H	46.0	-10.0	QP	143	1.2	
2500.260	41.3	H	54.0	-12.7	AVG	155	1.1	
2617.560	58.9	H	74.0	-15.1	PK	302	1.0	
2375.010	37.6	H	54.0	-16.4	AVG	100	1.8	
1358.600	34.6	H	54.0	-19.4	AVG	93	2.0	
2375.010	54.4	H	74.0	-19.6	PK	100	1.8	
2500.260	53.3	H	74.0	-20.7	PK	155	1.1	
1168.060	29.1	H	54.0	-24.9	AVG	258	1.8	
1358.600	47.2	H	74.0	-26.8	PK	93	2.0	
1168.060	45.2	H	74.0	-28.8	PK	258	1.8	

--	--	--	--	--	--	--	--	--



Client:	Meru Networks	Job Number:	J69452
Model:	RS 4000	T-Log Number:	T69548
		Account Manager:	Richard Gencev
Contact:	John Dorsey		
Standard:	FCC Part 15.247/RSS-210	Class:	N/A

## Radiated Spurious Emissions - FCC Part 15.E and RSS-210 A9

### Test Specific Details

Objective: The objective of this test session is to perform final qualification testing of the EUT with respect to the specification listed above.

### General Test Configuration

The EUT and all local support equipment were located on the turntable for radiated spurious emissions testing.

For radiated emissions testing the measurement antenna was located 3 meters from the EUT.

### Summary of Results

Run #	Freq MHz	Mode	Antenna	Power Setting	Limit	Margin/Result
1	5260	a	7dBi Sector Antenna	19	15.209/15.407(b)/ RSS-210 A9 and 2.6	50.8dB $\mu$ V/m (346.7 $\mu$ V/m) @ 10518.8MHz (-3.2dB)
1	5300	a	7dBi Sector Antenna	19	15.209/15.407(b)/ RSS-210 A9 and 2.6	49.0dB $\mu$ V/m (281.8 $\mu$ V/m) @ 10600.2MHz (-5.0dB)
1	5320	a	7dBi Sector Antenna	19	15.209/15.407(b)/ RSS-210 A9 and 2.6	51.2dB $\mu$ V/m (363.1 $\mu$ V/m) @ 5350.0MHz (-2.8dB)
2	5500	a	7dBi Sector Antenna	19	15.209/15.407(b)/ RSS-210 A9 and 2.6	50.2107.9 (323.67.9) @ 10998.65498.08 (-3.8dB)
2	5600	a	7dBi Sector Antenna	19	15.209/15.407(b)/ RSS-210 A9 and 2.6	44.5dB $\mu$ V/m (167.9 $\mu$ V/m) @ 11200.9MHz (-9.5dB)
2	5700	a	7dBi Sector Antenna	19	15.209/15.407(b)/ RSS-210 A9 and 2.6	43.6dB $\mu$ V/m (151.4 $\mu$ V/m) @ 17100.0MHz (-10.4dB)
3	5300	RX	7dBi Sector Antenna	-	RSS-GEN 4.10	48.5dB $\mu$ V/m (266.1 $\mu$ V/m) @ 2621.2MHz (-5.5dB)
3	5500	RX	7dBi Sector Antenna	-	RSS-GEN 4.10	49.3dB $\mu$ V/m (291.7 $\mu$ V/m) @ 2645.2MHz (-4.7dB)

### Modifications Made During Testing

No modifications were made to the EUT during testing

### Deviations From The Standard

No deviations were made from the requirements of the standard.



Client: Meru Networks	Job Number: J69452
Model: RS 4000	T-Log Number: T69548
Contact: John Dorsey	Account Manager: Richard Gencev
Standard: FCC Part 15.247/RSS-210	Class: N/A

Run #1c: TX Radiated Spurious Emissions, 30 - 40000 MHz. High Channel @ 5320 MHz  
 Power Setting: 19  
 Antenna:

Frequency	Level	Pol	15.209 / 15.247		Detector	Azimuth	Height	Comments
MHz	dB $\mu$ V/m	v/h	Limit	Margin	Pk/QP/Avg	degrees	meters	
5319.020	99.2	H	-	-	AVG	113	1.3	Fundamental
5319.020	107.8	H	-	-	PK	113	1.3	Fundamental
5318.750	94.9	V	-	-	AVG	123	1.0	Fundamental
5318.750	103.5	V	-	-	PK	123	1.0	Fundamental

Vertical

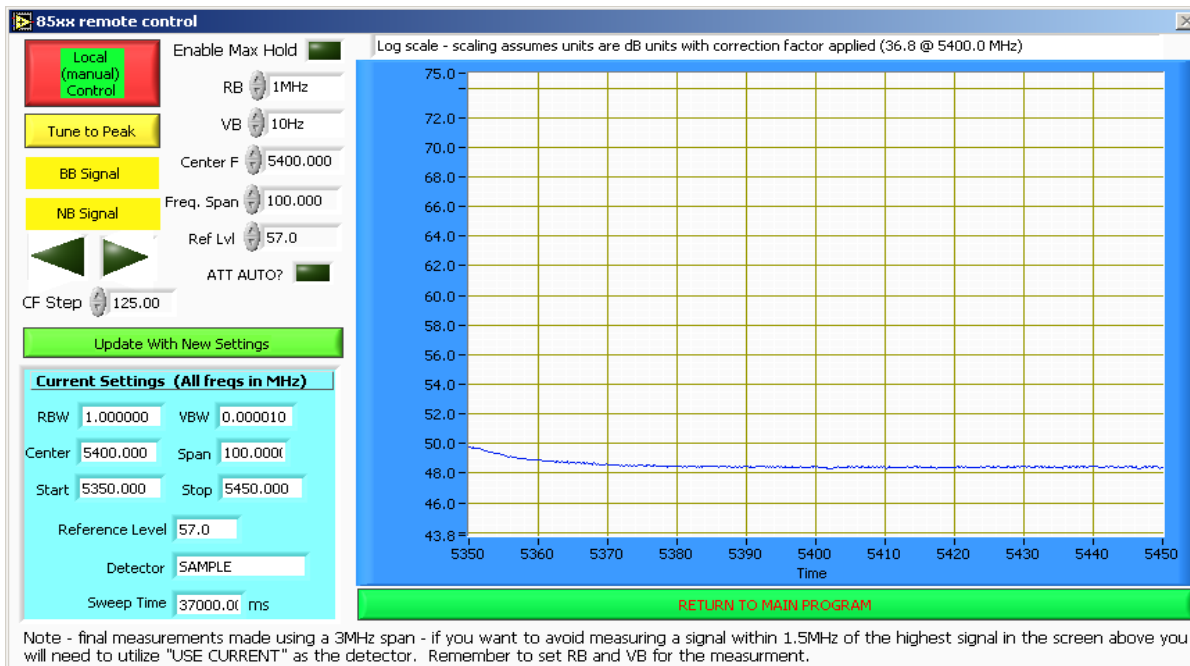

Client: Meru Networks	Job Number: J69452
Model: RS 4000	T-Log Number: T69548
Contact: John Dorsey	Account Manager: Richard Gencev
Standard: FCC Part 15.247/RSS-210	Class: N/A

### Run #1c: Continued

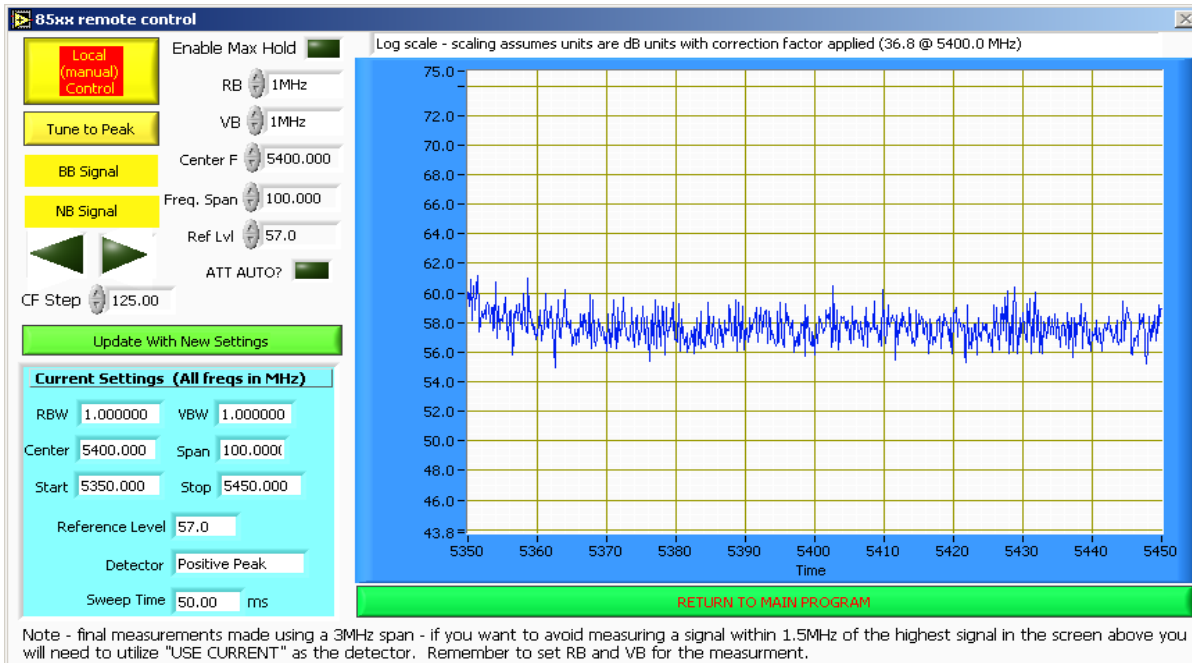

### Horizontal

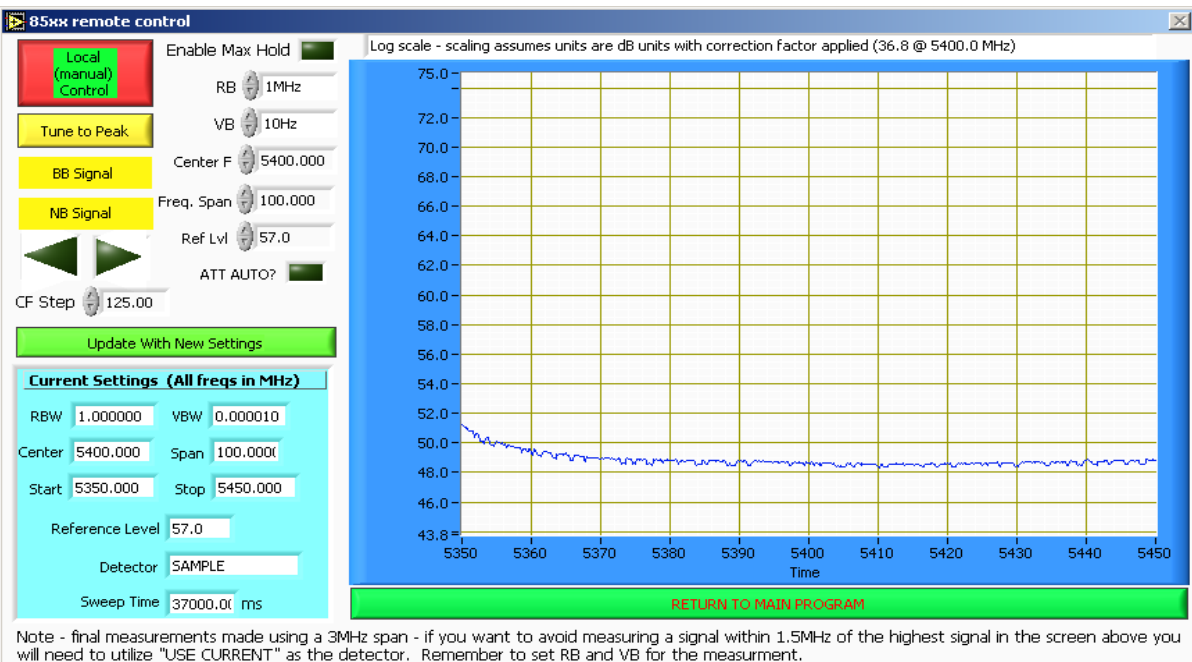

Client: Meru Networks	Job Number: J69452
Model: RS 4000	T-Log Number: T69548
Contact: John Dorsey	Account Manager: Richard Gencev
Standard: FCC Part 15.247/RSS-210	Class: N/A

### Run #1c: Continued

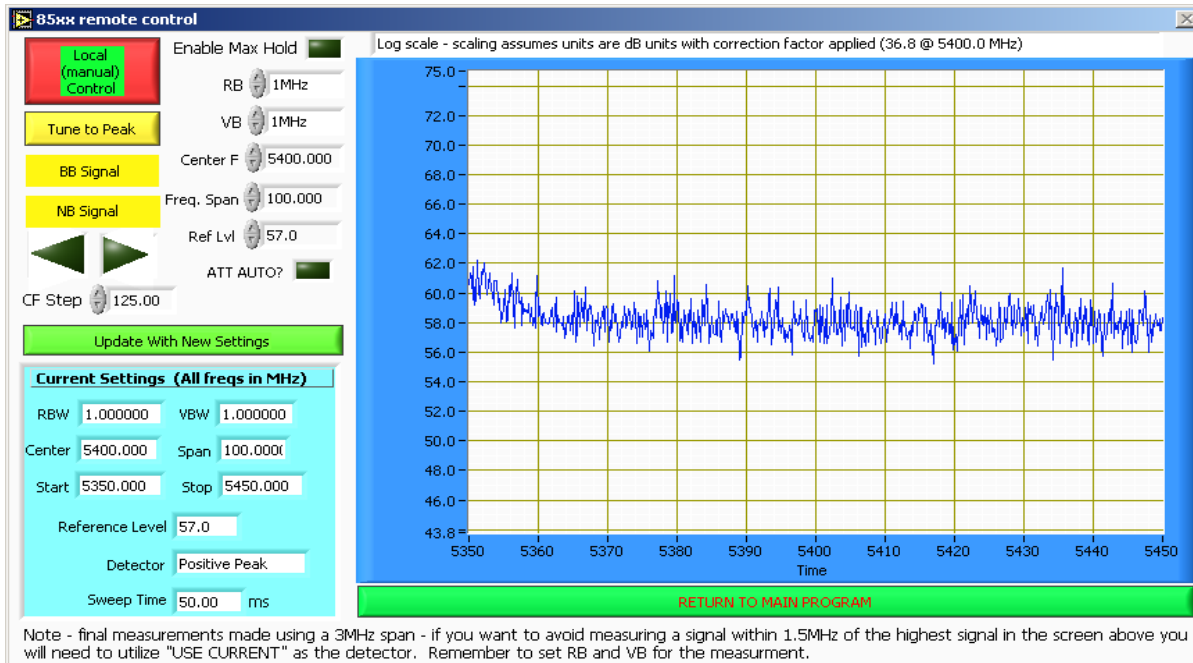

### Band Edge Signal Radiated Field Strength

Frequency	Level	Pol	15.209 / 15E		Detector	Azimuth	Height	Comments
MHz	dB $\mu$ V/m	v/h	Limit	Margin	Pk/QP/Avg	degrees	meters	
5350.020	51.2	H	54.0	-2.8	AVG	113	1.3	
5350.500	64.2	H	74.0	-9.8	Pk	113	1.3	
5350.140	49.8	V	54.0	-4.2	AVG	123	1.0	
5351.670	63.7	V	74.0	-10.3	Pk	123	1.0	

### Other Spurious Radiated Emissions:

Frequency	Level	Pol	15.209 / 15.247		Detector	Azimuth	Height	Comments
MHz	dB $\mu$ V/m	v/h	Limit	Margin	Pk/QP/Avg	degrees	meters	
10639.46	49.1	V	54.0	-4.9	AVG	150	1.5	
10639.41	46.6	H	54.0	-7.4	AVG	226	1.0	
10639.46	61.2	V	74.0	-12.8	PK	150	1.5	
10639.41	58.3	H	74.0	-15.7	PK	226	1.0	
15960.71	38.2	V	54.0	-15.8	AVG	345	1.9	
15958.64	37.9	H	54.0	-16.1	AVG	15	1.5	
15960.71	49.8	V	74.0	-24.2	PK	345	1.9	
15958.64	49.4	H	74.0	-24.6	PK	15	1.5	

Note 1: For emissions in restricted bands, the limit of 15.209 was used. For all other emissions, the limit was set to -27dBm/MHz (-68dBuV/m).



Client: Meru Networks	Job Number: J69452
Model: RS 4000	T-Log Number: T69548
Contact: John Dorsey	Account Manager: Richard Gencev
Standard: FCC Part 15.247/RSS-210	Class: N/A

### Run #2a: Continued

#### Vertical

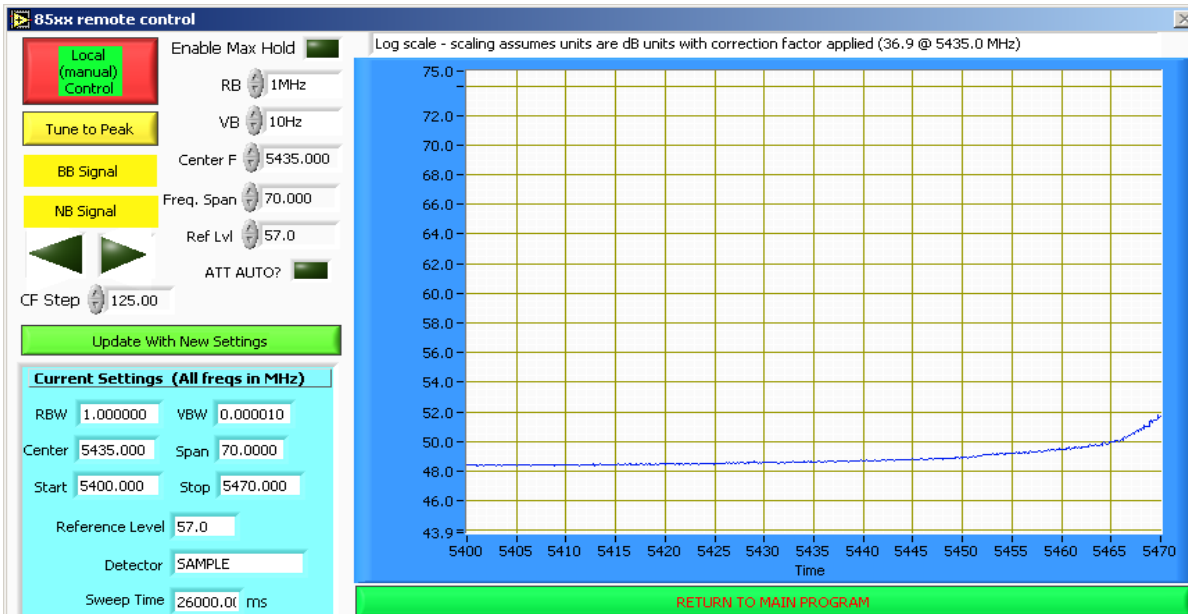

Note - final measurements made using a 3MHz span - if you want to avoid measuring a signal within 1.5MHz of the highest signal in the screen above you will need to utilize "USE CURRENT" as the detector. Remember to set RB and VB for the measurement.

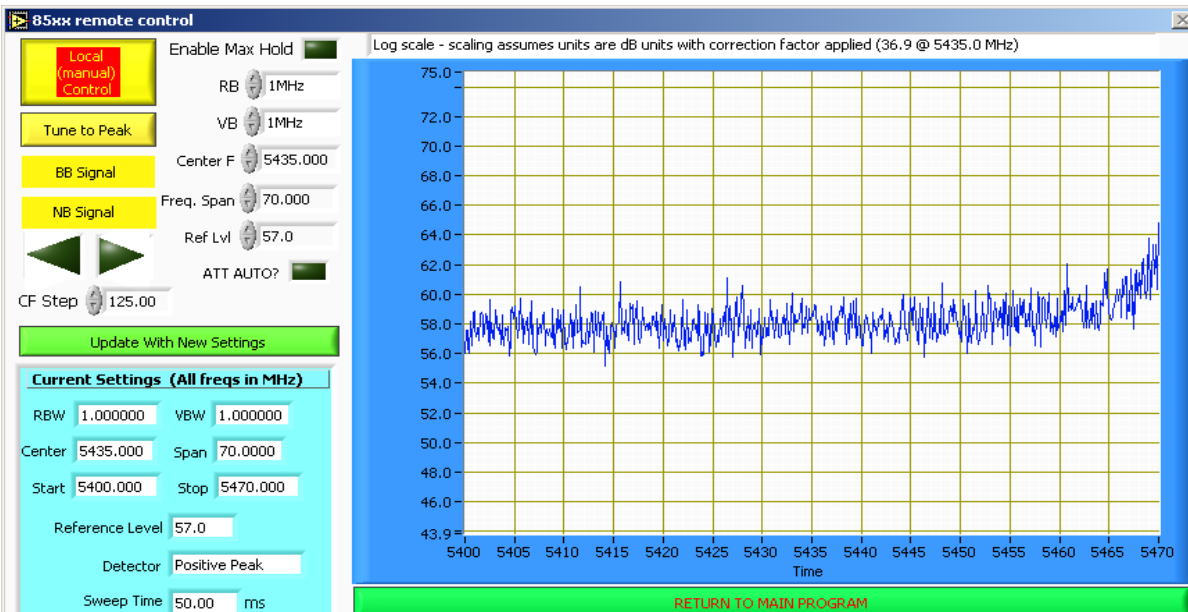

Note - final measurements made using a 3MHz span - if you want to avoid measuring a signal within 1.5MHz of the highest signal in the screen above you will need to utilize "USE CURRENT" as the detector. Remember to set RB and VB for the measurement.

Client: Meru Networks	Job Number: J69452
Model: RS 4000	T-Log Number: T69548
Contact: John Dorsey	Account Manager: Richard Gencev
Standard: FCC Part 15.247/RSS-210	Class: N/A

### Run #2a: Continued

#### Horizontal

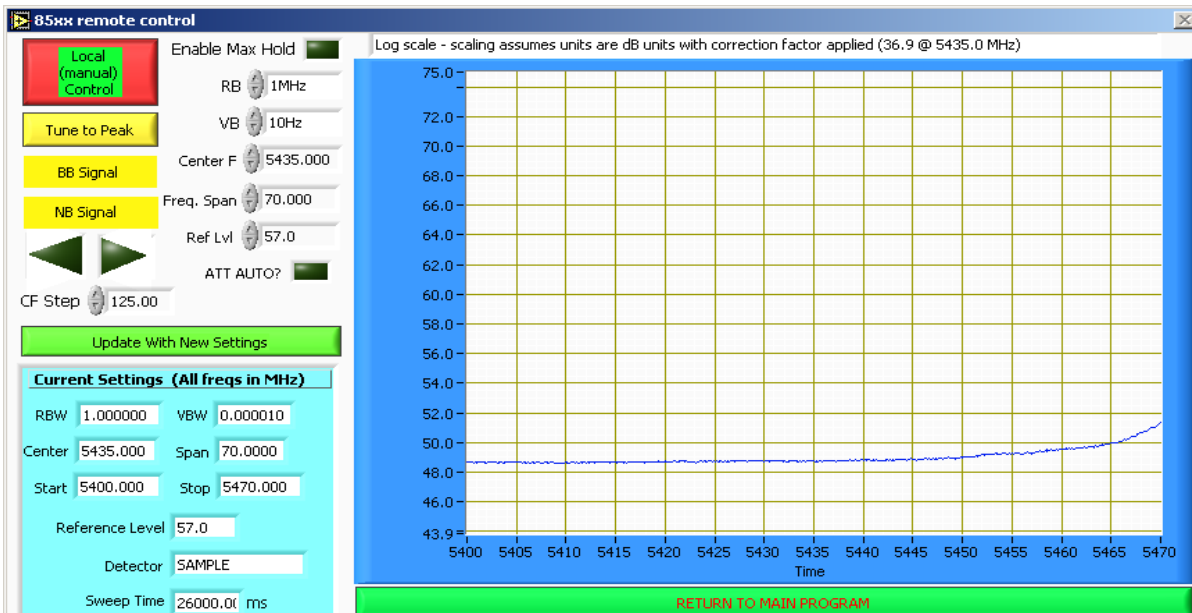

Note - final measurements made using a 3MHz span - if you want to avoid measuring a signal within 1.5MHz of the highest signal in the screen above you will need to utilize "USE CURRENT" as the detector. Remember to set RB and VB for the measurement.

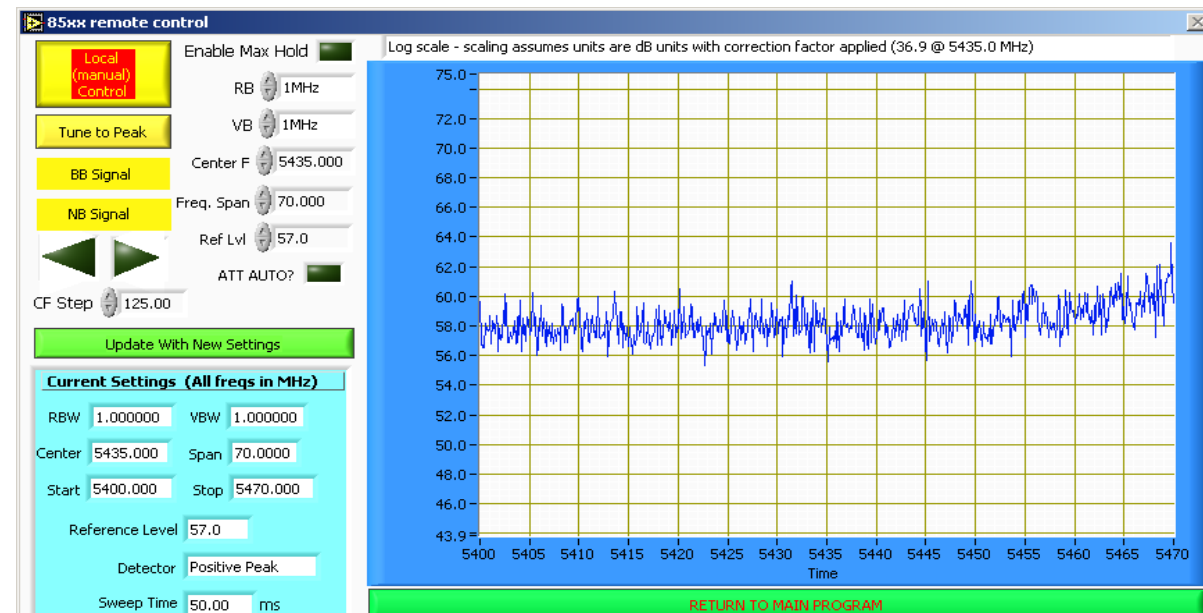

Note - final measurements made using a 3MHz span - if you want to avoid measuring a signal within 1.5MHz of the highest signal in the screen above you will need to utilize "USE CURRENT" as the detector. Remember to set RB and VB for the measurement.





# EMC Test Data

Client:	Meru Networks	Job Number:	J69452
Model:	RS 4000	T-Log Number:	T69548
Contact:	John Dorsey	Account Manager:	Richard Gencev
Standard:	FCC Part 15.247/RSS-210	Class:	N/A

### Band Edge Signal Radiated Field Strength - Restricted Band at 5.46 GHz

Frequency MHz	Level dB $\mu$ V/m	Pol v/h	15.209 / 15E		Detector Pk/QP/Avg	Azimuth degrees	Height meters	Comments
			Limit	Margin				
5459.000	49.6	V	54.0	-4.4	AVG	77	1.0	
5459.670	64.7	V	74.0	-9.3	Pk	77	1.0	
5459.560	49.6	H	54.0	-4.4	AVG	119	1.3	
5458.760	62.2	H	74.0	-11.8	Pk	119	1.3	

### Band Edge Signal Radiated Field Strength - 27dBm/MHz at 5470 MHz

Frequency MHz	Level dB $\mu$ V/m	Pol v/h	15.209 / 15E		Detector Pk/QP/Avg	Azimuth degrees	Height meters	Comments
			Limit	Margin				
5469.830	52.0	V	68.3	-16.3	AVG	77	1.0	Note 1
5469.820	51.3	H	68.3	-17.0	AVG	119	1.3	Note 1
5469.900	65.7	V	88.3	-22.6	PK	12	1.0	
5469.830	69.1	H	88.3	-19.2	PK	22	1.0	

Note 1: For emissions in restricted bands, the limit of 15.209 was used. For all other emissions, the limit was set to -27dBm/MHz (~68dB $\mu$ V/m).

### Run #2a: TX Radiated Spurious Emissions, 30 - 40000 MHz. Low Channel @ 5500 MHz

Power Setting: 19

Antenna:

### Other Spurious Radiated Emissions:

Frequency MHz	Level dB $\mu$ V/m	Pol v/h	15.209 / 15E		Detector Pk/QP/Avg	Azimuth degrees	Height meters	Comments
			Limit	Margin				
10998.55	50.2	V	54.0	-3.8	AVG	139	1.0	
11001.17	48.2	H	54.0	-5.8	AVG	163	1.2	
10998.55	62.5	V	74.0	-11.5	PK	139	1.0	
11001.17	60.7	H	74.0	-13.3	PK	163	1.2	
16498.75	40.2	V	54.0	-13.8	AVG	108	1.0	
16498.76	39.3	H	54.0	-14.7	AVG	142	1.1	
16498.75	55.0	V	74.0	-19.0	PK	108	1.0	
16498.76	51.3	H	74.0	-22.7	PK	142	1.1	

Note 1: For emissions in restricted bands, the limit of 15.209 was used. For all other emissions, the limit was set to -27dBm/MHz (~68dB $\mu$ V/m).



*EMC Test Data*

Client:	Meru Networks	Job Number:	J69452
Model:	RS 4000	T-Log Number:	T69548
		Account Manager:	Richard Gencev
Contact:	John Dorsey		
Standard:	FCC Part 15.247/RSS-210	Class:	N/A

Run #2b: TX Radiated Spurious Emissions, 30 - 40000 MHz. Center Channel @ 5600 MHz  
 Power Setting: 19  
 Antenna:

Other Spurious Radiated Emissions:

Frequency	Level	Pol	15.209 / 15.247		Detector	Azimuth	Height	Comments
MHz	dB $\mu$ V/m	v/h	Limit	Margin	Pk/QP/Avg	degrees	meters	
11200.91	44.5	H	54.0	-9.5	AVG	73	1.4	
11199.12	43.3	V	54.0	-10.7	AVG	31	1.0	
16800.98	39.9	H	54.0	-14.1	AVG	352	1.8	
16801.46	39.8	V	54.0	-14.2	AVG	256	1.0	
11200.91	56.7	H	74.0	-17.3	PK	73	1.4	
11199.12	55.0	V	74.0	-19.0	PK	31	1.0	
16801.46	52.0	V	74.0	-22.0	PK	256	1.0	
16800.98	51.2	H	74.0	-22.8	PK	352	1.8	

Note 1: For emissions in restricted bands, the limit of 15.209 was used. For all other emissions, the limit was set to -27dBm/MHz (-68dBuV/m).

Client: Meru Networks	Job Number: J69452
Model: RS 4000	T-Log Number: T69548
Contact: John Dorsey	Account Manager: Richard Gencev
Standard: FCC Part 15.247/RSS-210	Class: N/A

Run #2c: TX Radiated Spurious Emissions, 30 - 40000 MHz. High Channel @ 5700 MHz  
 Power Setting: 19  
 Antenna:

Frequency MHz	Level dB $\mu$ V/m	Pol v/h	15.209 / 15.247		Detector Pk/QP/Avg	Azimuth degrees	Height meters	Comments
			Limit	Margin				
5698.880	95.9	H	-	-	AVG	138	1.3	Fundamental
5698.880	104.8	H	-	-	PK	138	1.3	Fundamental
5699.150	96.8	V	-	-	AVG	146	1.0	Fundamental
5699.150	106.0	V	-	-	PK	146	1.0	Fundamental

### Vertical

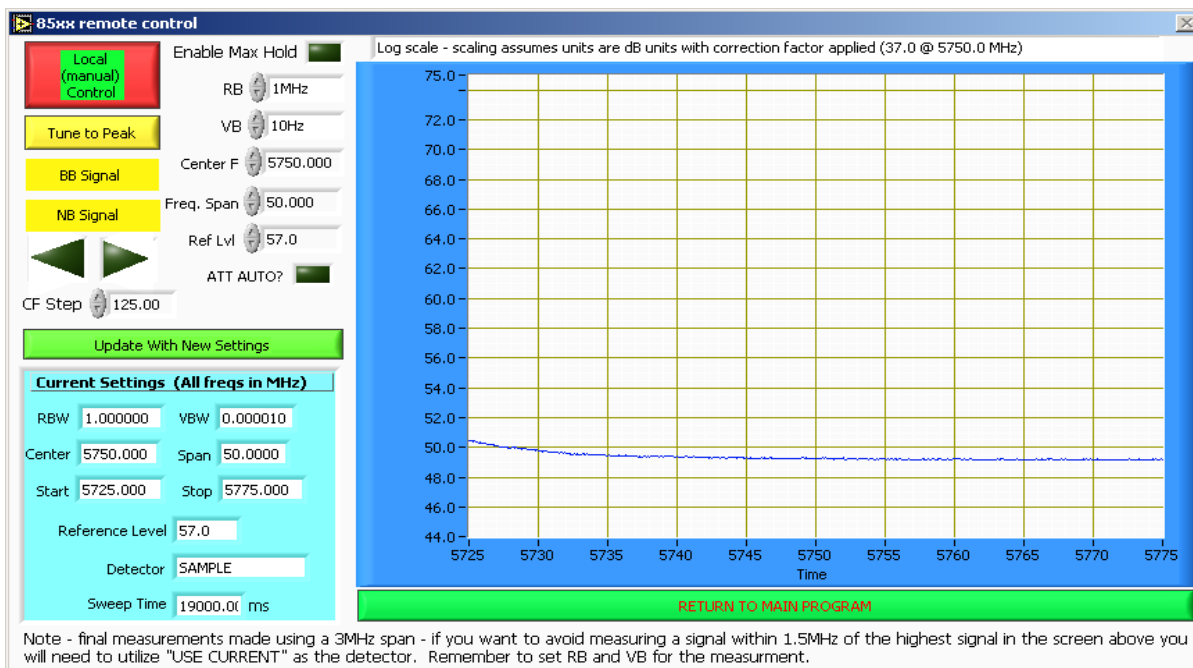

Client: Meru Networks	Job Number: J69452
Model: RS 4000	T-Log Number: T69548
Contact: John Dorsey	Account Manager: Richard Gencev
Standard: FCC Part 15.247/RSS-210	Class: N/A

## Run #2c: Continued

### Horizontal

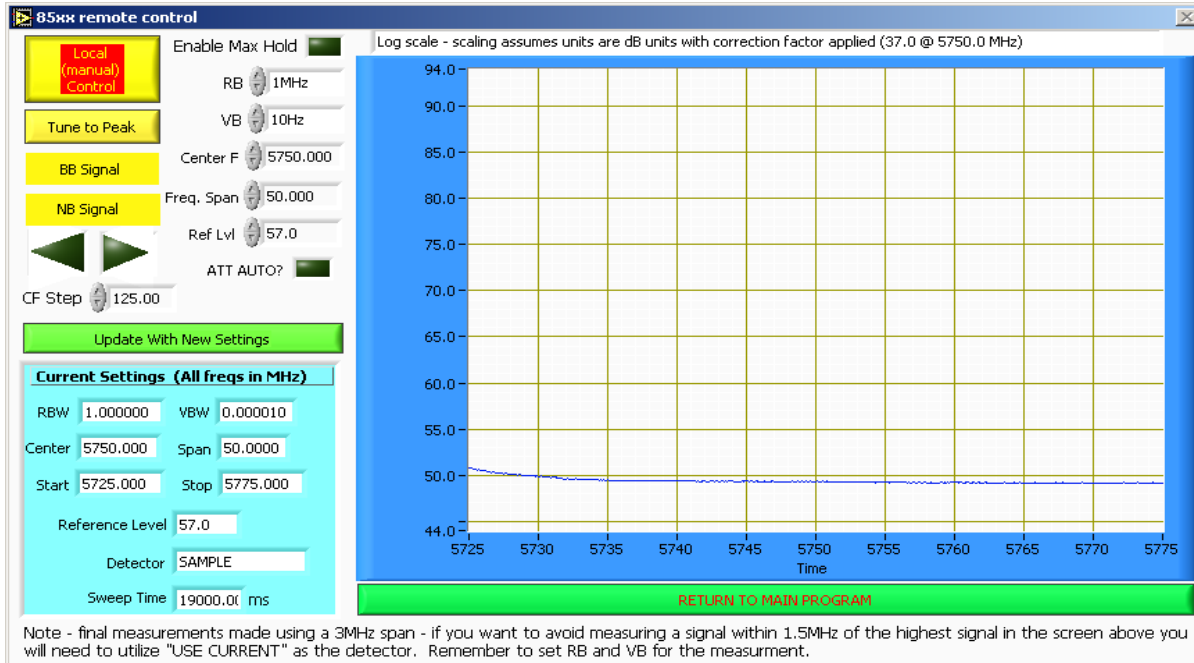

### Band Edge Signal Radiated Field Strength - 27dBm/MHz at 5725 MHz

Frequency	Level	Pol	15.209 / 15E		Detector	Azimuth	Height	Comments
MHz	dBμV/m	v/h	Limit	Margin	Pk/QP/Avg	degrees	meters	
5725.000	50.7	H	68.3	-17.6	AVG	138	1.2	Note 1
5725.270	52.5	V	68.3	-15.8	AVG	146	1.0	Note 1

### Other Spurious Radiated Emissions:

Frequency	Level	Pol	15.209 / 15.247		Detector	Azimuth	Height	Comments
MHz	dBμV/m	v/h	Limit	Margin	Pk/QP/Avg	degrees	meters	
17100.00	43.6	V	54.0	-10.4	AVG	261	1.0	
17098.83	43.5	H	54.0	-10.5	AVG	109	1.0	
11399.25	41.0	H	54.0	-13.0	AVG	70	1.5	
11399.70	39.6	V	54.0	-14.4	AVG	360	1.7	
17098.83	55.9	H	74.0	-18.1	PK	109	1.0	
17100.00	55.5	V	74.0	-18.5	PK	261	1.0	
11399.25	53.3	H	74.0	-20.7	PK	70	1.5	
11399.70	50.9	V	74.0	-23.1	PK	360	1.7	

Note 1: For emissions in restricted bands, the limit of 15.209 was used. For all other emissions, the limit was set to -27dBm/MHz (~68dBuV/m).





EMC Test Data

Client:	Meru Networks	Job Number:	J69452
Model:	RS 4000	T-Log Number:	T69548
		Account Manager:	Richard Gencev
Contact:	John Dorsey		
Standard:	FCC Part 15.247/RSS-210	Class:	N/A

Run #3a: RX Radiated Spurious Emissions, 30 - 18000 MHz. Center Channel @ 5300 MHz

2621.16	48.5	H	74.0	-25.5	PK	0	1.0	
10643.17	46.6	H	74.0	-27.4	PK	0	1.0	
1875.20	46.6	V	74.0	-27.4	PK	326	1.0	
2335.31	46.0	H	74.0	-28.0	PK	30	1.0	
10622.83	45.5	V	74.0	-28.5	PK	360	1.0	
6594.91	44.2	H	74.0	-29.8	PK	25	1.0	
4309.20	44.0	V	74.0	-30.0	PK	2	1.0	
1500.26	42.3	V	74.0	-31.7	PK	15	1.0	
1500.14	41.9	H	74.0	-32.1	PK	35	1.0	
1250.08	40.3	H	74.0	-33.7	PK	244	1.3	



*EMC Test Data*

Client:	Meru Networks	Job Number:	J69452
Model:	RS 4000	T-Log Number:	T69548
Contact:	John Dorsey	Account Manager:	Richard Gencev
Standard:	FCC Part 15.247/RSS-210	Class:	N/A

**Run #3b: RX Radiated Spurious Emissions, 30 - 18000 MHz. Center Channel @ 5600 MHz**

Frequency MHz	Level dBµV/m	Pol v/h	RSS-GEN		Detector Pk/QP/Avg	Azimuth degrees	Height meters	Comments
			Limit	Margin				
2645.24	49.3	H	54.0	-4.7	AVG	13	1.0	
2501.58	48.4	V	54.0	-5.6	AVG	360	1.0	
17787.27	46.0	H	54.0	-8.0	AVG	0	1.0	
17720.16	45.9	V	54.0	-8.1	AVG	0	1.0	
1209.54	64.4	V	74.0	-9.6	PK	5	1.0	
2186.67	41.0	V	54.0	-13.0	AVG	20	1.0	
16808.50	39.9	V	54.0	-14.1	AVG	360	1.0	
1250.17	39.9	H	54.0	-14.1	AVG	30	1.0	
16832.83	39.7	H	54.0	-14.3	AVG	0	1.0	
6595.04	39.2	V	54.0	-14.8	AVG	95	1.0	
1500.23	39.0	H	54.0	-15.0	AVG	36	1.0	
2335.41	38.9	H	54.0	-15.1	AVG	321	1.0	
11210.17	38.1	V	54.0	-15.9	AVG	0	1.0	
17720.16	57.6	V	74.0	-16.4	PK	0	1.0	
17787.27	57.0	H	74.0	-17.0	PK	0	1.0	
3926.14	36.8	V	54.0	-17.2	AVG	360	1.0	
4257.53	55.7	V	74.0	-18.3	PK	0	1.0	
4257.53	33.9	V	54.0	-20.1	AVG	0	1.0	
5801.15	33.4	H	54.0	-20.6	AVG	344	1.0	
2501.58	52.6	V	74.0	-21.4	PK	360	1.0	
5578.17	32.0	H	54.0	-22.0	AVG	359	1.0	
16808.50	51.8	V	74.0	-22.2	PK	360	1.0	
1209.54	31.8	V	54.0	-22.2	AVG	5	1.0	
16832.83	51.1	H	74.0	-22.9	PK	0	1.0	
2645.24	50.8	H	74.0	-23.2	PK	13	1.0	
1297.51	29.6	V	54.0	-24.4	AVG	249	1.0	
11210.17	49.4	V	74.0	-24.6	PK	0	1.0	
3926.14	46.3	V	74.0	-27.7	PK	360	1.0	
2335.41	45.9	H	74.0	-28.1	PK	321	1.0	
6595.04	44.4	V	74.0	-29.6	PK	95	1.0	
1250.17	44.2	H	74.0	-29.8	PK	30	1.0	
5801.15	44.0	H	74.0	-30.0	PK	344	1.0	
5578.17	43.7	H	74.0	-30.3	PK	359	1.0	
1621.48	23.6	V	54.0	-30.4	AVG	253	1.0	
1500.23	42.7	H	74.0	-31.3	PK	36	1.0	
2186.67	42.3	V	74.0	-31.7	PK	20	1.0	
1297.51	42.1	V	74.0	-31.9	PK	249	1.0	
1621.48	37.7	V	74.0	-36.3	PK	253	1.0	

***EXHIBIT 3: Photographs of Test Configurations***

2 Pages



***EXHIBIT 4: Proposed FCC ID Label & Label Location***

Unchanged from original application

*EXHIBIT 5: Detailed Photographs  
of Meru Networks Model RS-4000 Construction*

Unchanged from original application

***EXHIBIT 6: Operator's Manual  
for Meru Networks Model RS-4000***

Unchanged from original application

***EXHIBIT 7: Block Diagram  
of Meru Networks Model RS-4000***

Unchanged from original application

***EXHIBIT 8: Schematic Diagrams  
for Meru Networks Model RS-4000***

Unchanged from original application

***EXHIBIT 9: Theory of Operation  
for Meru Networks Model RS-4000***

Unchanged from original application

***EXHIBIT 10: Advertising Literature***

Unchanged from original application

***EXHIBIT 11: RF Exposure Information***

RSS-102 RF Exposure	1 age
MPE	3 pages
RS4000 full circle	3 pages
RS4000 half circle	3 pages