

FCC RADIO TEST REPORT

Applicant's company	Meru Networks Inc.
Applicant Address	1309 South Mary Avenue, Sunnyvale, CA 94087 U.S.A.
FCC ID	RE7-OAP180
Manufacturer's company	Accton Technology Corporation
Manufacturer Address	No. 1 Creation Rd., III, Science-based Industrial Park, Hsinchu 300, Taiwan, R.O.C.

Product Name	WLAN ENTERPRISE AP
Brand Name	Meru, Foundry
Model Name	OAP180
Test Rule Part(s)	47 CFR FCC Part 15 Subpart C § 15.247
Test Freq. Range	2400 ~ 2483.5MHz / 5725 ~ 5850MHz
Receive Date	Feb. 8, 2006
Test Date	May 17, 2006
Submission Type	Original Equipment
Multiple Listing	Please refer to section 3.7



Statement

Test result included is only for the 802.11b/g part and 802.11a (5725 ~ 5850MHz) of the product.

The test result in this report refers exclusively to the presented test model / sample.

Without written approval of SPORTON International Inc., the test report shall not be reproduced except in full.

The measurements and test results shown in this test report were made in accordance with the procedures and found in compliance with the limit given in **ANSI C63.4-2003** and **47 CFR FCC Part 15 Subpart C**.

The test equipment used to perform the test is calibrated and traceable to NML/ROC.

Table of Contents

1. CERTIFICATE OF COMPLIANCE	1
2. SUMMARY OF THE TEST RESULT	2
3. GENERAL INFORMATION	3
3.1. Product Details.....	3
3.2. Accessories.....	3
3.3. Table for Filed Antenna.....	3
3.4. Table for Carrier Frequencies	5
3.5. Table for Test Modes	6
3.6. Table for Testing Locations.....	6
3.7. Table for Multiple List.....	7
3.8. Table for Supporting Units	7
3.9. Table for Parameters of Test Software Setting	7
3.10. Test Configurations	10
4. TEST RESULT	20
4.1. AC Power Line Conducted Emissions Measurement.....	20
4.2. Maximum Peak Output Power Measurement	26
4.3. Power Spectral Density Measurement	34
4.4. 6dB Spectrum Bandwidth Measurement	63
4.5. Radiated Emissions Measurement	92
4.6. Band Edge Emissions Measurement	220
4.7. Antenna Requirements	277
5. LIST OF MEASURING EQUIPMENTS	278
6. SPORTON COMPANY PROFILE	280
6.1. Test Location.....	280
7. TAF CERTIFICATE OF ACCREDITATION	281
APPENDIX A. PHOTOGRAPHS OF EUT.....	A1 ~ A48
APPENDIX B. TEST PHOTOS.....	B1 ~ B31
APPENDIX C. MAXIMUM PERMISSIBLE EXPOSURE.....	C1 ~C4



History of This Test Report

Original Issue Date: May 4, 2007

Report No.: FR741616

No additional attachment.

Additional attachment were issued as following record:

Attachment No.	Issue Date	Description



1. CERTIFICATE OF COMPLIANCE

Product Name : WLAN ENTERPRISE AP
Brand Name : Meru, Foundry
Model Name : OAP180
Applicant : Meru Networks Inc.
Test Rule Part(s) : 47 CFR FCC Part 15 Subpart C § 15.247

Sporton International as requested by the applicant to evaluate the EMC performance of the product sample received on Feb. 8, 2006 would like to declare that the tested sample has been evaluated and found to be in compliance with the tested rule parts. The data recorded as well as the test configuration specified is true and accurate for showing the sample's EMC nature.

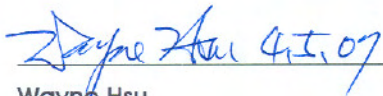
A handwritten signature in blue ink that reads "Wayne Hsu 4.5.07". The signature is written over a horizontal line.

Wayne Hsu

SPORTON INTERNATIONAL INC.

2. SUMMARY OF THE TEST RESULT

Applied Standard: 47 CFR FCC Part 15 Subpart C				
Part	Rule Section	Description of Test	Result	Under Limit
4.1	15.207	AC Power Line Conducted Emissions	Complies	2.69 dB
4.2	15.247(b)(3)	Maximum Peak Conducted Output Power	Complies	0.65 dB
4.3	15.247(e)	Power Spectral Density	Complies	7.8 dB
4.4	15.247(a)(2)	6dB Spectrum Bandwidth	Complies	-
4.5	15.247(d)	Radiated Emissions	Complies	0.24 dB
4.6	15.247(d)	Band Edge Emissions	Complies	0.16 dB
4.7	15.203	Antenna Requirements	Complies	-

Test Items	Uncertainty	Remark
AC Power Line Conducted Emissions	± 2.26 dB	Confidence levels of 95%
Maximum Peak Conducted Output Power	± 0.5 dB	Confidence levels of 95%
Power Spectral Density	± 0.71 dB	Confidence levels of 95%
6dB Spectrum Bandwidth	$\pm 6.25 \times 10^{-7}$	Confidence levels of 95%
Radiated Emissions/ Band Edge Emissions	± 3.72 dB	Confidence levels of 95%

3. GENERAL INFORMATION

3.1. Product Details

Items	Description
Product Type	WLAN(outdoor)
Power Type	POE
Interface Type	POE / Console / Antenna
Modulation	DSSS for IEEE 802.11b ; OFDM for IEEE 802.11a/g
Data Modulation	DSSS (BPSK / QPSK / CCK) ; OFDM (BPSK / QPSK / 16QAM / 64QAM)
Data Rate (Mbps)	DSSS (1/ 2/ 5.5/11) ; OFDM (6/9/12/18/24/36/48/54/108)
Frequency Range	2400 ~ 2483.5MHz / 5725 ~ 5850MHz
Channel Number	11b/g: 11 ; 11a: 7
Channel Band Width (99%)	11b: 15.68 MHz ; 11g: 16.56 MHz ; 11g Turbo: 32.94 MHz ; 11a: 16.56 MHz; 11a Turbo: 33.2 MHz
Conducted Output Power	11b: 20.23 dBm ; 11g: 18.33 dBm ; 11g Turbo: 18.05 dBm ; 11a: 21.15 dBm; 11a Turbo: 24.85 dBm
Carrier Frequencies	Please refer to section 3.4
Antenna	Please refer to section 3.3

3.2. Accessories

Power	Brand	Model	Rating
POE	CINCON	TR60A-POE-L	100-240VAC, 48VDC

3.3. Table for Filed Antenna

For 2.4GHz Band

Ant.	Model Name	Frequency Band	Antenna Type	Connector	Gain (dBi)
1	ACC04-05427A	2.4~2.5GHz	Omni-Directional Ant.	N Plug	8.0
2	ACC04-05028A	2.4~2.5GHz	Omni-Directional Ant.	N Jack	8.0
3	ACC04-053830	2.4~2.5GHz	0 Degree Sector Ant.	N Jack	10.0
4	ACC04-050090	2.4~2.5GHz	Directional Panel Ant.	N Jack	18.0
5	S24015P36NM	2.4~2.5GHz	Patch antenna Ant.	N Jack	14.5

Note: The difference between Antenna 1 & 2 is the antenna connector type.

For 5GHz Band

Ant.	Model Name	Frequency Band	Antenna Type	Connector	Gain (dBi)
8	ACC05-200180	5.5~5.825GHz	Omni-Directional Ant.	N Jack	8.0
9	ACC04-090380	5.5~5.825GHz	High-Gain Omni Directional Ant.	N Plug	8.0
10	ACC04-200010	5150~5.875GHz	Directional Sector Ant.	N Jack	13.5
11	-	5.150~5.875GHz	Embedded Ant.	MMCX	17.0
12	ACC04-20212A	5.150~5.875GHz	Directional Panel Ant.	N Jack	23.0
13	S51514WPB36NM	5.150~5.875GHz	Wideband Panel Ant.	N Jack	13.0

Note: The difference between Antenna 8&9 is the antenna connector type.

Collocate antenna cable length list for 2.4GHz antenna

Ant.	length	Attenuation at 2.4GHz
1	60m	14dB
2	60m	14dB
3	84m	18dB
4	84m	18dB
5	0.9m	0.9dB

Collocate antenna cable length list for 5GHz antenna

Ant.	length	Attenuation at 5GHz
6	30m	12dB
7	30m	12dB
8	30m	12dB
9	30m	12dB
10	1m	2dB
11	N/A	N/A
12	1m	2dB
13	0.9m	1.8dB

3.4. Table for Carrier Frequencies
Frequency Allocation for 802.11b/g

Frequency Band	Channel No.	Frequency	Channel No.	Frequency
2400~2483.5MHz	1	2412 MHz	Turbo 6	2437 MHz
	2	2417 MHz		
	3	2422 MHz		
	4	2427 MHz		
	5	2432 MHz		
	6	2437 MHz		
	7	2442 MHz		
	8	2447 MHz		
	9	2452 MHz		
	10	2457 MHz		
	11	2462 MHz		

Frequency Allocation for 802.11a

Frequency Band	Channel No.	Frequency	Channel No.	Frequency
5725~5850 MHz	149	5745 MHz	Turbo 152	5760 MHz
	153	5765 MHz	Turbo 160	5800 MHz
	157	5785 MHz		
	161	5805 MHz		
	165	5825 MHz		

3.5. Table for Test Modes

Preliminary tests were performed in different data rate to find the worst radiated emission. The data rate shown in the table below is the worst-case rate with respect to the specific test item. Investigation has been done on all the possible configurations for searching the worst cases. The following table is a list of the test modes shown in this test report.

Test Items	Mode	Data Rate	Channel	Antenna
AC Power Line Conducted Emissions	Normal Link	54 Mbps	6 / 157	4 / 12
Max. Peak Conducted Output Power Power Spectral Density 6dB Spectrum Bandwidth	11b/BPSK	1 Mbps	1/6/11	1/2/3/4/5
	11g/BPSK	6 Mbps	1/6/11	1/2/3/4/5
	11g/BPSK Turbo	12 Mbps	6	1/2/3/4/5
	11a/BPSK	6 Mbps	149/157/ 165	8/9/10/11/12/13
	11a/BPSK Turbo	12 Mbps	152/160	8/9/10/11/12/13
Radiated Emissions Below 1GHz	11g/BPSK	6 Mbps	6	1/2/3/4/5
	11a/BPSK	6 Mbps	157	8/9/10/11/12/13
Radiated Emissions Above 1GHz	11b/BPSK	11 Mbps	1/6/11	1/2/3/4/5
	11g/BPSK	6 Mbps	1/6/11	1/2/3/4/5
	11g/BPSK Turbo	12 Mbps	6	1/2/3/4/5
	11a/BPSK	6 Mbps	149/157/ 165	8/9/10/11/12/13
	11a/BPSK Turbo	12 Mbps	152/160	8/9/10/11/12/13
Band Edge Emissions	11b/BPSK	1 Mbps	1/11	1/2/3/4/5
	11g/BPSK	6 Mbps	1/11	1/2/3/4/5
	11g/BPSK Turbo	12 Mbps	6	1/2/3/4/5
	11a/BPSK	6 Mbps	149/165	8/9/10/11/12/13
	11a/BPSK Turbo	12 Mbps	152/160	8/9/10/11/12/13

3.6. Table for Testing Locations

Test Site No.	Site Category	Location	FCC Reg. No.	IC File No.	VCCI Reg. No
03CH03-HY	SAC	Hwa Ya	101377	IC 4088	-
CO04-HY	Conduction	Hwa Ya	-	-	-
TH01-HY	OVEN Room	Hwa Ya	-	-	-

Open Area Test Site (OATS); Semi Anechoic Chamber (SAC); Fully Anechoic Chamber (FAC).

Please refer section 6 for Test Site Address.

3.7. Table for Multiple List

The model listed below is series model to OAP180.

The model is identical, the difference model for difference marketing strategy.

Product Name	Brand Name	Model Name	Applicant
WLAN ENTERPRISE AP	Foundry	OAP180	Company: Foundry Networks Inc. Address: 4980 Great America Parkway, Santa Clara, California, 95054, U.S.A.

3.8. Table for Supporting Units

Support Unit	Brand	Model	FCC ID
Notebook	DELL	PP01L	DoC

3.9. Table for Parameters of Test Software Setting

During testing, Channel & Power Controlling Software provided by the customer was used to control the operating channel as well as the output power level. The RF output power selection is for the setting of RF output power expected by the customer and is going to be fixed on the firmware of the final end product.

For Ant. 1/2/3/4

Power Parameters of IEEE 802.11b/g

Test Software Version	ART		
Frequency	2412 MHz	2437 MHz	2462 MHz
IEEE 802.11b	21	21.5	21
IEEE 802.11g	19.5	19	19
IEEE 802.11g Turbo	-	18	-

For Ant. 5

Power Parameters of IEEE 802.11b/g

Test Software Version	ART		
Frequency	2412 MHz	2437 MHz	2462 MHz
IEEE 802.11b	13	15	15
IEEE 802.11g	7	12	7
IEEE 802.11g Turbo	-	10.5	-

For Ant. 8/9
Power Parameters of IEEE 802.11a

Test Software Version	ART		
Frequency	5745 MHz	5785 MHz	5825 MHz
IEEE 802.11a	22	22	22
Frequency	5760 MHz	5800 MHz	-
IEEE 802.11a Turbo	22	22	-

For Ant. 10
Power Parameters of IEEE 802.11a

Test Software Version	ART		
Frequency	5745 MHz	5785 MHz	5825 MHz
IEEE 802.11a	16	16	16
Frequency	5760 MHz	5800 MHz	-
IEEE 802.11a Turbo	23	23	-

For Ant. 11
Power Parameters of IEEE 802.11a

Test Software Version	ART		
Frequency	5745 MHz	5785 MHz	5825 MHz
IEEE 802.11a	6.5	4.5	2
Frequency	5760 MHz	5800 MHz	-
IEEE 802.11a Turbo	3	1.5	-

For Ant. 12
Power Parameters of IEEE 802.11a

Test Software Version	ART		
Frequency	5745 MHz	5785 MHz	5825 MHz
IEEE 802.11a	10	10	4
Frequency	5760 MHz	5800 MHz	-
IEEE 802.11a Turbo	7	10	-

For Ant. 13

Power Parameters of IEEE 802.11a

Test Software Version	ART		
Frequency	5745 MHz	5785 MHz	5825 MHz
IEEE 802.11a	8	9	8
Frequency	5760 MHz	5800 MHz	-
IEEE 802.11a Turbo	10	8	-

3.10. Test Configurations

3.10.1. Radiation Emissions Test Configuration

For Ant. 1/2

Test Configuration: 9KHz~1GHz

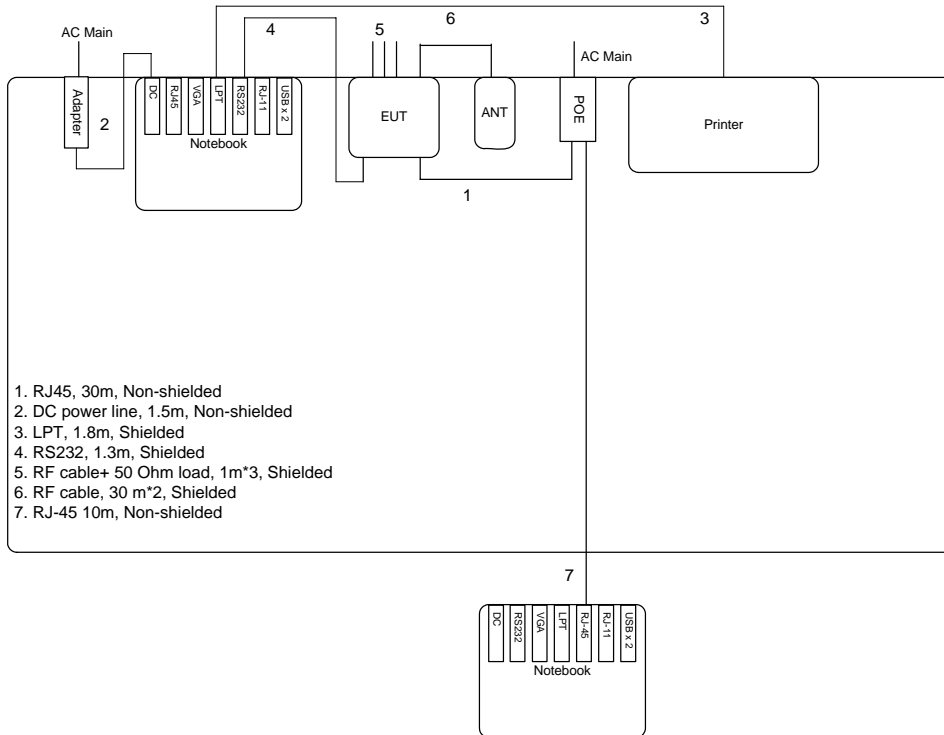

Test Configuration: above 1GHz

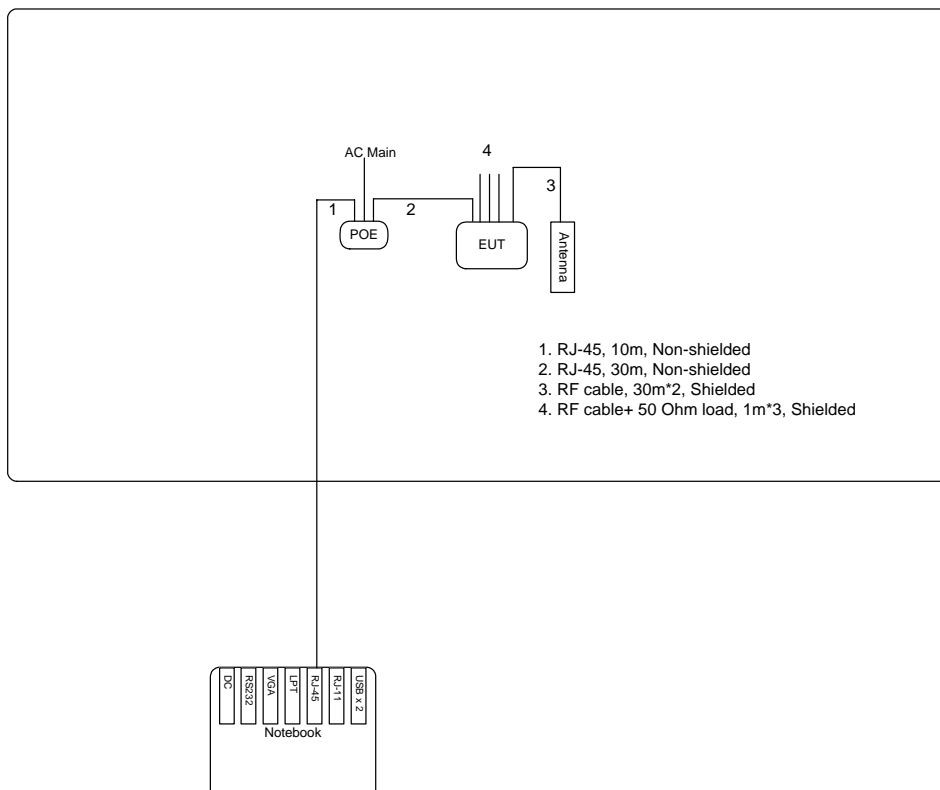

For Ant. 3

Test Configuration: 9KHz~1GHz

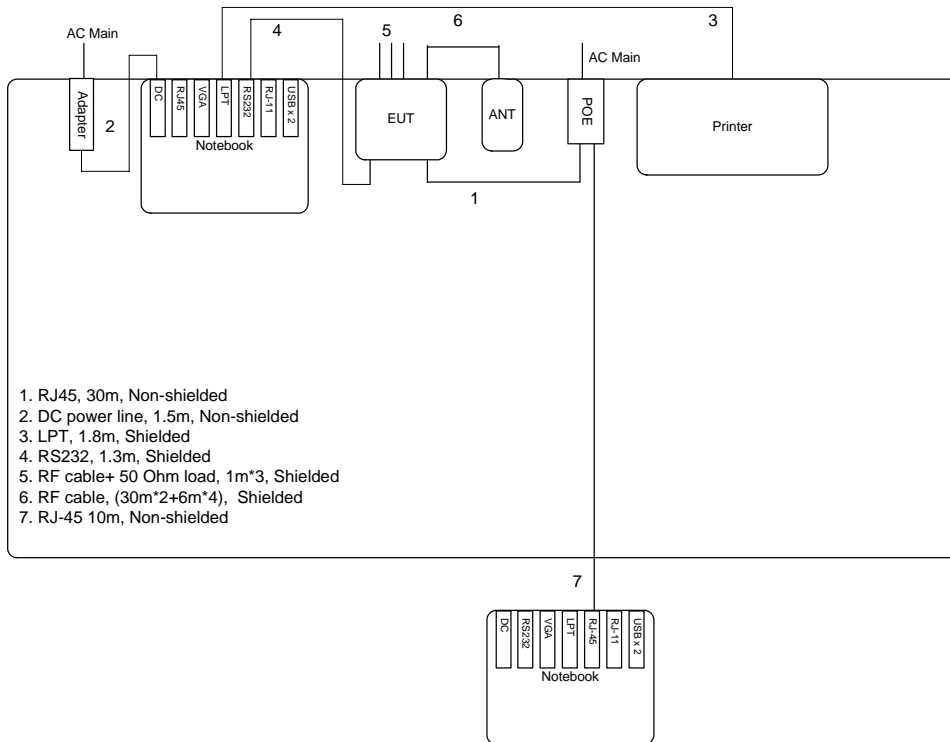

Test Configuration: above 1GHz

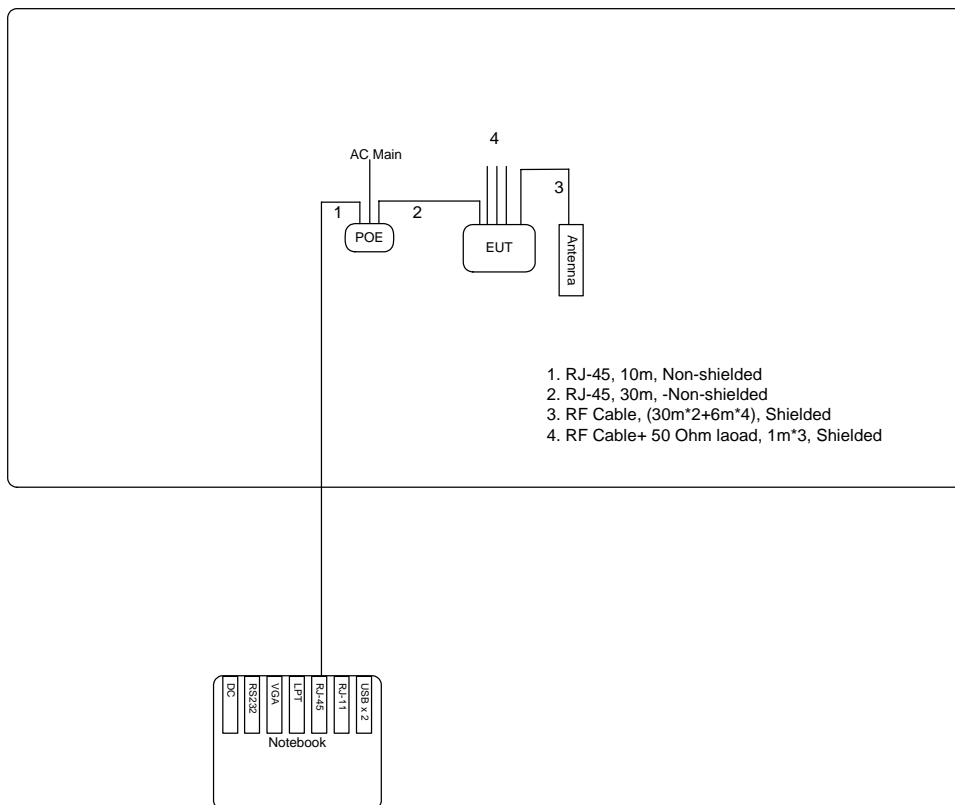

For Ant. 4

Test Configuration: 9KHz~1GHz

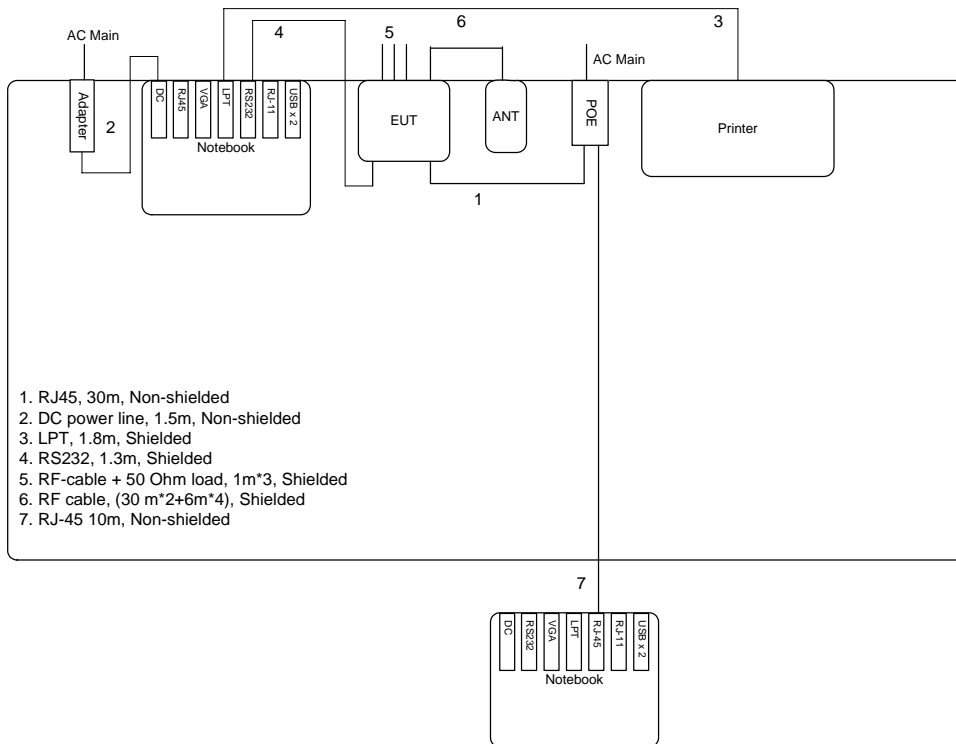

Test Configuration: above 1GHz

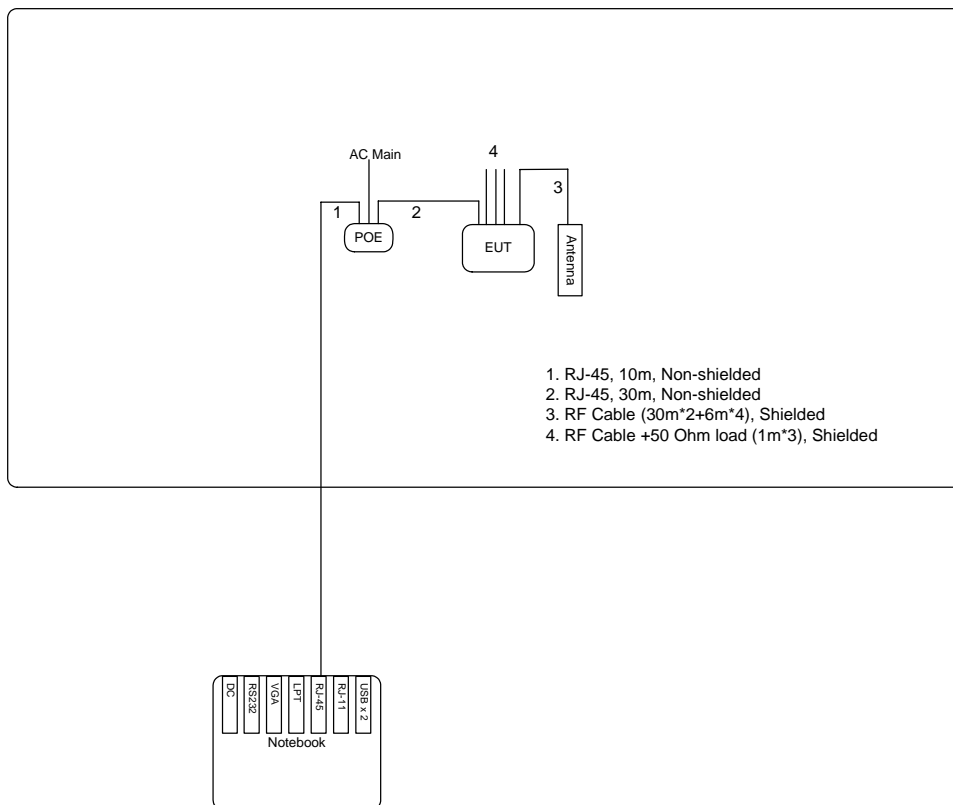

For Ant. 5

Test Configuration: 9KHz~1GHz

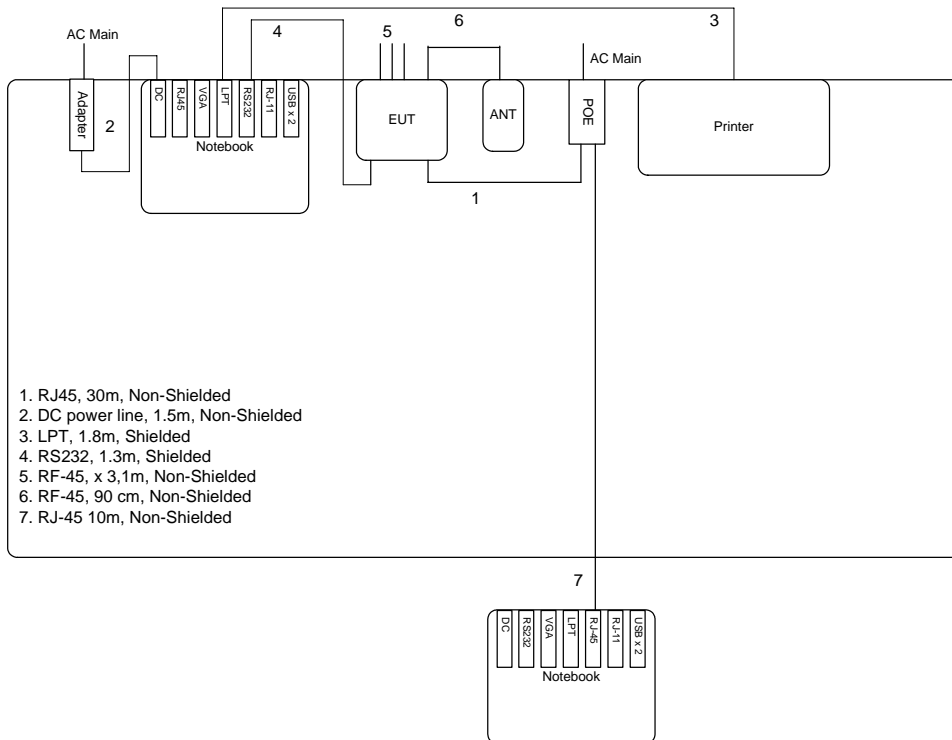

Test Configuration: above 1GHz

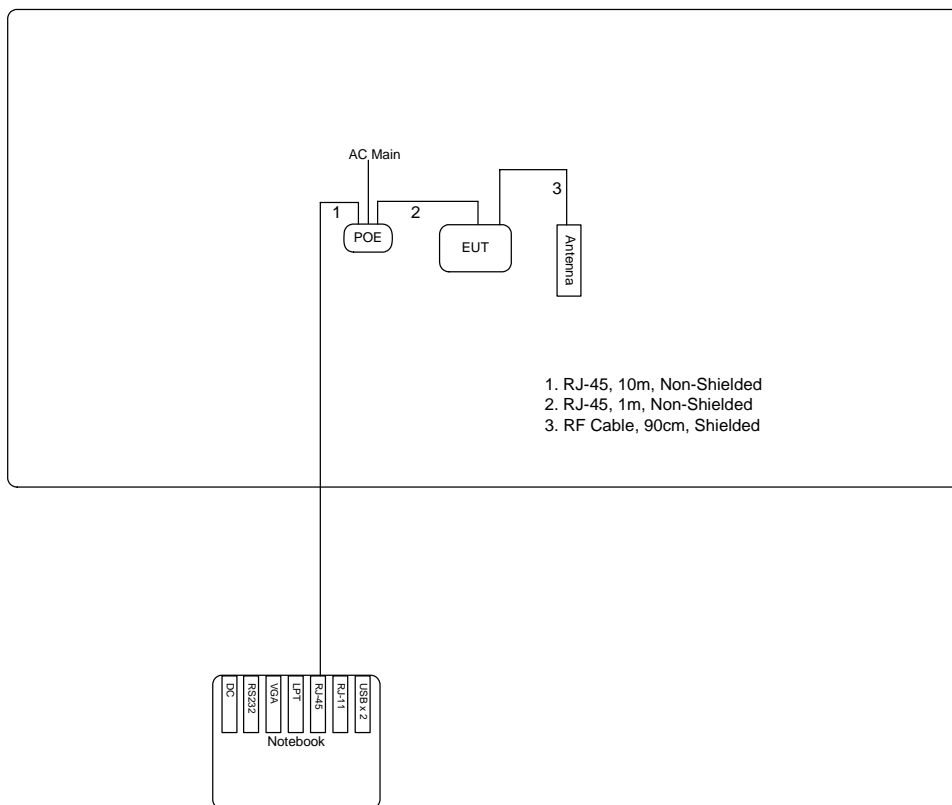

For Ant. 8/9

Test Configuration: 9KHz~1GHz

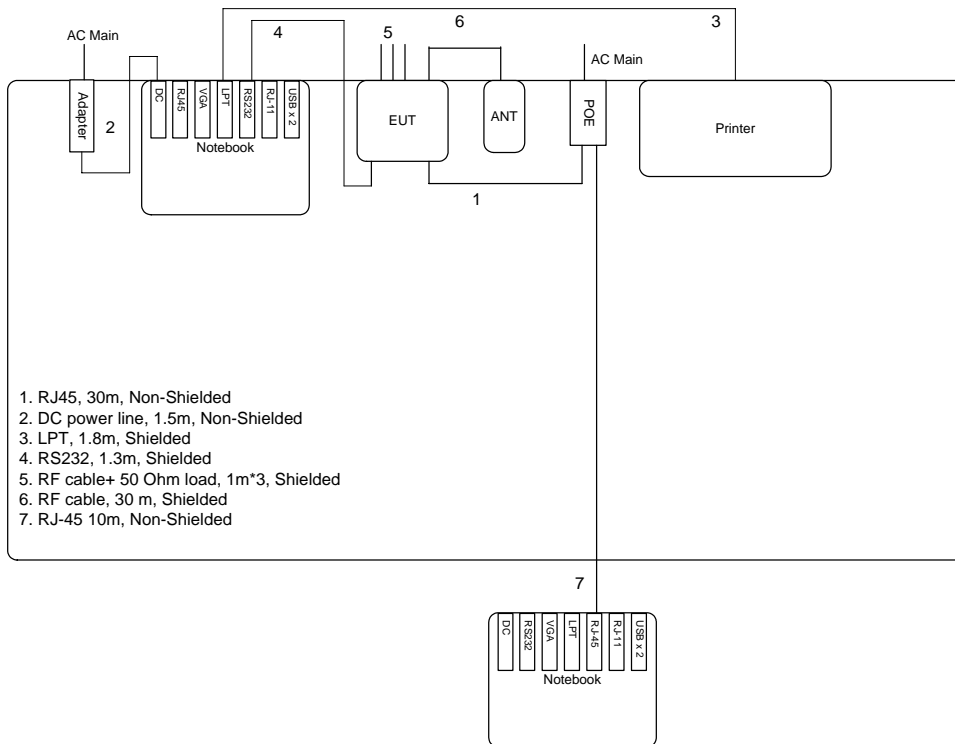

Test Configuration: above 1GHz

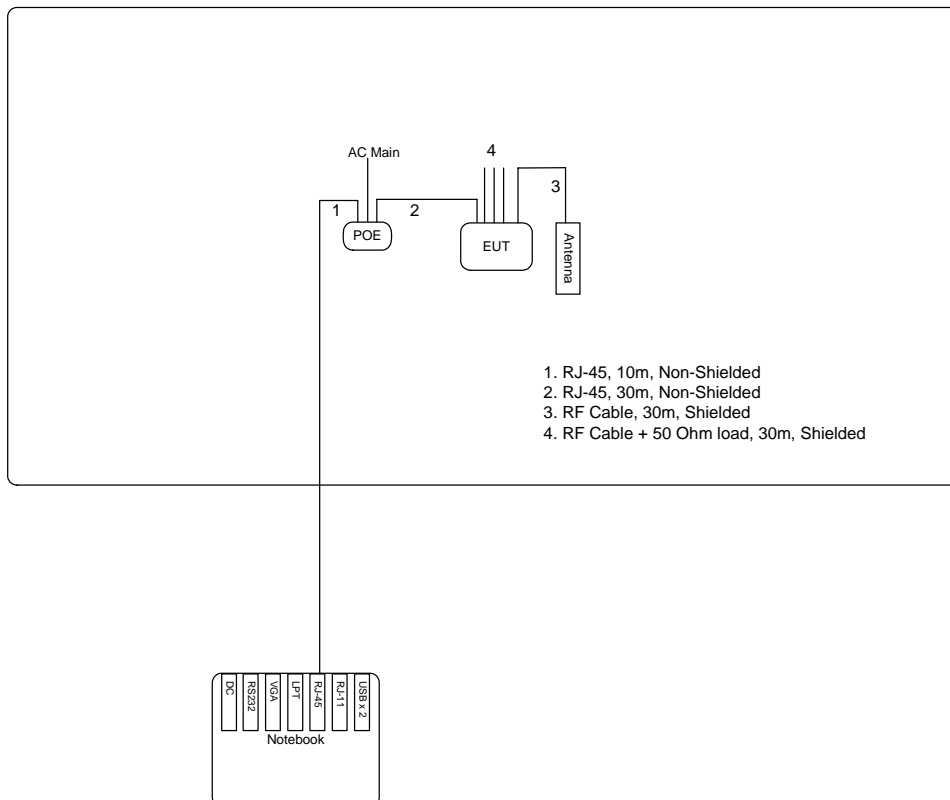

For Ant. 10

Test Configuration: 9KHz~1GHz

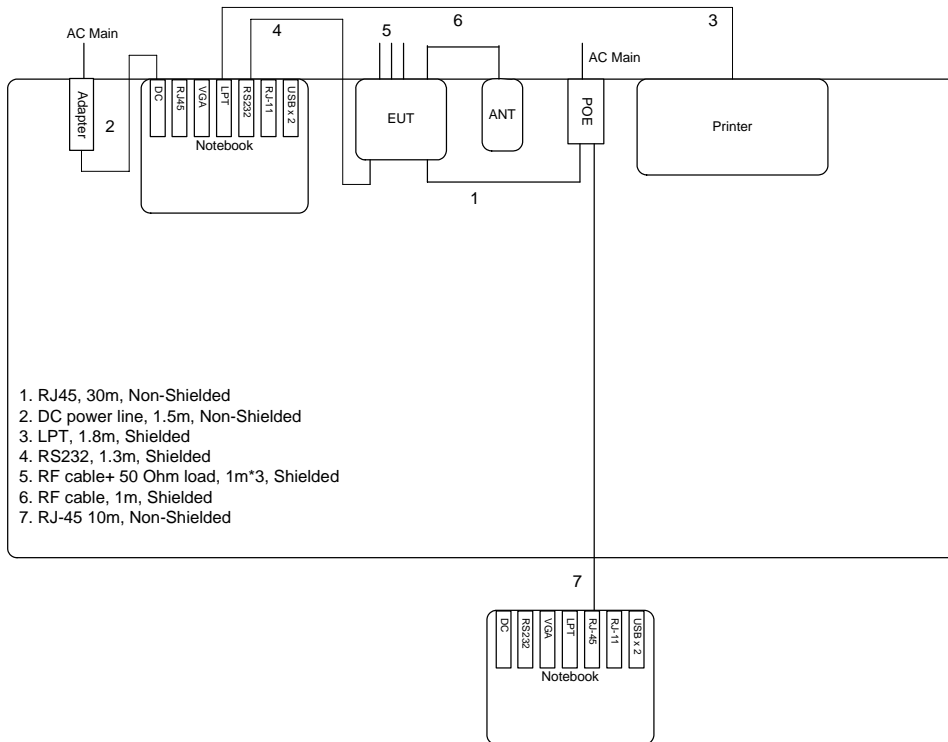

Test Configuration: above 1GHz

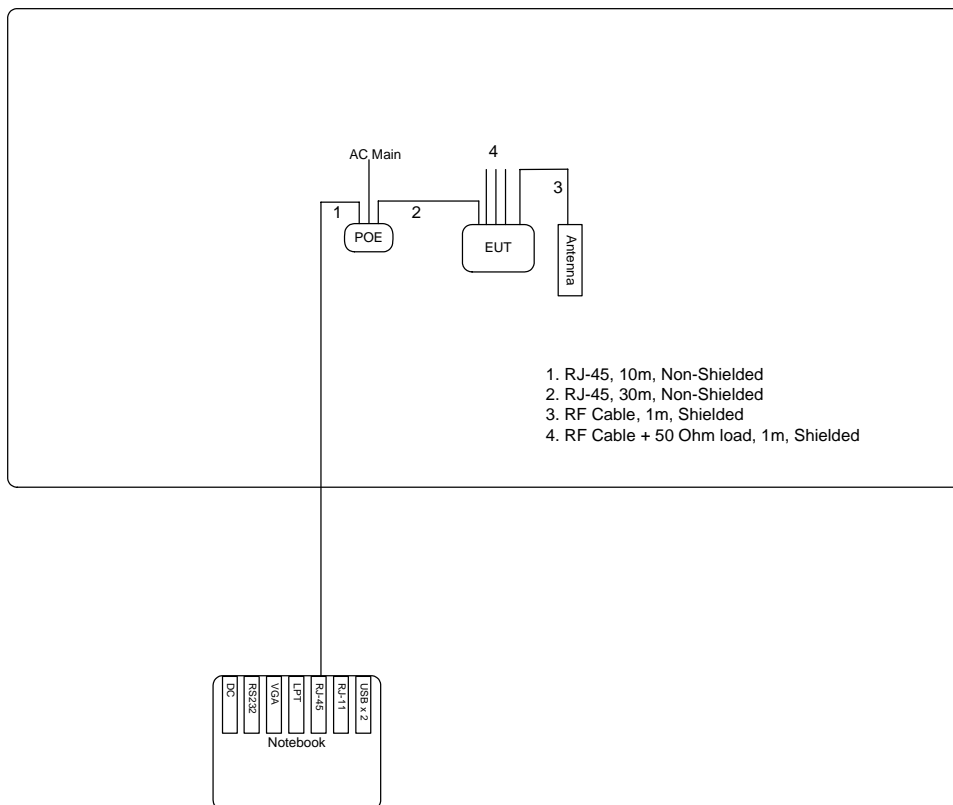

For Ant. 11

Test Configuration: 9KHz~1GHz

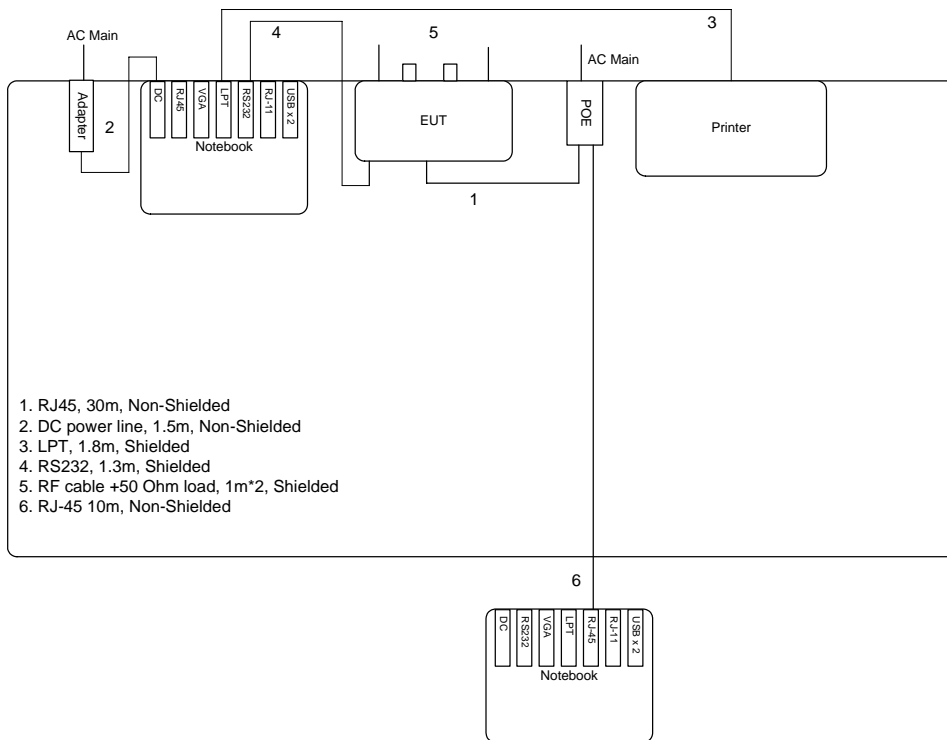

Test Configuration: above 1GHz

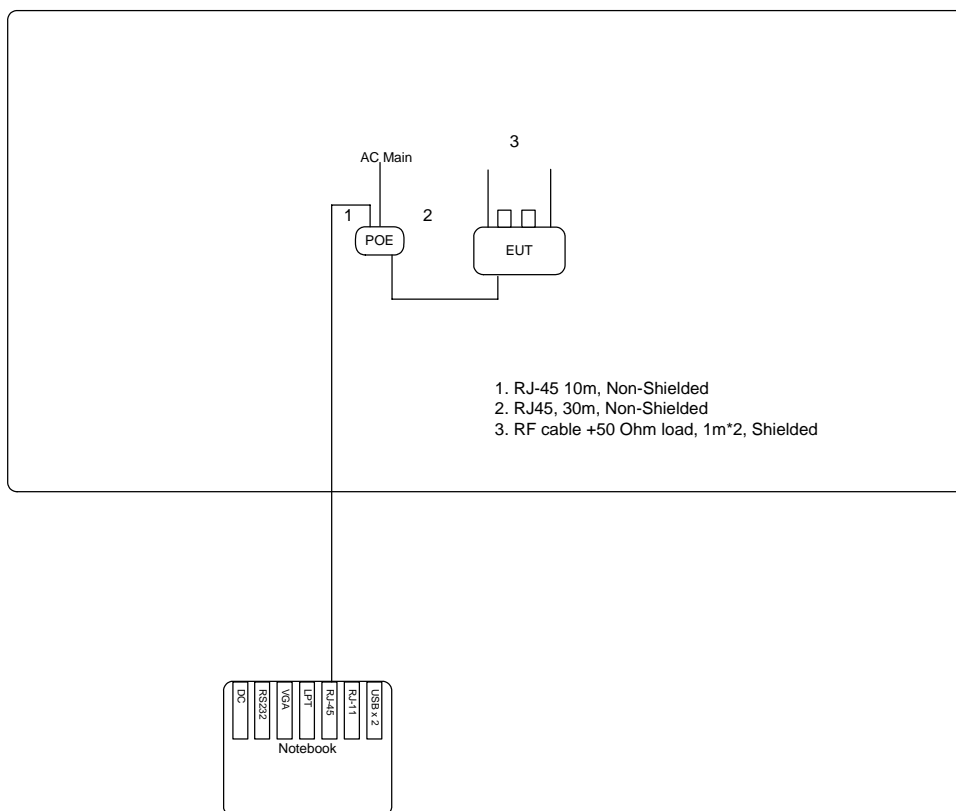

For Ant. 12

Test Configuration: 9KHz~1GHz

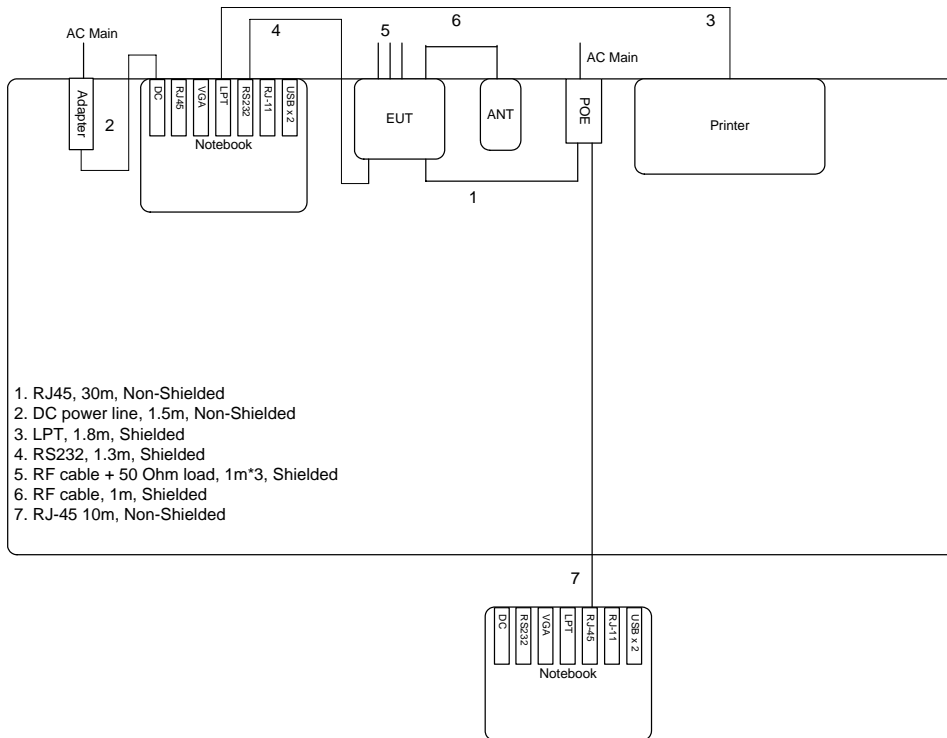

Test Configuration: above 1GHz

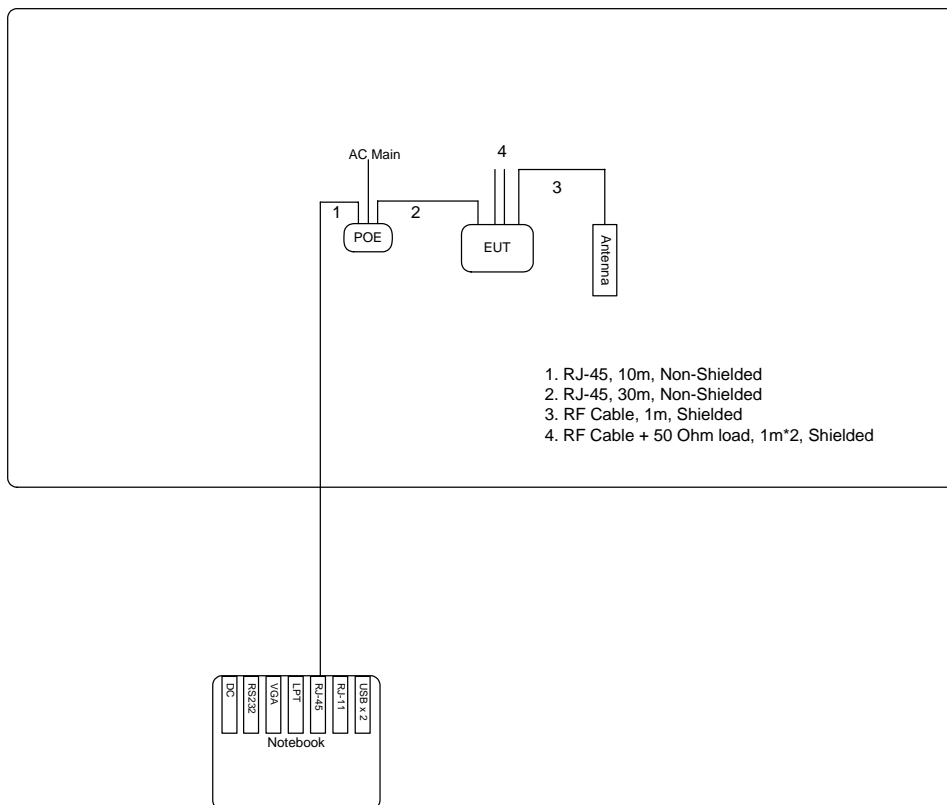

For Ant. 13

Test Configuration: 9KHz~1GHz

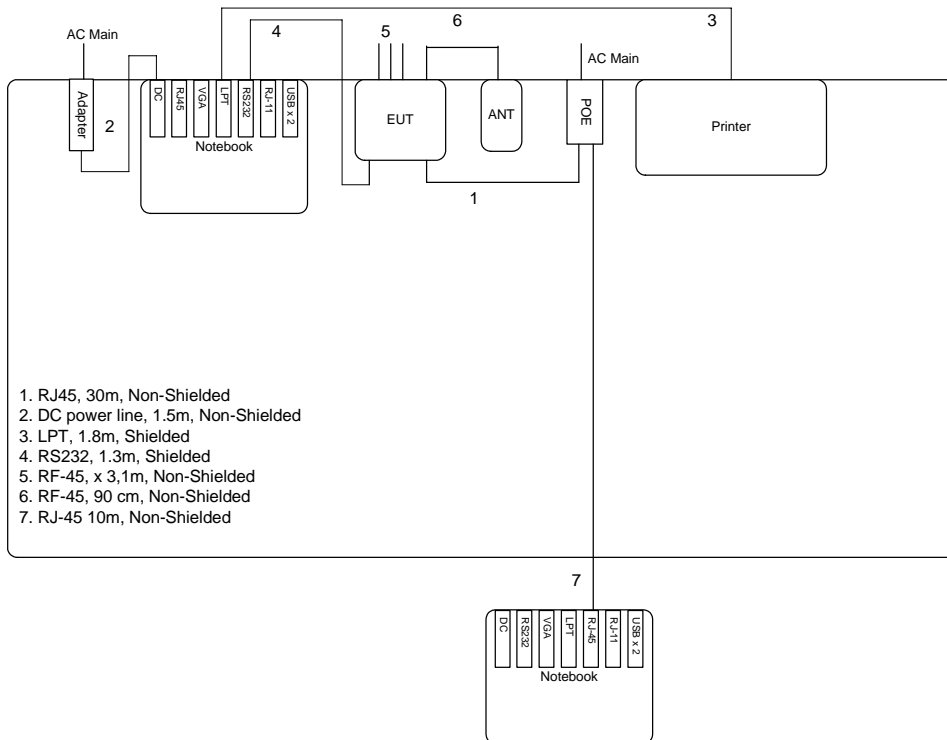

Test Configuration: above 1GHz

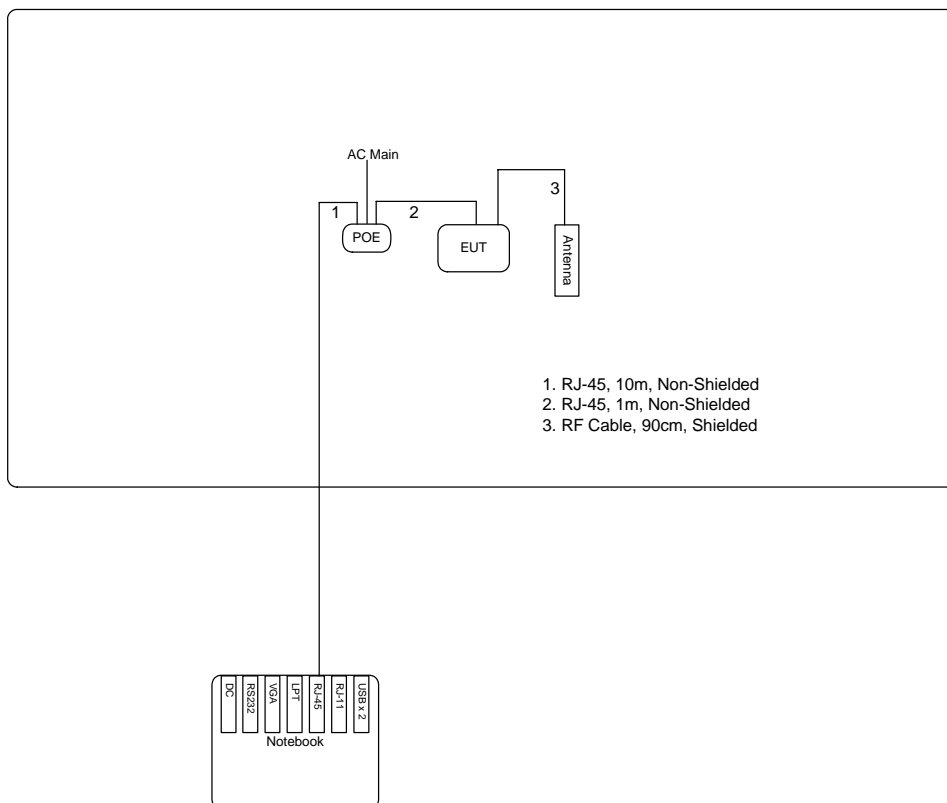

3.10.2.AC Power Line Conduction Emissions Test Configuration

For Ant. 4

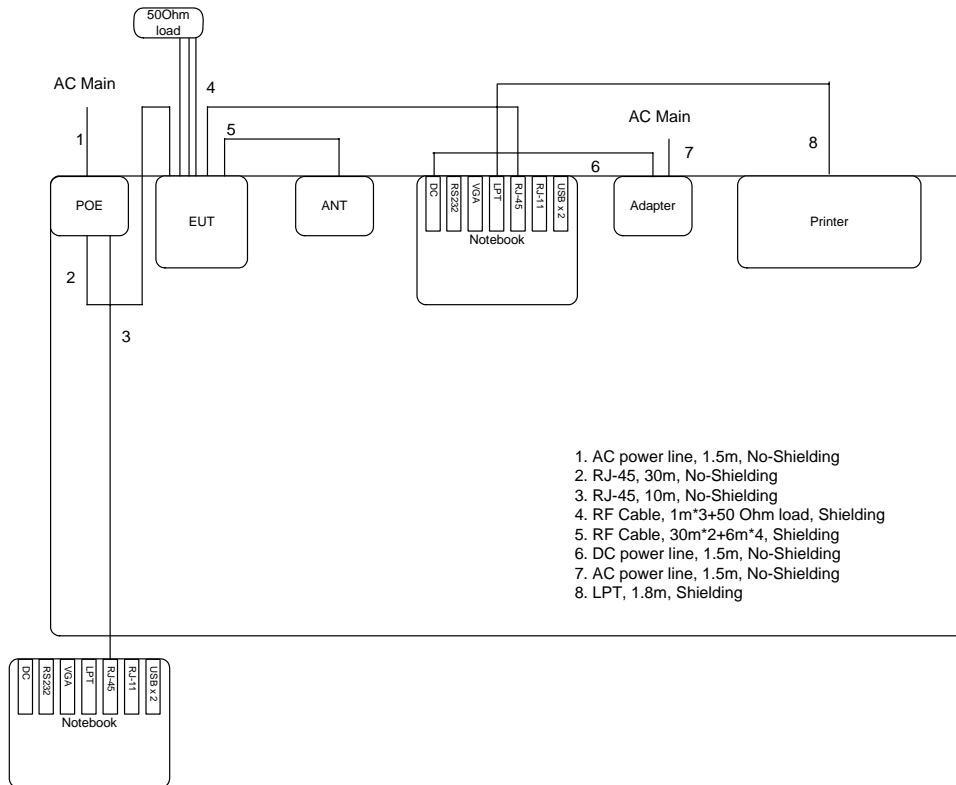

For Ant. 12

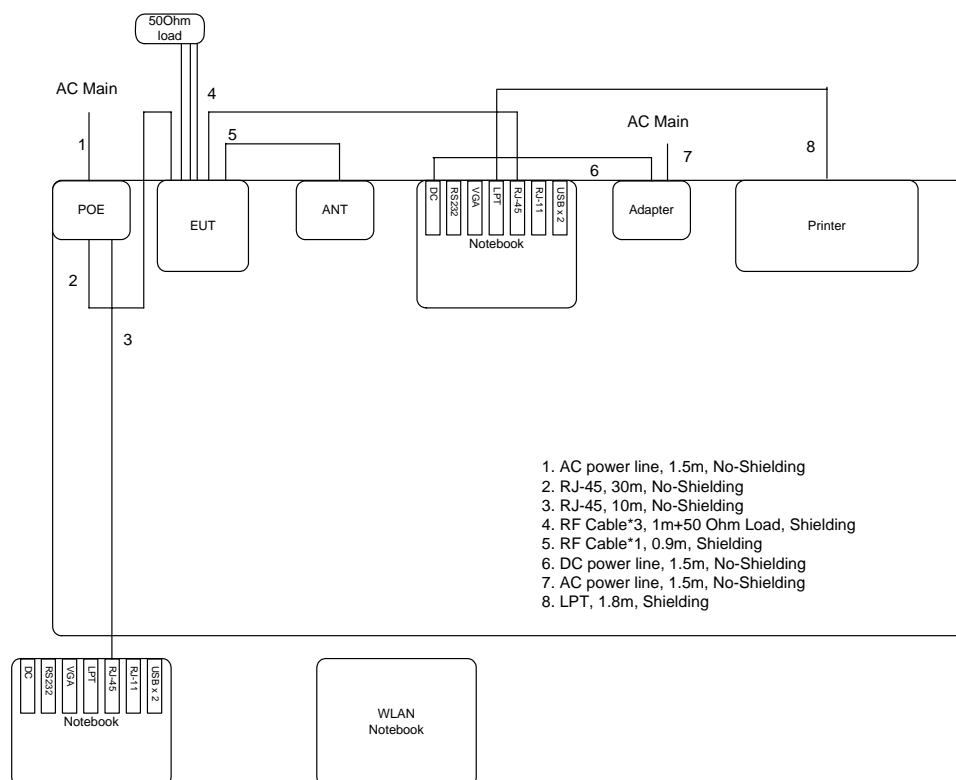

4. TEST RESULT

4.1. AC Power Line Conducted Emissions Measurement

4.1.1. Limit

For a Low-power Radio-frequency Device which is designed to be connected to the AC power line, the radio frequency voltage that is conducted back onto the AC power line on any frequency or frequencies within the band 150 kHz to 30 MHz shall not exceed below limits table.

Frequency (MHz)	QP Limit (dBuV)	AV Limit (dBuV)
0.15~0.5	66~56	56~46
0.5~5	56	46
5~30	60	50

4.1.2. Measuring Instruments and Setting

Please refer to section 5 in this report. The following table is the setting of the receiver.

Receiver Parameters	Setting
Attenuation	10 dB
Start Frequency	0.15 MHz
Stop Frequency	30 MHz
IF Bandwidth	9 KHz

4.1.3. Test Procedures

1. Configure the EUT according to ANSI C63.4. The EUT or host of EUT has to be placed 0.4 meter far from the conducting wall of the shielding room and at least 80 centimeters from any other grounded conducting surface.
2. Connect EUT or host of EUT to the power mains through a line impedance stabilization network (LISN).
3. All the support units are connected to the other LISNs. The LISN should provide 50uH/50ohms coupling impedance.
4. The frequency range from 150 KHz to 30 MHz was searched.
5. Set the test-receiver system to Peak Detect Function and Specified Bandwidth with Maximum Hold Mode.
6. The measurement has to be done between each power line and ground at the power terminal.

4.1.4. Test Setup Layout

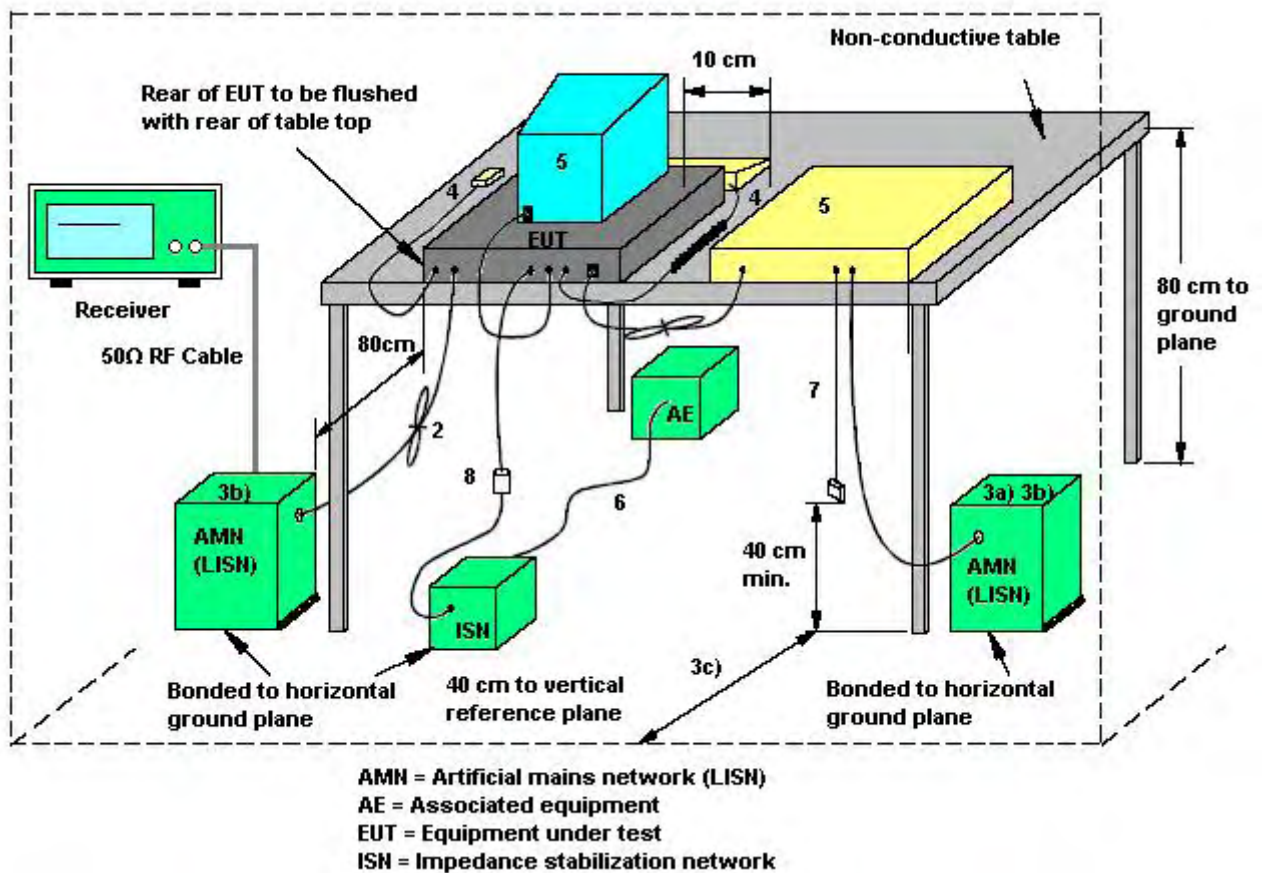

1. If cables, which hang closer than 40 cm to the horizontal metal groundplane, cannot be shortened to appropriate length, the excess shall be folded back and forth forming a bundle 30 cm to 40 cm long.
2. Excess mains cord shall be bundled in the centre or shortened to appropriate length.
3. EUT is connected to one artificial mains network (AMN). All AMNs and ISNs may alternatively be connected to a vertical reference plane or metal wall.
4. All other units of a system are powered from a second AMN. A multiple outlet strip can be used for multiple mains cords.
5. AMN and ISN are 80 cm from the EUT and at least 80 cm from other units and other metal planes.
6. Mains cords and signal cables shall be positioned for their entire lengths, as far as possible, at 40 cm from the vertical reference plane.
7. Cables of hand operated devices, such as keyboards, mice, etc. shall be placed as for normal usage.
8. Peripherals shall be placed at a distance of 10 cm from each other and from the controller, except for the monitor which, if this is an acceptable installation practice, shall be placed directly on the top of the controller.
9. I/O signal cable intended for external connection.
10. The end of the I/O signal cables which are not connected to an AE may be terminated, if required, using correct terminating impedance.
11. If used, the current probe shall be placed at 0,1 m from the ISN.

4.1.5. Test Deviation

There is no deviation with the original standard.

4.1.6. EUT Operation during Test

The EUT was placed on the test table and programmed in normal function.

4.1.7. Results of AC Power Line Conducted Emissions Measurement

Temperature	24°C	Humidity	64%
Test Engineer	Evelyn Shih	Phase	Line
Configuration	Normal Link / Ant. 4		

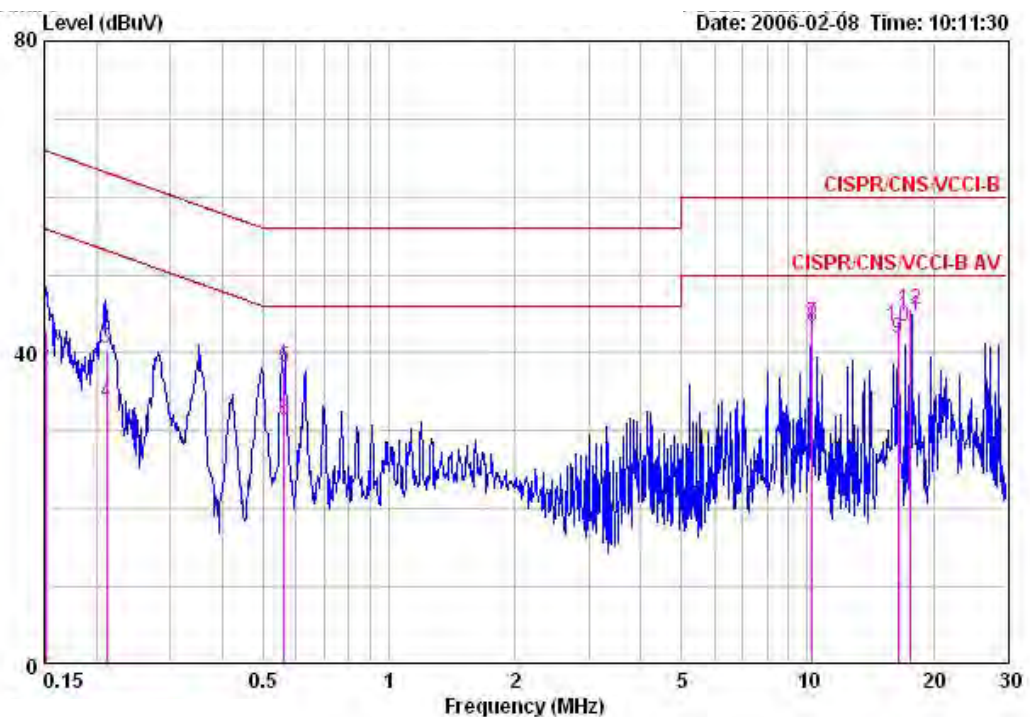

	Freq	Level	Over	Limit	Read	LISN	Cable	
	MHz	dBuV	Limit	Line	Level	Factor	Loss	Remark
			dB	dBuV	dBuV	dB	dB	
1	0.15080	43.04	-22.92	65.96	40.83	2.01	0.20	QP
2	0.15080	37.87	-18.09	55.96	35.66	2.01	0.20	AVERAGE
3	0.21194	40.52	-22.61	63.13	39.13	1.19	0.20	QP
4	0.21194	33.53	-19.60	53.13	32.14	1.19	0.20	AVERAGE
5	0.56111	38.16	-17.84	56.00	37.56	0.40	0.20	QP
6	0.56111	31.34	-14.66	46.00	30.74	0.40	0.20	AVERAGE
7	10.243	43.87	-16.13	60.00	43.23	0.30	0.34	QP
8	10.243	43.42	-6.58	50.00	42.78	0.30	0.34	AVERAGE
9	16.472	41.96	-8.04	50.00	41.26	0.30	0.40	AVERAGE
10	16.472	43.37	-16.63	60.00	42.67	0.30	0.40	QP
11	17.692	44.60	-5.40	50.00	43.80	0.30	0.50	AVERAGE
12	17.692	45.50	-14.50	60.00	44.70	0.30	0.50	QP

Temperature	24°C	Humidity	64%
Test Engineer	Evelyn Shih	Phase	Neutral
Configuration	Normal Link / Ant. 4		

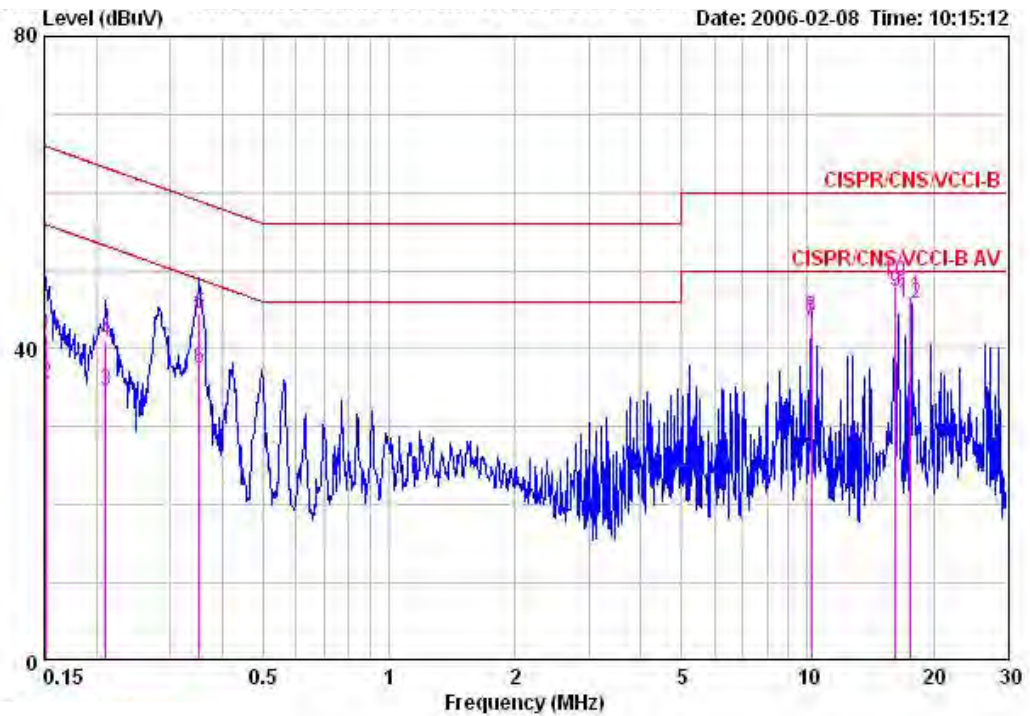

	Freq	Level	Over	Limit	Read	LISN	Cable	
	MHz	dBuV	Limit	Line	Level	Factor	Loss	Remark
			dB	dBuV	dBuV	dB	dB	
1	0.15160	41.81	-24.10	65.91	39.71	1.90	0.20	QP
2	0.15160	35.64	-20.27	55.91	33.54	1.90	0.20	AVERAGE
3	0.21055	34.73	-18.45	53.18	33.43	1.10	0.20	AVERAGE
4	0.21055	40.96	-22.22	63.18	39.66	1.10	0.20	QP
5	0.35201	44.41	-14.50	58.91	43.61	0.60	0.20	QP
6	0.35201	37.46	-11.45	48.91	36.66	0.60	0.20	AVERAGE
7	10.243	43.68	-6.32	50.00	43.04	0.30	0.34	AVERAGE
8	10.243	44.12	-15.88	60.00	43.48	0.30	0.34	QP
9	16.227	47.31	-2.69	50.00	46.61	0.30	0.40	AVERAGE
10	16.227	48.61	-11.39	60.00	47.91	0.30	0.40	QP
11	17.693	46.58	-13.42	60.00	45.78	0.30	0.50	QP
12	17.693	45.72	-4.28	50.00	44.92	0.30	0.50	AVERAGE

Note:

$$\text{Level} = \text{Read Level} + \text{LISN Factor} + \text{Cable Loss}$$

Temperature	24°C	Humidity	64%
Test Engineer	Evelyn Shih	Phase	Line
Configuration	Normal Link / Ant. 12		

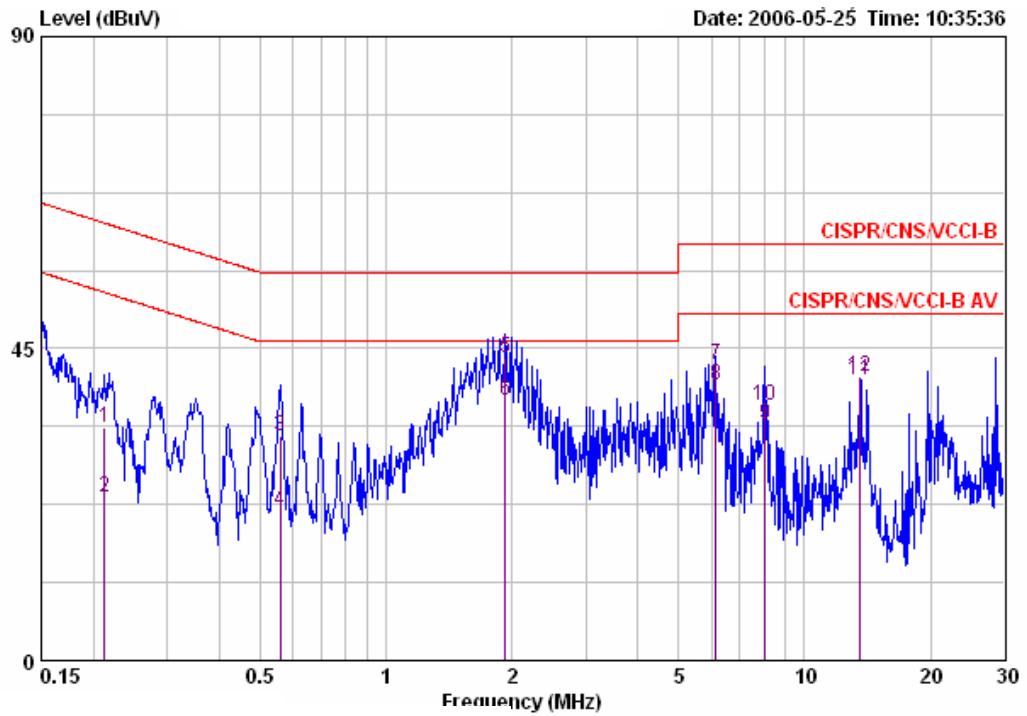

	Freq	Level	Over Limit	Limit Line	Read Level	LISN Factor	Cable Loss	Remark
	MHz	dBuV	dB	dBuV	dBuV	dB	dB	
1	0.21285	33.64	-29.45	63.09	32.27	1.18	0.20	QP
2	0.21285	23.48	-29.61	53.09	22.11	1.18	0.20	AVERAGE
3	0.55815	32.45	-23.55	56.00	31.85	0.40	0.20	QP
4	0.55815	21.63	-24.37	46.00	21.03	0.40	0.20	AVERAGE
5	1.928	43.69	-12.31	56.00	43.20	0.30	0.19	QP
6	1.928	37.64	-8.36	46.00	37.15	0.30	0.19	AVERAGE
7	6.150	42.61	-17.39	60.00	41.98	0.30	0.33	QP
8	6.150	39.64	-10.36	50.00	39.01	0.30	0.33	AVERAGE
9	8.036	34.12	-15.88	50.00	33.42	0.30	0.40	AVERAGE
10	8.036	36.74	-23.26	60.00	36.04	0.30	0.40	QP
11	13.600	40.45	-9.55	50.00	39.75	0.30	0.40	AVERAGE
12	13.600	40.87	-19.13	60.00	40.17	0.30	0.40	QP

Temperature	24°C	Humidity	64%
Test Engineer	Evelyn Shih	Phase	Neutral
Configuration	Normal Link / Ant. 12		

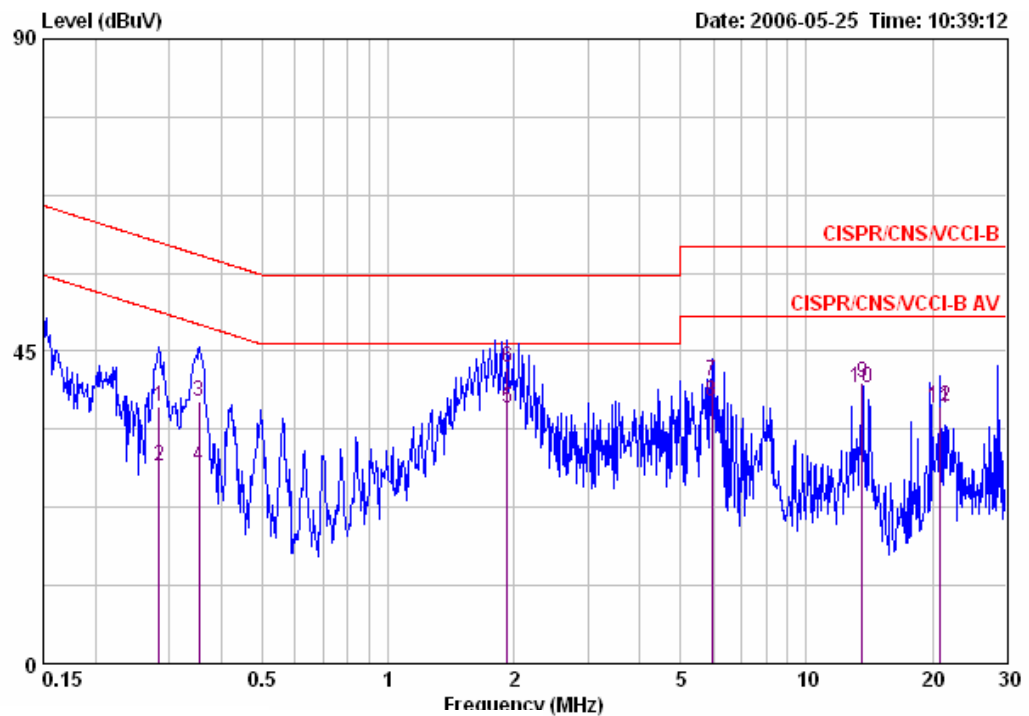

	Freq	Level	Over Limit	Limit Line	Read Level	LISN Factor	Cable Loss	Remark
	MHz	dBuV	dB	dBuV	dBuV	dB	dB	
1	0.28328	36.99	-23.73	60.72	36.09	0.70	0.20	QP
2	0.28328	28.46	-22.26	50.72	27.56	0.70	0.20	AVERAGE
3	0.35388	37.84	-21.03	58.87	37.04	0.60	0.20	QP
4	0.35388	28.46	-20.41	48.87	27.66	0.60	0.20	AVERAGE
5 @	1.928	36.84	-9.16	46.00	36.44	0.21	0.19	AVERAGE
6	1.928	42.74	-13.26	56.00	42.34	0.21	0.19	QP
7	5.952	40.67	-19.33	60.00	40.07	0.30	0.30	QP
8	5.952	37.84	-12.16	50.00	37.24	0.30	0.30	AVERAGE
9	13.602	40.35	-19.65	60.00	39.72	0.23	0.40	QP
10	13.602	39.85	-10.15	50.00	39.22	0.23	0.40	AVERAGE
11	20.928	36.74	-13.26	50.00	35.94	0.30	0.50	AVERAGE
12	20.928	36.91	-23.09	60.00	36.11	0.30	0.50	QP

Note:

$$\text{Level} = \text{Read Level} + \text{LISN Factor} + \text{Cable Loss}$$

4.2. Maximum Peak Output Power Measurement

4.2.1. Limit

For systems using digital modulation in the 2400-2483.5MHz, the limit for peak output power is 30dBm. The limited has to be reduced by the amount in dB that the gain of the antenna exceed 6dBi. In case of point-to-point operation, the limit has to be reduced by 1dB for every 3dB that the directional gain of the antenna exceeds 6dBi. Systems operating in the 5725-5850 MHz band that are used exclusively for fixed, point-to-point operations may employ the Antenna with directional gain greater than 6 dBi without any corresponding reduction in conducted output power.

4.2.2. Measuring Instruments and Setting

Please refer to section 5 in this report. The following table is the setting of the power meter.

Power Meter Parameter	Setting
Filter No.	Auto
Measurement time	0.135 s ~ 26 s
Used Peak Sensor	NRV-Z32 (model 04)

4.2.3. Test Procedures

1. The transmitter output (antenna port) was connected to the power meter.
2. Turn on the EUT and power meter and then record the peak power value.
3. Repeat above procedures on all channels needed to be tested.

4.2.4. Test Setup Layout

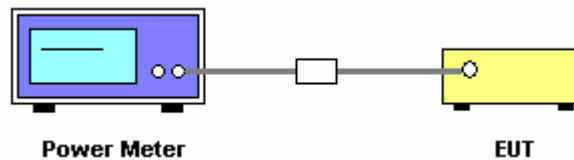

4.2.5. Test Deviation

There is no deviation with the original standard.

4.2.6. EUT Operation during Test

The EUT was programmed to be in continuously transmitting mode.

4.2.7. Test Result of Maximum Peak Output Power

Temperature	24°C	Humidity	64%
Test Engineer	Rush Kao	Configurations	802.11b/g / Ant. 1/2/3/4

Configuration IEEE 802.11b

Channel	Frequency	Conducted Power (dBm)	Max. Limit (dBm)	Result
1	2412 MHz	20.11	26.00	Complies
6	2437 MHz	20.23	26.00	Complies
11	2462 MHz	20.15	26.00	Complies

Configuration IEEE 802.11g

Channel	Frequency	Conducted Power (dBm)	Max. Limit (dBm)	Result
1	2412 MHz	18.32	26.00	Complies
6	2437 MHz	18.33	26.00	Complies
11	2462 MHz	18.25	26.00	Complies

Configuration IEEE 802.11g Turbo

Channel	Frequency	Conducted Power (dBm)	Max. Limit (dBm)	Result
6	2437 MHz	18.05	26.00	Complies

Temperature	24°C	Humidity	64%
Test Engineer	Rush Kao	Configurations	802.11b/g / Ant. 5

Configuration IEEE 802.11b

Channel	Frequency	Conducted Power (dBm)	Max. Limit (dBm)	Result
1	2412 MHz	12.11	27.00	Complies
6	2437 MHz	13.73	27.00	Complies
11	2462 MHz	13.15	27.00	Complies

Configuration IEEE 802.11g

Channel	Frequency	Conducted Power (dBm)	Max. Limit (dBm)	Result
1	2412 MHz	7.32	27.00	Complies
6	2437 MHz	11.33	27.00	Complies
11	2462 MHz	7.25	27.00	Complies

Configuration IEEE 802.11g Turbo

Channel	Frequency	Conducted Power (dBm)	Max. Limit (dBm)	Result
6	2437 MHz	10.32	27.00	Complies

Temperature	24°C	Humidity	64%
Test Engineer	Rush Kao	Configurations	802.11a / Ant. 8/9

Configuration IEEE 802.11a

Channel	Frequency	Conducted Power (dBm)	Max. Limit (dBm)	Result
149	5745 MHz	21.11	30.00	Complies
157	5785 MHz	21.03	30.00	Complies
165	5825 MHz	21.15	30.00	Complies

Configuration IEEE 802.11a Turbo

Channel	Frequency	Conducted Power (dBm)	Max. Limit (dBm)	Result
152	5760 MHz	21.85	30.00	Complies
160	5800 MHz	21.77	30.00	Complies

Temperature	24°C	Humidity	64%
Test Engineer	Rush Kao	Configurations	802.11a / Ant. 10

Configuration IEEE 802.11a

Channel	Frequency	Conducted Power (dBm)	Max. Limit (dBm)	Result
149	5745 MHz	20.20	30.00	Complies
157	5785 MHz	20.12	30.00	Complies
165	5825 MHz	20.23	30.00	Complies

Configuration IEEE 802.11a Turbo

Channel	Frequency	Conducted Power (dBm)	Max. Limit (dBm)	Result
152	5760 MHz	24.85	30.00	Complies
160	5800 MHz	24.77	30.00	Complies

Temperature	24°C	Humidity	64%
Test Engineer	Rush Kao	Configurations	802.11a / Ant. 11

Configuration IEEE 802.11a

Channel	Frequency	Conducted Power (dBm)	Max. Limit (dBm)	Result
149	5745 MHz	10.54	30.00	Complies
157	5785 MHz	8.94	30.00	Complies
165	5825 MHz	6.18	30.00	Complies

Configuration IEEE 802.11a Turbo

Channel	Frequency	Conducted Power (dBm)	Max. Limit (dBm)	Result
152	5760 MHz	7.23	30.00	Complies
160	5800 MHz	5.45	30.00	Complies

Temperature	24°C	Humidity	64%
Test Engineer	Rush Kao	Configurations	802.11a / Ant. 12

Configuration IEEE 802.11a

Channel	Frequency	Conducted Power (dBm)	Max. Limit (dBm)	Result
149	5745 MHz	14.35	30.00	Complies
157	5785 MHz	14.57	30.00	Complies
165	5825 MHz	8.14	30.00	Complies

Configuration IEEE 802.11a Turbo

Channel	Frequency	Conducted Power (dBm)	Max. Limit (dBm)	Result
152	5760 MHz	11.29	30.00	Complies
160	5800 MHz	14.23	30.00	Complies

Temperature	24°C	Humidity	64%
Test Engineer	Rush Kao	Configurations	802.11a / Ant. 13

Configuration IEEE 802.11a

Channel	Frequency	Conducted Power (dBm)	Max. Limit (dBm)	Result
149	5745 MHz	12.42	30.00	Complies
157	5785 MHz	13.45	30.00	Complies
165	5825 MHz	12.32	30.00	Complies

Configuration IEEE 802.11a Turbo

Channel	Frequency	Conducted Power (dBm)	Max. Limit (dBm)	Result
152	5760 MHz	14.31	30.00	Complies
160	5800 MHz	12.51	30.00	Complies

4.3. Power Spectral Density Measurement

4.3.1. Limit

For digitally modulated systems, the power spectral density conducted from the intentional radiator to the antenna shall not be greater than 8 dBm in any 3 kHz band during any time interval of continuous transmission. The limit has to be reduced by the amount in dB that the gain of the antenna exceeds 6dBi. In case of point-to-point operation, the limit has to be reduced by 1dB for every 3dB that the directional gain of the antenna exceeds 6dBi. Systems operating in the 5725-5850 MHz band that are used exclusively for fixed, point-to-point operations may employ the Antenna with directional gain greater than 6 dBi without any corresponding reduction in conducted output power.

4.3.2. Measuring Instruments and Setting

Please refer to section 5 in this report. The following table is the setting of Spectrum Analyzer.

Spectrum Parameter	Setting
Attenuation	Auto
Span Frequency	1.5MHz
RB	3 kHz
VB	30 kHz
Detector	Peak
Trace	Max Hold
Sweep Time	500s

4.3.3. Test Procedures

1. The transmitter output (antenna port) was connected to the spectrum analyser.
2. Set RBW of spectrum analyzer to 3kHz and VBW to 30kHz. Set Detector to Peak, Trace to Max Hold.
3. Mark the frequency with maximum peak power as the center of the display of the spectrum.
4. Set the span to 1.5MHz and the sweep time to 500s and record the maximum peak value.

4.3.4. Test Setup Layout

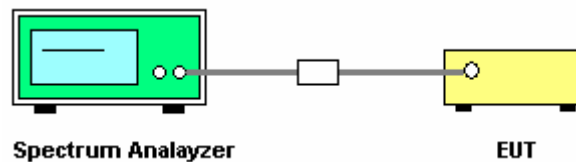

4.3.5. Test Deviation

There is no deviation with the original standard.

4.3.6. EUT Operation during Test

The EUT was programmed to be in continuously transmitting mode.

4.3.7. Test Result of Power Spectral Density

Temperature	24°C	Humidity	64%
Test Engineer	Rush Kao	Configurations	802.11b/g / Ant. 1/2/3/4

Configuration IEEE 802.11b

Channel	Frequency	Power Density (dBm)	Max. Limit (dBm)	Result
1	2412 MHz	-4.00	4.00	Complies
6	2437 MHz	0.20	4.00	Complies
11	2462 MHz	-0.90	4.00	Complies

Configuration IEEE 802.11g

Channel	Frequency	Power Density (dBm)	Max. Limit (dBm)	Result
1	2412 MHz	-2.04	4.00	Complies
6	2437 MHz	-4.64	4.00	Complies
11	2462 MHz	-4.77	4.00	Complies

Configuration IEEE 802.11g Turbo

Channel	Frequency	Power Density (dBm)	Max. Limit (dBm)	Result
6	2437 MHz	-2.15	4.00	Complies

Temperature	24°C	Humidity	64%
Test Engineer	Rush Kao	Configurations	802.11b/g / Ant. 5

Configuration IEEE 802.11b

Channel	Frequency	Power Density (dBm)	Max. Limit (dBm)	Result
1	2412 MHz	-6.31	5.00	Complies
6	2437 MHz	-4.23	5.00	Complies
11	2462 MHz	-7.00	5.00	Complies

Configuration IEEE 802.11g

Channel	Frequency	Power Density (dBm)	Max. Limit (dBm)	Result
1	2412 MHz	-16.09	5.00	Complies
6	2437 MHz	-5.14	5.00	Complies
11	2462 MHz	-10.17	5.00	Complies

Configuration IEEE 802.11g Turbo

Channel	Frequency	Power Density (dBm)	Max. Limit (dBm)	Result
6	2437 MHz	-11.88	5.00	Complies

Temperature	24°C	Humidity	64%
Test Engineer	Rush Kao	Configurations	802.11a / Ant. 8/9

Configuration IEEE 802.11a

Channel	Frequency	Power Density (dBm)	Max. Limit (dBm)	Result
149	5745 MHz	-6.14	8.00	Complies
157	5785 MHz	-7.05	8.00	Complies
165	5825 MHz	-7.07	8.00	Complies

Configuration IEEE 802.11a Turbo

Channel	Frequency	Power Density (dBm)	Max. Limit (dBm)	Result
152	5760 MHz	-2.56	8.00	Complies
160	5800 MHz	-4.77	8.00	Complies

Temperature	24°C	Humidity	64%
Test Engineer	Rush Kao	Configurations	802.11a / Ant. 10

Configuration IEEE 802.11a

Channel	Frequency	Power Density (dBm)	Max. Limit (dBm)	Result
149	5745 MHz	-7.61	8.00	Complies
157	5785 MHz	-8.42	8.00	Complies
165	5825 MHz	-8.90	8.00	Complies

Configuration IEEE 802.11a Turbo

Channel	Frequency	Power Density (dBm)	Max. Limit (dBm)	Result
152	5760 MHz	1.94	8.00	Complies
160	5800 MHz	-4.89	8.00	Complies

Temperature	24°C	Humidity	64%
Test Engineer	Rush Kao	Configurations	802.11a / Ant. 11

Configuration IEEE 802.11a

Channel	Frequency	Power Density (dBm)	Max. Limit (dBm)	Result
149	5745 MHz	-18.74	8.00	Complies
157	5785 MHz	-11.52	8.00	Complies
165	5825 MHz	-20.42	8.00	Complies

Configuration IEEE 802.11a Turbo

Channel	Frequency	Power Density (dBm)	Max. Limit (dBm)	Result
152	5760 MHz	-18.37	8.00	Complies
160	5800 MHz	-19.26	8.00	Complies

Temperature	24°C	Humidity	64%
Test Engineer	Rush Kao	Configurations	802.11a / Ant. 12

Configuration IEEE 802.11a

Channel	Frequency	Power Density (dBm)	Max. Limit (dBm)	Result
149	5745 MHz	-6.14	8.00	Complies
157	5785 MHz	-7.05	8.00	Complies
165	5825 MHz	-7.07	8.00	Complies

Configuration IEEE 802.11a Turbo

Channel	Frequency	Power Density (dBm)	Max. Limit (dBm)	Result
152	5760 MHz	-11.86	8.00	Complies
160	5800 MHz	-7.49	8.00	Complies

Temperature	24°C	Humidity	64%
Test Engineer	Rush Kao	Configurations	802.11a / Ant. 13

Configuration IEEE 802.11a

Channel	Frequency	Power Density (dBm)	Max. Limit (dBm)	Result
149	5745 MHz	-13.26	8.00	Complies
157	5785 MHz	-6.47	8.00	Complies
165	5825 MHz	-15.03	8.00	Complies

Configuration IEEE 802.11a Turbo

Channel	Frequency	Power Density (dBm)	Max. Limit (dBm)	Result
152	5760 MHz	-8.55	8.00	Complies
160	5800 MHz	-9.00	8.00	Complies

For Ant. 1/2/3/4

Power Density Plot on Configuration IEEE 802.11b / 2412 MHz

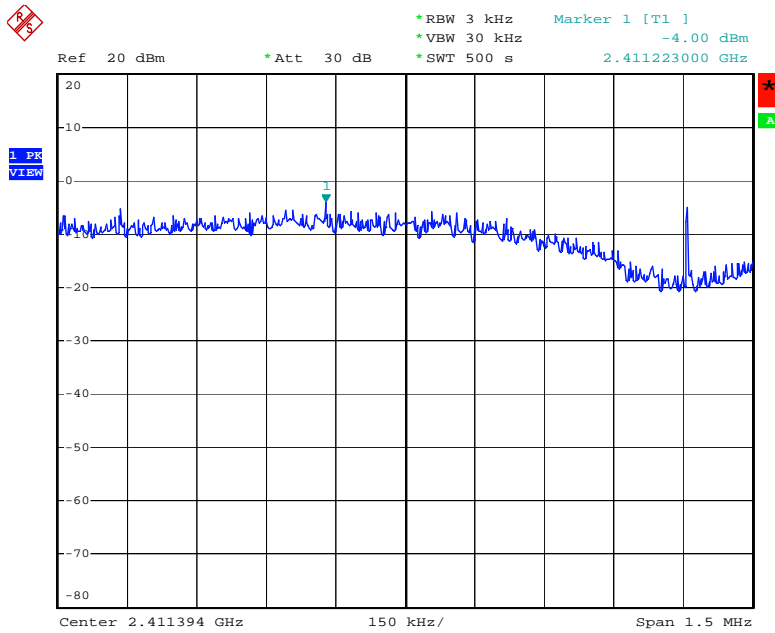

Date: 14.MAR.2006 10:47:18

Power Density Plot on Configuration IEEE 802.11b / 2437 MHz

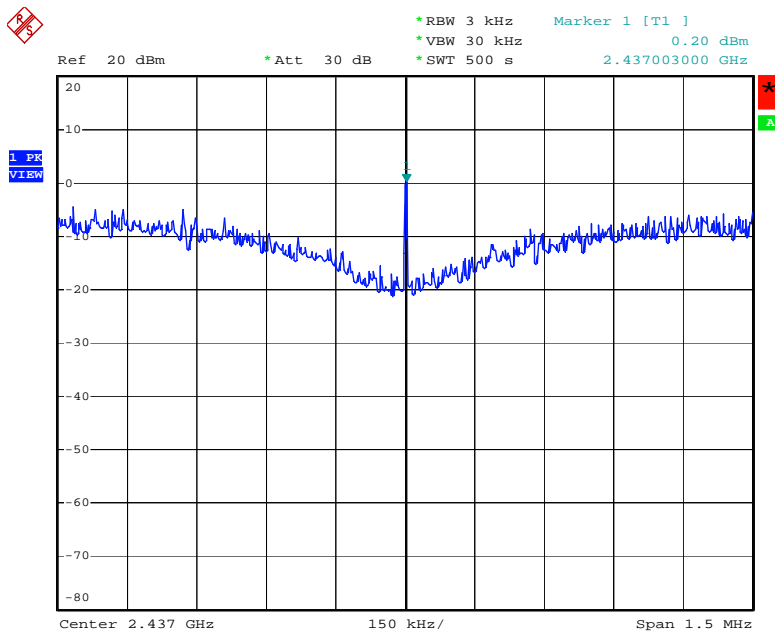

Date: 14.MAR.2006 10:48:52

Power Density Plot on Configuration IEEE 802.11g / 2437 MHz

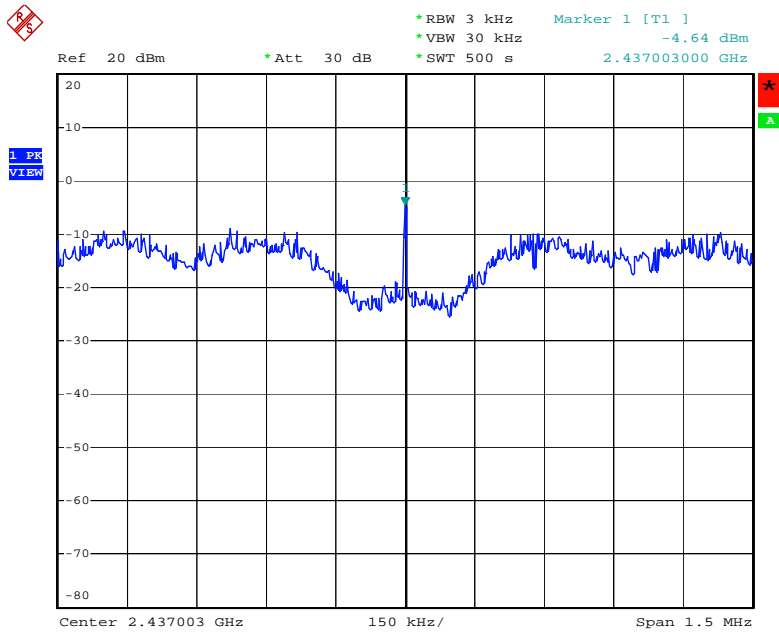

Date: 14.MAR.2006 10:32:58

Power Density Plot on Configuration IEEE 802.11g / 2462 MHz

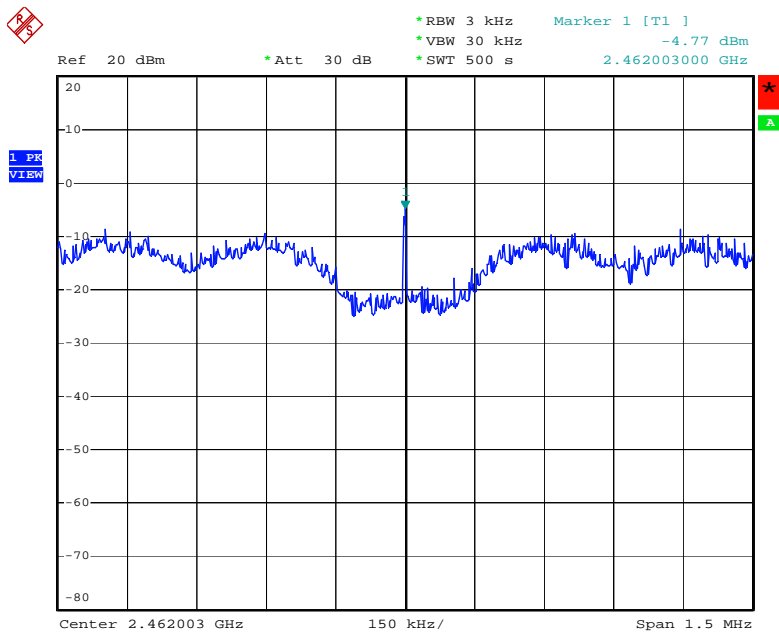

Date: 14.MAR.2006 10:35:41

Power Density Plot on Configuration IEEE 802.11g Turbo / 2437 MHz

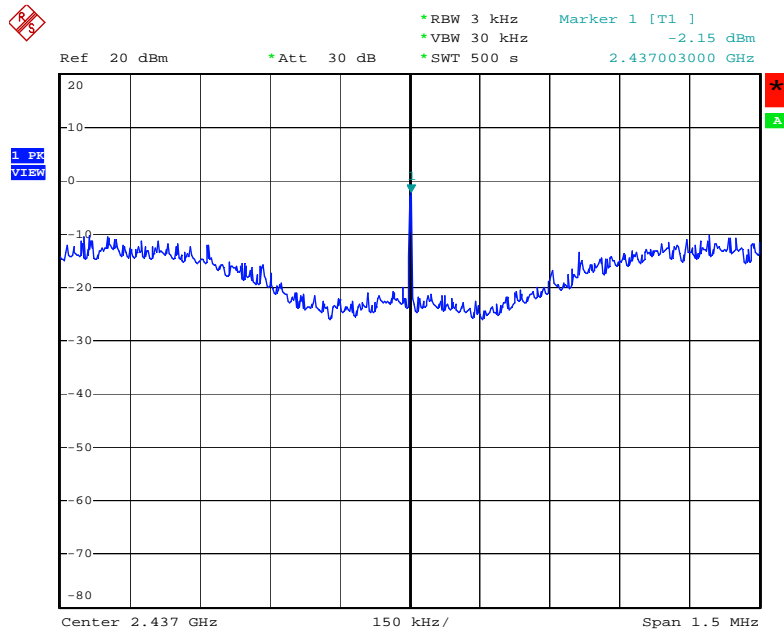

Date: 14.MAR.2006 10:45:45

For Ant. 5

Power Density Plot on Configuration IEEE 802.11b / 2412 MHz

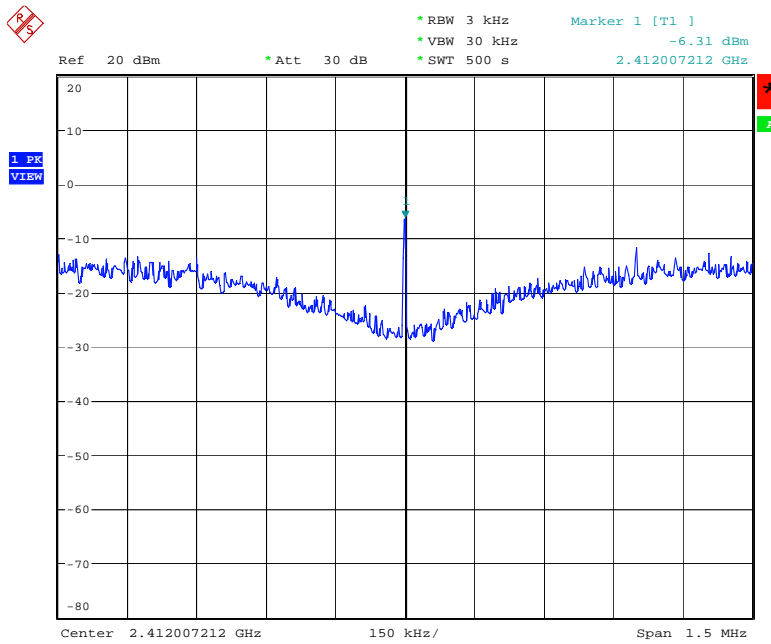

Date: 30.MAY.2006 19:44:09

Power Density Plot on Configuration IEEE 802.11b / 2437 MHz

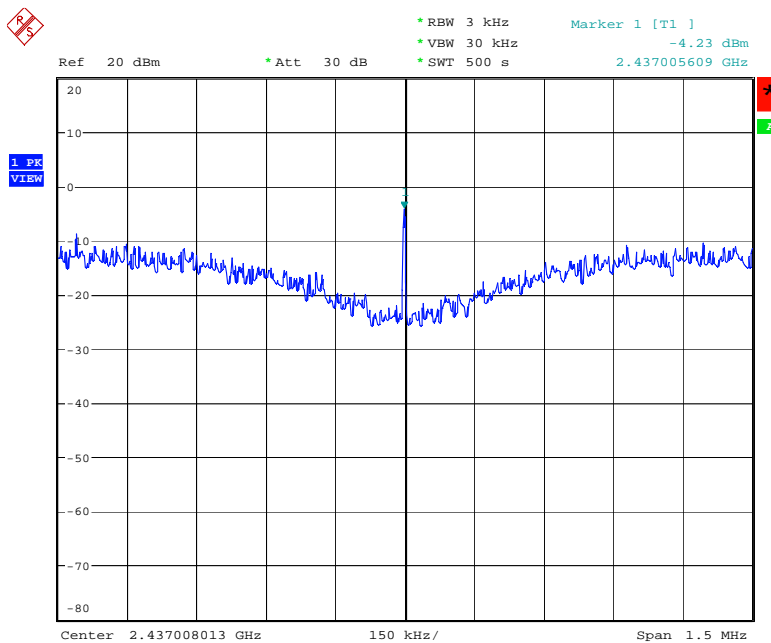

Date: 30.MAY.2006 19:46:39

Power Density Plot on Configuration IEEE 802.11b / 2462 MHz

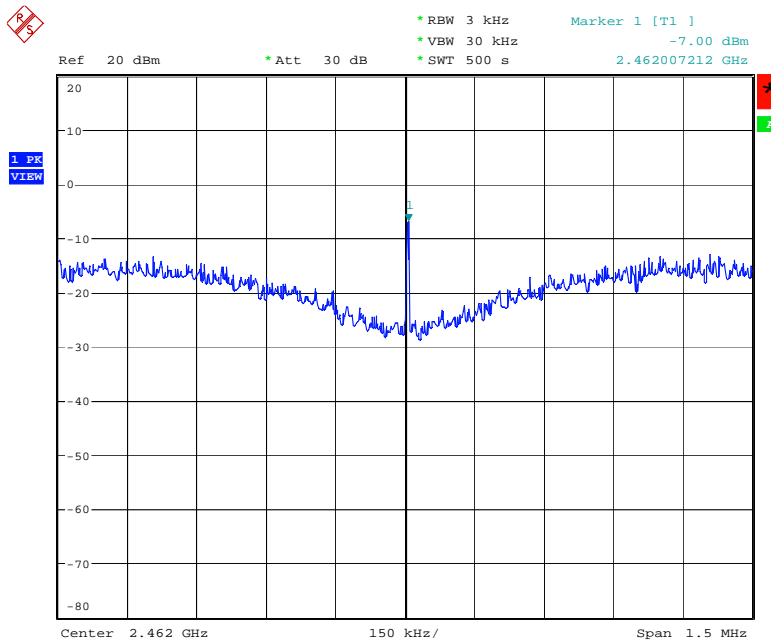

Date: 30.MAY.2006 19:48:10

Power Density Plot on Configuration IEEE 802.11g / 2412 MHz

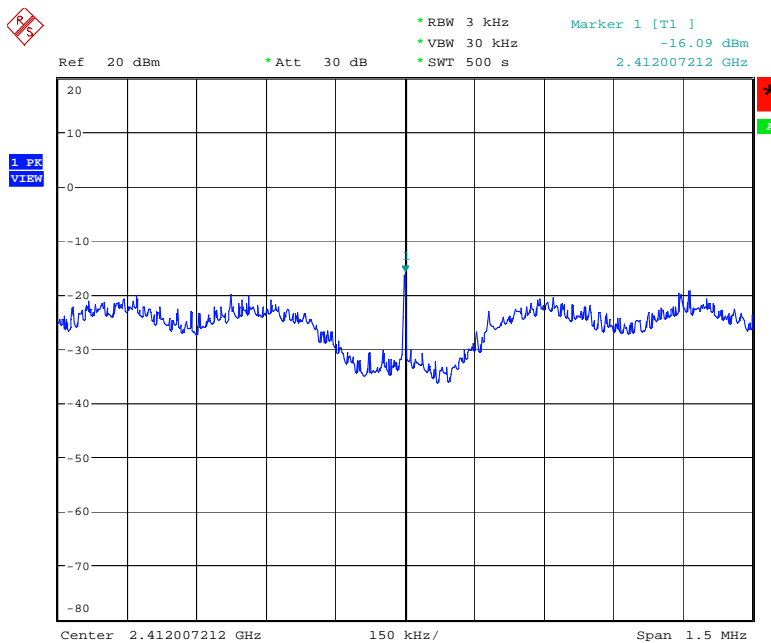

Date: 30.MAY.2006 19:35:52

Power Density Plot on Configuration IEEE 802.11g / 2437 MHz

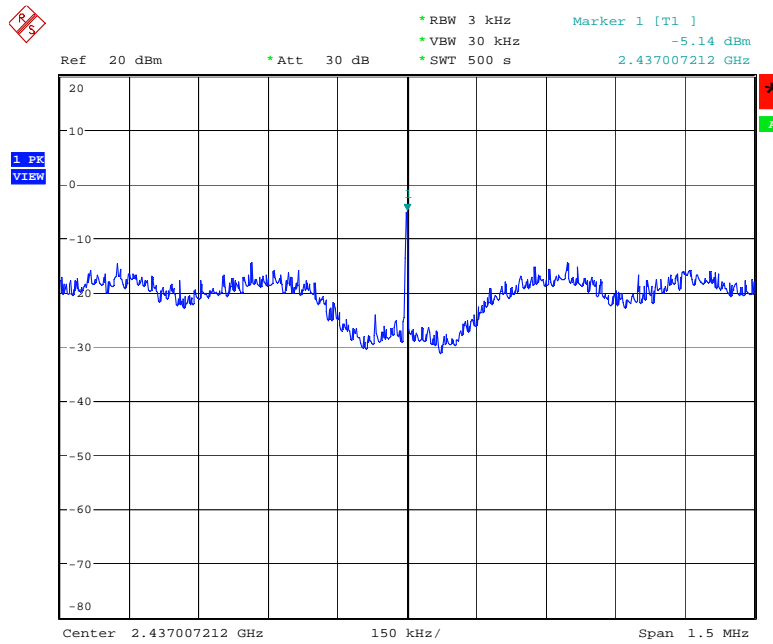

Date: 30.MAY.2006 19:34:34

Power Density Plot on Configuration IEEE 802.11g / 2462 MHz

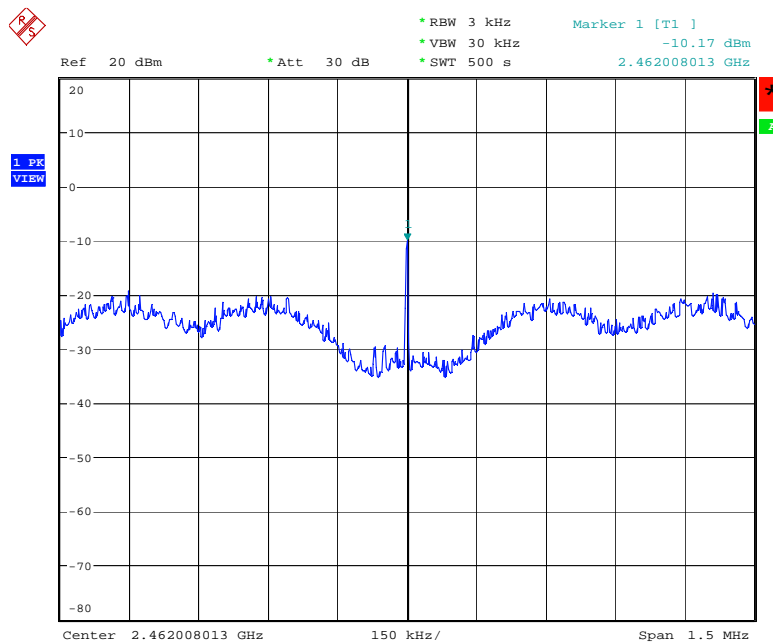

Date: 30.MAY.2006 19:29:54

Power Density Plot on Configuration IEEE 802.11g Turbo / 2437 MHz

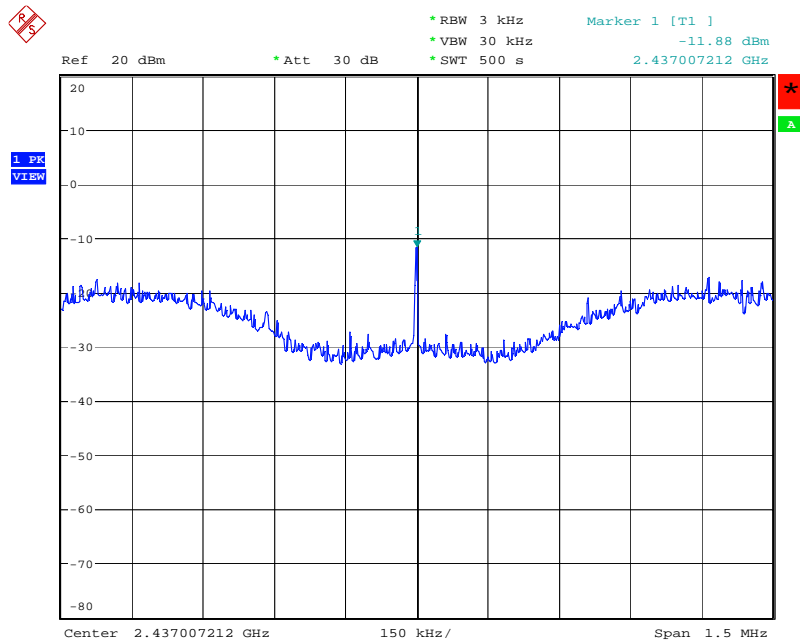

Date: 30.MAY.2006 19:42:00

For Ant. 8/9

Power Density Plot on Configuration IEEE 802.11a / 5745 MHz

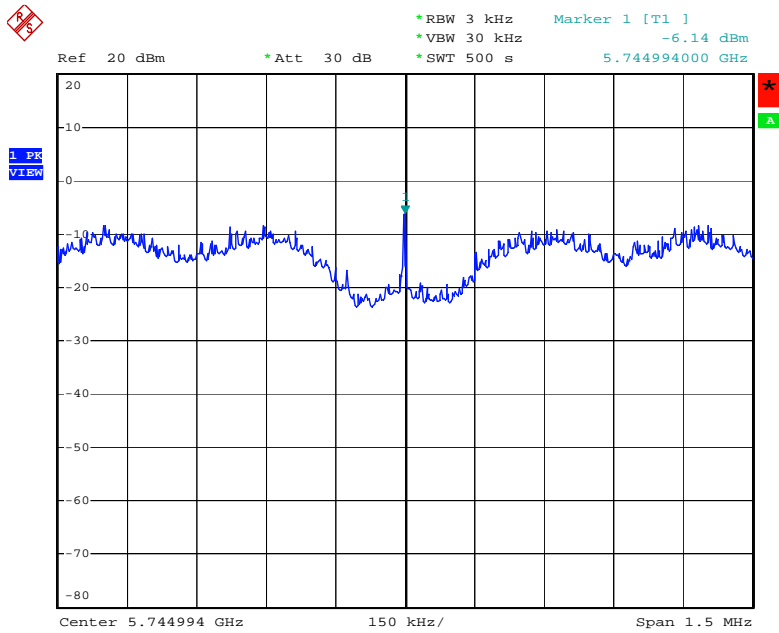

Date: 25.MAR.2006 19:38:17

Power Density Plot on Configuration IEEE 802.11a / 5785 MHz

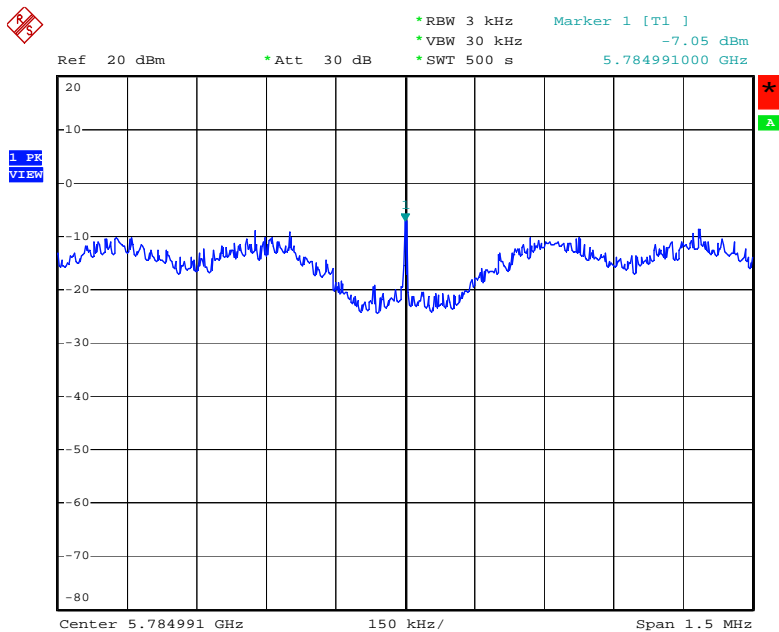

Date: 25.MAR.2006 19:42:03

Power Density Plot on Configuration IEEE 802.11a / 5825 MHz

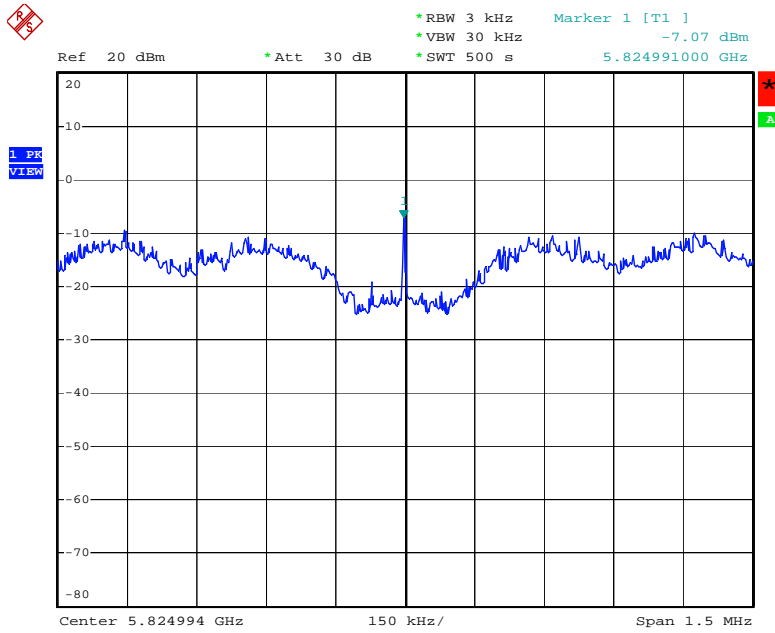

Date: 25.MAR.2006 19:42:42

Power Density Plot on Configuration IEEE 802.11a Turbo / 5760 MHz

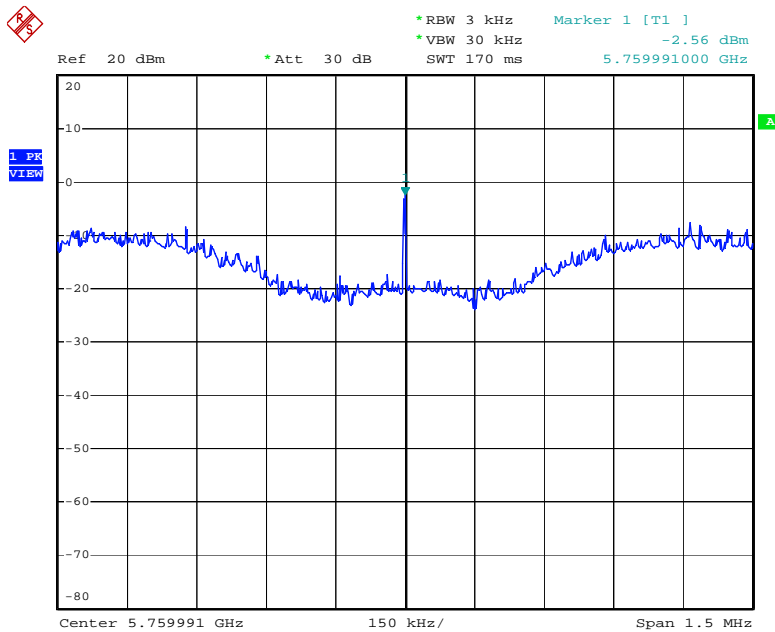

Date: 25.MAR.2006 19:48:57

Power Density Plot on Configuration IEEE 802.11a Turbo / 5800 MHz

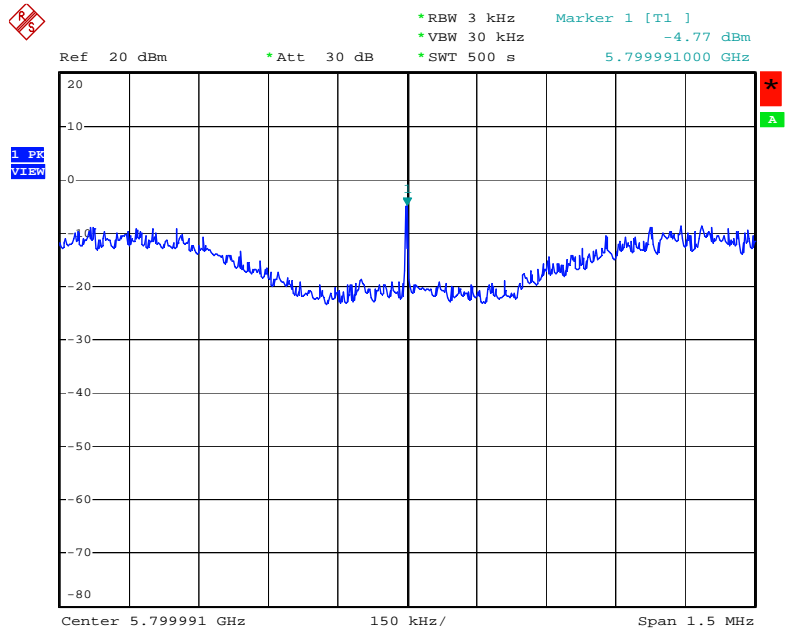

Date: 25.MAR.2006 19:48:20

For Ant. 10

Power Density Plot on Configuration IEEE 802.11a / 5745 MHz

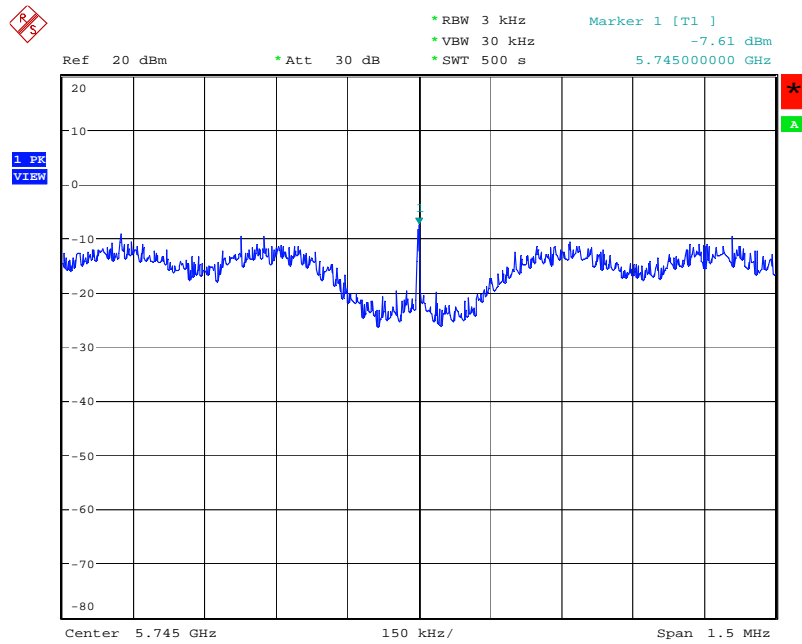

Date: 9.MAY.2006 19:22:11

Power Density Plot on Configuration IEEE 802.11a / 5785 MHz

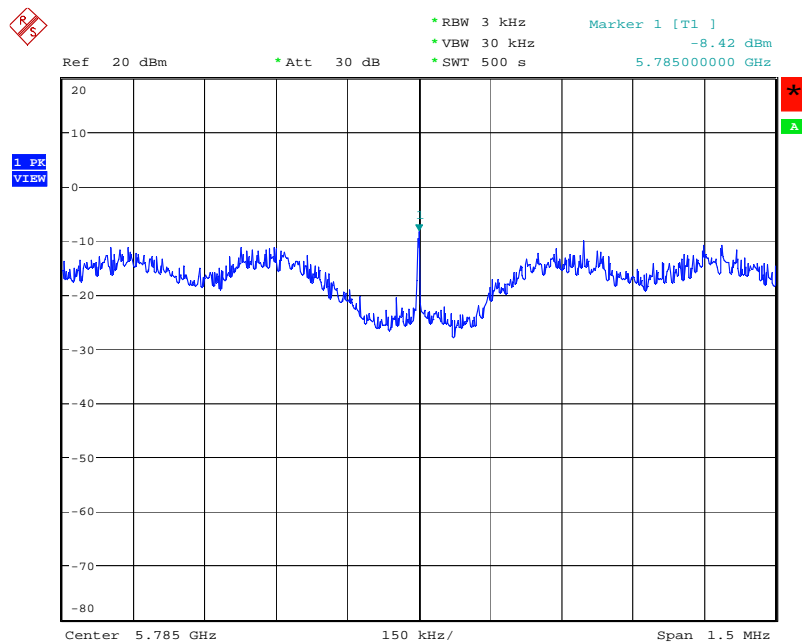

Date: 9.MAY.2006 19:21:14

Power Density Plot on Configuration IEEE 802.11a / 5825 MHz

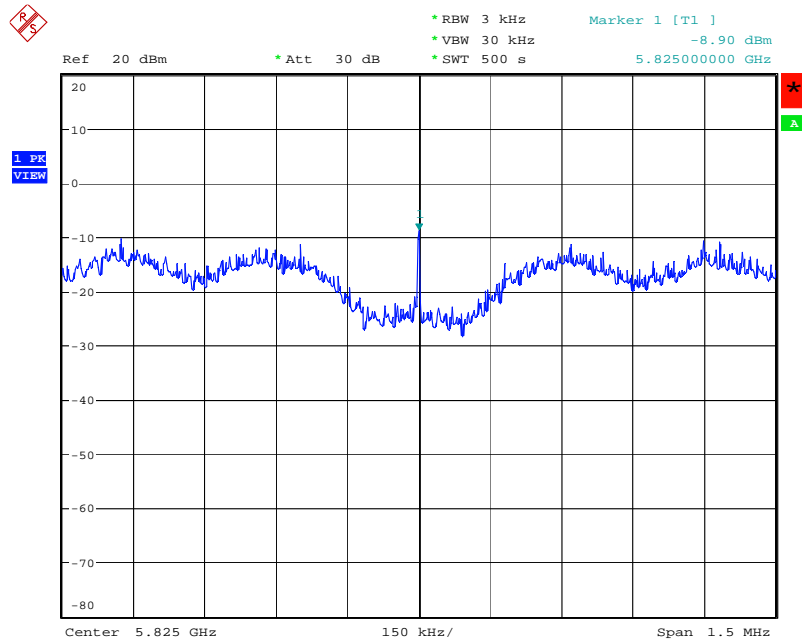

Date: 9.MAY.2006 19:20:07

Power Density Plot on Configuration IEEE 802.11a Turbo / 5760 MHz

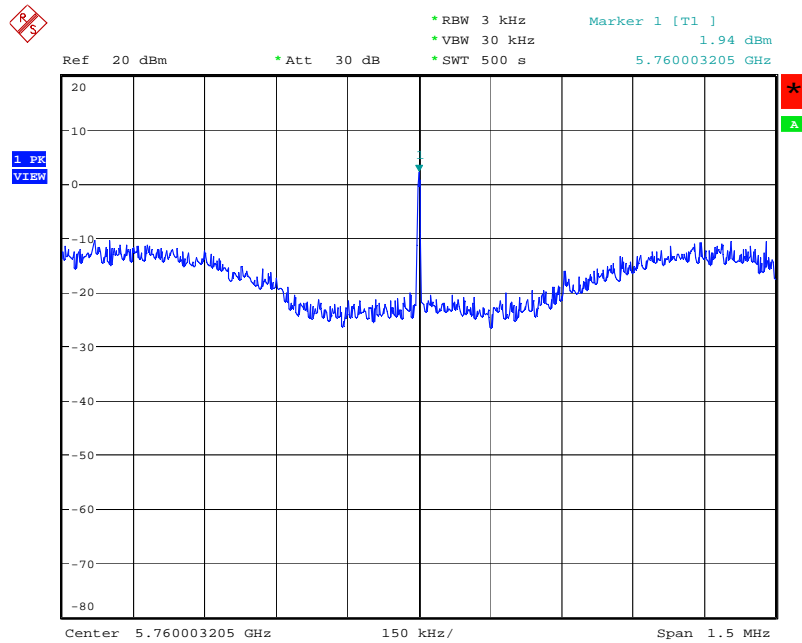

Date: 9.MAY.2006 19:17:43

Power Density Plot on Configuration IEEE 802.11a Turbo / 5800 MHz

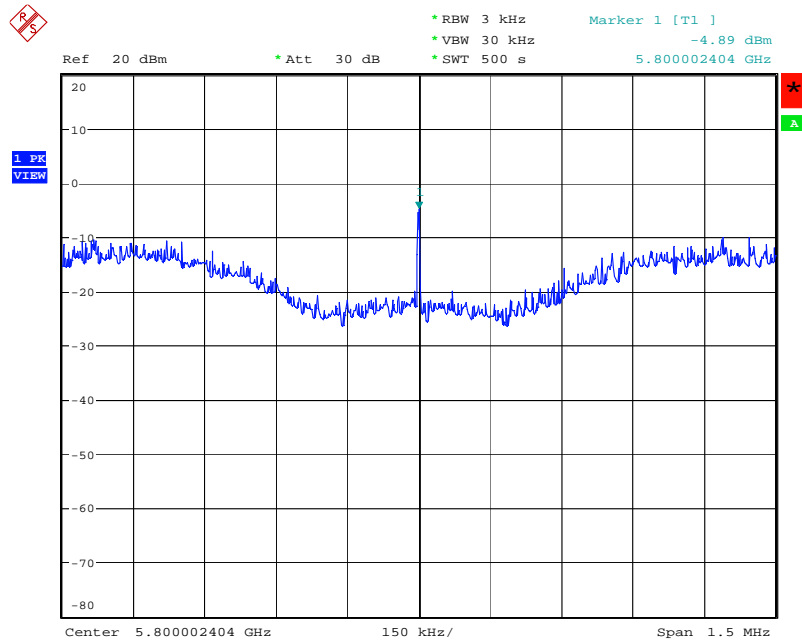

Date: 9.MAY.2006 19:18:49

For Ant. 11

Power Density Plot on Configuration IEEE 802.11a / 5745 MHz

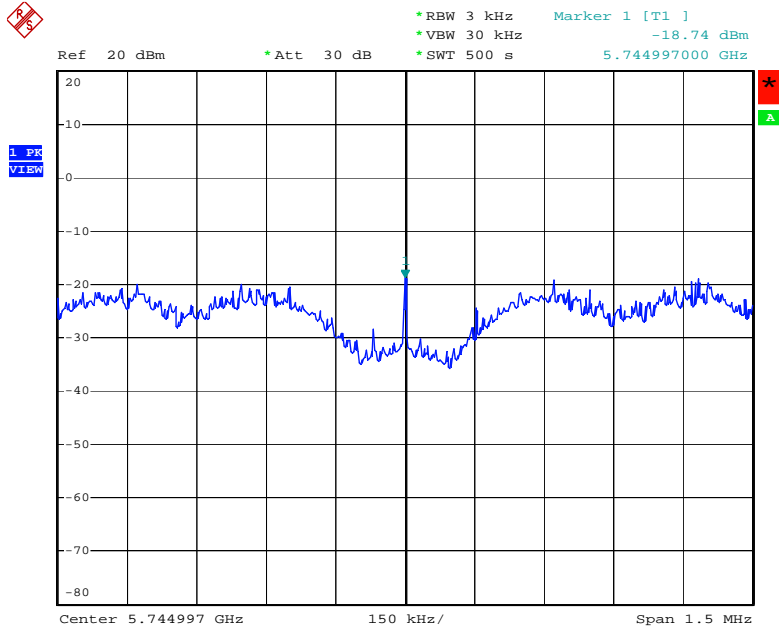

Date: 27.MAR.2006 19:26:01

Power Density Plot on Configuration IEEE 802.11a / 5785 MHz

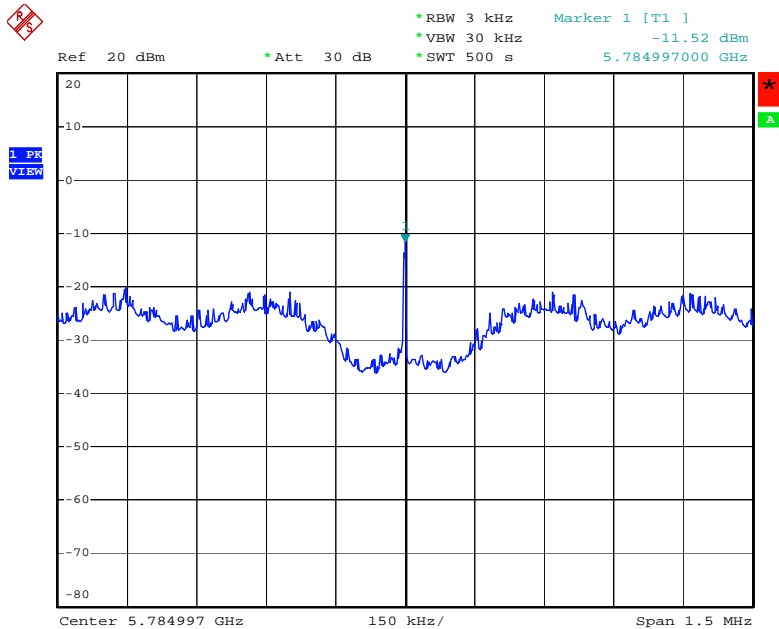

Date: 27.MAR.2006 19:29:04

Power Density Plot on Configuration IEEE 802.11a / 5825 MHz

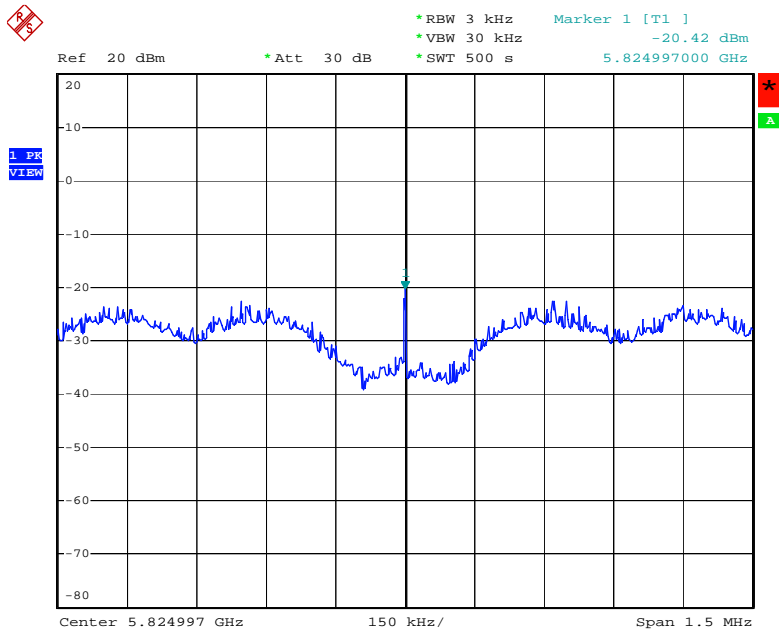

Date: 27.MAR.2006 19:29:49

Power Density Plot on Configuration IEEE 802.11a Turbo / 5760 MHz

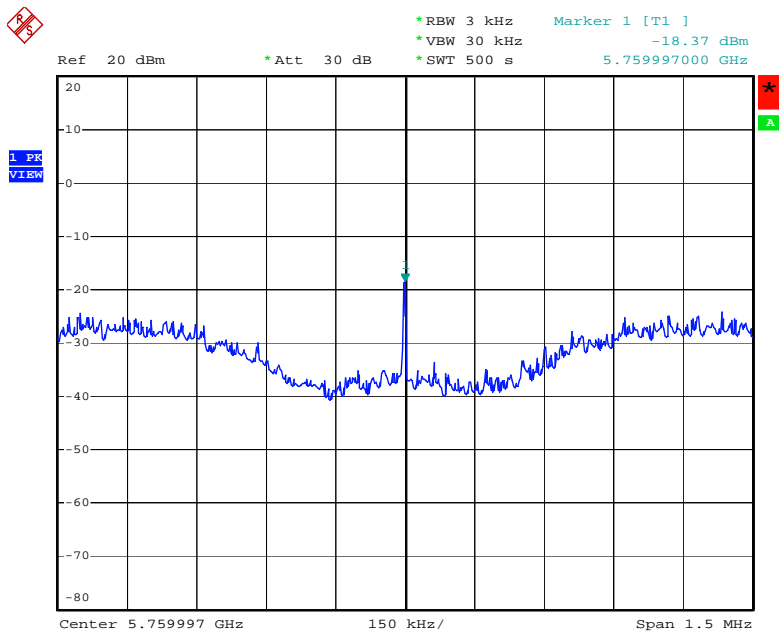

Date: 27.MAR.2006 19:36:01

Power Density Plot on Configuration IEEE 802.11a Turbo / 5800 MHz

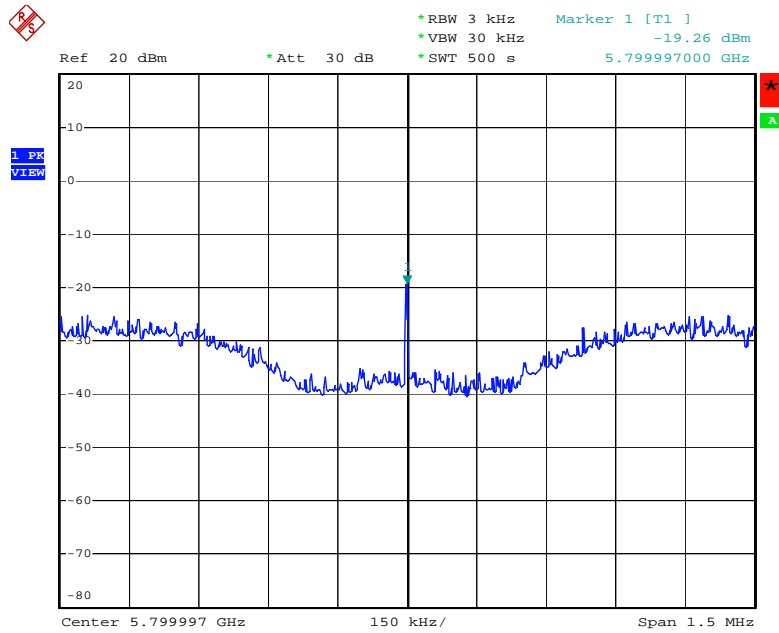

Date: 27.MAR.2006 19:33:19

For Ant. 12

Power Density Plot on Configuration IEEE 802.11a / 5745 MHz

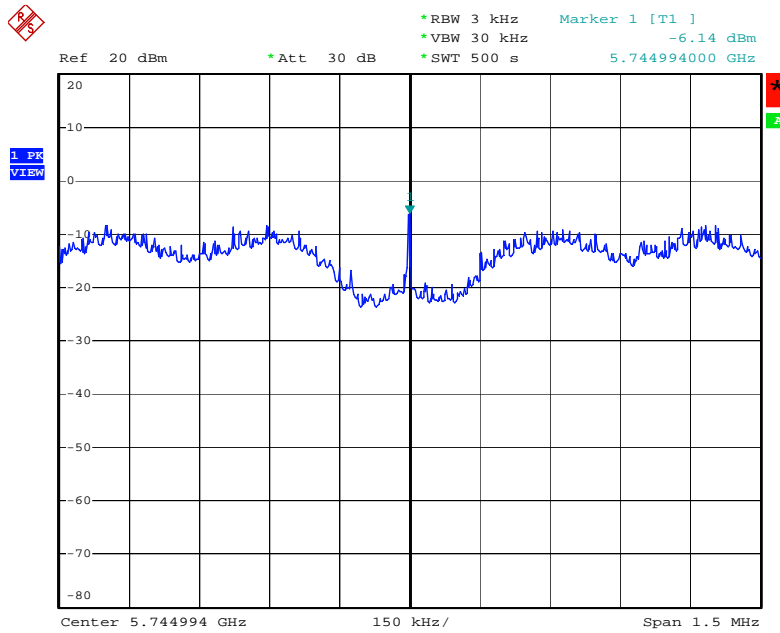

Date: 25.MAR.2006 19:38:17

Power Density Plot on Configuration IEEE 802.11a / 5785 MHz

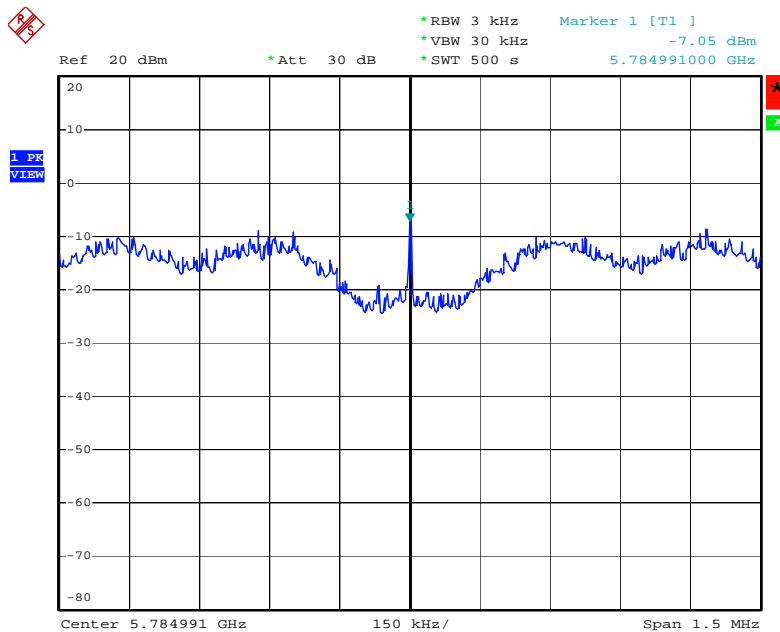

Date: 25.MAR.2006 19:42:03

Power Density Plot on Configuration IEEE 802.11a / 5825 MHz

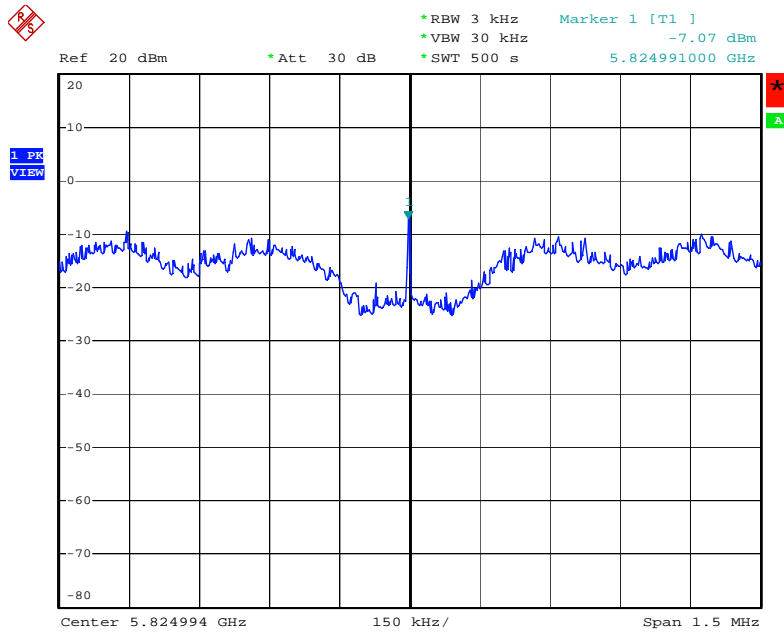

Date: 25.MAR.2006 19:42:42

Power Density Plot on Configuration IEEE 802.11a Turbo / 5760 MHz

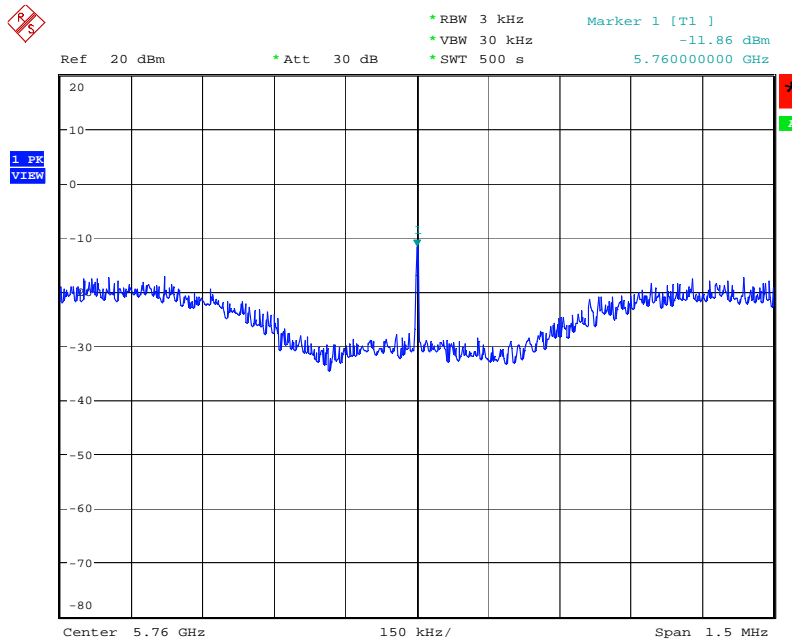

Date: 9.MAY.2006 20:35:53

Power Density Plot on Configuration IEEE 802.11a Turbo / 5800 MHz

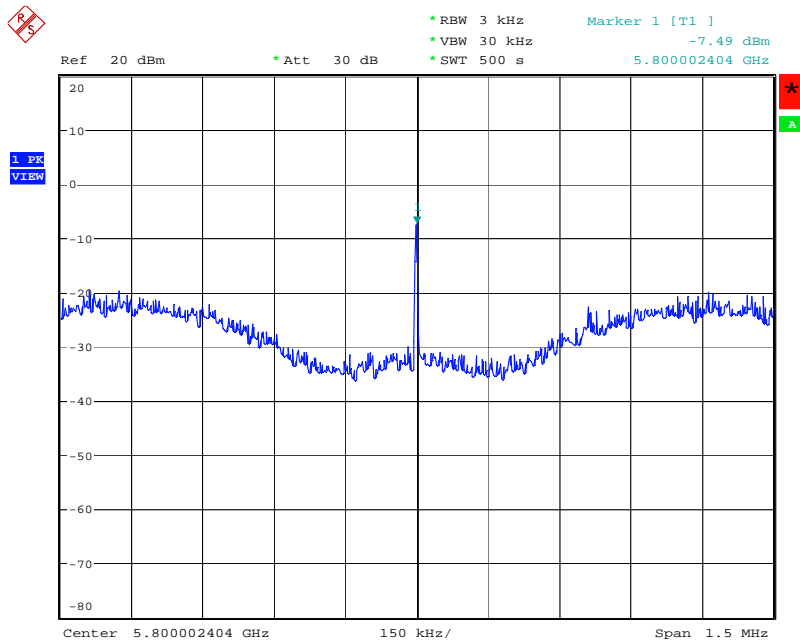

Date: 9.MAY.2006 20:34:47

For Ant. 13

Power Density Plot on Configuration IEEE 802.11a / 5745 MHz

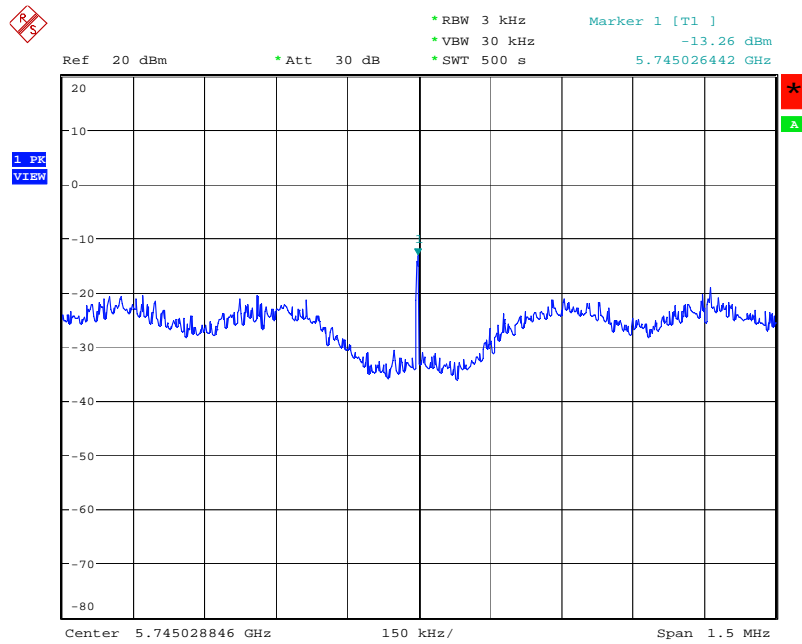

Date: 2.JUN.2006 14:04:24

Power Density Plot on Configuration IEEE 802.11a / 5785 MHz

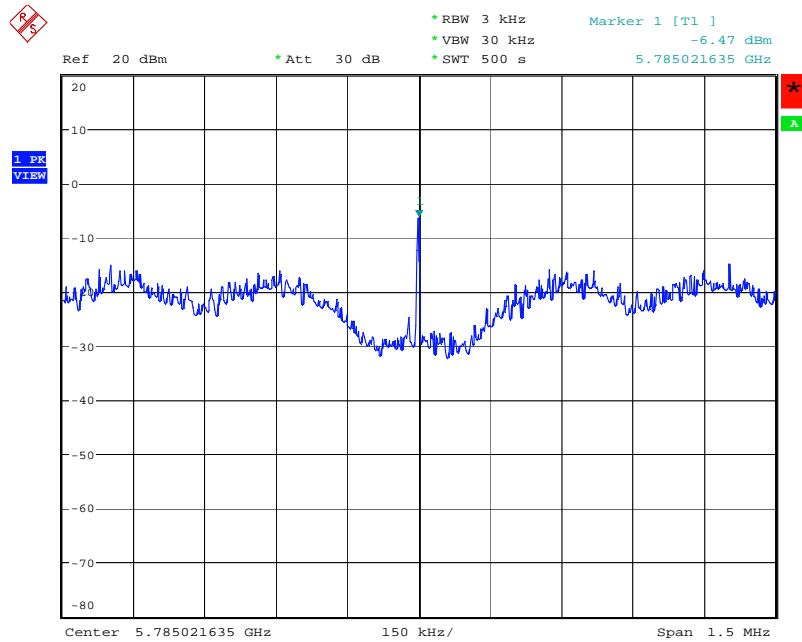

Date: 2.JUN.2006 14:05:14

Power Density Plot on Configuration IEEE 802.11a / 5825 MHz

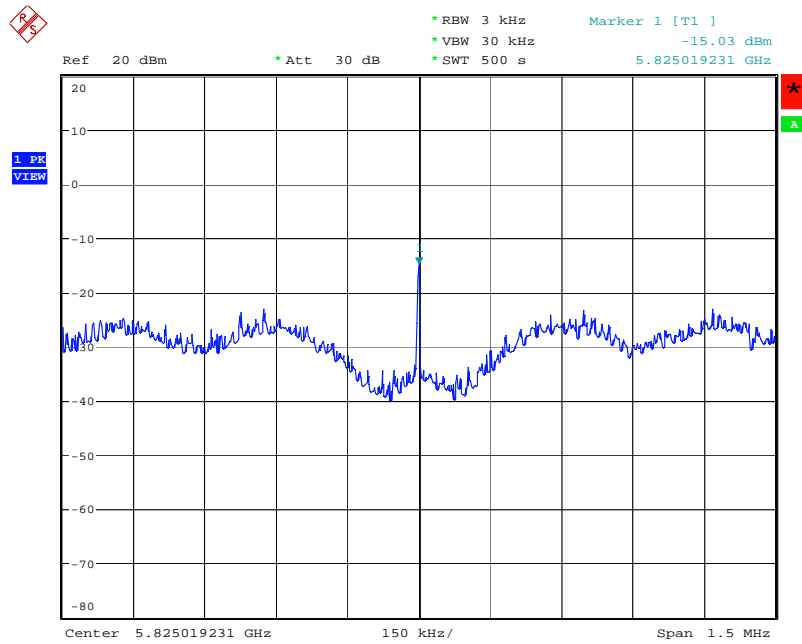

Date: 2.JUN.2006 14:06:08

Power Density Plot on Configuration IEEE 802.11a Turbo / 5760 MHz

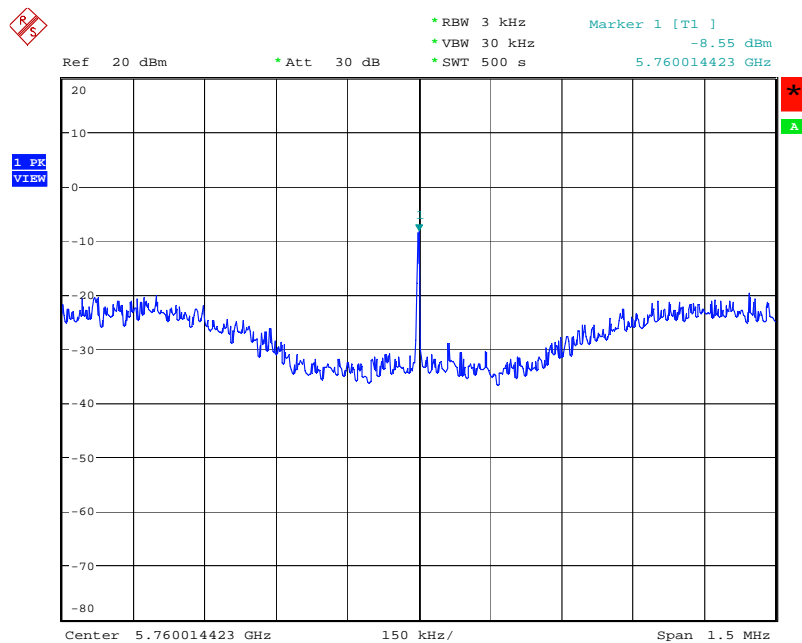

Date: 2.JUN.2006 14:09:44

Power Density Plot on Configuration IEEE 802.11a Turbo / 5800 MHz

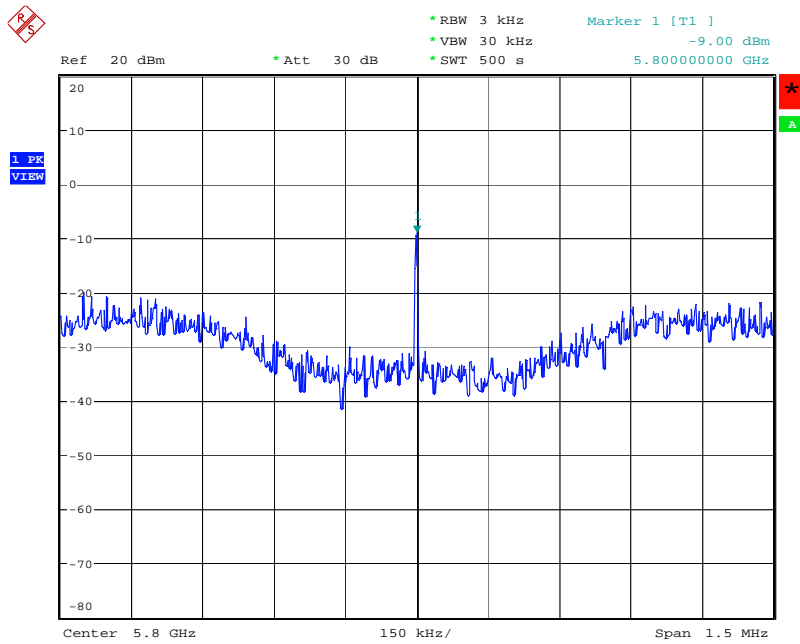

Date: 2.JUN.2006 14:08:43

4.4. 6dB Spectrum Bandwidth Measurement

4.4.1. Limit

For digital modulation systems, the minimum 6 dB bandwidth shall be at least 500 kHz.

4.4.2. Measuring Instruments and Setting

Please refer to section 5 in this report. The following table is the setting of the Spectrum Analyzer.

Spectrum Parameters	Setting
Attenuation	Auto
Span Frequency	> 6dB Bandwidth
RB	100 kHz
VB	100 kHz
Detector	Peak
Trace	Max Hold
Sweep Time	Auto

4.4.3. Test Procedures

1. The transmitter output (antenna port) was connected to the spectrum analyser in peak hold mode.
2. The resolution bandwidth of 100 kHz and the video bandwidth of 100 kHz were used.
3. Measured the spectrum width with power higher than 6dB below carrier.

4.4.4. Test Setup Layout

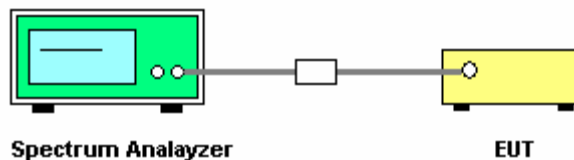

4.4.5. Test Deviation

There is no deviation with the original standard.

4.4.6. EUT Operation during Test

The EUT was programmed to be in continuously transmitting mode.

4.4.7. Test Result of 6dB Spectrum Bandwidth

Temperature	24°C	Humidity	64%
Test Engineer	Rush Kao	Configurations	802.11b/g / Ant. 1/2/3/4

Configuration IEEE 802.11b

Channel	Frequency	6dB Bandwidth (MHz)	99% Occupied Bandwidth (MHz)	Min. Limit (kHz)	Test Result
1	2412 MHz	11.56	15.68	500	Complies
6	2437 MHz	11.08	15.60	500	Complies
11	2462 MHz	11.08	15.64	500	Complies

Configuration IEEE 802.11g

Channel	Frequency	6dB Bandwidth (MHz)	99% Occupied Bandwidth (MHz)	Min. Limit (kHz)	Test Result
1	2412 MHz	16.40	16.56	500	Complies
6	2437 MHz	16.40	16.52	500	Complies
11	2462 MHz	16.36	16.52	500	Complies

Configuration IEEE 802.11g Turbo

Channel	Frequency	6dB Bandwidth (MHz)	99% Occupied Bandwidth (MHz)	Min. Limit (kHz)	Test Result
6	2437 MHz	32.64	32.88	500	Complies

Temperature	24°C	Humidity	64%
Test Engineer	Rush Kao	Configurations	802.11b/g / Ant. 5

Configuration IEEE 802.11b

Channel	Frequency	6dB Bandwidth (MHz)	99% Occupied Bandwidth (MHz)	Min. Limit (kHz)	Test Result
1	2412 MHz	11.08	15.57	500	Complies
6	2437 MHz	12.01	15.64	500	Complies
11	2462 MHz	12.50	15.51	500	Complies

Configuration IEEE 802.11g

Channel	Frequency	6dB Bandwidth (MHz)	99% Occupied Bandwidth (MHz)	Min. Limit (kHz)	Test Result
1	2412 MHz	16.41	16.50	500	Complies
6	2437 MHz	16.34	16.50	500	Complies
11	2462 MHz	16.44	16.50	500	Complies

Configuration IEEE 802.11g Turbo

Channel	Frequency	6dB Bandwidth (MHz)	99% Occupied Bandwidth (MHz)	Min. Limit (kHz)	Test Result
6	2437 MHz	32.62	32.94	500	Complies

Temperature	24°C	Humidity	64%
Test Engineer	Rush Kao	Configurations	802.11a / Ant. 8/9

Configuration IEEE 802.11a

Channel	Frequency	6dB Bandwidth (MHz)	99% Occupied Bandwidth (MHz)	Min. Limit (kHz)	Test Result
149	5745 MHz	16.40	16.56	500	Complies
157	5785 MHz	16.44	16.52	500	Complies
165	5825 MHz	16.44	16.56	500	Complies

Configuration IEEE 802.11a Turbo

Channel	Frequency	6dB Bandwidth (MHz)	99% Occupied Bandwidth (MHz)	Min. Limit (kHz)	Test Result
152	5760 MHz	32.48	33.20	500	Complies
160	5800 MHz	32.64	33.12	500	Complies

Temperature	24°C	Humidity	64%
Test Engineer	Rush Kao	Configurations	802.11a / Ant. 10

Configuration IEEE 802.11a

Channel	Frequency	6dB Bandwidth (MHz)	99% Occupied Bandwidth (MHz)	Min. Limit (kHz)	Test Result
149	5745 MHz	16.41	16.53	500	Complies
157	5785 MHz	16.41	16.50	500	Complies
165	5825 MHz	16.47	16.53	500	Complies

Configuration IEEE 802.11a Turbo

Channel	Frequency	6dB Bandwidth (MHz)	99% Occupied Bandwidth (MHz)	Min. Limit (kHz)	Test Result
152	5760 MHz	31.41	33.01	500	Complies
160	5800 MHz	31.41	33.01	500	Complies

Temperature	24°C	Humidity	64%
Test Engineer	Rush Kao	Configurations	802.11a / Ant. 11

Configuration IEEE 802.11a

Channel	Frequency	6dB Bandwidth (MHz)	99% Occupied Bandwidth (MHz)	Min. Limit (kHz)	Test Result
149	5745 MHz	16.40	16.56	500	Complies
157	5785 MHz	16.40	16.52	500	Complies
165	5825 MHz	16.48	16.52	500	Complies

Configuration IEEE 802.11a Turbo

Channel	Frequency	6dB Bandwidth (MHz)	99% Occupied Bandwidth (MHz)	Min. Limit (kHz)	Test Result
152	5760 MHz	32.56	32.96	500	Complies
160	5800 MHz	32.64	32.88	500	Complies

Temperature	24°C	Humidity	64%
Test Engineer	Rush Kao	Configurations	802.11a / Ant. 12

Configuration IEEE 802.11a

Channel	Frequency	6dB Bandwidth (MHz)	99% Occupied Bandwidth (MHz)	Min. Limit (kHz)	Test Result
149	5745 MHz	16.40	16.56	500	Complies
157	5785 MHz	16.44	16.52	500	Complies
165	5825 MHz	16.44	16.56	500	Complies

Configuration IEEE 802.11a Turbo

Channel	Frequency	6dB Bandwidth (MHz)	99% Occupied Bandwidth (MHz)	Min. Limit (kHz)	Test Result
152	5760 MHz	32.48	33.20	500	Complies
160	5800 MHz	32.64	33.12	500	Complies

Temperature	24°C	Humidity	64%
Test Engineer	Rush Kao	Configurations	802.11a / Ant. 13

Configuration IEEE 802.11a

Channel	Frequency	6dB Bandwidth (MHz)	99% Occupied Bandwidth (MHz)	Min. Limit (kHz)	Test Result
149	5745 MHz	16.41	16.53	500	Complies
157	5785 MHz	16.41	16.53	500	Complies
165	5825 MHz	16.34	16.50	500	Complies

Configuration IEEE 802.11a Turbo

Channel	Frequency	6dB Bandwidth (MHz)	99% Occupied Bandwidth (MHz)	Min. Limit (kHz)	Test Result
152	5760 MHz	32.56	32.88	500	Complies
160	5800 MHz	32.62	32.94	500	Complies

For Ant. 1/2/3/4

6 dB Bandwidth Plot on Configuration IEEE 802.11b / 2412 MHz

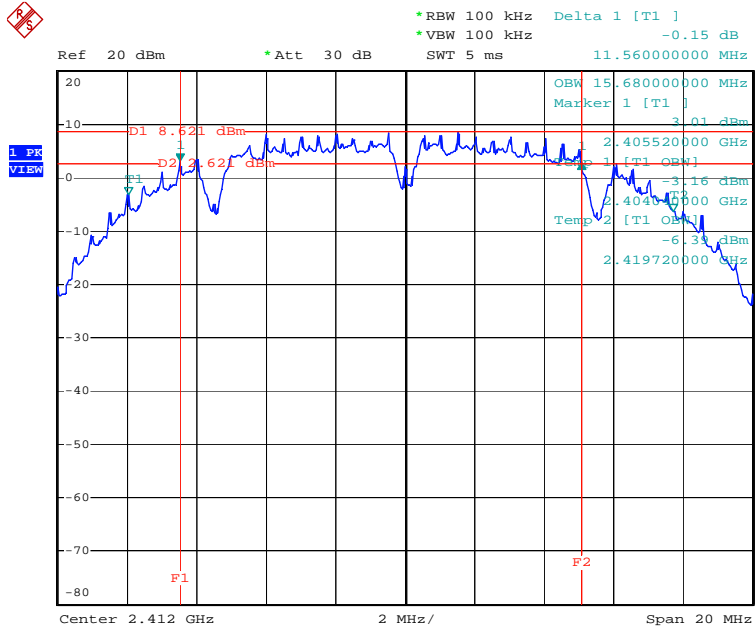

Date: 14.MAR.2006 10:46:53

6 dB Bandwidth Plot on Configuration IEEE 802.11b / 2437 MHz

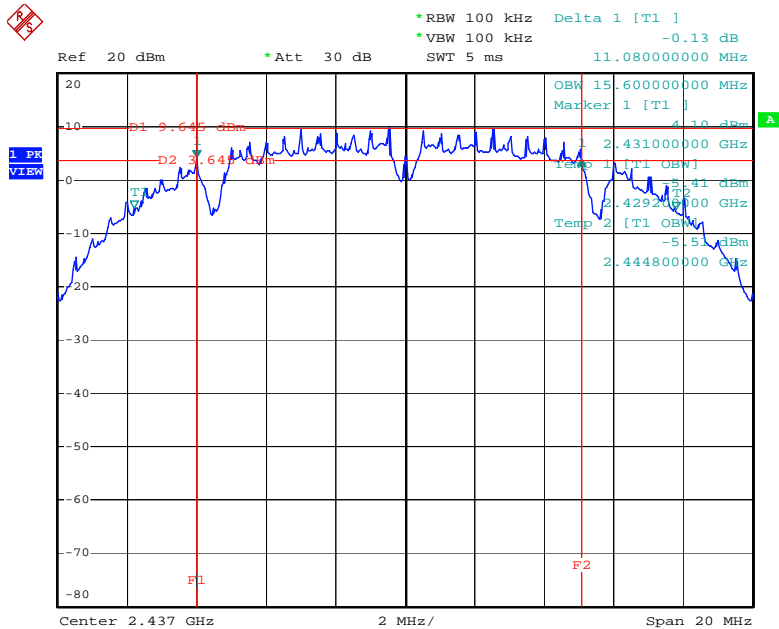

Date: 14.MAR.2006 10:48:36

6 dB Bandwidth Plot on Configuration IEEE 802.11b / 2462 MHz

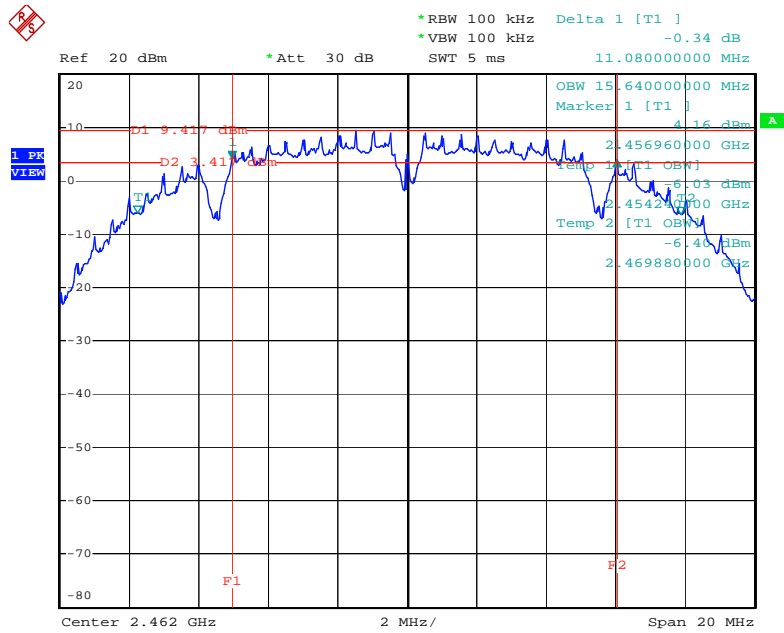

Date: 14.MAR.2006 10:50:06

6 dB Bandwidth Plot on Configuration IEEE 802.11g / 2412 MHz

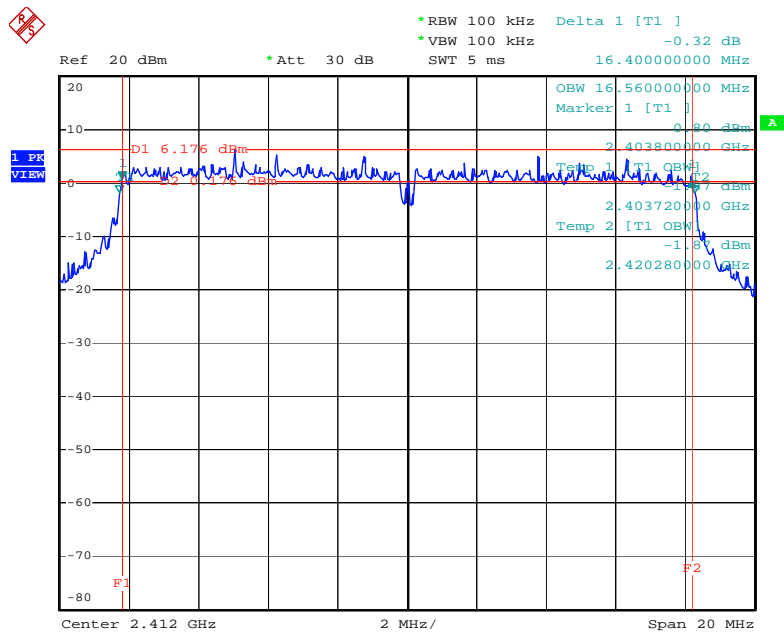

Date: 14.MAR.2006 10:31:27

6 dB Bandwidth Plot on Configuration IEEE 802.11g / 2437 MHz

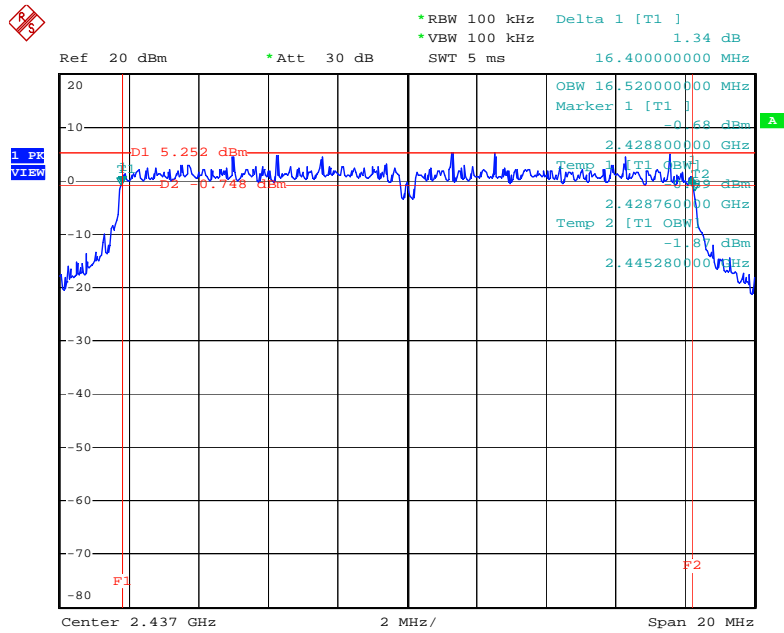

Date: 14.MAR.2006 10:32:42

6 dB Bandwidth Plot on Configuration IEEE 802.11g / 2462 MHz

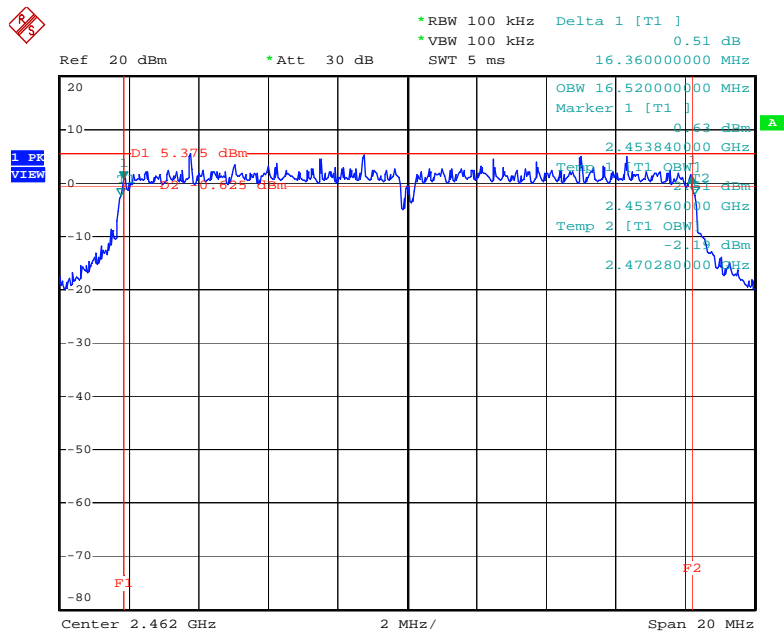

Date: 14.MAR.2006 10:35:26

6 dB Bandwidth Plot on Configuration IEEE 802.11g Turbo / 2437 MHz

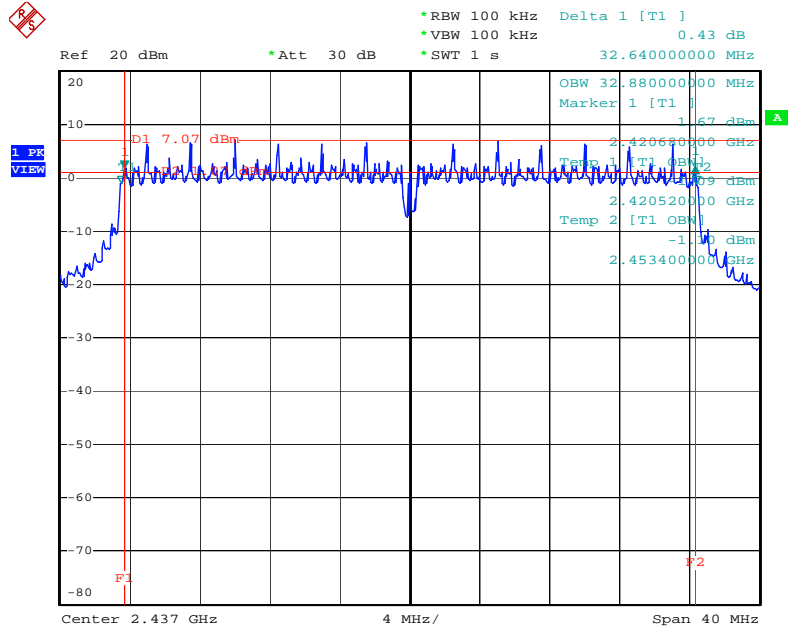

Date: 14.MAR.2006 10:41:13

For Ant. 5

6 dB Bandwidth Plot on Configuration IEEE 802.11b / 2412 MHz

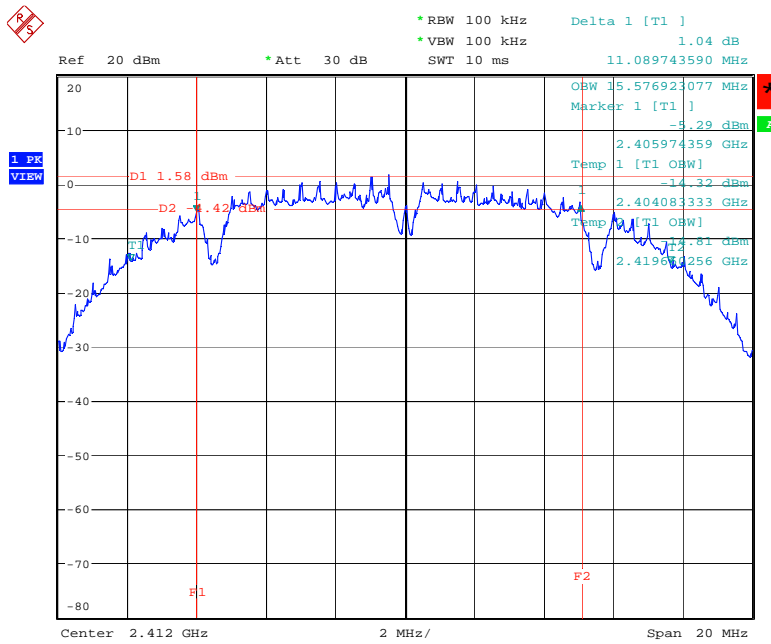

Date: 30.MAY.2006 19:43:40

6 dB Bandwidth Plot on Configuration IEEE 802.11b / 2437 MHz

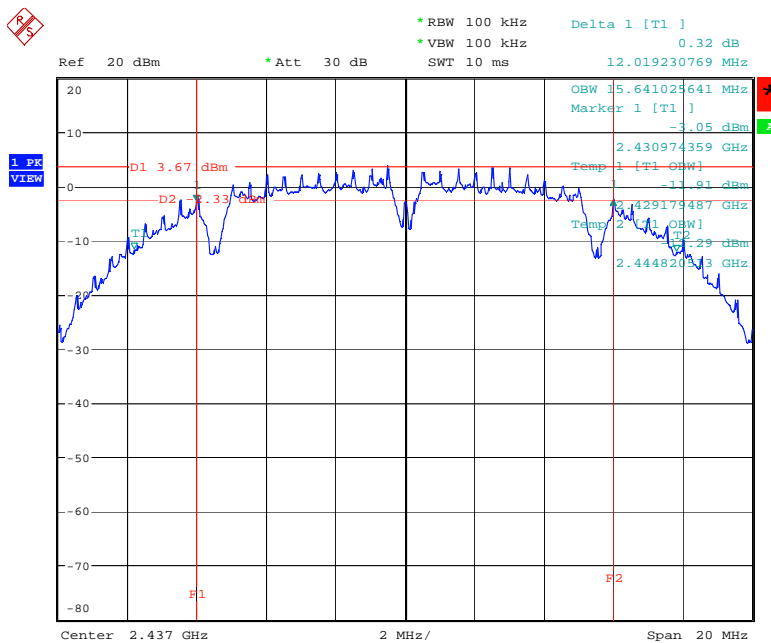

Date: 30.MAY.2006 19:45:53

6 dB Bandwidth Plot on Configuration IEEE 802.11b / 2462 MHz

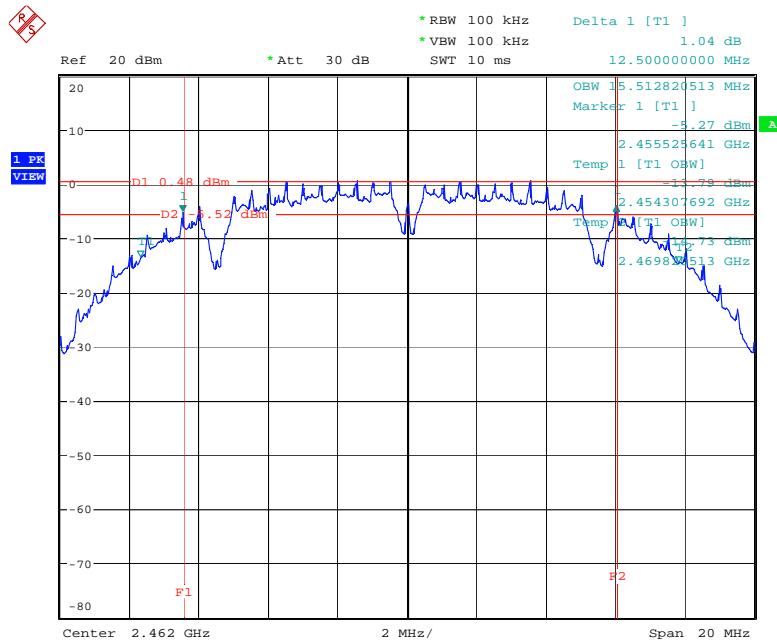

Date: 30.MAY.2006 19:47:42

6 dB Bandwidth Plot on Configuration IEEE 802.11g / 2412 MHz

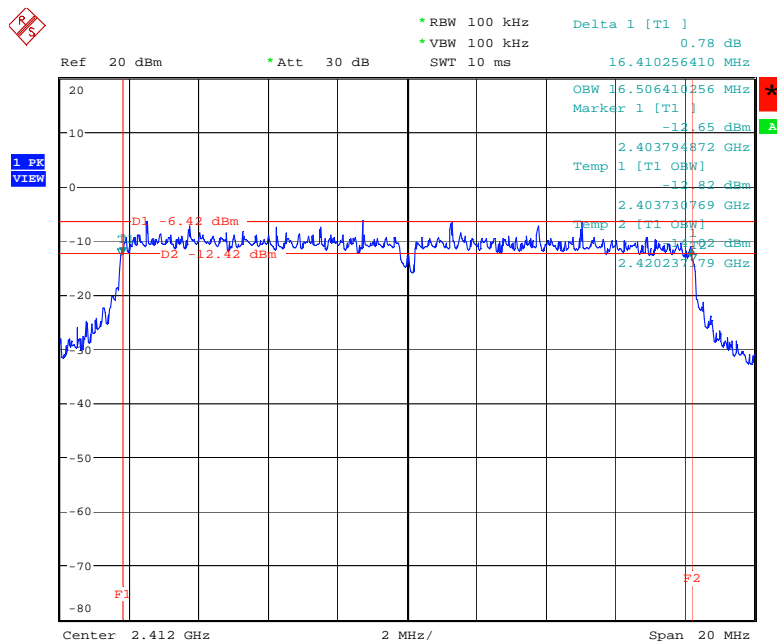

Date: 30.MAY.2006 19:37:44

6 dB Bandwidth Plot on Configuration IEEE 802.11g / 2437 MHz

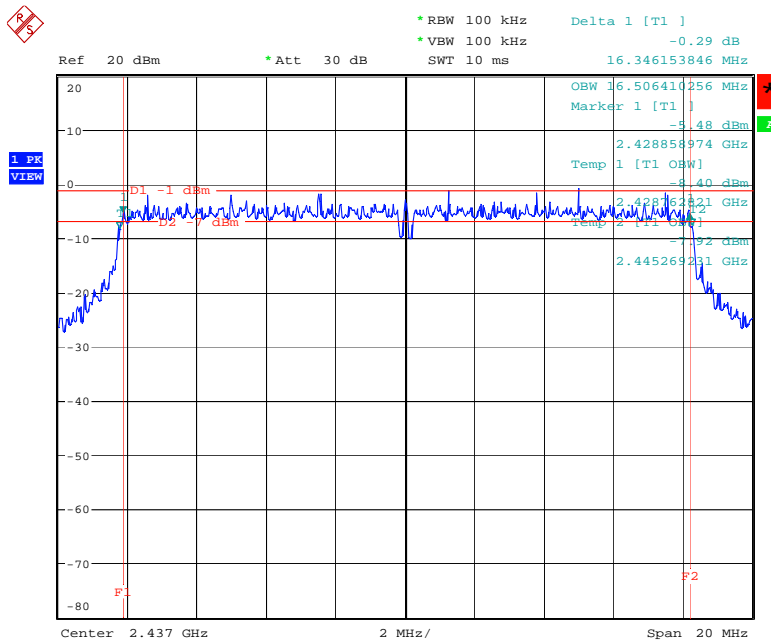

Date: 30.MAY.2006 19:33:18

6 dB Bandwidth Plot on Configuration IEEE 802.11g / 2462 MHz

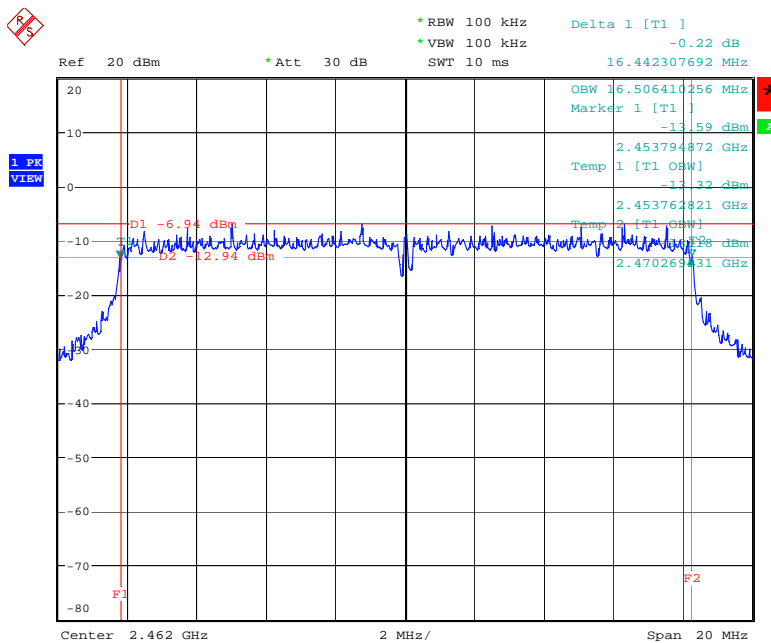

Date: 30.MAY.2006 19:32:21

6 dB Bandwidth Plot on Configuration IEEE 802.11g Turbo / 2437 MHz

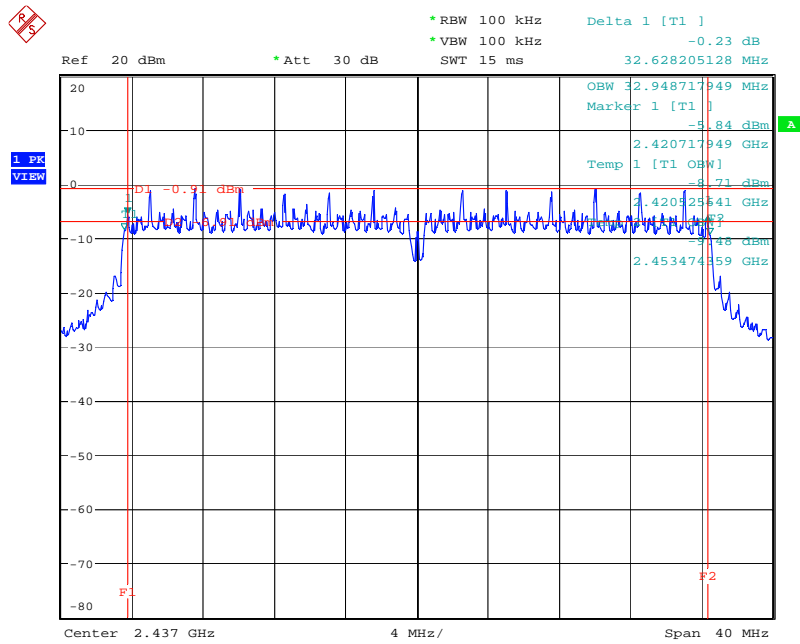

Date: 30.MAY.2006 19:39:46

For Ant. 8/9

6 dB Bandwidth Plot on Configuration IEEE 802.11a / 5745 MHz

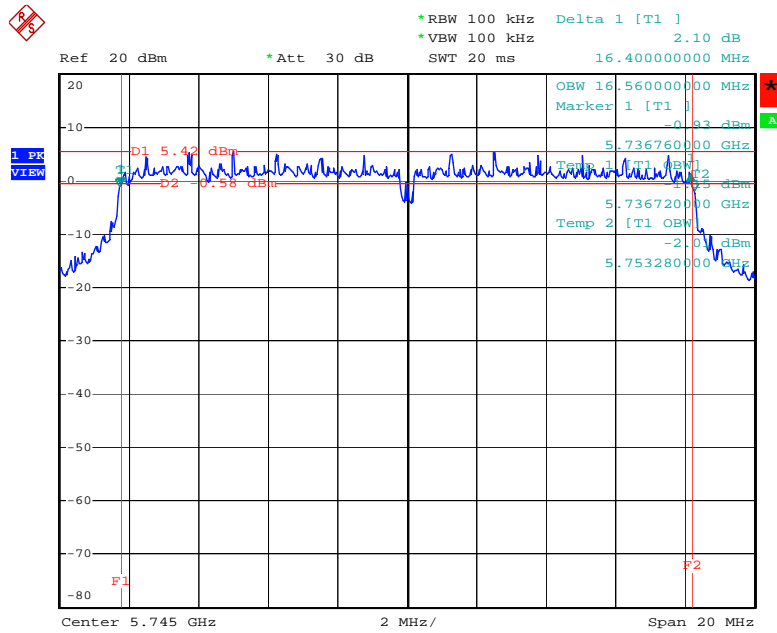

Date: 25.MAR.2006 19:40:15

6 dB Bandwidth Plot on Configuration IEEE 802.11a / 5785 MHz

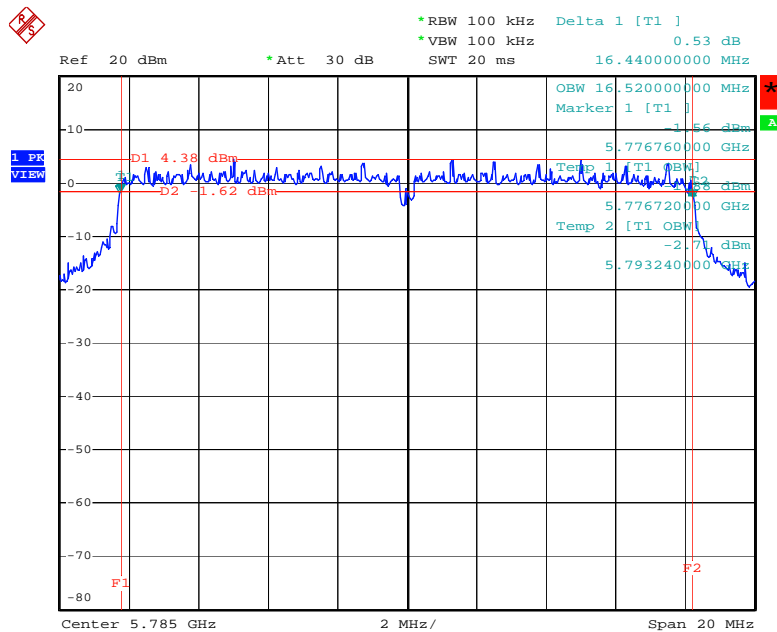

Date: 25.MAR.2006 19:41:18

6 dB Bandwidth Plot on Configuration IEEE 802.11a / 5825 MHz

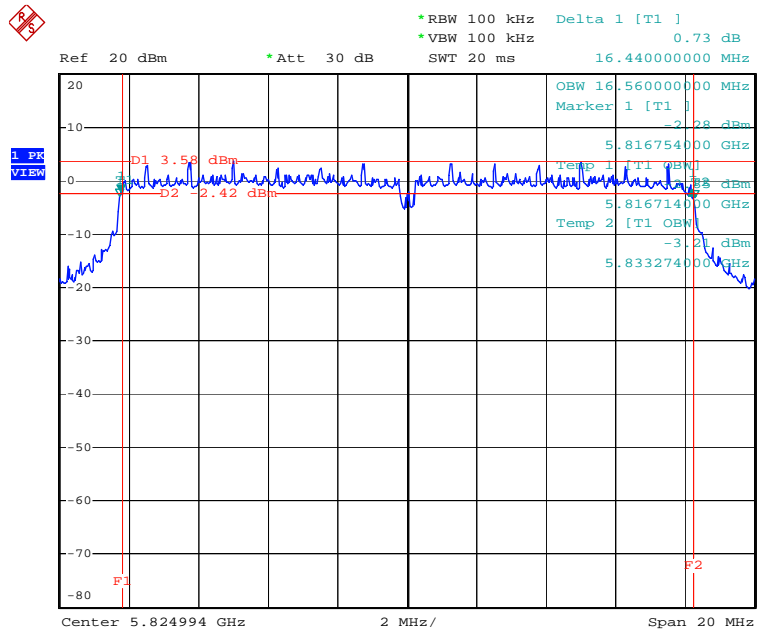

Date: 25.MAR.2006 19:43:46

6 dB Bandwidth Plot on Configuration IEEE 802.11a Turbo / 5760 MHz

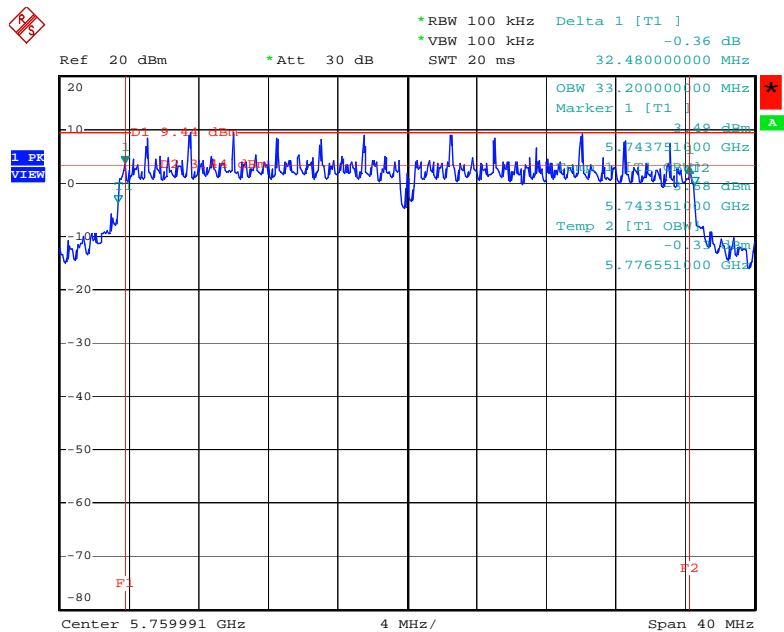

Date: 25.MAR.2006 19:49:55

6 dB Bandwidth Plot on Configuration IEEE 802.11a Turbo / 5800 MHz

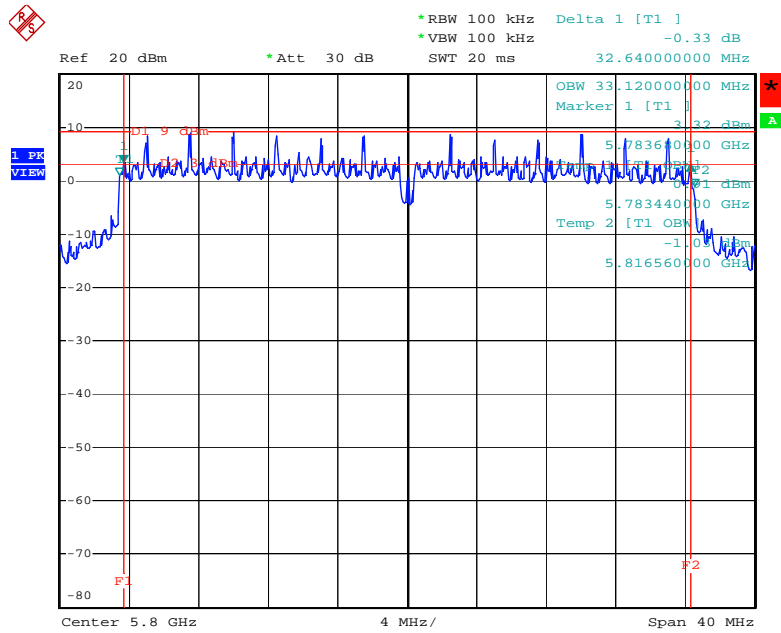

Date: 25.MAR.2006 19:46:52

For Ant. 10

6 dB Bandwidth Plot on Configuration IEEE 802.11a / 5745 MHz

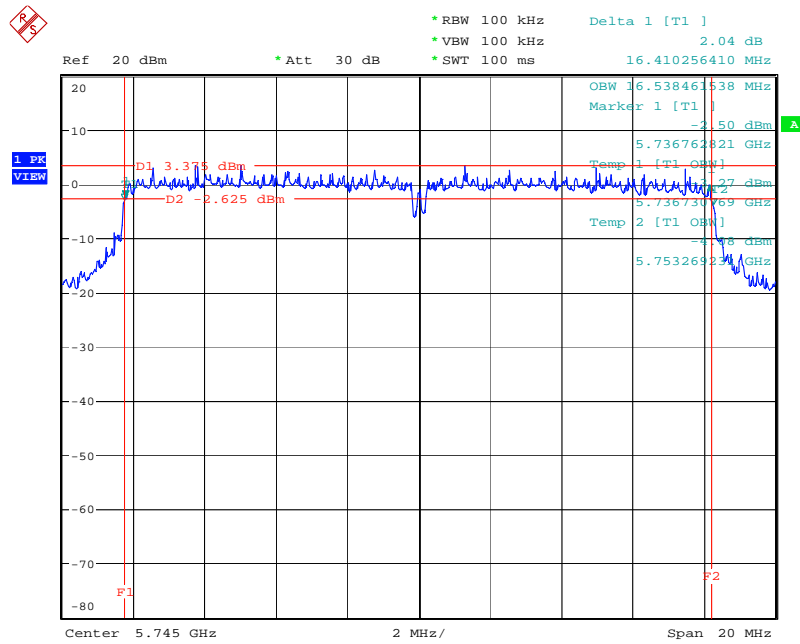

Date: 9.MAY.2006 19:21:46

6 dB Bandwidth Plot on Configuration IEEE 802.11a / 5785 MHz

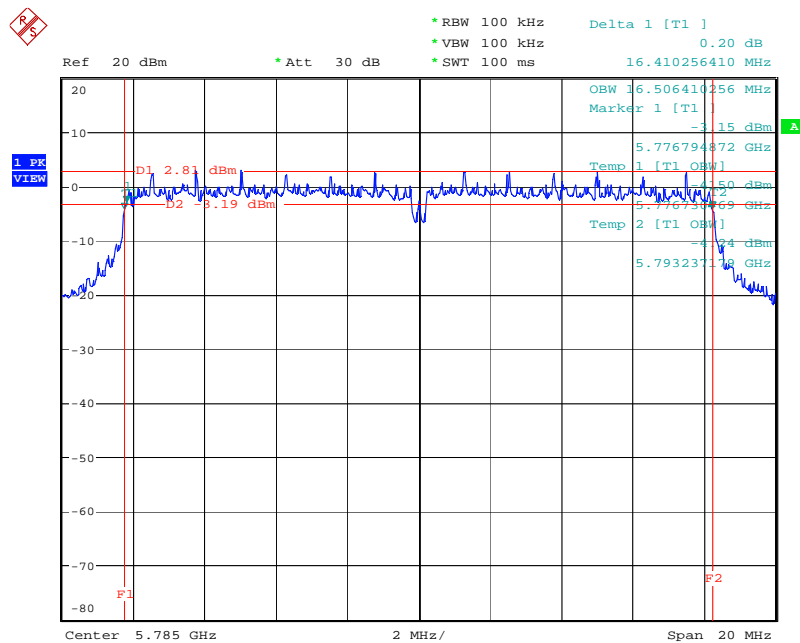

Date: 9.MAY.2006 19:20:49

6 dB Bandwidth Plot on Configuration IEEE 802.11a / 5825 MHz

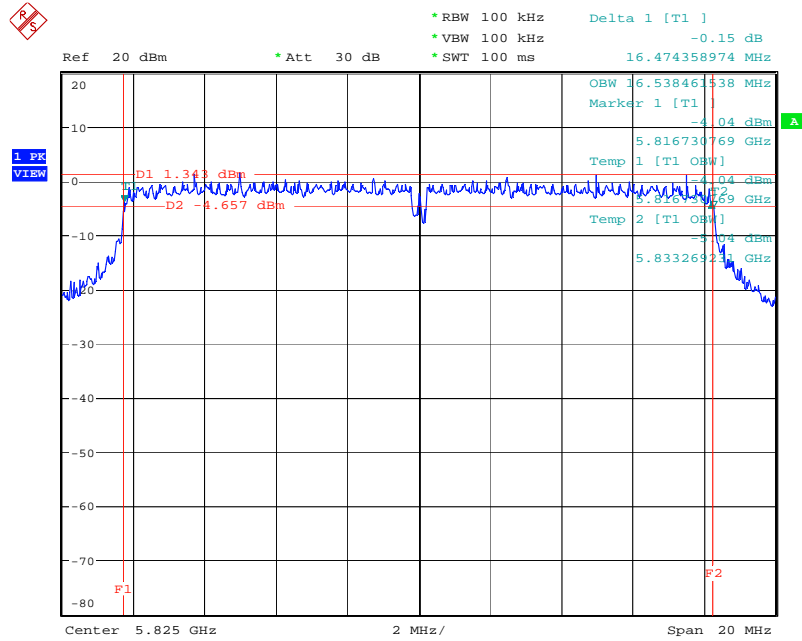

Date: 9.MAY.2006 19:19:42

6 dB Bandwidth Plot on Configuration IEEE 802.11a Turbo / 5760 MHz

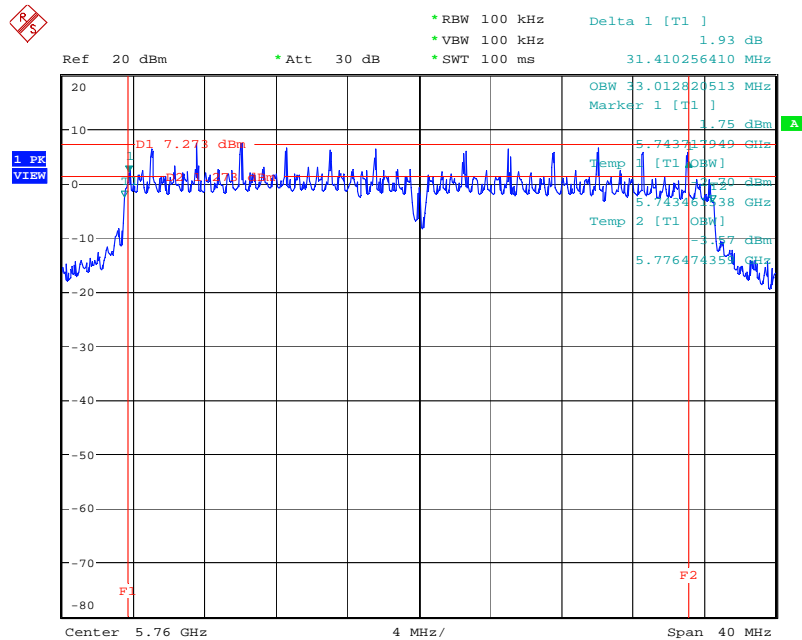

Date: 9.MAY.2006 19:17:17

6 dB Bandwidth Plot on Configuration IEEE 802.11a Turbo / 5800 MHz

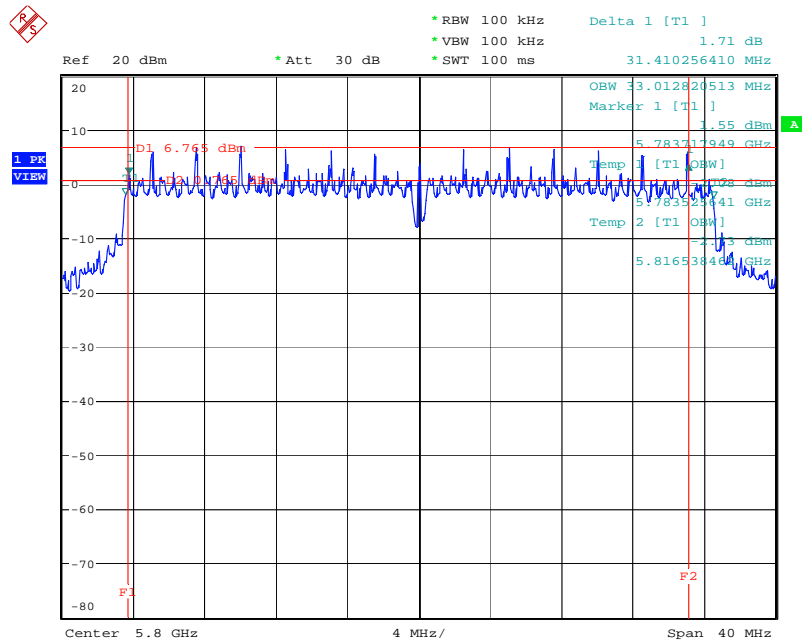

Date: 9.MAY.2006 19:18:23

For Ant. 11

6 dB Bandwidth Plot on Configuration IEEE 802.11a / 5745 MHz

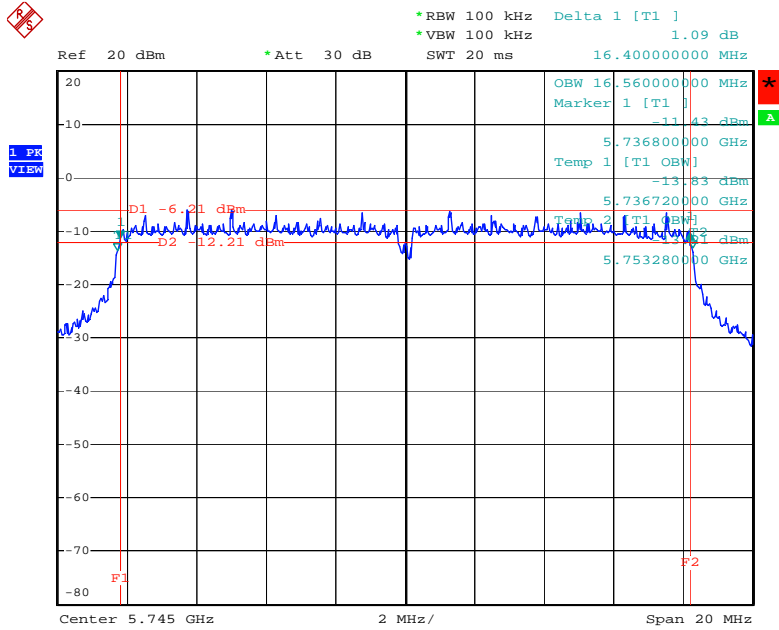

Date: 27.MAR.2006 19:25:22

6 dB Bandwidth Plot on Configuration IEEE 802.11a / 5785 MHz

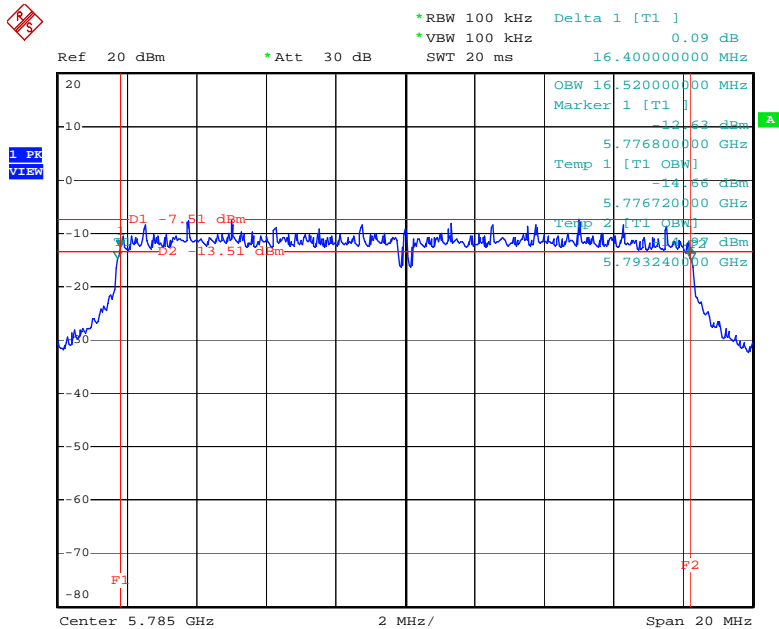

Date: 27.MAR.2006 19:28:30

6 dB Bandwidth Plot on Configuration IEEE 802.11a / 5825 MHz

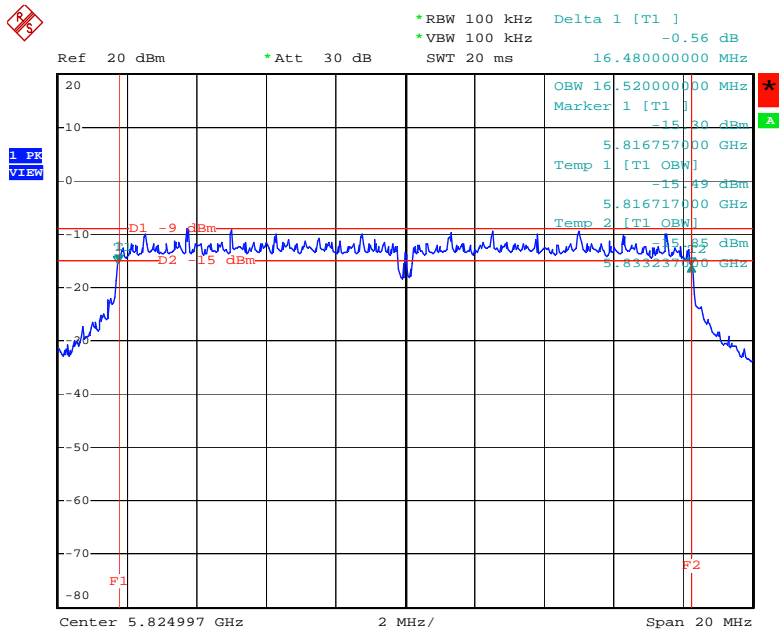

Date: 27.MAR.2006 19:30:34

6 dB Bandwidth Plot on Configuration IEEE 802.11a Turbo / 5760 MHz

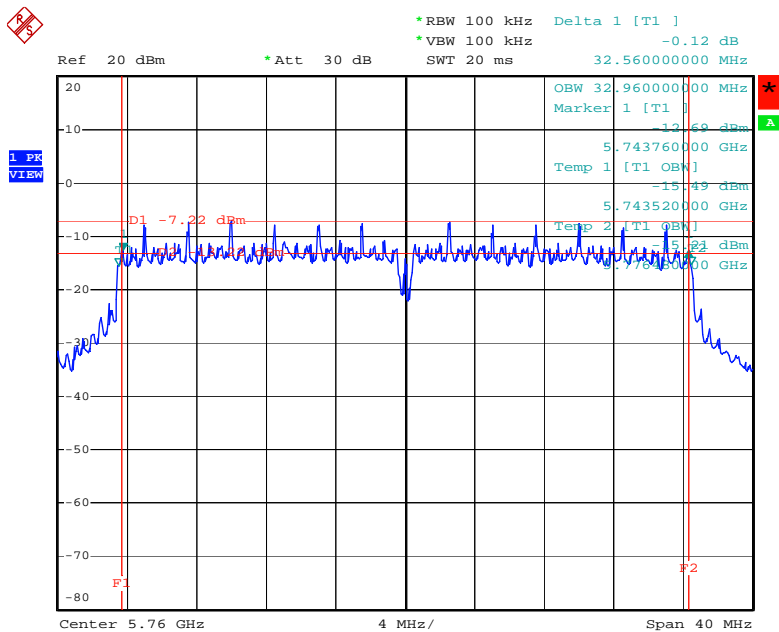

Date: 27.MAR.2006 19:35:17

6 dB Bandwidth Plot on Configuration IEEE 802.11a Turbo / 5800 MHz

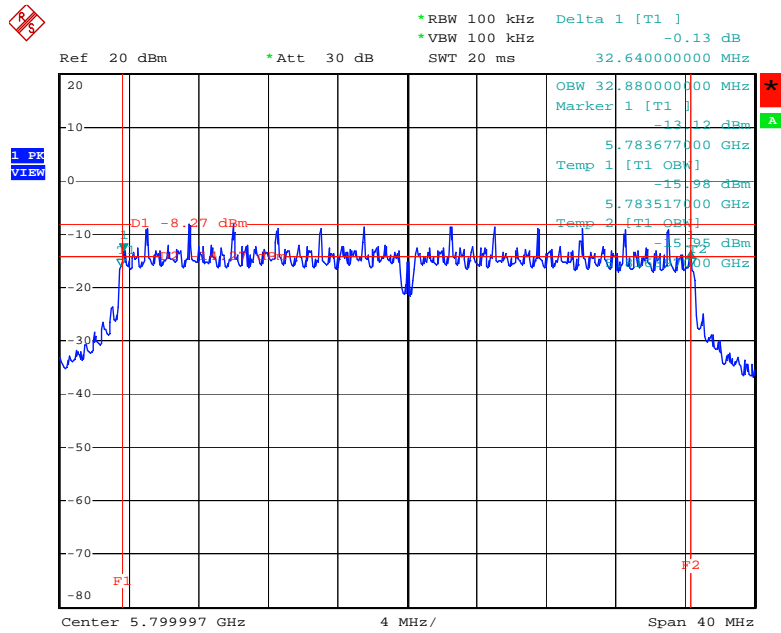

Date: 27.MAR.2006 19:34:12

For Ant. 12

6 dB Bandwidth Plot on Configuration IEEE 802.11a / 5745 MHz

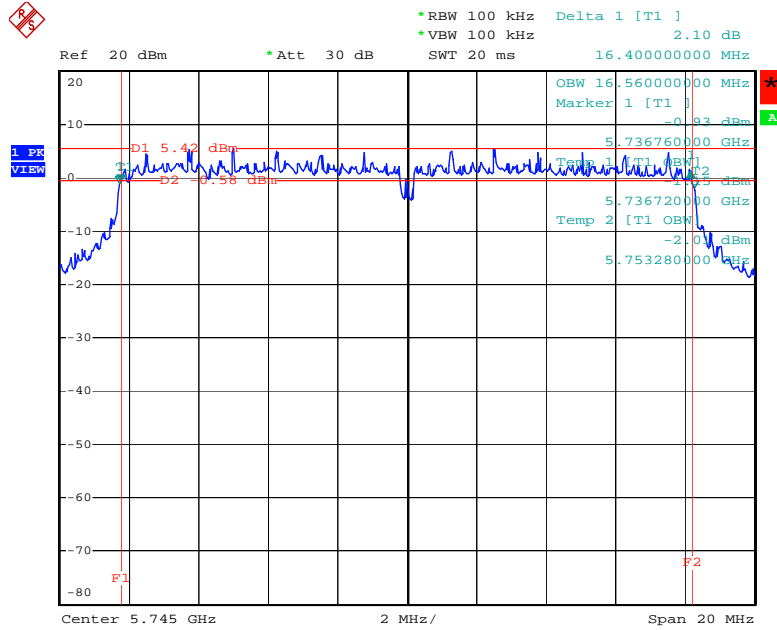

Date: 25.MAR.2006 19:40:15

6 dB Bandwidth Plot on Configuration IEEE 802.11a / 5785 MHz

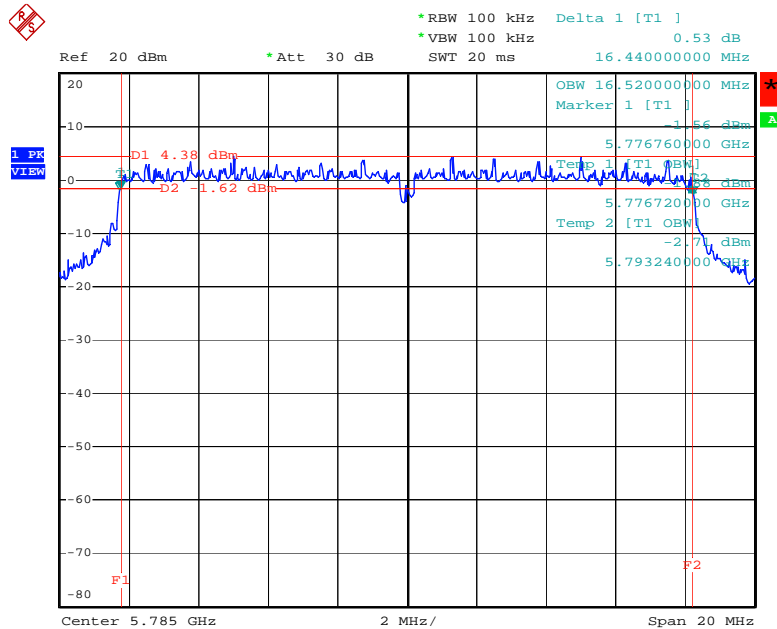

Date: 25.MAR.2006 19:41:18

6 dB Bandwidth Plot on Configuration IEEE 802.11a / 5825 MHz

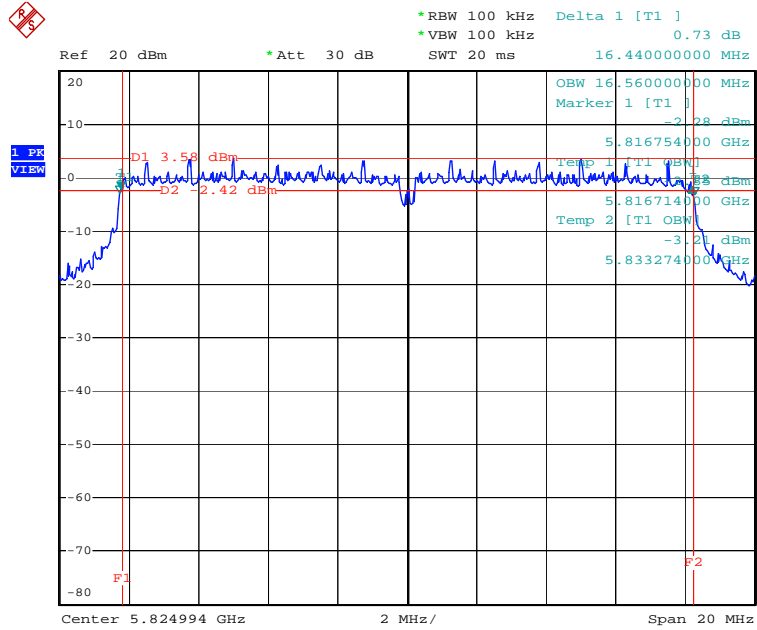

Date: 25.MAR.2006 19:43:46

6 dB Bandwidth Plot on Configuration IEEE 802.11a Turbo / 5760 MHz

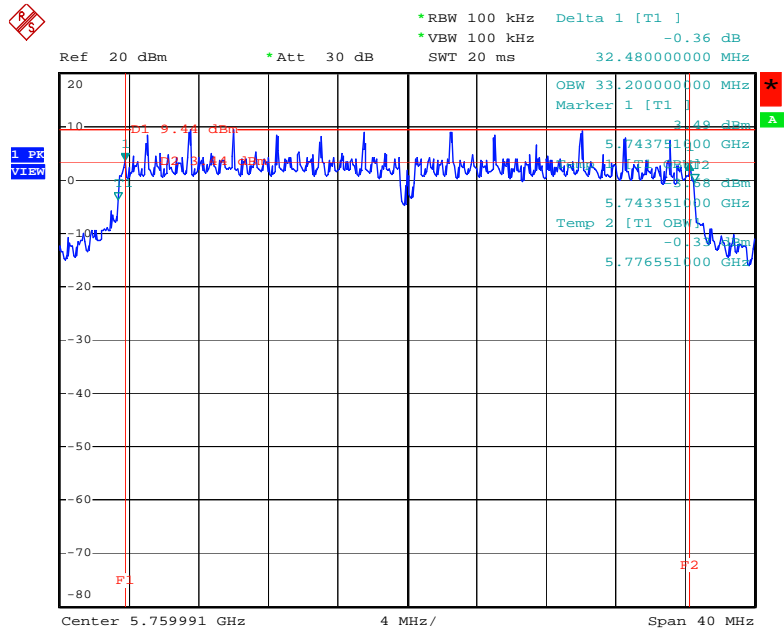

Date: 25.MAR.2006 19:49:55

6 dB Bandwidth Plot on Configuration IEEE 802.11a Turbo / 5800 MHz

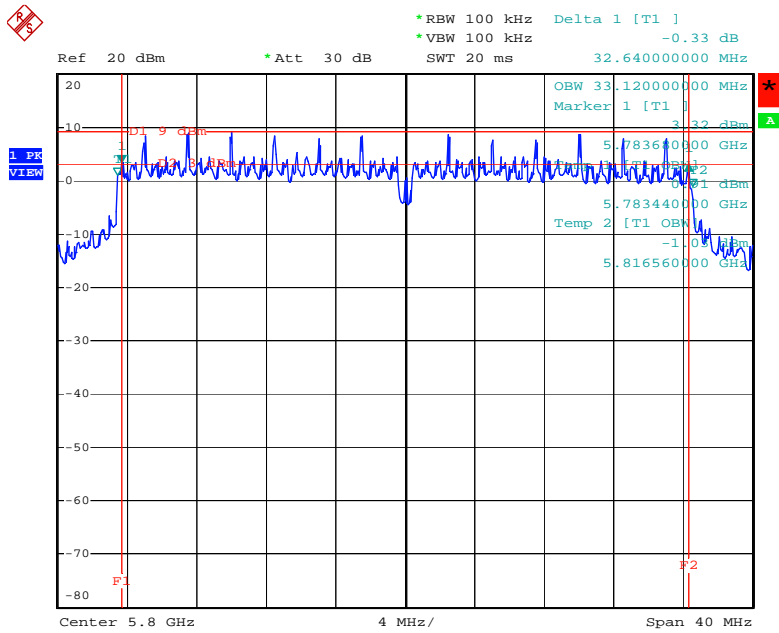

Date: 25.MAR.2006 19:46:52

For Ant. 13

6 dB Bandwidth Plot on Configuration IEEE 802.11a / 5745 MHz

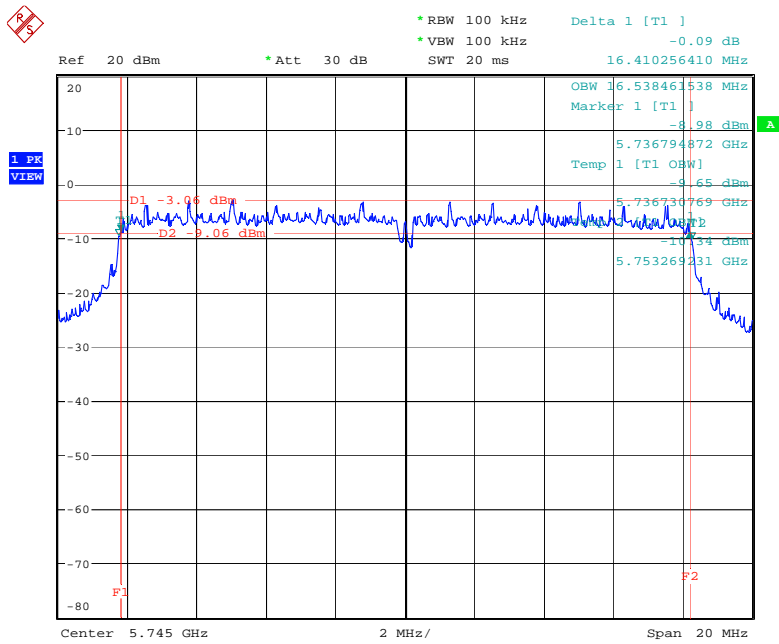

Date: 17.MAY.2006 09:52:17

6 dB Bandwidth Plot on Configuration IEEE 802.11a / 5785 MHz

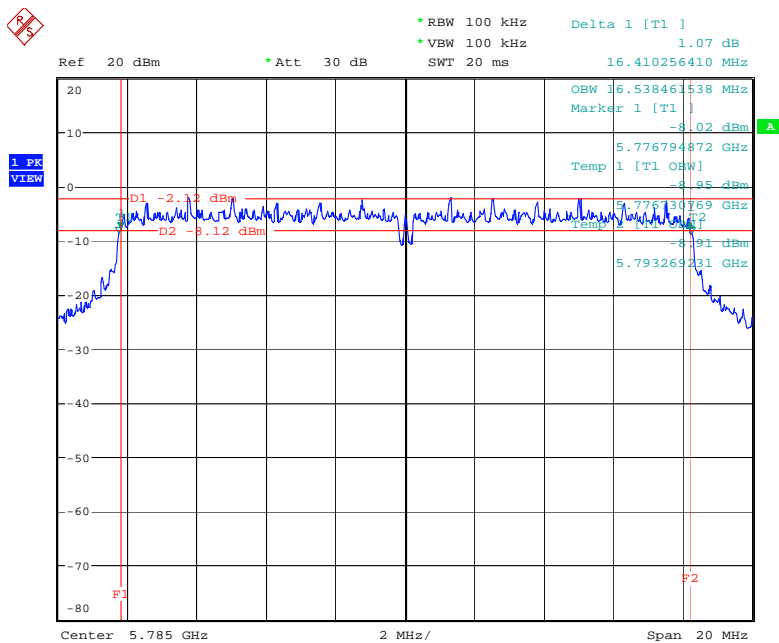

Date: 16.MAY.2006 14:30:57

6 dB Bandwidth Plot on Configuration IEEE 802.11a / 5825 MHz

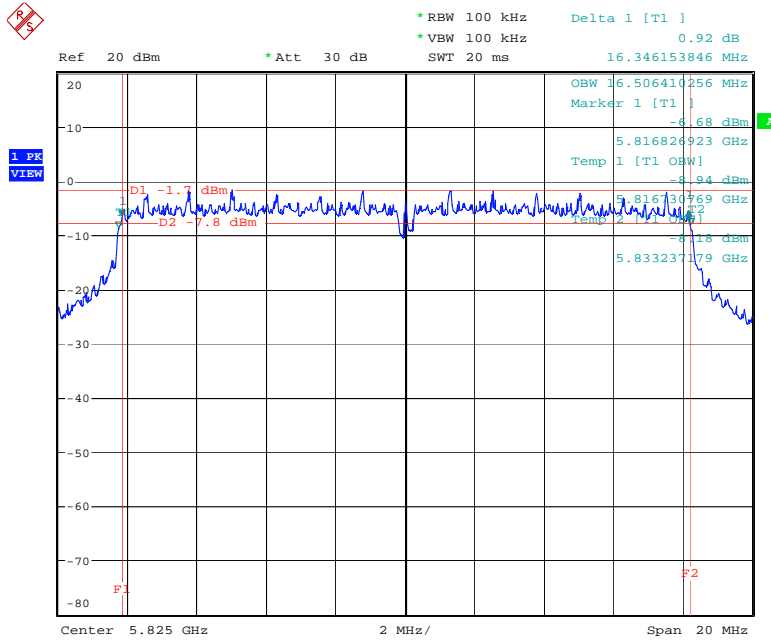

Date: 16.MAY.2006 14:33:41

6 dB Bandwidth Plot on Configuration IEEE 802.11a Turbo / 5760 MHz

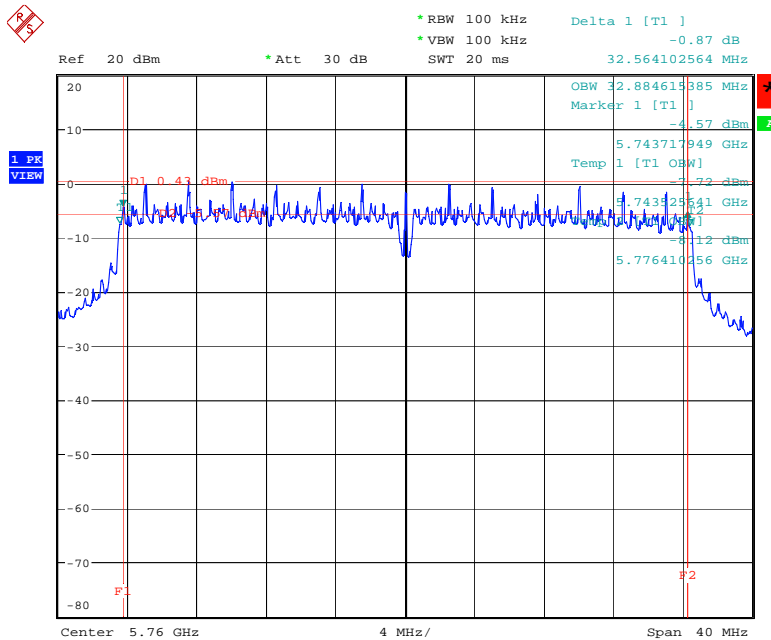

Date: 16.MAY.2006 14:39:52

6 dB Bandwidth Plot on Configuration IEEE 802.11a Turbo / 5800 MHz

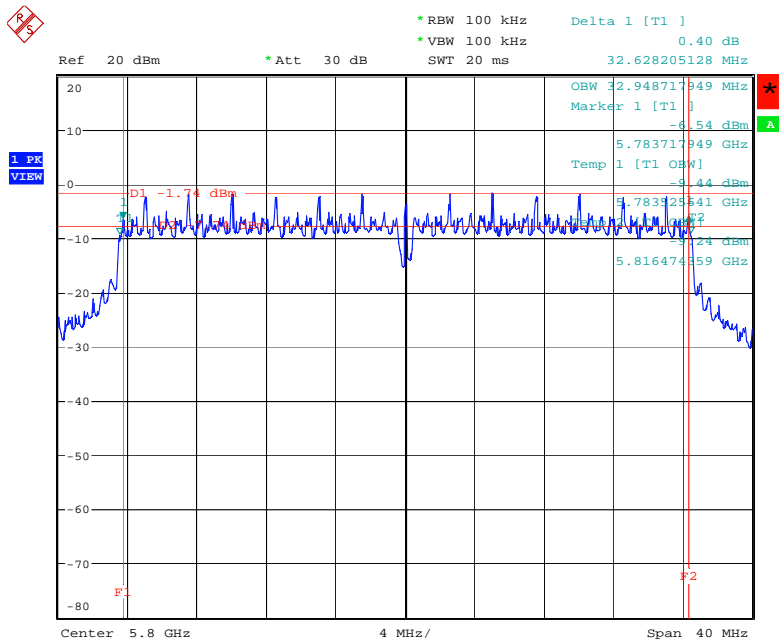

Date: 16.MAY.2006 14:36:53

4.5. Radiated Emissions Measurement

4.5.1. Limit

20dBc in any 100 kHz bandwidth outside the operating frequency band. In case the emission fall within the restricted band specified on 15.205(a), then the 15.209(a) limit in the table below has to be followed.

Frequencies (MHz)	Field Strength (microvolts/meter)	Measurement Distance (meters)
0.009~0.490	2400/F(KHz)	300
0.490~1.705	24000/F(KHz)	30
1.705~30.0	30	30
30~88	100	3
88~216	150	3
216~960	200	3
Above 960	500	3

4.5.2. Measuring Instruments and Setting

Please refer to section 5 in this report. The following table is the setting of spectrum analyzer and receiver.

Spectrum Parameter	Setting
Attenuation	Auto
Start Frequency	1000 MHz
Stop Frequency	10th carrier harmonic
RB / VB (emission in restricted band)	1MHz / 1MHz for Peak, 1 MHz / 10Hz for Average
RB / VB (other emission)	100KHz / 100KHz for peak

Receiver Parameter	Setting
Attenuation	Auto
Start ~ Stop Frequency	9kHz~150kHz / RB 200Hz for QP
Start ~ Stop Frequency	150kHz~30MHz / RB 9kHz for QP
Start ~ Stop Frequency	30MHz~1000MHz / RB 120kHz for QP

4.5.3. Test Procedures

1. Configure the EUT according to ANSI C63.4. The EUT was placed on the top of the turntable 0.8 meter above ground. The phase center of the receiving antenna mounted on the top of a height-variable antenna tower was placed 3 meters far away from the turntable.
2. Power on the EUT and all the supporting units. The turntable was rotated by 360 degrees to determine the position of the highest radiation.
3. The height of the broadband receiving antenna was varied between one meter and four meters above ground to find the maximum emissions field strength of both horizontal and vertical polarization.
4. For each suspected emissions, the antenna tower was scan (from 1 M to 4 M) and then the turntable was rotated (from 0 degree to 360 degrees) to find the maximum reading.
5. Set the test-receiver system to Peak or CISPR quasi-peak Detect Function with specified bandwidth under Maximum Hold Mode.
6. For emissions above 1GHz, use 1MHz VBW and RBW for peak reading. Then 1MHz RBW and 10Hz VBW for average reading in spectrum analyzer.
7. When the radiated emissions limits are expressed in terms of the average value of the emissions, and pulsed operation is employed, the measurement field strength shall be determined by averaging over one complete pulse train, including blanking intervals, as long as the pulse train does not exceed 0.1 seconds. As an alternative (provided the transmitter operates for longer than 0.1 seconds) or in cases where the pulse train exceeds 0.1 seconds, the measured field strength shall be determined from the average absolute voltage during a 0.1 second interval during which the field strength is at its maximum value.
8. If the emissions level of the EUT in peak mode was 3 dB lower than the average limit specified, then testing will be stopped and peak values of EUT will be reported, otherwise, the emissions which do not have 3 dB margin will be repeated one by one using the quasi-peak method for below 1GHz.
9. For testing above 1GHz, the emissions level of the EUT in peak mode was lower than average limit (that means the emissions level in peak mode also complies with the limit in average mode), then testing will be stopped and peak values of EUT will be reported, otherwise, the emissions will be measured in average mode again and reported.
10. In case the emission is lower than 30MHz, loop antenna has to be used for measurement and the recorded data should be QP measured by receiver. High – Low scan is not required in this case.

4.5.4. Test Setup Layout

For radiated emissions below 30MHz

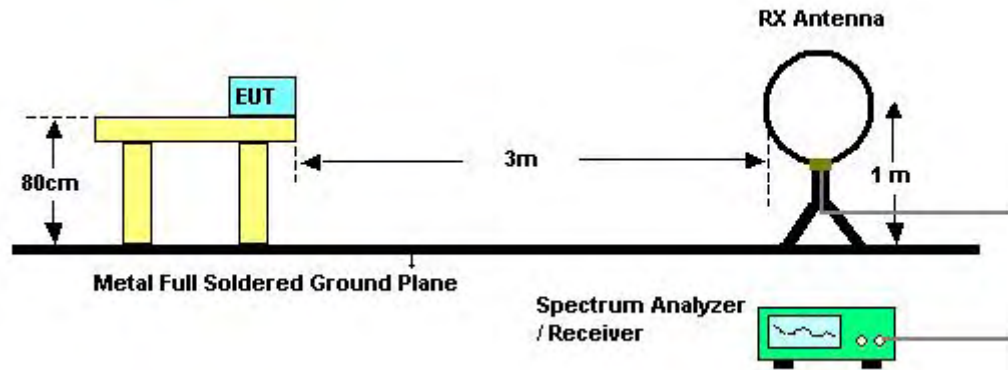

For radiated emissions above 30MHz

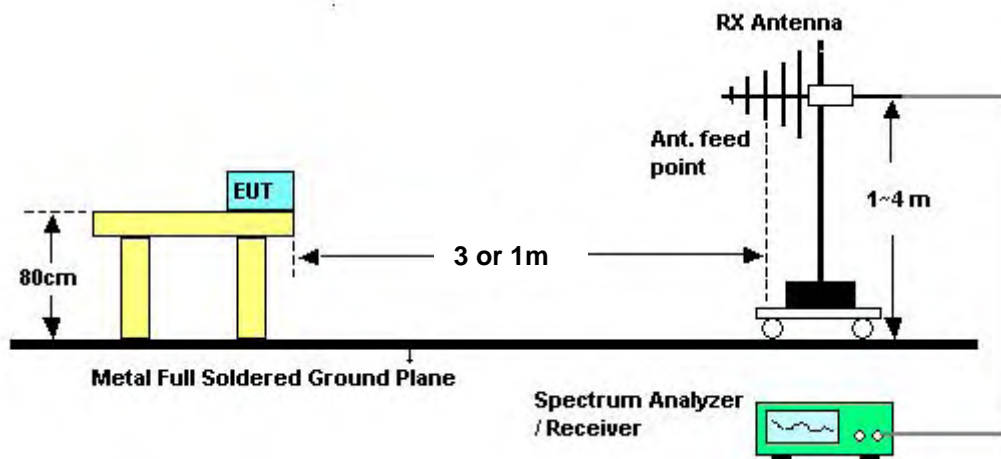

Above 10 GHz shall be extrapolated to the specified distance using an extrapolation factor of 20 dB/decade from 3m to 1.5m.

Distance extrapolation factor = $20 \log(\text{specific distance [3m]} / \text{test distance [1.5m]})$ (dB);

Limit line = specific limits (dBuV) + distance extrapolation factor [6 dB].

4.5.5. Test Deviation

There is no deviation with the original standard.

4.5.6. EUT Operation during Test

The EUT was programmed to be in continuously transmitting mode.

4.5.7. Results of Radiated Emissions (9kHz~30MHz)

Temperature	24°C	Humidity	64%
Test Engineer	Rush Kao	Configurations	802.11g Channel 6

Freq. (MHz)	Level (dBuV)	Over Limit (dB)	Limit Line (dBuV)	Remark
-	-	-	-	See Note

Note:

The amplitude of spurious emissions which are attenuated by more than 20 dB below the permissible value has no need to be reported.

Distance extrapolation factor = $40 \log(\text{specific distance} / \text{test distance})$ (dB);

Limit line = specific limits (dBuV) + distance extrapolation factor.

4.5.8. Results of Radiated Emissions (30MHz~1GHz)

Temperature	24°C	Humidity	64%
Test Engineer	Rush Kao	Configurations	802.11g Channel 6 / Ant. 1/2

Vertical

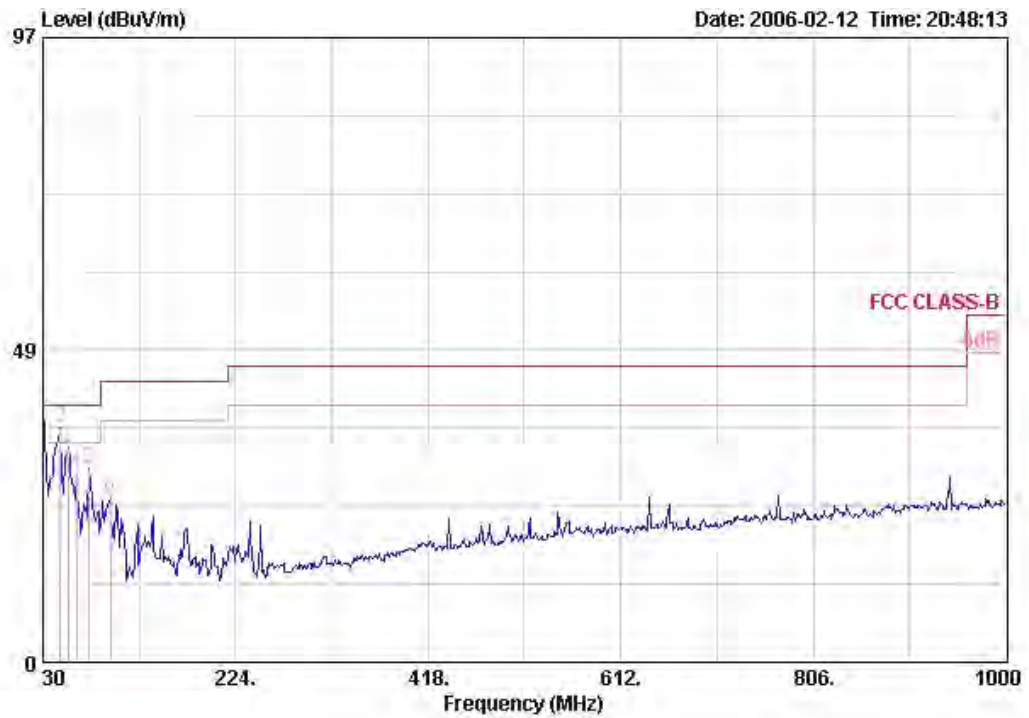

	Freq	Level	Over Limit	Limit	Antenna Line	Antenna Factor	Cable Loss	Preamp	Read Level	Remark	Ant Pos	Table Pos
	MHz	dBuV/m	dB	dBuV/m	dB/m	dB	dB	dB	dBuV		cm	deg
1 @	30.000	36.67	-3.33	40.00	18.10	0.47	29.80	47.90	QP		---	---
2 @	47.460	36.39	-3.61	40.00	8.77	0.58	29.83	56.86	Peak		---	---
3 @	56.190	33.40	-6.60	40.00	6.00	0.63	29.82	56.58	Peak		---	---
4 @	63.950	29.31	-10.69	40.00	5.10	0.67	29.89	53.43	Peak		---	---
5 @	75.590	30.18	-9.82	40.00	6.20	0.70	29.97	53.24	Peak		---	---
6 @	97.900	25.53	-17.97	43.50	10.20	0.80	30.10	44.63	Peak		---	---

Horizontal

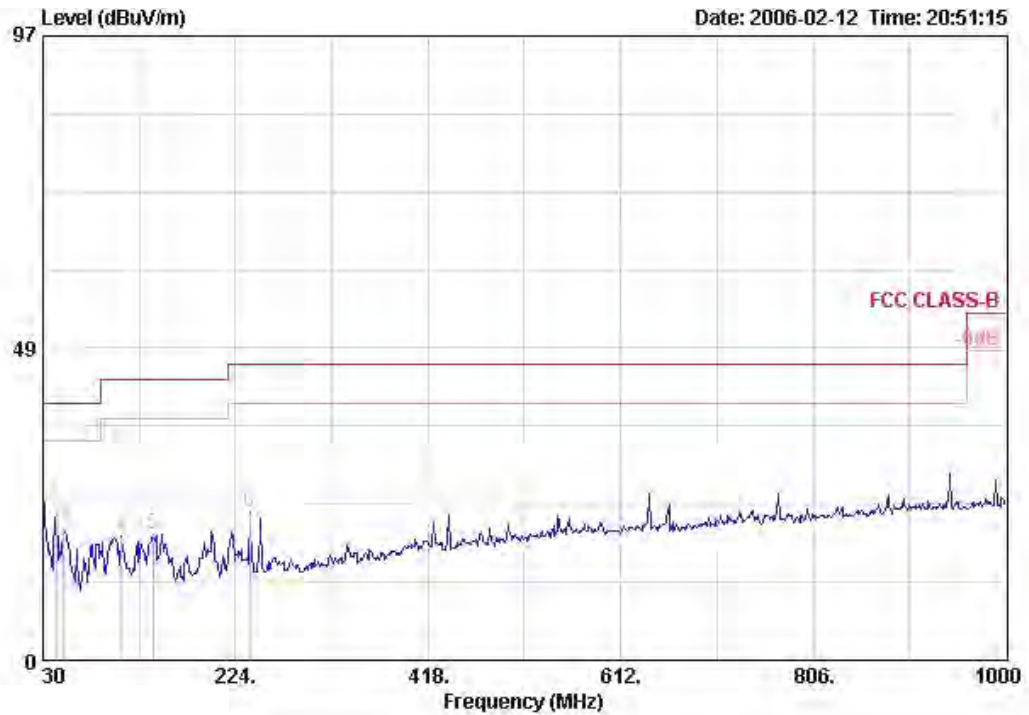

	Freq	Level	Over Limit	Antenna Line	Antenna Factor	Cable Loss	Preamp Factor	Read Level	Remark	Ant Pos	Table Pos
	MHz	dBuV/m	dB	dBuV/m	dB/m	dB	dB	dBuV		cm	deg
1 @	30.000	25.94	-14.06	40.00	18.10	0.47	29.80	37.17	Peak	---	---
2 @	43.580	23.16	-16.84	40.00	10.30	0.56	29.83	42.13	Peak	---	---
3 @	51.340	20.16	-19.84	40.00	7.35	0.61	29.83	42.03	Peak	---	---
4 @	109.540	19.34	-24.16	43.50	11.50	0.84	30.07	37.07	Peak	---	---
5 @	140.580	19.65	-23.85	43.50	10.93	0.93	30.04	37.82	Peak	---	---
6 @	238.550	23.04	-22.96	46.00	10.80	1.22	30.08	41.10	Peak	---	---

Note:

The amplitude of spurious emissions which are attenuated by more than 20 dB below the permissible value has no need to be reported.

Emission level (dBuV/m) = 20 log Emission level (uV/m).

Corrected Reading: Antenna Factor + Cable Loss + Read Level - Preamp Factor = Level.