



**MET Laboratories, Inc.** *Safety Certification - EMI - Telecom Environmental Simulation*

914 WEST PATAPSCO AVENUE • BALTIMORE, MARYLAND 21230-3432 • PHONE (410) 354-3300 • FAX (410) 354-3313  
33439 WESTERN AVENUE • UNION CITY, CALIFORNIA 94587 • PHONE (510) 489-6300 • FAX (510) 489-6372  
3162 BELICK STREET • SANTA CLARA, CALIFORNIA 95054 • PHONE (408) 748-3585 • FAX (510) 489-6372  
13301 MCCALLEN PASS • AUSTIN, TX 78753 • PHONE (512) 287-2500 • FAX (512) 287-2513

September 23, 2014

Meru Networks, Inc.  
894 Ross Dr.  
Sunnyvale, CA 94089

Dear Rajendran Chary,

Enclosed is the EMC Wireless test report for compliance testing of the Meru Networks, Inc., Mission Peak (AP822eV2) as tested to the requirements of Title 47 of the CFR, Ch. 1 (10-1-06 ed.), Title 47 of the CFR, Part 15, Subpart B for Unintentional Radiators and Part 15.407, Subpart E (UNII 1) for Intentional Radiators.

Thank you for using the services of MET Laboratories, Inc. If you have any questions regarding these results or if MET can be of further service to you, please feel free to contact me.

Sincerely yours,  
MET LABORATORIES, INC.

Jennifer Warnell  
Documentation Department

Reference: (\Meru Networks, Inc.\EMCS42577D-FCC407 (UNII 1))

Certificates and reports shall not be reproduced except in full, without the written permission of MET Laboratories, Inc.



**MET Laboratories, Inc.** *Safety Certification - EMI - Telecom Environmental Simulation*

914 WEST PATAPSCO AVENUE • BALTIMORE, MARYLAND 21230-3432 • PHONE (410) 354-3300 • FAX (410) 354-3313

33439 WESTERN AVENUE • UNION CITY, CALIFORNIA 94587 • PHONE (510) 489-6300 • FAX (510) 489-6372

3162 BELICK STREET • SANTA CLARA, CALIFORNIA 95054 • PHONE (408) 748-3585 • FAX (510) 489-6372

13301 MCCALLEN PASS • AUSTIN, TX 78753 • PHONE (512) 287-2500 • FAX (512) 287-2513

**Electromagnetic Compatibility Criteria  
Test Report**

for the

**Meru Networks, Inc.  
Model Mission Peak (AP822e V2)**

**Tested under**  
the FCC Certification Rules  
contained in  
Title 47 of the CFR, Parts 15 Subpart B  
for Class B Digital Devices  
&  
FCC Part 15.407 for Intentional Radiators

**MET Report: EMCS42577D-FCC407 (UNII 1)**

September 23, 2014

**Prepared For:**

**Meru Networks, Inc.  
894 Ross Dr.  
Sunnyvale, CA 94089**

**Prepared By:**  
**MET Laboratories, Inc.**  
914 W. Patapsco Ave.  
Baltimore, MD 21230

## Electromagnetic Compatibility Criteria Test Report

for the

**Meru Networks, Inc.**  
**Model Mission Peak (AP822eV2)**

**Tested under**  
the FCC Certification Rules  
contained in  
Title 47 of the CFR, Parts 15 Subpart B for Class B Digital Devices  
&  
FCC Part 15.407 for Intentional Radiators



Andy Shen, Project Engineer  
Electromagnetic Compatibility Lab



Jennifer Warnell  
Documentation Department

**Engineering Statement:** The measurements shown in this report were made in accordance with the procedures indicated, and the emissions from this equipment were found to be within the limits applicable. I assume full responsibility for the accuracy and completeness of these measurements, and for the qualifications of all persons taking them. It is further stated that upon the basis of the measurements made, the equipment tested is capable of operation in accordance with the requirements of Parts 15B, 15.407, of the FCC Rules under normal use and maintenance.



Asad Bajwa,  
Director, Electromagnetic Compatibility Lab

## Report Status Sheet

Revision	Report Date	Reason for Revision
Ø	September 23, 2014	Initial Issue.

## Table of Contents

<b>I.</b>	<b>Executive Summary .....</b>	<b>1</b>
	A. Purpose of Test .....	2
	B. Executive Summary .....	2
<b>II.</b>	<b>Equipment Configuration .....</b>	<b>3</b>
	A. Overview.....	4
	B. References.....	5
	C. Test Site .....	5
	D. Description of Test Sample.....	5
	E. Equipment Configuration.....	7
	F. Support Equipment .....	7
	G. Ports and Cabling Information.....	8
	H. Mode of Operation.....	8
	I. Method of Monitoring EUT Operation .....	8
	J. Modifications .....	8
	a) Modifications to EUT.....	8
	b) Modifications to Test Standard.....	8
	K. Disposition of EUT .....	8
<b>III.</b>	<b>Electromagnetic Compatibility Criteria for Unintentional Radiators .....</b>	<b>9</b>
	§ 15.107(a) Conducted Emissions Limits.....	10
	§ 15.109(a) Radiated Emissions Limits.....	15
<b>IV.</b>	<b>Electromagnetic Compatibility Criteria for Intentional Radiators .....</b>	<b>20</b>
	§ 15.203 Antenna Requirement .....	21
	§ 15.207(a) Conducted Emissions Limits.....	22
	§ 15.403(c) 26dB Bandwidth.....	27
	§ 15.407(a)(1) RF Power Output .....	35
	§ 15.407(a)(1) Peak Power Spectral Density .....	36
	§ 15.407(b) Undesirable Emissions .....	37
	Co-location .....	111
	§ 15.407(f) RF Exposure .....	166
	§ 15.407(g) Frequency Stability .....	167
<b>V.</b>	<b>Test Equipment .....</b>	<b>172</b>
<b>VI.</b>	<b>Certification &amp; User’s Manual Information .....</b>	<b>174</b>
	A. Certification Information .....	175
	B. Label and User’s Manual Information .....	179

## List of Tables

Table 1. Executive Summary of EMC Part 15.407 Compliance Testing .....	2
Table 2. EUT Summary.....	4
Table 3. References .....	5
Table 4. Equipment Configuration .....	7
Table 5. Support Equipment.....	7
Table 6. Antenna List .....	7
Table 7. Ports and Cabling Information .....	8
Table 8. Conducted Limits for Radio Frequency Devices calculated from FCC Part 15 Subsections 15.107(a) (b) .....	10
Table 9. Conducted Emissions - Voltage, AC Power, Phase Line (120 VAC, 60 Hz), PoE .....	11
Table 10. Conducted Emissions - Voltage, AC Power, Neutral Line (120 VAC, 60 Hz), PoE .....	12
Table 11. Conducted Emissions - Voltage, AC Power, Phase Line (120 VAC, 60 Hz), AC/DC.....	13
Table 12. Conducted Emissions - Voltage, AC Power, Neutral Line (120 VAC, 60 Hz), AC/DC .....	14
Table 13. Radiated Emissions Limits calculated from FCC Part 15, §15.109 (a) (b) .....	15
Table 14. Radiated Emissions Limits, Test Results, 30 MHz – 1 GHz, PoE .....	16
Table 15. Radiated Emissions Limits, Test Results, 1 GHz – 2 GHz, PoE.....	17
Table 16. Radiated Emissions Limits, Test Results, 30 MHz – 1 GHz, AC/DC.....	18
Table 17. Radiated Emissions Limits, Test Results, 1 GHz – 2 GHz, AC/DC .....	19
Table 18. Antenna List .....	21
Table 19. Conducted Limits for Intentional Radiators from FCC Part 15 § 15.207(a) .....	22
Table 20. Conducted Emissions - Voltage, AC Power, 15.207(a), Phase Line (120 VAC, 60 Hz), PoE.....	23
Table 21. Conducted Emissions - Voltage, AC Power, 15.207(a), Neutral Line (120 VAC, 60 Hz), PoE .....	24
Table 22. Conducted Emissions - Voltage, AC Power, 15.207(a), Phase Line (120 VAC, 60 Hz), AC/DC .....	25
Table 23. Conducted Emissions - Voltage, AC Power, 15.207(a), Neutral Line (120 VAC, 60 Hz), AC/DC.....	26
Table 24. RF Output Power, Test Results .....	35
Table 25. Peak Power Spectral Density, Test Results .....	36
Table 26. Test Equipment List .....	173

## List of Figures

Figure 1. Block Diagram of Test Configuration.....	6
Figure 2. Occupied Bandwidth, Test Setup .....	27
Figure 3. Power Output Test Setup .....	35
Figure 4. Power Spectral Density Test Setup .....	36

## List of Plots

Plot 1. Conducted Emissions, Phase Line, PoE.....	11
Plot 2. Conducted Emissions, Neutral Line, PoE.....	12
Plot 3. Conducted Emissions, Phase Line, AC/DC.....	13
Plot 4. Conducted Emissions, Neutral Line, AC/DC.....	14
Plot 5. Radiated Emissions, 30 MHz – 1 GHz, PoE.....	16
Plot 6. Radiated Emissions, 1 GHz – 2 GHz, PoE.....	17
Plot 7. Radiated Emissions, 30 MHz – 1 GHz, AC/DC.....	18
Plot 8. Radiated Emissions, 1 GHz – 2 GHz, AC/DC.....	19
Plot 9. Conducted Emissions, 15.207(a), Phase Line, PoE.....	23
Plot 10. Conducted Emissions, 15.207(a), Neutral Line, PoE.....	24
Plot 11. Conducted Emissions, 15.207(a), Phase Line, AC/DC.....	25
Plot 12. Conducted Emissions, 15.207(a), Neutral Line, AC/DC.....	26
Plot 13. 26 dB Occupied Bandwidth, 802.11a, 5180 MHz.....	28
Plot 14. 26 dB Occupied Bandwidth, 802.11a, 5190 MHz.....	28
Plot 15. 26 dB Occupied Bandwidth, 802.11a, 5200 MHz.....	28
Plot 16. 26 dB Occupied Bandwidth, 802.11a, 5230 MHz.....	29
Plot 17. 26 dB Occupied Bandwidth, 802.11a, 5240 MHz.....	29
Plot 18. 26 dB Occupied Bandwidth, 802.11n, Port 1, 5180 MHz.....	30
Plot 19. 26 dB Occupied Bandwidth, 802.11n, Port 1, 5190 MHz.....	30
Plot 20. 26 dB Occupied Bandwidth, 802.11n, Port 1, 5200 MHz.....	30
Plot 21. 26 dB Occupied Bandwidth, 802.11n, Port 1, 5230 MHz.....	31
Plot 22. 26 dB Occupied Bandwidth, 802.11n, Port 1, 5240 MHz.....	31
Plot 23. 26 dB Occupied Bandwidth, 802.11n, Port 2, 5180 MHz.....	32
Plot 24. 26 dB Occupied Bandwidth, 802.11n, Port 2, 5190 MHz.....	32
Plot 25. 26 dB Occupied Bandwidth, 802.11n, Port 2, 5200 MHz.....	32
Plot 26. 26 dB Occupied Bandwidth, 802.11n, Port 2, 5230 MHz.....	33
Plot 27. 26 dB Occupied Bandwidth, 802.11n, Port 2, 5240 MHz.....	33
Plot 28. 26 dB Occupied Bandwidth, 802.11ac, Port 1, 5210 MHz.....	34
Plot 29. 26 dB Occupied Bandwidth, 802.11ac, Port 2, 5210 MHz.....	34
Plot 30. Radiated Spurious Emissions, 802.11a, 20 MHz, Low Channel, 30 MHz – 1 GHz, Ceiling Antenna.....	38
Plot 31. Radiated Spurious Emissions, 802.11a, Low Channel, 1 GHz – 7 GHz, Average, Ceiling Antenna.....	38
Plot 32. Radiated Spurious Emissions, 802.11a, Low Channel, 1 GHz – 7 GHz, Peak, Ceiling Antenna.....	38
Plot 33. Radiated Spurious Emissions, 802.11a, Low Channel, 7 GHz – 18 GHz, Peak, Ceiling Antenna.....	39
Plot 34. Radiated Spurious Emissions, 802.11a, 40 MHz, Low Channel, 30 MHz – 1 GHz, Ceiling Antenna.....	39
Plot 35. Radiated Spurious Emissions, 802.11a, 40 MHz, Low Channel, 1 GHz – 7 GHz, Average, Ceiling Antenna.....	39
Plot 36. Radiated Spurious Emissions, 802.11a, 40 MHz, Low Channel, 1 GHz – 7 GHz, Peak, Ceiling Antenna.....	40
Plot 37. Radiated Spurious Emissions, 802.11a, 40 MHz, Low Channel, 7 GHz – 18 GHz, Peak, Ceiling Antenna.....	40
Plot 38. Radiated Spurious Emissions, 802.11a, 20 MHz, Mid Channel, 30 MHz – 1 GHz, Ceiling Antenna.....	40
Plot 39. Radiated Spurious Emissions, 802.11a, Mid Channel, 1 GHz – 7 GHz, Average, Ceiling Antenna.....	41
Plot 40. Radiated Spurious Emissions, 802.11a, Mid Channel, 1 GHz – 7 GHz, Peak, Ceiling Antenna.....	41
Plot 41. Radiated Spurious Emissions, 802.11a, Mid Channel, 7 GHz – 18 GHz, Peak, Ceiling Antenna.....	41
Plot 42. Radiated Spurious Emissions, 802.11a, 20 MHz, High Channel, 30 MHz – 1 GHz, Ceiling Antenna.....	42
Plot 43. Radiated Spurious Emissions, 802.11a, High Channel, 1 GHz – 7 GHz, Average, Ceiling Antenna.....	42
Plot 44. Radiated Spurious Emissions, 802.11a, High Channel, 1 GHz – 7 GHz, Peak, Ceiling Antenna.....	42
Plot 45. Radiated Spurious Emissions, 802.11a, High Channel, 7 GHz – 18 GHz, Peak, Ceiling Antenna.....	43
Plot 46. Radiated Spurious Emissions, 802.11a, 40 MHz, High Channel, 30 MHz – 1 GHz, Ceiling Antenna.....	43
Plot 47. Radiated Spurious Emissions, 802.11a, 40 MHz, High Channel, 1 GHz – 7 GHz, Average, Ceiling Antenna.....	43
Plot 48. Radiated Spurious Emissions, 802.11a, 40 MHz, High Channel, 1 GHz – 7 GHz, Peak, Ceiling Antenna.....	44
Plot 49. Radiated Spurious Emissions, 802.11a, 40 MHz, High Channel, 7 GHz – 18 GHz, Peak, Ceiling Antenna.....	44
Plot 50. Radiated Spurious Emissions, 802.11n, 20 MHz, Low Channel, 30 MHz – 1 GHz, Ceiling Antenna.....	45
Plot 51. Radiated Spurious Emissions, 802.11n, Low Channel, 1 GHz – 7 GHz, Average, Ceiling Antenna.....	45
Plot 52. Radiated Spurious Emissions, 802.11n, Low Channel, 1 GHz – 7 GHz, Peak, Ceiling Antenna.....	45

Plot 53. Radiated Spurious Emissions, 802.11n, Low Channel, 7 GHz – 18 GHz, Peak, Ceiling Antenna.....	46
Plot 54. Radiated Spurious Emissions, 802.11n, 40 MHz, Low Channel, 30 MHz – 1 GHz, Ceiling Antenna.....	46
Plot 55. Radiated Spurious Emissions, 802.11n, 40 MHz, Low Channel, 1 GHz – 7 GHz, Average, Ceiling Antenna.....	46
Plot 56. Radiated Spurious Emissions, 802.11n, 40 MHz, Low Channel, 1 GHz – 7 GHz, Peak, Ceiling Antenna.....	47
Plot 57. Radiated Spurious Emissions, 802.11n, 40 MHz, Low Channel, 7 GHz – 18 GHz, Peak, Ceiling Antenna.....	47
Plot 58. Radiated Spurious Emissions, 802.11n, 20 MHz, Mid Channel, 30 MHz – 1 GHz, Ceiling Antenna.....	47
Plot 59. Radiated Spurious Emissions, 802.11n, Mid Channel, 1 GHz – 7 GHz, Average, Ceiling Antenna.....	48
Plot 60. Radiated Spurious Emissions, 802.11n, Mid Channel, 1 GHz – 7 GHz, Peak, Ceiling Antenna.....	48
Plot 61. Radiated Spurious Emissions, 802.11n, Mid Channel, 7 GHz – 18 GHz, Peak, Ceiling Antenna.....	48
Plot 62. Radiated Spurious Emissions, 802.11n, 20 MHz, High Channel, 30 MHz – 1 GHz, Ceiling Antenna.....	49
Plot 63. Radiated Spurious Emissions, 802.11n, High Channel, 1 GHz – 7 GHz, Average, Ceiling Antenna.....	49
Plot 64. Radiated Spurious Emissions, 802.11n, High Channel, 1 GHz – 7 GHz, Peak, Ceiling Antenna.....	49
Plot 65. Radiated Spurious Emissions, 802.11n, High Channel, 7 GHz – 18 GHz, Peak, Ceiling Antenna.....	50
Plot 66. Radiated Spurious Emissions, 802.11n, 40 MHz, High Channel, 30 MHz – 1 GHz, Ceiling Antenna.....	50
Plot 67. Radiated Spurious Emissions, 802.11n, 40 MHz, High Channel, 1 GHz – 7 GHz, Average, Ceiling Antenna.....	50
Plot 68. Radiated Spurious Emissions, 802.11n, 40 MHz, High Channel, 1 GHz – 7 GHz, Peak, Ceiling Antenna.....	51
Plot 69. Radiated Spurious Emissions, 802.11n, 40 MHz, High Channel, 7 GHz – 18 GHz, Peak, Ceiling Antenna.....	51
Plot 70. Radiated Spurious Emissions, 802.11ac, 80 MHz, 30 MHz – 1 GHz, Ceiling Antenna.....	52
Plot 71. Radiated Spurious Emissions, 802.11ac, 1 GHz – 7 GHz, Average, Ceiling Antenna.....	52
Plot 72. Radiated Spurious Emissions, 802.11ac, 1 GHz – 7 GHz, Peak, Ceiling Antenna.....	52
Plot 73. Radiated Spurious Emissions, 802.11ac, 7 GHz – 18 GHz, Peak, Ceiling Antenna.....	53
Plot 74. Radiated Spurious Emissions, 802.11a, 20 MHz, Low Channel, 30 MHz – 1 GHz, Omni Antenna.....	54
Plot 75. Radiated Spurious Emissions, 802.11a, 20 MHz, Low Channel, 1 GHz – 7 GHz, Average, Omni Antenna.....	54
Plot 76. Radiated Spurious Emissions, 802.11a, 20 MHz, Low Channel, 7 GHz – 18 GHz, Omni Antenna.....	54
Plot 77. Radiated Spurious Emissions, 802.11a, 40 MHz, Low Channel, 30 MHz – 1 GHz, Omni Antenna.....	55
Plot 78. Radiated Spurious Emissions, 802.11a, 40 MHz, Low Channel, 1 GHz – 7 GHz, Average, Omni Antenna.....	55
Plot 79. Radiated Spurious Emissions, 802.11a, 40 MHz, Low Channel, 7 GHz – 18 GHz, Omni Antenna.....	55
Plot 80. Radiated Spurious Emissions, 802.11a, 20 MHz, Mid Channel, 30 MHz – 1 GHz, Omni Antenna.....	56
Plot 81. Radiated Spurious Emissions, 802.11a, 20 MHz, Mid Channel, 1 GHz – 7 GHz, Average, Omni Antenna.....	56
Plot 82. Radiated Spurious Emissions, 802.11a, 20 MHz, Mid Channel, 7 GHz – 18 GHz, Omni Antenna.....	56
Plot 83. Radiated Spurious Emissions, 802.11a, 20 MHz, High Channel, 30 MHz – 1 GHz, Omni Antenna.....	57
Plot 84. Radiated Spurious Emissions, 802.11a, 20 MHz, High Channel, 1 GHz – 7 GHz, Average, Omni Antenna.....	57
Plot 85. Radiated Spurious Emissions, 802.11a, 20 MHz, High Channel, 7 GHz – 18 GHz, Omni Antenna.....	57
Plot 86. Radiated Spurious Emissions, 802.11a, 40 MHz, High Channel, 30 MHz – 1 GHz, Omni Antenna.....	58
Plot 87. Radiated Spurious Emissions, 802.11a, 40 MHz, High Channel, 1 GHz – 7 GHz, Average, Omni Antenna.....	58
Plot 88. Radiated Spurious Emissions, 802.11a, 40 MHz, High Channel, 7 GHz – 18 GHz, Omni Antenna.....	58
Plot 89. Radiated Spurious Emissions, 802.11n, 20 MHz, Low Channel, 30 MHz – 1 GHz, Omni Antenna.....	59
Plot 90. Radiated Spurious Emissions, 802.11n, 20 MHz, Low Channel, 1 GHz – 7 GHz, Average, Omni Antenna.....	59
Plot 91. Radiated Spurious Emissions, 802.11n, 20 MHz, Low Channel, 7 GHz – 18 GHz, Omni Antenna.....	59
Plot 92. Radiated Spurious Emissions, 802.11n, 40 MHz, Low Channel, 30 MHz – 1 GHz, Omni Antenna.....	60
Plot 93. Radiated Spurious Emissions, 802.11n, 40 MHz, Low Channel, 1 GHz – 7 GHz, Average, Omni Antenna.....	60
Plot 94. Radiated Spurious Emissions, 802.11n, 40 MHz, Low Channel, 7 GHz – 18 GHz, Omni Antenna.....	60
Plot 95. Radiated Spurious Emissions, 802.11n, 20 MHz, Mid Channel, 30 MHz – 1 GHz, Omni Antenna.....	61
Plot 96. Radiated Spurious Emissions, 802.11n, 20 MHz, Mid Channel, 1 GHz – 7 GHz, Average, Omni Antenna.....	61
Plot 97. Radiated Spurious Emissions, 802.11n, 20 MHz, Mid Channel, 7 GHz – 18 GHz, Omni Antenna.....	61
Plot 98. Radiated Spurious Emissions, 802.11n, 20 MHz, High Channel, 30 MHz – 1 GHz, Omni Antenna.....	62
Plot 99. Radiated Spurious Emissions, 802.11n, 20 MHz, High Channel, 1 GHz – 7 GHz, Average, Omni Antenna.....	62
Plot 100. Radiated Spurious Emissions, 802.11n, 20 MHz, High Channel, 7 GHz – 18 GHz, Omni Antenna.....	62
Plot 101. Radiated Spurious Emissions, 802.11n, 40 MHz, High Channel, 30 MHz – 1 GHz, Omni Antenna.....	63
Plot 102. Radiated Spurious Emissions, 802.11n, 40 MHz, High Channel, 1 GHz – 7 GHz, Average, Omni Antenna.....	63
Plot 103. Radiated Spurious Emissions, 802.11n, 40 MHz, High Channel, 7 GHz – 18 GHz, Omni Antenna.....	63
Plot 104. Radiated Spurious Emissions, 802.11ac, 80 MHz, 30 MHz – 1 GHz, Omni Antenna.....	64
Plot 105. Radiated Spurious Emissions, 802.11ac, 1 GHz – 7 GHz, Average, Omni Antenna.....	64
Plot 106. Radiated Spurious Emissions, 802.11ac, 7 GHz – 18 GHz, Omni Antenna.....	64
Plot 107. Radiated Spurious Emissions, 802.11a, 20 MHz, Low Channel, 30 MHz – 1 GHz, Patch Antenna.....	65
Plot 108. Radiated Spurious Emissions, 802.11a, 20 MHz, Low Channel, 1 GHz – 7 GHz, Average, Patch Antenna.....	65



Plot 109. Radiated Spurious Emissions, 802.11a, 20 MHz, Low Channel, 1 GHz – 7 GHz, Peak, Patch Antenna.....	65
Plot 110. Radiated Spurious Emissions, 802.11a, 20 MHz, Low Channel, 7 GHz – 18 GHz, Peak, Patch Antenna.....	66
Plot 111. Radiated Spurious Emissions, 802.11a, 40 MHz, Low Channel, 30 MHz – 1 GHz, Patch Antenna.....	66
Plot 112. Radiated Spurious Emissions, 802.11a, 40 MHz, Low Channel, 1 GHz – 7 GHz, Average, Patch Antenna.....	66
Plot 113. Radiated Spurious Emissions, 802.11a, 40 MHz, Low Channel, 1 GHz – 7 GHz, Peak, Patch Antenna.....	67
Plot 114. Radiated Spurious Emissions, 802.11a, 40 MHz, Low Channel, 7 GHz – 18 GHz, Peak, Patch Antenna.....	67
Plot 115. Radiated Spurious Emissions, 802.11a, 20 MHz, Mid Channel, 30 MHz – 1 GHz, Patch Antenna.....	67
Plot 116. Radiated Spurious Emissions, 802.11a, 20 MHz, Mid Channel, 1 GHz – 7 GHz, Average, Patch Antenna.....	68
Plot 117. Radiated Spurious Emissions, 802.11a, 20 MHz, Mid Channel, 1 GHz – 7 GHz, Peak, Patch Antenna.....	68
Plot 118. Radiated Spurious Emissions, 802.11a, 20 MHz, Mid Channel, 7 GHz – 18 GHz, Peak, Patch Antenna.....	68
Plot 119. Radiated Spurious Emissions, 802.11a, 20 MHz, High Channel, 30 MHz – 1 GHz, Patch Antenna.....	69
Plot 120. Radiated Spurious Emissions, 802.11a, 20 MHz, High Channel, 1 GHz – 7 GHz, Average, Patch Antenna.....	69
Plot 121. Radiated Spurious Emissions, 802.11a, 20 MHz, High Channel, 1 GHz – 7 GHz, Peak, Patch Antenna.....	69
Plot 122. Radiated Spurious Emissions, 802.11a, 20 MHz, High Channel, 7 GHz – 18 GHz, Peak, Patch Antenna.....	70
Plot 123. Radiated Spurious Emissions, 802.11a, 40 MHz, High Channel, 30 MHz – 1 GHz, Patch Antenna.....	70
Plot 124. Radiated Spurious Emissions, 802.11a, 40 MHz, High Channel, 1 GHz – 7 GHz, Average, Patch Antenna.....	70
Plot 125. Radiated Spurious Emissions, 802.11a, 40 MHz, High Channel, 1 GHz – 7 GHz, Peak, Patch Antenna.....	71
Plot 126. Radiated Spurious Emissions, 802.11a, 40 MHz, High Channel, 7 GHz – 18 GHz, Peak, Patch Antenna.....	71
Plot 127. Radiated Spurious Emissions, 802.11n, 20 MHz, Low Channel, 30 MHz – 1 GHz, Patch Antenna.....	72
Plot 128. Radiated Spurious Emissions, 802.11n, 20 MHz, Low Channel, 1 GHz – 7 GHz, Average, Patch Antenna.....	72
Plot 129. Radiated Spurious Emissions, 802.11n, 20 MHz, Low Channel, 1 GHz – 7 GHz, Peak, Patch Antenna.....	72
Plot 130. Radiated Spurious Emissions, 802.11n, 20 MHz, Low Channel, 7 GHz – 18 GHz, Peak, Patch Antenna.....	73
Plot 131. Radiated Spurious Emissions, 802.11n, 40 MHz, Low Channel, 30 MHz – 1 GHz, Patch Antenna.....	73
Plot 132. Radiated Spurious Emissions, 802.11n, 40 MHz, Low Channel, 1 GHz – 7 GHz, Average, Patch Antenna.....	73
Plot 133. Radiated Spurious Emissions, 802.11n, 40 MHz, Low Channel, 1 GHz – 7 GHz, Peak, Patch Antenna.....	74
Plot 134. Radiated Spurious Emissions, 802.11n, 40 MHz, Low Channel, 7 GHz – 18 GHz, Peak, Patch Antenna.....	74
Plot 135. Radiated Spurious Emissions, 802.11n, 20 MHz, Mid Channel, 30 MHz – 1 GHz, Patch Antenna.....	74
Plot 136. Radiated Spurious Emissions, 802.11n, 20 MHz, Mid Channel, 1 GHz – 7 GHz, Average, Patch Antenna.....	75
Plot 137. Radiated Spurious Emissions, 802.11n, 20 MHz, Mid Channel, 1 GHz – 7 GHz, Patch Antenna.....	75
Plot 138. Radiated Spurious Emissions, 802.11n, 20 MHz, Mid Channel, 7 GHz – 18 GHz, Patch Antenna.....	75
Plot 139. Radiated Spurious Emissions, 802.11n, 20 MHz, High Channel, 30 MHz – 1 GHz, Patch Antenna.....	76
Plot 140. Radiated Spurious Emissions, 802.11n, 20 MHz, High Channel, 1 GHz – 7 GHz, Average, Patch Antenna.....	76
Plot 141. Radiated Spurious Emissions, 802.11n, 20 MHz, High Channel, 1 GHz – 7 GHz, Peak, Patch Antenna.....	76
Plot 142. Radiated Spurious Emissions, 802.11n, 20 MHz, High Channel, 7 GHz – 18 GHz, Peak, Patch Antenna.....	77
Plot 143. Radiated Spurious Emissions, 802.11n, 40 MHz, High Channel, 30 MHz – 1 GHz, Patch Antenna.....	77
Plot 144. Radiated Spurious Emissions, 802.11n, 40 MHz, High Channel, 1 GHz – 7 GHz, Average, Patch Antenna.....	77
Plot 145. Radiated Spurious Emissions, 802.11n, 40 MHz, High Channel, 1 GHz – 7 GHz, Peak, Patch Antenna.....	78
Plot 146. Radiated Spurious Emissions, 802.11n, 40 MHz, High Channel, 7 GHz – 18 GHz, Peak, Patch Antenna.....	78
Plot 147. Radiated Spurious Emissions, 802.11ac, 80 MHz, 30 MHz – 1 GHz, Patch Antenna.....	79
Plot 148. Radiated Spurious Emissions, 802.11ac, 1 GHz – 7 GHz, Average, Patch Antenna.....	79
Plot 149. Radiated Spurious Emissions, 802.11ac, 1 GHz – 7 GHz, Peak, Patch Antenna.....	79
Plot 150. Radiated Spurious Emissions, 802.11ac, 7 GHz – 18 GHz, Peak, Patch Antenna.....	80
Plot 151. Radiated Band Edge, 802.11a, 20 MHz, Low Channel, 6 dBi Omni Outdoor Antenna, Peak.....	81
Plot 152. Radiated Band Edge, 802.11a, 20 MHz, Low Channel, 6 dBi Omni Outdoor Antenna, Average.....	81
Plot 153. Radiated Band Edge, 802.11a, 40 MHz, Low Channel, 6 dBi Omni Outdoor Antenna, Peak.....	82
Plot 154. Radiated Band Edge, 802.11a, 40 MHz, Low Channel, 6 dBi Omni Outdoor Antenna, Average.....	82
Plot 155. Radiated Band Edge, 802.11a, 20 MHz, High Channel, 6 dBi Omni Outdoor Antenna, Peak.....	83
Plot 156. Radiated Band Edge, 802.11a, 20 MHz, High Channel, 6 dBi Omni Outdoor Antenna, Average.....	83
Plot 157. Radiated Band Edge, 802.11a, 40 MHz, Low Channel, 6 dBi Omni Outdoor Antenna, Peak.....	84
Plot 158. Radiated Band Edge, 802.11a, 40 MHz, Low Channel, 6 dBi Omni Outdoor Antenna, Average.....	84
Plot 159. Radiated Band Edge, 802.11n, 20 MHz, Low Channel, 6 dBi Omni Outdoor Antenna, Peak.....	85
Plot 160. Radiated Band Edge, 802.11n, 20 MHz, Low Channel, 6 dBi Omni Outdoor Antenna, Average.....	85
Plot 161. Radiated Band Edge, 802.11n, 40 MHz, Low Channel, 6 dBi Omni Outdoor Antenna, Peak.....	86
Plot 162. Radiated Band Edge, 802.11n, 40 MHz, Low Channel, 6 dBi Omni Outdoor Antenna, Average.....	86
Plot 163. Radiated Band Edge, 802.11n, 20 MHz, High Channel, 6 dBi Omni Outdoor Antenna, Peak.....	87
Plot 164. Radiated Band Edge, 802.11n, 20 MHz, High Channel, 6 dBi Omni Outdoor Antenna, Average.....	87

Plot 165. Radiated Band Edge, 802.11n, 40 MHz, High Channel, 6 dBi Omni Outdoor Antenna, Peak .....	88
Plot 166. Radiated Band Edge, 802.11n, 40 MHz, High Channel, 6 dBi Omni Outdoor Antenna, AverageBand Edge, 802.11ac, 6 dBi Outdoor Omni Antenna .....	88
Plot 167. Radiated Band Edge, 802.11ac, 80 MHz, Low Channel, 6 dBi Omni Outdoor Antenna, Peak .....	89
Plot 168. Radiated Band Edge, 802.11ac, 80 MHz, Low Channel, 6 dBi Omni Outdoor Antenna, Average .....	89
Plot 169. Radiated Band Edge, 802.11ac, 80 MHz, High Channel, 6 dBi Omni Outdoor Antenna, Peak .....	90
Plot 170. Radiated Band Edge, 802.11ac, 80 MHz, High Channel, 6 dBi Omni Outdoor Antenna, Average .....	90
Plot 171. Radiated Band Edge, 802.11a, 20 MHz, Low Channel, 4 dBi Antenna, Peak .....	91
Plot 172. Radiated Band Edge, 802.11a, 20 MHz, Low Channel, 4 dBi Antenna, Average .....	91
Plot 173. Radiated Band Edge, 802.11a, 40 MHz, Low Channel, 4 dBi Antenna, Peak .....	92
Plot 174. Radiated Band Edge, 802.11a, 40 MHz, Low Channel, 4 dBi Antenna, Average .....	92
Plot 175. Radiated Band Edge, 802.11a, 20 MHz, High Channel, 4 dBi Antenna, Peak .....	93
Plot 176. Radiated Band Edge, 802.11a, 20 MHz, High Channel, 4 dBi Antenna, Average .....	93
Plot 177. Radiated Band Edge, 802.11a, 40 MHz, High Channel, 4 dBi Antenna, Peak .....	94
Plot 178. Radiated Band Edge, 802.11a, 40 MHz, High Channel, 4 dBi Antenna, Average .....	94
Plot 179. Radiated Band Edge, 802.11n, 20 MHz, Low Channel, 4 dBi Antenna, Peak .....	95
Plot 180. Radiated Band Edge, 802.11n, 20 MHz, Low Channel, 4 dBi Antenna, Average .....	95
Plot 181. Radiated Band Edge, 802.11n, 40 MHz, Low Channel, 4 dBi Antenna, Peak .....	96
Plot 182. Radiated Band Edge, 802.11n, 40 MHz, Low Channel, 4 dBi Antenna, Average .....	96
Plot 183. Radiated Band Edge, 802.11n, 20 MHz, High Channel, 4 dBi Antenna, Peak .....	97
Plot 184. Radiated Band Edge, 802.11n, 20 MHz, High Channel, 4 dBi Antenna, Average .....	97
Plot 185. Radiated Band Edge, 802.11n, 40 MHz, High Channel, 4 dBi Antenna, Peak .....	98
Plot 186. Radiated Band Edge, 802.11n, 40 MHz, High Channel, 4 dBi Antenna, AverageBand Edge, 802.11ac, 4 dBi Antenna .....	98
Plot 187. Radiated Band Edge, 802.11ac, 80 MHz, Low Channel, 4 dBi Antenna, Peak .....	99
Plot 188. Radiated Band Edge, 802.11ac, 80 MHz, Low Channel, 4 dBi Antenna, Average .....	99
Plot 189. Radiated Band Edge, 802.11ac, 80 MHz, High Channel, 4 dBi Antenna, Peak .....	100
Plot 190. Radiated Band Edge, 802.11ac, 80 MHz, High Channel, 4 dBi Antenna, Average.....	100
Plot 191. Radiated Band Edge, 802.11a, 20 MHz, Low Channel, 7 dBi Antenna, Peak.....	101
Plot 192. Radiated Band Edge, 802.11a, 20 MHz, Low Channel, 7 dBi Antenna, Average .....	101
Plot 193. Radiated Band Edge, 802.11a, 40 MHz, Low Channel, 7 dBi Antenna, Peak.....	102
Plot 194. Radiated Band Edge, 802.11a, 40 MHz, Low Channel, 7 dBi Antenna, Average .....	102
Plot 195. Radiated Band Edge, 802.11a, 20 MHz, High Channel, 7 dBi Antenna, Peak .....	103
Plot 196. Radiated Band Edge, 802.11a, 20 MHz, High Channel, 7 dBi Antenna, Average .....	103
Plot 197. Radiated Band Edge, 802.11a, 40 MHz, High Channel, 7 dBi Antenna, Peak .....	104
Plot 198. Radiated Band Edge, 802.11a, 40 MHz, High Channel, 7 dBi Antenna, Average .....	104
Plot 199. Radiated Band Edge, 802.11n, 20 MHz, Low Channel, 7 dBi Antenna, Peak .....	105
Plot 200. Radiated Band Edge, 802.11n, 20 MHz, Low Channel, 7 dBi Antenna, Average .....	105
Plot 201. Radiated Band Edge, 802.11n, 40 MHz, Low Channel, 7 dBi Antenna, Peak .....	106
Plot 202. Radiated Band Edge, 802.11n, 40 MHz, Low Channel, 7 dBi Antenna, Average .....	106
Plot 203. Radiated Band Edge, 802.11n, 20 MHz, High Channel, 7 dBi Antenna, Peak .....	107
Plot 204. Radiated Band Edge, 802.11n, 20 MHz, High Channel, 7 dBi Antenna, Average .....	107
Plot 205. Radiated Band Edge, 802.11n, 40 MHz, High Channel, 7 dBi Antenna, Peak .....	108
Plot 206. Radiated Band Edge, 802.11n, 40 MHz, High Channel, 7 dBi Antenna, Average .....	108
Plot 207. Radiated Band Edge, 802.11ac, 80 MHz, Low Channel, 7 dBi Antenna, Peak .....	109
Plot 208. Radiated Band Edge, 802.11ac, 80 MHz, Low Channel, 7 dBi Antenna, Average .....	109
Plot 209. Radiated Band Edge, 802.11ac, 80 MHz, High Channel, 7 dBi Antenna, Peak .....	110
Plot 210. Radiated Band Edge, 802.11ac, 80 MHz, High Channel, 7 dBi Antenna, Average.....	110
Plot 211. Radiated Spurs, Co-Location, 802.11n 20 MHz, 2412 MHz & 2412 MHz, 30 MHz – 1 GHz, Peak, Omni.....	112
Plot 212. Radiated Spurs, Co-Location, 802.11n 20 MHz, 2412 MHz & 2412 MHz, 1 GHz – 7 GHz, Avg., Omni .....	112
Plot 213. Radiated Spurs, Co-Location, 802.11n 20 MHz, 2412 MHz & 2412 MHz, 1 GHz – 7 GHz, Peak, Omni .....	112
Plot 214. Radiated Spurs, Co-Location, 802.11n 20 MHz, 2412 MHz & 2412 MHz, 7 GHz – 18 GHz, Peak, Omni .....	113
Plot 215. Radiated Spurs, Co-Location, 802.11n 20 MHz, 2412 MHz & 2437 MHz, 30 MHz – 1 GHz, Peak, Omni.....	113
Plot 216. Radiated Spurs, Co-Location, 802.11n 20 MHz, 2412 MHz & 2437 MHz, 1 GHz – 7 GHz, Avg., Omni .....	113
Plot 217. Radiated Spurs, Co-Location, 802.11n 20 MHz, 2412 MHz & 2437 MHz, 1 GHz – 7 GHz, Peak, Omni .....	114
Plot 218. Radiated Spurs, Co-Location, 802.11n 20 MHz, 2412 MHz & 2437 MHz, 7 GHz – 18 GHz, Peak, Omni .....	114



Plot 275. Radiated Spurs, Co-Location, 802.11n 20 MHz, 2462 MHz & 5580 MHz, 30 MHz – 1 GHz, Peak, Omni.....133

Plot 276. Radiated Spurs, Co-Location, 802.11n 20 MHz, 2462 MHz & 5580 MHz, 1 GHz – 7 GHz, Avg., Omni .....133

Plot 277. Radiated Spurs, Co-Location, 802.11n 20 MHz, 2462 MHz & 5580 MHz, 1 GHz – 7 GHz, Peak, Omni .....134

Plot 278. Radiated Spurs, Co-Location, 802.11n 20 MHz, 2462 MHz & 5580 MHz, 7 GHz – 18 GHz, Peak, Omni .....134

Plot 279. Radiated Spurs, Co-Location, 802.11n 20 MHz, 2462 MHz & 5785 MHz, 30 MHz – 1 GHz, Peak, Omni.....134

Plot 280. Radiated Spurs, Co-Location, 802.11n 20 MHz, 2462 MHz & 5785 MHz, 1 GHz – 7 GHz, Avg., Omni .....135

Plot 281. Radiated Spurs, Co-Location, 802.11n 20 MHz, 2462 MHz & 5785 MHz, 1 GHz – 7 GHz, Peak, Omni .....135

Plot 282. Radiated Spurs, Co-Location, 802.11n 20 MHz, 2462 MHz & 5785 MHz, 7 GHz – 18 GHz, Peak, Omni .....135

Plot 283. Radiated Spurs, Co-Location, 802.11n 20 MHz, 5200 MHz & 5200 MHz, 30 MHz – 1 GHz, Peak, Omni.....136

Plot 284. Radiated Spurs, Co-Location, 802.11n 20 MHz, 5200 MHz & 5200 MHz, 1 GHz – 7 GHz, Avg., Omni .....136

Plot 285. Radiated Spurs, Co-Location, 802.11n 20 MHz, 5200 MHz & 5200 MHz, 1 GHz – 7 GHz, Peak, Omni .....136

Plot 286. Radiated Spurs, Co-Location, 802.11n 20 MHz, 5200 MHz & 5200 MHz, 7 GHz – 18 GHz, Peak, Omni .....137

Plot 287. Radiated Spurs, Co-Location, 802.11n 20 MHz, 5200 MHz & 5300 MHz, 30 MHz – 1 GHz, Peak, Omni.....137

Plot 288. Radiated Spurs, Co-Location, 802.11n 20 MHz, 5200 MHz & 5300 MHz, 1 GHz – 7 GHz, Avg., Omni .....137

Plot 289. Radiated Spurs, Co-Location, 802.11n 20 MHz, 5200 MHz & 5300 MHz, 1 GHz – 7 GHz, Peak, Omni .....138

Plot 290. Radiated Spurs, Co-Location, 802.11n 20 MHz, 5200 MHz & 5300 MHz, 7 GHz – 18 GHz, Peak, Omni .....138

Plot 291. Radiated Spurs, Co-Location, 802.11n 20 MHz, 5200 MHz & 5580 MHz, 30 MHz – 1 GHz, Peak, Omni.....138

Plot 292. Radiated Spurs, Co-Location, 802.11n 20 MHz, 5200 MHz & 5580 MHz, 1 GHz – 7 GHz, Avg., Omni .....139

Plot 293. Radiated Spurs, Co-Location, 802.11n 20 MHz, 5200 MHz & 5580 MHz, 1 GHz – 7 GHz, Peak, Omni .....139

Plot 294. Radiated Spurs, Co-Location, 802.11n 20 MHz, 5200 MHz & 5580 MHz, 7 GHz – 18 GHz, Peak, Omni .....139

Plot 295. Radiated Spurs, Co-Location, 802.11n 20 MHz, 5200 MHz & 5785 MHz, 30 MHz – 1 GHz, Peak, Omni.....140

Plot 296. Radiated Spurs, Co-Location, 802.11n 20 MHz, 5200 MHz & 5785 MHz, 1 GHz – 7 GHz, Avg., Omni .....140

Plot 297. Radiated Spurs, Co-Location, 802.11n 20 MHz, 5200 MHz & 5785 MHz, 1 GHz – 7 GHz, Peak, Omni .....140

Plot 298. Radiated Spurs, Co-Location, 802.11n 20 MHz, 5200 MHz & 5785 MHz, 7 GHz – 18 GHz, Peak, Omni .....141

Plot 299. Radiated Spurs, Co-Location, 802.11n 20 MHz, 5300 MHz & 5300 MHz, 30 MHz – 1 GHz, Peak, Omni.....141

Plot 300. Radiated Spurs, Co-Location, 802.11n 20 MHz, 5300 MHz & 5300 MHz, 1 GHz – 7 GHz, Avg., Omni .....141

Plot 301. Radiated Spurs, Co-Location, 802.11n 20 MHz, 5300 MHz & 5300 MHz, 1 GHz – 7 GHz, Peak, Omni .....142

Plot 302. Radiated Spurs, Co-Location, 802.11n 20 MHz, 5300 MHz & 5300 MHz, 7 GHz – 18 GHz, Peak, Omni .....142

Plot 303. Radiated Spurs, Co-Location, 802.11n 20 MHz, 5300 MHz & 5580 MHz, 30 MHz – 1 GHz, Peak, Omni.....142

Plot 304. Radiated Spurs, Co-Location, 802.11n 20 MHz, 5300 MHz & 5580 MHz, 1 GHz – 7 GHz, Avg., Omni .....143

Plot 305. Radiated Spurs, Co-Location, 802.11n 20 MHz, 5300 MHz & 5580 MHz, 1 GHz – 7 GHz, Peak, Omni .....143

Plot 306. Radiated Spurs, Co-Location, 802.11n 20 MHz, 5300 MHz & 5580 MHz, 7 GHz – 18 GHz, Peak, Omni .....143

Plot 307. Radiated Spurs, Co-Location, 802.11n 20 MHz, 5300 MHz & 5785 MHz, 30 MHz – 1 GHz, Peak, Omni.....144

Plot 308. Radiated Spurs, Co-Location, 802.11n 20 MHz, 5300 MHz & 5785 MHz, 1 GHz – 7 GHz, Avg., Omni .....144

Plot 309. Radiated Spurs, Co-Location, 802.11n 20 MHz, 5300 MHz & 5785 MHz, 1 GHz – 7 GHz, Peak, Omni .....144

Plot 310. Radiated Spurs, Co-Location, 802.11n 20 MHz, 5300 MHz & 5785 MHz, 7 GHz – 18 GHz, Peak, Omni .....145

Plot 311. Radiated Spurs, Co-Location, 802.11n 20 MHz, 5580 MHz & 5580 MHz, 30 MHz – 1 GHz, Peak, Omni.....145

Plot 312. Radiated Spurs, Co-Location, 802.11n 20 MHz, 5580 MHz & 5580 MHz, 1 GHz – 7 GHz, Avg., Omni .....145

Plot 313. Radiated Spurs, Co-Location, 802.11n 20 MHz, 5580 MHz & 5580 MHz, 1 GHz – 7 GHz, Peak, Omni .....146

Plot 314. Radiated Spurs, Co-Location, 802.11n 20 MHz, 5580 MHz & 5580 MHz, 7 GHz – 18 GHz, Peak, Omni .....146

Plot 315. Radiated Spurs, Co-Location, 802.11n 20 MHz, 5580 MHz & 5785 MHz, 30 MHz – 1 GHz, Peak, Omni.....146

Plot 316. Radiated Spurs, Co-Location, 802.11n 20 MHz, 5580 MHz & 5785 MHz, 1 GHz – 7 GHz, Avg., Omni .....147

Plot 317. Radiated Spurs, Co-Location, 802.11n 20 MHz, 5580 MHz & 5785 MHz, 1 GHz – 7 GHz, Peak, Omni .....147

Plot 318. Radiated Spurs, Co-Location, 802.11n 20 MHz, 5580 MHz & 5785 MHz, 7 GHz – 18 GHz, Peak, Omni .....147

Plot 319. Radiated Spurs, Co-Location, 802.11n 20 MHz, 5785 MHz & 5785 MHz, 30 MHz – 1 GHz, Peak, Omni.....148

Plot 320. Radiated Spurs, Co-Location, 802.11n 20 MHz, 5785 MHz & 5785 MHz, 1 GHz – 7 GHz, Avg., Omni .....148

Plot 321. Radiated Spurs, Co-Location, 802.11n 20 MHz, 5785 MHz & 5785 MHz, 1 GHz – 7 GHz, Peak, Omni .....148

Plot 322. Radiated Spurs, Co-Location, 802.11n 20 MHz, 5785 MHz & 5785 MHz, 7 GHz – 18 GHz, Peak, Omni .....149

Plot 323. Radiated Spurs, Co-Location, 802.11n 20 MHz, 2412 MHz & 5200 MHz, 30 MHz – 1 GHz, Peak, Patch .....150

Plot 324. Radiated Spurs, Co-Location, 802.11n 20 MHz, 2412 MHz & 5200 MHz, 1 GHz – 7 GHz, Avg., Patch .....150

Plot 325. Radiated Spurs, Co-Location, 802.11n 20 MHz, 2412 MHz & 5200 MHz, 1 GHz – 7 GHz, Peak, Patch.....150

Plot 326. Radiated Spurs, Co-Location, 802.11n 20 MHz, 2412 MHz & 5200 MHz, 7 GHz – 18 GHz, Peak, Patch.....151

Plot 327. Radiated Spurs, Co-Location, 802.11n 20 MHz, 2412 MHz & 5300 MHz, 30 MHz – 1 GHz, Peak, Patch.....151

Plot 328. Radiated Spurs, Co-Location, 802.11n 20 MHz, 2412 MHz & 5300 MHz, 1 GHz – 7 GHz, Avg., Patch .....151

Plot 329. Radiated Spurs, Co-Location, 802.11n 20 MHz, 2412 MHz & 5300 MHz, 1 GHz – 7 GHz, Peak, Patch.....152

Plot 330. Radiated Spurs, Co-Location, 802.11n 20 MHz, 2412 MHz & 5300 MHz, 7 GHz – 18 GHz, Peak, Patch.....152

Plot 331. Radiated Spurs, Co-Location, 802.11n 20 MHz, 2412 MHz & 5580 MHz, 30 MHz – 1 GHz, Peak, Patch.....	152
Plot 332. Radiated Spurs, Co-Location, 802.11n 20 MHz, 2412 MHz & 5580 MHz, 1 GHz – 7 GHz, Avg., Patch .....	153
Plot 333. Radiated Spurs, Co-Location, 802.11n 20 MHz, 2412 MHz & 5580 MHz, 1 GHz – 7 GHz, Peak, Patch.....	153
Plot 334. Radiated Spurs, Co-Location, 802.11n 20 MHz, 2412 MHz & 5580 MHz, 7 GHz – 18 GHz, Peak, Patch.....	153
Plot 335. Radiated Spurs, Co-Location, 802.11n 20 MHz, 2412 MHz & 5785 MHz, 30 MHz – 1 GHz, Peak, Patch.....	154
Plot 336. Radiated Spurs, Co-Location, 802.11n 20 MHz, 2412 MHz & 5785 MHz, 1 GHz – 7 GHz, Avg., Patch .....	154
Plot 337. Radiated Spurs, Co-Location, 802.11n 20 MHz, 2412 MHz & 5785 MHz, 1 GHz – 7 GHz, Peak, Patch.....	154
Plot 338. Radiated Spurs, Co-Location, 802.11n 20 MHz, 2412 MHz & 5785 MHz, 7 GHz – 18 GHz, Peak, Patch.....	155
Plot 339. Radiated Spurs, Co-Location, 802.11n 20 MHz, 2437 MHz & 5200 MHz, 30 MHz – 1 GHz, Peak, Patch.....	155
Plot 340. Radiated Spurs, Co-Location, 802.11n 20 MHz, 2437 MHz & 5200 MHz, 1 GHz – 7 GHz, Avg., Patch .....	155
Plot 341. Radiated Spurs, Co-Location, 802.11n 20 MHz, 2437 MHz & 5200 MHz, 1 GHz – 7 GHz, Peak, Patch.....	156
Plot 342. Radiated Spurs, Co-Location, 802.11n 20 MHz, 2437 MHz & 5200 MHz, 7 GHz – 18 GHz, Peak, Patch.....	156
Plot 343. Radiated Spurs, Co-Location, 802.11n 20 MHz, 2437 MHz & 5300 MHz, 30 MHz – 1 GHz, Peak, Patch.....	156
Plot 344. Radiated Spurs, Co-Location, 802.11n 20 MHz, 2437 MHz & 5300 MHz, 1 GHz – 7 GHz, Avg., Patch .....	157
Plot 345. Radiated Spurs, Co-Location, 802.11n 20 MHz, 2437 MHz & 5300 MHz, 1 GHz – 7 GHz, Peak, Patch.....	157
Plot 346. Radiated Spurs, Co-Location, 802.11n 20 MHz, 2437 MHz & 5300 MHz, 7 GHz – 18 GHz, Peak, Patch.....	157
Plot 347. Radiated Spurs, Co-Location, 802.11n 20 MHz, 2437 MHz & 5580 MHz, 30 MHz – 1 GHz, Peak, Patch.....	158
Plot 348. Radiated Spurs, Co-Location, 802.11n 20 MHz, 2437 MHz & 5580 MHz, 1 GHz – 7 GHz, Avg., Patch .....	158
Plot 349. Radiated Spurs, Co-Location, 802.11n 20 MHz, 2437 MHz & 5580 MHz, 1 GHz – 7 GHz, Peak, Patch.....	158
Plot 350. Radiated Spurs, Co-Location, 802.11n 20 MHz, 2437 MHz & 5580 MHz, 7 GHz – 18 GHz, Peak, Patch.....	159
Plot 351. Radiated Spurs, Co-Location, 802.11n 20 MHz, 2437 MHz & 5785 MHz, 30 MHz – 1 GHz, Peak, Patch.....	159
Plot 352. Radiated Spurs, Co-Location, 802.11n 20 MHz, 2437 MHz & 5785 MHz, 1 GHz – 7 GHz, Avg., Patch .....	159
Plot 353. Radiated Spurs, Co-Location, 802.11n 20 MHz, 2437 MHz & 5785 MHz, 1 GHz – 7 GHz, Peak, Patch.....	160
Plot 354. Radiated Spurs, Co-Location, 802.11n 20 MHz, 2437 MHz & 5785 MHz, 7 GHz – 18 GHz, Peak, Patch.....	160
Plot 355. Radiated Spurs, Co-Location, 802.11n 20 MHz, 2462 MHz & 5200 MHz, 30 MHz – 1 GHz, Peak, Patch.....	160
Plot 356. Radiated Spurs, Co-Location, 802.11n 20 MHz, 2462 MHz & 5200 MHz, 1 GHz – 7 GHz, Avg., Patch .....	161
Plot 357. Radiated Spurs, Co-Location, 802.11n 20 MHz, 2462 MHz & 5200 MHz, 1 GHz – 7 GHz, Peak, Patch.....	161
Plot 358. Radiated Spurs, Co-Location, 802.11n 20 MHz, 2462 MHz & 5200 MHz, 7 GHz – 18 GHz, Peak, Patch.....	161
Plot 359. Radiated Spurs, Co-Location, 802.11n 20 MHz, 2462 MHz & 5300 MHz, 30 MHz – 1 GHz, Peak, Patch.....	162
Plot 360. Radiated Spurs, Co-Location, 802.11n 20 MHz, 2462 MHz & 5300 MHz, 1 GHz – 7 GHz, Avg., Patch .....	162
Plot 361. Radiated Spurs, Co-Location, 802.11n 20 MHz, 2462 MHz & 5300 MHz, 1 GHz – 7 GHz, Peak, Patch.....	162
Plot 362. Radiated Spurs, Co-Location, 802.11n 20 MHz, 2462 MHz & 5300 MHz, 7 GHz – 18 GHz, Peak, Patch.....	163
Plot 363. Radiated Spurs, Co-Location, 802.11n 20 MHz, 2462 MHz & 5580 MHz, 30 MHz – 1 GHz, Peak, Patch.....	163
Plot 364. Radiated Spurs, Co-Location, 802.11n 20 MHz, 2462 MHz & 5580 MHz, 1 GHz – 7 GHz, Avg., Patch .....	163
Plot 365. Radiated Spurs, Co-Location, 802.11n 20 MHz, 2462 MHz & 5580 MHz, 1 GHz – 7 GHz, Peak, Patch.....	164
Plot 366. Radiated Spurs, Co-Location, 802.11n 20 MHz, 2462 MHz & 5580 MHz, 7 GHz – 18 GHz, Peak, Patch.....	164
Plot 367. Radiated Spurs, Co-Location, 802.11n 20 MHz, 2462 MHz & 5785 MHz, 30 MHz – 1 GHz, Peak, Patch.....	164
Plot 368. Radiated Spurs, Co-Location, 802.11n 20 MHz, 2462 MHz & 5785 MHz, 1 GHz – 7 GHz, Avg., Patch .....	165
Plot 369. Radiated Spurs, Co-Location, 802.11n 20 MHz, 2462 MHz & 5785 MHz, 1 GHz – 7 GHz, Peak, Patch.....	165
Plot 370. Radiated Spurs, Co-Location, 802.11n 20 MHz, 2462 MHz & 5785 MHz, 7 GHz – 18 GHz, Peak, Patch.....	165
Plot 371. Frequency Stability, 5150 – 5350 MHz, -40°C, 120 V.....	168
Plot 372. Frequency Stability, 5150 – 5350 MHz, -30°C, 120 V.....	168
Plot 373. Frequency Stability, 5150 – 5350 MHz, -20°C, 120 V.....	168
Plot 374. Frequency Stability, 5150 – 5350 MHz, -10°C, 120 V.....	169
Plot 375. Frequency Stability, 5150 – 5350 MHz, 0°C, 120 V.....	169
Plot 376. Frequency Stability, 5150 – 5350 MHz, 10°C, 120 V.....	169
Plot 377. Frequency Stability, 5150 – 5350 MHz, 20°C, 120 V.....	170
Plot 378. Frequency Stability, 5150 – 5350 MHz, 30°C, 120 V.....	170
Plot 379. Frequency Stability, 5150 – 5350 MHz, 40°C, 120 V.....	170
Plot 380. Frequency Stability, 5150 – 5350 MHz, 50°C, 120 V.....	171
Plot 381. Frequency Stability, 5150 – 5350 MHz, 55°C, 120 V.....	171

## List of Terms and Abbreviations

AC	Alternating Current
ACF	Antenna Correction Factor
Cal	Calibration
<i>d</i>	Measurement Distance
dB	Decibels
dB $\mu$ A	Decibels above one <b>microamp</b>
dB $\mu$ V	Decibels above one <b>microvolt</b>
dB $\mu$ A/m	Decibels above one <b>microamp per meter</b>
dB $\mu$ V/m	Decibels above one <b>microvolt per meter</b>
DC	Direct Current
E	Electric Field
DSL	Digital Subscriber Line
ESD	Electrostatic Discharge
EUT	Equipment Under Test
<i>f</i>	Frequency
FCC	Federal Communications Commission
GRP	Ground Reference Plane
H	Magnetic Field
HCP	Horizontal Coupling Plane
Hz	Hertz
IEC	International Electrotechnical Commission
kHz	kilohertz
kPa	kilopascal
kV	kilovolt
LISN	Line Impedance Stabilization Network
MHz	Megahertz
$\mu$ H	microhenry
$\mu$	microfarad
$\mu$ s	microseconds
PRF	Pulse Repetition Frequency
RF	Radio Frequency
RMS	Root-Mean-Square
TWT	Traveling Wave Tube
V/m	Volts <b>per meter</b>
VCP	Vertical Coupling Plane

# I. Executive Summary

## A. Purpose of Test

An EMC evaluation was performed to determine compliance of the Meru Networks, Inc. Mission Peak (AP822eV2), with the requirements of Part 15, §15.407. All references are to the most current version of Title 47 of the Code of Federal Regulations in effect. In accordance with §2.1033, the following data is presented in support of the Certification of the Mission Peak (AP822eV2). Meru Networks, Inc. should retain a copy of this document which should be kept on file for at least two years after the manufacturing of the Mission Peak (AP822eV2), has been **permanently** discontinued.

## B. Executive Summary

The following tests were conducted on a sample of the equipment for the purpose of demonstrating compliance with Part 15, §15.407, in accordance with Meru Networks, Inc., purchase order number 107001. All tests were conducted using measurement procedure ANSI C63.4-2003.

FCC Reference	Description	Results
§15.107	Conducted Emissions	Compliant
§15.109	Radiated Emissions	Compliant
§15.203	Antenna Requirements	Compliant
§15.207	AC Conducted Emissions 150KHz – 30MHz	Compliant
§15.403 (i)	26dB Occupied Bandwidth	Compliant
§15.407 (a)(1)(ii)	Conducted Transmitter Output Power	Compliant
§15.407 (a)(1)(ii)	Power Spectral Density	Compliant
§15.407 (b)(1), (3), (5), (6)	Undesirable Emissions (15.205/15.209 - General Field Strength Limits (Restricted Bands and Radiated Emission Limits)	Compliant
§15.407(f)	RF Exposure	Compliant
§15.407(g)	Frequency Stability	Compliant

**Table 1. Executive Summary of EMC Part 15.407 Compliance Testing**



## II. Equipment Configuration

## A. Overview

MET Laboratories, Inc. was contracted by Meru Networks, Inc. to perform testing on the Mission Peak (AP822eV2), under Meru Networks, Inc.'s purchase order number 107001.

This document describes the test setups, test methods, required test equipment, and the test limit criteria used to perform compliance testing of the Meru Networks, Inc. Mission Peak (AP822eV2).

The results obtained relate only to the item(s) tested.

<b>Model(s) Tested:</b>	Mission Peak (AP822eV2)	
<b>Model(s) Covered:</b>	Mission Peak (AP822eV2)	
<b>EUT Specifications:</b>	Primary Power: 120 VAC, 60 Hz	
	FCC ID: RE7-AP822EV2	
	Type of Modulations:	OFDM
	Equipment Code:	NII
	Peak RF Output Power:	24.67 dBm
	EUT Frequency Ranges:	5180-5240MHz
<b>Analysis:</b>	The results obtained relate only to the item(s) tested.	
<b>Environmental Test Conditions:</b>	Temperature: 15-35° C	
	Relative Humidity: 30-60%	
	Barometric Pressure: 860-1060 mbar	
<b>Evaluated by:</b>	Andy Shen	
<b>Report Date(s):</b>	September 23, 2014	

**Table 2. EUT Summary**

## B. References

<b>CFR 47, Part 15, Subpart B</b>	Electromagnetic Compatibility: Criteria for Radio Frequency Devices
<b>CFR 47, Part 15, Subpart E</b>	Unlicensed National Information Infrastructure Devices (UNII)
<b>ANSI C63.4:2003</b>	Methods and Measurements of Radio-Noise Emissions from Low-Voltage Electrical And Electronic Equipment in the Range of 9 kHz to 40 GHz
<b>ISO/IEC 17025:2005</b>	General Requirements for the Competence of Testing and Calibration Laboratories
<b>ANSI C63.10-2009</b>	American National Standard for Testing Unlicensed Wireless Devices

**Table 3. References**

## C. Test Site

All testing was performed at MET Laboratories, Inc., 3162 Belick St., Santa Clara, CA 95054. All equipment used in making physical determinations is accurate and bears recent traceability to the National Institute of Standards and Technology.

Radiated Emissions measurements were performed in a 3 meter semi-anechoic chamber (equivalent to an Open Area Test Site). In accordance with §2.948(a)(3), a complete site description is contained at MET Laboratories.

## D. Description of Test Sample

The Meru Networks, Inc. Mission Peak (AP822eV2), Equipment Under Test (EUT), is an 802.11AC wireless access point (WAP) that allows wireless devices to connect to a wired network using Wi-Fi, standard. The WAP usually connects to a router (via a wired network), and can relay data between the wireless devices (such as computers or printers) and wired devices on the network.

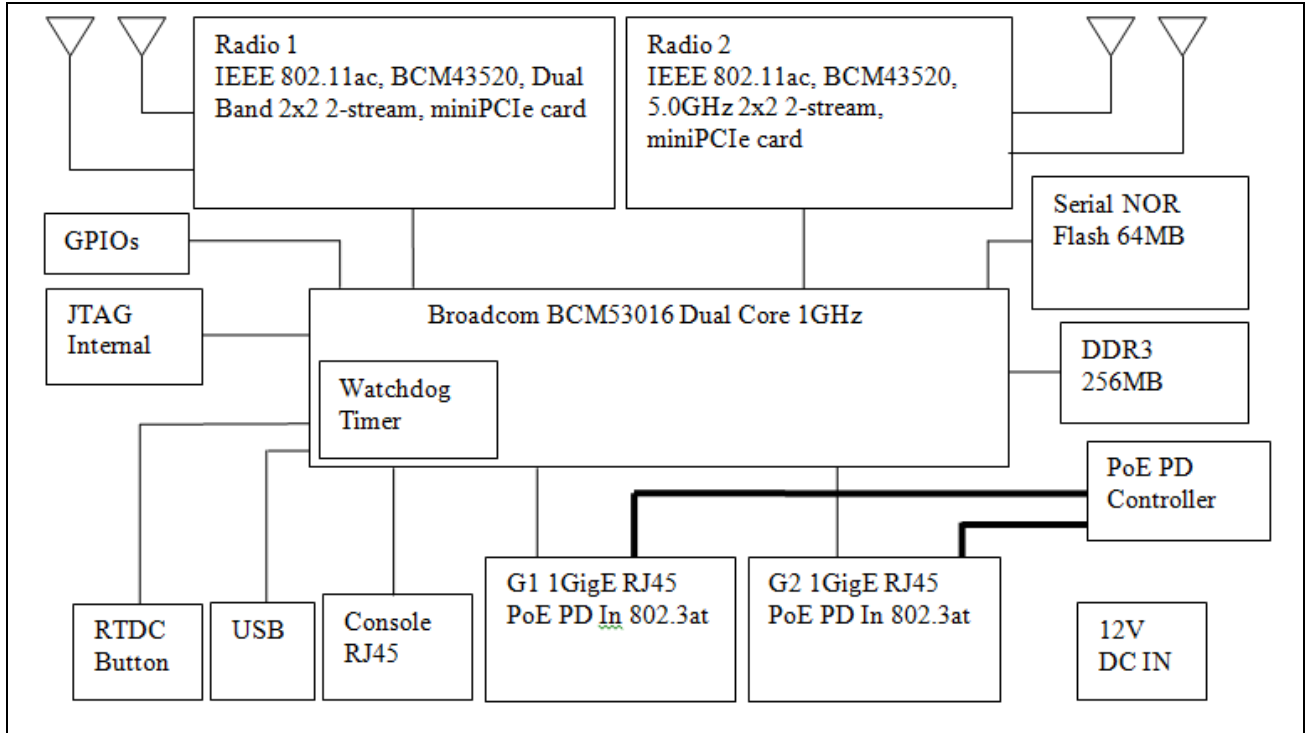

Figure 1. Block Diagram of Test Configuration

## E. Equipment Configuration

The EUT was set up as outlined in Figure 1, Block Diagram of Test Setup. All cards, racks, etc., incorporated as part of the EUT is included in the following list.

Ref. ID	Name / Description	Model Number	Serial Number	Rev. #
1	Dual Radio Access Point	AP822eV2	2414B822e16DB56	Rev 1
2	Dual Radio Access Point	AP822eV2	2614B822e16DB64	Rev 1

**Table 4. Equipment Configuration**

## F. Support Equipment

Support equipment necessary for the operation and testing of the EUT is included in the following list.

Ref. ID	Name / Description	Manufacturer	Model Number
1	PoE	Power Design	PD-9001GR/AC
2	Labtop	IBM	IBM Thinkpad

**Table 5. Support Equipment**

SN	Meru Part Number	Description	Gain 2.4GHz/5.0GHz
1	ANT-01ABGN-0303-0	Omni Directional Rubber Duck antenna	3/4 dBi
2	ANT-01ABGN-0406-O	High Gain Omni Directional Rubber Duck antenna	4/6 dBi
3	ANT-ABGN23O-W	Omni Directional Rubber Duck antenna	2/3 dBi
4	ANT-I2ABGN-0304-O	Ceiling mount Omni Directional Antenna	3/4 dBi
5	ANT-O4ABGN-0607-PT	Dual Band Wall Mount Patch 4-lead Antenna	6/7 dBi
6	ANT-O4ABGN-0606-O	Outdoor Omni Directional 4-leads Dual Band Antenna	6/6 dBi
7	ANT-ABGN-23	Dual Band Ceiling mount Omni Directional 3-lead Antenna	3/4 dBi
8	ANT-6ABGN-24	Dual Band Ceiling mount Omni Directional 6-lead Antenna	2.5/4 dBi
9	ANT-ABGN47O	Dual Band High Gain Dipole Omni Directional Antenna	4.7/4.7 dBi
10	ANT-O6ABGN-0606-O	Dual Band Omni Directional 6-lead Antenna	6/6 dBi
11	ANT-I3ABGN-0304-O	Dual Band Ceiling mount Omni Directional 3-lead Antenna	3/4 dBi
12	ANT-O6ABGN-0607-PT	Dual Band Wall Mount Patch 6-lead Antenna	6/7 dBi

**Table 6. Antenna List**

## G. Ports and Cabling Information

Ref. ID	Port name on EUT	Cable Description or reason for no cable	Qty	Length as tested (m)	Max Length (m)	Shielded? (Y/N)	Termination Box ID & Port Name
1	Reset Console	dB9 Serial cable	1	1	--	Yes	To computer serial port or USB to Serial adapter
2	G1PoE	Data and Power Ethernet port	1	2	10	YES	To PoE injector or Ethernet switch
3	G2PoE	Data and Power Ethernet port	1	2	10	Yes	To PoE injector or Ethernet switch
4	12 DC	12 DV Audio jack	1	1	10	Yes	To DC adapter
5	A1, A3, A4 and A6	RPSMA to SMA co-axial cable	4	0.5	1	Yes	To power meter or spectrum Analyzer

**Table 7. Ports and Cabling Information**

## H. Mode of Operation

During the normal operation the configuration is controlled by the Meru controller which sets the country code, ESSID, Operating frequency band and Channel etc.

## I. Method of Monitoring EUT Operation

During the normal operation with controller Green or Blue LED indication on the Access point indicate the normal operation of the Access point. A Red LED indicates a failure of hardware or software settings.

## J. Modifications

### a) Modifications to EUT

No modifications were made to the EUT.

### b) Modifications to Test Standard

No modifications were made to the test standard.

## K. Disposition of EUT

The test sample including all support equipment submitted to the Electro-Magnetic Compatibility Lab for testing was returned to Meru Networks, Inc. upon completion of testing.

### **III. Electromagnetic Compatibility Criteria for Unintentional Radiators**

## Electromagnetic Compatibility Criteria

### § 15.107 Conducted Emissions Limits

**Test Requirement(s):** **15.107 (a)** Except for Class A digital devices, for equipment that is designed to be connected to the public utility (AC) power line, the radio frequency voltage that is conducted back onto the AC power line on any frequency or frequencies within the band 150 kHz to 30 MHz shall not exceed the limits in Table 8. Compliance with this provision shall be based on the measurement of the radio frequency voltage between each power line and ground at the power terminals.

**15.107 (b)** For a Class A digital device that is designed to be connected to the public utility (AC) power line, the radio frequency voltage that is conducted back onto the AC power line on any frequency or frequencies within the band 150 kHz to 30 MHz shall not exceed the limits in Table 8. Compliance with this provision shall be based on the measurement of the radio frequency voltage between each power line and ground at the power terminals. The lower limit applies at the band edges.

Frequency range (MHz)	Class A Conducted Limits (dB $\mu$ V)		*Class B Conducted Limits (dB $\mu$ V)	
	Quasi-Peak	Average	Quasi-Peak	Average
* 0.15- 0.45	79	66	66 - 56	56 - 46
0.45 - 0.5	79	66	56	46
0.5 - 30	73	60	60	50

Note 1 — The lower limit shall apply at the transition frequencies.  
Note 2 — The limit decreases linearly with the logarithm if the frequency in the range 0.15 MHz to 0.5 MHz.

**Table 8. Conducted Limits for Radio Frequency Devices calculated from FCC Part 15 Subsections 15.107(a) (b)**

**Test Procedures:** The EUT was placed on a non-metallic table, 80 cm above the ground plane inside a semi-anechoic chamber. The method of testing, test conditions, and test procedures of ANSI C63.4 were used. The EUT was powered through a 50 $\Omega$ /50 $\mu$ H LISN. An EMI receiver, connected to the measurement port of the LISN, scanned the frequency range from 150 kHz to 30 MHz in order to find the peak conducted emissions. All peak emissions within 6 dB of the limit were re-measured using a quasi-peak and/or average detector as appropriate.

**Test Results:** The EUT was compliant with the Class B requirement(s) of this section. Measured emissions were below applicable limits.

**Test Engineer(s):** Danny Alvendia

**Test Date(s):** 07/28/14



**Conducted Emissions - Voltage, AC Power, Phase Line (120 VAC, 60 Hz), PoE**

Line	Freq. (MHz)	QP Amplitude	QP Limit	Delta	Pass	Average Amplitude	Average Limit	Delta	Pass
42577 Meru PoE Rad_Off 120V L	0.16	46.7	65.465	-18.765	Pass	35.04	55.465	-20.425	Pass
42577 Meru PoE Rad_Off 120V L	0.2	46.06	63.617	-17.557	Pass	28	53.617	-25.617	Pass
42577 Meru PoE Rad_Off 120V L	0.43	45.58	57.277	-11.697	Pass	36.36	47.277	-10.917	Pass
42577 Meru PoE Rad_Off 120V L	0.45	45.59	56.9	-11.31	Pass	37.01	46.9	-9.89	Pass
42577 Meru PoE Rad_Off 120V L	23.83	46.66	60	-13.34	Pass	30.59	50	-19.41	Pass
42577 Meru PoE Rad_Off 120V L	29.93	48.46	60	-11.54	Pass	32.52	50	-17.48	Pass

**Table 9. Conducted Emissions - Voltage, AC Power, Phase Line (120 VAC, 60 Hz), PoE**



**Plot 1. Conducted Emissions, Phase Line, PoE**

**Conducted Emissions - Voltage, AC Power, Neutral Line (120 VAC, 60 Hz), PoE**

Line	Freq. (MHz)	QP Amplitude	QP Limit	Delta	Pass	Average Amplitude	Average Limit	Delta	Pass
42577 Meru PoE Rad_Off 120V N	0.17	45.12	64.963	-19.843	Pass	29.37	54.963	-25.593	Pass
42577 Meru PoE Rad_Off 120V N	0.44	44.77	57.086	-12.316	Pass	32.92	47.086	-14.166	Pass
42577 Meru PoE Rad_Off 120V N	16.32	46.51	60	-13.49	Pass	29.57	50	-20.43	Pass
42577 Meru PoE Rad_Off 120V N	22.04	46.42	60	-13.58	Pass	27.54	50	-22.46	Pass
42577 Meru PoE Rad_Off 120V N	23.08	45.81	60	-14.19	Pass	29.23	50	-20.77	Pass
42577 Meru PoE Rad_Off 120V N	29.885	47.63	60	-12.37	Pass	32.59	50	-17.41	Pass

**Table 10. Conducted Emissions - Voltage, AC Power, Neutral Line (120 VAC, 60 Hz), PoE**



**Plot 2. Conducted Emissions, Neutral Line, PoE**

**Conducted Emissions - Voltage, AC Power, Phase Line (120 VAC, 60 Hz), AC/DC**

Line	Freq. (MHz)	QP Amplitude	QP Limit	Delta	Pass	Average Amplitude	Average Limit	Delta	Pass
42577 CEV ACDC RadOff L	0.195	57.81	63.827	-6.017	Pass	40.17	53.827	-13.657	Pass
42577 CEV ACDC RadOff L	0.255	51.09	61.605	-10.515	Pass	33.29	51.605	-18.315	Pass
42577 CEV ACDC RadOff L	0.315	42.22	59.854	-17.634	Pass	20.77	49.854	-29.084	Pass
42577 CEV ACDC RadOff L	0.445	40.87	56.993	-16.123	Pass	22.88	46.993	-24.113	Pass
42577 CEV ACDC RadOff L	14.47	46.73	60	-13.27	Pass	37.42	50	-12.58	Pass
42577 CEV ACDC RadOff L	15.785	46.88	60	-13.12	Pass	39.03	50	-10.97	Pass

**Table 11. Conducted Emissions - Voltage, AC Power, Phase Line (120 VAC, 60 Hz), AC/DC**

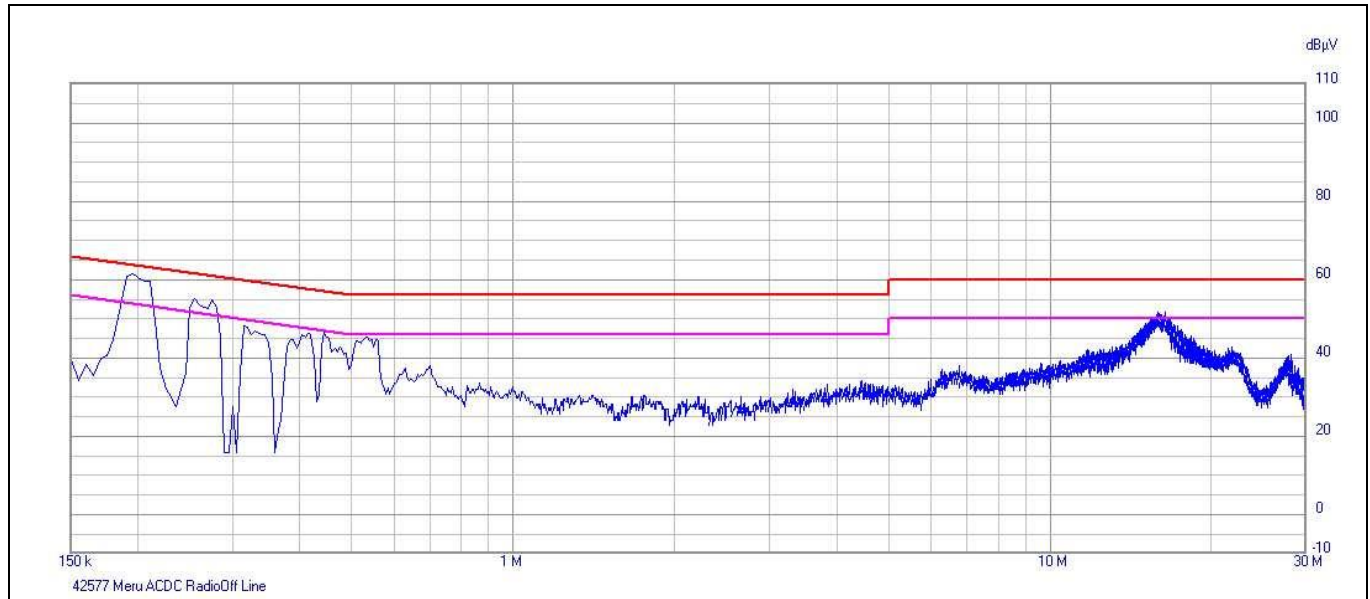

**Plot 3. Conducted Emissions, Phase Line, AC/DC**

**Conducted Emissions - Voltage, AC Power, Neutral Line (120 VAC, 60 Hz), AC/DC**

Line	Freq. (MHz)	QP Amplitude	QP Limit	Delta	Pass	Average Amplitude	Average Limit	Delta	Pass
42577 CEV ACDC RadOff N	0.205	56.12	63.413	-7.293	Pass	33.83	53.413	-19.583	Pass
42577 CEV ACDC RadOff N	0.26	50	61.444	-11.444	Pass	23.09	51.444	-28.354	Pass
42577 CEV ACDC RadOff N	0.27	49.45	61.131	-11.681	Pass	23.09	51.131	-28.041	Pass
42577 CEV ACDC RadOff N	0.32	40.09	59.724	-19.634	Pass	23.6	49.724	-26.124	Pass
42577 CEV ACDC RadOff N	0.46	35.09	56.712	-21.622	Pass	25.81	46.712	-20.902	Pass
42577 CEV ACDC RadOff N	16.07	38.45	60	-21.55	Pass	24.43	50	-25.57	Pass

**Table 12. Conducted Emissions - Voltage, AC Power, Neutral Line (120 VAC, 60 Hz), AC/DC**



**Plot 4. Conducted Emissions, Neutral Line, AC/DC**

## Radiated Emission Limits

### § 15.109 Radiated Emissions Limits

**Test Requirement(s):** **15.109 (a)** Except for Class A digital devices, the field strength of radiated emissions from unintentional radiators at a distance of 3 meters shall not exceed the Class B limits expressed in Table 13.

**15.109 (b)** The field strength of radiated emissions from a Class A digital device, as determined at a distance of 10 meters, shall not exceed the Class A limits expressed in Table 13.

Frequency (MHz)	Field Strength (dB $\mu$ V/m)	
	§15.109 (b), Class A Limit (dB $\mu$ V) @ 10m	§15.109 (a), Class B Limit (dB $\mu$ V) @ 3m
30 - 88	39.00	40.00
88 - 216	43.50	43.50
216 - 960	46.40	46.00
Above 960	49.50	54.00

**Table 13. Radiated Emissions Limits calculated from FCC Part 15, §15.109 (a) (b)**

**Test Procedures:** The EUT was placed on a non-metallic table, 80 cm above the ground plane inside a semi-anechoic chamber. The method of testing and test conditions of ANSI C63.4 were used. An antenna was located 3 m from the EUT on an adjustable mast. A pre-scan was first performed in order to find prominent radiated emissions. For final emissions measurements at each frequency of interest, the EUT was rotated and the antenna height was varied between 1 m and 4 m in order to maximize the emission. Measurements in both horizontal and vertical polarities were made and the data was recorded. Unless otherwise specified, measurements were made using a quasi-peak detector with a 120 kHz bandwidth.

**Test Results:** The EUT was compliant with the Class B requirement(s) of this section. Measured emissions were below applicable limits.

**Test Engineer(s):** Andy Shen

**Test Date(s):** 07/24/14

### Radiated Emissions Limits Test Results, Class B, PoE

Frequency (MHz)	Antenna Polarity	EUT Azimuth (Degrees)	Antenna Height (cm)	Uncorrected Amplitude (dB $\mu$ V)	ACF (dB/m)	Pre Amp Gain (dB)	CBL (dB)	DCF (dB)	Corrected Amplitude (dB $\mu$ V/m)	Limit (dB $\mu$ V/m)	Margin (dB)
187	H	79	130.11	9.1	9.52	0	2.43	0	21.05	43.5	-22.45
495.84	V	173	100	5.63	16.935	0	3.999	0	26.564	46	-19.436
500.02	H	267	181.41	5.66	17.01	0	4.017	0	26.687	46	-19.313
800	H	169	115.8	8.67	19.67	0	5.182	0	33.522	46	-12.478
806.78	V	46	100	5.63	19.758	0	5.204	0	30.592	46	-15.408
825.94	V	20	100	1.78	20.177	0	5.267	0	27.224	46	-18.776

Table 14. Radiated Emissions Limits, Test Results, 30 MHz – 1 GHz, PoE

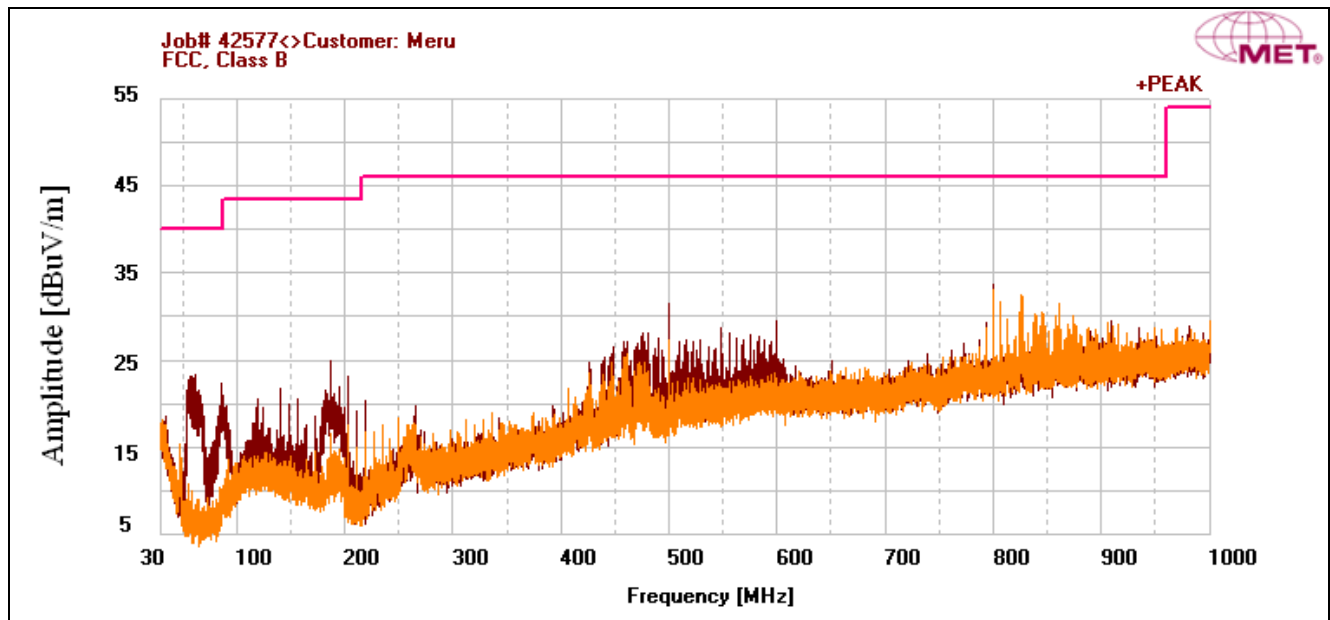

Plot 5. Radiated Emissions, 30 MHz – 1 GHz, PoE

Frequency (MHz)	Antenna Polarity	EUT Azimuth (Degrees)	Antenna Height (cm)	Uncorrected Amplitude (dBμV)	ACF (dB/m)	Pre Amp Gain (dB)	CBL (dB)	DCF (dB)	Corrected Amplitude (dBμV/m)	Limit (dBμV/m)	Margin (dB)
1189	H	104	160.23	29.03	28.507	33.471	0	0	24.066	54	-29.934
1282.5	V	133	215.88	29.61	28.722	33.431	0	0	24.901	54	-29.099
1594.367	V	120	114.94	30.2	28.955	33.3	0	0	25.855	54	-28.145
1860	H	17	100	29.14	30.816	33.189	0	0	26.767	54	-27.233
1924	V	73	100	30.44	31.174	33.162	0	0	28.452	54	-25.548
1956	H	0	100	29.79	31.354	33.148	0	0	27.996	54	-26.004

**Table 15. Radiated Emissions Limits, Test Results, 1 GHz – 2 GHz, PoE**

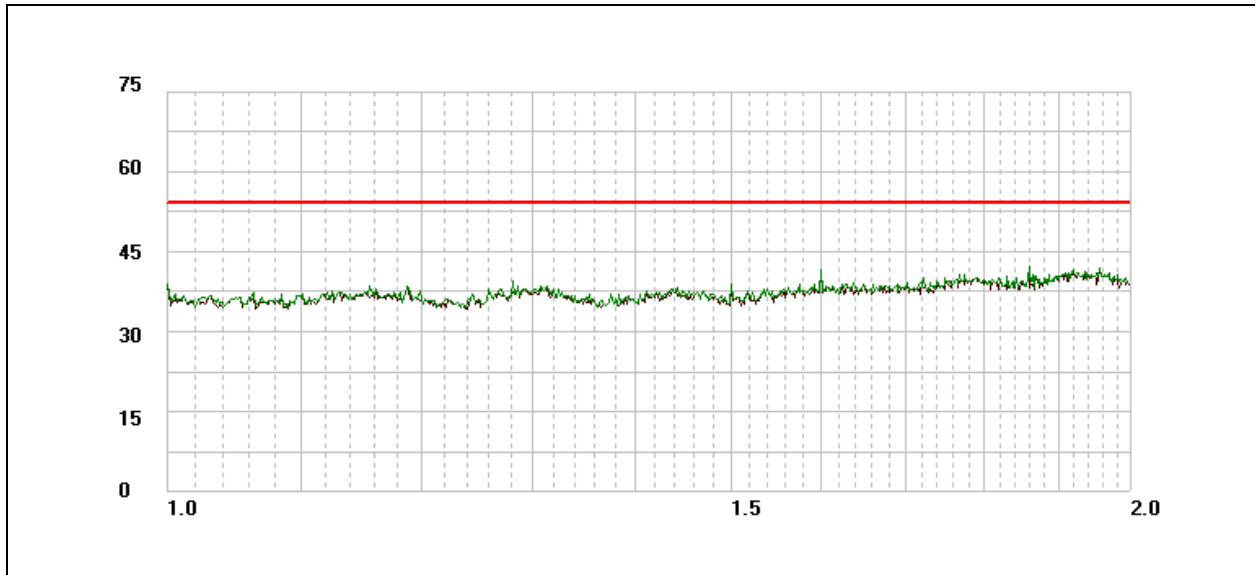

**Plot 6. Radiated Emissions, 1 GHz – 2 GHz, PoE**

### Radiated Emissions Limits Test Results, Class B, AC/DC

Frequency (MHz)	Antenna Polarity	EUT Azimuth (Degrees)	Antenna Height (cm)	Uncorrected Amplitude (dB $\mu$ V)	ACF (dB/m)	Pre Amp Gain (dB)	CBL (dB)	DCF (dB)	Corrected Amplitude (dB $\mu$ V/m)	Limit (dB $\mu$ V/m)	Margin (dB)
71.385	V	151	169.7	13.92	6.801	0	1.477	0	22.198	40	-17.802
131.229	V	283	125.7	13.92	12.479	0	2.021	0	28.42	43.5	-15.08
600.018	V	191	100	1.56	18.82	0	4.486	0	24.866	46	-21.134
793.23	H	269	100.11	5.61	19.792	0	5.156	0	30.558	46	-15.442
800.01	H	264	103.88	9.16	19.67	0	5.182	0	34.012	46	-11.988
806.74	H	270	100.11	3.77	19.758	0	5.204	0	28.732	46	-17.268

Table 16. Radiated Emissions Limits, Test Results, 30 MHz – 1 GHz, AC/DC

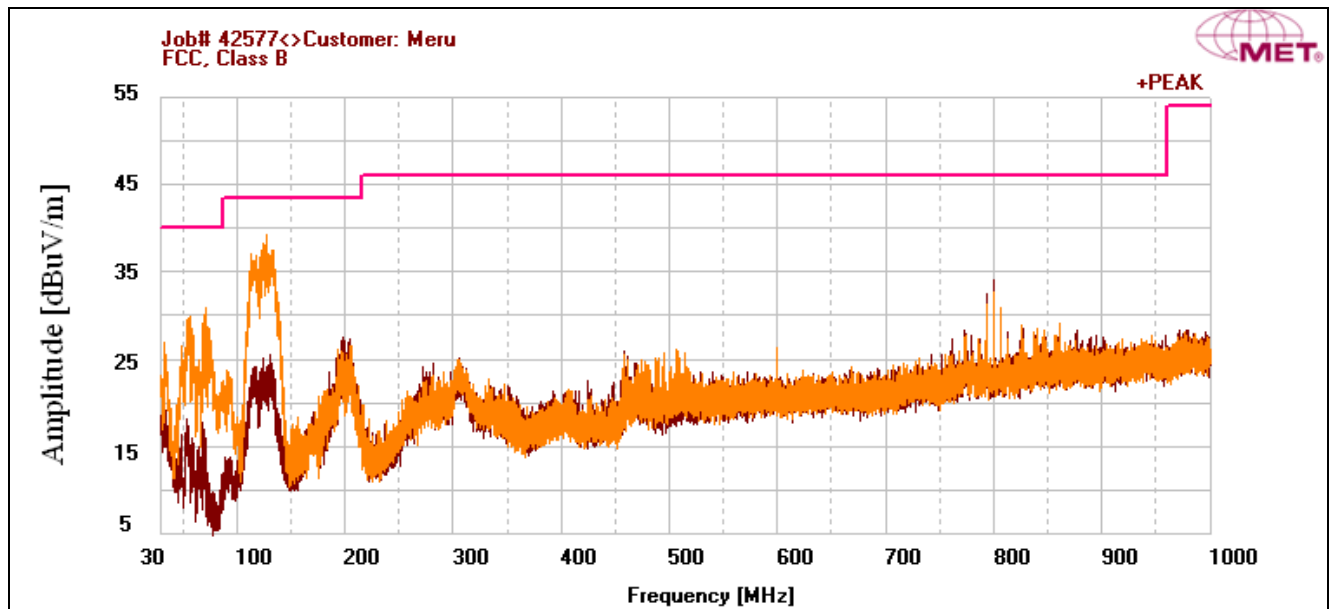

Plot 7. Radiated Emissions, 30 MHz – 1 GHz, AC/DC



Frequency (MHz)	Antenna Polarity	EUT Azimuth (Degrees)	Antenna Height (cm)	Uncorrected Amplitude (dBμV)	ACF (dB/m)	Pre Amp Gain (dB)	CBL (dB)	DCF (dB)	Corrected Amplitude (dBμV/m)	Limit (dBμV/m)	Margin (dB)
1062.667	H	0	167.17	45.04	27.901	33.524	0	0	39.417	54	-14.583
1375.133	H	37	130.05	38.25	28.5	33.392	0	0	33.358	54	-20.642
1500.267	H	99	137.52	47.17	28.202	33.34	0	0	42.032	54	-11.968
1625.333	V	154	198.29	46.69	29.203	33.287	0	0	42.606	54	-11.394
1625.333	H	169	128.58	43.51	29.203	33.287	0	0	39.426	54	-14.574
1750.5	V	0	128.11	43.42	30.203	33.235	0	0	40.388	54	-13.612

Table 17. Radiated Emissions Limits, Test Results, 1 GHz – 2 GHz, AC/DC

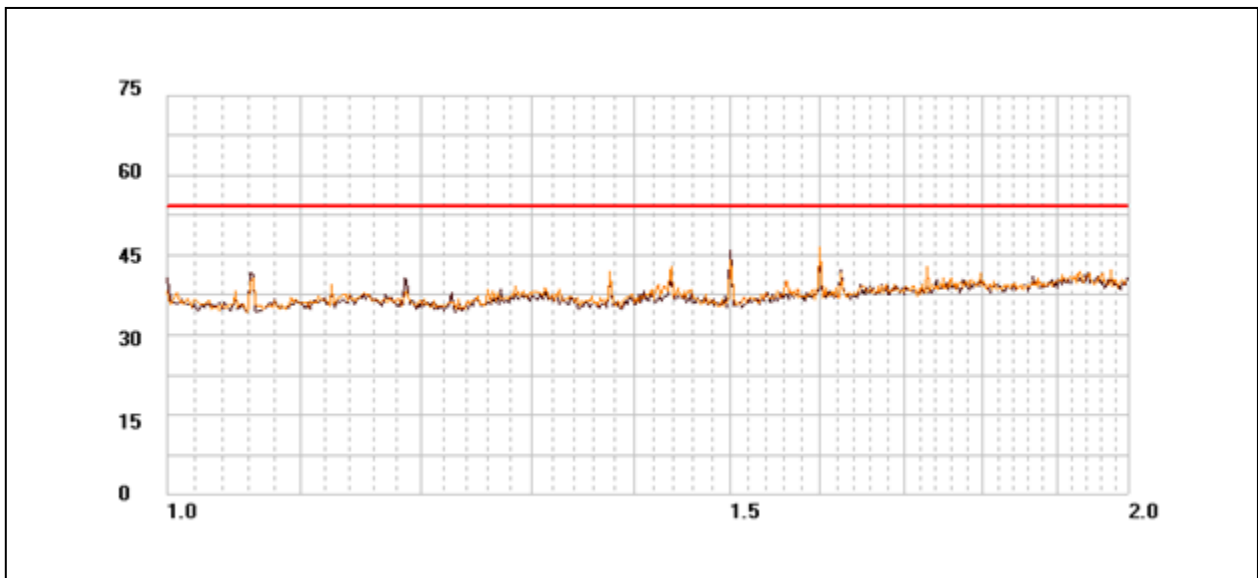

Plot 8. Radiated Emissions, 1 GHz – 2 GHz, AC/DC

## **IV. Electromagnetic Compatibility Criteria for Intentional Radiators**

## Electromagnetic Compatibility Criteria for Intentional Radiators

### § 15.203 Antenna Requirement

**Test Requirement:** § 15.203: An intentional radiator shall be designed to ensure that no antenna other than that furnished by the responsible party shall be used with the device. The use of a permanently attached antenna or of an antenna that uses a unique coupling to the intentional radiator shall be considered sufficient to comply with the provisions of this section. The manufacturer may design the unit so that a broken antenna can be replaced by the user, but the use of a standard antenna jack or electrical connector is prohibited.

The structure and application of the EUT were analyzed to determine compliance with Section 15.203 of the Rules. Section 15.203 states that the subject device must meet at least one of the following criteria:

- a.) Antenna must be permanently attached to the unit.
- b.) Antenna must use a unique type of connector to attach to the EUT.
- c.) Unit must be professionally installed. Installer shall be responsible for verifying that the correct antenna is employed with the unit.

**Results:** The EUT as tested is compliant the criteria of §15.203 as the unit is professionally installed.

**Test Engineer(s):** Andy Shen

**Test Date(s):** 07/26/14

SN	Meru Part Number	Description	Gain 2.4GHz/5.0GHz
1	ANT-ABGN330-W	Omni Directional Rubber Duck antenna	3/3dBi
2	ANT-ABGN460-W	High Gain Omni Directional Rubber Duck antenna	4/6dBi
3	ANT-ABGN230-W	Omni Directional Rubber Duck antenna	2/3dBi
4	ANT-I2ABGN-0304-O	Ceiling mount Omni Directional Antenna	3/4dBi
5	ANT-O4ABGN-0607-PT	Dual Band Wall Mount Patch 4-lead Antenna	6/7dBi
6	ANT-O4ABGN-0606-O	Outdoor Omni Directional 4-leads Dual Band Antenna	6/6dBi
7	ANT-ABGN-23	Dual Band Ceiling mount Omni Directional 3-lead Antenna	3/4dBi
8	ANT-6ABGN-24	Dual Band Ceiling mount Omni Directional 6-lead Antenna	2.5/4dBi
9	ANT-ABGN470	Dual Band High Gain Dipole Omni Directional Antenna	4.7/4.7dBi
10	ANT-O6ABGN-0606-O	Dual Band Omni Directional 6-lead Antenna	6/6dBi
11	ANT-I3ABGN-0304-O	Dual Band Ceiling mount Omni Directional 3-lead Antenna	3/4dBi
12	ANT-O6ABGN-0607-PT	Dual Band Wall Mount Patch 6-lead Antenna	6/7dBi
13	ANT-O6ABGN-0607-PT	Dual Band Wall Mount Patch 6-lead Antenna	6/7dBi

**Table 18. Antenna List**

## Electromagnetic Compatibility Criteria for Intentional Radiators

### § 15.207(a) Conducted Emissions Limits

**Test Requirement(s):** § 15.207 (a): For an intentional radiator that is designed to be connected to the public utility (AC) power line, the radio frequency voltage that is conducted back onto the AC power line on any frequency or frequencies, within the band 150 kHz to 30MHz, shall not exceed the limits in the following table, as measured using a 50  $\mu$ H/50  $\Sigma$  line impedance stabilization network (LISN). Compliance with the provisions of this paragraph shall be based on the measurement of the radio frequency voltage between each power line and ground at the power terminal. The lower limit applies at the boundary between the frequency ranges.

Frequency range (MHz)	§ 15.207(a), Conducted Limit (dB $\mu$ V)	
	Quasi-Peak	Average
* 0.15- 0.45	66 - 56	56 - 46
0.45 - 0.5	56	46
0.5 - 30	60	50

**Table 19. Conducted Limits for Intentional Radiators from FCC Part 15 § 15.207(a)**

**Test Procedure:** The EUT was placed on a 0.8 m-high wooden table inside a screen room. The EUT was situated such that the back of the EUT was 0.4 m from one wall of the vertical ground plane, and the remaining sides of the EUT were no closer than 0.8 m from any other conductive surface. The EUT was powered from a 50  $\Omega$ /50  $\mu$ H Line Impedance Stabilization Network (LISN). The EMC receiver scanned the frequency range from 150 kHz to 30 MHz. Conducted Emissions measurements were made in accordance with *ANSI C63.4-2003 "Methods and Measurements of Radio-Noise Emissions from Low-Voltage Electrical and Electronic Equipment in the Range of 9kHz to 40 GHz"*. The measurements were performed over the frequency range of 0.15 MHz to 30 MHz using a 50  $\Omega$ /50  $\mu$ H LISN as the input transducer to an EMC/field intensity meter. For the purpose of this testing, the transmitter was turned on. Scans were performed with the transmitter on.

**Test Results:** The EUT was compliant with this requirement.

**Test Engineer(s):** Danny Alvendia

**Test Date(s):** 07/28/14

**Conducted Emissions 15.207(a) - Voltage, AC Power, Phase Line (120 VAC, 60 Hz), PoE**

Line	Freq. (MHz)	QP Amplitude	QP Limit	Delta	Pass	Average Amplitude	Average Limit	Delta	Pass
42577 Meru PoE Rad_Off 120V L	0.16	46.7	65.465	-18.765	Pass	35.04	55.465	-20.425	Pass
42577 Meru PoE Rad_Off 120V L	0.2	46.06	63.617	-17.557	Pass	28	53.617	-25.617	Pass
42577 Meru PoE Rad_Off 120V L	0.43	45.58	57.277	-11.697	Pass	36.36	47.277	-10.917	Pass
42577 Meru PoE Rad_Off 120V L	0.45	45.59	56.9	-11.31	Pass	37.01	46.9	-9.89	Pass
42577 Meru PoE Rad_Off 120V L	23.83	46.66	60	-13.34	Pass	30.59	50	-19.41	Pass
42577 Meru PoE Rad_Off 120V L	29.93	48.46	60	-11.54	Pass	32.52	50	-17.48	Pass

**Table 20. Conducted Emissions - Voltage, AC Power, 15.207(a), Phase Line (120 VAC, 60 Hz), PoE**



**Plot 9. Conducted Emissions, 15.207(a), Phase Line, PoE**

**Conducted Emissions 15.207(a) - Voltage, AC Power, Neutral Line (120 VAC, 60 Hz), PoE**

Line	Freq. (MHz)	QP Amplitude	QP Limit	Delta	Pass	Average Amplitude	Average Limit	Delta	Pass
42577 Meru PoE Rad_Off 120V N	0.17	45.12	64.963	-19.843	Pass	29.37	54.963	-25.593	Pass
42577 Meru PoE Rad_Off 120V N	0.44	44.77	57.086	-12.316	Pass	32.92	47.086	-14.166	Pass
42577 Meru PoE Rad_Off 120V N	16.32	46.51	60	-13.49	Pass	29.57	50	-20.43	Pass
42577 Meru PoE Rad_Off 120V N	22.04	46.42	60	-13.58	Pass	27.54	50	-22.46	Pass
42577 Meru PoE Rad_Off 120V N	23.08	45.81	60	-14.19	Pass	29.23	50	-20.77	Pass
42577 Meru PoE Rad_Off 120V N	29.885	47.63	60	-12.37	Pass	32.59	50	-17.41	Pass

**Table 21. Conducted Emissions - Voltage, AC Power, 15.207(a), Neutral Line (120 VAC, 60 Hz), PoE**



**Plot 10. Conducted Emissions, 15.207(a), Neutral Line, PoE**

**Conducted Emissions 15.207(a) - Voltage, AC Power, Phase Line (120 VAC, 60 Hz), AC/DC**

Line	Freq. (MHz)	QP Amplitude	QP Limit	Delta	Pass	Average Amplitude	Average Limit	Delta	Pass
42577 CEV ACDC RadOff L	0.195	57.81	63.827	-6.017	Pass	40.17	53.827	-13.657	Pass
42577 CEV ACDC RadOff L	0.255	51.09	61.605	-10.515	Pass	33.29	51.605	-18.315	Pass
42577 CEV ACDC RadOff L	0.315	42.22	59.854	-17.634	Pass	20.77	49.854	-29.084	Pass
42577 CEV ACDC RadOff L	0.445	40.87	56.993	-16.123	Pass	22.88	46.993	-24.113	Pass
42577 CEV ACDC RadOff L	14.47	46.73	60	-13.27	Pass	37.42	50	-12.58	Pass
42577 CEV ACDC RadOff L	15.785	46.88	60	-13.12	Pass	39.03	50	-10.97	Pass

**Table 22. Conducted Emissions - Voltage, AC Power, 15.207(a), Phase Line (120 VAC, 60 Hz), AC/DC**

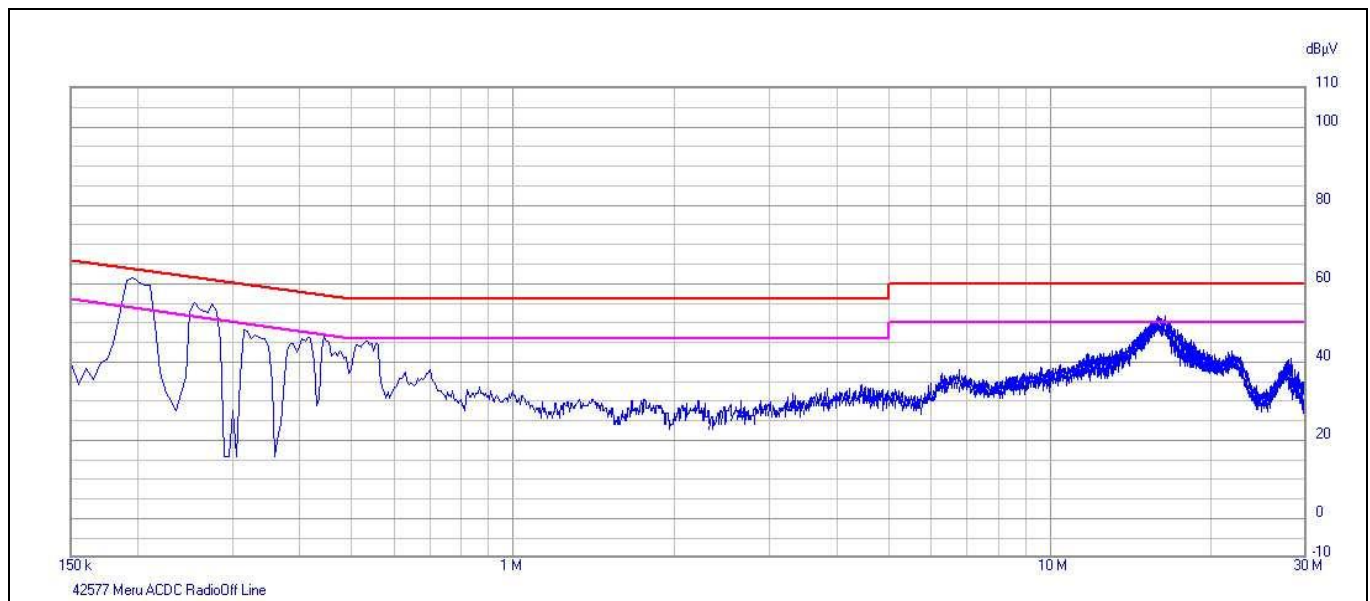

**Plot 11. Conducted Emissions, 15.207(a), Phase Line, AC/DC**

**Conducted Emissions 15.207(a) - Voltage, AC Power, Neutral Line (120 VAC, 60 Hz), AC/DC**

Line	Freq. (MHz)	QP Amplitude	QP Limit	Delta	Pass	Average Amplitude	Average Limit	Delta	Pass
42577 CEV ACDC RadOff N	0.205	56.12	63.413	-7.293	Pass	33.83	53.413	-19.583	Pass
42577 CEV ACDC RadOff N	0.26	50	61.444	-11.444	Pass	23.09	51.444	-28.354	Pass
42577 CEV ACDC RadOff N	0.27	49.45	61.131	-11.681	Pass	23.09	51.131	-28.041	Pass
42577 CEV ACDC RadOff N	0.32	40.09	59.724	-19.634	Pass	23.6	49.724	-26.124	Pass
42577 CEV ACDC RadOff N	0.46	35.09	56.712	-21.622	Pass	25.81	46.712	-20.902	Pass
42577 CEV ACDC RadOff N	16.07	38.45	60	-21.55	Pass	24.43	50	-25.57	Pass

**Table 23. Conducted Emissions - Voltage, AC Power, 15.207(a), Neutral Line (120 VAC, 60 Hz), AC/DC**



**Plot 12. Conducted Emissions, 15.207(a), Neutral Line, AC/DC**



## Electromagnetic Compatibility Criteria for Intentional Radiators

### § 15.403(i) 26dB Bandwidth

**Test Requirements:** § 15.403 (i): For purposes of this subpart the emission bandwidth shall be determined by measuring the width of the signal between two points, one below the carrier center frequency and one above the carrier center frequency, that are 26 dB down relative to the maximum level of the modulated carrier. Determination of the emissions bandwidth is based on the use of measurement instrumentation employing a peak detector function with an instrument resolution bandwidth approximately equal to 1.0 percent of the emission bandwidth of the device under measurement.

**Test Procedure:** The transmitter was set to low, mid, and high operating frequencies at the highest output power and connected to the spectrum analyzer through an attenuator. The bandwidth of the fundamental frequency was measured with the spectrum analyzer using a RBW approximately equal to 1% of the total emission bandwidth, VBW > RBW. The 26 dB Bandwidth was measured and recorded.

**Test Results** The 26 dB Bandwidth was compliant with the requirements of this section and was determined from the plots on the following pages.

**Test Engineer(s):** Andy Shen

**Test Date(s):** 09/05/14

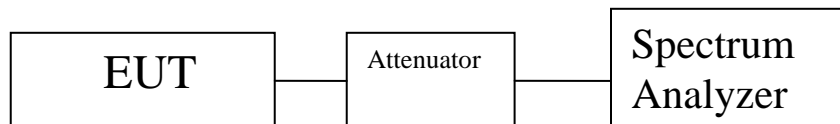
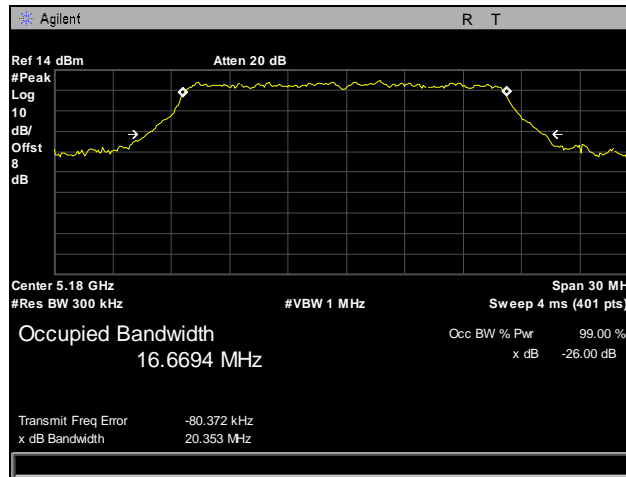
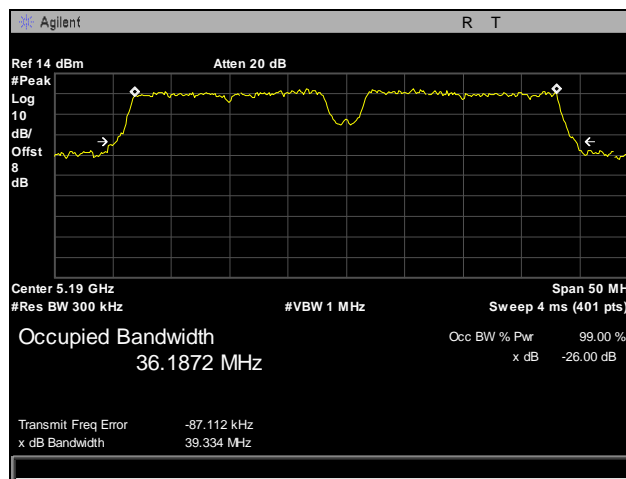

Figure 2. Occupied Bandwidth, Test Setup

**26 dB Occupied Bandwidth, 802.11a**



**Plot 13. 26 dB Occupied Bandwidth, 802.11a, 5180 MHz**



**Plot 14. 26 dB Occupied Bandwidth, 802.11a, 5190 MHz**

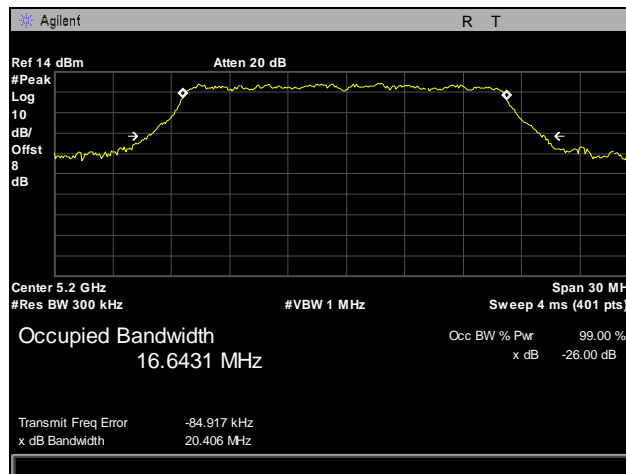

**Plot 15. 26 dB Occupied Bandwidth, 802.11a, 5200 MHz**

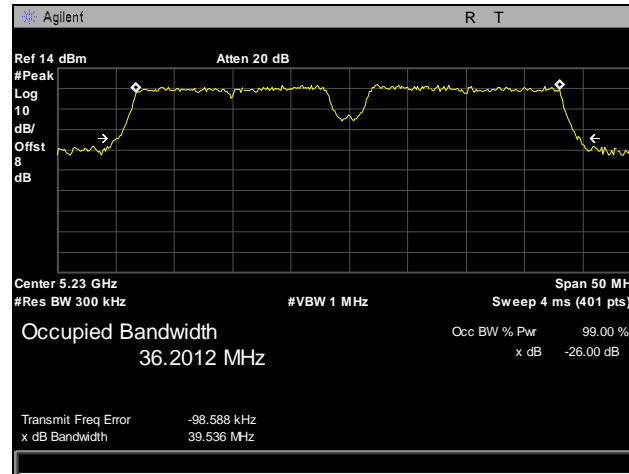

Plot 16. 26 dB Occupied Bandwidth, 802.11a, 5230 MHz

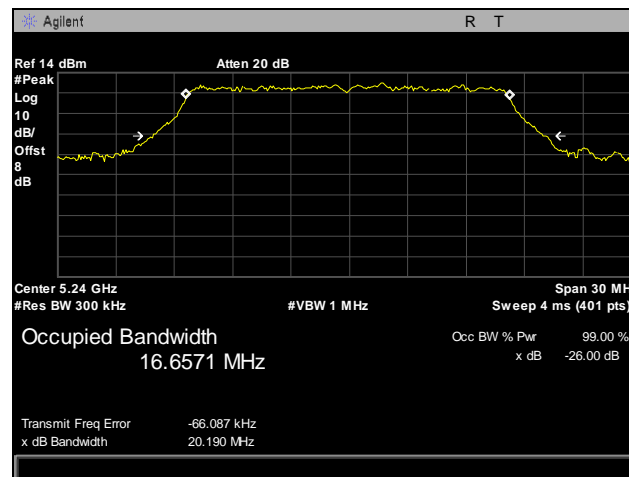

Plot 17. 26 dB Occupied Bandwidth, 802.11a, 5240 MHz

## 26 dB Occupied Bandwidth, 802.11n, Port 1

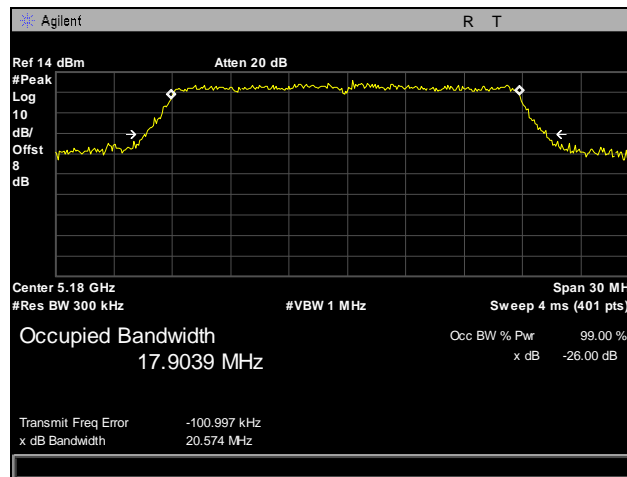

Plot 18. 26 dB Occupied Bandwidth, 802.11n, Port 1, 5180 MHz

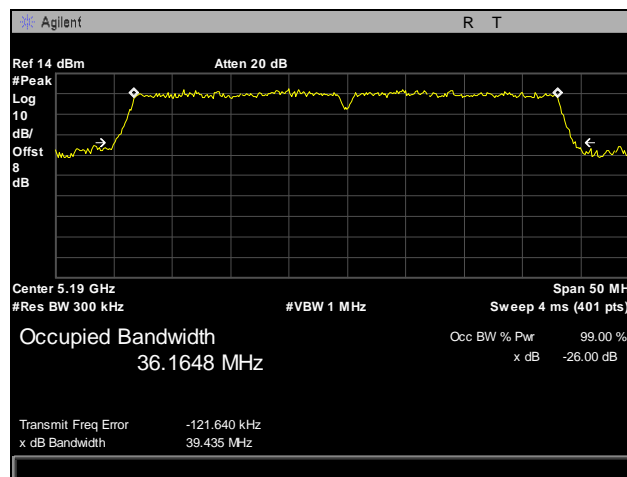

Plot 19. 26 dB Occupied Bandwidth, 802.11n, Port 1, 5190 MHz

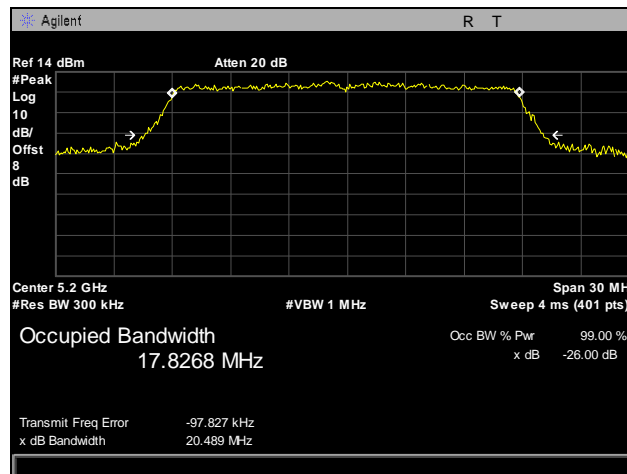

Plot 20. 26 dB Occupied Bandwidth, 802.11n, Port 1, 5200 MHz

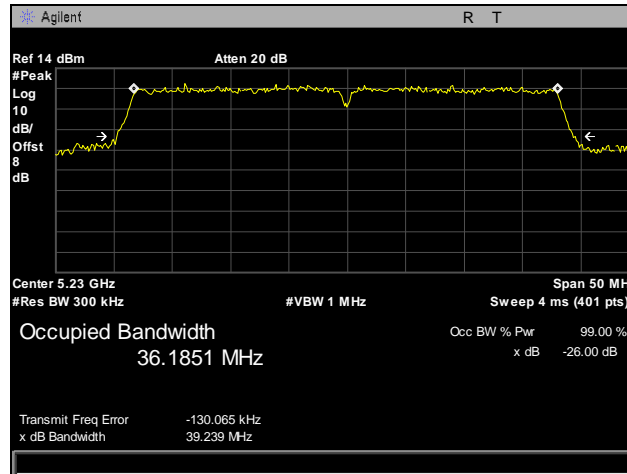

**Plot 21. 26 dB Occupied Bandwidth, 802.11n, Port 1, 5230 MHz**

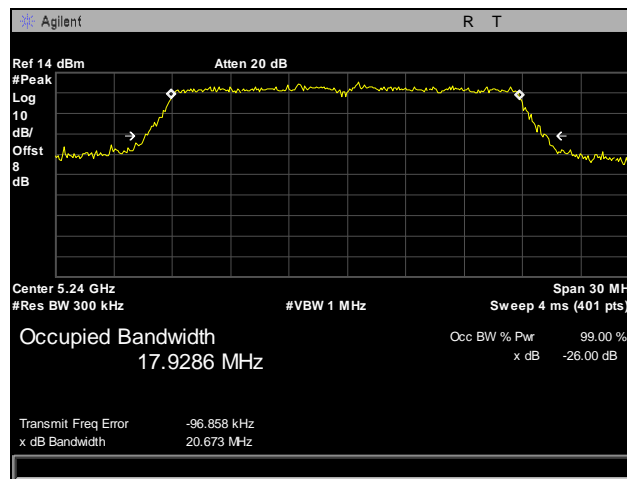

**Plot 22. 26 dB Occupied Bandwidth, 802.11n, Port 1, 5240 MHz**

**26 dB Occupied Bandwidth, 802.11n, Port 2**

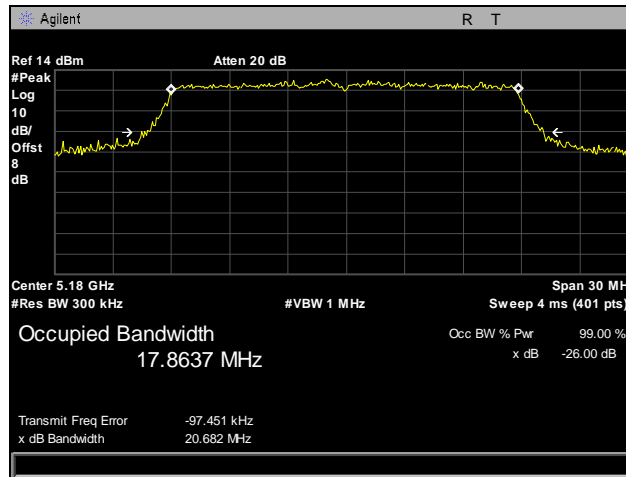

**Plot 23. 26 dB Occupied Bandwidth, 802.11n, Port 2, 5180 MHz**

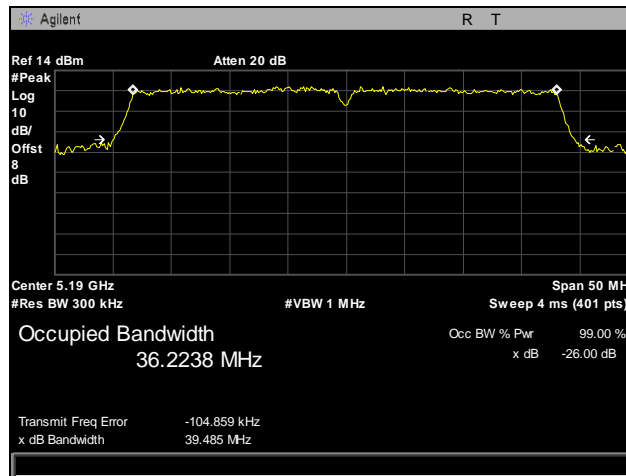

**Plot 24. 26 dB Occupied Bandwidth, 802.11n, Port 2, 5190 MHz**

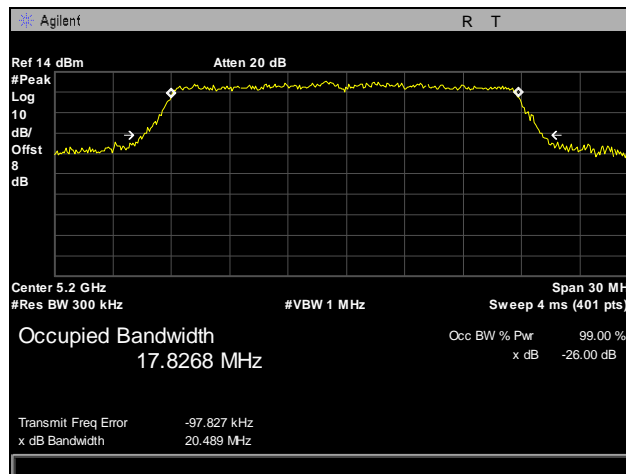

**Plot 25. 26 dB Occupied Bandwidth, 802.11n, Port 2, 5200 MHz**

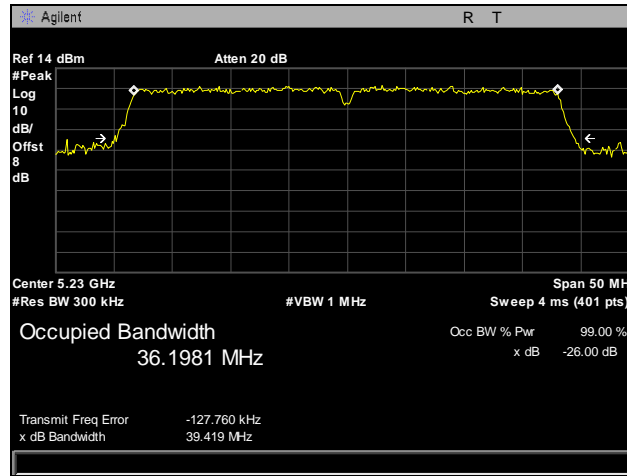

Plot 26. 26 dB Occupied Bandwidth, 802.11n, Port 2, 5230 MHz

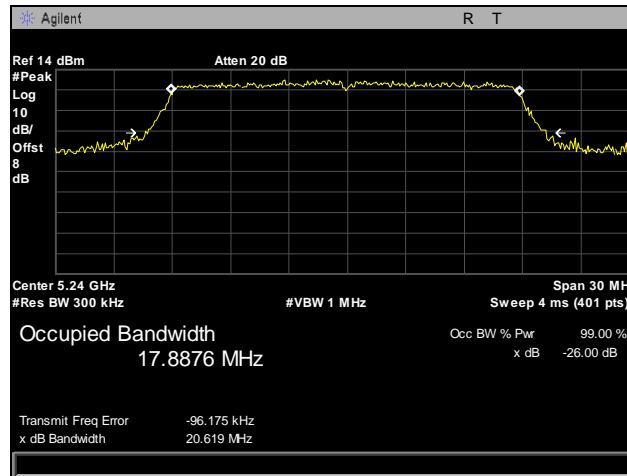

Plot 27. 26 dB Occupied Bandwidth, 802.11n, Port 2, 5240 MHz

**26 dB Occupied Bandwidth, 802.11ac**

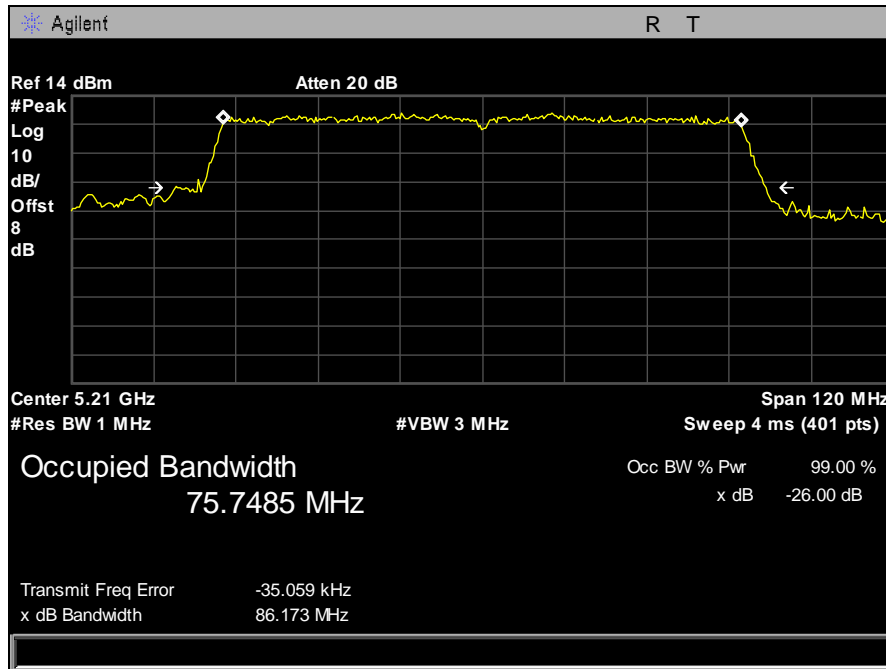

**Plot 28. 26 dB Occupied Bandwidth, 802.11ac, Port 1, 5210 MHz**

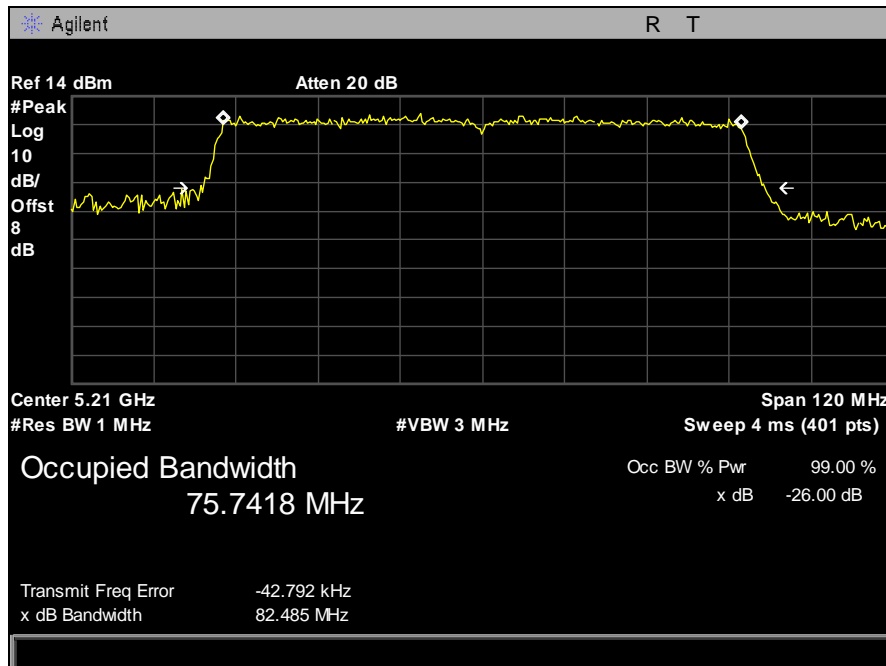

**Plot 29. 26 dB Occupied Bandwidth, 802.11ac, Port 2, 5210 MHz**



**Electromagnetic Compatibility Criteria for Intentional Radiators**

**§ 15. 407(a)(1)(ii) RF Power Output**

**Test Requirements:** §15.407(a)(1)(ii): For an indoor access point operating in the band 5.15-5.25 GHz, the maximum conducted output power over the frequency band of operation shall not exceed 1 W provided the maximum antenna gain does not exceed 6 dBi.

**Test Procedure:** The EUT was connected to a spectrum analyzer through an attenuator and set to transmit continuously on the low, mid, and high channels. Its power was measured according to measurement method SA-1, as described in 789033 D02 General UNII Test Procedures v01. Plots were corrected for attenuator and cable loss. Power levels shown in table below can be used with any antenna shown in 15.203. Patch antennas have dual elements that are cross-polarized and therefore they do not add. The Array gain is the gain shown in the tables in 15.203.

**Test Results:** Equipment was compliant with the Peak Power Output limits of § 15.401(a)(1)(ii).

**Test Engineer(s):** Benjamin Taylor

**Test Date(s):** 09/12/14

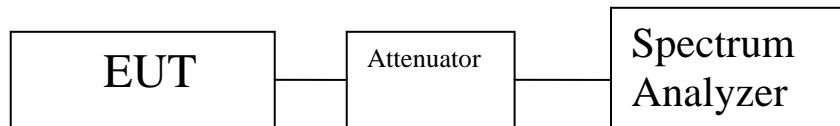

**Figure 3. Power Output Test Setup**

Frequency (MHz)	Mode	Port R1-A Power (dBm)	Port R1-B Power (dBm)	Summed Power (dBm)
5180	802.11a	14.57		14.57
5200	802.11a	21.40		21.40
5240	802.11a	21.55		21.55
5190	802.11a	14.97		14.97
5230	802.11a	21.53		21.53
5180	802.11n	11.67	12.08	14.89
5200	802.11n	21.62	21.48	24.56
5240	802.11n	21.46	21.86	24.67
5190	802.11n	11.96	12.24	15.11
5230	802.11n	21.17	21.77	24.49
5210	802.11ac	21.51	21.36	24.45

**Table 24. RF Output Power, Test Results**

## Electromagnetic Compatibility Criteria for Intentional Radiators

### § 15.407(a)(1)(ii) Peak Power Spectral Density

**Test Requirements:** § 15.407(a)(1)(ii): In addition, the maximum power spectral density shall not exceed 17 dBm in any 1 megahertz band. If transmitting antennas of directional gain greater than 6 dBi are used, both the maximum conducted output power and the maximum power spectral density shall be reduced by the amount in dB that the directional gain of the antenna exceeds 6 dBi.

**Test Procedure:** The transmitter was connected directly to a Spectrum Analyzer through an attenuator. The power level was set to the maximum level on the EUT. The RBW was set to 1MHz and the VBW was set to 3MHz. The method of measurement used was method SA-1 from 789033 D02 General UNII Test Procedures v01. Plots are correct for attenuators and cable loss.

**Test Results:** Equipment was compliant with the peak power spectral density limits of § 15.407 (a)(1)(ii). The peak power spectral density was determined from plots on the following page(s).

**Test Engineer(s):** Benjamin Taylor

**Test Date(s):** 09/10/14

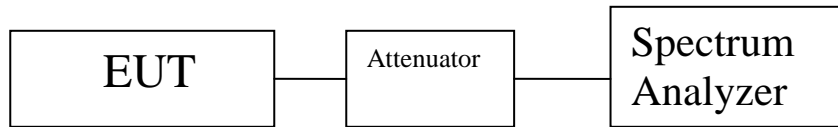

Figure 4. Power Spectral Density Test Setup

Frequency (MHz)	Mode	Port R1-A PSD (dBm)	Port R1-B PSD (dBm)	Summed PSD (dBm)	Margin (dB)
5180	802.11a	7.67		7.67	-7.63
5200	802.11a	11.32		11.32	-3.98
5240	802.11a	10.96		10.96	-4.34
5190	802.11a	6.04		6.04	-9.26
5230	802.11a	8.29		8.29	-7.02
5180	802.11n	5.67	7.18	9.50	-5.80
5200	802.11n	9.64	9.86	12.76	-2.54
5240	802.11n	11.06	9.39	12.32	-2.98
5190	802.11n	2.30	8.03	10.94	-9.0
5230	802.11n	7.82	8.03	10.94	-4.36
5210	802.11ac	4.867	4.748	7.82	-7.48

Table 25. Peak Power Spectral Density, Test Results

## Electromagnetic Compatibility Criteria for Intentional Radiators

### § 15.407(b)(1), (6), (7) Undesirable Emissions

**Test Requirements:** § 15.407(b)(1), (6), (7); §15.205: Emissions outside the frequency band.

§ 15.407(b)(1): For transmitters operating in the 5.15–5.25 GHz band: all emissions outside of the 5.15–5.35 GHz band shall not exceed an EIRP of –27 dBm/MHz.

§ 15.407(b)(6): Unwanted emissions below 1 GHz must comply with the general field strength limits set forth in Section 15.209. Further, any U-NII devices using an AC power line are required to comply also with the conducted limits set forth in Section 15.207.

§ 15.407(b)(7): The provisions of Section 15.205 of this part apply to intentional radiators operating under this section.

**Test Procedure:** The transmitter was placed on an 80cm wooden table inside in a semi-anechoic chamber. Measurements were performed with the EUT rotated 360 degrees and varying the adjustable antenna mast height to determine worst case orientation for maximum emissions. A preamp was used in the range from 7-18GHz to improve noise floor. Plots were corrected for cable loss, antenna, and preamp gain.

For frequencies from 30 MHz to 1 GHz, measurements were made using a quasi-peak detector with a 120 kHz bandwidth. The procedure was used for average.

For measurements above 1 GHz, measurements were made with a Peak detector with 1 MHz resolution bandwidth. A notch filter was use to filter out the transmitting channel. Where the spurious emissions fell into a restricted band, measurements were also made with an average detector to make sure they complied with 15.209 limits. Only noise floor was seen above 18 GHz. Worst case emissions shown by antenna.

**Test Results:** The EUT was compliant with the Radiated Emission limits for Intentional Radiators. See following pages for detailed test results. All emissions above 18 GHz were at the noise floor of the receiver.

**Test Engineer(s):** Andy Shen & Ajaz Khan

**Test Date(s):** 09/05/14

**Radiated Spurious Emissions, 802.11a, Ceiling Antenna**

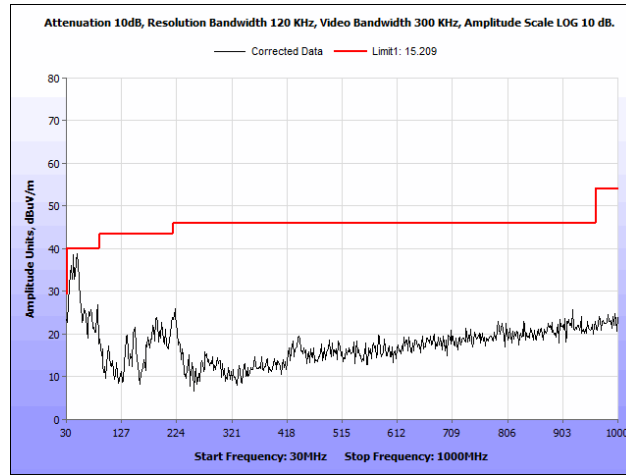

**Plot 30. Radiated Spurious Emissions, 802.11a, 20 MHz, Low Channel, 30 MHz – 1 GHz, Ceiling Antenna**

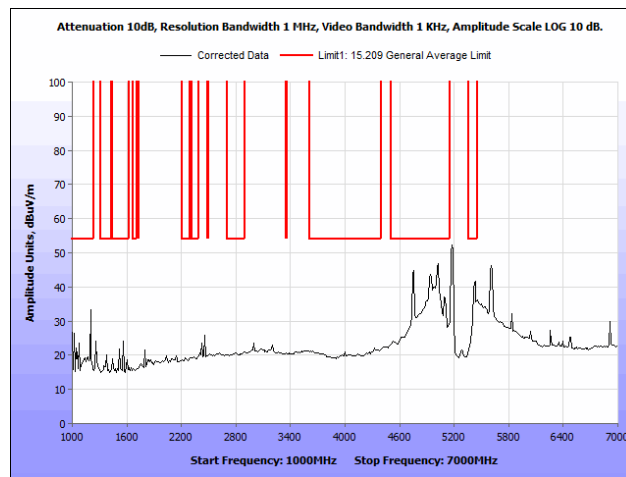

**Plot 31. Radiated Spurious Emissions, 802.11a, Low Channel, 1 GHz – 7 GHz, Average, Ceiling Antenna**

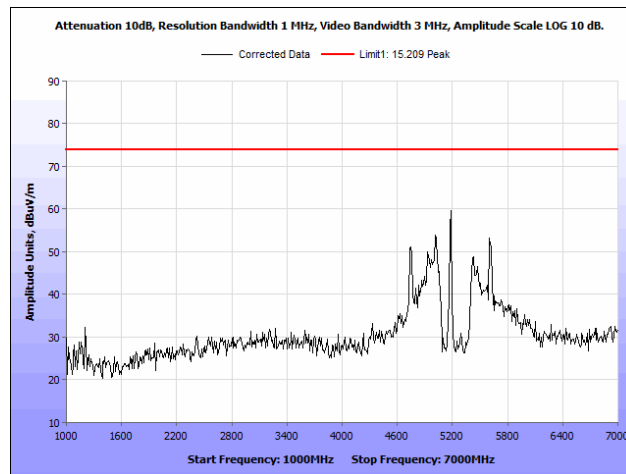

**Plot 32. Radiated Spurious Emissions, 802.11a, Low Channel, 1 GHz – 7 GHz, Peak, Ceiling Antenna**

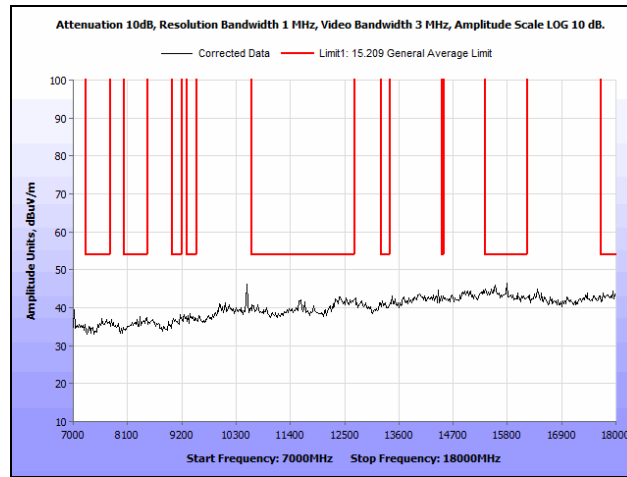

**Plot 33. Radiated Spurious Emissions, 802.11a, Low Channel, 7 GHz – 18 GHz, Peak, Ceiling Antenna**

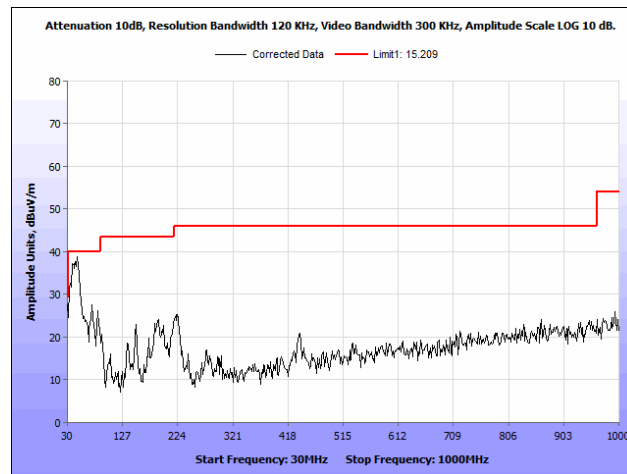

**Plot 34. Radiated Spurious Emissions, 802.11a, 40 MHz, Low Channel, 30 MHz – 1 GHz, Ceiling Antenna**

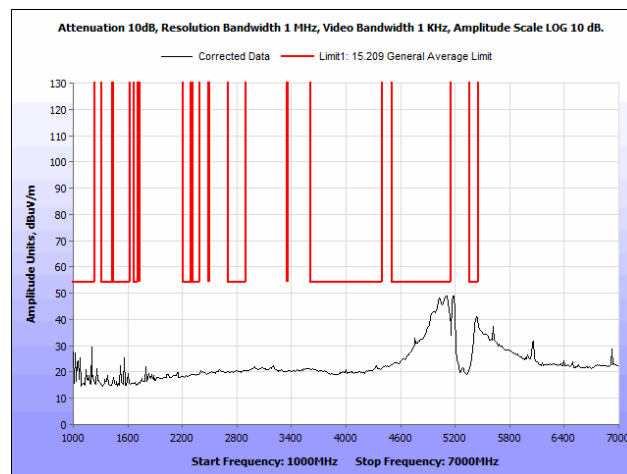

**Plot 35. Radiated Spurious Emissions, 802.11a, 40 MHz, Low Channel, 1 GHz – 7 GHz, Average, Ceiling Antenna**

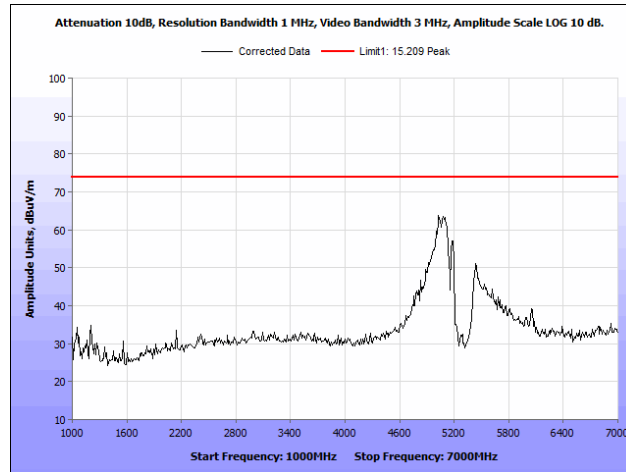

**Plot 36. Radiated Spurious Emissions, 802.11a, 40 MHz, Low Channel, 1 GHz – 7 GHz, Peak, Ceiling Antenna**

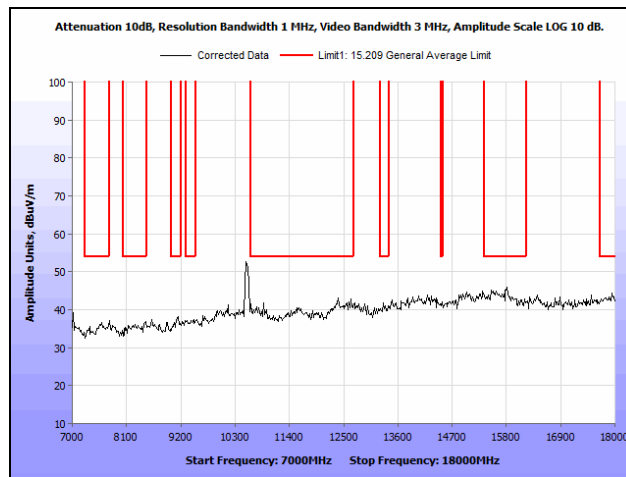

**Plot 37. Radiated Spurious Emissions, 802.11a, 40 MHz, Low Channel, 7 GHz – 18 GHz, Peak, Ceiling Antenna**

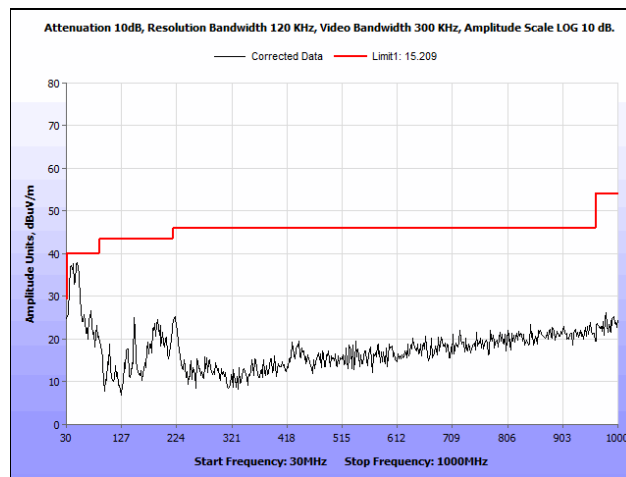

**Plot 38. Radiated Spurious Emissions, 802.11a, 20 MHz, Mid Channel, 30 MHz – 1 GHz, Ceiling Antenna**

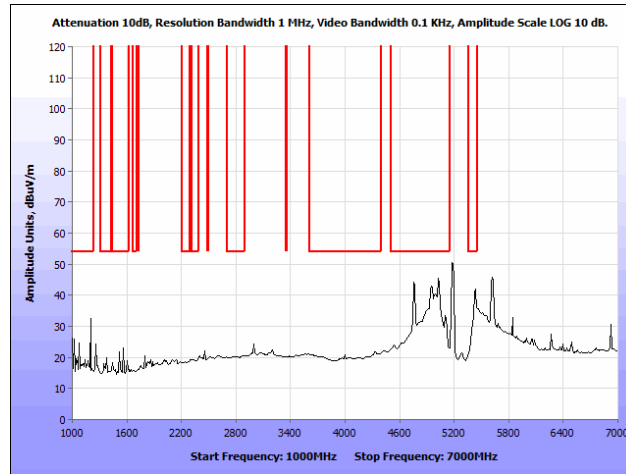

**Plot 39. Radiated Spurious Emissions, 802.11a, Mid Channel, 1 GHz – 7 GHz, Average, Ceiling Antenna**

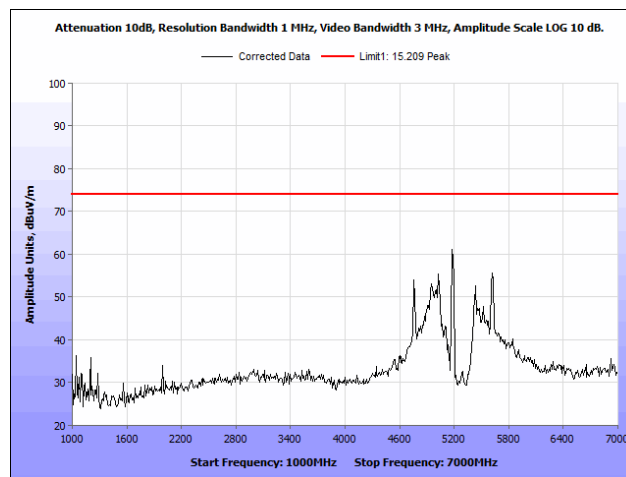

**Plot 40. Radiated Spurious Emissions, 802.11a, Mid Channel, 1 GHz – 7 GHz, Peak, Ceiling Antenna**

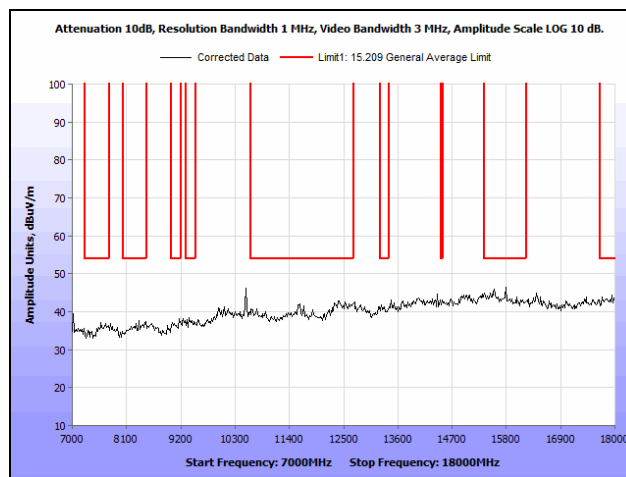

**Plot 41. Radiated Spurious Emissions, 802.11a, Mid Channel, 7 GHz – 18 GHz, Peak, Ceiling Antenna**

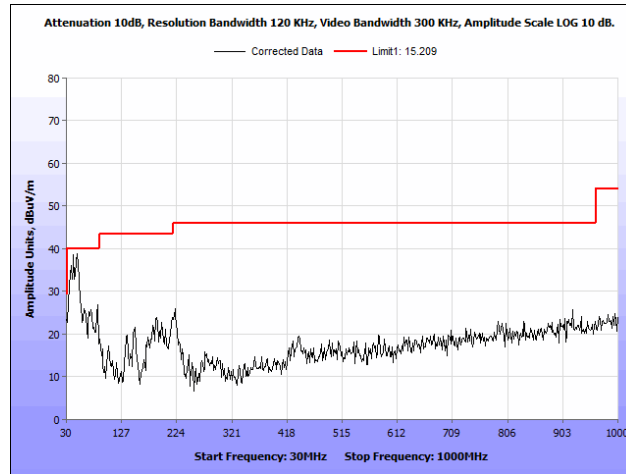

**Plot 42. Radiated Spurious Emissions, 802.11a, 20 MHz, High Channel, 30 MHz – 1 GHz, Ceiling Antenna**

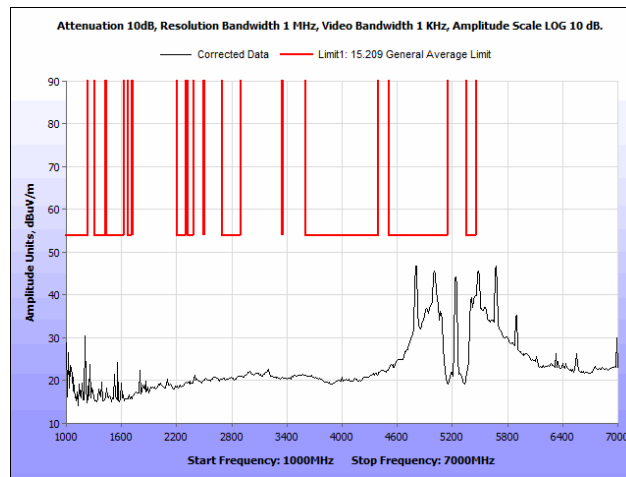

**Plot 43. Radiated Spurious Emissions, 802.11a, High Channel, 1 GHz – 7 GHz, Average, Ceiling Antenna**

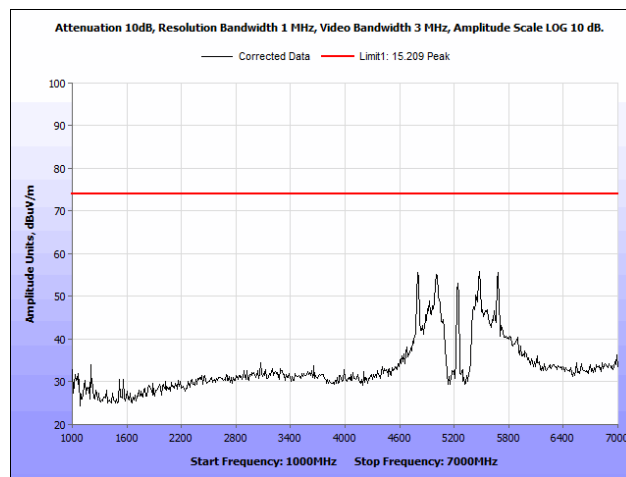

**Plot 44. Radiated Spurious Emissions, 802.11a, High Channel, 1 GHz – 7 GHz, Peak, Ceiling Antenna**



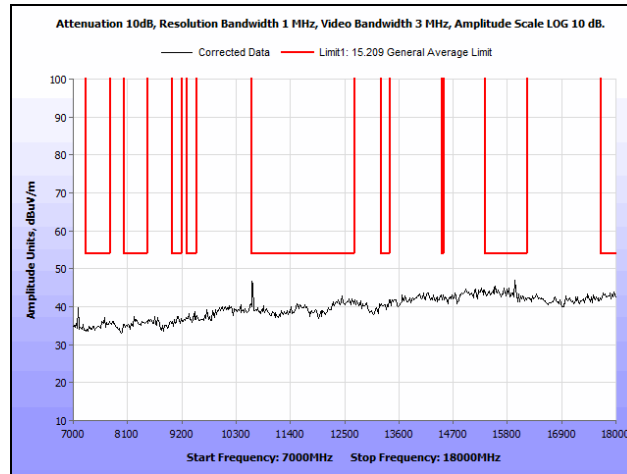

**Plot 45. Radiated Spurious Emissions, 802.11a, High Channel, 7 GHz – 18 GHz, Peak, Ceiling Antenna**

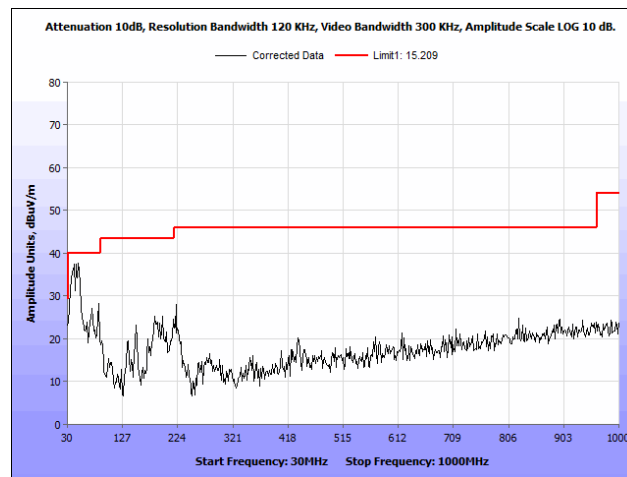

**Plot 46. Radiated Spurious Emissions, 802.11a, 40 MHz, High Channel, 30 MHz – 1 GHz, Ceiling Antenna**

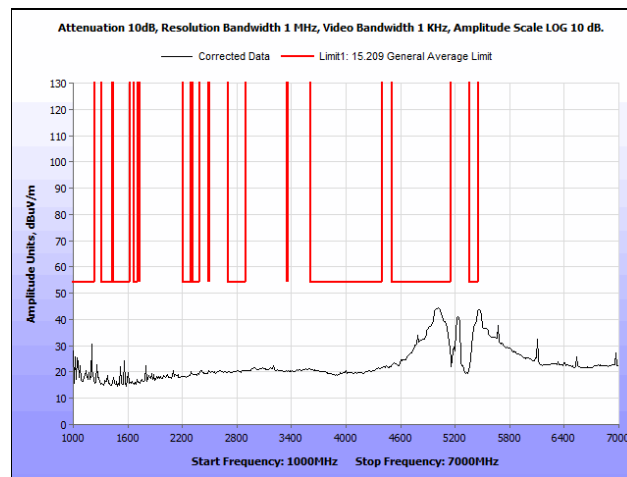

**Plot 47. Radiated Spurious Emissions, 802.11a, 40 MHz, High Channel, 1 GHz – 7 GHz, Average, Ceiling Antenna**

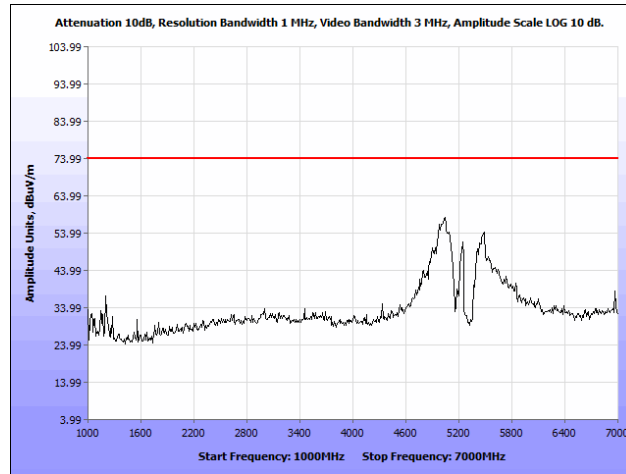

**Plot 48. Radiated Spurious Emissions, 802.11a, 40 MHz, High Channel, 1 GHz – 7 GHz, Peak, Ceiling Antenna**

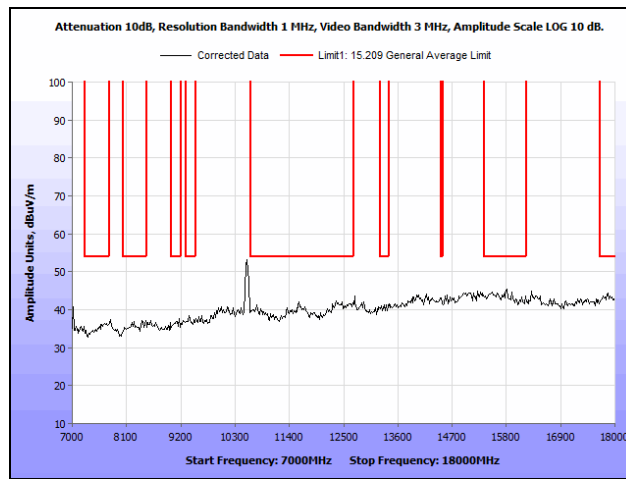

**Plot 49. Radiated Spurious Emissions, 802.11a, 40 MHz, High Channel, 7 GHz – 18 GHz, Peak, Ceiling Antenna**

**Radiated Spurious Emissions, 802.11n, Ceiling Antenna**

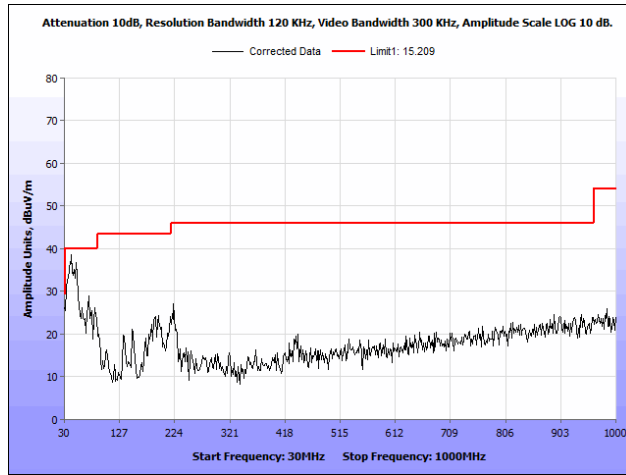

**Plot 50. Radiated Spurious Emissions, 802.11n, 20 MHz, Low Channel, 30 MHz – 1 GHz, Ceiling Antenna**

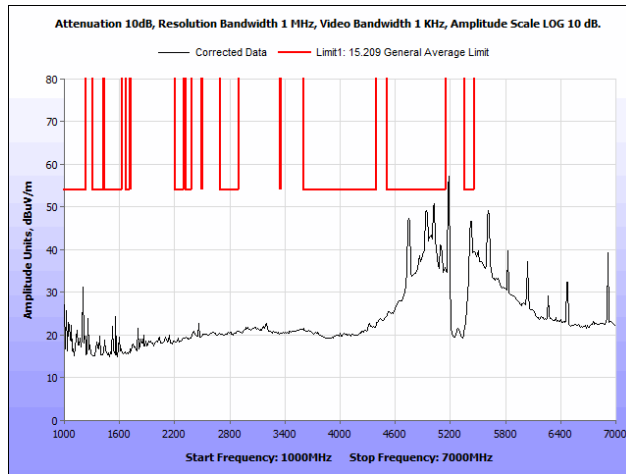

**Plot 51. Radiated Spurious Emissions, 802.11n, Low Channel, 1 GHz – 7 GHz, Average, Ceiling Antenna**

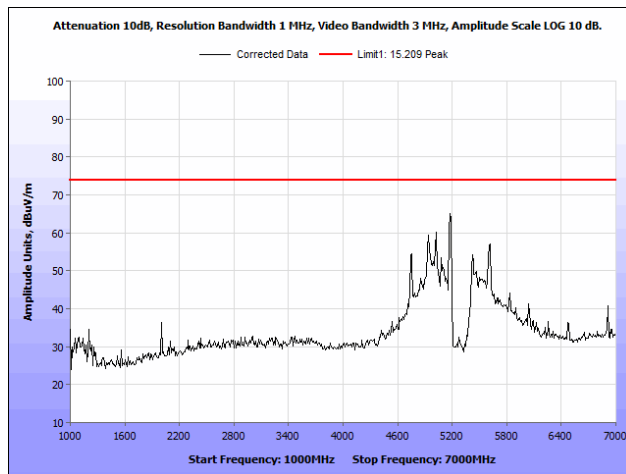

**Plot 52. Radiated Spurious Emissions, 802.11n, Low Channel, 1 GHz – 7 GHz, Peak, Ceiling Antenna**

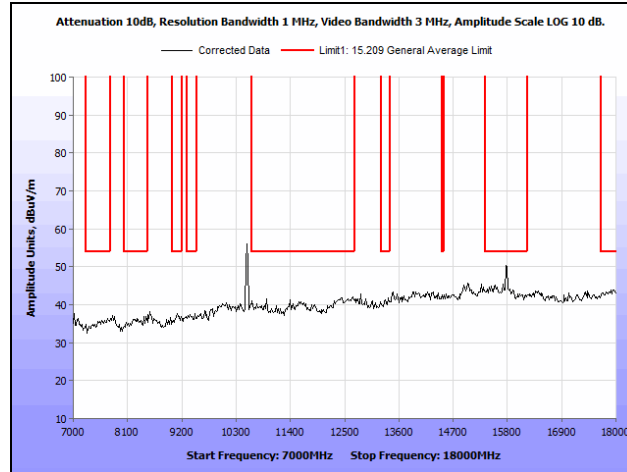

**Plot 53. Radiated Spurious Emissions, 802.11n, Low Channel, 7 GHz – 18 GHz, Peak, Ceiling Antenna**

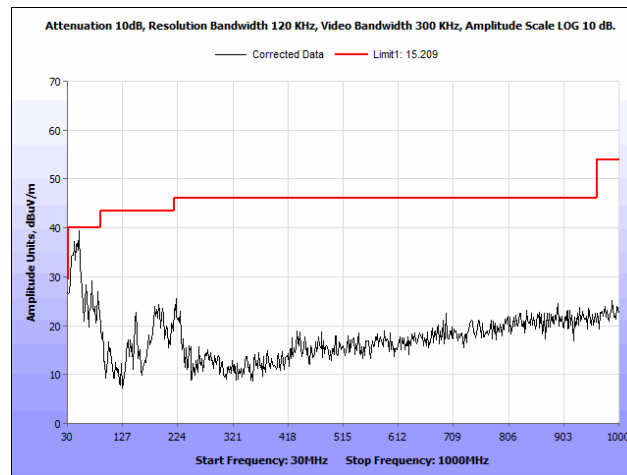

**Plot 54. Radiated Spurious Emissions, 802.11n, 40 MHz, Low Channel, 30 MHz – 1 GHz, Ceiling Antenna**

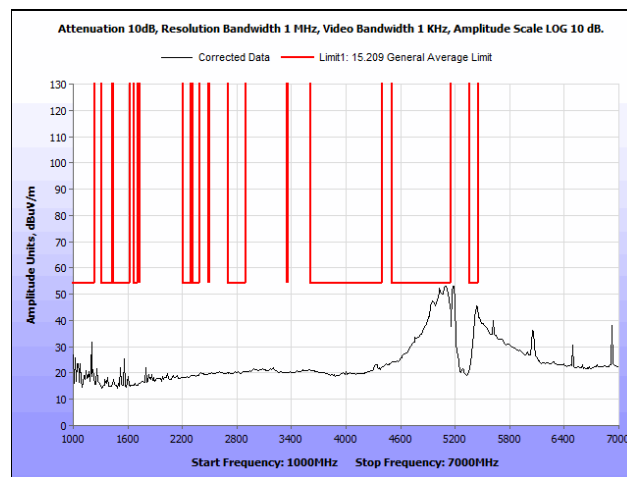

**Plot 55. Radiated Spurious Emissions, 802.11n, 40 MHz, Low Channel, 1 GHz – 7 GHz, Average, Ceiling Antenna**

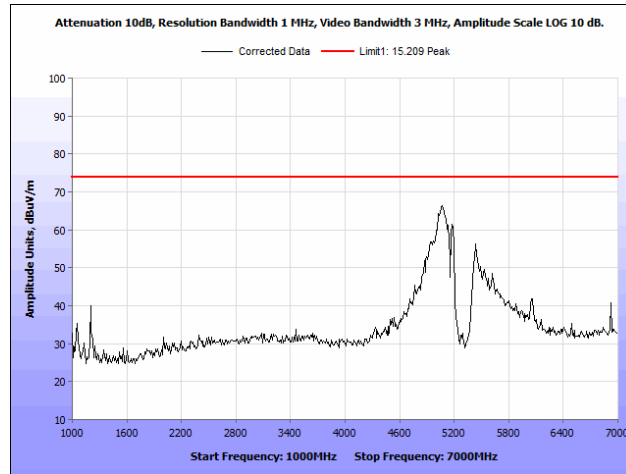

**Plot 56. Radiated Spurious Emissions, 802.11n, 40 MHz, Low Channel, 1 GHz – 7 GHz, Peak, Ceiling Antenna**

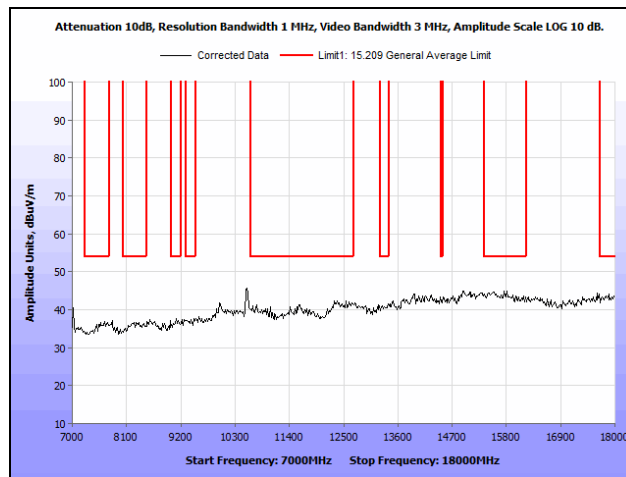

**Plot 57. Radiated Spurious Emissions, 802.11n, 40 MHz, Low Channel, 7 GHz – 18 GHz, Peak, Ceiling Antenna**

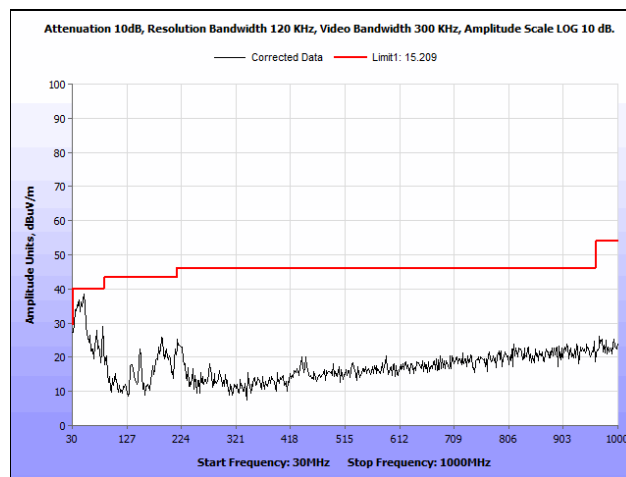

**Plot 58. Radiated Spurious Emissions, 802.11n, 20 MHz, Mid Channel, 30 MHz – 1 GHz, Ceiling Antenna**

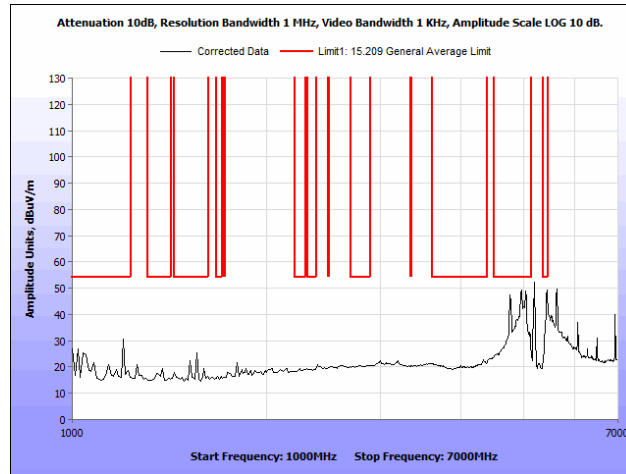

**Plot 59. Radiated Spurious Emissions, 802.11n, Mid Channel, 1 GHz – 7 GHz, Average, Ceiling Antenna**

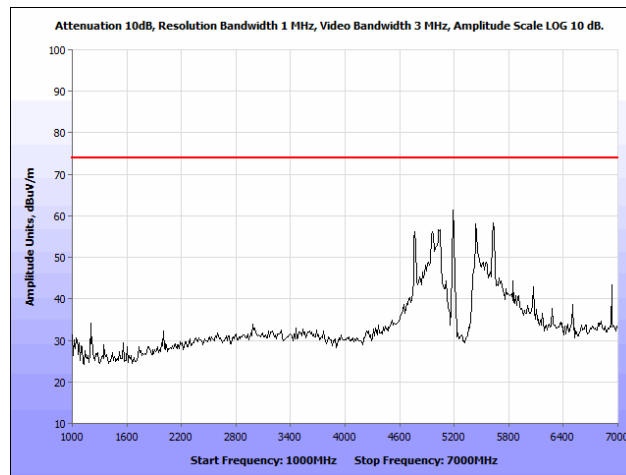

**Plot 60. Radiated Spurious Emissions, 802.11n, Mid Channel, 1 GHz – 7 GHz, Peak, Ceiling Antenna**

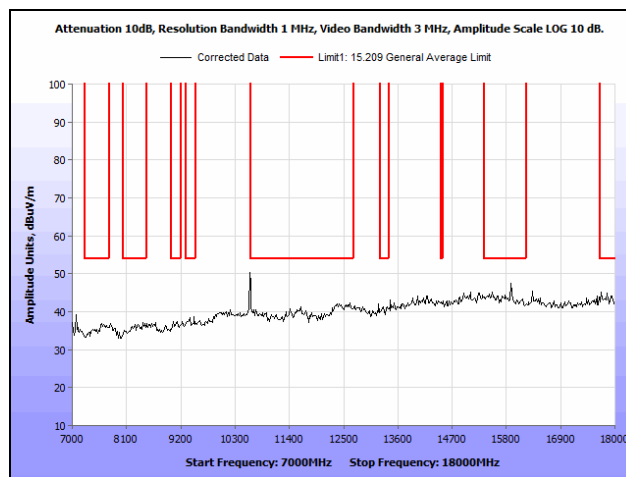

**Plot 61. Radiated Spurious Emissions, 802.11n, Mid Channel, 7 GHz – 18 GHz, Peak, Ceiling Antenna**

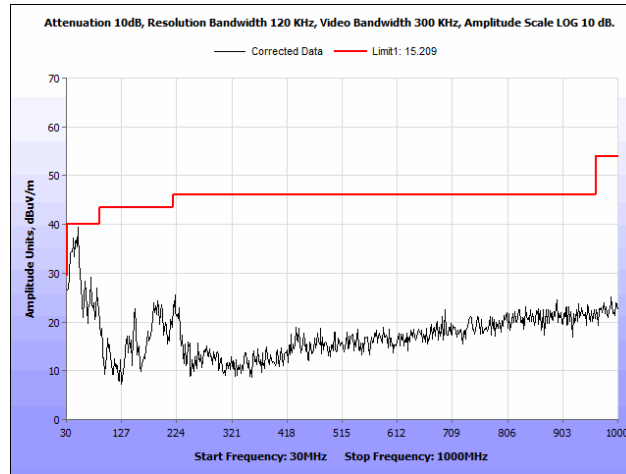

**Plot 62. Radiated Spurious Emissions, 802.11n, 20 MHz, High Channel, 30 MHz – 1 GHz, Ceiling Antenna**

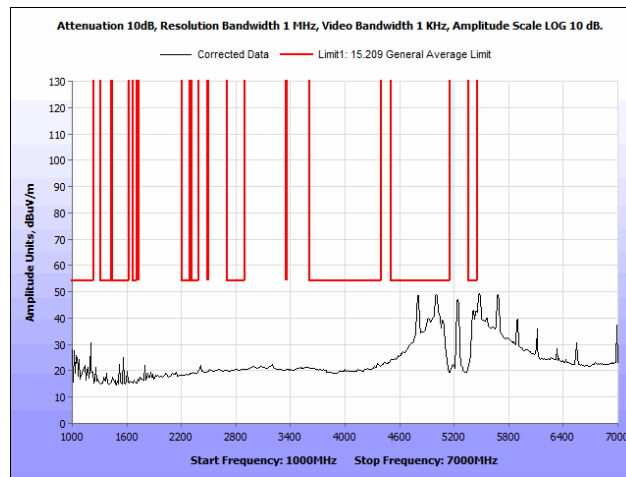

**Plot 63. Radiated Spurious Emissions, 802.11n, High Channel, 1 GHz – 7 GHz, Average, Ceiling Antenna**

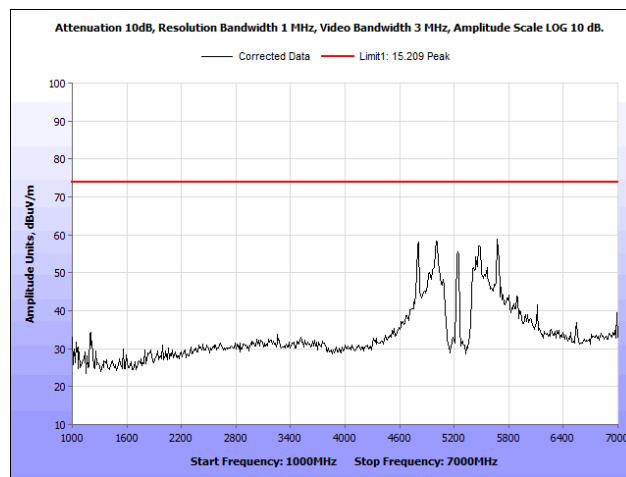

**Plot 64. Radiated Spurious Emissions, 802.11n, High Channel, 1 GHz – 7 GHz, Peak, Ceiling Antenna**

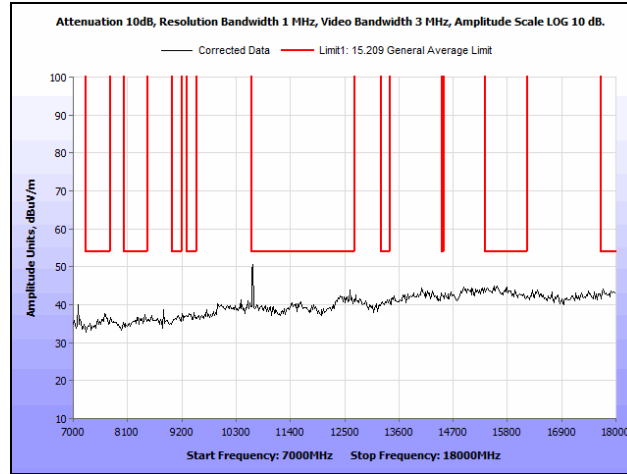

**Plot 65. Radiated Spurious Emissions, 802.11n, High Channel, 7 GHz – 18 GHz, Peak, Ceiling Antenna**

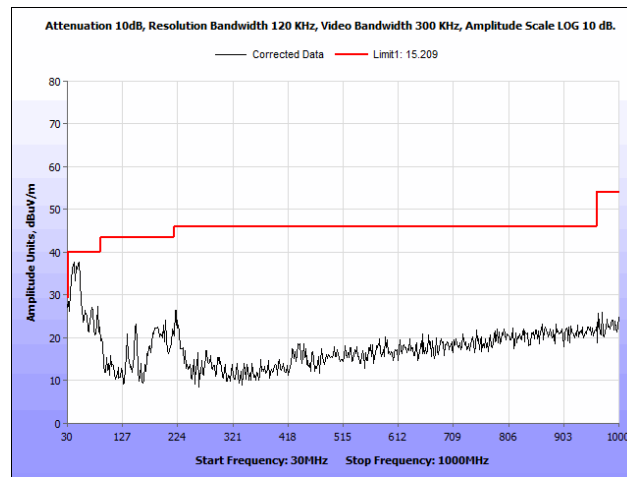

**Plot 66. Radiated Spurious Emissions, 802.11n, 40 MHz, High Channel, 30 MHz – 1 GHz, Ceiling Antenna**

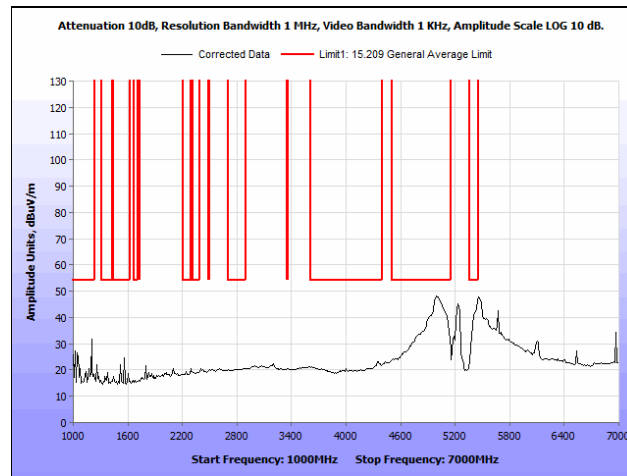

**Plot 67. Radiated Spurious Emissions, 802.11n, 40 MHz, High Channel, 1 GHz – 7 GHz, Average, Ceiling Antenna**



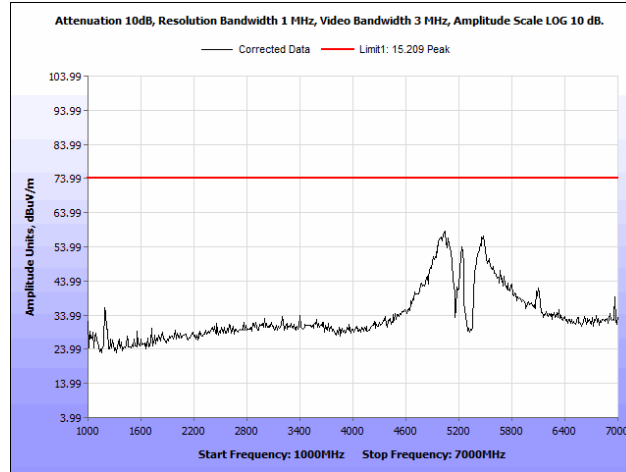

**Plot 68. Radiated Spurious Emissions, 802.11n, 40 MHz, High Channel, 1 GHz – 7 GHz, Peak, Ceiling Antenna**

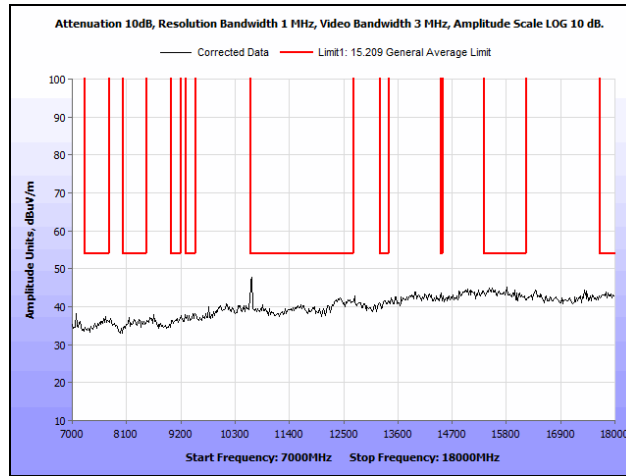

**Plot 69. Radiated Spurious Emissions, 802.11n, 40 MHz, High Channel, 7 GHz – 18 GHz, Peak, Ceiling Antenna**

**Radiated Spurious Emissions, 802.11ac, Ceiling Antenna**

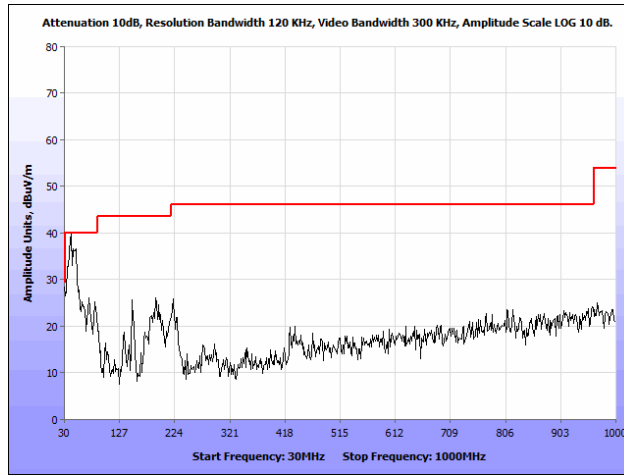

**Plot 70. Radiated Spurious Emissions, 802.11ac, 80 MHz, 30 MHz – 1 GHz, Ceiling Antenna**

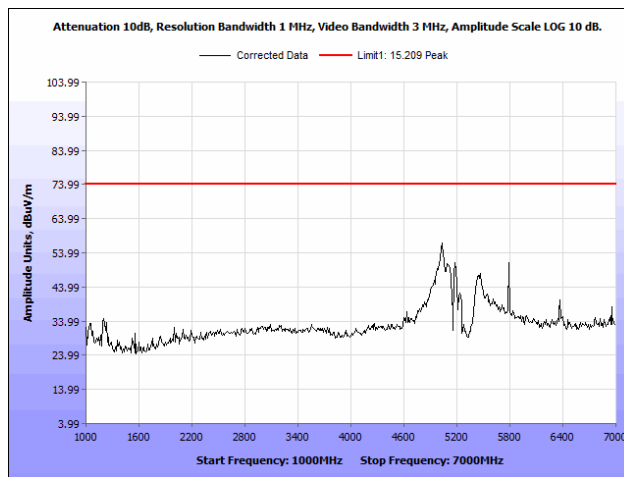

**Plot 71. Radiated Spurious Emissions, 802.11ac, 1 GHz – 7 GHz, Average, Ceiling Antenna**

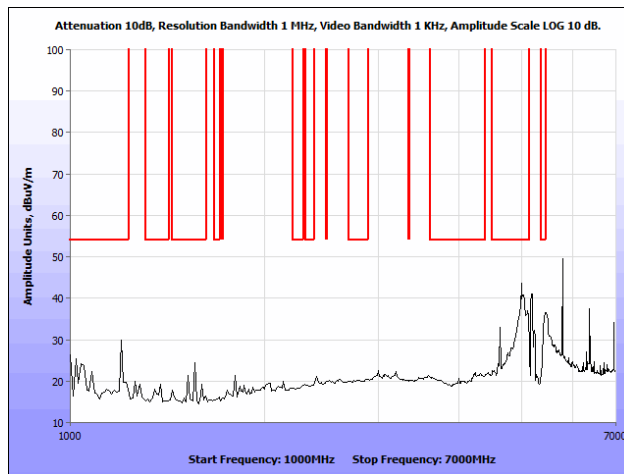

**Plot 72. Radiated Spurious Emissions, 802.11ac, 1 GHz – 7 GHz, Peak, Ceiling Antenna**

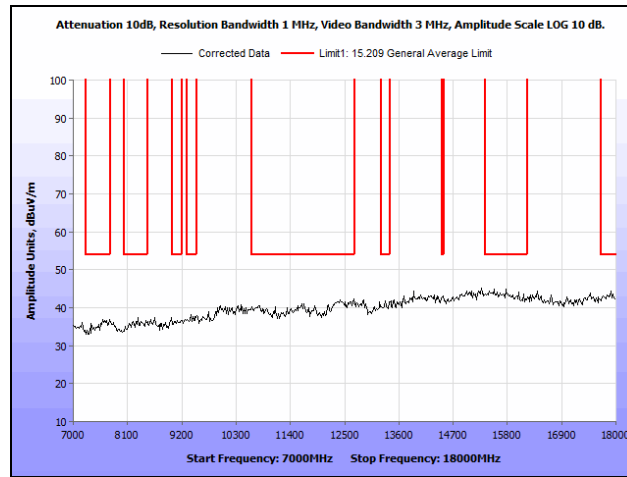

**Plot 73. Radiated Spurious Emissions, 802.11ac, 7 GHz – 18 GHz, Peak, Ceiling Antenna**

**Radiated Spurious Emissions, 802.11a, Omni Antenna**

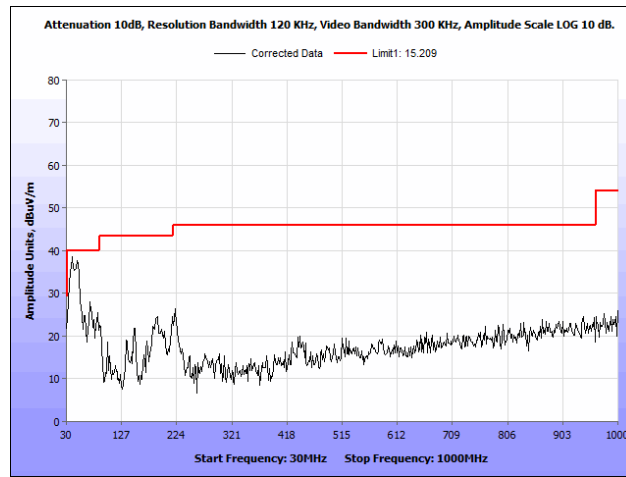

**Plot 74. Radiated Spurious Emissions, 802.11a, 20 MHz, Low Channel, 30 MHz – 1 GHz, Omni Antenna**

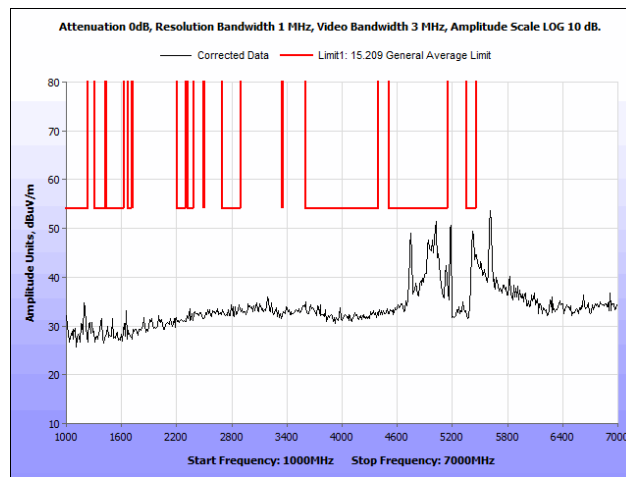

**Plot 75. Radiated Spurious Emissions, 802.11a, 20 MHz, Low Channel, 1 GHz – 7 GHz, Average, Omni Antenna**

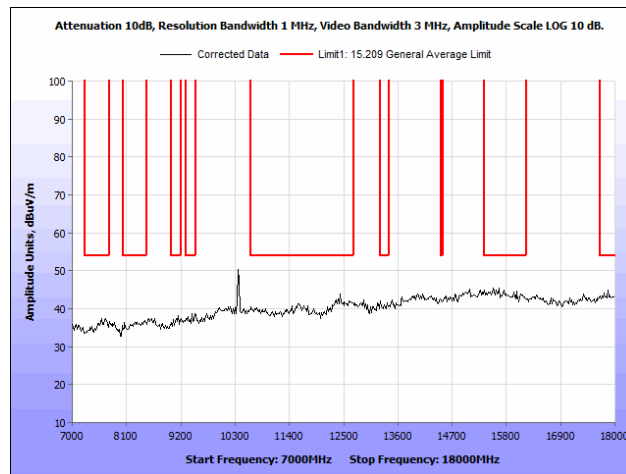

**Plot 76. Radiated Spurious Emissions, 802.11a, 20 MHz, Low Channel, 7 GHz – 18 GHz, Omni Antenna**

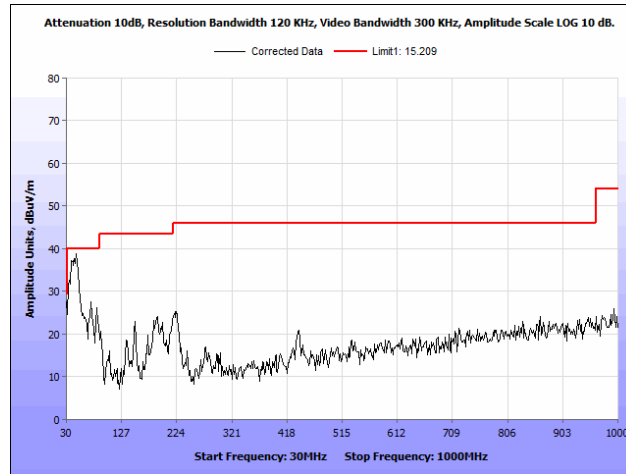

**Plot 77. Radiated Spurious Emissions, 802.11a, 40 MHz, Low Channel, 30 MHz – 1 GHz, Omni Antenna**

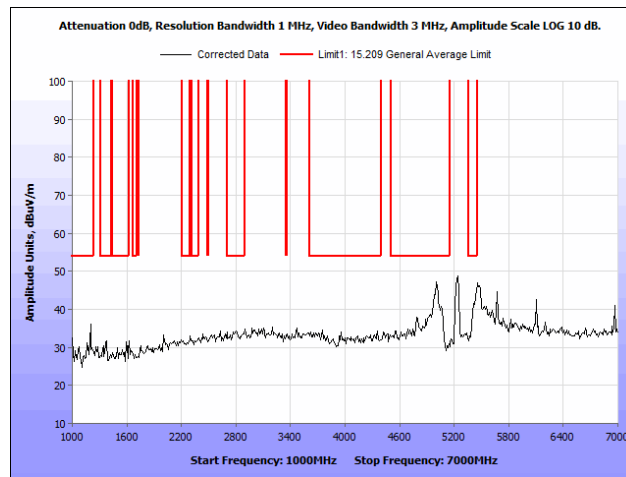

**Plot 78. Radiated Spurious Emissions, 802.11a, 40 MHz, Low Channel, 1 GHz – 7 GHz, Average, Omni Antenna**

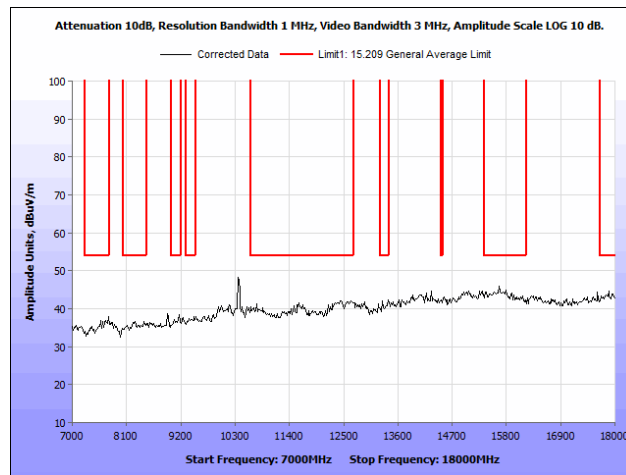

**Plot 79. Radiated Spurious Emissions, 802.11a, 40 MHz, Low Channel, 7 GHz – 18 GHz, Omni Antenna**

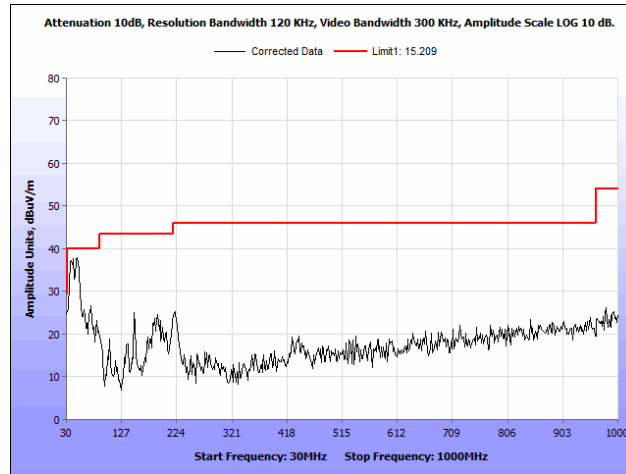

**Plot 80. Radiated Spurious Emissions, 802.11a, 20 MHz, Mid Channel, 30 MHz – 1 GHz, Omni Antenna**

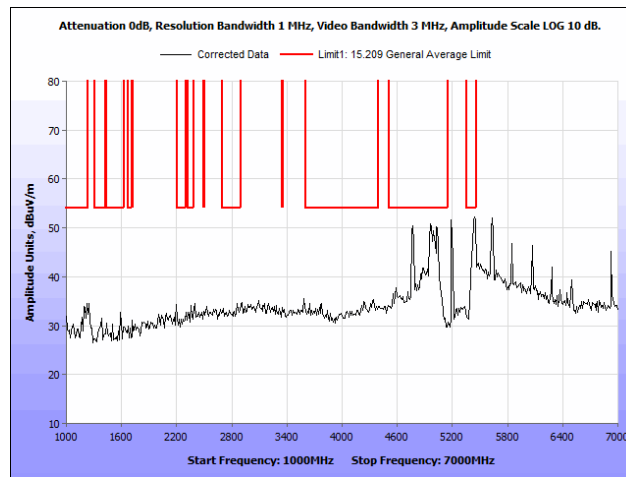

**Plot 81. Radiated Spurious Emissions, 802.11a, 20 MHz, Mid Channel, 1 GHz – 7 GHz, Average, Omni Antenna**

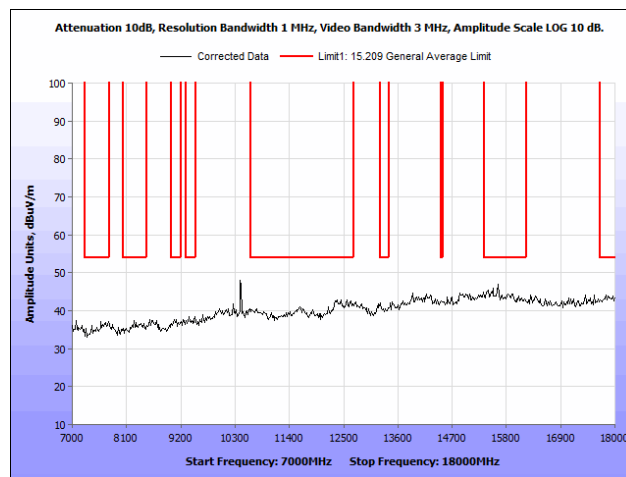

**Plot 82. Radiated Spurious Emissions, 802.11a, 20 MHz, Mid Channel, 7 GHz – 18 GHz, Omni Antenna**

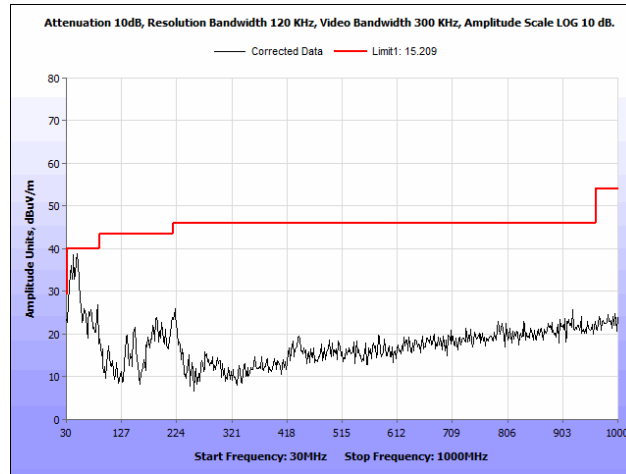

**Plot 83. Radiated Spurious Emissions, 802.11a, 20 MHz, High Channel, 30 MHz – 1 GHz, Omni Antenna**

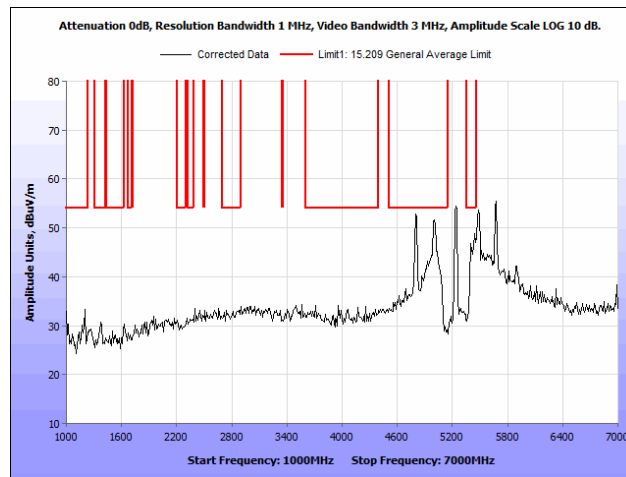

**Plot 84. Radiated Spurious Emissions, 802.11a, 20 MHz, High Channel, 1 GHz – 7 GHz, Average, Omni Antenna**

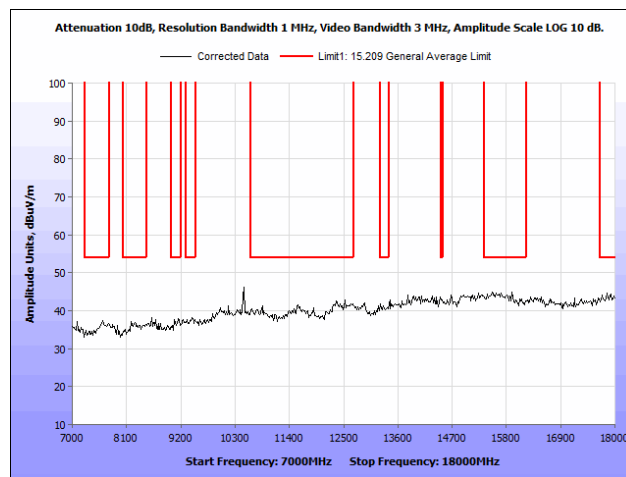

**Plot 85. Radiated Spurious Emissions, 802.11a, 20 MHz, High Channel, 7 GHz – 18 GHz, Omni Antenna**

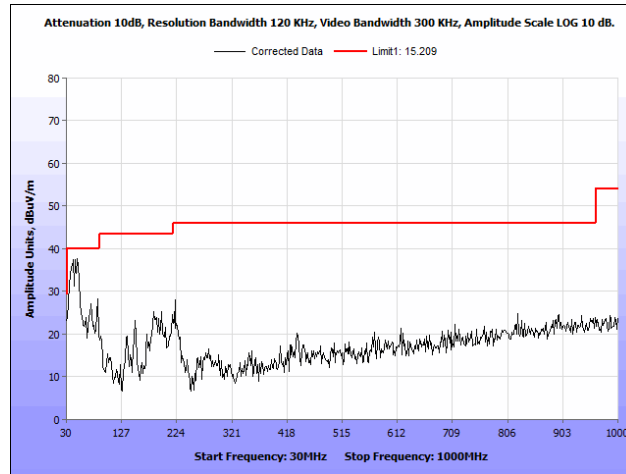

**Plot 86. Radiated Spurious Emissions, 802.11a, 40 MHz, High Channel, 30 MHz – 1 GHz, Omni Antenna**

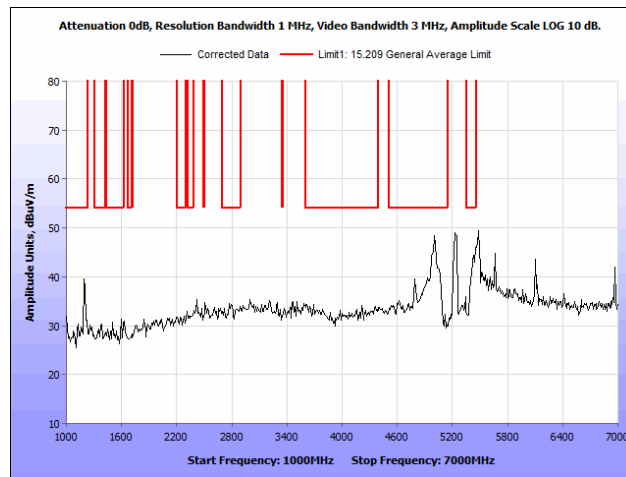

**Plot 87. Radiated Spurious Emissions, 802.11a, 40 MHz, High Channel, 1 GHz – 7 GHz, Average, Omni Antenna**

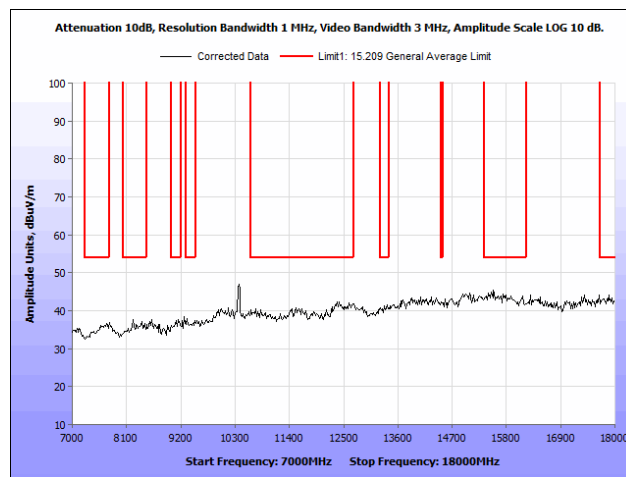

**Plot 88. Radiated Spurious Emissions, 802.11a, 40 MHz, High Channel, 7 GHz – 18 GHz, Omni Antenna**



### Radiated Spurious Emissions, 802.11n, Omni Antenna

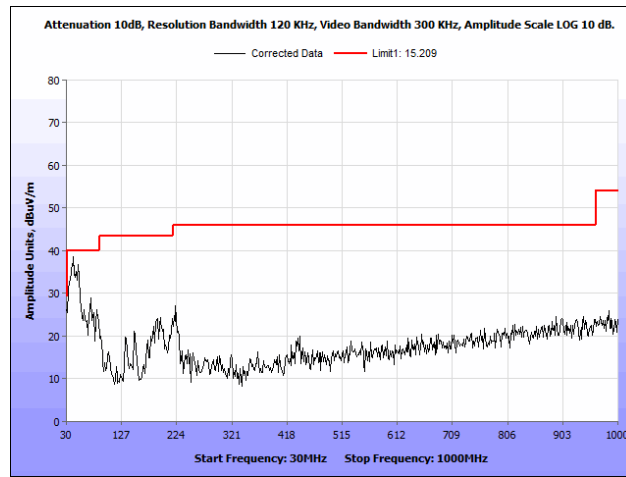

Plot 89. Radiated Spurious Emissions, 802.11n, 20 MHz, Low Channel, 30 MHz – 1 GHz, Omni Antenna

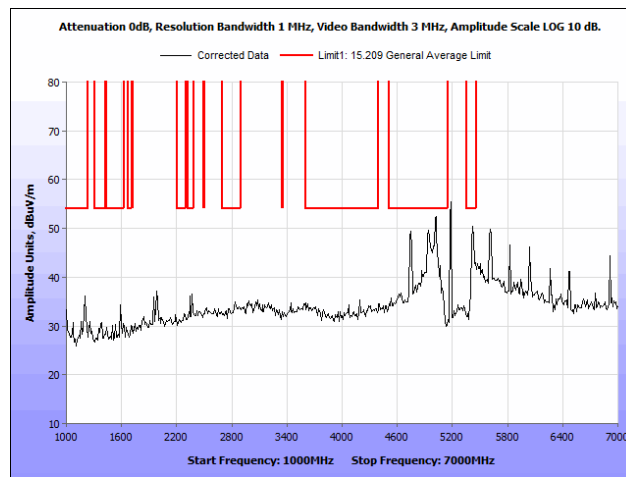

Plot 90. Radiated Spurious Emissions, 802.11n, 20 MHz, Low Channel, 1 GHz – 7 GHz, Average, Omni Antenna

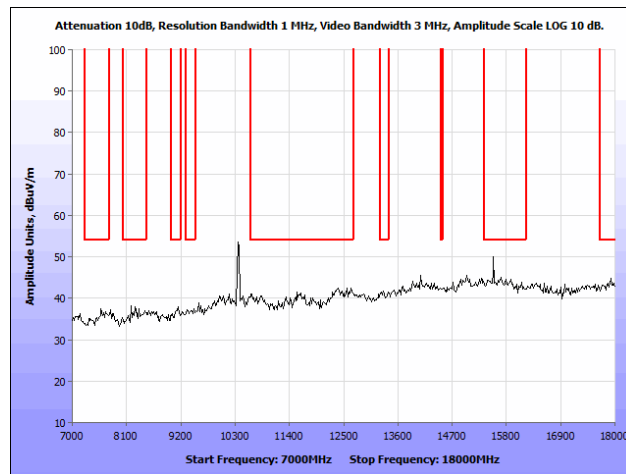

Plot 91. Radiated Spurious Emissions, 802.11n, 20 MHz, Low Channel, 7 GHz – 18 GHz, Omni Antenna

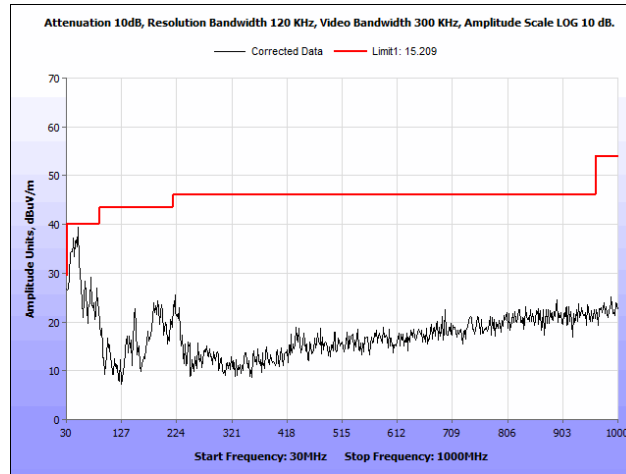

**Plot 92. Radiated Spurious Emissions, 802.11n, 40 MHz, Low Channel, 30 MHz – 1 GHz, Omni Antenna**

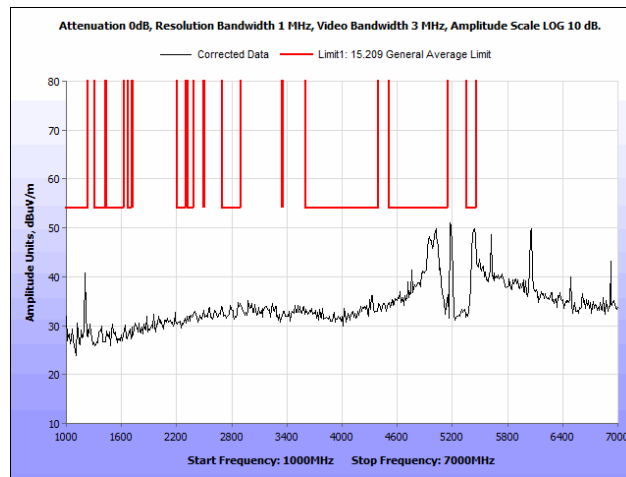

**Plot 93. Radiated Spurious Emissions, 802.11n, 40 MHz, Low Channel, 1 GHz – 7 GHz, Average, Omni Antenna**

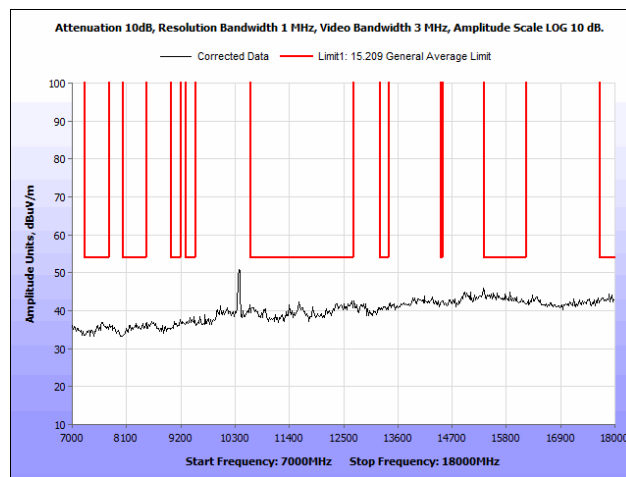

**Plot 94. Radiated Spurious Emissions, 802.11n, 40 MHz, Low Channel, 7 GHz – 18 GHz, Omni Antenna**

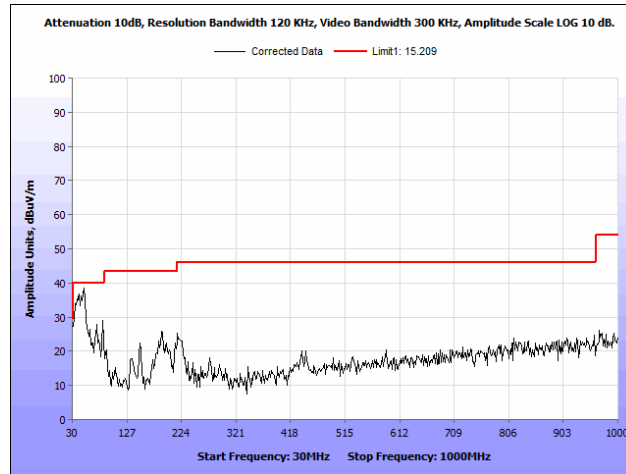

**Plot 95. Radiated Spurious Emissions, 802.11n, 20 MHz, Mid Channel, 30 MHz – 1 GHz, Omni Antenna**

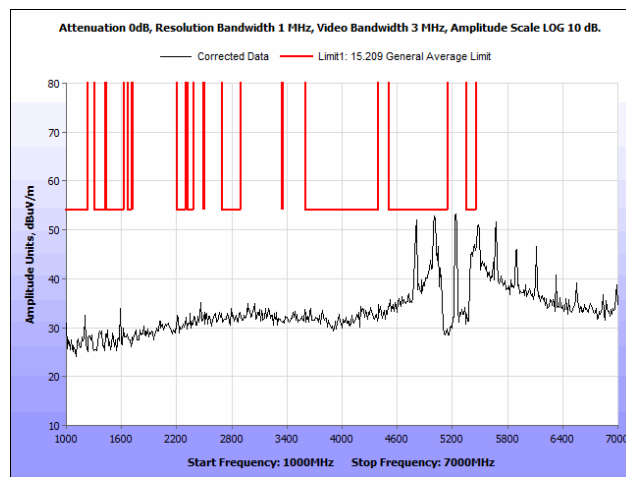

**Plot 96. Radiated Spurious Emissions, 802.11n, 20 MHz, Mid Channel, 1 GHz – 7 GHz, Average, Omni Antenna**

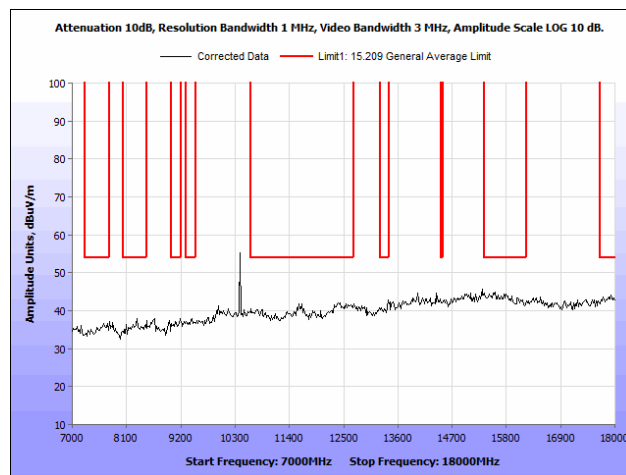

**Plot 97. Radiated Spurious Emissions, 802.11n, 20 MHz, Mid Channel, 7 GHz – 18 GHz, Omni Antenna**

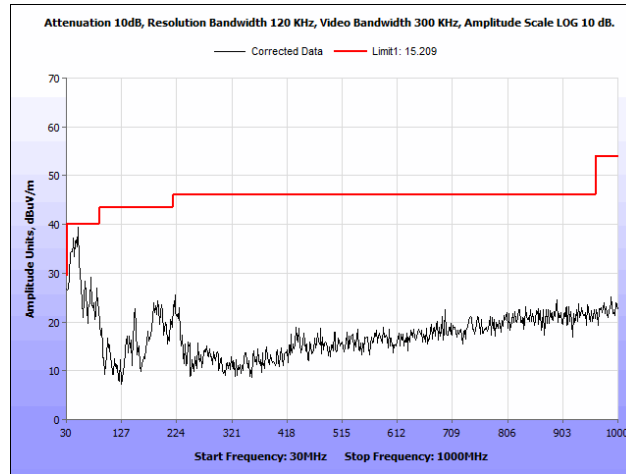

**Plot 98. Radiated Spurious Emissions, 802.11n, 20 MHz, High Channel, 30 MHz – 1 GHz, Omni Antenna**

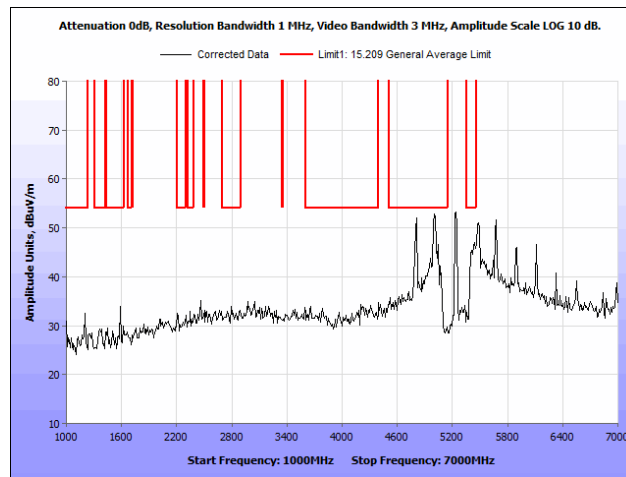

**Plot 99. Radiated Spurious Emissions, 802.11n, 20 MHz, High Channel, 1 GHz – 7 GHz, Average, Omni Antenna**

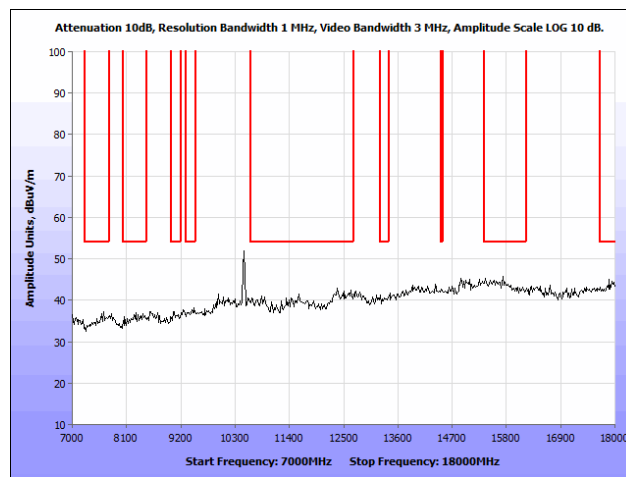

**Plot 100. Radiated Spurious Emissions, 802.11n, 20 MHz, High Channel, 7 GHz – 18 GHz, Omni Antenna**

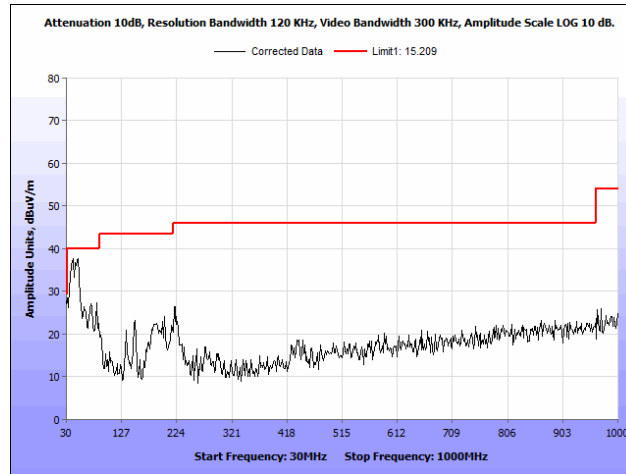

**Plot 101. Radiated Spurious Emissions, 802.11n, 40 MHz, High Channel, 30 MHz – 1 GHz, Omni Antenna**

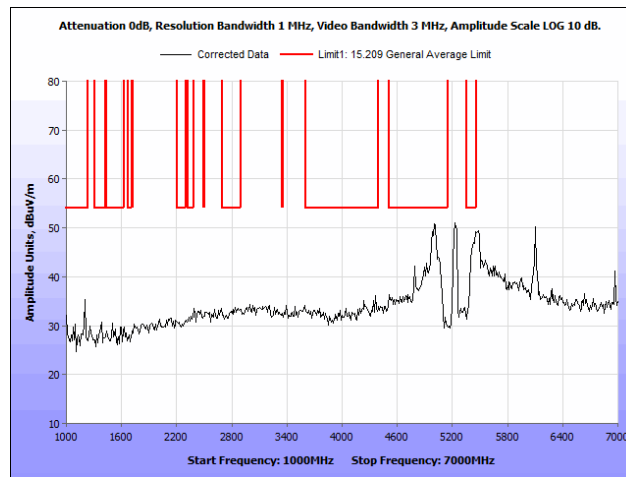

**Plot 102. Radiated Spurious Emissions, 802.11n, 40 MHz, High Channel, 1 GHz – 7 GHz, Average, Omni Antenna**

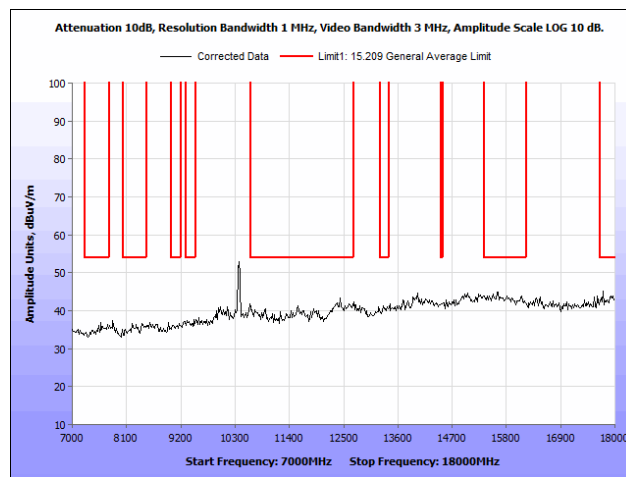

**Plot 103. Radiated Spurious Emissions, 802.11n, 40 MHz, High Channel, 7 GHz – 18 GHz, Omni Antenna**

**Radiated Spurious Emissions, 802.11ac, Omni Antenna**

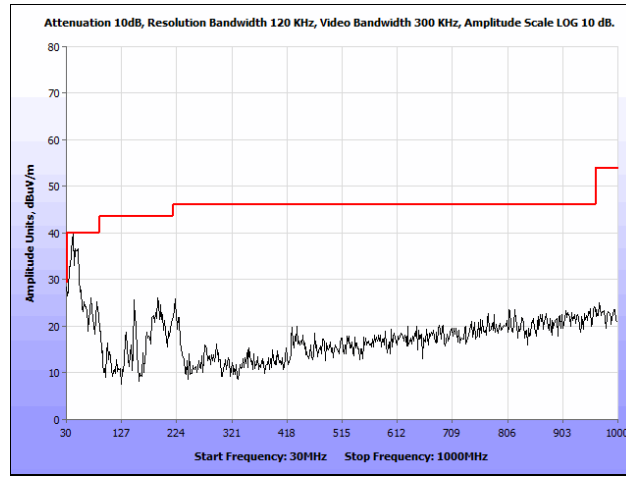

**Plot 104. Radiated Spurious Emissions, 802.11ac, 80 MHz, 30 MHz – 1 GHz, Omni Antenna**

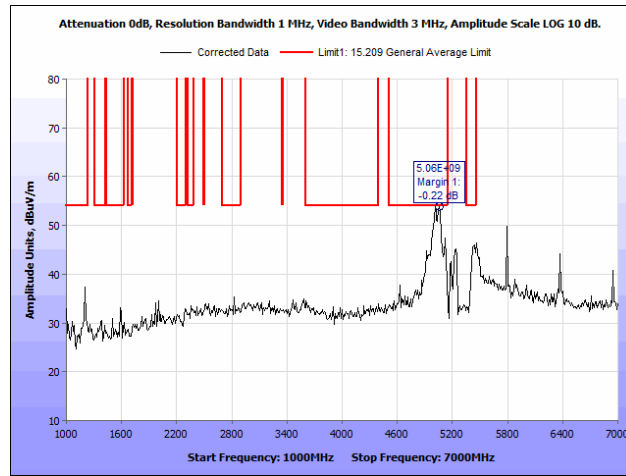

**Plot 105. Radiated Spurious Emissions, 802.11ac, 1 GHz – 7 GHz, Average, Omni Antenna**

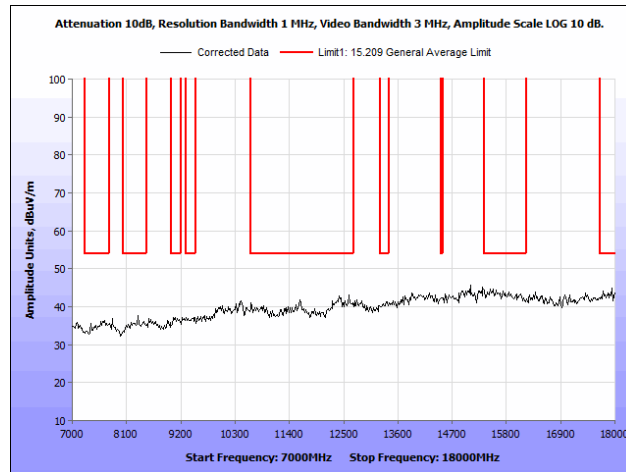

**Plot 106. Radiated Spurious Emissions, 802.11ac, 7 GHz – 18 GHz, Omni Antenna**

### Radiated Spurious Emissions, 802.11a, Patch Antenna

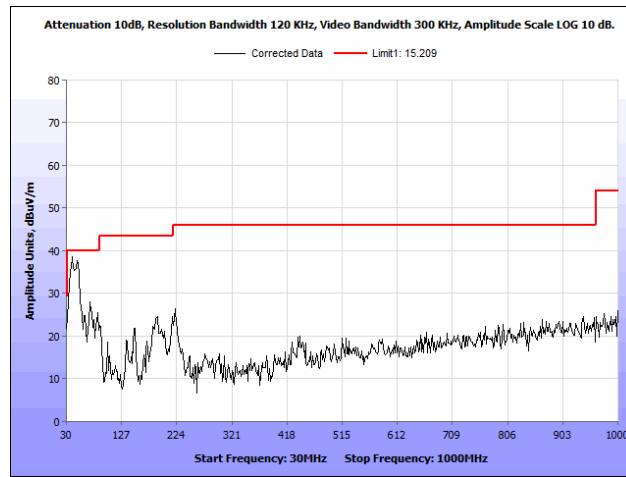

Plot 107. Radiated Spurious Emissions, 802.11a, 20 MHz, Low Channel, 30 MHz – 1 GHz, Patch Antenna

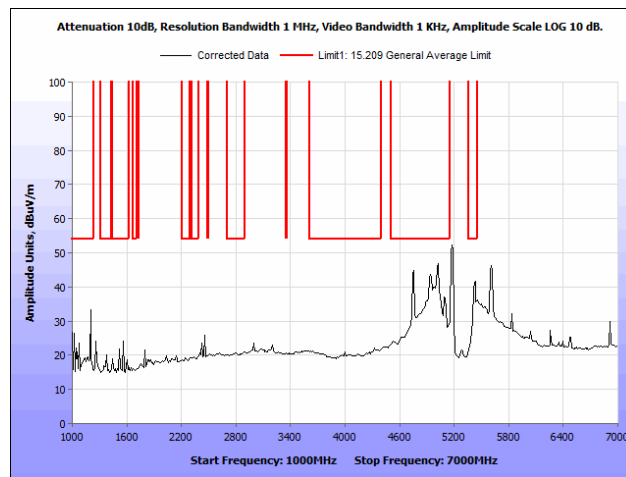

Plot 108. Radiated Spurious Emissions, 802.11a, 20 MHz, Low Channel, 1 GHz – 7 GHz, Average, Patch Antenna

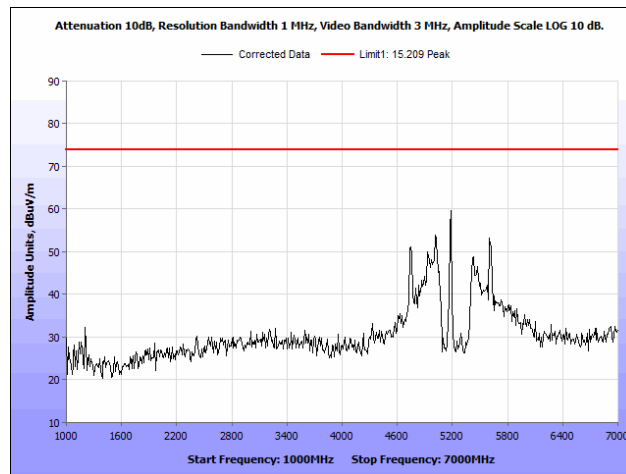

Plot 109. Radiated Spurious Emissions, 802.11a, 20 MHz, Low Channel, 1 GHz – 7 GHz, Peak, Patch Antenna

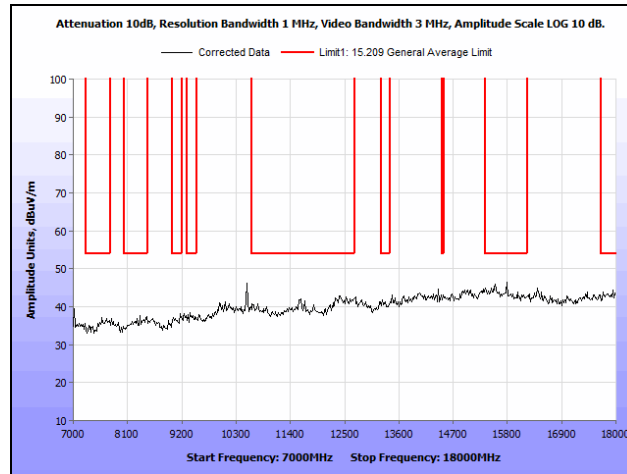

Plot 110. Radiated Spurious Emissions, 802.11a, 20 MHz, Low Channel, 7 GHz – 18 GHz, Peak, Patch Antenna

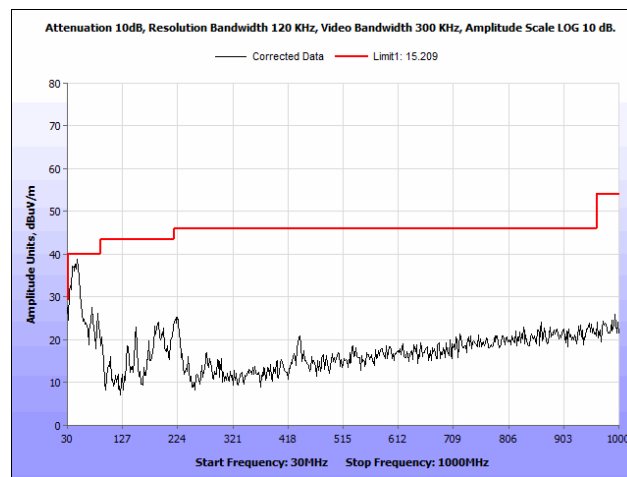

Plot 111. Radiated Spurious Emissions, 802.11a, 40 MHz, Low Channel, 30 MHz – 1 GHz, Patch Antenna

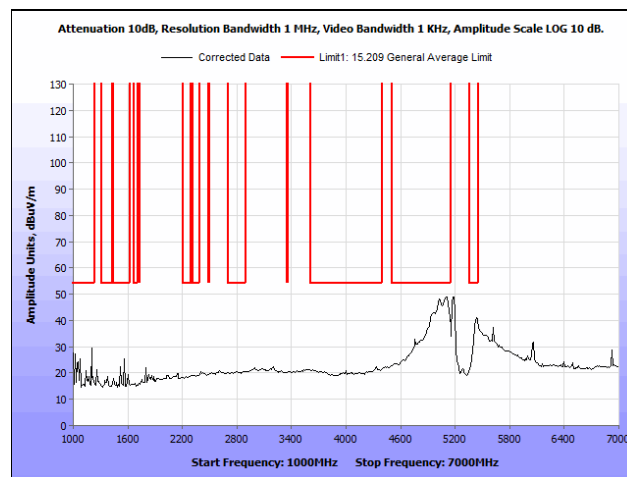

Plot 112. Radiated Spurious Emissions, 802.11a, 40 MHz, Low Channel, 1 GHz – 7 GHz, Average, Patch Antenna



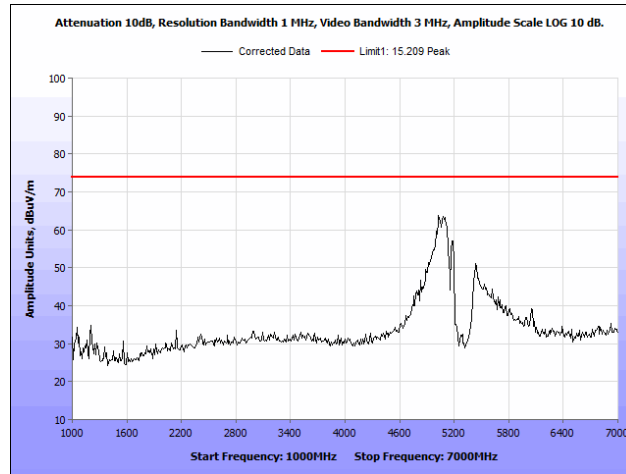

**Plot 113. Radiated Spurious Emissions, 802.11a, 40 MHz, Low Channel, 1 GHz – 7 GHz, Peak, Patch Antenna**

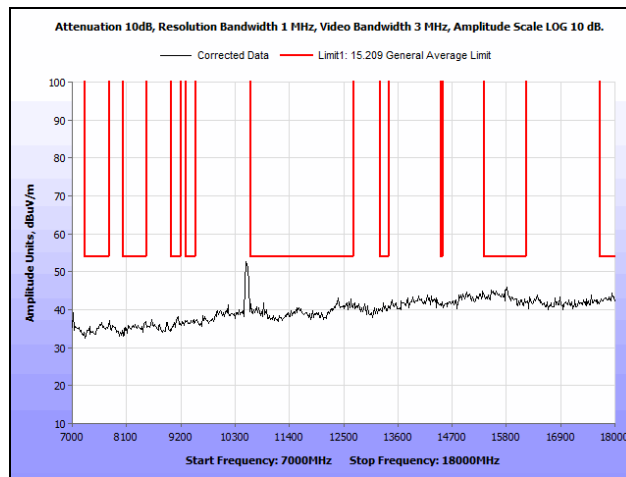

**Plot 114. Radiated Spurious Emissions, 802.11a, 40 MHz, Low Channel, 7 GHz – 18 GHz, Peak, Patch Antenna**

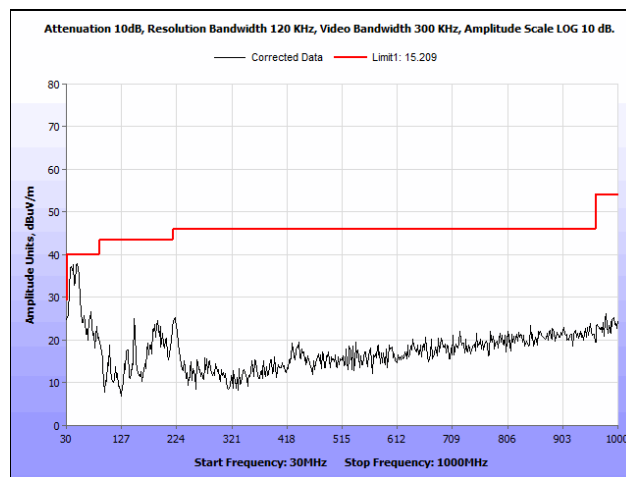

**Plot 115. Radiated Spurious Emissions, 802.11a, 20 MHz, Mid Channel, 30 MHz – 1 GHz, Patch Antenna**

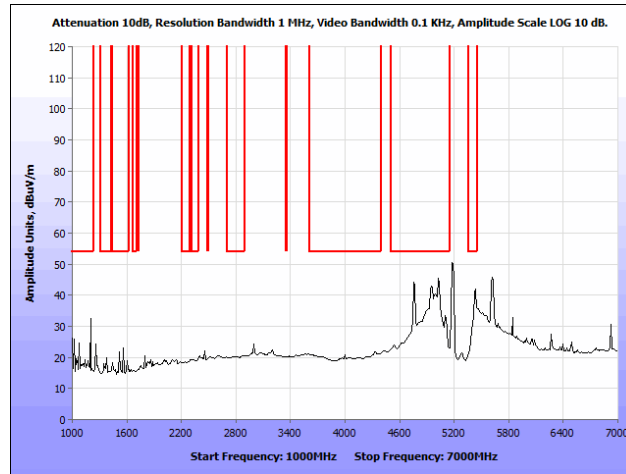

Plot 116. Radiated Spurious Emissions, 802.11a, 20 MHz, Mid Channel, 1 GHz – 7 GHz, Average, Patch Antenna

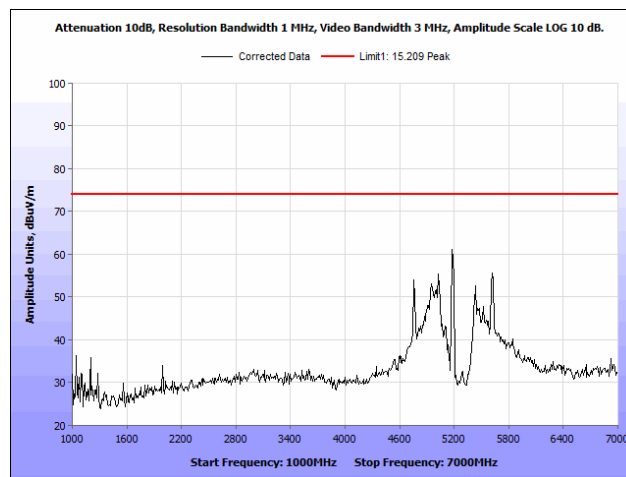

Plot 117. Radiated Spurious Emissions, 802.11a, 20 MHz, Mid Channel, 1 GHz – 7 GHz, Peak, Patch Antenna

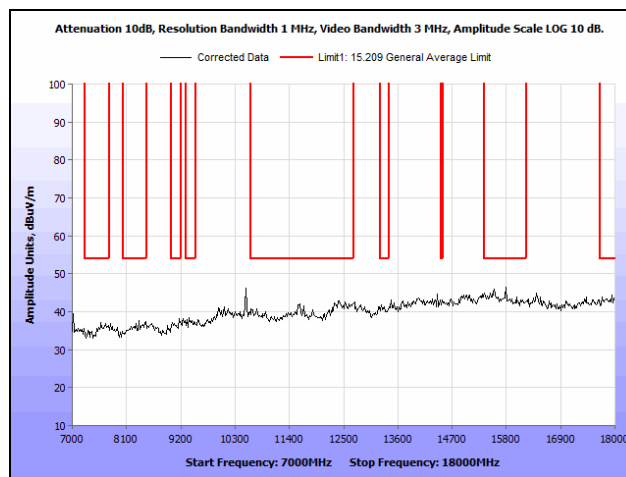

Plot 118. Radiated Spurious Emissions, 802.11a, 20 MHz, Mid Channel, 7 GHz – 18 GHz, Peak, Patch Antenna

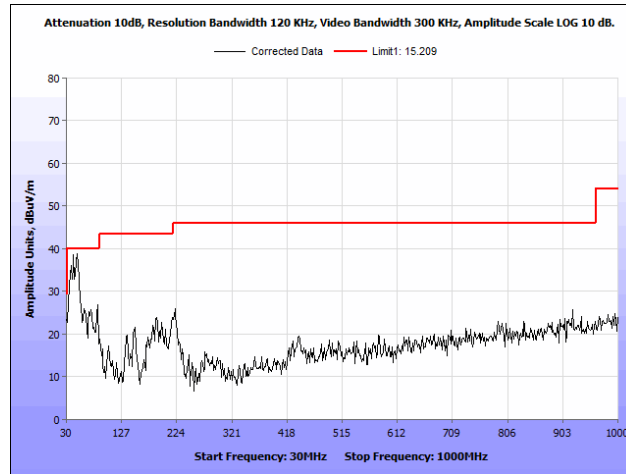

**Plot 119. Radiated Spurious Emissions, 802.11a, 20 MHz, High Channel, 30 MHz – 1 GHz, Patch Antenna**

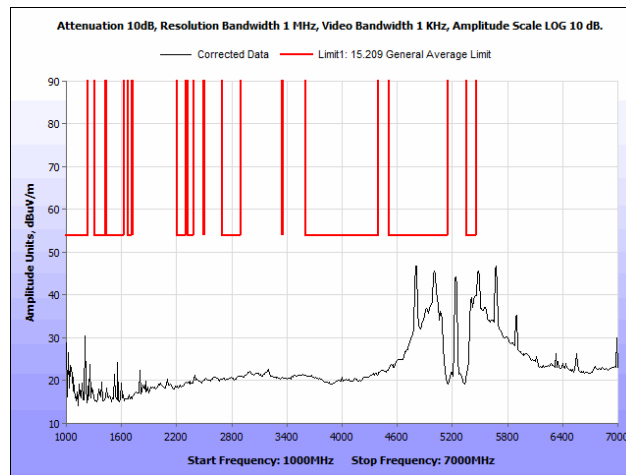

**Plot 120. Radiated Spurious Emissions, 802.11a, 20 MHz, High Channel, 1 GHz – 7 GHz, Average, Patch Antenna**

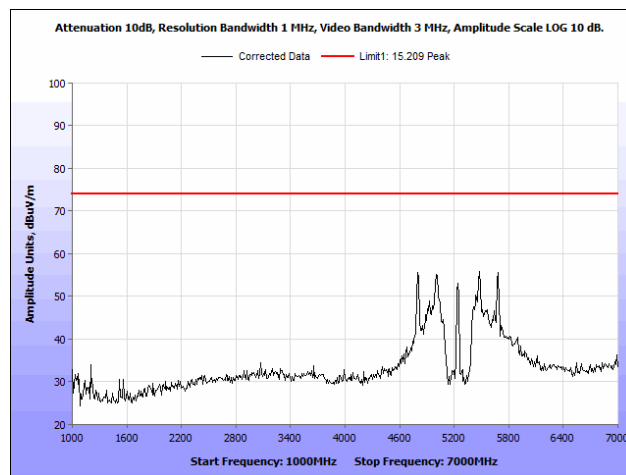

**Plot 121. Radiated Spurious Emissions, 802.11a, 20 MHz, High Channel, 1 GHz – 7 GHz, Peak, Patch Antenna**

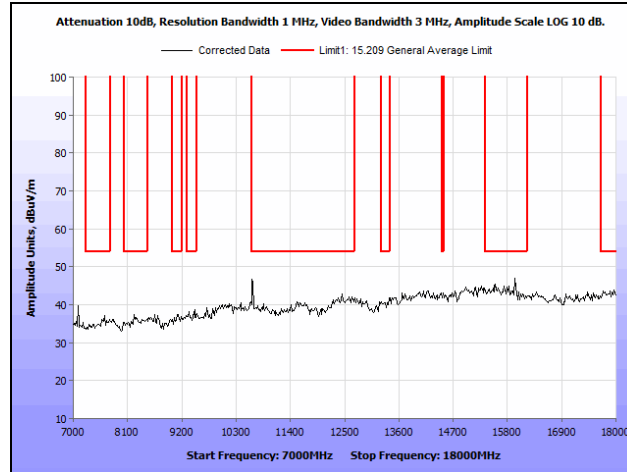

**Plot 122. Radiated Spurious Emissions, 802.11a, 20 MHz, High Channel, 7 GHz – 18 GHz, Peak, Patch Antenna**

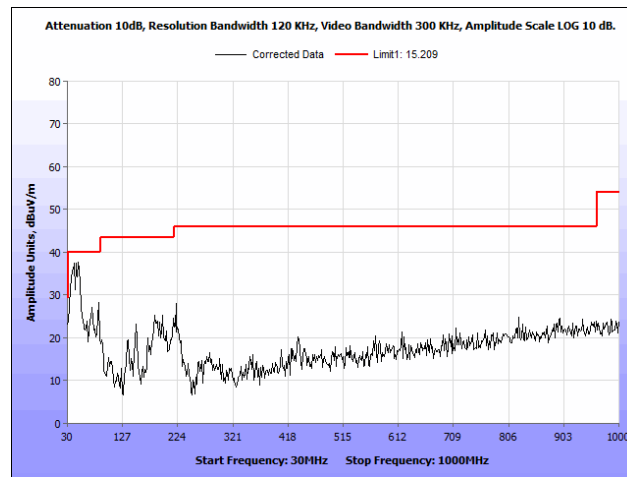

**Plot 123. Radiated Spurious Emissions, 802.11a, 40 MHz, High Channel, 30 MHz – 1 GHz, Patch Antenna**

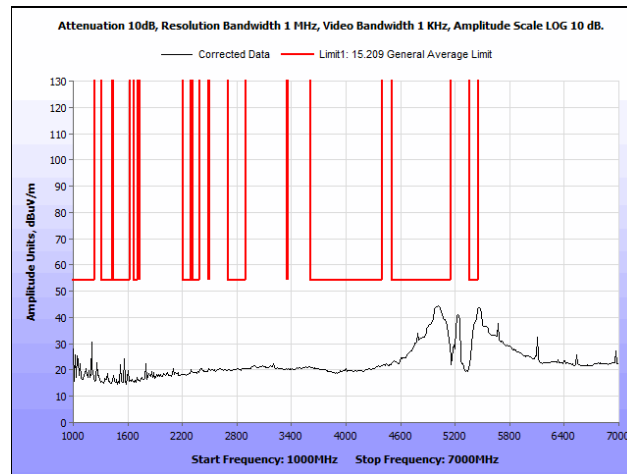

**Plot 124. Radiated Spurious Emissions, 802.11a, 40 MHz, High Channel, 1 GHz – 7 GHz, Average, Patch Antenna**

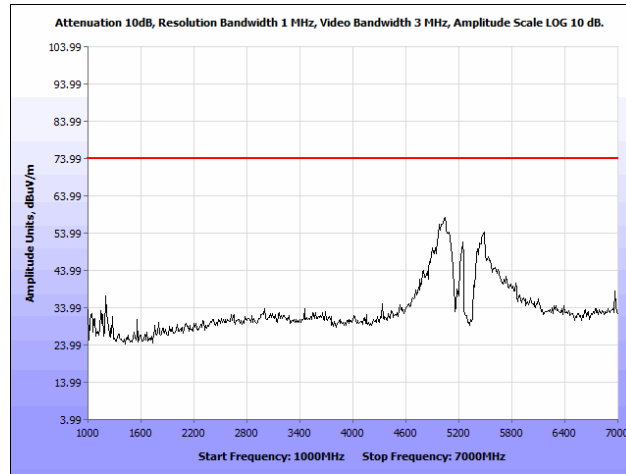

**Plot 125. Radiated Spurious Emissions, 802.11a, 40 MHz, High Channel, 1 GHz – 7 GHz, Peak, Patch Antenna**

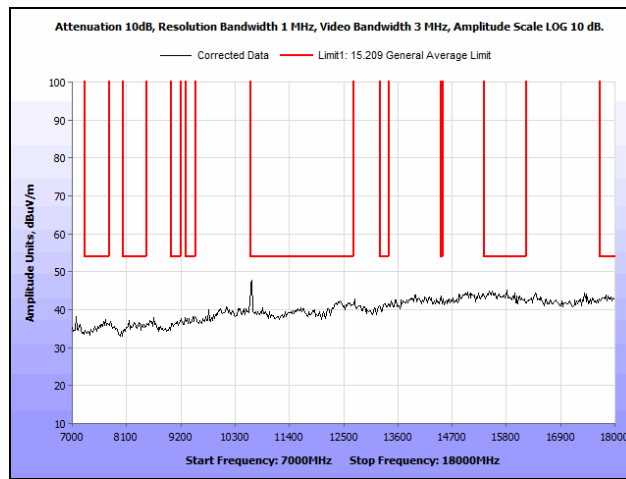

**Plot 126. Radiated Spurious Emissions, 802.11a, 40 MHz, High Channel, 7 GHz – 18 GHz, Peak, Patch Antenna**

**Radiated Spurious Emissions, 802.11n, Patch Antenna**

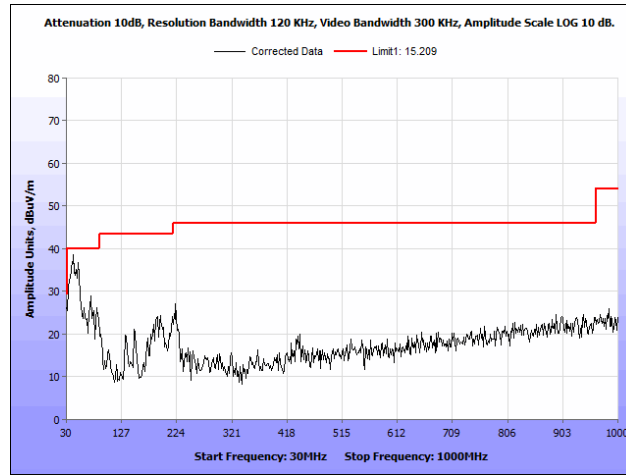

**Plot 127. Radiated Spurious Emissions, 802.11n, 20 MHz, Low Channel, 30 MHz – 1 GHz, Patch Antenna**

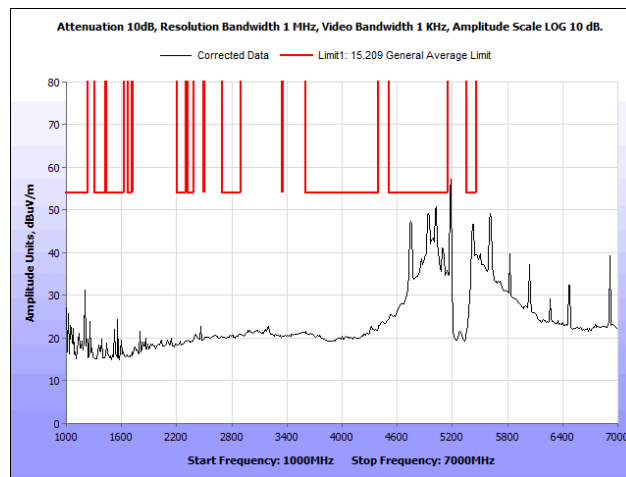

**Plot 128. Radiated Spurious Emissions, 802.11n, 20 MHz, Low Channel, 1 GHz – 7 GHz, Average, Patch Antenna**

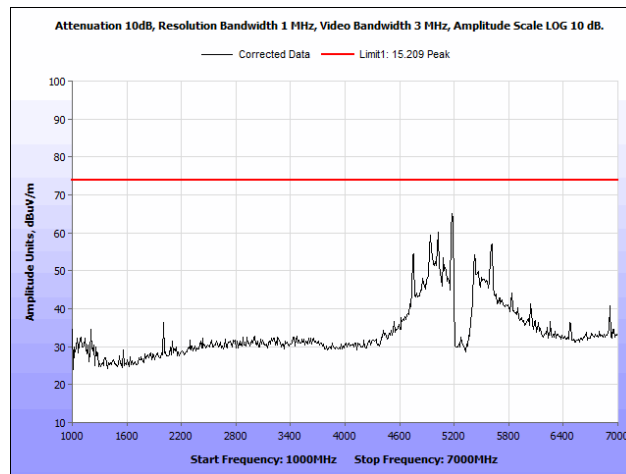

**Plot 129. Radiated Spurious Emissions, 802.11n, 20 MHz, Low Channel, 1 GHz – 7 GHz, Peak, Patch Antenna**

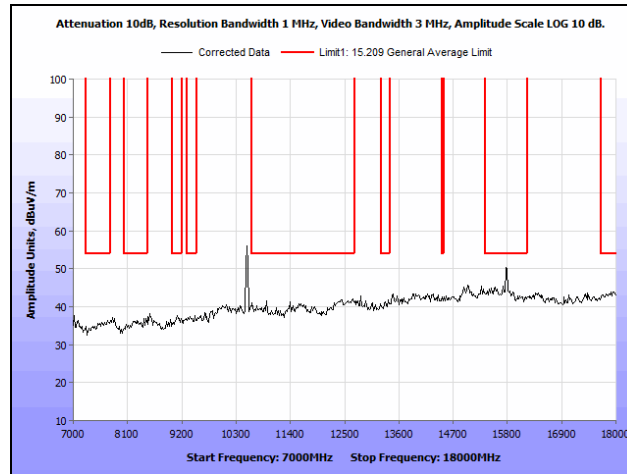

Plot 130. Radiated Spurious Emissions, 802.11n, 20 MHz, Low Channel, 7 GHz – 18 GHz, Peak, Patch Antenna

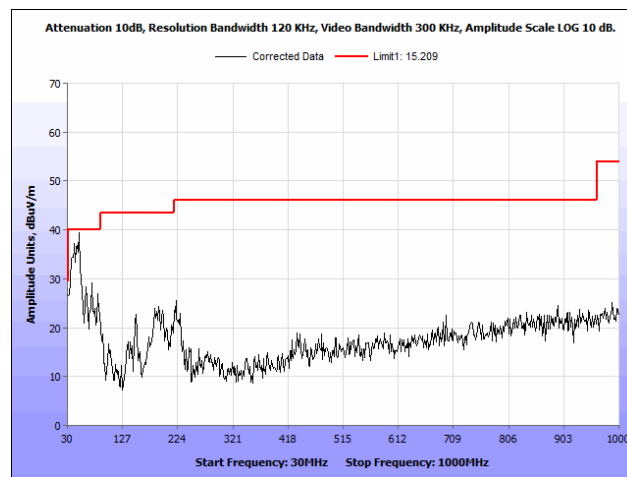

Plot 131. Radiated Spurious Emissions, 802.11n, 40 MHz, Low Channel, 30 MHz – 1 GHz, Patch Antenna

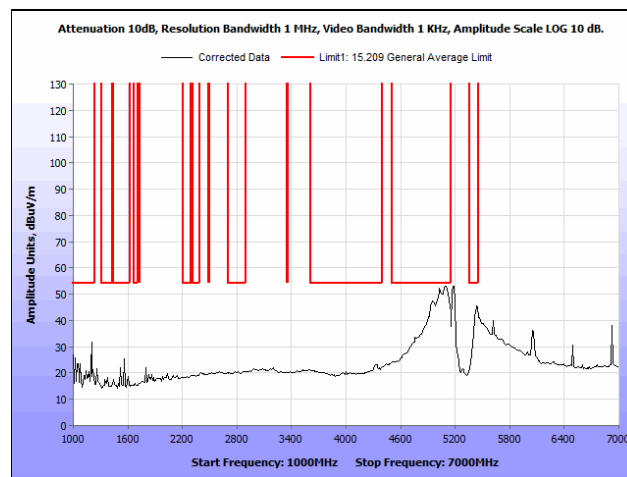

Plot 132. Radiated Spurious Emissions, 802.11n, 40 MHz, Low Channel, 1 GHz – 7 GHz, Average, Patch Antenna

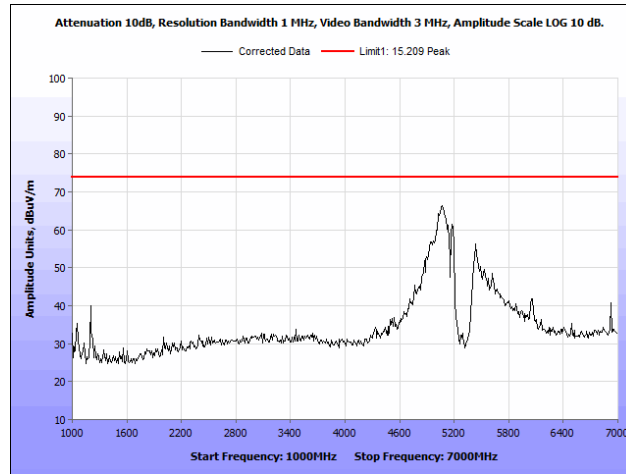

**Plot 133. Radiated Spurious Emissions, 802.11n, 40 MHz, Low Channel, 1 GHz – 7 GHz, Peak, Patch Antenna**

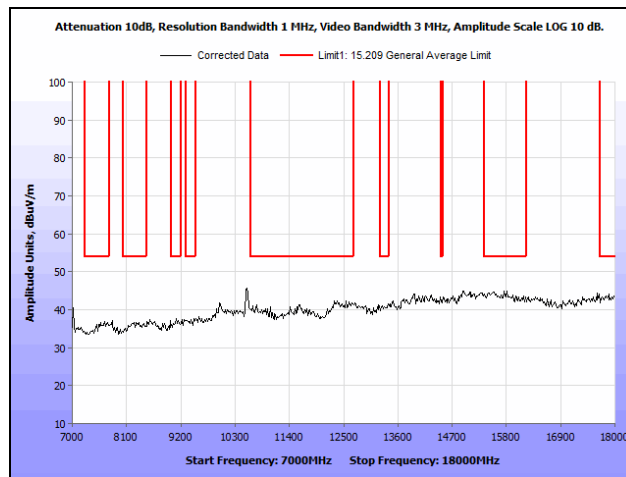

**Plot 134. Radiated Spurious Emissions, 802.11n, 40 MHz, Low Channel, 7 GHz – 18 GHz, Peak, Patch Antenna**

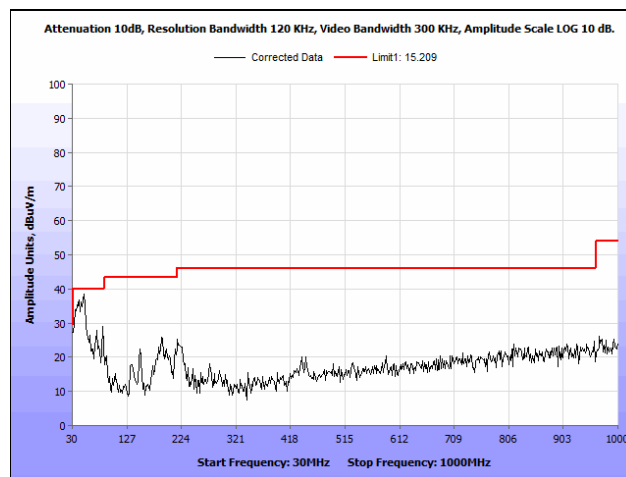

**Plot 135. Radiated Spurious Emissions, 802.11n, 20 MHz, Mid Channel, 30 MHz – 1 GHz, Patch Antenna**



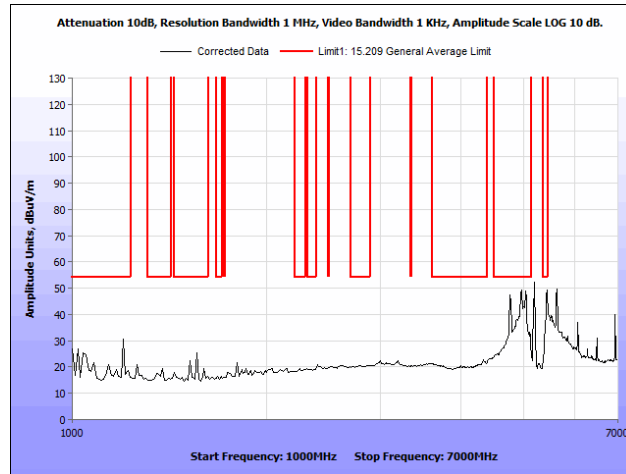

**Plot 136. Radiated Spurious Emissions, 802.11n, 20 MHz, Mid Channel, 1 GHz – 7 GHz, Average, Patch Antenna**

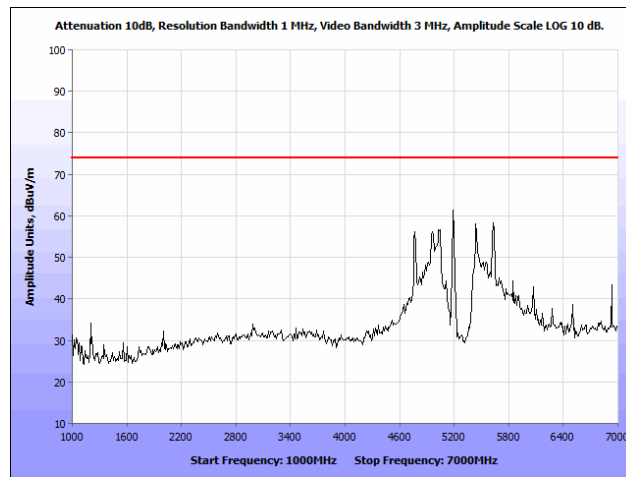

**Plot 137. Radiated Spurious Emissions, 802.11n, 20 MHz, Mid Channel, 1 GHz – 7 GHz, Patch Antenna**

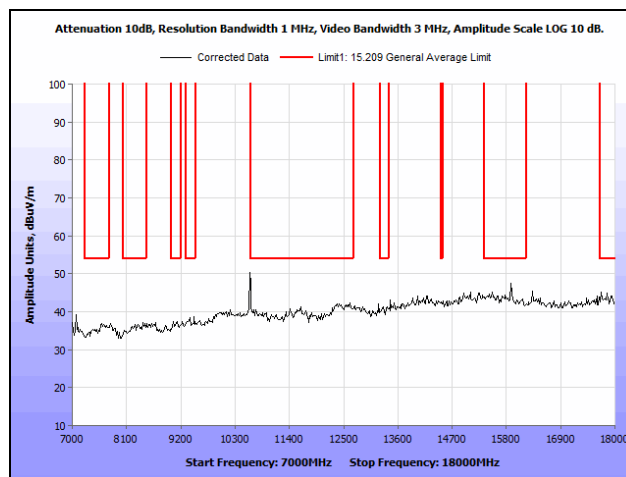

**Plot 138. Radiated Spurious Emissions, 802.11n, 20 MHz, Mid Channel, 7 GHz – 18 GHz, Patch Antenna**

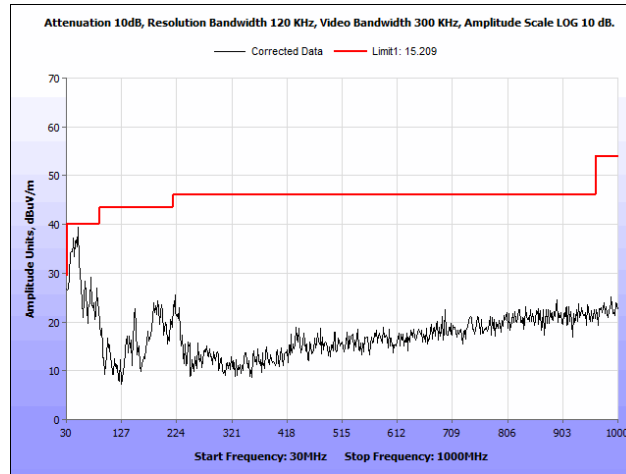

**Plot 139. Radiated Spurious Emissions, 802.11n, 20 MHz, High Channel, 30 MHz – 1 GHz, Patch Antenna**

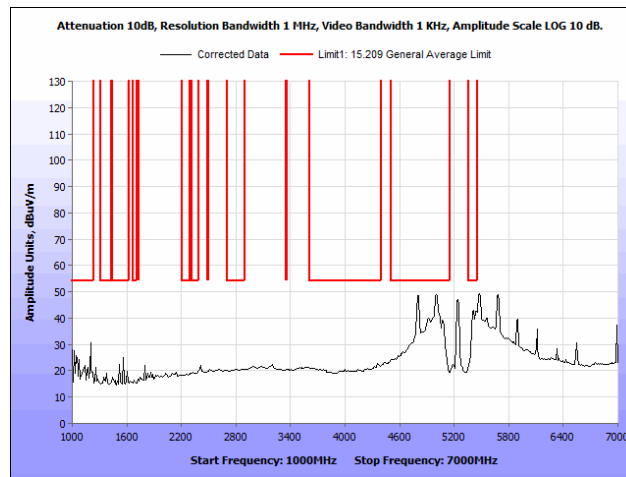

**Plot 140. Radiated Spurious Emissions, 802.11n, 20 MHz, High Channel, 1 GHz – 7 GHz, Average, Patch Antenna**

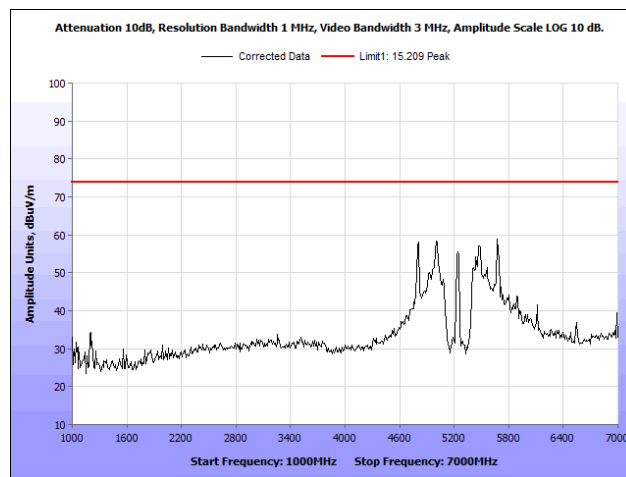

**Plot 141. Radiated Spurious Emissions, 802.11n, 20 MHz, High Channel, 1 GHz – 7 GHz, Peak, Patch Antenna**

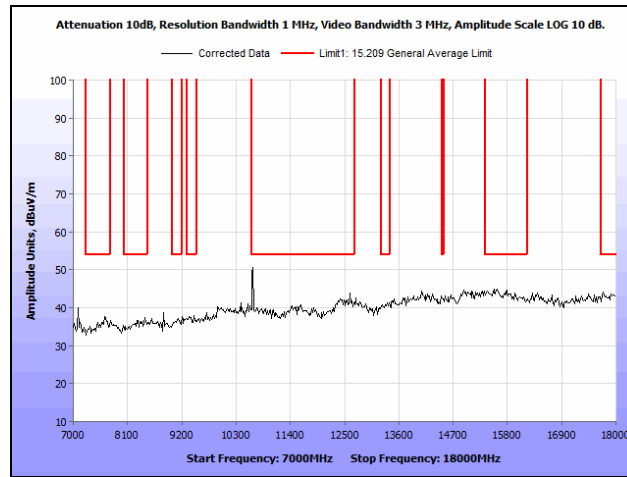

**Plot 142. Radiated Spurious Emissions, 802.11n, 20 MHz, High Channel, 7 GHz – 18 GHz, Peak, Patch Antenna**

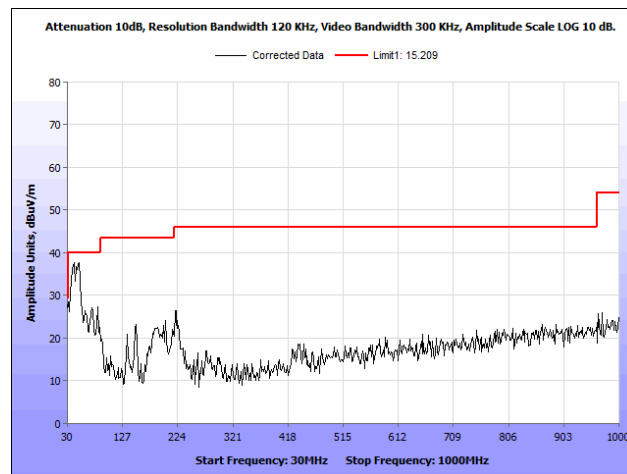

**Plot 143. Radiated Spurious Emissions, 802.11n, 40 MHz, High Channel, 30 MHz – 1 GHz, Patch Antenna**

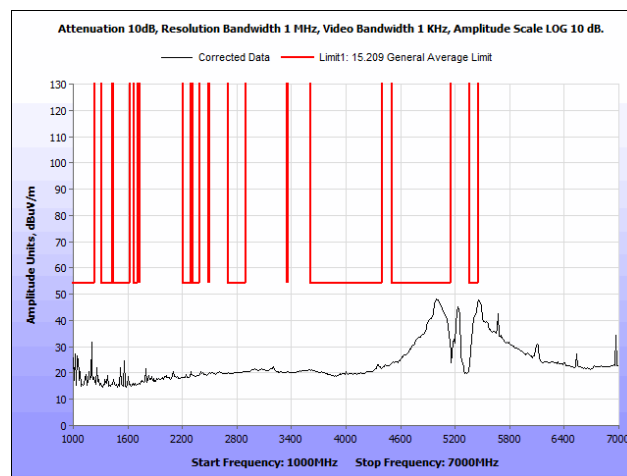

**Plot 144. Radiated Spurious Emissions, 802.11n, 40 MHz, High Channel, 1 GHz – 7 GHz, Average, Patch Antenna**

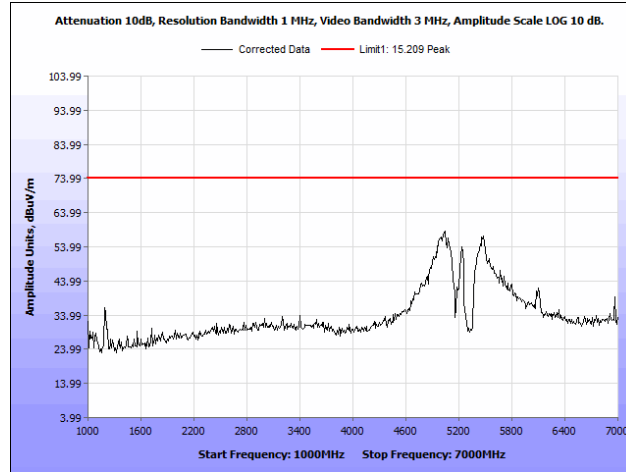

**Plot 145. Radiated Spurious Emissions, 802.11n, 40 MHz, High Channel, 1 GHz – 7 GHz, Peak, Patch Antenna**

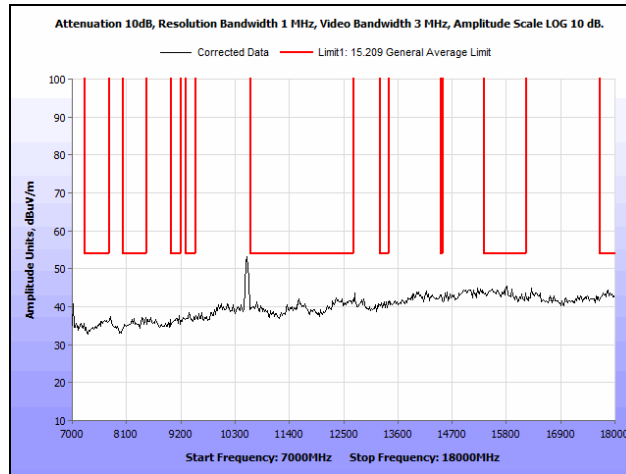

**Plot 146. Radiated Spurious Emissions, 802.11n, 40 MHz, High Channel, 7 GHz – 18 GHz, Peak, Patch Antenna**

**Radiated Spurious Emissions, 802.11ac, Patch Antenna**

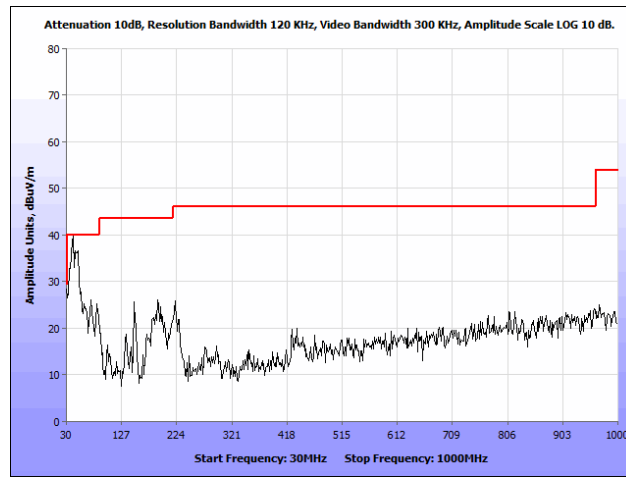

**Plot 147. Radiated Spurious Emissions, 802.11ac, 80 MHz, 30 MHz – 1 GHz, Patch Antenna**

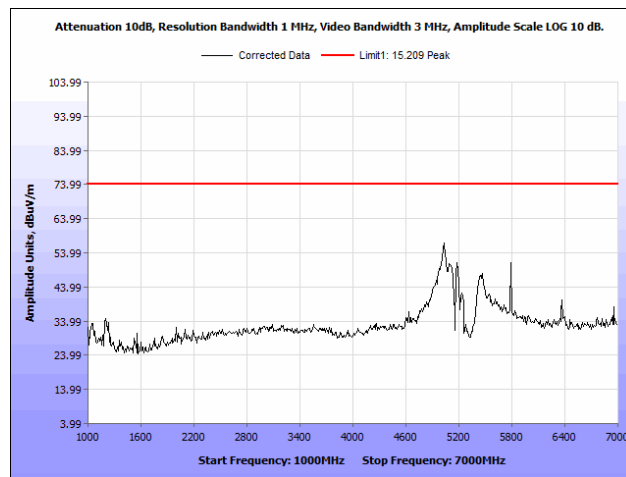

**Plot 148. Radiated Spurious Emissions, 802.11ac, 1 GHz – 7 GHz, Average, Patch Antenna**

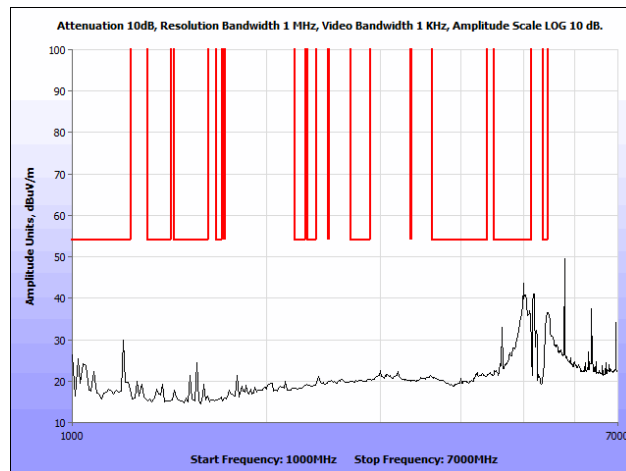

**Plot 149. Radiated Spurious Emissions, 802.11ac, 1 GHz – 7 GHz, Peak, Patch Antenna**

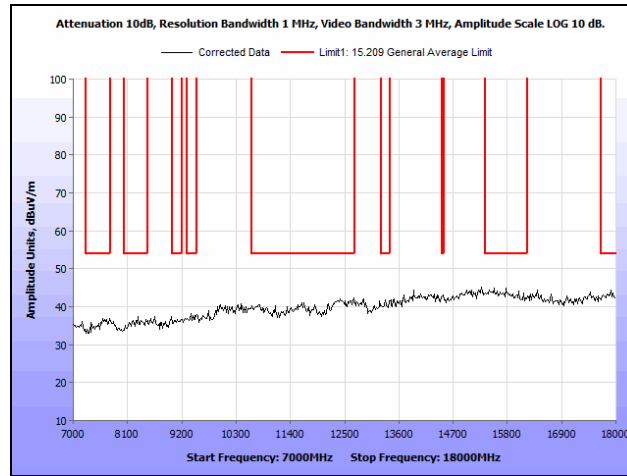

Plot 150. Radiated Spurious Emissions, 802.11ac, 7 GHz – 18 GHz, Peak, Patch Antenna

**Band Edge, 802.11a, 6 dBi Outdoor Omni Antenna**

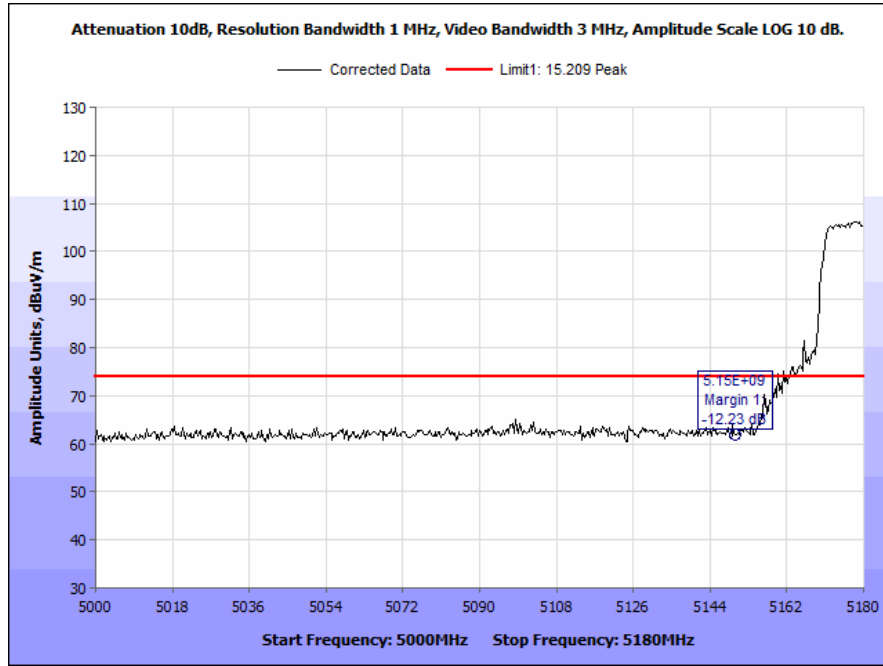

**Plot 151. Radiated Band Edge, 802.11a, 20 MHz, Low Channel, 6 dBi Omni Outdoor Antenna, Peak**

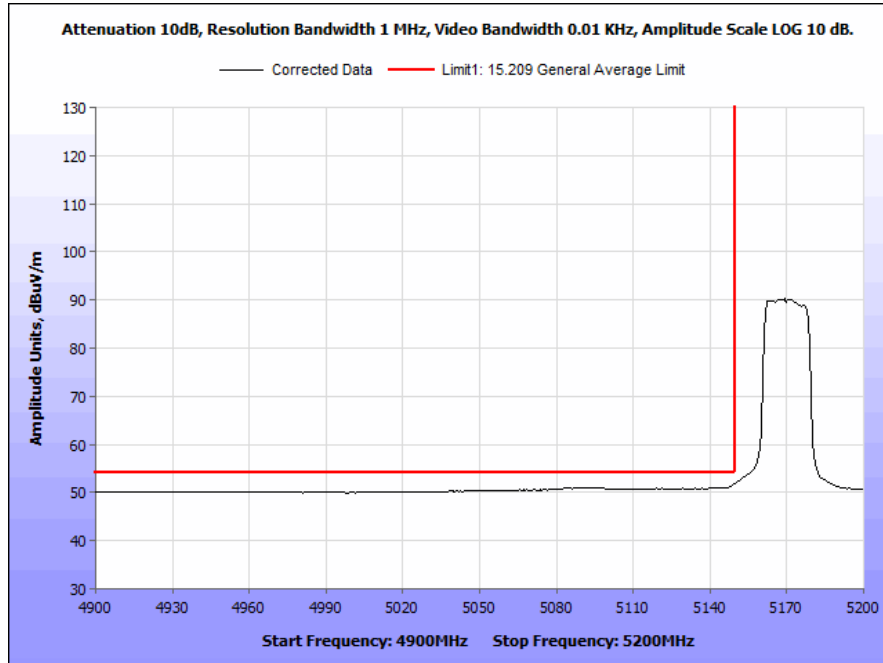

**Plot 152. Radiated Band Edge, 802.11a, 20 MHz, Low Channel, 6 dBi Omni Outdoor Antenna, Average**

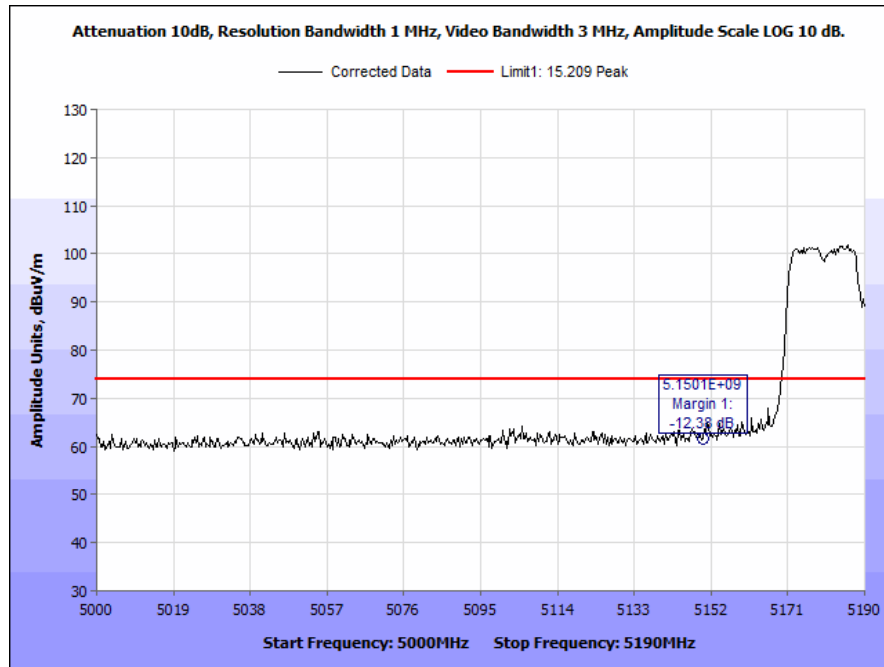

Plot 153. Radiated Band Edge, 802.11a, 40 MHz, Low Channel, 6 dBi Omni Outdoor Antenna, Peak

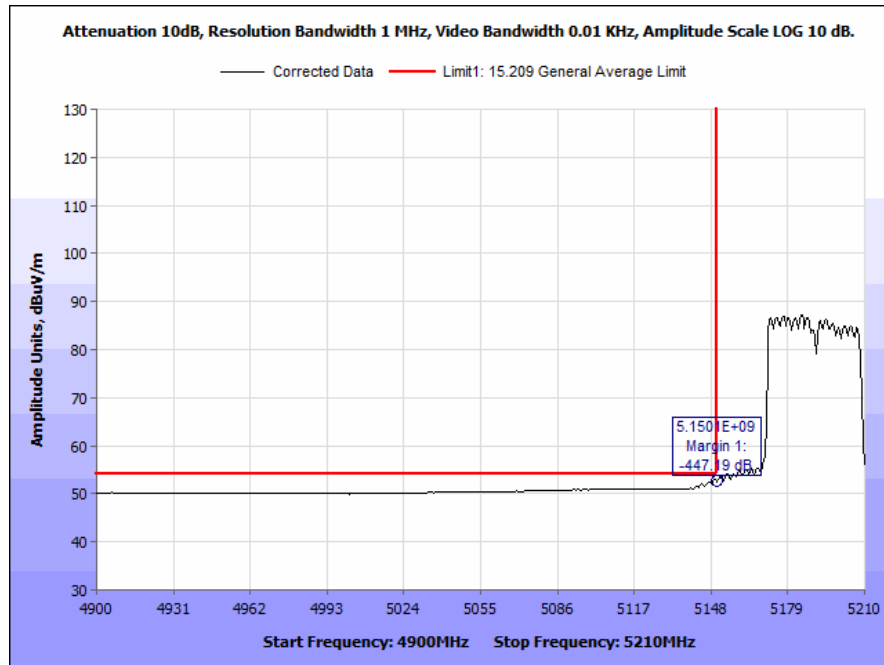

Plot 154. Radiated Band Edge, 802.11a, 40 MHz, Low Channel, 6 dBi Omni Outdoor Antenna, Average



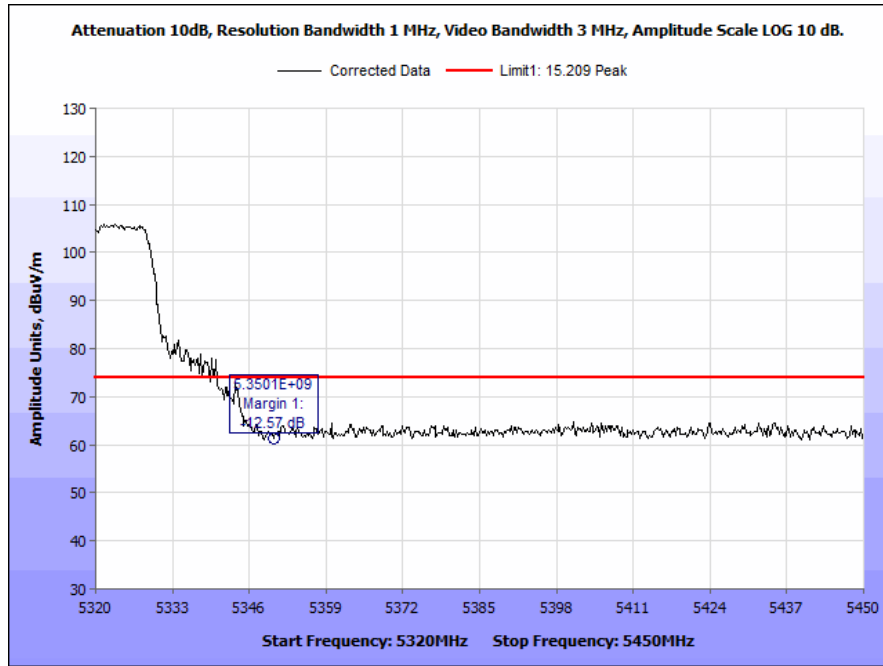

Plot 155. Radiated Band Edge, 802.11a, 20 MHz, High Channel, 6 dBi Omni Outdoor Antenna, Peak

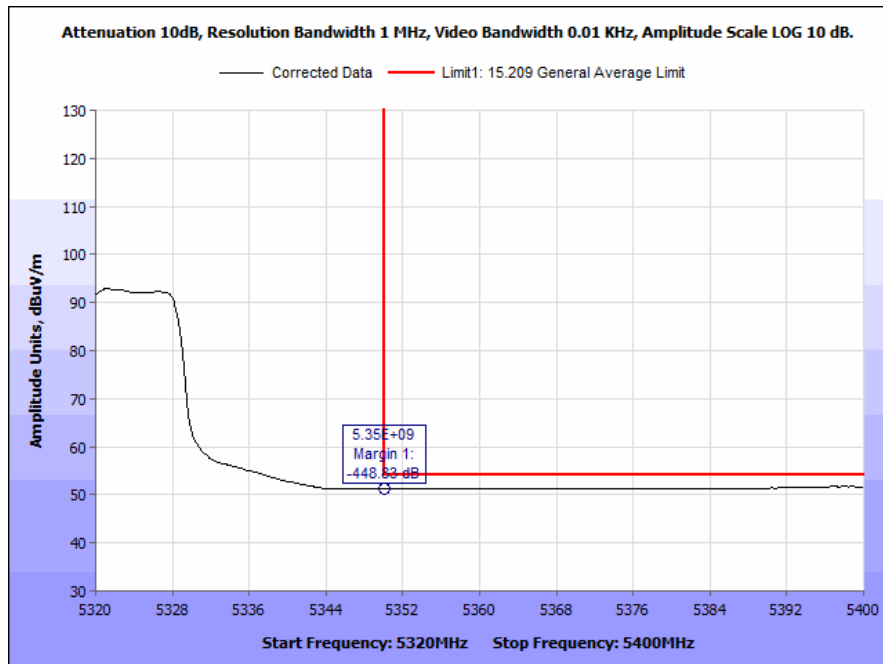

Plot 156. Radiated Band Edge, 802.11a, 20 MHz, High Channel, 6 dBi Omni Outdoor Antenna, Average

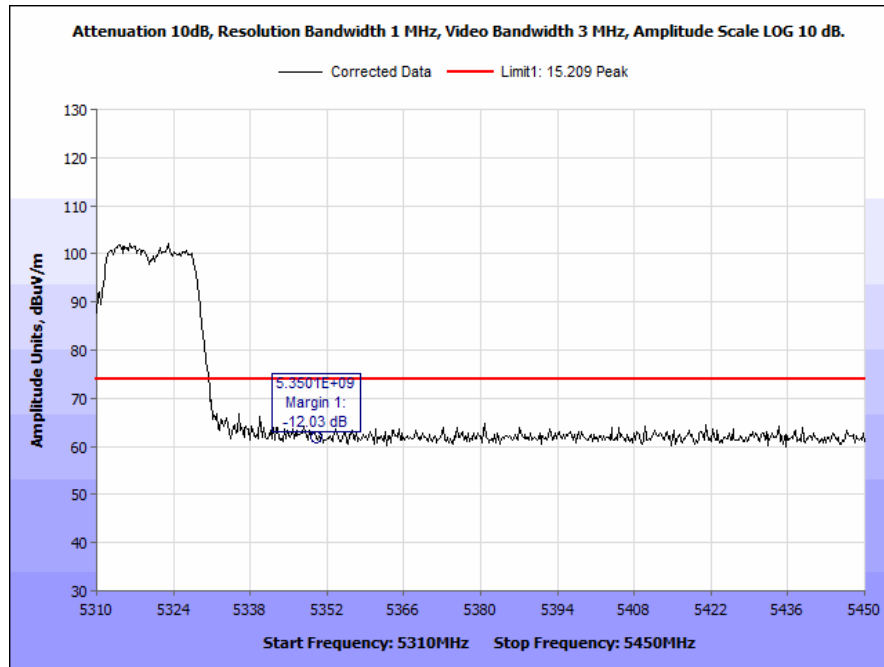

Plot 157. Radiated Band Edge, 802.11a, 40 MHz, Low Channel, 6 dBi Omni Outdoor Antenna, Peak

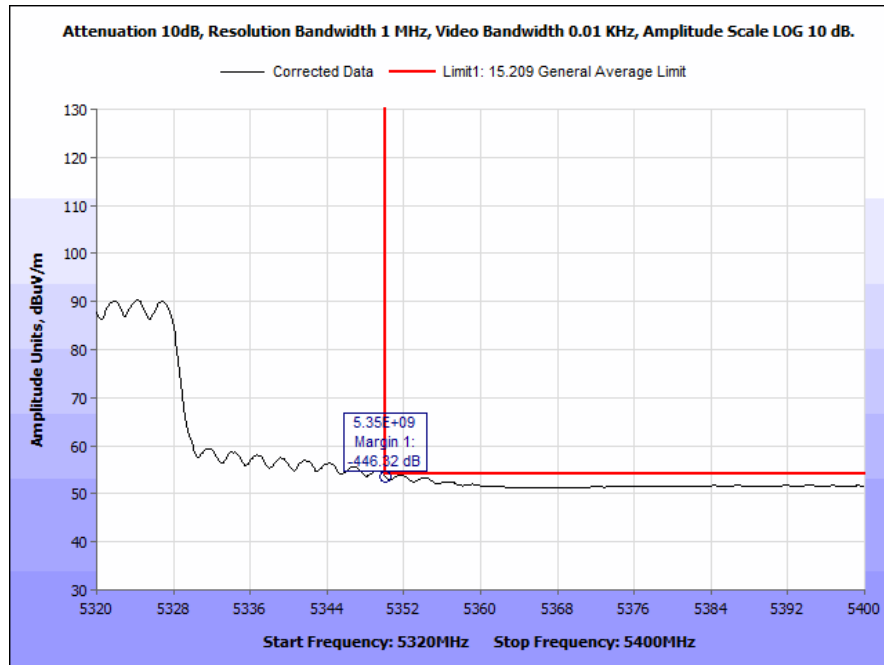

Plot 158. Radiated Band Edge, 802.11a, 40 MHz, Low Channel, 6 dBi Omni Outdoor Antenna, Average

**Band Edge, 802.11n, 6 dBi Outdoor Omni Antenna**

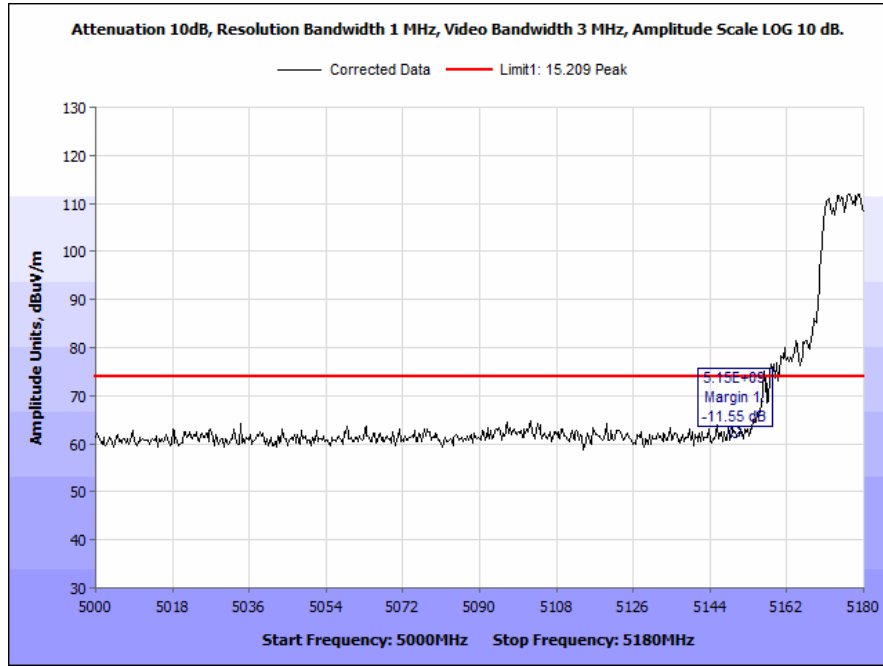

**Plot 159. Radiated Band Edge, 802.11n, 20 MHz, Low Channel, 6 dBi Omni Outdoor Antenna, Peak**

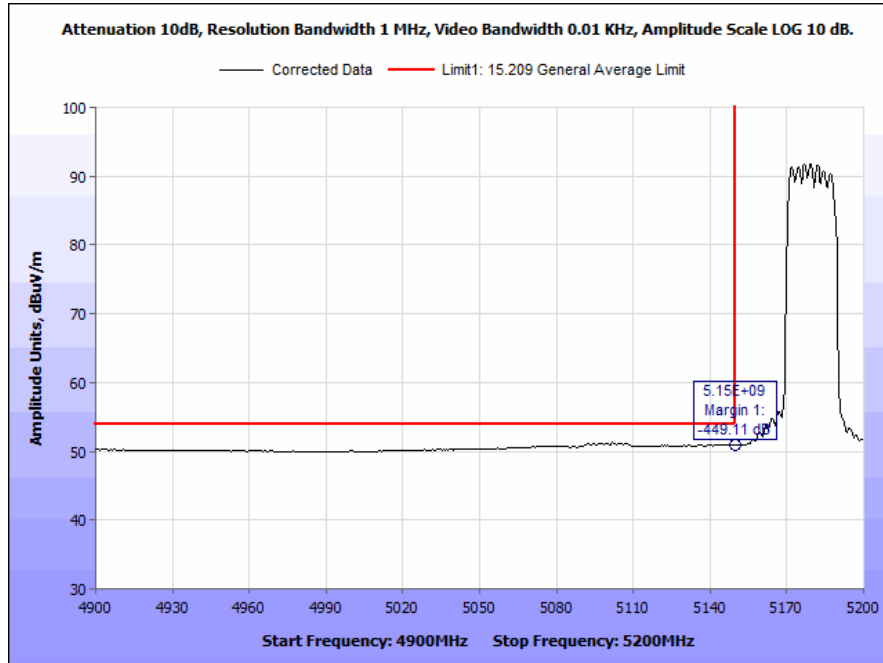

**Plot 160. Radiated Band Edge, 802.11n, 20 MHz, Low Channel, 6 dBi Omni Outdoor Antenna, Average**

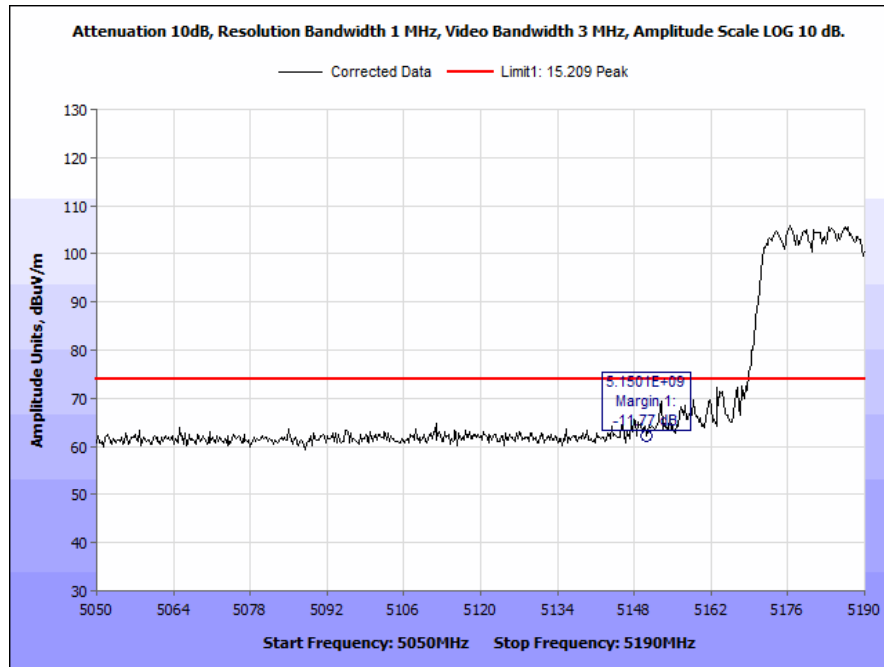

Plot 161. Radiated Band Edge, 802.11n, 40 MHz, Low Channel, 6 dBi Omni Outdoor Antenna, Peak

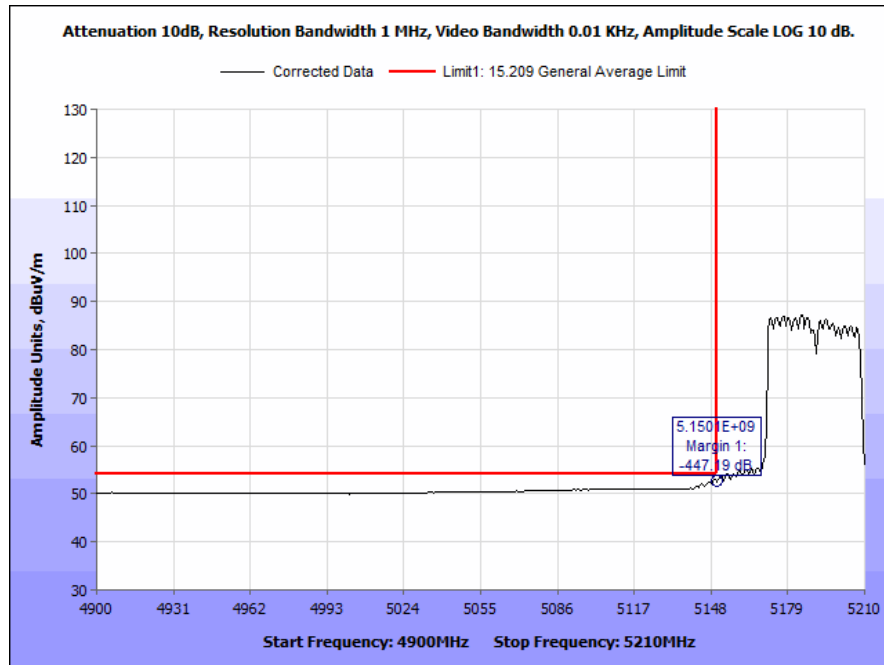

Plot 162. Radiated Band Edge, 802.11n, 40 MHz, Low Channel, 6 dBi Omni Outdoor Antenna, Average

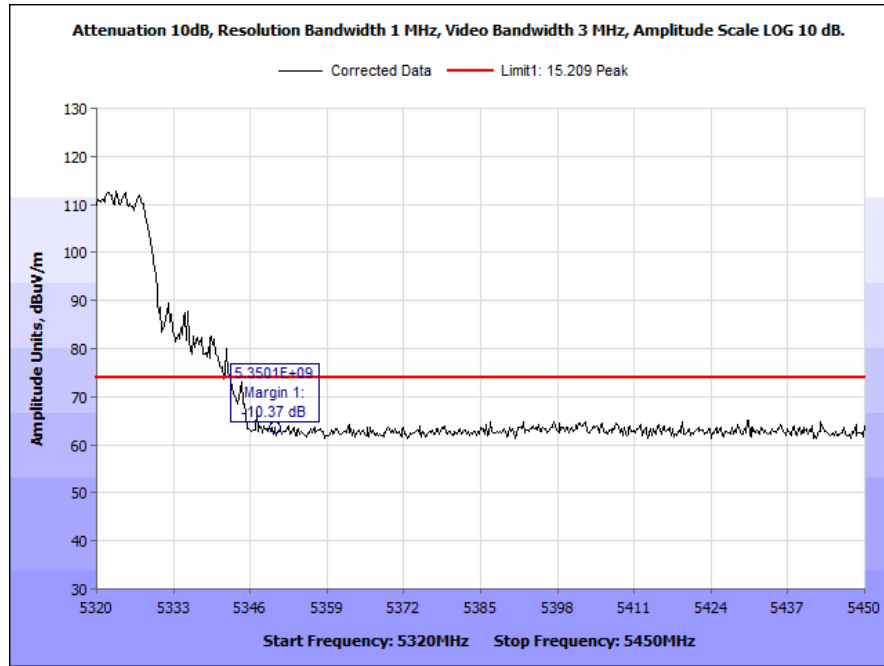

Plot 163. Radiated Band Edge, 802.11n, 20 MHz, High Channel, 6 dBi Omni Outdoor Antenna, Peak

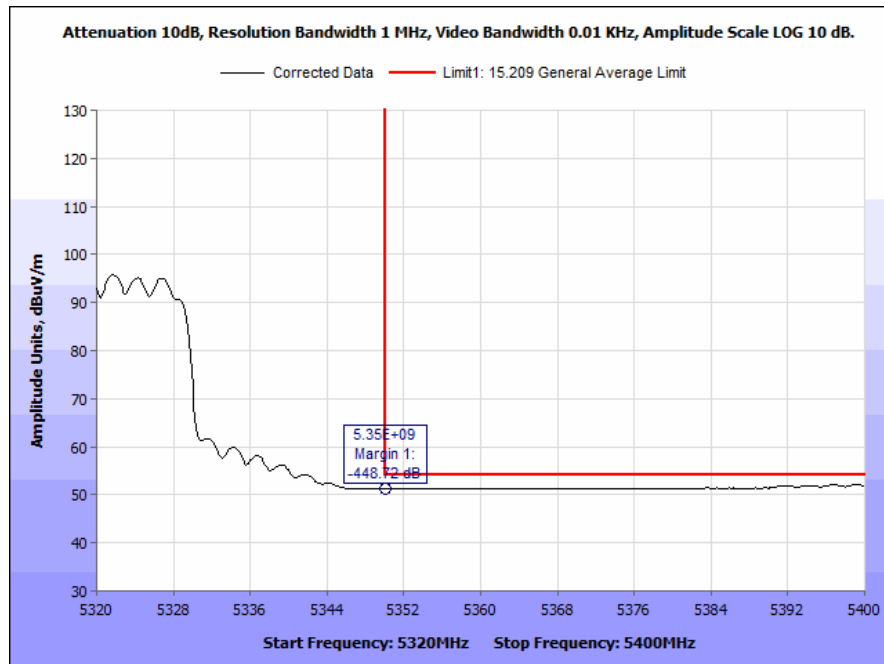

Plot 164. Radiated Band Edge, 802.11n, 20 MHz, High Channel, 6 dBi Omni Outdoor Antenna, Average

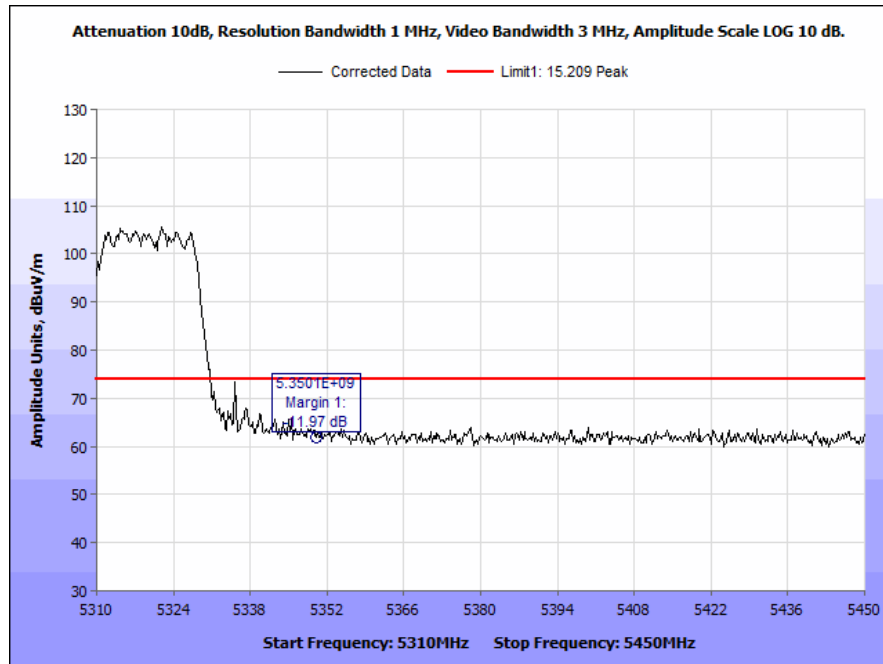

Plot 165. Radiated Band Edge, 802.11n, 40 MHz, High Channel, 6 dBi Omni Outdoor Antenna, Peak

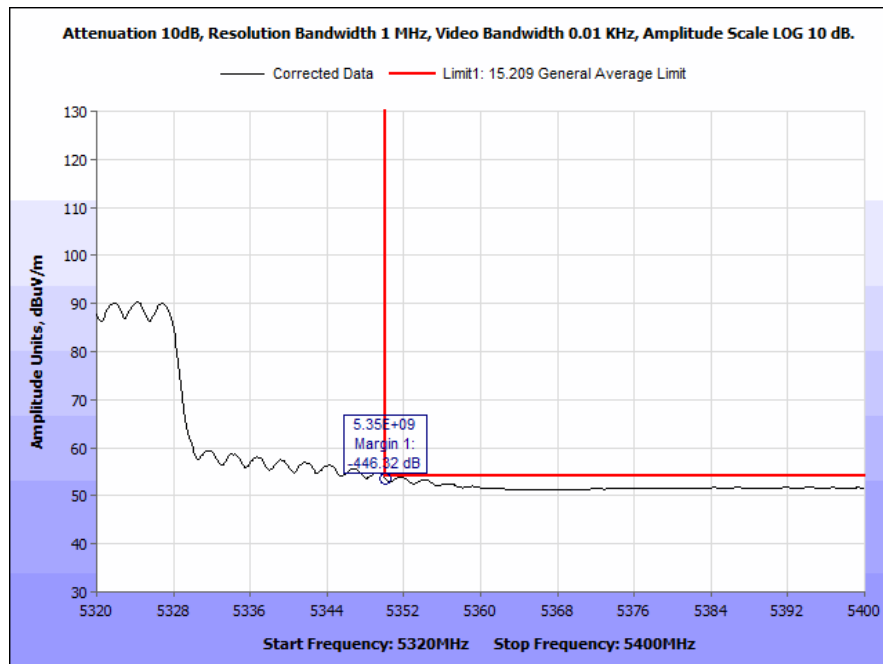

Plot 166. Radiated Band Edge, 802.11n, 40 MHz, High Channel, 6 dBi Omni Outdoor Antenna, Average

### Band Edge, 802.11ac, 6 dBi Outdoor Omni Antenna

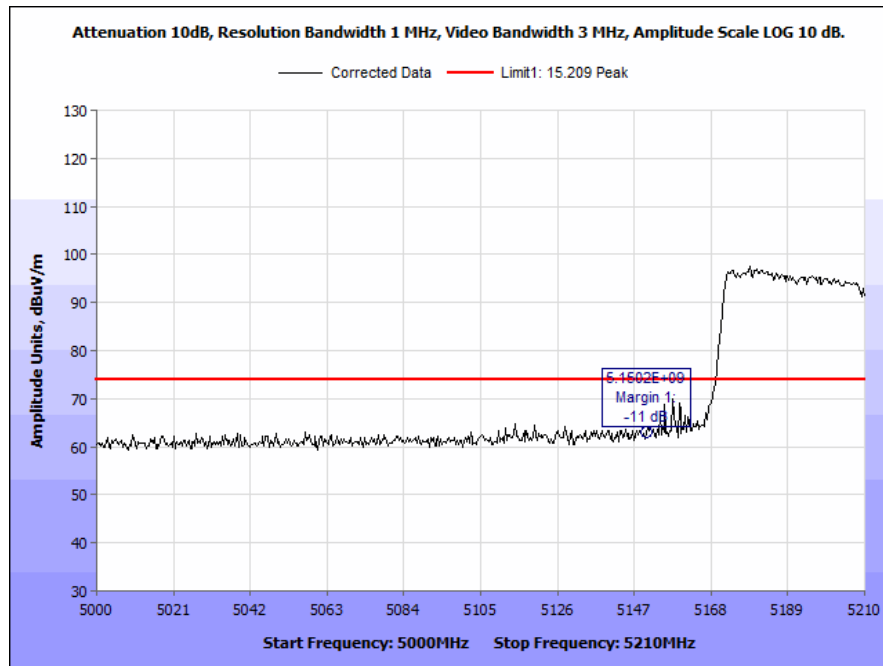

Plot 167. Radiated Band Edge, 802.11ac, 80 MHz, Low Channel, 6 dBi Omni Outdoor Antenna, Peak

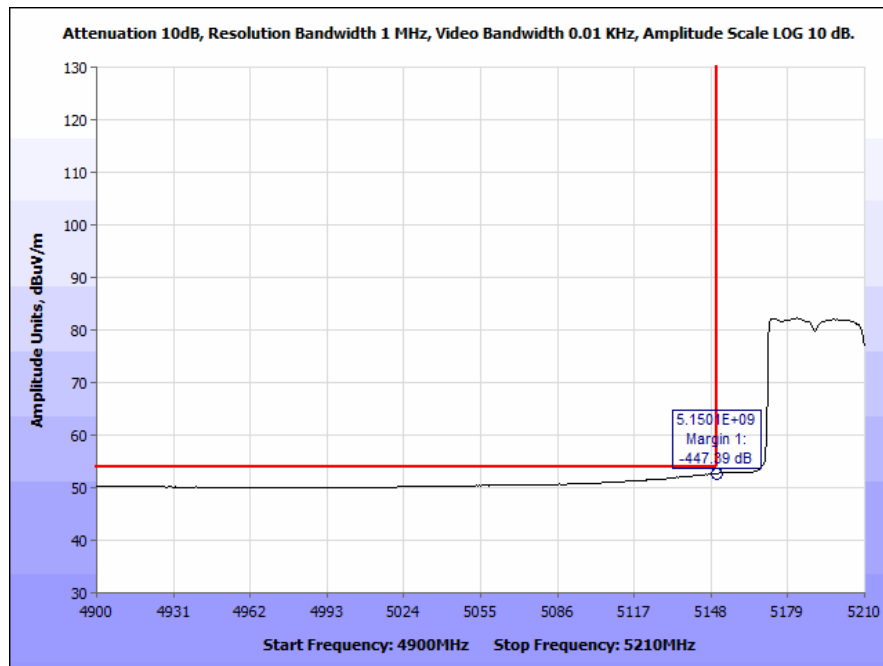

Plot 168. Radiated Band Edge, 802.11ac, 80 MHz, Low Channel, 6 dBi Omni Outdoor Antenna, Average

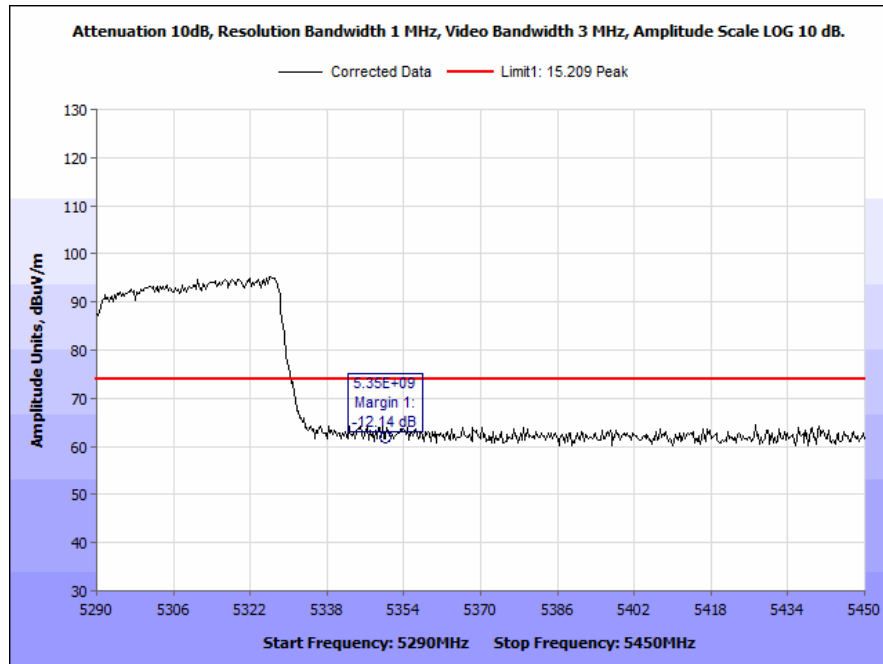

Plot 169. Radiated Band Edge, 802.11ac, 80 MHz, High Channel, 6 dBi Omni Outdoor Antenna, Peak

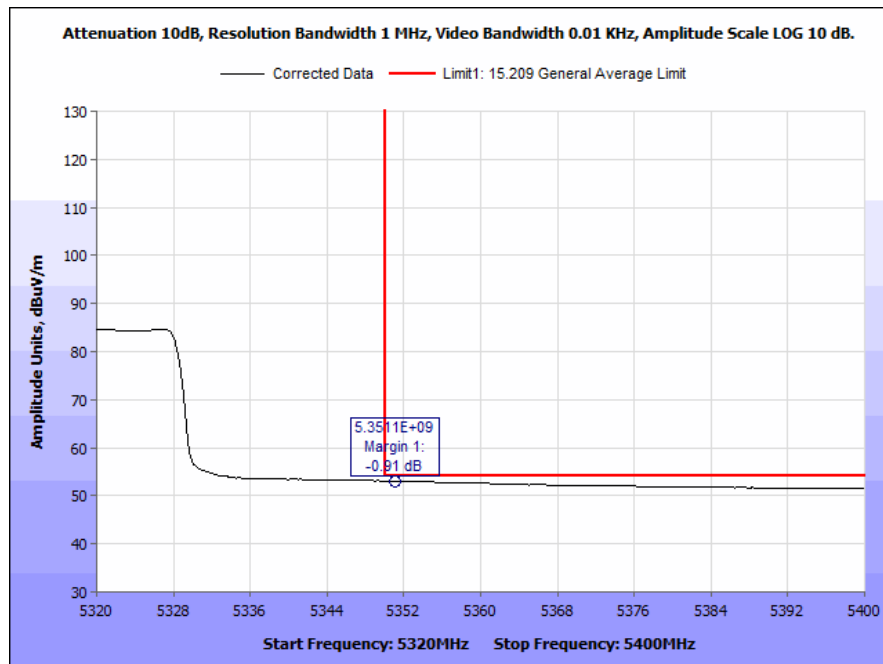

Plot 170. Radiated Band Edge, 802.11ac, 80 MHz, High Channel, 6 dBi Omni Outdoor Antenna, Average



**Band Edge, 802.11a, 4 dBi Antenna**

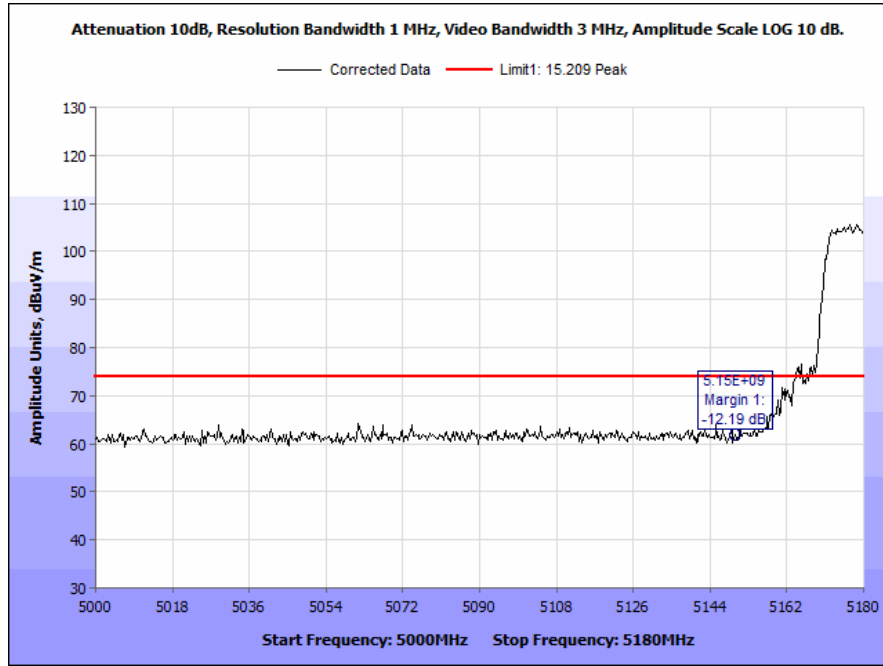

**Plot 171. Radiated Band Edge, 802.11a, 20 MHz, Low Channel, 4 dBi Antenna, Peak**

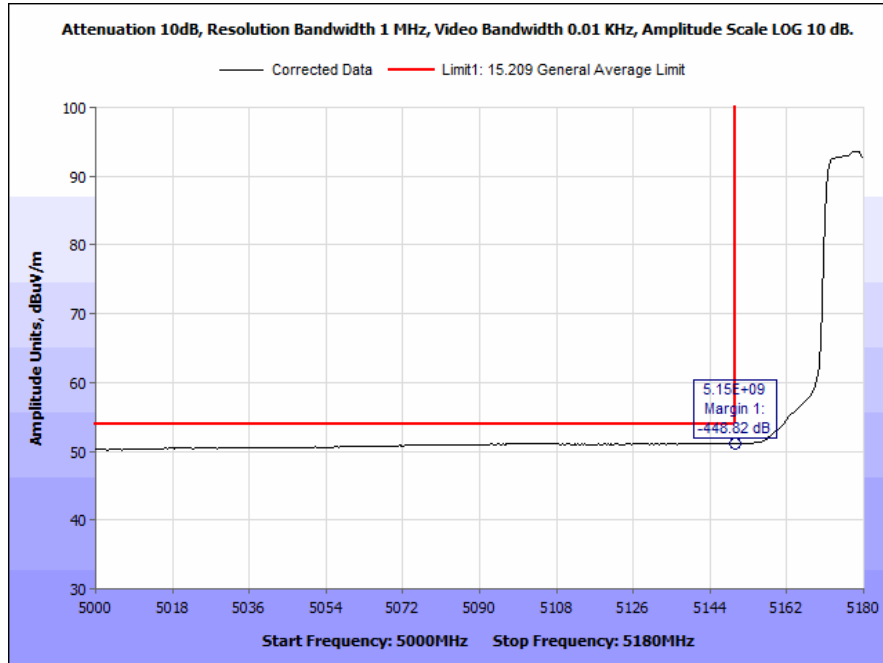

**Plot 172. Radiated Band Edge, 802.11a, 20 MHz, Low Channel, 4 dBi Antenna, Average**

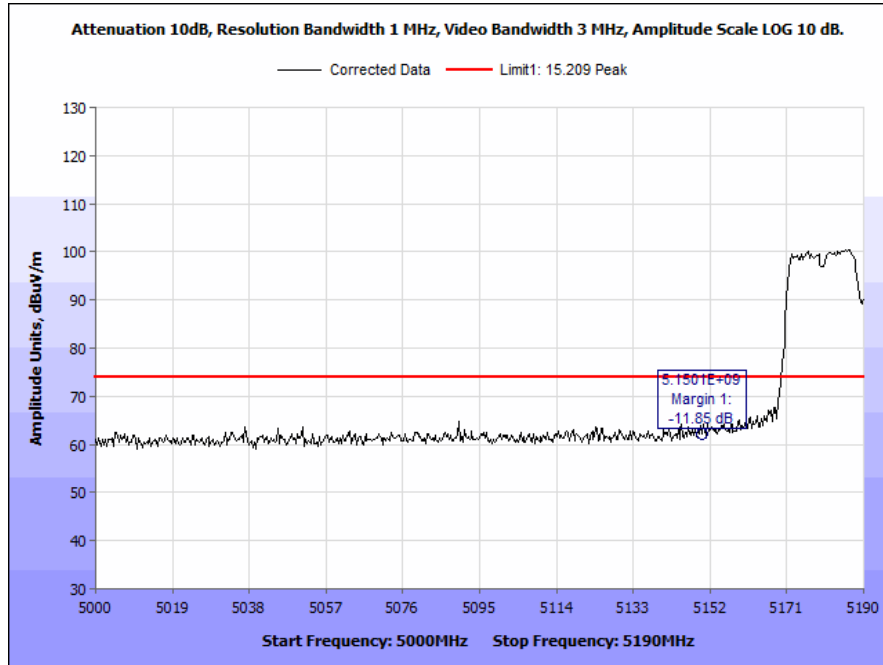

Plot 173. Radiated Band Edge, 802.11a, 40 MHz, Low Channel, 4 dBi Antenna, Peak

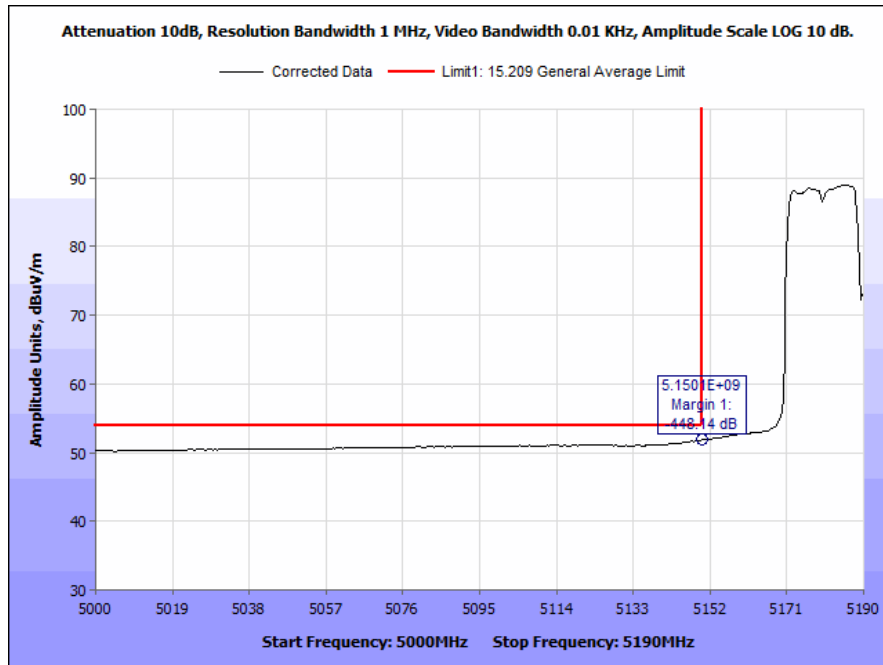

Plot 174. Radiated Band Edge, 802.11a, 40 MHz, Low Channel, 4 dBi Antenna, Average

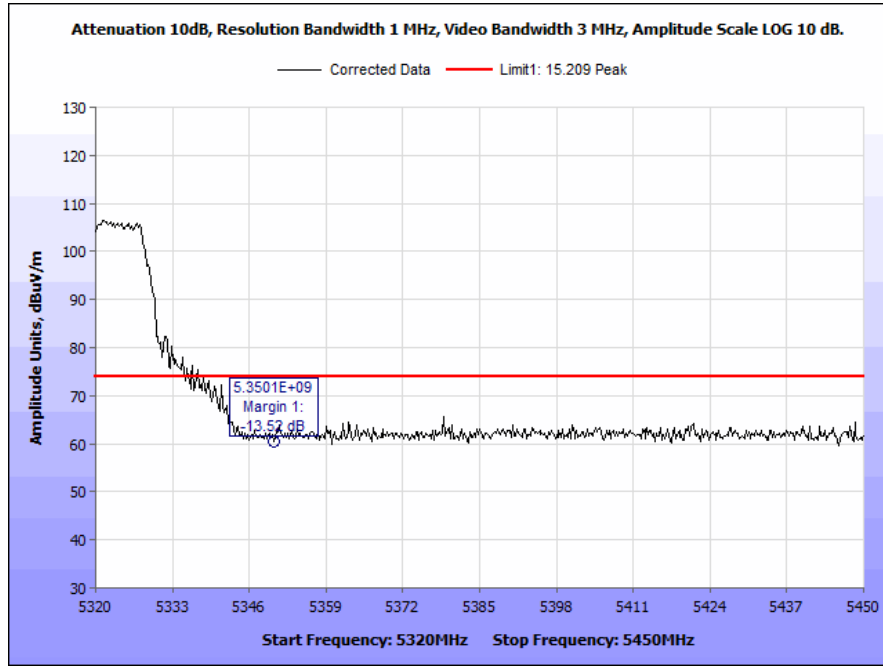

Plot 175. Radiated Band Edge, 802.11a, 20 MHz, High Channel, 4 dBi Antenna, Peak

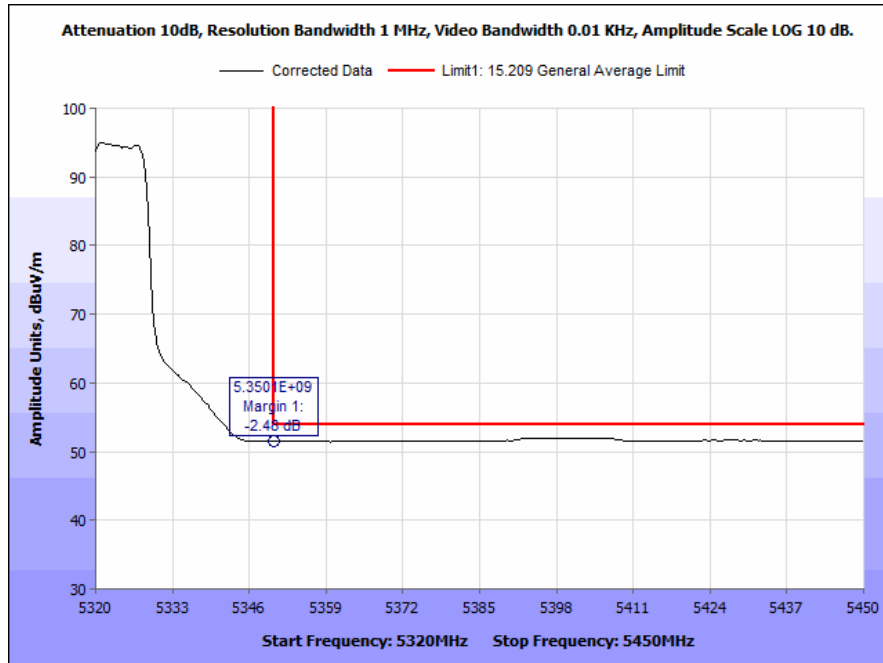

Plot 176. Radiated Band Edge, 802.11a, 20 MHz, High Channel, 4 dBi Antenna, Average

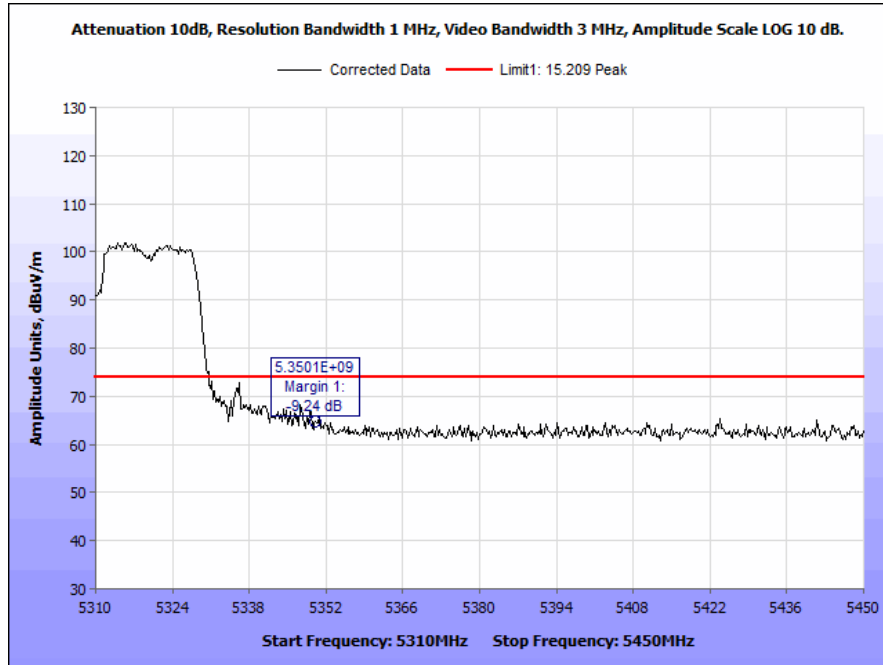

Plot 177. Radiated Band Edge, 802.11a, 40 MHz, High Channel, 4 dBi Antenna, Peak

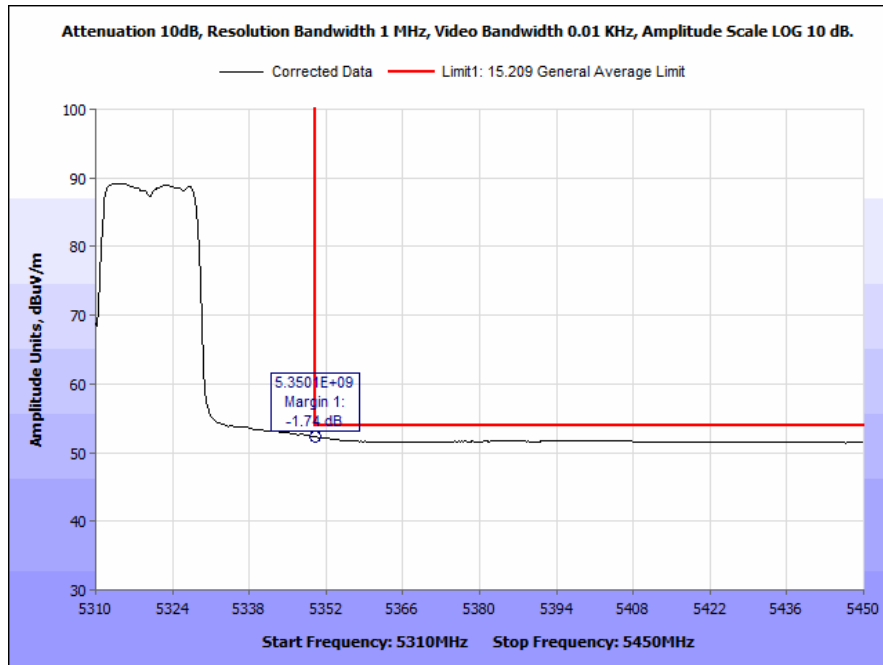

Plot 178. Radiated Band Edge, 802.11a, 40 MHz, High Channel, 4 dBi Antenna, Average

**Band Edge, 802.11n, 4 dBi Antenna**

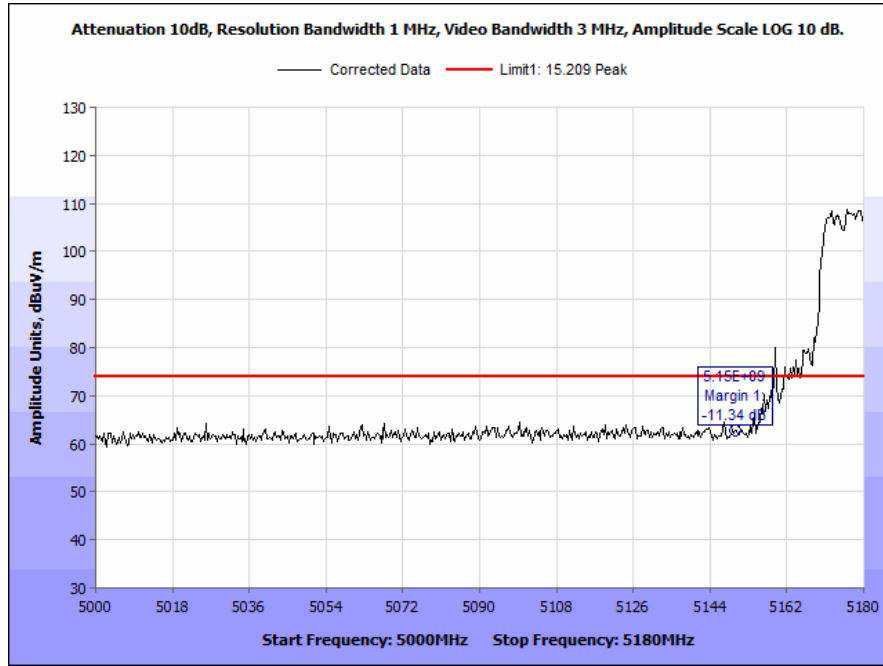

**Plot 179. Radiated Band Edge, 802.11n, 20 MHz, Low Channel, 4 dBi Antenna, Peak**

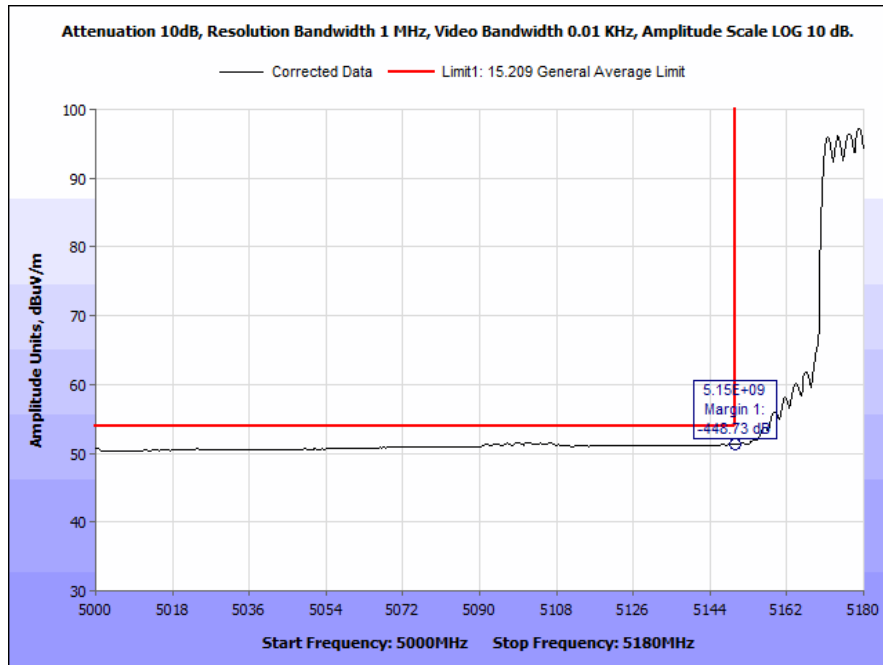

**Plot 180. Radiated Band Edge, 802.11n, 20 MHz, Low Channel, 4 dBi Antenna, Average**

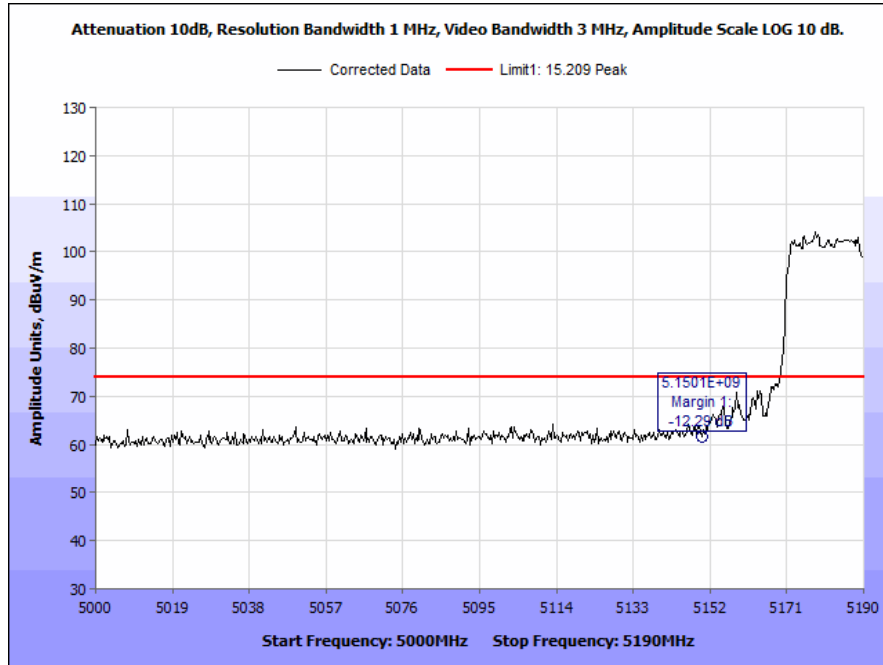

Plot 181. Radiated Band Edge, 802.11n, 40 MHz, Low Channel, 4 dBi Antenna, Peak

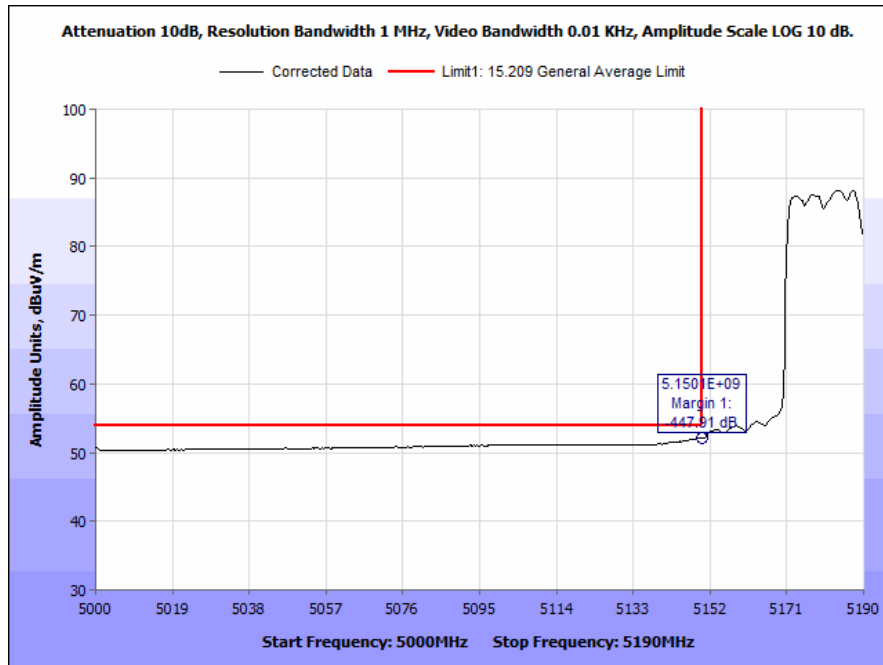

Plot 182. Radiated Band Edge, 802.11n, 40 MHz, Low Channel, 4 dBi Antenna, Average

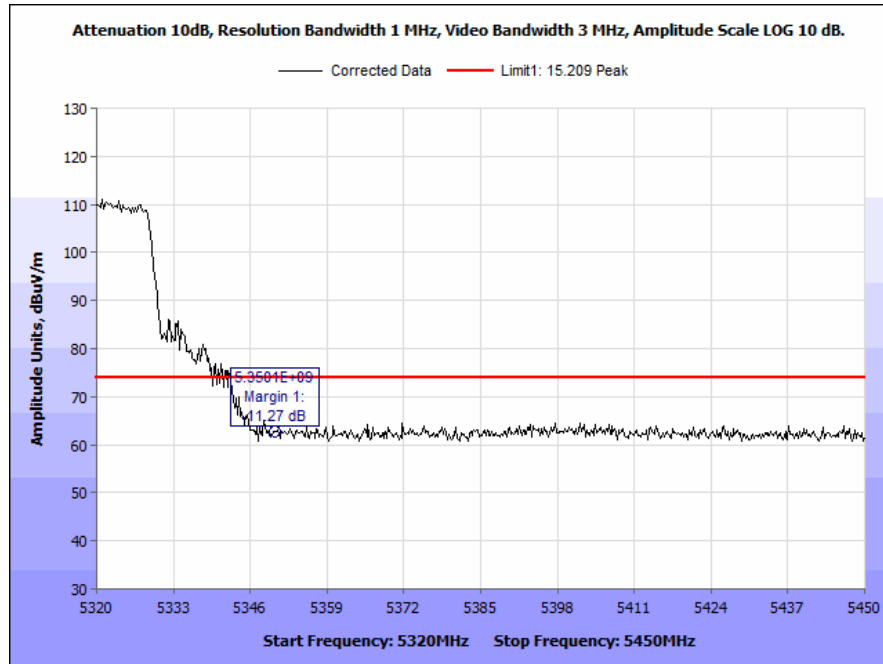

Plot 183. Radiated Band Edge, 802.11n, 20 MHz, High Channel, 4 dBi Antenna, Peak

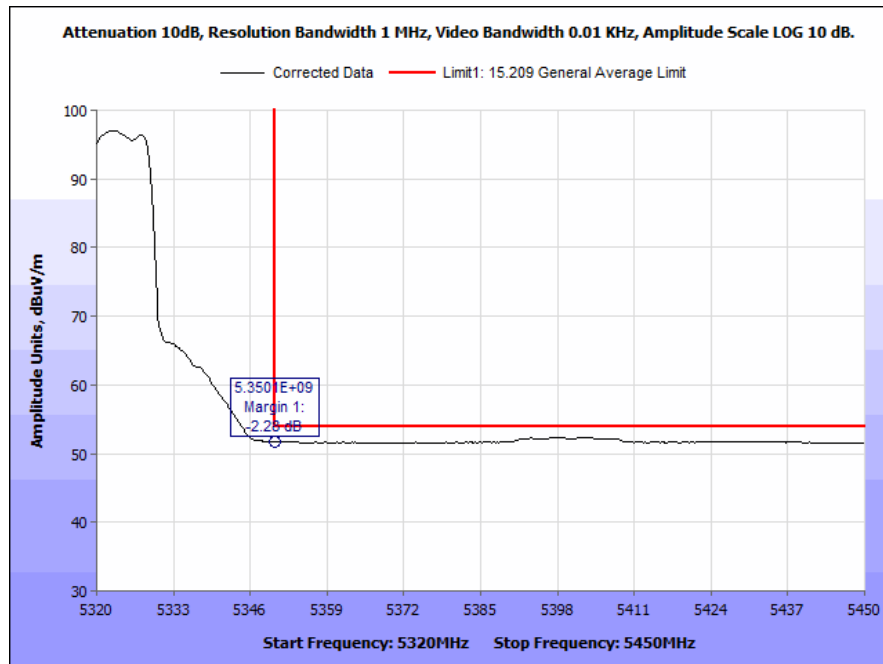

Plot 184. Radiated Band Edge, 802.11n, 20 MHz, High Channel, 4 dBi Antenna, Average

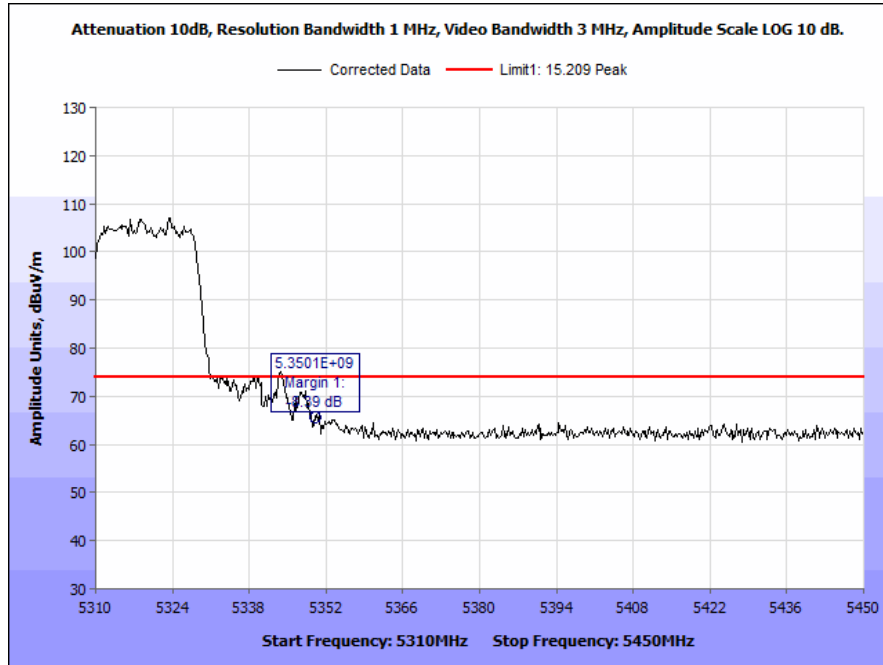

**Plot 185. Radiated Band Edge, 802.11n, 40 MHz, High Channel, 4 dBi Antenna, Peak**

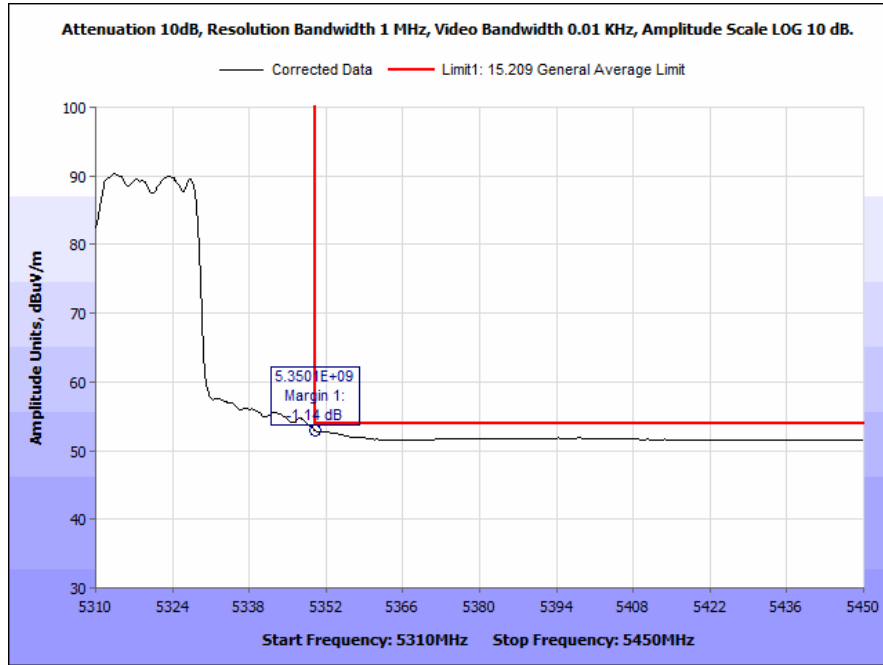

**Plot 186. Radiated Band Edge, 802.11n, 40 MHz, High Channel, 4 dBi Antenna, Average**



**Band Edge, 802.11ac, 4 dBi Antenna**

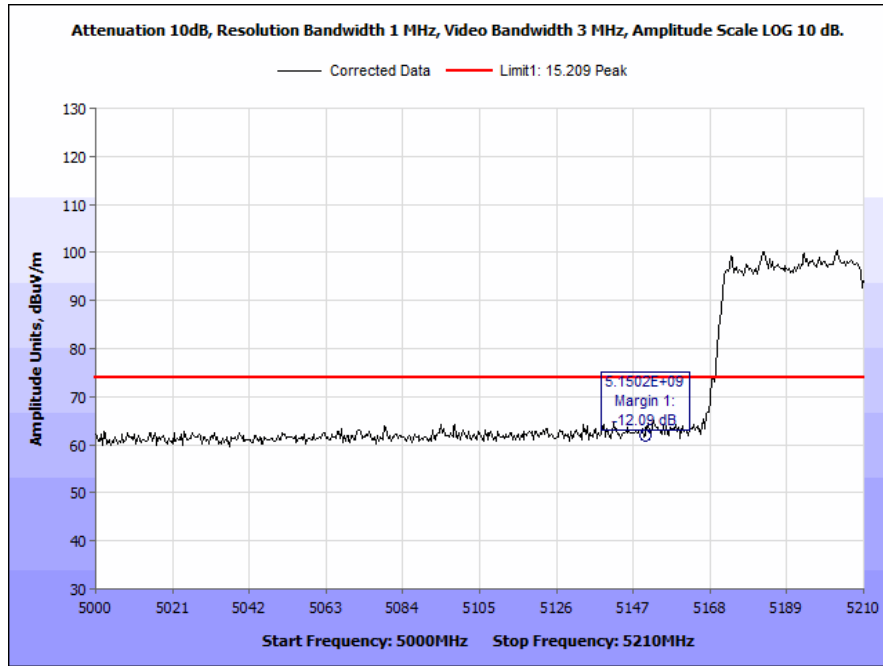

**Plot 187. Radiated Band Edge, 802.11ac, 80 MHz, Low Channel, 4 dBi Antenna, Peak**

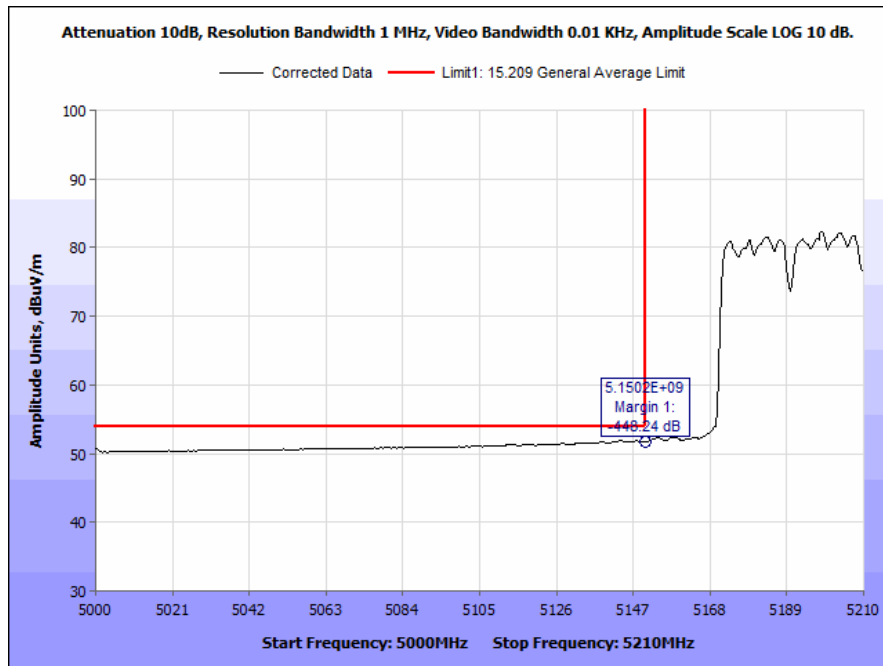

**Plot 188. Radiated Band Edge, 802.11ac, 80 MHz, Low Channel, 4 dBi Antenna, Average**

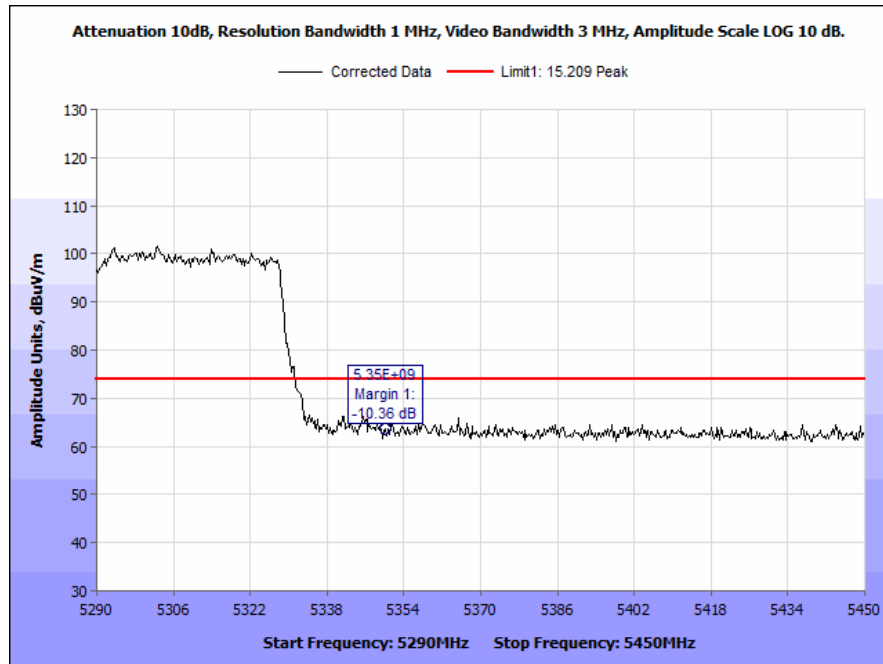

Plot 189. Radiated Band Edge, 802.11ac, 80 MHz, High Channel, 4 dBi Antenna, Peak

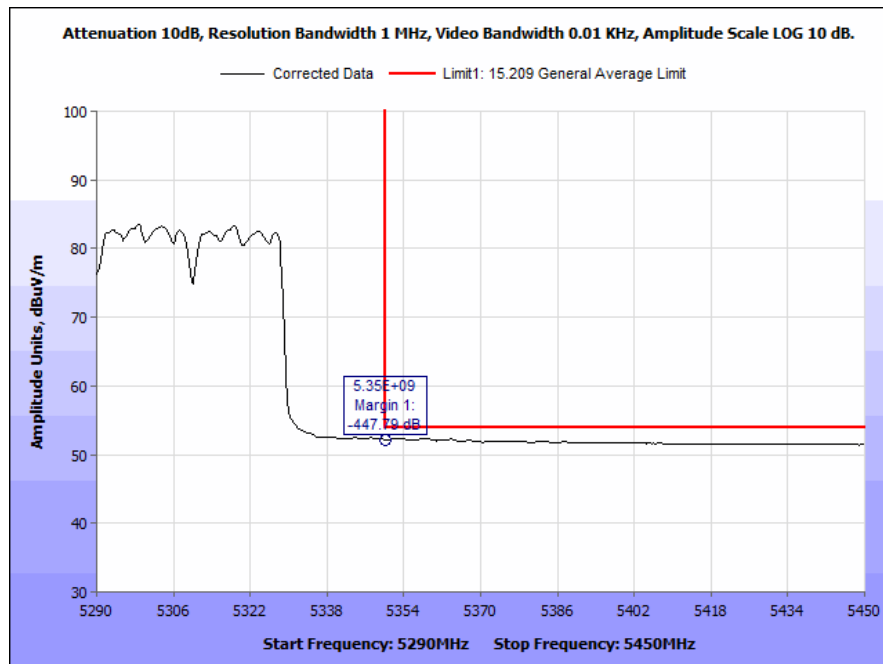

Plot 190. Radiated Band Edge, 802.11ac, 80 MHz, High Channel, 4 dBi Antenna, Average

**Band Edge, 802.11a, 7 dBi Antenna**

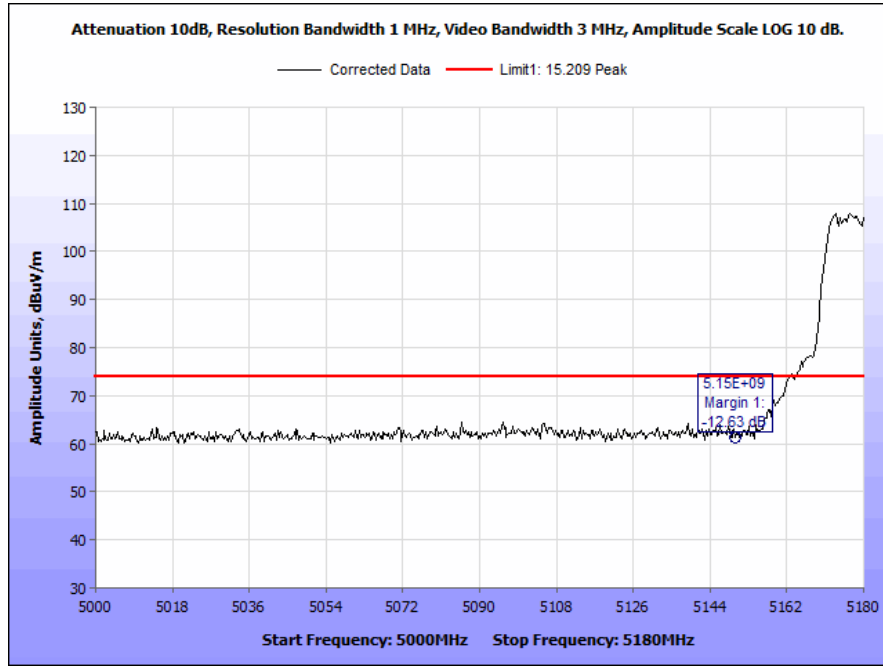

**Plot 191. Radiated Band Edge, 802.11a, 20 MHz, Low Channel, 7 dBi Antenna, Peak**

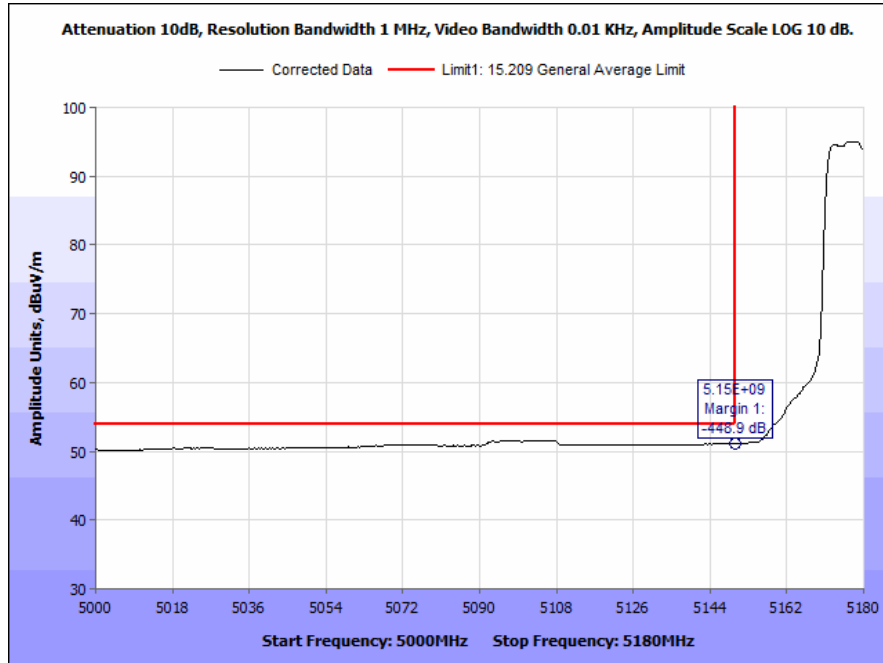

**Plot 192. Radiated Band Edge, 802.11a, 20 MHz, Low Channel, 7 dBi Antenna, Average**

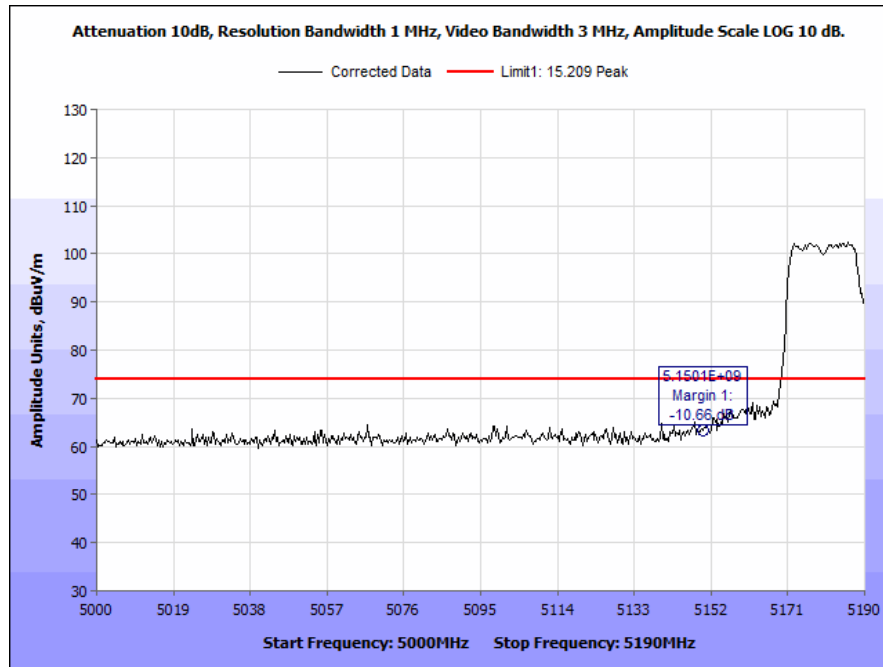

Plot 193. Radiated Band Edge, 802.11a, 40 MHz, Low Channel, 7 dBi Antenna, Peak

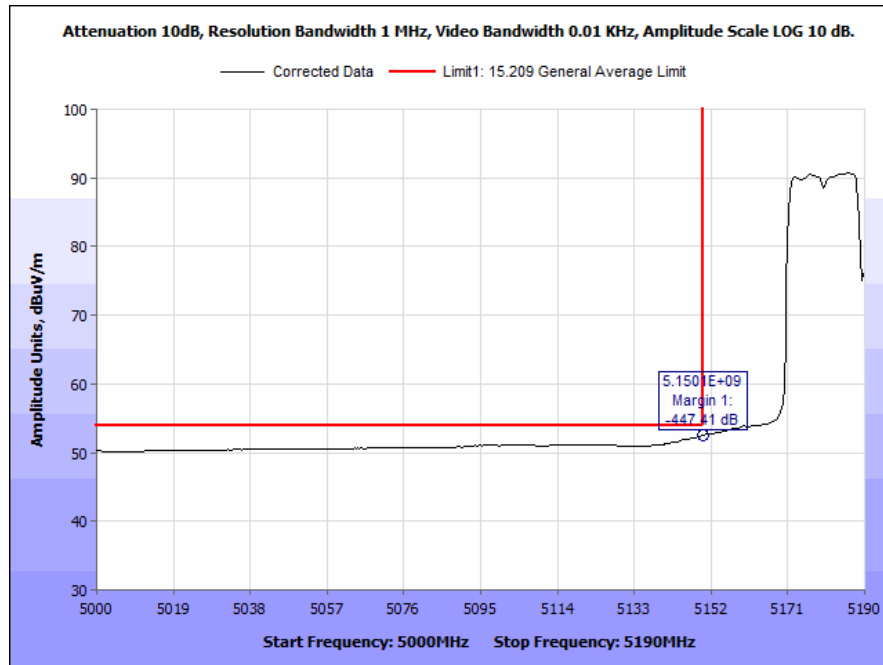

Plot 194. Radiated Band Edge, 802.11a, 40 MHz, Low Channel, 7 dBi Antenna, Average

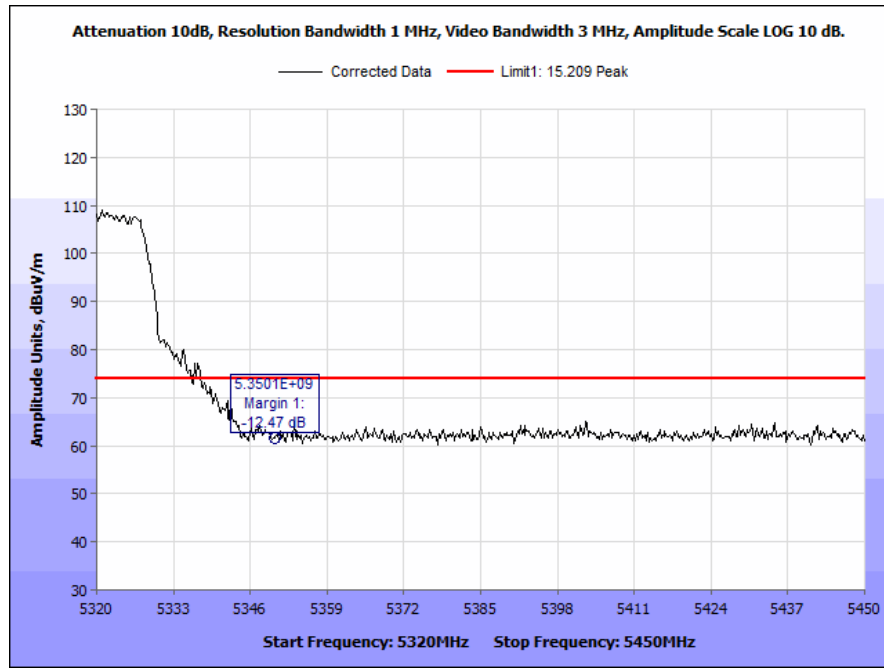

Plot 195. Radiated Band Edge, 802.11a, 20 MHz, High Channel, 7 dBi Antenna, Peak

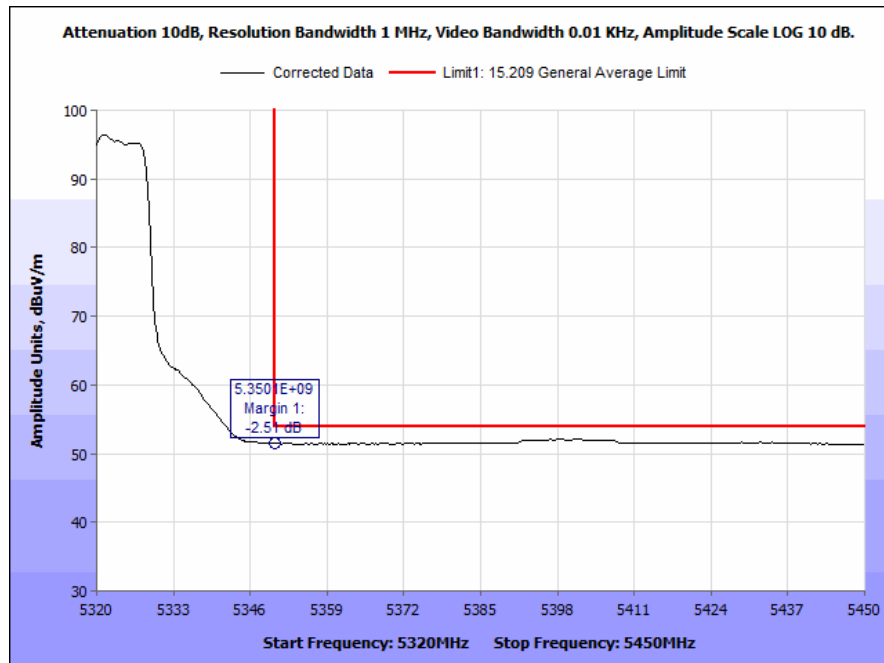

Plot 196. Radiated Band Edge, 802.11a, 20 MHz, High Channel, 7 dBi Antenna, Average

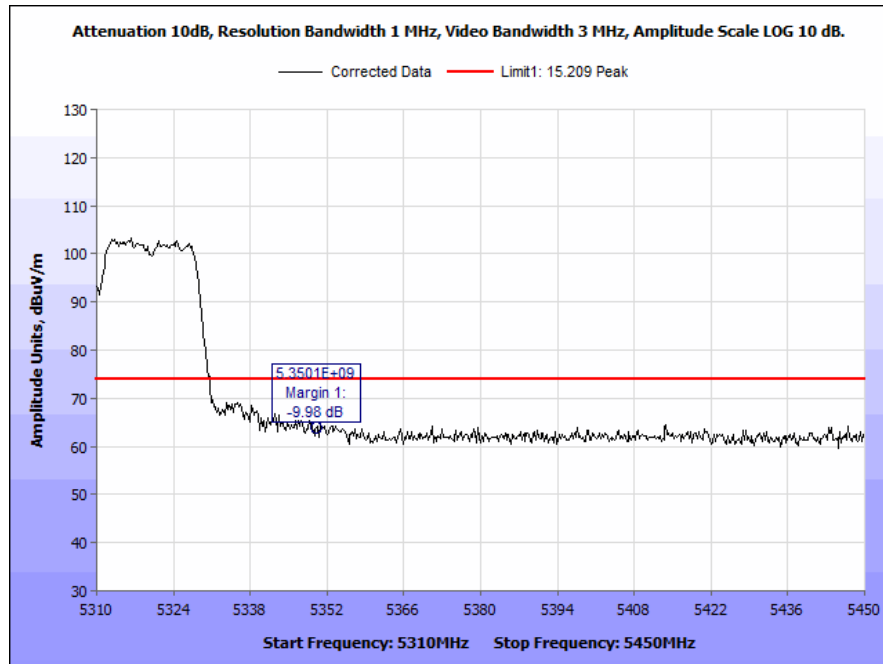

Plot 197. Radiated Band Edge, 802.11a, 40 MHz, High Channel, 7 dBi Antenna, Peak

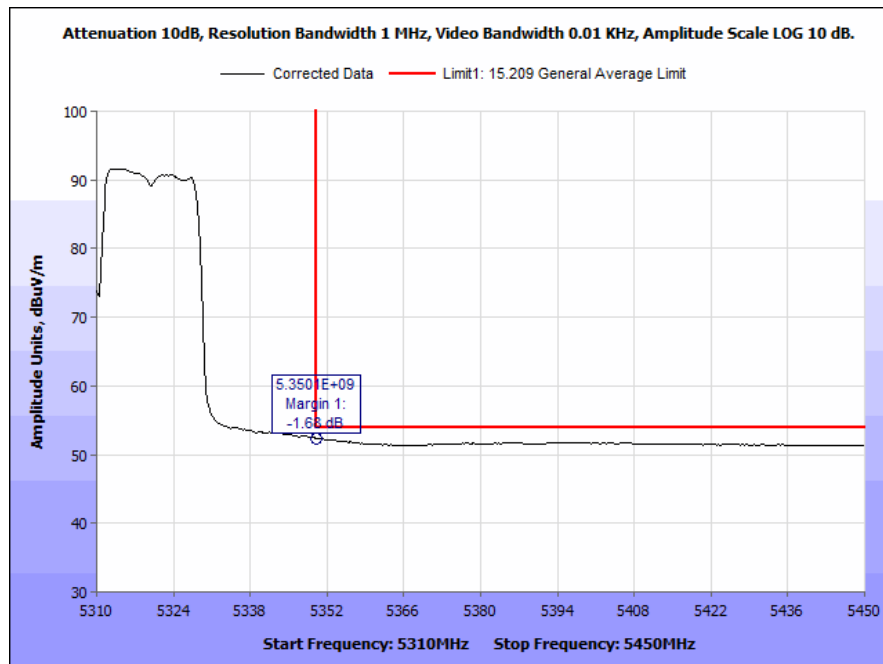

Plot 198. Radiated Band Edge, 802.11a, 40 MHz, High Channel, 7 dBi Antenna, Average

**Band Edge, 802.11n, 7 dBi Antenna**

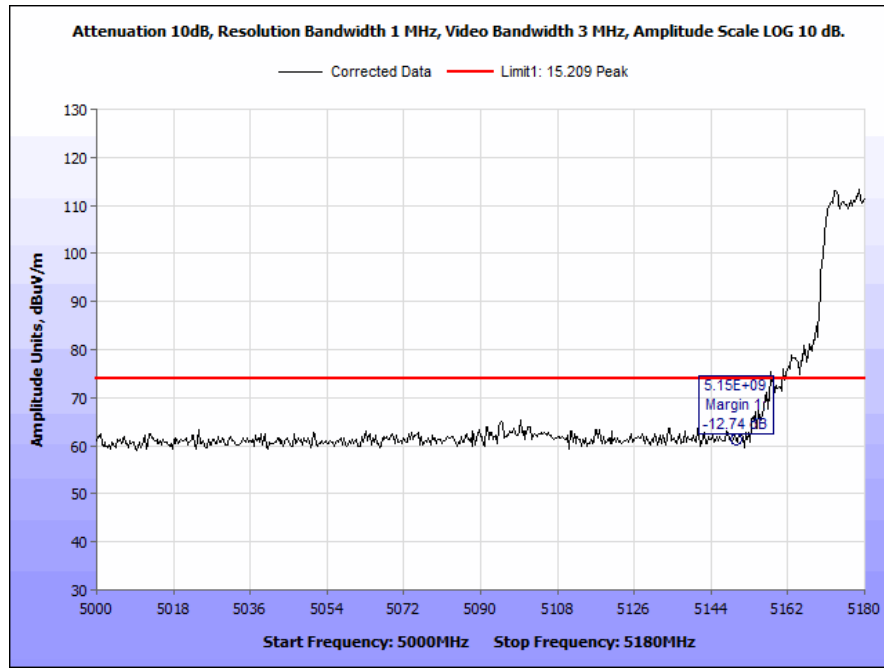

**Plot 199. Radiated Band Edge, 802.11n, 20 MHz, Low Channel, 7 dBi Antenna, Peak**

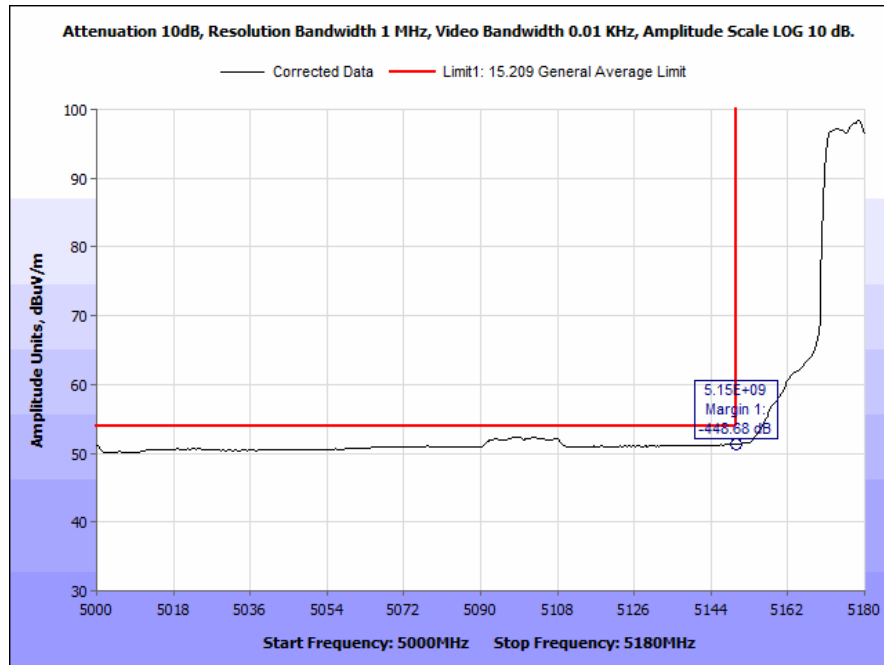

**Plot 200. Radiated Band Edge, 802.11n, 20 MHz, Low Channel, 7 dBi Antenna, Average**

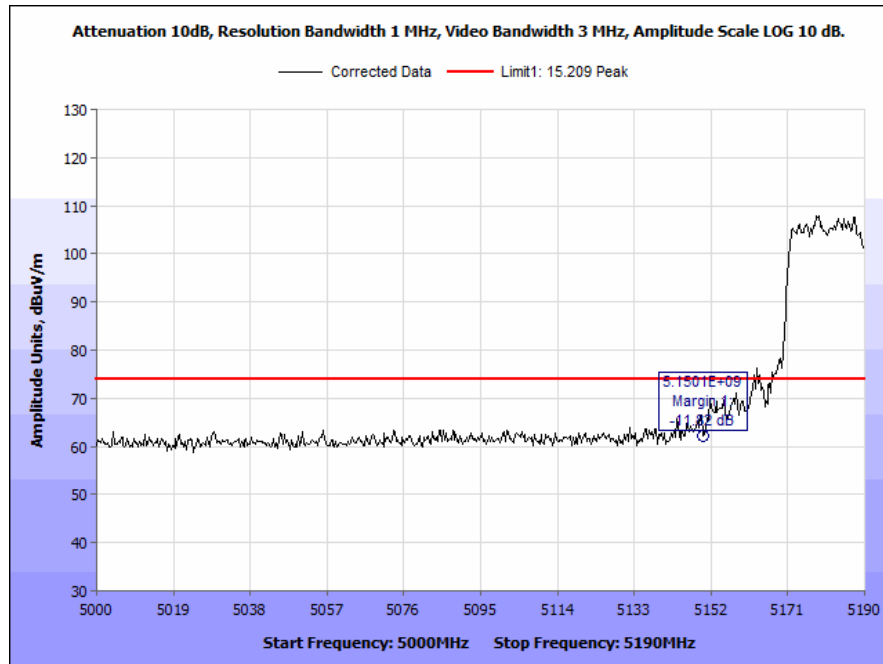

Plot 201. Radiated Band Edge, 802.11n, 40 MHz, Low Channel, 7 dBi Antenna, Peak

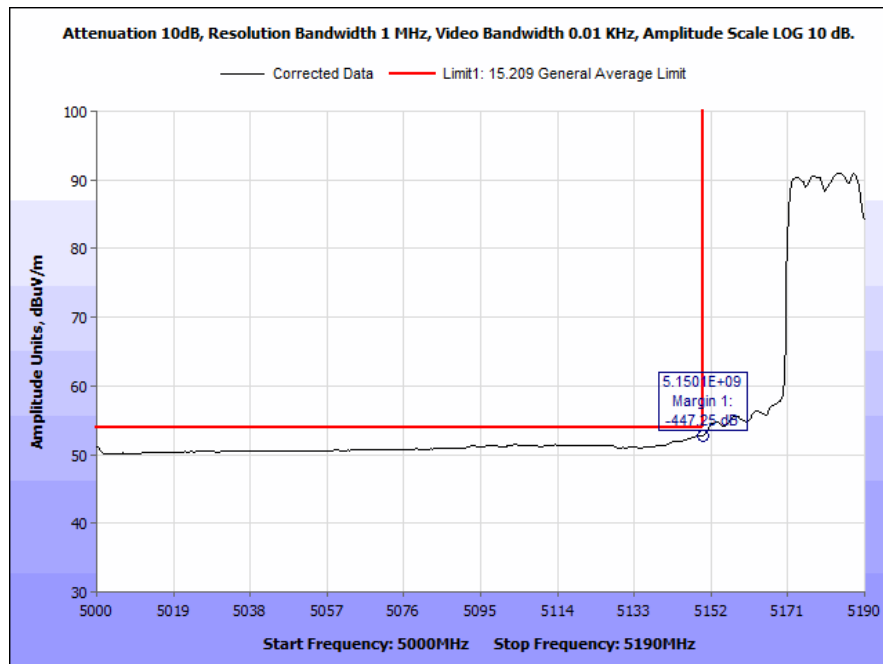

Plot 202. Radiated Band Edge, 802.11n, 40 MHz, Low Channel, 7 dBi Antenna, Average



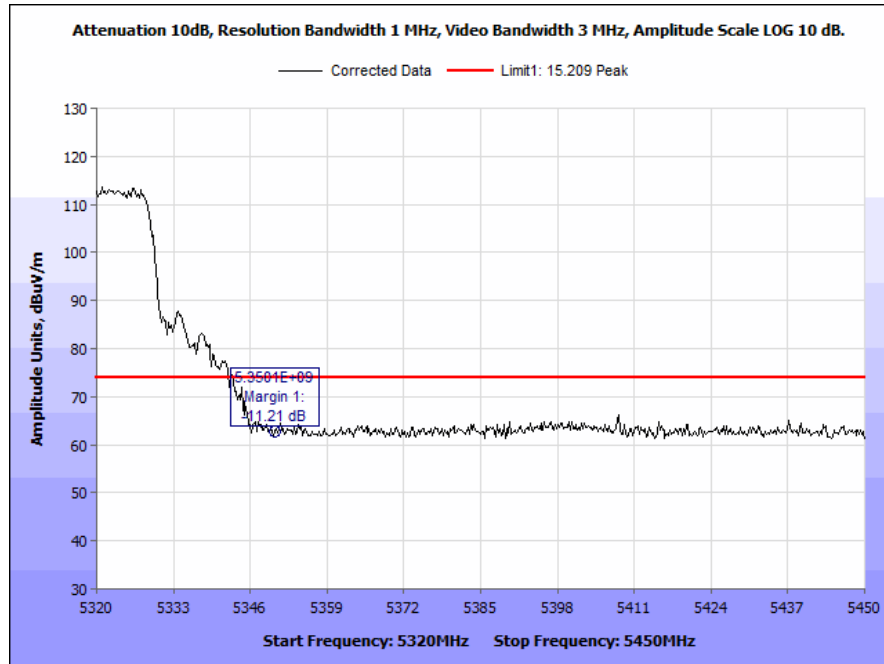

Plot 203. Radiated Band Edge, 802.11n, 20 MHz, High Channel, 7 dBi Antenna, Peak

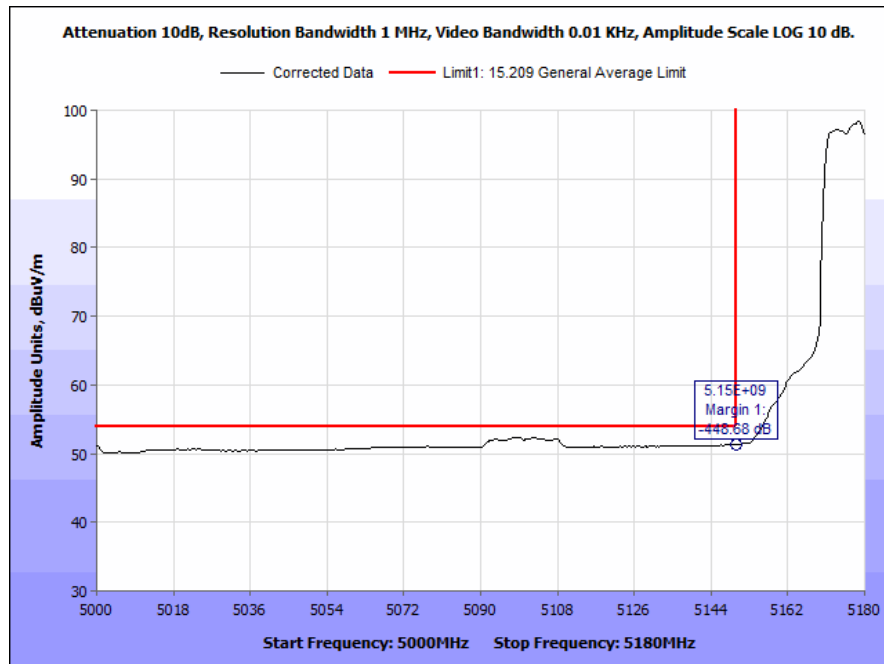

Plot 204. Radiated Band Edge, 802.11n, 20 MHz, High Channel, 7 dBi Antenna, Average

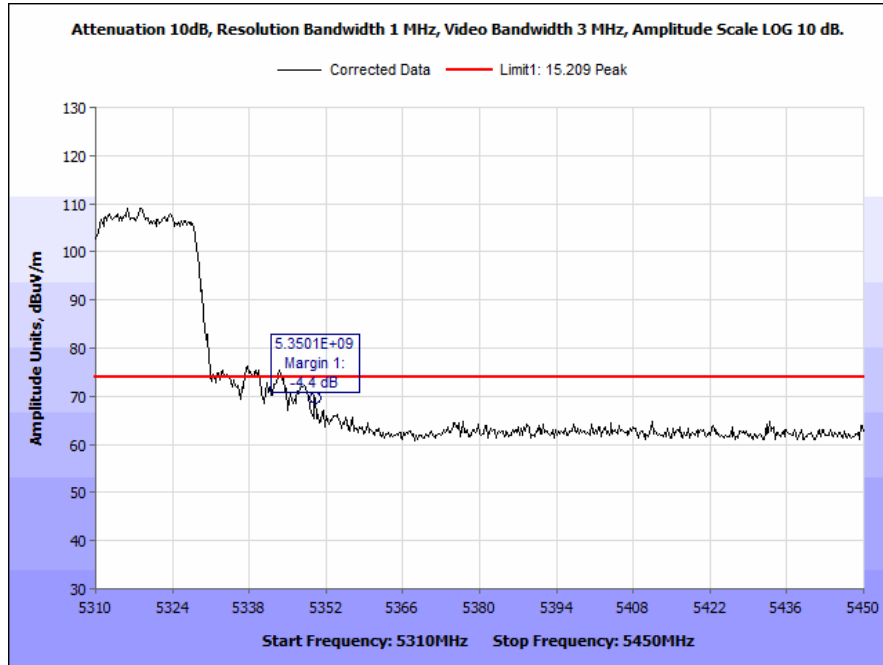

Plot 205. Radiated Band Edge, 802.11n, 40 MHz, High Channel, 7 dBi Antenna, Peak

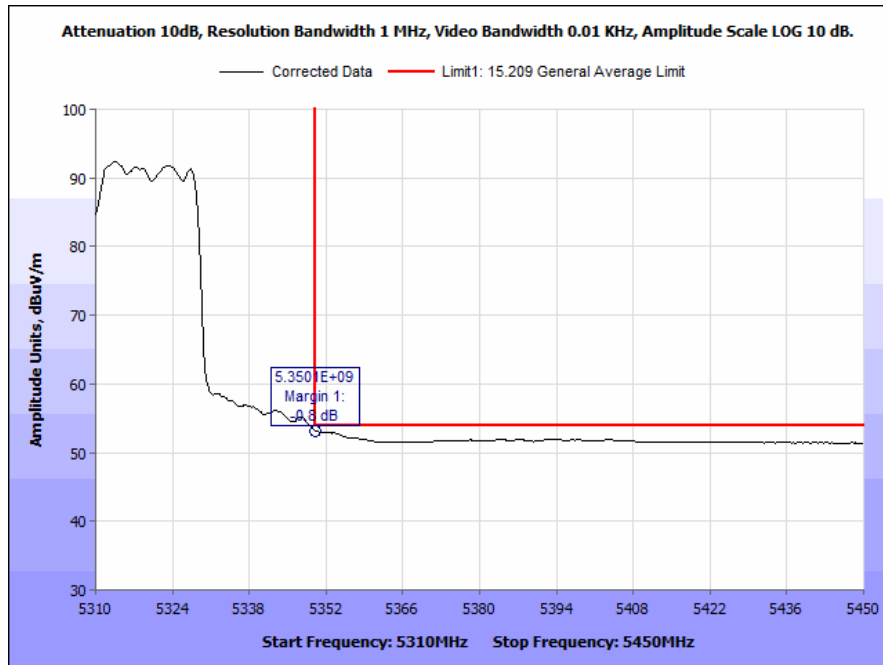

Plot 206. Radiated Band Edge, 802.11n, 40 MHz, High Channel, 7 dBi Antenna, Average

**Band Edge, 802.11ac, 7 dBi Antenna**

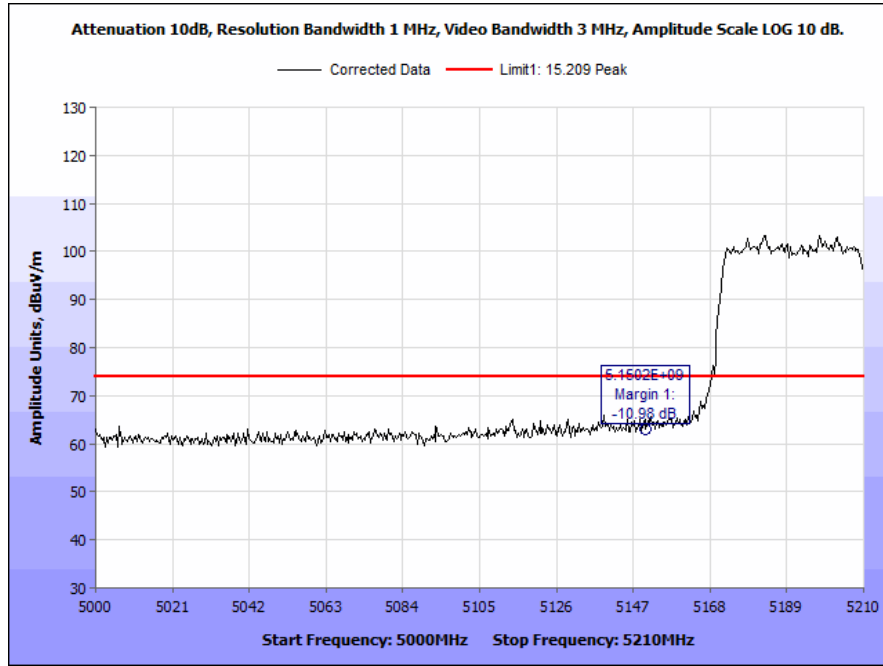

**Plot 207. Radiated Band Edge, 802.11ac, 80 MHz, Low Channel, 7 dBi Antenna, Peak**

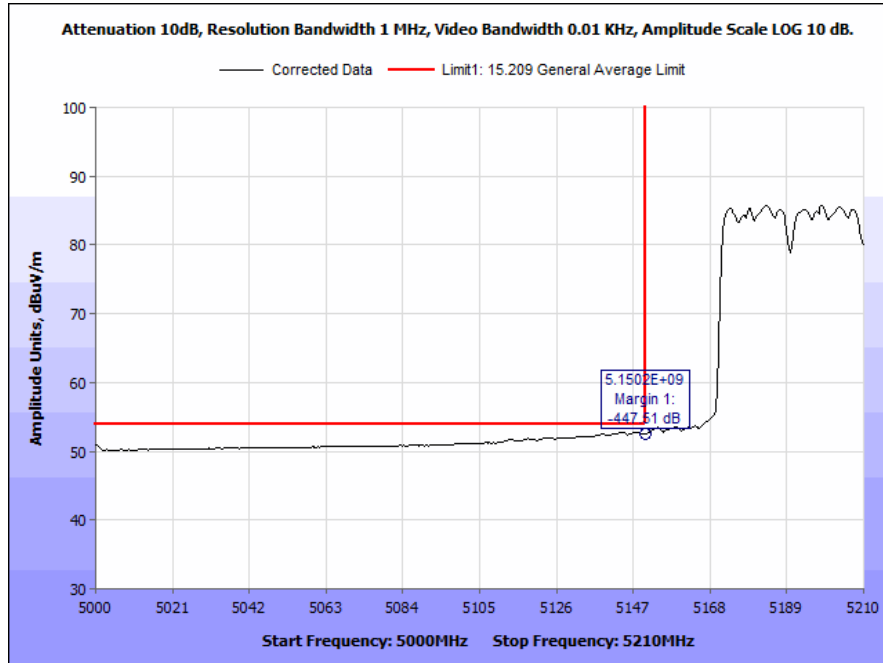

**Plot 208. Radiated Band Edge, 802.11ac, 80 MHz, Low Channel, 7 dBi Antenna, Average**

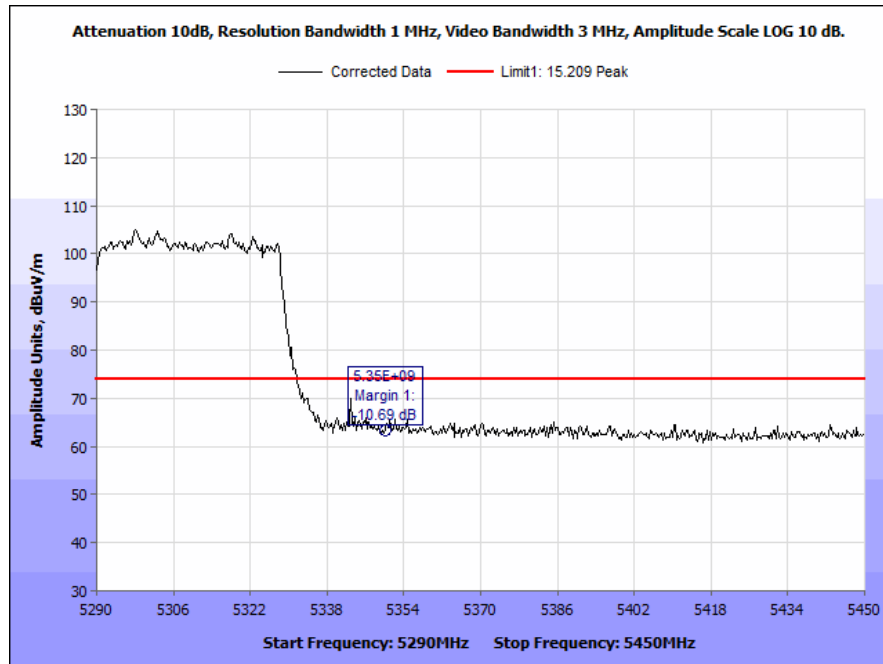

Plot 209. Radiated Band Edge, 802.11ac, 80 MHz, High Channel, 7 dBi Antenna, Peak

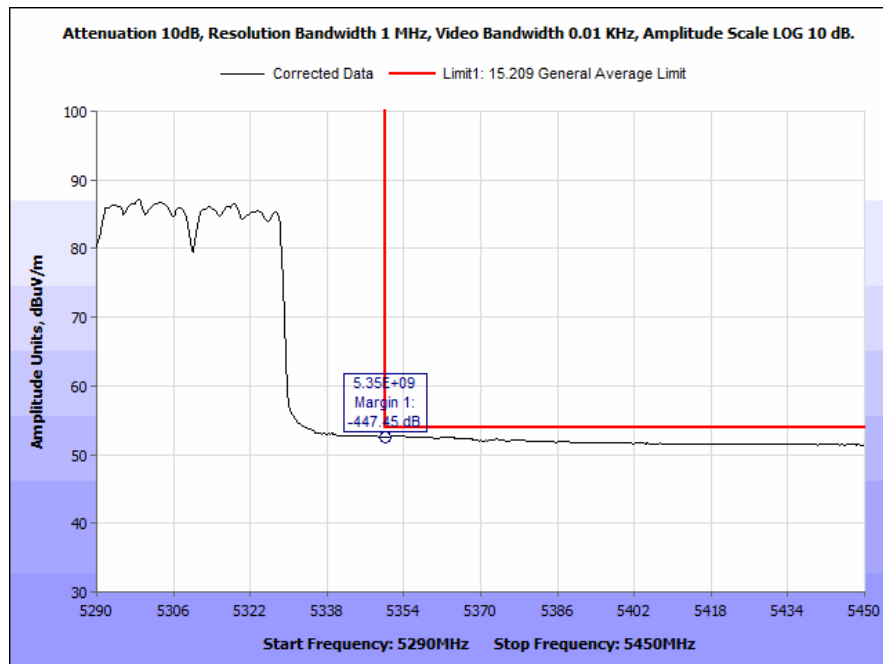

Plot 210. Radiated Band Edge, 802.11ac, 80 MHz, High Channel, 7 dBi Antenna, Average

## Electromagnetic Compatibility Criteria for Intentional Radiators

### Co-location

**Test Requirements:** Devices designed to transmit simultaneously in multiple channels in single or multiple frequency bands or those using new “carrier aggregation techniques”, excluding cellular base stations or where specific guidance has been proved.

All devices that are capable of transmitting simultaneously in more than one Part-15 band between 5 and 6 GHz (*i.e.*, in two or more of the four U-NII bands or in the 5.8 GHz 15.247 band and at least one U-NII band) are subject to Permit But Ask provisions. This includes devices marketed as IEEE Std 802.11ac or “pre-standard” IEEE Std 802.11ac.

**Test Procedure:** The transmitter was placed on an 80cm wooden table inside in a semi-anechoic chamber. Measurements were performed with the EUT rotated 360 degrees and varying the adjustable antenna mast height to determine worst case orientation for maximum emissions. A preamp was used in the range from 7-18GHz to improve noise floor. Plots were corrected for cable loss, antenna, and preamp gain.

For frequencies from 30 MHz to 1 GHz, measurements were made using a quasi-peak detector with a 120 kHz bandwidth.

For measurements above 1 GHz, measurements were made with a Peak detector with 1 MHz resolution bandwidth. Where the spurious emissions fell into a restricted band, measurements were also made with an average detector to make sure they complied with 15.209 limits. Only noise floor was seen above 18 GHz.

The EUT uses 2 radios that are co-located. The EUT was set to transmit on both radios using the following matrix below.

**Omni Antenna**

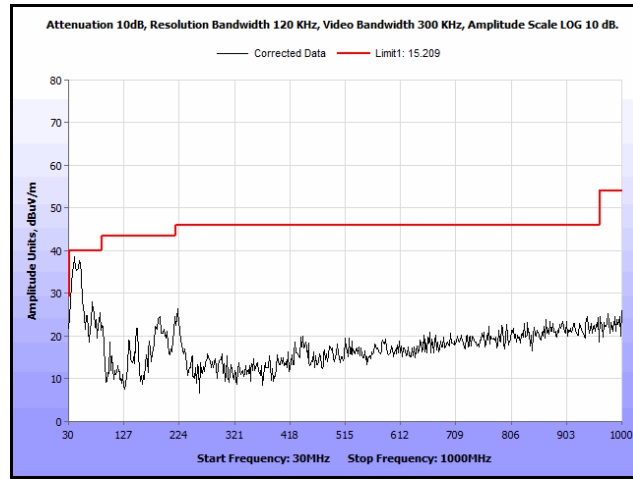

**Plot 211. Radiated Spurs, Co-Location, 802.11n 20 MHz, 2412 MHz & 2412 MHz, 30 MHz – 1 GHz, Peak, Omni**

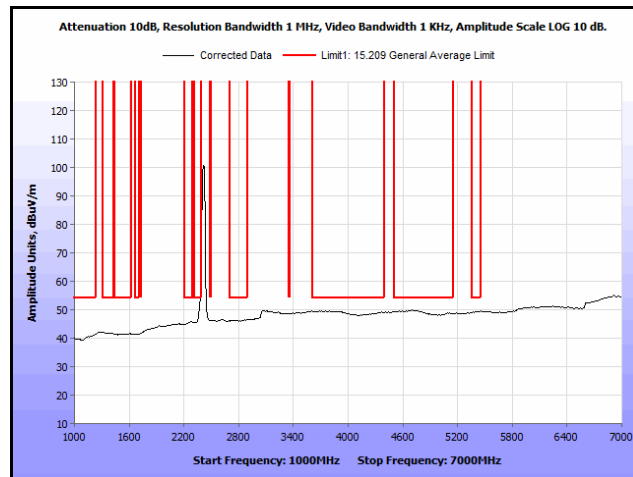

**Plot 212. Radiated Spurs, Co-Location, 802.11n 20 MHz, 2412 MHz & 2412 MHz, 1 GHz – 7 GHz, Avg., Omni**

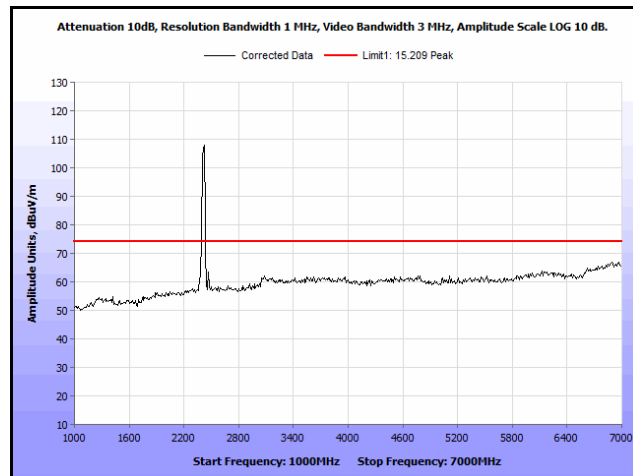

**Plot 213. Radiated Spurs, Co-Location, 802.11n 20 MHz, 2412 MHz & 2412 MHz, 1 GHz – 7 GHz, Peak, Omni**

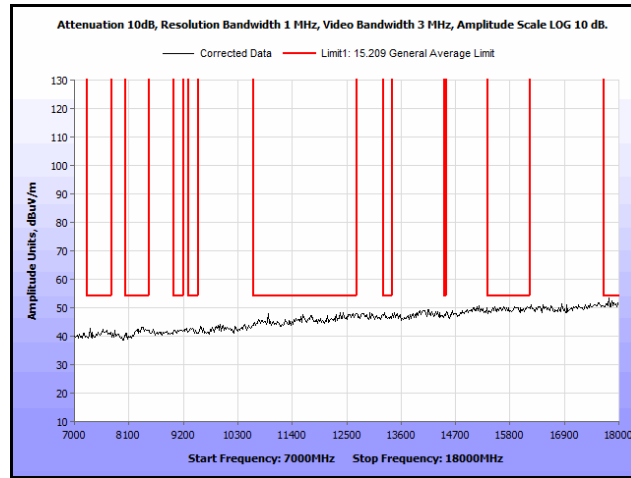

**Plot 214. Radiated Spurs, Co-Location, 802.11n 20 MHz, 2412 MHz & 2412 MHz, 7 GHz – 18 GHz, Peak, Omni**

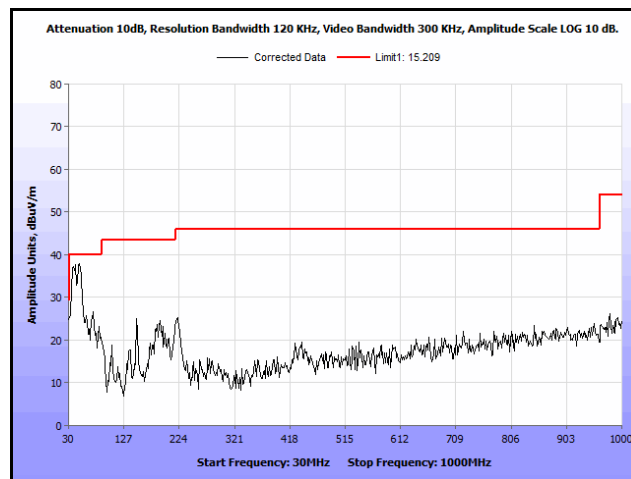

**Plot 215. Radiated Spurs, Co-Location, 802.11n 20 MHz, 2412 MHz & 2437 MHz, 30 MHz – 1 GHz, Peak, Omni**

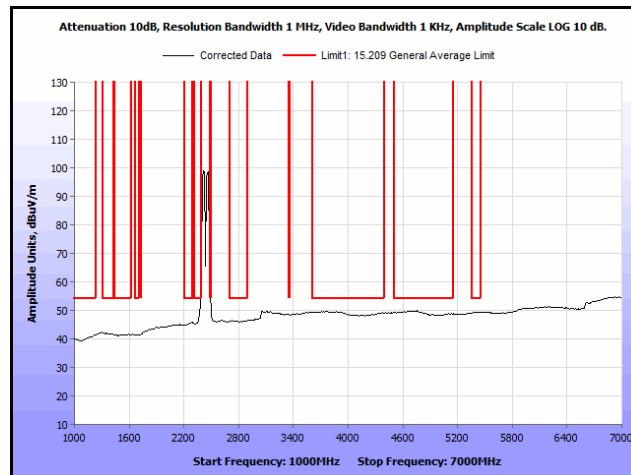

**Plot 216. Radiated Spurs, Co-Location, 802.11n 20 MHz, 2412 MHz & 2437 MHz, 1 GHz – 7 GHz, Avg., Omni**

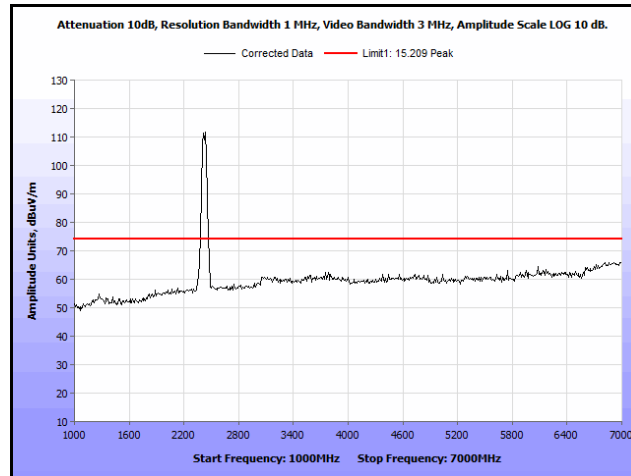

**Plot 217. Radiated Spurs, Co-Location, 802.11n 20 MHz, 2412 MHz & 2437 MHz, 1 GHz – 7 GHz, Peak, Omni**

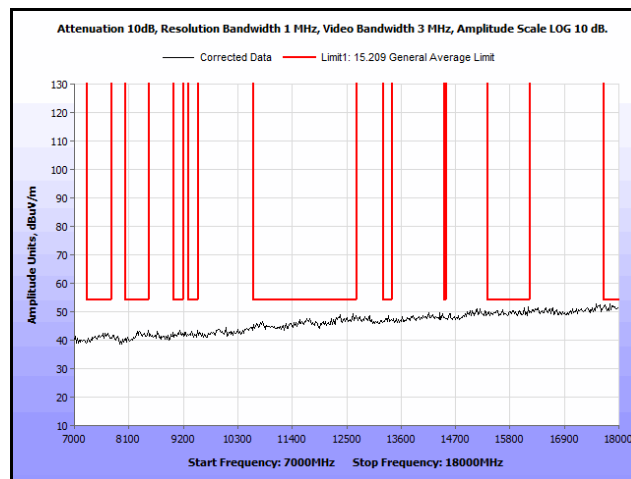

**Plot 218. Radiated Spurs, Co-Location, 802.11n 20 MHz, 2412 MHz & 2437 MHz, 7 GHz – 18 GHz, Peak, Omni**

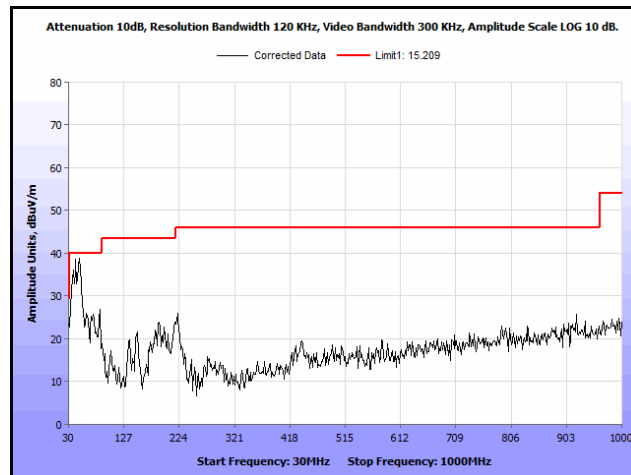

**Plot 219. Radiated Spurs, Co-Location, 802.11n 20 MHz, 2412 MHz & 2462 MHz, 30 MHz – 1 GHz, Peak, Omni**



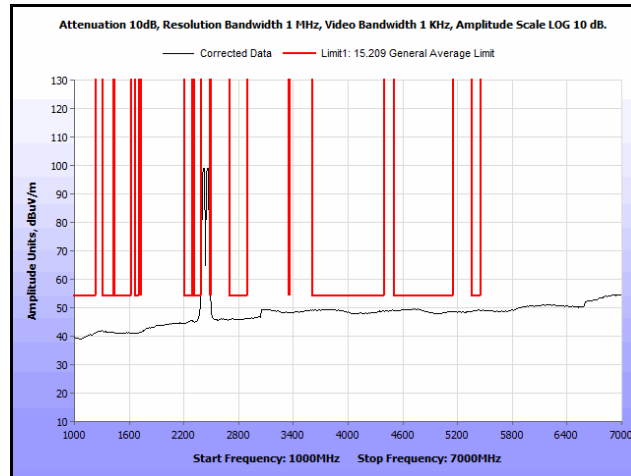

Plot 220. Radiated Spurs, Co-Location, 802.11n 20 MHz, 2412 MHz & 2462 MHz, 1 GHz – 7 GHz, Avg., Omni

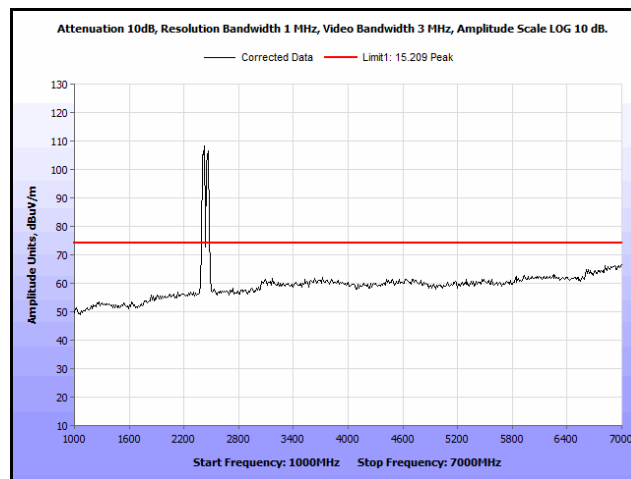

Plot 221. Radiated Spurs, Co-Location, 802.11n 20 MHz, 2412 MHz & 2462 MHz, 1 GHz – 7 GHz, Peak, Omni

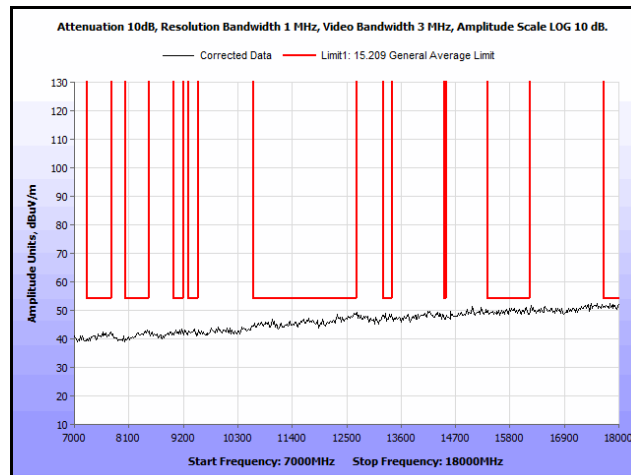

Plot 222. Radiated Spurs, Co-Location, 802.11n 20 MHz, 2412 MHz & 2462 MHz, 7 GHz – 18 GHz, Peak, Omni

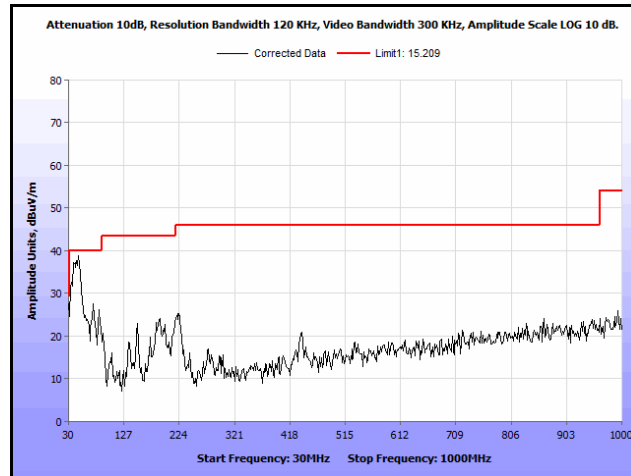

**Plot 223. Radiated Spurs, Co-Location, 802.11n 20 MHz, 2437 MHz & 2437 MHz, 30 MHz – 1 GHz, Peak, Omni**

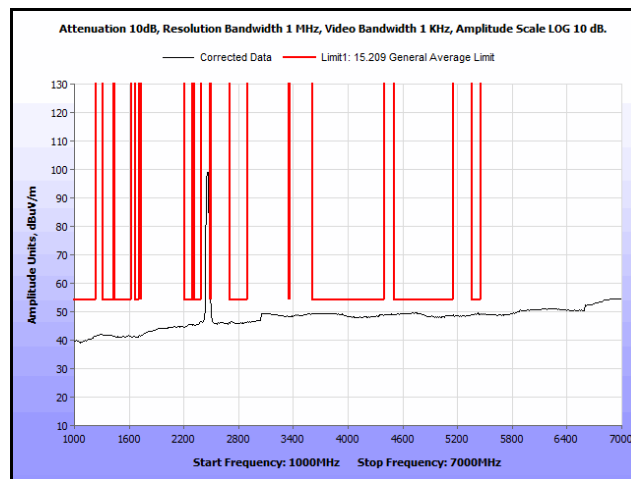

**Plot 224. Radiated Spurs, Co-Location, 802.11n 20 MHz, 2437 MHz & 2437 MHz, 1 GHz – 7 GHz, Avg., Omni**

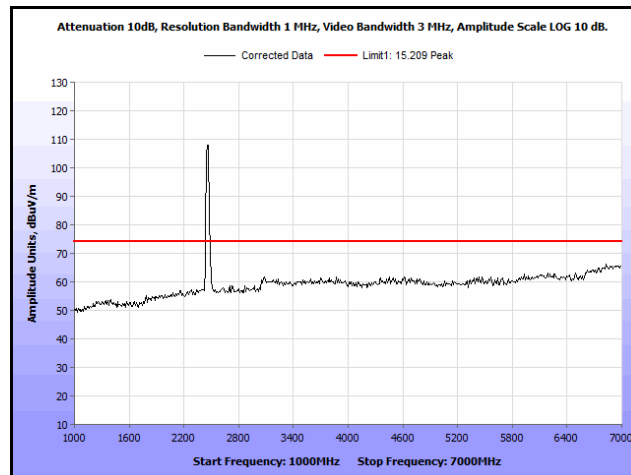

**Plot 225. Radiated Spurs, Co-Location, 802.11n 20 MHz, 2437 MHz & 2437 MHz, 1 GHz – 7 GHz, Peak, Omni**

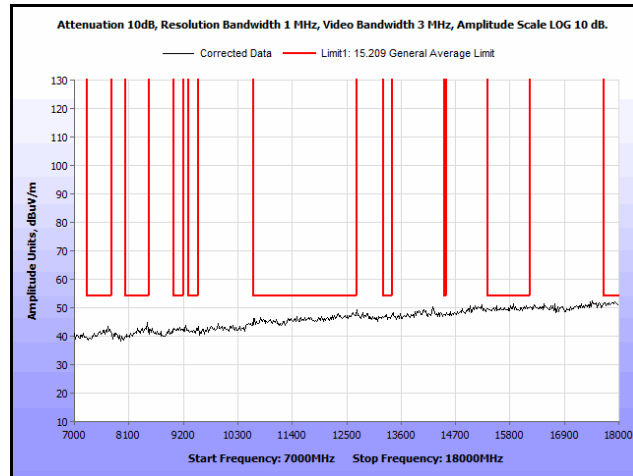

**Plot 226. Radiated Spurs, Co-Location, 802.11n 20 MHz, 2437 MHz & 2437 MHz, 7 GHz – 18 GHz, Peak, Omni**

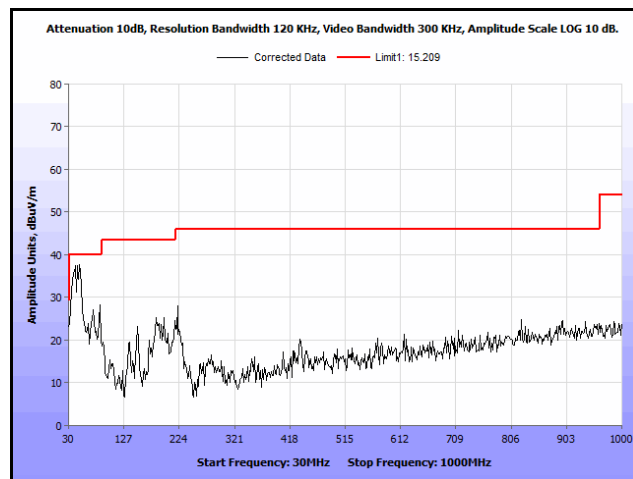

**Plot 227. Radiated Spurs, Co-Location, 802.11n 20 MHz, 2437 MHz & 2462 MHz, 30 MHz – 1 GHz, Peak, Omni**

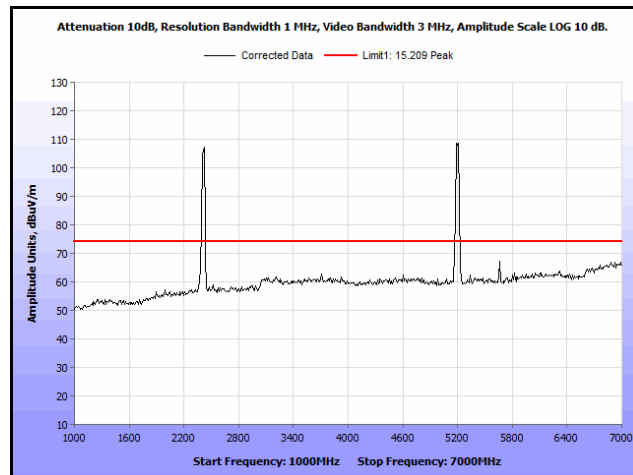

**Plot 228. Radiated Spurs, Co-Location, 802.11n 20 MHz, 2437 MHz & 2462 MHz, 1 GHz – 7 GHz, Avg., Omni**

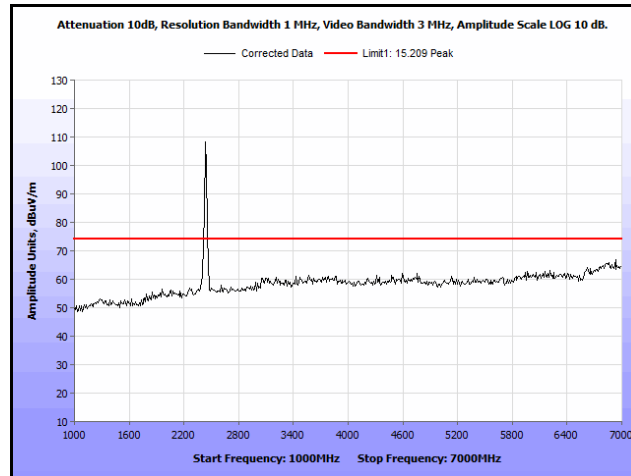

**Plot 229. Radiated Spurs, Co-Location, 802.11n 20 MHz, 2437 MHz & 2462 MHz, 1 GHz – 7 GHz, Peak, Omni**

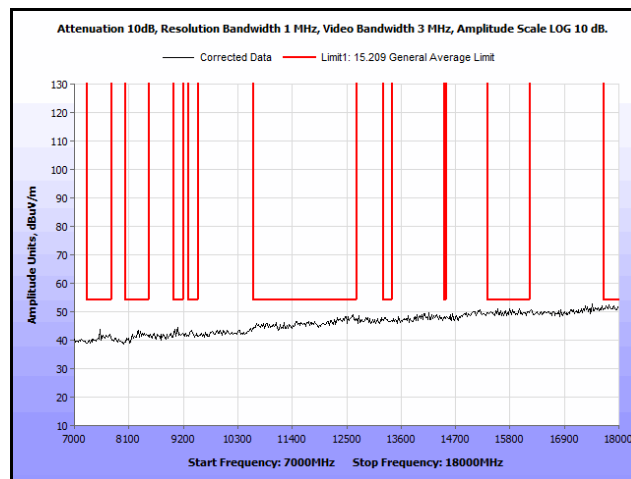

**Plot 230. Radiated Spurs, Co-Location, 802.11n 20 MHz, 2437 MHz & 2462 MHz, 7 GHz – 18 GHz, Peak, Omni**

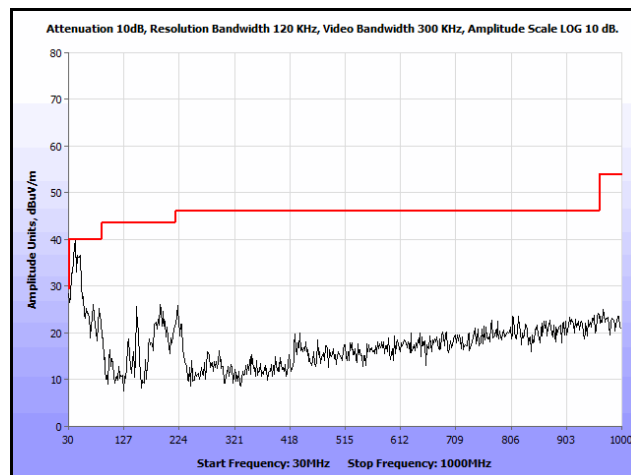

**Plot 231. Radiated Spurs, Co-Location, 802.11n 20 MHz, 2462 MHz & 2462 MHz, 30 MHz – 1 GHz, Peak, Omni**

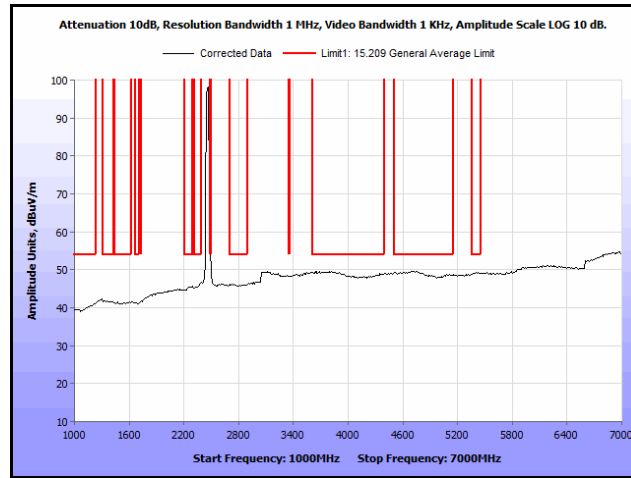

Plot 232. Radiated Spurs, Co-Location, 802.11n 20 MHz, 2462 MHz & 2462 MHz, 1 GHz – 7 GHz, Avg., Omni

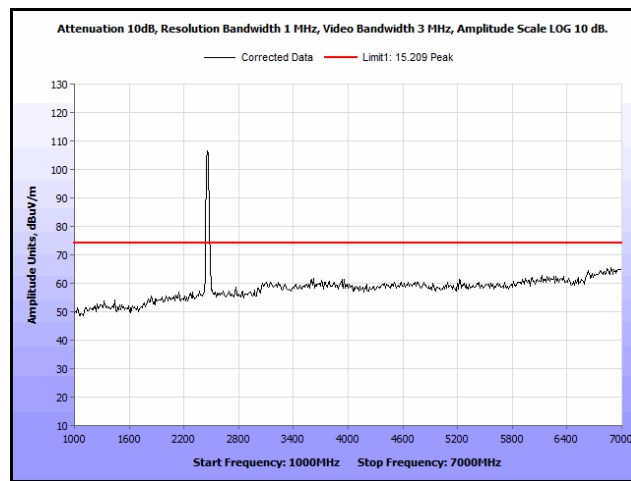

Plot 233. Radiated Spurs, Co-Location, 802.11n 20 MHz, 2462 MHz & 2462 MHz, 1 GHz – 7 GHz, Peak, Omni

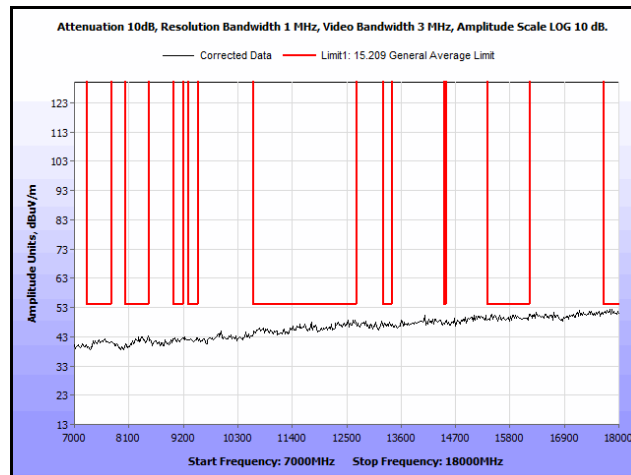

Plot 234. Radiated Spurs, Co-Location, 802.11n 20 MHz, 2462 MHz & 2462 MHz, 7 GHz – 18 GHz, Peak, Omni

**Omni Antenna**

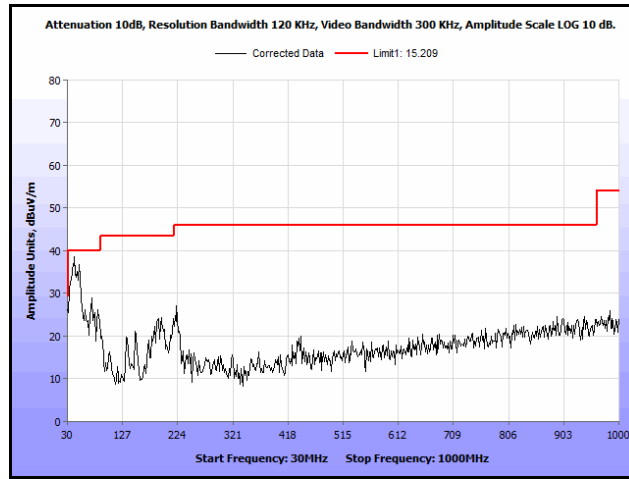

**Plot 235. Radiated Spurs, Co-Location, 802.11n 20 MHz, 2412 MHz & 5200 MHz, 30 MHz – 1 GHz, Peak, Omni**

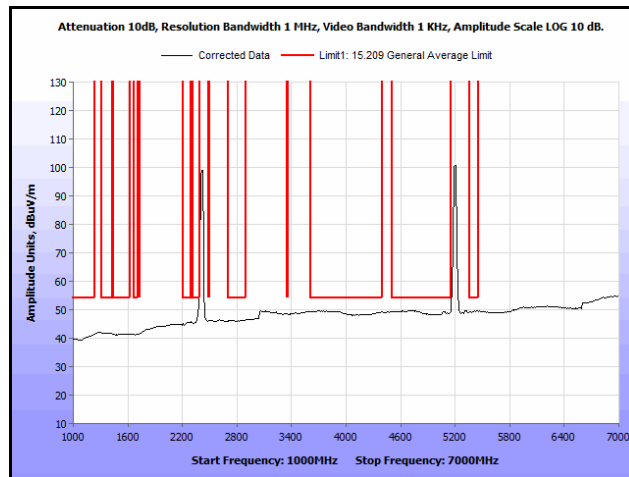

**Plot 236. Radiated Spurs, Co-Location, 802.11n 20 MHz, 2412 MHz & 5200 MHz, 1 GHz – 7 GHz, Avg., Omni**

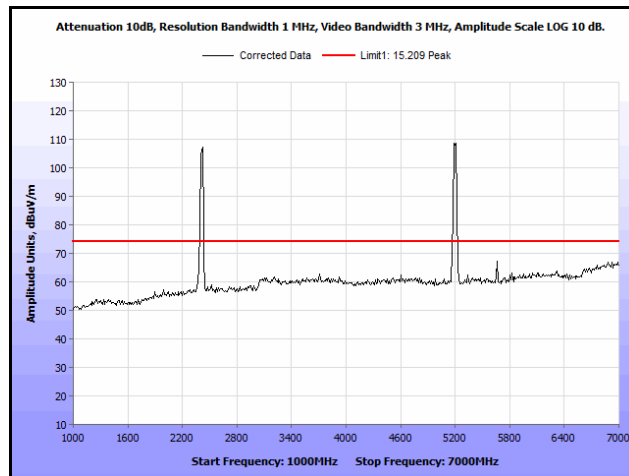

**Plot 237. Radiated Spurs, Co-Location, 802.11n 20 MHz, 2412 MHz & 5200 MHz, 1 GHz – 7 GHz, Peak, Omni**

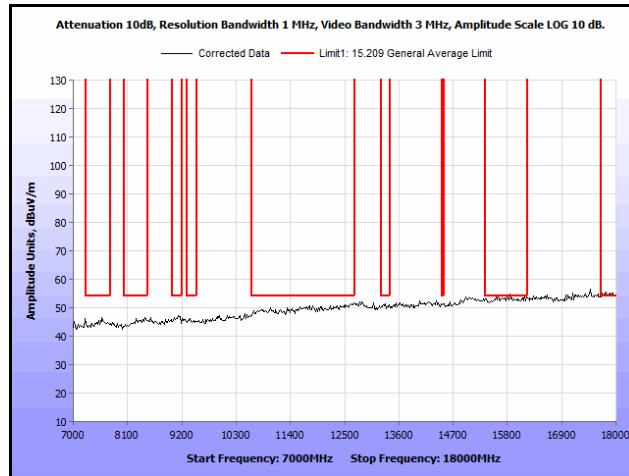

**Plot 238. Radiated Spurs, Co-Location, 802.11n 20 MHz, 2412 MHz & 5200 MHz, 7 GHz – 18 GHz, Peak, Omni**

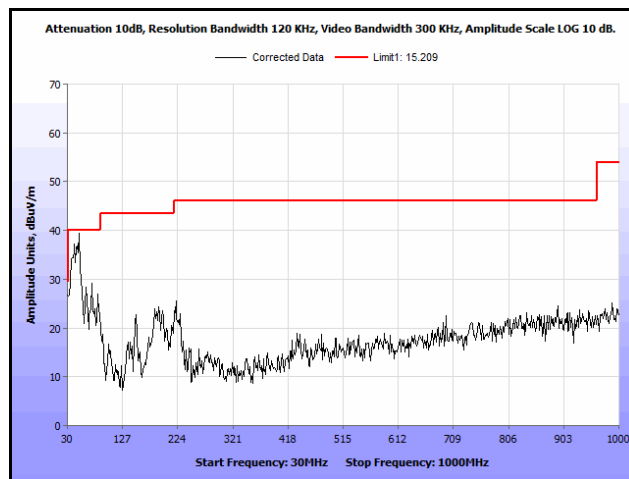

**Plot 239. Radiated Spurs, Co-Location, 802.11n 20 MHz, 2412 MHz & 5300 MHz, 30 MHz – 1 GHz, Peak, Omni**

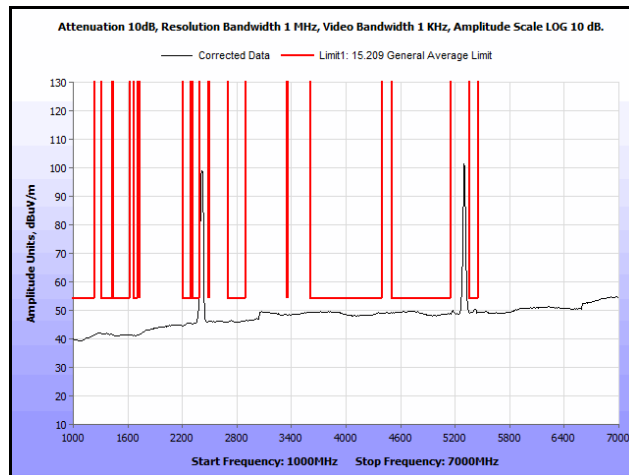

**Plot 240. Radiated Spurs, Co-Location, 802.11n 20 MHz, 2412 MHz & 5300 MHz, 1 GHz – 7 GHz, Avg., Omni**

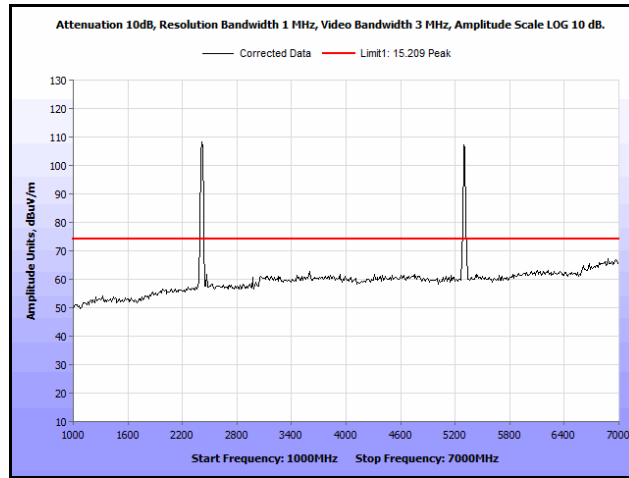

**Plot 241. Radiated Spurs, Co-Location, 802.11n 20 MHz, 2412 MHz & 5300 MHz, 1 GHz – 7 GHz, Peak, Omni**

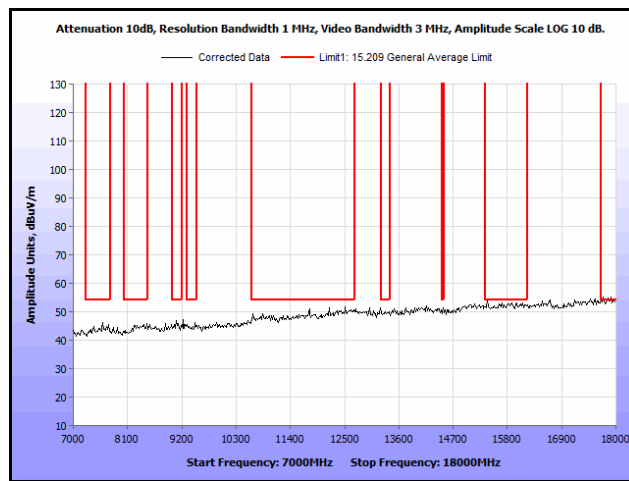

**Plot 242. Radiated Spurs, Co-Location, 802.11n 20 MHz, 2412 MHz & 5300 MHz, 7 GHz – 18 GHz, Peak, Omni**

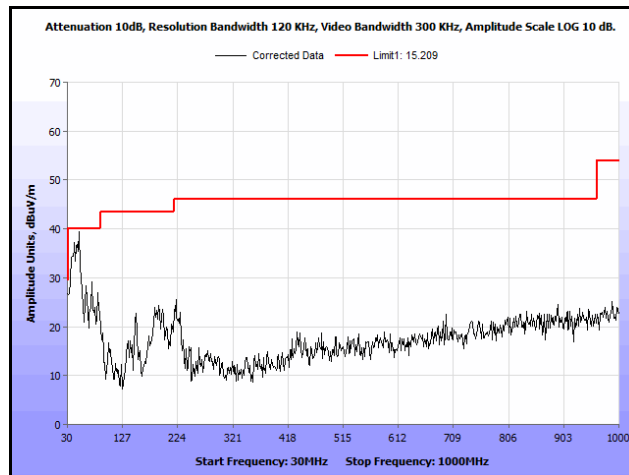

**Plot 243. Radiated Spurs, Co-Location, 802.11n 20 MHz, 2412 MHz & 5580 MHz, 30 MHz – 1 GHz, Peak, Omni**



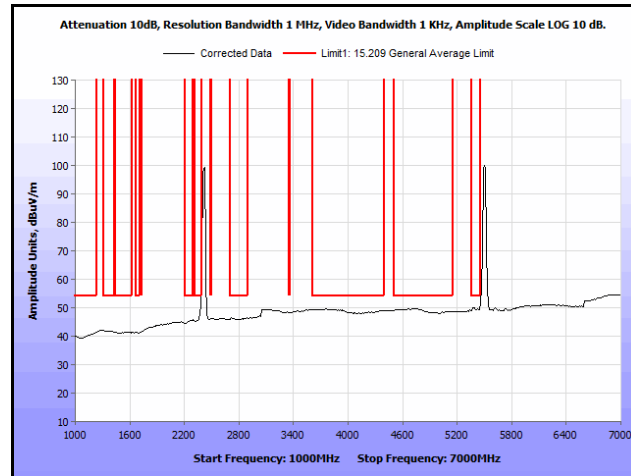

**Plot 244. Radiated Spurs, Co-Location, 802.11n 20 MHz, 2412 MHz & 5580 MHz, 1 GHz – 7 GHz, Avg., Omni**

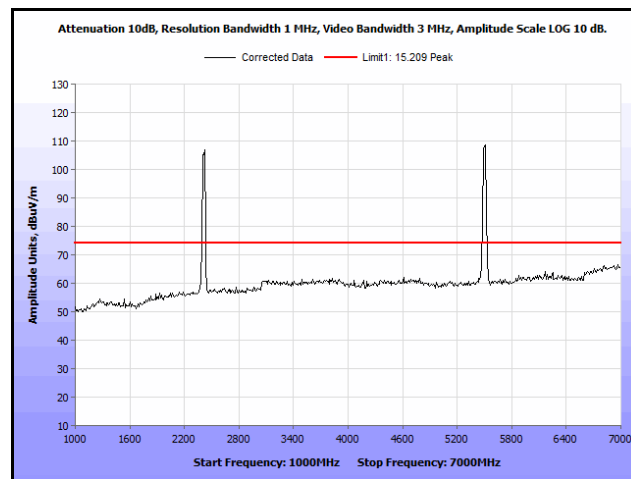

**Plot 245. Radiated Spurs, Co-Location, 802.11n 20 MHz, 2412 MHz & 5580 MHz, 1 GHz – 7 GHz, Peak, Omni**

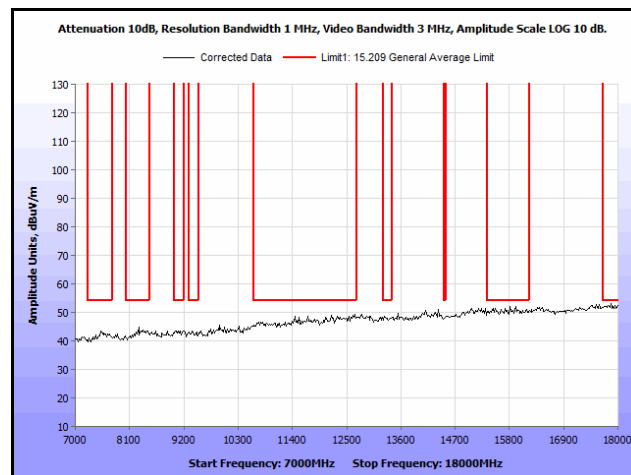

**Plot 246. Radiated Spurs, Co-Location, 802.11n 20 MHz, 2412 MHz & 5580 MHz, 7 GHz – 18 GHz, Peak, Omni**

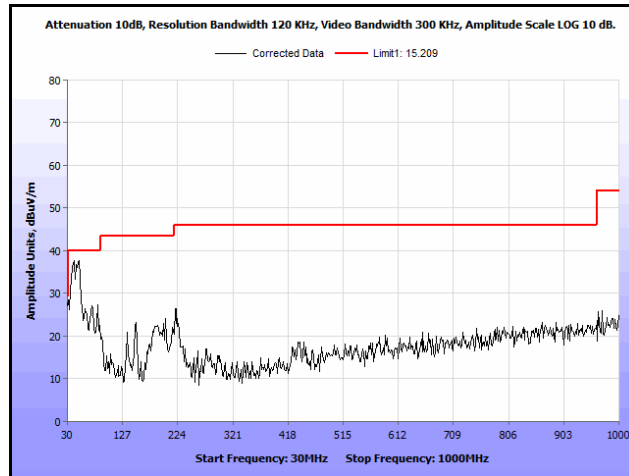

**Plot 247. Radiated Spurs, Co-Location, 802.11n 20 MHz, 2412 MHz & 5785 MHz, 30 MHz – 1 GHz, Peak, Omni**

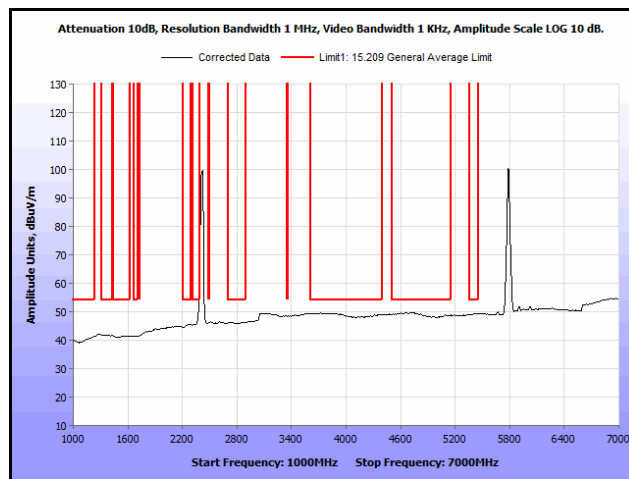

**Plot 248. Radiated Spurs, Co-Location, 802.11n 20 MHz, 2412 MHz & 5785 MHz, 1 GHz – 7 GHz, Avg., Omni**

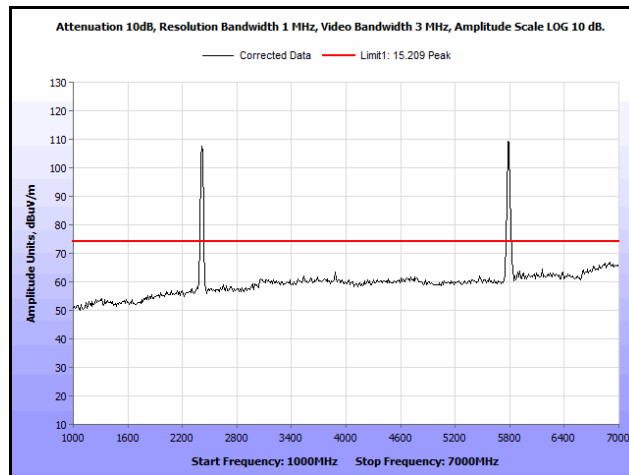

**Plot 249. Radiated Spurs, Co-Location, 802.11n 20 MHz, 2412 MHz & 5785 MHz, 1 GHz – 7 GHz, Peak, Omni**

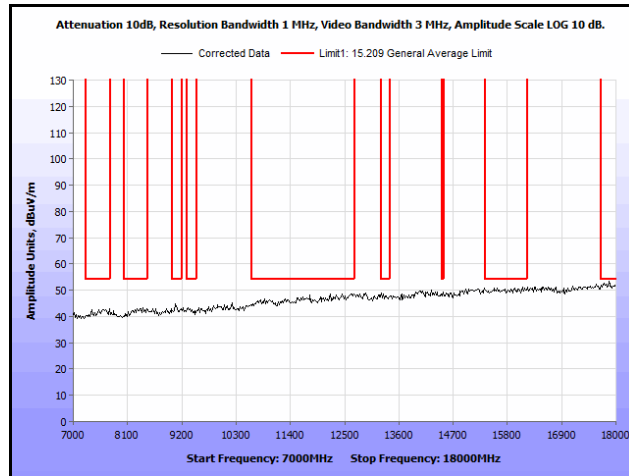

**Plot 250. Radiated Spurs, Co-Location, 802.11n 20 MHz, 2412 MHz & 5785 MHz, 7 GHz – 18 GHz, Peak, Omni**

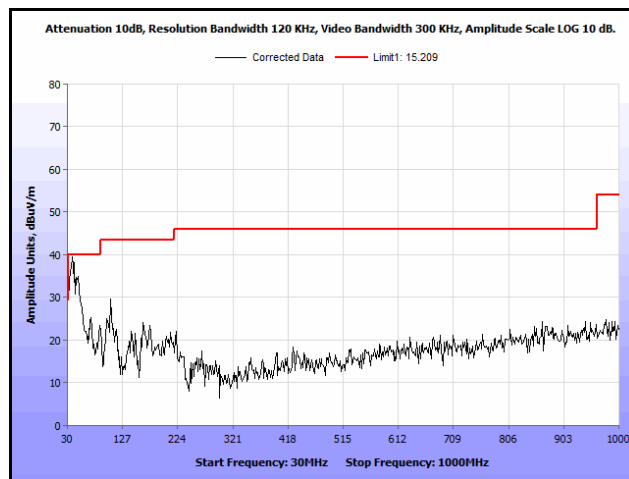

**Plot 251. Radiated Spurs, Co-Location, 802.11n 20 MHz, 2437 MHz & 5200 MHz, 30 MHz – 1 GHz, Peak, Omni**

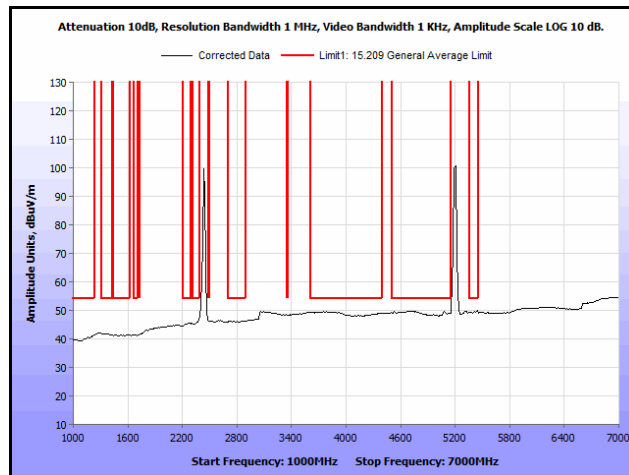

**Plot 252. Radiated Spurs, Co-Location, 802.11n 20 MHz, 2437 MHz & 5200 MHz, 1 GHz – 7 GHz, Avg., Omni**

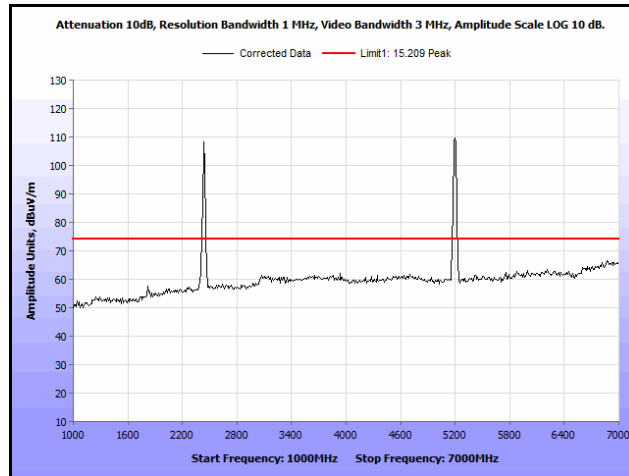

**Plot 253. Radiated Spurs, Co-Location, 802.11n 20 MHz, 2437 MHz & 5200 MHz, 1 GHz – 7 GHz, Peak, Omni**

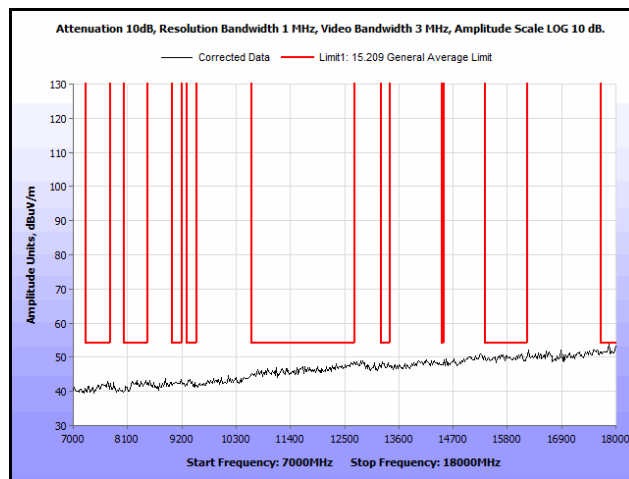

**Plot 254. Radiated Spurs, Co-Location, 802.11n 20 MHz, 2437 MHz & 5200 MHz, 7 GHz – 18 GHz, Peak, Omni**

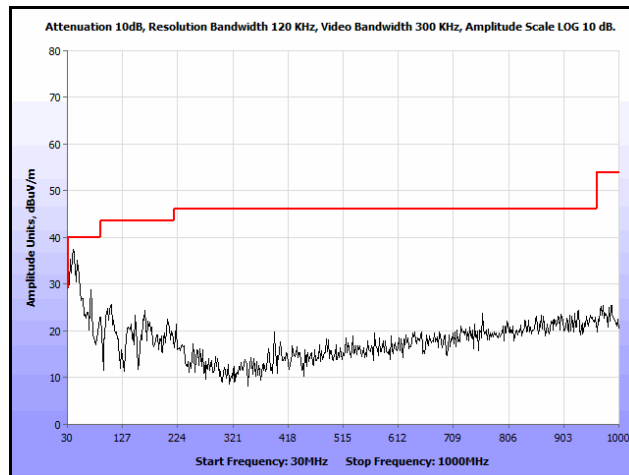

**Plot 255. Radiated Spurs, Co-Location, 802.11n 20 MHz, 2437 MHz & 5300 MHz, 30 MHz – 1 GHz, Peak, Omni**

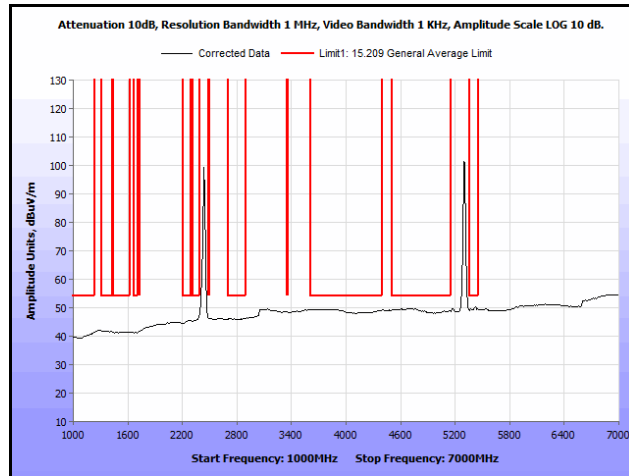

Plot 256. Radiated Spurs, Co-Location, 802.11n 20 MHz, 2437 MHz & 5300 MHz, 1 GHz – 7 GHz, Avg., Omni

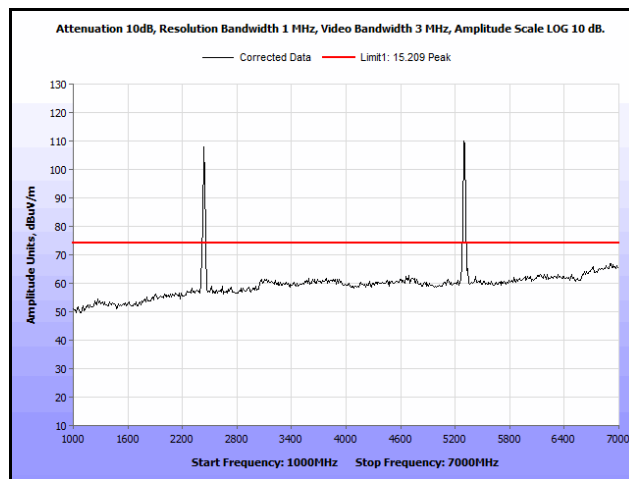

Plot 257. Radiated Spurs, Co-Location, 802.11n 20 MHz, 2437 MHz & 5300 MHz, 1 GHz – 7 GHz, Peak, Omni

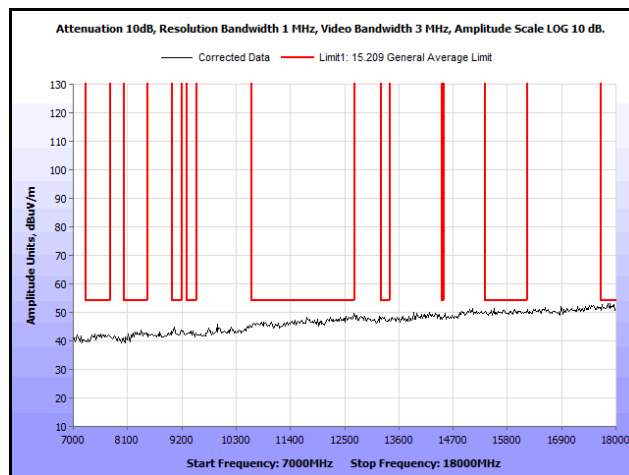

Plot 258. Radiated Spurs, Co-Location, 802.11n 20 MHz, 2437 MHz & 5300 MHz, 7 GHz – 18 GHz, Peak, Omni

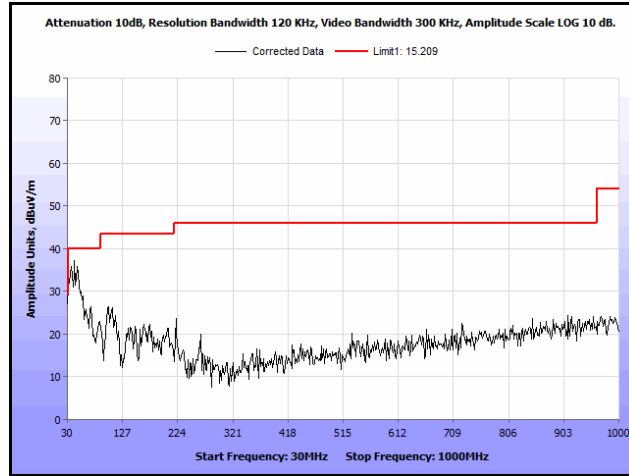

Plot 259. Radiated Spurs, Co-Location, 802.11n 20 MHz, 2437 MHz & 5580 MHz, 30 MHz – 1 GHz, Peak, Omni

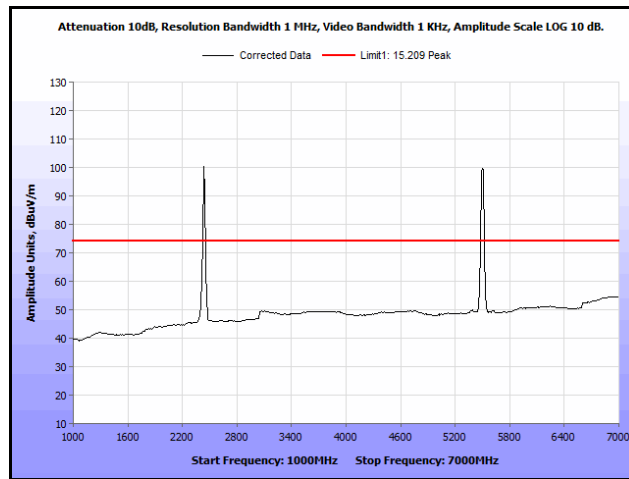

Plot 260. Radiated Spurs, Co-Location, 802.11n 20 MHz, 2437 MHz & 5580 MHz, 1 GHz – 7 GHz, Avg., Omni

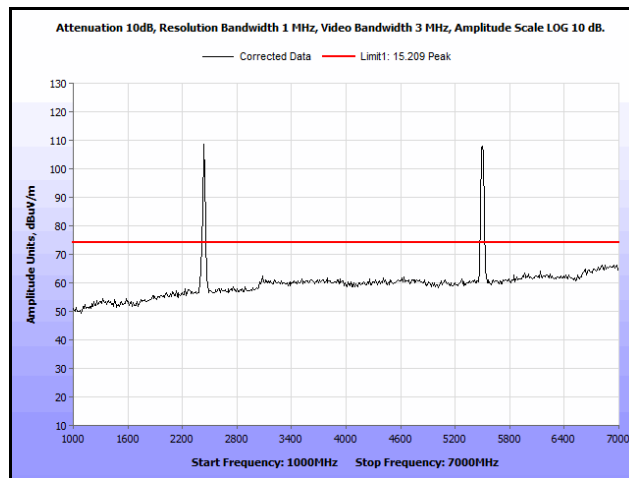

Plot 261. Radiated Spurs, Co-Location, 802.11n 20 MHz, 2437 MHz & 5580 MHz, 1 GHz – 7 GHz, Peak, Omni

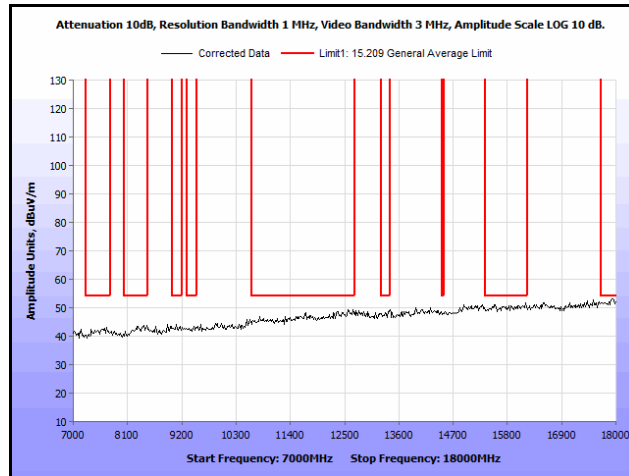

**Plot 262. Radiated Spurs, Co-Location, 802.11n 20 MHz, 2437 MHz & 5580 MHz, 7 GHz – 18 GHz, Peak, Omni**

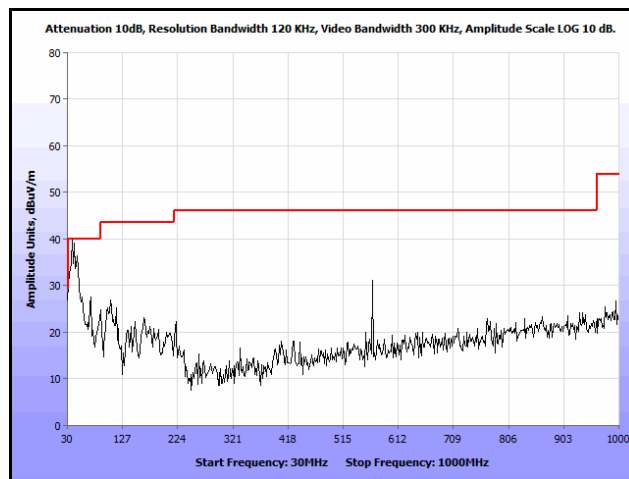

**Plot 263. Radiated Spurs, Co-Location, 802.11n 20 MHz, 2437 MHz & 5785 MHz, 30 MHz – 1 GHz, Peak, Omni**

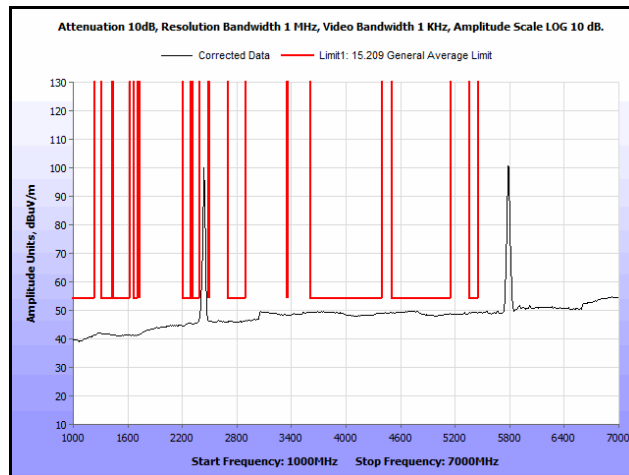

**Plot 264. Radiated Spurs, Co-Location, 802.11n 20 MHz, 2437 MHz & 5785 MHz, 1 GHz – 7 GHz, Avg., Omni**

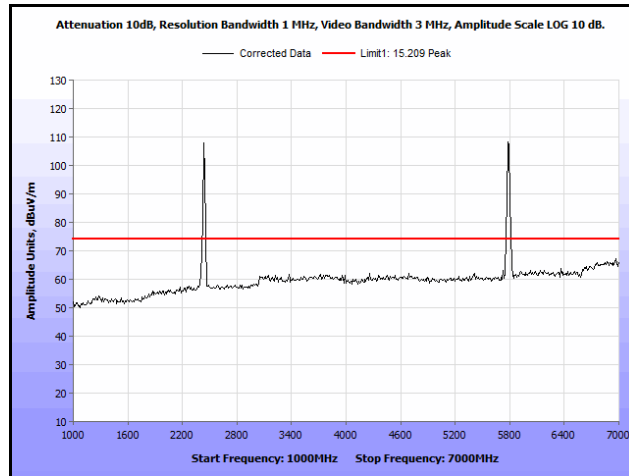

**Plot 265. Radiated Spurs, Co-Location, 802.11n 20 MHz, 2437 MHz & 5785 MHz, 1 GHz – 7 GHz, Peak, Omni**

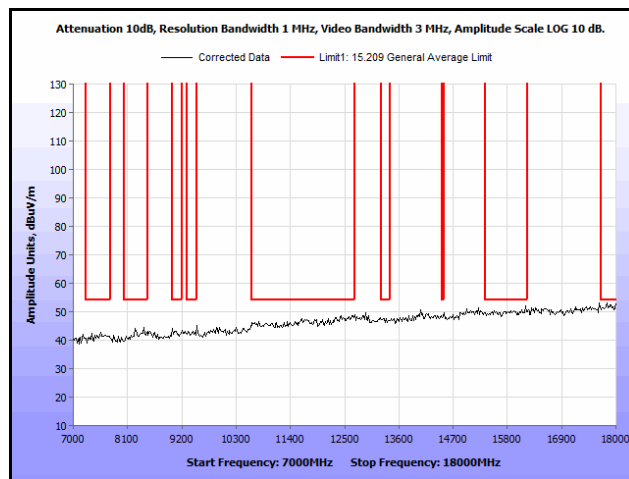

**Plot 266. Radiated Spurs, Co-Location, 802.11n 20 MHz, 2437 MHz & 5785 MHz, 7 GHz – 18 GHz, Peak, Omni**

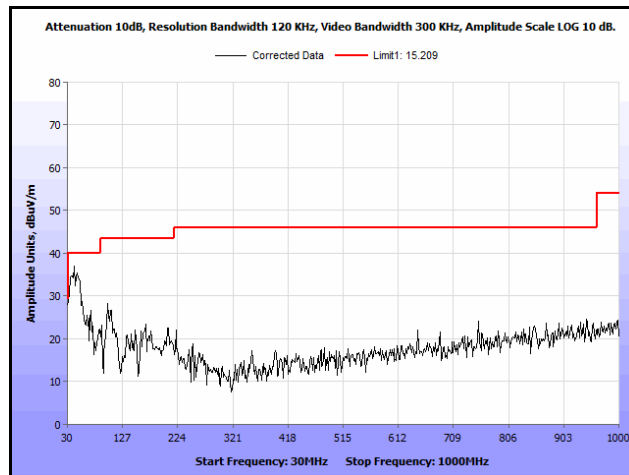

**Plot 267. Radiated Spurs, Co-Location, 802.11n 20 MHz, 2462 MHz & 5200 MHz, 30 MHz – 1 GHz, Peak, Omni**



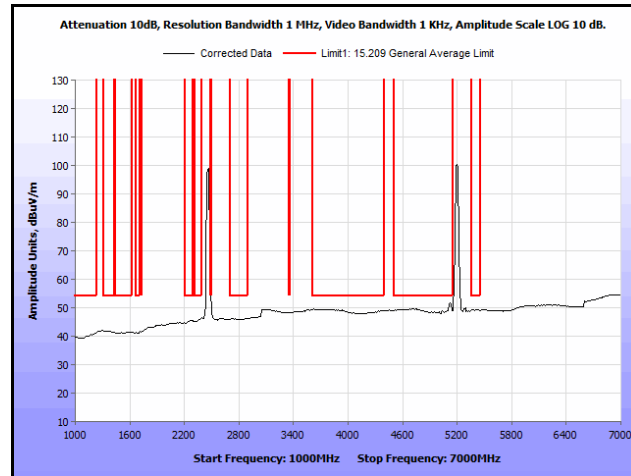

Plot 268. Radiated Spurs, Co-Location, 802.11n 20 MHz, 2462 MHz & 5200 MHz, 1 GHz – 7 GHz, Avg., Omni

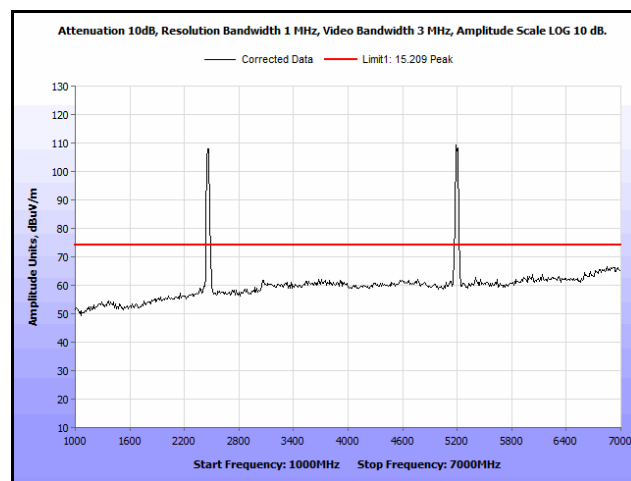

Plot 269. Radiated Spurs, Co-Location, 802.11n 20 MHz, 2462 MHz & 5200 MHz, 1 GHz – 7 GHz, Peak, Omni

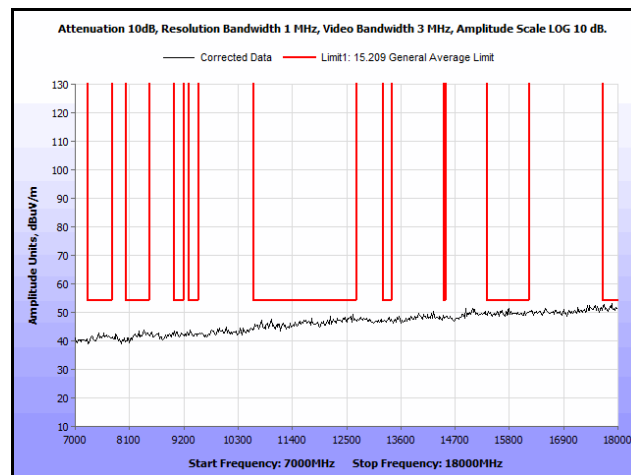

Plot 270. Radiated Spurs, Co-Location, 802.11n 20 MHz, 2462 MHz & 5200 MHz, 7 GHz – 18 GHz, Peak, Omni

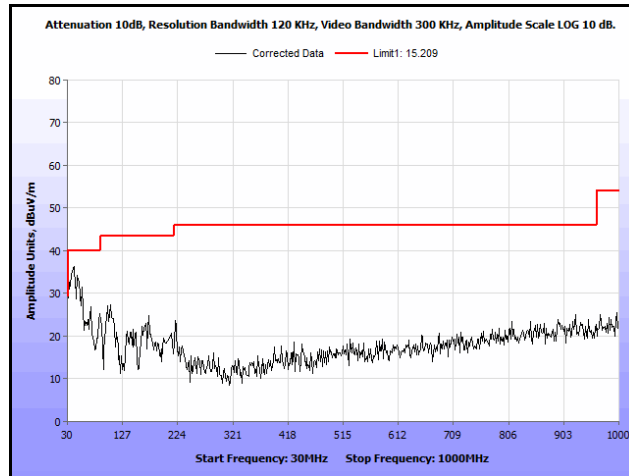

**Plot 271. Radiated Spurs, Co-Location, 802.11n 20 MHz, 2462 MHz & 5300 MHz, 30 MHz – 1 GHz, Peak, Omni**

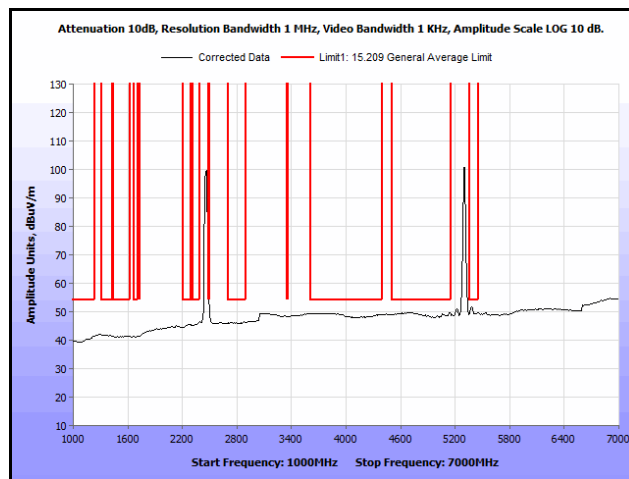

**Plot 272. Radiated Spurs, Co-Location, 802.11n 20 MHz, 2462 MHz & 5300 MHz, 1 GHz – 7 GHz, Avg., Omni**

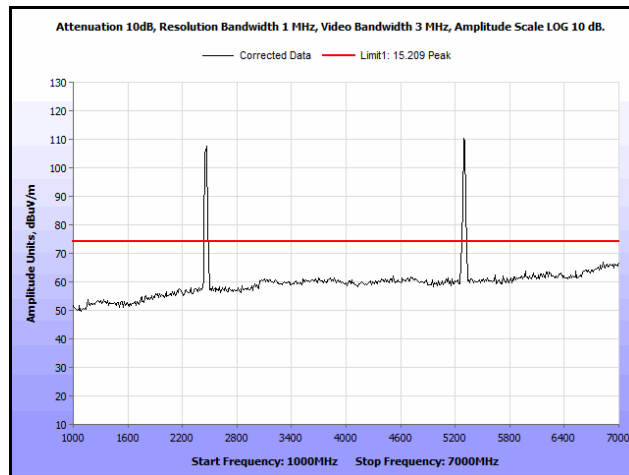

**Plot 273. Radiated Spurs, Co-Location, 802.11n 20 MHz, 2462 MHz & 5300 MHz, 1 GHz – 7 GHz, Peak, Omni**

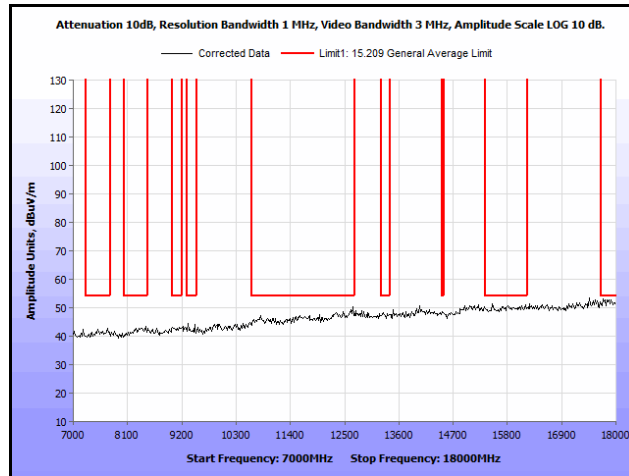

**Plot 274. Radiated Spurs, Co-Location, 802.11n 20 MHz, 2462 MHz & 5300 MHz, 7 GHz – 18 GHz, Peak, Omni**

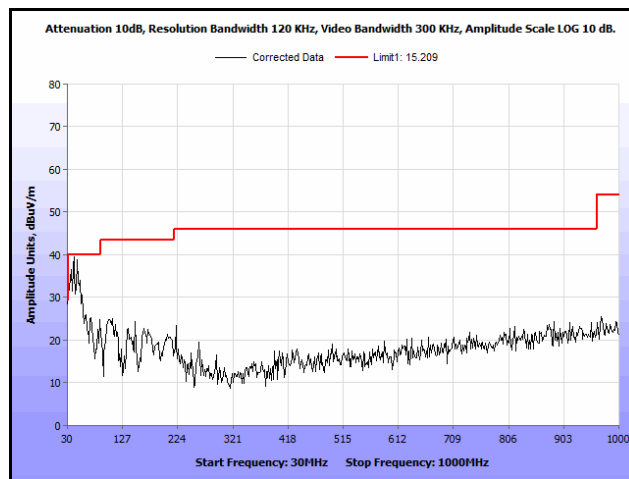

**Plot 275. Radiated Spurs, Co-Location, 802.11n 20 MHz, 2462 MHz & 5580 MHz, 30 MHz – 1 GHz, Peak, Omni**

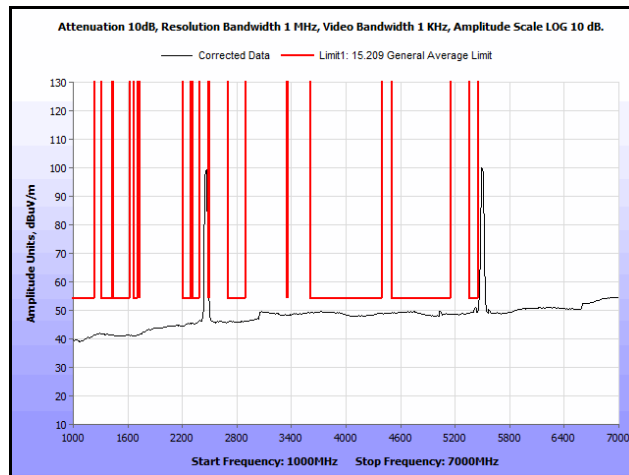

**Plot 276. Radiated Spurs, Co-Location, 802.11n 20 MHz, 2462 MHz & 5580 MHz, 1 GHz – 7 GHz, Avg., Omni**

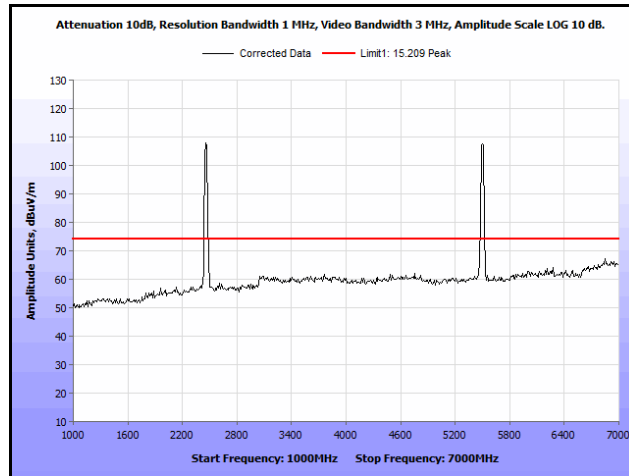

**Plot 277. Radiated Spurs, Co-Location, 802.11n 20 MHz, 2462 MHz & 5580 MHz, 1 GHz – 7 GHz, Peak, Omni**

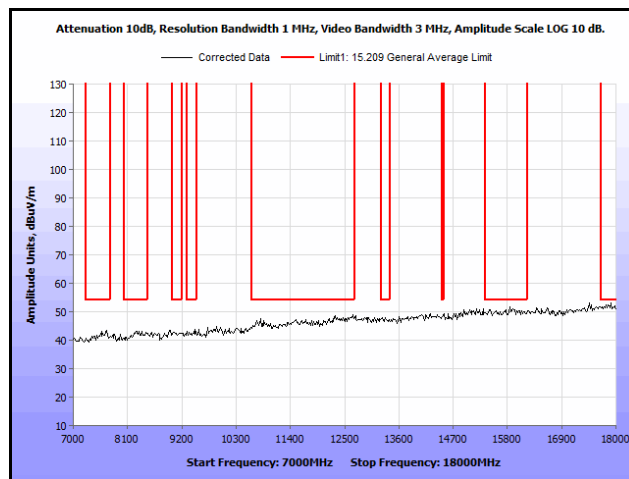

**Plot 278. Radiated Spurs, Co-Location, 802.11n 20 MHz, 2462 MHz & 5580 MHz, 7 GHz – 18 GHz, Peak, Omni**

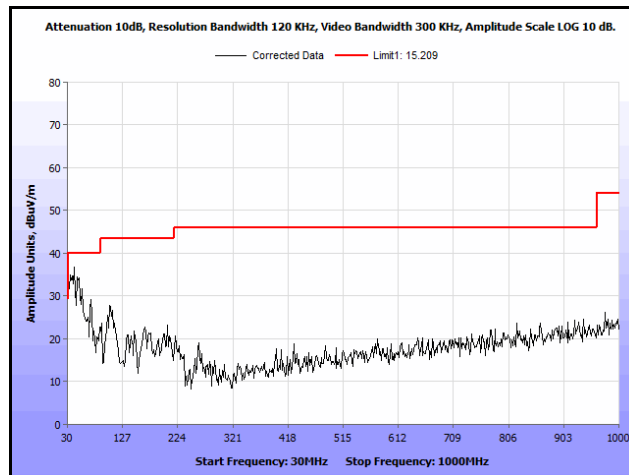

**Plot 279. Radiated Spurs, Co-Location, 802.11n 20 MHz, 2462 MHz & 5785 MHz, 30 MHz – 1 GHz, Peak, Omni**

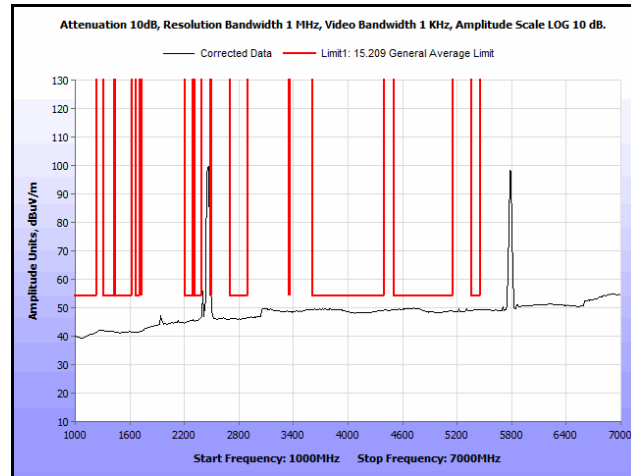

Plot 280. Radiated Spurs, Co-Location, 802.11n 20 MHz, 2462 MHz & 5785 MHz, 1 GHz – 7 GHz, Avg., Omni

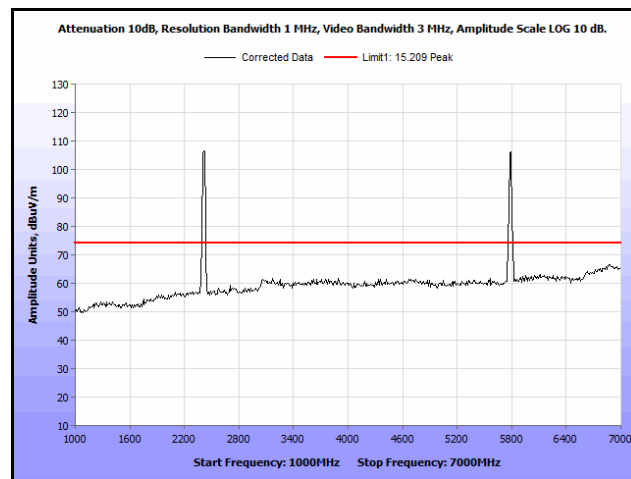

Plot 281. Radiated Spurs, Co-Location, 802.11n 20 MHz, 2462 MHz & 5785 MHz, 1 GHz – 7 GHz, Peak, Omni

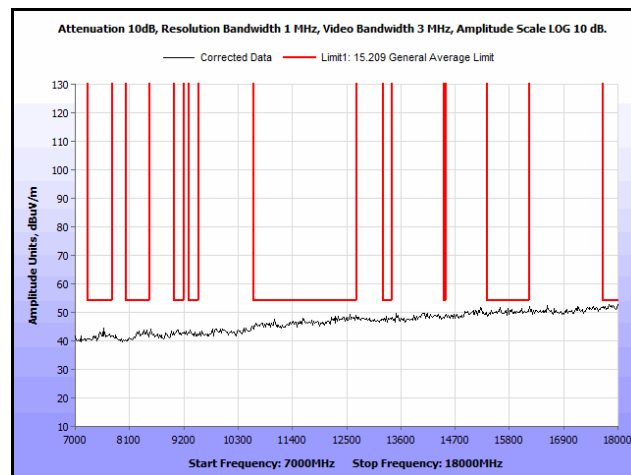

Plot 282. Radiated Spurs, Co-Location, 802.11n 20 MHz, 2462 MHz & 5785 MHz, 7 GHz – 18 GHz, Peak, Omni

**Omni Antenna**

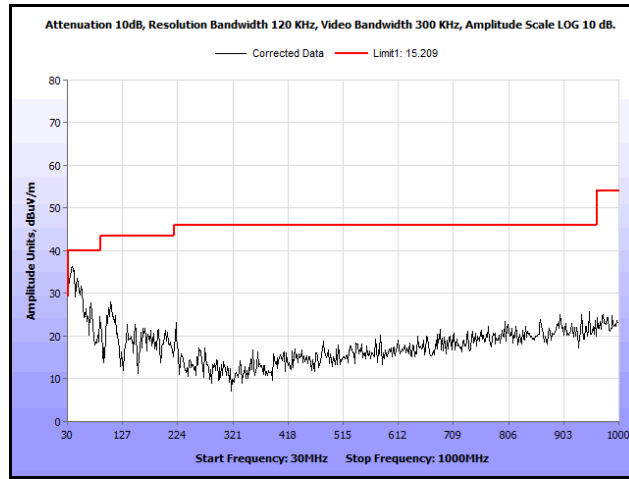

**Plot 283. Radiated Spurs, Co-Location, 802.11n 20 MHz, 5200 MHz & 5200 MHz, 30 MHz – 1 GHz, Peak, Omni**

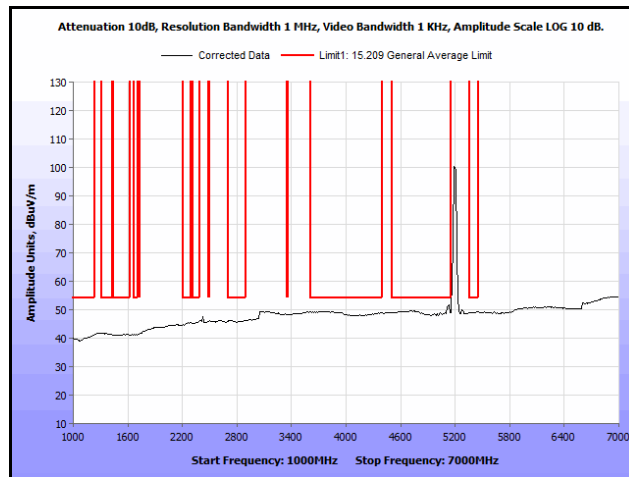

**Plot 284. Radiated Spurs, Co-Location, 802.11n 20 MHz, 5200 MHz & 5200 MHz, 1 GHz – 7 GHz, Avg., Omni**

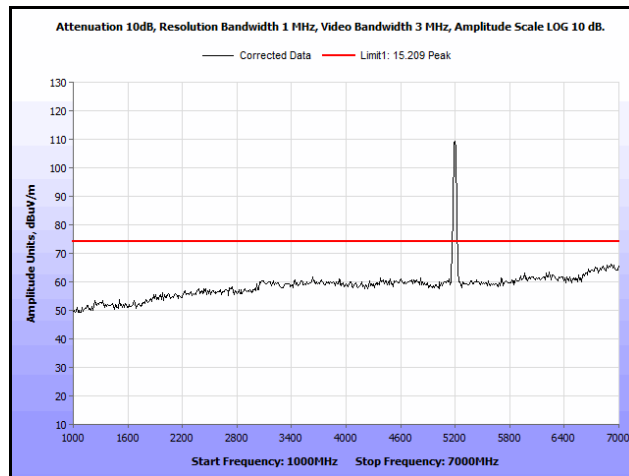

**Plot 285. Radiated Spurs, Co-Location, 802.11n 20 MHz, 5200 MHz & 5200 MHz, 1 GHz – 7 GHz, Peak, Omni**

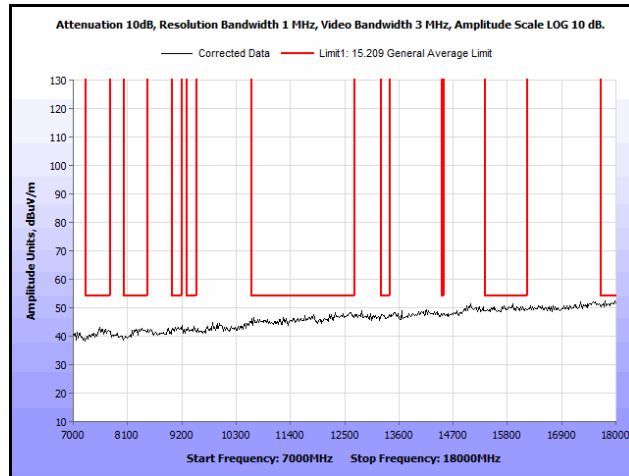

**Plot 286. Radiated Spurs, Co-Location, 802.11n 20 MHz, 5200 MHz & 5200 MHz, 7 GHz – 18 GHz, Peak, Omni**

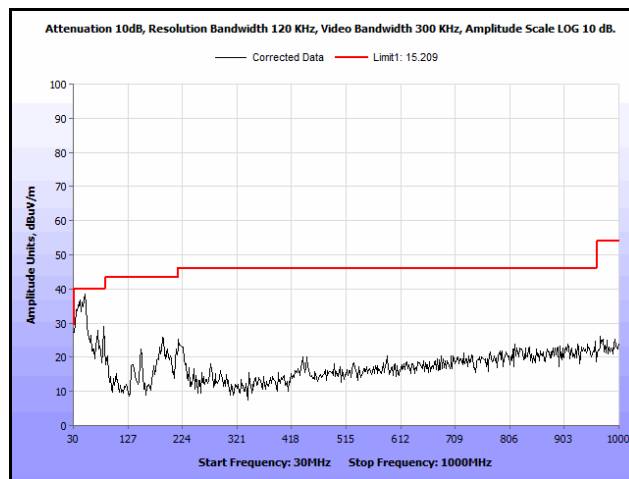

**Plot 287. Radiated Spurs, Co-Location, 802.11n 20 MHz, 5200 MHz & 5300 MHz, 30 MHz – 1 GHz, Peak, Omni**

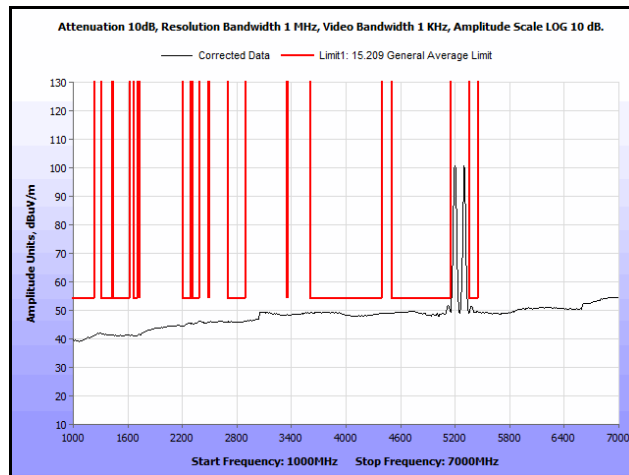

**Plot 288. Radiated Spurs, Co-Location, 802.11n 20 MHz, 5200 MHz & 5300 MHz, 1 GHz – 7 GHz, Avg., Omni**

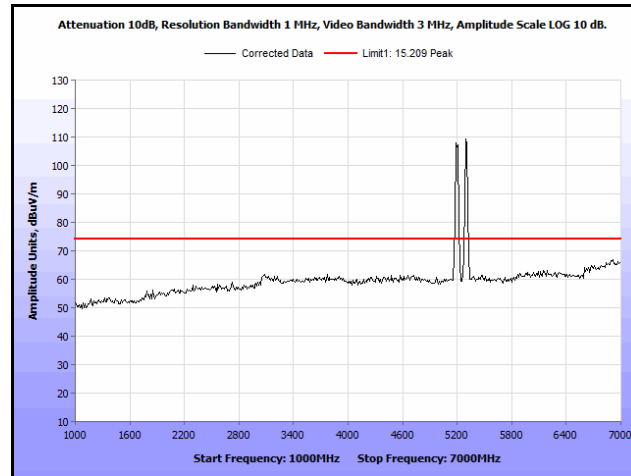

**Plot 289. Radiated Spurs, Co-Location, 802.11n 20 MHz, 5200 MHz & 5300 MHz, 1 GHz – 7 GHz, Peak, Omni**

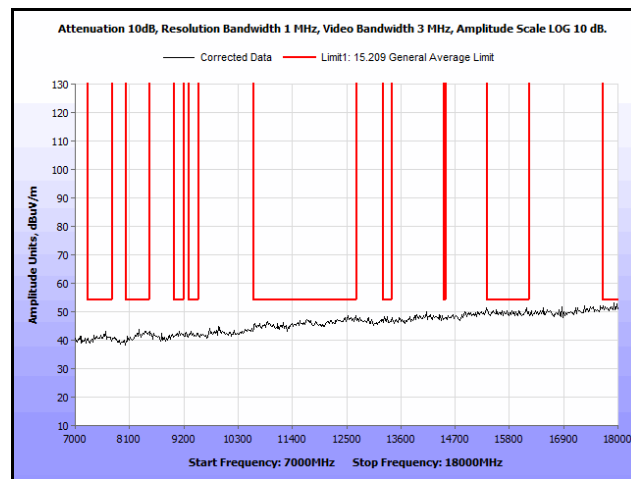

**Plot 290. Radiated Spurs, Co-Location, 802.11n 20 MHz, 5200 MHz & 5300 MHz, 7 GHz – 18 GHz, Peak, Omni**

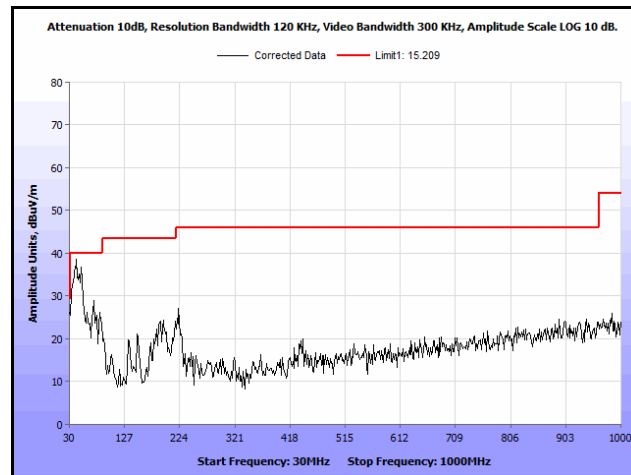

**Plot 291. Radiated Spurs, Co-Location, 802.11n 20 MHz, 5200 MHz & 5580 MHz, 30 MHz – 1 GHz, Peak, Omni**



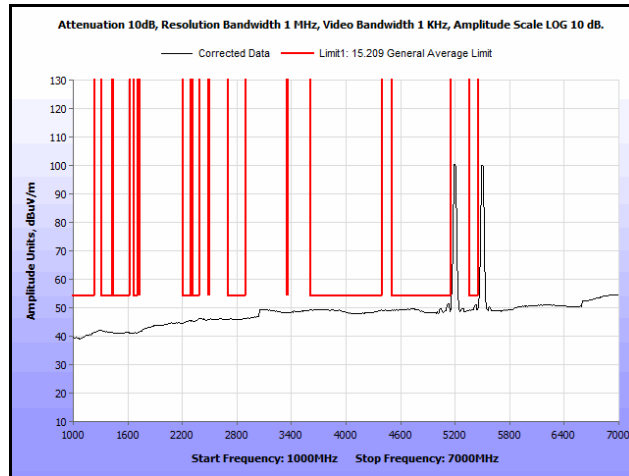

**Plot 292. Radiated Spurs, Co-Location, 802.11n 20 MHz, 5200 MHz & 5580 MHz, 1 GHz – 7 GHz, Avg., Omni**

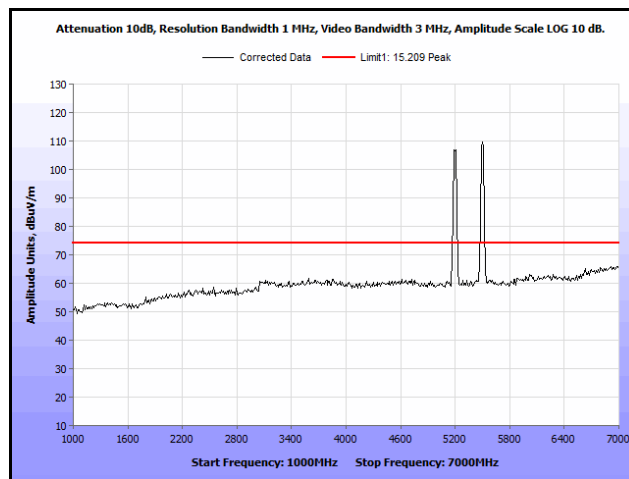

**Plot 293. Radiated Spurs, Co-Location, 802.11n 20 MHz, 5200 MHz & 5580 MHz, 1 GHz – 7 GHz, Peak, Omni**

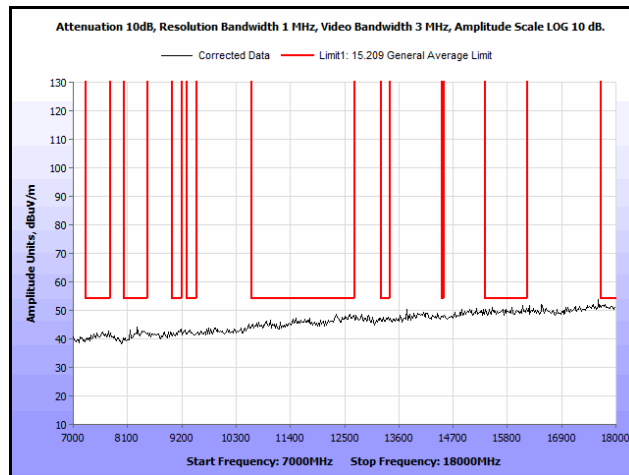

**Plot 294. Radiated Spurs, Co-Location, 802.11n 20 MHz, 5200 MHz & 5580 MHz, 7 GHz – 18 GHz, Peak, Omni**

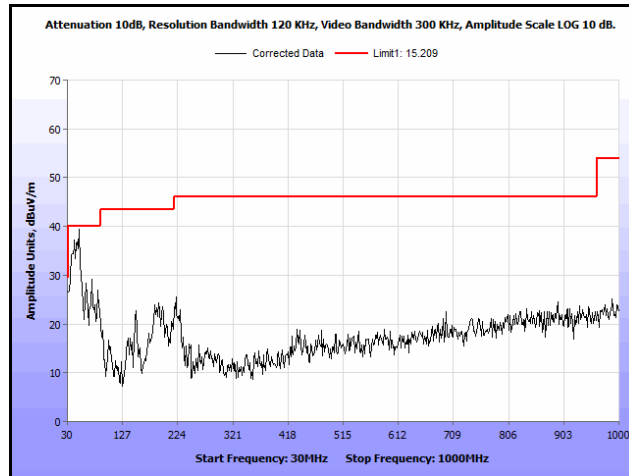

**Plot 295. Radiated Spurs, Co-Location, 802.11n 20 MHz, 5200 MHz & 5785 MHz, 30 MHz – 1 GHz, Peak, Omni**

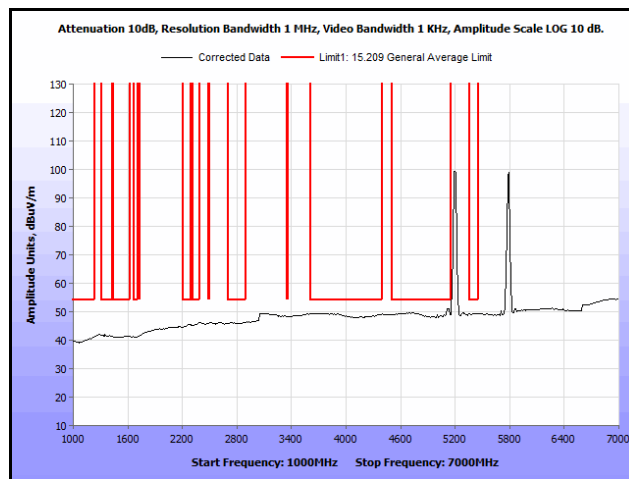

**Plot 296. Radiated Spurs, Co-Location, 802.11n 20 MHz, 5200 MHz & 5785 MHz, 1 GHz – 7 GHz, Avg., Omni**

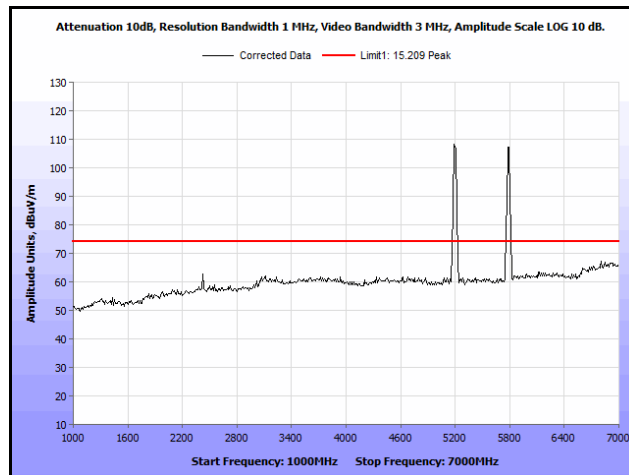

**Plot 297. Radiated Spurs, Co-Location, 802.11n 20 MHz, 5200 MHz & 5785 MHz, 1 GHz – 7 GHz, Peak, Omni**

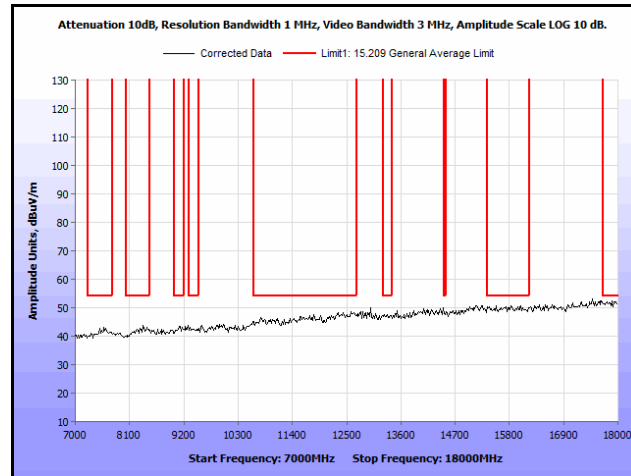

**Plot 298. Radiated Spurs, Co-Location, 802.11n 20 MHz, 5200 MHz & 5785 MHz, 7 GHz – 18 GHz, Peak, Omni**

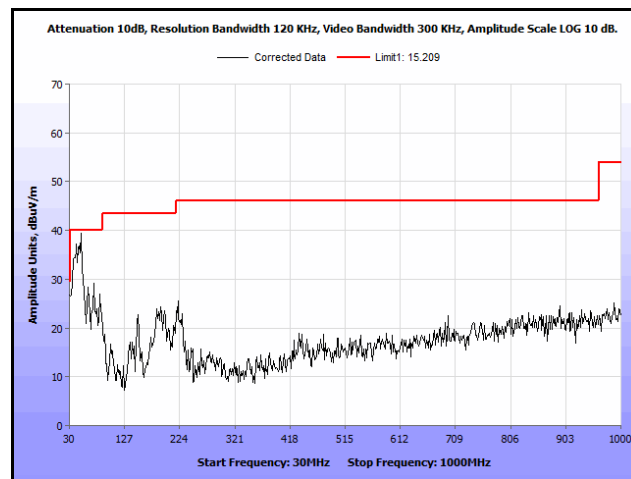

**Plot 299. Radiated Spurs, Co-Location, 802.11n 20 MHz, 5300 MHz & 5300 MHz, 30 MHz – 1 GHz, Peak, Omni**

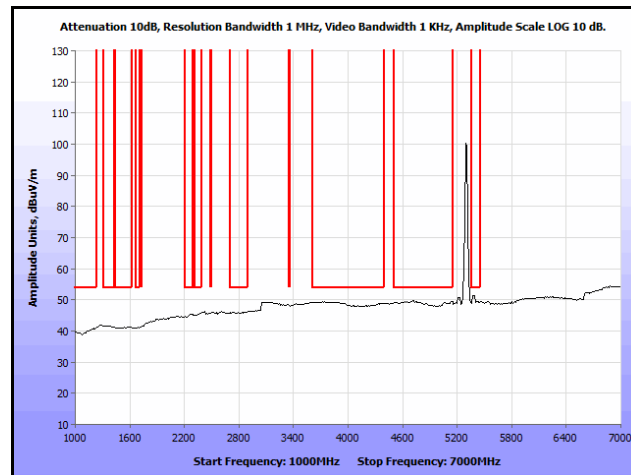

**Plot 300. Radiated Spurs, Co-Location, 802.11n 20 MHz, 5300 MHz & 5300 MHz, 1 GHz – 7 GHz, Avg., Omni**

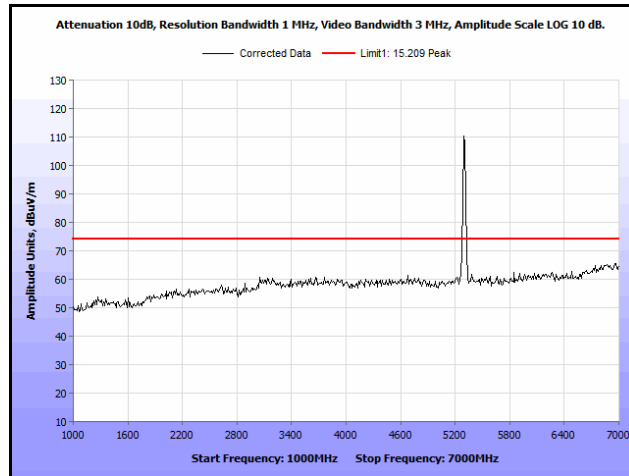

**Plot 301. Radiated Spurs, Co-Location, 802.11n 20 MHz, 5300 MHz & 5300 MHz, 1 GHz – 7 GHz, Peak, Omni**

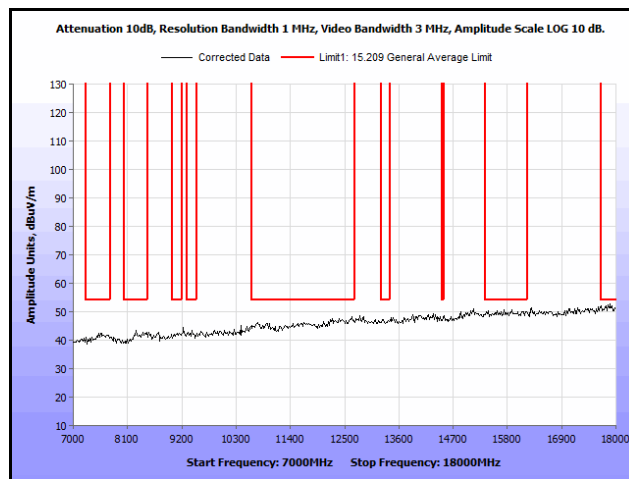

**Plot 302. Radiated Spurs, Co-Location, 802.11n 20 MHz, 5300 MHz & 5300 MHz, 7 GHz – 18 GHz, Peak, Omni**

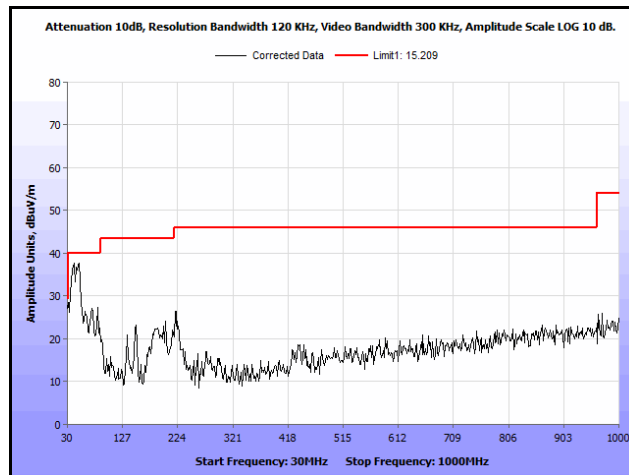

**Plot 303. Radiated Spurs, Co-Location, 802.11n 20 MHz, 5300 MHz & 5580 MHz, 30 MHz – 1 GHz, Peak, Omni**

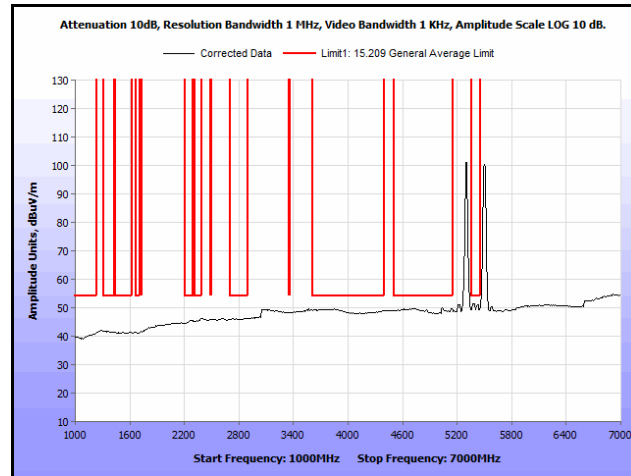

**Plot 304. Radiated Spurs, Co-Location, 802.11n 20 MHz, 5300 MHz & 5580 MHz, 1 GHz – 7 GHz, Avg., Omni**

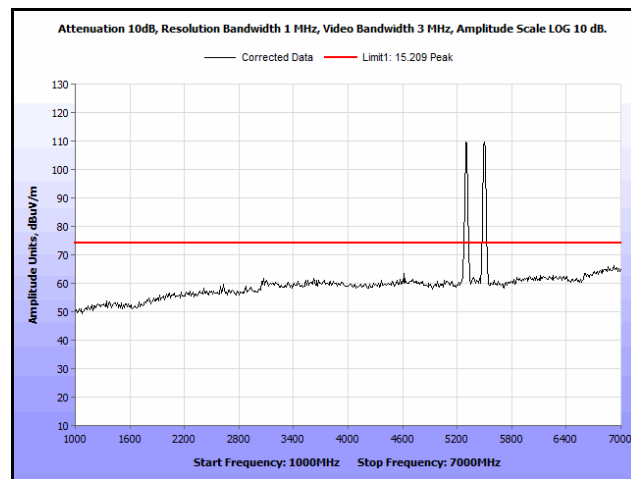

**Plot 305. Radiated Spurs, Co-Location, 802.11n 20 MHz, 5300 MHz & 5580 MHz, 1 GHz – 7 GHz, Peak, Omni**

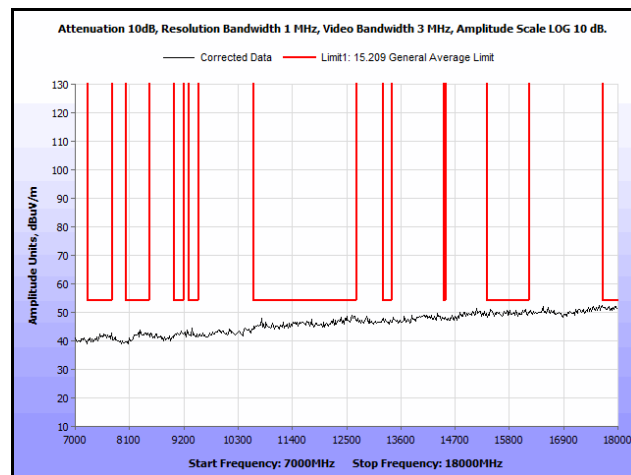

**Plot 306. Radiated Spurs, Co-Location, 802.11n 20 MHz, 5300 MHz & 5580 MHz, 7 GHz – 18 GHz, Peak, Omni**

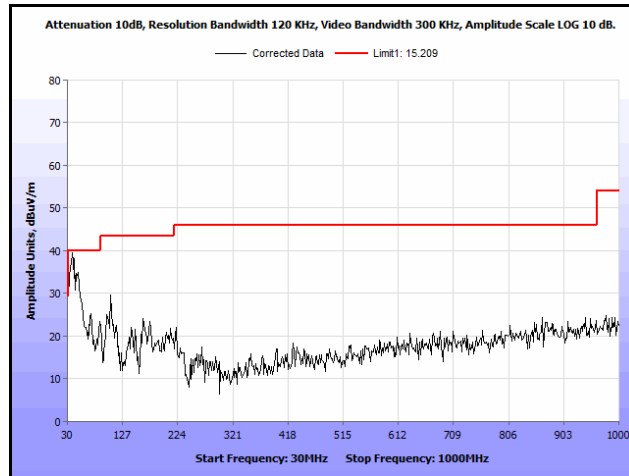

**Plot 307. Radiated Spurs, Co-Location, 802.11n 20 MHz, 5300 MHz & 5785 MHz, 30 MHz – 1 GHz, Peak, Omni**

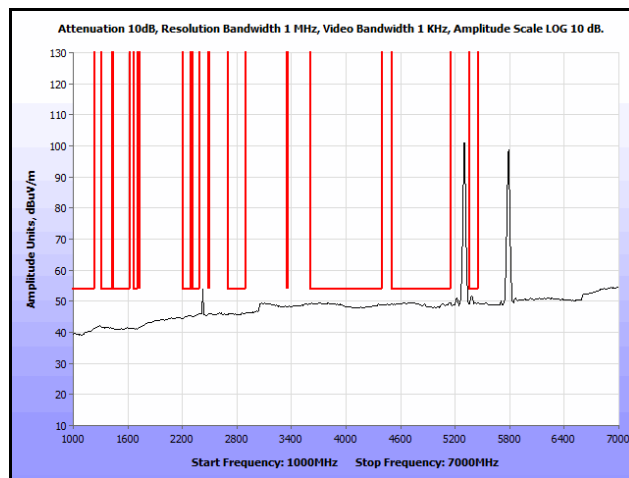

**Plot 308. Radiated Spurs, Co-Location, 802.11n 20 MHz, 5300 MHz & 5785 MHz, 1 GHz – 7 GHz, Avg., Omni**

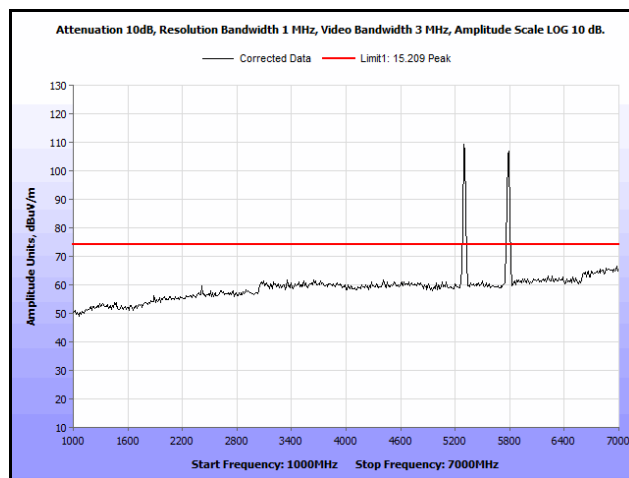

**Plot 309. Radiated Spurs, Co-Location, 802.11n 20 MHz, 5300 MHz & 5785 MHz, 1 GHz – 7 GHz, Peak, Omni**

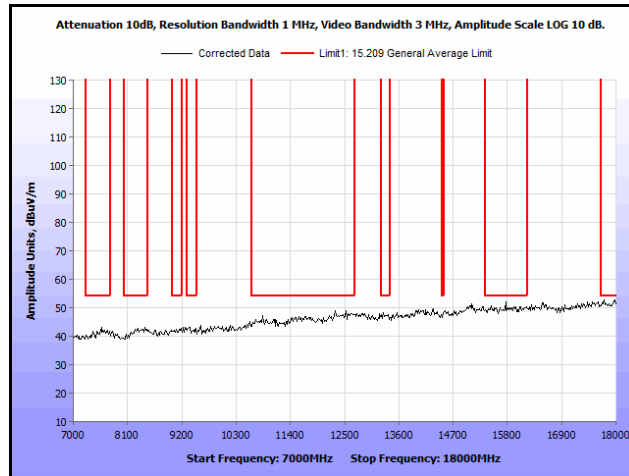

**Plot 310. Radiated Spurs, Co-Location, 802.11n 20 MHz, 5300 MHz & 5785 MHz, 7 GHz – 18 GHz, Peak, Omni**

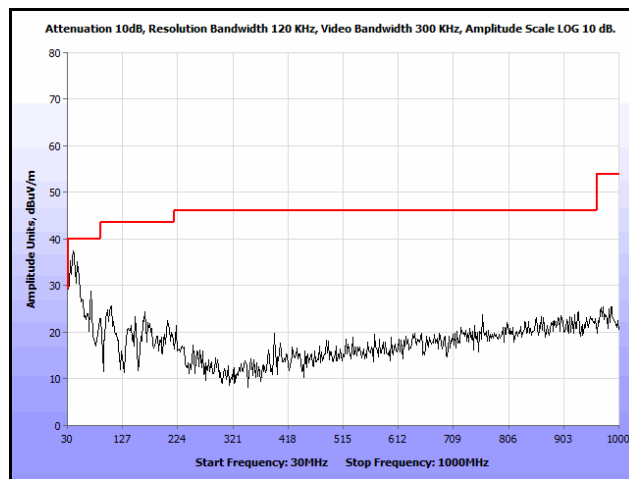

**Plot 311. Radiated Spurs, Co-Location, 802.11n 20 MHz, 5580 MHz & 5580 MHz, 30 MHz – 1 GHz, Peak, Omni**

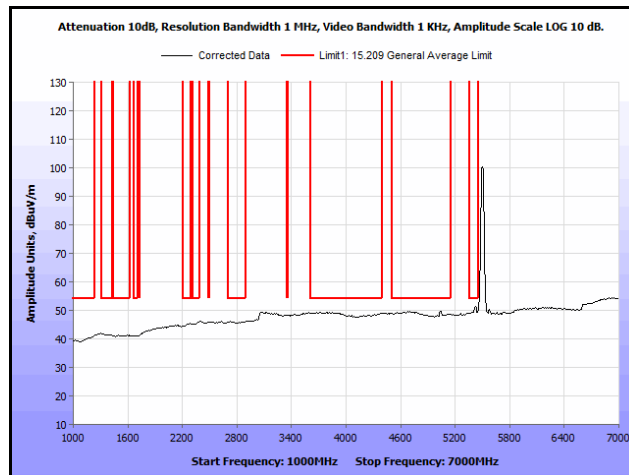

**Plot 312. Radiated Spurs, Co-Location, 802.11n 20 MHz, 5580 MHz & 5580 MHz, 1 GHz – 7 GHz, Avg., Omni**

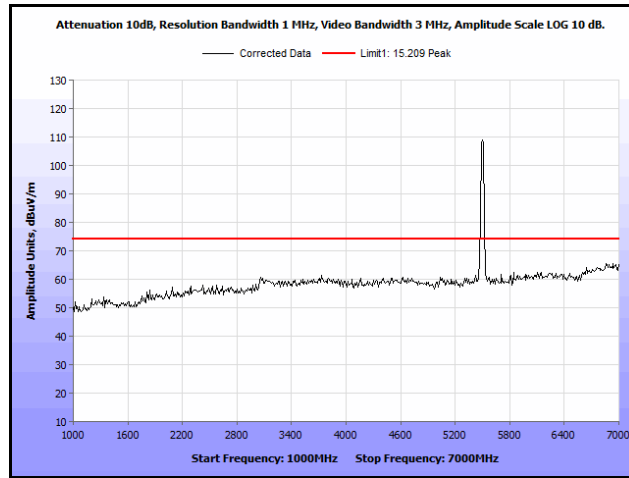

**Plot 313. Radiated Spurs, Co-Location, 802.11n 20 MHz, 5580 MHz & 5580 MHz, 1 GHz – 7 GHz, Peak, Omni**

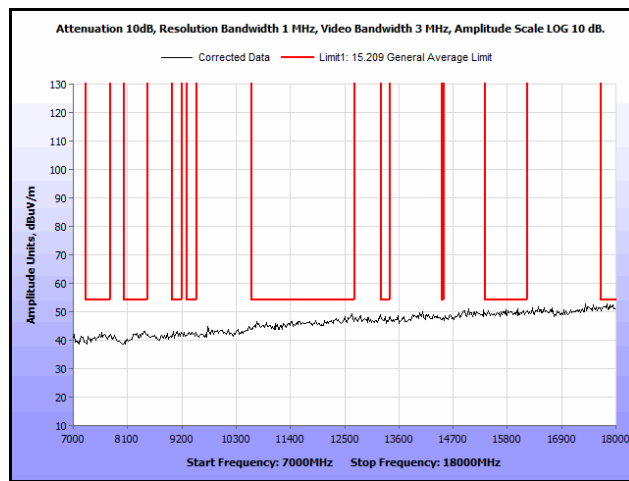

**Plot 314. Radiated Spurs, Co-Location, 802.11n 20 MHz, 5580 MHz & 5580 MHz, 7 GHz – 18 GHz, Peak, Omni**

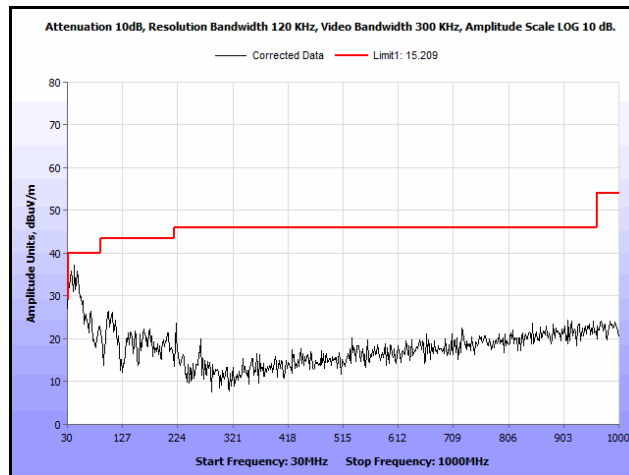

**Plot 315. Radiated Spurs, Co-Location, 802.11n 20 MHz, 5580 MHz & 5785 MHz, 30 MHz – 1 GHz, Peak, Omni**



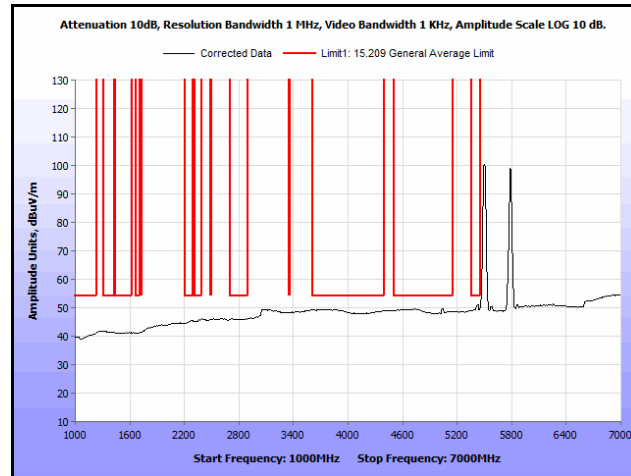

**Plot 316. Radiated Spurs, Co-Location, 802.11n 20 MHz, 5580 MHz & 5785 MHz, 1 GHz – 7 GHz, Avg., Omni**

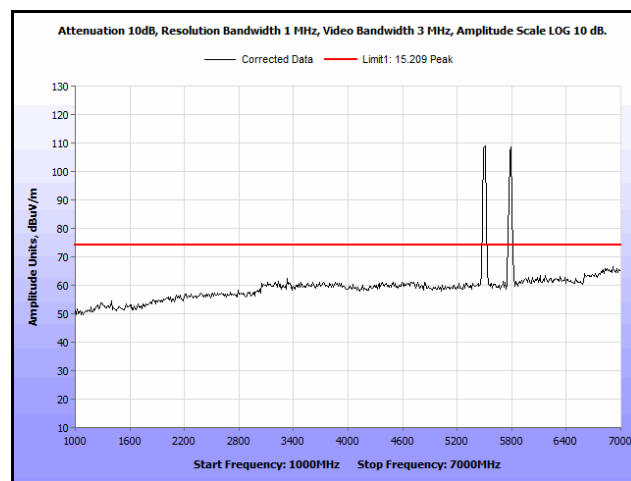

**Plot 317. Radiated Spurs, Co-Location, 802.11n 20 MHz, 5580 MHz & 5785 MHz, 1 GHz – 7 GHz, Peak, Omni**

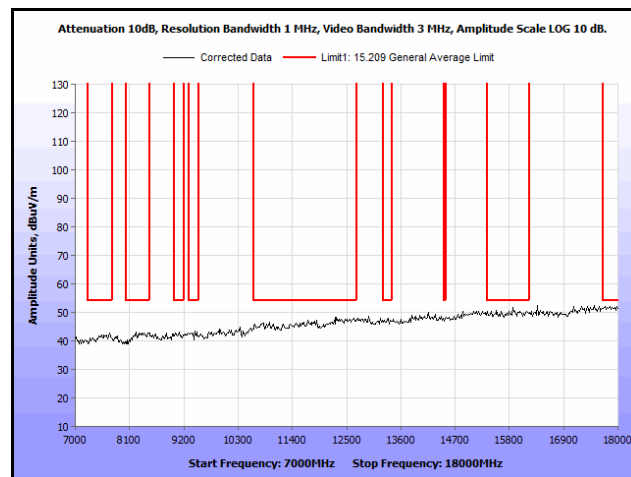

**Plot 318. Radiated Spurs, Co-Location, 802.11n 20 MHz, 5580 MHz & 5785 MHz, 7 GHz – 18 GHz, Peak, Omni**

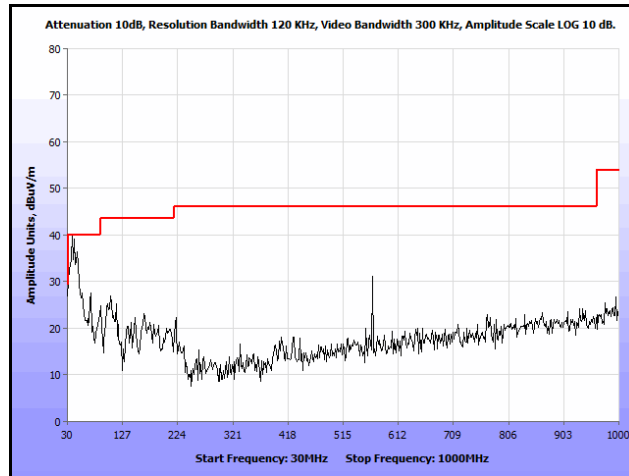

Plot 319. Radiated Spurs, Co-Location, 802.11n 20 MHz, 5785 MHz & 5785 MHz, 30 MHz – 1 GHz, Peak, Omni

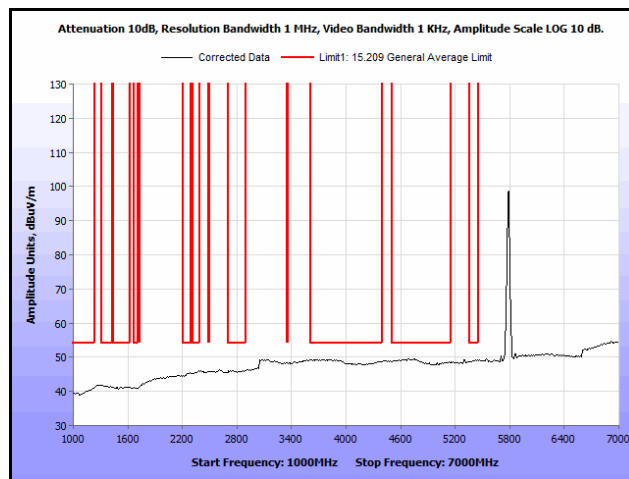

Plot 320. Radiated Spurs, Co-Location, 802.11n 20 MHz, 5785 MHz & 5785 MHz, 1 GHz – 7 GHz, Avg., Omni

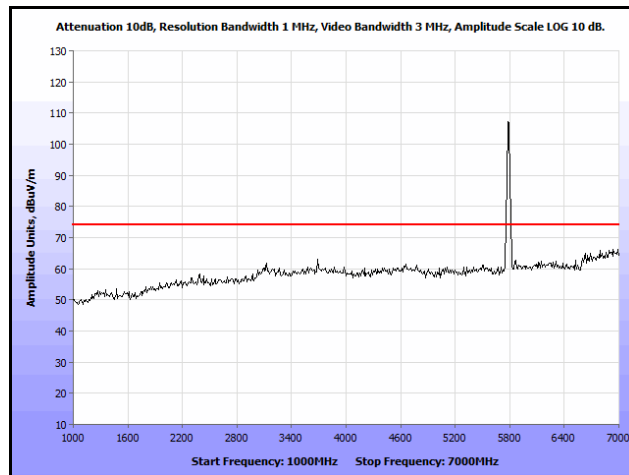

Plot 321. Radiated Spurs, Co-Location, 802.11n 20 MHz, 5785 MHz & 5785 MHz, 1 GHz – 7 GHz, Peak, Omni

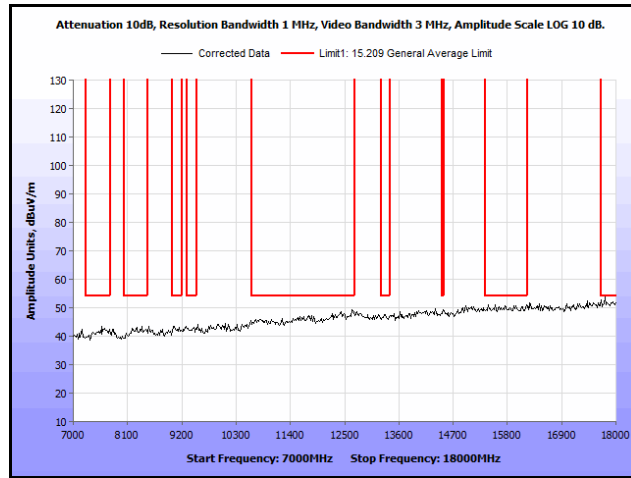

Plot 322. Radiated Spurs, Co-Location, 802.11n 20 MHz, 5785 MHz & 5785 MHz, 7 GHz – 18 GHz, Peak, Omni

**Patch Antenna**

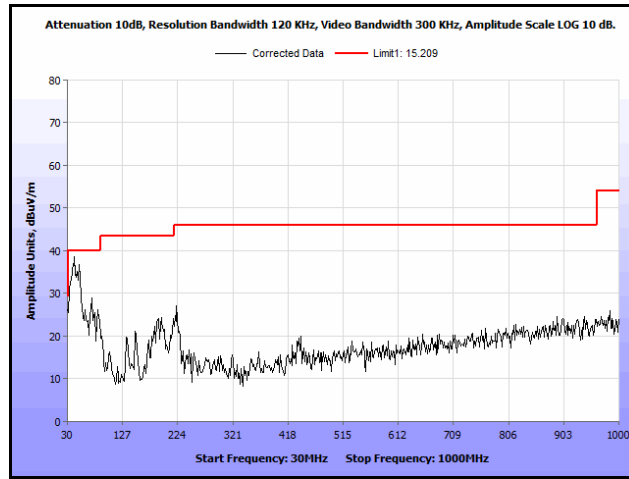

**Plot 323. Radiated Spurs, Co-Location, 802.11n 20 MHz, 2412 MHz & 5200 MHz, 30 MHz – 1 GHz, Peak, Patch**

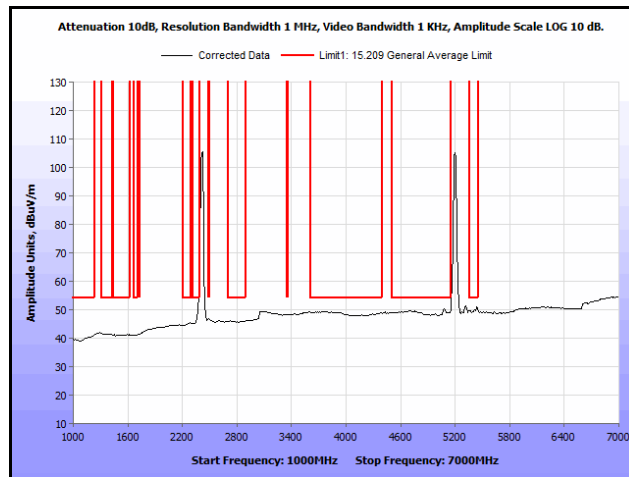

**Plot 324. Radiated Spurs, Co-Location, 802.11n 20 MHz, 2412 MHz & 5200 MHz, 1 GHz – 7 GHz, Avg., Patch**

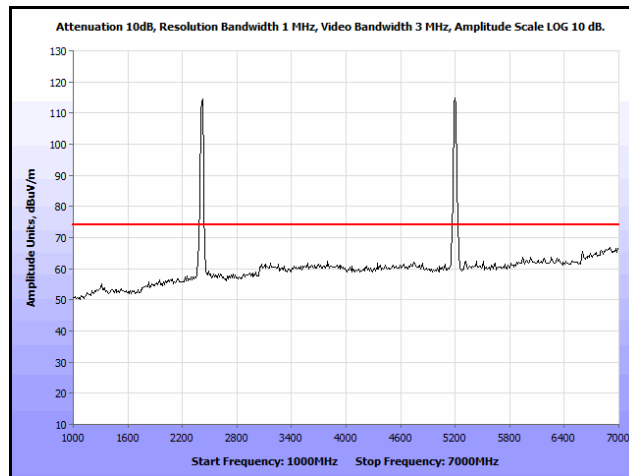

**Plot 325. Radiated Spurs, Co-Location, 802.11n 20 MHz, 2412 MHz & 5200 MHz, 1 GHz – 7 GHz, Peak, Patch**

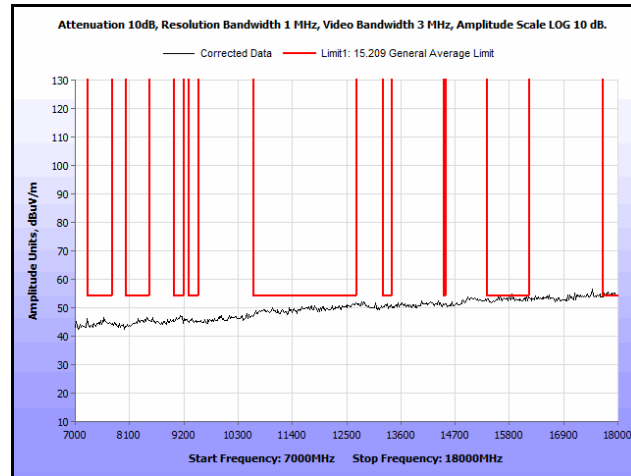

**Plot 326. Radiated Spurs, Co-Location, 802.11n 20 MHz, 2412 MHz & 5200 MHz, 7 GHz – 18 GHz, Peak, Patch**

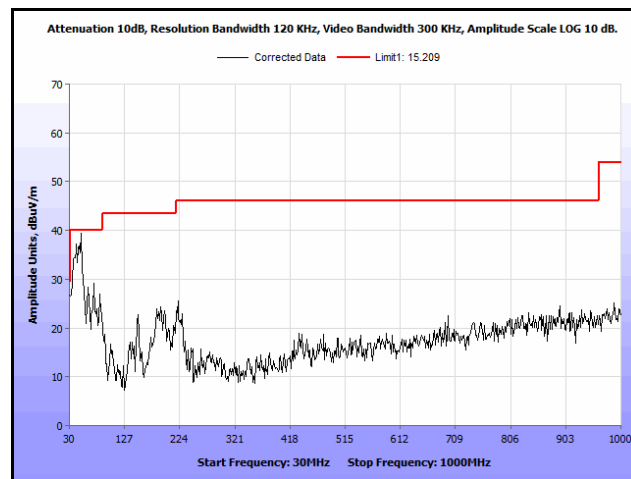

**Plot 327. Radiated Spurs, Co-Location, 802.11n 20 MHz, 2412 MHz & 5300 MHz, 30 MHz – 1 GHz, Peak, Patch**

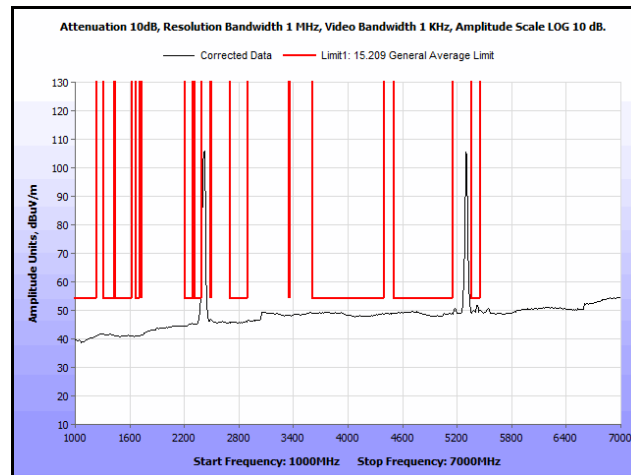

**Plot 328. Radiated Spurs, Co-Location, 802.11n 20 MHz, 2412 MHz & 5300 MHz, 1 GHz – 7 GHz, Avg., Patch**

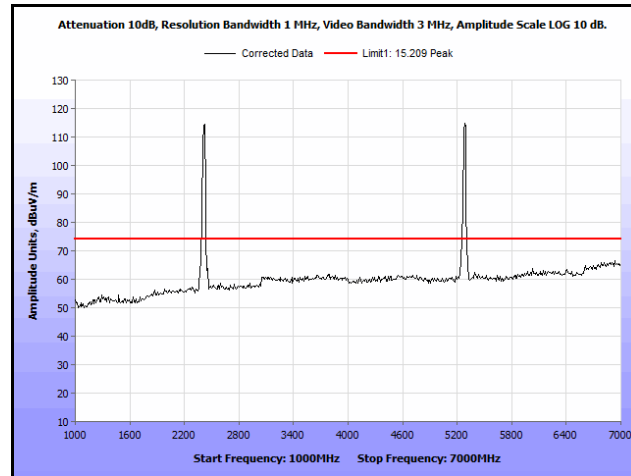

**Plot 329. Radiated Spurs, Co-Location, 802.11n 20 MHz, 2412 MHz & 5300 MHz, 1 GHz – 7 GHz, Peak, Patch**

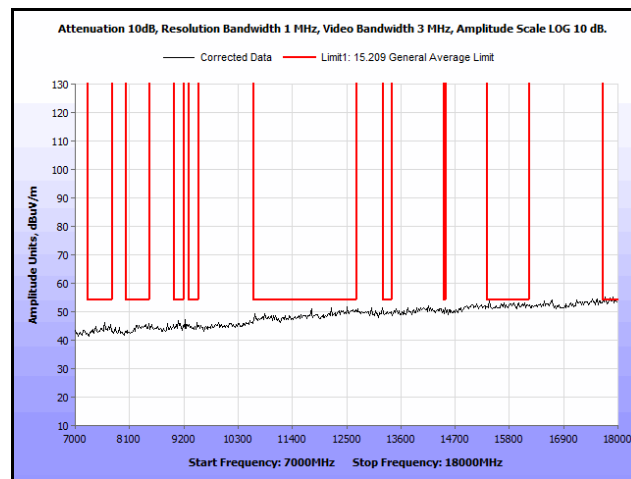

**Plot 330. Radiated Spurs, Co-Location, 802.11n 20 MHz, 2412 MHz & 5300 MHz, 7 GHz – 18 GHz, Peak, Patch**

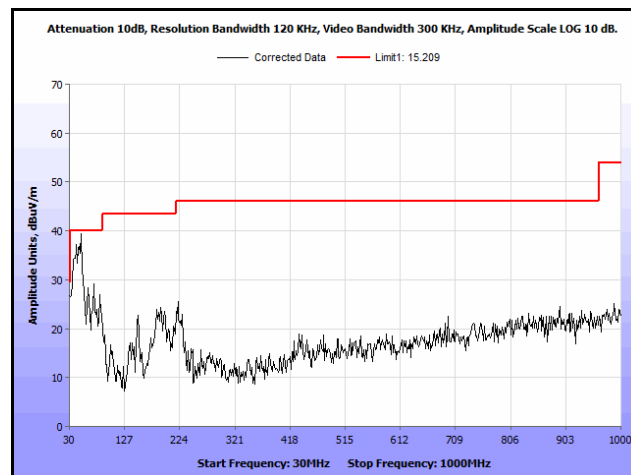

**Plot 331. Radiated Spurs, Co-Location, 802.11n 20 MHz, 2412 MHz & 5580 MHz, 30 MHz – 1 GHz, Peak, Patch**

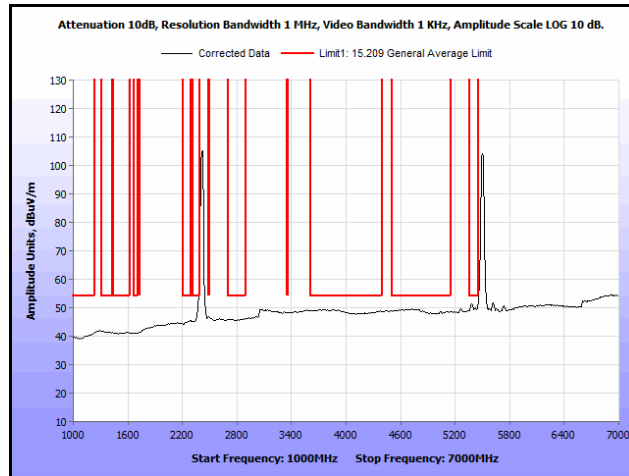

**Plot 332. Radiated Spurs, Co-Location, 802.11n 20 MHz, 2412 MHz & 5580 MHz, 1 GHz – 7 GHz, Avg., Patch**

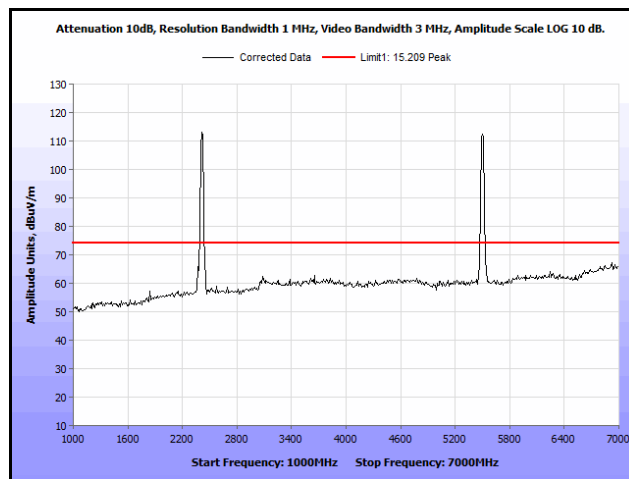

**Plot 333. Radiated Spurs, Co-Location, 802.11n 20 MHz, 2412 MHz & 5580 MHz, 1 GHz – 7 GHz, Peak, Patch**

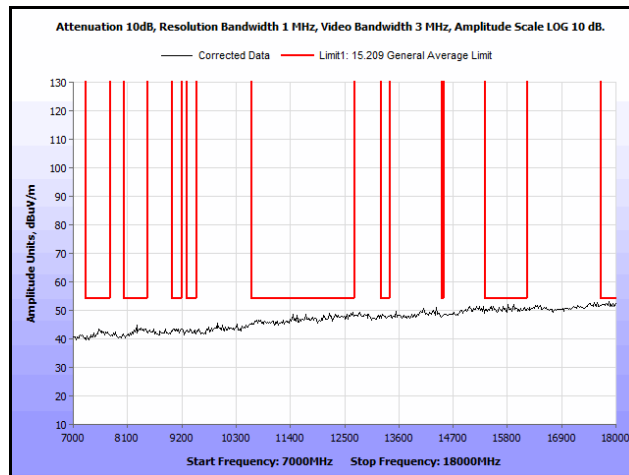

**Plot 334. Radiated Spurs, Co-Location, 802.11n 20 MHz, 2412 MHz & 5580 MHz, 7 GHz – 18 GHz, Peak, Patch**

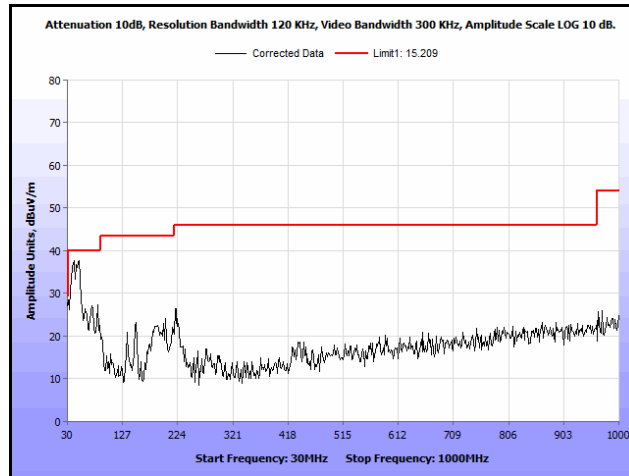

**Plot 335. Radiated Spurs, Co-Location, 802.11n 20 MHz, 2412 MHz & 5785 MHz, 30 MHz – 1 GHz, Peak, Patch**

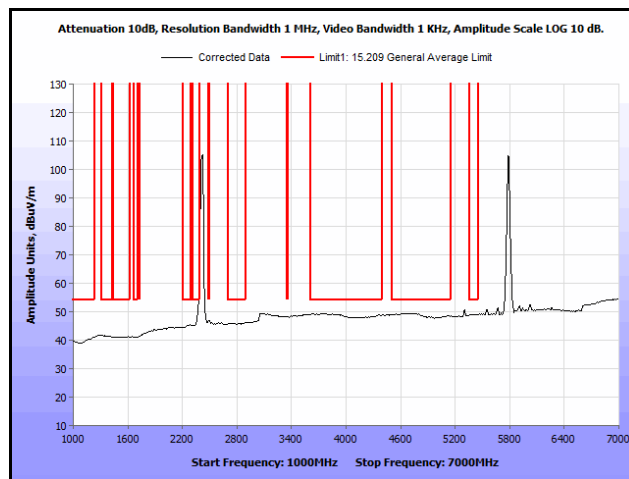

**Plot 336. Radiated Spurs, Co-Location, 802.11n 20 MHz, 2412 MHz & 5785 MHz, 1 GHz – 7 GHz, Avg., Patch**

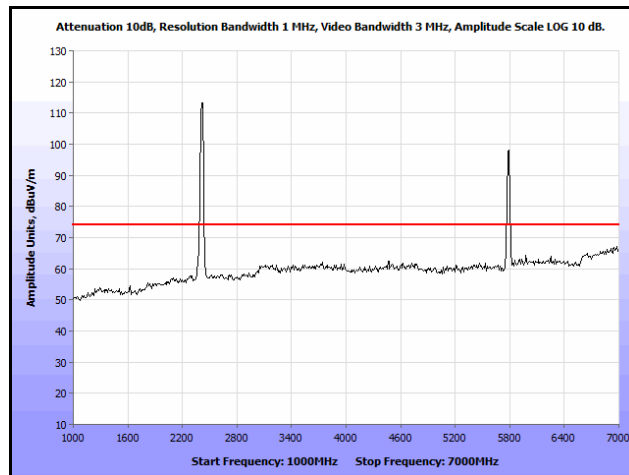

**Plot 337. Radiated Spurs, Co-Location, 802.11n 20 MHz, 2412 MHz & 5785 MHz, 1 GHz – 7 GHz, Peak, Patch**



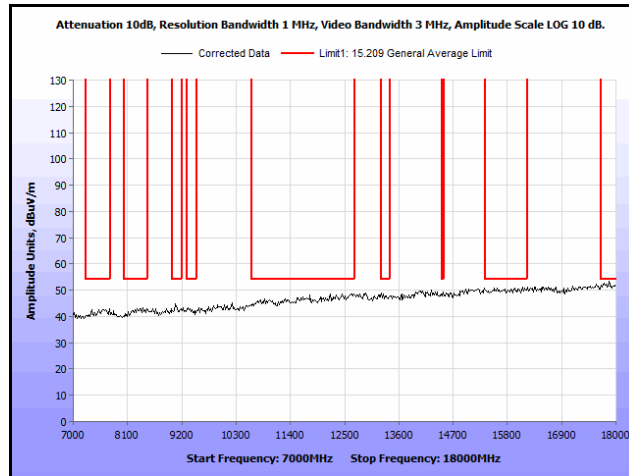

**Plot 338. Radiated Spurs, Co-Location, 802.11n 20 MHz, 2412 MHz & 5785 MHz, 7 GHz – 18 GHz, Peak, Patch**

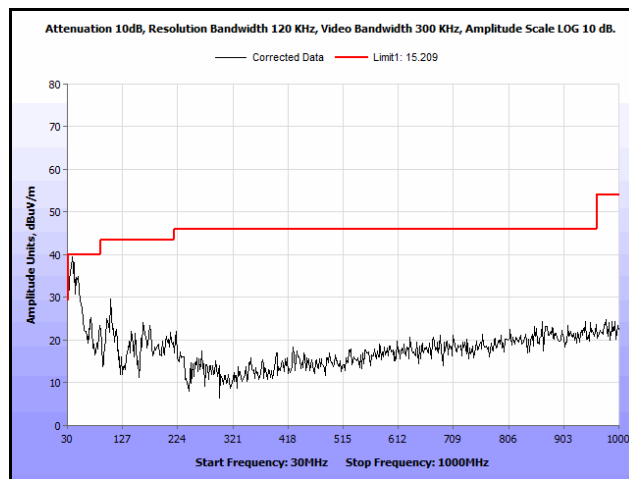

**Plot 339. Radiated Spurs, Co-Location, 802.11n 20 MHz, 2437 MHz & 5200 MHz, 30 MHz – 1 GHz, Peak, Patch**

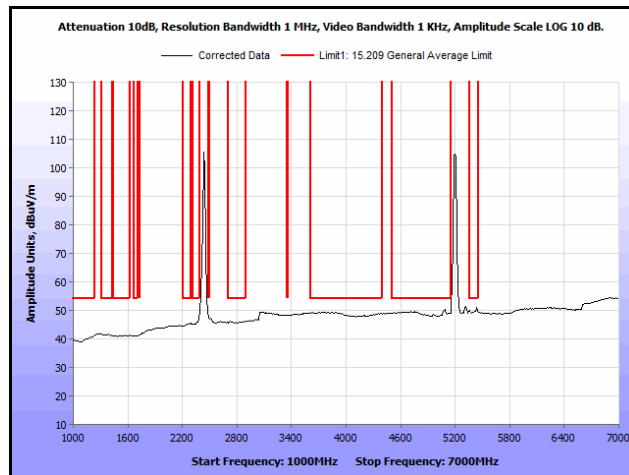

**Plot 340. Radiated Spurs, Co-Location, 802.11n 20 MHz, 2437 MHz & 5200 MHz, 1 GHz – 7 GHz, Avg., Patch**

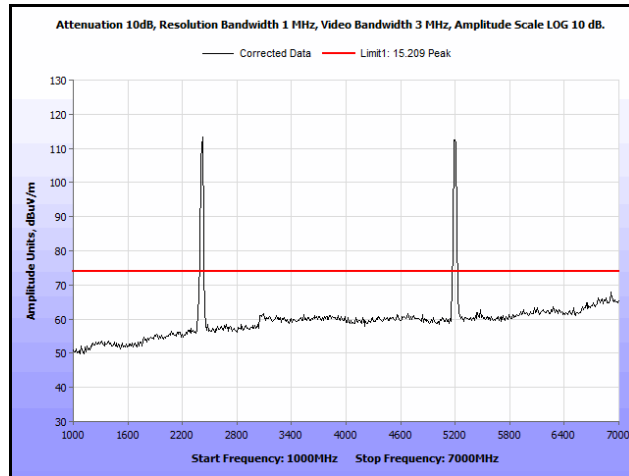

Plot 341. Radiated Spurs, Co-Location, 802.11n 20 MHz, 2437 MHz & 5200 MHz, 1 GHz – 7 GHz, Peak, Patch

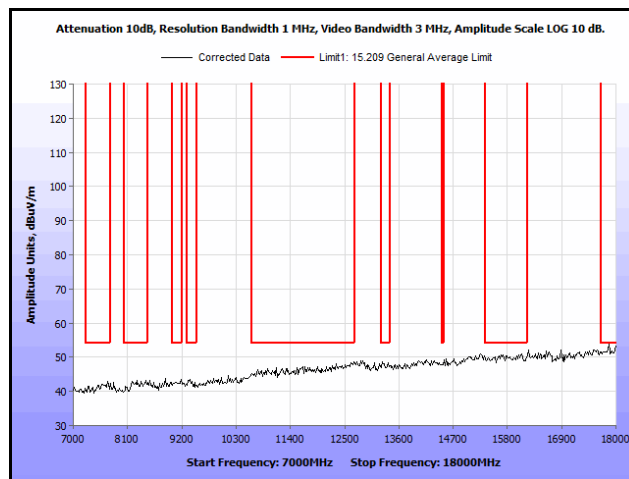

Plot 342. Radiated Spurs, Co-Location, 802.11n 20 MHz, 2437 MHz & 5200 MHz, 7 GHz – 18 GHz, Peak, Patch

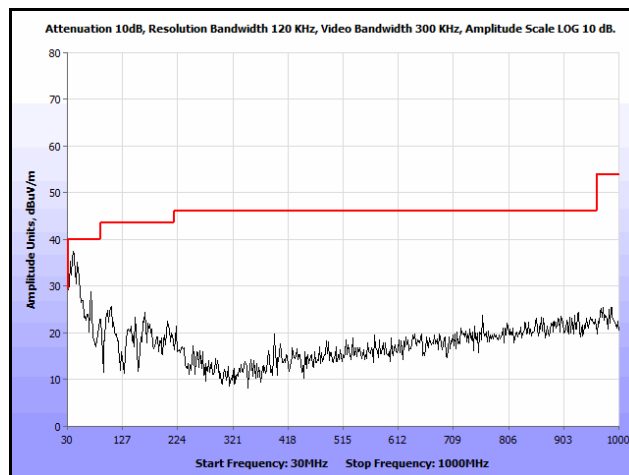

Plot 343. Radiated Spurs, Co-Location, 802.11n 20 MHz, 2437 MHz & 5300 MHz, 30 MHz – 1 GHz, Peak, Patch

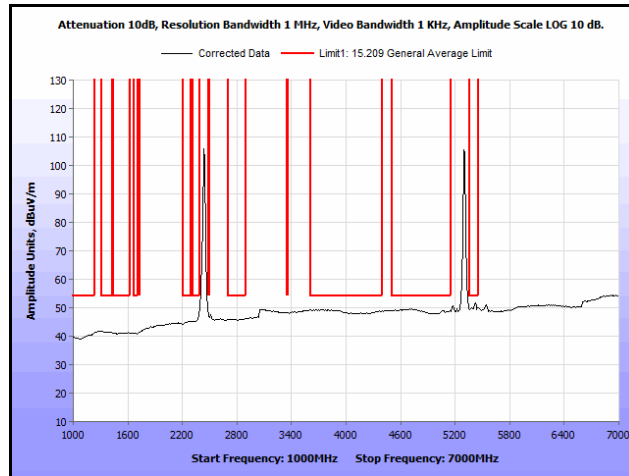

**Plot 344. Radiated Spurs, Co-Location, 802.11n 20 MHz, 2437 MHz & 5300 MHz, 1 GHz – 7 GHz, Avg., Patch**

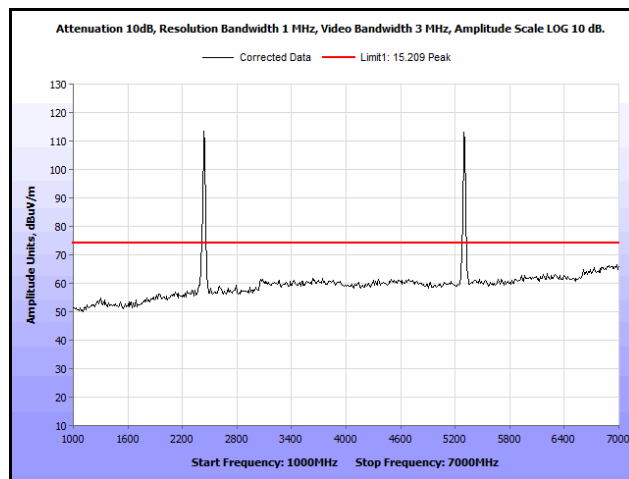

**Plot 345. Radiated Spurs, Co-Location, 802.11n 20 MHz, 2437 MHz & 5300 MHz, 1 GHz – 7 GHz, Peak, Patch**

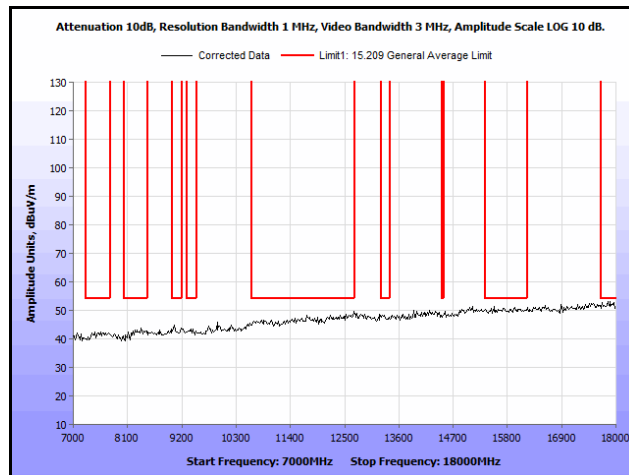

**Plot 346. Radiated Spurs, Co-Location, 802.11n 20 MHz, 2437 MHz & 5300 MHz, 7 GHz – 18 GHz, Peak, Patch**

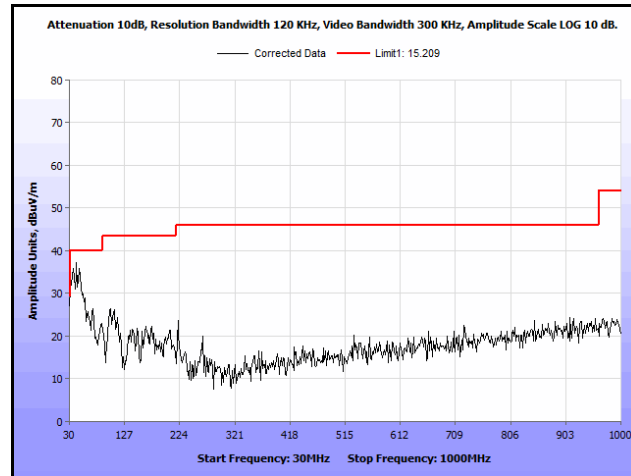

Plot 347. Radiated Spurs, Co-Location, 802.11n 20 MHz, 2437 MHz & 5580 MHz, 30 MHz – 1 GHz, Peak, Patch

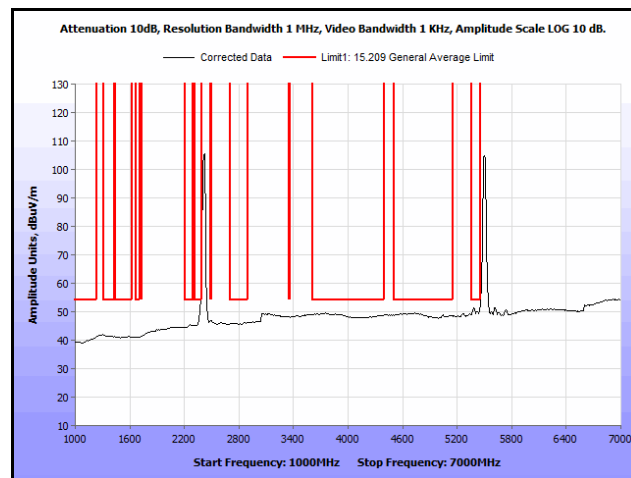

Plot 348. Radiated Spurs, Co-Location, 802.11n 20 MHz, 2437 MHz & 5580 MHz, 1 GHz – 7 GHz, Avg., Patch

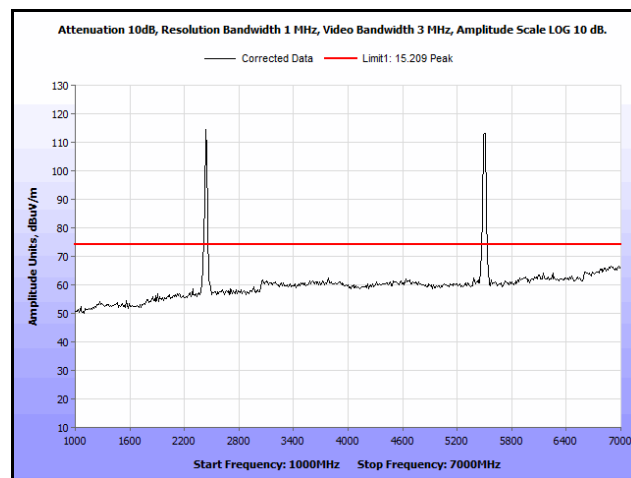

Plot 349. Radiated Spurs, Co-Location, 802.11n 20 MHz, 2437 MHz & 5580 MHz, 1 GHz – 7 GHz, Peak, Patch

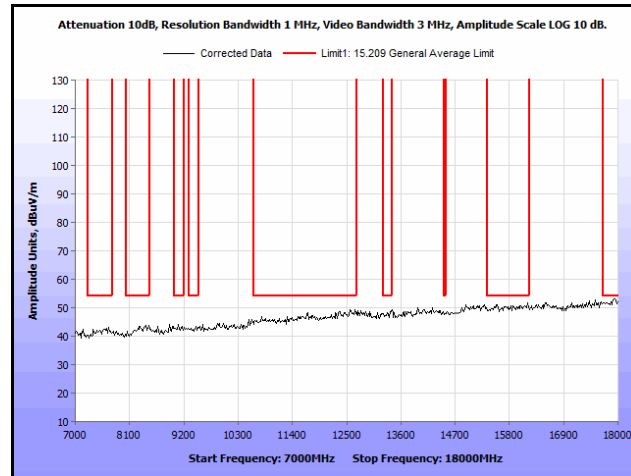

**Plot 350. Radiated Spurs, Co-Location, 802.11n 20 MHz, 2437 MHz & 5580 MHz, 7 GHz – 18 GHz, Peak, Patch**

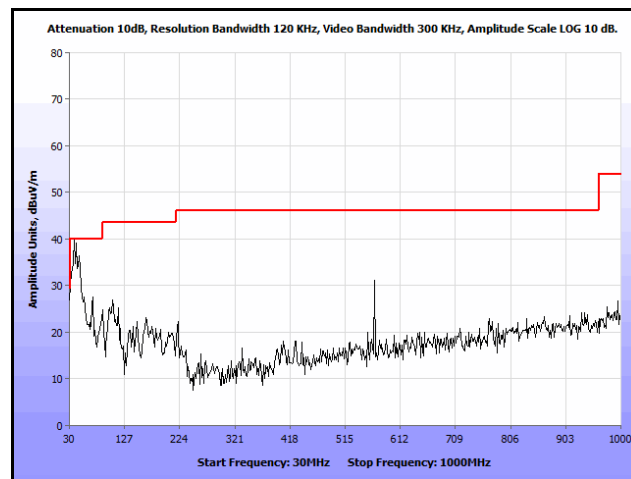

**Plot 351. Radiated Spurs, Co-Location, 802.11n 20 MHz, 2437 MHz & 5785 MHz, 30 MHz – 1 GHz, Peak, Patch**

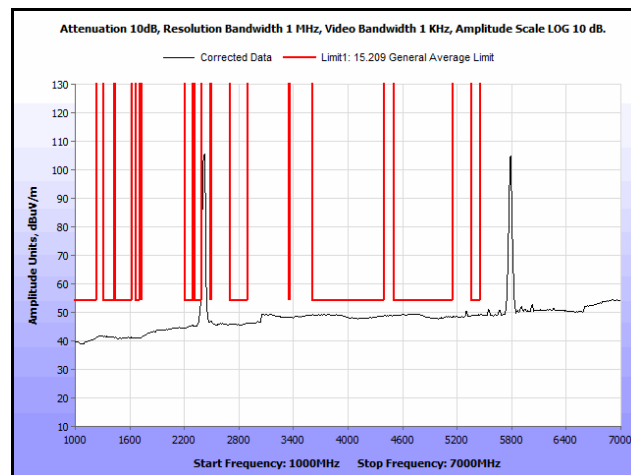

**Plot 352. Radiated Spurs, Co-Location, 802.11n 20 MHz, 2437 MHz & 5785 MHz, 1 GHz – 7 GHz, Avg., Patch**

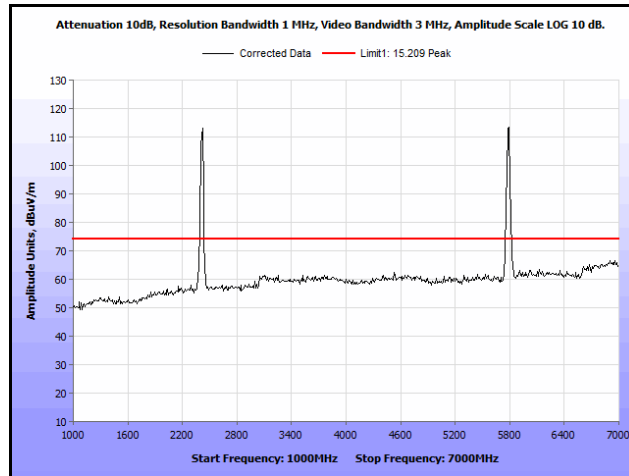

**Plot 353. Radiated Spurs, Co-Location, 802.11n 20 MHz, 2437 MHz & 5785 MHz, 1 GHz – 7 GHz, Peak, Patch**

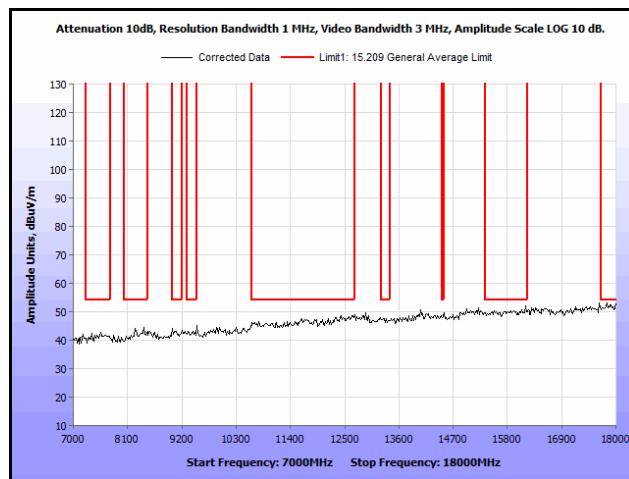

**Plot 354. Radiated Spurs, Co-Location, 802.11n 20 MHz, 2437 MHz & 5785 MHz, 7 GHz – 18 GHz, Peak, Patch**

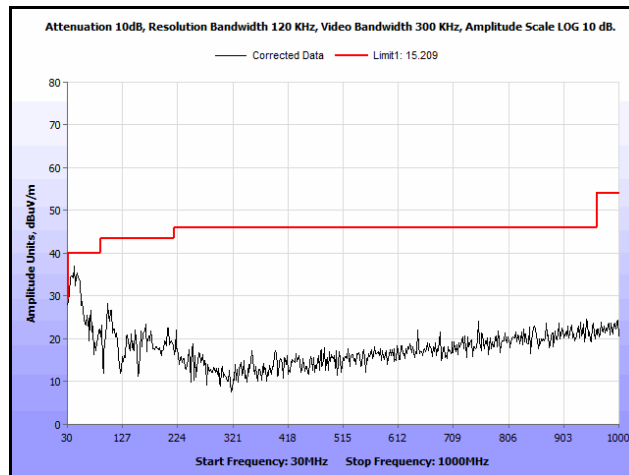

**Plot 355. Radiated Spurs, Co-Location, 802.11n 20 MHz, 2462 MHz & 5200 MHz, 30 MHz – 1 GHz, Peak, Patch**

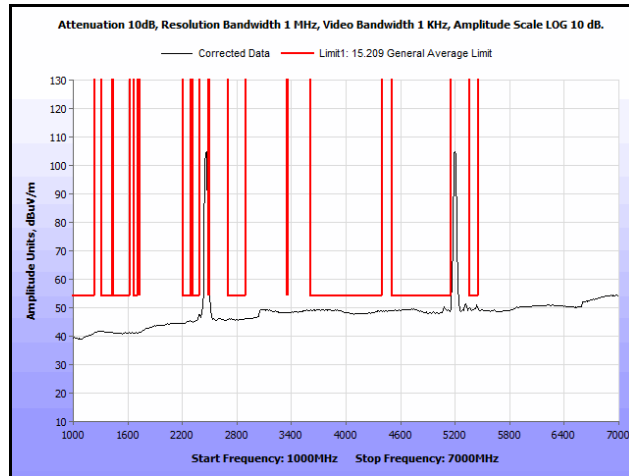

**Plot 356. Radiated Spurs, Co-Location, 802.11n 20 MHz, 2462 MHz & 5200 MHz, 1 GHz – 7 GHz, Avg., Patch**

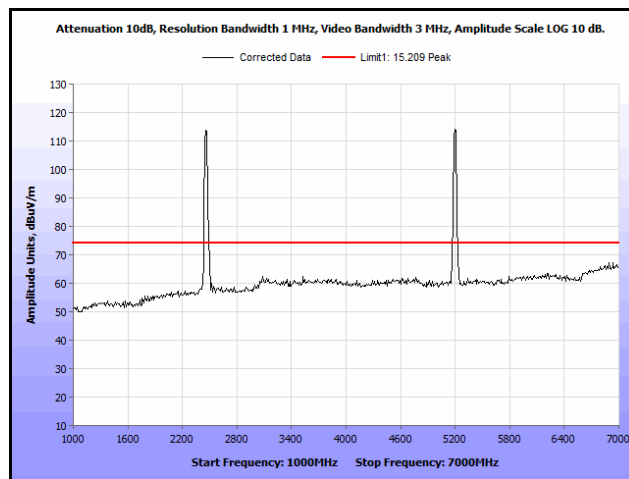

**Plot 357. Radiated Spurs, Co-Location, 802.11n 20 MHz, 2462 MHz & 5200 MHz, 1 GHz – 7 GHz, Peak, Patch**

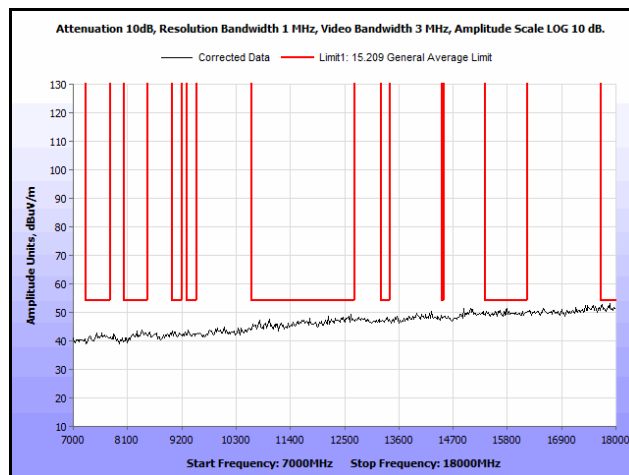

**Plot 358. Radiated Spurs, Co-Location, 802.11n 20 MHz, 2462 MHz & 5200 MHz, 7 GHz – 18 GHz, Peak, Patch**

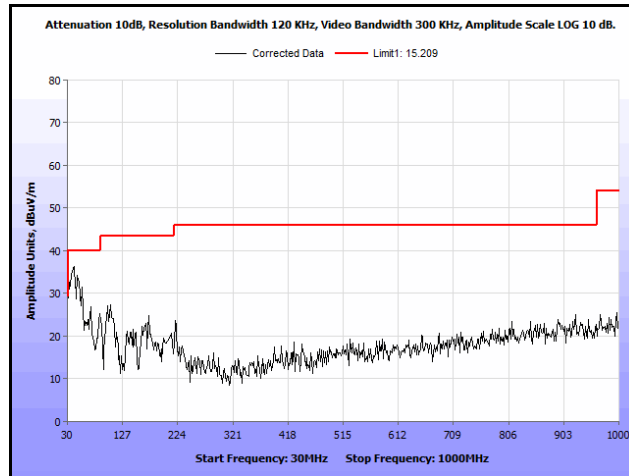

**Plot 359. Radiated Spurs, Co-Location, 802.11n 20 MHz, 2462 MHz & 5300 MHz, 30 MHz – 1 GHz, Peak, Patch**

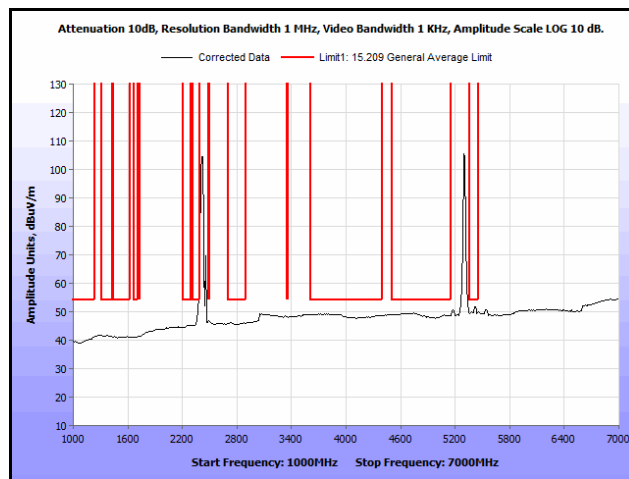

**Plot 360. Radiated Spurs, Co-Location, 802.11n 20 MHz, 2462 MHz & 5300 MHz, 1 GHz – 7 GHz, Avg., Patch**

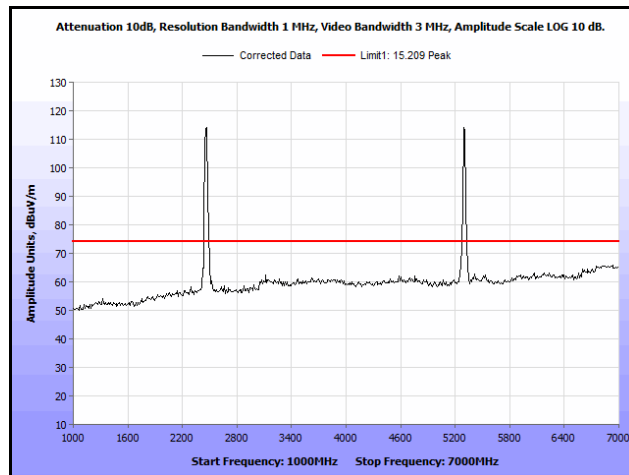

**Plot 361. Radiated Spurs, Co-Location, 802.11n 20 MHz, 2462 MHz & 5300 MHz, 1 GHz – 7 GHz, Peak, Patch**



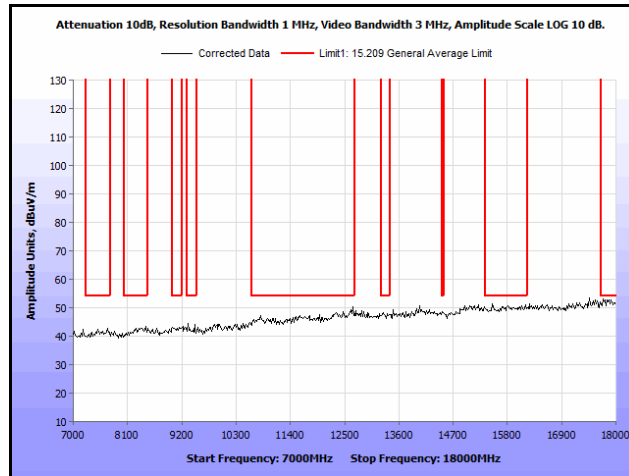

**Plot 362. Radiated Spurs, Co-Location, 802.11n 20 MHz, 2462 MHz & 5300 MHz, 7 GHz – 18 GHz, Peak, Patch**

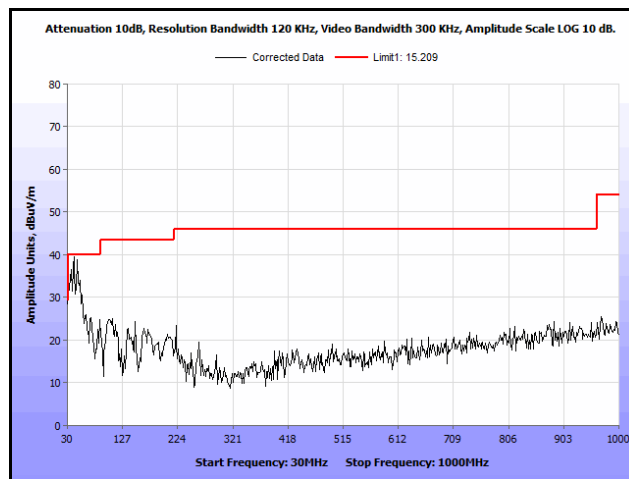

**Plot 363. Radiated Spurs, Co-Location, 802.11n 20 MHz, 2462 MHz & 5580 MHz, 30 MHz – 1 GHz, Peak, Patch**

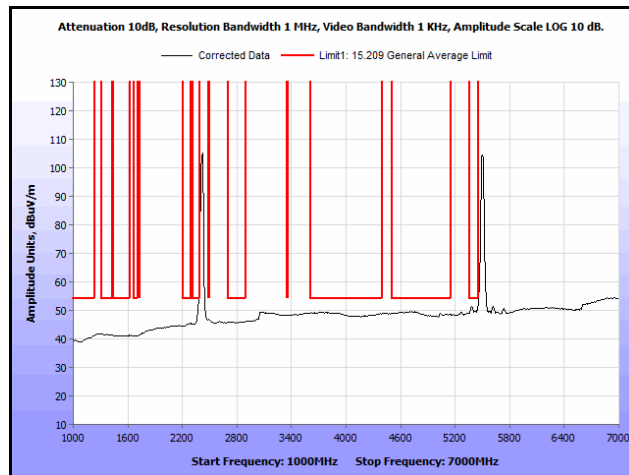

**Plot 364. Radiated Spurs, Co-Location, 802.11n 20 MHz, 2462 MHz & 5580 MHz, 1 GHz – 7 GHz, Avg., Patch**

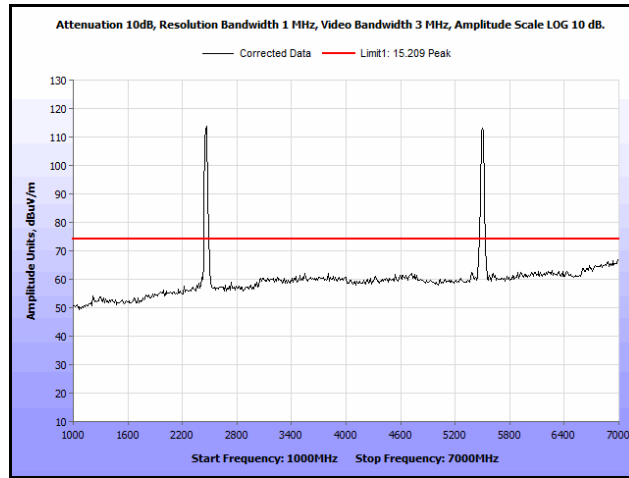

Plot 365. Radiated Spurs, Co-Location, 802.11n 20 MHz, 2462 MHz & 5580 MHz, 1 GHz – 7 GHz, Peak, Patch

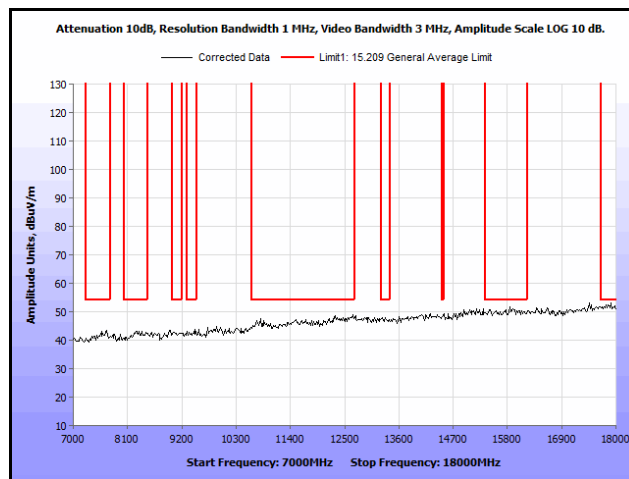

Plot 366. Radiated Spurs, Co-Location, 802.11n 20 MHz, 2462 MHz & 5580 MHz, 7 GHz – 18 GHz, Peak, Patch

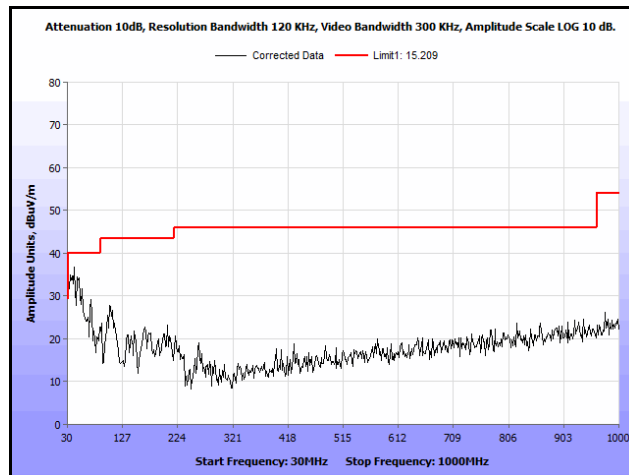

Plot 367. Radiated Spurs, Co-Location, 802.11n 20 MHz, 2462 MHz & 5785 MHz, 30 MHz – 1 GHz, Peak, Patch

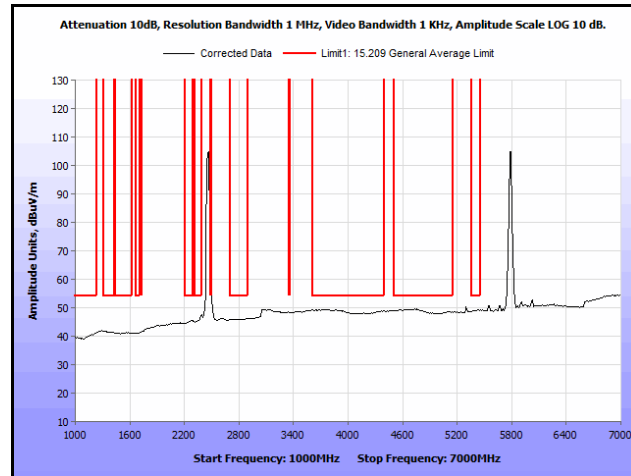

**Plot 368. Radiated Spurs, Co-Location, 802.11n 20 MHz, 2462 MHz & 5785 MHz, 1 GHz – 7 GHz, Avg., Patch**

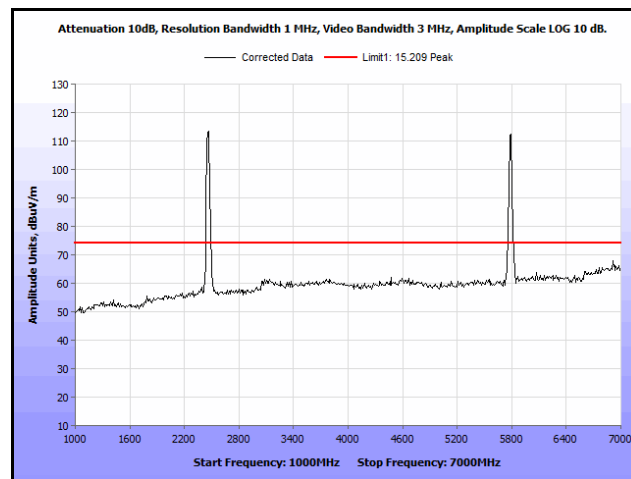

**Plot 369. Radiated Spurs, Co-Location, 802.11n 20 MHz, 2462 MHz & 5785 MHz, 1 GHz – 7 GHz, Peak, Patch**

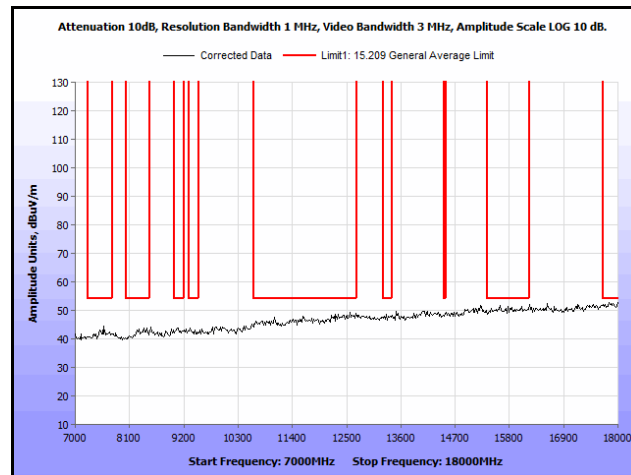

**Plot 370. Radiated Spurs, Co-Location, 802.11n 20 MHz, 2462 MHz & 5785 MHz, 7 GHz – 18 GHz, Peak, Patch**

## Electromagnetic Compatibility Criteria for Intentional Radiators

### § 15.407(f) RF Exposure

**RF Exposure Requirements:** §1.1307(b)(1) and §1.1307(b)(2): Systems operating under the provisions of this section shall be operated in a manner that ensures that the public is not exposed to radio frequency energy levels in excess of the Commission’s guidelines.

**RF Radiation Exposure Limit:** §1.1310: As specified in this section, the Maximum Permissible Exposure (MPE) Limit shall be used to evaluate the environmental impact of human exposure to radiofrequency (RF) radiation as specified in Sec. 1.1307(b), except in the case of portable devices which shall be evaluated according to the provisions of Sec. 2.1093 of this chapter.

MPE Limit Calculation: EUT’s operating frequencies @ 5150-5250 MHz; **Limit for Uncontrolled exposure: 1 mW/cm<sup>2</sup> or 10 W/m<sup>2</sup>**

Equation from page 18 of OET 65, Edition 97-01

$$S = PG / 4\pi R^2 \quad \text{or} \quad R = \sqrt{PG / 4\pi S}$$

where, S = Power Density  
P = Power Input to antenna (293 mW)  
G = Antenna Gain 9dBi (7.94 linear)  
R = Minimum Distance between User and Antenna (25cm)

$$S = (293 * 7.94) / (4 * 3.14 * 625) = 0.296 \text{ mW/cm}^2$$

Since  $S < 1 \text{ mW/cm}^2$ , the minimum distance (R) is 25cm

**Co-location:**

Frequency Range	MPE Result (mW/cm <sup>2</sup> )	Limit (mW/cm <sup>2</sup> )
2.4GHz	0.43	1
5.150-5.250GHz	0.30	1

**Test Requirements:**  $[MPE(f1) / \text{limit}(f1) + MPE(f2) / \text{limit}(f2)] < 1$

**Test Results:**

MPE(f1)	MPE(f2)	Calculation [MPE(f1) / limit(f1) + MPE(f2) / limit(f2)]	MPE Result (mW/cm <sup>2</sup> )
Frequency (MHZ)	Frequency (MHZ)		
2412 - 2462	5150-5250	$0.43 / 1 + 0.3 / 1 = (0.43 + 0.30)$	<b>0.73</b>

Therefore, the uncontrolled exposure limit is not exceeded at 25 cm.

## Electromagnetic Compatibility Criteria for Intentional Radiators

### § 15.407(g) Frequency Stability

- Test Requirements:** § 15.407(g): Manufacturers of U-NII devices are responsible for ensuring frequency stability such that an emission is maintained within the band of operation under all conditions of normal operation as specified in the user's manual.
- Test Procedure:** The EUT was connected directly to a spectrum analyzer through an attenuator. The resolution band width of the spectrum analyzer was set to 1 MHz. The Low and High channels were transmitted and viewed from the 5150MHz and 5350MHz edge.
- Test Results:** The EUT was compliant with the requirements of §15.407(g).
- Test Engineer(s):** Andy Shen
- Test Date(s):** 09/10/14

## Frequency Stability

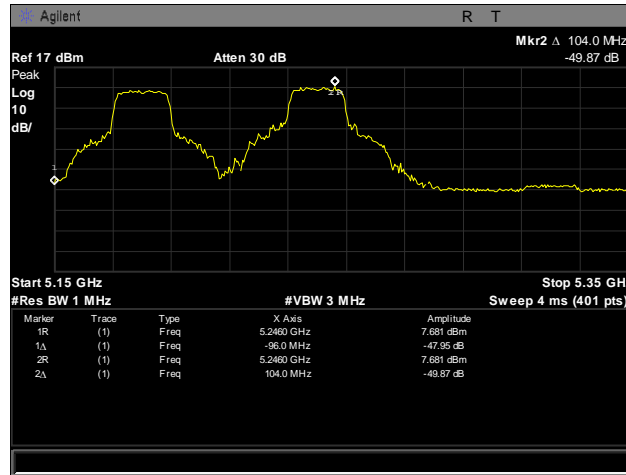

Plot 371. Frequency Stability, 5150 – 5350 MHz, -40°C, 120 V

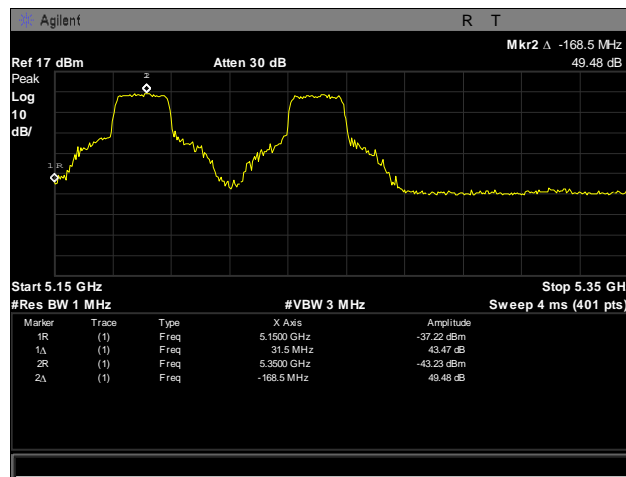

Plot 372. Frequency Stability, 5150 – 5350 MHz, -30°C, 120 V

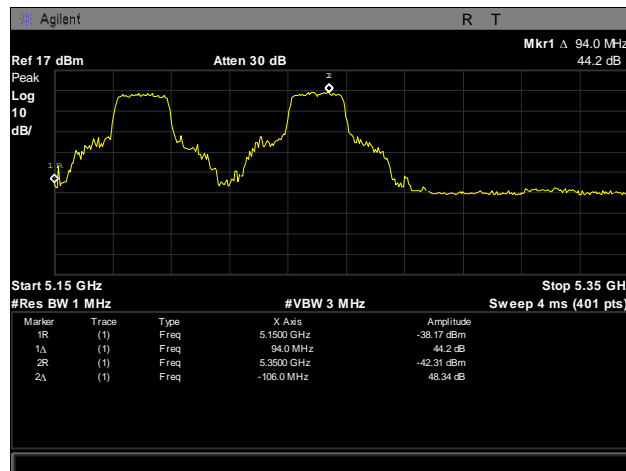

Plot 373. Frequency Stability, 5150 – 5350 MHz, -20°C, 120 V

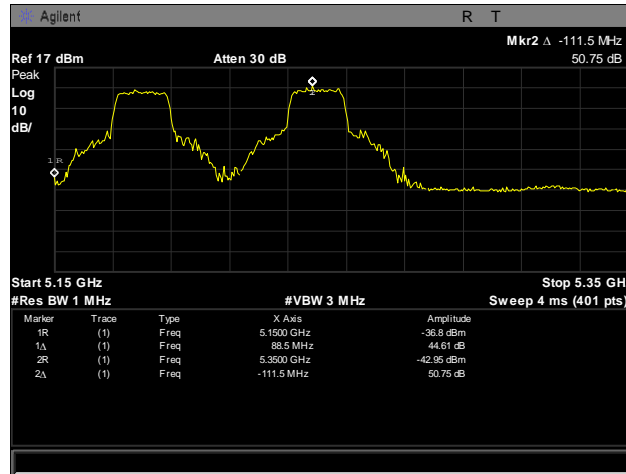

Plot 374. Frequency Stability, 5150 – 5350 MHz, -10°C, 120 V

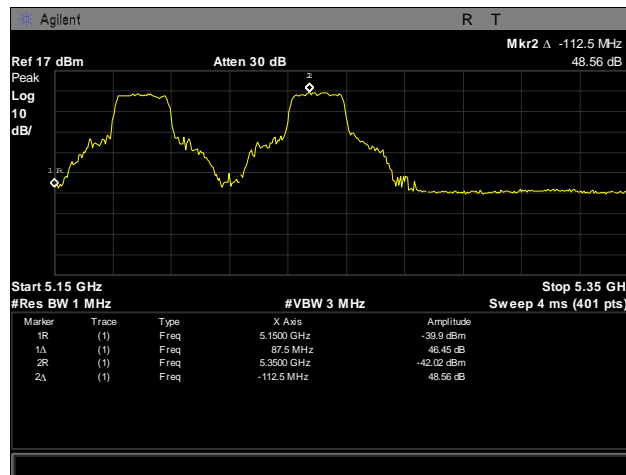

Plot 375. Frequency Stability, 5150 – 5350 MHz, 0°C, 120 V

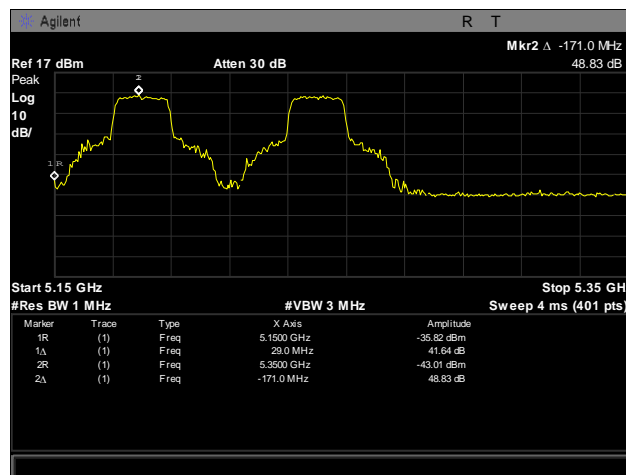

Plot 376. Frequency Stability, 5150 – 5350 MHz, 10°C, 120 V

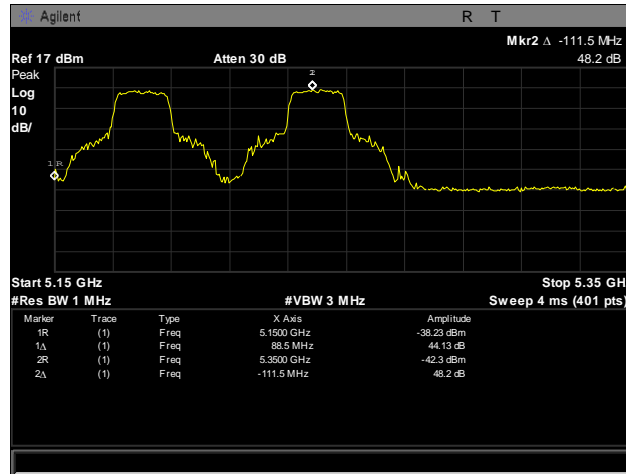

Plot 377. Frequency Stability, 5150 – 5350 MHz, 20°C, 120 V

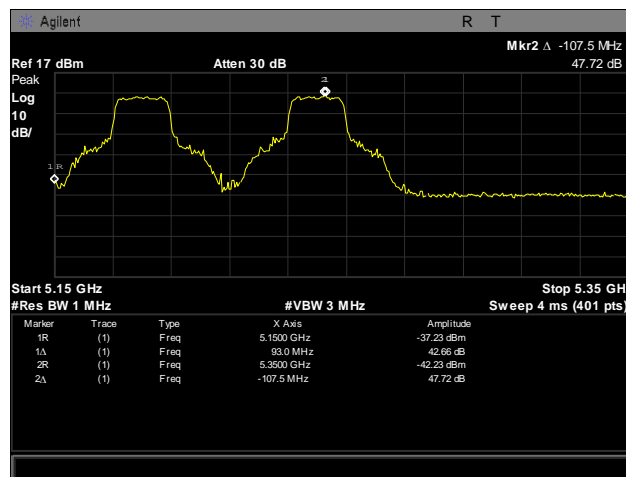

Plot 378. Frequency Stability, 5150 – 5350 MHz, 30°C, 120 V

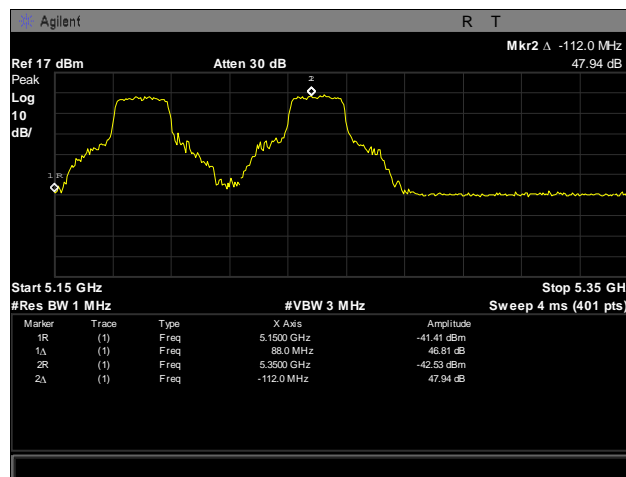

Plot 379. Frequency Stability, 5150 – 5350 MHz, 40°C, 120 V



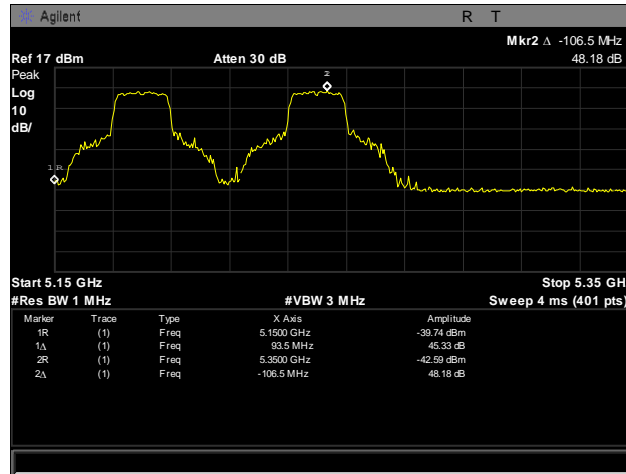

Plot 380. Frequency Stability, 5150 – 5350 MHz, 50°C, 120 V

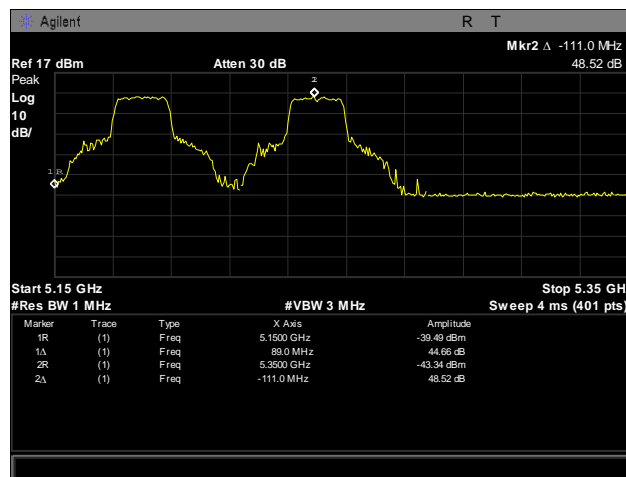

Plot 381. Frequency Stability, 5150 – 5350 MHz, 55°C, 120 V

## V. Test Equipment

## Test Equipment

Calibrated test equipment utilized during testing was maintained in a current state of calibration per the requirements of ISO/IEC 17025:2005.

MET Asset #	Equipment	Manufacturer	Model	Last Cal Date	Cal Due Date
1S2600	BILOG ANTENNA	TESEQ	CBL6112D	8/29/2013	8/29/2015
1S2482	5 METER CHAMBER (NSA)	PANASHIELD	5 METER SEMI-ANECHOIC CHAMBER	8/12/2013	2/12/2015
1S2583	SPECTRUM ANALYZER	AGILENT/HP	E4447A	11/1/2013	5/1/2015
1S2460	1-26GHZ SPECTRUM ANALYZER	AGILENT TECHNOLOGIES	E4407B	2/27/2014	8/27/2015
1S2603	DOUBLE RIDGED WAVEGUIDE HORN	ETS-LINDGREN	3117	4/24/2013	4/24/2015
1S2523	PREAMPLIFIER	AGILENT TECHNOLOGIES	8449B	SEE NOTE	
1S2729	SONOMA AMPLIFIER	SONOMA INSTRUMENT	310N	SEE NOTE	
1S2460	1-26GHZ SPECTRUM ANALYZER	AGILENT TECHNOLOGIES	E4407B	2/27/2014	8/27/2015
N/A	NOTCH FILTER	MIRCRO-TRONICS	BRM50702	SEE NOTE	
N/A	HIGH PASS FILTER	MICRO-TRONICS	BRM50705	SEE NOTE	

**Table 26. Test Equipment List**

Note: Functionally tested equipment is verified using calibrated instrumentation at the time of testing.

## **VI. Certification & User's Manual Information**

## Certification & User's Manual Information

### L. Certification Information

The following is extracted from Title 47 of the Code of Federal Regulations, Part 2, Subpart I — Marketing of Radio frequency devices:

#### § 2.801 Radio-frequency device defined.

As used in this part, a radio-frequency device is any device which in its operation is capable of Emitting radio-frequency energy by radiation, conduction, or other means. Radio- frequency devices include, but are not limited to:

- (a) The various types of radio communication transmitting devices described throughout this chapter.
- (b) *The incidental, unintentional and intentional radiators defined in Part 15 of this chapter.*
- (c) The industrial, scientific, and medical equipment described in Part 18 of this chapter.
- (d) Any part or component thereof which in use emits radio-frequency energy by radiation, conduction, or other means.

#### § 2.803 Marketing of radio frequency devices prior to equipment authorization.

- (a) Except as provided elsewhere in this chapter, no person shall sell or lease, or offer for sale or lease (including advertising for sale or lease), or import, ship or distribute for the purpose of selling or leasing or offering for sale or lease, any radio frequency device unless:
  - (1) In the case of a device subject to certification, such device has been authorized by the Commission in accordance with the rules in this chapter and is properly identified and labeled as required by §2.925 and other relevant sections in this chapter; or
  - (2) In the case of a device that is not required to have a grant of equipment authorization issued by the Commission, but which must comply with the specified technical standards prior to use, such device also complies with all applicable administrative (including verification of the equipment or authorization under a Declaration of Conformity, where required), technical, labeling and identification requirements specified in this chapter.
- (d) Notwithstanding the provisions of paragraph (a) of this section, the offer for sale solely to business, commercial, industrial, scientific or medical users (but not an offer for sale to other parties or to end users located in a residential environment) of a radio frequency device that is in the conceptual, developmental, design or pre-production stage is permitted prior to equipment authorization or, for devices not subject to the equipment authorization requirements, prior to a determination of compliance with the applicable technical requirements *provided* that the prospective buyer is advised in writing at the time of the offer for sale that the equipment is subject to the FCC rules and that the equipment will comply with the appropriate rules before delivery to the buyer or to centers of distribution.

- (e)(1) Notwithstanding the provisions of paragraph (a) of this section, prior to equipment authorization or determination of compliance with the applicable technical requirements any radio frequency device may be operated, but not marketed, for the following purposes and under the following conditions:
- (i) *Compliance testing*;
  - (ii) Demonstrations at a trade show provided the notice contained in paragraph (c) of this section is displayed in a conspicuous location on, or immediately adjacent to, the device;
  - (iii) Demonstrations at an exhibition conducted at a business, commercial, industrial, scientific or medical location, but excluding locations in a residential environment, provided the notice contained in paragraphs (c) or (d) of this section, as appropriate, is displayed in a conspicuous location on, or immediately adjacent to, the device;
  - (iv) Evaluation of product performance and determination of customer acceptability, provided such operation takes place at the manufacturer's facilities during developmental, design or pre-production states; or
  - (v) Evaluation of product performance and determination of customer acceptability where customer acceptability of a radio frequency device cannot be determined at the manufacturer's facilities because of size or unique capability of the device, provided the device is operated at a business, commercial, industrial, scientific or medical user's site, but not at a residential site, during the development, design or pre-production stages.
- (e)(2) For the purpose of paragraphs (e)(1)(iv) and (e)(1)(v) of this section, the term *manufacturer's facilities* includes the facilities of the party responsible for compliance with the regulations and the manufacturer's premises, as well as the facilities of other entities working under the authorization of the responsible party in connection with the development and manufacture, but not the marketing, of the equipment.
- (f) For radio frequency devices subject to verification and sold solely to business, commercial, industrial, scientific and medical users (excluding products sold to other parties or for operation in a residential environment), parties responsible for verification of the devices shall have the option of ensuring compliance with the applicable technical specifications of this chapter at each end user's location after installation, provided that the purchase or lease agreement includes a proviso that such a determination of compliance be made and is the responsibility of the party responsible for verification of the equipment.

---

## Certification & User's Manual Information

The following is extracted from Title 47 of the Code of Federal Regulations, Part 2, Subpart J — Equipment Authorization Procedures:

### § 2.901 Basis and Purpose

- (a) In order to carry out its responsibilities under the Communications Act and the various treaties and international regulations, and in order to promote efficient use of the radio spectrum, the Commission has developed technical standards for radio frequency equipment and parts or components thereof. The technical standards applicable to individual types of equipment are found in that part of the rules governing the service wherein the equipment is to be operated.<sup>1</sup> *In addition to the technical standards provided, the rules governing the service may require that such equipment be verified by the manufacturer or importer, be authorized under a Declaration of Conformity, or receive an equipment authorization from the Commission by one of the following procedures: certification or registration.*
- (b) The following sections describe the verification procedure, the procedure for a Declaration of Conformity, and the procedures to be followed in obtaining certification from the Commission and the conditions attendant to such a grant.

### § 2.907 Certification.

- (a) Certification is an equipment authorization issued by the Commission, based on representation and test data submitted by the applicant.
- (b) Certification attaches to all units subsequently marketed by the grantee which are identical (see Section 2.908) to the sample tested except for permissive changes or other variations authorized by the Commission pursuant to Section 2.1043.

---

<sup>1</sup> In this case, the equipment is subject to the rules of Part 15. More specifically, the equipment falls under Subpart B (of Part 15), which deals with unintentional radiators.

## Certification & User's Manual Information

### § 2.948 Description of measurement facilities.

- (a) Each party making measurements of equipment that is subject to an equipment authorization under Part 15 or Part 18 of this chapter, regardless of whether the measurements are filed with the Commission or kept on file by the party responsible for compliance of equipment marketed within the U.S. or its possessions, shall compile a description of the measurement facilities employed.
  - (1) If the measured equipment is subject to the verification procedure, the description of the measurement facilities shall be retained by the party responsible for verification of the equipment.
    - (i) *If the equipment is verified through measurements performed by an independent laboratory, it is acceptable for the party responsible for verification of the equipment to rely upon the description of the measurement facilities retained by or placed on file with the Commission by that laboratory. In this situation, the party responsible for the verification of the equipment is not required to retain a duplicate copy of the description of the measurement facilities.*
    - (ii) If the equipment is verified based on measurements performed at the installation site of the equipment, no specific site calibration data is required. It is acceptable to retain the description of the measurement facilities at the site at which the measurements were performed.
  - (2) If the equipment is to be authorized by the Commission under the certification procedure, the description of the measurement facilities shall be filed with the Commission's Laboratory in Columbia, Maryland. The data describing the measurement facilities need only be filed once but must be updated as changes are made to the measurement facilities or as otherwise described in this section. At least every three years, the organization responsible for filing the data with the Commission shall certify that the data on file is current.



## Certification & User's Manual Information

### Label and User's Manual Information

The following is extracted from Title 47 of the Code of Federal Regulations, Part 15, Subpart A — General:

#### § 15.19 Labeling requirements.

(a) *In addition to the requirements in Part 2 of this chapter, a device subject to certification or verification shall be labeled as follows:*

- (1) Receivers associated with the operation of a licensed radio service, e.g., FM broadcast under Part 73 of this chapter, land mobile operation under Part 90, etc., shall bear the following statement in a conspicuous location on the device:

This device complies with Part 15 of the FCC Rules. Operation is subject to the condition that this device does not cause harmful interference.

- (2) A stand-alone cable input selector switch, shall bear the following statement in a conspicuous location on the device:

This device is verified to comply with Part 15 of the FCC Rules for use with cable television service.

- (3) All other devices shall bear the following statement in a conspicuous location on the device:

*This device complies with Part 15 of the FCC Rules. Operation is subject to the following two conditions: (1) This device may not cause harmful interference, and (2) this device must accept any interference received, including interference that may cause undesired operation.*

- (4) Where a device is constructed in two or more sections connected by wires and marketed together, the statement specified under paragraph (a) of this section is required to be affixed only to the main control unit.

- (5) When the device is so small or for such use that it is not practicable to place the statement specified under paragraph (a) of this section on it, the information required by this paragraph shall be placed in a prominent location in the instruction manual or pamphlet supplied to the user or, alternatively, shall be placed on the container in which the device is marketed. However, the FCC identifier or the unique identifier, as appropriate, must be displayed on the device.

#### § 15.21 Information to user.

The users manual or instruction manual for an intentional or unintentional radiator shall caution the user that changes or modifications not expressly approved by the party responsible for compliance could void the user's authority to operate the equipment.

## Verification & User's Manual Information

The following is extracted from Title 47 of the Code of Federal Regulations, Part 15, Subpart B — Unintentional Radiators:

### § 15.105 Information to the user.

- (a) For a Class A digital device or peripheral, the instructions furnished the user shall include the following or similar statement, placed in a prominent location in the text of the manual:

Note: This equipment has been tested and found to comply with the limits for a Class A digital device, pursuant to Part 15 of the FCC Rules. These limits are designed to provide reasonable protection against harmful interference when the equipment is operated in a commercial environment. This equipment generates, uses, and can radiate radio frequency energy and, if not installed and used in accordance with the instruction manual, may cause harmful interference to radio communications. Operation of this equipment in a residential area is likely to cause harmful interference in which case the user will be required to correct the interference at own expense.

- (b) For a Class B digital device or peripheral, the instructions furnished the user shall include the following or similar statement, placed in a prominent location in the text of the manual:

Note: This equipment has been tested and found to comply with the limits for a Class B digital device, pursuant to Part 15 of the FCC Rules. These limits are designed to provide reasonable protection against harmful interference when the equipment is operated in a residential environment. This equipment generates, uses, and can radiate radio frequency energy and, if not installed and used in accordance with the instruction manual, may cause harmful interference to radio communications. However, there is no guarantee that interference will not occur in a particular installation. If this equipment does cause harmful interference to radio or television reception, which can be determined by turning the equipment off and on, the user is encouraged to try to correct the interference by one or more of the following measures:

- Reorient or relocate the receiving antenna.
- Increase the separation between the equipment and receiver.
- Connect the equipment into an outlet on a circuit different from that to which the receiver is connected.
- Consult the dealer or an experienced radio/TV technician for help.