



MET Laboratories, Inc. *Safety Certification - EMI - Telecom Environmental Simulation*

914 WEST PATAPSCO AVENUE • BALTIMORE, MARYLAND 21230-3432 • PHONE (410) 354-3300 • FAX (410) 354-3313
33439 WESTERN AVENUE • UNION CITY, CALIFORNIA 94587 • PHONE (510) 489-6300 • FAX (510) 489-6372
3162 BELICK STREET • SANTA CLARA, CA 95054 • PHONE (408) 748-3585 • FAX (510) 489-6372
13301 MCCALLEN PASS • AUSTIN, TEXAS 78753 • PHONE (512) 287-2500 • FAX (512) 287-2513

January 15, 2014

Meru Networks, Inc.
894 Ross Dr.
Sunnyvale, CA 94089

Dear Rajendran Chary,

Enclosed is the EMC Wireless test report for compliance testing of the Meru Networks, Inc., AP433i as tested to the requirements of Title 47 of the CFR, Ch. 1 (10-1-06 ed.), Part 15, Subpart C, E and RSS-210, Issue 8, Dec. 2010 for Intentional Radiators.

Thank you for using the services of MET Laboratories, Inc. If you have any questions regarding these results or if MET can be of further service to you, please feel free to contact me.

Sincerely yours,
MET LABORATORIES, INC.

Jennifer Warnell
Documentation Department

Reference: (\Meru Networks, Inc.\EMCS39792B-FCC247 Rev. 2)

Certificates and reports shall not be reproduced except in full, without the written permission of MET Laboratories, Inc.

Electromagnetic Compatibility Criteria Test Report

for the

**Meru Networks, Inc.
AP433i**

Tested under
the FCC Certification Rules
contained in
15.247 Subpart C & RSS-210, Issue 8, Dec. 2010
for Intentional Radiators

MET Report: EMCS39792B-FCC247 Rev. 2

January 15, 2014

Prepared For:

**Meru Networks, Inc.
894 Ross Dr.
Sunnyvale, CA 94089**

Prepared By:
MET Laboratories, Inc.
914 W. Patapsco Ave.
Baltimore, MD 21230

Electromagnetic Compatibility Criteria Test Report

for the

Meru Networks, Inc.
AP433i

Tested under
the FCC Certification Rules
contained in
15.247 Subpart C & RSS-210, Issue 8, Dec. 2010
for Intentional Radiators



Benjamin Taylor, Project Engineer
Electromagnetic Compatibility Lab



Jennifer Warnell
Documentation Department

Engineering Statement: The measurements shown in this report were made in accordance with the procedures indicated, and the emissions from this equipment were found to be within the limits applicable. I assume full responsibility for the accuracy and completeness of these measurements, and for the qualifications of all persons taking them. It is further stated that upon the basis of the measurements made, the equipment tested is capable of operation in accordance with the requirements of the FCC Rules Parts 15.247 and Industry Canada standards RSS-210, Issue 8, Dec. 2010 under normal use and maintenance.



Asad Bajwa,
Director, Electromagnetic Compatibility Lab

Report Status Sheet

Revision	Report Date	Reason for Revision
∅	December 10, 2013	Initial Issue.
1	January 13, 2014	Revised to reflect customer corrections.
2	January 15, 2014	Revised to reflect engineer corrections.

Table of Contents

I.	Executive Summary	1
	A. Purpose of Test	2
	B. Executive Summary	2
II.	Equipment Configuration	3
	A. Overview.....	4
	B. References.....	5
	C. Test Site	5
	D. Description of Test Sample.....	6
	E. Equipment Configuration.....	6
	F. Support Equipment	7
	G. Mode of Operation.....	7
	H. Method of Monitoring EUT Operation.....	7
	I. Modifications	7
	a) Modifications to EUT.....	7
	b) Modifications to Test Standard.....	7
	J. Disposition of EUT.....	7
III.	Electromagnetic Compatibility Criteria for Intentional Radiators.....	8
	§ 15.203 Antenna Requirement	9
	§ 15.207(a) Conducted Emissions Limits.....	10
	§ 15.209 Radiated Spurious Emissions Requirements and Band Edge	13
	§ 15.247(i) Maximum Permissible Exposure	30
IV.	Test Equipment	31
V.	Certification & User’s Manual Information.....	33
	A. Certification Information	34
	B. Label and User’s Manual Information	38
VI.	ICES-003 Procedural & Labeling Requirements.....	40

List of Tables

Table 1. Executive Summary of EMC Part 15.247 Compliance Testing	2
Table 2. EUT Summary Table.....	4
Table 3. References	5
Table 4. Equipment Configuration	6
Table 5. Support Equipment.....	7
Table 6. Antenna List	9
Table 7. Conducted Limits for Intentional Radiators from FCC Part 15 § 15.207(a)	10
Table 8. Conducted Emissions, 15.207(a), Phase Line, Test Results.....	11
Table 9. Conducted Emissions, 15.207(a), Neutral Line, Test Results	12
Table 10. Radiated Emissions Limits Calculated from FCC Part 15, § 15.209 (a)	13
Table 11. Test Equipment List	32

List of Plots

Plot 1. Conducted Emissions, 15.207(a), Phase Line	11
Plot 2. Conducted Emissions, 15.207(a), Neutral Line	12
Plot 3. Radiated Spurs Emissions, Low 2.4 GHz Radio, Low 5.1 GHz Radio, Low 5.8 GHz Radio, 30 MHz – 1 GHz, Panel.....	14
Plot 4. Radiated Spurs Emissions, Low 2.4 GHz Radio, Low 5.1 GHz Radio, Low 5.8 GHz Radio, 1 GHz – 18 GHz, Average, Panel	14
Plot 5. Radiated Spurs Emissions, Low 2.4 GHz Radio, Low 5.1 GHz Radio, Low 5.8 GHz Radio, 1 GHz – 18 GHz, Peak, Panel.....	14
Plot 6. Radiated Spurious Emissions, Low 2.4 GHz Radio, Low 5.1 GHz Radio, High 5.8 GHz Radio, 30 MHz – 1 GHz, Panel.....	15
Plot 7. Radiated Spurious Emissions, Low 2.4 GHz Radio, Low 5.1 GHz Radio, High 5.8 GHz Radio, 1 GHz – 18 GHz, Average, Panel	15
Plot 8. Radiated Spurious Emissions, Low 2.4 GHz Radio, Low 5.1 GHz Radio, High 5.8 GHz Radio, 1 GHz – 18 GHz, Peak, Panel	15
Plot 9. Radiated Spurious Emissions, Low 2.4 GHz Radio, High 5.1 GHz Radio, Low 5.8 GHz Radio, 30 MHz – 1 GHz, Panel.....	16
Plot 10. Radiated Spurious Emissions, Low 2.4 GHz Radio, High 5.1 GHz Radio, Low 5.8 GHz Radio, 1 GHz – 18 GHz, Average, Panel	16
Plot 11. Radiated Spurious Emissions, Low 2.4 GHz Radio, High 5.1 GHz Radio, Low 5.8 GHz Radio, 1 GHz – 18 GHz, Peak, Panel	16
Plot 12. Radiated Spurious Emissions, Low 2.4 GHz Radio, High 5.1 GHz Radio, High 5.8 GHz Radio, 30 MHz – 1 GHz, Panel.....	17
Plot 13. Radiated Spurious Emissions, Low 2.4 GHz Radio, High 5.1 GHz Radio, High 5.8 GHz Radio, 1 GHz – 18 GHz, Average, Panel	17
Plot 14. Radiated Spurious Emissions, Low 2.4 GHz Radio, High 5.1 GHz Radio, High 5.8 GHz Radio, 1 GHz – 18 GHz, Peak, Panel	17
Plot 15. Radiated Spurious Emissions, High 2.4 GHz Radio, Low 5.1 GHz Radio, Low 5.8 GHz Radio, 30 MHz – 1 GHz, Panel.....	18
Plot 16. Radiated Spurious Emissions, High 2.4 GHz Radio, Low 5.1 GHz Radio, Low 5.8 GHz Radio, 1 GHz – 18 GHz, Average, Panel	18
Plot 17. Radiated Spurious Emissions, High 2.4 GHz Radio, Low 5.1 GHz Radio, Low 5.8 GHz Radio, 1 GHz – 18 GHz, Peak, Panel	18
Plot 18. Radiated Spurious Emissions, High 2.4 GHz Radio, Low 5.1 GHz Radio, High 5.8 GHz Radio, 30 MHz – 1 GHz, Panel.....	19
Plot 19. Radiated Spurious Emissions, High 2.4 GHz Radio, Low 5.1 GHz Radio, High 5.8 GHz Radio, 1 GHz – 18 GHz, Average, Panel	19

Plot 20. Radiated Spurious Emissions, High 2.4 GHz Radio, Low 5.1 GHz Radio, High 5.8 GHz Radio, 1 GHz – 18 GHz, Peak, Panel	19
Plot 21. Radiated Spurious Emissions, High 2.4 GHz Radio, High 5.1 GHz Radio, Low 5.8 GHz Radio, 30 MHz – 1 GHz, Panel	20
Plot 22. Radiated Spurious Emissions, High 2.4 GHz Radio, High 5.1 GHz Radio, Low 5.8 GHz Radio, 1 GHz – 18 GHz, Average, Panel	20
Plot 23. Radiated Spurious Emissions, High 2.4 GHz Radio, High 5.1 GHz Radio, Low 5.8 GHz Radio, 1 GHz – 18 GHz, Peak, Panel	20
Plot 24. Radiated Spurious Emissions, High 2.4 GHz Radio, High 5.1 GHz Radio, High 5.8 GHz Radio, 30 MHz – 1 GHz, Panel	21
Plot 25. Radiated Spurious Emissions, High 2.4 GHz Radio, High 5.1 GHz Radio, High 5.8 GHz Radio, 1 GHz – 18 GHz, Average, Panel	21
Plot 26. Radiated Spurious Emissions, High 2.4 GHz Radio, High 5.1 GHz Radio, High 5.8 GHz Radio, 1 GHz – 18 GHz, Peak, Panel	21
Plot 27. Radiated Spurs Emissions, Low 2.4 GHz Radio, Low 5.1 GHz Radio, Low 5.8 GHz Radio, 30 MHz – 1 GHz, Omni	22
Plot 28. Radiated Spurs Emissions, Low 2.4 GHz Radio, Low 5.1 GHz Radio, Low 5.8 GHz Radio, 1 GHz – 18 GHz, Average, Omni	22
Plot 29. Radiated Spurs Emissions, Low 2.4 GHz Radio, Low 5.1 GHz Radio, Low 5.8 GHz Radio, 1 GHz – 18 GHz, Peak, Omni	22
Plot 30. Radiated Spurious Emissions, Low 2.4 GHz Radio, Low 5.1 GHz Radio, High 5.8 GHz Radio, 30 MHz – 1 GHz, Omni	23
Plot 31. Radiated Spurious Emissions, Low 2.4 GHz Radio, Low 5.1 GHz Radio, High 5.8 GHz Radio, 1 GHz – 18 GHz, Average, Omni	23
Plot 32. Radiated Spurious Emissions, Low 2.4 GHz Radio, Low 5.1 GHz Radio, High 5.8 GHz Radio, 1 GHz – 18 GHz, Peak, Omni	23
Plot 33. Radiated Spurious Emissions, Low 2.4 GHz Radio, High 5.1 GHz Radio, Low 5.8 GHz Radio, 30 MHz – 1 GHz, Omni	24
Plot 34. Radiated Spurious Emissions, Low 2.4 GHz Radio, High 5.1 GHz Radio, Low 5.8 GHz Radio, 1 GHz – 18 GHz, Average, Omni	24
Plot 35. Radiated Spurious Emissions, Low 2.4 GHz Radio, High 5.1 GHz Radio, Low 5.8 GHz Radio, 1 GHz – 18 GHz, Peak, Omni	24
Plot 36. Radiated Spurious Emissions, Low 2.4 GHz Radio, High 5.1 GHz Radio, High 5.8 GHz Radio, 30 MHz – 1 GHz, Omni	25
Plot 37. Radiated Spurious Emissions, Low 2.4 GHz Radio, High 5.1 GHz Radio, High 5.8 GHz Radio, 1 GHz – 18 GHz, Average, Omni	25
Plot 38. Radiated Spurious Emissions, Low 2.4 GHz Radio, High 5.1 GHz Radio, High 5.8 GHz Radio, 1 GHz – 18 GHz, Peak, Omni	25
Plot 39. Radiated Spurious Emissions, High 2.4 GHz Radio, Low 5.1 GHz Radio, Low 5.8 GHz Radio, 30 MHz – 1 GHz, Omni	26
Plot 40. Radiated Spurious Emissions, High 2.4 GHz Radio, Low 5.1 GHz Radio, Low 5.8 GHz Radio, 1 GHz – 18 GHz, Average, Omni	26
Plot 41. Radiated Spurious Emissions, High 2.4 GHz Radio, Low 5.1 GHz Radio, Low 5.8 GHz Radio, 1 GHz – 18 GHz, Peak, Omni	26
Plot 42. Radiated Spurious Emissions, High 2.4 GHz Radio, Low 5.1 GHz Radio, High 5.8 GHz Radio, 30 MHz – 1 GHz, Omni	27
Plot 43. Radiated Spurious Emissions, High 2.4 GHz Radio, Low 5.1 GHz Radio, High 5.8 GHz Radio, 1 GHz – 18 GHz, Average, Omni	27
Plot 44. Radiated Spurious Emissions, High 2.4 GHz Radio, Low 5.1 GHz Radio, High 5.8 GHz Radio, 1 GHz – 18 GHz, Peak, Omni	27
Plot 45. Radiated Spurious Emissions, High 2.4 GHz Radio, High 5.1 GHz Radio, Low 5.8 GHz Radio, 30 MHz – 1 GHz, Omni	28

Plot 46. Radiated Spurious Emissions, High 2.4 GHz Radio, High 5.1 GHz Radio, Low 5.8 GHz Radio, 1 GHz – 18 GHz, Average, Omni	28
Plot 47. Radiated Spurious Emissions, High 2.4 GHz Radio, High 5.1 GHz Radio, Low 5.8 GHz Radio, 1 GHz – 18 GHz, Peak, Omni	28
Plot 48. Radiated Spurious Emissions, High 2.4 GHz Radio, High 5.1 GHz Radio, High 5.8 GHz Radio, 30 MHz – 1 GHz, Omni	29
Plot 49. Radiated Spurious Emissions, High 2.4 GHz Radio, High 5.1 GHz Radio, High 5.8 GHz Radio, 1 GHz – 18 GHz, Average, Omni	29
Plot 50. Radiated Spurious Emissions, High 2.4 GHz Radio, High 5.1 GHz Radio, High 5.8 GHz Radio, 1 GHz – 18 GHz, Peak, Omni	29

List of Terms and Abbreviations

AC	Alternating Current
ACF	Antenna Correction Factor
Cal	Calibration
<i>d</i>	Measurement Distance
dB	Decibels
dBμA	Decibels above one microamp
dBμV	Decibels above one microvolt
dBμA/m	Decibels above one microamp per meter
dBμV/m	Decibels above one microvolt per meter
DC	Direct Current
E	Electric Field
DSL	Digital Subscriber Line
ESD	Electrostatic Discharge
EUT	Equipment Under Test
<i>f</i>	Frequency
FCC	Federal Communications Commission
GRP	Ground Reference Plane
H	Magnetic Field
HCP	Horizontal Coupling Plane
Hz	Hertz
IEC	International Electrotechnical Commission
kHz	kilohertz
kPa	kilopascal
kV	kilovolt
LISN	Line Impedance Stabilization Network
MHz	Megahertz
μH	microhenry
μ	microfarad
μs	microseconds
NEBS	Network Equipment-Building System
PRF	Pulse Repetition Frequency
RF	Radio Frequency
RMS	Root-Mean-Square
TWT	Traveling Wave Tube
V/m	Volts per meter
VCP	Vertical Coupling Plane

I. Executive Summary

A. Purpose of Test

An EMC evaluation was performed to determine compliance of the Meru Networks, Inc. AP433i, with the requirements of Part 15, §15.247. All references are to the most current version of Title 47 of the Code of Federal Regulations in effect. In accordance with §2.1033, the following data is presented in support of the Certification of the AP433i. Meru Networks, Inc. should retain a copy of this document which should be kept on file for at least two years after the manufacturing of the AP433i, has been **permanently** discontinued.

B. Executive Summary

The following tests were conducted on a sample of the equipment for the purpose of demonstrating compliance with Part 15, §15.247, §15.407 in accordance with Meru Networks, Inc., purchase order number 105928. All tests were conducted using measurement procedure ANSI C63.4-2003.

FCC Reference 47 CFR Part 15.247:2005	IC Reference RSS-210 Issue 8: 2010; RSS-GEN Issue 3: 2010	Description	Compliance
47 CFR Part 15.203	N/A	Antenna Requirements	Compliant
47 CFR Part 15.207(a)	RSS-GEN (7.2.4)	Conducted Emissions Voltage	Compliant
Title 47 of the CFR, Part 15 §15.247(d); §15.407; §15.209; §15.205	RSS-210(A8.5)	Radiated Spurious Emissions Requirements	Compliant
Title 47 of the CFR, Part 15 §15.247(i)	RSS-Gen(5.6)	Maximum Permissible Exposure (MPE)	Compliant

Table 1. Executive Summary of EMC Part 15.247 Compliance Testing

II. Equipment Configuration

A. Overview

MET Laboratories, Inc. was contracted by Meru Networks, Inc. to perform testing on the AP433i, under Meru Networks, Inc.'s purchase order number 105928.

This document describes the test setups, test methods, required test equipment, and the test limit criteria used to perform compliance testing of the Meru Networks, Inc., AP433i.

The results obtained relate only to the item(s) tested.

Model(s) Tested:	AP433i	
Model(s) Covered:	AP433i	
EUT Specifications:	Primary Power: 120 VAC, 60 Hz	
	FCC ID: RE7-AP433I IC: 6749A-AP433I	
	Type of Modulations:	OFDM
	Equipment Code:	DTS
	EUT Frequency Ranges:	2400-2483.5MHz, 5150-5250MHz, 5725-5850
Analysis:	The results obtained relate only to the item(s) tested.	
Environmental Test Conditions:	Temperature: 15-35° C	
	Relative Humidity: 30-60%	
	Barometric Pressure: 860-1060 mbar	
Evaluated by:	Benjamin Taylor	
Report Date(s):	January 15, 2014	

Table 2. EUT Summary Table

B. References

CFR 47, Part 15, Subpart C	Federal Communication Commission, Code of Federal Regulations, Title 47, Part 15: General Rules and Regulations, Allocation, Assignment, and Use of Radio Frequencies
CFR 47, Part 15, Subpart B	Electromagnetic Compatibility: Criteria for Radio Frequency Devices
CFR 47, Part 15, Subpart E	Federal Communication Commission, Code of Federal Regulations, Title 47, Part 15: General Rules and Regulations, Allocation, Assignment, and Use of Radio Frequencies
RSS-210, Issue 8, Dec. 2010	Low-power Licence-exempt Radiocommunications Devices (All Frequency Bands): Category I Equipment
RSS-GEN, Issue 3, Dec. 2010	General Requirements and Information for the Certification of Radio Apparatus
ICES-003, Issue 5 August 2012	Information Technology Equipment (ITE) — Limits and methods of measurement
ANSI C63.4:2003	Methods and Measurements of Radio-Noise Emissions from Low-Voltage Electrical And Electronic Equipment in the Range of 9 kHz to 40 GHz
ISO/IEC 17025:2005	General Requirements for the Competence of Testing and Calibration Laboratories
ANSI C63.10-2009	American National Standard for Testing Unlicensed Wireless Devices

Table 3. References

C. Test Site

All testing was performed at MET Laboratories, Inc., 914 W. Patapsco Ave., Baltimore, MD 21230. All equipment used in making physical determinations is accurate and bears recent traceability to the National Institute of Standards and Technology.

Radiated Emissions measurements were performed in a 3 meter semi-anechoic chamber (equivalent to an Open Area Test Site). In accordance with §2.948(a)(3), a complete site description is contained at MET Laboratories.

D. Description of Test Sample

The Meru Networks, Inc. AP433i, Equipment Under Test (EUT), is 802.11 wireless access point (WAP) that allows wireless devices to connect to a wired network using Wi-Fi, standard. The WAP usually connects to a router (via a wired network), and can relay data between the wireless devices (such as computers or printers) and wired devices on the network. AP433i has 3 radio modules. Each radio module has modular approval (FCC ID: RE7-AP433). All 3 radio modules can operate simultaneously. This radio report addresses the simultaneous operation. AP433i is an indoor device.

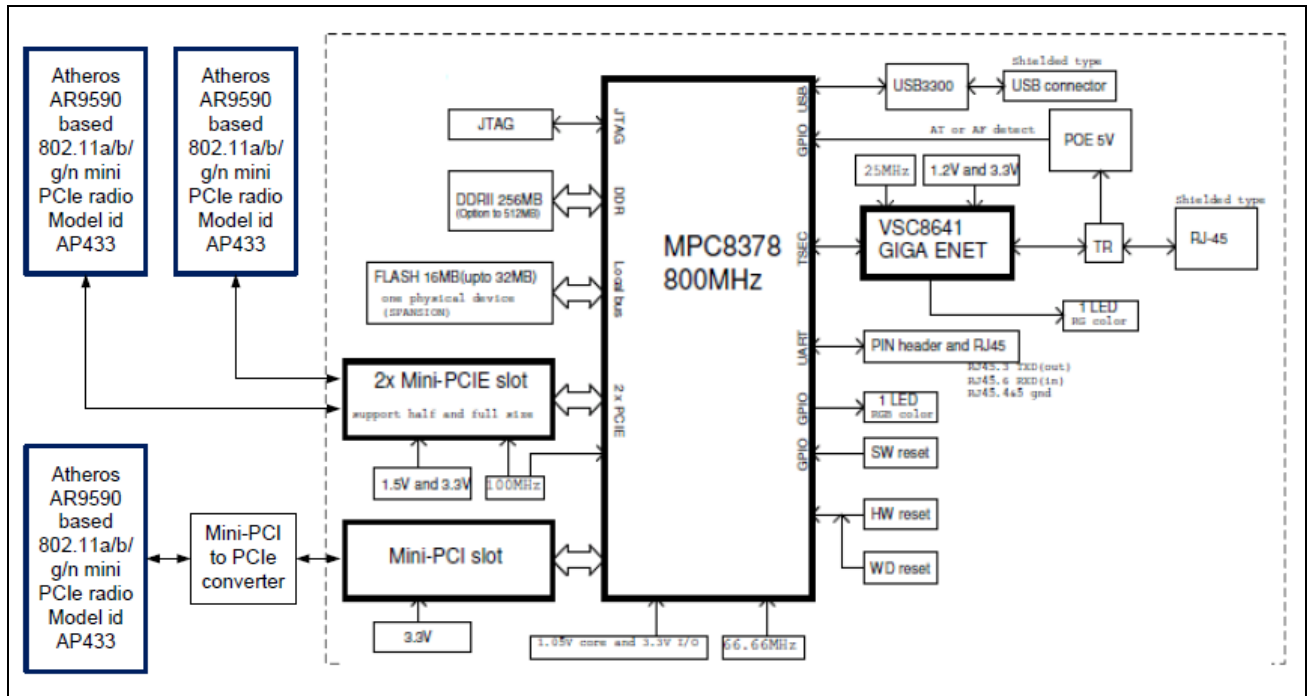

Figure 1. Block Diagram of Test Configuration

E. Equipment Configuration

All cards, racks, etc., incorporated as part of the EUT is included in the following list.

Ref. ID	Name / Description	Model Number	Serial Number
1	Dual Radio Access Point	AP433e	2411A433e000CE60A5B01
2	Dual Radio Access Point	AP433i	2312A433i0CD3CC
3	Dual Radio Access Point	AP433is	0312A433is0A6752
4	Dual Radio Access Point	OAP433e	53110A4330A6733

Table 4. Equipment Configuration

F. Support Equipment

Support equipment necessary for the operation and testing of the EUT is included in the following list.

SN	Type	Model and Serial Number	Quantity
1	PoE	PD-9001GR/AC	1
2	Cable	Serial cable	1
3	Cable	Ethernet cable	2

Table 5. Support Equipment

G. Mode of Operation

During the normal operation the configuration is controlled by the Meru controller which sets the country code, ESSID, Operating frequency band and Channel etc.

H. Method of Monitoring EUT Operation

During the normal operation with controller Green or Blue LED indication on the Access point indicate the normal operation of the Access point. A Red LED indicates a failure of hardware or software settings.

I. Modifications

a) Modifications to EUT

No modifications were made to the EUT.

b) Modifications to Test Standard

No modifications were made to the test standard.

J. Disposition of EUT

The test sample including all support equipment submitted to the Electro-Magnetic Compatibility Lab for testing was returned to Meru Networks, Inc. upon completion of testing.

III. Electromagnetic Compatibility Criteria for Intentional Radiators

Electromagnetic Compatibility Criteria for Intentional Radiators

§ 15.203 Antenna Requirement

Test Requirement: § 15.203: An intentional radiator shall be designed to ensure that no antenna other than that furnished by the responsible party shall be used with the device. The use of a permanently attached antenna or of an antenna that uses a unique coupling to the intentional radiator shall be considered sufficient to comply with the provisions of this section. The manufacturer may design the unit so that a broken antenna can be replaced by the user, but the use of a standard antenna jack or electrical connector is prohibited.

The structure and application of the EUT were analyzed to determine compliance with Section 15.203 of the Rules. Section 15.203 states that the subject device must meet at least one of the following criteria:

- a.) Antenna must be permanently attached to the unit.
- b.) Antenna must use a unique type of connector to attach to the EUT.
- c.) Unit must be professionally installed. Installer shall be responsible for verifying that the correct antenna is employed with the unit.

Results: The EUT is compliant the criteria of §15.203. The EUT has an integral antenna. This antenna was originally approved with the radio module (FCC ID: RE7-AP433).

Test Engineer(s): Ben Taylor

Test Date(s): 10/21/2013

SN	Type	Model and Serial Number	Quantity
1	Antenna	Meru-ANT-PI623 Internal Omni Directional PIFA antenna	1
2	Antenna	Meru-ANT-PD313	1

Table 6. Antenna List

Electromagnetic Compatibility Criteria for Intentional Radiators

§ 15.207(a) Conducted Emissions Limits

Test Requirement(s): § 15.207 (a): For an intentional radiator that is designed to be connected to the public utility (AC) power line, the radio frequency voltage that is conducted back onto the AC power line on any frequency or frequencies, within the band 150 kHz to 30MHz, shall not exceed the limits in the following table, as measured using a 50 μ H/50 Σ line impedance stabilization network (LISN). Compliance with the provisions of this paragraph shall be based on the measurement of the radio frequency voltage between each power line and ground at the power terminal. The lower limit applies at the boundary between the frequency ranges.

Frequency range (MHz)	§ 15.207(a), Conducted Limit (dB μ V)	
	Quasi-Peak	Average
* 0.15- 0.45	66 - 56	56 - 46
0.45 - 0.5	56	46
0.5 - 30	60	50

Table 7. Conducted Limits for Intentional Radiators from FCC Part 15 § 15.207(a)

Test Procedure: The EUT was placed on a 0.8 m-high wooden table on a ground plane, and 40cm from a vertical ground plane. The EUT was situated such that the back of the EUT was 0.4 m from one wall of the vertical ground plane, and the remaining sides of the EUT were no closer than 0.8 m from any other conductive surface. The EUT was powered from a 50 Ω /50 μ H Line Impedance Stabilization Network (LISN). The EMC receiver scanned the frequency range from 150 kHz to 30 MHz. Conducted Emissions measurements were made in accordance with *ANSI C63.4-2003 "Methods and Measurements of Radio-Noise Emissions from Low-Voltage Electrical and Electronic Equipment in the Range of 9kHz to 40 GHz"*. The measurements were performed over the frequency range of 0.15 MHz to 30 MHz using a 50 Ω /50 μ H LISN as the input transducer to an EMC/field intensity meter. For the purpose of this testing, the transmitter was turned on. Scans were performed with the transmitter on.

Test Results: The EUT was compliant with this requirement. Measured emissions were below applicable limits.

Test Engineer(s): Benjamin Taylor

Test Date(s): 11/05/13

15.207(a) Conducted Emissions Test Results

Frequency (MHz)	Uncorrected Meter Reading (dBuV) QP	Cable Loss (dB)	Corrected Measurement (dBuV) QP	Limit (dBuV) QP	Margin (dB) QP	Uncorrected Meter Reading (dBuV) Avg.	Cable Loss (dB)	Corrected Measurement (dBuV) AVG	Limit (dBuV) AVG	Margin (dB) AVG
0.1527	46.45	0	46.45	65.85	-19.4	36.74	0	36.74	55.85	-19.11
0.4967	35.66	0	35.66	56.06	-20.4	28.28	0	28.28	46.06	-17.78
1.02	32.21	0	32.21	56	-23.79	25.23	0	25.23	46	-20.77
8.414	35.68	0	35.68	60	-24.32	32.45	0	32.45	50	-17.55
14.804	53.95	0	53.95	60	-6.05	53.68	0	53.68	50	3.68
20.233	43.2	0	43.2	60	-16.8	41.46	0	41.46	50	-8.54

Table 8. Conducted Emissions, 15.207(a), Phase Line, Test Results

Note: Highlighted line item exceeds the limits.

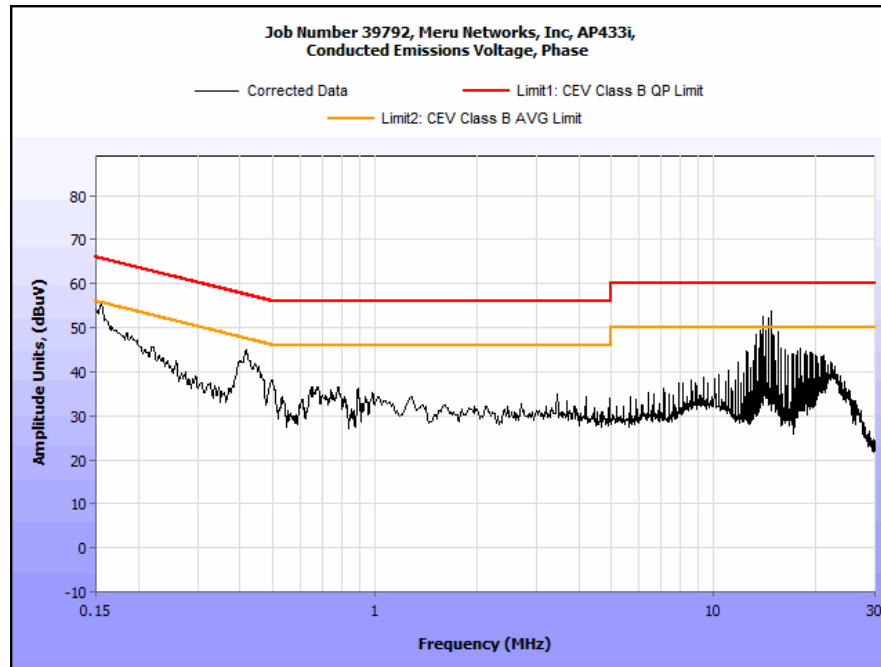

Plot 1. Conducted Emissions, 15.207(a), Phase Line

15.207(a) Conducted Emissions Test Results

Frequency (MHz)	Uncorrected Meter Reading (dBuV) QP	Cable Loss (dB)	Corrected Measurement (dBuV) QP	Limit (dBuV) QP	Margin (dB) QP	Uncorrected Meter Reading (dBuV) Avg.	Cable Loss (dB)	Corrected Measurement (dBuV) AVG	Limit (dBuV) AVG	Margin (dB) AVG
0.171	42.46	0	42.46	64.91	-22.45	25.62	0	25.62	54.91	-29.29
0.416	42.45	0	42.45	57.53	-15.08	35.75	0	35.75	47.53	-11.78
0.6763	32.8	0	32.8	56	-23.2	26.78	0	26.78	46	-19.22
8.654	36.03	0	36.03	60	-23.97	32.8	0	32.8	50	-17.2
14.805	53.05	0	53.05	60	-6.95	52.59	0	52.59	50	2.59
20.233	43.56	0	43.56	60	-16.44	40.78	0	40.78	50	-9.22

Table 9. Conducted Emissions, 15.207(a), Neutral Line, Test Results

Note: Highlighted line item exceeds the limits.

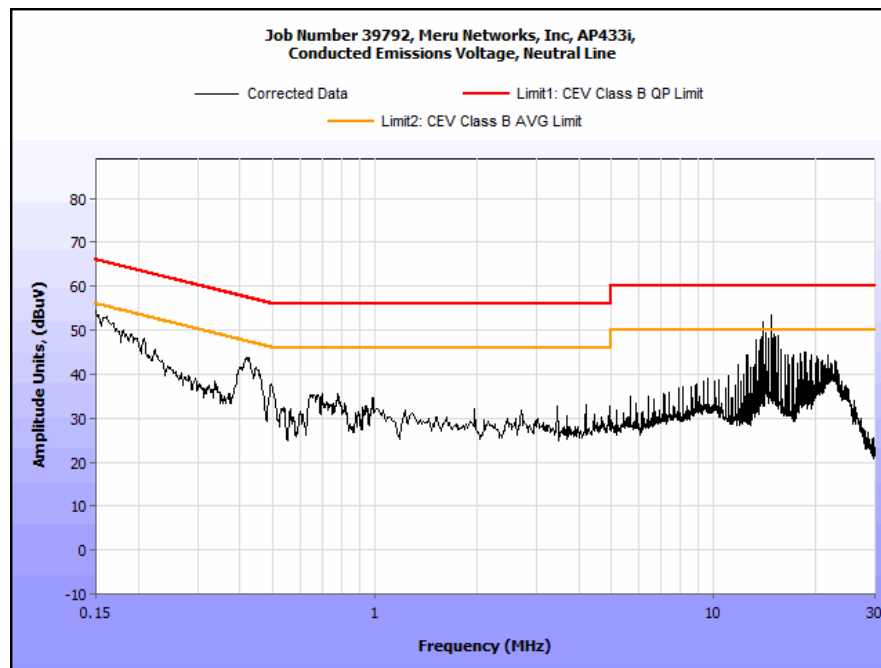

Plot 2. Conducted Emissions, 15.207(a), Neutral Line

Electromagnetic Compatibility Criteria for Intentional Radiators

§ 15.209 Radiated Spurious Emissions Requirements and Band Edge

Test Requirement(s): § 15.209 (a): Except as provided elsewhere in this subpart, the emissions from an intentional radiator shall not exceed the field strength levels specified in Table 10.

Frequency (MHz)	§ 15.209(a), Radiated Emission Limits (dB μ V) @ 3m
30 - 88	40.00
88 - 216	43.50
216 - 960	46.00
Above 960	54.00

Table 10. Radiated Emissions Limits Calculated from FCC Part 15, § 15.209 (a)

Test Procedures: The transmitter was turned on. Measurements were performed of the low, mid and high Channels. The EUT was rotated orthogonally through all three axes. Plots shown are corrected for both antenna correction factor and distance and compared to a 3 m limit line. Only noise floor was measured above 18 GHz.

Test Results: The EUT was compliant with the Radiated Spurious Emission limits of § 15.209. Radios have each been tested previously; §15.209 was performed to confirm there is no intermodulation as the product of simultaneous operation of all three radios, in their respective bands. Emissions in the 30MHz-1GHz range that appear to be in excess of the limit are exclusively digital emissions, and not applicable to the 15.209 limit.

Test Engineer(s): Benjamin Taylor

Test Date(s): 11/03/13

Radiated Spurious Emissions, Simultaneous Operation, Panel Antenna

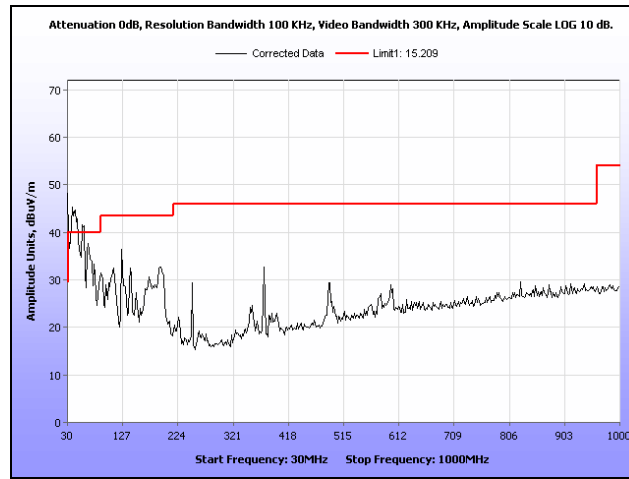

Plot 3. Radiated Spurs Emissions, Low 2.4 GHz Radio, Low 5.1 GHz Radio, Low 5.8 GHz Radio, 30 MHz – 1 GHz, Panel

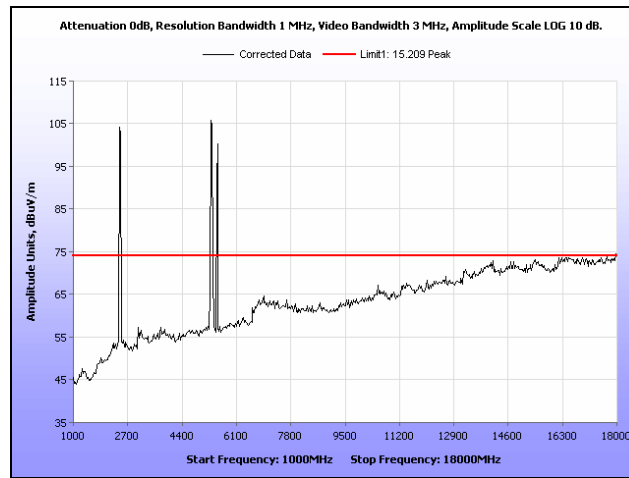

Plot 4. Radiated Spurs Emissions, Low 2.4 GHz Radio, Low 5.1 GHz Radio, Low 5.8 GHz Radio, 1 GHz – 18 GHz, Average, Panel

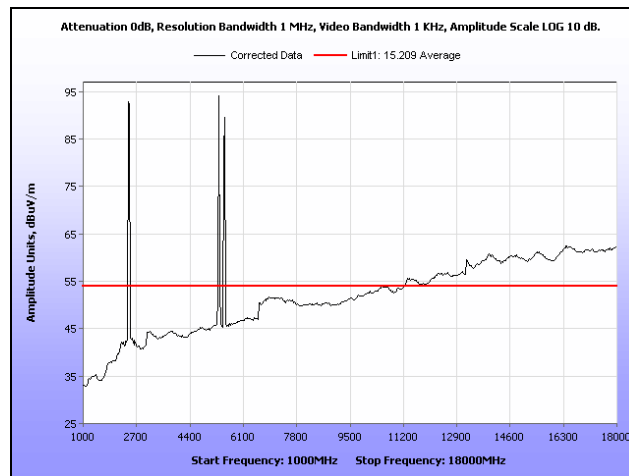

Plot 5. Radiated Spurs Emissions, Low 2.4 GHz Radio, Low 5.1 GHz Radio, Low 5.8 GHz Radio, 1 GHz – 18 GHz, Peak, Panel

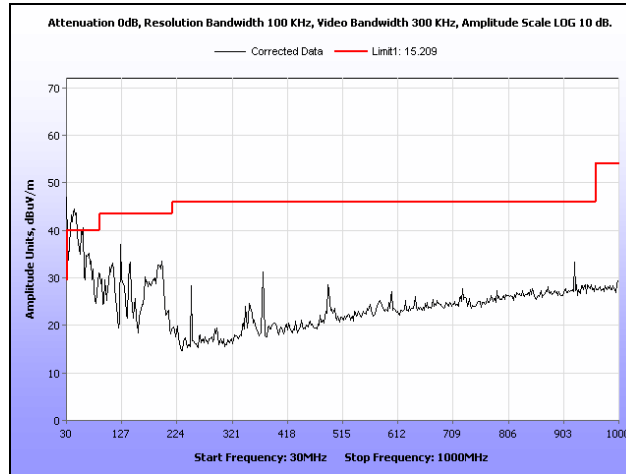

Plot 6. Radiated Spurious Emissions, Low 2.4 GHz Radio, Low 5.1 GHz Radio, High 5.8 GHz Radio, 30 MHz – 1 GHz, Panel

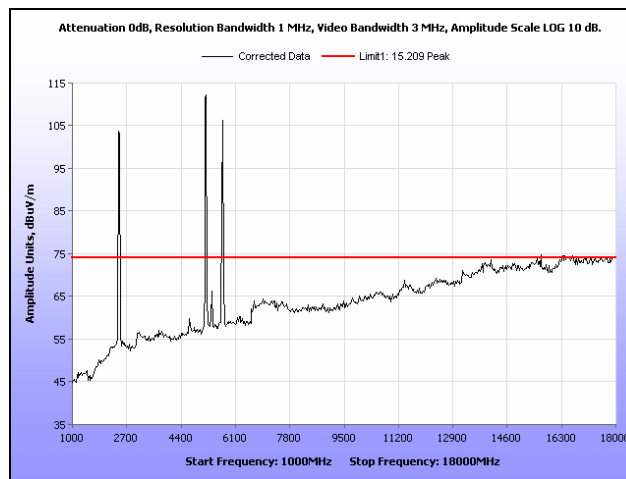

Plot 7. Radiated Spurious Emissions, Low 2.4 GHz Radio, Low 5.1 GHz Radio, High 5.8 GHz Radio, 1 GHz – 18 GHz, Average, Panel

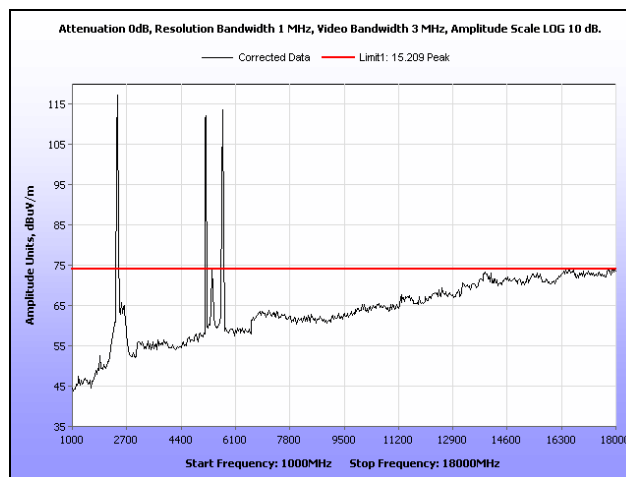

Plot 8. Radiated Spurious Emissions, Low 2.4 GHz Radio, Low 5.1 GHz Radio, High 5.8 GHz Radio, 1 GHz – 18 GHz, Peak, Panel

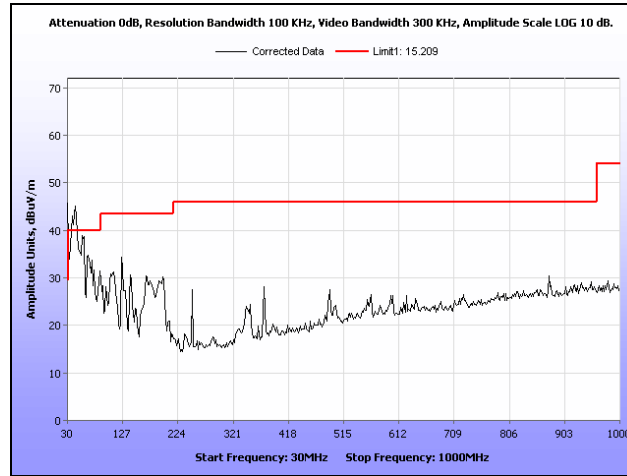

Plot 9. Radiated Spurious Emissions, Low 2.4 GHz Radio, High 5.1 GHz Radio, Low 5.8 GHz Radio, 30 MHz – 1 GHz, Panel

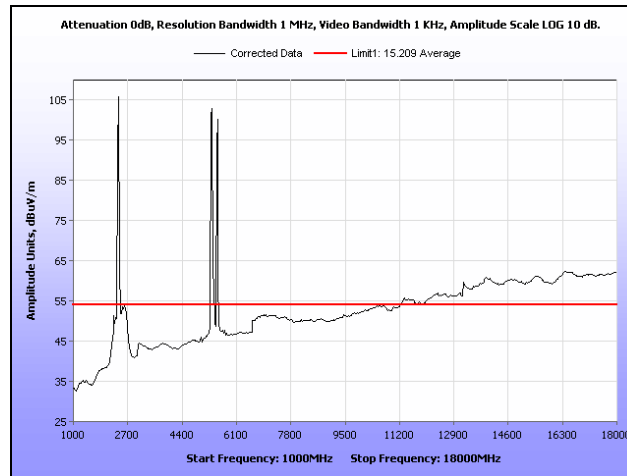

Plot 10. Radiated Spurious Emissions, Low 2.4 GHz Radio, High 5.1 GHz Radio, Low 5.8 GHz Radio, 1 GHz – 18 GHz, Average, Panel

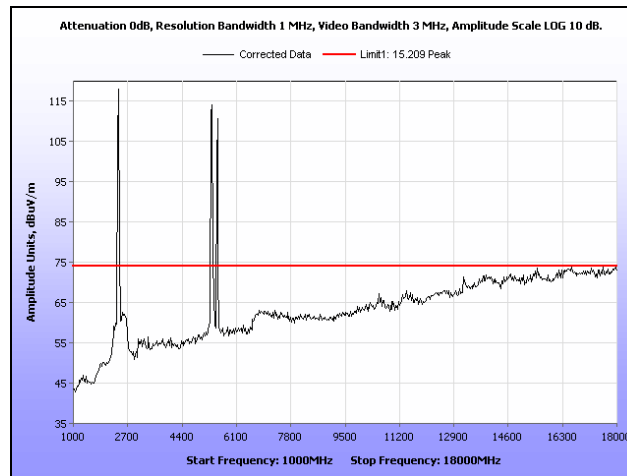

Plot 11. Radiated Spurious Emissions, Low 2.4 GHz Radio, High 5.1 GHz Radio, Low 5.8 GHz Radio, 1 GHz – 18 GHz, Peak, Panel

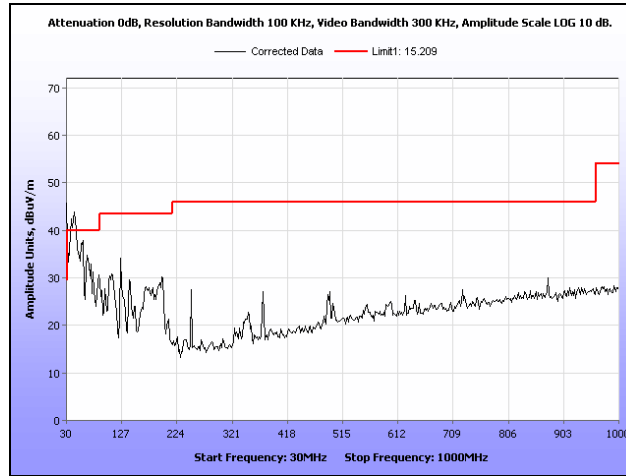

Plot 12. Radiated Spurious Emissions, Low 2.4 GHz Radio, High 5.1 GHz Radio, High 5.8 GHz Radio, 30 MHz – 1 GHz, Panel

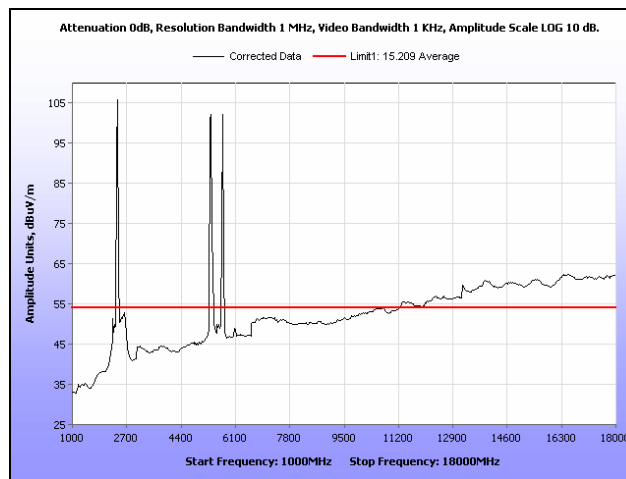

Plot 13. Radiated Spurious Emissions, Low 2.4 GHz Radio, High 5.1 GHz Radio, High 5.8 GHz Radio, 1 GHz – 18 GHz, Average, Panel

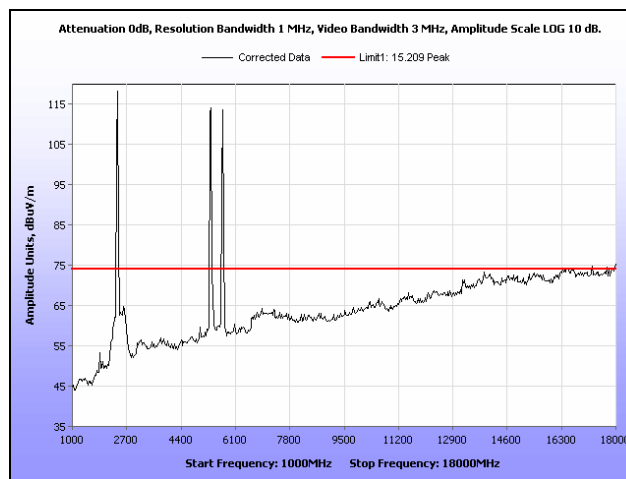

Plot 14. Radiated Spurious Emissions, Low 2.4 GHz Radio, High 5.1 GHz Radio, High 5.8 GHz Radio, 1 GHz – 18 GHz, Peak, Panel

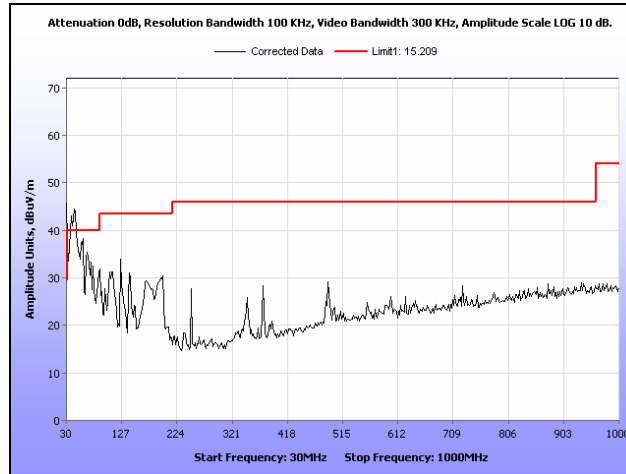

Plot 15. Radiated Spurious Emissions, High 2.4 GHz Radio, Low 5.1 GHz Radio, Low 5.8 GHz Radio, 30 MHz – 1 GHz, Panel

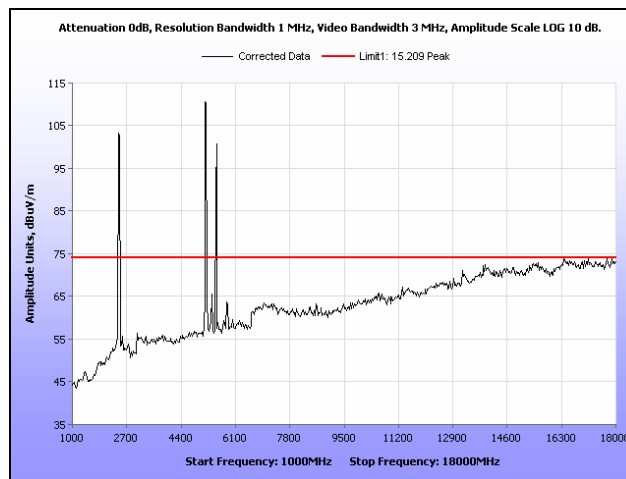

Plot 16. Radiated Spurious Emissions, High 2.4 GHz Radio, Low 5.1 GHz Radio, Low 5.8 GHz Radio, 1 GHz – 18 GHz, Average, Panel

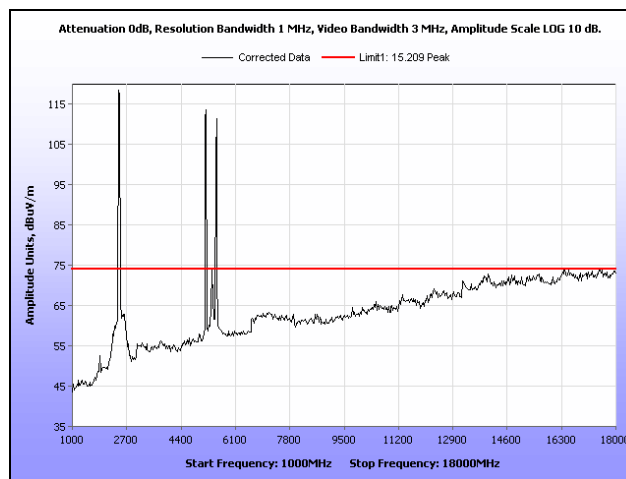

Plot 17. Radiated Spurious Emissions, High 2.4 GHz Radio, Low 5.1 GHz Radio, Low 5.8 GHz Radio, 1 GHz – 18 GHz, Peak, Panel

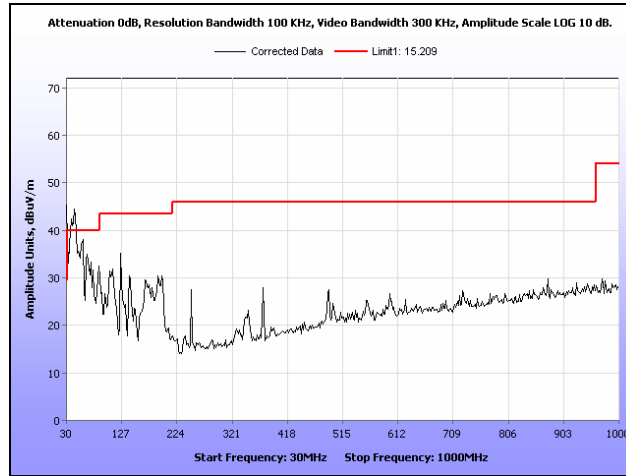

Plot 18. Radiated Spurious Emissions, High 2.4 GHz Radio, Low 5.1 GHz Radio, High 5.8 GHz Radio, 30 MHz – 1 GHz, Panel

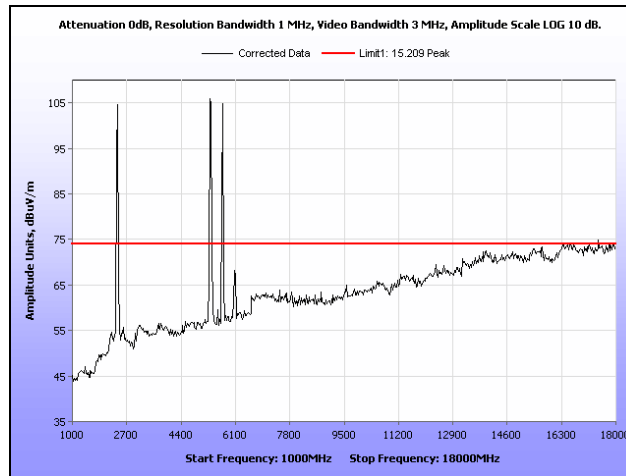

Plot 19. Radiated Spurious Emissions, High 2.4 GHz Radio, Low 5.1 GHz Radio, High 5.8 GHz Radio, 1 GHz – 18 GHz, Average, Panel

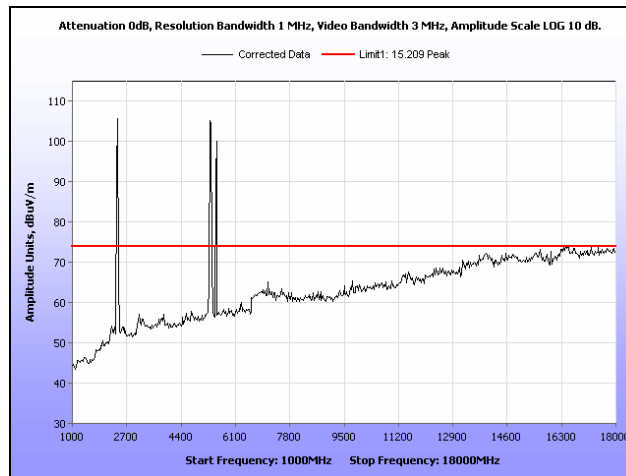

Plot 20. Radiated Spurious Emissions, High 2.4 GHz Radio, Low 5.1 GHz Radio, High 5.8 GHz Radio, 1 GHz – 18 GHz, Peak, Panel

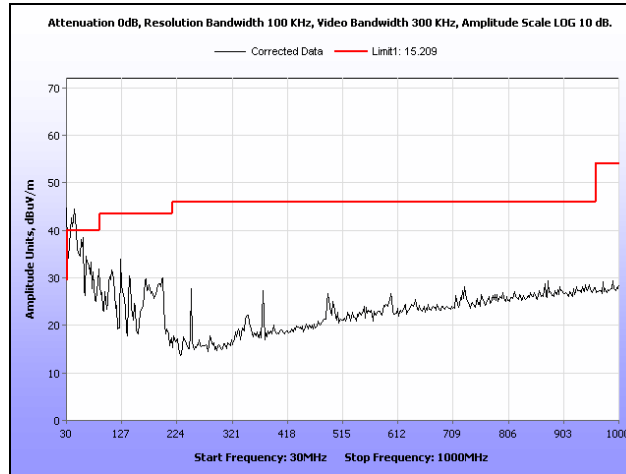

Plot 21. Radiated Spurious Emissions, High 2.4 GHz Radio, High 5.1 GHz Radio, Low 5.8 GHz Radio, 30 MHz – 1 GHz, Panel

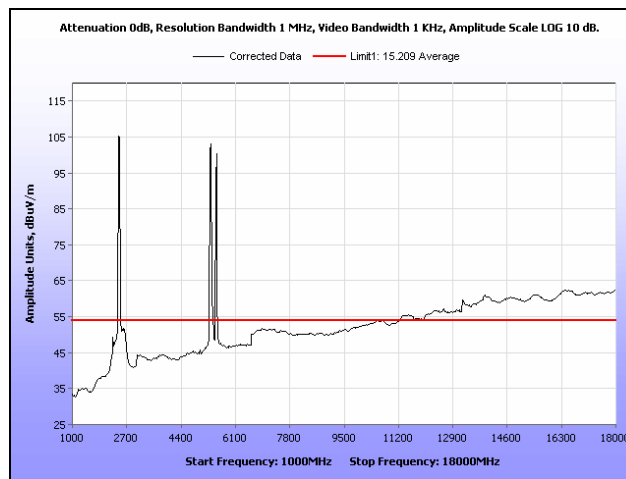

Plot 22. Radiated Spurious Emissions, High 2.4 GHz Radio, High 5.1 GHz Radio, Low 5.8 GHz Radio, 1 GHz – 18 GHz, Average, Panel

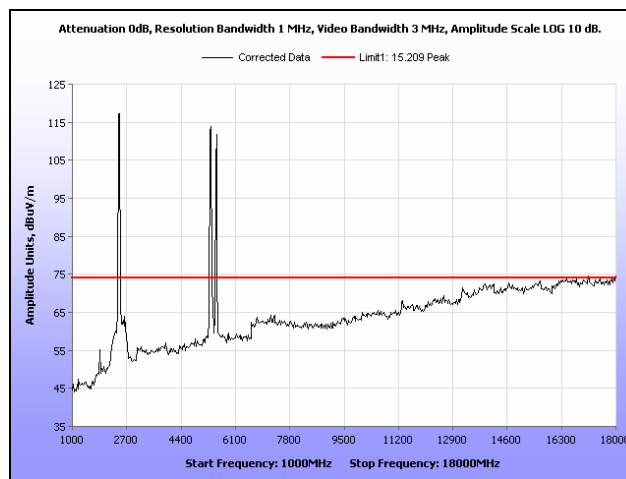

Plot 23. Radiated Spurious Emissions, High 2.4 GHz Radio, High 5.1 GHz Radio, Low 5.8 GHz Radio, 1 GHz – 18 GHz, Peak, Panel

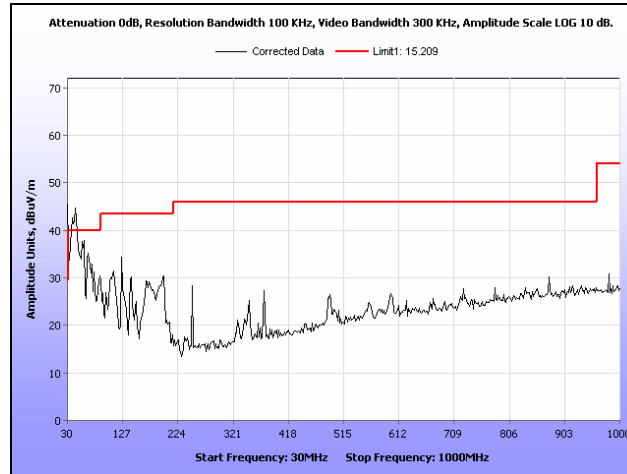

Plot 24. Radiated Spurious Emissions, High 2.4 GHz Radio, High 5.1 GHz Radio, High 5.8 GHz Radio, 30 MHz – 1 GHz, Panel

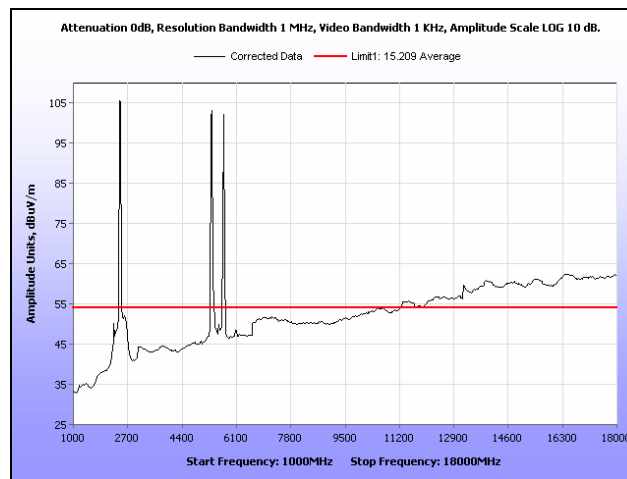

Plot 25. Radiated Spurious Emissions, High 2.4 GHz Radio, High 5.1 GHz Radio, High 5.8 GHz Radio, 1 GHz – 18 GHz, Average, Panel

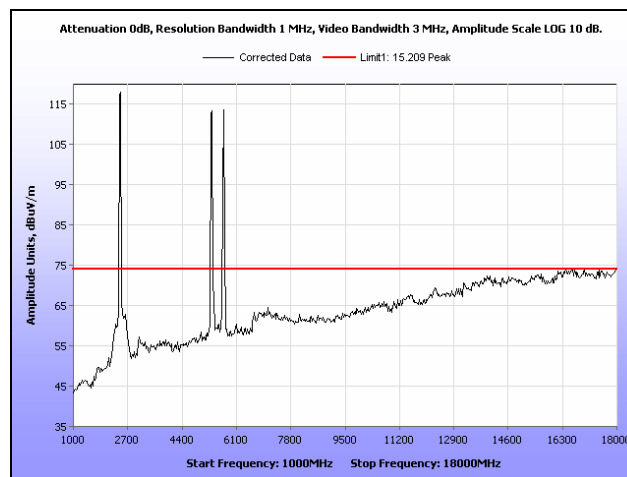

Plot 26. Radiated Spurious Emissions, High 2.4 GHz Radio, High 5.1 GHz Radio, High 5.8 GHz Radio, 1 GHz – 18 GHz, Peak, Panel

Radiated Spurious Emissions, Simultaneous Operation, Omni Antenna

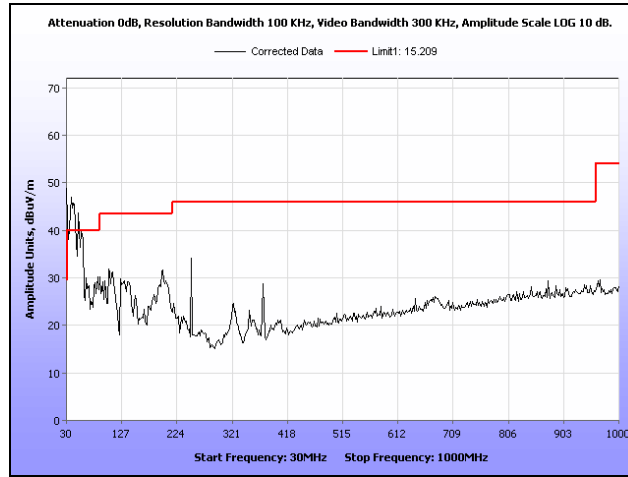

Plot 27. Radiated Spurs Emissions, Low 2.4 GHz Radio, Low 5.1 GHz Radio, Low 5.8 GHz Radio, 30 MHz – 1 GHz, Omni

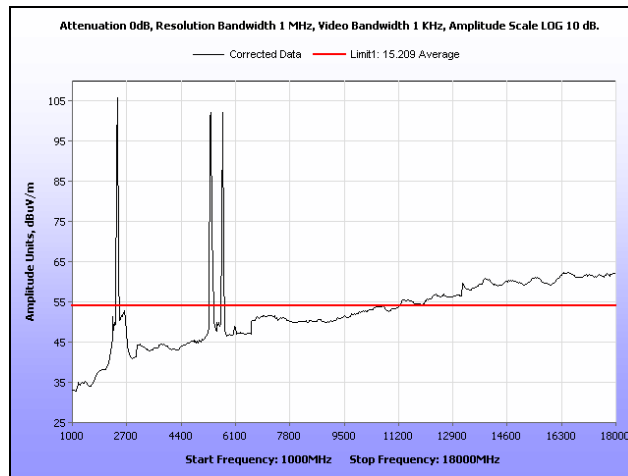

Plot 28. Radiated Spurs Emissions, Low 2.4 GHz Radio, Low 5.1 GHz Radio, Low 5.8 GHz Radio, 1 GHz – 18 GHz, Average, Omni

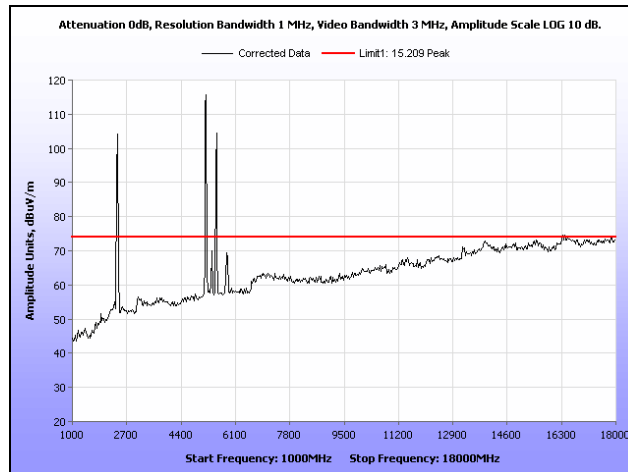

Plot 29. Radiated Spurs Emissions, Low 2.4 GHz Radio, Low 5.1 GHz Radio, Low 5.8 GHz Radio, 1 GHz – 18 GHz, Peak, Omni

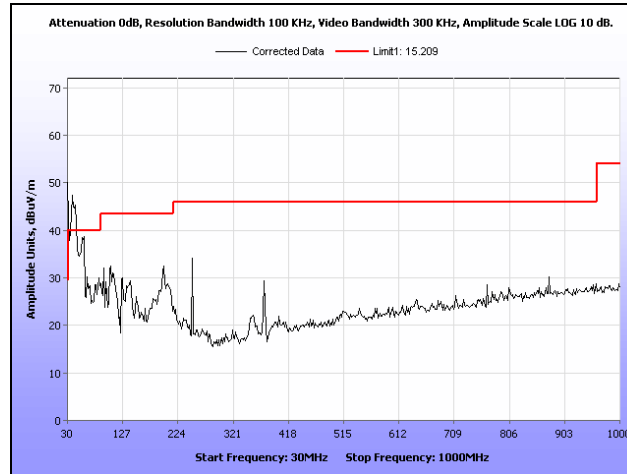

Plot 30. Radiated Spurious Emissions, Low 2.4 GHz Radio, Low 5.1 GHz Radio, High 5.8 GHz Radio, 30 MHz – 1 GHz, Omni

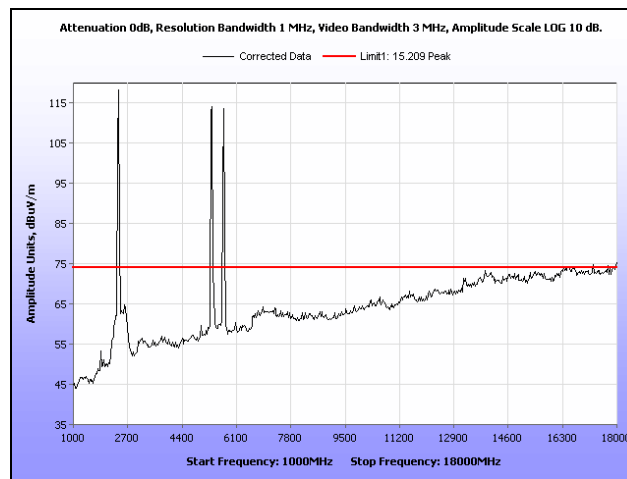

Plot 31. Radiated Spurious Emissions, Low 2.4 GHz Radio, Low 5.1 GHz Radio, High 5.8 GHz Radio, 1 GHz – 18 GHz, Average, Omni

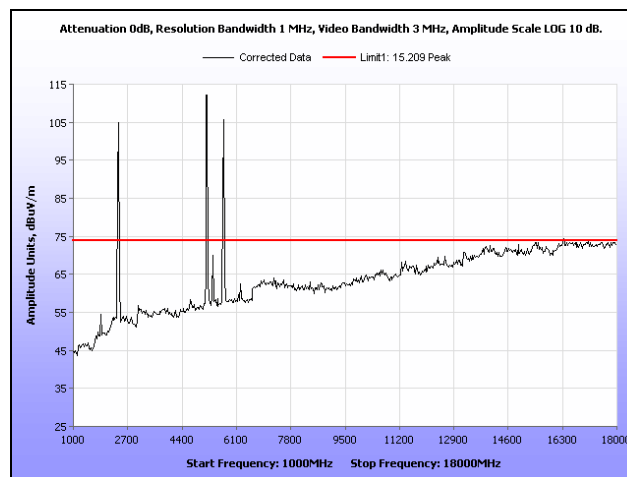

Plot 32. Radiated Spurious Emissions, Low 2.4 GHz Radio, Low 5.1 GHz Radio, High 5.8 GHz Radio, 1 GHz – 18 GHz, Peak, Omni

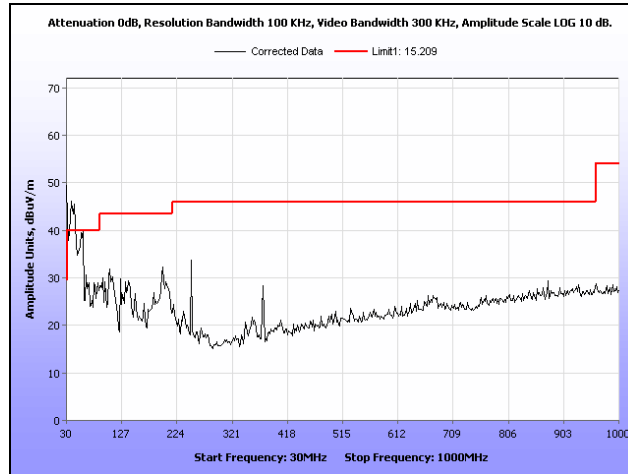

Plot 33. Radiated Spurious Emissions, Low 2.4 GHz Radio, High 5.1 GHz Radio, Low 5.8 GHz Radio, 30 MHz – 1 GHz, Omni

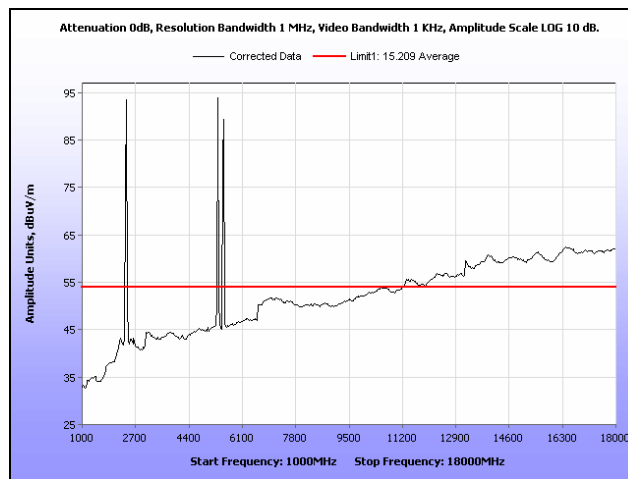

Plot 34. Radiated Spurious Emissions, Low 2.4 GHz Radio, High 5.1 GHz Radio, Low 5.8 GHz Radio, 1 GHz – 18 GHz, Average, Omni

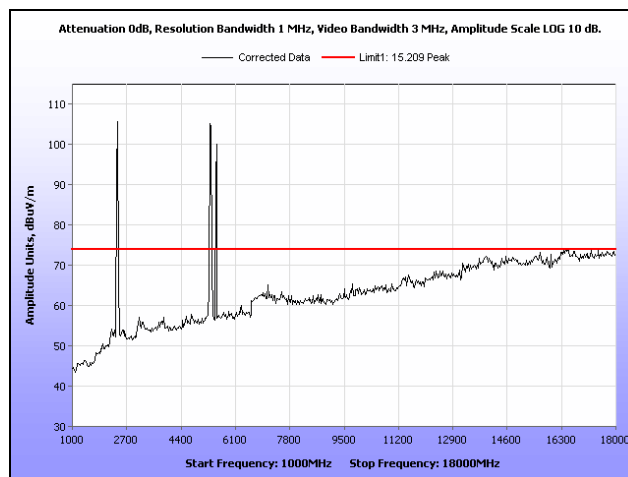

Plot 35. Radiated Spurious Emissions, Low 2.4 GHz Radio, High 5.1 GHz Radio, Low 5.8 GHz Radio, 1 GHz – 18 GHz, Peak, Omni

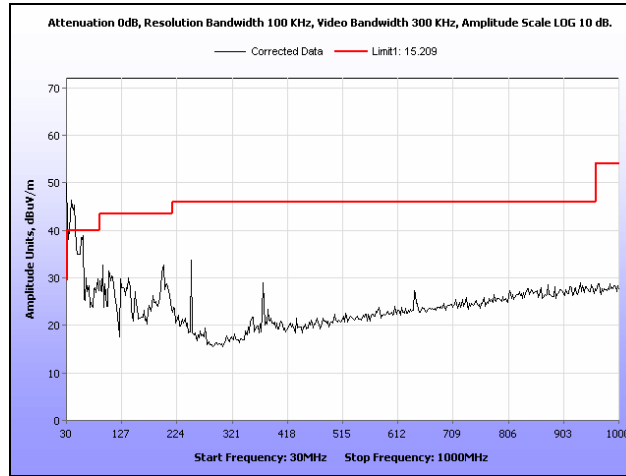

Plot 36. Radiated Spurious Emissions, Low 2.4 GHz Radio, High 5.1 GHz Radio, High 5.8 GHz Radio, 30 MHz – 1 GHz, Omni

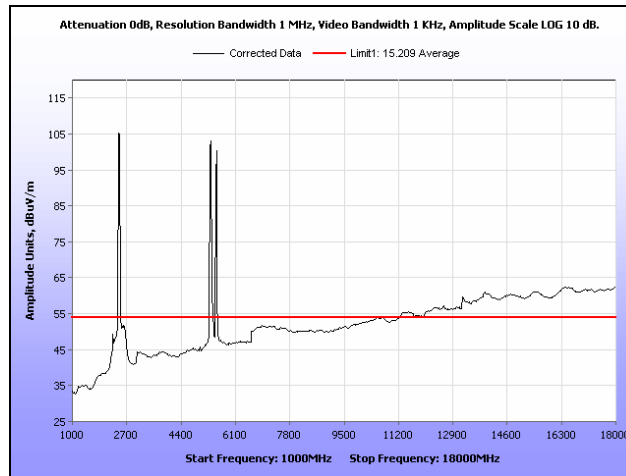

Plot 37. Radiated Spurious Emissions, Low 2.4 GHz Radio, High 5.1 GHz Radio, High 5.8 GHz Radio, 1 GHz – 18 GHz, Average, Omni

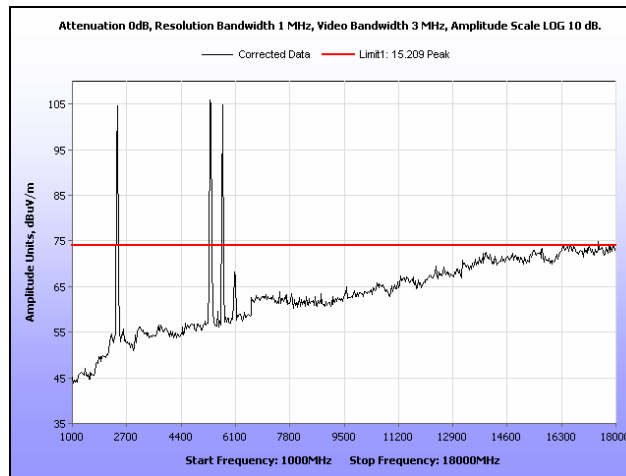

Plot 38. Radiated Spurious Emissions, Low 2.4 GHz Radio, High 5.1 GHz Radio, High 5.8 GHz Radio, 1 GHz – 18 GHz, Peak, Omni

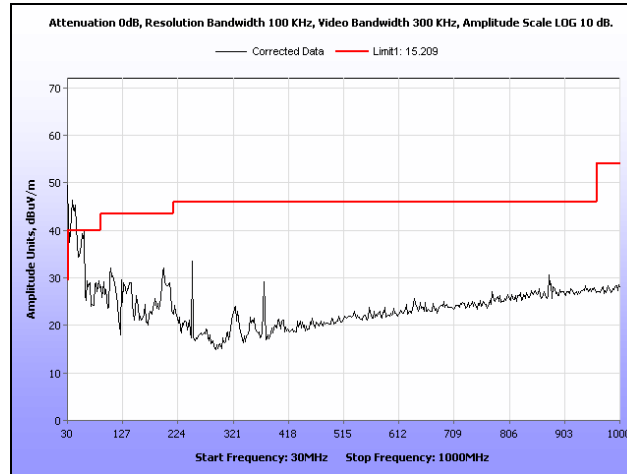

Plot 39. Radiated Spurious Emissions, High 2.4 GHz Radio, Low 5.1 GHz Radio, Low 5.8 GHz Radio, 30 MHz – 1 GHz, Omni

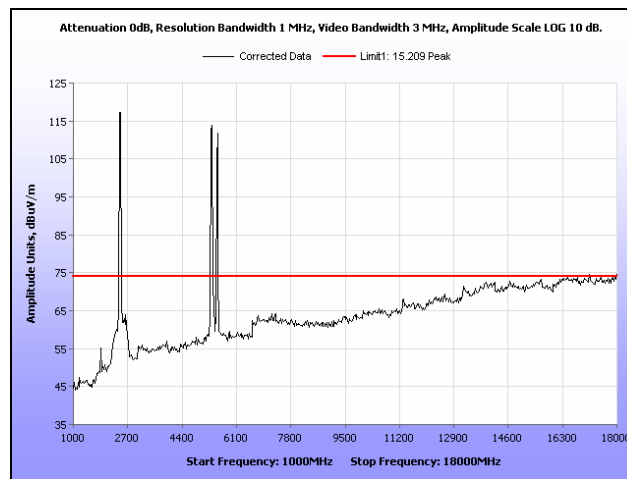

Plot 40. Radiated Spurious Emissions, High 2.4 GHz Radio, Low 5.1 GHz Radio, Low 5.8 GHz Radio, 1 GHz – 18 GHz, Average, Omni

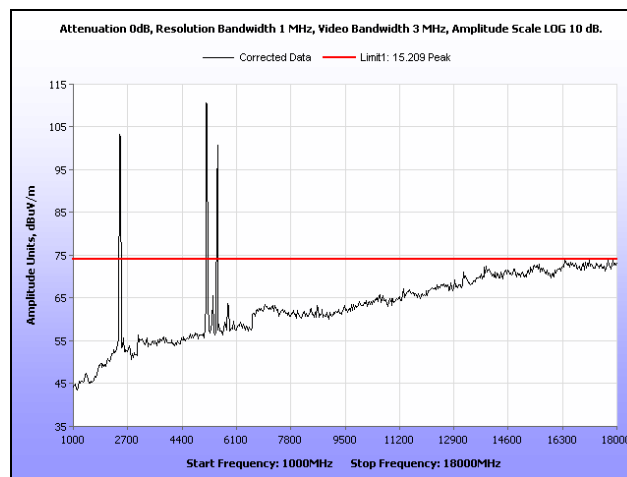

Plot 41. Radiated Spurious Emissions, High 2.4 GHz Radio, Low 5.1 GHz Radio, Low 5.8 GHz Radio, 1 GHz – 18 GHz, Peak, Omni

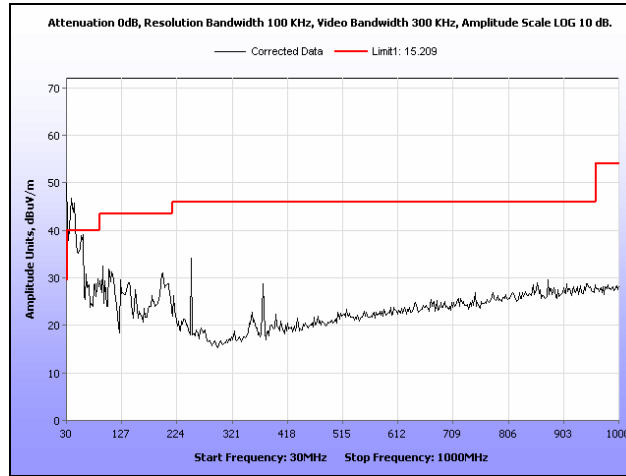

Plot 42. Radiated Spurious Emissions, High 2.4 GHz Radio, Low 5.1 GHz Radio, High 5.8 GHz Radio, 30 MHz – 1 GHz, Omni

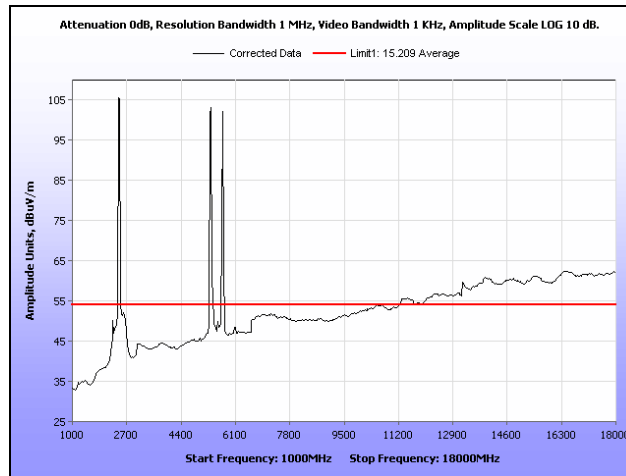

Plot 43. Radiated Spurious Emissions, High 2.4 GHz Radio, Low 5.1 GHz Radio, High 5.8 GHz Radio, 1 GHz – 18 GHz, Average, Omni

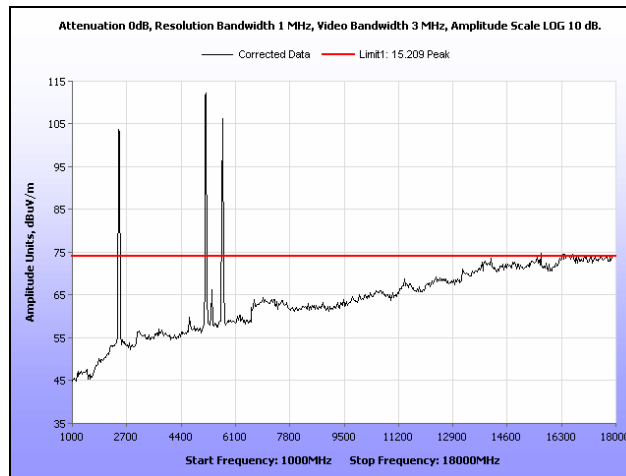

Plot 44. Radiated Spurious Emissions, High 2.4 GHz Radio, Low 5.1 GHz Radio, High 5.8 GHz Radio, 1 GHz – 18 GHz, Peak, Omni

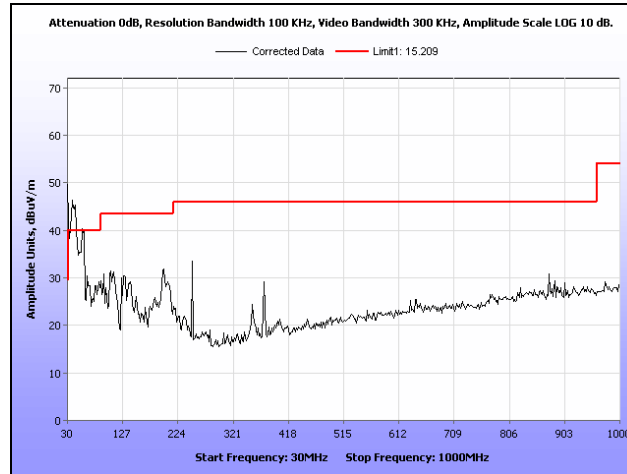

Plot 45. Radiated Spurious Emissions, High 2.4 GHz Radio, High 5.1 GHz Radio, Low 5.8 GHz Radio, 30 MHz – 1 GHz, Omni

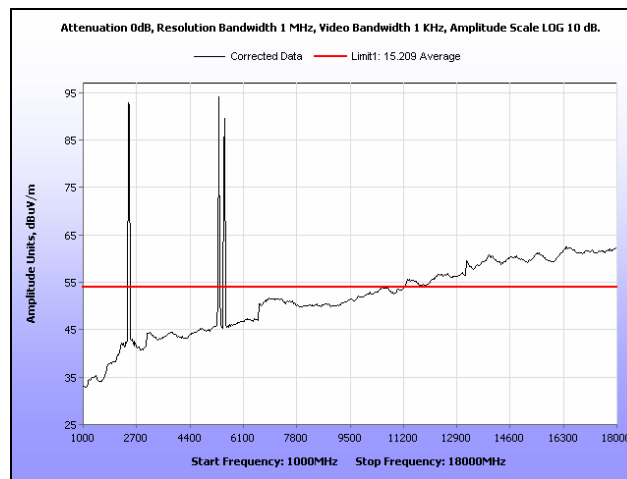

Plot 46. Radiated Spurious Emissions, High 2.4 GHz Radio, High 5.1 GHz Radio, Low 5.8 GHz Radio, 1 GHz – 18 GHz, Average, Omni

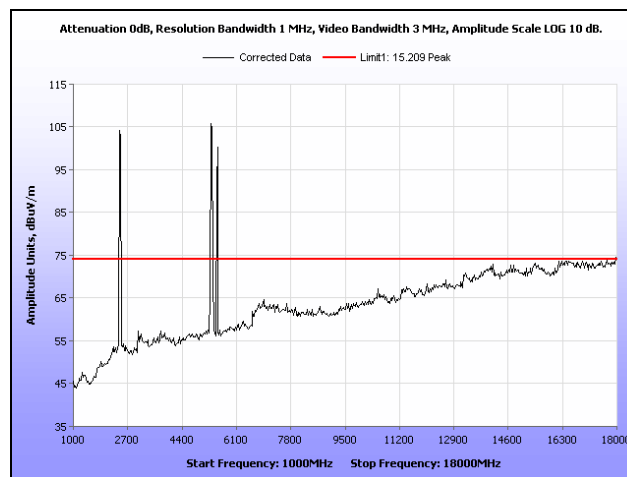

Plot 47. Radiated Spurious Emissions, High 2.4 GHz Radio, High 5.1 GHz Radio, Low 5.8 GHz Radio, 1 GHz – 18 GHz, Peak, Omni

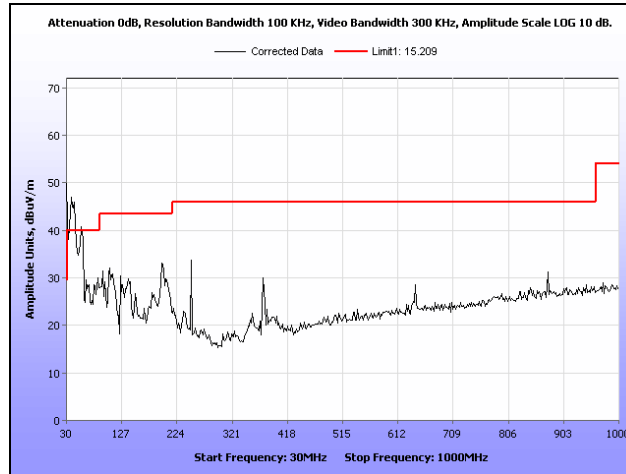

Plot 48. Radiated Spurious Emissions, High 2.4 GHz Radio, High 5.1 GHz Radio, High 5.8 GHz Radio, 30 MHz – 1 GHz, Omni

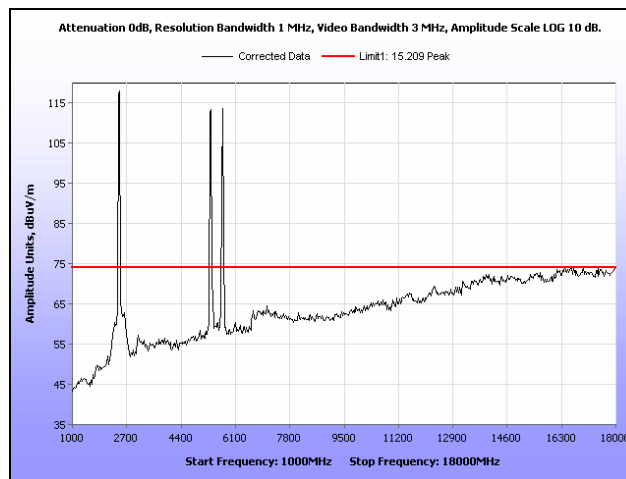

Plot 49. Radiated Spurious Emissions, High 2.4 GHz Radio, High 5.1 GHz Radio, High 5.8 GHz Radio, 1 GHz – 18 GHz, Average, Omni

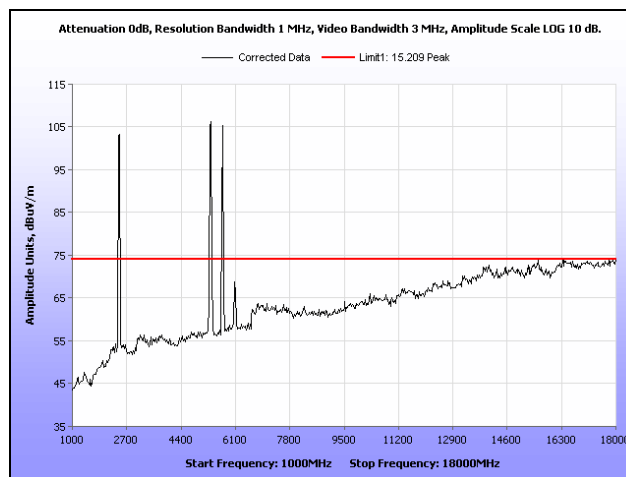

Plot 50. Radiated Spurious Emissions, High 2.4 GHz Radio, High 5.1 GHz Radio, High 5.8 GHz Radio, 1 GHz – 18 GHz, Peak, Omni

Electromagnetic Compatibility Criteria for Intentional Radiators

§ 15.247(i) Maximum Permissible Exposure

RF Exposure Requirements: §1.1307(b)(1) and §1.1307(b)(2): Systems operating under the provisions of this section shall be operated in a manner that ensures that the public is not exposed to radio frequency energy levels in excess of the Commission's guidelines.

RF Radiation Exposure Limit: §1.1310: As specified in this section, the Maximum Permissible Exposure (MPE) Limit shall be used to evaluate the environmental impact of human exposure to radiofrequency (RF) radiation as specified in Sec. 1.1307(b), except in the case of portable devices which shall be evaluated according to the provisions of Sec. 2.1093 of this chapter.

Test Results: The EUT was compliant with the requirements of this section.

Highest Antenna gain in 2.4 & 5 GHz bands is 6 dBi
Directional gain since 3x3 MIMO = $6 + 10 \log(3) = 10.77$ dBi

2.4 GHz Band	5.8 GHz	5.1 GHz
$S = \frac{PG}{4\pi R^2}$ $\frac{(559.8 \text{ mW})(10)}{4\pi(40)^2}$	$S = \frac{PG}{4\pi R^2}$ $\frac{(453.9 \text{ mW})(10)}{4\pi(40)^2}$	$S = \frac{PG}{4\pi R^2}$ $\frac{(39.4 \text{ mW})(10)}{4\pi(40)^2}$
$S1 = 0.278 \text{ mW/cm}^2$	$S2 = 0.226 \text{ mW/cm}^2$	$S3 = 0.02 \text{ mW/cm}^2$

All 3 radios operating in 2.4 GHz band:

S	Power density (mW/cm ²)	General Population Limit (mW/cm ²)	S as a fraction of the limit (%)
S1	0.278	1	27.8
S1	0.278	1	27.8
S1	0.278	1	27.8

Radios operating in each band:

S	Power density (mW/cm ²)	General Population Limit (mW/cm ²)	S as a fraction of the limit (%)
S1	0.278	1	27.8
S2	0.226	1	22.6
S3	0.02	1	2.0

The total percentages do not exceed 100 % per OET 65 requirements when the spectral power density is calculated at least 40cm away from the unit. Therefore, the EUTs meet the Uncontrolled Exposure limit.

Test Engineer(s): Ben Taylor

IV. Test Equipment

Test Equipment

Calibrated test equipment utilized during testing was maintained in a current state of calibration per the requirements of ISO/IEC 17025:2005.

MET Asset #	Equipment	Manufacturer	Model	Last Cal Date	Cal Due Date
1T4612	SPECTRUM ANALYZER	AGILENT TECHNOLOGIES	E4407B	05/23/2012	11/23/2013
1T4563	LISN (10 AMP)	SOLAR ELECTRONICS	9322-50-R-10-BNC	11/27/2012	05/27/2014
1T4502	COMB GENERATOR	COM-POWER	CGC-255	08/21/2012	02/21/2014
1T4786	HYGROMETER / THERMOMETER / BAROMETER / DEW POINT PEN	CONTROL COMPANY	15-078-198, FB70423, 245CD	02/01/2012	02/01/2014
1T4504	SHIELDED ROOM	UNIVERSAL SHIELDING CORP	N/A	NOT REQUIRED	
1T4751	ANTENNA - BILOG	SUNOL SCIENCES	JB6	01/08/2013	07/08/2014
1T4300	SEMI-ANECHOIC CHAMBER # 1 (NSA)	EMC TEST SYSTEMS	NONE	07/24/2012	01/24/2014
1T4409	EMI RECEIVER	ROHDE & SCHWARZ	ESIB7	07/16/2012	07/16/2014
1T4818	COMB GENERATOR	COM-POWER	CGO-520	SEE NOTE	
1T4787	HYGROMETER / THERMOMETER / BAROMETER / DEW POINT PEN	CONTROL COMPANY	15-078-198, FB70423, 245CD	02/15/2012	02/15/2014

Table 11. Test Equipment List

Note: Functionally tested equipment is verified using calibrated instrumentation at the time of testing.

V. Certification & User's Manual Information

Certification & User's Manual Information

A. Certification Information

The following is extracted from Title 47 of the Code of Federal Regulations, Part 2, Subpart I — Marketing of Radio frequency devices:

§ 2.801 Radio-frequency device defined.

As used in this part, a radio-frequency device is any device which in its operation is capable of Emitting radio-frequency energy by radiation, conduction, or other means. Radio- frequency devices include, but are not limited to:

- (a) The various types of radio communication transmitting devices described throughout this chapter.
- (b) *The incidental, unintentional and intentional radiators defined in Part 15 of this chapter.*
- (c) The industrial, scientific, and medical equipment described in Part 18 of this chapter.
- (d) Any part or component thereof which in use emits radio-frequency energy by radiation, conduction, or other means.

§ 2.803 Marketing of radio frequency devices prior to equipment authorization.

- (a) Except as provided elsewhere in this chapter, no person shall sell or lease, or offer for sale or lease (including advertising for sale or lease), or import, ship or distribute for the purpose of selling or leasing or offering for sale or lease, any radio frequency device unless:
 - (1) In the case of a device subject to certification, such device has been authorized by the Commission in accordance with the rules in this chapter and is properly identified and labeled as required by §2.925 and other relevant sections in this chapter; or
 - (2) In the case of a device that is not required to have a grant of equipment authorization issued by the Commission, but which must comply with the specified technical standards prior to use, such device also complies with all applicable administrative (including verification of the equipment or authorization under a Declaration of Conformity, where required), technical, labeling and identification requirements specified in this chapter.
- (d) Notwithstanding the provisions of paragraph (a) of this section, the offer for sale solely to business, commercial, industrial, scientific or medical users (but not an offer for sale to other parties or to end users located in a residential environment) of a radio frequency device that is in the conceptual, developmental, design or pre-production stage is permitted prior to equipment authorization or, for devices not subject to the equipment authorization requirements, prior to a determination of compliance with the applicable technical requirements *provided* that the prospective buyer is advised in writing at the time of the offer for sale that the equipment is subject to the FCC rules and that the equipment will comply with the appropriate rules before delivery to the buyer or to centers of distribution.

- (e)(1) Notwithstanding the provisions of paragraph (a) of this section, prior to equipment authorization or determination of compliance with the applicable technical requirements any radio frequency device may be operated, but not marketed, for the following purposes and under the following conditions:
- (i) *Compliance testing*;
 - (ii) Demonstrations at a trade show provided the notice contained in paragraph (c) of this section is displayed in a conspicuous location on, or immediately adjacent to, the device;
 - (iii) Demonstrations at an exhibition conducted at a business, commercial, industrial, scientific or medical location, but excluding locations in a residential environment, provided the notice contained in paragraphs (c) or (d) of this section, as appropriate, is displayed in a conspicuous location on, or immediately adjacent to, the device;
 - (iv) Evaluation of product performance and determination of customer acceptability, provided such operation takes place at the manufacturer's facilities during developmental, design or pre-production states; or
 - (v) Evaluation of product performance and determination of customer acceptability where customer acceptability of a radio frequency device cannot be determined at the manufacturer's facilities because of size or unique capability of the device, provided the device is operated at a business, commercial, industrial, scientific or medical user's site, but not at a residential site, during the development, design or pre-production stages.
- (e)(2) For the purpose of paragraphs (e)(1)(iv) and (e)(1)(v) of this section, the term *manufacturer's facilities* includes the facilities of the party responsible for compliance with the regulations and the manufacturer's premises, as well as the facilities of other entities working under the authorization of the responsible party in connection with the development and manufacture, but not the marketing, of the equipment.
- (f) For radio frequency devices subject to verification and sold solely to business, commercial, industrial, scientific and medical users (excluding products sold to other parties or for operation in a residential environment), parties responsible for verification of the devices shall have the option of ensuring compliance with the applicable technical specifications of this chapter at each end user's location after installation, provided that the purchase or lease agreement includes a proviso that such a determination of compliance be made and is the responsibility of the party responsible for verification of the equipment.

Certification & User's Manual Information

The following is extracted from Title 47 of the Code of Federal Regulations, Part 2, Subpart J — Equipment Authorization Procedures:

§ 2.901 Basis and Purpose

- (a) In order to carry out its responsibilities under the Communications Act and the various treaties and international regulations, and in order to promote efficient use of the radio spectrum, the Commission has developed technical standards for radio frequency equipment and parts or components thereof. The technical standards applicable to individual types of equipment are found in that part of the rules governing the service wherein the equipment is to be operated.¹ *In addition to the technical standards provided, the rules governing the service may require that such equipment be verified by the manufacturer or importer, be authorized under a Declaration of Conformity, or receive an equipment authorization from the Commission by one of the following procedures: certification or registration.*
- (b) The following sections describe the verification procedure, the procedure for a Declaration of Conformity, and the procedures to be followed in obtaining certification from the Commission and the conditions attendant to such a grant.

§ 2.907 Certification.

- (a) Certification is an equipment authorization issued by the Commission, based on representation and test data submitted by the applicant.
- (b) Certification attaches to all units subsequently marketed by the grantee which are identical (see Section 2.908) to the sample tested except for permissive changes or other variations authorized by the Commission pursuant to Section 2.1043.

¹ In this case, the equipment is subject to the rules of Part 15. More specifically, the equipment falls under Subpart B (of Part 15), which deals with unintentional radiators.

Certification & User's Manual Information

§ 2.948 Description of measurement facilities.

- (a) Each party making measurements of equipment that is subject to an equipment authorization under Part 15 or Part 18 of this chapter, regardless of whether the measurements are filed with the Commission or kept on file by the party responsible for compliance of equipment marketed within the U.S. or its possessions, shall compile a description of the measurement facilities employed.
- (1) If the measured equipment is subject to the verification procedure, the description of the measurement facilities shall be retained by the party responsible for verification of the equipment.
- (i) *If the equipment is verified through measurements performed by an independent laboratory, it is acceptable for the party responsible for verification of the equipment to rely upon the description of the measurement facilities retained by or placed on file with the Commission by that laboratory. In this situation, the party responsible for the verification of the equipment is not required to retain a duplicate copy of the description of the measurement facilities.*
- (ii) If the equipment is verified based on measurements performed at the installation site of the equipment, no specific site calibration data is required. It is acceptable to retain the description of the measurement facilities at the site at which the measurements were performed.
- (2) If the equipment is to be authorized by the Commission under the certification procedure, the description of the measurement facilities shall be filed with the Commission's Laboratory in Columbia, Maryland. The data describing the measurement facilities need only be filed once but must be updated as changes are made to the measurement facilities or as otherwise described in this section. At least every three years, the organization responsible for filing the data with the Commission shall certify that the data on file is current.

Certification & User's Manual Information

1. Label and User's Manual Information

The following is extracted from Title 47 of the Code of Federal Regulations, Part 15, Subpart A — General:

§ 15.19 Labeling requirements.

(a) *In addition to the requirements in Part 2 of this chapter, a device subject to certification or verification shall be labeled as follows:*

- (1) Receivers associated with the operation of a licensed radio service, e.g., FM broadcast under Part 73 of this chapter, land mobile operation under Part 90, etc., shall bear the following statement in a conspicuous location on the device:

This device complies with Part 15 of the FCC Rules. Operation is subject to the condition that this device does not cause harmful interference.

- (2) A stand-alone cable input selector switch, shall bear the following statement in a conspicuous location on the device:

This device is verified to comply with Part 15 of the FCC Rules for use with cable television service.

- (3) All other devices shall bear the following statement in a conspicuous location on the device:

This device complies with Part 15 of the FCC Rules. Operation is subject to the following two conditions: (1) This device may not cause harmful interference, and (2) this device must accept any interference received, including interference that may cause undesired operation.

- (4) Where a device is constructed in two or more sections connected by wires and marketed together, the statement specified under paragraph (a) of this section is required to be affixed only to the main control unit.

- (5) When the device is so small or for such use that it is not practicable to place the statement specified under paragraph (a) of this section on it, the information required by this paragraph shall be placed in a prominent location in the instruction manual or pamphlet supplied to the user or, alternatively, shall be placed on the container in which the device is marketed. However, the FCC identifier or the unique identifier, as appropriate, must be displayed on the device.

§ 15.21 Information to user.

The user's manual or instruction manual for an intentional or unintentional radiator shall caution the user that changes or modifications not expressly approved by the party responsible for compliance could void the user's authority to operate the equipment.

Verification & User's Manual Information

The following is extracted from Title 47 of the Code of Federal Regulations, Part 15, Subpart B — Unintentional Radiators:

§ 15.105 Information to the user.

- (a) For a Class A digital device or peripheral, the instructions furnished the user shall include the following or similar statement, placed in a prominent location in the text of the manual:

Note: This equipment has been tested and found to comply with the limits for a Class A digital device, pursuant to Part 15 of the FCC Rules. These limits are designed to provide reasonable protection against harmful interference when the equipment is operated in a commercial environment. This equipment generates, uses, and can radiate radio frequency energy and, if not installed and used in accordance with the instruction manual, may cause harmful interference to radio communications. Operation of this equipment in a residential area is likely to cause harmful interference in which case the user will be required to correct the interference at own expense.

- (b) For a Class B digital device or peripheral, the instructions furnished the user shall include the following or similar statement, placed in a prominent location in the text of the manual:

Note: This equipment has been tested and found to comply with the limits for a Class B digital device, pursuant to Part 15 of the FCC Rules. These limits are designed to provide reasonable protection against harmful interference when the equipment is operated in a residential environment. This equipment generates, uses, and can radiate radio frequency energy and, if not installed and used in accordance with the instruction manual, may cause harmful interference to radio communications. However, there is no guarantee that interference will not occur in a particular installation. If this equipment does cause harmful interference to radio or television reception, which can be determined by turning the equipment off and on, the user is encouraged to try to correct the interference by one or more of the following measures:

- Reorient or relocate the receiving antenna.
- Increase the separation between the equipment and receiver.
- Connect the equipment into an outlet on a circuit different from that to which the receiver is connected.
- Consult the dealer or an experienced radio/TV technician for help.

ICES-003 Procedural & Labeling Requirements

From the Industry Canada Electromagnetic Compatibility Advisory Bulletin entitled, "Implementation and Interpretation of the Interference-Causing Equipment Standard for Digital Apparatus, ICES-003" (EMCAB-3, Issue 2, July 1995):

"At present, CISPR 22: 2002 and ICES technical requirements are essentially equivalent. Therefore, if you have CISPR 22: 2002 approval by meeting CISPR Publication 22, the only additional requirements are: to attach a note to the report of the test results for compliance, indicating that these results are deemed satisfactory evidence of compliance with ICES-003 of the Canadian Interference-Causing Equipment Regulations; to maintain these records on file for the requisite five year period; and to provide the device with a notice of compliance in accordance with ICES-003."

Procedural Requirements:

According to Industry Canada's Interference Causing Equipment Standard for Digital Apparatus ICES-003 Issue 5 August 2012:

- Section 6.1: A record of the measurements and results, showing the date that the measurements were completed, shall be retained by the manufacturer or importer for a period of at least five years from the date shown in the record and made available for examination on the request of the Minister.
- Section 6.2: A written notice indicating compliance must accompany each unit of digital apparatus to the end user. The notice shall be in the form of a label that is affixed to the apparatus. Where because of insufficient space or other constraints it is not feasible to affix a label to the apparatus, the notice may be in the form of a statement in the users' manual.

Labeling Requirements:

The suggested text for the notice, in English and in French, is provided below, from the Annex of ICES-003:

This Class [²] digital apparatus complies with Canadian ICES-003.

Cet appareil numérique de la classe [¹] est conforme à la norme NMB-003 du Canada.

² Insert either A or B but not both as appropriate for the equipment requirements.

End of Report