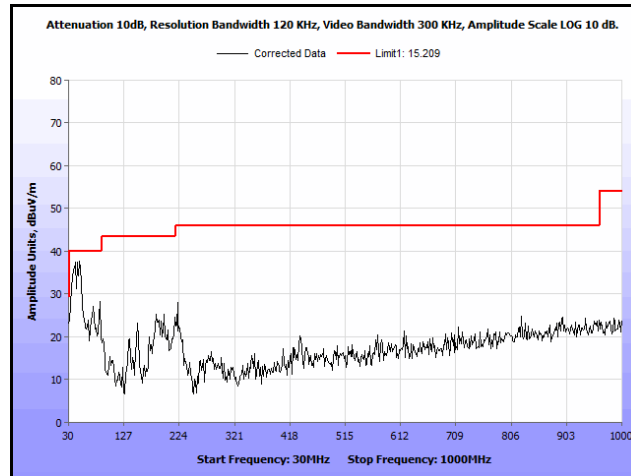
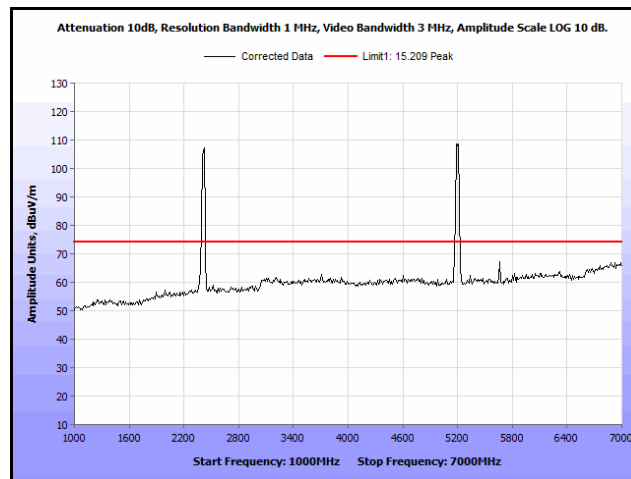


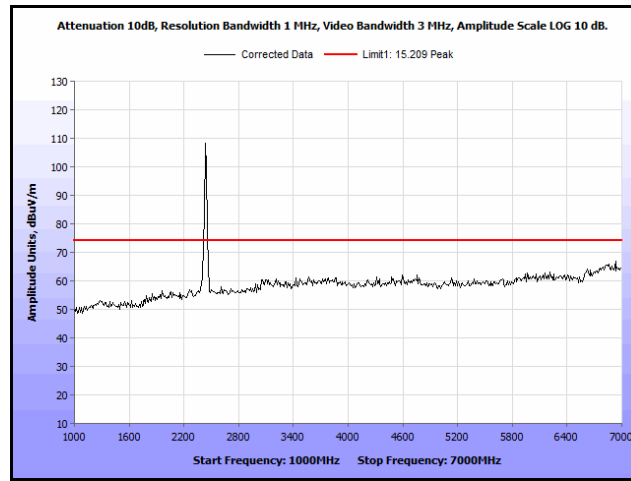
**Plot 181. Radiated Spurs, Co-Location, 802.11n 20 MHz, 2437 MHz & 2437 MHz, 7 GHz – 18 GHz, Peak**



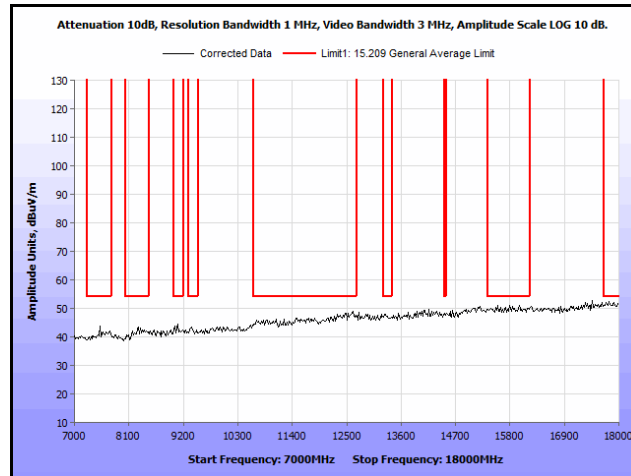
**Plot 182. Radiated Spurs, Co-Location, 802.11n 20 MHz, 2437 MHz & 2462 MHz, 30 MHz – 1 GHz, Peak**



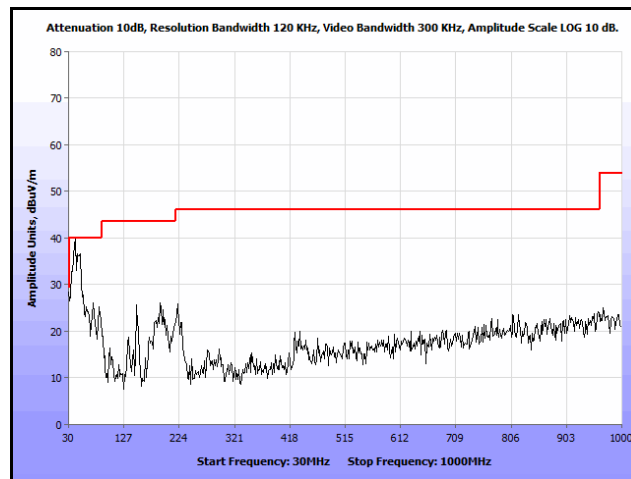
**Plot 183. Radiated Spurs, Co-Location, 802.11n 20 MHz, 2437 MHz & 2462 MHz, 1 GHz – 7 GHz, Avg.**



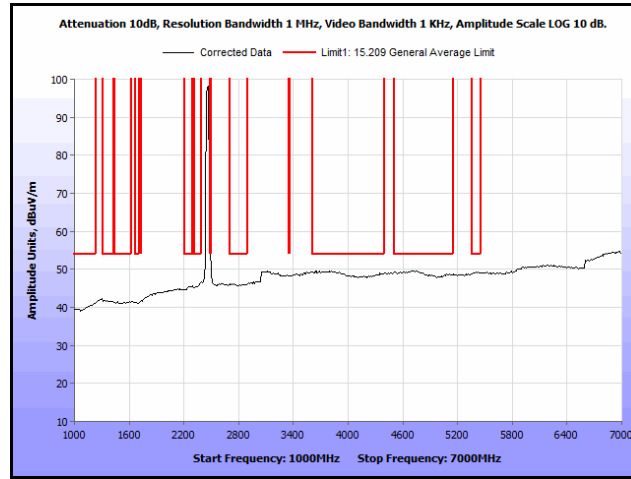
Plot 184. Radiated Spurs, Co-Location, 802.11n 20 MHz, 2437 MHz & 2462 MHz, 1 GHz – 7 GHz, Peak



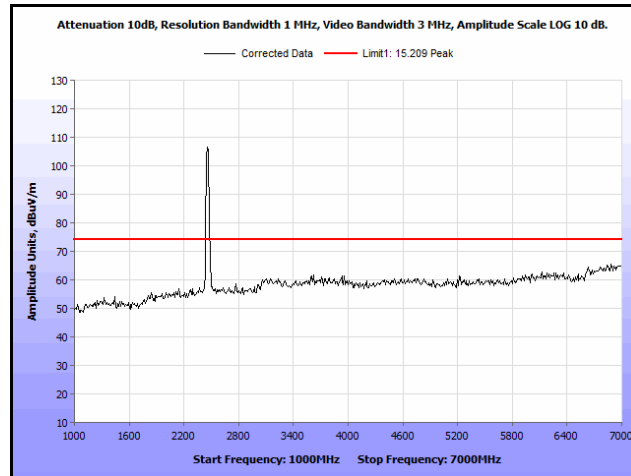
Plot 185. Radiated Spurs, Co-Location, 802.11n 20 MHz, 2437 MHz & 2462 MHz, 7 GHz – 18 GHz, Peak



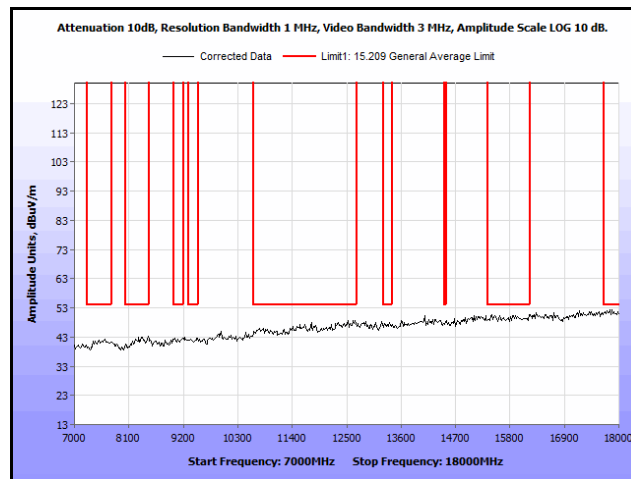
Plot 186. Radiated Spurs, Co-Location, 802.11n 20 MHz, 2462 MHz & 2462 MHz, 30 MHz – 1 GHz, Peak



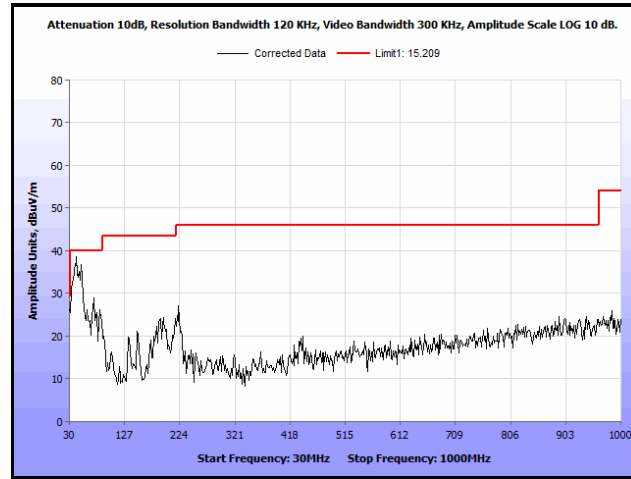
Plot 187. Radiated Spurs, Co-Location, 802.11n 20 MHz, 2462 MHz & 2462 MHz, 1 GHz – 7 GHz, Avg.



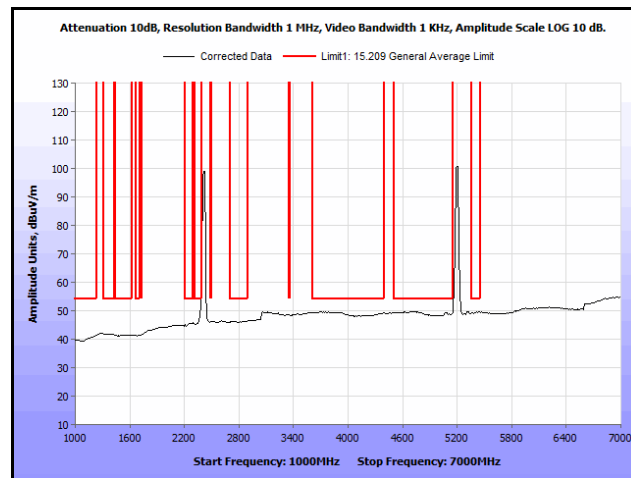
Plot 188. Radiated Spurs, Co-Location, 802.11n 20 MHz, 2462 MHz & 2462 MHz, 1 GHz – 7 GHz, Peak



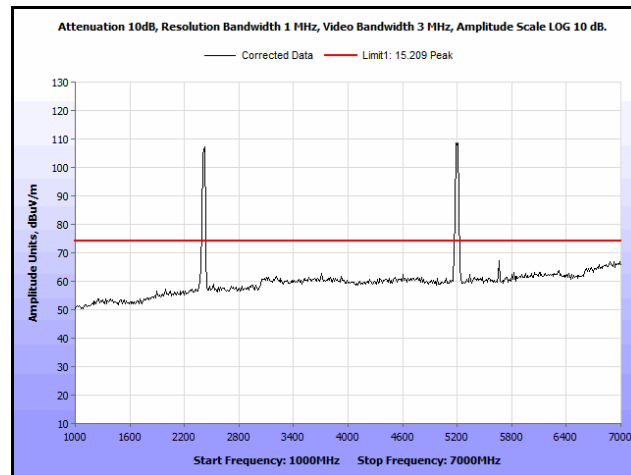
Plot 189. Radiated Spurs, Co-Location, 802.11n 20 MHz, 2462 MHz & 2462 MHz, 7 GHz – 18 GHz, Peak



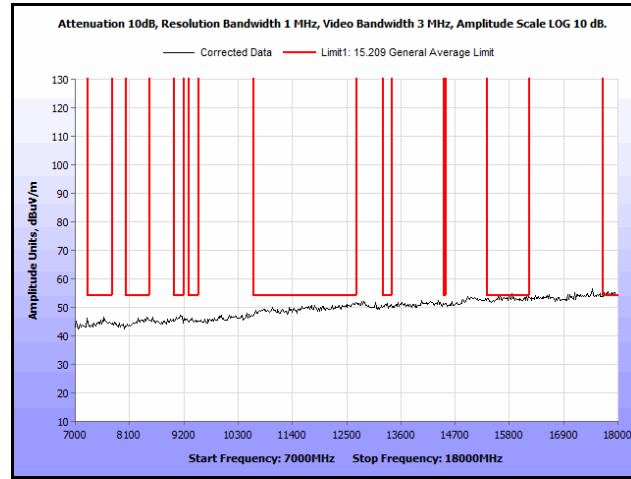
Plot 190. Radiated Spurs, Co-Location, 802.11n 20 MHz, 2412 MHz & 5200 MHz, 30 MHz – 1 GHz, Peak



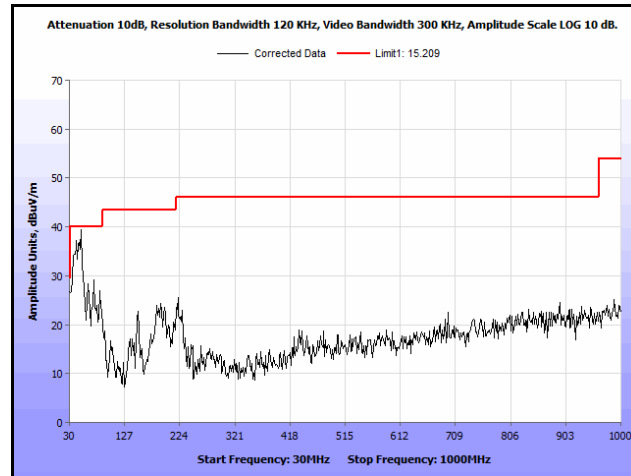
Plot 191. Radiated Spurs, Co-Location, 802.11n 20 MHz, 2412 MHz & 5200 MHz, 1 GHz – 7 GHz, Avg.



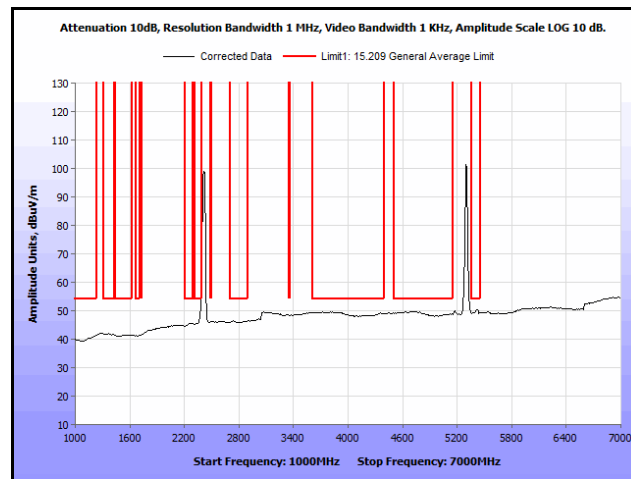
Plot 192. Radiated Spurs, Co-Location, 802.11n 20 MHz, 2412 MHz & 5200 MHz, 1 GHz – 7 GHz, Peak



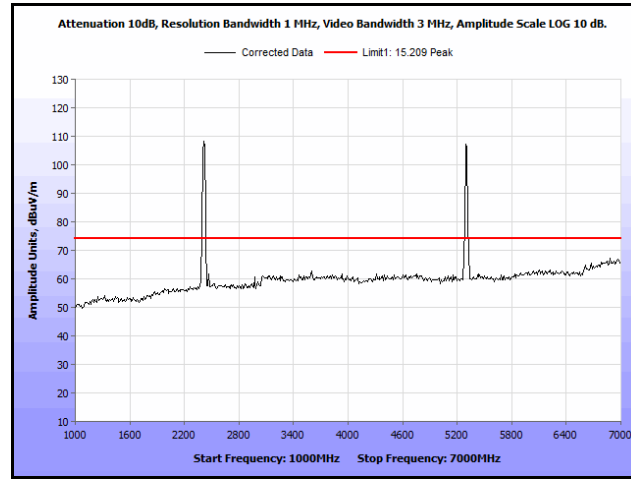
**Plot 193. Radiated Spurs, Co-Location, 802.11n 20 MHz, 2412 MHz & 5200 MHz, 7 GHz – 18 GHz, Peak**



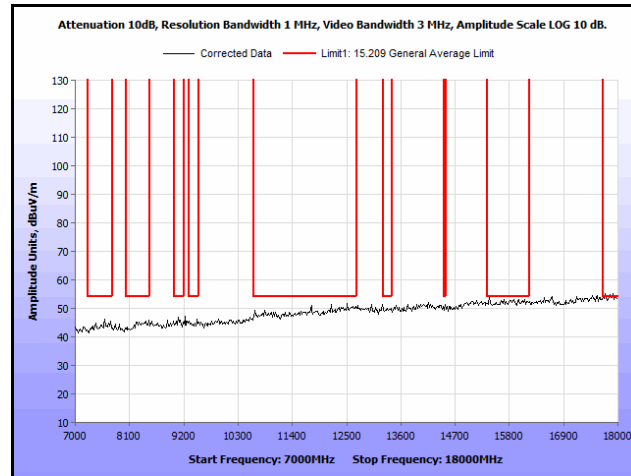
**Plot 194. Radiated Spurs, Co-Location, 802.11n 20 MHz, 2412 MHz & 5300 MHz, 30 MHz – 1 GHz, Peak**



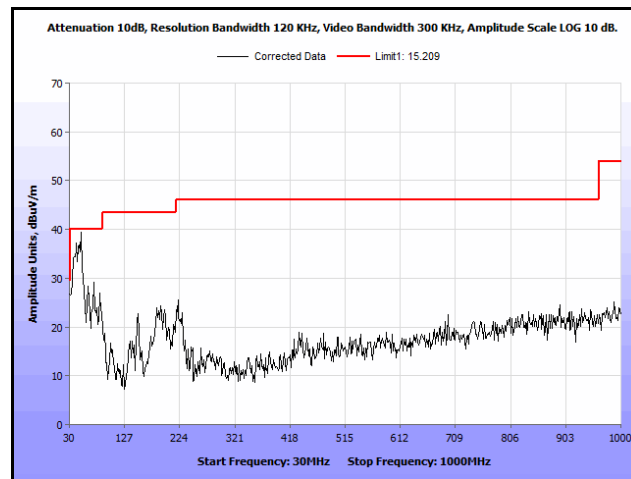
**Plot 195. Radiated Spurs, Co-Location, 802.11n 20 MHz, 2412 MHz & 5300 MHz, 1 GHz – 7 GHz, Avg.**



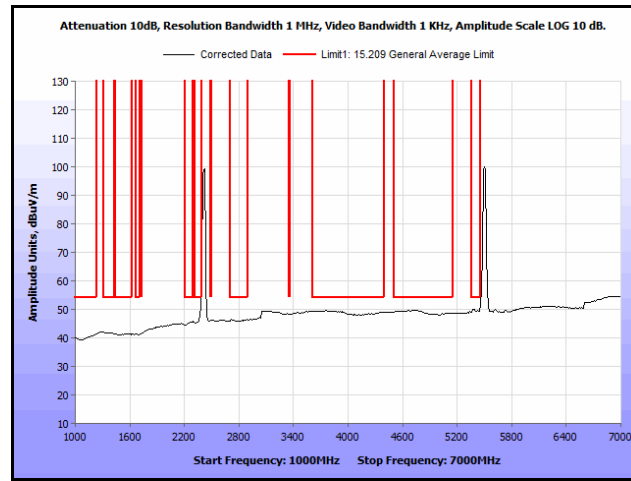
**Plot 196. Radiated Spurs, Co-Location, 802.11n 20 MHz, 2412 MHz & 5300 MHz, 1 GHz – 7 GHz, Peak**



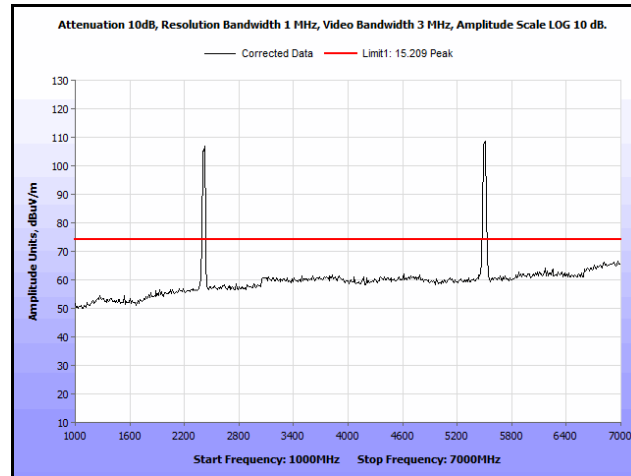
**Plot 197. Radiated Spurs, Co-Location, 802.11n 20 MHz, 2412 MHz & 5300 MHz, 7 GHz – 18 GHz, Peak**



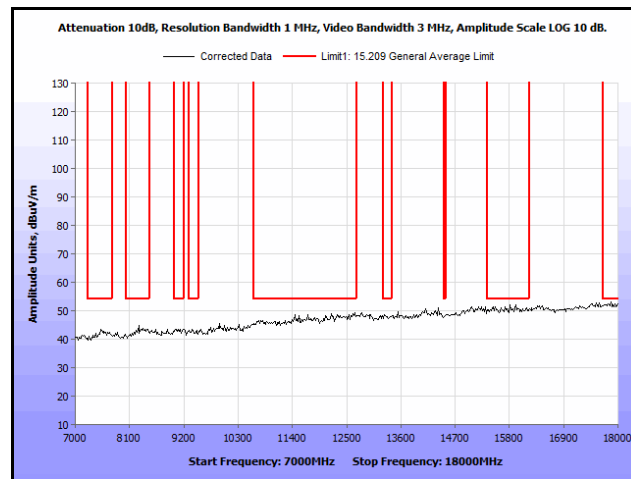
**Plot 198. Radiated Spurs, Co-Location, 802.11n 20 MHz, 2412 MHz & 5580 MHz, 30 MHz – 1 GHz, Peak**



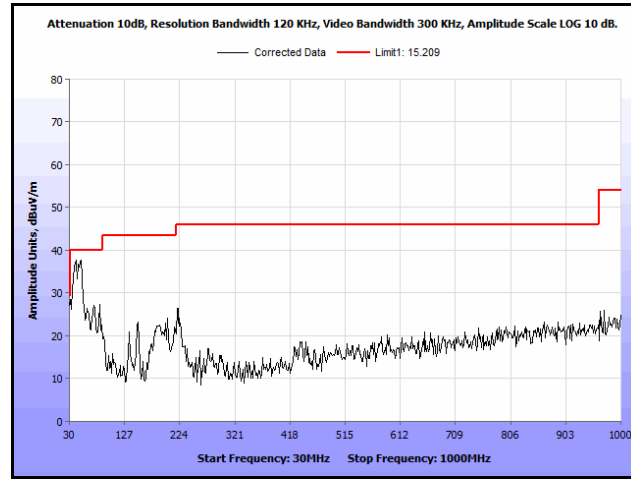
Plot 199. Radiated Spurs, Co-Location, 802.11n 20 MHz, 2412 MHz & 5580 MHz, 1 GHz – 7 GHz, Avg.



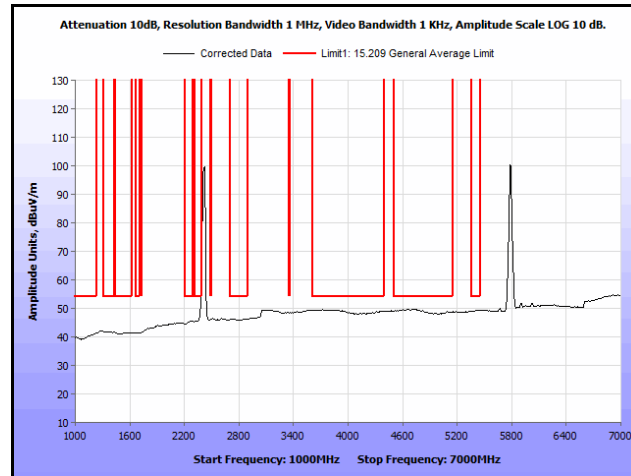
Plot 200. Radiated Spurs, Co-Location, 802.11n 20 MHz, 2412 MHz & 5580 MHz, 1 GHz – 7 GHz, Peak



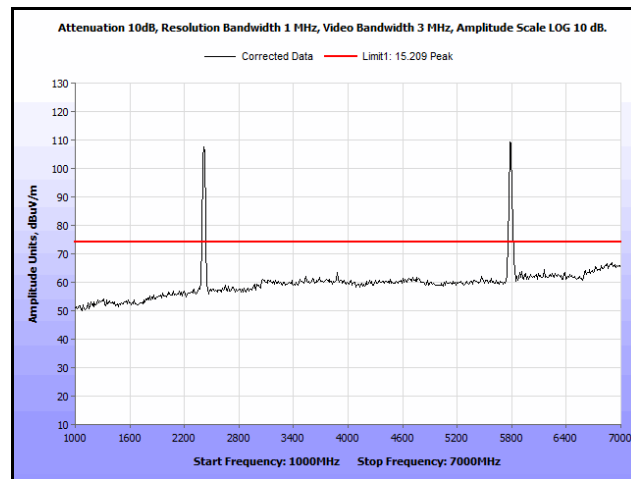
Plot 201. Radiated Spurs, Co-Location, 802.11n 20 MHz, 2412 MHz & 5580 MHz, 7 GHz – 18 GHz, Peak



Plot 202. Radiated Spurs, Co-Location, 802.11n 20 MHz, 2412 MHz & 5785 MHz, 30 MHz – 1 GHz, Peak

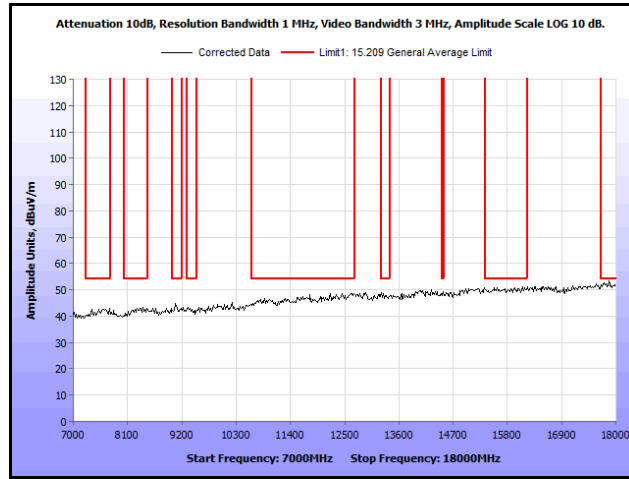


Plot 203. Radiated Spurs, Co-Location, 802.11n 20 MHz, 2412 MHz & 5785 MHz, 1 GHz – 7 GHz, Avg.

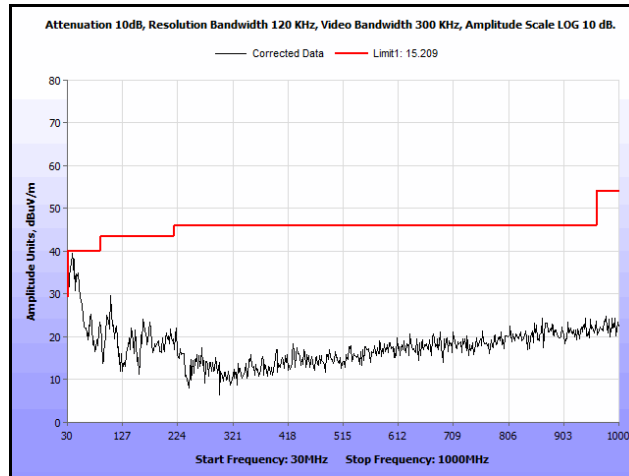


Plot 204. Radiated Spurs, Co-Location, 802.11n 20 MHz, 2412 MHz & 5785 MHz, 1 GHz – 7 GHz, Peak

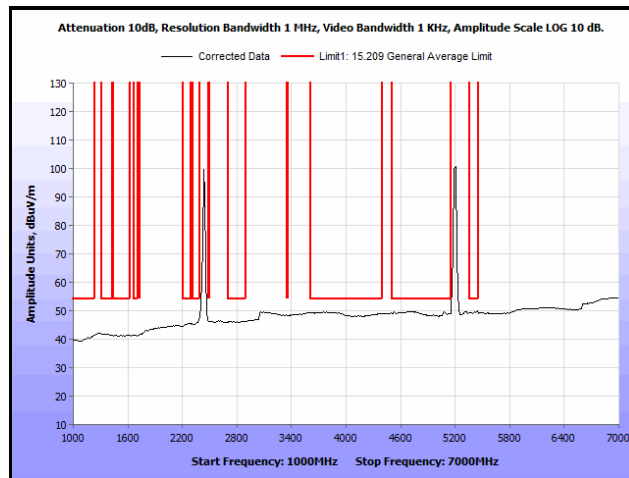




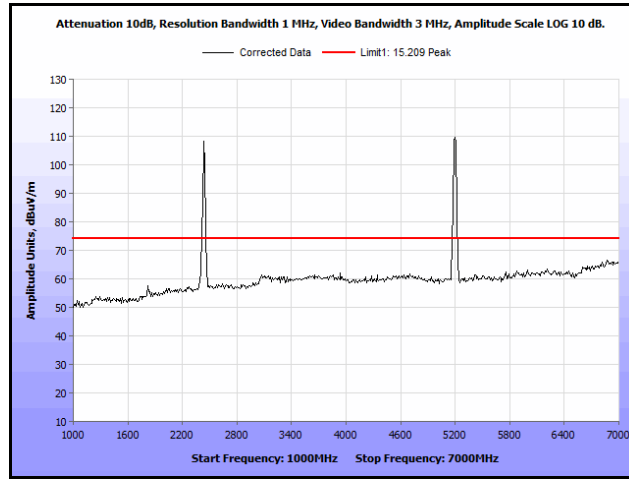
**Plot 205. Radiated Spurs, Co-Location, 802.11n 20 MHz, 2412 MHz & 5785 MHz, 7 GHz – 18 GHz, Peak**



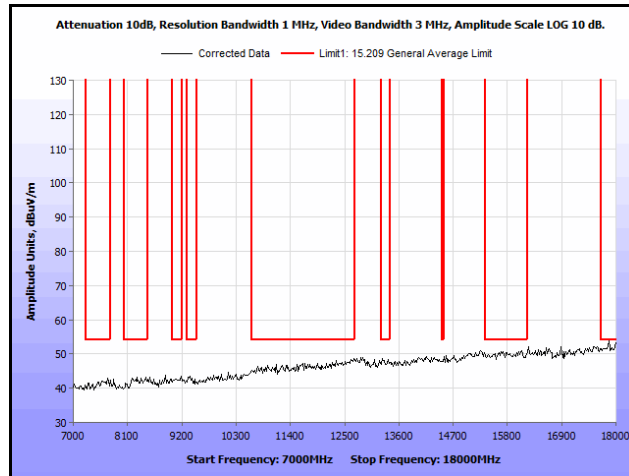
**Plot 206. Radiated Spurs, Co-Location, 802.11n 20 MHz, 2437 MHz & 5200 MHz, 30 MHz – 1 GHz, Peak**



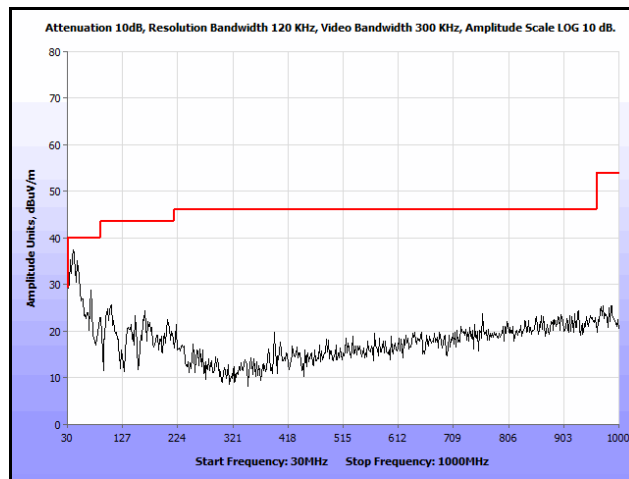
**Plot 207. Radiated Spurs, Co-Location, 802.11n 20 MHz, 2437 MHz & 5200 MHz, 1 GHz – 7 GHz, Avg.**



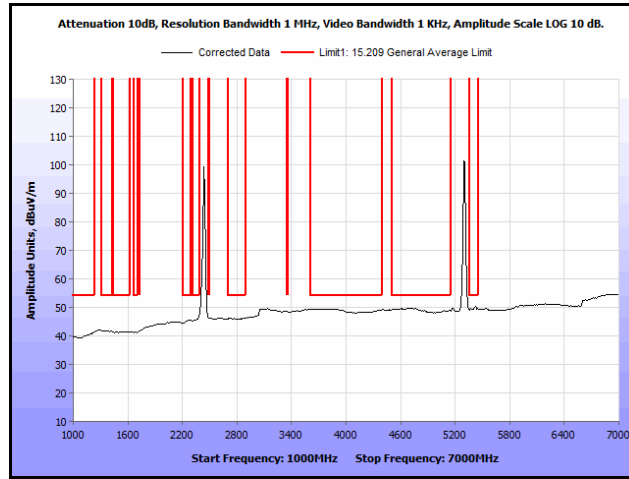
**Plot 208. Radiated Spurs, Co-Location, 802.11n 20 MHz, 2437 MHz & 5200 MHz, 1 GHz – 7 GHz, Peak**



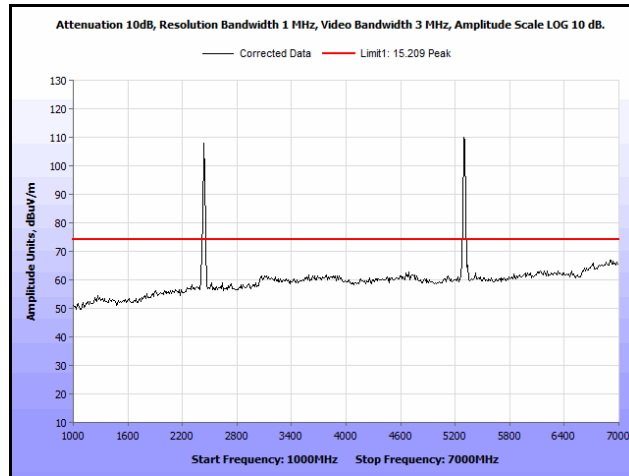
**Plot 209. Radiated Spurs, Co-Location, 802.11n 20 MHz, 2437 MHz & 5200 MHz, 7 GHz – 18 GHz, Peak**



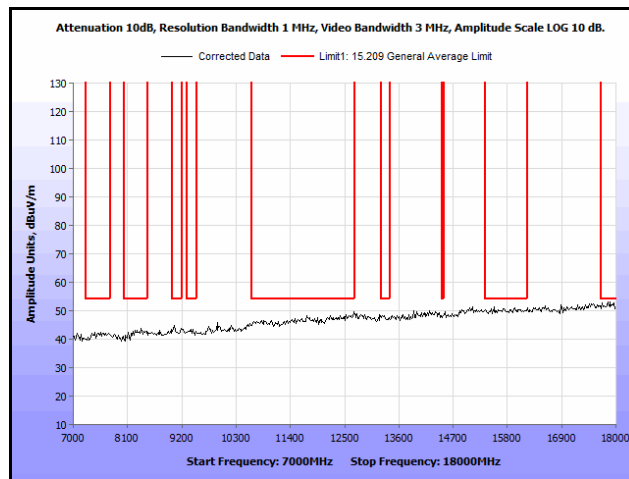
**Plot 210. Radiated Spurs, Co-Location, 802.11n 20 MHz, 2437 MHz & 5300 MHz, 30 MHz – 1 GHz, Peak**



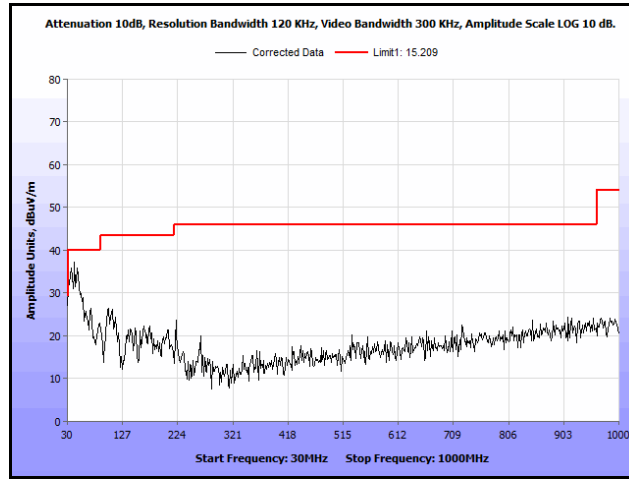
Plot 211. Radiated Spurs, Co-Location, 802.11n 20 MHz, 2437 MHz & 5300 MHz, 1 GHz – 7 GHz, Avg.



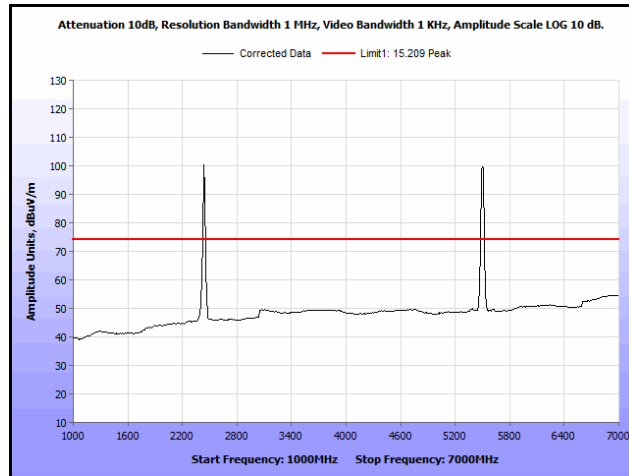
Plot 212. Radiated Spurs, Co-Location, 802.11n 20 MHz, 2437 MHz & 5300 MHz, 1 GHz – 7 GHz, Peak



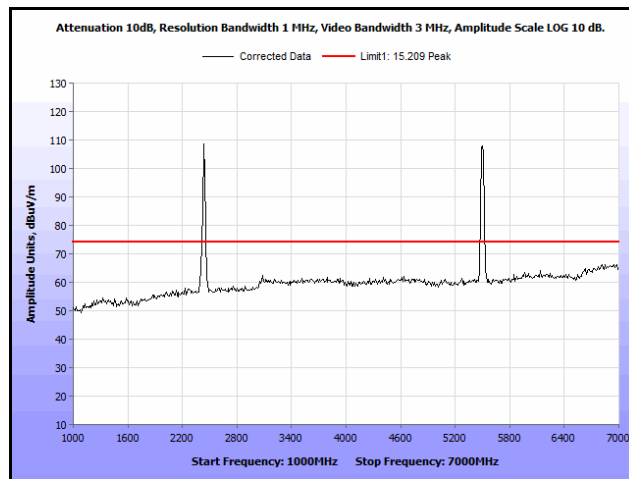
Plot 213. Radiated Spurs, Co-Location, 802.11n 20 MHz, 2437 MHz & 5300 MHz, 7 GHz – 18 GHz, Peak



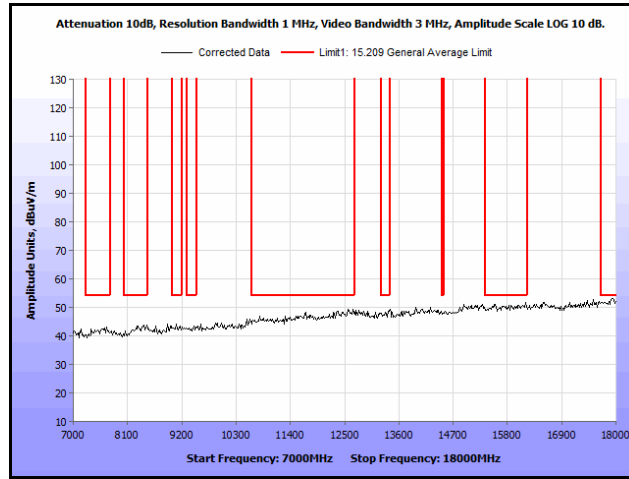
Plot 214. Radiated Spurs, Co-Location, 802.11n 20 MHz, 2437 MHz & 5580 MHz, 30 MHz – 1 GHz, Peak



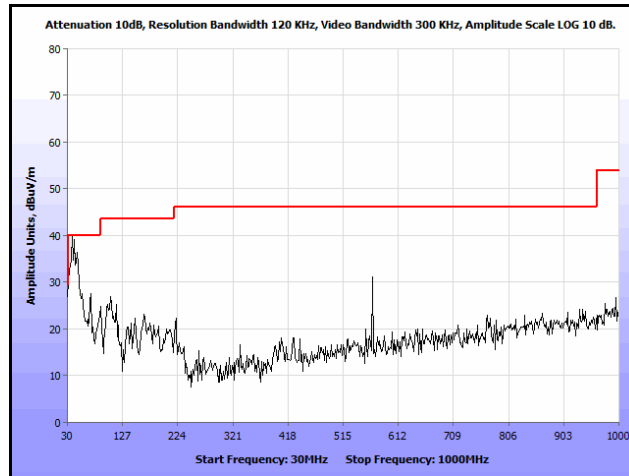
Plot 215. Radiated Spurs, Co-Location, 802.11n 20 MHz, 2437 MHz & 5580 MHz, 1 GHz – 7 GHz, Avg.



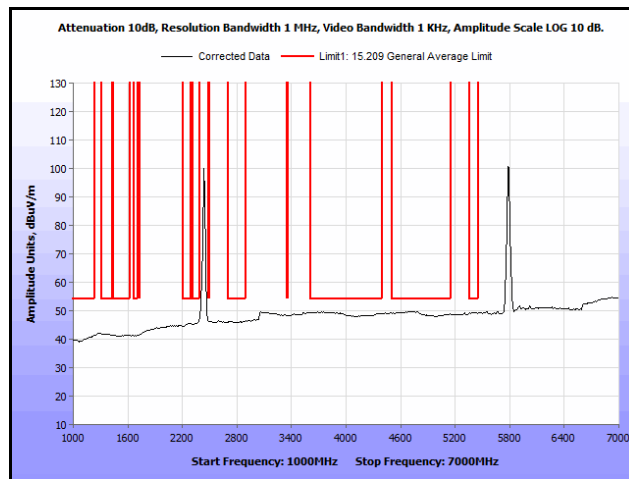
Plot 216. Radiated Spurs, Co-Location, 802.11n 20 MHz, 2437 MHz & 5580 MHz, 1 GHz – 7 GHz, Peak



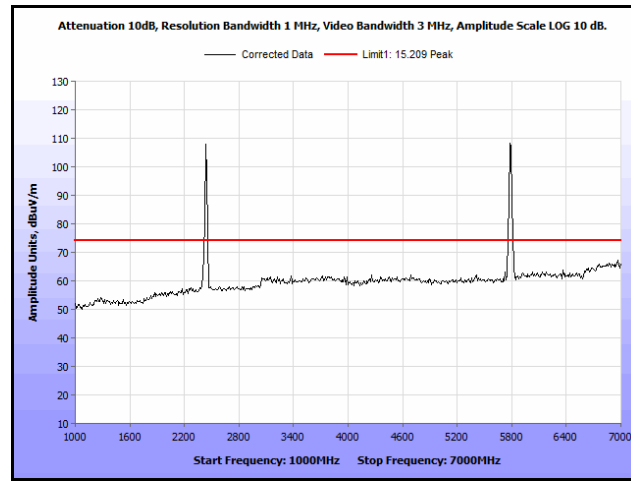
**Plot 217. Radiated Spurs, Co-Location, 802.11n 20 MHz, 2437 MHz & 5580 MHz, 7 GHz – 18 GHz, Peak**



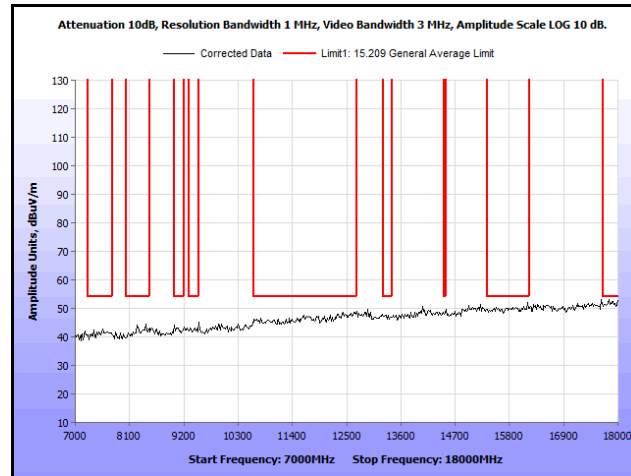
**Plot 218. Radiated Spurs, Co-Location, 802.11n 20 MHz, 2437 MHz & 5785 MHz, 30 MHz – 1 GHz, Peak**



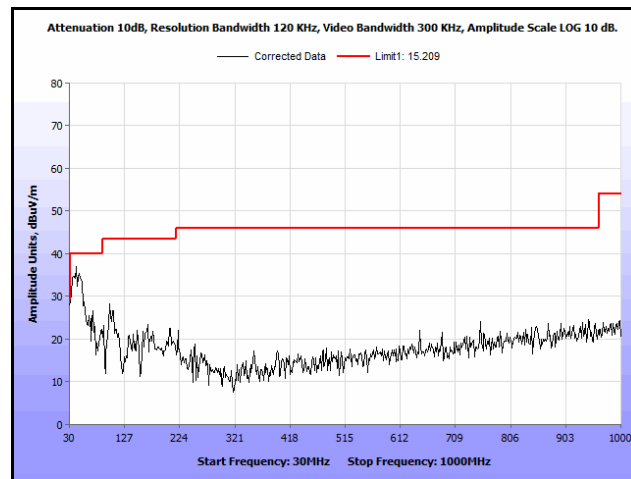
**Plot 219. Radiated Spurs, Co-Location, 802.11n 20 MHz, 2437 MHz & 5785 MHz, 1 GHz – 7 GHz, Avg.**



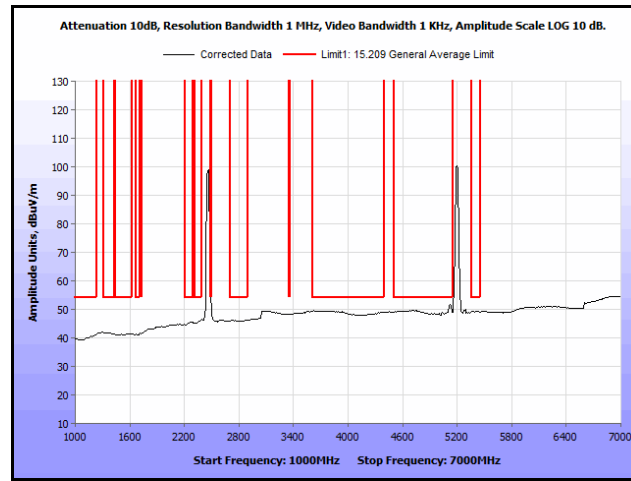
Plot 220. Radiated Spurs, Co-Location, 802.11n 20 MHz, 2437 MHz & 5785 MHz, 1 GHz – 7 GHz, Peak



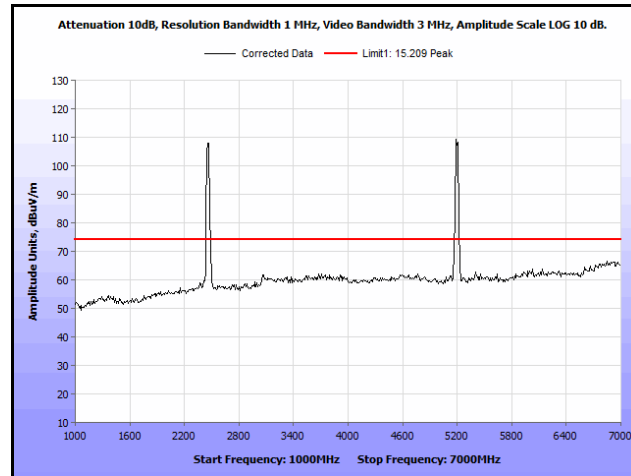
Plot 221. Radiated Spurs, Co-Location, 802.11n 20 MHz, 2437 MHz & 5785 MHz, 7 GHz – 18 GHz, Peak



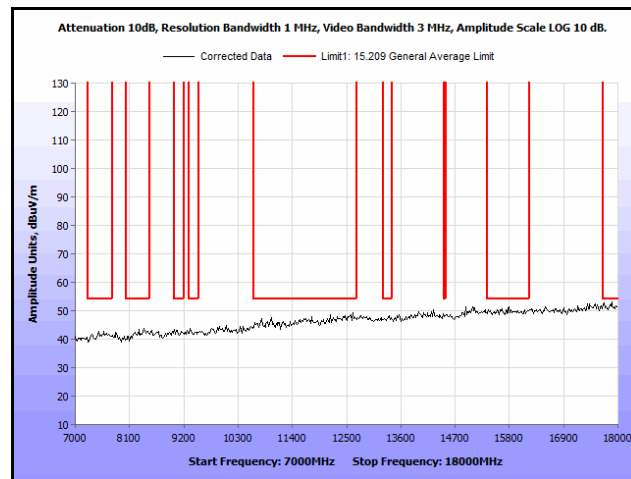
Plot 222. Radiated Spurs, Co-Location, 802.11n 20 MHz, 2462 MHz & 5200 MHz, 30 MHz – 1 GHz, Peak



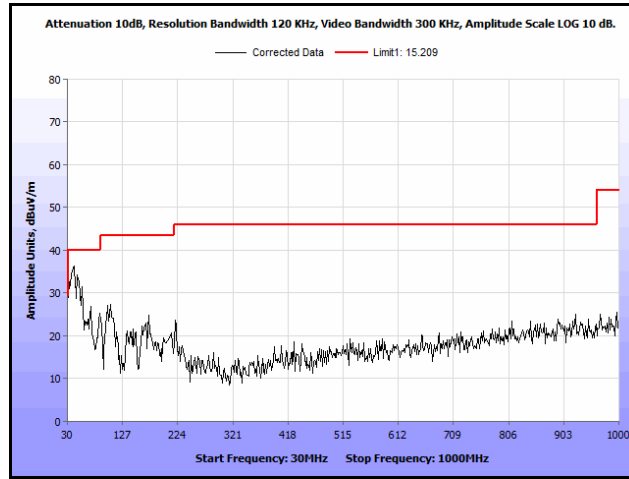
Plot 223. Radiated Spurs, Co-Location, 802.11n 20 MHz, 2462 MHz & 5200 MHz, 1 GHz – 7 GHz, Avg.



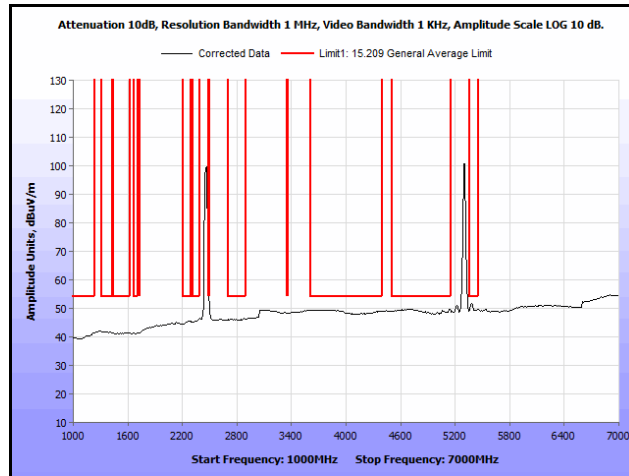
Plot 224. Radiated Spurs, Co-Location, 802.11n 20 MHz, 2462 MHz & 5200 MHz, 1 GHz – 7 GHz, Peak



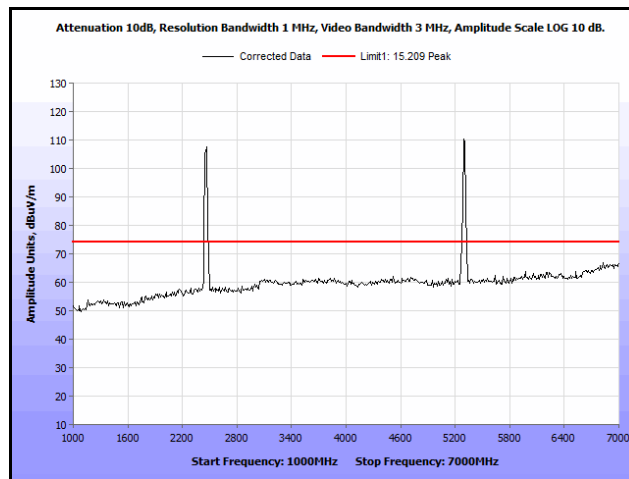
Plot 225. Radiated Spurs, Co-Location, 802.11n 20 MHz, 2462 MHz & 5200 MHz, 7 GHz – 18 GHz, Peak



Plot 226. Radiated Spurs, Co-Location, 802.11n 20 MHz, 2462 MHz & 5300 MHz, 30 MHz – 1 GHz, Peak

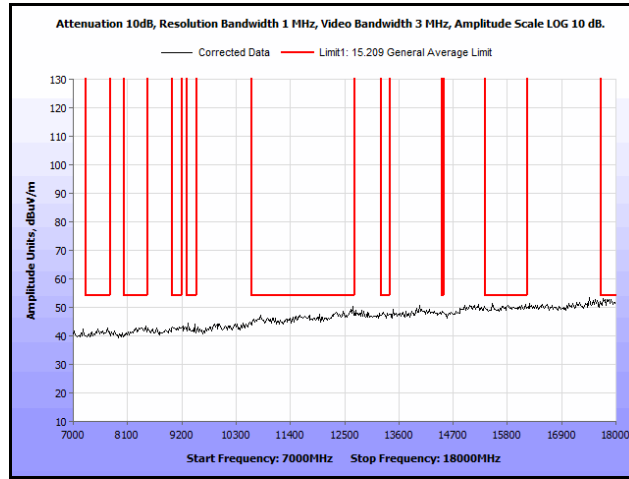


Plot 227. Radiated Spurs, Co-Location, 802.11n 20 MHz, 2462 MHz & 5300 MHz, 1 GHz – 7 GHz, Avg.

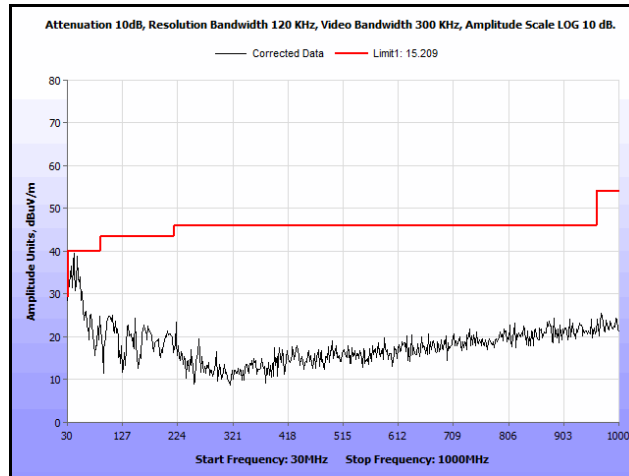


Plot 228. Radiated Spurs, Co-Location, 802.11n 20 MHz, 2462 MHz & 5300 MHz, 1 GHz – 7 GHz, Peak

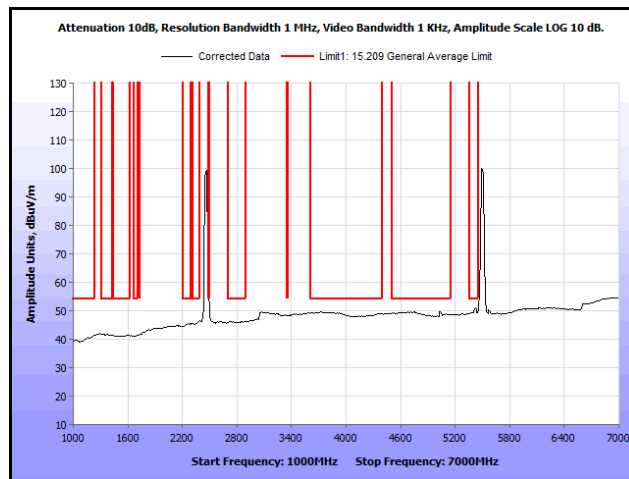




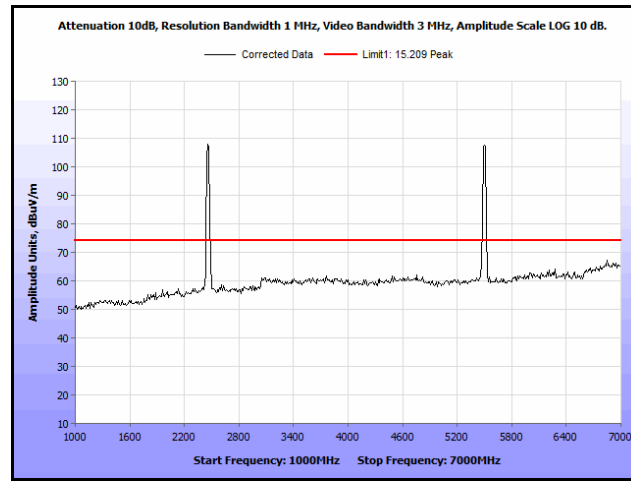
**Plot 229. Radiated Spurs, Co-Location, 802.11n 20 MHz, 2462 MHz & 5300 MHz, 7 GHz – 18 GHz, Peak**



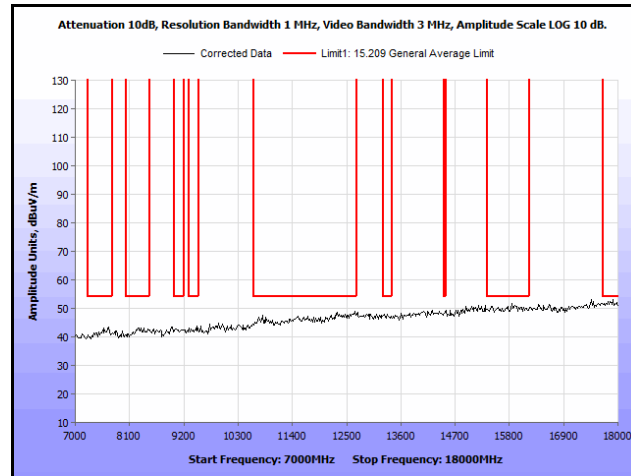
**Plot 230. Radiated Spurs, Co-Location, 802.11n 20 MHz, 2462 MHz & 5580 MHz, 30 MHz – 1 GHz, Peak**



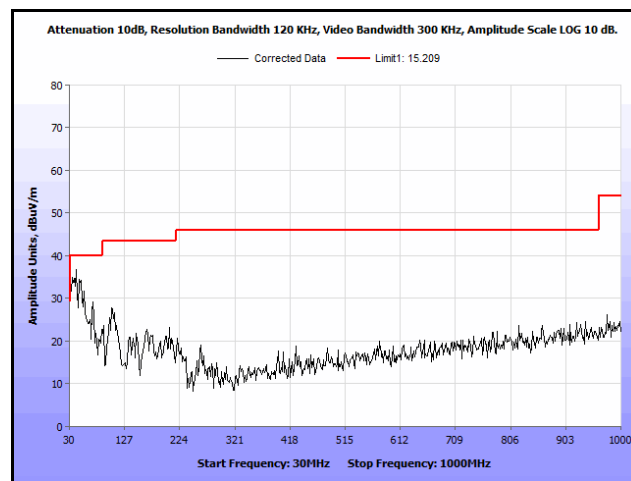
**Plot 231. Radiated Spurs, Co-Location, 802.11n 20 MHz, 2462 MHz & 5580 MHz, 1 GHz – 7 GHz, Avg.**



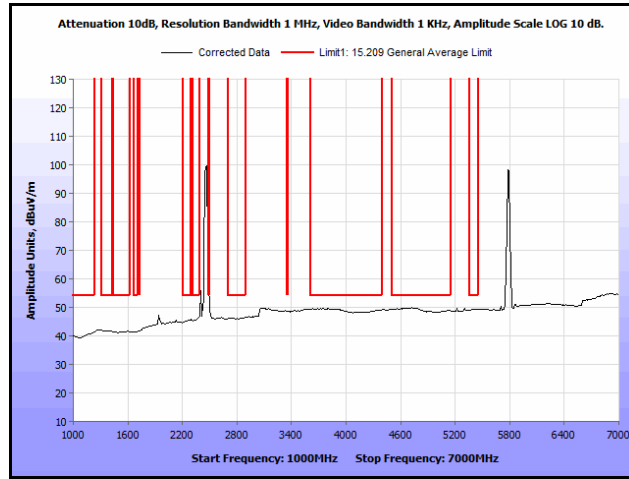
Plot 232. Radiated Spurs, Co-Location, 802.11n 20 MHz, 2462 MHz & 5580 MHz, 1 GHz – 7 GHz, Peak



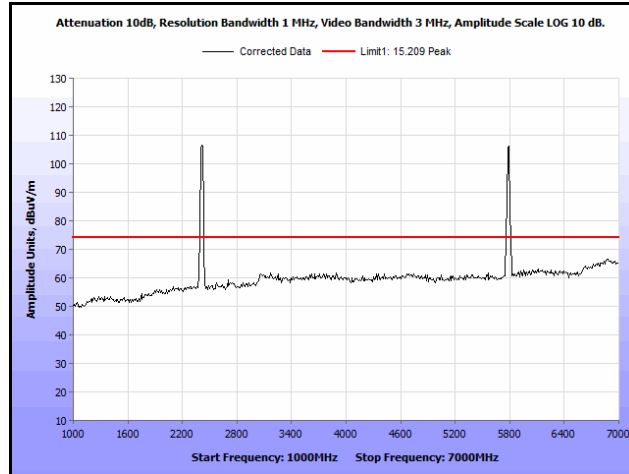
Plot 233. Radiated Spurs, Co-Location, 802.11n 20 MHz, 2462 MHz & 5580 MHz, 7 GHz – 18 GHz, Peak



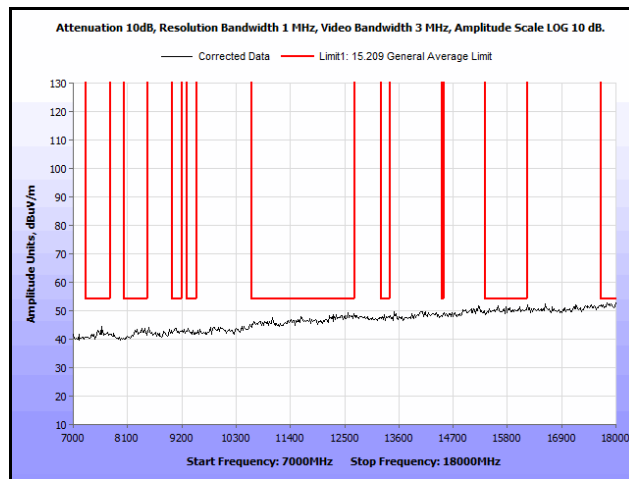
Plot 234. Radiated Spurs, Co-Location, 802.11n 20 MHz, 2462 MHz & 5785 MHz, 30 MHz – 1 GHz, Peak



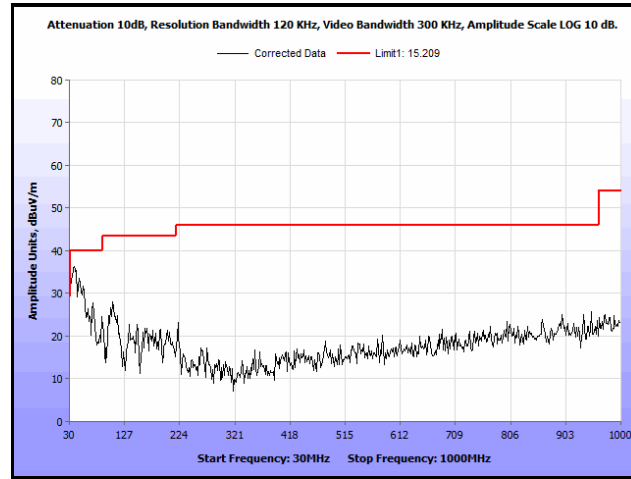
Plot 235. Radiated Spurs, Co-Location, 802.11n 20 MHz, 2462 MHz & 5785 MHz, 1 GHz – 7 GHz, Avg.



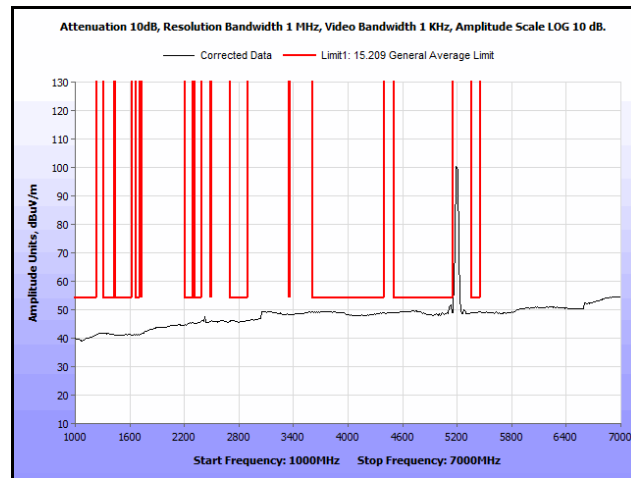
Plot 236. Radiated Spurs, Co-Location, 802.11n 20 MHz, 2462 MHz & 5785 MHz, 1 GHz – 7 GHz, Peak



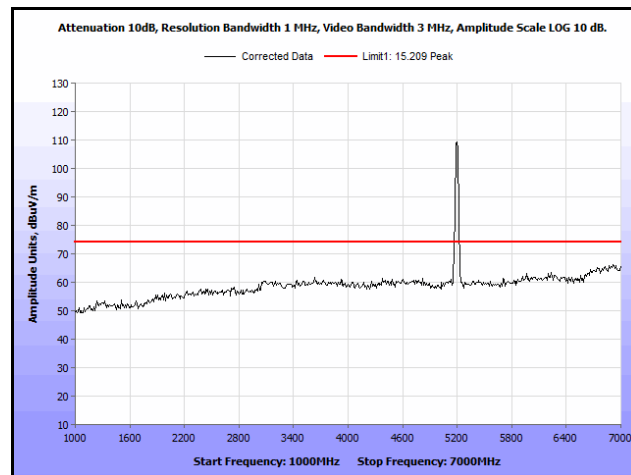
Plot 237. Radiated Spurs, Co-Location, 802.11n 20 MHz, 2462 MHz & 5785 MHz, 7 GHz – 18 GHz, Peak



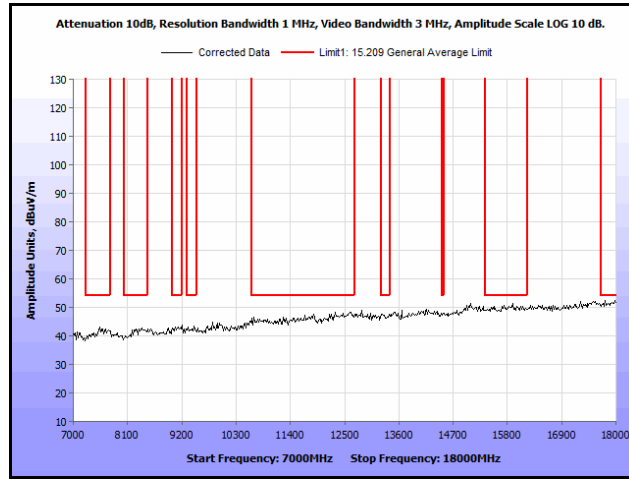
Plot 238. Radiated Spurs, Co-Location, 802.11n 20 MHz, 5200 MHz & 5200 MHz, 30 MHz – 1 GHz, Peak



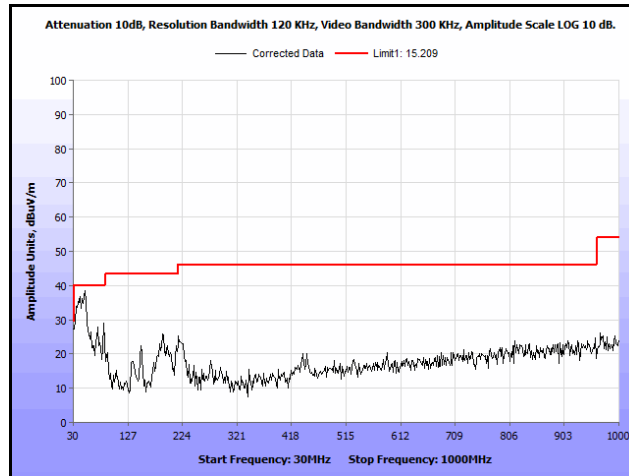
Plot 239. Radiated Spurs, Co-Location, 802.11n 20 MHz, 5200 MHz & 5200 MHz, 1 GHz – 7 GHz, Avg.



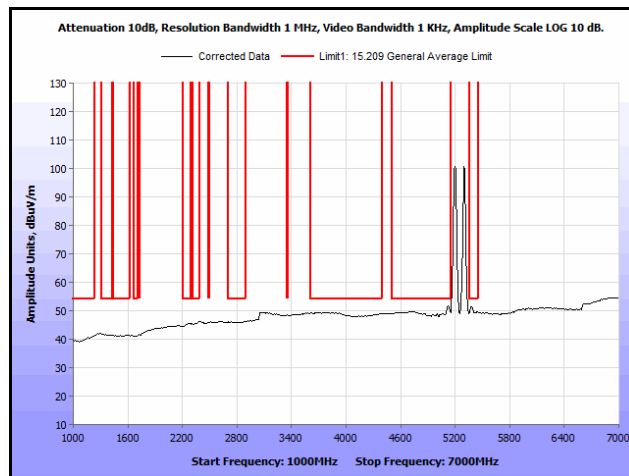
Plot 240. Radiated Spurs, Co-Location, 802.11n 20 MHz, 5200 MHz & 5200 MHz, 1 GHz – 7 GHz, Peak



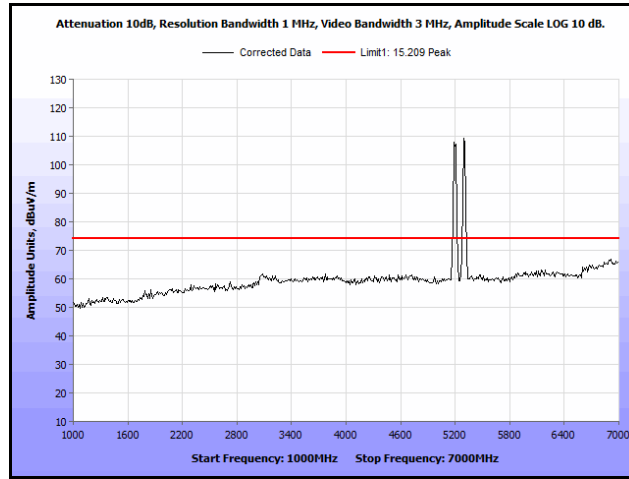
**Plot 241. Radiated Spurs, Co-Location, 802.11n 20 MHz, 5200 MHz & 5200 MHz, 7 GHz – 18 GHz, Peak**



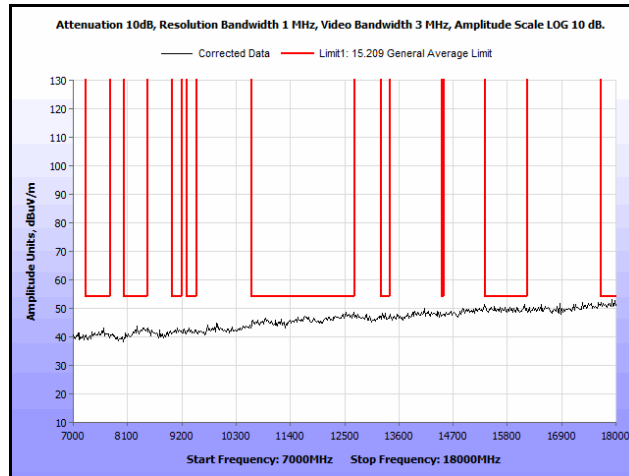
**Plot 242. Radiated Spurs, Co-Location, 802.11n 20 MHz, 5200 MHz & 5300 MHz, 30 MHz – 1 GHz, Peak**



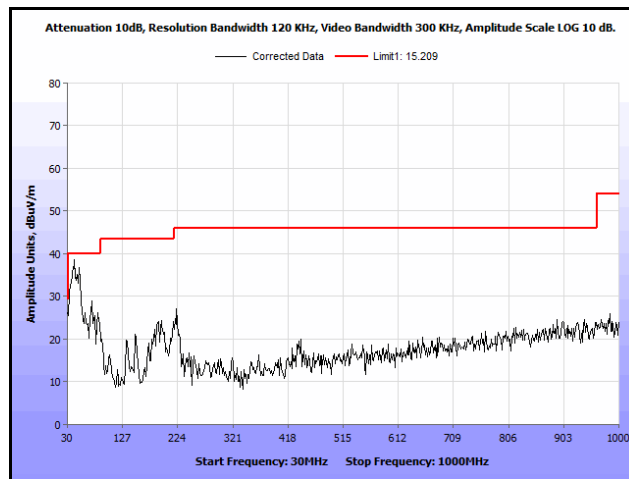
**Plot 243. Radiated Spurs, Co-Location, 802.11n 20 MHz, 5200 MHz & 5300 MHz, 1 GHz – 7 GHz, Avg.**



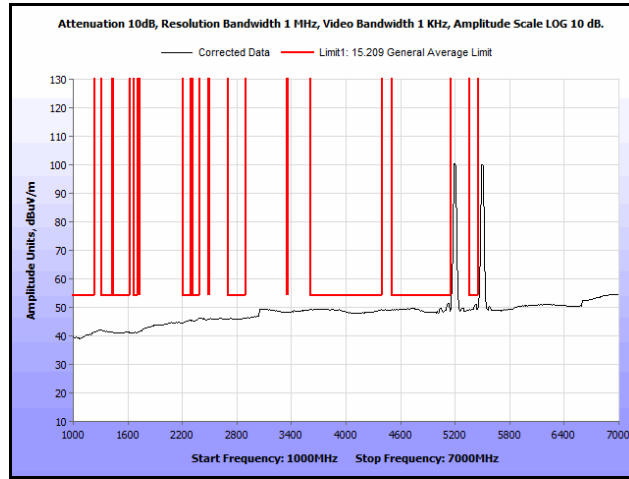
**Plot 244. Radiated Spurs, Co-Location, 802.11n 20 MHz, 5200 MHz & 5300 MHz, 1 GHz – 7 GHz, Peak**



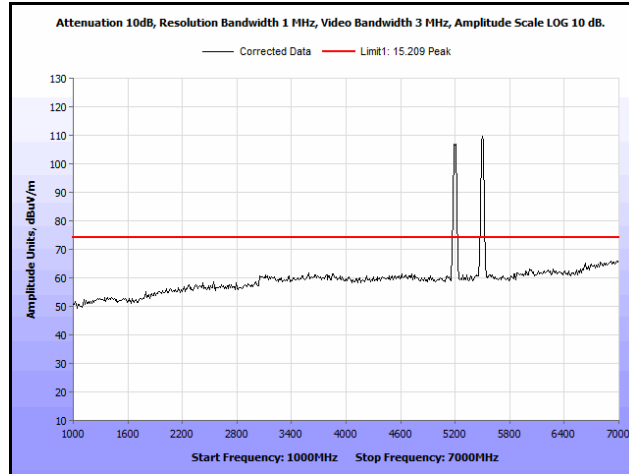
**Plot 245. Radiated Spurs, Co-Location, 802.11n 20 MHz, 5200 MHz & 5300 MHz, 7 GHz – 18 GHz, Peak**



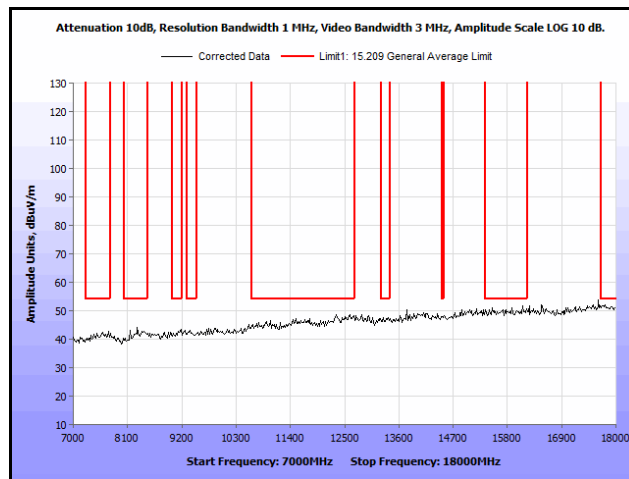
**Plot 246. Radiated Spurs, Co-Location, 802.11n 20 MHz, 5200 MHz & 5580 MHz, 30 MHz – 1 GHz, Peak**



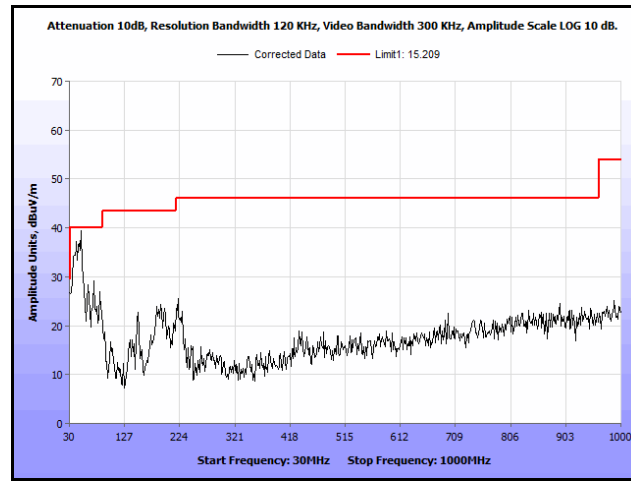
Plot 247. Radiated Spurs, Co-Location, 802.11n 20 MHz, 5200 MHz & 5580 MHz, 1 GHz – 7 GHz, Avg.



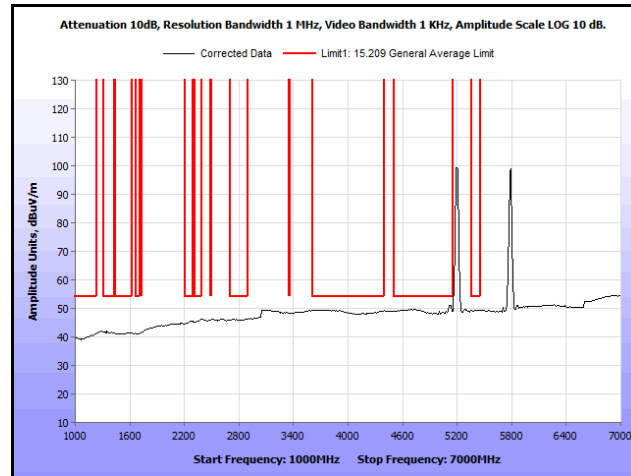
Plot 248. Radiated Spurs, Co-Location, 802.11n 20 MHz, 5200 MHz & 5580 MHz, 1 GHz – 7 GHz, Peak



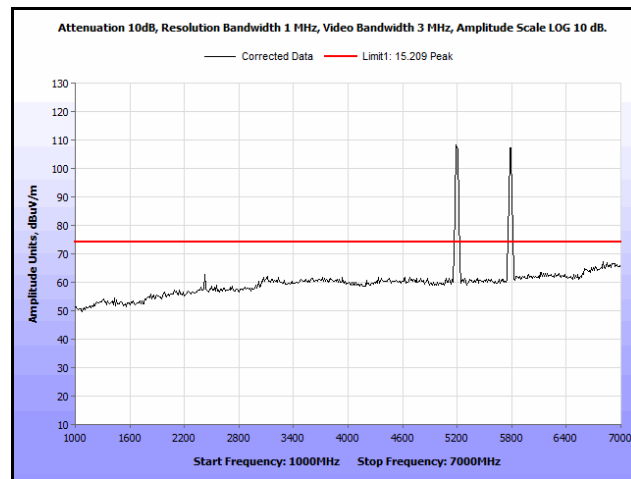
Plot 249. Radiated Spurs, Co-Location, 802.11n 20 MHz, 5200 MHz & 5580 MHz, 7 GHz – 18 GHz, Peak



Plot 250. Radiated Spurs, Co-Location, 802.11n 20 MHz, 5200 MHz & 5785 MHz, 30 MHz – 1 GHz, Peak

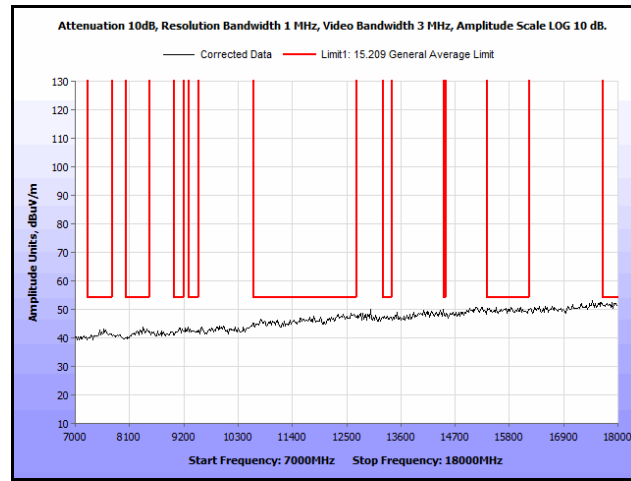


Plot 251. Radiated Spurs, Co-Location, 802.11n 20 MHz, 5200 MHz & 5785 MHz, 1 GHz – 7 GHz, Avg.

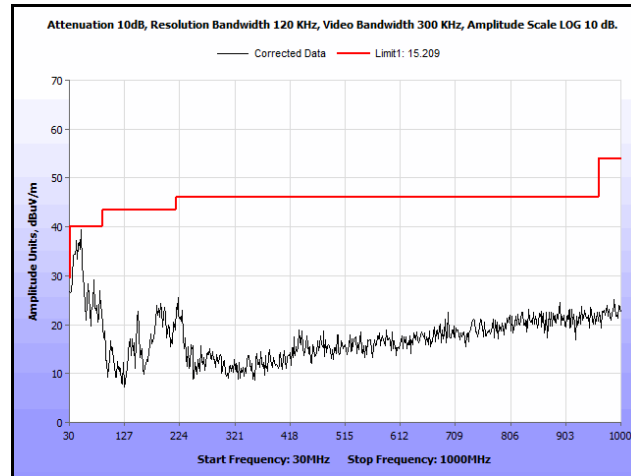


Plot 252. Radiated Spurs, Co-Location, 802.11n 20 MHz, 5200 MHz & 5785 MHz, 1 GHz – 7 GHz, Peak

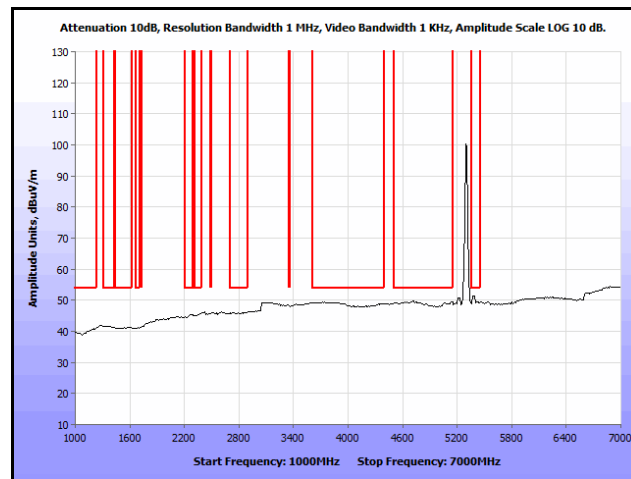




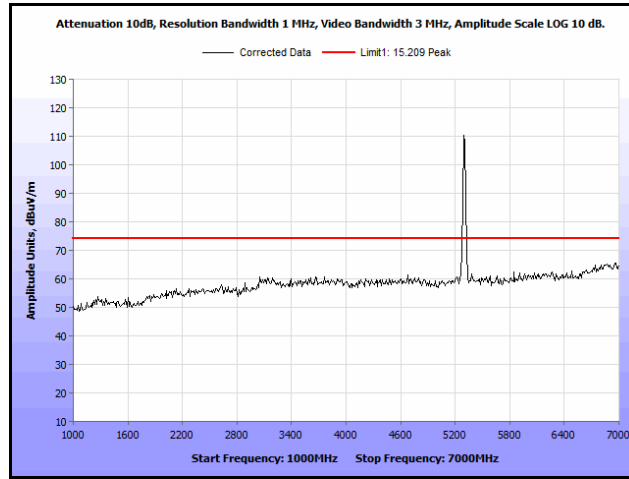
**Plot 253. Radiated Spurs, Co-Location, 802.11n 20 MHz, 5200 MHz & 5785 MHz, 7 GHz – 18 GHz, Peak**



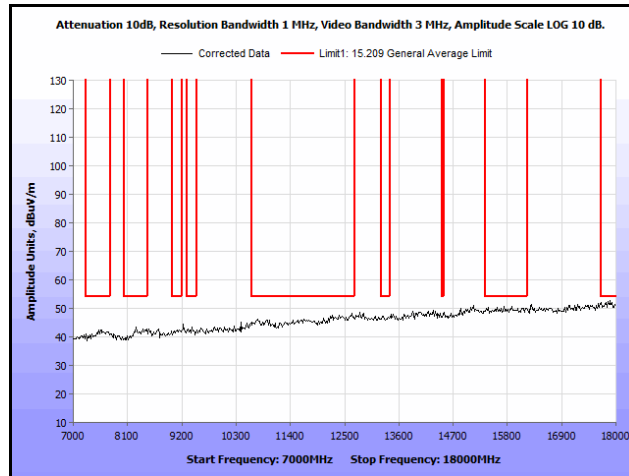
**Plot 254. Radiated Spurs, Co-Location, 802.11n 20 MHz, 5300 MHz & 5300 MHz, 30 MHz – 1 GHz, Peak**



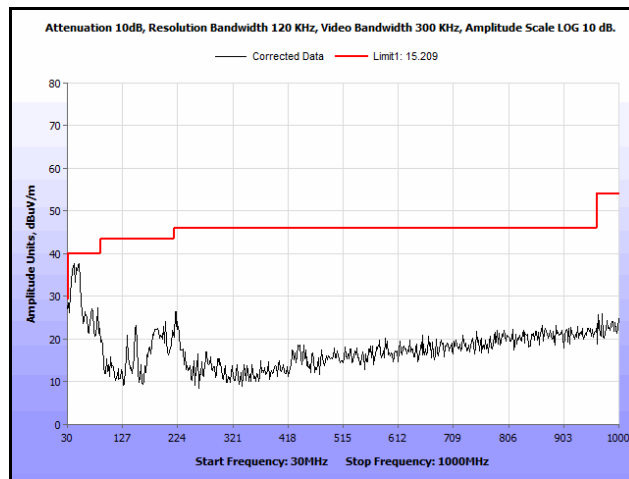
**Plot 255. Radiated Spurs, Co-Location, 802.11n 20 MHz, 5300 MHz & 5300 MHz, 1 GHz – 7 GHz, Avg.**



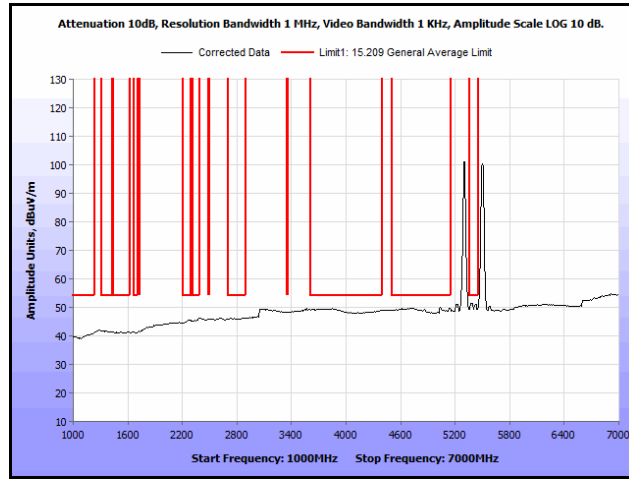
**Plot 256. Radiated Spurs, Co-Location, 802.11n 20 MHz, 5300 MHz & 5300 MHz, 1 GHz – 7 GHz, Peak**



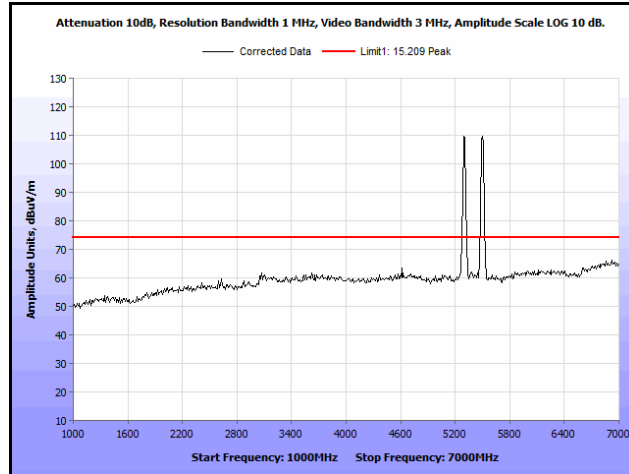
**Plot 257. Radiated Spurs, Co-Location, 802.11n 20 MHz, 5300 MHz & 5300 MHz, 7 GHz – 18 GHz, Peak**



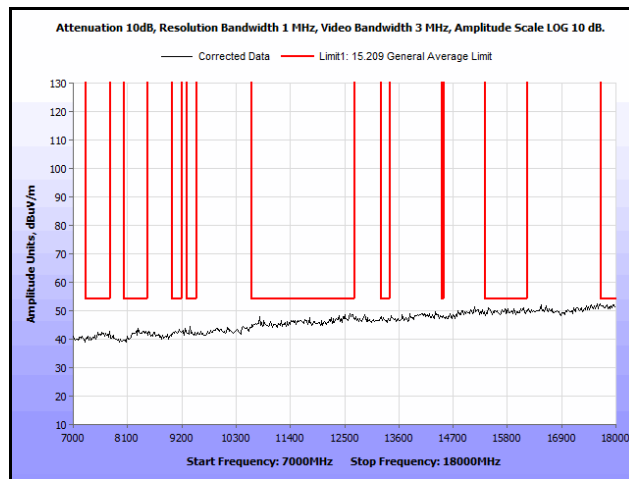
**Plot 258. Radiated Spurs, Co-Location, 802.11n 20 MHz, 5300 MHz & 5580 MHz, 30 MHz – 1 GHz, Peak**



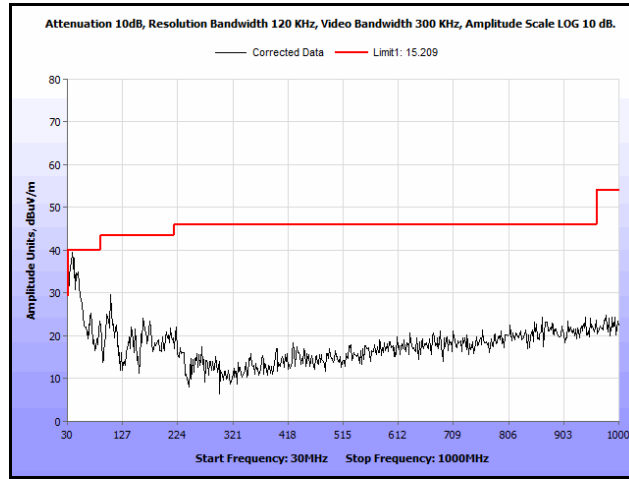
Plot 259. Radiated Spurs, Co-Location, 802.11n 20 MHz, 5300 MHz & 5580 MHz, 1 GHz – 7 GHz, Avg.



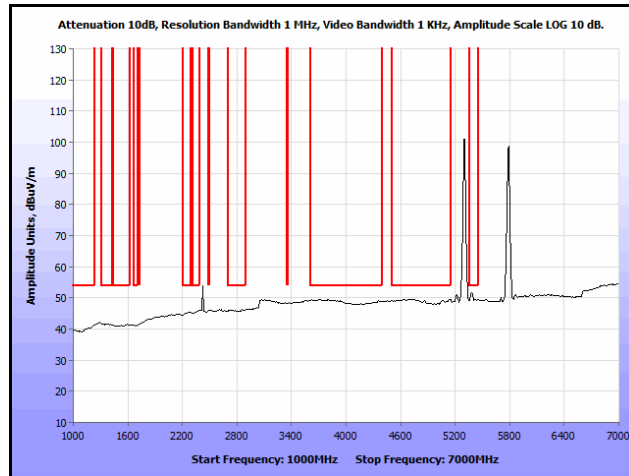
Plot 260. Radiated Spurs, Co-Location, 802.11n 20 MHz, 5300 MHz & 5580 MHz, 1 GHz – 7 GHz, Peak



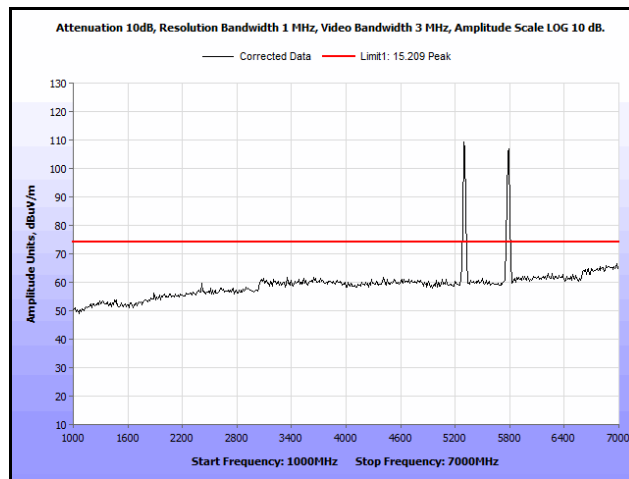
Plot 261. Radiated Spurs, Co-Location, 802.11n 20 MHz, 5300 MHz & 5580 MHz, 7 GHz – 18 GHz, Peak



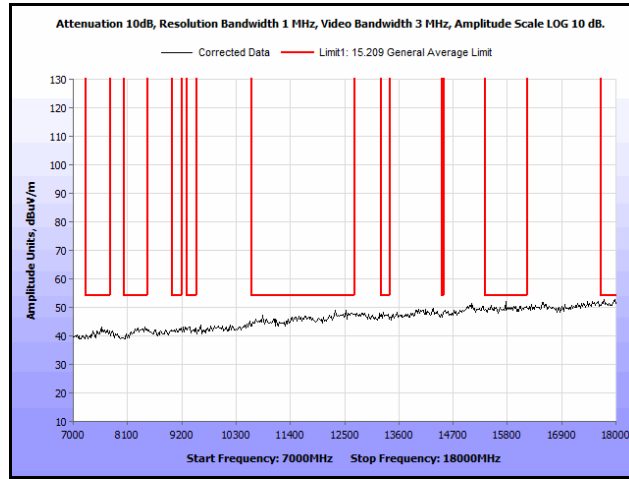
Plot 262. Radiated Spurs, Co-Location, 802.11n 20 MHz, 5300 MHz & 5785 MHz, 30 MHz – 1 GHz, Peak



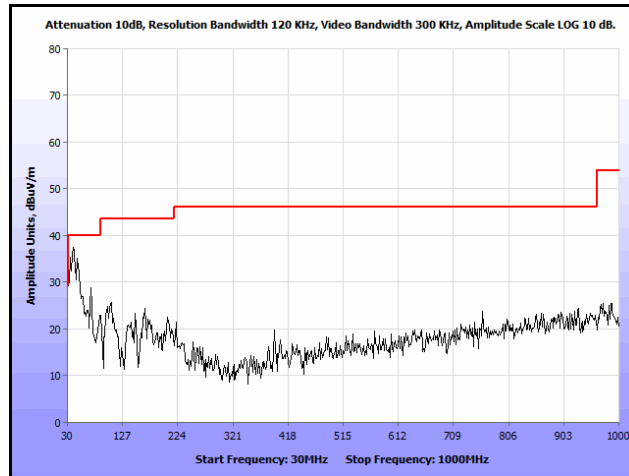
Plot 263. Radiated Spurs, Co-Location, 802.11n 20 MHz, 5300 MHz & 5785 MHz, 1 GHz – 7 GHz, Avg.



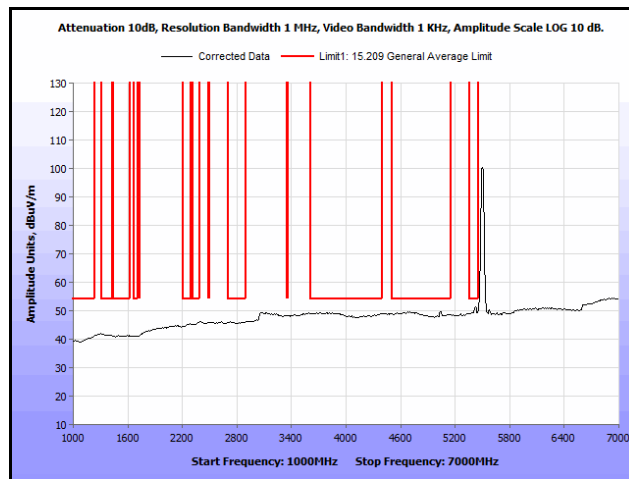
Plot 264. Radiated Spurs, Co-Location, 802.11n 20 MHz, 5300 MHz & 5785 MHz, 1 GHz – 7 GHz, Peak



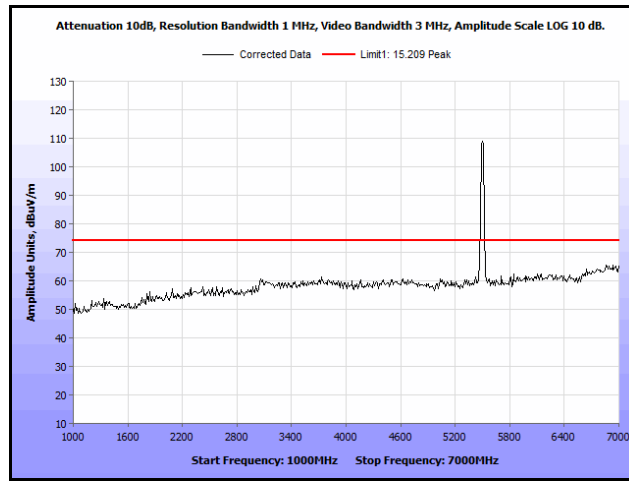
**Plot 265. Radiated Spurs, Co-Location, 802.11n 20 MHz, 5300 MHz & 5785 MHz, 7 GHz – 18 GHz, Peak**



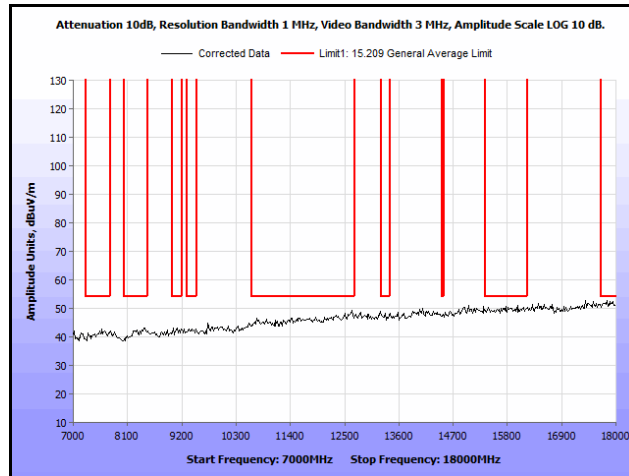
**Plot 266. Radiated Spurs, Co-Location, 802.11n 20 MHz, 5580 MHz & 5580 MHz, 30 MHz – 1 GHz, Peak**



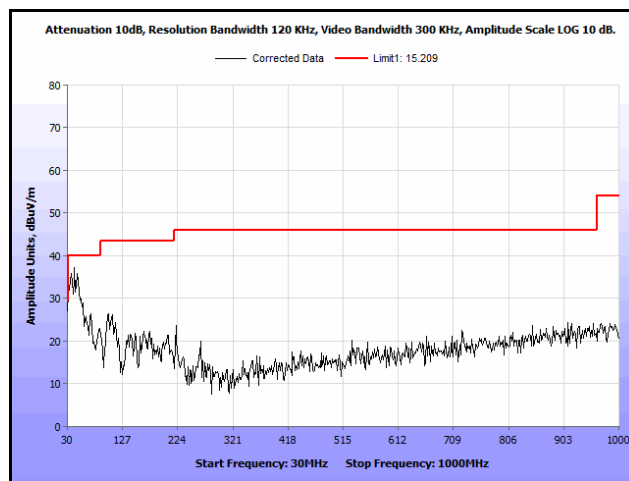
**Plot 267. Radiated Spurs, Co-Location, 802.11n 20 MHz, 5580 MHz & 5580 MHz, 1 GHz – 7 GHz, Avg.**



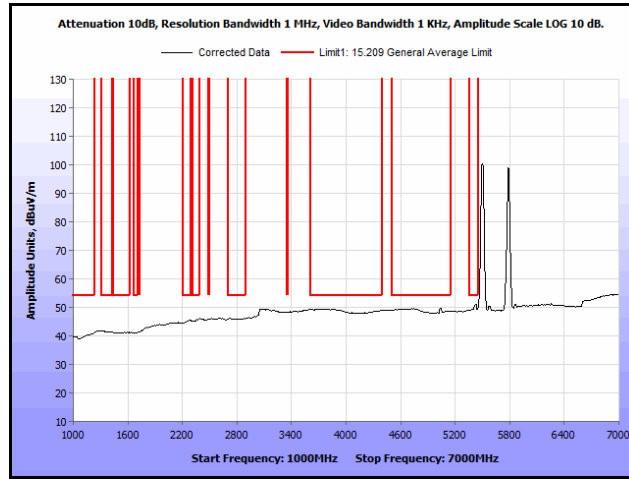
**Plot 268. Radiated Spurs, Co-Location, 802.11n 20 MHz, 5580 MHz & 5580 MHz, 1 GHz – 7 GHz, Peak**



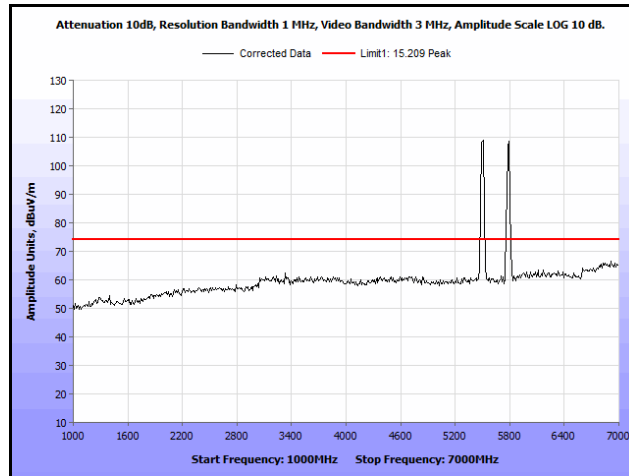
**Plot 269. Radiated Spurs, Co-Location, 802.11n 20 MHz, 5580 MHz & 5580 MHz, 7 GHz – 18 GHz, Peak**



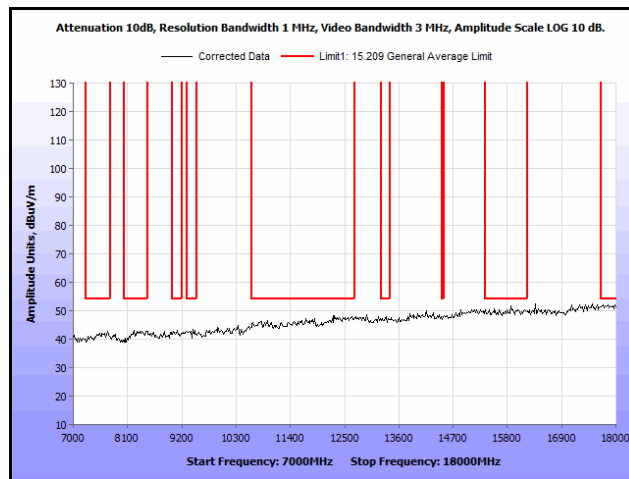
**Plot 270. Radiated Spurs, Co-Location, 802.11n 20 MHz, 5580 MHz & 5785 MHz, 30 MHz – 1 GHz, Peak**



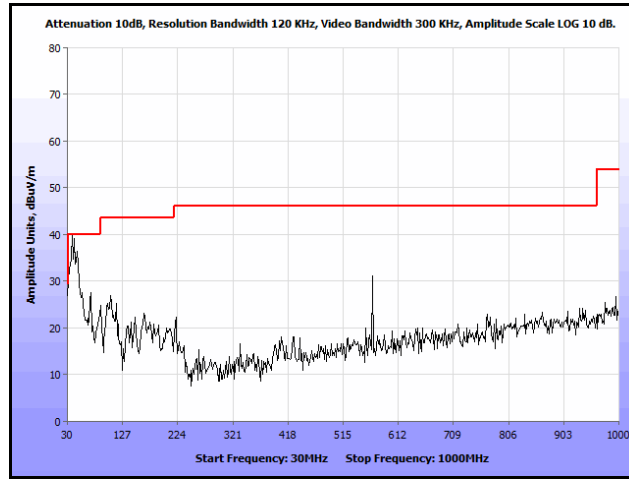
Plot 271. Radiated Spurs, Co-Location, 802.11n 20 MHz, 5580 MHz & 5785 MHz, 1 GHz – 7 GHz, Avg



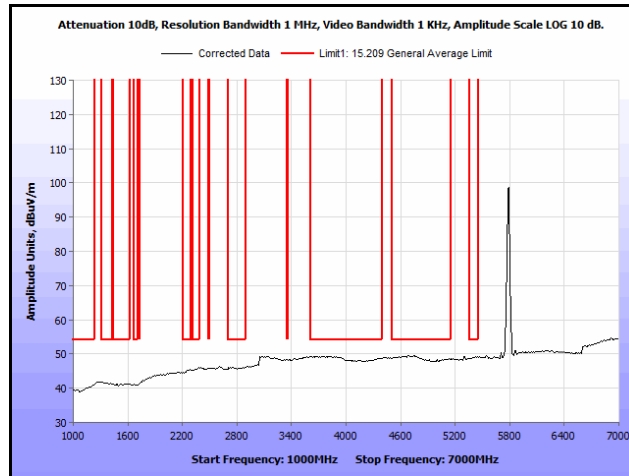
Plot 272. Radiated Spurs, Co-Location, 802.11n 20 MHz, 5580 MHz & 5785 MHz, 1 GHz – 7 GHz, Peak



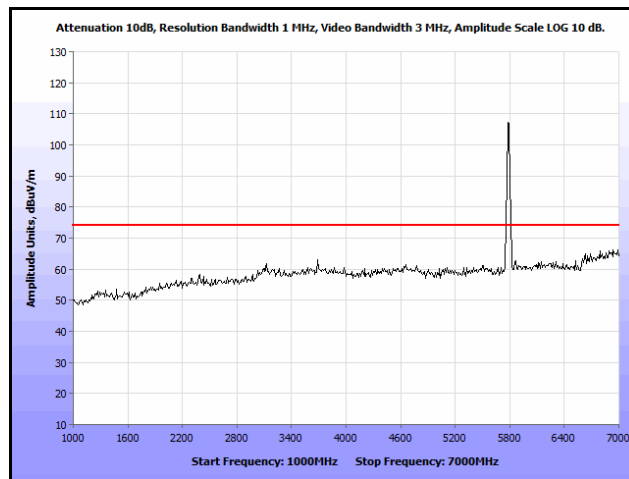
Plot 273. Radiated Spurs, Co-Location, 802.11n 20 MHz, 5580 MHz & 5785 MHz, 7 GHz – 18 GHz, Peak



Plot 274. Radiated Spurs, Co-Location, 802.11n 20 MHz, 5785 MHz & 5785 MHz, 30 MHz – 1 GHz, Peak

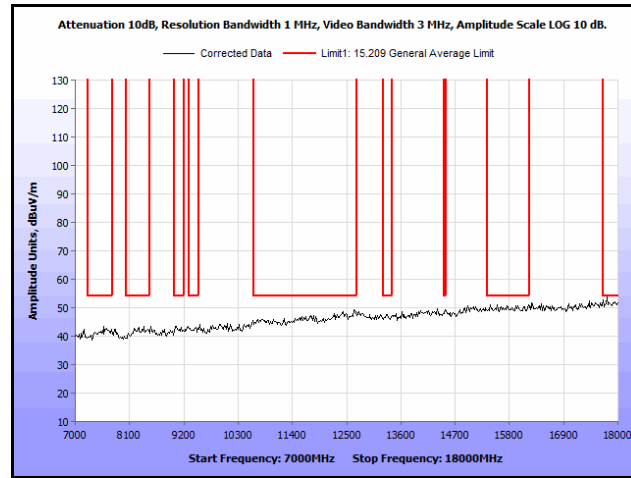


Plot 275. Radiated Spurs, Co-Location, 802.11n 20 MHz, 5785 MHz & 5785 MHz, 1 GHz – 7 GHz, Avg.



Plot 276. Radiated Spurs, Co-Location, 802.11n 20 MHz, 5785 MHz & 5785 MHz, 1 GHz – 7 GHz, Peak

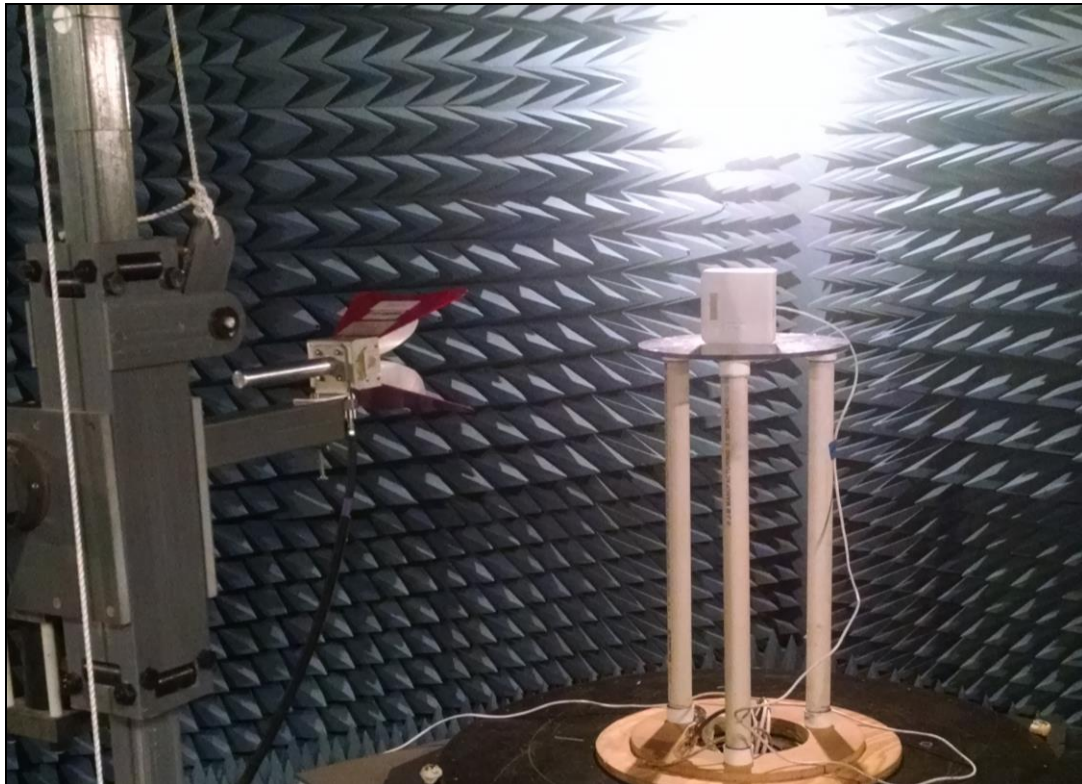




Plot 277. Radiated Spurs, Co-Location, 802.11n 20 MHz, 5785 MHz & 5785 MHz, 7 GHz – 18 GHz, Peak



**Photograph 5. . Radiated Spurious Emissions, Test Setup, 30 MHz – 1 GHz**



**Photograph 6. Radiated Spurious Emissions, Test Setup, 1 GHz – 18 GHz**



**Photograph 7. Radiated Spurious Emissions, Test Setup, 18 MHz – 40 GHz**

## Electromagnetic Compatibility Criteria for Intentional Radiators

### § 15.407(f) RF Exposure

**RF Exposure Requirements:** §1.1307(b)(1) and §1.1307(b)(2): Systems operating under the provisions of this section shall be operated in a manner that ensures that the public is not exposed to radio frequency energy levels in excess of the Commission’s guidelines.

**RF Radiation Exposure Limit:** §1.1310: As specified in this section, the Maximum Permissible Exposure (MPE) Limit shall be used to evaluate the environmental impact of human exposure to radiofrequency (RF) radiation as specified in Sec. 1.1307(b), except in the case of portable devices which shall be evaluated according to the provisions of Sec. 2.1093 of this chapter.

MPE Limit Calculation: EUT’s operating frequencies @ 5250-5350 MHz & 5470-5725 MHz; **Limit for Uncontrolled exposure: 1 mW/cm<sup>2</sup> or 10 W/m<sup>2</sup>**

Equation from page 18 of OET 65, Edition 97-01

$$S = PG / 4\pi R^2 \quad \text{or} \quad R = \sqrt{PG / 4\pi S}$$

where, S = Power Density

P = Power Input to antenna = 20.76 dBm (119 mW)

G = Max Antenna Gain = 4+10log(2) = 7 dBi (5 numeric)

R = Minimum Distance between User and Antenna (25 cm)

$$S = (119 * 5) / (4 * 3.14 * 25^2) = 0.08 \text{ mW/cm}^2$$

Since  $S < 1 \text{ mW/cm}^2$ , the minimum distance (R) is 25cm

#### Co-location:

Frequency Range	MPE Result (mW/cm <sup>2</sup> )	Limit (mW/cm <sup>2</sup> )
2.4GHz	0.43	1
5.250-5.725GHz	0.08	1

**Test Requirements:**  $[MPE(f1) / \text{limit}(f1) + MPE(f2) / \text{limit}(f2)] < 1$

#### Test Results:

MPE(f1)	MPE(f2)	Calculation [MPE(f1) / limit(f1) + MPE(f2) / limit(f2)]	MPE Result (mW/cm <sup>2</sup> )
Frequency (MHZ)	Frequency (MHZ)		
2412 - 2462	5.250-5.725GHz	$0.43 / 1 + 0.08 / 1 = (0.43 + 0.08)$	<b>0.51</b>

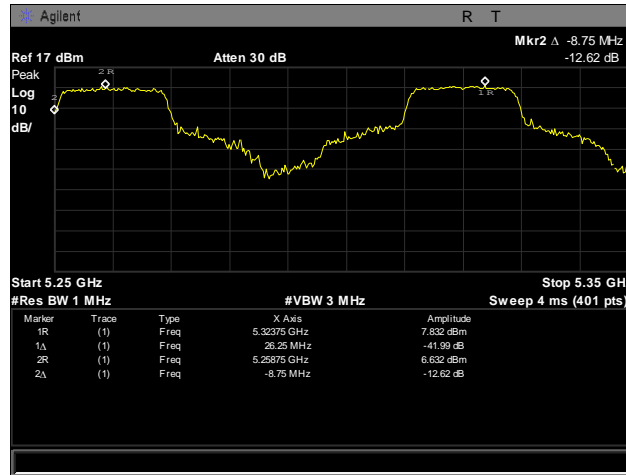
Therefore, the uncontrolled exposure limit is not exceeded at 25 cm.

## Electromagnetic Compatibility Criteria for Intentional Radiators

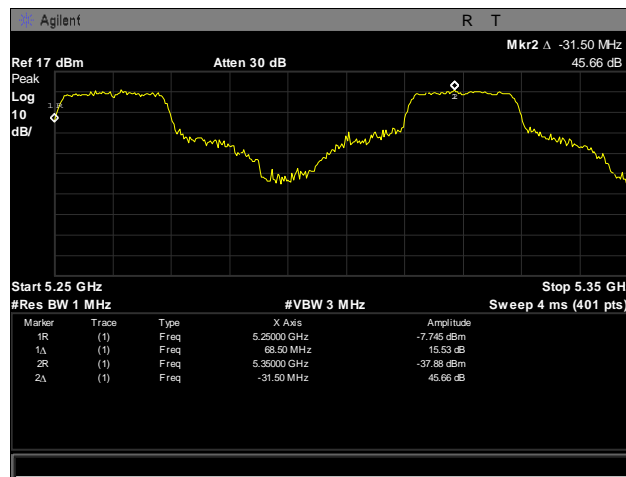
### § 15.407(g) Frequency Stability

- Test Requirements:** § 15.407(g): Manufacturers of U-NII devices are responsible for ensuring frequency stability such that an emission is maintained within the band of operation under all conditions of normal operation as specified in the user's manual.
- Test Procedure:** The EUT was connected directly to a spectrum analyzer through an attenuator. The transmitter was set to low and high channels and the emissions were observed. The Low and High channels were transmitted and viewed from the 5150MHz and 5350MHz edge.
- Test Results:** The EUT was compliant with the requirements of §15.407(g).
- Test Engineer(s):** Andy Shen
- Test Date(s):** 09/10/14

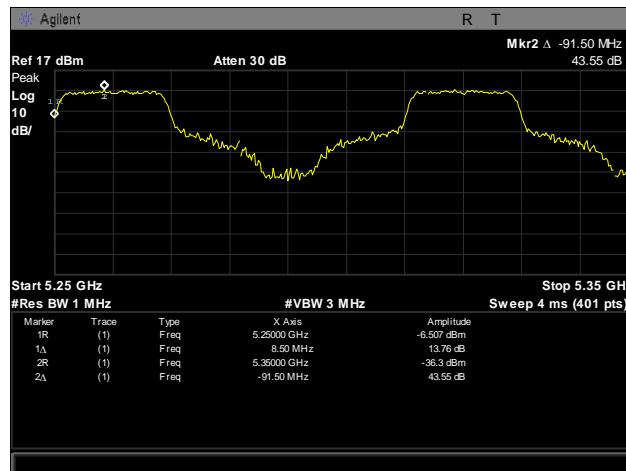
### Frequency Stability, Lower Band



Plot 278. Frequency Stability, 5250 – 5350 MHz, -40°C, 120 V

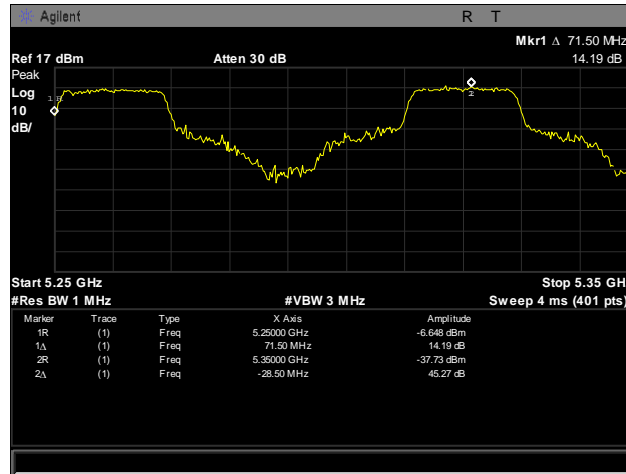


Plot 279. Frequency Stability, 5250 – 5350 MHz, -30°C, 120 V

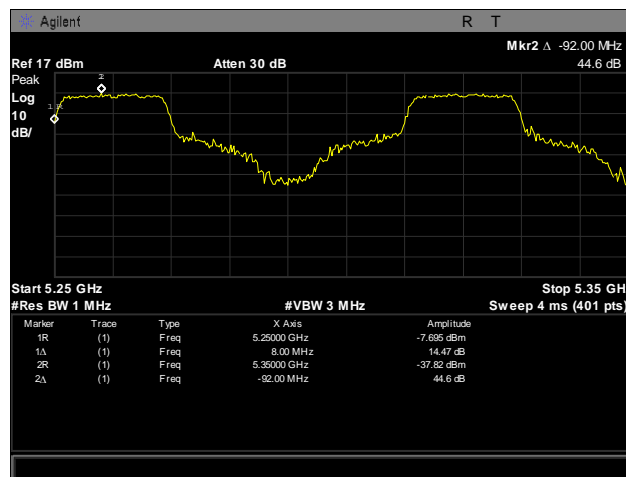


Plot 280. Frequency Stability, 5250 – 5350 MHz, -20°C, 120 V

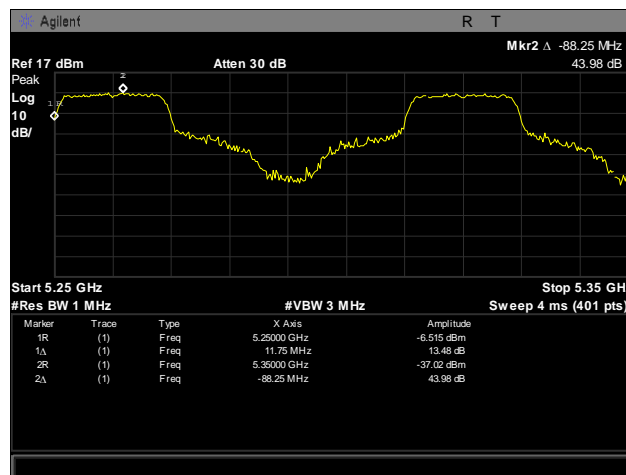




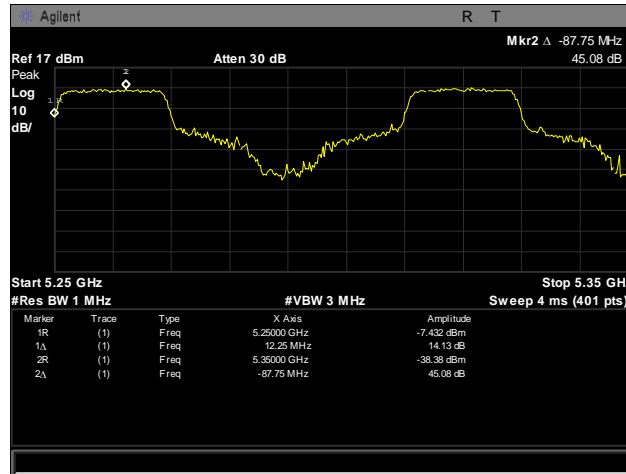
Plot 281. Frequency Stability, 5250 – 5350 MHz, -10°C, 120 V



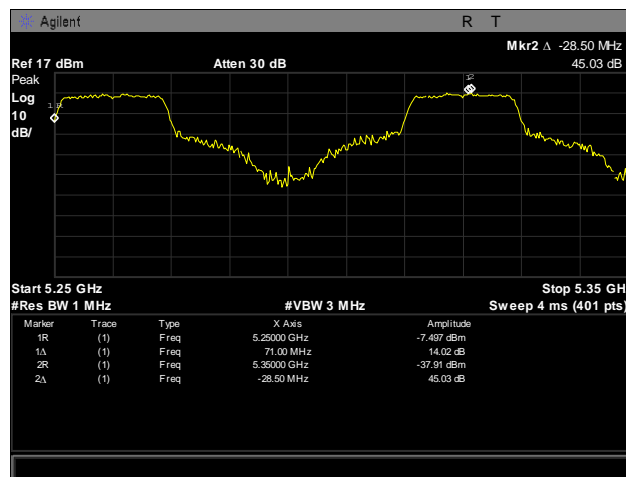
Plot 282. Frequency Stability, 5250 – 5350 MHz, 0°C, 120 V



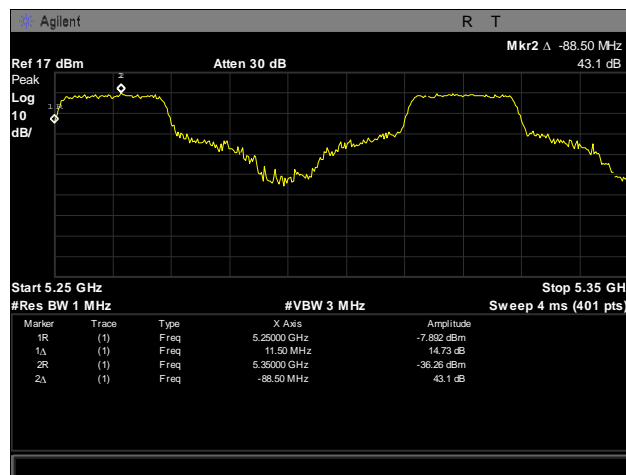
Plot 283. Frequency Stability, 5250 – 5350 MHz, 10°C, 120 V



Plot 284. Frequency Stability, 5250 – 5350 MHz, 20°C, 120 V

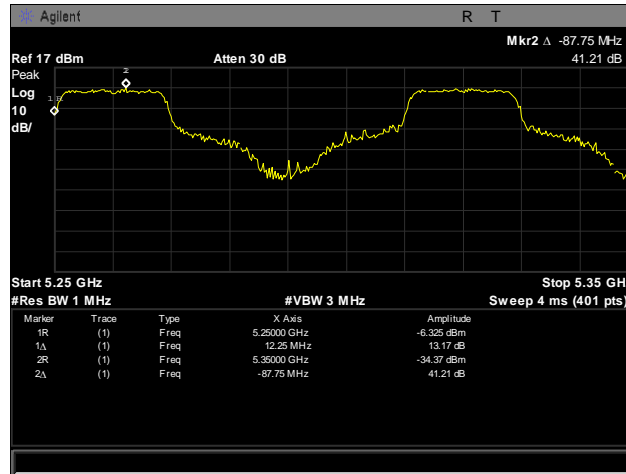


Plot 285. Frequency Stability, 5250 – 5350 MHz, 30°C, 120 V

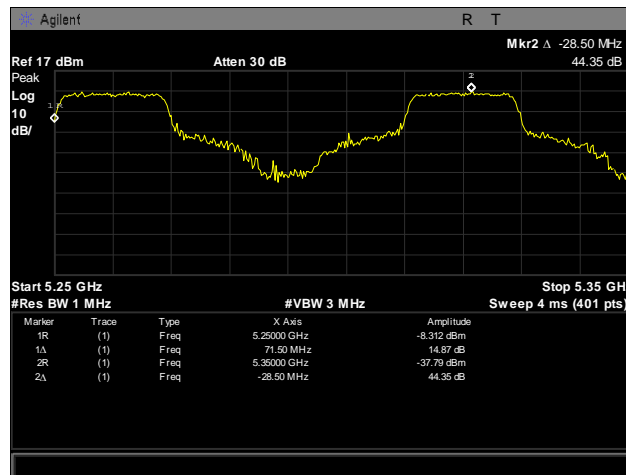


Plot 286. Frequency Stability, 5250 – 5350 MHz, 40°C, 120 V



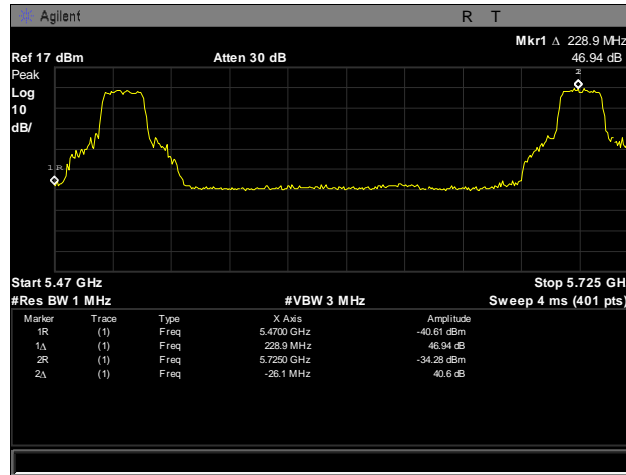


Plot 287. Frequency Stability, 5250 – 5350 MHz, 50°C, 120 V

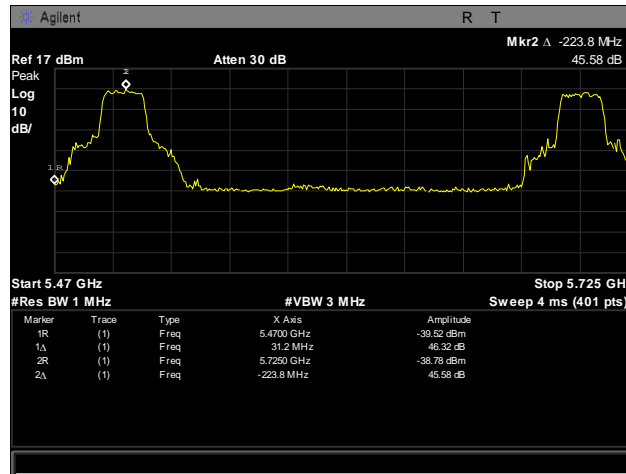


Plot 288. Frequency Stability, 5250 – 5350 MHz, 55°C, 120 V

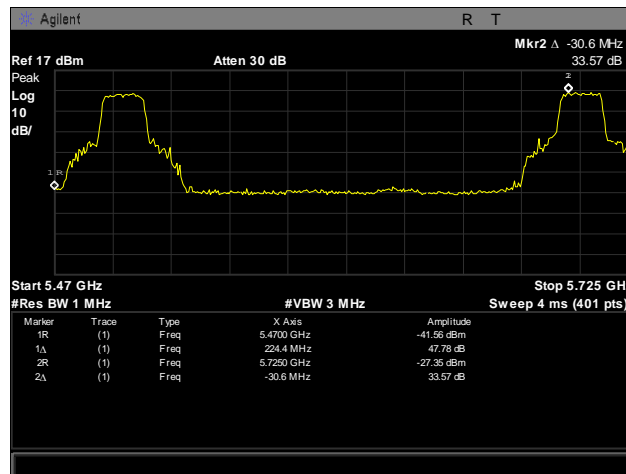
### Frequency Stability, Upper Band



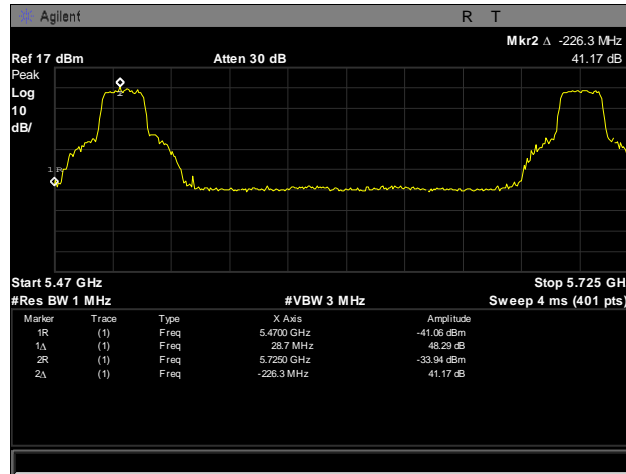
Plot 289. Frequency Stability, 5470 – 5725 MHz, -40°C, 120 V



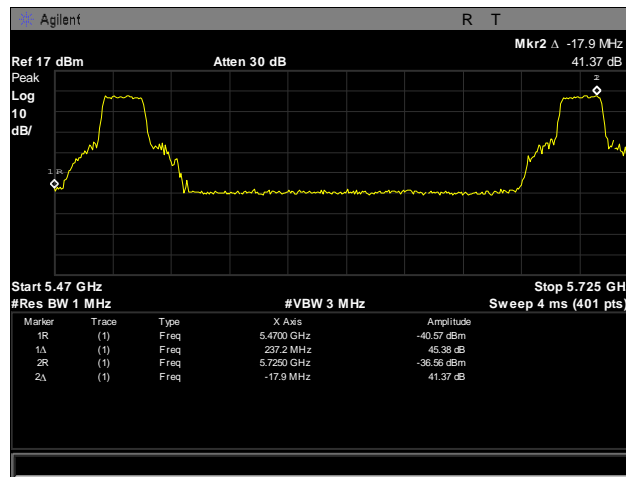
Plot 290. Frequency Stability, 5470 – 5725 MHz, -30°C, 120 V



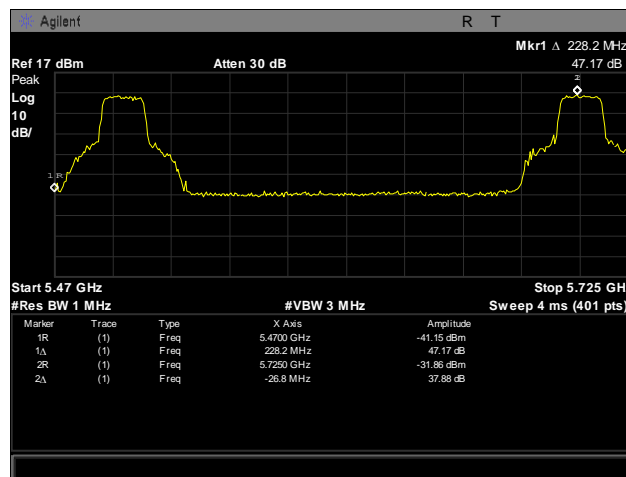
Plot 291. Frequency Stability, 5470 – 5725 MHz, -20°C, 120 V



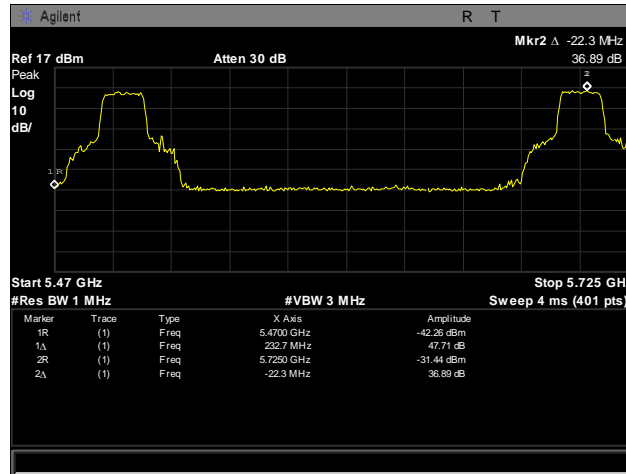
Plot 292. Frequency Stability, 5470 – 5725 MHz, -10°C, 120 V



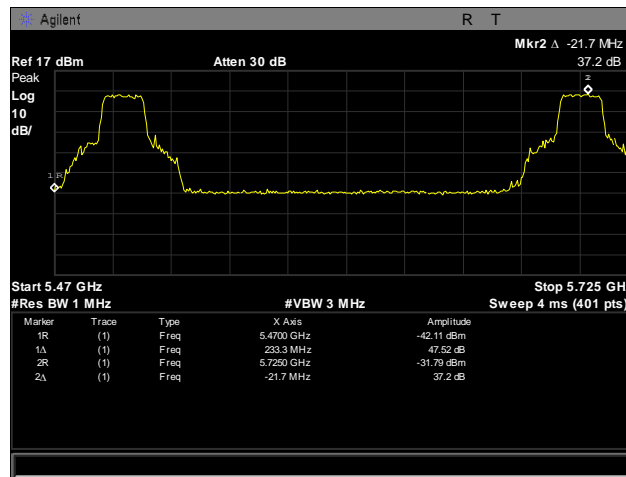
Plot 293. Frequency Stability, 5470 – 5725 MHz, 0°C, 120 V



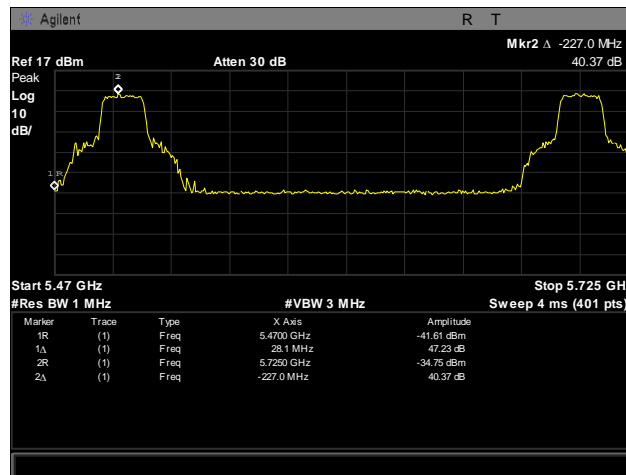
Plot 294. Frequency Stability, 5470 – 5725 MHz, 10°C, 120 V



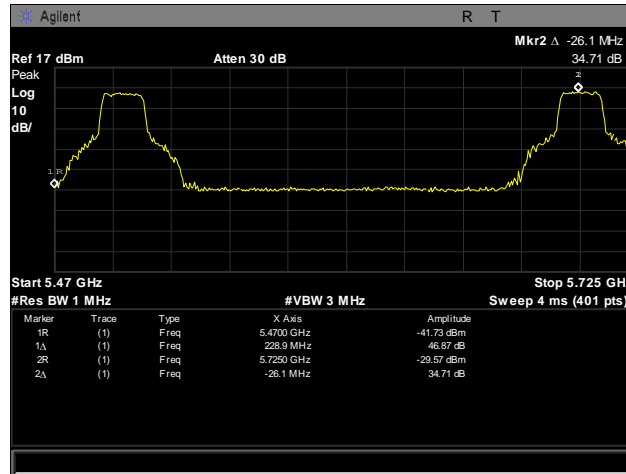
Plot 295. Frequency Stability, 5470 – 5725 MHz, 20°C, 120 V



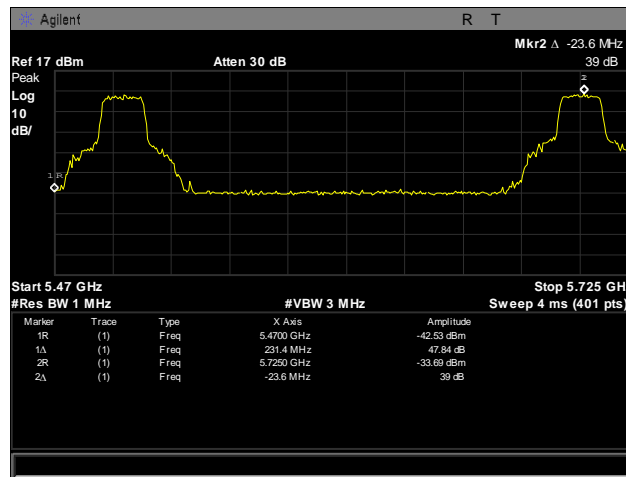
Plot 296. Frequency Stability, 5470 – 5725 MHz, 30°C, 120 V



Plot 297. Frequency Stability, 5470 – 5725 MHz, 40°C, 120 V



Plot 298. Frequency Stability, 5470 – 5725 MHz, 50°C, 120 V



Plot 299. Frequency Stability, 5470 – 5725 MHz, 55°C, 120 V

## **V. DFS Requirements and Radar Waveform Description & Calibration**

## A. DFS Requirements

Requirement	Operational Mode		
	Master	Client Without Radar Detection	Client With Radar Detection
<i>Non-Occupancy Period</i>	Yes	Not required	Yes
<i>DFS Detection Threshold</i>	Yes	Not required	Yes
<i>Channel Availability Check Time</i>	Yes	Not required	Not required
<i>U-NII Detection Bandwidth</i>	Yes	Not required	Yes

Table 29. Applicability of DFS Requirements Prior to Use of a Channel

Requirement	Operational Mode	
	Master Device or Client with Radar Detection	Client Without Radar Detection
<i>DFS Detection Threshold</i>	Yes	Not required
<i>Channel Closing Transmission Time</i>	Yes	Yes
<i>Channel Move Time</i>	Yes	Yes
<i>U-NII Detection Bandwidth</i>	Yes	Not required
<b>Additional requirements for devices with multiple bandwidth modes</b>	<b>Master Device or Client with Radar Detection</b>	<b>Client Without Radar Detection</b>
<i>U-NII Detection Bandwidth and Statistical Performance Check</i>	All BW modes must be tested	Not required
<i>Channel Move Time and Channel Closing Transmission Time</i>	Test using widest BW mode available	Test using the widest BW mode available for the link
<i>All other tests</i>	Any single BW mode	Not required
<p><b>Note:</b> Frequencies selected for statistical performance check (Section 7.8.4) should include several frequencies within the radar detection bandwidth and frequencies near the edge of the radar detection bandwidth. For 802.11 devices it is suggested to select frequencies in each of the bonded 20 MHz channels and the channel center frequency.</p>		

Table 30. Applicability of DFS Requirements During Normal Operation

Maximum Transmit Power	Value (See Notes 1, 2, and 3)
EIRP $\geq$ 200 milliwatt	-64 dBm
EIRP < 200 milliwatt and power spectral density < 10 dBm/MHz	-62 dBm
EIRP < 200 milliwatt that do not meet the power spectral density requirement	-64 dBm
<p><b>Note 1:</b> This is the level at the input of the receiver assuming a 0 dBi receive antenna.</p> <p><b>Note 2:</b> Throughout these test procedures an additional 1 dB has been added to the amplitude of the test transmission waveforms to account for variations in measurement equipment. This will ensure that the test signal is at or above the detection threshold level to trigger a DFS response.</p> <p><b>Note 3:</b> EIRP is based on the highest antenna gain. For MIMO devices refer to KDB Publication 662911 D01.</p>	

**Table 31. DFS Detection Thresholds for Master or Client Devices Incorporating DFS**

Parameter	Value
<i>Non-occupancy period</i>	Minimum 30 minutes
<i>Channel Availability Check Time</i>	60 seconds
<i>Channel Move Time</i>	10 seconds See Note 1.
<i>Channel Closing Transmission Time</i>	200 milliseconds + an aggregate of 60 milliseconds over remaining 10 second period. See Notes 1 and 2.
<i>U-NII Detection Bandwidth</i>	Minimum 100% of the U- NII 99% transmission power bandwidth. See Note 3.
<p><b>Note 1:</b> <i>Channel Move Time</i> and the <i>Channel Closing Transmission Time</i> should be performed with Radar Type 0. The measurement timing begins at the end of the Radar Type 0 burst.</p> <p><b>Note 2:</b> The <i>Channel Closing Transmission Time</i> is comprised of 200 milliseconds starting at the beginning of the <i>Channel Move Time</i> plus any additional intermittent control signals required to facilitate a <i>Channel</i> move (an aggregate of 60 milliseconds) during the remainder of the 10 second period. The aggregate duration of control signals will not count quiet periods in between transmissions.</p> <p><b>Note 3:</b> During the <i>U-NII Detection Bandwidth</i> detection test, radar type 0 should be used. For each frequency step the minimum percentage of detection is 90 percent. Measurements are performed with no data traffic.</p>	

**Table 32. DFS Response Requirement Values**



## B. Radar Test Waveforms

This section provides the parameters for required test waveforms, minimum percentage of successful detections, and the minimum number of trials that must be used for determining DFS conformance. Step intervals of 0.1 microsecond for Pulse Width, 1 microsecond for PRI, 1 MHz for chirp width and 1 for the number of pulses will be utilized for the random determination of specific test waveforms.

### Short Pulse Radar Test Waveforms

Radar Type	Pulse Width (μsec)	PRI (μsec)	Number of Pulses	Minimum Percentage of Successful Detection	Minimum Number of Trials
0	1	1428	18	See Note 1	See Note 1
1	1	Test A: 15 unique PRI values randomly selected from the list of 23 PRI values in Table 5a	Roundup $\left\{ \begin{array}{l} \left( \frac{1}{360} \right) \cdot \\ \left( \frac{19 \cdot 10^6}{\text{PRI}_{\mu\text{sec}}} \right) \end{array} \right\}$	60%	30
		Test B: 15 unique PRI values randomly selected within the range of 518-3066 μsec, with a minimum increment of 1 μsec, excluding PRI values selected in Test A			
2	1-5	150-230	23-29	60%	30
3	6-10	200-500	16-18	60%	30
4	11-20	200-500	12-16	60%	30
Aggregate (Radar Types 1-4)				80%	120
<b>Note 1: Short Pulse Radar Type 0 should be used for the detection bandwidth test, channel move time, and channel closing time tests.</b>					

A minimum of 30 unique waveforms are required for each of the short pulse radar types 2 through 4. If more than 30 waveforms are used for short pulse radar types 2 through 4, then each additional waveform must also be unique and not repeated from the previous waveforms. If more than 30 waveforms are used for Short Pulse Radar Type 1, then each additional waveform is generated with Test B and must also be unique and not repeated from the previous waveforms in Tests A or B.

For example if in Short Pulse Radar Type 1 Test B a PRI of 3066 usec is selected, the number of pulses

would be  $\text{Roundup} \left\{ \left( \frac{1}{360} \right) \cdot \left( \frac{19 \cdot 10^6}{3066} \right) \right\} = \text{Roundup} \{17.2\} = 18.$

Pulse Repetition Frequency Number	Pulse Repetition Frequency (Pulses Per Second)	Pulse Repetition Interval (Microseconds)
1	1930.5	518
2	1858.7	538
3	1792.1	558
4	1730.1	578
5	1672.2	598
6	1618.1	618
7	1567.4	638
8	1519.8	658
9	1474.9	678
10	1432.7	698
11	1392.8	718
12	1355	738
13	1319.3	758
14	1285.3	778
15	1253.1	798
16	1222.5	818
17	1193.3	838
18	1165.6	858
19	1139	878
20	1113.6	898
21	1089.3	918
22	1066.1	938
23	326.2	3066

**Table 33. Pulse Repetition Intervals Values for Test A**

The aggregate is the average of the percentage of successful detections of Short Pulse Radar Types 1-4. For example, the following table indicates how to compute the aggregate of percentage of successful detections.

Radar Type	Number of Trials	Number of Successful Detections	Minimum Percentage of Successful Detection
1	35	29	82.9%
2	30	18	60%
3	30	27	90%
4	50	44	88%
Aggregate $(82.9\% + 60\% + 90\% + 88\%)/4 = 80.2\%$			

**Long Pulse Radar Test Waveform**

<b>Radar Type</b>	<b>Pulse Width (μsec)</b>	<b>Chirp Width (MHz)</b>	<b>PRI (μsec)</b>	<b>Number of Pulses per Bursts</b>	<b>Number of Bursts</b>	<b>Minimum Percentage of Successful Detection</b>	<b>Minimum Trials</b>
5	50-100	5-20	1000-2000	1-3	8-20	80%	30

The parameters for this waveform are randomly chosen. Thirty unique waveforms are required for the Long Pulse radar test signal. If more than 30 waveforms are used for the Long Pulse radar test signal, then each additional waveform must also be unique and not repeated from the previous waveforms.

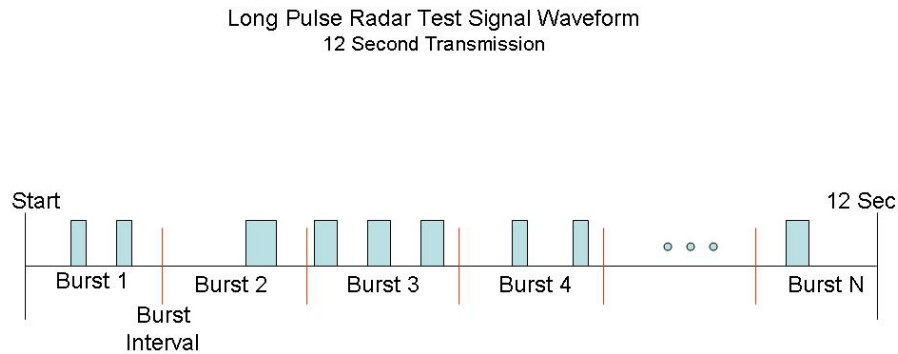
Each waveform is defined as follows:

- 1) The transmission period for the Long Pulse Radar test signal is 12 seconds.
- 2) There are a total of 8 to 20 Bursts in the 12 second period, with the number of Bursts being randomly chosen. This number is Burst\_Count.
- 3) Each Burst consists of 1 to 3 pulses, with the number of pulses being randomly chosen. Each Burst within the 12 second sequence may have a different number of pulses.
- 4) The pulse width is between 50 and 100 microseconds, with the pulse width being randomly chosen. Each pulse within a Burst will have the same pulse width. Pulses in different Bursts may have different pulse widths.
- 5) Each pulse has a linear FM chirp between 5 and 20 MHz, with the chirp width being randomly chosen. Each pulse within a Burst will have the same chirp width. Pulses in different Bursts may have different chirp widths. The chirp is centered on the pulse. For example, with radar frequency of 5300 MHz and a 20 MHz chirped signal, the chirp starts at 5290 MHz and ends at 5310 MHz.
- 6) If more than one pulse is present in a Burst, the time between the pulses will be between 1000 and 2000 microseconds, with the time being randomly chosen. If three pulses are present in a Burst, the time between the first and second pulses is chosen independently of the time between the second and third pulses.
- 7) The 12 second transmission period is divided into even intervals. The number of intervals is equal to Burst\_Count. Each interval is of length  $(12,000,000 / \text{Burst\_Count})$  microseconds. Each interval contains one Burst. The start time for the Burst, relative to the beginning of the interval, is between 1 and  $[(12,000,000 / \text{Burst\_Count}) - (\text{Total Burst Length}) + (\text{One Random PRI Interval})]$  microseconds, with the start time being randomly chosen. The step interval for the start time is 1 microsecond. The start time for each Burst is chosen independently.

**A representative example of a Long Pulse radar test waveform:**

- 1) The total test signal length is 12 seconds.
- 2) 8 Bursts are randomly generated for the Burst\_Count.
- 3) Burst 1 has 2 randomly generated pulses.
- 4) The pulse width (for both pulses) is randomly selected to be 75 microseconds.
- 5) The PRI is randomly selected to be at 1213 microseconds.
- 6) Bursts 2 through 8 are generated using steps 3 – 5.
- 7) Each Burst is contained in even intervals of 1,500,000 microseconds. The starting location for Pulse 1, Burst 1 is randomly generated (1 to 1,500,000 minus the total Burst 1 length + 1 random PRI interval) at the 325,001 microsecond step. Bursts 2 through 8 randomly fall in successive 1,500,000 microsecond intervals (i.e. Burst 2 falls in the 1,500,001 – 3,000,000 microsecond range).

## Graphical Representation of a Long Pulse radar Test Waveform



**Figure 5. Long Pulse Radar Test Signal Waveform**

### Frequency Hopping Radar Test Waveform

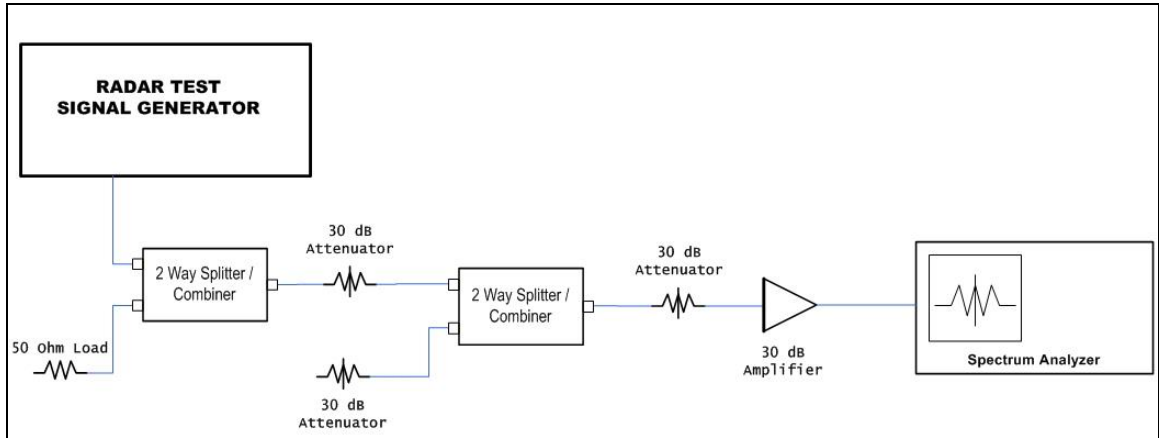
Radar Type	Pulse Width (µsec)	PRI (µsec)	Pulses per Hop	Hopping Rate (kHz)	Hopping Sequence Length (msec)	Minimum Percentage of Successful Detection	Minimum Trials
6	1	333	9	.333	300	70%	30

For the Frequency Hopping Radar Type, the same *Burst* parameters are used for each waveform. The hopping sequence is different for each waveform and a 100-length segment is selected from the hopping sequence defined by the following algorithm:

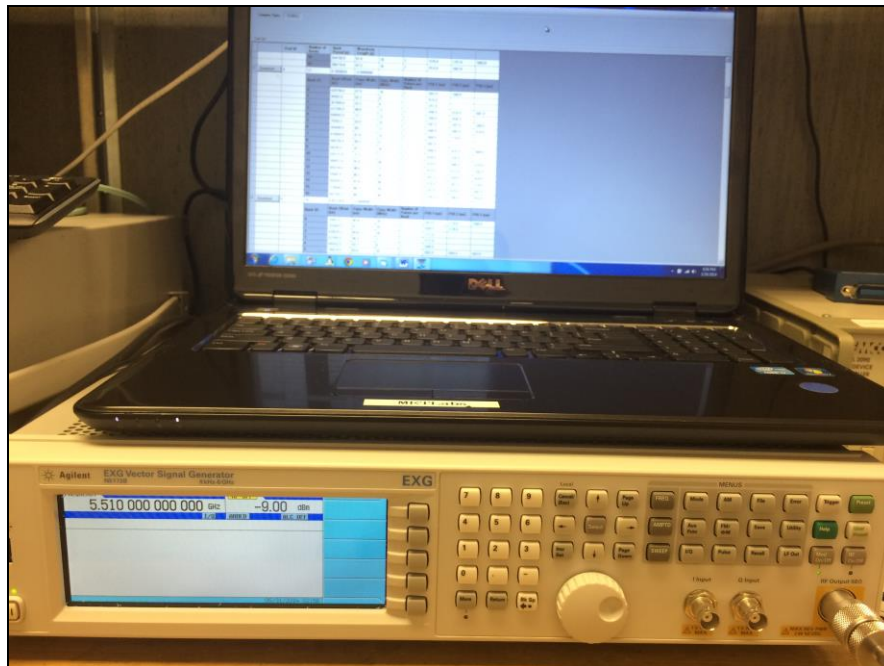
The first frequency in a hopping sequence is selected randomly from the group of 475 integer frequencies from 5250 – 5724 MHz. Next, the frequency that was just chosen is removed from the group and a frequency is randomly selected from the remaining 474 frequencies in the group. This process continues until all 475 frequencies are chosen for the set. For selection of a random frequency, the frequencies remaining within the group are always treated as equally likely.

### C. Radar Waveform Calibration

The following equipment setup was used to calibrate the radiated Radar Waveform. A spectrum analyzer was used to establish the test signal level for each radar type. During this process there were no transmissions by either the Master or Client Device. The spectrum analyzer was switched to the zero span (Time Domain) mode at the frequency of the Radar Waveform generator. Peak detection was utilized. The spectrum analyzer's resolution bandwidth (RBW) was set to 3 MHz and the video bandwidth (VBW) was set to 3 MHz. The calibration setup is diagrammed in Figure 6, and the radar test signal generator is shown in Photograph 8.

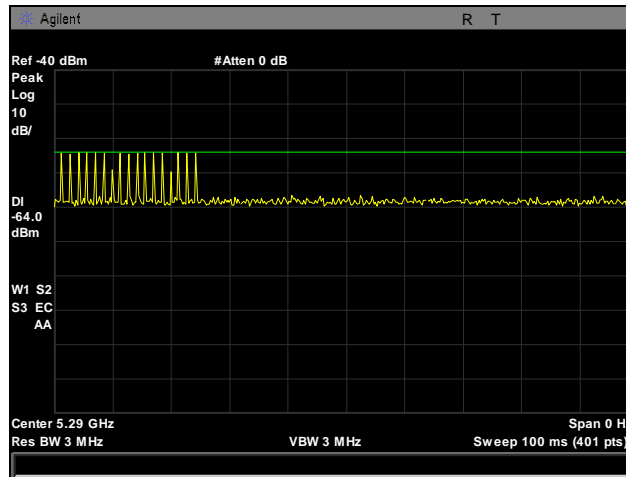


**Figure 6. Calibration Test Setup**

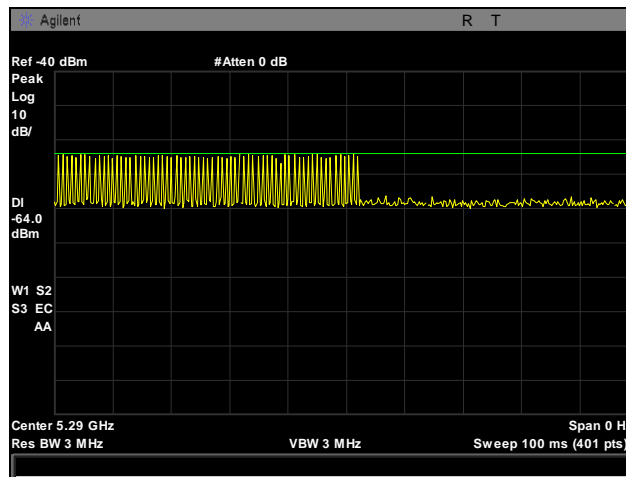


**Photograph 8. DFS Radar Test Signal Generator**

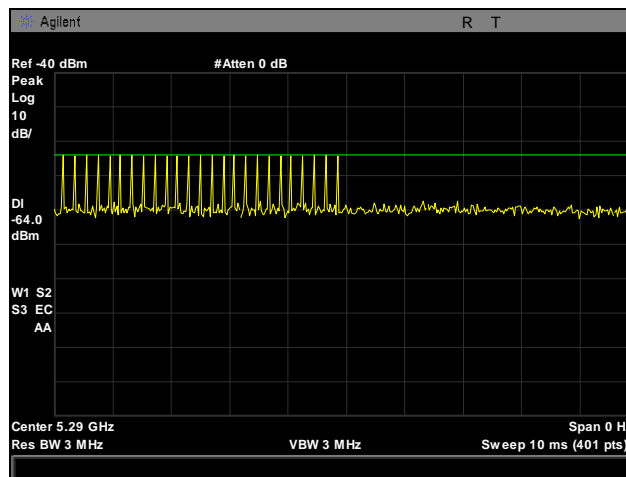
## Radar Waveform Calibration, 5290 MHz



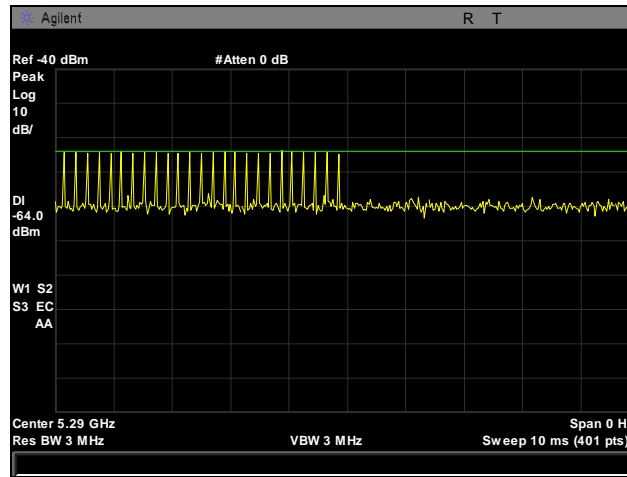
**Plot 300. Radar Type 0 Calibration, 5290 MHz**



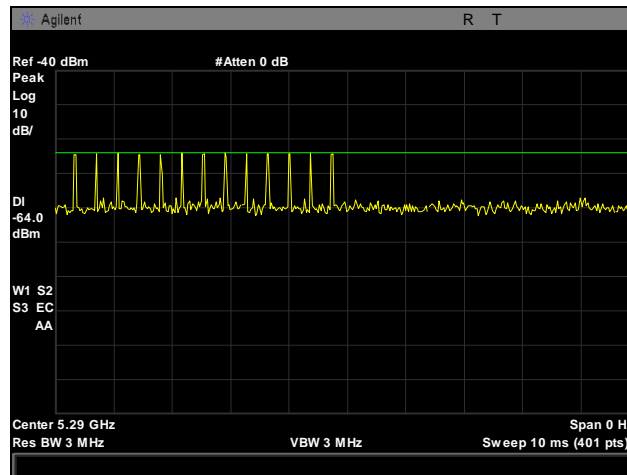
**Plot 301. Radar Type 1 Calibration, 5290 MHz**



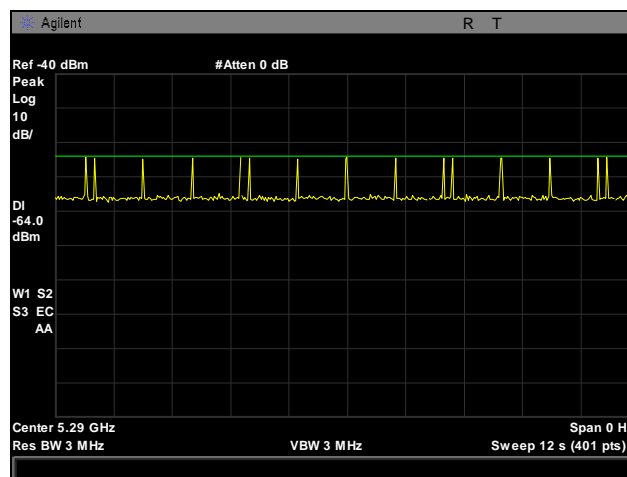
**Plot 302. Radar Type 2 Calibration, 5290 MHz**



**Plot 303. Radar Type 3 Calibration, 5290 MHz**

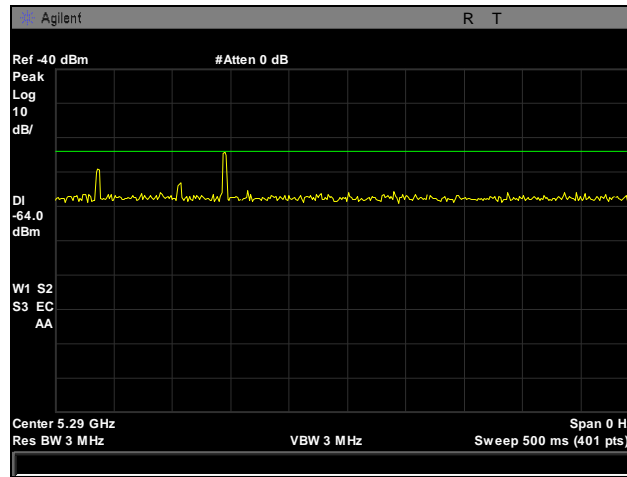


**Plot 304. Radar Type 4 Calibration, 5290 MHz**



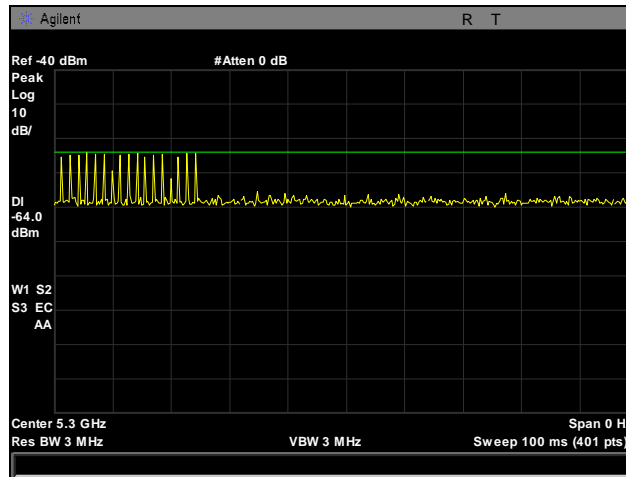
**Plot 305. Radar Type 5 Calibration, 5290 MHz**



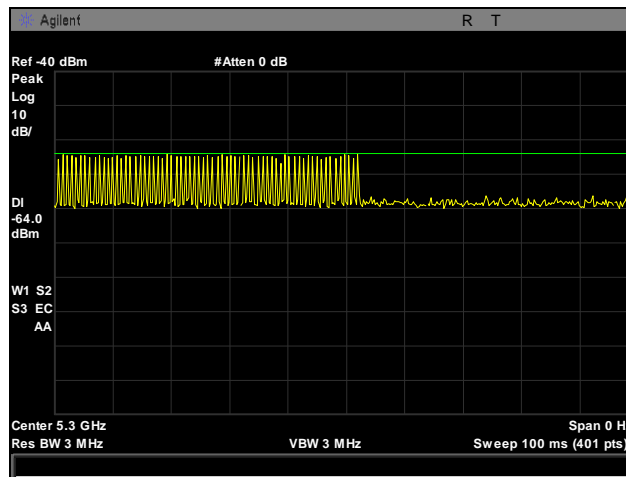


**Plot 306. Radar Type 6 Calibration, 5290 MHz**

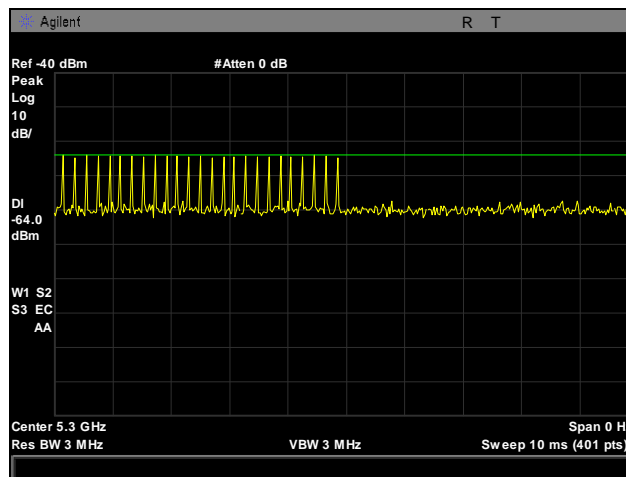
## Radar Waveform Calibration, 5300 MHz



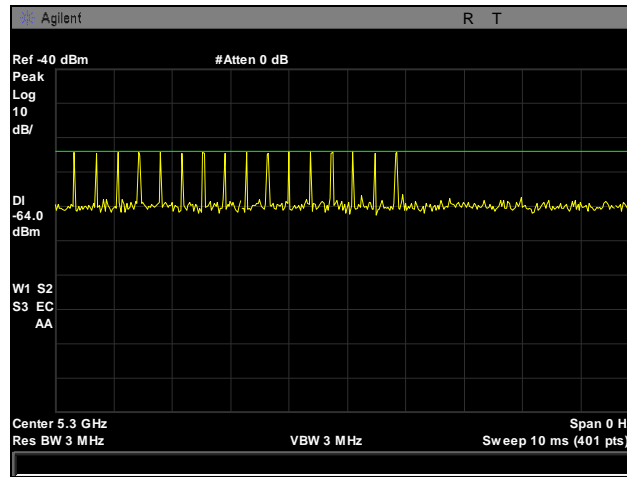
**Plot 307. Radar Type 0 Calibration, 5300 MHz**



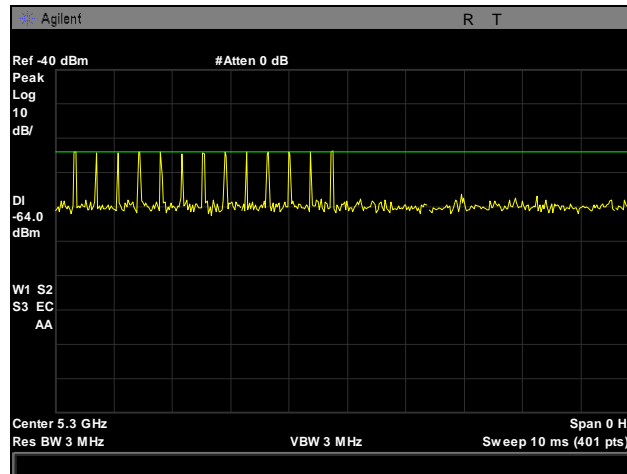
**Plot 308. Radar Type 1 Calibration, 5300 MHz**



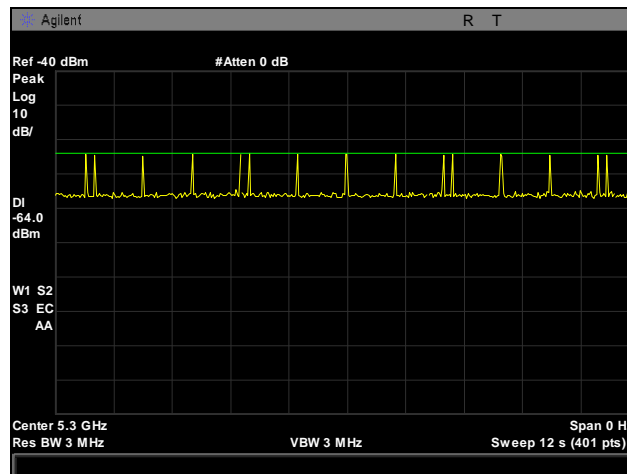
**Plot 309. Radar Type 2 Calibration, 5300 MHz**



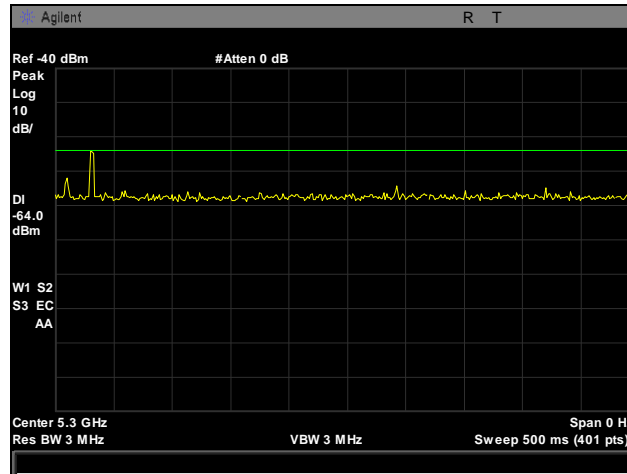
**Plot 310. Radar Type 3 Calibration, 5300 MHz**



**Plot 311. Radar Type 4 Calibration, 5300 MHz**

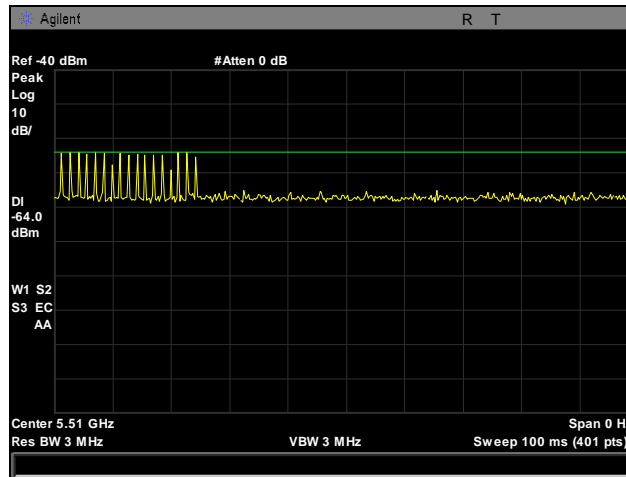


**Plot 312. Radar Type 5 Calibration, 5300 MHz**

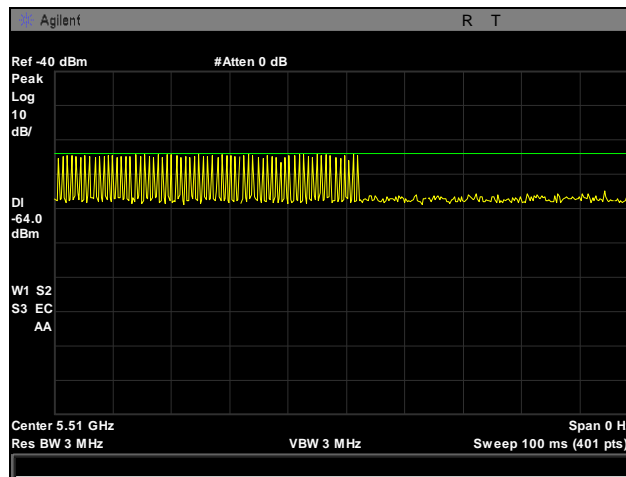


**Plot 313. Radar Type 6 Calibration, 5300 MHz**

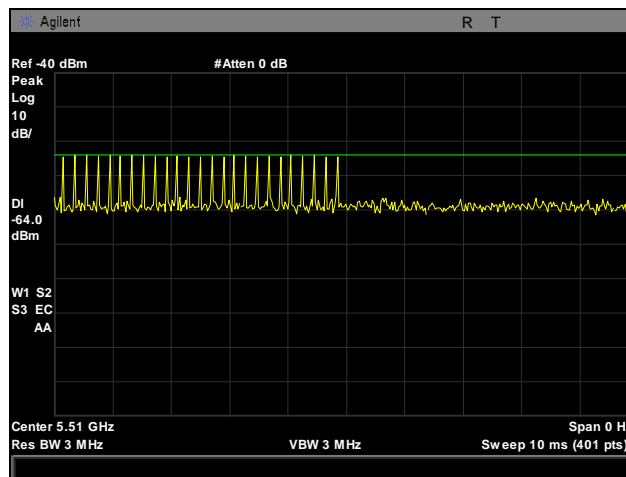
## Radar Waveform Calibration, 5510 MHz



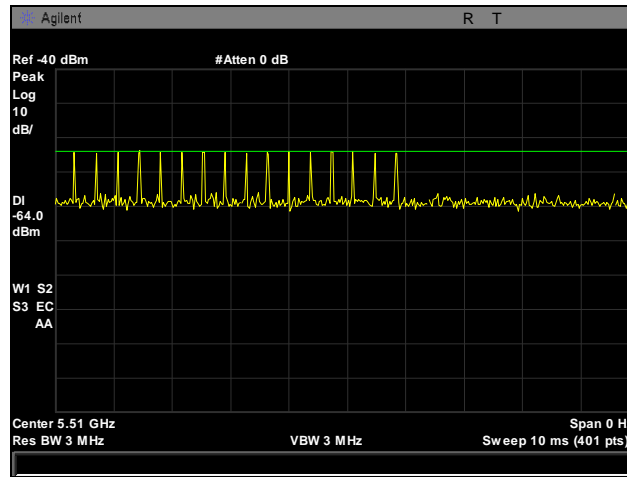
**Plot 314. Radar Type 0 Calibration, 5510 MHz**



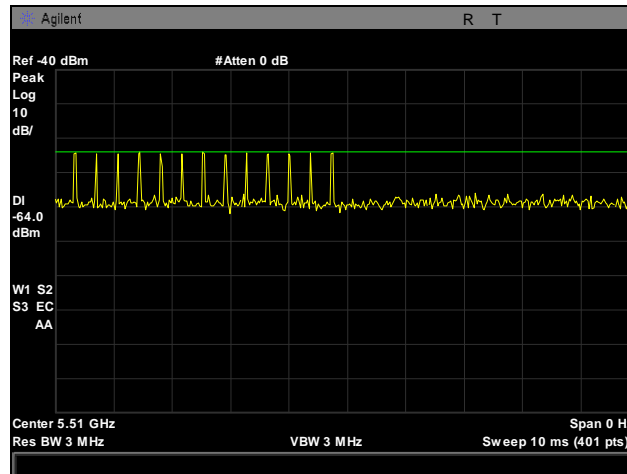
**Plot 315. Radar Type 1 Calibration, 5510 MHz**



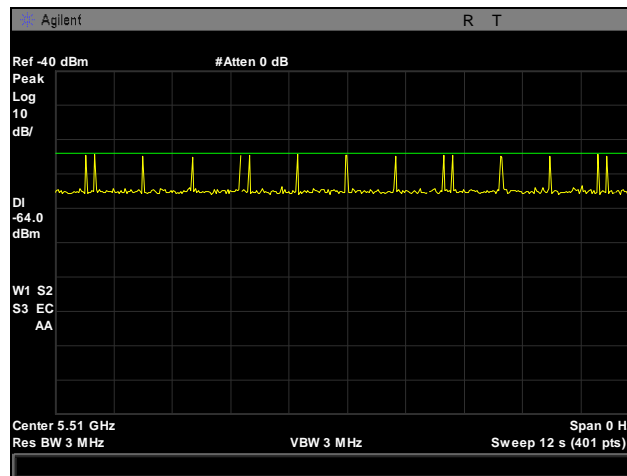
**Plot 316. Radar Type 2 Calibration, 5510 MHz**



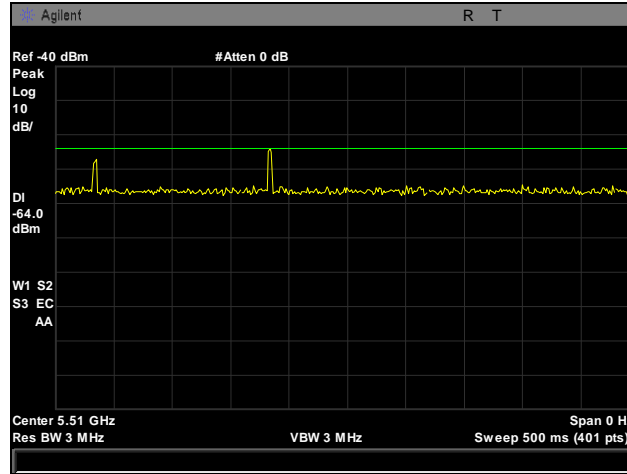
**Plot 317. Radar Type 3 Calibration, 5510 MHz**



**Plot 318. Radar Type 4 Calibration, 5510 MHz**



**Plot 319. Radar Type 5 Calibration, 5510 MHz**



**Plot 320. Radar Type 6 Calibration, 5510 MHz**

## **VI. DFS Test Procedure and Test Results**



## A. DFS Test Setup

1. A spectrum analyzer is used as a monitor to verify that the Unit Under Test (UUT) has vacated the Channel within the Channel Closing Transmission Time and Channel Move Time, and does not transmit on a Channel during the Non-Occupancy Period after the detection and subsequent Channel move. It is also used to monitor UUT transmissions during the Channel Availability Check Time.
2. The test setup, which consists of test equipment and equipment under test (EUT), is diagrammed in Figure 7.

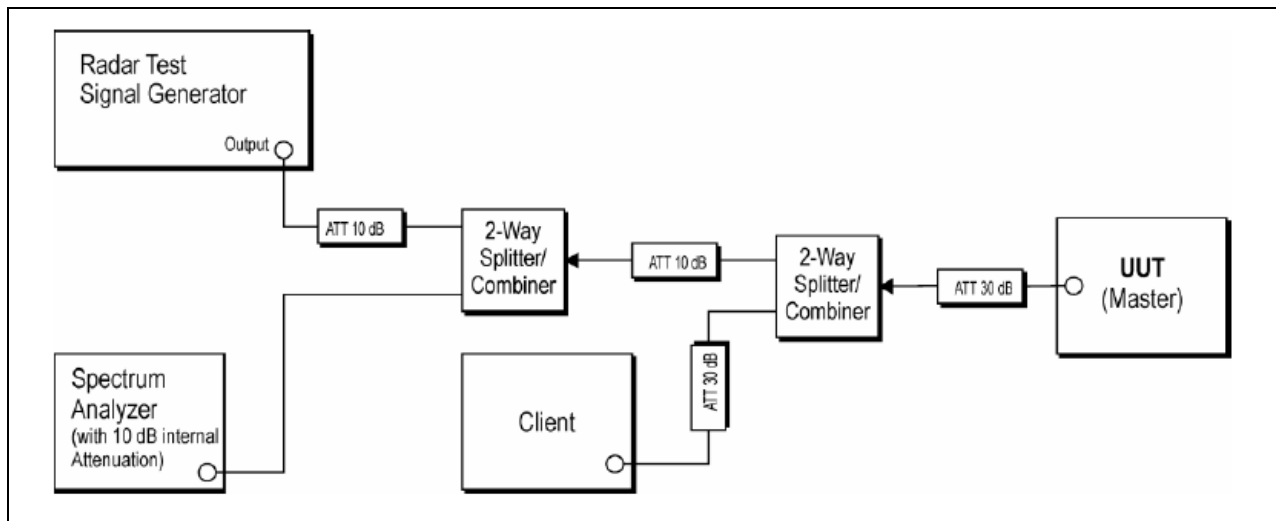


Figure 7. Test Setup Diagram

## **B. Description of Master Device**

1. Operating Frequency Range: 5150-5250 MHz, 5250-5350 MHz, 5470-5725 MHz, 5725-5825 MHz
2. Modes of Operation: Master device
3. List all antennas and associated gains: See antenna data sheets
4. List output power ranges: The output power range is +3 to +24dBm EIRP for 2.4GHz band and +3 to +23dBm EIRP for the 5 GHz band
5. List antenna impedance: 50 Ohms
6. Antenna gain verification - Use antenna data sheet
7. State test file that is transmitted: 6.5 magical hours
8. TCP description: Refer to information below
9. Time for master to complete its power-on-cycle: 2 minutes
10. Describe EUT's uniform channel spreading: Refer to information below

The AP DFS operational behavior as described below.

The AP shall support DFS for following country: USA, Canada, Europe and Japan.

1. When AP switches a radio to fallback channel after detecting radar in current operating channel, if the fallback channel is a DFS channel, AP shall perform DFS procedure on that channel
2. When AP switches a radio to another channel (other than fallback channel) after detecting radar, it shall ensure that the selected channel has a minimum separation of 140MHz i.e., 28 channel numbers from any other operational radio on that AP. If such a channel cannot be found, then the radio shall be disabled.
3. When user specifies fallback channel for a wireless interface of AP433, NMS shall verify that it has a separation of at least 140MHz from the configured channel of any other radios of that AP which are operating in same band.

## C. UNII Detection Bandwidth

**Test Requirement(s):** § 15.407 A minimum 100% detection rate is required across an EUT's 99% bandwidth.

**Test Procedure:** All UNII channels for this device have identical channel bandwidths.

A single burst of the short pulse radar type 1 is produced at 5300 MHz, 5510MHz, and 5290MHz, at the -63dBm test level. The UUT is set up as a standalone device (no associated client, and no data traffic).

A single radar burst is generated for a minimum of 10 trials, and the response of the UUT is recorded. The UUT must detect the radar waveform 90% or more of the time.

The radar frequency is increased in 1 MHz steps, repeating the above test sequence, until the detection rate falls below 90%. The highest frequency at which detection is greater than or equal to 90% is denoted  $F_H$ .

The radar frequency is decreased in 1 MHz steps, repeating the above test sequence, until the detection rate falls below 90%. The lowest frequency at which detection is greater than or equal to 90% is denoted  $F_L$ .

The U-NII Detection Bandwidth is calculated as follows:

$$\text{U-NII Detection Bandwidth} = F_H - F_L$$

**Test Engineer:** Andy Shen

**Test Date:** 12/03/14

### UNII Detection Bandwidth – Test Results

EUT Frequency- 5300MHz											
	DFS Detection Trials (1=Detection, 0= No Detection)										
Radar Frequency (MHz)	1	2	3	4	5	6	7	8	9	10	Detection Rate (%)
5290	0	0	0	0	0	0	0	0	0	0	0
5291.625 (FL)	1	1	1	1	1	1	1	1	1	1	100
5292	1	1	1	1	1	1	1	1	1	1	100
5293	1	1	1	1	1	1	1	1	1	1	100
5294	1	1	1	1	1	1	1	1	1	1	100
5295	1	1	1	1	1	1	1	1	1	1	100
5296	1	1	1	1	1	1	1	1	1	1	100
5297	1	1	1	1	1	1	1	1	1	1	100
5298	1	1	1	1	1	1	1	1	1	1	100
5299	1	1	1	1	1	1	1	1	1	1	100
5300	1	1	1	1	1	1	1	1	1	1	100
5301	1	1	1	1	1	1	1	1	1	1	100
5302	1	1	1	1	1	1	1	1	1	1	100
5303	1	1	1	1	1	1	1	1	1	1	100
5304	1	1	1	1	1	1	1	1	1	1	100
5305	1	1	1	1	1	1	1	1	1	1	100
5306	1	1	1	1	1	1	1	1	1	1	100
5307	1	1	1	1	1	1	1	1	1	1	100
5308.348 (FH)	1	1	1	1	1	1	1	1	1	1	100
5309	0	0	0	0	0	0	0	0	0	0	60
Overall Detection Percentage											%
Detection Bandwidth = $f_h - f_l = 5308.348\text{MHz} - 5291.625\text{MHz} = 16.723\text{MHz}$											
EUT 99% Bandwidth = 16.7MHz											
OBW* 100% = 16.7											

**Table 34. UNII Detection Bandwidth, Test Results, 5300 MHz 20 MHz**

EUT Frequency- 5510MHz											
Radar Frequency (MHz)	DFS Detection Trials (1=Detection, 0= No Detection)										Detection Rate (%)
	1	2	3	4	5	6	7	8	9	10	
5490	0	0	0	0	0	0	0	0	0	0	0
5491.92(FL)	1	1	1	1	1	1	1	1	1	1	1
5492	1	1	1	1	1	1	1	1	1	1	1
5493	1	1	1	1	1	1	1	1	1	1	1
5494	1	1	1	1	1	1	1	1	1	1	1
5495	1	1	1	1	1	1	1	1	1	1	1
5496	1	1	1	1	1	1	1	1	1	1	1
5497	1	1	1	1	1	1	1	1	1	1	1
5498	1	1	1	1	1	1	1	1	1	1	1
5499	1	1	1	1	1	1	1	1	1	1	1
5500	1	1	1	1	1	1	1	1	1	1	1
5501	1	1	1	1	1	1	1	1	1	1	1
5502	1	1	1	1	1	1	1	1	1	1	1
5503	1	1	1	1	1	1	1	1	1	1	1
5504	1	1	1	1	1	1	1	1	1	1	1
5505	1	1	1	1	1	1	1	1	1	1	1
5506	1	1	1	1	1	1	1	1	1	1	1
5507	1	1	1	1	1	1	1	1	1	1	1
5508	1	1	1	1	1	1	1	1	1	1	1
5509	1	1	1	1	1	1	1	1	1	1	1
5510	1	1	1	1	1	1	1	1	1	1	1
5511	1	1	1	1	1	1	1	1	1	1	1
5512	1	1	1	1	1	1	1	1	1	1	1
5513	1	1	1	1	1	1	1	1	1	1	1
5514	1	1	1	1	1	1	1	1	1	1	1
5515	1	1	1	1	1	1	1	1	1	1	1
5516	1	1	1	1	1	1	1	1	1	1	1
5517	1	1	1	1	1	1	1	1	1	1	1
5518	1	1	1	1	1	1	1	1	1	1	1
5519	1	1	1	1	1	1	1	1	1	1	1
5520	1	1	1	1	1	1	1	1	1	1	1
5521	1	1	1	1	1	1	1	1	1	1	1
5522	1	1	1	1	1	1	1	1	1	1	1
5523	1	1	1	1	1	1	1	1	1	1	1
5524	1	1	1	1	1	1	1	1	1	1	1
5525	1	1	1	1	1	1	1	1	1	1	1
5526	1	1	1	1	1	1	1	1	1	1	1
5527	1	1	1	1	1	1	1	1	1	1	1
5528.08(FH)	1	1	1	1	1	1	1	1	1	1	1
5529	0	0	0	0	0	0	0	0	0	0	0
Overall Detection Percentage											%
Detection Bandwidth = $f_h - f_l = 5528.08\text{MHz} - 5491.92\text{MHz} = 36.16\text{MHz}$											
EUT 99% Bandwidth = 36.16											
OBW* 100% = 36.16											

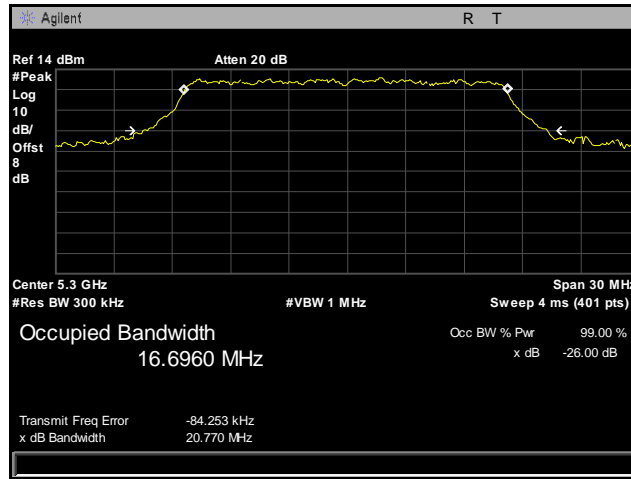
**Table 35. UNII Detection Bandwidth, Test Results, 5510 MHz 40 MHz**

EUT Frequency- 5290MHz											
Radar Frequency (MHz)	DFS Detection Trials (1=Detection, 0= No Detection)										Detection Rate (%)
	1	2	3	4	5	6	7	8	9	10	
5251	0	0	0	0	0	0	0	0	0	0	0
5252.09(FL)	1	1	1	1	1	1	1	1	1	1	1
5253	1	1	1	1	1	1	1	1	1	1	1
5254	1	1	1	1	1	1	1	1	1	1	1
5255	1	1	1	1	1	1	1	1	1	1	1
5256	1	1	1	1	1	1	1	1	1	1	1
5257	1	1	1	1	1	1	1	1	1	1	1
5258	1	1	1	1	1	1	1	1	1	1	1
5259	1	1	1	1	1	1	1	1	1	1	1
6260	1	1	1	1	1	1	1	1	1	1	1
5261	1	1	1	1	1	1	1	1	1	1	1
5262	1	1	1	1	1	1	1	1	1	1	1
5263	1	1	1	1	1	1	1	1	1	1	1
5264	1	1	1	1	1	1	1	1	1	1	1
5265	1	1	1	1	1	1	1	1	1	1	1
5266	1	1	1	1	1	1	1	1	1	1	1
5267	1	1	1	1	1	1	1	1	1	1	1
5268	1	1	1	1	1	1	1	1	1	1	1
5269	1	1	1	1	1	1	1	1	1	1	1
5270	1	1	1	1	1	1	1	1	1	1	1
5271	1	1	1	1	1	1	1	1	1	1	1
5272	1	1	1	1	1	1	1	1	1	1	1
5273	1	1	1	1	1	1	1	1	1	1	1
5274	1	1	1	1	1	1	1	1	1	1	1
5275	1	1	1	1	1	1	1	1	1	1	1
5276	1	1	1	1	1	1	1	1	1	1	1
5277	1	1	1	1	1	1	1	1	1	1	1
5278	1	1	1	1	1	1	1	1	1	1	1
5279	1	1	1	1	1	1	1	1	1	1	1
5280	1	1	1	1	1	1	1	1	1	1	1
5281	1	1	1	1	1	1	1	1	1	1	1
5282	1	1	1	1	1	1	1	1	1	1	1
5283	1	1	1	1	1	1	1	1	1	1	1
5284	1	1	1	1	1	1	1	1	1	1	1
5285	1	1	1	1	1	1	1	1	1	1	1
5286	1	1	1	1	1	1	1	1	1	1	1
5287	1	1	1	1	1	1	1	1	1	1	1
5288	1	1	1	1	1	1	1	1	1	1	1
5289	1	1	1	1	1	1	1	1	1	1	1
5290	1	1	1	1	1	1	1	1	1	1	1
5291	1	1	1	1	1	1	1	1	1	1	1
5292	1	1	1	1	1	1	1	1	1	1	1
5293	1	1	1	1	1	1	1	1	1	1	1
5294	1	1	1	1	1	1	1	1	1	1	1
5295	1	1	1	1	1	1	1	1	1	1	1
5296	1	1	1	1	1	1	1	1	1	1	1
5297	1	1	1	1	1	1	1	1	1	1	1
5298	1	1	1	1	1	1	1	1	1	1	1

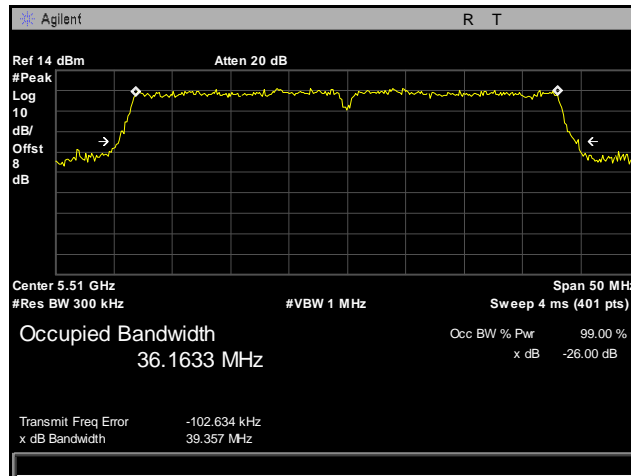
5299	1	1	1	1	1	1	1	1	1	1	100
5300	1	1	1	1	1	1	1	1	1	1	100
5301	1	1	1	1	1	1	1	1	1	1	100
5302	1	1	1	1	1	1	1	1	1	1	100
5303	1	1	1	1	1	1	1	1	1	1	100
5304	1	1	1	1	1	1	1	1	1	1	100
5305	1	1	1	1	1	1	1	1	1	1	100
5306	1	1	1	1	1	1	1	1	1	1	100
5307	1	1	1	1	1	1	1	1	1	1	100
5308	1	1	1	1	1	1	1	1	1	1	100
5309	1	1	1	1	1	1	1	1	1	1	100
5310	1	1	1	1	1	1	1	1	1	1	100
5311	1	1	1	1	1	1	1	1	1	1	100
5312	1	1	1	1	1	1	1	1	1	1	100
5313	1	1	1	1	1	1	1	1	1	1	100
5314	1	1	1	1	1	1	1	1	1	1	100
5315	1	1	1	1	1	1	1	1	1	1	100
5316	1	1	1	1	1	1	1	1	1	1	100
5317	1	1	1	1	1	1	1	1	1	1	100
5318	1	1	1	1	1	1	1	1	1	1	100
5319	1	1	1	1	1	1	1	1	1	1	100
5320	1	1	1	1	1	1	1	1	1	1	100
5321	1	1	1	1	1	1	1	1	1	1	100
5322	1	1	1	1	1	1	1	1	1	1	100
5323	1	1	1	1	1	1	1	1	1	1	100
5324	1	1	1	1	1	1	1	1	1	1	100
5325	1	1	1	1	1	1	1	1	1	1	100
5326	1	1	1	1	1	1	1	1	1	1	100
5327	1	1	1	1	1	1	1	1	1	1	100
5328 (FH)	1	1	1	1	1	1	1	1	1	1	100
5330	0	0	0	0	0	0	0	0	0	0	0
Overall Detection Percentage											%
Detection Bandwidth = $f_h - f_l = 5328\text{MHz} - 5252.09\text{MHz} = 75.91\text{MHz}$											
EUT 99% Bandwidth = 75.8167											
OBW* 100% = 75.91											

**Table 36. UNII Detection Bandwidth, Test Results, 5290 MHz 80 MHz**

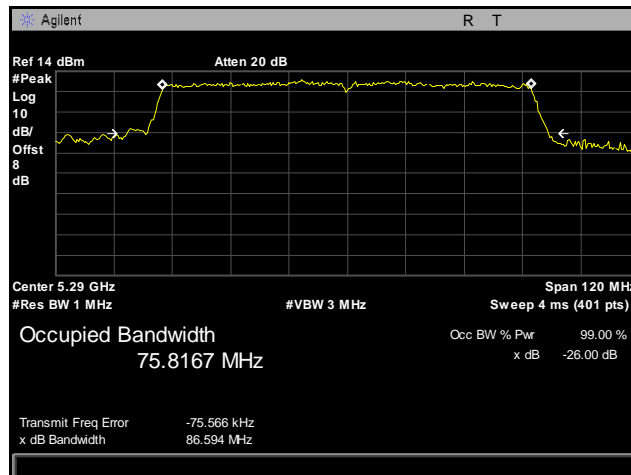
## UNII Detection Bandwidth Plots



Plot 321. Occupied Bandwidth, 802.11a, 5300 MHz



Plot 322. Occupied Bandwidth, 802.11n, 5510 MHz, Port 2



Plot 323. Occupied Bandwidth, 802.11ac, 5290 MHz, Port 1



## **D. Initial Channel Availability Check Time**

**Test Requirements:** § 15.407 The Initial Channel Availability Check Time tests that the UUT does not emit beacon, control, or data signals on the test channel until the power-up sequence has been completed and the U-NII device has checked for radar waveforms, for one minute, on the test channel. This test does not use any of the radar waveforms and only needs to be performed once.

The UUT should not make any transmissions over the test channel, for at least 1 minute after completion of its power-on cycle.

**Test Procedure:** The U-NII device is powered on and instructed to operate at 5300 MHz. At the same time the UUT is powered on, the spectrum analyzer is set to 5300MHz with a zero span and a 2.5 minute sweep time. The analyzer is triggered at the same time power is applied to the U-NII device.

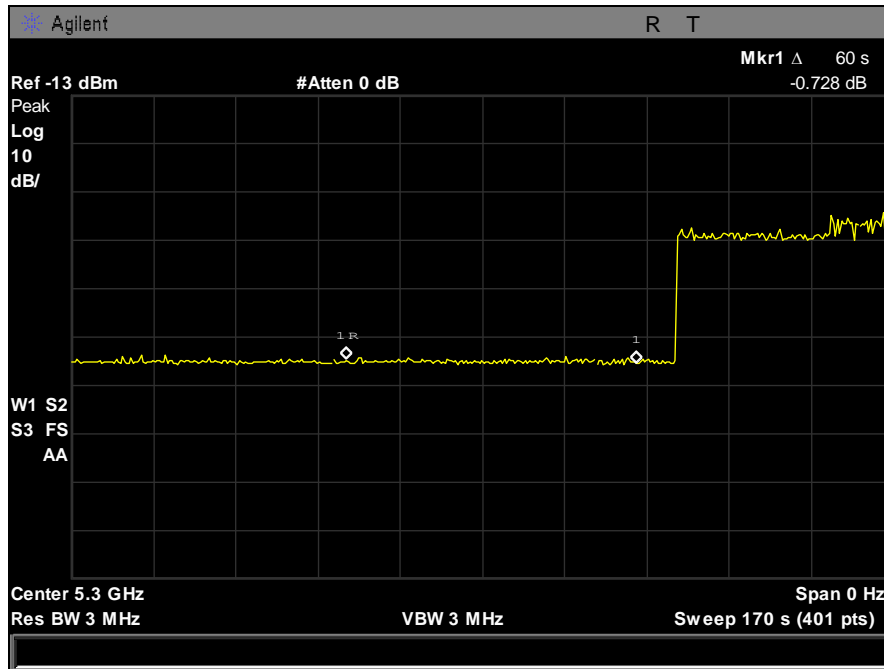
**Test Results:** Marker 1R on plot 332 indicates the start of the channel availability check time.

The Equipment was compliant with § 15.407 Initial Channel Availability Check Time.

**Test Engineer:** Andy Shen

**Test Date:** 11/21/14

### Initial Channel Availability Check Time – Plot



Plot 324. Initial Channel Availability Check Time

## **E. Radar Burst at the Beginning of Channel Availability Check Time**

**Test Requirements:** § 15.407 A Radar Burst at the Beginning of the Channel Availability Check Time tests that the UUT does not emit beacon, control, or data signals on the test Channel if it has detected a radar burst during that time period until the power-up sequence has been completed and the U-NII device checks for Radar Waveforms for one minute on the test Channel. The steps below define the procedure to verify successful radar detection on the selected Channel during a period equal to the Channel Availability Check Time and avoidance of operation on that Channel when a radar Burst with a level equal to the DFS Detection Threshold + 1 dB (-63dBm) occurs at the beginning of the Channel Availability Check Time.

**Test Procedure:** The UUT is powered on at T0. T1 denotes the instant when the UUT has completed its power-up sequence. The Channel Availability Check Time commences at instant T1 and will end no sooner than T1 + 60 seconds.

A single Burst of short pulse radar type 1, at -63 dBm, will commence within a 6 second window starting at T1.

Visual indication of the UUT of successful detection of the radar Burst will be recorded and reported. Observation of transmission at 5300MHz will continue for 2.5 minutes after the radar Burst has been generated.

Verify that during the 2.5 minute measurement window, no UUT transmissions occur at 5300MHz.

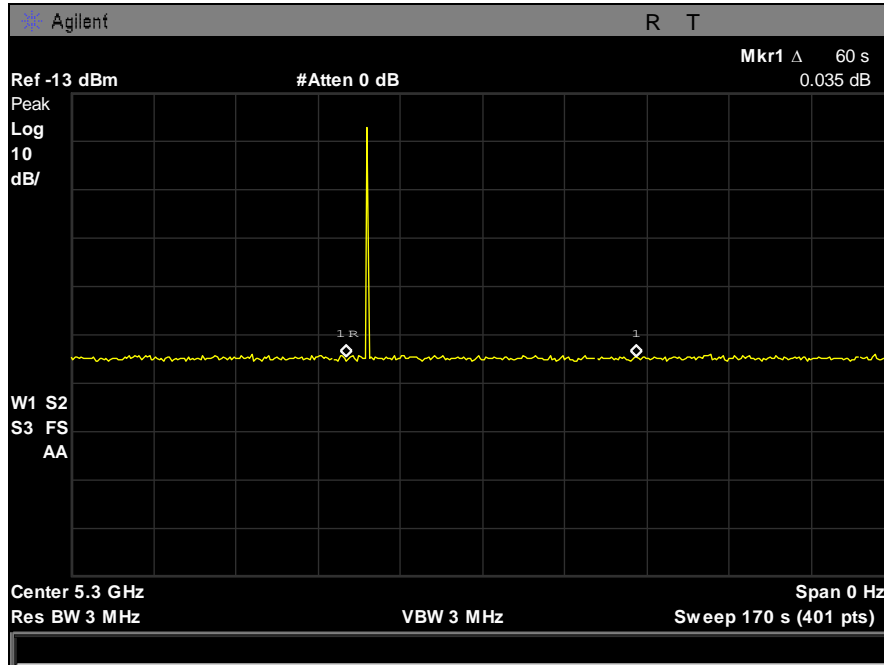
**Test Results** Plot 333 below indicates that there were no UUT transmissions during the 2.5 minute measurement window when a radar burst was injected 6 seconds into the CACT. Therefore, the UUT detected the presence of a radar during the CACT and moved away from that channel.

The equipment was compliant with § 15.407 Radar Burst at the Beginning of the Channel Availability Check Time.

**Test Engineer:** Andy Shen

**Test Date:** 11/21/14

### Radar Burst at the Beginning of Channel Availability Check Time – Plot



Plot 325. Radar Burst at the Beginning of CACT

## **F. Radar Burst at the End of Channel Availability Check Time**

**Test Requirements:** § 15.407 A Radar Burst at the End of the Channel Availability Check Time tests that the UUT does not emit beacon, control, or data signals on the test Channel if it has detected a radar burst during that time period until the power-up sequence has been completed and the U-NII device checks for Radar Waveforms for one minute on the test Channel. The steps below define the procedure to verify successful radar detection on the selected Channel during a period equal to the Channel Availability Check Time and avoidance of operation on that Channel when a radar Burst with a level equal to the DFS Detection Threshold + 1 dB (-63dBm) occurs at the end of the Channel Availability Check Time.

**Test Procedure:** The steps below define the procedure to verify successful radar detection on the selected Channel during a period equal to the Channel Availability Check Time and avoidance of operation on that Channel when a radar Burst with a level equal to the DFS Detection Threshold + 1 dB (-63dBm) occurs at the end of the Channel Availability Check Time.

The UUT is powered on at T0. T1 denotes the instant when the UUT has completed its power-up sequence. The Channel Availability Check Time commences at instant T1 and will end no sooner than T1 + 60 seconds.

A single Burst of short pulse of radar type 1 at -63 dBm will commence within a 6 second window starting at T1+ 54 seconds.

Visual indication on the UUT of successful detection of the radar Burst will be recorded and reported. Observation of emissions at 5300MHz will continue for 2.5 minutes after the radar Burst has been generated.

Verify that during the 2.5 minute measurement window no UUT transmissions occurred at 5300MHz.

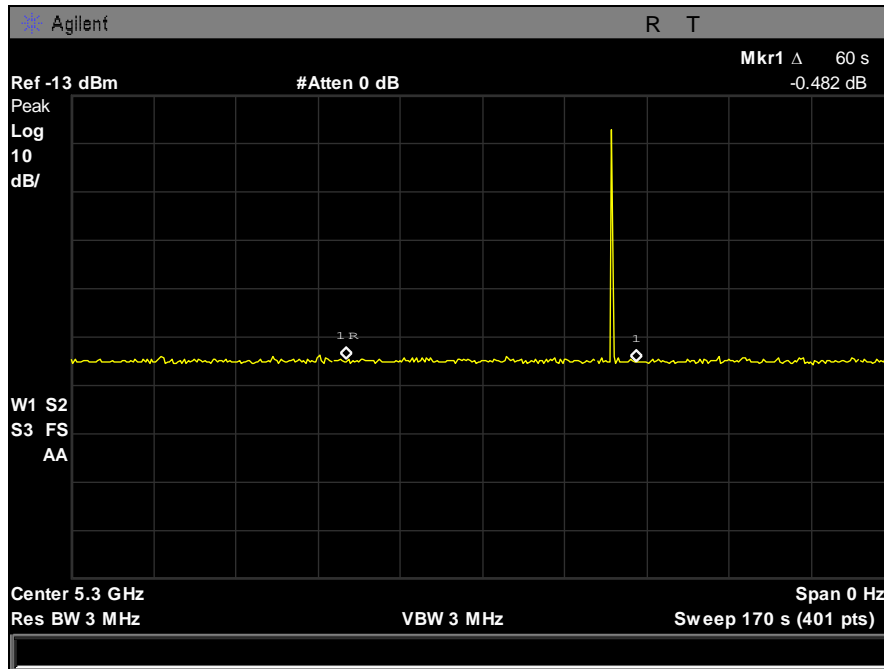
**Test Results:** Plot 334 indicates that no UUT transmissions occurred during the 2.5 minute measurement window when a radar burst was injected 6 seconds before the end of the CACT. Therefore, the UUT detected the presence of a radar and moved away from that channel.

The equipment was compliant with § 15.407 Radar Burst at the End of the Channel Availability Check Time.

**Test Engineer:** Andy Shen

**Test Date:** 11/21/14

### Radar Burst at the End of Channel Availability Check Time – Plot



Plot 326. Radar Burst at the End of CACT

## **G. In-Service Monitoring for Channel Move Time, Channel Closing Transmission Time, and Non-Occupancy Period**

**Test Requirements:** § 15.407 (Refer to DFS Response Requirement Values table in section III-A of this report.) The UUT shall continuously monitor for radar transmissions in the operating test channel. When a radar burst occurs in the test channel, it has 10 seconds to move to another channel. This 10 second window is termed Channel Move Time (CMT).

When a radar burst occurs, the UUT has 200 milliseconds, plus an aggregate of 60 milliseconds over remaining 10 second period, to cease transmission in the operating test channel. This 200 ms + 60 ms over remaining 10 second period requirement is termed Channel Closing Transmission Time (CCT).

After radar burst and subsequent move to another channel, the UUT shall not resume transmission, on the channel it moved from, for a period of 30 minutes. This requirement is termed Non-Occupancy Period (NOP).

**Test Procedure:** These tests define how the following DFS parameters are verified during In-Service Monitoring: Channel Closing Transmission Time, Channel Move Time, and Non-Occupancy Period.

The steps below define the procedure to determine the above mentioned parameters when a radar Burst with a level equal to the DFS Detection Threshold + 1dB (-63dBm) is generated on the Operating Channel of the U-NII device.

A U-NII device operating as a Client Device will associate with the UUT (Master) at 5300 MHz. Stream the MPEG test file from the Master Device to the Client Device on the selected Channel for the entire period of the test.

At time T<sub>0</sub> the Radar Waveform generator sends a Burst of pulses for each of the radar types at -63dBm.

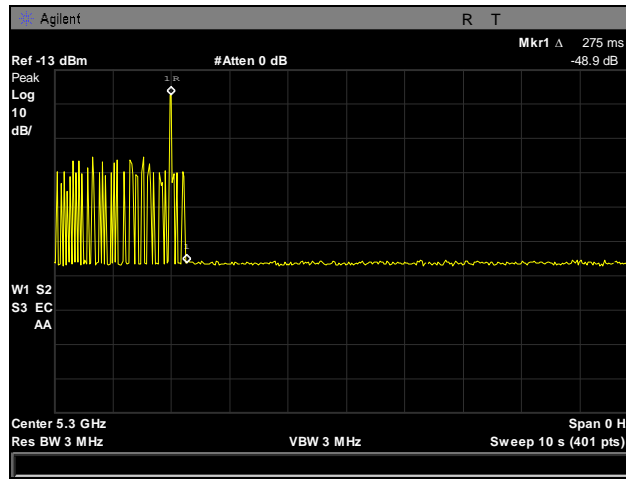
Observe the transmissions of the UUT at the end of the radar Burst on the Operating Channel for duration greater than 10 seconds. Measure and record the transmissions from the UUT during the observation time (Channel Move Time). Compare the Channel Move Time and Channel Closing Transmission Time results to the limits defined in the *DFS Response Requirement Values table*.

**Test Results:** The EUT was compliant with § 15.407 In-Service Monitoring for Channel Move Time, Channel Closing Transmission Time, and Non-Occupancy Period.

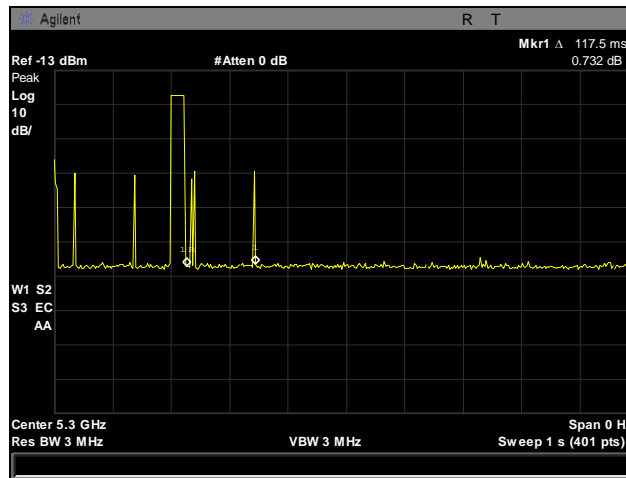
**Test Engineer:** Andy Shen

**Test Date:** 11/21/14

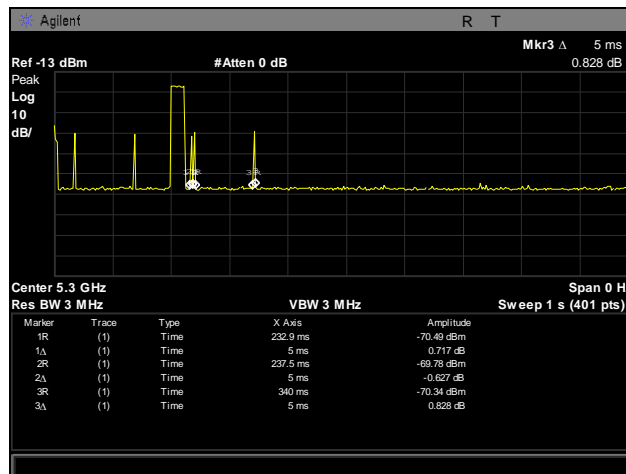
### Channel Move Time – Plots



Plot 327. Channel Move Time, 10s



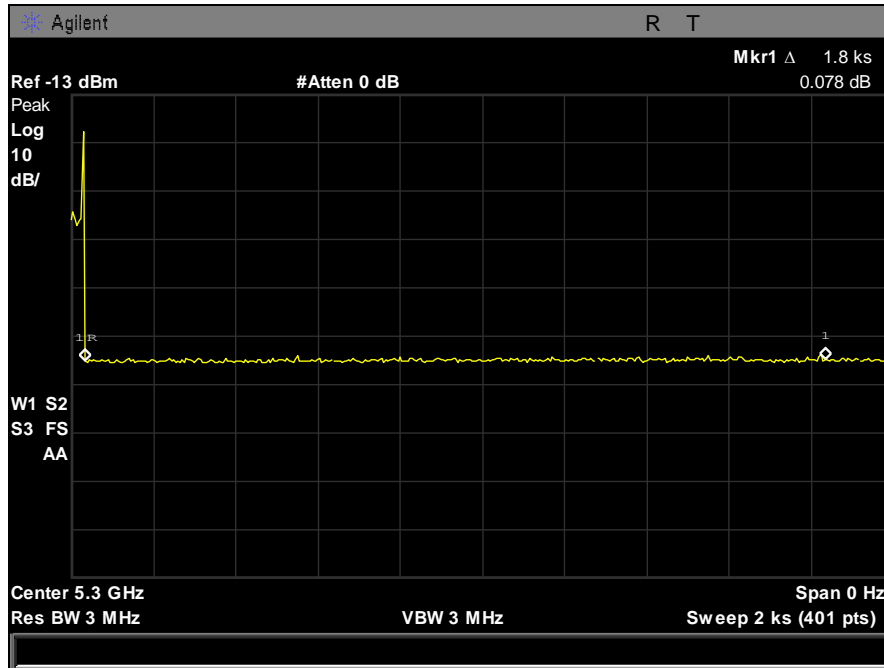
Plot 328. Channel Closing Transmission Time, 1s



Plot 329. Channel Closing Transmission Time, Aggregate



### Non-Occupancy Period – Plot



Plot 330. Non-Occupancy Period

## H. Statistical Performance Check

**Test Requirements:** § 15.407 During In-Service Monitoring, the EUT requires a minimum percentage of successful radar detections from all required radar waveforms at a level equal to the DFS Detection Threshold + 1dB.

**Test Procedure:** Stream the MPEG test file from the Master Device to the Client Device on the selected Channel for the entire period of the test. The Radar Waveform generator sends the individual waveform for each of the radar types 1-6 at -63dbm. Statistical data is gathered to determine the ability of the device to detect the radar test waveforms. The device can utilize a test mode to demonstrate when detection occurs to prevent the need to reset the device between trial runs. The percentage of successful detection is calculated by:

$$\frac{\textit{TotalWaveformDetections}}{\textit{TotalWaveformTrials}} \times 100$$

The Minimum number of trails, minimum percentage of successful detection and the average minimum percentage of successful detection are found in the Radar Test Waveforms section.

**Test Results:** The equipment was compliant with § 15.407 Statistical Performance Check.

**Test Engineer:** Andy Shen

**Test Date:** 12/03/14

**Statistical Performance Check – Radar Type 0, 20 MHz**

Radar Type	Trial #	Pulses per Burst	Pulse Width (µsec)	PRI (µsec)	Detection
					1 = Yes, 0 = No
1	1	18	1	1428	1
	2	18	1	1428	1
	3	18	1	1428	1
	4	18	1	1428	1
	5	18	1	1428	1
	6	18	1	1428	1
	7	18	1	1428	1
	8	18	1	1428	1
	9	18	1	1428	1
	10	18	1	1428	1
	11	18	1	1428	1
	12	18	1	1428	1
	13	18	1	1428	1
	14	18	1	1428	1
	15	18	1	1428	1
	16	18	1	1428	1
	17	18	1	1428	1
	18	18	1	1428	1
	19	18	1	1428	1
	20	18	1	1428	1
	21	18	1	1428	1
	22	18	1	1428	1
	23	18	1	1428	1
	24	18	1	1428	1
	25	18	1	1428	1
	26	18	1	1428	1
	27	18	1	1428	1
	28	18	1	1428	1
	29	18	1	1428	1
	30	18	1	1428	1
<b>Detection Percentage</b>					<b>100% (&gt; 60%)</b>

**Table 37. Statistical Performance Check – Radar Type 0, 20 MHz**

**Statistical Performance Check – Radar Type 1, 20 MHz**

Radar Type	Trial #	Pulses per Burst	Pulse Width (µsec)	PRI (µsec)	Detection
					1 = Yes, 0 = No
1	1	86	1	618	1
	2	72	1	738	1
	3	102	1	518	1
	4	67	1	798	1
	5	58	1	918	1
	6	61	1	878	1
	7	59	1	898	1
	8	78	1	678	1
	9	63	1	838	1
	10	62	1	858	1
	11	83	1	638	1
	12	70	1	758	1
	13	95	1	558	1
	14	57	1	938	1
	15	89	1	598	1
	16	20	1	1603	1
	17	92	1	2771	1
	18	75	1	574	1
	19	33	1	713	1
	20	22	1	1625	1
	21	80	1	2436	1
	22	53	1	666	1
	23	25	1	998	1
	24	67	1	2196	1
	25	52	1	790	1
	26	40	1	1028	1
	27	27	1	1332	1
	28	19	1	2021	1
	29	25	1	2884	1
	30	23	1	2113	1
<b>Detection Percentage</b>					<b>100% (&gt; 60%)</b>

**Table 38. Statistical Performance Check – Radar Type 1, 20 MHz**

**Statistical Performance Check – Radar Type 2, 20 MHz**

Radar Type	Trial #	Pulse Width 1 to 5 $\mu$ sec	PRI 150 to 230 $\mu$ sec	Pulses per Burst 23 to 29	Detection
					1 = Yes, 0 = No
2	1	1.9	155	28	1
	2	4.8	185	29	1
	3	3.3	163	29	1
	4	4.8	158	28	1
	5	1.7	204	26	1
	6	1.5	230	28	1
	7	1.2	181	26	1
	8	1.4	194	28	1
	9	1.2	194	28	1
	10	3.6	197	23	1
	11	2.5	213	29	1
	12	1.7	190	29	1
	13	1.2	206	27	1
	14	3.5	193	24	1
	15	1.4	169	24	1
	16	1.4	182	23	1
	17	4.7	221	25	1
	18	4	197	29	1
	19	1.5	230	23	1
	20	3.2	178	23	1
	21	3.7	158	25	1
	22	3.1	150	27	1
	23	2.3	217	27	1
	24	3.3	164	29	1
	25	5	195	25	1
	26	4.9	162	26	1
	27	3.5	164	24	1
	28	3.8	201	29	1
	29	4.8	162	25	1
	30	1.2	151	23	1
<b>Detection Percentage</b>					<b>100% (&gt; 60%)</b>

**Table 39. Statistical Performance Check – Radar Type 2, 20 MHz**

**Statistical Performance Check – Radar Type 3, 20 MHz**

Radar Type	Trial #	Pulse Width 6 to 10 µsec	PRI 200 to 500 µsec	Pulses per Burst 16 to 18	Detection
					1 = Yes, 0 = No
3	1	9.3	255	17	1
	2	6.7	423	18	1
	3	6.9	494	16	1
	4	7	341	18	1
	5	9.9	211	18	1
	6	8.6	337	17	1
	7	9.2	322	18	1
	8	7.8	228	16	1
	9	8.4	203	17	1
	10	8.3	284	16	1
	11	7.7	362	18	1
	12	6.5	233	17	1
	13	8	432	16	1
	14	9.9	238	17	1
	15	8.4	304	17	1
	16	9.2	488	16	1
	17	7	415	17	1
	18	8.5	273	17	1
	19	8	269	18	1
	20	6.7	422	18	1
	21	6.2	401	18	1
	22	7.9	378	16	1
	23	9.1	387	16	1
	24	8	322	18	1
	25	7.5	401	18	1
	26	6	355	16	1
	27	6.4	497	18	1
	28	8.5	237	18	1
	29	7.8	223	16	1
	30	8.8	289	16	1
<b>Detection Percentage</b>					<b>100% (&gt; 60%)</b>

**Table 40. Statistical Performance Check – Radar Type 3, 20 MHz**

**Statistical Performance Check – Radar Type 4, 20 MHz**

Radar Type	Trial #	Pulse Width 11 to 20 $\mu$ sec	PRI 200 to 500 $\mu$ sec	Pulses per Burst 12 to 16	Detection
					1 = Yes, 0 = No
4	1	17.6	273	15	1
	2	15.9	310	16	1
	3	18.4	494	15	1
	4	16	333	15	1
	5	15.9	302	14	1
	6	16.9	354	15	1
	7	12.3	331	14	1
	8	13	307	14	1
	9	15.8	436	12	1
	10	18	277	16	1
	11	16.4	272	15	1
	12	15.3	420	16	1
	13	13.4	440	14	1
	14	17.3	224	16	1
	15	11.3	426	13	1
	16	13	250	14	1
	17	11.1	271	16	1
	18	13	238	16	1
	19	13.4	270	13	1
	20	17.1	205	13	1
	21	19.6	297	14	1
	22	15.8	355	12	1
	23	14.2	222	15	1
	24	19.1	296	12	1
	25	13.3	310	14	1
	26	16.2	293	13	1
	27	12.1	402	12	1
	28	13.9	266	16	1
	29	16.8	278	13	1
	30	15.4	461	13	1
<b>Detection Percentage</b>					<b>100% (&gt; 60%)</b>

**Table 41. Statistical Performance Check – Radar Type 4, 20 MHz**

### Statistical Performance Check – Radar Type 5, 20 MHz

Radar Type	Trial #	Filename*	Detection
			1 = Yes, 0 = No
5	1	bin5-trial 1	1
	2	bin5-trial 2	1
	3	bin5-trial 3	1
	4	bin5-trial 4	1
	5	bin5-trial 5	1
	6	bin5-trial 6	1
	7	bin5-trial 7	1
	8	bin5-trial 8	1
	9	bin5-trial 9	1
	10	bin5-trial 10	1
	11	bin5-trial 11	1
	12	bin5-trial 12	1
	13	bin5-trial 13	1
	14	bin5-trial 14	1
	15	bin5-trial 15	1
	16	bin5-trial 16	1
	17	bin5-trial 17	1
	18	bin5-trial 18	1
	19	bin5-trial 19	1
	20	bin5-trial 20	1
	21	bin5-trial 21	1
	22	bin5-trial 22	1
	23	bin5-trial 23	1
	24	bin5-trial 24	1
	25	bin5-trial 25	1
	26	bin5-trial 26	1
	27	bin5-trial 27	1
	28	bin5-trial 28	1
	29	bin5-trial 29	1
	30	bin5-trial 30	1
<b>Detection Percentage</b>			<b>100% (&gt; 80%)</b>

Table 42. Statistical Performance Check – Radar Type 5, 20 MHz



**Statistical Performance Check – Radar Type 6, 20 MHz**

Radar Type	Trial #	Frequency (MHz)	Pulses/Hop	Pulse Width (µsec)	PRI (µsec)	Detection
						1 = Yes, 0 = No
6	1		9	1	333	1
	2		9	1	333	1
	3		9	1	333	1
	4		9	1	333	1
	5		9	1	333	1
	6		9	1	333	1
	7		9	1	333	1
	8		9	1	333	1
	9		9	1	333	1
	10		9	1	333	1
	11		9	1	333	1
	12		9	1	333	1
	13		9	1	333	1
	14		9	1	333	1
	15		9	1	333	1
	16		9	1	333	1
	17		9	1	333	1
	18		9	1	333	1
	19		9	1	333	1
	20		9	1	333	1
	21		9	1	333	1
	22		9	1	333	1
	23		9	1	333	1
	24		9	1	333	1
	25		9	1	333	1
	26		9	1	333	1
	27		9	1	333	1
	28		9	1	333	1
	29		9	1	333	1
	30		9	1	333	1
<b>Detection Percentage</b>						<b>100% (&gt; 60%)</b>

**Table 43. Statistical Performance Check – Radar Type 6, 20 MHz**

**Statistical Performance Check – Radar Type 0, 40 MHz**

Radar Type	Trial #	Pulses per Burst	Pulse Width (µsec)	PRI (µsec)	Detection
					1 = Yes, 0 = No
1	1	18	1	1428	1
	2	18	1	1428	1
	3	18	1	1428	1
	4	18	1	1428	1
	5	18	1	1428	1
	6	18	1	1428	1
	7	18	1	1428	1
	8	18	1	1428	1
	9	18	1	1428	1
	10	18	1	1428	1
	11	18	1	1428	1
	12	18	1	1428	1
	13	18	1	1428	1
	14	18	1	1428	1
	15	18	1	1428	1
	16	18	1	1428	1
	17	18	1	1428	1
	18	18	1	1428	1
	19	18	1	1428	1
	20	18	1	1428	1
	21	18	1	1428	1
	22	18	1	1428	1
	23	18	1	1428	1
	24	18	1	1428	1
	25	18	1	1428	1
	26	18	1	1428	1
	27	18	1	1428	1
	28	18	1	1428	1
	29	18	1	1428	1
	30	18	1	1428	1
<b>Detection Percentage</b>					<b>100% (&gt; 60%)</b>

**Table 44. Statistical Performance Check – Radar Type 0, 40 MHz**

**Statistical Performance Check – Radar Type 1, 40 MHz**

Radar Type	Trial #	Pulses per Burst	Pulse Width (µsec)	PRI (µsec)	Detection
					1 = Yes, 0 = No
1	1	86	1	618	1
	2	72	1	738	1
	3	102	1	518	1
	4	67	1	798	1
	5	58	1	918	1
	6	61	1	878	1
	7	59	1	898	1
	8	78	1	678	1
	9	63	1	838	1
	10	62	1	858	1
	11	83	1	638	1
	12	70	1	758	1
	13	95	1	558	1
	14	57	1	938	1
	15	89	1	598	1
	16	20	1	1603	1
	17	92	1	2771	1
	18	75	1	574	1
	19	33	1	713	1
	20	22	1	1625	1
	21	80	1	2436	1
	22	53	1	666	1
	23	25	1	998	1
	24	67	1	2196	1
	25	52	1	790	1
	26	40	1	1028	1
	27	27	1	1332	1
	28	19	1	2021	1
	29	25	1	2884	1
	30	23	1	2113	1
<b>Detection Percentage</b>					<b>100% (&gt; 60%)</b>

**Table 45. Statistical Performance Check – Radar Type 1, 40 MHz**

**Statistical Performance Check – Radar Type 2, 40 MHz**

Radar Type	Trial #	Pulse Width 1 to 5 $\mu$ sec	PRI 150 to 230 $\mu$ sec	Pulses per Burst 23 to 29	Detection
					1 = Yes, 0 = No
2	1	1.9	155	28	1
	2	4.8	185	29	1
	3	3.3	163	29	1
	4	4.8	158	28	1
	5	1.7	204	26	1
	6	1.5	230	28	1
	7	1.2	181	26	1
	8	1.4	194	28	1
	9	1.2	194	28	1
	10	3.6	197	23	1
	11	2.5	213	29	1
	12	1.7	190	29	1
	13	1.2	206	27	1
	14	3.5	193	24	1
	15	1.4	169	24	1
	16	1.4	182	23	1
	17	4.7	221	25	1
	18	4	197	29	1
	19	1.5	230	23	1
	20	3.2	178	23	1
	21	3.7	158	25	1
	22	3.1	150	27	1
	23	2.3	217	27	1
	24	3.3	164	29	1
	25	5	195	25	1
	26	4.9	162	26	1
	27	3.5	164	24	1
	28	3.8	201	29	1
	29	4.8	162	25	1
	1	1.9	155	28	1
<b>Detection Percentage</b>					<b>100% (&gt; 60%)</b>

**Table 46. Statistical Performance Check – Radar Type 2, 40 MHz**

**Statistical Performance Check – Radar Type 3, 40 MHz**

Radar Type	Trial #	Pulse Width 6 to 10 µsec	PRI 200 to 500 µsec	Pulses per Burst 16 to 18	Detection
					1 = Yes, 0 = No
3	1	9.3	255	17	1
	2	6.7	423	18	1
	3	6.9	494	16	1
	4	7	341	18	1
	5	9.9	211	18	1
	6	8.6	337	17	1
	7	9.2	322	18	1
	8	7.8	228	16	1
	9	8.4	203	17	1
	10	8.3	284	16	1
	11	7.7	362	18	1
	12	6.5	233	17	1
	13	8	432	16	1
	14	9.9	238	17	1
	15	8.4	304	17	1
	16	9.2	488	16	1
	17	7	415	17	1
	18	8.5	273	17	1
	19	8	269	18	1
	20	6.7	422	18	1
	21	6.2	401	18	1
	22	7.9	378	16	1
	23	9.1	387	16	1
	24	8	322	18	1
	25	7.5	401	18	1
	26	6	355	16	1
	27	6.4	497	18	1
	28	8.5	237	18	1
	29	7.8	223	16	1
	30	8.8	289	16	1
<b>Detection Percentage</b>					<b>100% (&gt; 60%)</b>

**Table 47. Statistical Performance Check – Radar Type 3, 40 MHz**

**Statistical Performance Check – Radar Type 4, 40 MHz**

Radar Type	Trial #	Pulse Width 11 to 20 $\mu$ sec	PRI 200 to 500 $\mu$ sec	Pulses per Burst 12 to 16	Detection
					1 = Yes, 0 = No
4	1	17.6	273	15	1
	2	15.9	310	16	1
	3	18.4	494	15	1
	4	16	333	15	1
	5	15.9	302	14	1
	6	16.9	354	15	1
	7	12.3	331	14	1
	8	13	307	14	1
	9	15.8	436	12	1
	10	18	277	16	1
	11	16.4	272	15	1
	12	15.3	420	16	1
	13	13.4	440	14	1
	14	17.3	224	16	1
	15	11.3	426	13	1
	16	13	250	14	1
	17	11.1	271	16	1
	18	13	238	16	1
	19	13.4	270	13	1
	20	17.1	205	13	1
	21	19.6	297	14	1
	22	15.8	355	12	1
	23	14.2	222	15	1
	24	19.1	296	12	1
	25	13.3	310	14	1
	26	16.2	293	13	1
	27	12.1	402	12	1
	28	13.9	266	16	1
	29	16.8	278	13	1
	30	15.4	461	13	1
<b>Detection Percentage</b>					<b>100% (&gt; 60%)</b>

**Table 48. Statistical Performance Check – Radar Type 4, 40 MHz**

**Statistical Performance Check – Radar Type 5, 40 MHz**

Radar Type	Trial #	Filename*	Detection
			1 = Yes, 0 = No
5	1	bin5-trial 1	1
	2	bin5-trial 2	1
	3	bin5-trial 3	1
	4	bin5-trial 4	1
	5	bin5-trial 5	1
	6	bin5-trial 6	1
	7	bin5-trial 7	1
	8	bin5-trial 8	1
	9	bin5-trial 9	1
	10	bin5-trial 10	1
	11	bin5-trial 11	1
	12	bin5-trial 12	1
	13	bin5-trial 13	1
	14	bin5-trial 14	1
	15	bin5-trial 15	1
	16	bin5-trial 16	1
	17	bin5-trial 17	1
	18	bin5-trial 18	1
	19	bin5-trial 19	1
	20	bin5-trial 20	1
	21	bin5-trial 21	1
	22	bin5-trial 22	1
	23	bin5-trial 23	1
	24	bin5-trial 24	1
	25	bin5-trial 25	1
	26	bin5-trial 26	1
	27	bin5-trial 27	1
	28	bin5-trial 28	1
	29	bin5-trial 29	1
	30	bin5-trial 30	1
<b>Detection Percentage</b>			<b>100% (&gt; 80%)</b>

**Table 49. Statistical Performance Check – Radar Type 5, 40 MHz**

**Statistical Performance Check – Radar Type 6, 40 MHz**

Radar Type	Trial #	Frequency (MHz)	Pulses/Hop	Pulse Width (µsec)	PRI (µsec)	Detection
						1 = Yes, 0 = No
6	1		9	1	333	1
	2		9	1	333	1
	3		9	1	333	1
	4		9	1	333	1
	5		9	1	333	1
	6		9	1	333	1
	7		9	1	333	1
	8		9	1	333	1
	9		9	1	333	1
	10		9	1	333	1
	11		9	1	333	1
	12		9	1	333	1
	13		9	1	333	1
	14		9	1	333	1
	15		9	1	333	1
	16		9	1	333	1
	17		9	1	333	1
	18		9	1	333	1
	19		9	1	333	1
	20		9	1	333	1
	21		9	1	333	1
	22		9	1	333	1
	23		9	1	333	1
	24		9	1	333	1
	25		9	1	333	1
	26		9	1	333	1
	27		9	1	333	1
	28		9	1	333	1
	29		9	1	333	1
	30		9	1	333	1
<b>Detection Percentage</b>						<b>100% (&gt; 60%)</b>

**Table 50. Statistical Performance Check – Radar Type 6, 40 MHz**



**Statistical Performance Check – Radar Type 0, 80 MHz**

Radar Type	Trial #	Pulses per Burst	Pulse Width (µsec)	PRI (µsec)	Detection
					1 = Yes, 0 = No
1	1	18	1	1428	1
	2	18	1	1428	1
	3	18	1	1428	1
	4	18	1	1428	1
	5	18	1	1428	1
	6	18	1	1428	1
	7	18	1	1428	1
	8	18	1	1428	1
	9	18	1	1428	1
	10	18	1	1428	1
	11	18	1	1428	1
	12	18	1	1428	1
	13	18	1	1428	1
	14	18	1	1428	1
	15	18	1	1428	1
	16	18	1	1428	1
	17	18	1	1428	1
	18	18	1	1428	1
	19	18	1	1428	1
	20	18	1	1428	1
	21	18	1	1428	1
	22	18	1	1428	1
	23	18	1	1428	1
	24	18	1	1428	1
	25	18	1	1428	1
	26	18	1	1428	1
	27	18	1	1428	1
	28	18	1	1428	1
	29	18	1	1428	1
	30	18	1	1428	1
<b>Detection Percentage</b>					<b>100% (&gt; 60%)</b>

**Table 51. Statistical Performance Check – Radar Type 0, 80 MHz**

**Statistical Performance Check – Radar Type 1, 80 MHz**

Radar Type	Trial #	Pulses per Burst	Pulse Width (µsec)	PRI (µsec)	Detection
					1 = Yes, 0 = No
1	1	86	1	618	1
	2	72	1	738	1
	3	102	1	518	1
	4	67	1	798	1
	5	58	1	918	1
	6	61	1	878	1
	7	59	1	898	1
	8	78	1	678	1
	9	63	1	838	1
	10	62	1	858	1
	11	83	1	638	1
	12	70	1	758	1
	13	95	1	558	1
	14	57	1	938	1
	15	89	1	598	1
	16	20	1	1603	1
	17	92	1	2771	1
	18	75	1	574	1
	19	33	1	713	1
	20	22	1	1625	1
	21	80	1	2436	1
	22	53	1	666	1
	23	25	1	998	1
	24	67	1	2196	1
	25	52	1	790	1
	26	40	1	1028	1
	27	27	1	1332	1
	28	19	1	2021	1
	29	25	1	2884	1
	30	23	1	2113	1
<b>Detection Percentage</b>					<b>100% (&gt; 60%)</b>

**Table 52. Statistical Performance Check – Radar Type 1, 80 MHz**

**Statistical Performance Check – Radar Type 2, 80 MHz**

Radar Type	Trial #	Pulse Width 1 to 5 $\mu$ sec	PRI 150 to 230 $\mu$ sec	Pulses per Burst 23 to 29	Detection
					1 = Yes, 0 = No
2	1	1.9	155	28	1
	2	4.8	185	29	1
	3	3.3	163	29	1
	4	4.8	158	28	1
	5	1.7	204	26	1
	6	1.5	230	28	1
	7	1.2	181	26	1
	8	1.4	194	28	1
	9	1.2	194	28	1
	10	3.6	197	23	1
	11	2.5	213	29	1
	12	1.7	190	29	1
	13	1.2	206	27	1
	14	3.5	193	24	1
	15	1.4	169	24	1
	16	1.4	182	23	1
	17	4.7	221	25	1
	18	4	197	29	1
	19	1.5	230	23	1
	20	3.2	178	23	1
	21	3.7	158	25	1
	22	3.1	150	27	1
	23	2.3	217	27	1
	24	3.3	164	29	1
	25	5	195	25	1
	26	4.9	162	26	1
	27	3.5	164	24	1
	28	3.8	201	29	1
	29	4.8	162	25	1
	30	1.2	151	23	1
<b>Detection Percentage</b>					<b>100% (&gt; 60%)</b>

**Table 53. Statistical Performance Check – Radar Type 2, 80 MHz**

**Statistical Performance Check – Radar Type 3, 80 MHz**

Radar Type	Trial #	Pulse Width 6 to 10 µsec	PRI 200 to 500 µsec	Pulses per Burst 16 to 18	Detection
					1 = Yes, 0 = No
3	1	9.3	255	17	1
	2	6.7	423	18	1
	3	6.9	494	16	1
	4	7	341	18	1
	5	9.9	211	18	1
	6	8.6	337	17	1
	7	9.2	322	18	1
	8	7.8	228	16	1
	9	8.4	203	17	1
	10	8.3	284	16	1
	11	7.7	362	18	1
	12	6.5	233	17	1
	13	8	432	16	1
	14	9.9	238	17	1
	15	8.4	304	17	1
	16	9.2	488	16	1
	17	7	415	17	1
	18	8.5	273	17	1
	19	8	269	18	1
	20	6.7	422	18	1
	21	6.2	401	18	1
	22	7.9	378	16	1
	23	9.1	387	16	1
	24	8	322	18	1
	25	7.5	401	18	1
	26	6	355	16	1
	27	6.4	497	18	1
	28	8.5	237	18	1
	29	7.8	223	16	1
	30	8.8	289	16	1
<b>Detection Percentage</b>					<b>100% (&gt; 60%)</b>

**Table 54. Statistical Performance Check – Radar Type 3, 80 MHz**

**Statistical Performance Check – Radar Type 4, 80 MHz**

Radar Type	Trial #	Pulse Width 11 to 20 $\mu$ sec	PRI 200 to 500 $\mu$ sec	Pulses per Burst 12 to 16	Detection
					1 = Yes, 0 = No
4	1	17.6	273	15	1
	2	15.9	310	16	1
	3	18.4	494	15	1
	4	16	333	15	1
	5	15.9	302	14	1
	6	16.9	354	15	1
	7	12.3	331	14	1
	8	13	307	14	1
	9	15.8	436	12	1
	10	18	277	16	1
	11	16.4	272	15	1
	12	15.3	420	16	1
	13	13.4	440	14	1
	14	17.3	224	16	1
	15	11.3	426	13	1
	16	13	250	14	1
	17	11.1	271	16	1
	18	13	238	16	1
	19	13.4	270	13	1
	20	17.1	205	13	1
	21	19.6	297	14	1
	22	15.8	355	12	1
	23	14.2	222	15	1
	24	19.1	296	12	1
	25	13.3	310	14	1
	26	16.2	293	13	1
	27	12.1	402	12	1
	28	13.9	266	16	1
	29	16.8	278	13	1
	30	15.4	461	13	1
<b>Detection Percentage</b>					<b>100% (&gt; 60%)</b>

**Table 55. Statistical Performance Check – Radar Type 4, 80 MHz**

**Statistical Performance Check – Radar Type 5, 80 MHz**

Radar Type	Trial #	Filename*	Detection
			1 = Yes, 0 = No
5	1	bin5-trial 1	1
	2	bin5-trial 2	1
	3	bin5-trial 3	1
	4	bin5-trial 4	1
	5	bin5-trial 5	1
	6	bin5-trial 6	1
	7	bin5-trial 7	1
	8	bin5-trial 8	1
	9	bin5-trial 9	1
	10	bin5-trial 10	1
	11	bin5-trial 11	1
	12	bin5-trial 12	1
	13	bin5-trial 13	1
	14	bin5-trial 14	1
	15	bin5-trial 15	1
	16	bin5-trial 16	1
	17	bin5-trial 17	1
	18	bin5-trial 18	1
	19	bin5-trial 19	1
	20	bin5-trial 20	1
	21	bin5-trial 21	1
	22	bin5-trial 22	1
	23	bin5-trial 23	1
	24	bin5-trial 24	1
	25	bin5-trial 25	1
	26	bin5-trial 26	1
	27	bin5-trial 27	1
	28	bin5-trial 28	1
	29	bin5-trial 29	1
	30	bin5-trial 30	1
		<b>Detection Percentage</b>	<b>100% (&gt; 80%)</b>

**Table 56. Statistical Performance Check – Radar Type 5, 80 MHz**

**Statistical Performance Check – Radar Type 6, 80 MHz**

Radar Type	Trial #	Frequency (MHz)	Pulses/Hop	Pulse Width (µsec)	PRI (µsec)	Detection
						1 = Yes, 0 = No
6	1		9	1	333	1
	2		9	1	333	1
	3		9	1	333	1
	4		9	1	333	1
	5		9	1	333	1
	6		9	1	333	1
	7		9	1	333	1
	8		9	1	333	1
	9		9	1	333	1
	10		9	1	333	1
	11		9	1	333	1
	12		9	1	333	1
	13		9	1	333	1
	14		9	1	333	1
	15		9	1	333	1
	16		9	1	333	1
	17		9	1	333	1
	18		9	1	333	1
	19		9	1	333	1
	20		9	1	333	1
	21		9	1	333	1
	22		9	1	333	1
	23		9	1	333	1
	24		9	1	333	1
	25		9	1	333	1
	26		9	1	333	1
	27		9	1	333	1
	28		9	1	333	1
	29		9	1	333	1
	30		9	1	333	1
<b>Detection Percentage</b>						<b>100% (&gt; 60%)</b>

**Table 57. Statistical Performance Check – Radar Type 6, 80 MHz**

## VII. Test Equipment



## Test Equipment

Calibrated test equipment utilized during testing was maintained in a current state of calibration per the requirements of ISO/IEC 17025:2005.

MET Asset #	Equipment	Manufacturer	Model	Last Cal Date	Cal Due Date
1S2600	BILOG ANTENNA	TESEQ	CBL6112D	8/29/2013	8/29/2015
1S2482	5 METER CHAMBER (NSA)	PANASHIELD	5 METER SEMI-ANECHOIC CHAMBER	8/12/2013	2/12/2015
1S2583	SPECTRUM ANALYZER	AGILENT/HP	E4447A	11/1/2013	5/1/2015
1S2460	1-26GHZ SPECTRUM ANALYZER	AGILENT TECHNOLOGIES	E4407B	2/27/2014	8/27/2015
1S2603	DOUBLE RIDGED WAVEGUIDE HORN	ETS-LINDGREN	3117	4/24/2013	4/24/2015
1S2523	PREAMPLIFIER	AGILENT TECHNOLOGIES	8449B	SEE NOTE	
1S2729	SONOMA AMPLIFIER	SONOMA INSTRUMENT	310N	SEE NOTE	
1S2460	1-26GHZ SPECTRUM ANALYZER	AGILENT TECHNOLOGIES	E4407B	2/27/2014	8/27/2015
N/A	NOTCH FILTER	MIRCRO-TRONICS	BRM50702	SEE NOTE	
N/A	HIGH PASS FILTER	MICRO-TRONICS	BRM50705	SEE NOTE	

**Table 58. Test Equipment List**

Note: Functionally tested equipment is verified using calibrated instrumentation at the time of testing.

Asset	Equipment	Manufacturer	Model	Calibration Date	Calibration Due Date
1T4871	VECTOR SIGNAL GENERATOR	AGILENT	N5172B	6/16/2014	12/16/2015
1S2460	1-26GHZ SPECTRUM ANALYZER	AGILENT TECHNOLOGIES	E4407B	2/27/2014	8/27/2015
N/A	ATTENUATOR	N/A	N/A	SEE NOTE	
N/A	COMBINNER/SPILLTER	N/A	N/A	SEE NOTE	

**Table 59. DFT Test Equipment List**

Note: Functionally tested equipment is verified using calibrated instrumentation at the time of testing.

## **VIII. Certification & User's Manual Information**

## Certification & User's Manual Information

### L. Certification Information

The following is extracted from Title 47 of the Code of Federal Regulations, Part 2, Subpart I — Marketing of Radio frequency devices:

#### § 2.801 Radio-frequency device defined.

As used in this part, a radio-frequency device is any device which in its operation is capable of Emitting radio-frequency energy by radiation, conduction, or other means. Radio- frequency devices include, but are not limited to:

- (a) The various types of radio communication transmitting devices described throughout this chapter.
- (b) *The incidental, unintentional and intentional radiators defined in Part 15 of this chapter.*
- (c) The industrial, scientific, and medical equipment described in Part 18 of this chapter.
- (d) Any part or component thereof which in use emits radio-frequency energy by radiation, conduction, or other means.

#### § 2.803 Marketing of radio frequency devices prior to equipment authorization.

- (a) Except as provided elsewhere in this chapter, no person shall sell or lease, or offer for sale or lease (including advertising for sale or lease), or import, ship or distribute for the purpose of selling or leasing or offering for sale or lease, any radio frequency device unless:
  - (1) In the case of a device subject to certification, such device has been authorized by the Commission in accordance with the rules in this chapter and is properly identified and labeled as required by §2.925 and other relevant sections in this chapter; or
  - (2) In the case of a device that is not required to have a grant of equipment authorization issued by the Commission, but which must comply with the specified technical standards prior to use, such device also complies with all applicable administrative (including verification of the equipment or authorization under a Declaration of Conformity, where required), technical, labeling and identification requirements specified in this chapter.
- (d) Notwithstanding the provisions of paragraph (a) of this section, the offer for sale solely to business, commercial, industrial, scientific or medical users (but not an offer for sale to other parties or to end users located in a residential environment) of a radio frequency device that is in the conceptual, developmental, design or pre-production stage is permitted prior to equipment authorization or, for devices not subject to the equipment authorization requirements, prior to a determination of compliance with the applicable technical requirements *provided* that the prospective buyer is advised in writing at the time of the offer for sale that the equipment is subject to the FCC rules and that the equipment will comply with the appropriate rules before delivery to the buyer or to centers of distribution.

- (e)(1) Notwithstanding the provisions of paragraph (a) of this section, prior to equipment authorization or determination of compliance with the applicable technical requirements any radio frequency device may be operated, but not marketed, for the following purposes and under the following conditions:
- (i) *Compliance testing*;
  - (ii) Demonstrations at a trade show provided the notice contained in paragraph (c) of this section is displayed in a conspicuous location on, or immediately adjacent to, the device;
  - (iii) Demonstrations at an exhibition conducted at a business, commercial, industrial, scientific or medical location, but excluding locations in a residential environment, provided the notice contained in paragraphs (c) or (d) of this section, as appropriate, is displayed in a conspicuous location on, or immediately adjacent to, the device;
  - (iv) Evaluation of product performance and determination of customer acceptability, provided such operation takes place at the manufacturer's facilities during developmental, design or pre-production states; or
  - (v) Evaluation of product performance and determination of customer acceptability where customer acceptability of a radio frequency device cannot be determined at the manufacturer's facilities because of size or unique capability of the device, provided the device is operated at a business, commercial, industrial, scientific or medical user's site, but not at a residential site, during the development, design or pre-production stages.
- (e)(2) For the purpose of paragraphs (e)(1)(iv) and (e)(1)(v) of this section, the term *manufacturer's facilities* includes the facilities of the party responsible for compliance with the regulations and the manufacturer's premises, as well as the facilities of other entities working under the authorization of the responsible party in connection with the development and manufacture, but not the marketing, of the equipment.
- (f) For radio frequency devices subject to verification and sold solely to business, commercial, industrial, scientific and medical users (excluding products sold to other parties or for operation in a residential environment), parties responsible for verification of the devices shall have the option of ensuring compliance with the applicable technical specifications of this chapter at each end user's location after installation, provided that the purchase or lease agreement includes a proviso that such a determination of compliance be made and is the responsibility of the party responsible for verification of the equipment.

## Certification & User's Manual Information

The following is extracted from Title 47 of the Code of Federal Regulations, Part 2, Subpart J — Equipment Authorization Procedures:

### § 2.901 Basis and Purpose

- (a) In order to carry out its responsibilities under the Communications Act and the various treaties and international regulations, and in order to promote efficient use of the radio spectrum, the Commission has developed technical standards for radio frequency equipment and parts or components thereof. The technical standards applicable to individual types of equipment are found in that part of the rules governing the service wherein the equipment is to be operated.<sup>1</sup> *In addition to the technical standards provided, the rules governing the service may require that such equipment be verified by the manufacturer or importer, be authorized under a Declaration of Conformity, or receive an equipment authorization from the Commission by one of the following procedures: certification or registration.*
- (b) The following sections describe the verification procedure, the procedure for a Declaration of Conformity, and the procedures to be followed in obtaining certification from the Commission and the conditions attendant to such a grant.

### § 2.907 Certification.

- (a) Certification is an equipment authorization issued by the Commission, based on representation and test data submitted by the applicant.
- (b) Certification attaches to all units subsequently marketed by the grantee which are identical (see Section 2.908) to the sample tested except for permissive changes or other variations authorized by the Commission pursuant to Section 2.1043.

---

<sup>1</sup> In this case, the equipment is subject to the rules of Part 15. More specifically, the equipment falls under Subpart B (of Part 15), which deals with unintentional radiators.

## Certification & User's Manual Information

### § 2.948 Description of measurement facilities.

- (a) Each party making measurements of equipment that is subject to an equipment authorization under Part 15 or Part 18 of this chapter, regardless of whether the measurements are filed with the Commission or kept on file by the party responsible for compliance of equipment marketed within the U.S. or its possessions, shall compile a description of the measurement facilities employed.
  - (1) If the measured equipment is subject to the verification procedure, the description of the measurement facilities shall be retained by the party responsible for verification of the equipment.
    - (i) *If the equipment is verified through measurements performed by an independent laboratory, it is acceptable for the party responsible for verification of the equipment to rely upon the description of the measurement facilities retained by or placed on file with the Commission by that laboratory. In this situation, the party responsible for the verification of the equipment is not required to retain a duplicate copy of the description of the measurement facilities.*
    - (ii) If the equipment is verified based on measurements performed at the installation site of the equipment, no specific site calibration data is required. It is acceptable to retain the description of the measurement facilities at the site at which the measurements were performed.
  - (2) If the equipment is to be authorized by the Commission under the certification procedure, the description of the measurement facilities shall be filed with the Commission's Laboratory in Columbia, Maryland. The data describing the measurement facilities need only be filed once but must be updated as changes are made to the measurement facilities or as otherwise described in this section. At least every three years, the organization responsible for filing the data with the Commission shall certify that the data on file is current.

## Certification & User's Manual Information

### Label and User's Manual Information

The following is extracted from Title 47 of the Code of Federal Regulations, Part 15, Subpart A — General:

#### § 15.19 Labeling requirements.

(a) *In addition to the requirements in Part 2 of this chapter, a device subject to certification or verification shall be labeled as follows:*

- (1) Receivers associated with the operation of a licensed radio service, e.g., FM broadcast under Part 73 of this chapter, land mobile operation under Part 90, etc., shall bear the following statement in a conspicuous location on the device:

This device complies with Part 15 of the FCC Rules. Operation is subject to the condition that this device does not cause harmful interference.

- (2) A stand-alone cable input selector switch, shall bear the following statement in a conspicuous location on the device:

This device is verified to comply with Part 15 of the FCC Rules for use with cable television service.

- (3) All other devices shall bear the following statement in a conspicuous location on the device:

*This device complies with Part 15 of the FCC Rules. Operation is subject to the following two conditions: (1) This device may not cause harmful interference, and (2) this device must accept any interference received, including interference that may cause undesired operation.*

- (4) Where a device is constructed in two or more sections connected by wires and marketed together, the statement specified under paragraph (a) of this section is required to be affixed only to the main control unit.

- (5) When the device is so small or for such use that it is not practicable to place the statement specified under paragraph (a) of this section on it, the information required by this paragraph shall be placed in a prominent location in the instruction manual or pamphlet supplied to the user or, alternatively, shall be placed on the container in which the device is marketed. However, the FCC identifier or the unique identifier, as appropriate, must be displayed on the device.

#### § 15.21 Information to user.

The users manual or instruction manual for an intentional or unintentional radiator shall caution the user that changes or modifications not expressly approved by the party responsible for compliance could void the user's authority to operate the equipment.

## Verification & User's Manual Information

The following is extracted from Title 47 of the Code of Federal Regulations, Part 15, Subpart B — Unintentional Radiators:

### § 15.105 Information to the user.

- (a) For a Class A digital device or peripheral, the instructions furnished the user shall include the following or similar statement, placed in a prominent location in the text of the manual:

Note: This equipment has been tested and found to comply with the limits for a Class A digital device, pursuant to Part 15 of the FCC Rules. These limits are designed to provide reasonable protection against harmful interference when the equipment is operated in a commercial environment. This equipment generates, uses, and can radiate radio frequency energy and, if not installed and used in accordance with the instruction manual, may cause harmful interference to radio communications. Operation of this equipment in a residential area is likely to cause harmful interference in which case the user will be required to correct the interference at own expense.

- (b) For a Class B digital device or peripheral, the instructions furnished the user shall include the following or similar statement, placed in a prominent location in the text of the manual:

Note: This equipment has been tested and found to comply with the limits for a Class B digital device, pursuant to Part 15 of the FCC Rules. These limits are designed to provide reasonable protection against harmful interference when the equipment is operated in a residential environment. This equipment generates, uses, and can radiate radio frequency energy and, if not installed and used in accordance with the instruction manual, may cause harmful interference to radio communications. However, there is no guarantee that interference will not occur in a particular installation. If this equipment does cause harmful interference to radio or television reception, which can be determined by turning the equipment off and on, the user is encouraged to try to correct the interference by one or more of the following measures:

- Reorient or relocate the receiving antenna.
- Increase the separation between the equipment and receiver.
- Connect the equipment into an outlet on a circuit different from that to which the receiver is connected.
- Consult the dealer or an experienced radio/TV technician for help.