



**MET Laboratories, Inc.** *Safety Certification - EMI - Telecom Environmental Simulation*

914 WEST PATAPSCO AVENUE • BALTIMORE, MARYLAND 21230-3432 • PHONE (410) 354-3300 • FAX (410) 354-3313

33439 WESTERN AVENUE • UNION CITY, CALIFORNIA 94587 • PHONE (510) 489-6300 • FAX (510) 489-6372

3162 BELICK STREET • SANTA CLARA, CA 95054 • PHONE (408) 748-3585 • FAX (510) 489-6372

13301 MCCALLEN PASS • AUSTIN, TEXAS 78753 • PHONE (512) 287-2500 • FAX (512) 287-2513

October 8, 2014

Meru Networks, Inc.  
894 Ross Dr.  
Sunnyvale, CA 94089

Dear Rajendran Chary,

Enclosed is the EMC Wireless test report for compliance testing of the Meru Networks, Inc., Broad Peak (AP121 & AP122) as tested to the requirements of Title 47 of the CFR, Ch. 1 (10-1-06 ed.), Part 15, Subpart B and FCC Part 15 Subpart C for Intentional Radiators.

Thank you for using the services of MET Laboratories, Inc. If you have any questions regarding these results or if MET can be of further service to you, please feel free to contact me.

Sincerely yours,  
MET LABORATORIES, INC.

Jennifer Warnell  
Documentation Department

Reference: (\Meru Networks, Inc.\EMCS42577A-FCC247 Rev. 1)

Certificates and reports shall not be reproduced except in full, without the written permission of MET Laboratories, Inc.

## **Electromagnetic Compatibility Criteria Test Report**

for the

**Meru Networks, Inc.  
Broad Peak (AP121 & AP122)**

**Tested under**  
the FCC Certification Rules  
contained in  
Title 47 of the CFR, Parts 15 Subpart B  
for Class B Digital Devices  
&  
15.247 Subpart C for Intentional Radiators

**MET Report: EMCS42577A-FCC247 Rev. 1**

October 8, 2014

**Prepared For:**

**Meru Networks, Inc.  
894 Ross Dr.  
Sunnyvale, CA 94089**

**Prepared By:**  
**MET Laboratories, Inc.**  
914 W. Patapsco Ave  
Baltimore, MD 21230

## Electromagnetic Compatibility Criteria Test Report

for the

**Meru Networks, Inc.**  
**Broad Peak (AP121 & AP122)**

**Tested under**  
the FCC Certification Rules  
contained in  
Title 47 of the CFR, Parts 15 Subpart B  
for Class B Digital Devices  
&  
15.247 Subpart C  
for Intentional Radiators



Ben Taylor, Project Engineer  
Electromagnetic Compatibility Lab



Jennifer Warnell  
Documentation Department

**Engineering Statement:** The measurements shown in this report were made in accordance with the procedures indicated, and the emissions from this equipment were found to be within the limits applicable. I assume full responsibility for the accuracy and completeness of these measurements, and for the qualifications of all persons taking them. It is further stated that upon the basis of the measurements made, the equipment tested is capable of operation in accordance with the requirements of the FCC Rules Parts 15B, 15.247 under normal use and maintenance.



Asad Bajwa,  
Director, Electromagnetic Compatibility Lab

## Report Status Sheet

Revision	Report Date	Reason for Revision
∅	September 30, 2014	Initial Issue.
1	October 8, 2014	Revised to add model AP121.

## Table of Contents

<b>I.</b>	<b>Executive Summary .....</b>	<b>1</b>
	A. Purpose of Test .....	2
	B. Executive Summary .....	2
<b>II.</b>	<b>Equipment Configuration .....</b>	<b>3</b>
	A. Overview.....	4
	B. References.....	5
	C. Test Site .....	5
	D. Description of Test Sample.....	5
	E. Equipment Configuration.....	7
	F. Support Equipment .....	7
	G. Ports and Cabling Information.....	7
	H. Mode of Operation.....	8
	I. Method of Monitoring EUT Operation .....	8
	J. Modifications .....	8
	a) Modifications to EUT.....	8
	b) Modifications to Test Standard.....	8
	K. Disposition of EUT .....	8
<b>III.</b>	<b>Electromagnetic Compatibility Criteria for Unintentional Radiators .....</b>	<b>9</b>
	§ 15.107(a) Conducted Emissions Limits.....	10
	§ 15.109(a) Radiated Emissions Limits.....	15
<b>IV.</b>	<b>Electromagnetic Compatibility Criteria for Intentional Radiators .....</b>	<b>20</b>
	§ 15.203 Antenna Requirement .....	21
	§ 15.207(a) Conducted Emissions Limits.....	22
	§ 15.247(a)(a) 6 dB and 99% Bandwidth .....	27
	§ 15.247(b) Peak Power Output .....	41
	§ 15.247(d) Radiated Spurious Emissions Requirements and Band Edge.....	49
	§ 15.247(d) RF Conducted Spurious Emissions Requirements and Band Edge.....	67
	§ 15.247(e) Peak Power Spectral Density .....	86
	§ 15.247(i) Maximum Permissible Exposure .....	94
	Co-Location.....	95
<b>V.</b>	<b>Test Equipment .....</b>	<b>125</b>
<b>VI.</b>	<b>Certification &amp; User's Manual Information .....</b>	<b>127</b>
	A. Certification Information .....	128
	B. Label and User's Manual Information .....	132

## List of Tables

Table 1. Executive Summary of EMC Part 15.247 Compliance Testing .....	2
Table 2. EUT Summary Table.....	4
Table 3. References .....	5
Table 4. Equipment Configuration .....	7
Table 5. Support Equipment.....	7
Table 6. Antenna List .....	7
Table 7. Ports and Cabling Information .....	7
Table 8. Conducted Limits for Radio Frequency Devices calculated from FCC Part 15 Subsections 15.107(a) (b) .....	10
Table 9. Conducted Emissions - Voltage, AC Power, Phase Line (120 VAC, 60 Hz), PoE .....	11
Table 10. Conducted Emissions - Voltage, AC Power, Neutral Line (120 VAC, 60 Hz), PoE .....	12
Table 11. Conducted Emissions - Voltage, AC Power, Phase Line (120 VAC, 60 Hz), AC/DC.....	13
Table 12. Conducted Emissions - Voltage, AC Power, Neutral Line (120 VAC, 60 Hz), AC/DC .....	14
Table 13. Radiated Emissions Limits calculated from FCC Part 15, §15.109 (a) (b) .....	15
Table 14. Radiated Emissions Limits, Test Results, 30 MHz – 1 GHz, PoE .....	16
Table 15. Radiated Emissions Limits, Test Results, 30 MHz – 1 GHz, AC/DC.....	18
Table 16. Conducted Limits for Intentional Radiators from FCC Part 15 § 15.207(a) .....	22
Table 17. Conducted Emissions - Voltage, AC Power, 15.207(a), Phase Line (120 VAC, 60 Hz), PoE.....	23
Table 18. Conducted Emissions - Voltage, AC Power, 15.207(a), Neutral Line (120 VAC, 60 Hz), PoE .....	24
Table 19. Conducted Emissions - Voltage, AC Power, 15.207(a), Phase Line (120 VAC, 60 Hz), AC/DC .....	25
Table 20. Conducted Emissions - Voltage, AC Power, 15.207(a), Neutral Line (120 VAC, 60 Hz), AC/DC.....	26
Table 21. 6 dB Occupied Bandwidth, Test Results, 2.4 GHz.....	28
Table 22. 99% Occupied Bandwidth, Test Results, 2.4 GHz.....	28
Table 23. Output Power Requirements from §15.247(b) .....	41
Table 24. Peak Power Output, Test Results, 2.4 GHz.....	42
Table 25. Peak Power Output, Test Results, 2.4 GHz, Summed.....	42
Table 26. Restricted Bands of Operation.....	49
Table 27. Radiated Emissions Limits Calculated from FCC Part 15, § 15.209 (a) .....	50
Table 28. Peak Power Spectral Density, Test Results, 2.4 GHz.....	87
Table 29. Test Equipment List .....	126

## List of Plots

Plot 1. Conducted Emissions, Phase Line, PoE.....	11
Plot 2. Conducted Emissions, Neutral Line, PoE.....	12
Plot 3. Conducted Emissions, Phase Line, AC/DC .....	13
Plot 4. Conducted Emissions, Neutral Line, AC/DC.....	14
Plot 5. Radiated Emissions, 30 MHz – 1 GHz, PoE.....	16
Plot 6. Radiated Emissions, 1 GHz – 6 GHz, PoE .....	17
Plot 7. Radiated Emissions, 30 MHz – 1 GHz, AC/DC .....	18
Plot 8. Radiated Emissions, 1 GHz – 6 GHz, AC/DC.....	19
Plot 9. Conducted Emissions, 15.207(a), Phase Line, PoE .....	23
Plot 10. Conducted Emissions, 15.207(a), Neutral Line, PoE.....	24
Plot 11. Conducted Emissions, 15.207(a), Phase Line, AC/DC .....	25
Plot 12. Conducted Emissions, 15.207(a), Neutral Line, AC/DC .....	26
Plot 13. 6 dB Occupied Bandwidth, Low Channel, 2412 MHz, 802.11b.....	29
Plot 14. 6 dB Occupied Bandwidth, Mid Channel, 2437 MHz, 802.11b .....	29
Plot 15. 6 dB Occupied Bandwidth, High Channel, 2462 MHz, 802.11b .....	29
Plot 16. 6 dB Occupied Bandwidth, Low Channel, 2412 MHz, 802.11g.....	30
Plot 17. 6 dB Occupied Bandwidth, Mid Channel, 2437 MHz, 802.11g .....	30
Plot 18. 6 dB Occupied Bandwidth, High Channel, 2462 MHz, 802.11g.....	30
Plot 19. 6 dB Occupied Bandwidth, Low Channel, 2412 MHz, 802.11n 20 MHz, Port 1 .....	31
Plot 20. 6 dB Occupied Bandwidth, Mid Channel, 2437 MHz, 802.11n 20 MHz, Port 1 .....	31

Plot 21. 6 dB Occupied Bandwidth, High Channel, 2462 MHz, 802.11n 20 MHz, Port 1 .....	31
Plot 22. 6 dB Occupied Bandwidth, Low Channel, 2412 MHz, 802.11n 20 MHz, Port 2 .....	32
Plot 23. 6 dB Occupied Bandwidth, Mid Channel, 2437 MHz, 802.11n 20 MHz, Port 2 .....	32
Plot 24. 6 dB Occupied Bandwidth, High Channel, 2462 MHz, 802.11n 20 MHz, Port 2 .....	32
Plot 25. 6 dB Occupied Bandwidth, Low Channel, 2422 MHz, 802.11n 40 MHz, Port 1 .....	33
Plot 26. 6 dB Occupied Bandwidth, Mid Channel, 2437 MHz, 802.11n 40 MHz, Port 1 .....	33
Plot 27. 6 dB Occupied Bandwidth, High Channel, 2452 MHz, 802.11n 40 MHz, Port 1 .....	33
Plot 28. 6 dB Occupied Bandwidth, Low Channel, 2422 MHz, 802.11n 40 MHz, Port 2 .....	34
Plot 29. 6 dB Occupied Bandwidth, Mid Channel, 2437 MHz, 802.11n 40 MHz, Port 2 .....	34
Plot 30. 6 dB Occupied Bandwidth, High Channel, 2452 MHz, 802.11n 40 MHz, Port 2 .....	34
Plot 31. 99% Occupied Bandwidth, Low Channel, 2412 MHz, 802.11b .....	35
Plot 32. 99% Occupied Bandwidth, Mid Channel, 2437 MHz, 802.11b .....	35
Plot 33. 99% Occupied Bandwidth, High Channel, 2462 MHz, 802.11b .....	35
Plot 34. 99% Occupied Bandwidth, Low Channel, 2412 MHz, 802.11g .....	36
Plot 35. 99% Occupied Bandwidth, Mid Channel, 2437 MHz, 802.11g .....	36
Plot 36. 99% Occupied Bandwidth, High Channel, 2462 MHz, 802.11g .....	36
Plot 37. 99% Occupied Bandwidth, Low Channel, 2412 MHz, 802.11n 20 MHz, Port 1 .....	37
Plot 38. 99% Occupied Bandwidth, Mid Channel, 2437 MHz, 802.11n 20 MHz, Port 1 .....	37
Plot 39. 99% Occupied Bandwidth, High Channel, 2462 MHz, 802.11n 20 MHz, Port 1 .....	37
Plot 40. 99% Occupied Bandwidth, Low Channel, 2412 MHz, 802.11n 20 MHz, Port 2 .....	38
Plot 41. 99% Occupied Bandwidth, Mid Channel, 2437 MHz, 802.11n 20 MHz, Port 2 .....	38
Plot 42. 99% Occupied Bandwidth, High Channel, 2462 MHz, 802.11n 20 MHz, Port 2 .....	38
Plot 43. 99% Occupied Bandwidth, Low Channel, 2422 MHz, 802.11n 40 MHz, Port 1 .....	39
Plot 44. 99% Occupied Bandwidth, Mid Channel, 2437 MHz, 802.11n 40 MHz, Port 1 .....	39
Plot 45. 99% Occupied Bandwidth, High Channel, 2452 MHz, 802.11n 40 MHz, Port 1 .....	39
Plot 46. 99% Occupied Bandwidth, Low Channel, 2422 MHz, 802.11n 40 MHz, Port 2 .....	40
Plot 47. 99% Occupied Bandwidth, Mid Channel, 2437 MHz, 802.11n 40 MHz, Port 2 .....	40
Plot 48. 99% Occupied Bandwidth, High Channel, 2452 MHz, 802.11n 40 MHz, Port 2 .....	40
Plot 49. Peak Power Output, Low Channel, 2412 MHz, 802.11b .....	43
Plot 50. Peak Power Output, Mid Channel, 2437 MHz, 802.11b .....	43
Plot 51. Peak Power Output, High Channel, 2462 MHz, 802.11b .....	43
Plot 52. Peak Power Output, Low Channel, 2412 MHz, 802.11g .....	44
Plot 53. Peak Power Output, Mid Channel, 2437 MHz, 802.11g .....	44
Plot 54. Peak Power Output, High Channel, 2462 MHz, 802.11g .....	44
Plot 55. Peak Power Output, Low Channel, 2412 MHz, 802.11n 20 MHz, Port 1 .....	45
Plot 56. Peak Power Output, Mid Channel, 2437 MHz, 802.11n 20 MHz, Port 1 .....	45
Plot 57. Peak Power Output, High Channel, 2462 MHz, 802.11n 20 MHz, Port 1 .....	45
Plot 58. Peak Power Output, Low Channel, 2412 MHz, 802.11n 20 MHz, Port 2 .....	46
Plot 59. Peak Power Output, Mid Channel, 2437 MHz, 802.11n 20 MHz, Port 2 .....	46
Plot 60. Peak Power Output, High Channel, 2462 MHz, 802.11n 20 MHz, Port 2 .....	46
Plot 61. Peak Power Output, Low Channel, 2422 MHz, 802.11n 40 MHz, Port 1 .....	47
Plot 62. Peak Power Output, Mid Channel, 2437 MHz, 802.11n 40 MHz, Port 1 .....	47
Plot 63. Peak Power Output, High Channel, 2452 MHz, 802.11n 40 MHz, Port 1 .....	47
Plot 64. Peak Power Output, Low Channel, 2422 MHz, 802.11n 40 MHz, Port 2 .....	48
Plot 65. Peak Power Output, Mid Channel, 2437 MHz, 802.11n 40 MHz, Port 2 .....	48
Plot 66. Peak Power Output, High Channel, 2452 MHz, 802.11n 40 MHz, Port 2 .....	48
Plot 67. Radiated Spurious Emissions, Low Channel, 802.11b, 30 MHz – 1 GHz .....	51
Plot 68. Radiated Spurious Emissions, Low Channel, 802.11b, 1 GHz – 18 GHz .....	51
Plot 69. Radiated Spurious Emissions, Mid Channel, 802.11b, 30 MHz – 1 GHz .....	51
Plot 70. Radiated Spurious Emissions, Mid Channel, 802.11b, 1 GHz – 18 GHz .....	52
Plot 71. Radiated Spurious Emissions, High Channel, 802.11b, 30 MHz – 1 GHz .....	52
Plot 72. Radiated Spurious Emissions, High Channel, 802.11b, 1 GHz – 18 GHz .....	52
Plot 73. Radiated Spurious Emissions, Low Channel, 802.11g, 30 MHz – 1 GHz .....	53
Plot 74. Radiated Spurious Emissions, Low Channel, 802.11g, 1 GHz – 18 GHz .....	53
Plot 75. Radiated Spurious Emissions, Mid Channel, 802.11g, 30 MHz – 1 GHz .....	53



Plot 76. Radiated Spurious Emissions, Mid Channel, 802.11g, 1 GHz – 18 GHz .....	54
Plot 77. Radiated Spurious Emissions, High Channel, 802.11g, 30 MHz – 1 GHz .....	54
Plot 78. Radiated Spurious Emissions, High Channel, 802.11g, 1 GHz – 18 GHz.....	54
Plot 79. Radiated Spurious Emissions, Low Channel, 802.11n 20 MHz, 30 MHz – 1 GHz.....	55
Plot 80. Radiated Spurious Emissions, Low Channel, 802.11n 20 MHz, 1 GHz – 18 GHz .....	55
Plot 81. Radiated Spurious Emissions, Mid Channel, 802.11n 20 MHz, 30 MHz – 1 GHz .....	55
Plot 82. Radiated Spurious Emissions, Mid Channel, 802.11n 20 MHz, 1 GHz – 18 GHz .....	56
Plot 83. Radiated Spurious Emissions, High Channel, 802.11n 20 MHz, 30 MHz – 1 GHz .....	56
Plot 84. Radiated Spurious Emissions, High Channel, 802.11n 20 MHz, 1 GHz – 18 GHz.....	56
Plot 85. Radiated Spurious Emissions, Low Channel, 802.11n 40 MHz, 30 MHz – 1 GHz.....	57
Plot 86. Radiated Spurious Emissions, Low Channel, 802.11n 40 MHz, 1 GHz – 18 GHz .....	57
Plot 87. Radiated Spurious Emissions, Mid Channel, 802.11n 40 MHz, 30 MHz – 1 GHz .....	57
Plot 88. Radiated Spurious Emissions, Mid Channel, 802.11n 40 MHz, 1 GHz – 18 GHz .....	58
Plot 89. Radiated Spurious Emissions, High Channel, 802.11n 40 MHz, 30 MHz – 1 GHz .....	58
Plot 90. Radiated Spurious Emissions, High Channel, 802.11n 40 MHz, 1 GHz – 18 GHz.....	58
Plot 91. Radiated Restricted Band Edge, 802.11b, 2412 MHz @ 2390 MHz, Average.....	59
Plot 92. Radiated Restricted Band Edge, 802.11b, 2412 MHz @ 2390 MHz, Peak .....	59
Plot 93. Radiated Restricted Band Edge, 802.11b, 2462 MHz @ 2483.5 MHz, Average.....	60
Plot 94. Radiated Restricted Band Edge, 802.11b, 2462 MHz @ 2483.5 MHz, Peak .....	60
Plot 95. Radiated Restricted Band Edge, 802.11g, 2412 MHz @ 2390 MHz, Average.....	61
Plot 96. Radiated Restricted Band Edge, 802.11g, 2412 MHz @ 2390 MHz, Peak .....	61
Plot 97. Radiated Restricted Band Edge, 802.11g, 2462 MHz @ 2483.5 MHz, Average.....	61
Plot 98. Radiated Restricted Band Edge, 802.11g, 2462 MHz @ 2483.5 MHz, Peak .....	62
Plot 99. Radiated Restricted Band Edge, 802.11n 20 MHz, 2412 MHz @ 2390 MHz, Average .....	63
Plot 100. Radiated Restricted Band Edge, 802.11n 20 MHz, 2412 MHz @ 2390 MHz, Peak .....	63
Plot 101. Radiated Restricted Band Edge, 802.11n 20 MHz, 2462 MHz @ 2483.5 MHz, Average.....	63
Plot 102. Radiated Restricted Band Edge, 802.11n 20 MHz, 2462 MHz @ 2483.5 MHz, Peak .....	64
Plot 103. Radiated Restricted Band Edge, 802.11n 40 MHz, 2412 MHz @ 2390 MHz, Average .....	65
Plot 104. Radiated Restricted Band Edge, 802.11n 40 MHz, 2412 MHz @ 2390 MHz, Peak .....	65
Plot 105. Radiated Restricted Band Edge, 802.11n 40 MHz, 2452 MHz @ 2483.5 MHz, Average.....	65
Plot 106. Radiated Restricted Band Edge, 802.11n 40 MHz, 2452 MHz @ 2483.5 MHz, Peak .....	66
Plot 107. Conducted Spurious Emissions, Low Channel, 802.11b, 2412 MHz, 30 MHz – 1 GHz.....	68
Plot 108. Conducted Spurious Emissions, Low Channel, 802.11b, 2412 MHz, 1 GHz – 26 GHz .....	68
Plot 109. Conducted Spurious Emissions, Mid Channel, 802.11b, 2437 MHz, 30 MHz – 1 GHz .....	68
Plot 110. Conducted Spurious Emissions, Mid Channel, 802.11b, 2437 MHz, 1 GHz – 26 GHz .....	69
Plot 111. Conducted Spurious Emissions, High Channel, 802.11b, 2462 MHz, 30 MHz – 1 GHz .....	69
Plot 112. Conducted Spurious Emissions, High Channel, 802.11b, 2462 MHz, 1 GHz – 26 GHz.....	69
Plot 113. Conducted Spurious Emissions, Low Channel, 802.11g, 2412 MHz, 30 MHz – 1 GHz.....	70
Plot 114. Conducted Spurious Emissions, Low Channel, 802.11g, 2412 MHz, 1 GHz – 26 GHz .....	70
Plot 115. Conducted Spurious Emissions, Mid Channel, 802.11g, 2437 MHz, 30 MHz – 1 GHz .....	70
Plot 116. Conducted Spurious Emissions, Mid Channel, 802.11g, 2437 MHz, 1 GHz – 26 GHz .....	71
Plot 117. Conducted Spurious Emissions, High Channel, 802.11g, 2462 MHz, 30 MHz – 1 GHz .....	71
Plot 118. Conducted Spurious Emissions, High Channel, 802.11g, 2462 MHz, 1 GHz – 26 GHz.....	71
Plot 119. Conducted Spurious Emissions, Low Channel, 802.11n 20 MHz, Port 1, 2412 MHz, 30 MHz – 1 GHz.....	72
Plot 120. Conducted Spurious Emissions, Low Channel, 802.11n 20 MHz, Port 1, 2412 MHz, 1 GHz – 26 GHz.....	72
Plot 121. Conducted Spurious Emissions, Mid Channel, 802.11n 20 MHz, Port 1, 2437 MHz, 30 MHz – 1 GHz.....	72
Plot 122. Conducted Spurious Emissions, Mid Channel, 802.11n 20 MHz, Port 1, 2437 MHz, 1 GHz – 26 GHz .....	73
Plot 123. Conducted Spurious Emissions, High Channel, 802.11n 20 MHz, Port 1, 2462 MHz, 30 MHz – 1 GHz .....	73
Plot 124. Conducted Spurious Emissions, High Channel, 802.11n 20 MHz, Port 1, 2462 MHz, 1 GHz – 26 GHz.....	73
Plot 125. Conducted Spurious Emissions, Low Channel, 802.11n 20 MHz, Port 2, 2412 MHz, 30 MHz – 1 GHz.....	74
Plot 126. Conducted Spurious Emissions, Low Channel, 802.11n 20 MHz, Port 2, 2412 MHz, 1 GHz – 26 GHz.....	74
Plot 127. Conducted Spurious Emissions, Mid Channel, 802.11n 20 MHz, Port 2, 2437 MHz, 30 MHz – 1 GHz.....	74
Plot 128. Conducted Spurious Emissions, Mid Channel, 802.11n 20 MHz, Port 2, 2437 MHz, 1 GHz – 26 GHz .....	75
Plot 129. Conducted Spurious Emissions, High Channel, 802.11n 20 MHz, Port 2, 2462 MHz, 30 MHz – 1 GHz .....	75
Plot 130. Conducted Spurious Emissions, High Channel, 802.11n 20 MHz, Port 2, 2462 MHz, 1 GHz – 26 GHz .....	75



Plot 131. Conducted Spurious Emissions, Low Channel, 802.11n 40 MHz, Port 1, 2422 MHz, 30 MHz – 1 GHz .....	76
Plot 132. Conducted Spurious Emissions, Low Channel, 802.11n 40 MHz, Port 1, 2422 MHz, 1 GHz – 26 GHz.....	76
Plot 133. Conducted Spurious Emissions, Mid Channel, 802.11n 40 MHz, Port 1, 2437 MHz, 30 MHz – 1 GHz.....	76
Plot 134. Conducted Spurious Emissions, Mid Channel, 802.11n 40 MHz, Port 1, 2437 MHz, 1 GHz – 26 GHz .....	77
Plot 135. Conducted Spurious Emissions, High Channel, 802.11n 40 MHz, Port 1, 2452 MHz, 30 MHz – 1 GHz .....	77
Plot 136. Conducted Spurious Emissions, High Channel, 802.11n 40 MHz, Port 1, 2452 MHz, 1 GHz – 26 GHz .....	77
Plot 137. Conducted Spurious Emissions, Low Channel, 802.11n 40 MHz, Port 2, 2422 MHz, 30 MHz – 1 GHz .....	78
Plot 138. Conducted Spurious Emissions, Low Channel, 802.11n 40 MHz, Port 2, 2422 MHz, 1 GHz – 26 GHz.....	78
Plot 139. Conducted Spurious Emissions, Mid Channel, 802.11n 40 MHz, Port 2, 2437 MHz, 30 MHz – 1 GHz.....	78
Plot 140. Conducted Spurious Emissions, Mid Channel, 802.11n 40 MHz, Port 2, 2437 MHz, 1 GHz – 26 GHz .....	79
Plot 141. Conducted Spurious Emissions, High Channel, 802.11n 40 MHz, Port 2, 2452 MHz, 30 MHz – 1 GHz .....	79
Plot 142. Conducted Spurious Emissions, High Channel, 802.11n 40 MHz, Port 2, 2452 MHz, 1 GHz – 26 GHz .....	79
Plot 143. Conducted Band Edge, 802.11b, 2412 MHz.....	80
Plot 144. Conducted Band Edge, 802.11b, 2462 MHz.....	80
Plot 145. Conducted Band Edge, 802.11g, 2412 MHz.....	81
Plot 146. Conducted Band Edge, 802.11g, 2462 MHz.....	81
Plot 147. Conducted Band Edge, 802.11n 20 MHz, Port 1, 2412 MHz .....	82
Plot 148. Conducted Band Edge, 802.11n 20 MHz, Port 1, 2462 MHz .....	82
Plot 149. Conducted Band Edge, 802.11n 20 MHz, Port 2, 2412 MHz .....	83
Plot 150. Conducted Band Edge, 802.11n 20 MHz, Port 2, 2462 MHz .....	83
Plot 151. Conducted Band Edge, 802.11n 40 MHz, Port 1, 2422 MHz .....	84
Plot 152. Conducted Band Edge, 802.11n 40 MHz, Port 1, 2452 MHz .....	84
Plot 153. Conducted Band Edge, 802.11n 40 MHz, Port 2, 2422 MHz .....	85
Plot 154. Conducted Band Edge, 802.11n 40 MHz, Port 2, 2452 MHz .....	85
Plot 155. Peak Power Spectral Density, Low Channel, 802.11b, 2412 MHz.....	88
Plot 156. Peak Power Spectral Density, Mid Channel, 802.11b, 2437 MHz .....	88
Plot 157. Peak Power Spectral Density, High Channel, 802.11b, 2462 MHz .....	88
Plot 158. Peak Power Spectral Density, Low Channel, 802.11g, 2412 MHz.....	89
Plot 159. Peak Power Spectral Density, Mid Channel, 802.11g, 2437 MHz .....	89
Plot 160. Peak Power Spectral Density, High Channel, 802.11g, 2462 MHz .....	89
Plot 161. Peak Power Spectral Density, Low Channel, 802.11n 20 MHz, Port 1, 2412 MHz .....	90
Plot 162. Peak Power Spectral Density, Mid Channel, 802.11n 20 MHz, Port 1, 2437 MHz.....	90
Plot 163. Peak Power Spectral Density, High Channel, 802.11n 20 MHz, Port 1, 2462 MHz .....	90
Plot 164. Peak Power Spectral Density, Low Channel, 802.11n 20 MHz, Port 2, 2412 MHz .....	91
Plot 165. Peak Power Spectral Density, Mid Channel, 802.11n 20 MHz, Port 2, 2437 MHz.....	91
Plot 166. Peak Power Spectral Density, High Channel, 802.11n 20 MHz, Port 2, 2462 MHz .....	91
Plot 167. Peak Power Spectral Density, Low Channel, 802.11n 40 MHz, Port 1, 2422 MHz .....	92
Plot 168. Peak Power Spectral Density, Mid Channel, 802.11n 40 MHz, Port 1, 2437 MHz.....	92
Plot 169. Peak Power Spectral Density, High Channel, 802.11n 40 MHz, Port 1, 2452 MHz .....	92
Plot 170. Peak Power Spectral Density, Low Channel, 802.11n 40 MHz, Port 2, 2422 MHz .....	93
Plot 171. Peak Power Spectral Density, Mid Channel, 802.11n 40 MHz, Port 2, 2437 MHz.....	93
Plot 172. Peak Power Spectral Density, High Channel, 802.11n 40 MHz, Port 2, 2452 MHz .....	93
Plot 173. Radiated Spurs, Co-Location, 802.11n 20 MHz, 2412 MHz & 5200 MHz, 30 MHz – 1 GHz, Peak.....	95
Plot 174. Radiated Spurs, Co-Location, 802.11n 20 MHz, 2412 MHz & 5200 MHz, 1 GHz – 7 GHz, Avg. ....	95
Plot 175. Radiated Spurs, Co-Location, 802.11n 20 MHz, 2412 MHz & 5200 MHz, 1 GHz – 7 GHz, Peak .....	95
Plot 176. Radiated Spurs, Co-Location, 802.11n 20 MHz, 2412 MHz & 5200 MHz, 7 GHz – 18 GHz .....	96
Plot 177. Radiated Spurs, Co-Location, 802.11n 20 MHz, 2412 MHz & 5300 MHz, 30 MHz – 1 GHz, Peak.....	96
Plot 178. Radiated Spurs, Co-Location, 802.11n 20 MHz, 2412 MHz & 5300 MHz, 1 GHz – 7 GHz, Avg. ....	96
Plot 179. Radiated Spurs, Co-Location, 802.11n 20 MHz, 2412 MHz & 5300 MHz, 1 GHz – 7 GHz, Peak .....	97
Plot 180. Radiated Spurs, Co-Location, 802.11n 20 MHz, 2412 MHz & 5300 MHz, 7 GHz – 18 GHz, Peak .....	97
Plot 181. Radiated Spurs, Co-Location, 802.11n 20 MHz, 2412 MHz & 5580 MHz, 30 MHz – 1 GHz, Peak.....	97
Plot 182. Radiated Spurs, Co-Location, 802.11n 20 MHz, 2412 MHz & 5580 MHz, 1 GHz – 7 GHz, Avg. ....	98
Plot 183. Radiated Spurs, Co-Location, 802.11n 20 MHz, 2412 MHz & 5580 MHz, 1 GHz – 7 GHz, Peak .....	98
Plot 184. Radiated Spurs, Co-Location, 802.11n 20 MHz, 2412 MHz & 5580 MHz, 7 GHz – 18 GHz, Peak .....	98
Plot 185. Radiated Spurs, Co-Location, 802.11n 20 MHz, 2412 MHz & 5785 MHz, 30 MHz – 1 GHz, Peak.....	99

Plot 186. Radiated Spurs, Co-Location, 802.11n 20 MHz, 2412 MHz & 5785 MHz, 1 GHz – 7 GHz, Avg. ....	99
Plot 187. Radiated Spurs, Co-Location, 802.11n 20 MHz, 2412 MHz & 5785 MHz, 1 GHz – 7 GHz, Peak .....	99
Plot 188. Radiated Spurs, Co-Location, 802.11n 20 MHz, 2412 MHz & 5785 MHz, 7 GHz – 18 GHz, Peak .....	100
Plot 189. Radiated Spurs, Co-Location, 802.11n 20 MHz, 2437 MHz & 5200 MHz, 30 MHz – 1 GHz, Peak.....	100
Plot 190. Radiated Spurs, Co-Location, 802.11n 20 MHz, 2437 MHz & 5200 MHz, 1 GHz – 7 GHz, Avg. ....	100
Plot 191. Radiated Spurs, Co-Location, 802.11n 20 MHz, 2437 MHz & 5200 MHz, 1 GHz – 7 GHz, Peak .....	101
Plot 192. Radiated Spurs, Co-Location, 802.11n 20 MHz, 2437 MHz & 5200 MHz, 7 GHz – 18 GHz, Peak .....	101
Plot 193. Radiated Spurs, Co-Location, 802.11n 20 MHz, 2437 MHz & 5300 MHz, 30 MHz – 1 GHz, Peak.....	101
Plot 194. Radiated Spurs, Co-Location, 802.11n 20 MHz, 2437 MHz & 5300 MHz, 1 GHz – 7 GHz, Avg. ....	102
Plot 195. Radiated Spurs, Co-Location, 802.11n 20 MHz, 2437 MHz & 5300 MHz, 1 GHz – 7 GHz, Peak .....	102
Plot 196. Radiated Spurs, Co-Location, 802.11n 20 MHz, 2437 MHz & 5300 MHz, 7 GHz – 18 GHz, Peak .....	102
Plot 197. Radiated Spurs, Co-Location, 802.11n 20 MHz, 2437 MHz & 5580 MHz, 30 MHz – 1 GHz, Peak.....	103
Plot 198. Radiated Spurs, Co-Location, 802.11n 20 MHz, 2437 MHz & 5580 MHz, 1 GHz – 7 GHz, Avg. ....	103
Plot 199. Radiated Spurs, Co-Location, 802.11n 20 MHz, 2437 MHz & 5580 MHz, 1 GHz – 7 GHz, Peak .....	103
Plot 200. Radiated Spurs, Co-Location, 802.11n 20 MHz, 2437 MHz & 5580 MHz, 7 GHz – 18 GHz, Peak .....	104
Plot 201. Radiated Spurs, Co-Location, 802.11n 20 MHz, 2437 MHz & 5785 MHz, 30 MHz – 1 GHz, Peak.....	104
Plot 202. Radiated Spurs, Co-Location, 802.11n 20 MHz, 2437 MHz & 5785 MHz, 1 GHz – 7 GHz, Avg. ....	104
Plot 203. Radiated Spurs, Co-Location, 802.11n 20 MHz, 2437 MHz & 5785 MHz, 1 GHz – 7 GHz, Peak .....	105
Plot 204. Radiated Spurs, Co-Location, 802.11n 20 MHz, 2437 MHz & 5785 MHz, 7 GHz – 18 GHz, Peak .....	105
Plot 205. Radiated Spurs, Co-Location, 802.11n 20 MHz, 2462 MHz & 5200 MHz, 30 MHz – 1 GHz, Peak.....	105
Plot 206. Radiated Spurs, Co-Location, 802.11n 20 MHz, 2462 MHz & 5200 MHz, 1 GHz – 7 GHz, Avg. ....	106
Plot 207. Radiated Spurs, Co-Location, 802.11n 20 MHz, 2462 MHz & 5200 MHz, 1 GHz – 7 GHz, Peak .....	106
Plot 208. Radiated Spurs, Co-Location, 802.11n 20 MHz, 2462 MHz & 5200 MHz, 7 GHz – 18 GHz, Peak .....	106
Plot 209. Radiated Spurs, Co-Location, 802.11n 20 MHz, 2462 MHz & 5300 MHz, 30 MHz – 1 GHz, Peak.....	107
Plot 210. Radiated Spurs, Co-Location, 802.11n 20 MHz, 2462 MHz & 5300 MHz, 1 GHz – 7 GHz, Avg. ....	107
Plot 211. Radiated Spurs, Co-Location, 802.11n 20 MHz, 2462 MHz & 5300 MHz, 1 GHz – 7 GHz, Peak .....	107
Plot 212. Radiated Spurs, Co-Location, 802.11n 20 MHz, 2462 MHz & 5300 MHz, 7 GHz – 18 GHz, Peak .....	108
Plot 213. Radiated Spurs, Co-Location, 802.11n 20 MHz, 2462 MHz & 5580 MHz, 30 MHz – 1 GHz, Peak.....	108
Plot 214. Radiated Spurs, Co-Location, 802.11n 20 MHz, 2462 MHz & 5580 MHz, 1 GHz – 7 GHz, Avg. ....	108
Plot 215. Radiated Spurs, Co-Location, 802.11n 20 MHz, 2462 MHz & 5580 MHz, 1 GHz – 7 GHz, Peak .....	109
Plot 216. Radiated Spurs, Co-Location, 802.11n 20 MHz, 2462 MHz & 5580 MHz, 7 GHz – 18 GHz, Peak .....	109
Plot 217. Radiated Spurs, Co-Location, 802.11n 20 MHz, 2462 MHz & 5785 MHz, 30 MHz – 1 GHz, Peak.....	109
Plot 218. Radiated Spurs, Co-Location, 802.11n 20 MHz, 2462 MHz & 5785 MHz, 1 GHz – 7 GHz, Avg. ....	110
Plot 219. Radiated Spurs, Co-Location, 802.11n 20 MHz, 2462 MHz & 5785 MHz, 1 GHz – 7 GHz, Peak .....	110
Plot 220. Radiated Spurs, Co-Location, 802.11n 20 MHz, 2462 MHz & 5785 MHz, 7 GHz – 18 GHz, Peak .....	110
Plot 221. Radiated Spurs, Co-Location, 802.11n 20 MHz, 5200 MHz & 5200 MHz, 30 MHz – 1 GHz, Peak.....	111
Plot 222. Radiated Spurs, Co-Location, 802.11n 20 MHz, 5200 MHz & 5200 MHz, 1 GHz – 7 GHz, Avg. ....	111
Plot 223. Radiated Spurs, Co-Location, 802.11n 20 MHz, 5200 MHz & 5200 MHz, 1 GHz – 7 GHz, Peak .....	111
Plot 224. Radiated Spurs, Co-Location, 802.11n 20 MHz, 5200 MHz & 5200 MHz, 7 GHz – 18 GHz, Peak .....	112
Plot 225. Radiated Spurs, Co-Location, 802.11n 20 MHz, 5200 MHz & 5300 MHz, 30 MHz – 1 GHz, Peak.....	112
Plot 226. Radiated Spurs, Co-Location, 802.11n 20 MHz, 5200 MHz & 5300 MHz, 1 GHz – 7 GHz, Avg. ....	112
Plot 227. Radiated Spurs, Co-Location, 802.11n 20 MHz, 5200 MHz & 5300 MHz, 1 GHz – 7 GHz, Peak .....	113
Plot 228. Radiated Spurs, Co-Location, 802.11n 20 MHz, 5200 MHz & 5300 MHz, 7 GHz – 18 GHz, Peak .....	113
Plot 229. Radiated Spurs, Co-Location, 802.11n 20 MHz, 5200 MHz & 5580 MHz, 30 MHz – 1 GHz, Peak.....	113
Plot 230. Radiated Spurs, Co-Location, 802.11n 20 MHz, 5200 MHz & 5580 MHz, 1 GHz – 7 GHz, Avg. ....	114
Plot 231. Radiated Spurs, Co-Location, 802.11n 20 MHz, 5200 MHz & 5580 MHz, 1 GHz – 7 GHz, Peak .....	114
Plot 232. Radiated Spurs, Co-Location, 802.11n 20 MHz, 5200 MHz & 5580 MHz, 7 GHz – 18 GHz, Peak .....	114
Plot 233. Radiated Spurs, Co-Location, 802.11n 20 MHz, 5200 MHz & 5785 MHz, 30 MHz – 1 GHz, Peak.....	115
Plot 234. Radiated Spurs, Co-Location, 802.11n 20 MHz, 5200 MHz & 5785 MHz, 1 GHz – 7 GHz, Avg. ....	115
Plot 235. Radiated Spurs, Co-Location, 802.11n 20 MHz, 5200 MHz & 5785 MHz, 1 GHz – 7 GHz, Peak .....	115
Plot 236. Radiated Spurs, Co-Location, 802.11n 20 MHz, 5200 MHz & 5785 MHz, 7 GHz – 18 GHz, Peak .....	116
Plot 237. Radiated Spurs, Co-Location, 802.11n 20 MHz, 5300 MHz & 5300 MHz, 30 MHz – 1 GHz, Peak.....	116
Plot 238. Radiated Spurs, Co-Location, 802.11n 20 MHz, 5300 MHz & 5300 MHz, 1 GHz – 7 GHz, Avg. ....	116
Plot 239. Radiated Spurs, Co-Location, 802.11n 20 MHz, 5300 MHz & 5300 MHz, 1 GHz – 7 GHz.....	117
Plot 240. Radiated Spurs, Co-Location, 802.11n 20 MHz, 5300 MHz & 5300 MHz, 7 GHz – 18 GHz, Peak .....	117

Plot 241. Radiated Spurs, Co-Location, 802.11n 20 MHz, 5300 MHz & 5580 MHz, 30 MHz – 1 GHz, Peak.....	117
Plot 242. Radiated Spurs, Co-Location, 802.11n 20 MHz, 5300 MHz & 5580 MHz, 1 GHz – 7 GHz, Avg. ....	118
Plot 243. Radiated Spurs, Co-Location, 802.11n 20 MHz, 5300 MHz & 5580 MHz, 1 GHz – 7 GHz, Peak .....	118
Plot 244. Radiated Spurs, Co-Location, 802.11n 20 MHz, 5300 MHz & 5580 MHz, 7 GHz – 18 GHz, Peak .....	118
Plot 245. Radiated Spurs, Co-Location, 802.11n 20 MHz, 5300 MHz & 5785 MHz, 30 MHz – 1 GHz, Peak.....	119
Plot 246. Radiated Spurs, Co-Location, 802.11n 20 MHz, 5300 MHz & 5785 MHz, 1 GHz – 7 GHz, Avg. ....	119
Plot 247. Radiated Spurs, Co-Location, 802.11n 20 MHz, 5300 MHz & 5785 MHz, 1 GHz – 7 GHz, Peak .....	119
Plot 248. Radiated Spurs, Co-Location, 802.11n 20 MHz, 5300 MHz & 5785 MHz, 7 GHz – 18 GHz, Peak .....	120
Plot 249. Radiated Spurs, Co-Location, 802.11n 20 MHz, 5580 MHz & 5580 MHz, 30 MHz – 1 GHz, Peak.....	120
Plot 250. Radiated Spurs, Co-Location, 802.11n 20 MHz, 5580 MHz & 5580 MHz, 1 GHz – 7 GHz, Avg. ....	120
Plot 251. Radiated Spurs, Co-Location, 802.11n 20 MHz, 5580 MHz & 5580 MHz, 1 GHz – 7 GHz, Peak .....	121
Plot 252. Radiated Spurs, Co-Location, 802.11n 20 MHz, 5580 MHz & 5580 MHz, 7 GHz – 18 GHz, Peak .....	121
Plot 253. Radiated Spurs, Co-Location, 802.11n 20 MHz, 5580 MHz & 5785 MHz, 30 MHz – 1 GHz, Peak.....	121
Plot 254. Radiated Spurs, Co-Location, 802.11n 20 MHz, 5580 MHz & 5785 MHz, 1 GHz – 7 GHz, Avg. ....	122
Plot 255. Radiated Spurs, Co-Location, 802.11n 20 MHz, 5580 MHz & 5785 MHz, 1 GHz – 7 GHz, Peak .....	122
Plot 256. Radiated Spurs, Co-Location, 802.11n 20 MHz, 5580 MHz & 5785 MHz, 7 GHz – 18 GHz, Peak .....	122
Plot 257. Radiated Spurs, Co-Location, 802.11n 20 MHz, 5785 MHz & 5785 MHz, 30 MHz – 1 GHz, Peak.....	123
Plot 258. Radiated Spurs, Co-Location, 802.11n 20 MHz, 5785 MHz & 5785 MHz, 1 GHz – 7 GHz, Avg. ....	123
Plot 259. Radiated Spurs, Co-Location, 802.11n 20 MHz, 5785 MHz & 5785 MHz, 1 GHz – 7 GHz, Peak .....	123
Plot 260. Radiated Spurs, Co-Location, 802.11n 20 MHz, 5785 MHz & 5785 MHz, 7 GHz – 18 GHz, Peak .....	124

## List of Figures

Figure 1. Block Diagram of Test Configuration.....	6
Figure 2. Block Diagram, Occupied Bandwidth Test Setup.....	27
Figure 3. Peak Power Output Test Setup.....	41
Figure 4. Block Diagram, Conducted Spurious Emissions Test Setup.....	67
Figure 5. Block Diagram, Peak Power Spectral Density Test Setup .....	86

## List of Terms and Abbreviations

AC	Alternating Current
ACF	Antenna Correction Factor
Cal	Calibration
<i>d</i>	Measurement Distance
dB	Decibels
dB $\mu$ A	Decibels above one <b>microamp</b>
dB $\mu$ V	Decibels above one <b>microvolt</b>
dB $\mu$ A/m	Decibels above one <b>microamp per meter</b>
dB $\mu$ V/m	Decibels above one <b>microvolt per meter</b>
DC	Direct Current
E	Electric Field
DSL	Digital Subscriber Line
ESD	Electrostatic Discharge
EUT	Equipment Under Test
<i>f</i>	Frequency
FCC	Federal Communications Commission
GRP	Ground Reference Plane
H	Magnetic Field
HCP	Horizontal Coupling Plane
Hz	Hertz
IEC	International Electrotechnical Commission
kHz	kilohertz
kPa	kilopascal
kV	kilovolt
LISN	Line Impedance Stabilization Network
MHz	Megahertz
$\mu$ H	microhenry
$\mu$	microfarad
$\mu$ s	microseconds
NEBS	Network Equipment-Building System
PRF	Pulse Repetition Frequency
RF	Radio Frequency
RMS	Root-Mean-Square
TWT	Traveling Wave Tube
V/m	Volts per meter
VCP	Vertical Coupling Plane

# I. Executive Summary

## A. Purpose of Test

An EMC evaluation was performed to determine compliance of the Meru Networks, Inc. Broad Peak (AP121 & AP122), with the requirements of Part 15, §15.247. All references are to the most current version of Title 47 of the Code of Federal Regulations in effect. In accordance with §2.1033, the following data is presented in support of the Certification of the Broad Peak (AP121 & AP122). Meru Networks, Inc. should retain a copy of this document which should be kept on file for at least two years after the manufacturing of the Broad Peak (AP121 & AP122), has been **permanently** discontinued.

## B. Executive Summary

The following tests were conducted on a sample of the equipment for the purpose of demonstrating compliance with Part 15, §15.247, in accordance with Meru Networks, Inc., purchase order number 107001. All tests were conducted using measurement procedure ANSI C63.4-2003.

FCC Reference 47 CFR Part 15.247:2005	Description	Compliance
47 CFR Part 15.107 (a)	Conducted Emission Limits for a Class B Digital Device	Compliant
47 CFR Part 15.109 (a)	Radiated Emission Limits for a Class B Digital Device	Compliant
Title 47 of the CFR, Part 15 §15.203	Antenna Requirement	Compliant
Title 47 of the CFR, Part 15 §15.207(a)	Conducted Emission Limits	Compliant
Title 47 of the CFR, Part 15 §15.247(a)(2)	6dB Occupied Bandwidth	Compliant
	99% Occupied Bandwidth	Compliant
Title 47 of the CFR, Part 15 §15.247(b)	Peak Power Output	Compliant
Title 47 of the CFR, Part 15 §15.247(d); §15.209; §15.205	Radiated Spurious Emissions Requirements	Compliant
Title 47 of the CFR, Part 15 §15.247(d)	RF Conducted Spurious Emissions Requirements	Compliant
Title 47 of the CFR, Part 15 §15.247(d)	RF Conducted Band Edge	Compliant
Title 47 of the CFR, Part 15; §15.247(e)	Peak Power Spectral Density	Compliant
Title 47 of the CFR, Part 15 §15.247(i)	Maximum Permissible Exposure (MPE)	Compliant

**Table 1. Executive Summary of EMC Part 15.247 Compliance Testing**

## II. Equipment Configuration



## A. Overview

MET Laboratories, Inc. was contracted by Meru Networks, Inc. to perform testing on the Broad Peak (AP121 & AP122), under Meru Networks, Inc.'s purchase order number 107001.

This document describes the test setups, test methods, required test equipment, and the test limit criteria used to perform compliance testing of the Meru Networks, Inc., Broad Peak (AP121 & AP122).

The results obtained relate only to the item(s) tested.

<b>Model(s) Tested:</b>	Broad Peak (AP122)	
<b>Model(s) Covered:</b>	Broad Peak (AP121 & AP122)	
<b>EUT Specifications:</b>	Primary Power: 120 VAC, 60 Hz	
	FCC ID: RE7-AP122	
	Type of Modulations:	BPSK, QPSK, QAM16 and QAM64
	Equipment Code:	DTS
	Peak RF Output Power:	29.32 dBm
	EUT Frequency Ranges:	2.412 GHz – 2.462 GHz
<b>Analysis:</b>	The results obtained relate only to the item(s) tested.	
<b>Environmental Test Conditions:</b>	Temperature: 15-35° C	
	Relative Humidity: 30-60%	
	Barometric Pressure: 860-1060 mbar	
<b>Evaluated by:</b>	Ben Taylor	
<b>Report Date(s):</b>	October 8, 2014	

**Table 2. EUT Summary Table**

## B. References

<b>CFR 47, Part 15, Subpart C</b>	Federal Communication Commission, Code of Federal Regulations, Title 47, Part 15: General Rules and Regulations, Allocation, Assignment, and Use of Radio Frequencies
<b>CFR 47, Part 15, Subpart B</b>	Electromagnetic Compatibility: Criteria for Radio Frequency Devices
<b>ANSI C63.4:2003</b>	Methods and Measurements of Radio-Noise Emissions from Low-Voltage Electrical And Electronic Equipment in the Range of 9 kHz to 40 GHz
<b>ISO/IEC 17025:2005</b>	General Requirements for the Competence of Testing and Calibration Laboratories
<b>ANSI C63.10-2009</b>	American National Standard for Testing Unlicensed Wireless Devices

**Table 3. References**

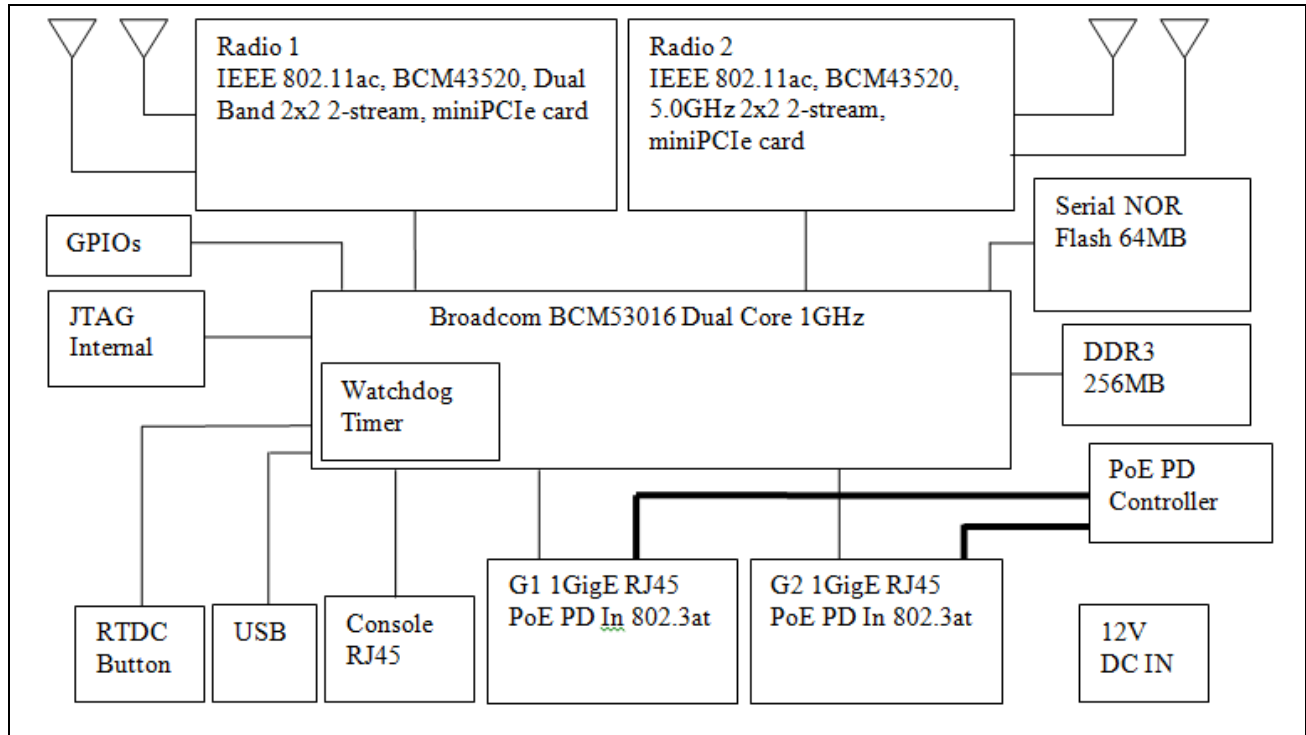
## C. Test Site

All testing was performed at MET Laboratories, Inc., 914 W. Patapsco Ave, Baltimore, MD 21230. All equipment used in making physical determinations is accurate and bears recent traceability to the National Institute of Standards and Technology.

Radiated Emissions measurements were performed in a 3 meter semi-anechoic chamber (equivalent to an Open Area Test Site). In accordance with §2.948(a)(3), a complete site description is contained at MET Laboratories.

## D. Description of Test Sample

The Meru Networks, Inc. Broad Peak (AP121 & AP122), Equipment Under Test (EUT), is an 802.11AC wireless access point (WAP) that allows wireless devices to connect to a wired network using Wi-Fi, standard. The WAP usually connects to a router (via a wired network), and can relay data between the wireless devices (such as computers or printers) and wired devices on the network. The EUT supports 2.4 GHz and 5 GHz operation.



**Figure 1. Block Diagram of Test Configuration**

## E. Equipment Configuration

The EUT was set up as outlined in Figure 1, Block Diagram of Test Setup. All cards, racks, etc., incorporated as part of the EUT is included in the following list.

Ref. ID	Name / Description	Model Number	Serial Number	Rev. #
1	Dual Radio Access Point	AP122	2914AP12216DCFD	Rev 1
2	Dual Radio Access Point	AP121	2914AP1210FF001	Rev 1

**Table 4. Equipment Configuration**

## F. Support Equipment

Support equipment necessary for the operation and testing of the EUT is included in the following list.

Ref. ID	Name / Description	Manufacturer	Model Number
3	PoE	Power Design	PD-9001GR/AC
4	Labtop	IBM	IBM Thinkpad

**Table 5. Support Equipment**

Meru Part Number	Description	Gain
RFA-25-P375-79-200RF	Internal PCB antenna (radio 1)	3 dBi at 2.4 GHz and 4dBi at 5 GHz
RFA-25-P375-70B-60RB	Internal PCB antenna (radio 2)	4dBi at 5 GHz

**Table 6. Antenna List**

## G. Ports and Cabling Information

Ref. ID	Port name on EUT	Cable Description or reason for no cable	Qty	Length as tested (m)	Max Length (m)	Shielded? (Y/N)	Termination Box ID & Port Name
1	Reset Console	dB9 Serial cable	1	1	--	Yes	To computer serial port or USB to Serial adapter
2	G1PoE	Data and Power Ethernet port	1	2	10	YES	To PoE injector or Ethernet switch
3	G2PoE	Data and Power Ethernet port	1	2	10	Yes	To PoE injector or Ethernet switch
4	12 DC	12 DV Audio jack	1	1	10	Yes	To DC adapter
5	A1, A3, A4 and A6	RPSMA to SMA co-axial cable	4	0.5	1	Yes	To power meter or spectrum Analyzer

**Table 7. Ports and Cabling Information**

## **H. Mode of Operation**

During the normal operation the configuration is controlled by the Meru controller which sets the country code, ESSID, Operating frequency band and Channel etc.

## **I. Method of Monitoring EUT Operation**

During the normal operation with controller Green or Blue LED indication on the Access point indicate the normal operation of the Access point. A Red LED indicates a failure of hardware or software settings.

## **J. Modifications**

### **a) Modifications to EUT**

No modifications were made to the EUT.

### **b) Modifications to Test Standard**

No modifications were made to the test standard.

## **K. Disposition of EUT**

The test sample including all support equipment submitted to the Electro-Magnetic Compatibility Lab for testing was returned to Meru Networks, Inc. upon completion of testing.

### **III. Electromagnetic Compatibility Criteria for Unintentional Radiators**

## Electromagnetic Compatibility Criteria

### § 15.107 Conducted Emissions Limits

**Test Requirement(s):** **15.107 (a)** Except for Class A digital devices, for equipment that is designed to be connected to the public utility (AC) power line, the radio frequency voltage that is conducted back onto the AC power line on any frequency or frequencies within the band 150 kHz to 30 MHz shall not exceed the limits in Table 8. Compliance with this provision shall be based on the measurement of the radio frequency voltage between each power line and ground at the power terminals.

**15.107 (b)** For a Class A digital device that is designed to be connected to the public utility (AC) power line, the radio frequency voltage that is conducted back onto the AC power line on any frequency or frequencies within the band 150 kHz to 30 MHz shall not exceed the limits in Table 8. Compliance with this provision shall be based on the measurement of the radio frequency voltage between each power line and ground at the power terminals. The lower limit applies at the band edges.

Frequency range (MHz)	Class A Conducted Limits (dB $\mu$ V)		*Class B Conducted Limits (dB $\mu$ V)	
	Quasi-Peak	Average	Quasi-Peak	Average
* 0.15- 0.45	79	66	66 - 56	56 - 46
0.45 - 0.5	79	66	56	46
0.5 - 30	73	60	60	50

Note 1 — The lower limit shall apply at the transition frequencies.  
Note 2 — The limit decreases linearly with the logarithm if the frequency in the range 0.15 MHz to 0.5 MHz.

**Table 8. Conducted Limits for Radio Frequency Devices calculated from FCC Part 15 Subsections 15.107(a) (b)**

**Test Procedures:** The EUT was placed on a non-metallic table, 80 cm above the ground plane inside a semi-anechoic chamber. The method of testing, test conditions, and test procedures of ANSI C63.4 were used. The EUT was powered through a 50 $\Omega$ /50 $\mu$ H LISN. An EMI receiver, connected to the measurement port of the LISN, scanned the frequency range from 150 kHz to 30 MHz in order to find the peak conducted emissions. All peak emissions within 6 dB of the limit were re-measured using a quasi-peak and/or average detector as appropriate.

**Test Results:** The EUT was compliant with the Class B requirement(s) of this section. Measured emissions were below applicable limits.

**Test Engineer(s):** Benjamin Taylor

**Test Date(s):** 08/20/14

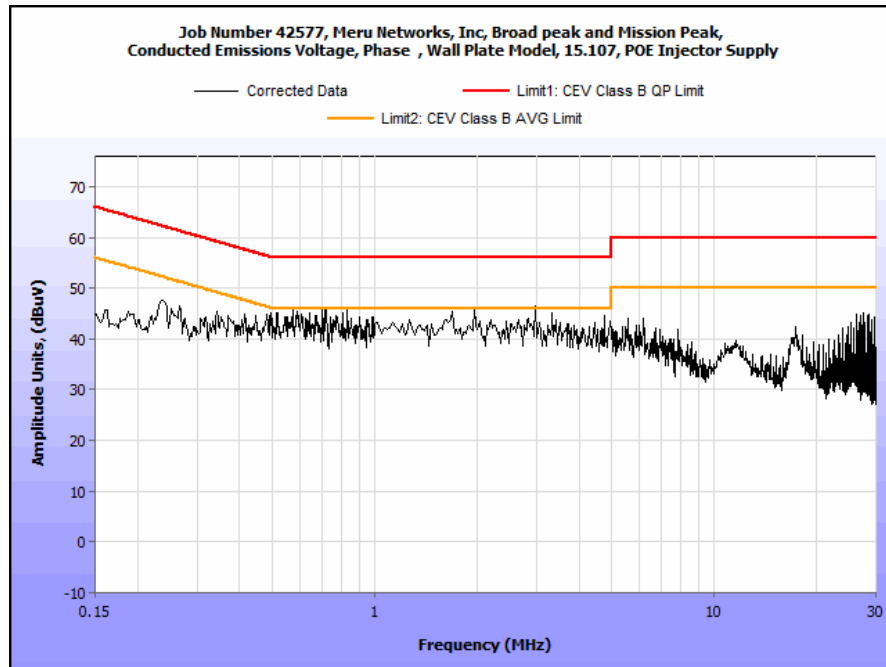




**Conducted Emissions - Voltage, AC Power, Phase Line (120 VAC, 60 Hz), PoE**

Frequency (MHz)	Uncorrected Meter Reading (dBμV) QP	Cable Loss (dB)	Corrected Measurement (dBμV) QP	Limit (dBμV) Avg.	Margin (dB) QP	Uncorrected Meter Reading (dBμV) Avg.	Cable Loss (dB)	Corrected Measurement (dBμV) Avg.	Limit (dBμV) Avg.	Margin (dB) Avg.
0.2238	37.09	0	37.09	62.68	-25.59	24.85	0	24.85	52.68	-27.83
0.34	34.48	0	34.48	59.2	-24.72	23.22	0	23.22	49.2	-25.98
0.577	33.43	0	33.43	56	-22.57	23.28	0	23.28	46	-22.72
0.8595	33.43	0	33.43	56	-22.57	17.8	0	17.8	46	-28.2
1.42	34.46	0	34.46	56	-21.54	27.56	0	27.56	46	-18.44
4.17	31.07	0.03	31.1	56	-24.9	18.22	0.03	18.25	46	-27.75

**Table 9. Conducted Emissions - Voltage, AC Power, Phase Line (120 VAC, 60 Hz), PoE**

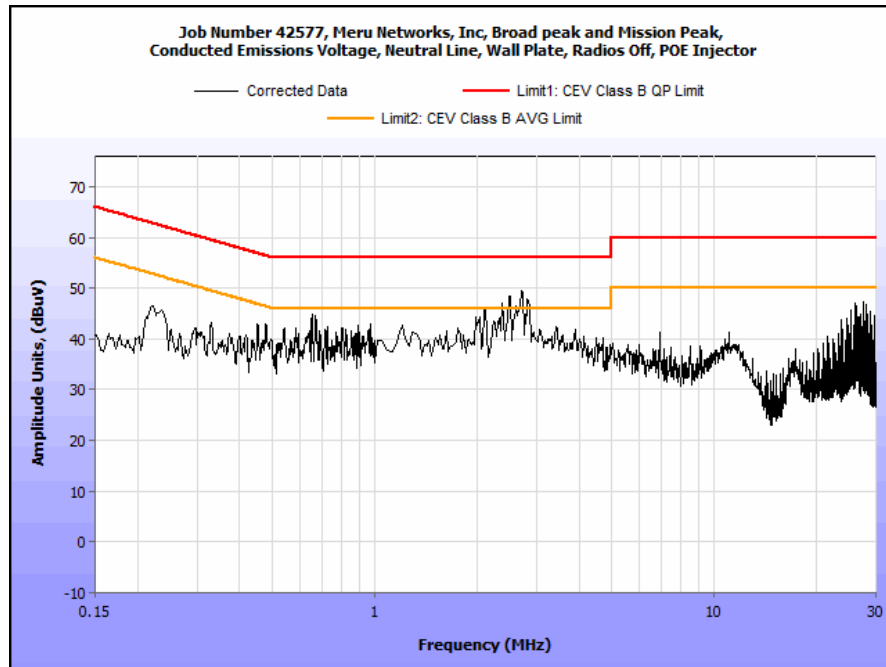


**Plot 1. Conducted Emissions, Phase Line, PoE**

**Conducted Emissions - Voltage, AC Power, Neutral Line (120 VAC, 60 Hz), PoE**

Frequency (MHz)	Uncorrected Meter Reading (dBµV) QP	Cable Loss (dB)	Corrected Measurement (dBµV) QP	Limit (dBµV) Avg.	Margin (dB) QP	Uncorrected Meter Reading (dBµV) Avg.	Cable Loss (dB)	Corrected Measurement (dBµV) Avg.	Limit (dBµV) Avg.	Margin (dB) Avg.
0.2335	42.19	0	42.19	62.32	-20.13	29.98	0	29.98	52.32	-22.34
0.384	29.43	0	29.43	58.19	-28.76	17.72	0	17.72	48.19	-30.47
0.4395	29.45	0	29.45	57.07	-27.62	17.54	0	17.54	47.07	-29.53
0.6415	29.56	0	29.56	56	-26.44	17.4	0	17.4	46	-28.6
1.58	30.02	0	30.02	56	-25.98	16.91	0	16.91	46	-29.09
26.23	43.03	0.17	43.2	60	-16.8	41.25	0.17	41.42	50	-8.58

**Table 10. Conducted Emissions - Voltage, AC Power, Neutral Line (120 VAC, 60 Hz), PoE**

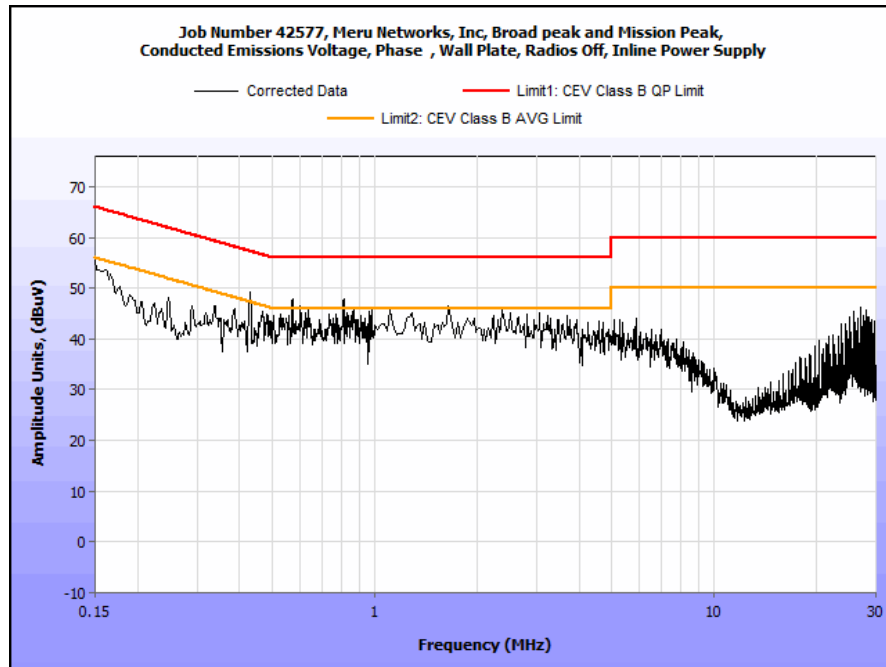


**Plot 2. Conducted Emissions, Neutral Line, PoE**

**Conducted Emissions - Voltage, AC Power, Phase Line (120 VAC, 60 Hz), AC/DC**

Frequency (MHz)	Uncorrected Meter Reading (dBµV) QP	Cable Loss (dB)	Corrected Measurement (dBµV) QP	Limit (dBµV) Avg.	Margin (dB) QP	Uncorrected Meter Reading (dBµV) Avg.	Cable Loss (dB)	Corrected Measurement (dBµV) Avg.	Limit (dBµV) Avg.	Margin (dB) Avg.
0.1508	50.55	0	50.55	64.96	-15.41	36.23	0	36.23	55.96	-19.73
0.4945	33.81	0	33.81	56.09	-22.28	20.33	0	20.33	46.09	-25.76
0.5225	33.86	0	33.86	56	-22.14	21.11	0	21.11	46	-24.89
0.7322	33.58	0	33.58	56	-22.42	23.34	0	23.34	46	-22.66
1.34	33.51	0	33.51	56	-22.49	22.6	0	22.6	46	-23.4
27.61	35.44	0.17	35.61	60	-24.39	32.62	0.17	32.79	50	-17.21

**Table 11. Conducted Emissions - Voltage, AC Power, Phase Line (120 VAC, 60 Hz), AC/DC**



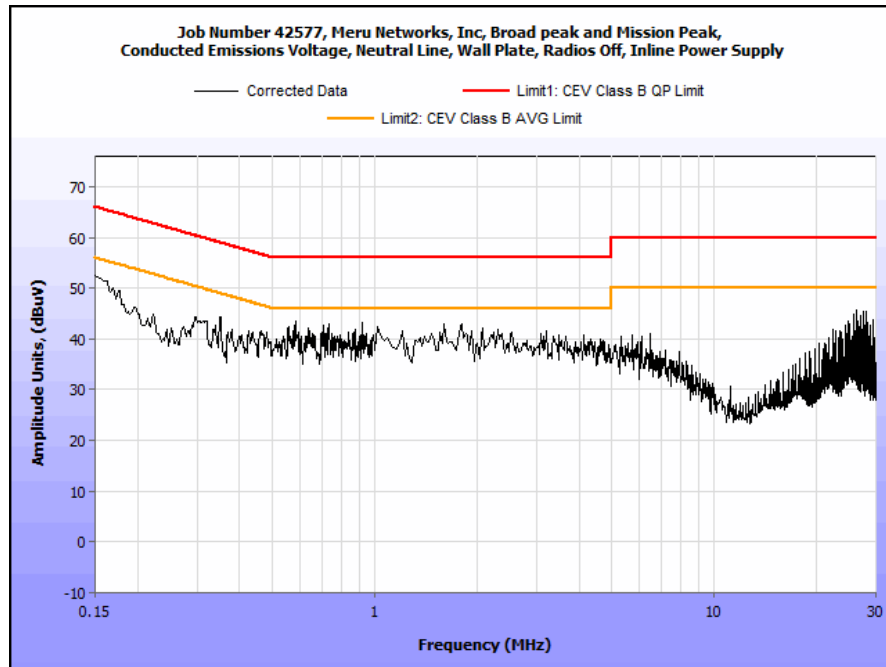
**Plot 3. Conducted Emissions, Phase Line, AC/DC**



**Conducted Emissions - Voltage, AC Power, Neutral Line (120 VAC, 60 Hz), AC/DC**

Frequency (MHz)	Uncorrected Meter Reading (dBµV) QP	Cable Loss (dB)	Corrected Measurement (dBµV) QP	Limit (dBµV) Avg.	Margin (dB) QP	Uncorrected Meter Reading (dBµV) Avg.	Cable Loss (dB)	Corrected Measurement (dBµV) Avg.	Limit (dBµV) Avg.	Margin (dB) Avg.
0.1562	48.35	0	48.35	65.66	-17.31	34.39	0	34.39	55.66	-21.27
0.304	41.643	0	41.643	60.13	-18.487	36.12	0	36.12	50.13	-14.01
0.598	31.21	0	31.21	56	-24.79	23.71	0	23.71	46	-22.29
0.704	30.95	0	30.95	56	-25.05	21.88	0	21.88	46	-24.12
1.808	30.38	0	30.38	56	-25.62	22.42	0	22.42	46	-23.58
27.61	41.82	0.17	41.99	60	-18.01	37.52	0.17	37.69	50	-12.31

**Table 12. Conducted Emissions - Voltage, AC Power, Neutral Line (120 VAC, 60 Hz), AC/DC**



**Plot 4. Conducted Emissions, Neutral Line, AC/DC**

## Radiated Emission Limits

### § 15.109 Radiated Emissions Limits

**Test Requirement(s):** **15.109 (a)** Except for Class A digital devices, the field strength of radiated emissions from unintentional radiators at a distance of 3 meters shall not exceed the Class B limits expressed in Table 13.

**15.109 (b)** The field strength of radiated emissions from a Class A digital device, as determined at a distance of 10 meters, shall not exceed the Class A limits expressed in Table 13.

Frequency (MHz)	Field Strength (dB $\mu$ V/m)	
	§15.109 (b), Class A Limit (dB $\mu$ V) @ 10m	§15.109 (a), Class B Limit (dB $\mu$ V) @ 3m
30 - 88	39.00	40.00
88 - 216	43.50	43.50
216 - 960	46.40	46.00
Above 960	49.50	54.00

**Table 13. Radiated Emissions Limits calculated from FCC Part 15, §15.109 (a) (b)**

**Test Procedures:** The EUT was placed on a non-metallic table, 80 cm above the ground plane inside a semi-anechoic chamber. The method of testing and test conditions of ANSI C63.4 were used. An antenna was located 3 m from the EUT on an adjustable mast. A pre-scan was first performed in order to find prominent radiated emissions. For final emissions measurements at each frequency of interest, the EUT was rotated and the antenna height was varied between 1 m and 4 m in order to maximize the emission. Measurements in both horizontal and vertical polarities were made and the data was recorded. Unless otherwise specified, measurements were made using a quasi-peak detector with a 120 kHz bandwidth.

**Test Results:** The EUT was compliant with the Class B requirement(s) of this section. Measured emissions were below applicable limits.

**Test Engineer(s):** Ben Taylor

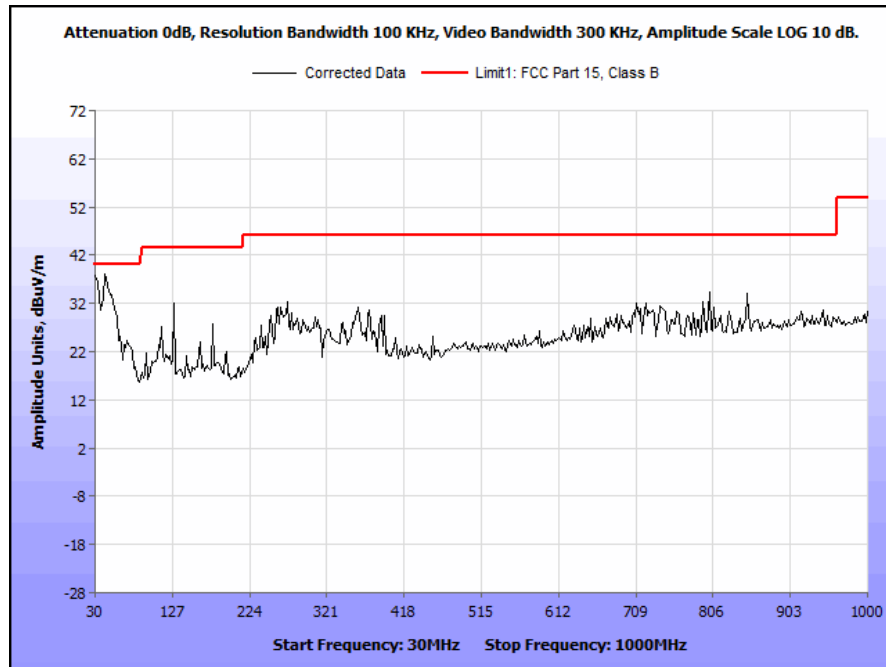
**Test Date(s):** 08/21/14



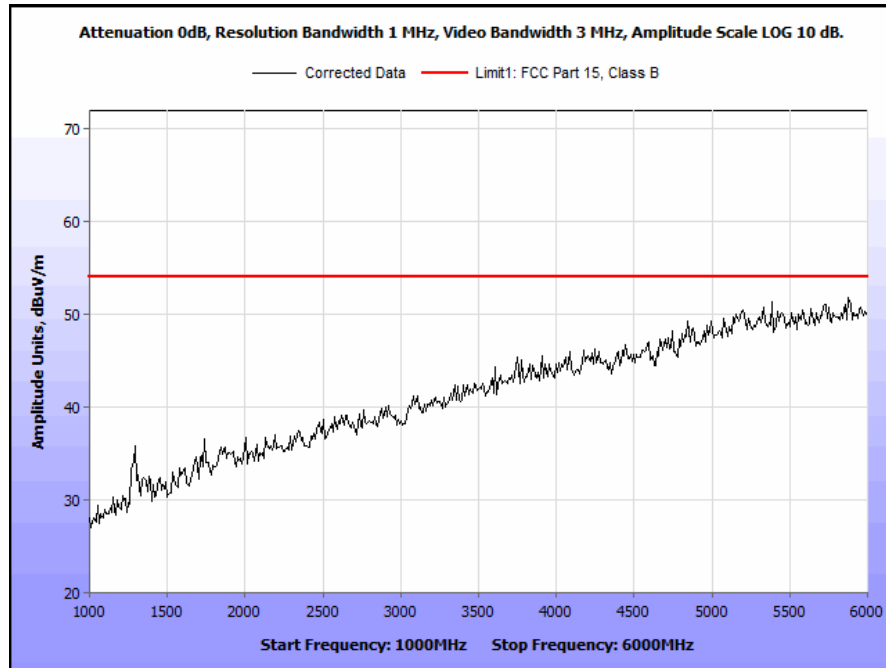
### Radiated Emissions Limits Test Results, Class B, PoE

Frequency (MHz)	EUT Azimuth (Degrees)	Antenna Polarity (H/V)	Antenna Height (m)	Uncorrected Amplitude (dBμV)	Antenna Correction Factor (dB) (+)	Cable Loss (dB) (+)	Distance Correction Factor (dB) (-)	Corrected Amplitude (dBμV/m)	Limit (dBμV/m)	Margin (dB)
49.498998	17	H	1.05	5.80	8.85	0.66	0.00	15.31	40.00	-24.69
49.498998	9	V	1.03	14.12	8.85	0.66	0.00	23.63	40.00	-16.37
129.5992	26	H	1.03	11.71	13.80	0.95	0.00	26.46	43.50	-17.04
129.5992	30	V	1.05	15.82	13.80	0.95	0.00	30.57	43.50	-12.93
257.31463	26	H	1.03	11.12	12.48	1.37	0.00	24.97	46.00	-21.03
257.31463	38	V	1.07	6.78	12.48	1.37	0.00	20.63	46.00	-25.37
359.07816	17	H	1.05	6.85	15.40	1.65	0.00	23.90	46.00	-22.10
359.07816	30	V	1.01	4.86	15.40	1.65	0.00	21.91	46.00	-24.09
737.07415	7	H	1.01	5.57	21.14	2.28	0.00	28.99	46.00	-17.01
737.07415	19	V	1.02	5.42	21.14	2.28	0.00	28.84	46.00	-17.16
817.11423	25	H	1.00	5.72	22.24	2.60	0.00	30.56	46.00	-15.44
817.11423	33	V	1.02	6.34	22.24	2.60	0.00	31.18	46.00	-14.82

Table 14. Radiated Emissions Limits, Test Results, 30 MHz – 1 GHz, PoE



Plot 5. Radiated Emissions, 30 MHz – 1 GHz, PoE



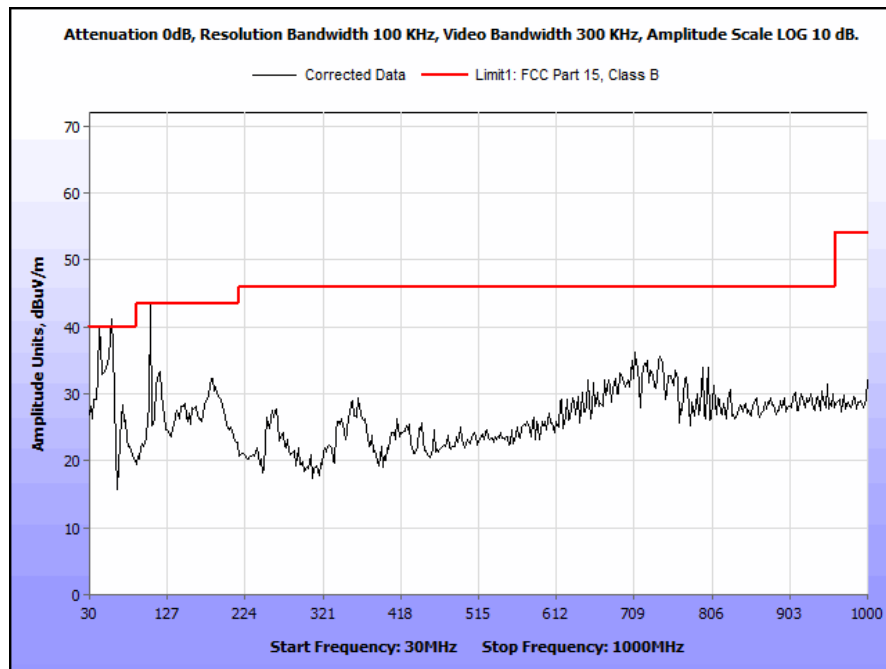
Plot 6. Radiated Emissions, 1 GHz – 6 GHz, PoE



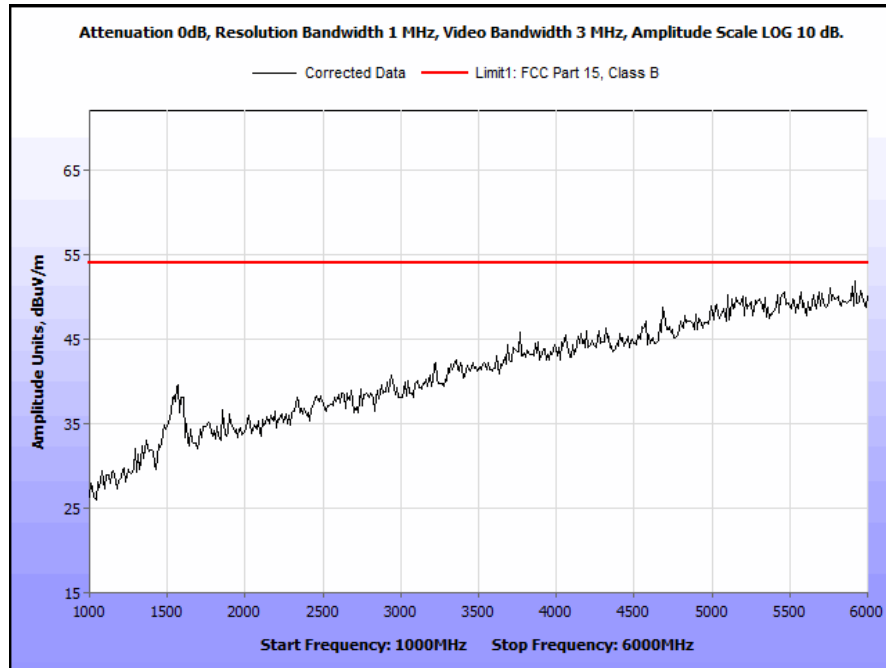
### Radiated Emissions Limits Test Results, Class B, AC/DC

Frequency (MHz)	EUT Azimuth (Degrees)	Antenna Polarity (H/V)	Antenna Height (m)	Uncorrected Amplitude (dBµV)	Antenna Correction Factor (dB) (+)	Cable Loss (dB) (+)	Distance Correction Factor (dB) (-)	Corrected Amplitude (dBµV/m)	Limit (dBµV/m)	Margin (dB)
42.825651	9	H	1.06	5.65	12.22	0.61	0.00	18.48	40.00	-21.52
42.825651	11	V	1.05	20.38	12.22	0.61	0.00	33.21	40.00	-6.79
59.960121	2	H	1.06	6.71	7.40	0.69	0.00	14.80	40.00	-25.20
59.960121	7	V	1.05	25.08	7.40	0.69	0.00	33.17	40.00	-6.83
71.193754	2	H	1.04	5.87	8.18	0.79	0.00	14.84	40.00	-25.16
71.193754	5	V	1.08	20.21	8.18	0.79	0.00	29.18	40.00	-10.82
118.32359	12	H	1.04	6.16	13.66	0.91	0.00	20.73	43.50	-22.77
118.32359	3	V	1.06	14.18	13.66	0.91	0.00	28.75	43.50	-14.75
188.31663	14	H	1.01	7.78	11.30	1.12	0.00	20.20	43.50	-23.30
188.31663	10	V	1.02	15.46	11.30	1.12	0.00	27.88	43.50	-15.62
709.31864	19	H	1.05	5.57	20.79	2.23	0.00	28.59	46.00	-17.41
709.31864	16	V	1.03	9.54	20.79	2.23	0.00	32.56	46.00	-13.44

Table 15. Radiated Emissions Limits, Test Results, 30 MHz – 1 GHz, AC/DC



Plot 7. Radiated Emissions, 30 MHz – 1 GHz, AC/DC



Plot 8. Radiated Emissions, 1 GHz – 6 GHz, AC/DC

## **IV. Electromagnetic Compatibility Criteria for Intentional Radiators**

## Electromagnetic Compatibility Criteria for Intentional Radiators

### § 15.203 Antenna Requirement

**Test Requirement:** § 15.203: An intentional radiator shall be designed to ensure that no antenna other than that furnished by the responsible party shall be used with the device. The use of a permanently attached antenna or of an antenna that uses a unique coupling to the intentional radiator shall be considered sufficient to comply with the provisions of this section. The manufacturer may design the unit so that a broken antenna can be replaced by the user, but the use of a standard antenna jack or electrical connector is prohibited.

The structure and application of the EUT were analyzed to determine compliance with Section 15.203 of the Rules. Section 15.203 states that the subject device must meet at least one of the following criteria:

- a.) Antenna must be permanently attached to the unit.
- b.) Antenna must use a unique type of connector to attach to the EUT.
- c.) Unit must be professionally installed. Installer shall be responsible for verifying that the correct antenna is employed with the unit.

**Results:** The EUT as tested is compliant the criteria of §15.203 by having internal antennas.

**Test Engineer(s):** Ben Taylor

**Test Date(s):** 08/20/14

## Electromagnetic Compatibility Criteria for Intentional Radiators

### § 15.207(a) Conducted Emissions Limits

**Test Requirement(s):** § 15.207 (a): For an intentional radiator that is designed to be connected to the public utility (AC) power line, the radio frequency voltage that is conducted back onto the AC power line on any frequency or frequencies, within the band 150 kHz to 30MHz, shall not exceed the limits in the following table, as measured using a 50  $\mu$ H/50  $\Sigma$  line impedance stabilization network (LISN). Compliance with the provisions of this paragraph shall be based on the measurement of the radio frequency voltage between each power line and ground at the power terminal. The lower limit applies at the boundary between the frequency ranges.

Frequency range (MHz)	§ 15.207(a), Conducted Limit (dB $\mu$ V)	
	Quasi-Peak	Average
* 0.15- 0.45	66 - 56	56 - 46
0.45 - 0.5	56	46
0.5 - 30	60	50

**Table 16. Conducted Limits for Intentional Radiators from FCC Part 15 § 15.207(a)**

**Test Procedure:** The EUT was placed on a 0.8 m-high wooden table inside a screen room. The EUT was situated such that the back of the EUT was 0.4 m from one wall of the vertical ground plane, and the remaining sides of the EUT were no closer than 0.8 m from any other conductive surface. The EUT was powered from a 50  $\Omega$ /50  $\mu$ H Line Impedance Stabilization Network (LISN). The EMC receiver scanned the frequency range from 150 kHz to 30 MHz. Conducted Emissions measurements were made in accordance with *ANSI C63.4-2003 "Methods and Measurements of Radio-Noise Emissions from Low-Voltage Electrical and Electronic Equipment in the Range of 9kHz to 40 GHz"*. The measurements were performed over the frequency range of 0.15 MHz to 30 MHz using a 50  $\Omega$ /50  $\mu$ H LISN as the input transducer to an EMC/field intensity meter. For the purpose of this testing, the transmitter was turned on. Scans were performed with the transmitter on.

**Test Results:** The EUT was compliant with this requirement.

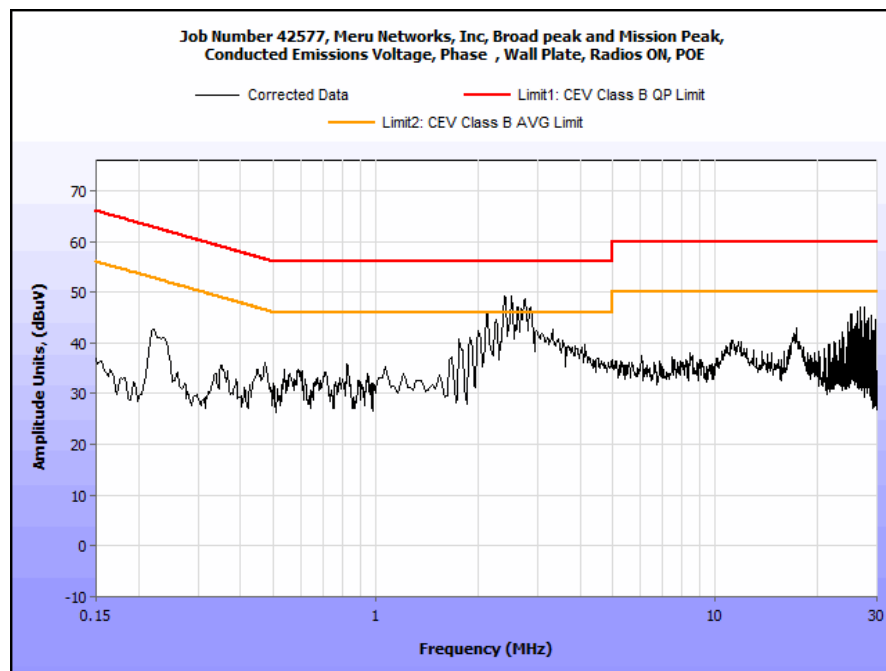
**Test Engineer(s):** Ben Taylor

**Test Date(s):** 08/21/14

**Conducted Emissions 15.207(a) - Voltage, AC Power, Phase Line (120 VAC, 60 Hz), PoE**

Frequency (MHz)	Uncorrected Meter Reading (dBμV) QP	Cable Loss (dB)	Corrected Measurement (dBμV) QP	Limit (dBμV) QP	Margin (dB) QP	Uncorrected Meter Reading (dBμV) Avg.	Cable Loss (dB)	Corrected Measurement (dBμV) Avg.	Limit (dBμV) Avg.	Margin (dB) Avg.
0.2365	39.51	0	39.51	62.22	-22.71	34.9	0	34.9	52.22	-17.32
0.4725	33.1	0	33.1	56.47	-23.37	30.8	0	30.8	46.47	-15.67
1.893	34.07	0	34.07	56	-21.93	23.18	0	23.18	46	-22.82
2.502	45.88	0	45.88	56	-10.12	33.03	0	33.03	46	-12.97
17.43	34.97	0	34.97	60	-25.03	25.83	0	25.83	50	-24.17
27.6	44.67	0.17	44.84	60	-15.16	41.93	0.17	42.1	50	-7.9

**Table 17. Conducted Emissions - Voltage, AC Power, 15.207(a), Phase Line (120 VAC, 60 Hz), PoE**

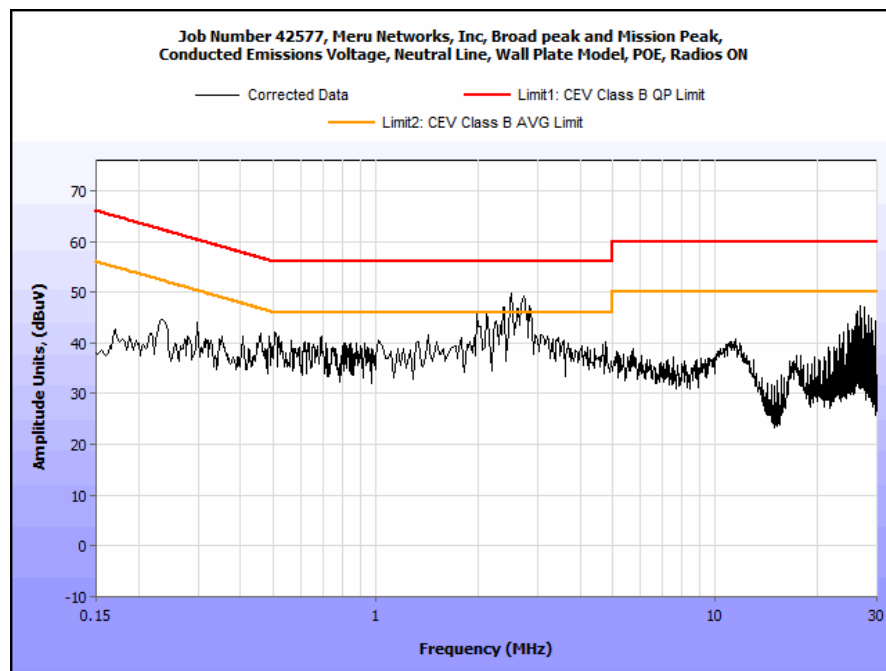


**Plot 9. Conducted Emissions, 15.207(a), Phase Line, PoE**

**Conducted Emissions 15.207(a) - Voltage, AC Power, Neutral Line (120 VAC, 60 Hz), PoE**

Frequency (MHz)	Uncorrected Meter Reading (dB $\mu$ V) QP	Cable Loss (dB)	Corrected Measurement (dB $\mu$ V) QP	Limit (dB $\mu$ V) QP	Margin (dB) QP	Uncorrected Meter Reading (dB $\mu$ V) Avg.	Cable Loss (dB)	Corrected Measurement (dB $\mu$ V) Avg.	Limit (dB $\mu$ V) Avg.	Margin (dB) Avg.
0.234	39.12	0	39.12	62.31	-23.19	26.5	0	26.5	52.31	-25.81
0.283	28.73	0	28.73	60.73	-32	17.9	0	17.9	50.73	-32.83
0.636	28.81	0	28.81	56	-27.19	18	0	18	46	-28
1.885	35.64	0	35.64	56	-20.36	25.85	0	25.85	46	-20.15
2.51	45.5	0	45.5	56	-10.5	36.52	0	36.52	46	-9.48
27.61	43.3	0.17	43.47	60	-16.53	38.81	0.17	38.98	50	-11.02

**Table 18. Conducted Emissions - Voltage, AC Power, 15.207(a), Neutral Line (120 VAC, 60 Hz), PoE**



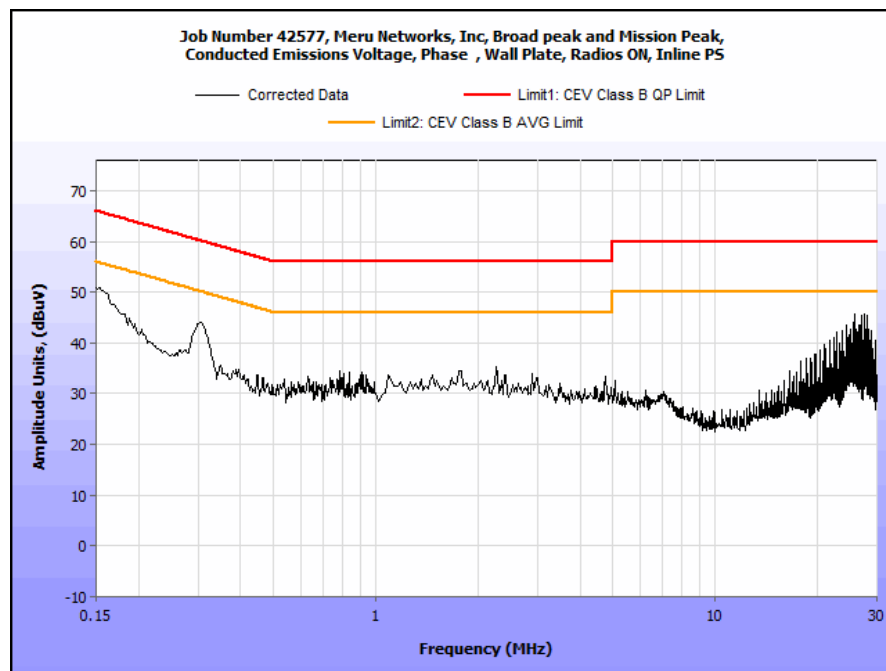
**Plot 10. Conducted Emissions, 15.207(a), Neutral Line, PoE**



**Conducted Emissions 15.207(a) - Voltage, AC Power, Phase Line (120 VAC, 60 Hz), AC/DC**

Frequency (MHz)	Uncorrected Meter Reading (dBμV) QP	Cable Loss (dB)	Corrected Measurement (dBμV) QP	Limit (dBμV) QP	Margin (dB) QP	Uncorrected Meter Reading (dBμV) Avg.	Cable Loss (dB)	Corrected Measurement (dBμV) Avg.	Limit (dBμV) Avg.	Margin (dB) Avg.
0.153	48.21	0	48.21	79	-30.79	34.76	0	34.76	66	-31.24
0.3045	42.25	0	42.25	79	-36.75	36.15	0	36.15	66	-29.85
0.59	26.84	0	26.84	73	-46.16	21.94	0	21.94	60	-38.06
1.995	26.9	0	26.9	73	-46.1	21.6	0	21.6	60	-38.4
2.038	27.18	0	27.18	73	-45.82	21.82	0	21.82	60	-38.18
27.6	42.56	0.17	42.73	73	-30.27	39.31	0.17	39.48	60	-20.52

**Table 19. Conducted Emissions - Voltage, AC Power, 15.207(a), Phase Line (120 VAC, 60 Hz), AC/DC**

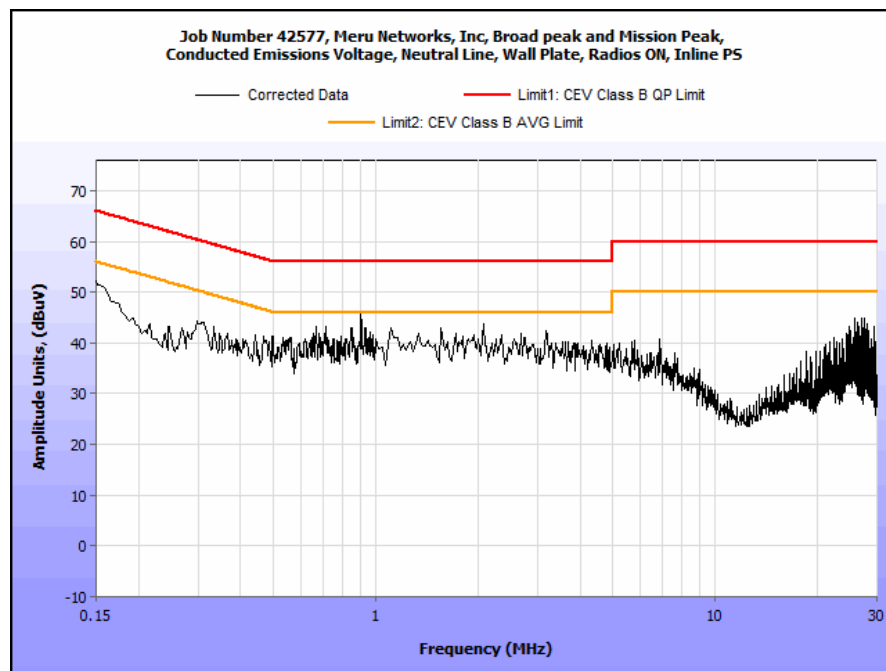


**Plot 11. Conducted Emissions, 15.207(a), Phase Line, AC/DC**

**Conducted Emissions 15.207(a) - Voltage, AC Power, Neutral Line (120 VAC, 60 Hz), AC/DC**

Frequency (MHz)	Uncorrected Meter Reading (dBμV) QP	Cable Loss (dB)	Corrected Measurement (dBμV) QP	Limit (dBμV) QP	Margin (dB) QP	Uncorrected Meter Reading (dBμV) Avg.	Cable Loss (dB)	Corrected Measurement (dBμV) Avg.	Limit (dBμV) Avg.	Margin (dB) Avg.
0.1664	45.2	0	45.2	79	-33.8	32.8	0	32.8	66	-33.2
0.3085	42.03	0	42.03	79	-36.97	36.41	0	36.41	66	-29.59
0.6168	31.1	0	31.1	73	-41.9	23.69	0	23.69	60	-36.31
0.8978	30.98	0	30.98	73	-42.02	24.07	0	24.07	60	-35.93
1.637	30.37	0	30.37	73	-42.63	22.78	0	22.78	60	-37.22
27.61	41.95	0.17	42.12	73	-30.88	38.15	0.17	38.32	60	-21.68

**Table 20. Conducted Emissions - Voltage, AC Power, 15.207(a), Neutral Line (120 VAC, 60 Hz), AC/DC**



**Plot 12. Conducted Emissions, 15.207(a), Neutral Line, AC/DC**

## Electromagnetic Compatibility Criteria for Intentional Radiators

### § 15.247(a)(2) 6 dB and 99% Bandwidth

**Test Requirements:** § 15.247(a)(2): Operation under the provisions of this section is limited to frequency hopping and digitally modulated intentional radiators that comply with the following provisions:

For systems using digital modulation techniques, the EUT may operate in the 902-928 MHz, 2400-2483.5 MHz and 5725-5850 MHz bands. The minimum 6dB bandwidth shall be at least 500 kHz.

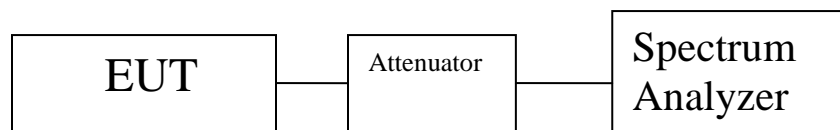
**Test Procedure:** The transmitter was on and transmitting at the highest output power. The bandwidth of the fundamental frequency was measured with the spectrum analyzer using a RBW approximately 1% of the total emission bandwidth, VBW > RBW. The 6 dB Bandwidth was measured and recorded. The measurements were performed on the low, mid and high channels.

**Test Results** The EUT was compliant with § 15.247 (a)(2).

The 6 dB and 99% Bandwidth was determined from the plots on the following pages.

**Test Engineer(s):** Andy Shen

**Test Date(s):** 07/26/14



**Figure 2. Block Diagram, Occupied Bandwidth Test Setup**

### Occupied Bandwidth Test Results

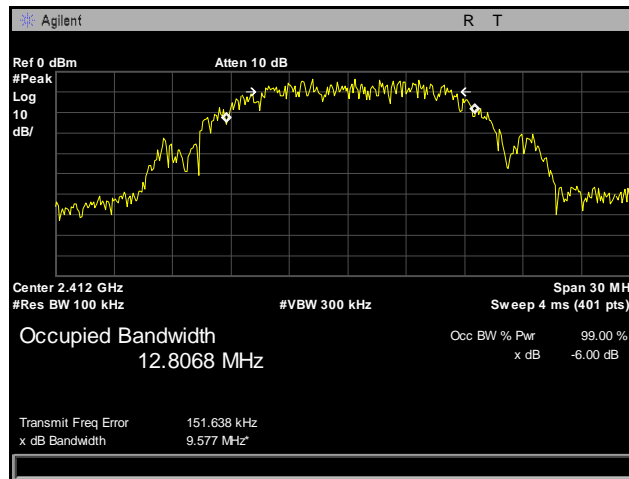
Occupied Bandwidth			
	Carrier Channel	Frequency (MHz)	Measured 6 dB Bandwidth (MHz)
802.11b	Low	2412	12.806
	Mid	2437	12.666
	High	2462	12.751
802.11g	Low	2412	16.408
	Mid	2437	16.437
	High	2462	16.446
802.11n 20 MHz Port 1	Low	2412	17.577
	Mid	2437	17.637
	High	2462	17.631
802.11n 20 MHz Port 2	Low	2412	17.611
	Mid	2437	17.620
	High	2462	17.641
802.11n 40 MHz Port 1	Low	2422	35.683
	Mid	2437	35.965
	High	2452	36.225
802.11n 40 MHz Port 2	Low	2422	35.792
	Mid	2437	35.941
	High	2452	36.239

Table 21. 6 dB Occupied Bandwidth, Test Results, 2.4 GHz

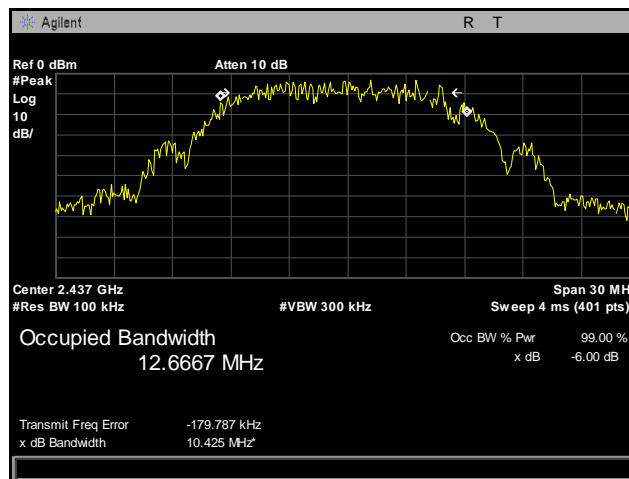
Occupied Bandwidth			
	Carrier Channel	Frequency (MHz)	Measured 6 dB Bandwidth (MHz)
802.11b	Low	2412	13.1701
	Mid	2437	13.171
	High	2462	13.2097
802.11g	Low	2412	16.7061
	Mid	2437	16.7268
	High	2462	16.7102
802.11n 20 MHz Port 1	Low	2412	17.8129
	Mid	2437	17.8044
	High	2462	17.855
802.11n 20 MHz Port 2	Low	2412	17.6712
	Mid	2437	17.7314
	High	2462	17.7856
802.11n 40 MHz Port 1	Low	2422	36.0937
	Mid	2437	36.3668
	High	2452	36.7825
802.11n 40 MHz Port 2	Low	2422	36.1265
	Mid	2437	36.4717
	High	2452	36.8336

Table 22. 99% Occupied Bandwidth, Test Results, 2.4 GHz

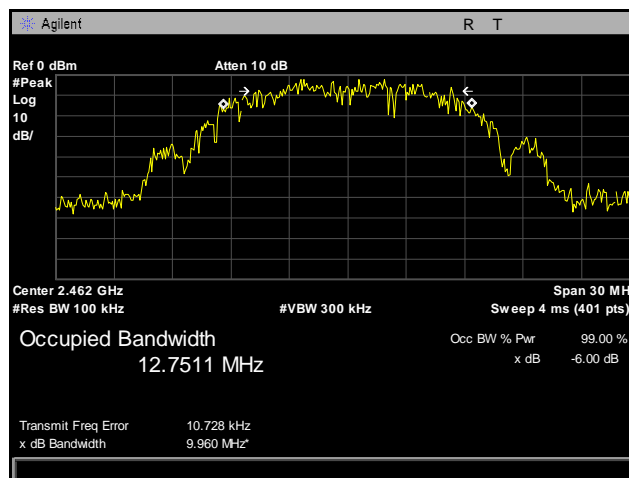
**6 dB Occupied Bandwidth Test Results, 2.4 GHz, 802.11b**



**Plot 13. 6 dB Occupied Bandwidth, Low Channel, 2412 MHz, 802.11b**

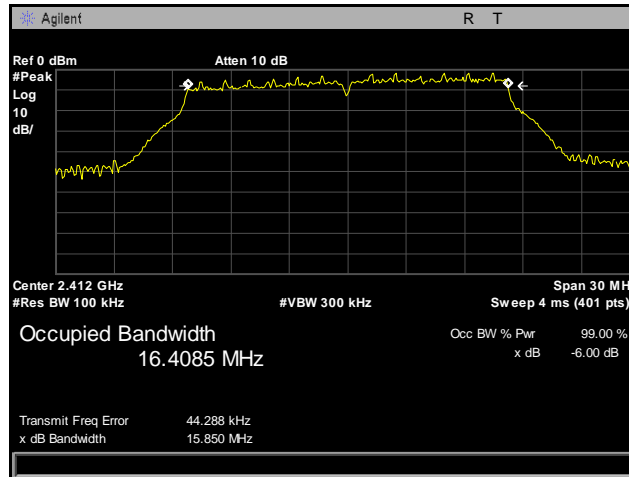


**Plot 14. 6 dB Occupied Bandwidth, Mid Channel, 2437 MHz, 802.11b**

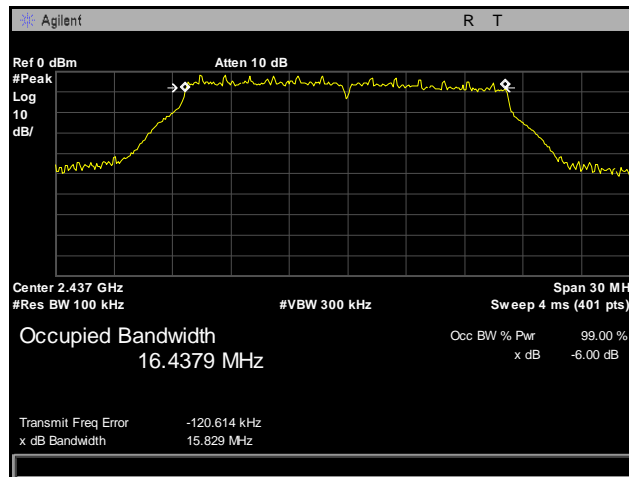


**Plot 15. 6 dB Occupied Bandwidth, High Channel, 2462 MHz, 802.11b**

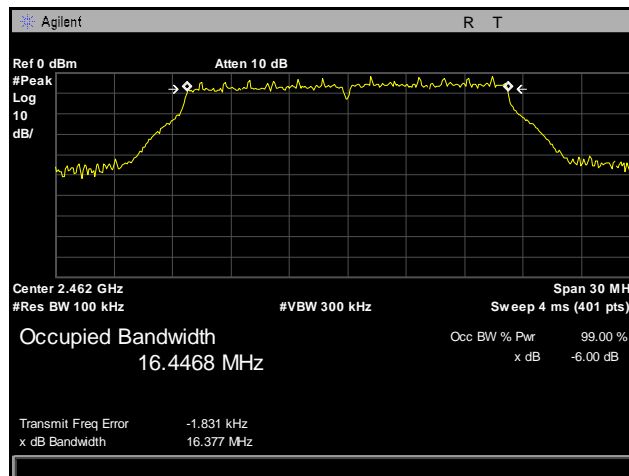
### 6 dB Occupied Bandwidth Test Results, 2.4 GHz, 802.11g



Plot 16. 6 dB Occupied Bandwidth, Low Channel, 2412 MHz, 802.11g

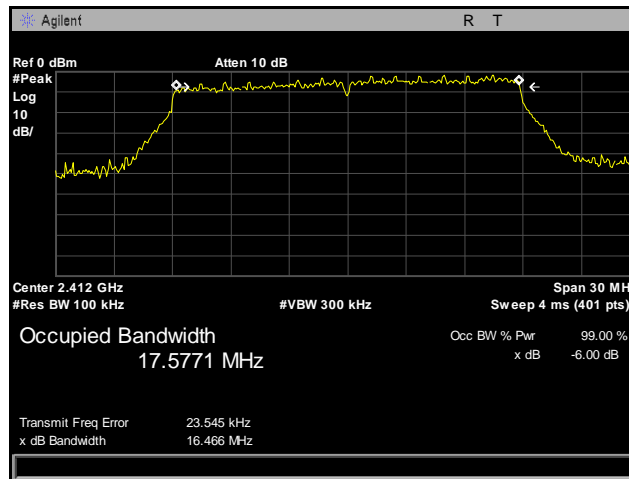


Plot 17. 6 dB Occupied Bandwidth, Mid Channel, 2437 MHz, 802.11g

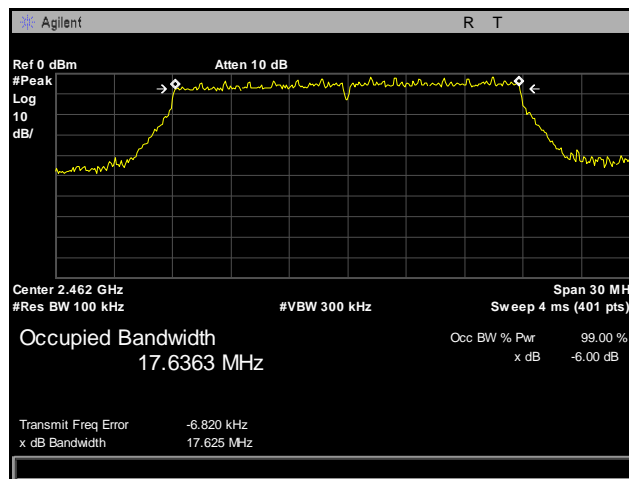


Plot 18. 6 dB Occupied Bandwidth, High Channel, 2462 MHz, 802.11g

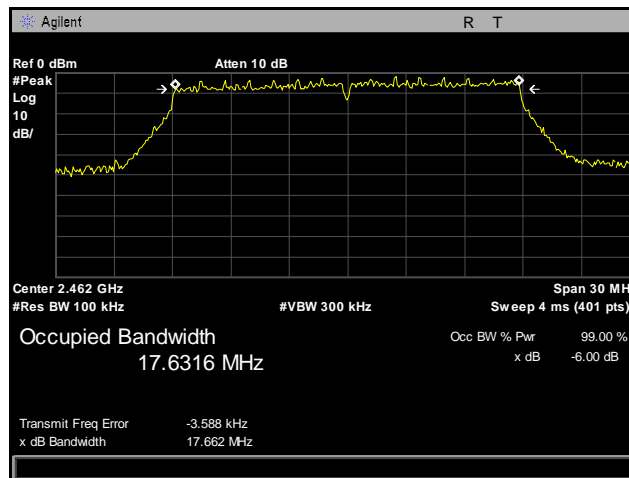
**6 dB Occupied Bandwidth Test Results, 2.4 GHz, 802.11n 20 MHz, Port 1**



**Plot 19. 6 dB Occupied Bandwidth, Low Channel, 2412 MHz, 802.11n 20 MHz, Port 1**

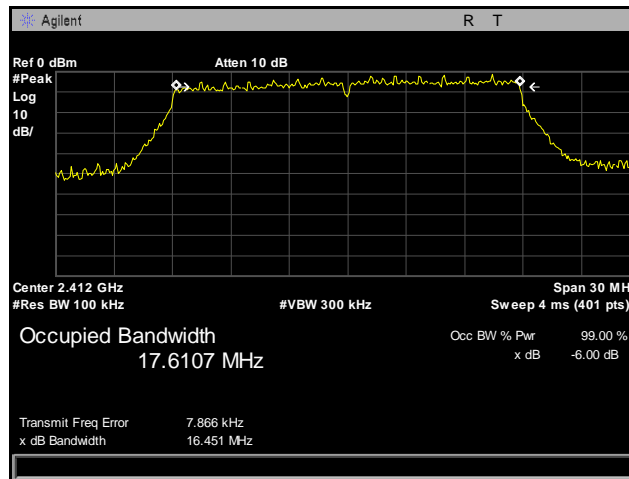


**Plot 20. 6 dB Occupied Bandwidth, Mid Channel, 2437 MHz, 802.11n 20 MHz, Port 1**

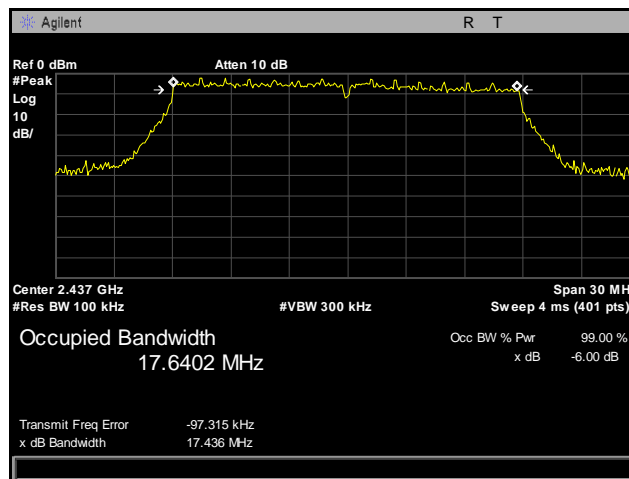


**Plot 21. 6 dB Occupied Bandwidth, High Channel, 2462 MHz, 802.11n 20 MHz, Port 1**

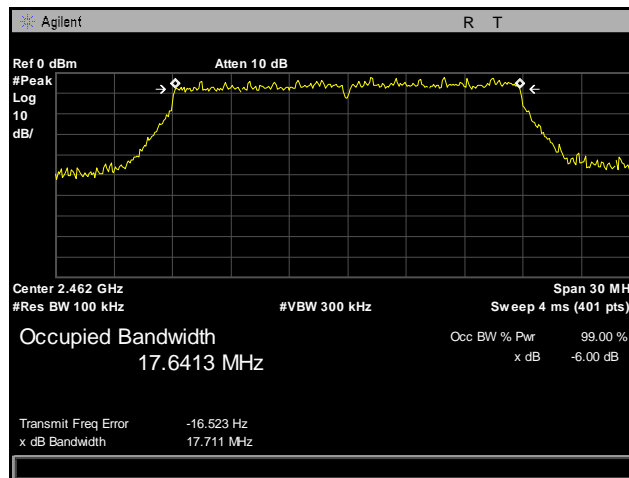
### 6 dB Occupied Bandwidth Test Results, 2.4 GHz, 802.11n 20 MHz, Port 2



Plot 22. 6 dB Occupied Bandwidth, Low Channel, 2412 MHz, 802.11n 20 MHz, Port 2



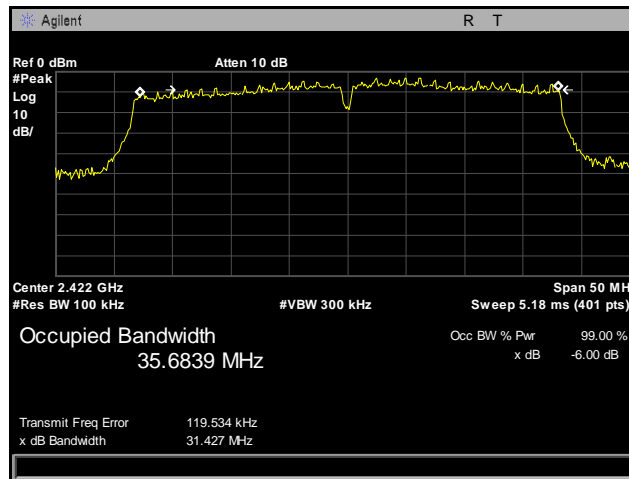
Plot 23. 6 dB Occupied Bandwidth, Mid Channel, 2437 MHz, 802.11n 20 MHz, Port 2



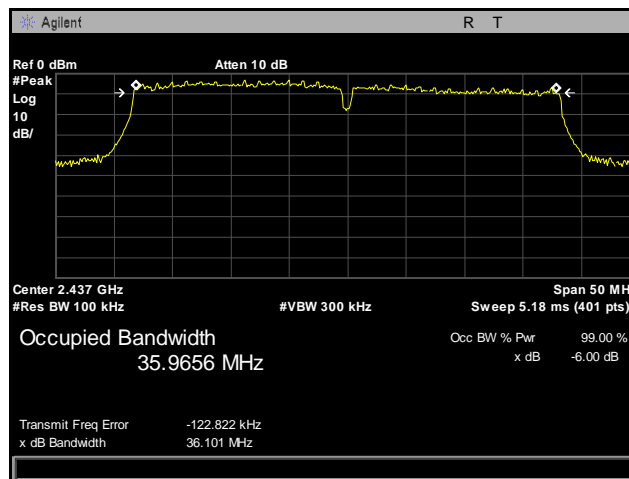
Plot 24. 6 dB Occupied Bandwidth, High Channel, 2462 MHz, 802.11n 20 MHz, Port 2



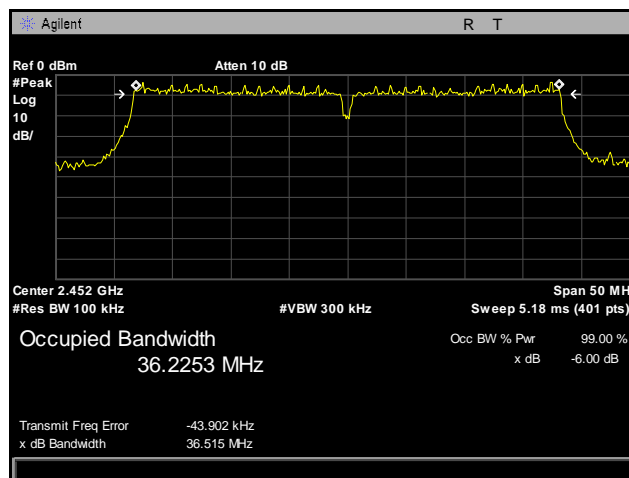
### 6 dB Occupied Bandwidth Test Results, 2.4 GHz, 802.11n 40 MHz, Port 1



Plot 25. 6 dB Occupied Bandwidth, Low Channel, 2422 MHz, 802.11n 40 MHz, Port 1

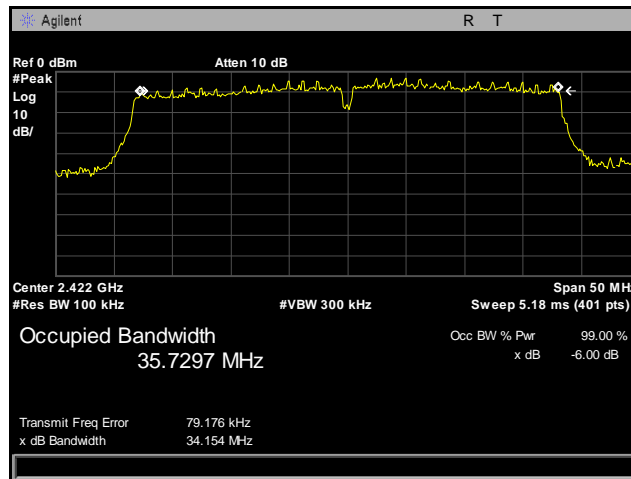


Plot 26. 6 dB Occupied Bandwidth, Mid Channel, 2437 MHz, 802.11n 40 MHz, Port 1

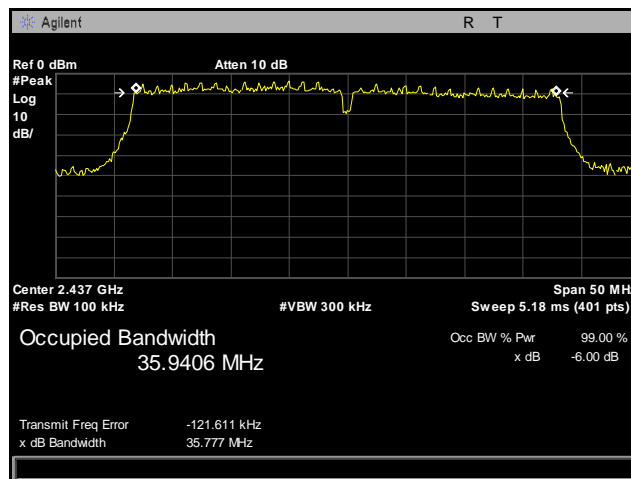


Plot 27. 6 dB Occupied Bandwidth, High Channel, 2452 MHz, 802.11n 40 MHz, Port 1

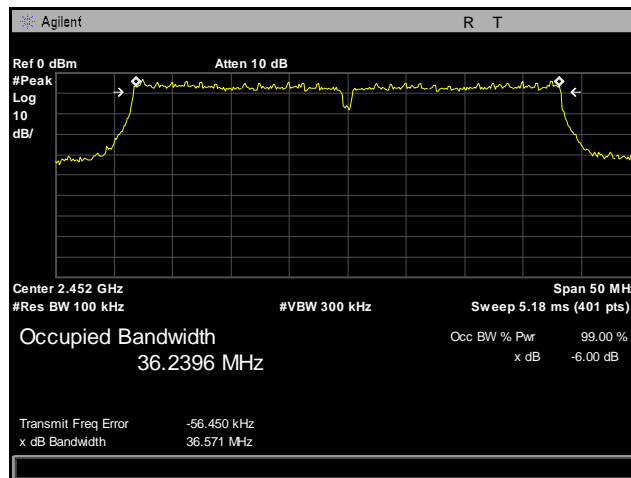
**6 dB Occupied Bandwidth Test Results, 2.4 GHz, 802.11n 40 MHz, Port 2**



**Plot 28. 6 dB Occupied Bandwidth, Low Channel, 2422 MHz, 802.11n 40 MHz, Port 2**

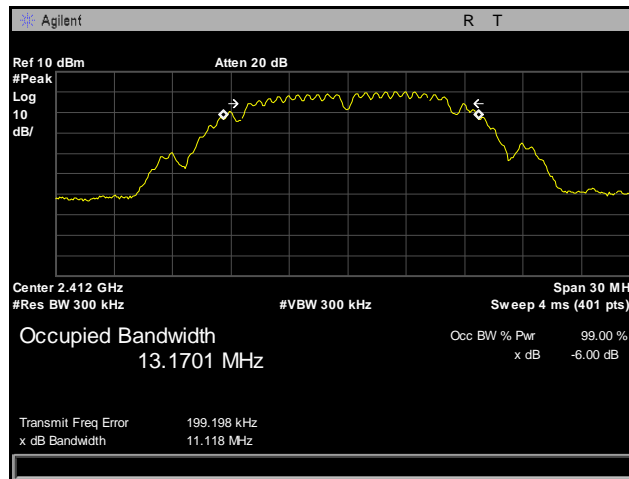


**Plot 29. 6 dB Occupied Bandwidth, Mid Channel, 2437 MHz, 802.11n 40 MHz, Port 2**

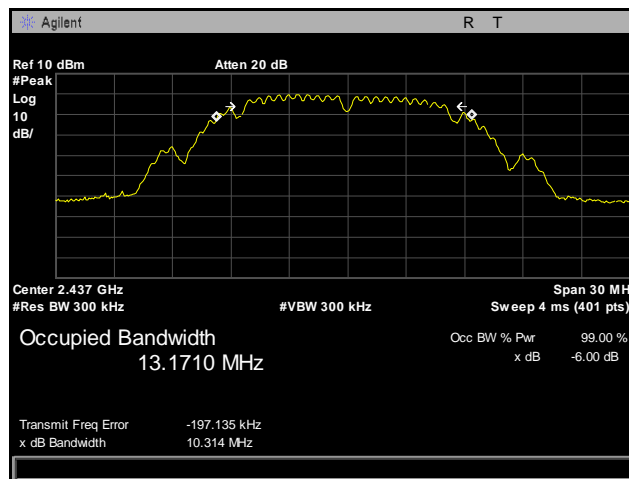


**Plot 30. 6 dB Occupied Bandwidth, High Channel, 2452 MHz, 802.11n 40 MHz, Port 2**

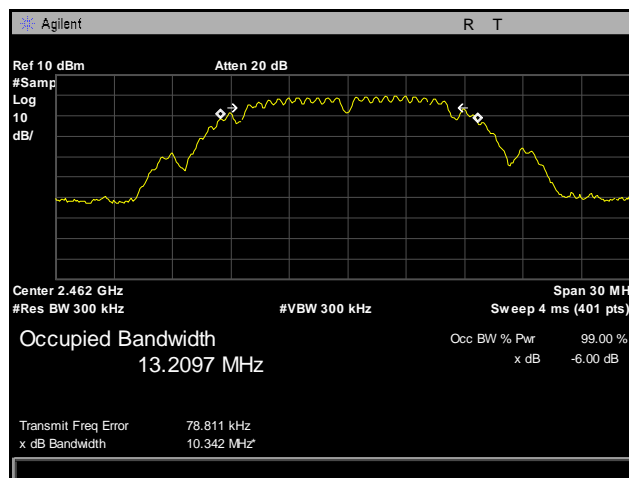
### 99% Occupied Bandwidth Test Results, 2.4 GHz, 802.11b



Plot 31. 99% Occupied Bandwidth, Low Channel, 2412 MHz, 802.11b

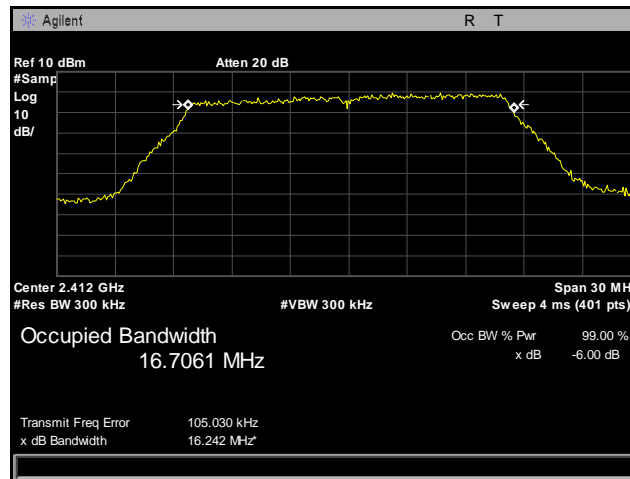


Plot 32. 99% Occupied Bandwidth, Mid Channel, 2437 MHz, 802.11b

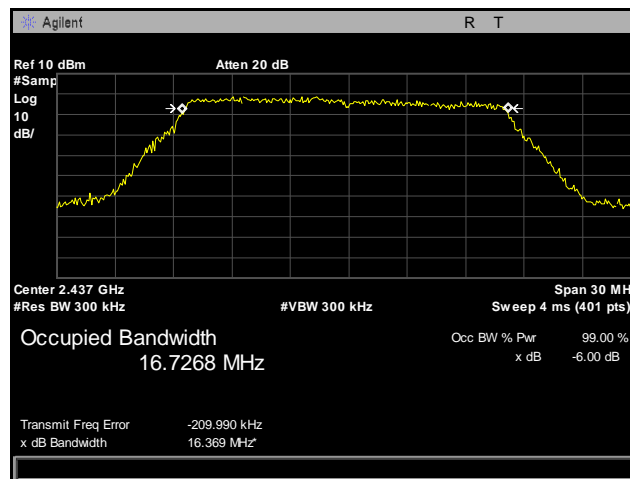


Plot 33. 99% Occupied Bandwidth, High Channel, 2462 MHz, 802.11b

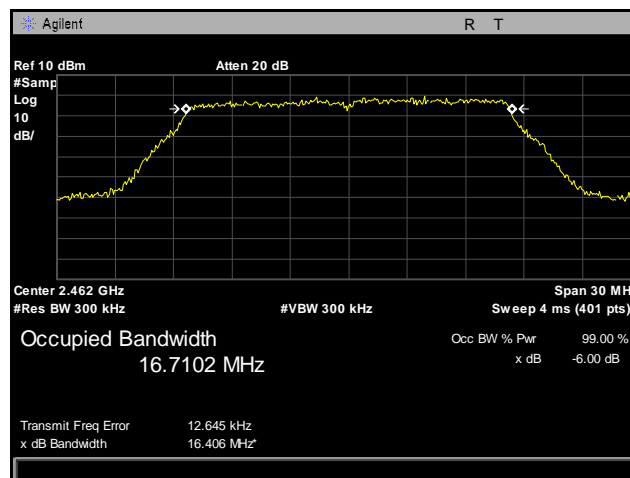
### 99% Occupied Bandwidth Test Results, 2.4 GHz, 802.11g



Plot 34. 99% Occupied Bandwidth, Low Channel, 2412 MHz, 802.11g

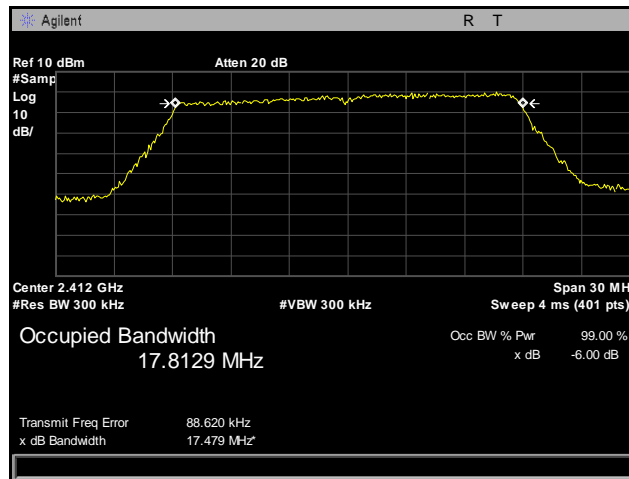


Plot 35. 99% Occupied Bandwidth, Mid Channel, 2437 MHz, 802.11g

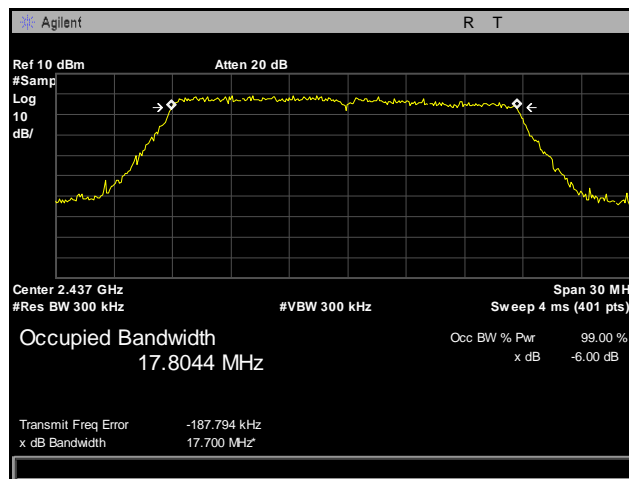


Plot 36. 99% Occupied Bandwidth, High Channel, 2462 MHz, 802.11g

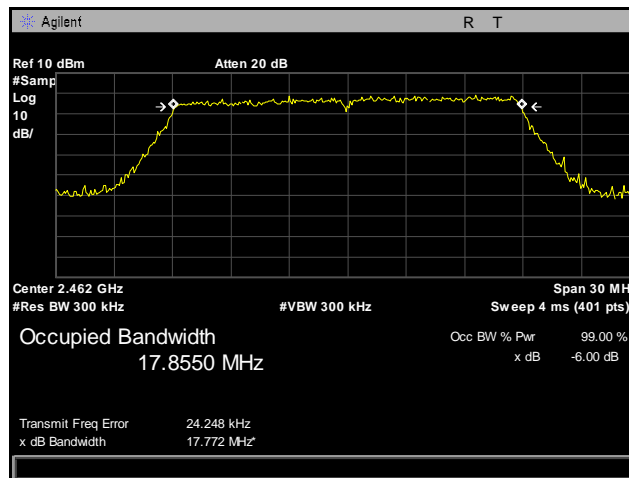
**99% Occupied Bandwidth Test Results, 2.4 GHz, 802.11n 20 MHz, Port 1**



**Plot 37. 99% Occupied Bandwidth, Low Channel, 2412 MHz, 802.11n 20 MHz, Port 1**

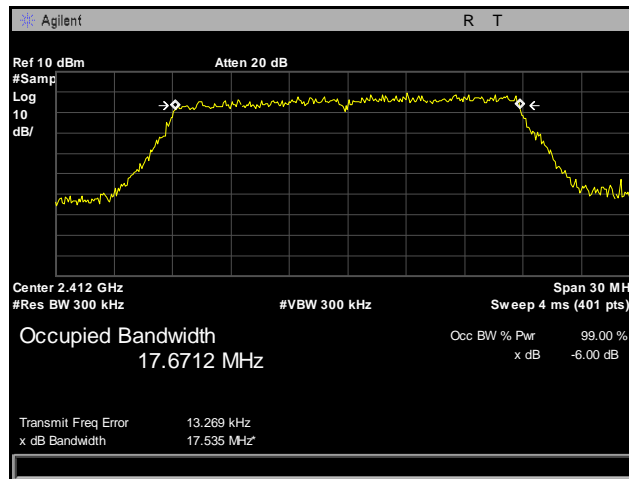


**Plot 38. 99% Occupied Bandwidth, Mid Channel, 2437 MHz, 802.11n 20 MHz, Port 1**

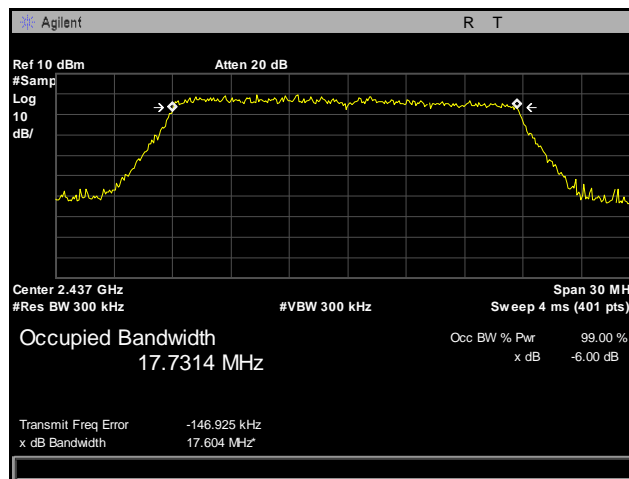


**Plot 39. 99% Occupied Bandwidth, High Channel, 2462 MHz, 802.11n 20 MHz, Port 1**

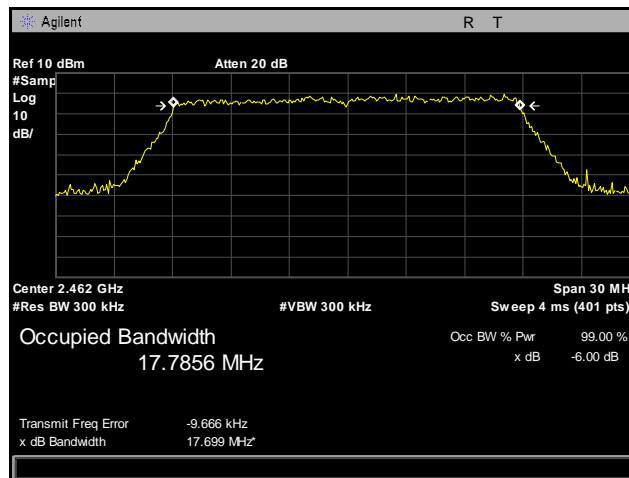
**99% Occupied Bandwidth Test Results, 2.4 GHz, 802.11n 20 MHz, Port 2**



**Plot 40. 99% Occupied Bandwidth, Low Channel, 2412 MHz, 802.11n 20 MHz, Port 2**

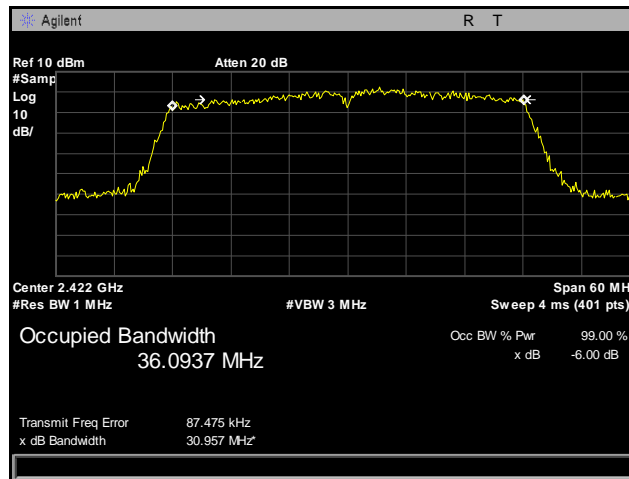


**Plot 41. 99% Occupied Bandwidth, Mid Channel, 2437 MHz, 802.11n 20 MHz, Port 2**

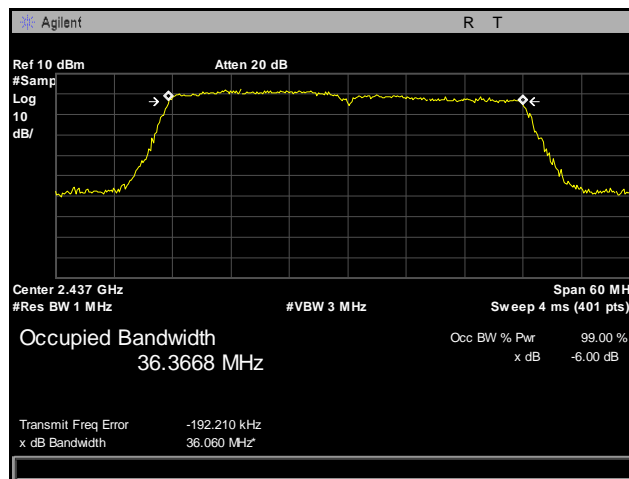


**Plot 42. 99% Occupied Bandwidth, High Channel, 2462 MHz, 802.11n 20 MHz, Port 2**

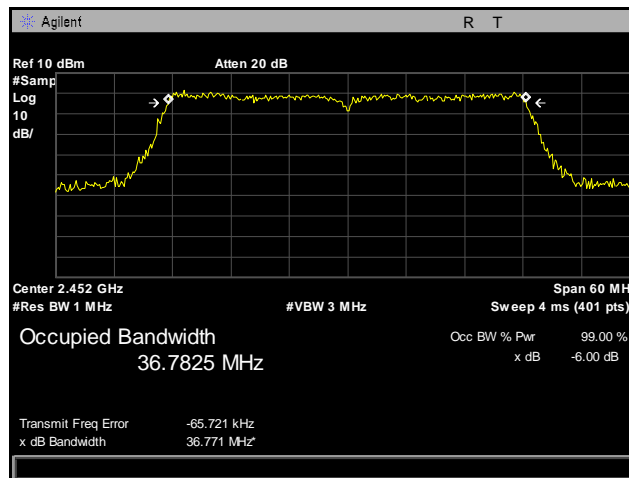
**99% Occupied Bandwidth Test Results, 2.4 GHz, 802.11n 40 MHz, Port 1**



**Plot 43. 99% Occupied Bandwidth, Low Channel, 2422 MHz, 802.11n 40 MHz, Port 1**

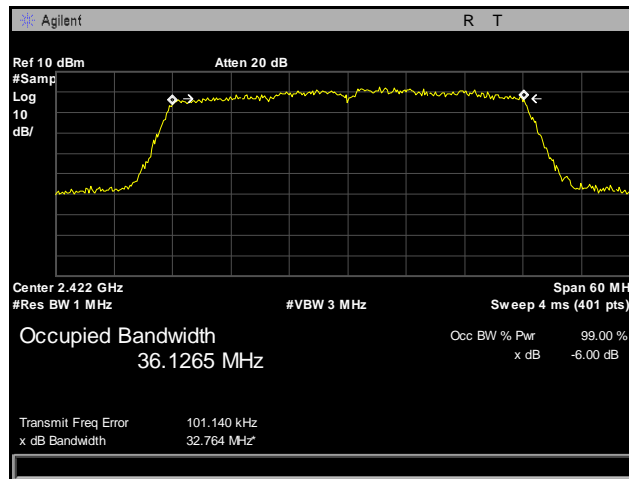


**Plot 44. 99% Occupied Bandwidth, Mid Channel, 2437 MHz, 802.11n 40 MHz, Port 1**

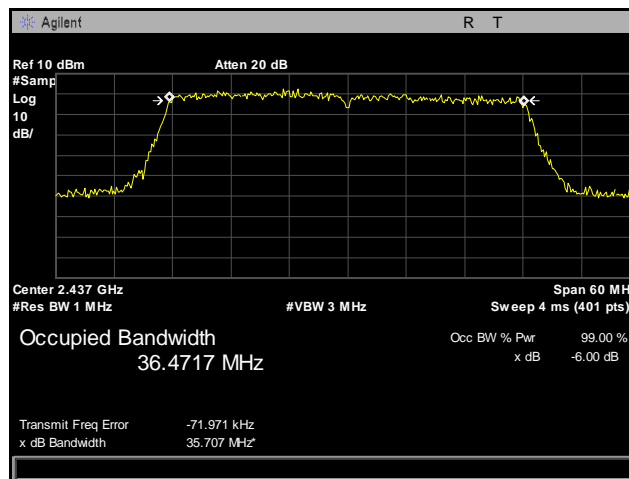


**Plot 45. 99% Occupied Bandwidth, High Channel, 2452 MHz, 802.11n 40 MHz, Port 1**

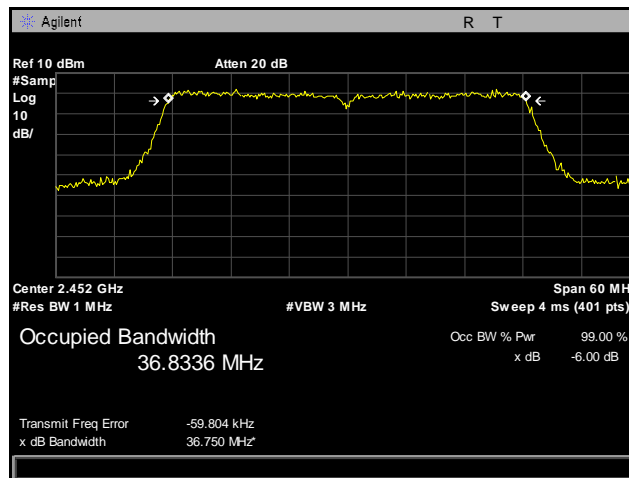
**99% Occupied Bandwidth Test Results, 2.4 GHz, 802.11n 40 MHz, Port 2**



**Plot 46. 99% Occupied Bandwidth, Low Channel, 2422 MHz, 802.11n 40 MHz, Port 2**



**Plot 47. 99% Occupied Bandwidth, Mid Channel, 2437 MHz, 802.11n 40 MHz, Port 2**



**Plot 48. 99% Occupied Bandwidth, High Channel, 2452 MHz, 802.11n 40 MHz, Port 2**



## Electromagnetic Compatibility Criteria for Intentional Radiators

### § 15.247(b) Peak Power Output

**Test Requirements:** §15.247(b): The maximum peak output power of the intentional radiator shall not exceed the following:

Digital Transmission Systems (MHz)	Output Limit (Watts)
902-928	1.000
2400-2483.5	1.000
5725- 5850	1.000

**Table 23. Output Power Requirements from §15.247(b)**

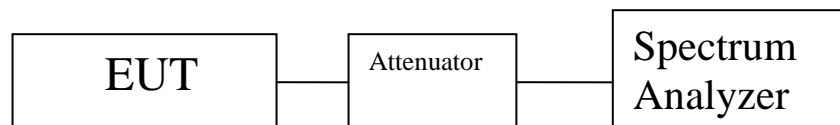
§15.247(b)(4): The conducted output power limit specified in paragraph (b) of this section is based on the use of antennas with directional gains that do not exceed 6 dBi. Except as shown in paragraph (c) of this section, if transmitting antennas of directional gain greater than 6 dBi are used, the conducted output power from the intentional radiator shall be reduced below the stated values in paragraphs (b)(1), (b)(2), and (b)(3) of this section, as appropriate, by the amount in dB that the directional gain of the antenna exceeds 6 dBi.

**Test Procedure:** The transmitter was connected to a calibrated spectrum analyzer. The EUT was measured at the low, mid and high channels of each band at the maximum power level.

**Test Results:** The EUT was compliant with the Peak Power Output limits of §15.247(b).

**Test Engineer(s):** Andy Shen

**Test Date(s):** 09/04/14



**Figure 3. Peak Power Output Test Setup**

## Peak Power Output Test Results

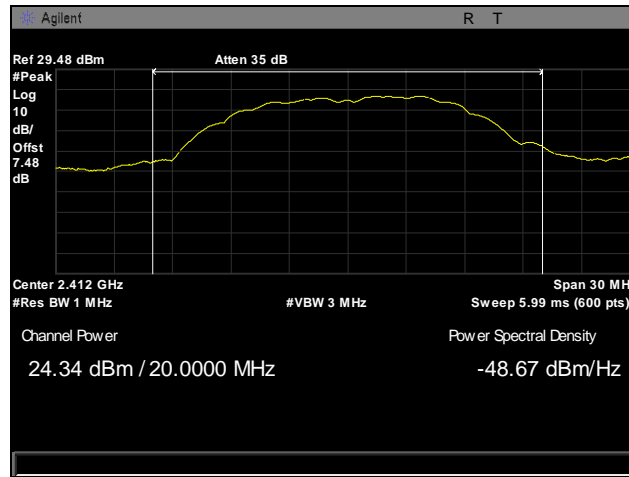
Peak Conducted Output Power			
	Channel	Frequency (MHz)	Measured Peak Output Power (dBm)
802.11b	Low	2412	24.34
	Mid	2437	24.85
	High	2462	24.45
802.11g	Low	2412	24.13
	Mid	2437	26.18
	High	2462	23.08
802.11n 20 MHz Port 1	Low	2412	22.96
	Mid	2437	25.90
	High	2462	22.26
802.11n 20 MHz Port 2	Low	2412	22.33
	Mid	2437	26.68
	High	2462	22.23
802.11n 40 MHz Port 1	Low	2422	22.02
	Mid	2437	26.38
	High	2452	20.85
802.11n 40 MHz Port 2	Low	2422	21.86
	Mid	2437	25.92
	High	2452	21.08

**Table 24. Peak Power Output, Test Results, 2.4 GHz**

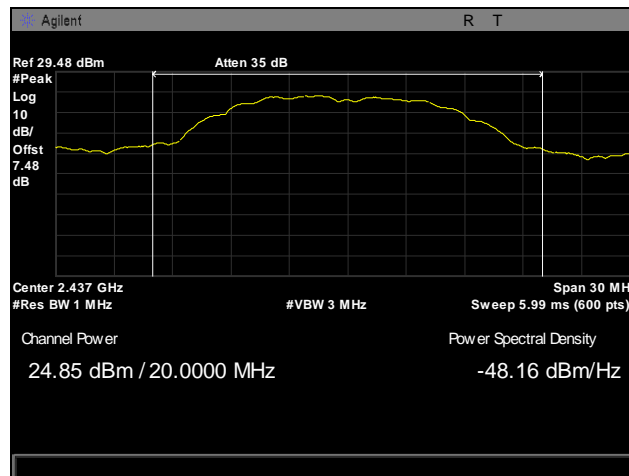
Summed Peak Conducted Output Power			
	Carrier	Frequency	Measured Peak Output Power
802.11n 20 MHz Summed	Low	2412	25.67
	Mid	2437	29.32
	High	2462	28.02
802.11n 40 MHz Summed	Low	2422	24.95
	Mid	2437	29.17
	High	2452	23.98

**Table 25. Peak Power Output, Test Results, 2.4 GHz, Summed**

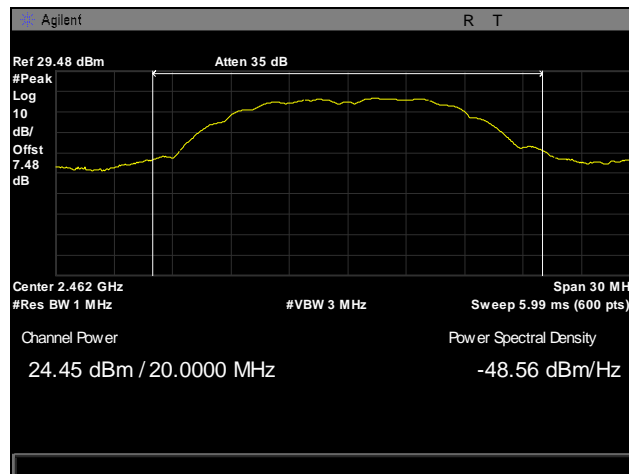
### Peak Power Output Test Results, 2.4 GHz, 802.11b



Plot 49. Peak Power Output, Low Channel, 2412 MHz, 802.11b

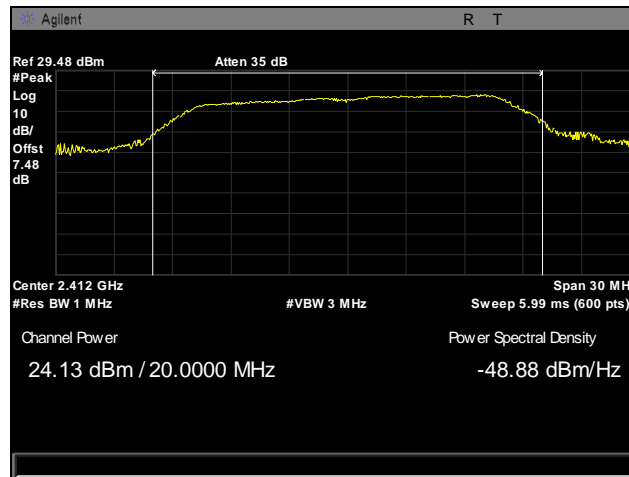


Plot 50. Peak Power Output, Mid Channel, 2437 MHz, 802.11b

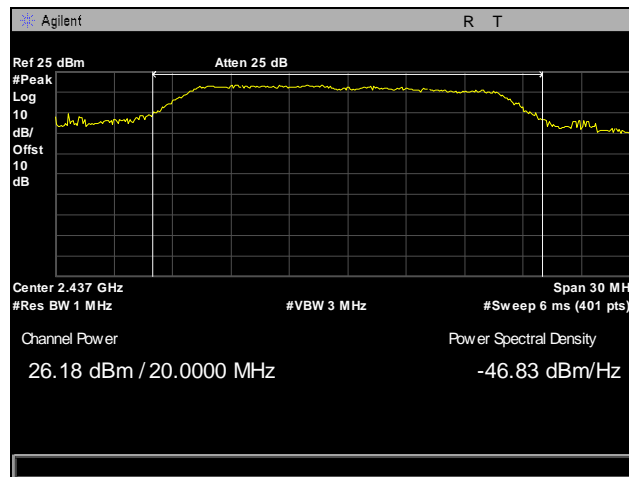


Plot 51. Peak Power Output, High Channel, 2462 MHz, 802.11b

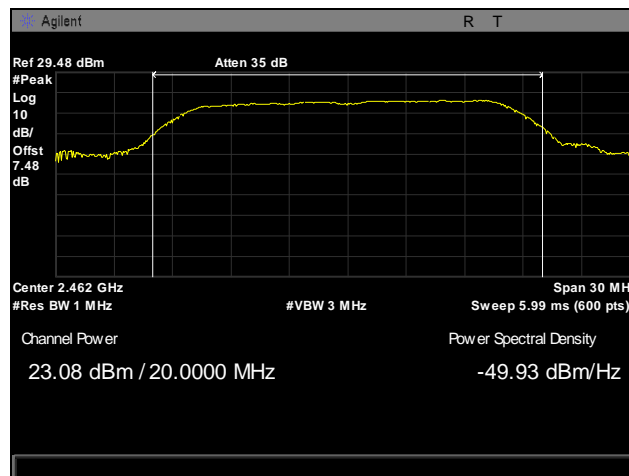
### Peak Power Output Test Results, 2.4 GHz, 802.11g



Plot 52. Peak Power Output, Low Channel, 2412 MHz, 802.11g

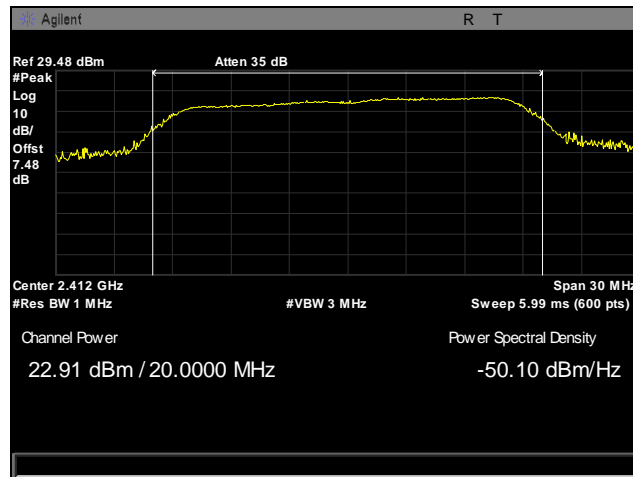


Plot 53. Peak Power Output, Mid Channel, 2437 MHz, 802.11g

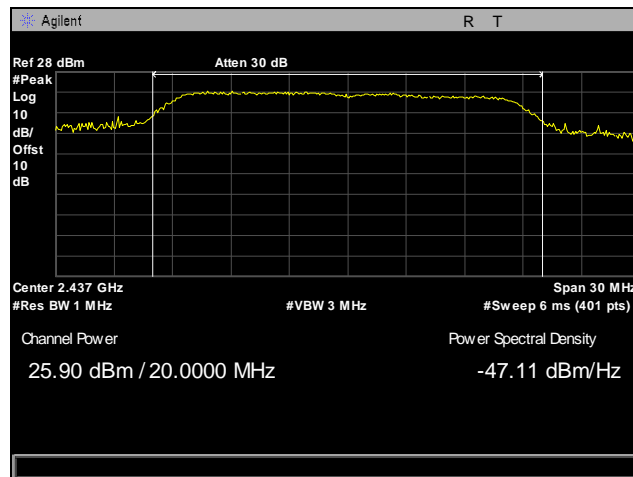


Plot 54. Peak Power Output, High Channel, 2462 MHz, 802.11g

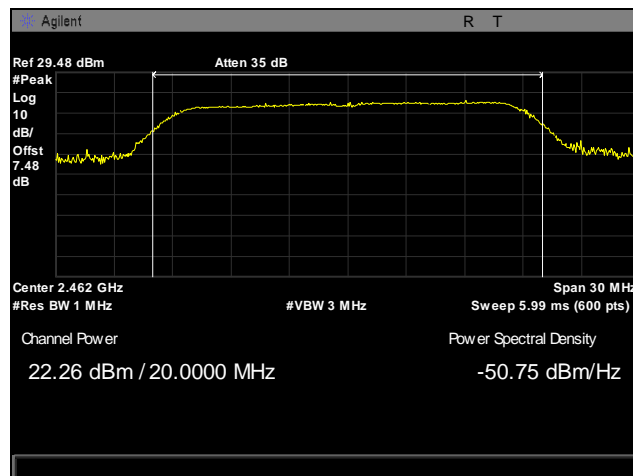
### Peak Power Output Test Results, 2.4 GHz, 802.11n 20 MHz, Port 1



Plot 55. Peak Power Output, Low Channel, 2412 MHz, 802.11n 20 MHz, Port 1

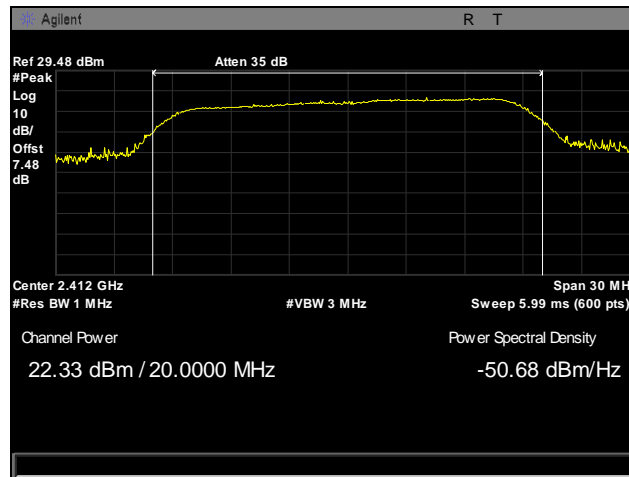


Plot 56. Peak Power Output, Mid Channel, 2437 MHz, 802.11n 20 MHz, Port 1

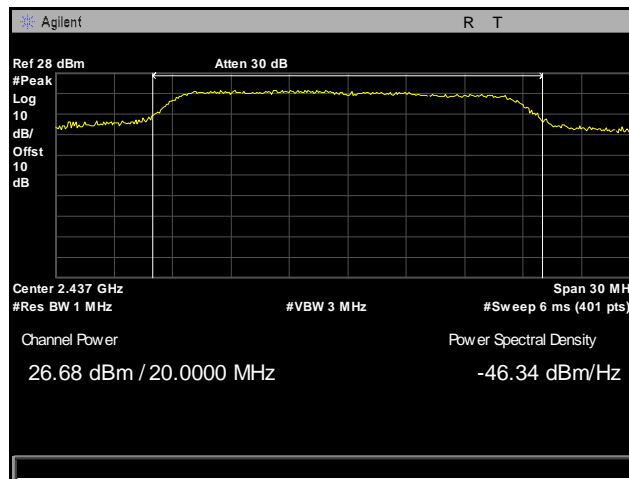


Plot 57. Peak Power Output, High Channel, 2462 MHz, 802.11n 20 MHz, Port 1

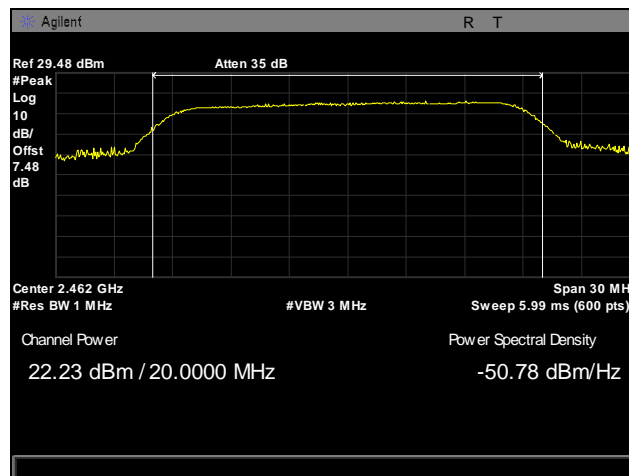
### Peak Power Output Test Results, 2.4 GHz, 802.11n 20 MHz, Port 2



Plot 58. Peak Power Output, Low Channel, 2412 MHz, 802.11n 20 MHz, Port 2

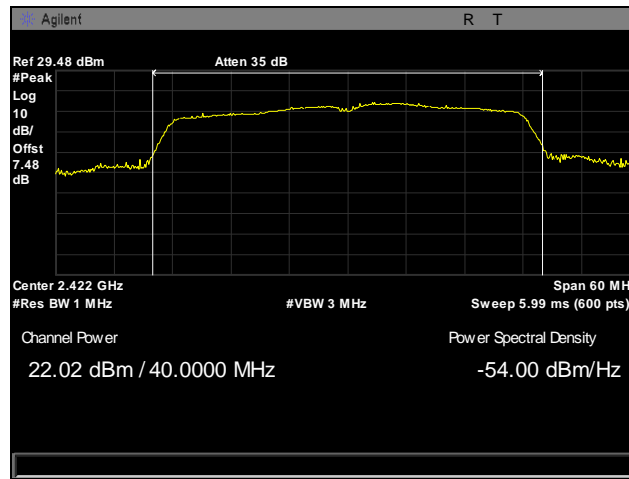


Plot 59. Peak Power Output, Mid Channel, 2437 MHz, 802.11n 20 MHz, Port 2

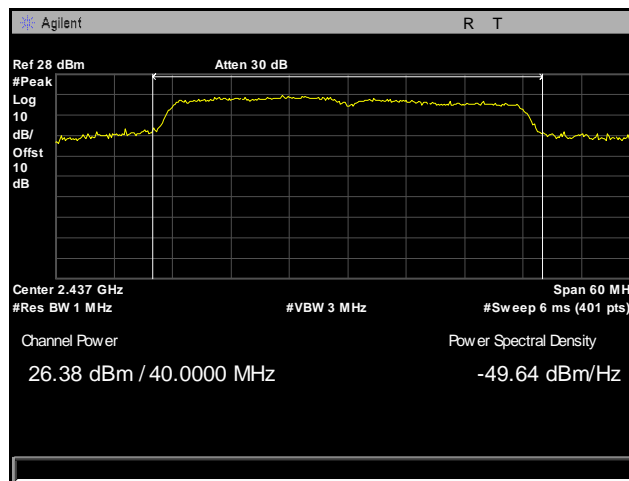


Plot 60. Peak Power Output, High Channel, 2462 MHz, 802.11n 20 MHz, Port 2

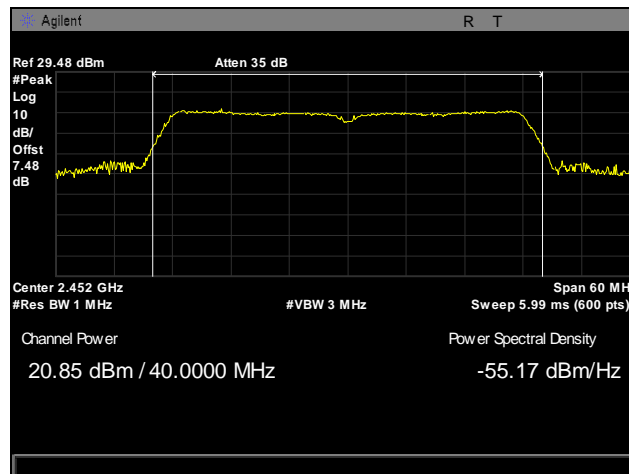
### Peak Power Output Test Results, 2.4 GHz, 802.11n 40 MHz, Port 1



Plot 61. Peak Power Output, Low Channel, 2422 MHz, 802.11n 40 MHz, Port 1

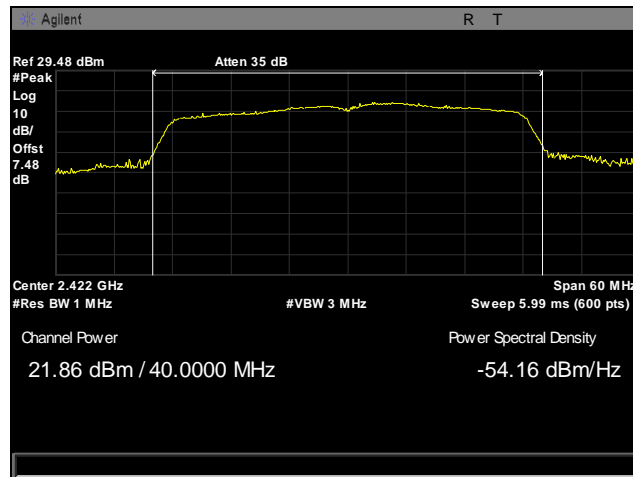


Plot 62. Peak Power Output, Mid Channel, 2437 MHz, 802.11n 40 MHz, Port 1

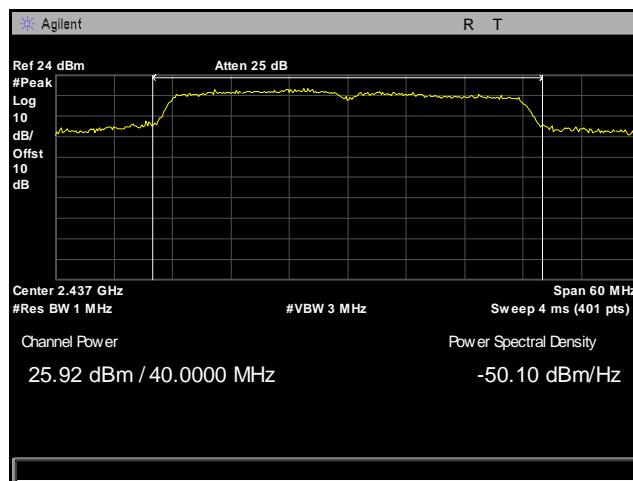


Plot 63. Peak Power Output, High Channel, 2452 MHz, 802.11n 40 MHz, Port 1

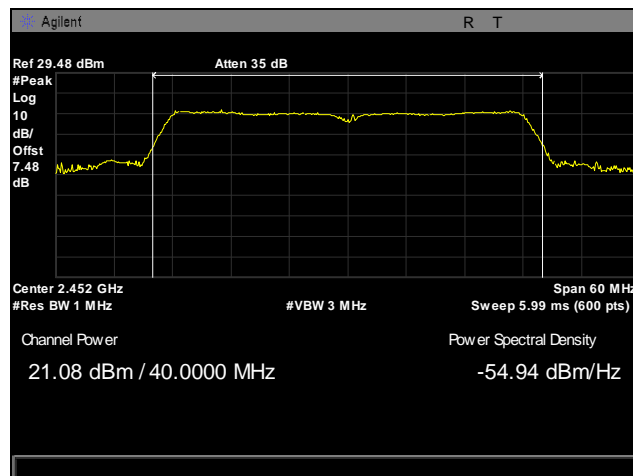
### Peak Power Output Test Results, 2.4 GHz, 802.11n 40 MHz



Plot 64. Peak Power Output, Low Channel, 2422 MHz, 802.11n 40 MHz, Port 2



Plot 65. Peak Power Output, Mid Channel, 2437 MHz, 802.11n 40 MHz, Port 2



Plot 66. Peak Power Output, High Channel, 2452 MHz, 802.11n 40 MHz, Port 2



## Electromagnetic Compatibility Criteria for Intentional Radiators

### § 15.247(d) Radiated Spurious Emissions Requirements and Band Edge

**Test Requirements:** §15.247(d); §15.205: Emissions outside the frequency band.

**§15.247(d):** In any 100 kHz bandwidth outside the frequency band in which the spread spectrum or digitally modulated intentional radiator is operating, the radio frequency power that is produced by the intentional radiator shall be at least 20 dB below that in the 100 kHz bandwidth within the band that contains the highest level of the desired power, based on either an RF conducted or a radiated measurement. Attenuation below the general limits specified in § 15.209(a) is not required. In addition, radiated emissions which fall in the restricted bands, as defined in § 15.205(a), must also comply with the radiated emission limits specified in § 15.209(a).

**§15.205(a):** Except as shown in paragraph (d) of this section, only spurious emissions are permitted in any of the frequency bands listed below:

MHz	MHz	MHz	GHz
0.090–0.110-----	16.42–16.423	399.9–410	4.5–5.15
<sup>1</sup> 0.495–0.505-----	16.69475–16.69525	608–614	5.35–5.46
2.1735–2.1905-----	16.80425–16.80475	960–1240	7.25–7.75
4.125–4.128-----	25.5–25.67	1300–1427	8.025–8.5
4.17725–4.17775-----	37.5–38.25	1435–1626.5	9.0–9.2
4.20725–4.20775-----	73–74.6	1645.5–1646.5	9.3–9.5
6.215–6.218-----	74.8–75.2	1660–1710	10.6–12.7
6.26775–6.26825-----	108–121.94	1718.8–1722.2	13.25–13.4
6.31175–6.31225-----	123–138	2200–2300	14.47–14.5
8.291–8.294-----	149.9–150.05	2310–2390	15.35–16.2
8.362–8.366-----	156.52475–156.52525	2483.5–2500	17.7–21.4
8.37625–8.38675-----	156.7–156.9	2655–2900	22.01–23.12
8.41425–8.41475-----	162.0125–167.17	3260–3267	23.6–24.0
12.29–12.293-----	167.72–173.2	3332–3339	31.2–31.8
12.51975–12.52025-----	240–285	3345.8–3358 36.	43–36.5
12.57675–12.57725-----	322–335.4	3600–4400	( <sup>2</sup> )

**Table 26. Restricted Bands of Operation**

<sup>1</sup> Until February 1, 1999, this restricted band shall be 0.490 – 0.510 MHz.

<sup>2</sup> Above 38.6

**Test Requirement(s):** § 15.209 (a): Except as provided elsewhere in this subpart, the emissions from an intentional radiator shall not exceed the field strength levels specified in Table 27.

Frequency (MHz)	§ 15.209(a), Radiated Emission Limits (dB $\mu$ V) @ 3m
30 - 88	40.00
88 - 216	43.50
216 - 960	46.00
Above 960	54.00

**Table 27. Radiated Emissions Limits Calculated from FCC Part 15, § 15.209 (a)**

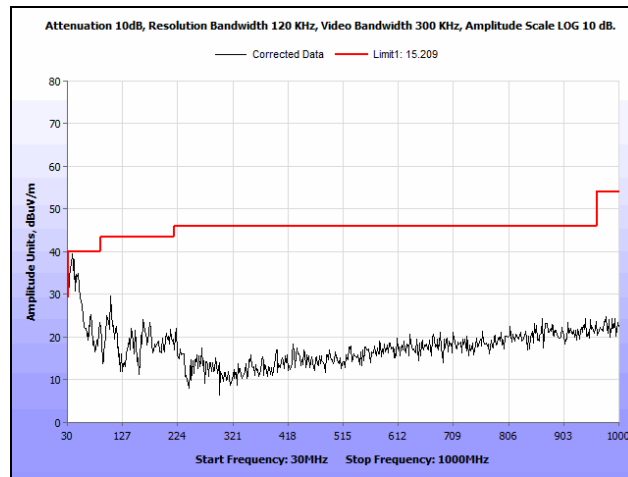
**Test Procedures:** The transmitter was turned on. Measurements were performed of the low, mid and high Channels. The EUT was rotated orthogonally through all three axes. Plots shown are corrected for both antenna correction factor and distance and compared to a 3 m limit line. Only noise floor was measured above 18 GHz.

**Test Results:** The EUT was compliant with the Radiated Spurious Emission limits of § 15.247(d).

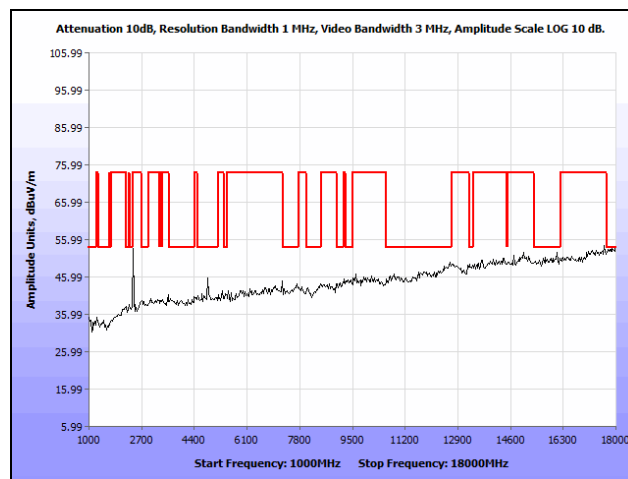
**Test Engineer(s):** Ben Taylor

**Test Date(s):** 08/25/14

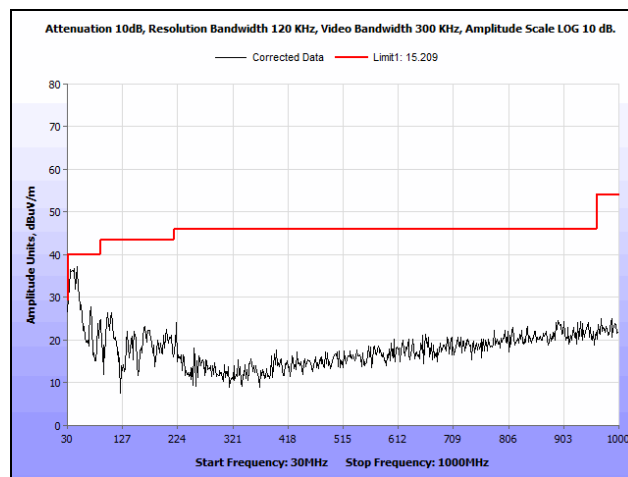
## Radiated Spurious Emissions Test Results, 802.11b



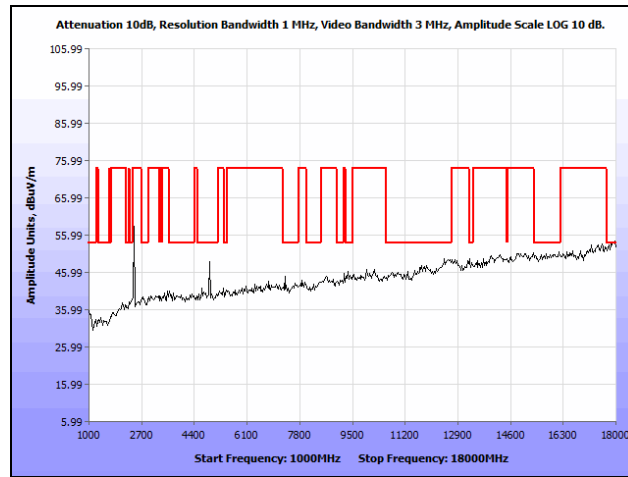
**Plot 67. Radiated Spurious Emissions, Low Channel, 802.11b, 30 MHz – 1 GHz**



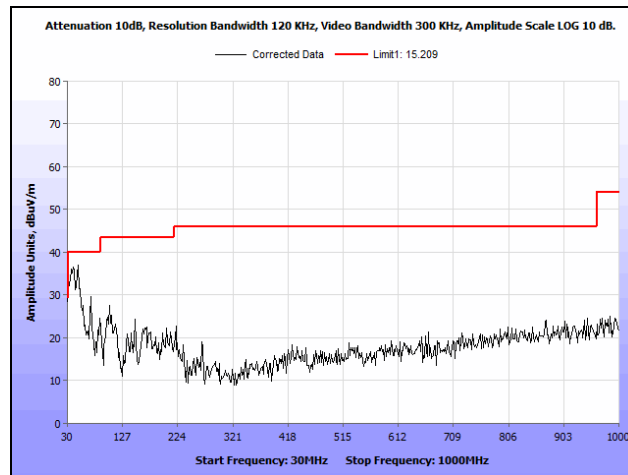
**Plot 68. Radiated Spurious Emissions, Low Channel, 802.11b, 1 GHz – 18 GHz**



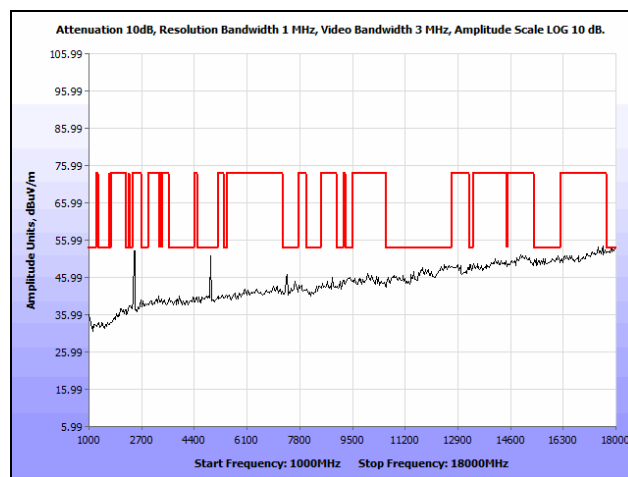
**Plot 69. Radiated Spurious Emissions, Mid Channel, 802.11b, 30 MHz – 1 GHz**



**Plot 70. Radiated Spurious Emissions, Mid Channel, 802.11b, 1 GHz – 18 GHz**

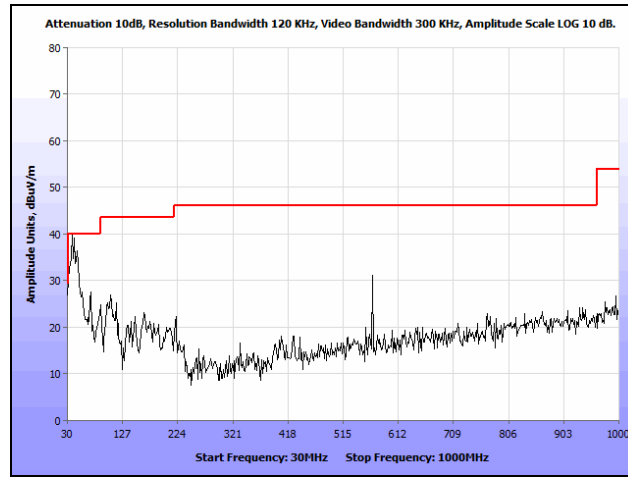


**Plot 71. Radiated Spurious Emissions, High Channel, 802.11b, 30 MHz – 1 GHz**

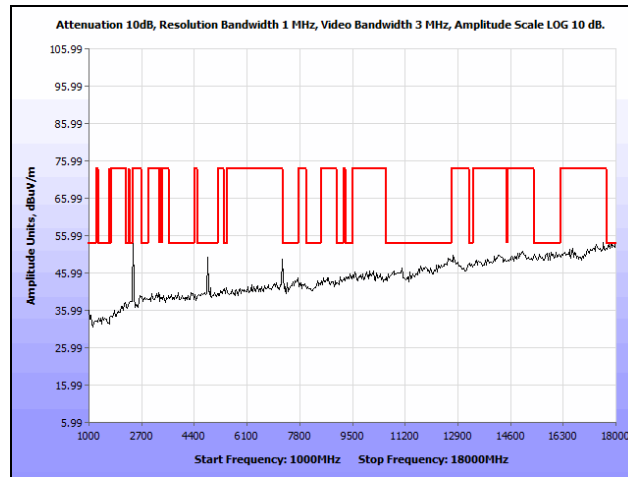


**Plot 72. Radiated Spurious Emissions, High Channel, 802.11b, 1 GHz – 18 GHz**

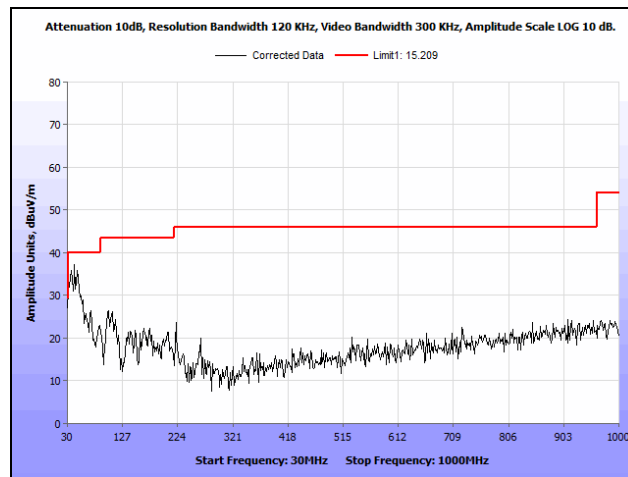
## Radiated Spurious Emissions Test Results, 802.11g



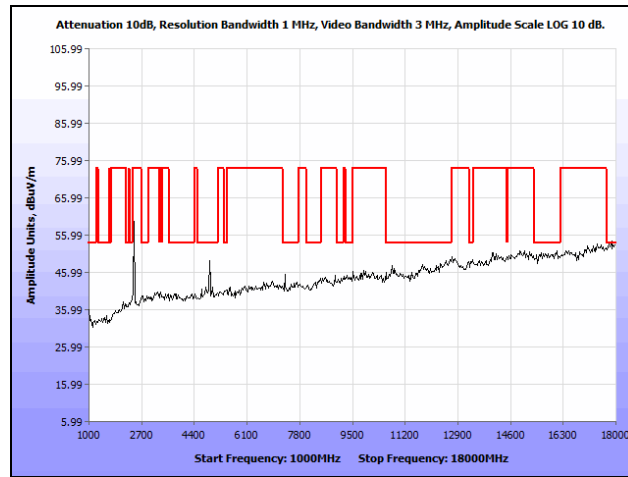
Plot 73. Radiated Spurious Emissions, Low Channel, 802.11g, 30 MHz – 1 GHz



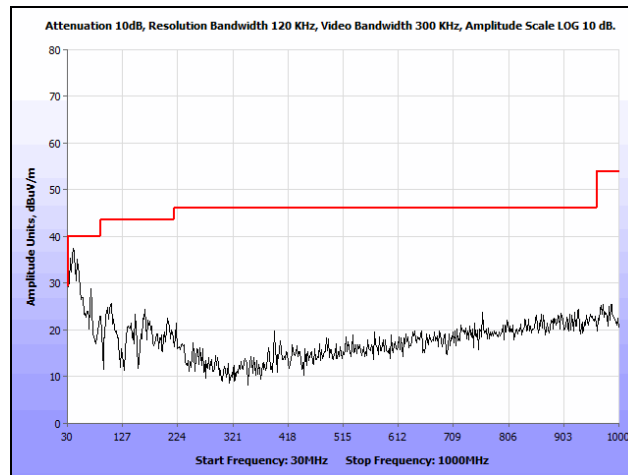
Plot 74. Radiated Spurious Emissions, Low Channel, 802.11g, 1 GHz – 18 GHz



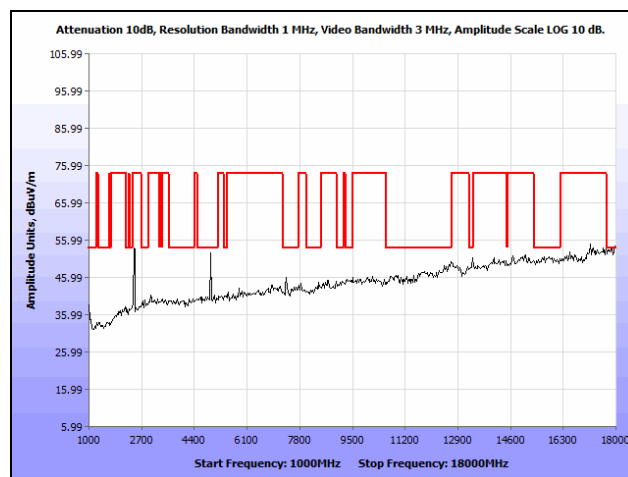
Plot 75. Radiated Spurious Emissions, Mid Channel, 802.11g, 30 MHz – 1 GHz



**Plot 76. Radiated Spurious Emissions, Mid Channel, 802.11g, 1 GHz – 18 GHz**

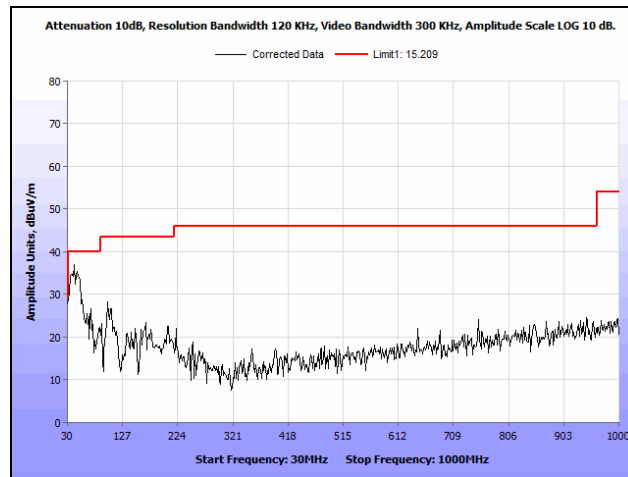


**Plot 77. Radiated Spurious Emissions, High Channel, 802.11g, 30 MHz – 1 GHz**

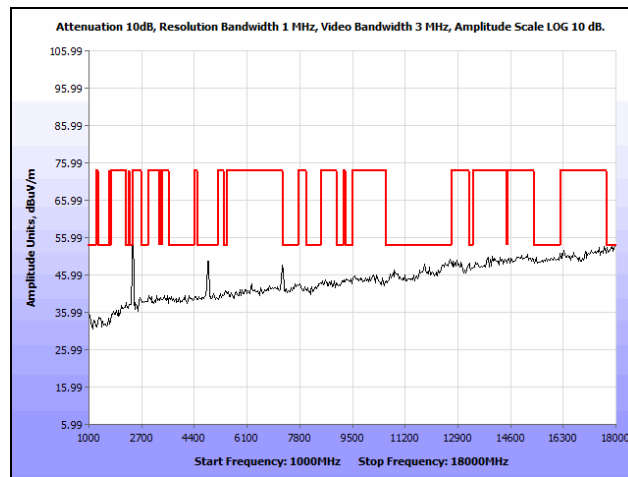


**Plot 78. Radiated Spurious Emissions, High Channel, 802.11g, 1 GHz – 18 GHz**

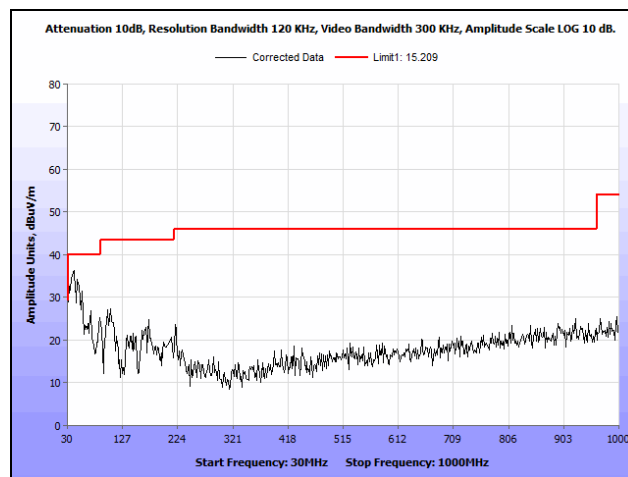
**Radiated Spurious Emissions Test Results, 802.11n 20 MHz, Patch Antenna**



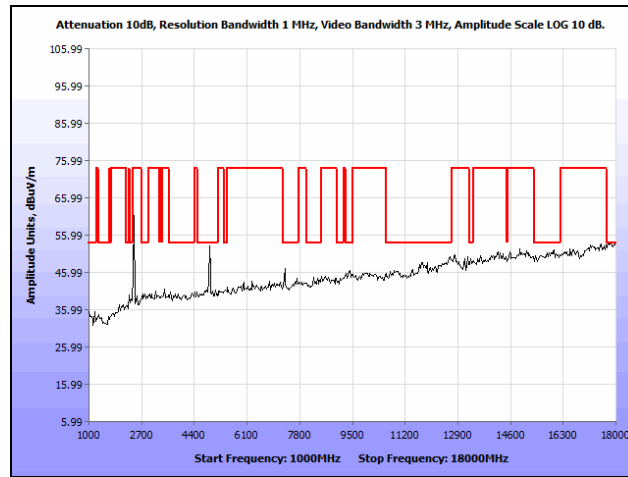
**Plot 79. Radiated Spurious Emissions, Low Channel, 802.11n 20 MHz, 30 MHz – 1 GHz**



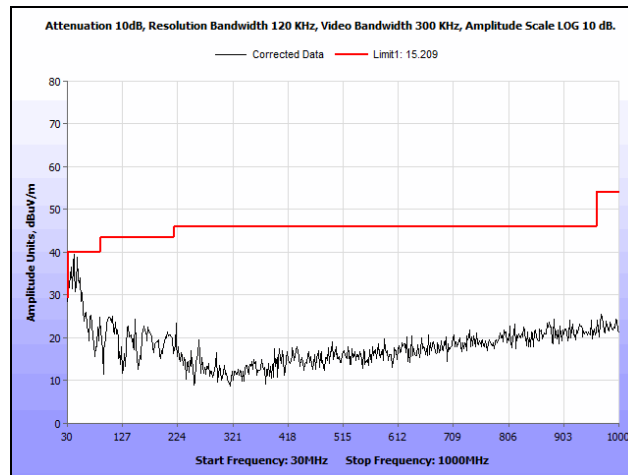
**Plot 80. Radiated Spurious Emissions, Low Channel, 802.11n 20 MHz, 1 GHz – 18 GHz**



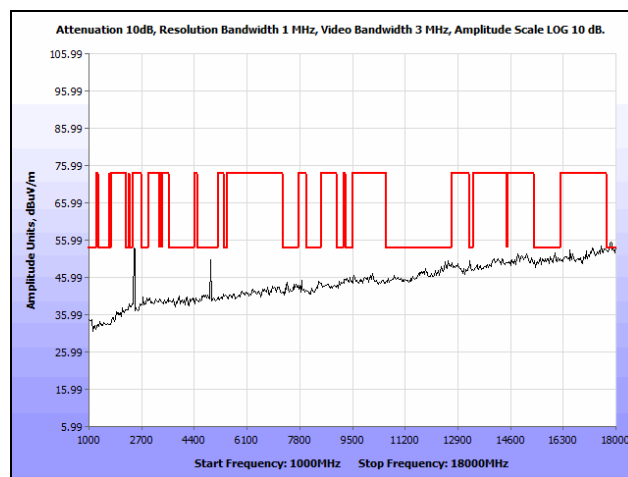
**Plot 81. Radiated Spurious Emissions, Mid Channel, 802.11n 20 MHz, 30 MHz – 1 GHz**



**Plot 82. Radiated Spurious Emissions, Mid Channel, 802.11n 20 MHz, 1 GHz – 18 GHz**



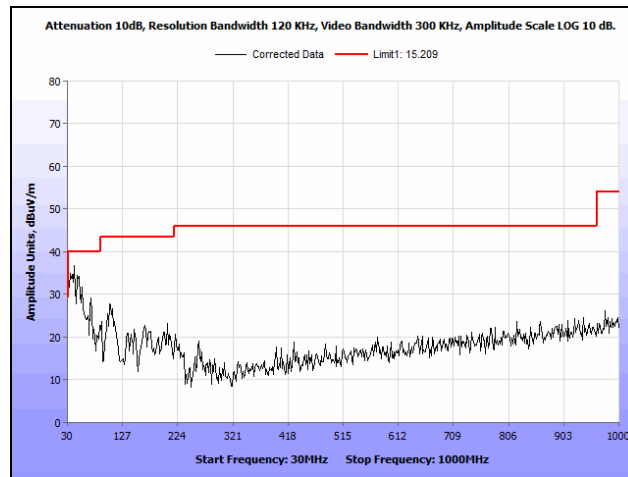
**Plot 83. Radiated Spurious Emissions, High Channel, 802.11n 20 MHz, 30 MHz – 1 GHz**



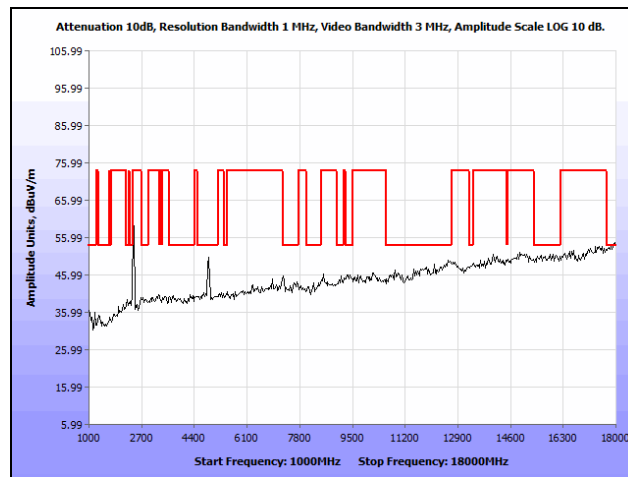
**Plot 84. Radiated Spurious Emissions, High Channel, 802.11n 20 MHz, 1 GHz – 18 GHz**



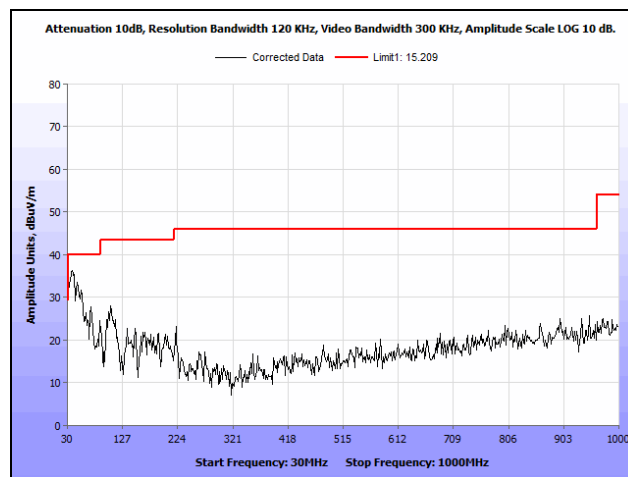
### Radiated Spurious Emissions Test Results, 802.11n 40 MHz



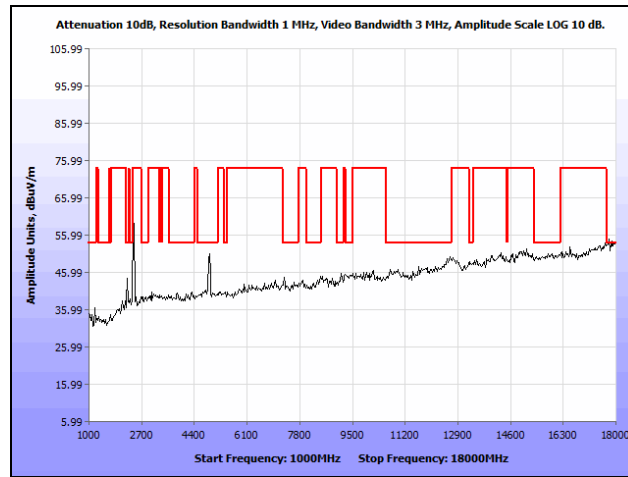
Plot 85. Radiated Spurious Emissions, Low Channel, 802.11n 40 MHz, 30 MHz – 1 GHz



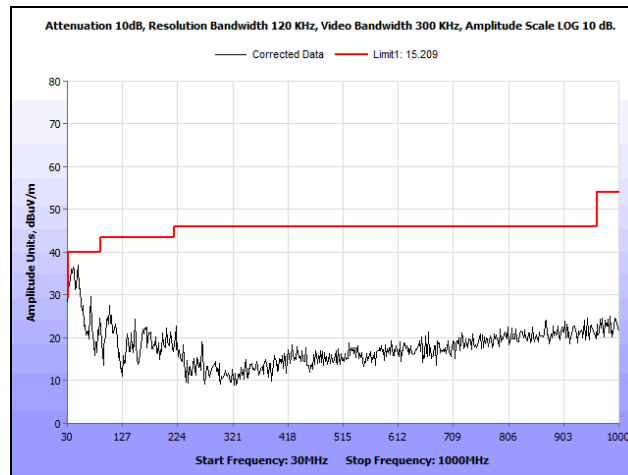
Plot 86. Radiated Spurious Emissions, Low Channel, 802.11n 40 MHz, 1 GHz – 18 GHz



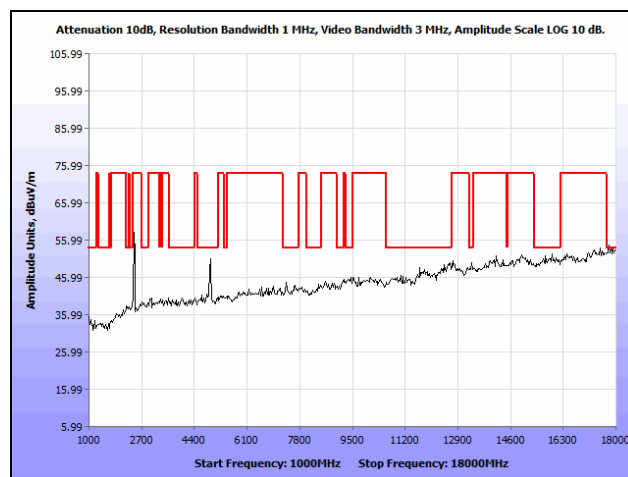
Plot 87. Radiated Spurious Emissions, Mid Channel, 802.11n 40 MHz, 30 MHz – 1 GHz



**Plot 88. Radiated Spurious Emissions, Mid Channel, 802.11n 40 MHz, 1 GHz – 18 GHz**



**Plot 89. Radiated Spurious Emissions, High Channel, 802.11n 40 MHz, 30 MHz – 1 GHz**

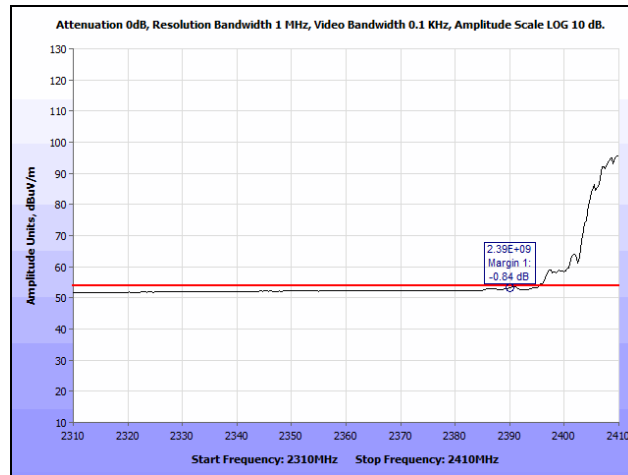


**Plot 90. Radiated Spurious Emissions, High Channel, 802.11n 40 MHz, 1 GHz – 18 GHz**

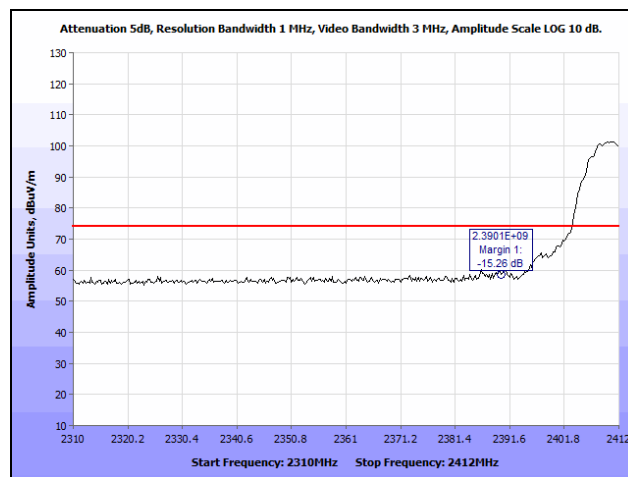
## Radiated Band Edge Measurements

**Test Procedures:** The transmitter was turned on. Measurements were performed of the low and high Channels. The EUT was rotated orthogonally through all three axes. Plots shown are corrected for both antenna correction factor and distance and compared to a 3 m limit line.

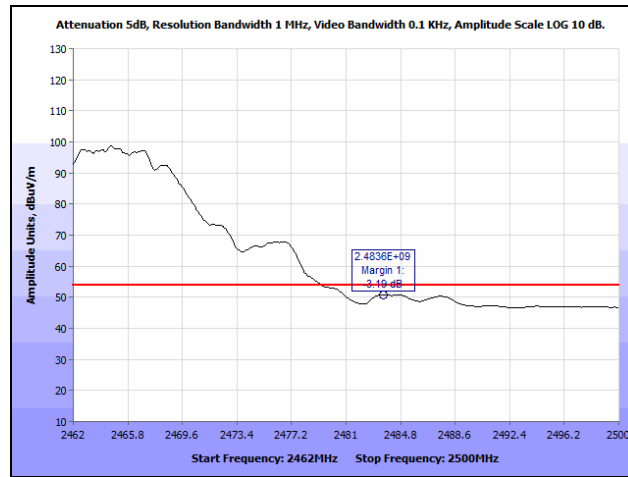
### Radiated Band Edge Measurements, 802.11b



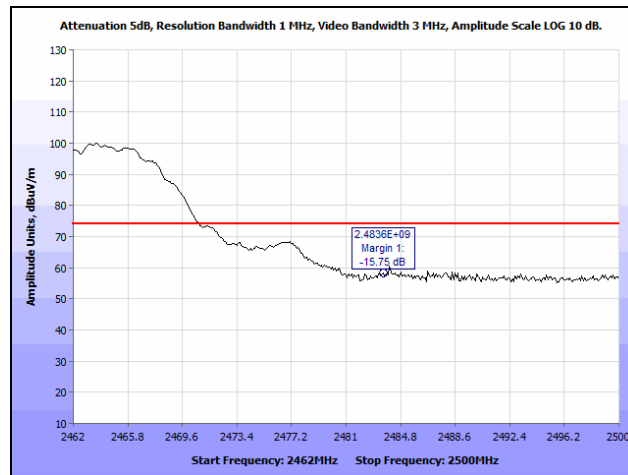
**Plot 91. Radiated Restricted Band Edge, 802.11b, 2412 MHz @ 2390 MHz, Average**



**Plot 92. Radiated Restricted Band Edge, 802.11b, 2412 MHz @ 2390 MHz, Peak**

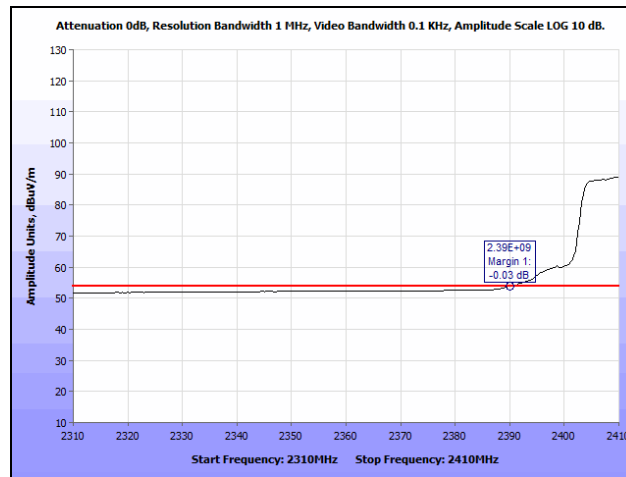


**Plot 93. Radiated Restricted Band Edge, 802.11b, 2462 MHz @ 2483.5 MHz, Average**

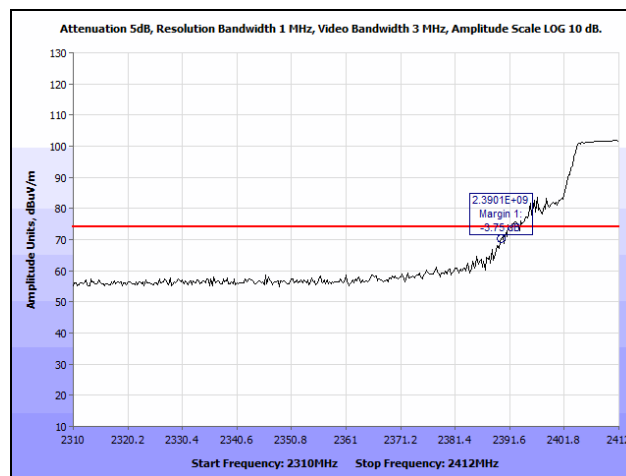


**Plot 94. Radiated Restricted Band Edge, 802.11b, 2462 MHz @ 2483.5 MHz, Peak**

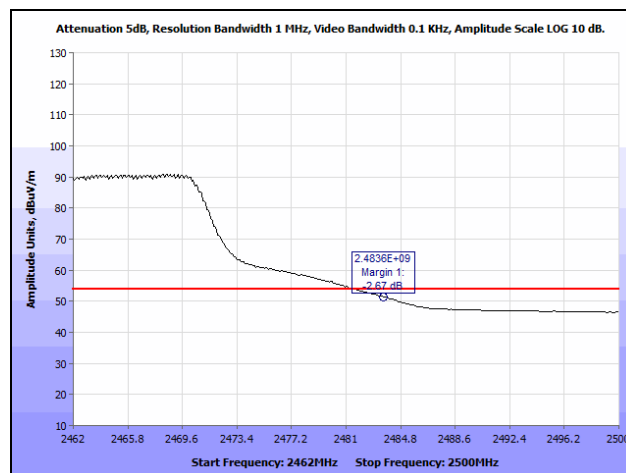
## Radiated Band Edge Measurements, 802.11g



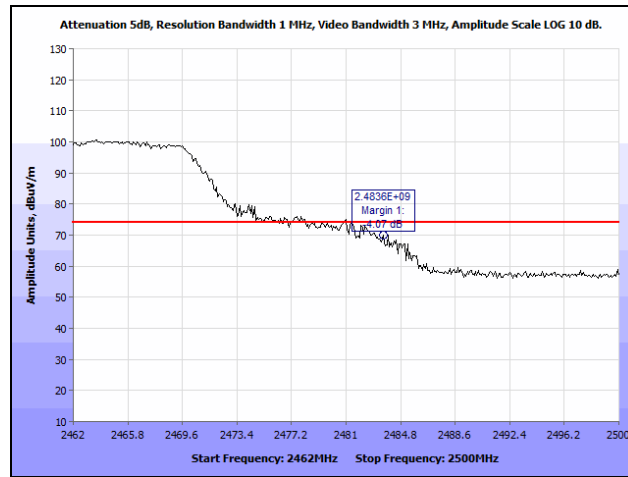
**Plot 95. Radiated Restricted Band Edge, 802.11g, 2412 MHz @ 2390 MHz, Average**



**Plot 96. Radiated Restricted Band Edge, 802.11g, 2412 MHz @ 2390 MHz, Peak**

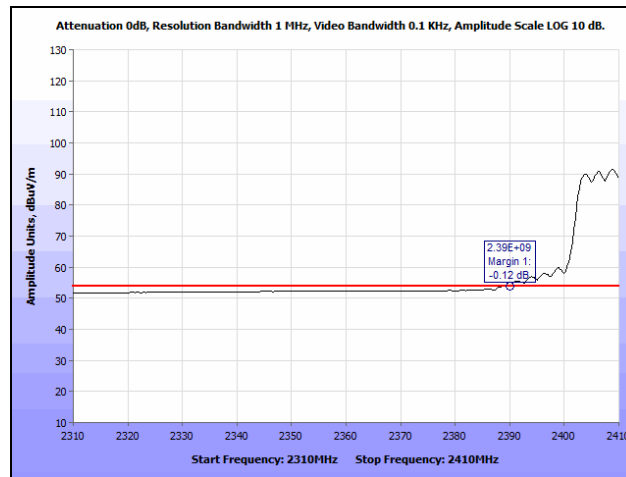


**Plot 97. Radiated Restricted Band Edge, 802.11g, 2462 MHz @ 2483.5 MHz, Average**

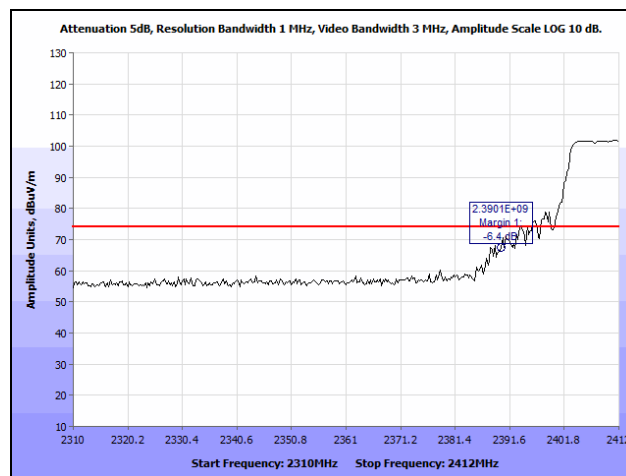


**Plot 98. Radiated Restricted Band Edge, 802.11g, 2462 MHz @ 2483.5 MHz, Peak**

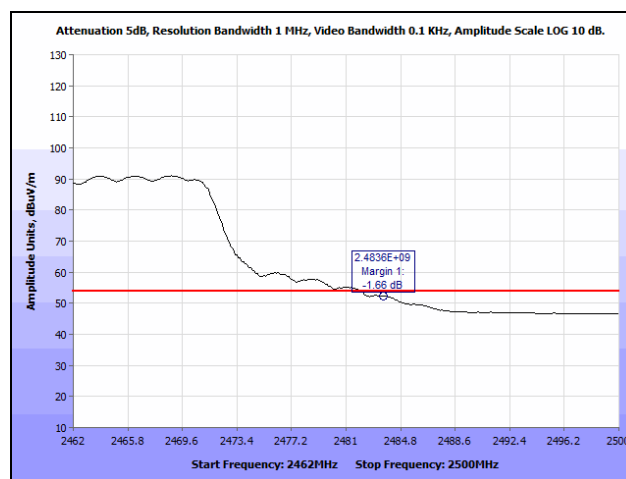
## Radiated Band Edge Measurements, 802.11n 20 MHz



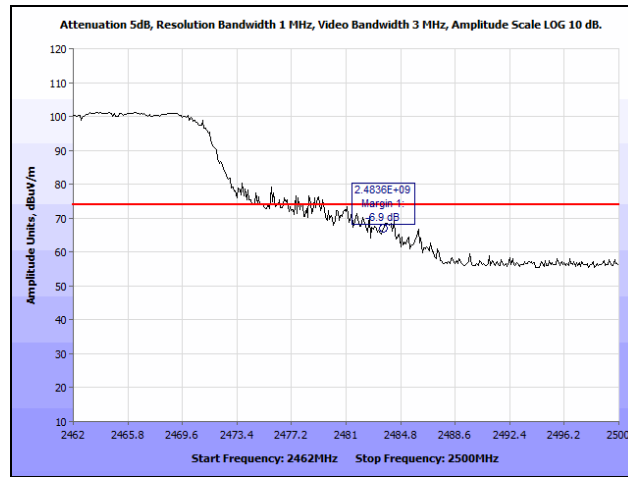
Plot 99. Radiated Restricted Band Edge, 802.11n 20 MHz, 2412 MHz @ 2390 MHz, Average



Plot 100. Radiated Restricted Band Edge, 802.11n 20 MHz, 2412 MHz @ 2390 MHz, Peak



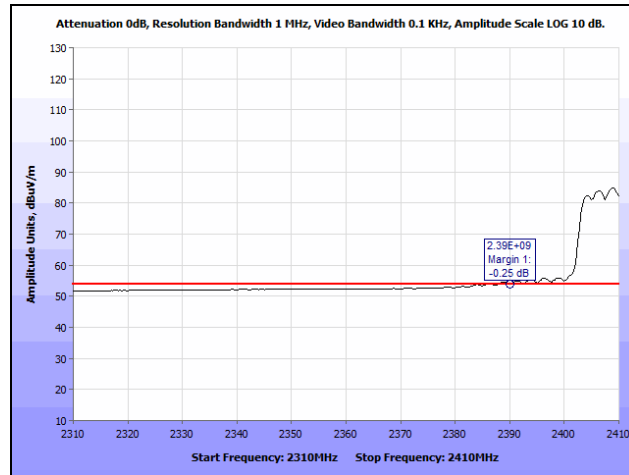
Plot 101. Radiated Restricted Band Edge, 802.11n 20 MHz, 2462 MHz @ 2483.5 MHz, Average



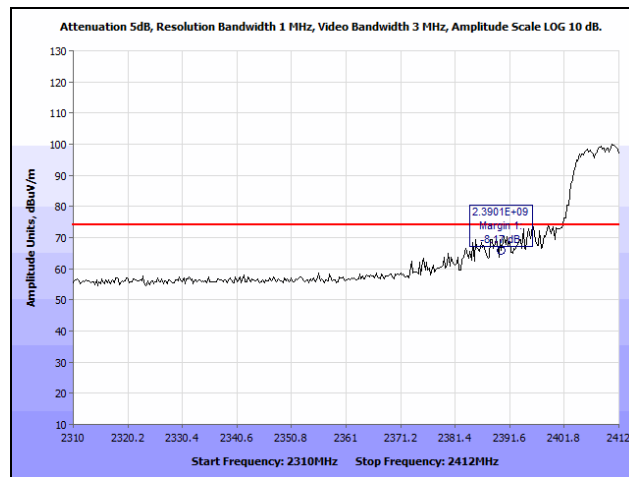
Plot 102. Radiated Restricted Band Edge, 802.11n 20 MHz, 2462 MHz @ 2483.5 MHz, Peak



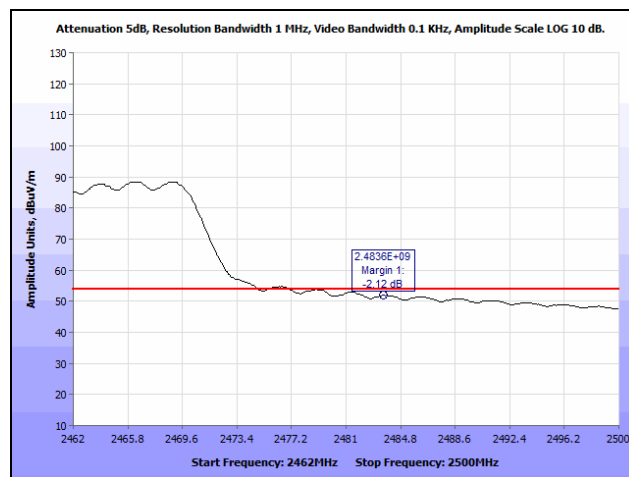
### Radiated Band Edge Measurements, 802.11n 40 MHz



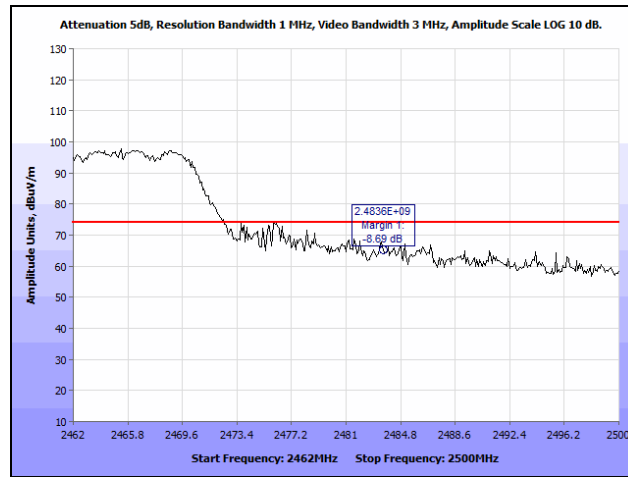
**Plot 103. Radiated Restricted Band Edge, 802.11n 40 MHz, 2412 MHz @ 2390 MHz, Average**



**Plot 104. Radiated Restricted Band Edge, 802.11n 40 MHz, 2412 MHz @ 2390 MHz, Peak**



**Plot 105. Radiated Restricted Band Edge, 802.11n 40 MHz, 2452 MHz @ 2483.5 MHz, Average**



Plot 106. Radiated Restricted Band Edge, 802.11n 40 MHz, 2452 MHz @ 2483.5 MHz, Peak

## Electromagnetic Compatibility Criteria for Intentional Radiators

### § 15.247(d) RF Conducted Spurious Emissions Requirements and Band Edge

**Test Requirement:** **15.247(d)** In any 100 kHz bandwidth outside the frequency band in which the spread spectrum or digitally modulated intentional radiator is operating, the radio frequency power that is produced by the intentional radiator shall be at least 20 dB below that in the 100 kHz bandwidth within the band that contains the highest level of the desired power, based on either an RF conducted or a radiated measurement, provided the transmitter demonstrates compliance with the peak conducted power limits. If the transmitter complies with the conducted power limits based on the use of RMS averaging over a time interval, as permitted under paragraph (b)(3) of this section, the attenuation required under this paragraph shall be 30 dB instead of 20 dB.

**Test Procedure:** For intentional radiators with a digital device portion which operates below 10 GHz, the spectrum was investigated as per §15.33(a)(1) and §15.33(a)(4); i.e., the lowest RF signal generated or used in the device up to the 10<sup>th</sup> harmonic of the highest fundamental frequency or to 40 GHz, whichever is lower.

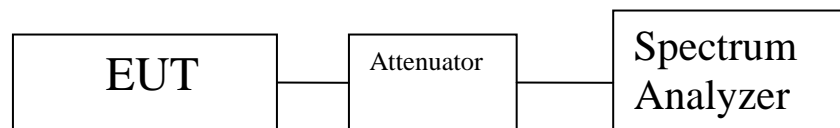
Since the EUT had an integral antenna, conducted measurements could not be performed. Measurements needed to be taken radiated. An antenna was located 3 m away from the EUT and plots were taken. The EUT was rotated through all three orthogonal axes. The plots were corrected for both antenna correction factor and cable loss.

See following pages for detailed test results with RF Conducted Spurious Emissions.

**Test Results:** The EUT was compliant with the Conducted Spurious Emission limits of **§15.247(d)**.

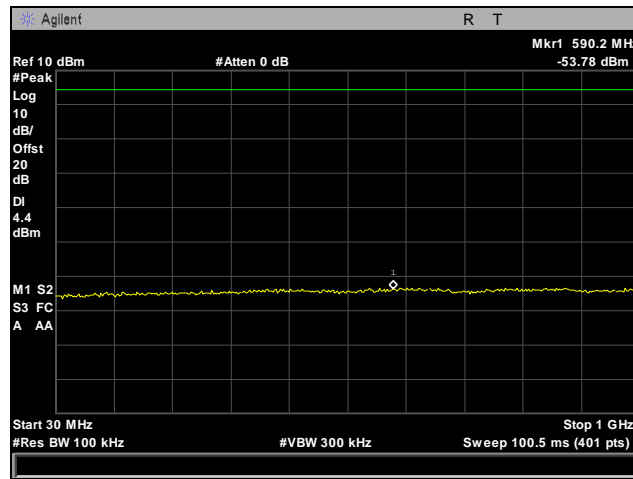
**Test Engineer(s):** Andy Shen

**Test Date(s):** 08/27/14

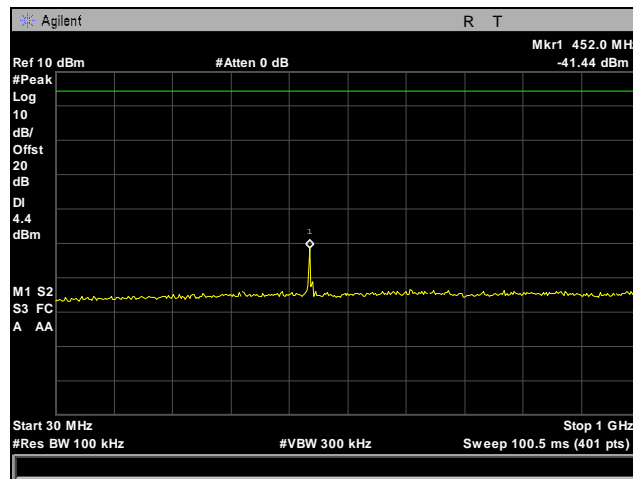


**Figure 4. Block Diagram, Conducted Spurious Emissions Test Setup**

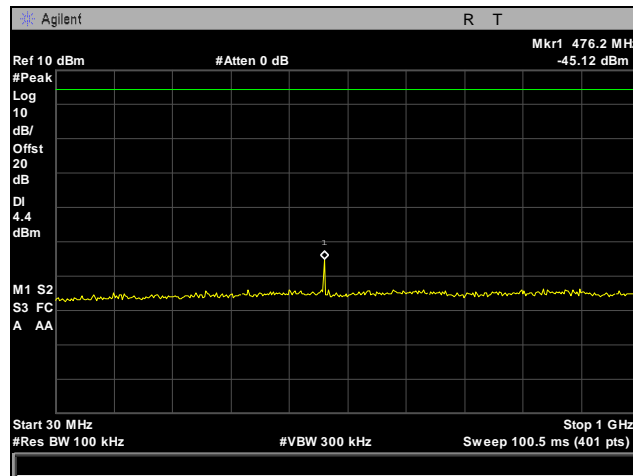
### Conducted Spurious Emissions Test Results, 802.11b, 2.4 GHz



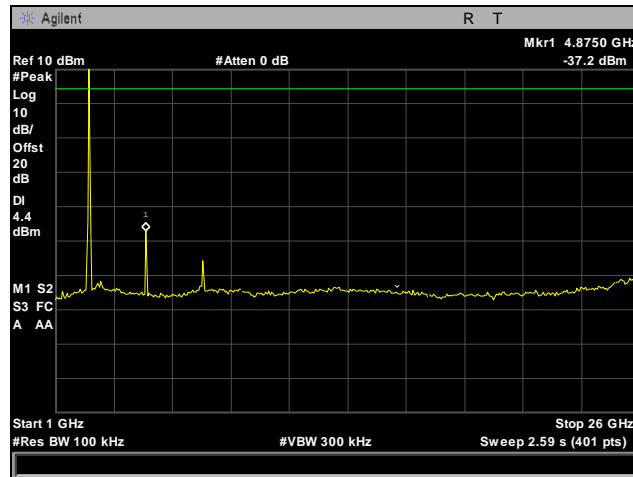
Plot 107. Conducted Spurious Emissions, Low Channel, 802.11b, 2412 MHz, 30 MHz – 1 GHz



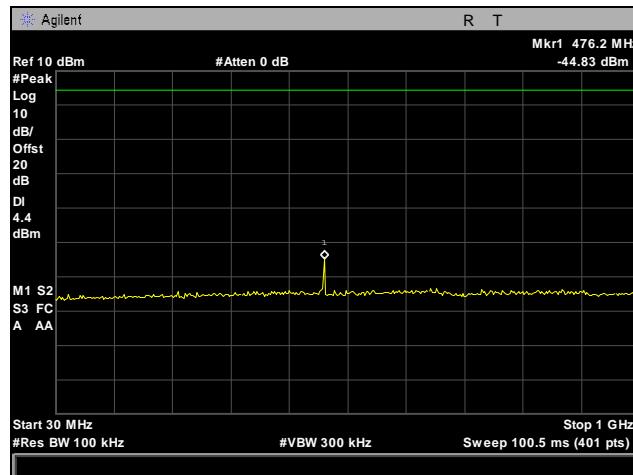
Plot 108. Conducted Spurious Emissions, Low Channel, 802.11b, 2412 MHz, 1 GHz – 26 GHz



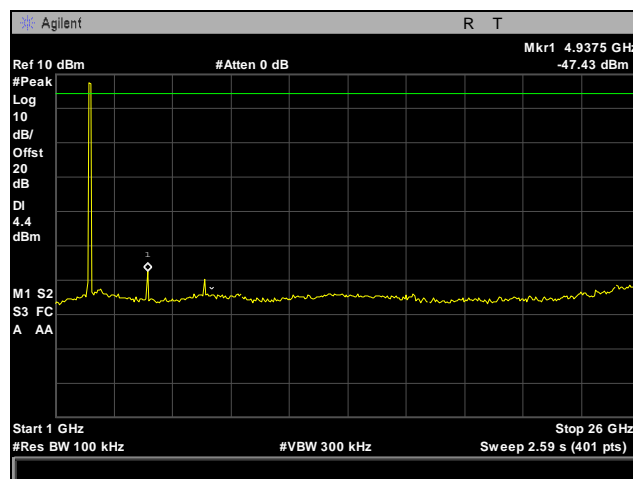
Plot 109. Conducted Spurious Emissions, Mid Channel, 802.11b, 2437 MHz, 30 MHz – 1 GHz



Plot 110. Conducted Spurious Emissions, Mid Channel, 802.11b, 2437 MHz, 1 GHz – 26 GHz

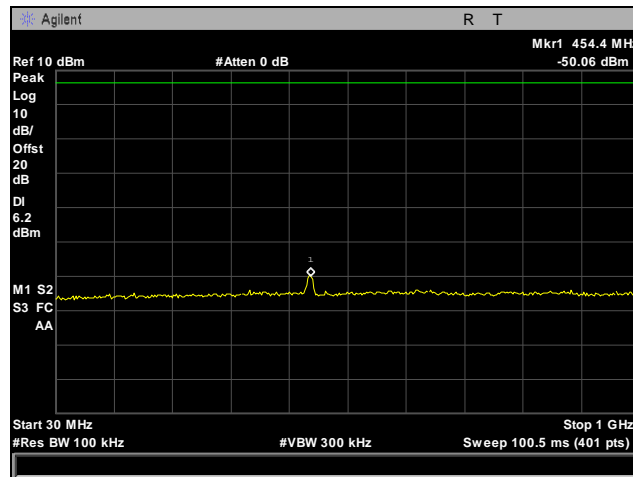


Plot 111. Conducted Spurious Emissions, High Channel, 802.11b, 2462 MHz, 30 MHz – 1 GHz

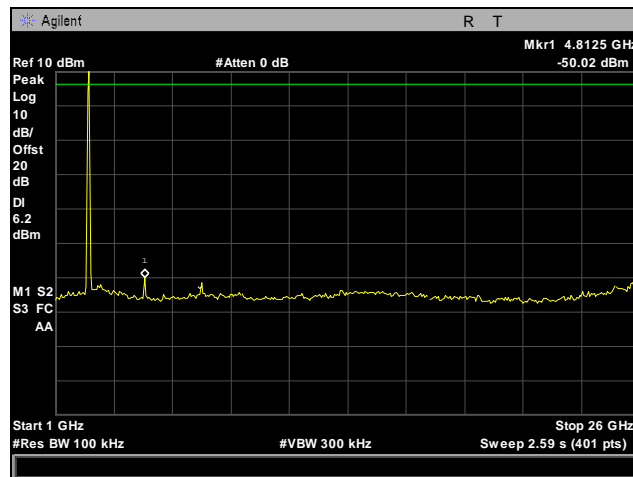


Plot 112. Conducted Spurious Emissions, High Channel, 802.11b, 2462 MHz, 1 GHz – 26 GHz

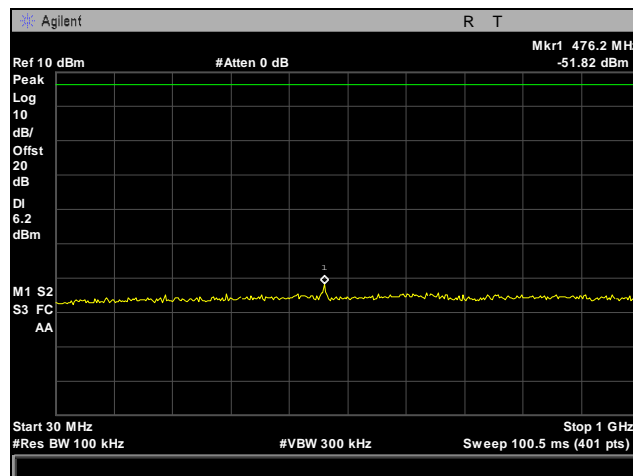
### Conducted Spurious Emissions Test Results, 802.11g, 2.4 GHz



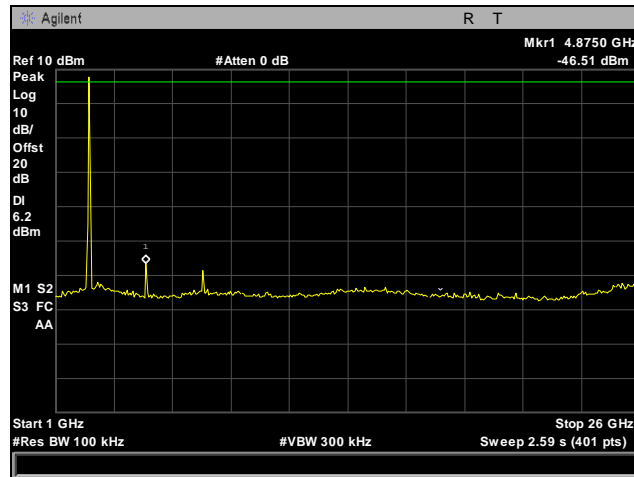
Plot 113. Conducted Spurious Emissions, Low Channel, 802.11g, 2412 MHz, 30 MHz – 1 GHz



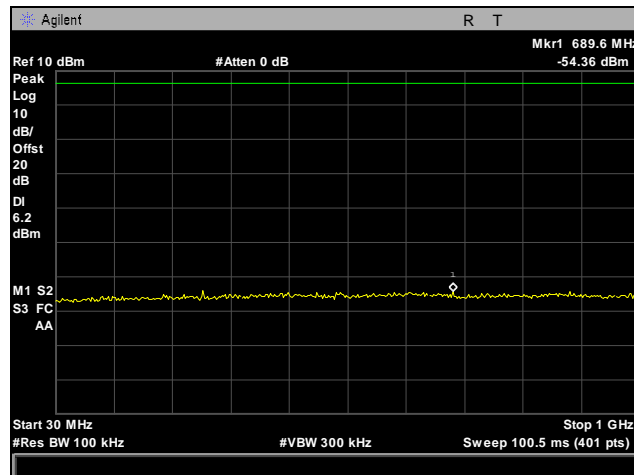
Plot 114. Conducted Spurious Emissions, Low Channel, 802.11g, 2412 MHz, 1 GHz – 26 GHz



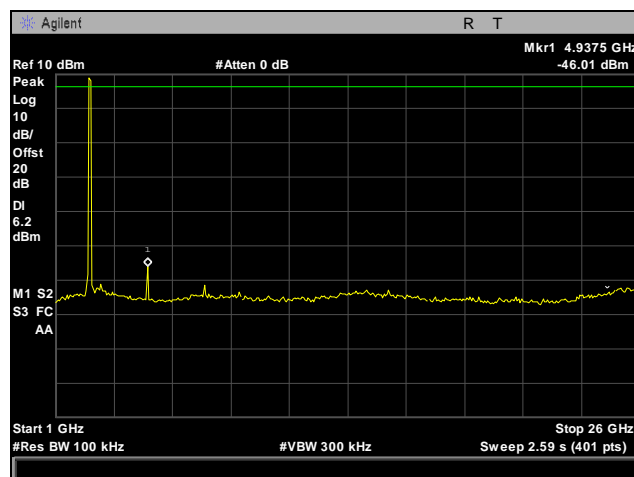
Plot 115. Conducted Spurious Emissions, Mid Channel, 802.11g, 2437 MHz, 30 MHz – 1 GHz



Plot 116. Conducted Spurious Emissions, Mid Channel, 802.11g, 2437 MHz, 1 GHz – 26 GHz

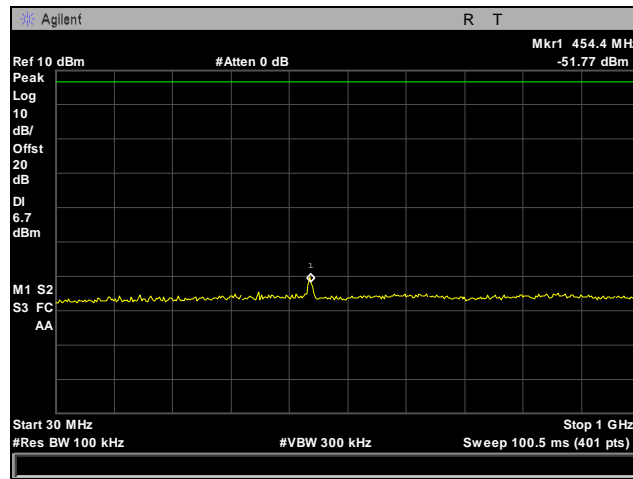


Plot 117. Conducted Spurious Emissions, High Channel, 802.11g, 2462 MHz, 30 MHz – 1 GHz

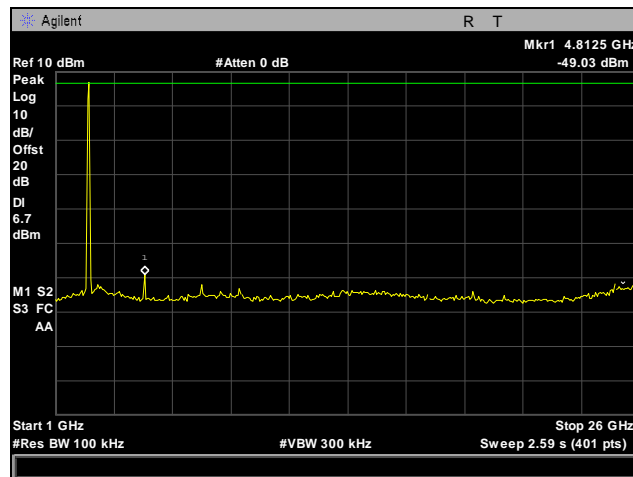


Plot 118. Conducted Spurious Emissions, High Channel, 802.11g, 2462 MHz, 1 GHz – 26 GHz

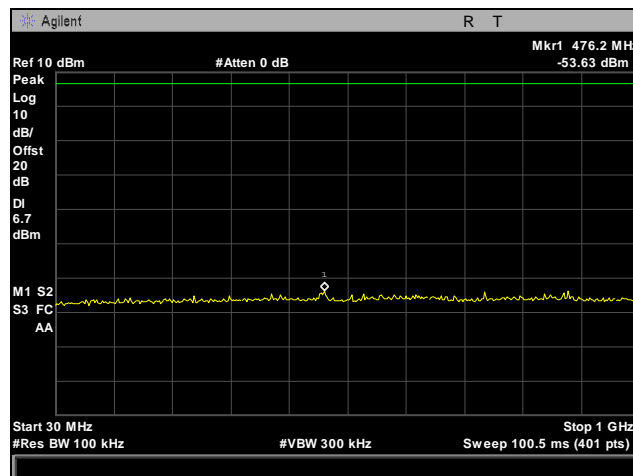
**Conducted Spurious Emissions Test Results, 802.11n 20 MHz, Port 1, 2.4 GHz**



**Plot 119. Conducted Spurious Emissions, Low Channel, 802.11n 20 MHz, Port 1, 2412 MHz, 30 MHz – 1 GHz**

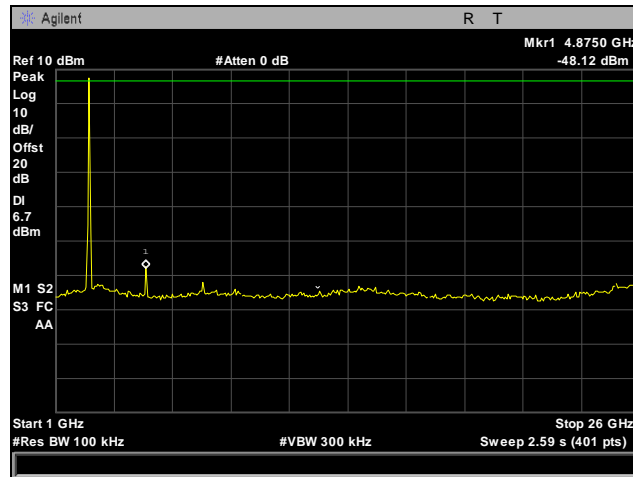


**Plot 120. Conducted Spurious Emissions, Low Channel, 802.11n 20 MHz, Port 1, 2412 MHz, 1 GHz – 26 GHz**

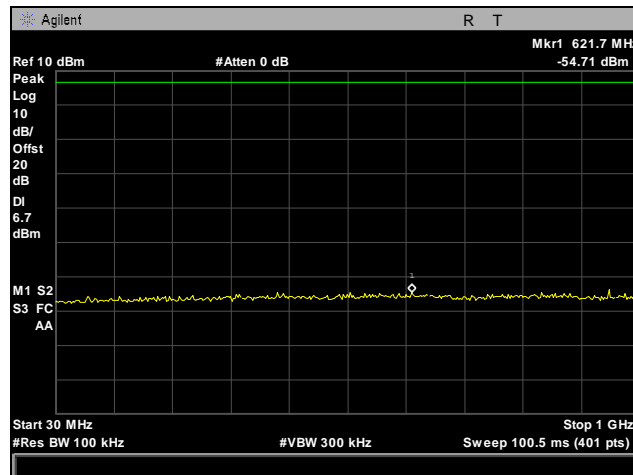


**Plot 121. Conducted Spurious Emissions, Mid Channel, 802.11n 20 MHz, Port 1, 2437 MHz, 30 MHz – 1 GHz**

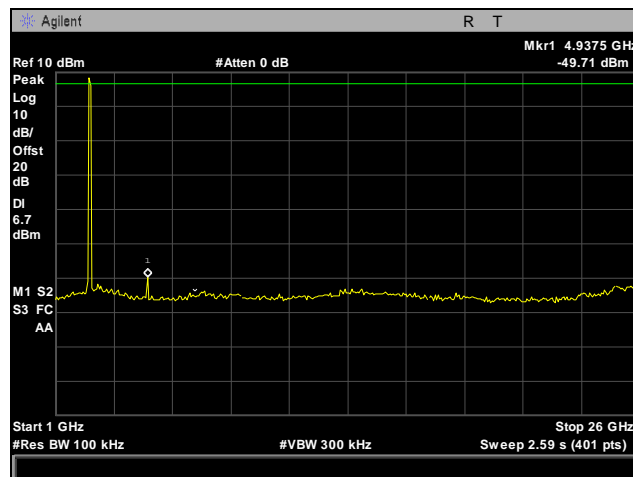




Plot 122. Conducted Spurious Emissions, Mid Channel, 802.11n 20 MHz, Port 1, 2437 MHz, 1 GHz – 26 GHz

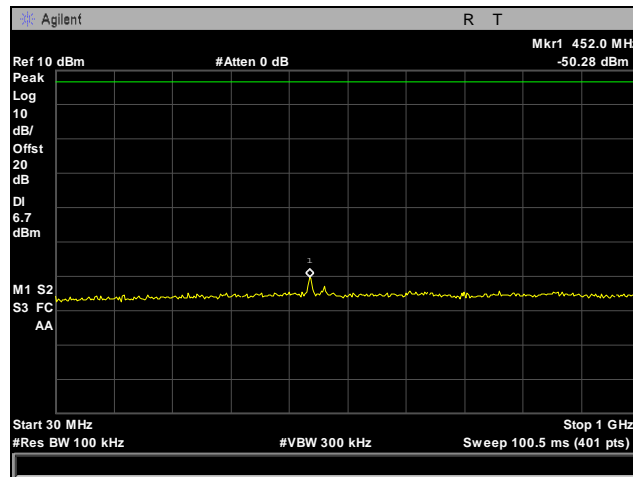


Plot 123. Conducted Spurious Emissions, High Channel, 802.11n 20 MHz, Port 1, 2462 MHz, 30 MHz – 1 GHz

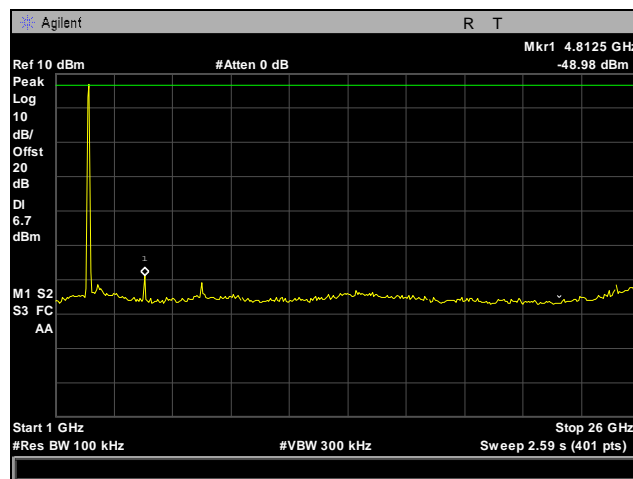


Plot 124. Conducted Spurious Emissions, High Channel, 802.11n 20 MHz, Port 1, 2462 MHz, 1 GHz – 26 GHz

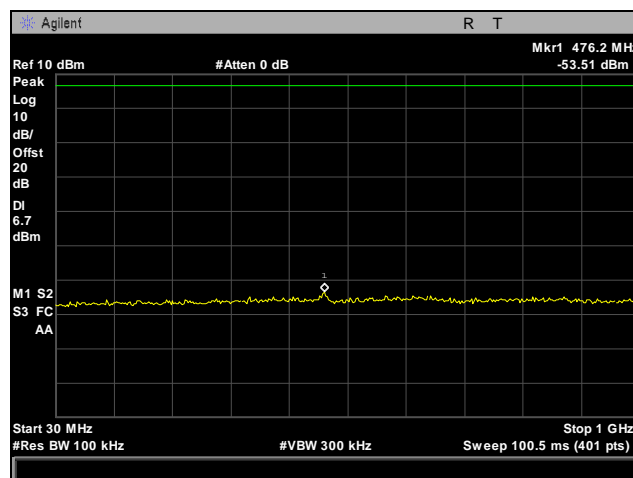
### Conducted Spurious Emissions Test Results, 802.11n 20 MHz, Port 2, 2.4 GHz



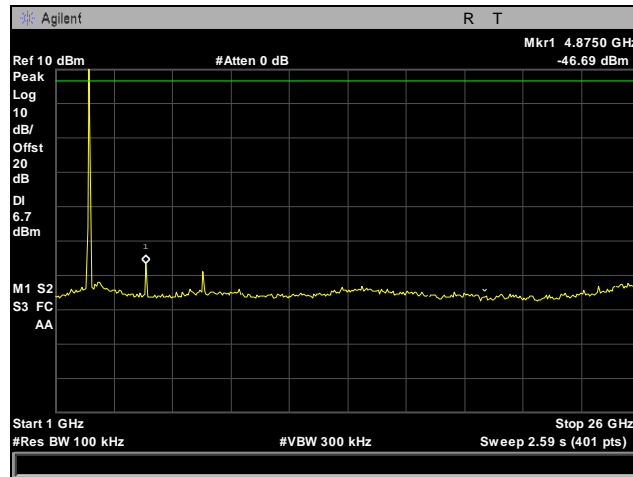
Plot 125. Conducted Spurious Emissions, Low Channel, 802.11n 20 MHz, Port 2, 2412 MHz, 30 MHz – 1 GHz



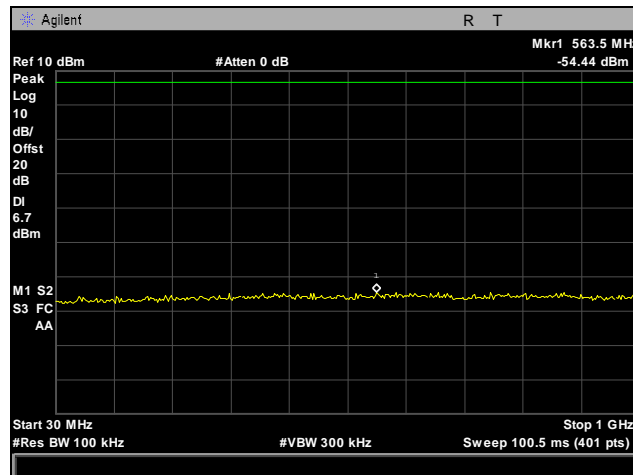
Plot 126. Conducted Spurious Emissions, Low Channel, 802.11n 20 MHz, Port 2, 2412 MHz, 1 GHz – 26 GHz



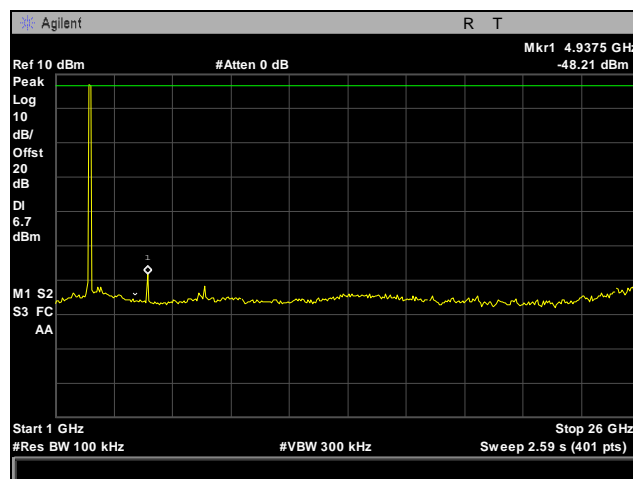
Plot 127. Conducted Spurious Emissions, Mid Channel, 802.11n 20 MHz, Port 2, 2437 MHz, 30 MHz – 1 GHz



Plot 128. Conducted Spurious Emissions, Mid Channel, 802.11n 20 MHz, Port 2, 2437 MHz, 1 GHz – 26 GHz

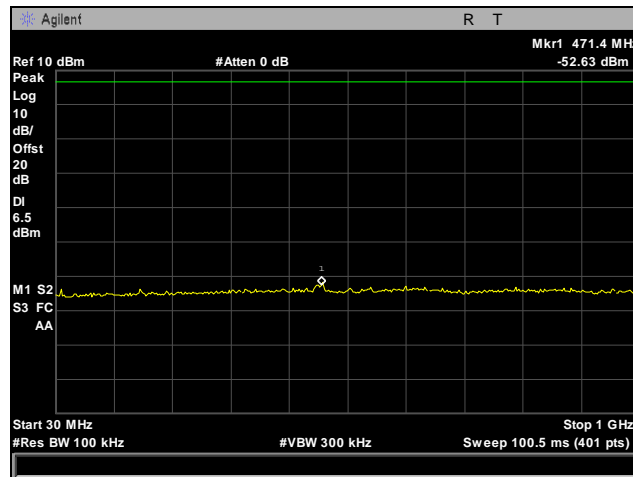


Plot 129. Conducted Spurious Emissions, High Channel, 802.11n 20 MHz, Port 2, 2462 MHz, 30 MHz – 1 GHz

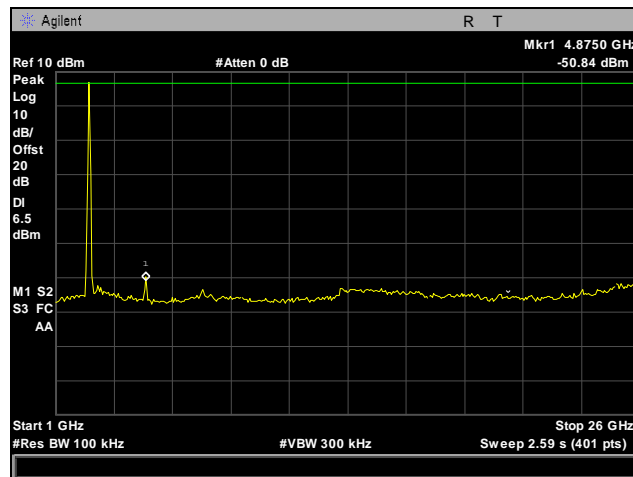


Plot 130. Conducted Spurious Emissions, High Channel, 802.11n 20 MHz, Port 2, 2462 MHz, 1 GHz – 26 GHz

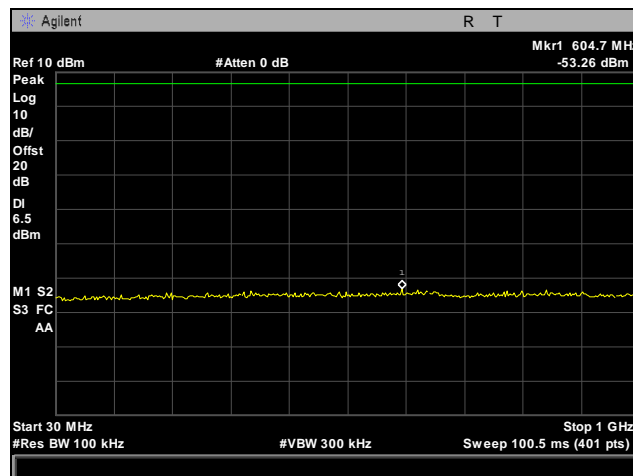
### Conducted Spurious Emissions Test Results, 802.11n 40 MHz, Port 1, 2.4 GHz



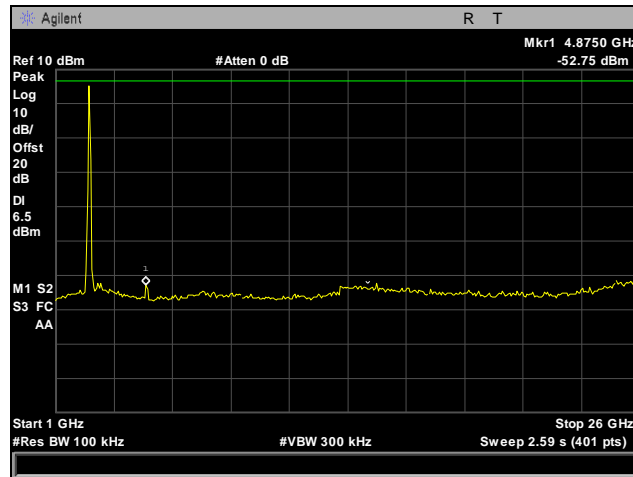
Plot 131. Conducted Spurious Emissions, Low Channel, 802.11n 40 MHz, Port 1, 2422 MHz, 30 MHz – 1 GHz



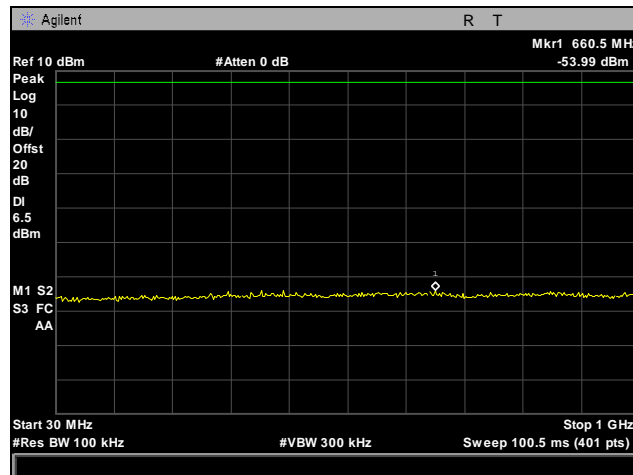
Plot 132. Conducted Spurious Emissions, Low Channel, 802.11n 40 MHz, Port 1, 2422 MHz, 1 GHz – 26 GHz



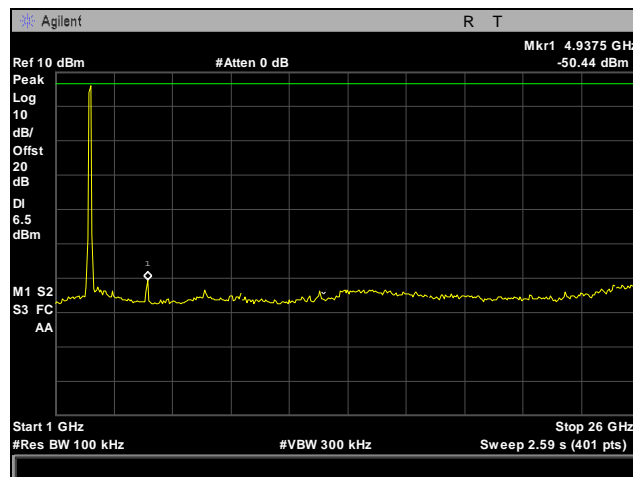
Plot 133. Conducted Spurious Emissions, Mid Channel, 802.11n 40 MHz, Port 1, 2437 MHz, 30 MHz – 1 GHz



Plot 134. Conducted Spurious Emissions, Mid Channel, 802.11n 40 MHz, Port 1, 2437 MHz, 1 GHz – 26 GHz

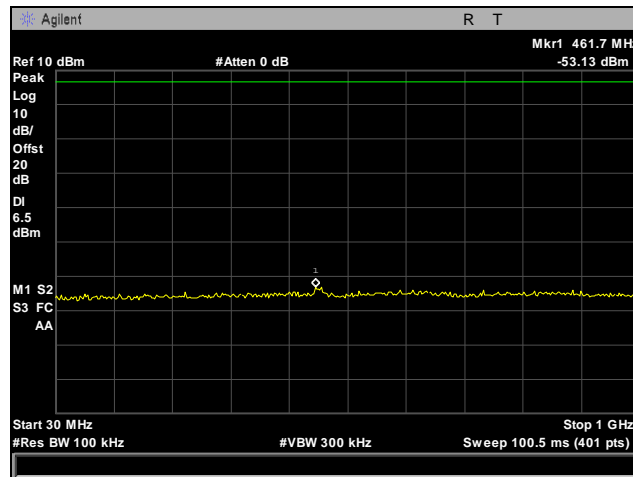


Plot 135. Conducted Spurious Emissions, High Channel, 802.11n 40 MHz, Port 1, 2452 MHz, 30 MHz – 1 GHz

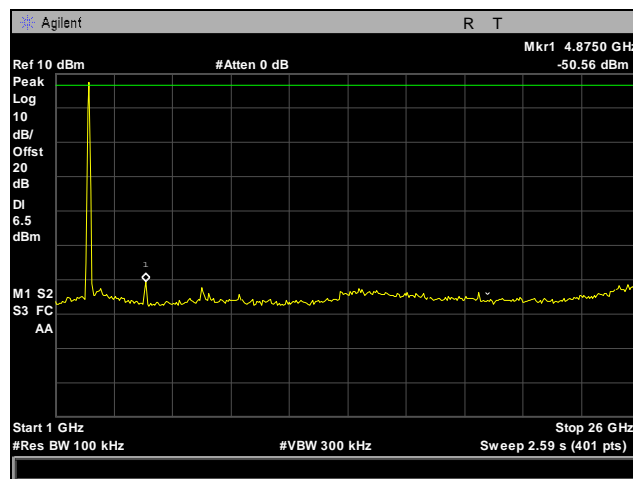


Plot 136. Conducted Spurious Emissions, High Channel, 802.11n 40 MHz, Port 1, 2452 MHz, 1 GHz – 26 GHz

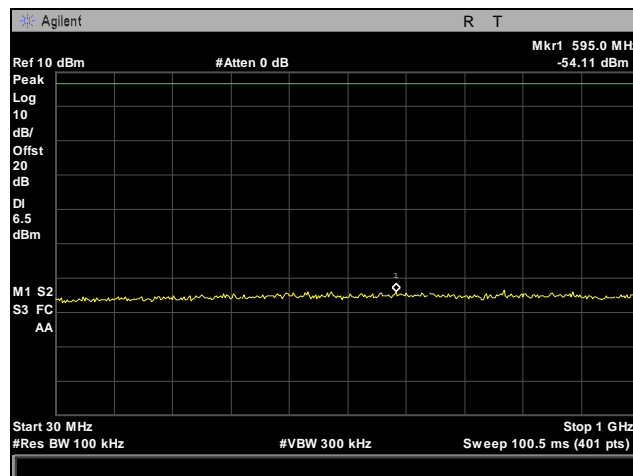
**Conducted Spurious Emissions Test Results, 802.11n 40 MHz, Port 2, 2.4 GHz**



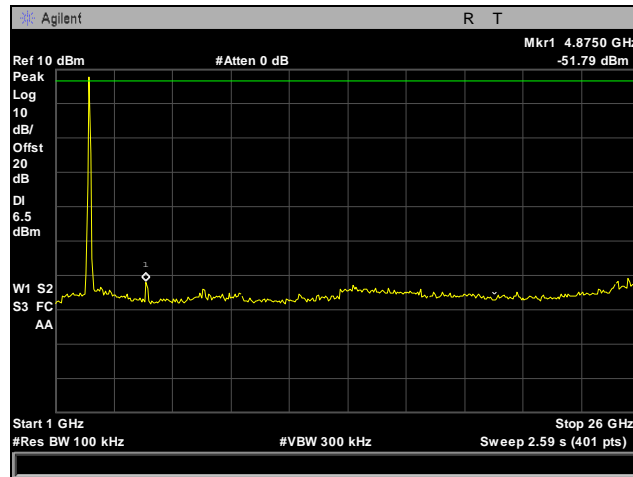
**Plot 137. Conducted Spurious Emissions, Low Channel, 802.11n 40 MHz, Port 2, 2422 MHz, 30 MHz – 1 GHz**



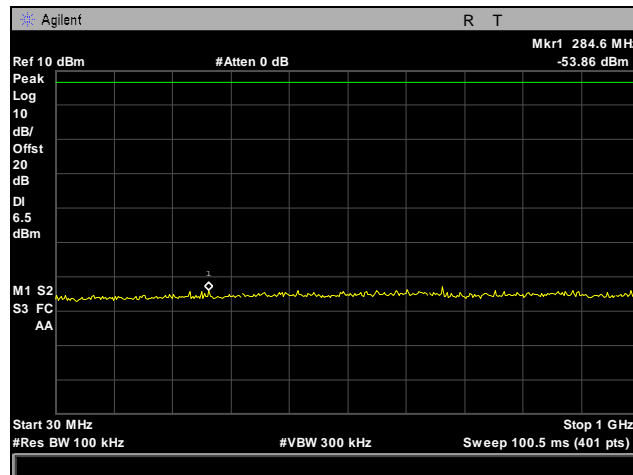
**Plot 138. Conducted Spurious Emissions, Low Channel, 802.11n 40 MHz, Port 2, 2422 MHz, 1 GHz – 26 GHz**



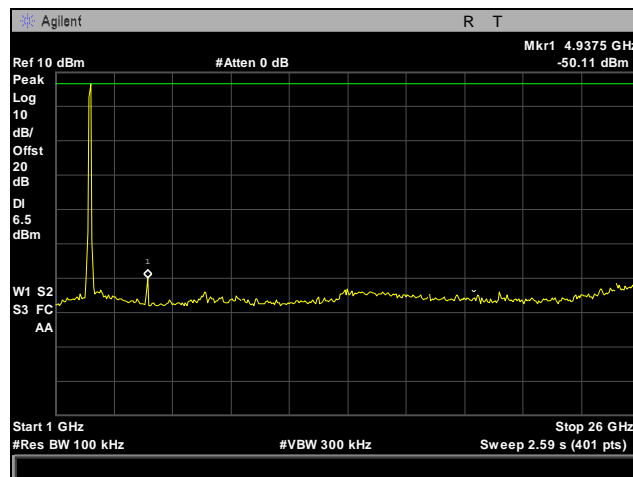
**Plot 139. Conducted Spurious Emissions, Mid Channel, 802.11n 40 MHz, Port 2, 2437 MHz, 30 MHz – 1 GHz**



Plot 140. Conducted Spurious Emissions, Mid Channel, 802.11n 40 MHz, Port 2, 2437 MHz, 1 GHz – 26 GHz

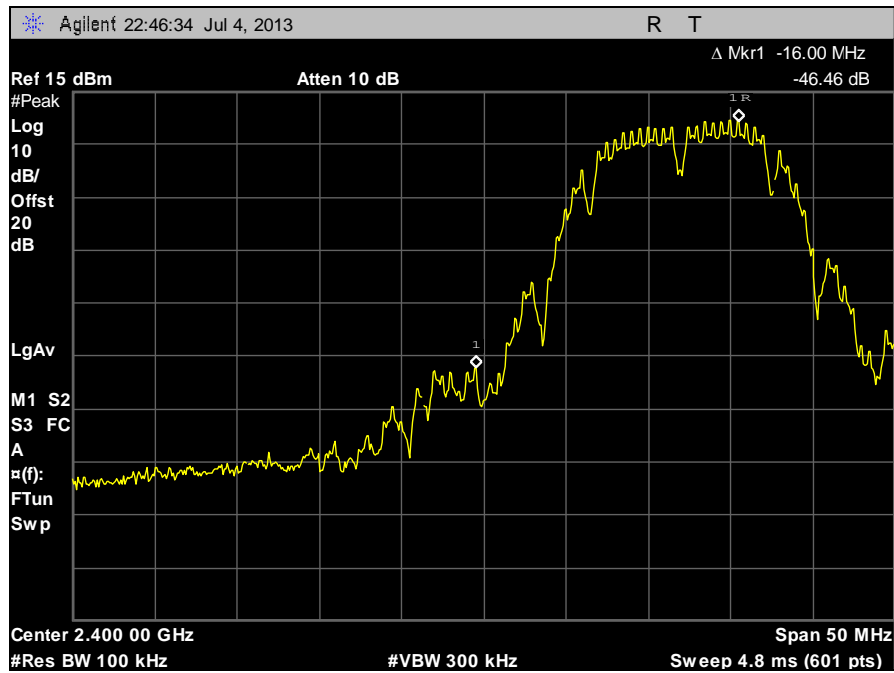


Plot 141. Conducted Spurious Emissions, High Channel, 802.11n 40 MHz, Port 2, 2452 MHz, 30 MHz – 1 GHz

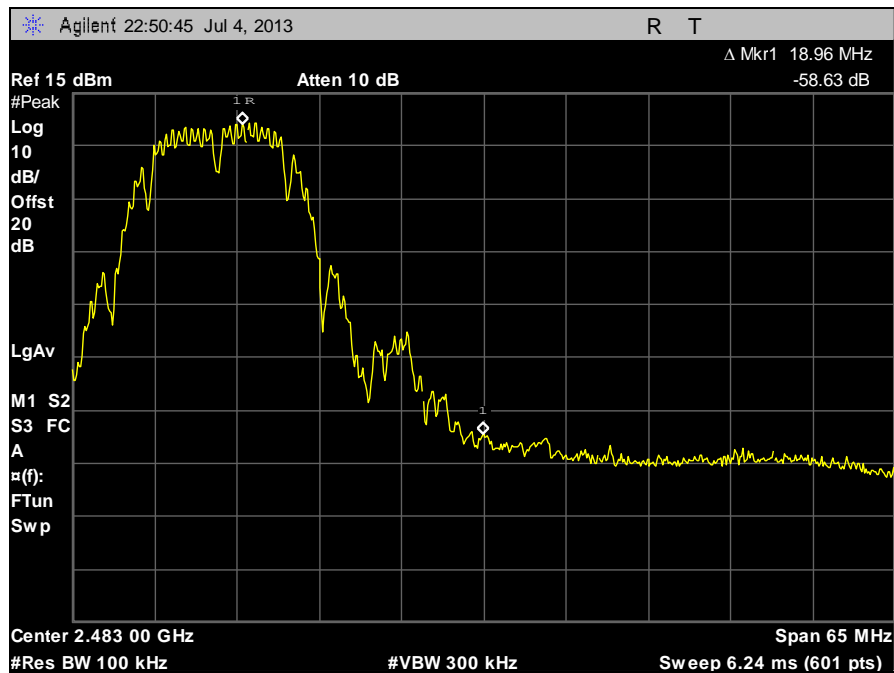


Plot 142. Conducted Spurious Emissions, High Channel, 802.11n 40 MHz, Port 2, 2452 MHz, 1 GHz – 26 GHz

### Conducted Band Edge Test Results, 802.11b, 2.4 GHz



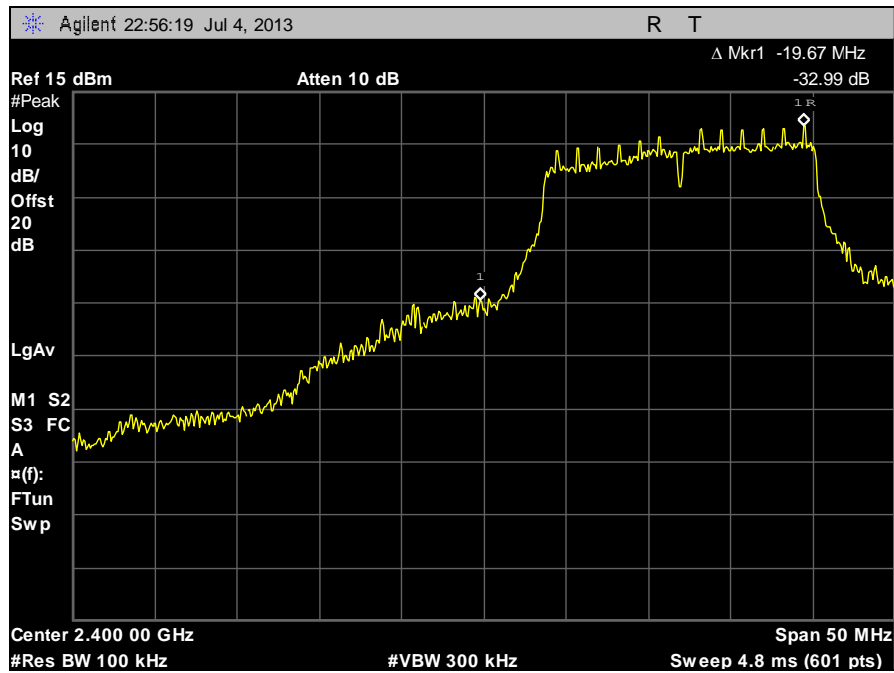
Plot 143. Conducted Band Edge, 802.11b, 2412 MHz



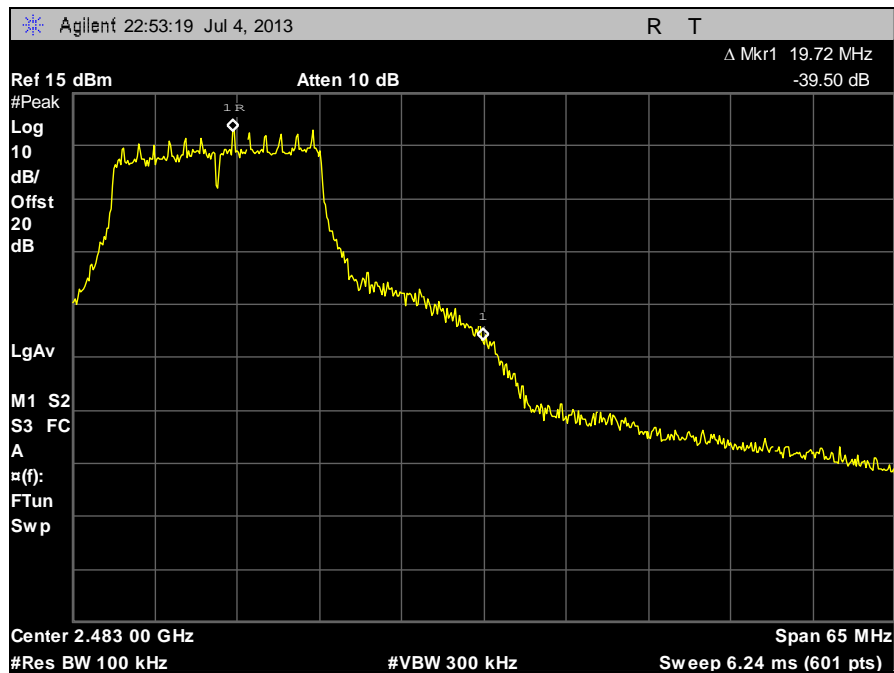
Plot 144. Conducted Band Edge, 802.11b, 2462 MHz



### Conducted Band Edge Test Results, 802.11g, 2.4 GHz

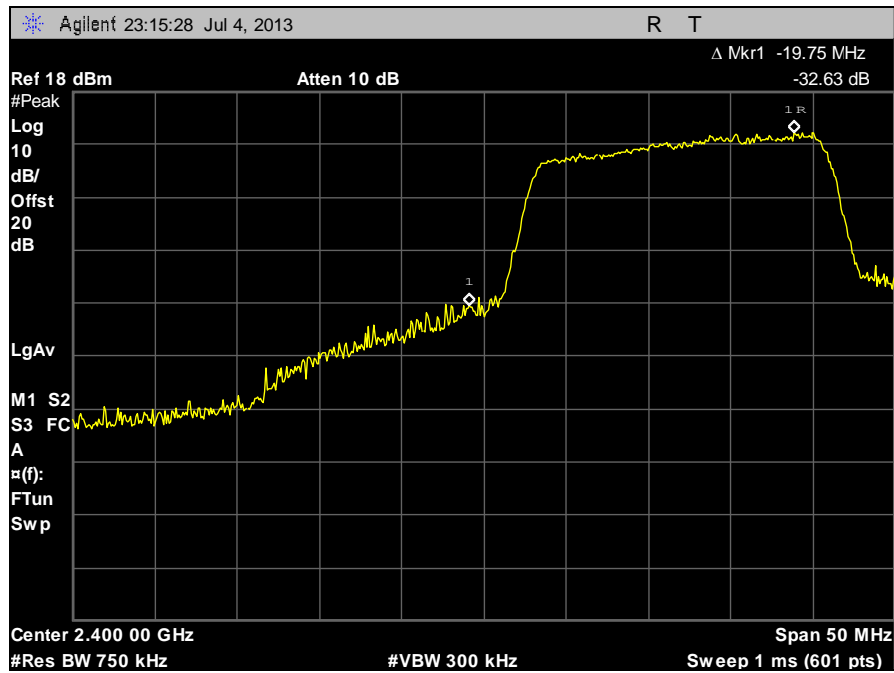


Plot 145. Conducted Band Edge, 802.11g, 2412 MHz

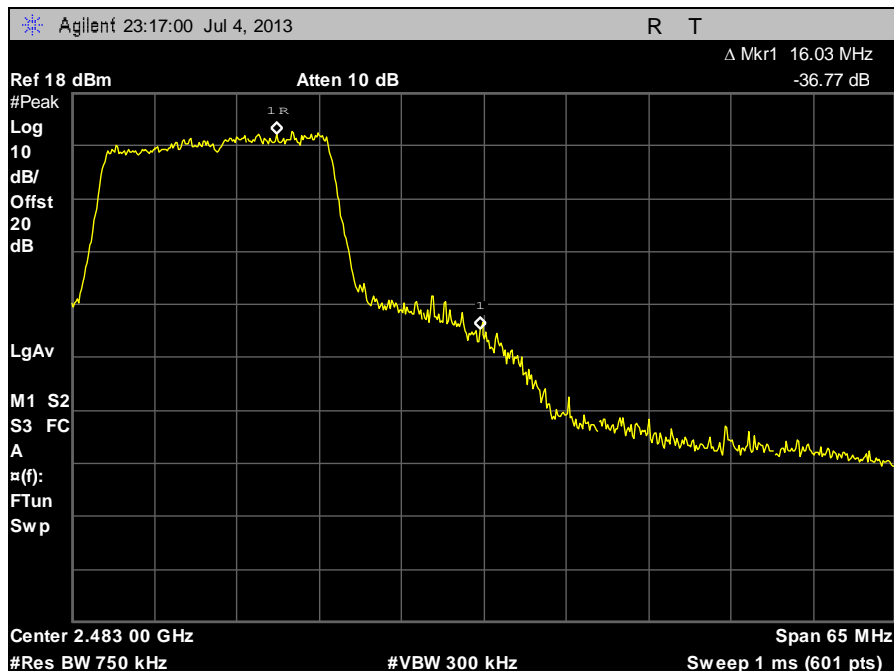


Plot 146. Conducted Band Edge, 802.11g, 2462 MHz

### Conducted Band Edge Test Results, 802.11n 20 MHz, Port 1, 2.4 GHz

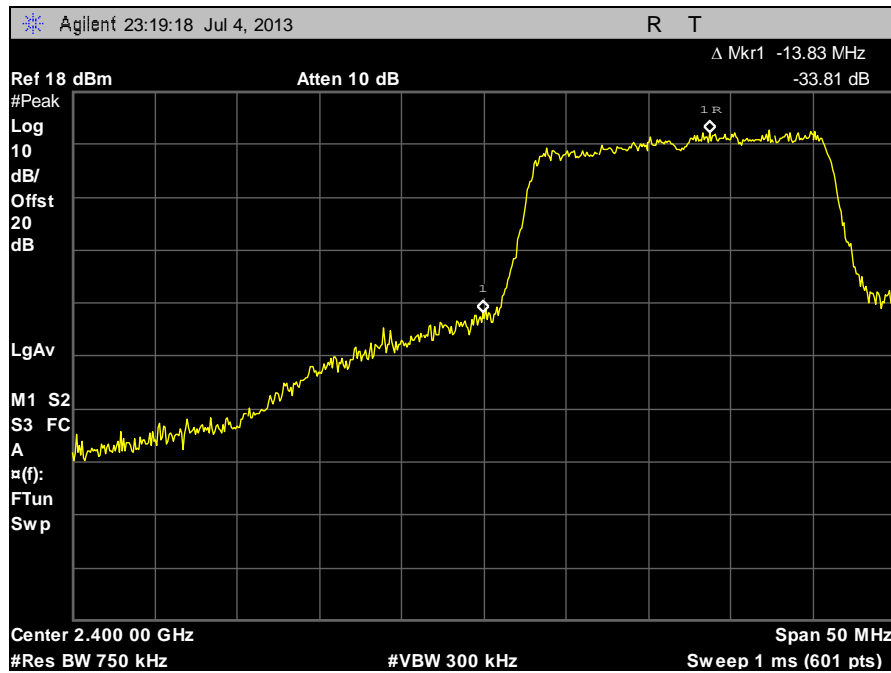


Plot 147. Conducted Band Edge, 802.11n 20 MHz, Port 1, 2412 MHz

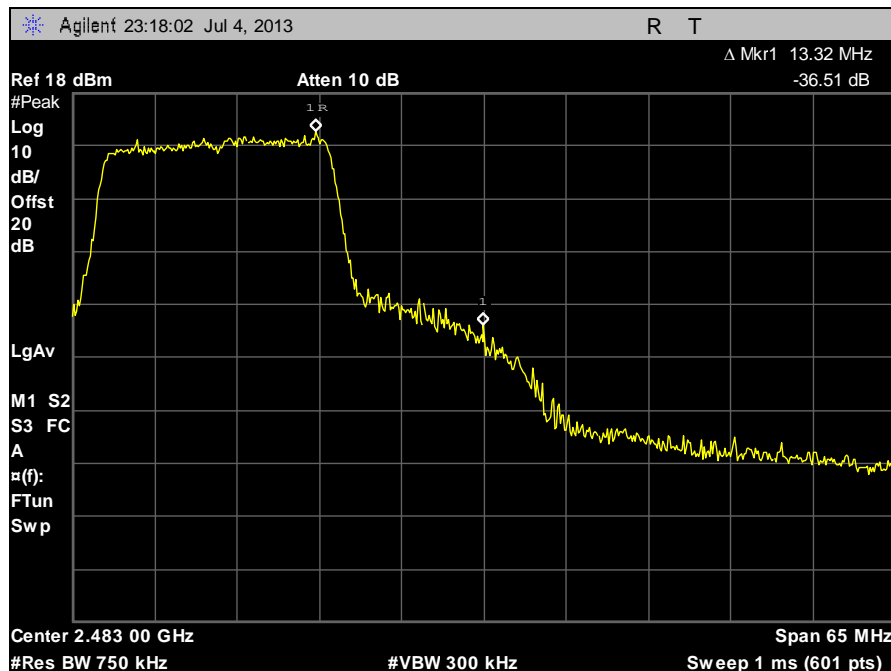


Plot 148. Conducted Band Edge, 802.11n 20 MHz, Port 1, 2462 MHz

**Conducted Band Edge Test Results, 802.11n 20 MHz, Port 2, 2.4 GHz**

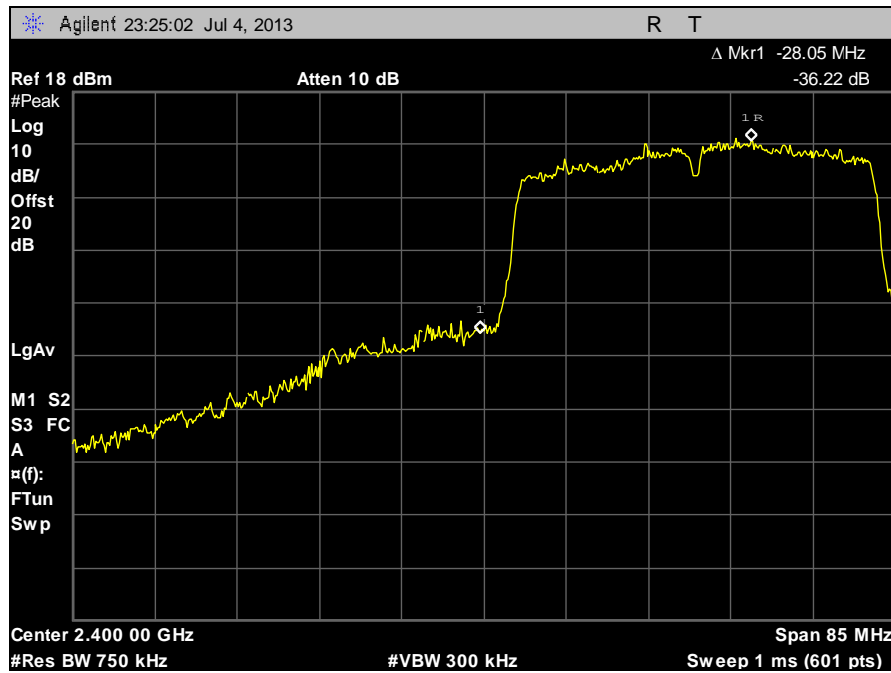


**Plot 149. Conducted Band Edge, 802.11n 20 MHz, Port 2, 2412 MHz**

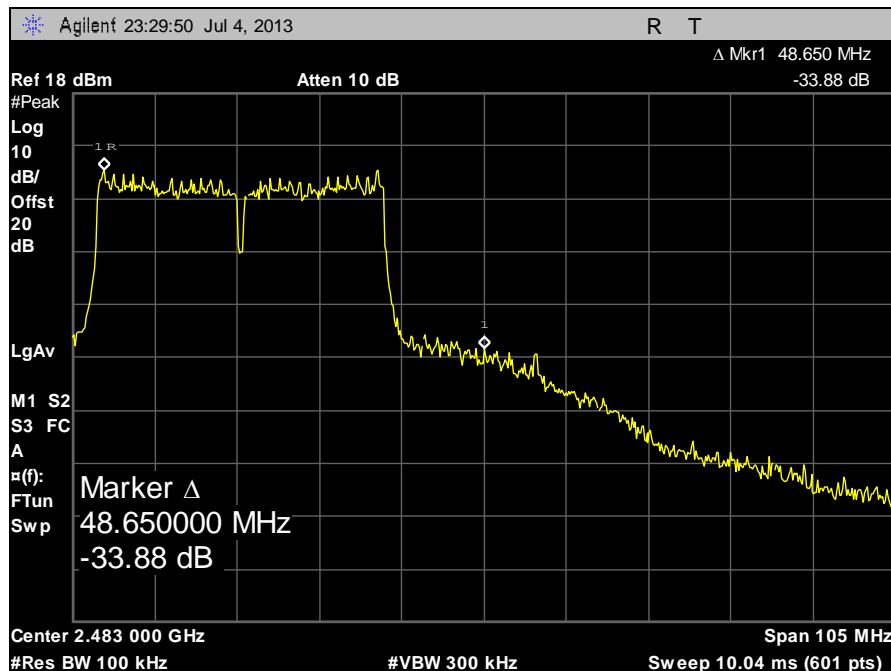


**Plot 150. Conducted Band Edge, 802.11n 20 MHz, Port 2, 2462 MHz**

**Conducted Band Edge Test Results, 802.11n 40 MHz, Port 1, 2.4 GHz**

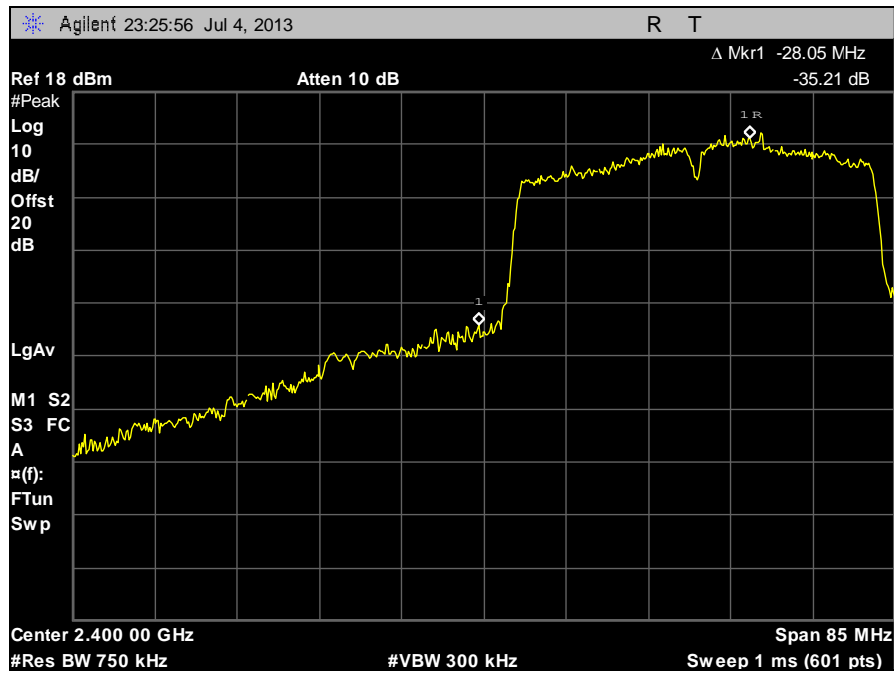


**Plot 151. Conducted Band Edge, 802.11n 40 MHz, Port 1, 2422 MHz**

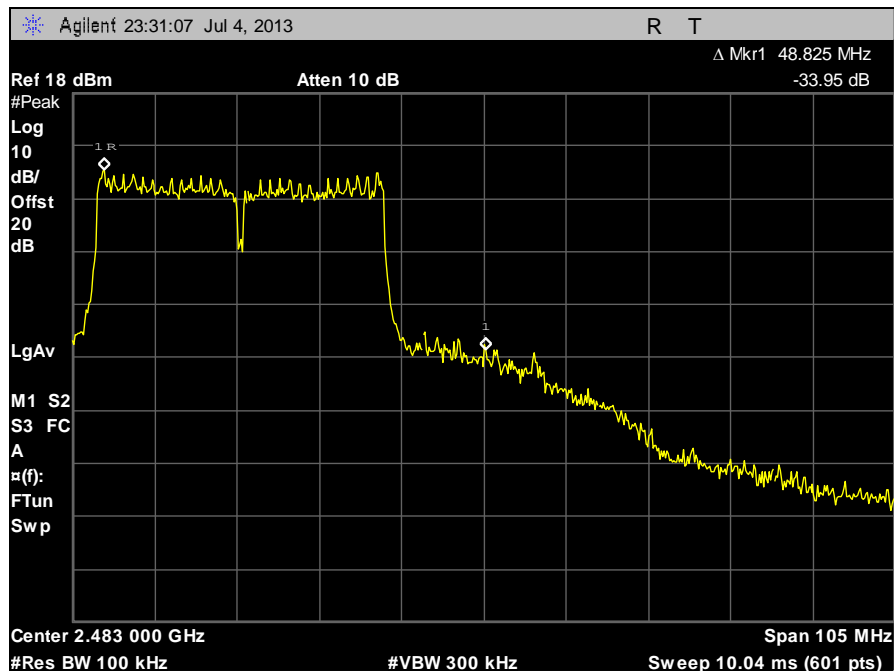


**Plot 152. Conducted Band Edge, 802.11n 40 MHz, Port 1, 2452 MHz**

### Conducted Band Edge Test Results, 802.11n 40 MHz, Port 2, 2.4 GHz



Plot 153. Conducted Band Edge, 802.11n 40 MHz, Port 2, 2422 MHz



Plot 154. Conducted Band Edge, 802.11n 40 MHz, Port 2, 2452 MHz

## Electromagnetic Compatibility Criteria for Intentional Radiators

### § 15.247(e) Peak Power Spectral Density

**Test Requirements:** §15.247(e): For digitally modulated systems, the peak power spectral density conducted from the intentional radiator to the antenna shall not be greater than 8dBm in any 3 kHz band during any time interval of continuous transmission.

**Test Procedure:** The transmitter was connected directly to a Spectrum Analyzer through an attenuator. The power level was set to the maximum level. A RBW of 1 MHz and VBW of 3 MHz were used to determine the peak emissions within the band. The Spectrum analyzer was then set to a RBW of 3 kHz and VBW was set to 10 kHz. The SPAN of the analyzer was set to 1 MHz with a 333.3 second sweep. Measurements were carried out at the low, mid and high channels.

**Test Results:** The EUT was compliant with the peak power spectral density limits of § 15.247 (e).

The peak power spectral density was determined from plots on the following page(s).

**Test Engineer:** Andy Shen

**Test Date:** 09/04/14

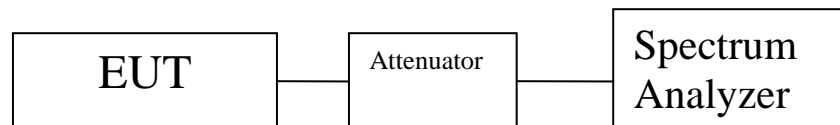


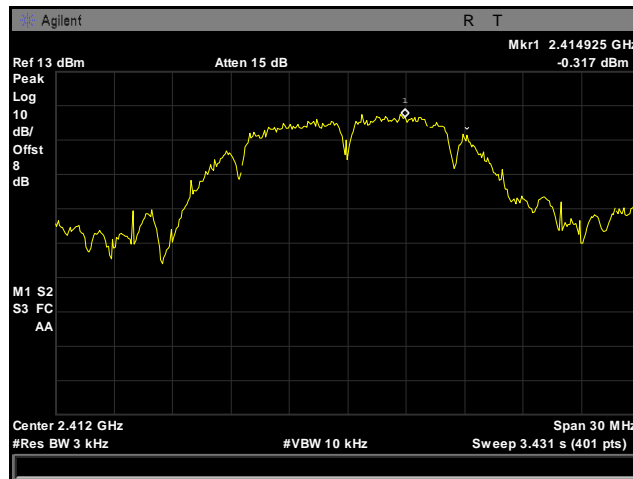
Figure 5. Block Diagram, Peak Power Spectral Density Test Setup

## Peak Power Spectral Density Test Results

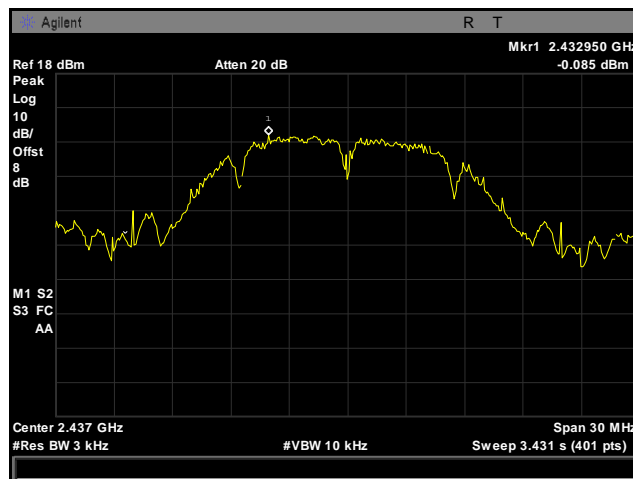
Peak Power Spectral Density					
	Carrier Channel	Frequency (MHz)	Measured PPSD (dBm)	Limit (dBm)	Margin (dB)
802.11b	Low	2412.00	-0.71	8.00	-8.71
	Mid	2437.00	0.09	8.00	-7.92
	High	2462.00	-1.82	8.00	-9.82
802.11g	Low	2412.00	-2.98	8.00	-10.98
	Mid	2437.00	-2.01	8.00	-10.01
	High	2462.00	-4.72	8.00	-12.72
802.11n 20 MHz Port 1	Low	2412.00	-2.84	5.00	-7.84
	Mid	2437.00	-1.37	5.00	-6.37
	High	2462.00	-2.61	5.00	-7.61
802.11n 20 MHz Port 2	Low	2412.00	-2.42	5.00	-7.42
	Mid	2437.00	-2.77	5.00	-7.77
	High	2462.00	-2.89	5.00	-7.89
802.11n 20 MHz Summed	Low	2422.00	0.39	8.00	-7.61
	Mid	2437.00	1.00	8.00	-7.00
	High	2452.00	0.27	8.00	-7.73
802.11n 40 MHz Port 1	Low	2422.00	-5.59	5.00	-10.59
	Mid	2437.00	-5.34	5.00	-10.34
	High	2452.00	-6.33	5.00	-11.33
802.11n 40 MHz Port 2	Low	2422.00	-5.47	5.00	-10.47
	Mid	2437.00	-5.46	5.00	-10.46
	High	2452.00	-5.39	5.00	-10.39
802.11n 40 MHz Summed	Low	2422.00	-2.52	8.01	-10.53
	Mid	2437.00	-2.39	8.01	-10.40
	High	2452.00	-2.82	8.01	-10.83

Table 28. Peak Power Spectral Density, Test Results, 2.4 GHz

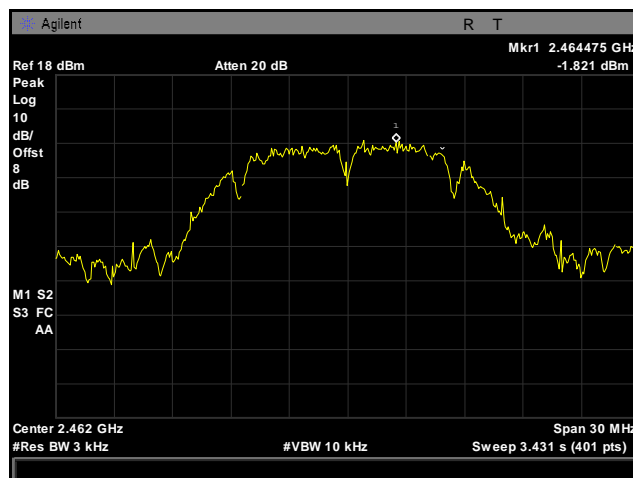
### Peak Power Spectral Density, 802.11b, 2.4 GHz



Plot 155. Peak Power Spectral Density, Low Channel, 802.11b, 2412 MHz



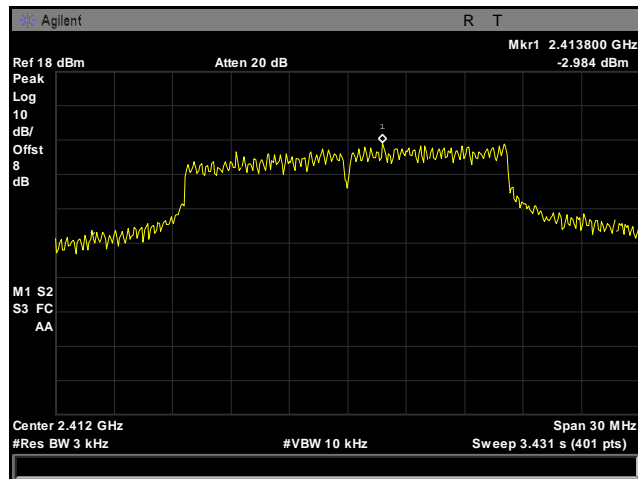
Plot 156. Peak Power Spectral Density, Mid Channel, 802.11b, 2437 MHz



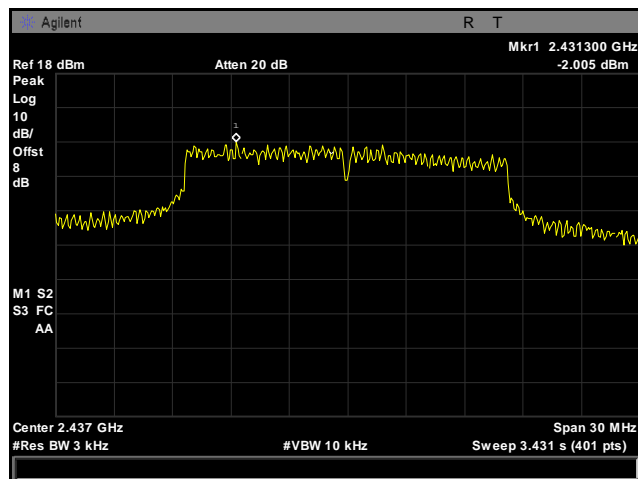
Plot 157. Peak Power Spectral Density, High Channel, 802.11b, 2462 MHz



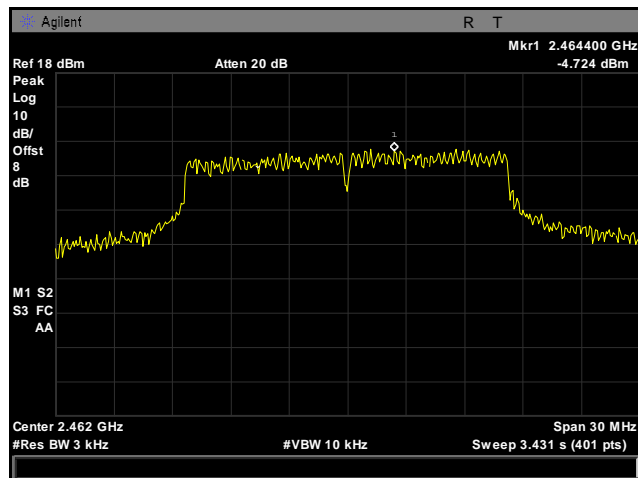
**Peak Power Spectral Density, 802.11g, 2.4 GHz**



**Plot 158. Peak Power Spectral Density, Low Channel, 802.11g, 2412 MHz**

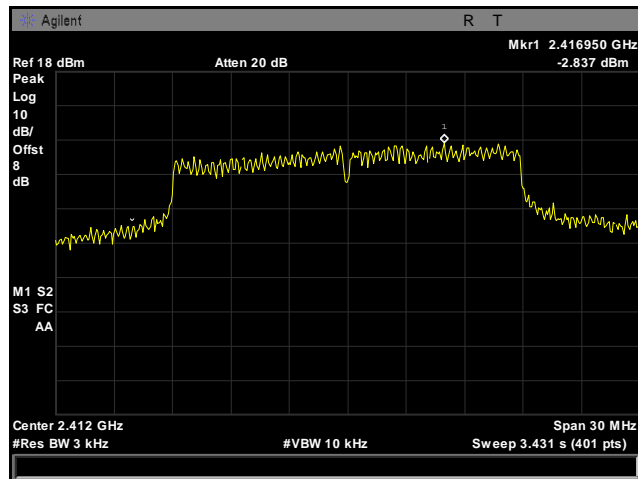


**Plot 159. Peak Power Spectral Density, Mid Channel, 802.11g, 2437 MHz**

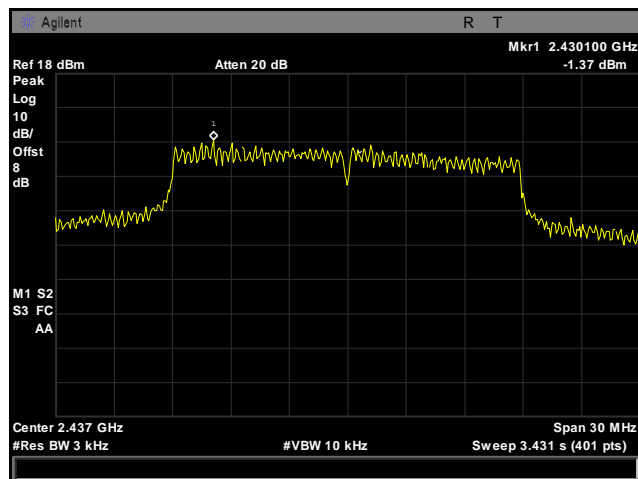


**Plot 160. Peak Power Spectral Density, High Channel, 802.11g, 2462 MHz**

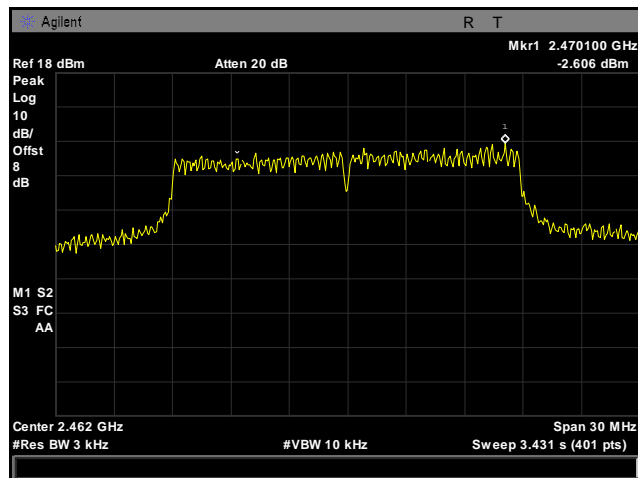
**Peak Power Spectral Density, 802.11n 20 MHz, Port 1, 2.4 GHz**



**Plot 161. Peak Power Spectral Density, Low Channel, 802.11n 20 MHz, Port 1, 2412 MHz**

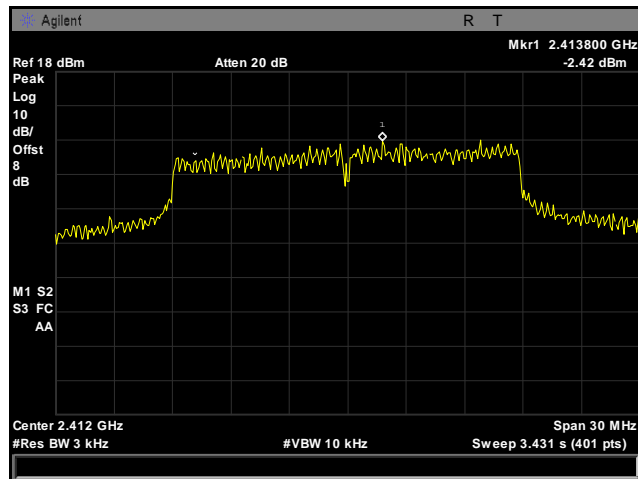


**Plot 162. Peak Power Spectral Density, Mid Channel, 802.11n 20 MHz, Port 1, 2437 MHz**

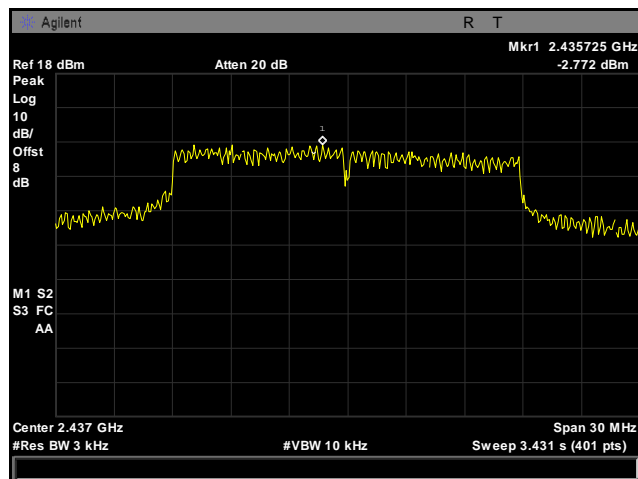


**Plot 163. Peak Power Spectral Density, High Channel, 802.11n 20 MHz, Port 1, 2462 MHz**

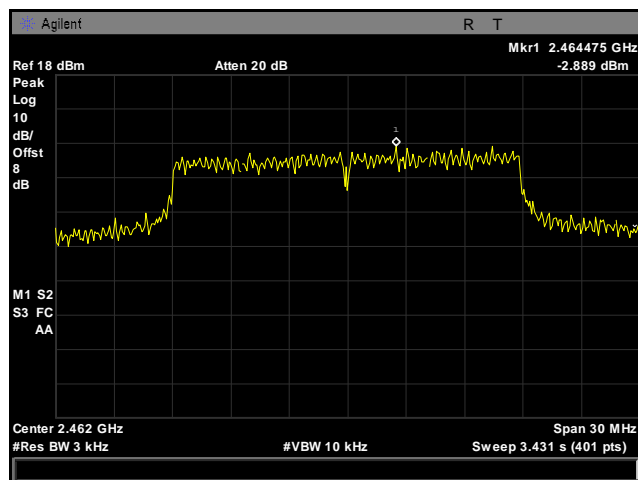
**Peak Power Spectral Density, 802.11n 20 MHz, Port 2, 2.4 GHz**



**Plot 164. Peak Power Spectral Density, Low Channel, 802.11n 20 MHz, Port 2, 2412 MHz**

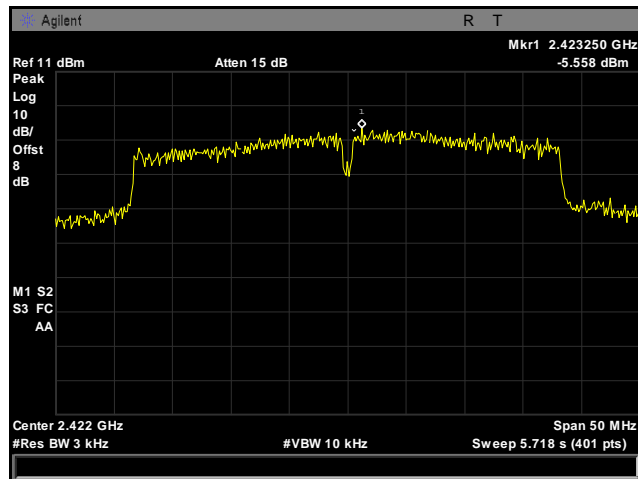


**Plot 165. Peak Power Spectral Density, Mid Channel, 802.11n 20 MHz, Port 2, 2437 MHz**

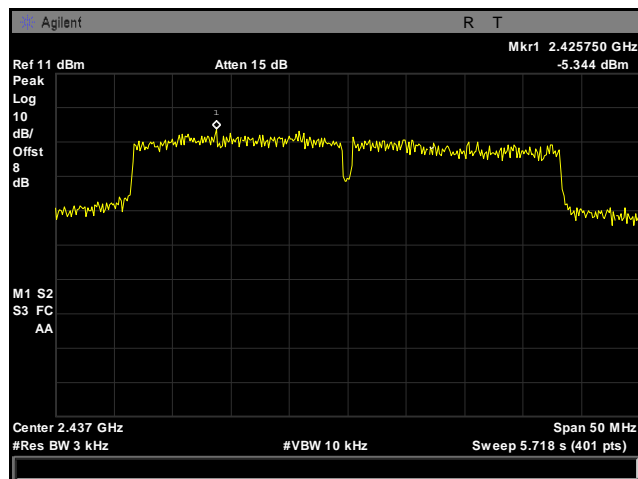


**Plot 166. Peak Power Spectral Density, High Channel, 802.11n 20 MHz, Port 2, 2462 MHz**

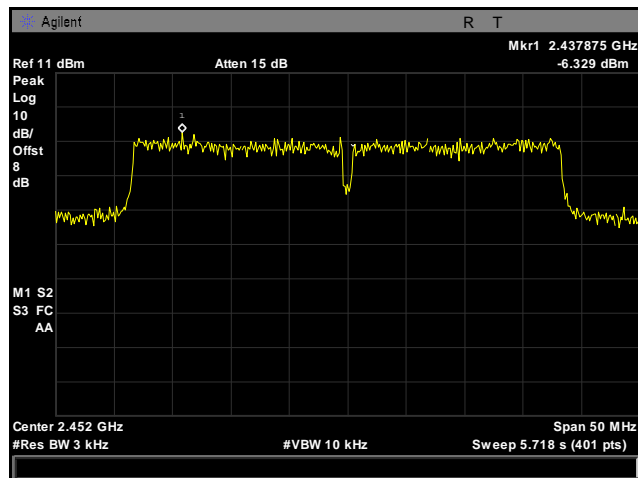
**Peak Power Spectral Density, 802.11n 40 MHz, Port 1, 2.4 GHz**



**Plot 167. Peak Power Spectral Density, Low Channel, 802.11n 40 MHz, Port 1, 2422 MHz**

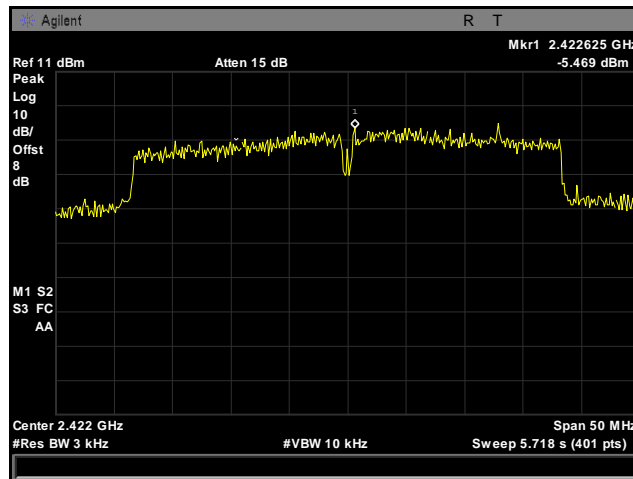


**Plot 168. Peak Power Spectral Density, Mid Channel, 802.11n 40 MHz, Port 1, 2437 MHz**

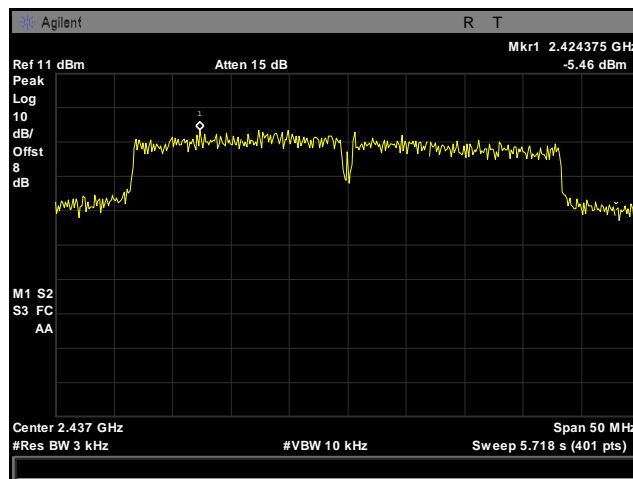


**Plot 169. Peak Power Spectral Density, High Channel, 802.11n 40 MHz, Port 1, 2452 MHz**

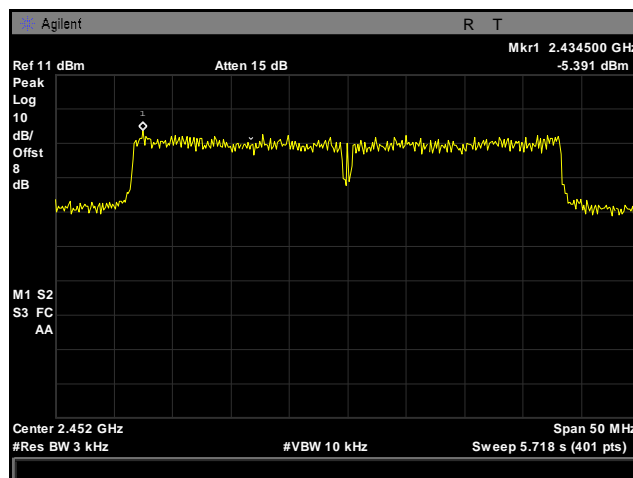
**Peak Power Spectral Density, 802.11n 40 MHz, Port 2, 2.4 GHz**



**Plot 170. Peak Power Spectral Density, Low Channel, 802.11n 40 MHz, Port 2, 2422 MHz**



**Plot 171. Peak Power Spectral Density, Mid Channel, 802.11n 40 MHz, Port 2, 2437 MHz**



**Plot 172. Peak Power Spectral Density, High Channel, 802.11n 40 MHz, Port 2, 2452 MHz**

## Electromagnetic Compatibility Criteria for Intentional Radiators

### § 15.247(i) Maximum Permissible Exposure

**RF Exposure Requirements:** §1.1307(b)(1) and §1.1307(b)(2): Systems operating under the provisions of this section shall be operated in a manner that ensures that the public is not exposed to radio frequency energy levels in excess of the Commission’s guidelines.

**RF Radiation Exposure Limit:** §1.1310: As specified in this section, the Maximum Permissible Exposure (MPE) Limit shall be used to evaluate the environmental impact of human exposure to radiofrequency (RF) radiation as specified in Sec. 1.1307(b), except in the case of portable devices which shall be evaluated according to the provisions of Sec. 2.1093 of this chapter.

MPE Limit Calculation: EUT’s operating frequencies @ 2400-2483.5 MHz; highest conducted power = 29.32dBm (peak) therefore, **Limit for Uncontrolled exposure: 1 mW/cm<sup>2</sup> or 10 W/m<sup>2</sup>**

**2.4 GHz highest power density:**

EUT antenna gain = 3 + 10log (2) = 6.01 dBi (3.99 linear); power = 855 mW

Equation from page 18 of OET 65, Edition 97-01

$$S = PG / 4\pi R^2 \quad \text{or} \quad R = \sqrt{PG / 4\pi S}$$

where, S = Power Density

P = Power Input to antenna

G = Antenna Gain

R = 25 cm

$$S = (855 * 3.99 / 4 * 3.14 * 625) = 0.43 \text{ mW/cm}^2$$

**Co-location:**

Frequency Range	MPE Result (mW/cm <sup>2</sup> )	Limit (mW/cm <sup>2</sup> )
2.4GHz	0.43	1
5.745-5.805GHz	0.29	1

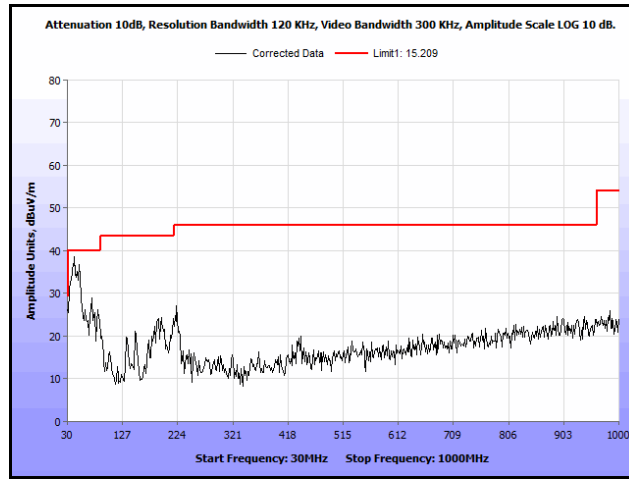
**Test Requirements:** [MPE(f1) / limit(f1) + MPE(f2) / limit(f2)] < 1

**Test Results:**

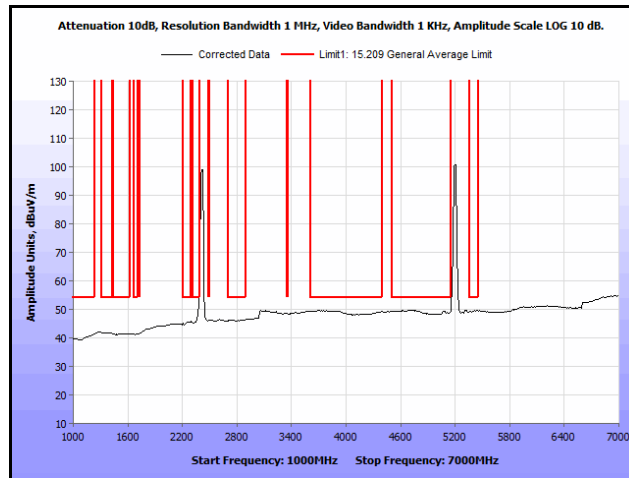
MPE(f1)	MPE(f2)	Calculation [MPE(f1) / limit(f1) + MPE(f2) / limit(f2)]	MPE Result (mW/cm <sup>2</sup> )
Frequency (MHZ)	Frequency (MHZ)		
2412 - 2462	5745-5825	0.43 / 1 + 0.29 / 1 = (0.43+ 0.29)	<b>0.72</b>

Therefore, the uncontrolled exposure limit is not exceeded at 25 cm.

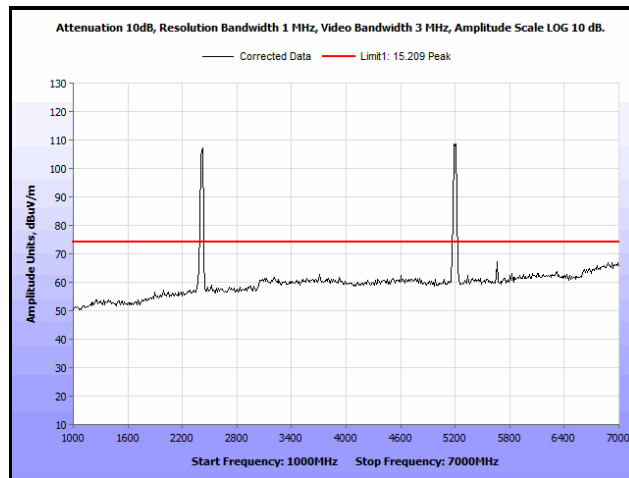
**Co-Location**



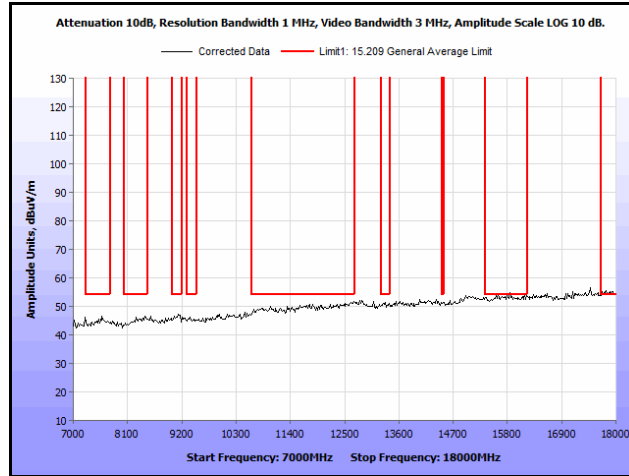
**Plot 173. Radiated Spurs, Co-Location, 802.11n 20 MHz, 2412 MHz & 5200 MHz, 30 MHz – 1 GHz, Peak**



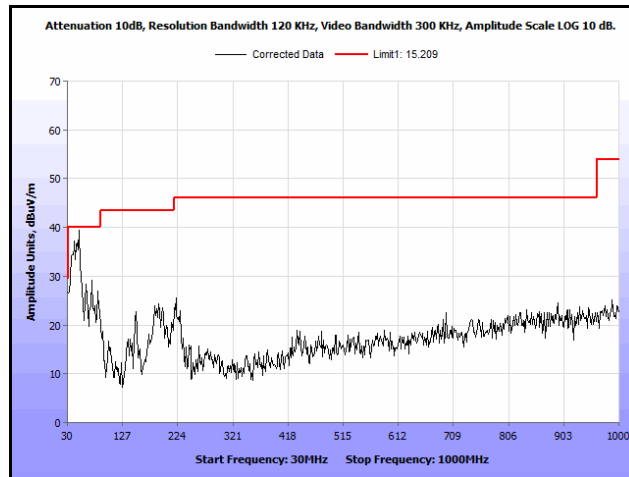
**Plot 174. Radiated Spurs, Co-Location, 802.11n 20 MHz, 2412 MHz & 5200 MHz, 1 GHz – 7 GHz, Avg.**



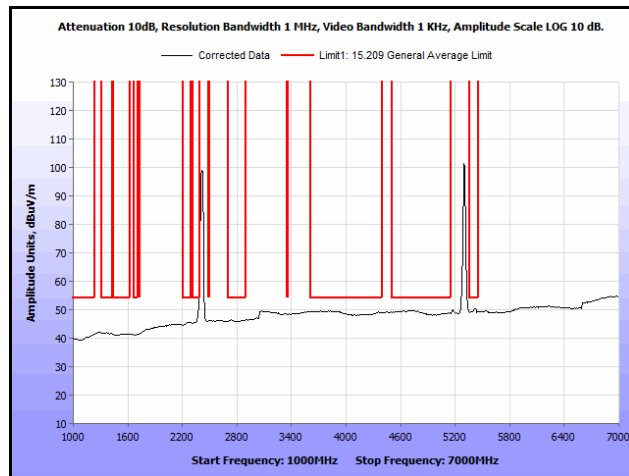
**Plot 175. Radiated Spurs, Co-Location, 802.11n 20 MHz, 2412 MHz & 5200 MHz, 1 GHz – 7 GHz, Peak**



Plot 176. Radiated Spurs, Co-Location, 802.11n 20 MHz, 2412 MHz & 5200 MHz, 7 GHz – 18 GHz

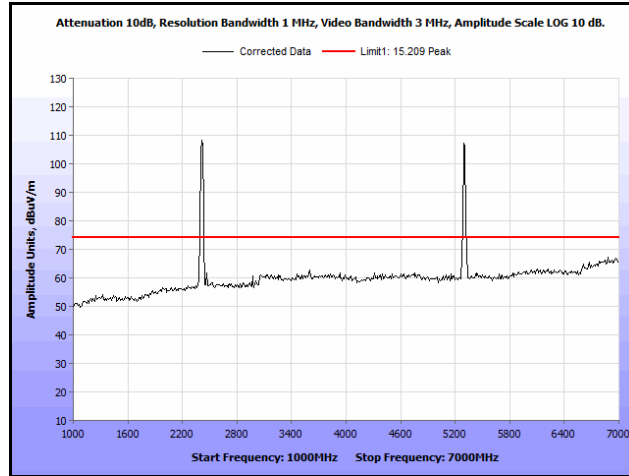


Plot 177. Radiated Spurs, Co-Location, 802.11n 20 MHz, 2412 MHz & 5300 MHz, 30 MHz – 1 GHz, Peak

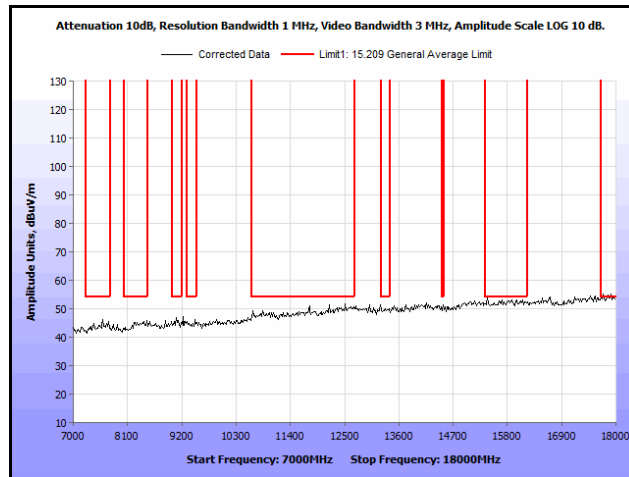


Plot 178. Radiated Spurs, Co-Location, 802.11n 20 MHz, 2412 MHz & 5300 MHz, 1 GHz – 7 GHz, Avg.

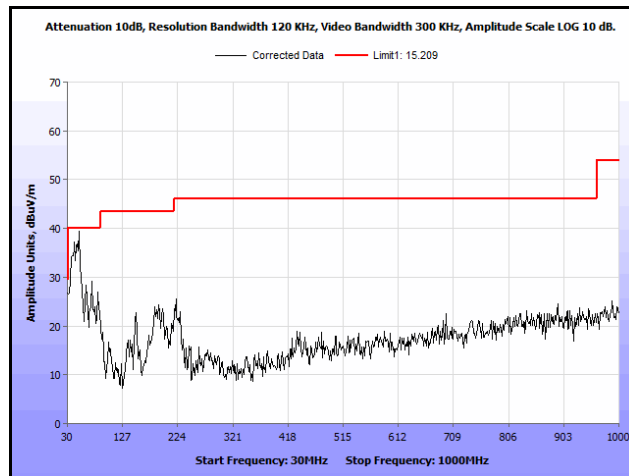




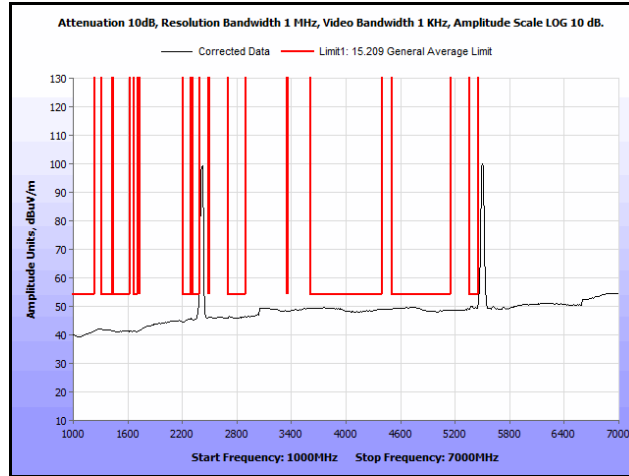
**Plot 179. Radiated Spurs, Co-Location, 802.11n 20 MHz, 2412 MHz & 5300 MHz, 1 GHz – 7 GHz, Peak**



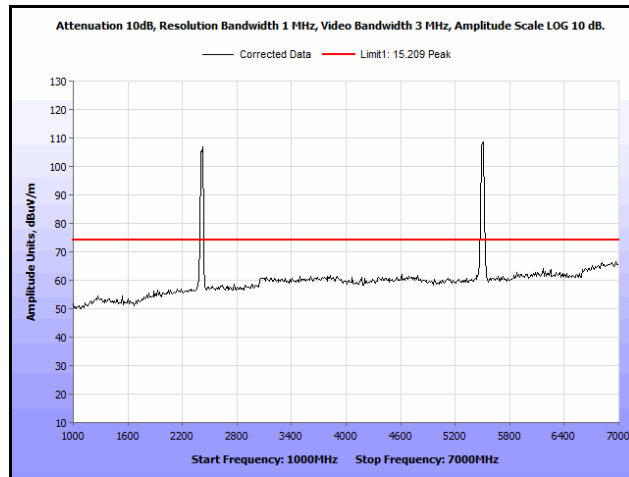
**Plot 180. Radiated Spurs, Co-Location, 802.11n 20 MHz, 2412 MHz & 5300 MHz, 7 GHz – 18 GHz, Peak**



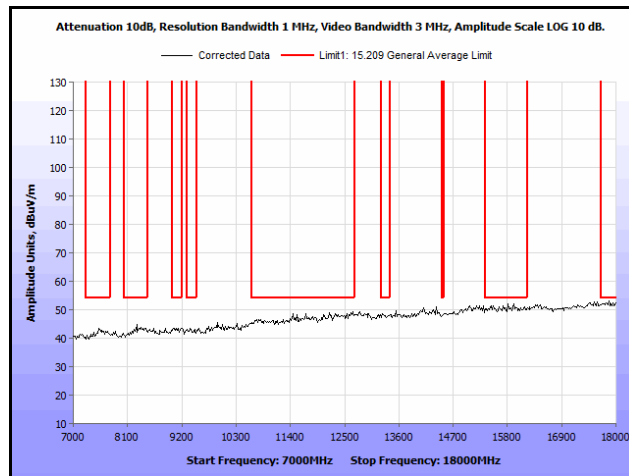
**Plot 181. Radiated Spurs, Co-Location, 802.11n 20 MHz, 2412 MHz & 5580 MHz, 30 MHz – 1 GHz, Peak**



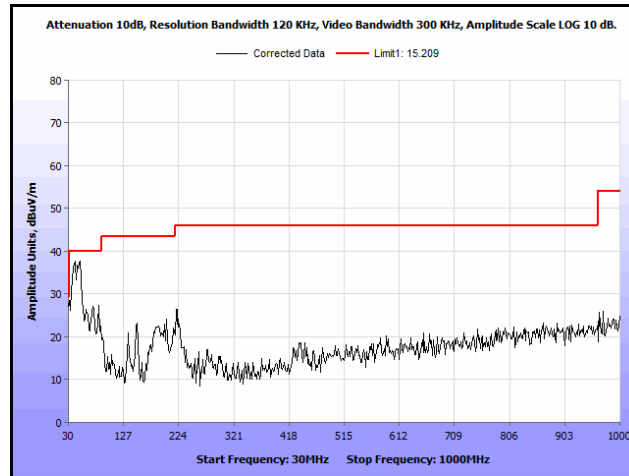
**Plot 182. Radiated Spurs, Co-Location, 802.11n 20 MHz, 2412 MHz & 5580 MHz, 1 GHz – 7 GHz, Avg.**



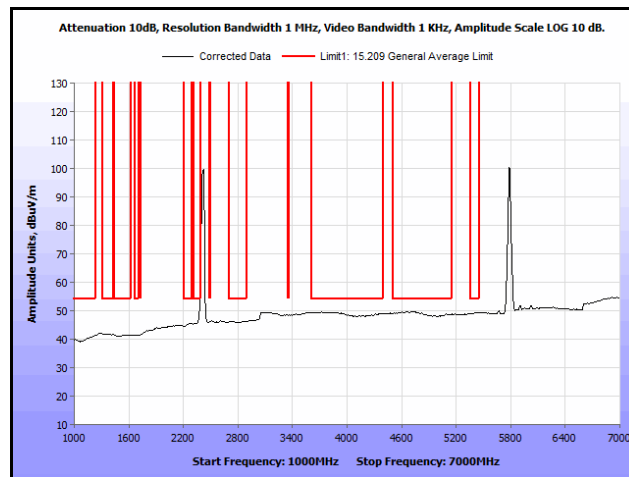
**Plot 183. Radiated Spurs, Co-Location, 802.11n 20 MHz, 2412 MHz & 5580 MHz, 1 GHz – 7 GHz, Peak**



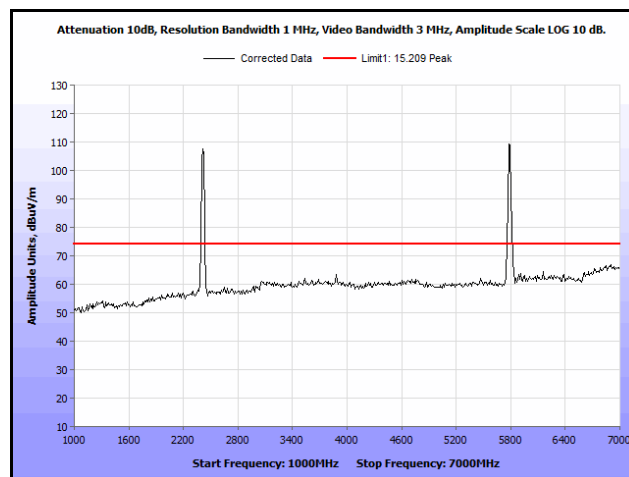
**Plot 184. Radiated Spurs, Co-Location, 802.11n 20 MHz, 2412 MHz & 5580 MHz, 7 GHz – 18 GHz, Peak**



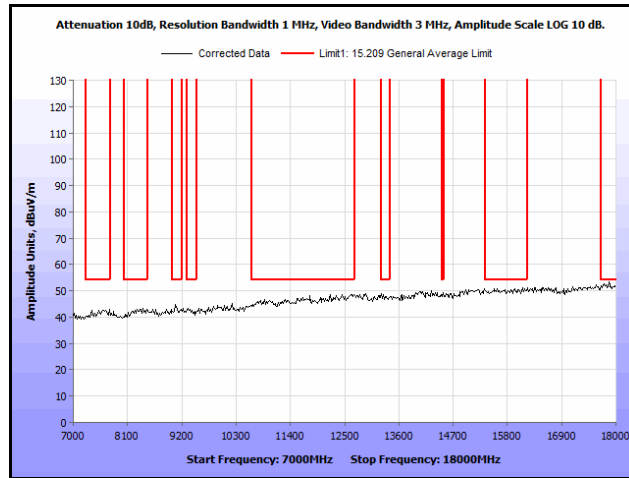
Plot 185. Radiated Spurs, Co-Location, 802.11n 20 MHz, 2412 MHz & 5785 MHz, 30 MHz – 1 GHz, Peak



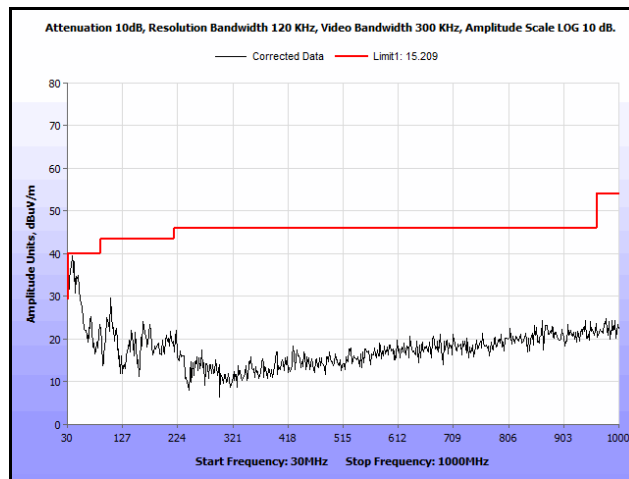
Plot 186. Radiated Spurs, Co-Location, 802.11n 20 MHz, 2412 MHz & 5785 MHz, 1 GHz – 7 GHz, Avg.



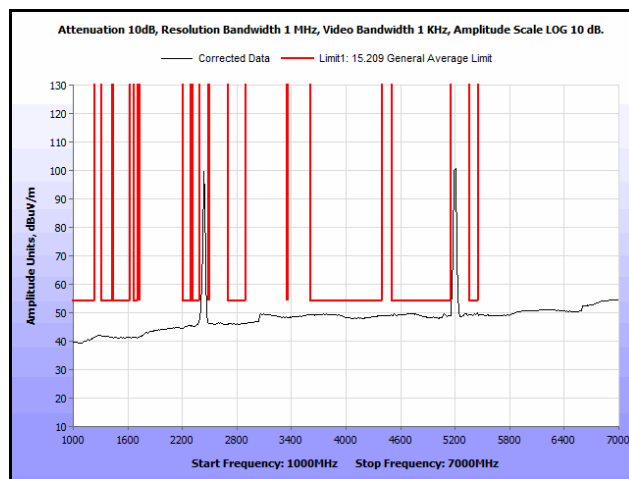
Plot 187. Radiated Spurs, Co-Location, 802.11n 20 MHz, 2412 MHz & 5785 MHz, 1 GHz – 7 GHz, Peak



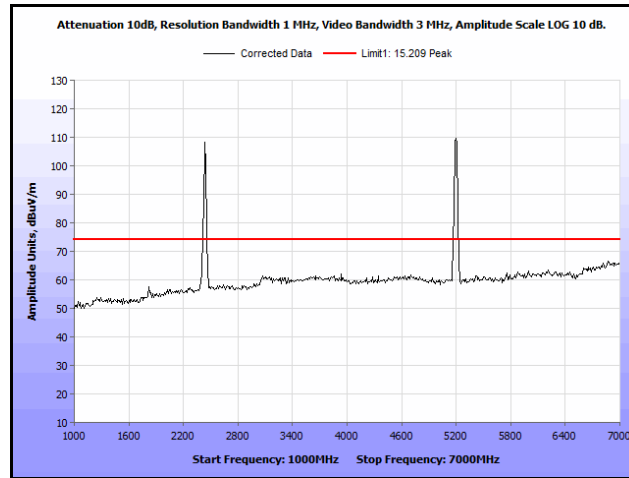
**Plot 188. Radiated Spurs, Co-Location, 802.11n 20 MHz, 2412 MHz & 5785 MHz, 7 GHz – 18 GHz, Peak**



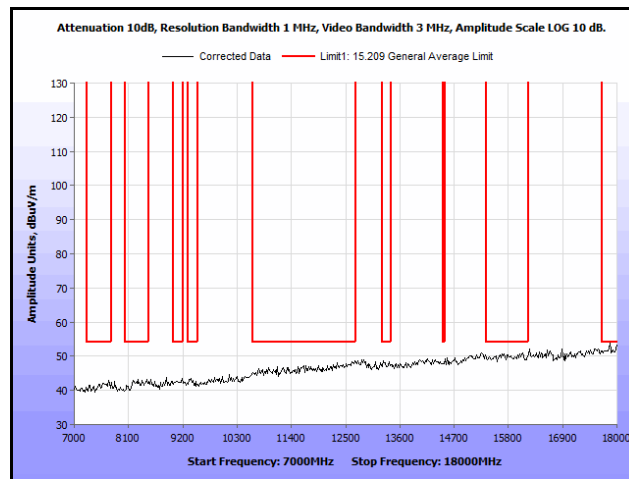
**Plot 189. Radiated Spurs, Co-Location, 802.11n 20 MHz, 2437 MHz & 5200 MHz, 30 MHz – 1 GHz, Peak**



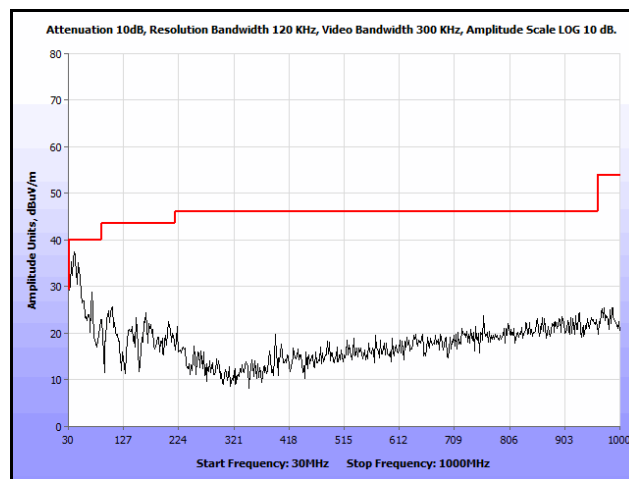
**Plot 190. Radiated Spurs, Co-Location, 802.11n 20 MHz, 2437 MHz & 5200 MHz, 1 GHz – 7 GHz, Avg.**



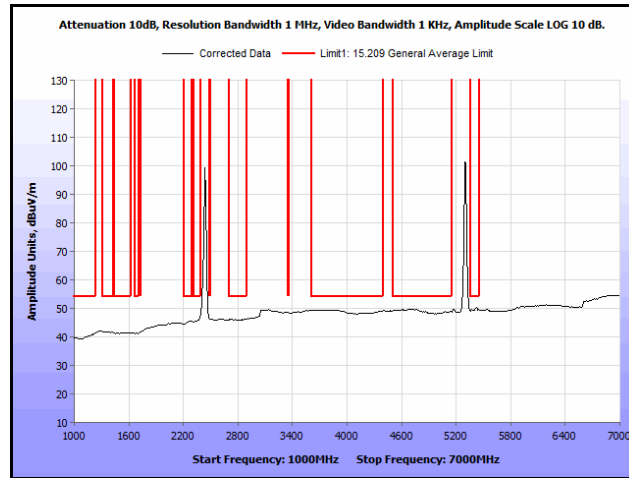
**Plot 191. Radiated Spurs, Co-Location, 802.11n 20 MHz, 2437 MHz & 5200 MHz, 1 GHz – 7 GHz, Peak**



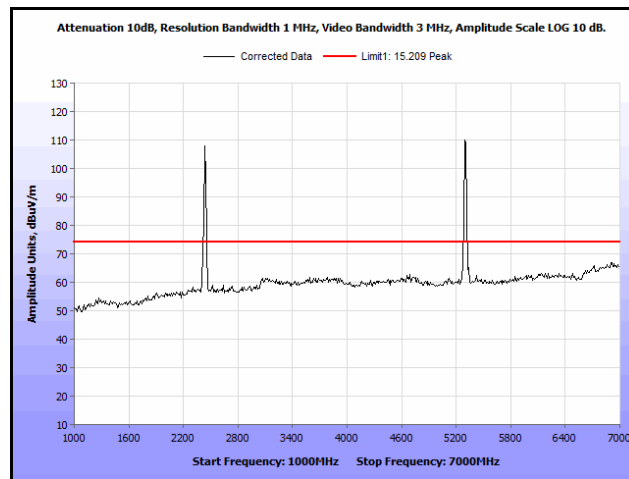
**Plot 192. Radiated Spurs, Co-Location, 802.11n 20 MHz, 2437 MHz & 5200 MHz, 7 GHz – 18 GHz, Peak**



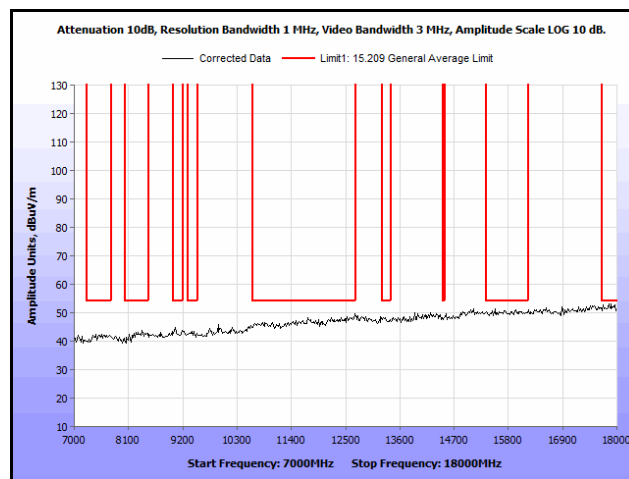
**Plot 193. Radiated Spurs, Co-Location, 802.11n 20 MHz, 2437 MHz & 5300 MHz, 30 MHz – 1 GHz, Peak**



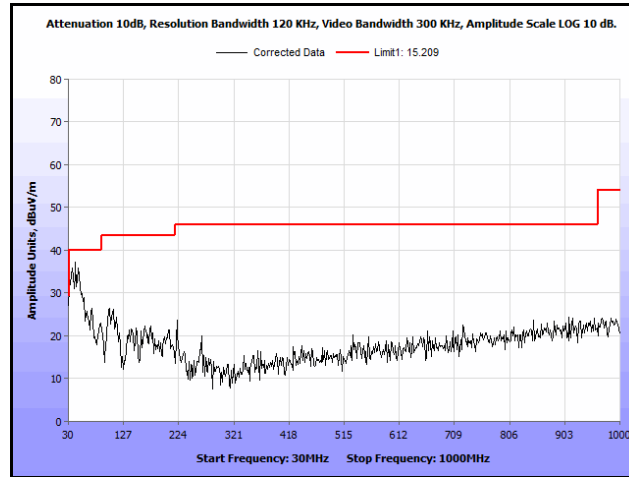
**Plot 194. Radiated Spurs, Co-Location, 802.11n 20 MHz, 2437 MHz & 5300 MHz, 1 GHz – 7 GHz, Avg.**



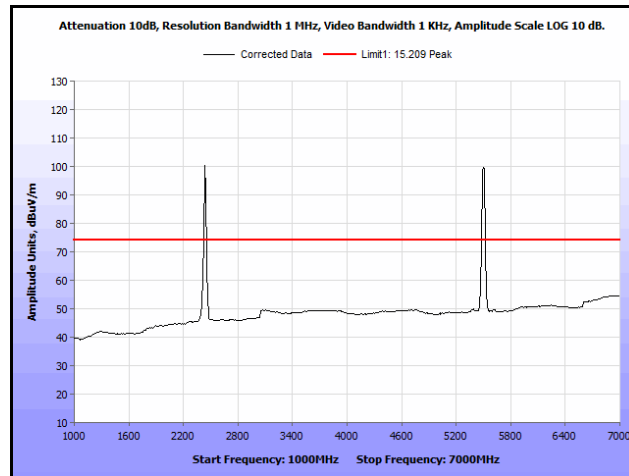
**Plot 195. Radiated Spurs, Co-Location, 802.11n 20 MHz, 2437 MHz & 5300 MHz, 1 GHz – 7 GHz, Peak**



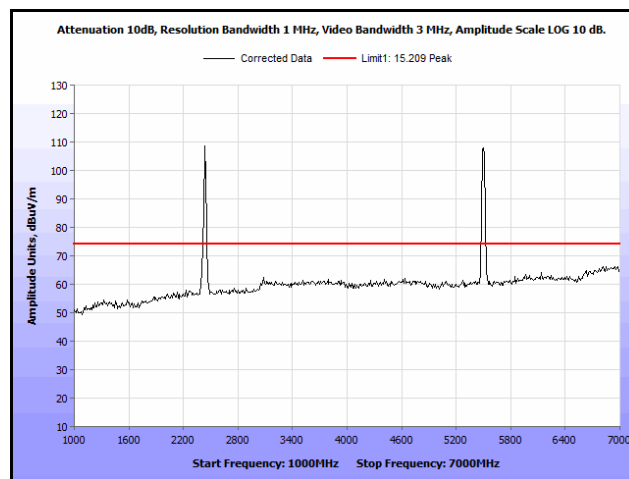
**Plot 196. Radiated Spurs, Co-Location, 802.11n 20 MHz, 2437 MHz & 5300 MHz, 7 GHz – 18 GHz, Peak**



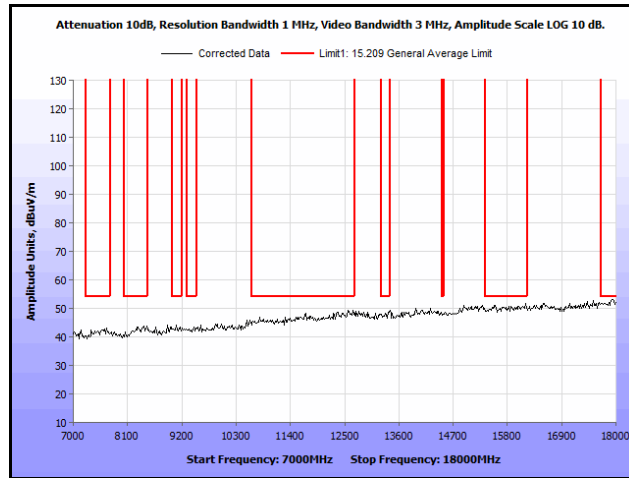
**Plot 197. Radiated Spurs, Co-Location, 802.11n 20 MHz, 2437 MHz & 5580 MHz, 30 MHz – 1 GHz, Peak**



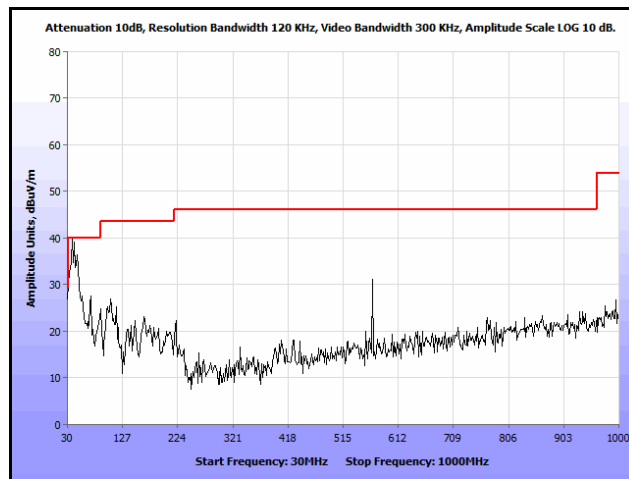
**Plot 198. Radiated Spurs, Co-Location, 802.11n 20 MHz, 2437 MHz & 5580 MHz, 1 GHz – 7 GHz, Avg.**



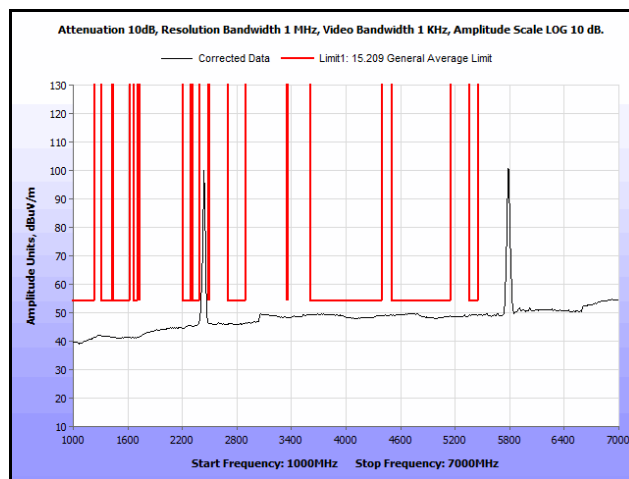
**Plot 199. Radiated Spurs, Co-Location, 802.11n 20 MHz, 2437 MHz & 5580 MHz, 1 GHz – 7 GHz, Peak**



**Plot 200. Radiated Spurs, Co-Location, 802.11n 20 MHz, 2437 MHz & 5580 MHz, 7 GHz – 18 GHz, Peak**

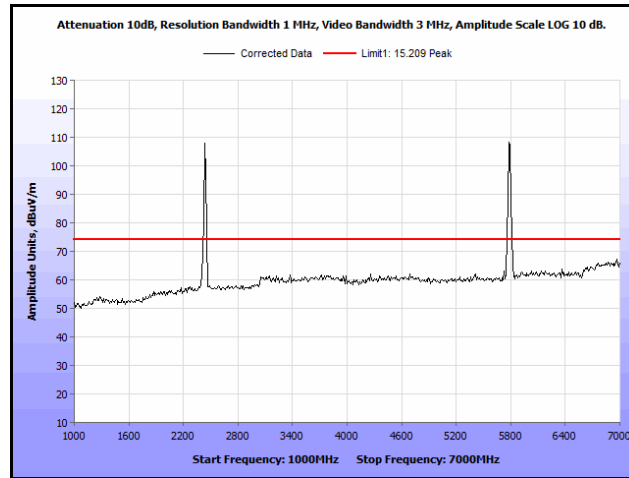


**Plot 201. Radiated Spurs, Co-Location, 802.11n 20 MHz, 2437 MHz & 5785 MHz, 30 MHz – 1 GHz, Peak**

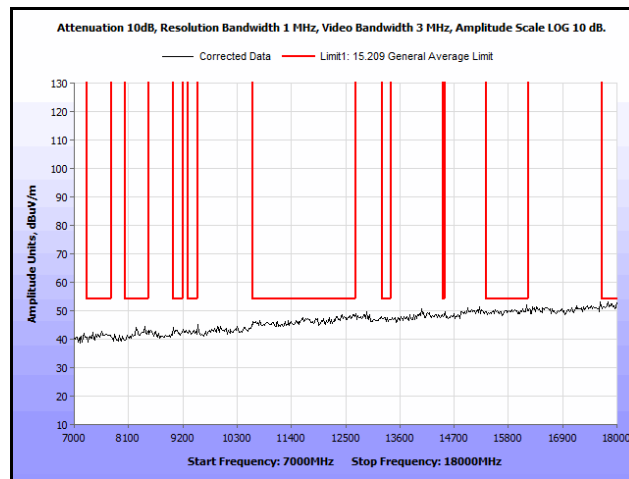


**Plot 202. Radiated Spurs, Co-Location, 802.11n 20 MHz, 2437 MHz & 5785 MHz, 1 GHz – 7 GHz, Avg.**

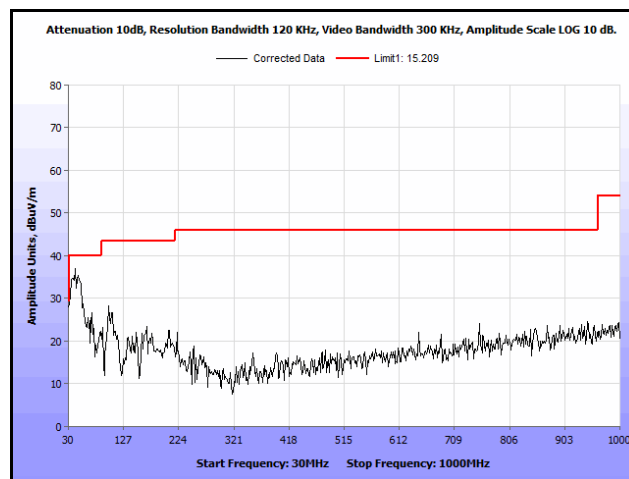




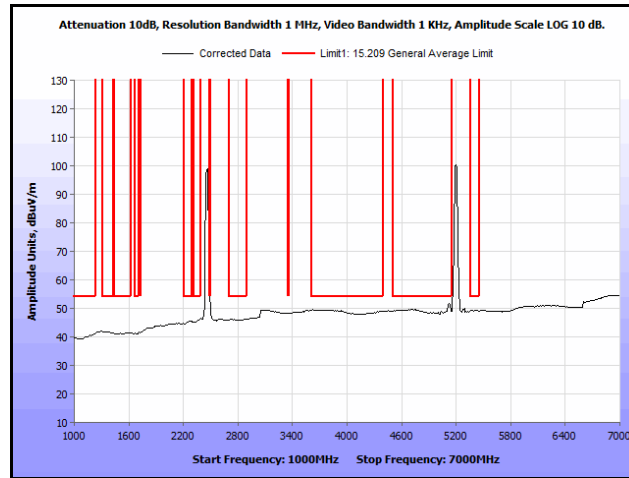
**Plot 203. Radiated Spurs, Co-Location, 802.11n 20 MHz, 2437 MHz & 5785 MHz, 1 GHz – 7 GHz, Peak**



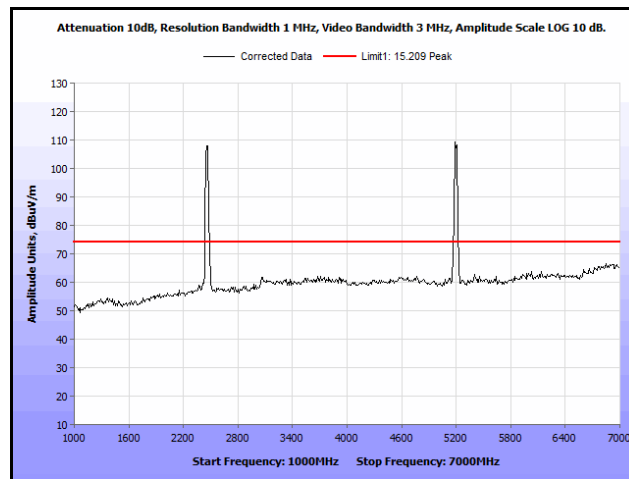
**Plot 204. Radiated Spurs, Co-Location, 802.11n 20 MHz, 2437 MHz & 5785 MHz, 7 GHz – 18 GHz, Peak**



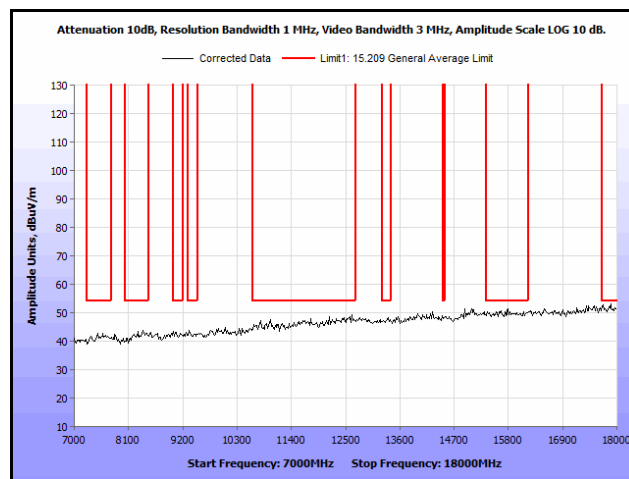
**Plot 205. Radiated Spurs, Co-Location, 802.11n 20 MHz, 2462 MHz & 5200 MHz, 30 MHz – 1 GHz, Peak**



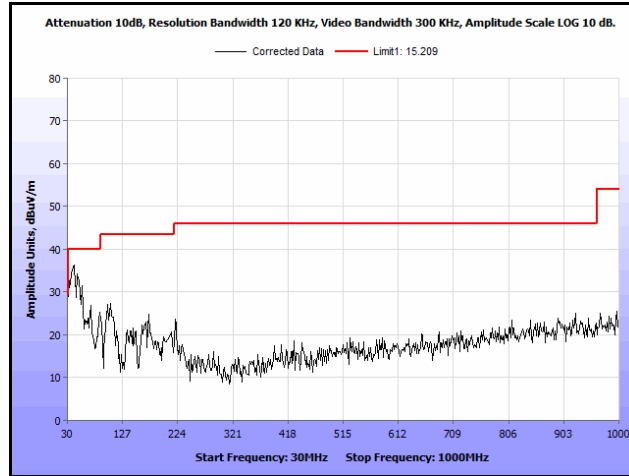
**Plot 206. Radiated Spurs, Co-Location, 802.11n 20 MHz, 2462 MHz & 5200 MHz, 1 GHz – 7 GHz, Avg.**



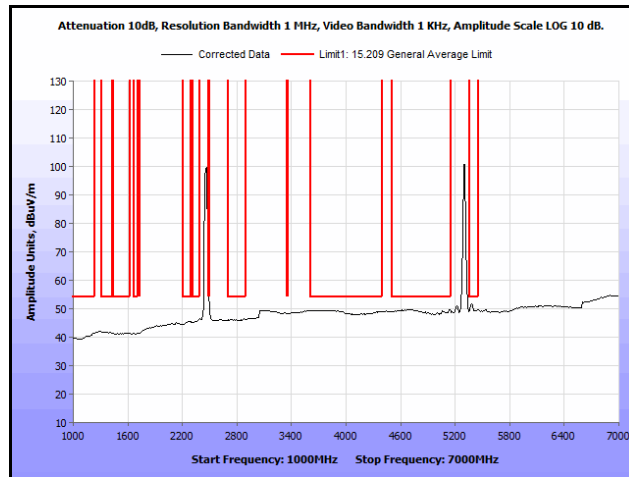
**Plot 207. Radiated Spurs, Co-Location, 802.11n 20 MHz, 2462 MHz & 5200 MHz, 1 GHz – 7 GHz, Peak**



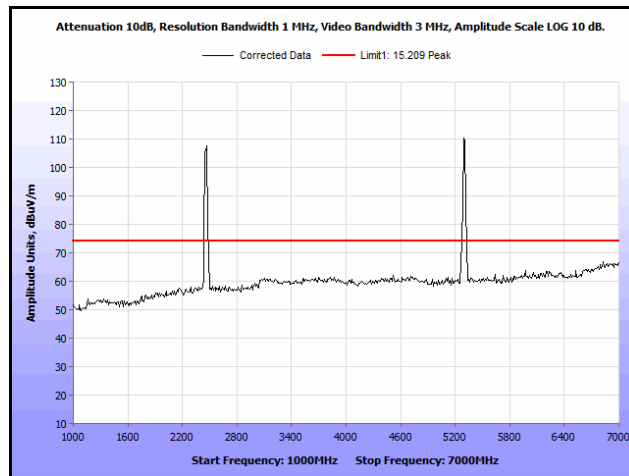
**Plot 208. Radiated Spurs, Co-Location, 802.11n 20 MHz, 2462 MHz & 5200 MHz, 7 GHz – 18 GHz, Peak**



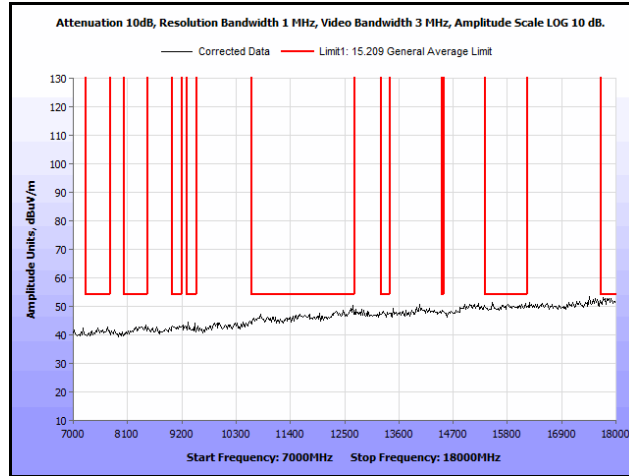
**Plot 209. Radiated Spurs, Co-Location, 802.11n 20 MHz, 2462 MHz & 5300 MHz, 30 MHz – 1 GHz, Peak**



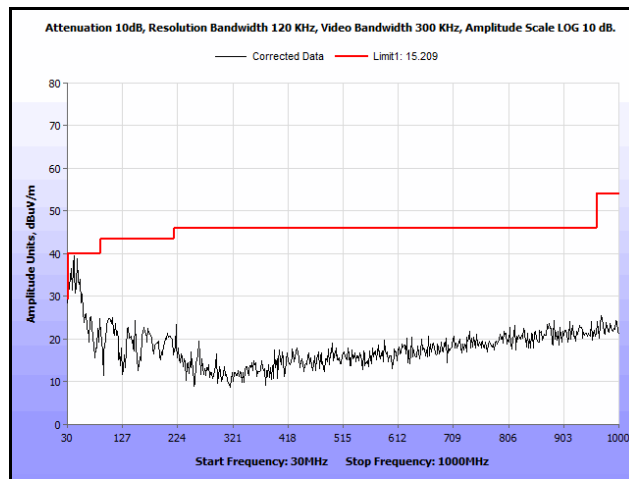
**Plot 210. Radiated Spurs, Co-Location, 802.11n 20 MHz, 2462 MHz & 5300 MHz, 1 GHz – 7 GHz, Avg.**



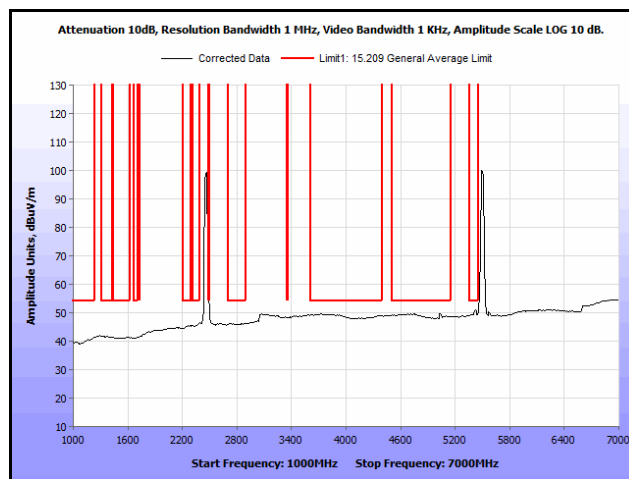
**Plot 211. Radiated Spurs, Co-Location, 802.11n 20 MHz, 2462 MHz & 5300 MHz, 1 GHz – 7 GHz, Peak**



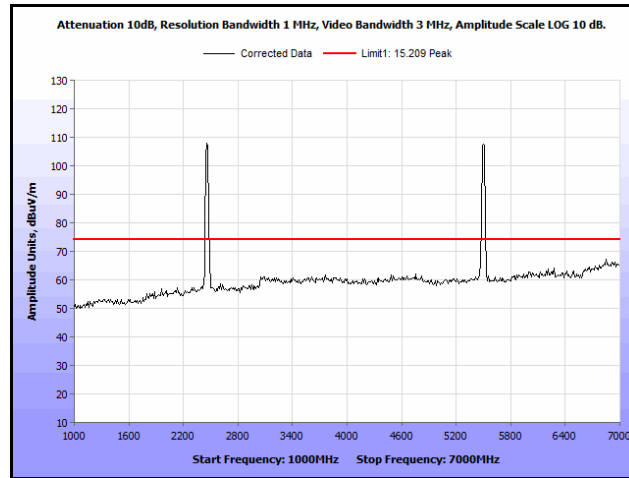
**Plot 212. Radiated Spurs, Co-Location, 802.11n 20 MHz, 2462 MHz & 5300 MHz, 7 GHz – 18 GHz, Peak**



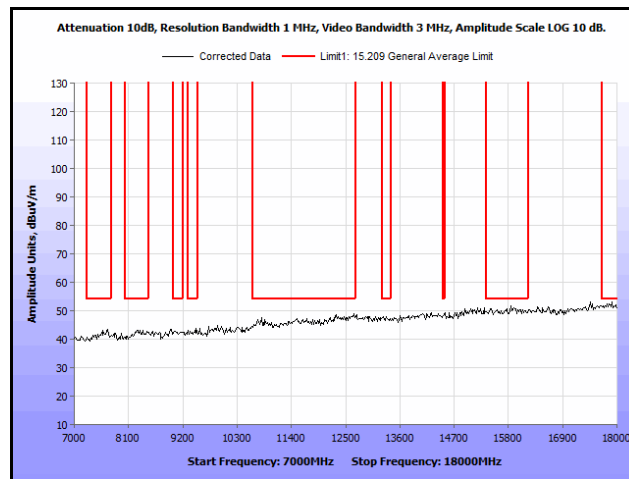
**Plot 213. Radiated Spurs, Co-Location, 802.11n 20 MHz, 2462 MHz & 5580 MHz, 30 MHz – 1 GHz, Peak**



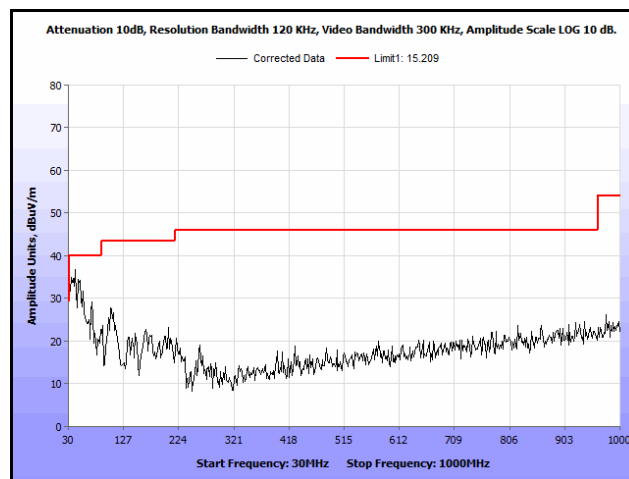
**Plot 214. Radiated Spurs, Co-Location, 802.11n 20 MHz, 2462 MHz & 5580 MHz, 1 GHz – 7 GHz, Avg.**



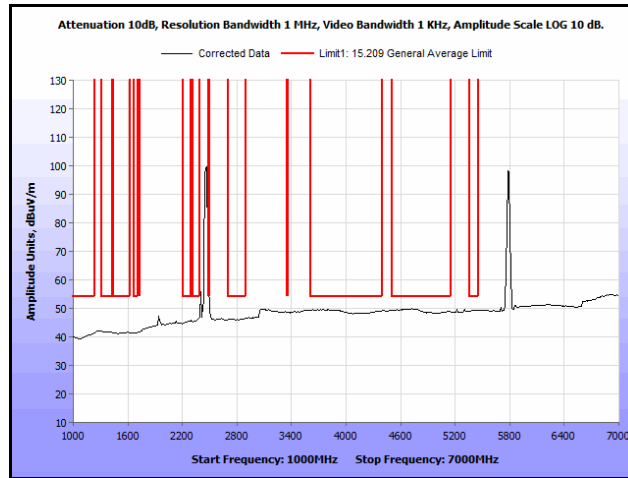
**Plot 215. Radiated Spurs, Co-Location, 802.11n 20 MHz, 2462 MHz & 5580 MHz, 1 GHz – 7 GHz, Peak**



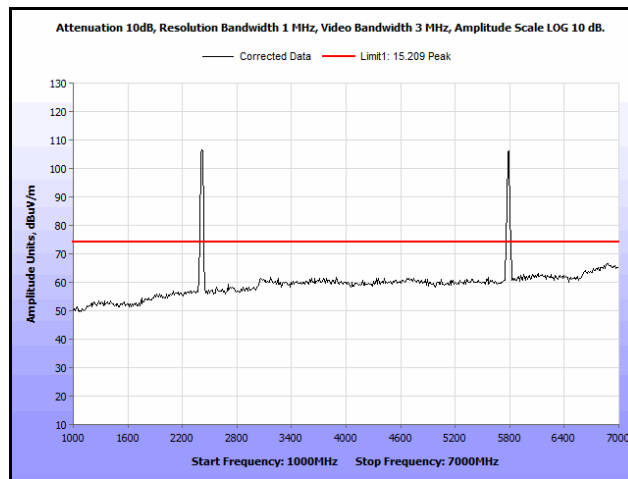
**Plot 216. Radiated Spurs, Co-Location, 802.11n 20 MHz, 2462 MHz & 5580 MHz, 7 GHz – 18 GHz, Peak**



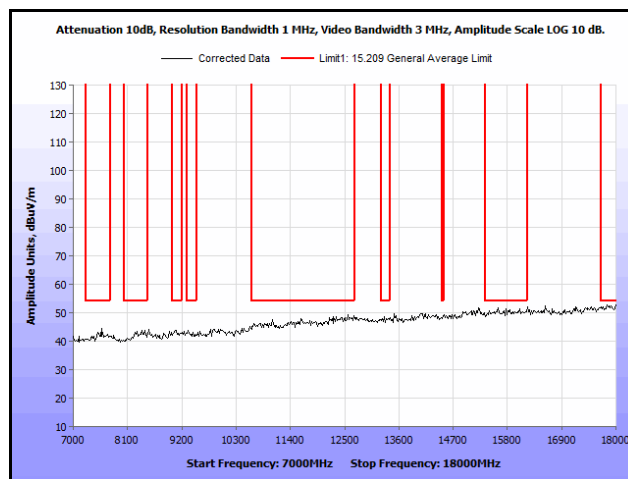
**Plot 217. Radiated Spurs, Co-Location, 802.11n 20 MHz, 2462 MHz & 5785 MHz, 30 MHz – 1 GHz, Peak**



Plot 218. Radiated Spurs, Co-Location, 802.11n 20 MHz, 2462 MHz & 5785 MHz, 1 GHz – 7 GHz, Avg.

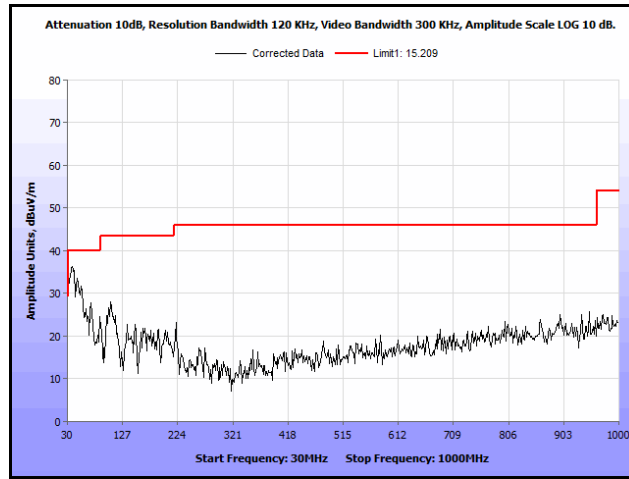


Plot 219. Radiated Spurs, Co-Location, 802.11n 20 MHz, 2462 MHz & 5785 MHz, 1 GHz – 7 GHz, Peak

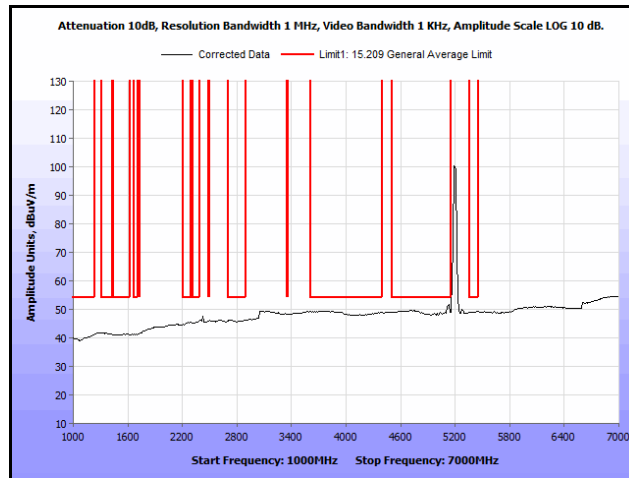


Plot 220. Radiated Spurs, Co-Location, 802.11n 20 MHz, 2462 MHz & 5785 MHz, 7 GHz – 18 GHz, Peak

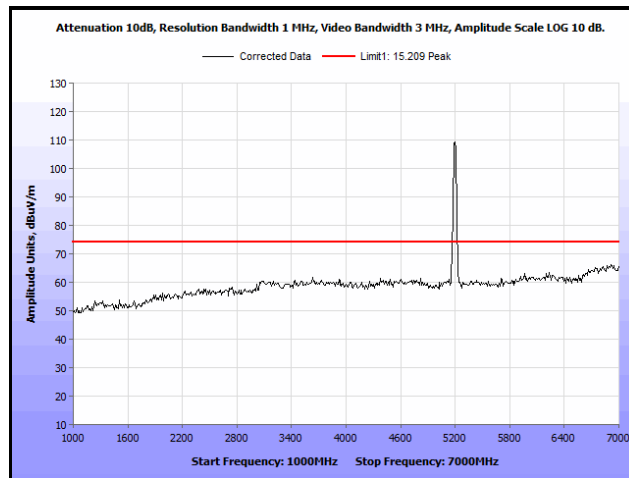
**Omni Antenna**



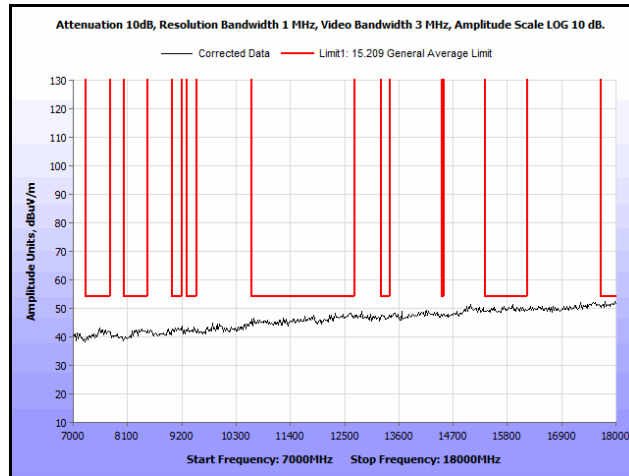
**Plot 221. Radiated Spurs, Co-Location, 802.11n 20 MHz, 5200 MHz & 5200 MHz, 30 MHz – 1 GHz, Peak**



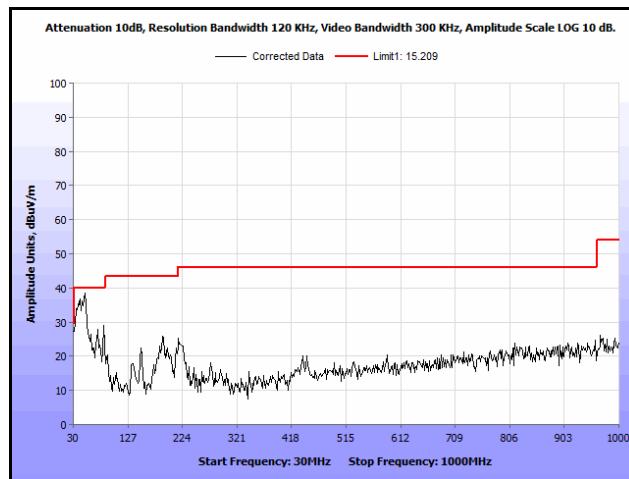
**Plot 222. Radiated Spurs, Co-Location, 802.11n 20 MHz, 5200 MHz & 5200 MHz, 1 GHz – 7 GHz, Avg.**



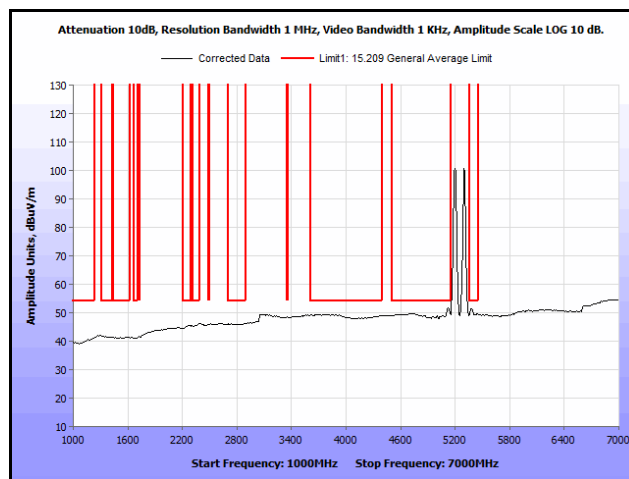
**Plot 223. Radiated Spurs, Co-Location, 802.11n 20 MHz, 5200 MHz & 5200 MHz, 1 GHz – 7 GHz, Peak**



**Plot 224. Radiated Spurs, Co-Location, 802.11n 20 MHz, 5200 MHz & 5200 MHz, 7 GHz – 18 GHz, Peak**

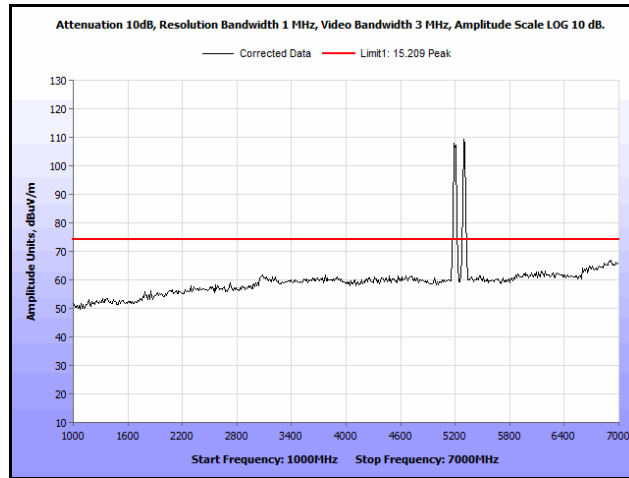


**Plot 225. Radiated Spurs, Co-Location, 802.11n 20 MHz, 5200 MHz & 5300 MHz, 30 MHz – 1 GHz, Peak**

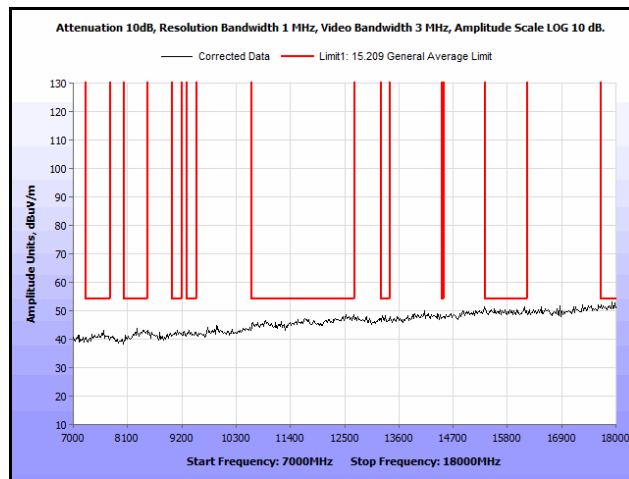


**Plot 226. Radiated Spurs, Co-Location, 802.11n 20 MHz, 5200 MHz & 5300 MHz, 1 GHz – 7 GHz, Avg.**

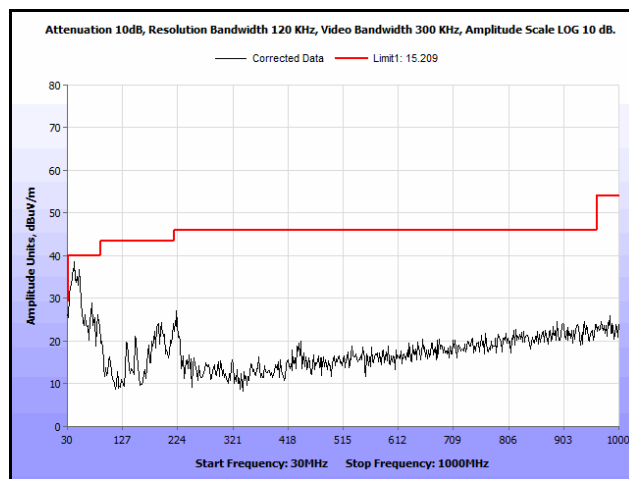




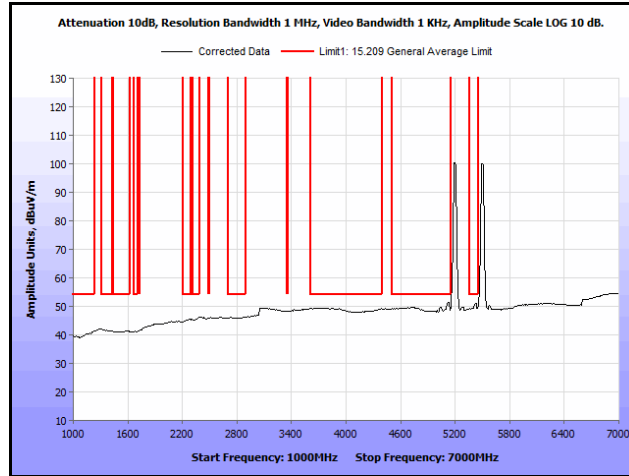
**Plot 227. Radiated Spurs, Co-Location, 802.11n 20 MHz, 5200 MHz & 5300 MHz, 1 GHz – 7 GHz, Peak**



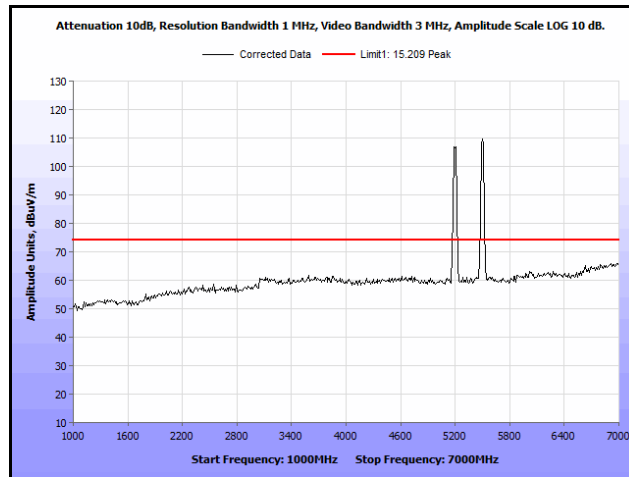
**Plot 228. Radiated Spurs, Co-Location, 802.11n 20 MHz, 5200 MHz & 5300 MHz, 7 GHz – 18 GHz, Peak**



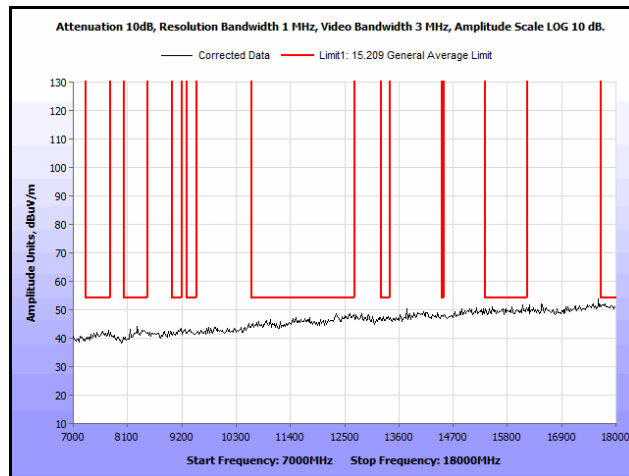
**Plot 229. Radiated Spurs, Co-Location, 802.11n 20 MHz, 5200 MHz & 5580 MHz, 30 MHz – 1 GHz, Peak**



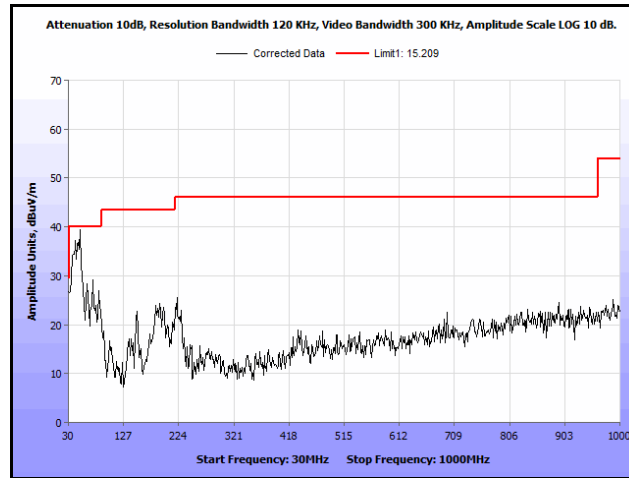
**Plot 230. Radiated Spurs, Co-Location, 802.11n 20 MHz, 5200 MHz & 5580 MHz, 1 GHz – 7 GHz, Avg.**



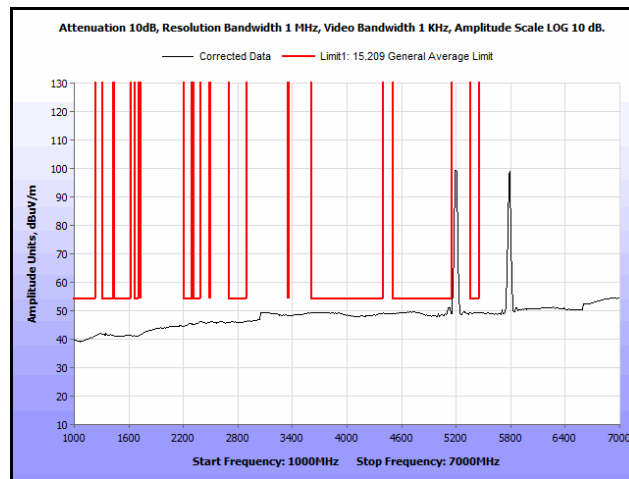
**Plot 231. Radiated Spurs, Co-Location, 802.11n 20 MHz, 5200 MHz & 5580 MHz, 1 GHz – 7 GHz, Peak**



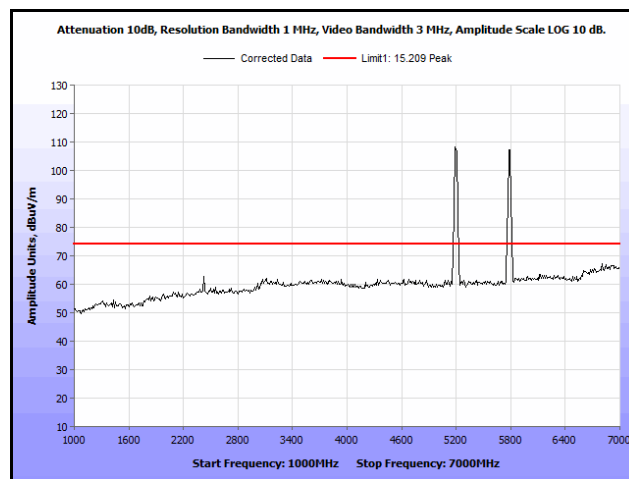
**Plot 232. Radiated Spurs, Co-Location, 802.11n 20 MHz, 5200 MHz & 5580 MHz, 7 GHz – 18 GHz, Peak**



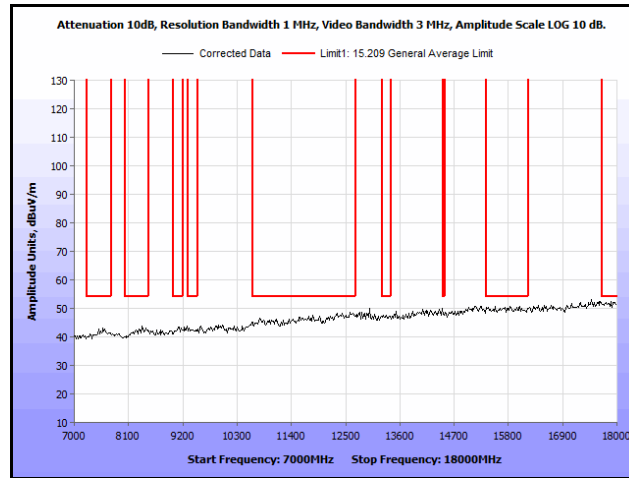
Plot 233. Radiated Spurs, Co-Location, 802.11n 20 MHz, 5200 MHz & 5785 MHz, 30 MHz – 1 GHz, Peak



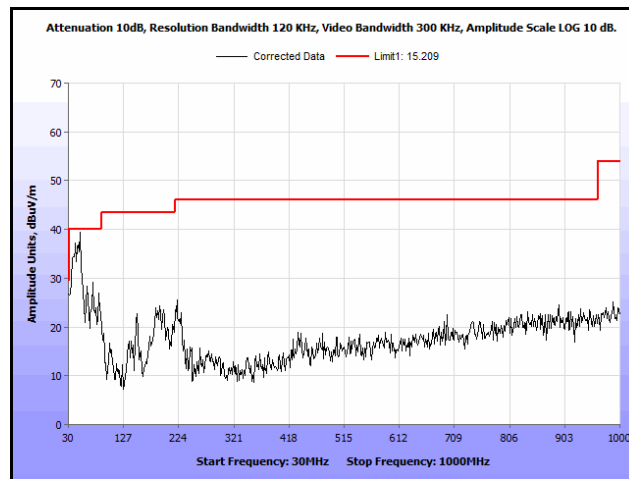
Plot 234. Radiated Spurs, Co-Location, 802.11n 20 MHz, 5200 MHz & 5785 MHz, 1 GHz – 7 GHz, Avg.



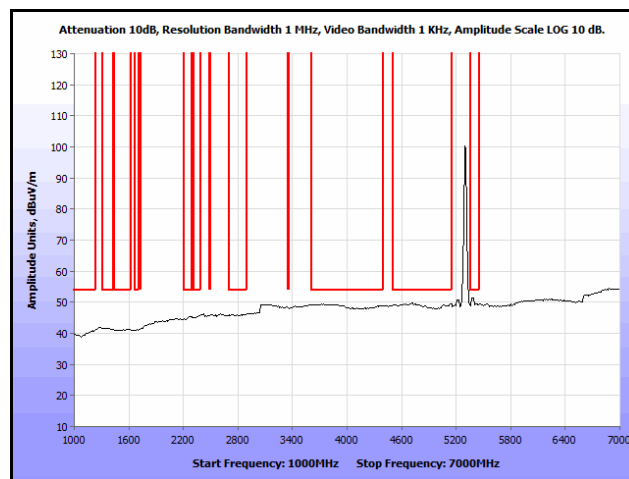
Plot 235. Radiated Spurs, Co-Location, 802.11n 20 MHz, 5200 MHz & 5785 MHz, 1 GHz – 7 GHz, Peak



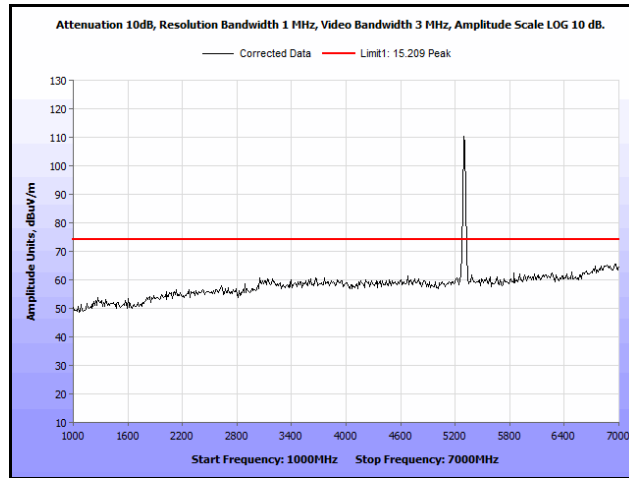
**Plot 236. Radiated Spurs, Co-Location, 802.11n 20 MHz, 5200 MHz & 5785 MHz, 7 GHz – 18 GHz, Peak**



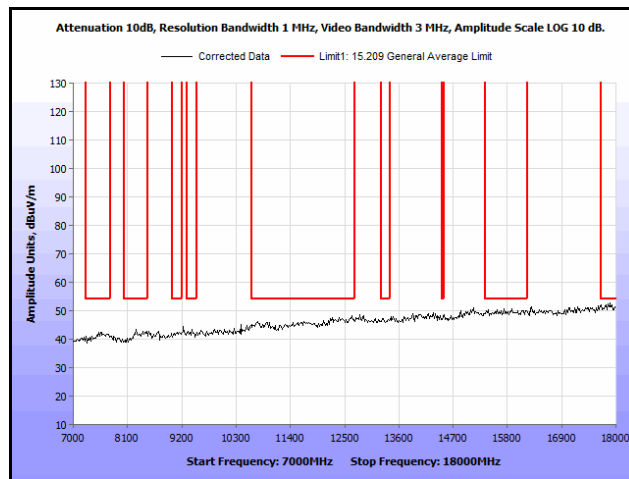
**Plot 237. Radiated Spurs, Co-Location, 802.11n 20 MHz, 5300 MHz & 5300 MHz, 30 MHz – 1 GHz, Peak**



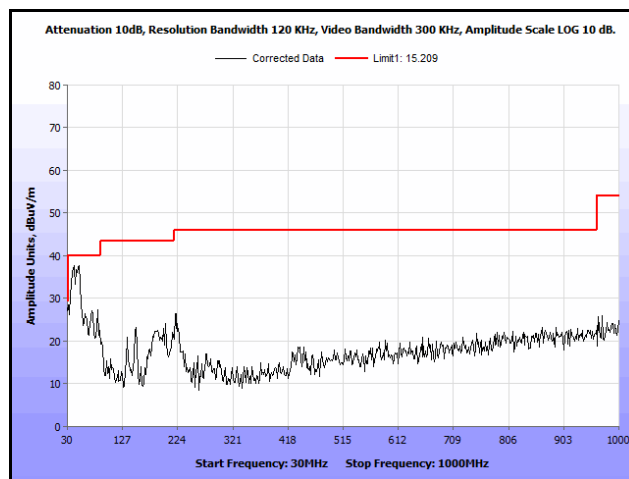
**Plot 238. Radiated Spurs, Co-Location, 802.11n 20 MHz, 5300 MHz & 5300 MHz, 1 GHz – 7 GHz, Avg.**



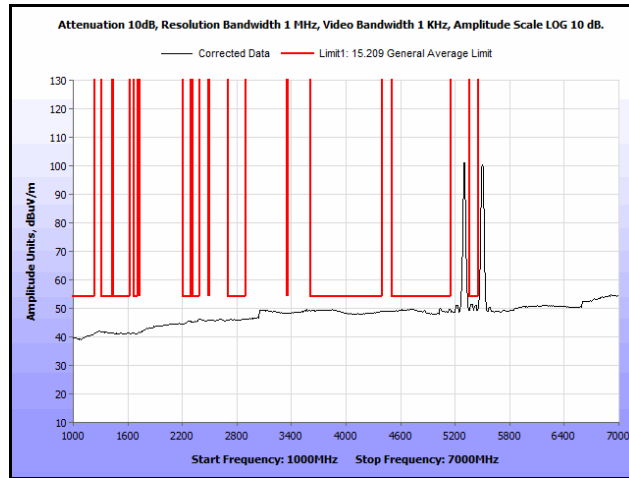
**Plot 239. Radiated Spurs, Co-Location, 802.11n 20 MHz, 5300 MHz & 5300 MHz, 1 GHz – 7 GHz**



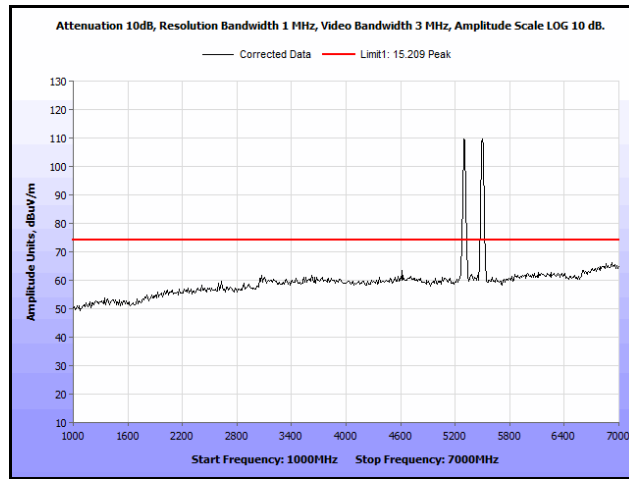
**Plot 240. Radiated Spurs, Co-Location, 802.11n 20 MHz, 5300 MHz & 5300 MHz, 7 GHz – 18 GHz, Peak**



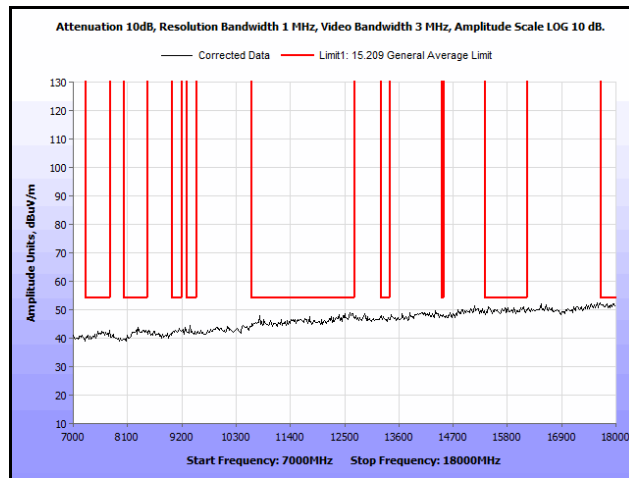
**Plot 241. Radiated Spurs, Co-Location, 802.11n 20 MHz, 5300 MHz & 5580 MHz, 30 MHz – 1 GHz, Peak**



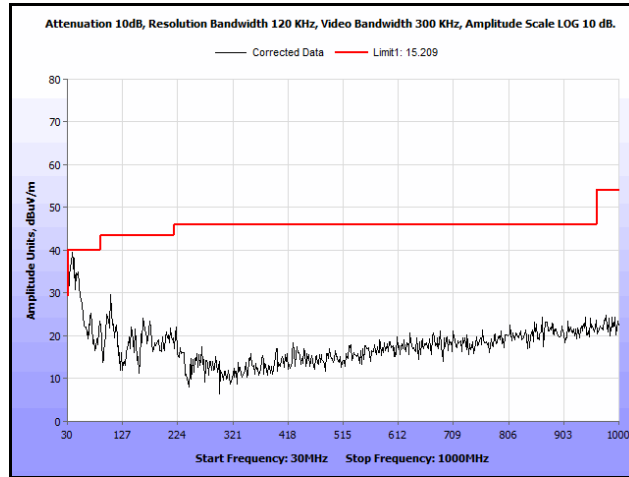
Plot 242. Radiated Spurs, Co-Location, 802.11n 20 MHz, 5300 MHz & 5580 MHz, 1 GHz – 7 GHz, Avg.



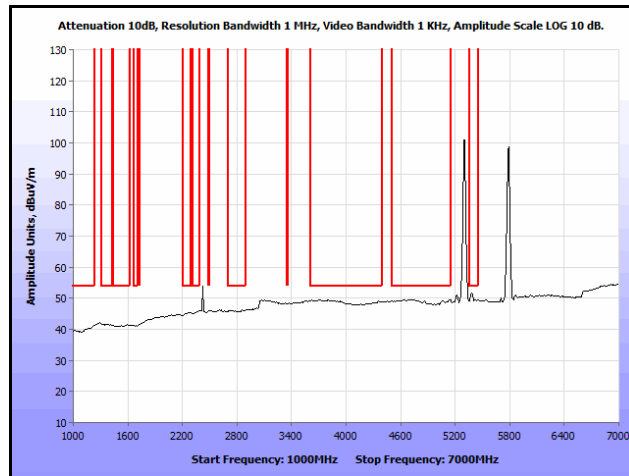
Plot 243. Radiated Spurs, Co-Location, 802.11n 20 MHz, 5300 MHz & 5580 MHz, 1 GHz – 7 GHz, Peak



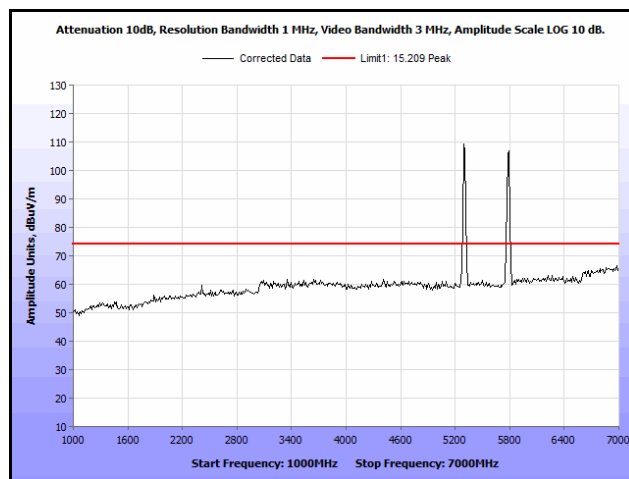
Plot 244. Radiated Spurs, Co-Location, 802.11n 20 MHz, 5300 MHz & 5580 MHz, 7 GHz – 18 GHz, Peak



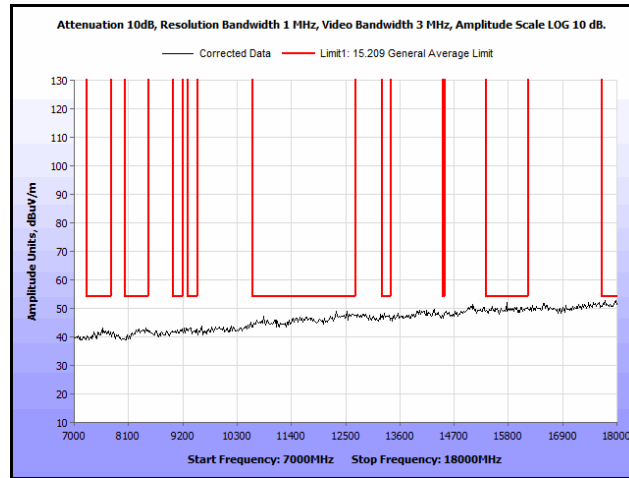
**Plot 245. Radiated Spurs, Co-Location, 802.11n 20 MHz, 5300 MHz & 5785 MHz, 30 MHz – 1 GHz, Peak**



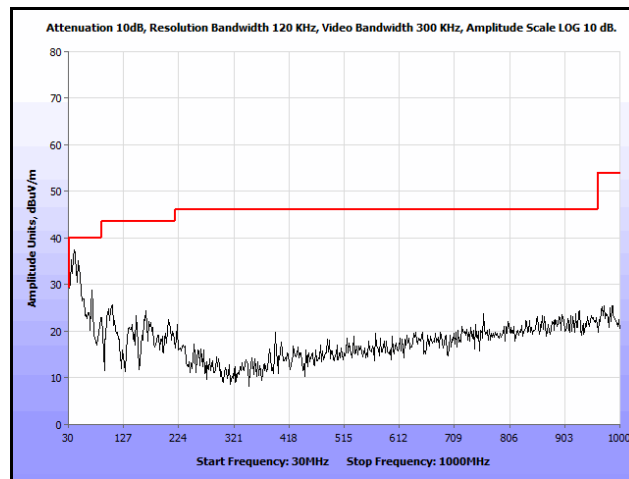
**Plot 246. Radiated Spurs, Co-Location, 802.11n 20 MHz, 5300 MHz & 5785 MHz, 1 GHz – 7 GHz, Avg.**



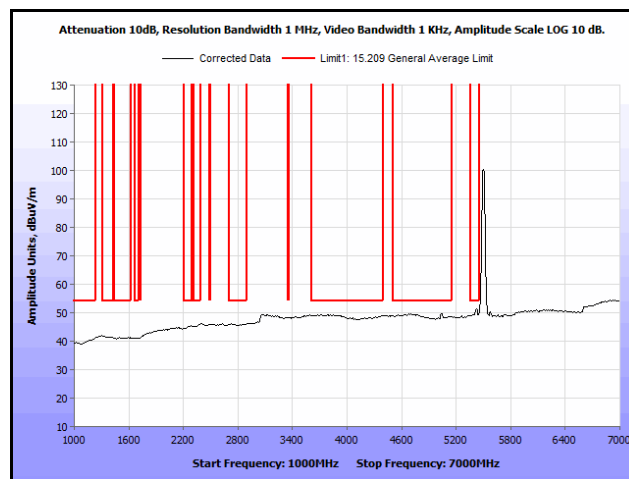
**Plot 247. Radiated Spurs, Co-Location, 802.11n 20 MHz, 5300 MHz & 5785 MHz, 1 GHz – 7 GHz, Peak**



**Plot 248. Radiated Spurs, Co-Location, 802.11n 20 MHz, 5300 MHz & 5785 MHz, 7 GHz – 18 GHz, Peak**

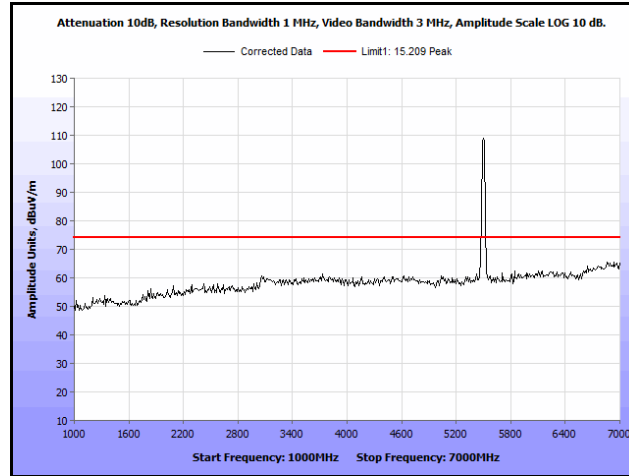


**Plot 249. Radiated Spurs, Co-Location, 802.11n 20 MHz, 5580 MHz & 5580 MHz, 30 MHz – 1 GHz, Peak**

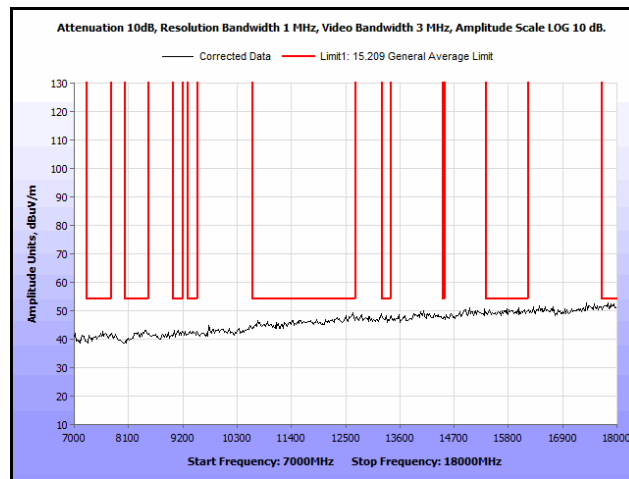


**Plot 250. Radiated Spurs, Co-Location, 802.11n 20 MHz, 5580 MHz & 5580 MHz, 1 GHz – 7 GHz, Avg.**

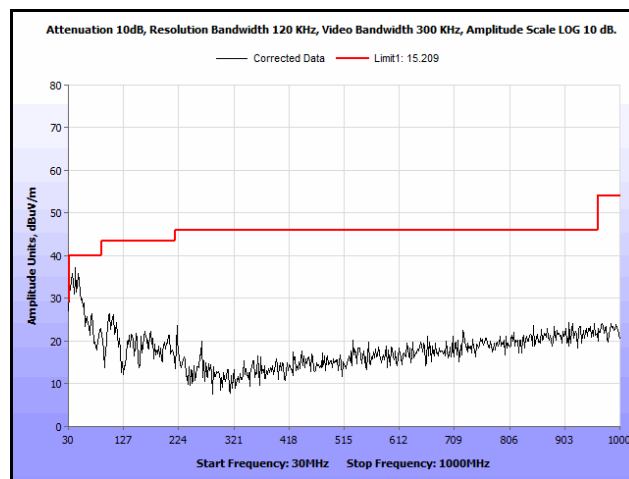




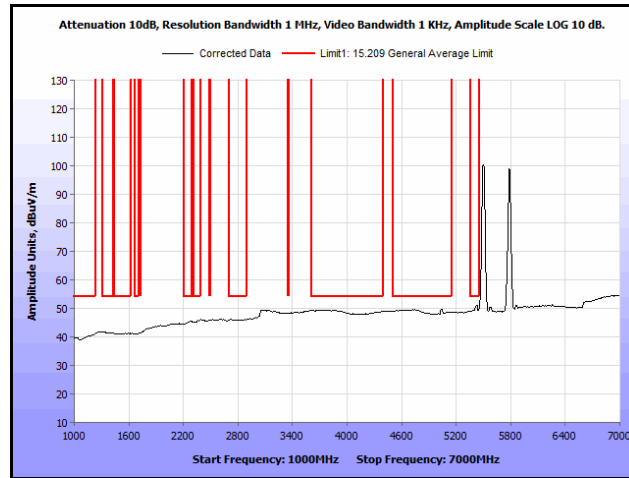
**Plot 251. Radiated Spurs, Co-Location, 802.11n 20 MHz, 5580 MHz & 5580 MHz, 1 GHz – 7 GHz, Peak**



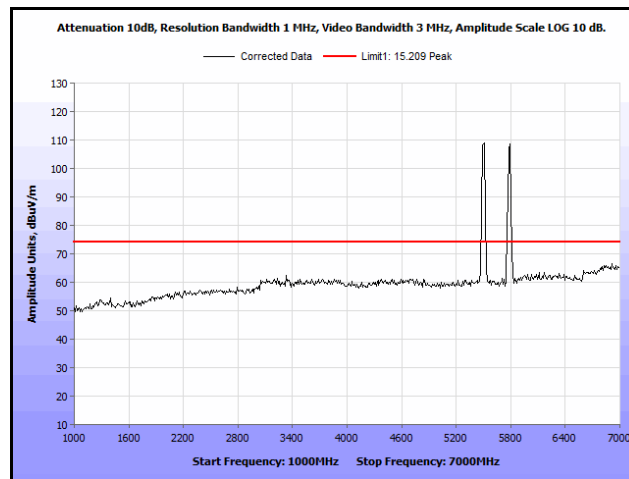
**Plot 252. Radiated Spurs, Co-Location, 802.11n 20 MHz, 5580 MHz & 5580 MHz, 7 GHz – 18 GHz, Peak**



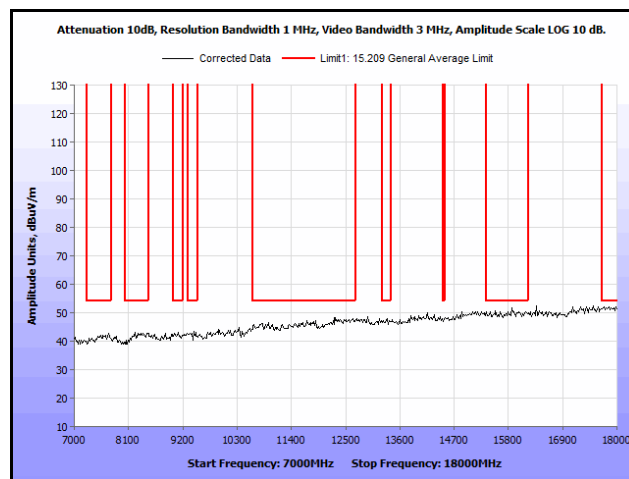
**Plot 253. Radiated Spurs, Co-Location, 802.11n 20 MHz, 5580 MHz & 5785 MHz, 30 MHz – 1 GHz, Peak**



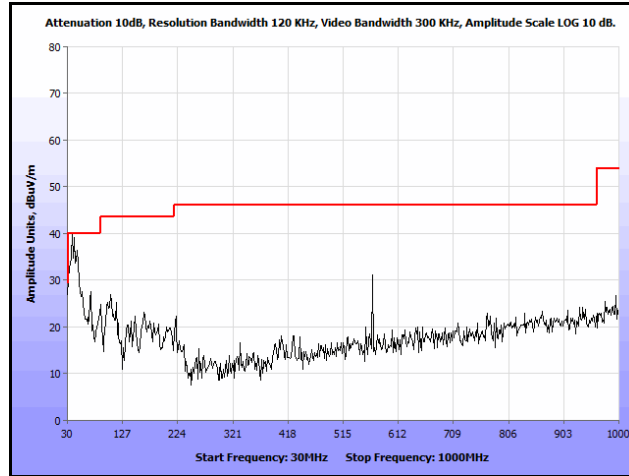
Plot 254. Radiated Spurs, Co-Location, 802.11n 20 MHz, 5580 MHz & 5785 MHz, 1 GHz – 7 GHz, Avg.



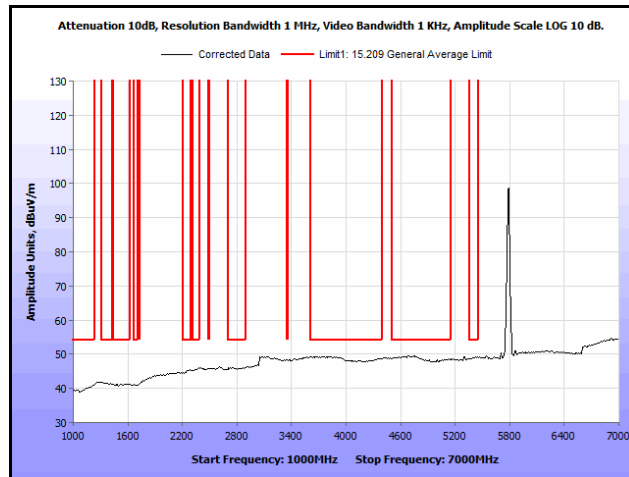
Plot 255. Radiated Spurs, Co-Location, 802.11n 20 MHz, 5580 MHz & 5785 MHz, 1 GHz – 7 GHz, Peak



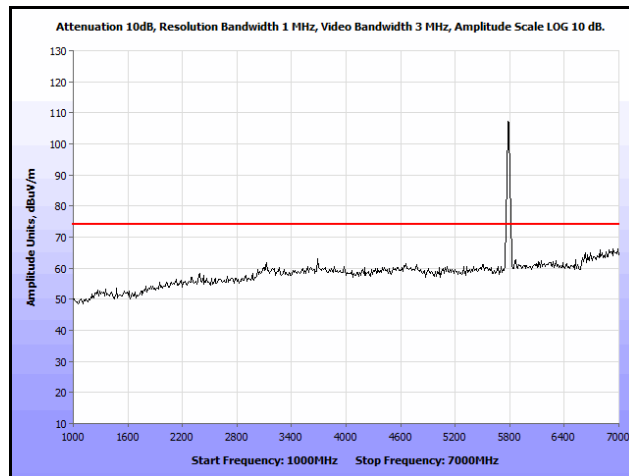
Plot 256. Radiated Spurs, Co-Location, 802.11n 20 MHz, 5580 MHz & 5785 MHz, 7 GHz – 18 GHz, Peak



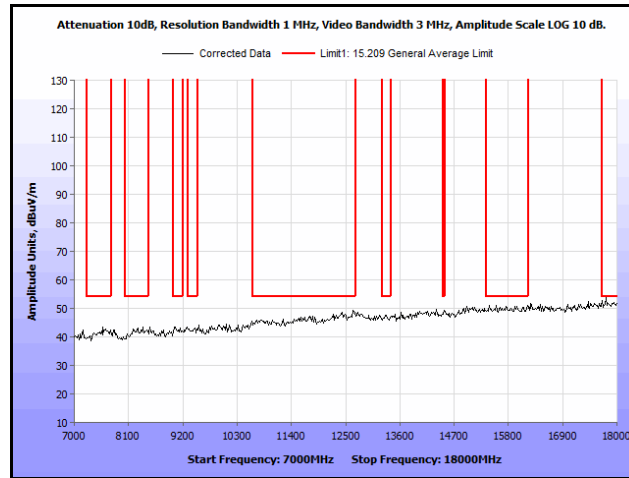
Plot 257. Radiated Spurs, Co-Location, 802.11n 20 MHz, 5785 MHz & 5785 MHz, 30 MHz – 1 GHz, Peak



Plot 258. Radiated Spurs, Co-Location, 802.11n 20 MHz, 5785 MHz & 5785 MHz, 1 GHz – 7 GHz, Avg.



Plot 259. Radiated Spurs, Co-Location, 802.11n 20 MHz, 5785 MHz & 5785 MHz, 1 GHz – 7 GHz, Peak



**Plot 260. Radiated Spurs, Co-Location, 802.11n 20 MHz, 5785 MHz & 5785 MHz, 7 GHz – 18 GHz, Peak**

## IV. Test Equipment

## Test Equipment

Calibrated test equipment utilized during testing was maintained in a current state of calibration per the requirements of ISO/IEC 17025:2005.

MET Asset #	Equipment	Manufacturer	Model	Last Cal Date	Cal Due Date
1S2600	BILOG ANTENNA	TESEQ	CBL6112D	8/29/2013	8/29/2015
1S2482	5 METER CHAMBER (NSA)	PANASHIELD	5 METER SEMI-ANECHOIC CHAMBER	8/12/2013	2/12/2015
1S2583	SPECTRUM ANALYZER	AGILENT/HP	E4447A	11/1/2013	5/1/2015
1S2460	1-26GHZ SPECTRUM ANALYZER	AGILENT TECHNOLOGIES	E4407B	2/27/2014	8/27/2015
1S2603	DOUBLE RIDGED WAVEGUIDE HORN	ETS-LINDGREN	3117	4/24/2013	4/24/2015
1S2523	PREAMPLIFIER	AGILENT TECHNOLOGIES	8449B	SEE NOTE	
1S2729	SONOMA AMPLIFIER	SONOMA INSTRUMENT	310N	SEE NOTE	
1S2460	1-26GHZ SPECTRUM ANALYZER	AGILENT TECHNOLOGIES	E4407B	2/27/2014	8/27/2015
N/A	NOTCH FILTER	MIRCRO-TRONICS	BRM50702	SEE NOTE	
N/A	HIGH PASS FILTER	MICRO-TRONICS	BRM50705	SEE NOTE	

**Table 29. Test Equipment List**

Note: Functionally tested equipment is verified using calibrated instrumentation at the time of testing.

## **V. Certification & User's Manual Information**

## Certification & User's Manual Information

### A. Certification Information

The following is extracted from Title 47 of the Code of Federal Regulations, Part 2, Subpart I — Marketing of Radio frequency devices:

#### § 2.801 Radio-frequency device defined.

As used in this part, a radio-frequency device is any device which in its operation is capable of Emitting radio-frequency energy by radiation, conduction, or other means. Radio- frequency devices include, but are not limited to:

- (a) The various types of radio communication transmitting devices described throughout this chapter.
- (b) *The incidental, unintentional and intentional radiators defined in Part 15 of this chapter.*
- (c) The industrial, scientific, and medical equipment described in Part 18 of this chapter.
- (d) Any part or component thereof which in use emits radio-frequency energy by radiation, conduction, or other means.

#### § 2.803 Marketing of radio frequency devices prior to equipment authorization.

- (a) Except as provided elsewhere in this chapter, no person shall sell or lease, or offer for sale or lease (including advertising for sale or lease), or import, ship or distribute for the purpose of selling or leasing or offering for sale or lease, any radio frequency device unless:
  - (1) In the case of a device subject to certification, such device has been authorized by the Commission in accordance with the rules in this chapter and is properly identified and labeled as required by §2.925 and other relevant sections in this chapter; or
  - (2) In the case of a device that is not required to have a grant of equipment authorization issued by the Commission, but which must comply with the specified technical standards prior to use, such device also complies with all applicable administrative (including verification of the equipment or authorization under a Declaration of Conformity, where required), technical, labeling and identification requirements specified in this chapter.
- (d) Notwithstanding the provisions of paragraph (a) of this section, the offer for sale solely to business, commercial, industrial, scientific or medical users (but not an offer for sale to other parties or to end users located in a residential environment) of a radio frequency device that is in the conceptual, developmental, design or pre-production stage is permitted prior to equipment authorization or, for devices not subject to the equipment authorization requirements, prior to a determination of compliance with the applicable technical requirements *provided* that the prospective buyer is advised in writing at the time of the offer for sale that the equipment is subject to the FCC rules and that the equipment will comply with the appropriate rules before delivery to the buyer or to centers of distribution.



- (e)(1) Notwithstanding the provisions of paragraph (a) of this section, prior to equipment authorization or determination of compliance with the applicable technical requirements any radio frequency device may be operated, but not marketed, for the following purposes and under the following conditions:
- (i) *Compliance testing*;
  - (ii) Demonstrations at a trade show provided the notice contained in paragraph (c) of this section is displayed in a conspicuous location on, or immediately adjacent to, the device;
  - (iii) Demonstrations at an exhibition conducted at a business, commercial, industrial, scientific or medical location, but excluding locations in a residential environment, provided the notice contained in paragraphs (c) or (d) of this section, as appropriate, is displayed in a conspicuous location on, or immediately adjacent to, the device;
  - (iv) Evaluation of product performance and determination of customer acceptability, provided such operation takes place at the manufacturer's facilities during developmental, design or pre-production states; or
  - (v) Evaluation of product performance and determination of customer acceptability where customer acceptability of a radio frequency device cannot be determined at the manufacturer's facilities because of size or unique capability of the device, provided the device is operated at a business, commercial, industrial, scientific or medical user's site, but not at a residential site, during the development, design or pre-production stages.
- (e)(2) For the purpose of paragraphs (e)(1)(iv) and (e)(1)(v) of this section, the term *manufacturer's facilities* includes the facilities of the party responsible for compliance with the regulations and the manufacturer's premises, as well as the facilities of other entities working under the authorization of the responsible party in connection with the development and manufacture, but not the marketing, of the equipment.
- (f) For radio frequency devices subject to verification and sold solely to business, commercial, industrial, scientific and medical users (excluding products sold to other parties or for operation in a residential environment), parties responsible for verification of the devices shall have the option of ensuring compliance with the applicable technical specifications of this chapter at each end user's location after installation, provided that the purchase or lease agreement includes a proviso that such a determination of compliance be made and is the responsibility of the party responsible for verification of the equipment.

## Certification & User's Manual Information

The following is extracted from Title 47 of the Code of Federal Regulations, Part 2, Subpart J — Equipment Authorization Procedures:

### § 2.901 Basis and Purpose

- (a) In order to carry out its responsibilities under the Communications Act and the various treaties and international regulations, and in order to promote efficient use of the radio spectrum, the Commission has developed technical standards for radio frequency equipment and parts or components thereof. The technical standards applicable to individual types of equipment are found in that part of the rules governing the service wherein the equipment is to be operated.<sup>1</sup> *In addition to the technical standards provided, the rules governing the service may require that such equipment be verified by the manufacturer or importer, be authorized under a Declaration of Conformity, or receive an equipment authorization from the Commission by one of the following procedures: certification or registration.*
- (b) The following sections describe the verification procedure, the procedure for a Declaration of Conformity, and the procedures to be followed in obtaining certification from the Commission and the conditions attendant to such a grant.

### § 2.907 Certification.

- (a) Certification is an equipment authorization issued by the Commission, based on representation and test data submitted by the applicant.
- (b) Certification attaches to all units subsequently marketed by the grantee which are identical (see Section 2.908) to the sample tested except for permissive changes or other variations authorized by the Commission pursuant to Section 2.1043.

---

<sup>1</sup> In this case, the equipment is subject to the rules of Part 15. More specifically, the equipment falls under Subpart B (of Part 15), which deals with unintentional radiators.

## Certification & User's Manual Information

### § 2.948 Description of measurement facilities.

- (a) Each party making measurements of equipment that is subject to an equipment authorization under Part 15 or Part 18 of this chapter, regardless of whether the measurements are filed with the Commission or kept on file by the party responsible for compliance of equipment marketed within the U.S. or its possessions, shall compile a description of the measurement facilities employed.
- (1) If the measured equipment is subject to the verification procedure, the description of the measurement facilities shall be retained by the party responsible for verification of the equipment.
- (i) *If the equipment is verified through measurements performed by an independent laboratory, it is acceptable for the party responsible for verification of the equipment to rely upon the description of the measurement facilities retained by or placed on file with the Commission by that laboratory. In this situation, the party responsible for the verification of the equipment is not required to retain a duplicate copy of the description of the measurement facilities.*
- (ii) If the equipment is verified based on measurements performed at the installation site of the equipment, no specific site calibration data is required. It is acceptable to retain the description of the measurement facilities at the site at which the measurements were performed.
- (2) If the equipment is to be authorized by the Commission under the certification procedure, the description of the measurement facilities shall be filed with the Commission's Laboratory in Columbia, Maryland. The data describing the measurement facilities need only be filed once but must be updated as changes are made to the measurement facilities or as otherwise described in this section. At least every three years, the organization responsible for filing the data with the Commission shall certify that the data on file is current.

## Certification & User's Manual Information

### 1. Label and User's Manual Information

The following is extracted from Title 47 of the Code of Federal Regulations, Part 15, Subpart A — General:

#### § 15.19 Labeling requirements.

(a) *In addition to the requirements in Part 2 of this chapter, a device subject to certification or verification shall be labeled as follows:*

- (1) Receivers associated with the operation of a licensed radio service, e.g., FM broadcast under Part 73 of this chapter, land mobile operation under Part 90, etc., shall bear the following statement in a conspicuous location on the device:

This device complies with Part 15 of the FCC Rules. Operation is subject to the condition that this device does not cause harmful interference.

- (2) A stand-alone cable input selector switch, shall bear the following statement in a conspicuous location on the device:

This device is verified to comply with Part 15 of the FCC Rules for use with cable television service.

- (3) All other devices shall bear the following statement in a conspicuous location on the device:

*This device complies with Part 15 of the FCC Rules. Operation is subject to the following two conditions: (1) This device may not cause harmful interference, and (2) this device must accept any interference received, including interference that may cause undesired operation.*

- (4) Where a device is constructed in two or more sections connected by wires and marketed together, the statement specified under paragraph (a) of this section is required to be affixed only to the main control unit.

- (5) When the device is so small or for such use that it is not practicable to place the statement specified under paragraph (a) of this section on it, the information required by this paragraph shall be placed in a prominent location in the instruction manual or pamphlet supplied to the user or, alternatively, shall be placed on the container in which the device is marketed. However, the FCC identifier or the unique identifier, as appropriate, must be displayed on the device.

#### § 15.21 Information to user.

The user's manual or instruction manual for an intentional or unintentional radiator shall caution the user that changes or modifications not expressly approved by the party responsible for compliance could void the user's authority to operate the equipment.

## Verification & User's Manual Information

The following is extracted from Title 47 of the Code of Federal Regulations, Part 15, Subpart B — Unintentional Radiators:

### § 15.105 Information to the user.

- (a) For a Class A digital device or peripheral, the instructions furnished the user shall include the following or similar statement, placed in a prominent location in the text of the manual:

Note: This equipment has been tested and found to comply with the limits for a Class A digital device, pursuant to Part 15 of the FCC Rules. These limits are designed to provide reasonable protection against harmful interference when the equipment is operated in a commercial environment. This equipment generates, uses, and can radiate radio frequency energy and, if not installed and used in accordance with the instruction manual, may cause harmful interference to radio communications. Operation of this equipment in a residential area is likely to cause harmful interference in which case the user will be required to correct the interference at own expense.

- (b) For a Class B digital device or peripheral, the instructions furnished the user shall include the following or similar statement, placed in a prominent location in the text of the manual:

Note: This equipment has been tested and found to comply with the limits for a Class B digital device, pursuant to Part 15 of the FCC Rules. These limits are designed to provide reasonable protection against harmful interference when the equipment is operated in a residential environment. This equipment generates, uses, and can radiate radio frequency energy and, if not installed and used in accordance with the instruction manual, may cause harmful interference to radio communications. However, there is no guarantee that interference will not occur in a particular installation. If this equipment does cause harmful interference to radio or television reception, which can be determined by turning the equipment off and on, the user is encouraged to try to correct the interference by one or more of the following measures:

- Reorient or relocate the receiving antenna.
- Increase the separation between the equipment and receiver.
- Connect the equipment into an outlet on a circuit different from that to which the receiver is connected.
- Consult the dealer or an experienced radio/TV technician for help.

# End of Report