



WHA YU INDUSTRIAL CO., LTD.(HEAD OFFICE)  
DONGGUAN AEON TECH CO.,LTD.(CHINA)  
SUZHOU AEON TECH CO.,LTD.(CHINA)  
AEON TECH (SHANGHAI) CO.,LTD(CHINA)  
DONGGUAN PARNER TECH CO.,LTD.(CHINA)

## SPECIFICATION FOR APPROVAL

**CUSTOMER:** 中磊電子股份有限公司

**PART NAME:** RF PIFA Antenna Assembly

**PART NO.:**

**REVISION:**

**W. Y. P/NO.:** C147-510803-A(SSR-12846)

**REV.:** X2

	MANUFACTURER SIGNATURE	CUSTOMER SIGNATURE
APPROVED BY :		
DATE :		

### WHA YU GROUP

WHA YU INDUSTRIAL CO., LTD.(HEAD OFFICE)

譚裕實業股份有限公司

Address: No. 326, Sec. 2, Kung Tao 5 Road, Hsin Chu City, Taiwan, R.O.C.

Tel: +886-3-5714225(REP.) Fax: +886-3-5713853 · +886-3-5723600

DONGGUAN AEON TECH CO., LTD.(CHINA)

東莞台霖電子通訊有限公司

Address: Hupan Industrial District, Tai Ling Shan Town, Dong Guan City, Guangdong, China

Tel: +86-769-85655858 Fax: +86-769-85655258

SUZHOU AEON TECH CO., LTD.(CHINA)

蘇州華廣電通有限公司

Address: Limin North Road, LiLi Town, LiLi Industrial Park, LinHu Economic Zone

Wujiang City, Jiangsu Province, China

Tel: +86-512-63627980 Fax: +86-512-63627981

AEON TECH (SHANGHAI) CO., LTD.(CHINA)

普翔電子貿易(上海)有限公司

Address: Flat 501, 5F, Build 27, NO.68, Guiqing Road, Huhui District, Shanghai, China

Tel: +86-21-64959151 Fax: +86-21-64959059

DONGGUAN PARNER TECH CO., LTD.(CHINA)

東莞倍能電子有限公司

Address: Hupan Industrial District, Shida Road, Tai Ling Shan Town,

Dong Guan City, Guangdong, China

Tel: +86-769-81662366 Fax: +86-769-81602681

# *Contents*

<i>Item</i>	<i>Description</i>	<i>Page</i>
1. ....	天線規格表	..... 1
2. ....	成品圖	..... 2
3. ....	測試報告	..... 3~5

# RF PIFA Antenna Assembly

## Specification

### 1. Electrical Properties (With Housing)

- 1.1 Frequency Range..... 2.4 ~2.5GHz
- 1.2 Impedance ..... 50Ω Nominal
- 1.3 VSWR ..... 1.92 : 1 Max.
- 1.4 Return Loss..... -10 dB Max.
- 1.5 Radiation ..... Omni-directional
- 1.6 Peak Gain..... 3.12 dBi @2.4 ~2.5GHz
- 1.7 Cable Loss..... 0.16dB Max.
- 1.8 Polarization..... Linear
- 1.9 Admitted Power..... 1W
- 1.10 Cable..... Φ1.13Coaxial Cable ; Gray
- 1.11 Connector..... MHF Plug

### 2. Physical Properties :

- 2.1 Operating Temp. .... -10°C ~ +60°C
- 2.2 Storage Temp. .... -10°C ~ +70°C

CG-

REV	DATE	DESCRIPTION
X1	6/8-2011	New Issue
X2	7/12-2011	Modify 出線位置、線長

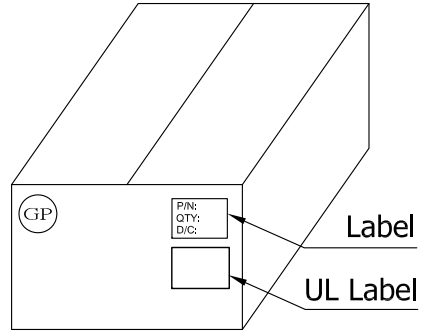

GP標籤貼於外箱兩邊側麥左上角共2PCS  
 標示Label貼於外箱兩邊側麥共2PCS  
 UL Label貼於外箱側麥共1PCS

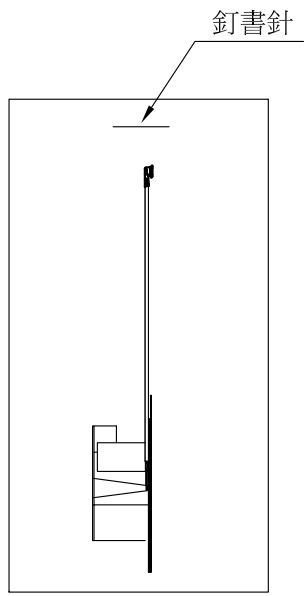
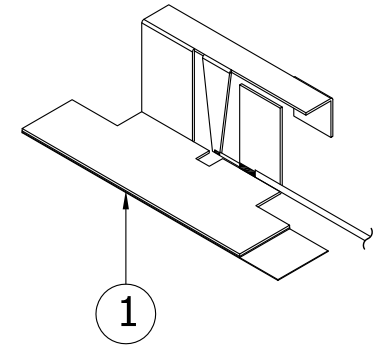

Packing : 1 pcs/bag  
 (每5袋用釘書機訂起來)

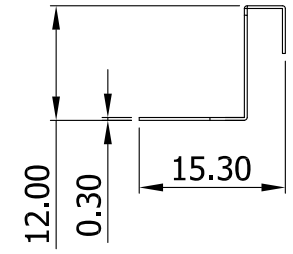
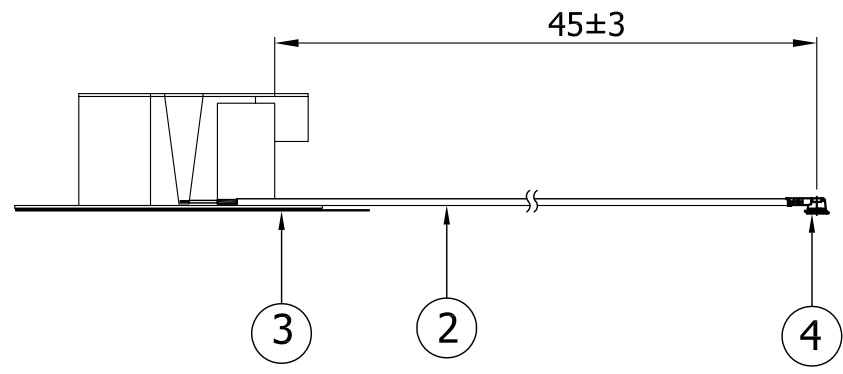

NO	DESCRIPTION	Q'TY	REMARK
4	Connector	MHF Connector	1
3	雙面背膠	Sony G4000	1 32*7*0.15mm
2	Cable	φ1.13 Coaxial Cable ; Gray	1
1	PIFA	SUS 430 Nickel Plating	1

CUSTOMER'S SINGATURE	XX.	±5	APPROVED 周東生 2011.7.14	CUSTOMER: 中磊		
	X.	±3.0	CHECKED 林泰宏 2011.7.12	PART NO :		
	.X	±1.0	DRAWING 徐筱惠 2011.7.12	PARTNAME: PIFA Antenna		
	.XX	±0.5		W.Y P/NO : C147-510803-A		
	.XXX	±0.1		REV	UNIT	FILE : SSR-12846
			X2		m/m	SHEET : 1/1

**M.gear** Wha Yu Group

THIS DRAWING, AND IT'S INHERANT DESIGN CONCEPTS, ARE THE PROPERTY OF WHA YU AND AS SUCH MAY NOT BE COPIED, REPRODUCED, OR GIVEN TO THIRD PARTIES WITHOUT THE WRITTEN CONSENT OF WHA YU.

RF Antenna Assembly

P/NO : C147-510803-A(SSR-12846) SPEC : 2.4~2.5 GHz

With housing

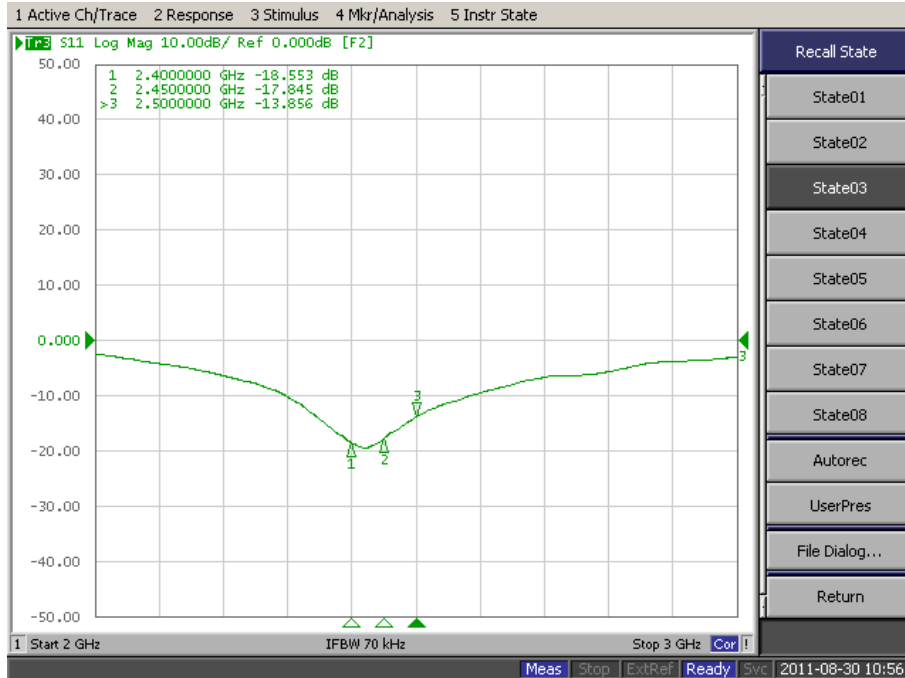

Isolation Test Results

SPEC : 2.4~2.5 GHz

With housing

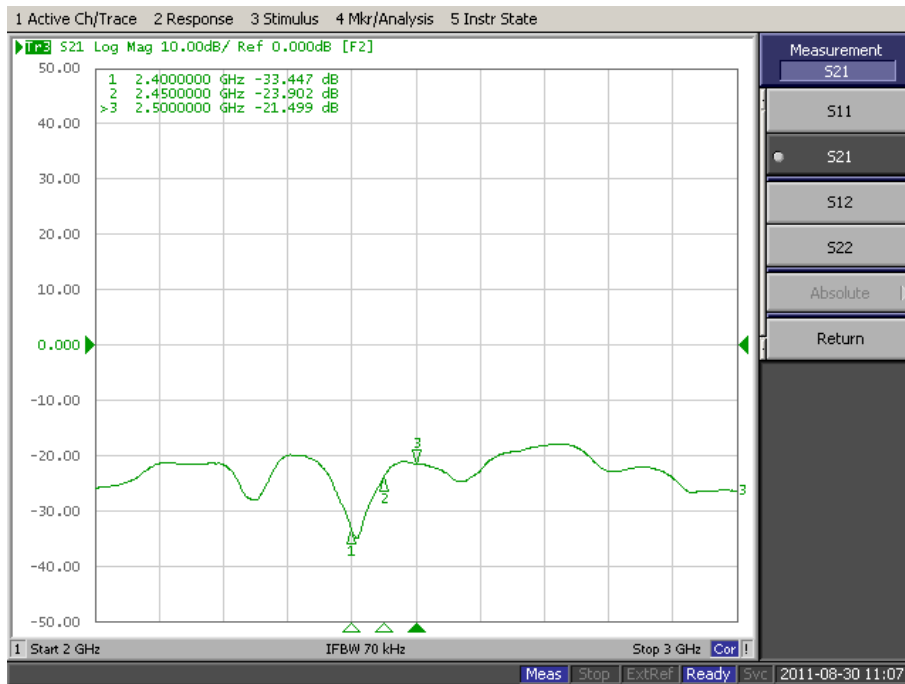

2007/08/13

C147-510803-A(SSR-12846)  
X-Z plane(Phi=0)

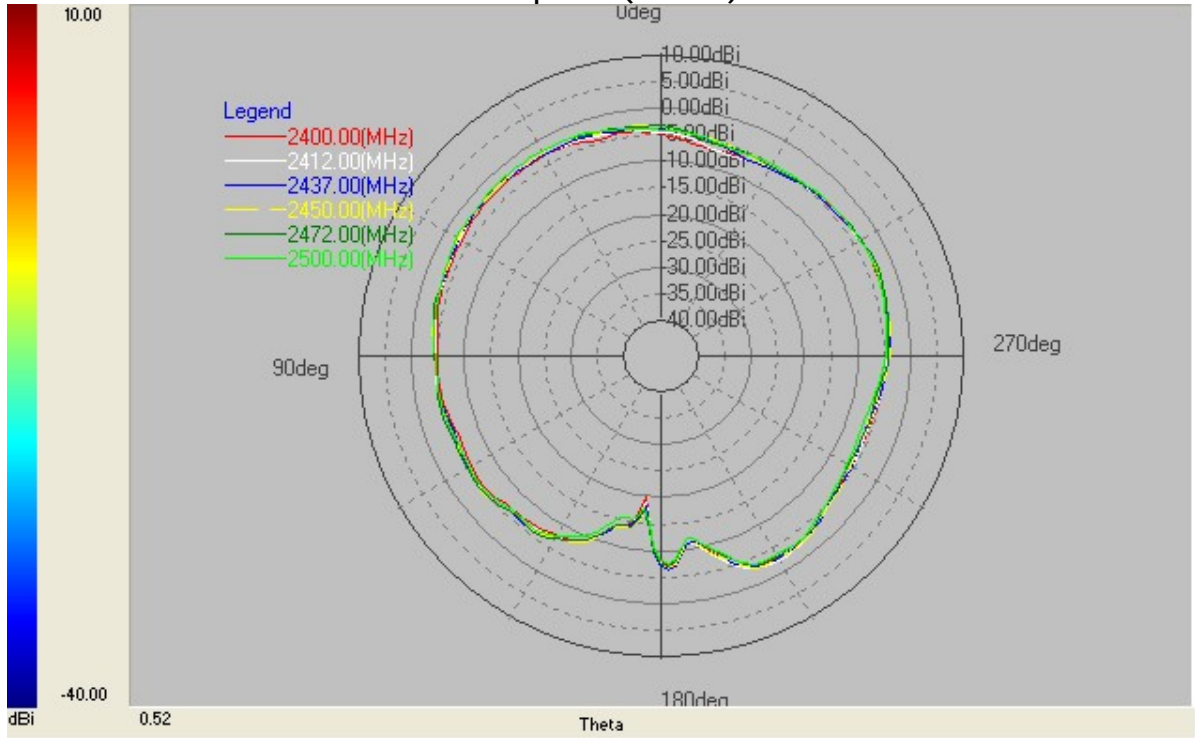

C147-510803-A(SSR-12846)  
Y-Z plane(Phi=90)

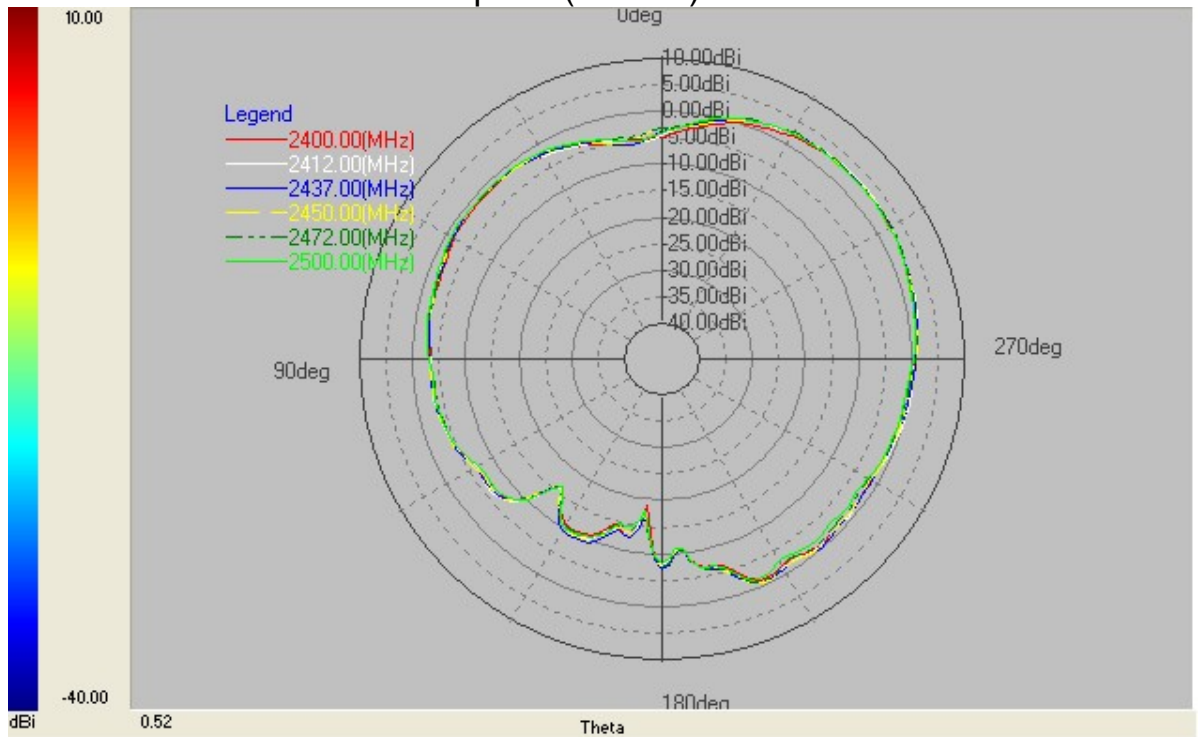

C147-510803-A(SSR-12846)

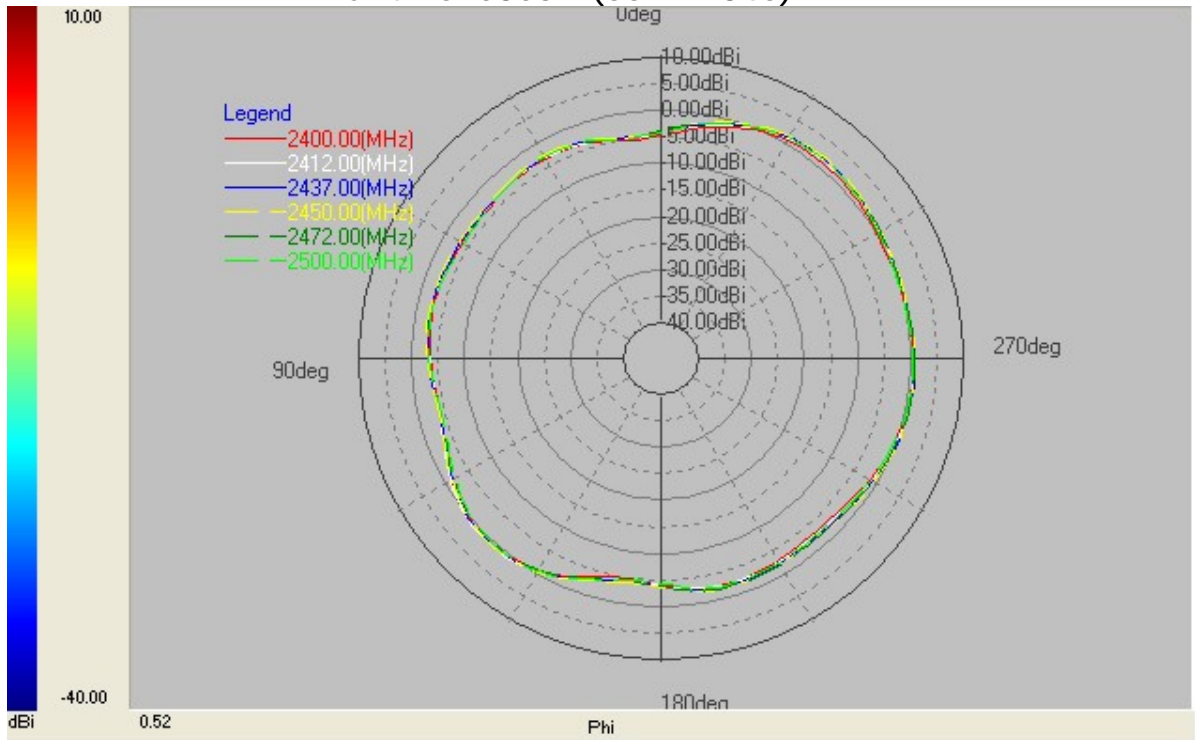

X-Y plane(theta=90)