



FCC PART 15.407(H)
RSS-210, ISSUE 8, DEC 2010
DYNAMIC FREQUENCY SELECTION
TEST AND MEASUREMENT REPORT

For
Meru Networks Inc.

894 Ross Drive,
Sunnyvale, CA 94089, USA

FCC ID: RE7-AP1020
IC: 6749A-AP1020

Report Type: Original Report	Product Type: 802.11 a/b/g/n Wi-Fi Access Point
Test Engineer: Ning Ma	
Report Number: R1108081-DFS-1	
Report Date: 2012-01-18	
Reviewed By: Victor Zhang EMC/RF Lead	
Prepared By: (84)	Bay Area Compliance Laboratories Corporation (BACL) 1274 Anvilwood Avenue, Sunnyvale, CA 94089 Tel: (408) 732-9162 Fax: (408) 732 9164

Note: This test report is prepared for the customer shown above and for the device described herein. It may not be duplicated or used in part without prior written consent from Bay Area Compliance Laboratories Corp. This report **must not** be used by the customer to claim product certification, approval, or endorsement by NVLAP*, NIST, or any agency of the Federal Government.

* This report may contain data that are not covered by the NVLAP accreditation and are marked with an asterisk "*" ...

TABLE OF CONTENTS

1	GENERAL DESCRIPTION.....	5
1.1	PRODUCT DESCRIPTION FOR EQUIPMENT UNDER TEST (EUT).....	5
1.2	MECHANICAL DESCRIPTION OF EUT	5
1.3	OBJECTIVE.....	5
1.4	RELATED SUBMITTAL(S)/GRANT(S)	5
1.5	TEST METHODOLOGY	5
1.6	TEST FACILITY	6
2	EUT TEST CONFIGURATION.....	7
2.1	JUSTIFICATION.....	7
2.2	EUT EXERCISE SOFTWARE.....	7
2.3	EQUIPMENT MODIFICATIONS.....	7
2.4	SPECIAL EQUIPMENT	7
2.5	LOCAL SUPPORT EQUIPMENT	7
2.6	POWER SUPPLY LIST AND DETAILS	7
2.7	EUT INTERNAL CONFIGURATION DETAILS.....	7
2.8	EXTERNAL I/O CABLING LIST AND DETAILS	7
3	APPLICABLE STANDARDS.....	8
3.1	DFS REQUIREMENT.....	8
3.2	DFS MEASUREMENT SYSTEM	11
3.3	SYSTEM BLOCK DIAGRAM.....	11
3.4	CONDUCTED METHOD.....	11
3.5	RADIATED METHOD	13
3.6	TEST PROCEDURE	13
4	SUMMARY OF TEST RESULT	14
5	TEST RESULTS.....	15
5.1	DESCRIPTION OF EUT.....	15
5.2	TEST EQUIPMENT LIST AND DETAILS	15
5.3	TEST ENVIRONMENTAL CONDITIONS.....	16
5.4	RADAR WAVEFORM CALIBRATION.....	16
5.5	CHANNEL AVAILABILITY CHECK TIME (CAC).....	25
6	CHANNEL MOVE TIME AND CHANNEL CLOSING TRANSMISSION TIME	40
6.1	TEST PROCEDURE	40
6.2	TEST RESULTS	40
7	NON-OCCUPANCY PERIOD.....	66
7.1	TEST PROCEDURE	66
7.2	RESULTS.....	66
8	DETCETIO BANDWIDTH.....	71
8.1	PROCEDURE.....	71
8.2	TEST RESULTS	71
8.3	RADAR DETECTION	80
9	APPENDIX A - TEST SETUP PHOTOGRAPHS	345
9.1	DFS TEST SETUP VIEW	345
10	APPENDIX B - EUT PHOTOGRAPHS	346
10.1	EUT AP1020I- TOP VIEW.....	346

10.2	EUT 1020I-BOTTOM VIEW	346
10.3	EUT AP1020I- COVER OFF VIEW	347
10.4	EUT AP1020I –BOARD TOP VIEW	347
10.5	EUT AP1020I –BOARD BACK VIEW	348
10.6	EUT – ADAPTER FOR POE	348
10.7	EUT AP1020E– TOP VIEW	349
10.8	EUT 1020E-BOTTOM VIEW	349
10.9	EUT AP1020E - COVER OFF VIEW	350
10.10	EUT AP1020E – BOARD TOP VIEW	350
10.11	EUT AP1020E –BOARD BACK VIEW	351
10.12	EUT AP1020E ANTENNA.....	351

DOCUMENT REVISION HISTORY

Revision Number	Report Number	Description of Revision	Date of Revision
0	R1108081-DFS-1	Original Report	2012-01-18

1 GENERAL DESCRIPTION

1.1 Product Description for Equipment under Test (EUT)

This test and measurement report was prepared on behalf of *Meru Network*, and their product FCC ID: *RE7-AP1020*, IC: *6749A-AP1020*, model: *AP1020i/AP1020e* or the “EUT” as referred on this report is a dual band Wireless 802.11a/n outdoor access point. The EUT’s DFS operating Frequency is 5250-5350 MHz and 5470-5725 MHz (802.11 a/n mode)

1.2 Mechanical Description of EUT

AP1020i

The EUT has measured approximately 172 mm L x 172 mm W x 41 mm H

The test data gathered are from typical production sample, serial number: 4310A102i000CE60997F3 provided by the manufacturer.

1.3 Objective

This report is prepared on behalf of *Meru Networks, Inc.* in accordance with FCC CFR47 §15.407 (h) and FCC 06-96 Appendix.

The objective is to determine compliance with FCC rules for Non-Occupancy Period, DFS Detection Threshold, Channel Availability Check Time, Uniform Spreading U-NII Detection Bandwidth, Channel Closing Transmission Time, and Channel Move time

1.4 Related Submittal(s)/Grant(s)

FCC ID: RE7-AP1010

1.5 Test Methodology

FCC CFR 47 Part2, Part15.407 (h)

FCC 06-96 Appendix “COMPLIANCE MEASUREMENT PROCEDURES FOR UNLICENSED NATIONAL INFORMATION INFRASTRUCTURE DEVICES OPERATING IN THE 5250-5350 MHz AND 5470-5725 MHz BANDS INCORPORATING DYNAMIC FREQUENCY SELECTION”

1.6 Test Facility

The test site used by BACL Corp. to collect radiated and conducted emissions measurement data is located at its facility in Sunnyvale, California, USA.

The test site at BACL Corp. has been fully described in reports submitted to the Federal Communication Commission (FCC) and Voluntary Control Council for Interference (VCCI). The details of these reports have been found to be in compliance with the requirements of Section 2.948 of the FCC Rules on February 11 and December 10, 1997, and Article 8 of the VCCI regulations on December 25, 1997. The test site also complies with the test methods and procedures set forth in CISPR 22:2005 + A1:2005 + A2:2006 §10.4 for measurements below 1 GHz and §10.6 for measurements above 1 GHz. The facility also complies with the test methods and procedures set forth in ANSI C63.4-2003 & TIA/EIA-603.

The Federal Communications Commission and Voluntary Control Council for Interference have the reports on file and they are listed under FCC registration number: 90464 and VCCI Registration No.: R-3729, C-4176, G-469, and T-1206. The test site has been approved by the FCC and VCCI for public use and is listed in the FCC Public Access Link (PAL) database.

Additionally, BACL Corp. is a National Institute of Standards and Technology (NIST) accredited laboratory under the National Voluntary Laboratory Accredited Program (Lab Code 200167-0). The current scope of accreditations can be found at <http://ts.nist.gov/Standards/scopes/2001670.htm>

2 EUT TEST CONFIGURATION

2.1 Justification

The EUT was configured for testing according to FCC Part 15.407(H)/IC RSS-210 Standards.

2.2 EUT Exercise Software

The software used, SCRT5.5.1, was provided by customer and verified by Ning Ma to comply with the standard requirements being tested against.

2.3 Equipment Modifications

None.

2.4 Special Equipment

N/A

2.5 Local Support Equipment

Manufacturers	Description	Models	Serial Number
DELL	Laptop	1XDRM A00	4SD2LQ1
NETGEAR	Router	GS605 v2	1FE1715K02A42

2.6 Power Supply List and Details

Manufacturer	Description	Model Number	Serial Number
Power Dsine	Power Adapter	PD-7001G/AC	D0844644000023FA01
Delta Electronics	Power Adapter	ADP-15KB	DNW0517000319

2.7 EUT Internal Configuration Details

Objects/Parts	Manufacturer	Models	Series Number
Wi-Fi Module	Broadcom	LOG-M11	E150630
Main Board	Meru Network, Inc	MVT1.0	40AB103V 8501-6000386-01

2.8 External I/O Cabling List and Details

Cable Description	Length (M)	From	To
RJ 45	< 1.0	Power Adapter	Router
RJ 45	< 1.0	Power Adapter	EUT
RJ 45	< 1.0	Router	Laptop

3 APPLICABLE STANDARDS

3.1 DFS Requirement

FCC CFR47 §15.407 (h) and FCC 06-96 Appendix.

Table 1: Applicability of DFS requirements prior to use of a channel

Requirement	Operational Mode		
	Master	Client (Without radar detection)	Client (With radar detection)
Non-Occupancy Period	Yes	Not Required	Yes
DFS Detection Threshold	Yes	Not Required	Yes
Channel Availability Check Time	Yes	Not Required	Not Required
Uniform Spreading	Yes	Not Required	Not Required
U-NII Detection Bandwidth	Yes	Not Required	Yes

Table 2: Applicability of DFS requirements during normal operation

Requirement	Operational Mode		
	Master	Client (Without DFS)	Client (With DFS)
DFS Detection Threshold	Yes	Not Required	Yes
Channel Closing Transmission Time	Yes	Yes	Yes
Channel Move Time	Yes	Yes	Yes

Table 3: Interference Threshold values, Master or Client incorporating In-Service Monitoring

Maximum Transmit Power	Value (See Notes 1 and 2)
≥ 200 milliwatt	-64 dBm
< 200 milliwatt	-62 dBm

Note 1: This is the level at the input of the receiver assuming a 0 dBi receive antenna.

Note 2: Throughout these test procedures an additional 1 dB has been added to the amplitude of the test transmission waveforms to account for variations in measurement equipment. This will ensure that the test signal is at or above the detection threshold level to trigger a DFS response.

Table 4: DFS Response requirement values

Parameter	Value
Non-occupancy period	Minimum 30 minutes
Channel Availability Check Time	60 seconds
Channel Move Time	10 seconds See Note 1.
Channel Closing Transmission Time	200 milliseconds + an aggregate of 60 milliseconds over remaining 10 second period. See Notes 1 and 2.
U-NII Detection Bandwidth	Minimum 80% of the UNII 99% transmission power bandwidth. See Note 3.

Note 1: The instant that the *Channel Move Time* and the *Channel Closing Transmission Time* begins is as follows:

- For the Short Pulse Radar Test Signals this instant is the end of the *Burst*.
- For the Frequency Hopping radar Test Signal, this instant is the end of the last radar *Burst* generated.
- For the Long Pulse Radar Test Signal this instant is the end of the 12 second period defining the *Radar Waveform*.

Note 2: The *Channel Closing Transmission Time* is comprised of 200 milliseconds starting at the beginning of the *Channel Move Time* plus any additional intermittent control signals required to facilitate a *Channel* move (an aggregate of 60 milliseconds) during the remainder of the 10 second period. The aggregate duration of control signals will not count quiet periods in between transmissions.

Note 3: During the *U-NII Detection Bandwidth* detection test, radar type 1 is used and for each frequency step the minimum percentage of detection is 90 percent. Measurements are performed with no data traffic.

Table 5: Short Pulse Radar Test Waveforms

Radar Type	Pulse Width (Microseconds)	PRI (Microseconds)	Pulses	Minimum Percentage of Successful Detection	Minimum Number of Trials
1	1	1428	18	60%	30
2	1-5	150-230	23-29	60%	30
3	6-10	200-500	16-18	60%	30
4	11-20	200-500	12-16	60%	30
Aggregate (Radar Types 1-4)				80%	120

Table 6: Long Pulse Radar Test Signal

Radar Type	Bursts	Chirp Width (MHz)	PRI (usec)	Number of Pulses per Burst	Number of Bursts	Minimum Percentage of Successful Detection	Minimum Number of Trials
5	50-100	5-20	1000-2000	1-3	8-20	80%	30

Table 7: Frequency Hopping Radar Test Signal

Radar Type	Pulse Width (usec)	PRI (usec)	Pulses per Hop	Hopping Rate (kHz)	Hopping Sequence Length (msec)	Minimum Percentage of Successful Detection	Minimum Number of Trials
6	1	333	9	0.333	300	70%	30

3.2 DFS Measurement System

BACL DFS measurement system consists of two subsystems: (1) The radar signal generating subsystem and (2) the traffic monitoring subsystem.

3.3 System Block Diagram

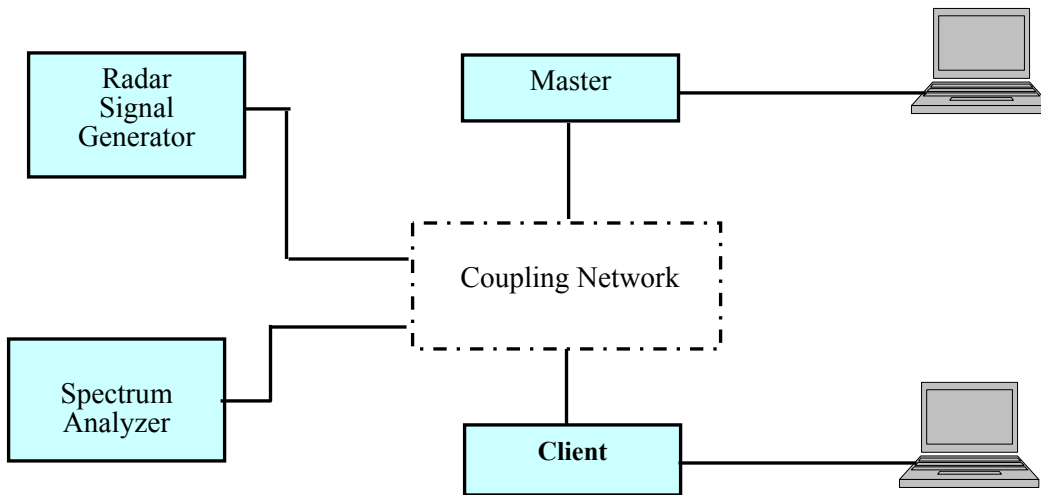

3.4 Conducted Method

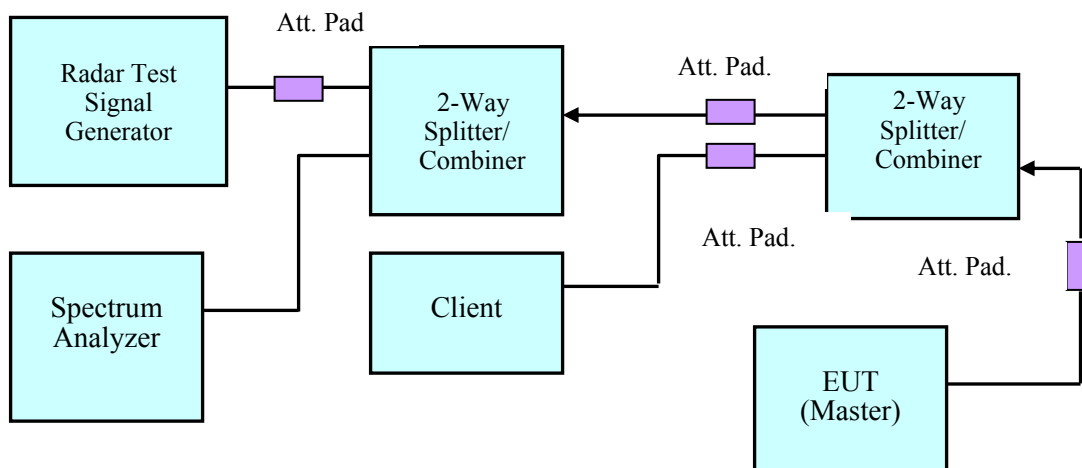

Setup for Master with injection at the Master

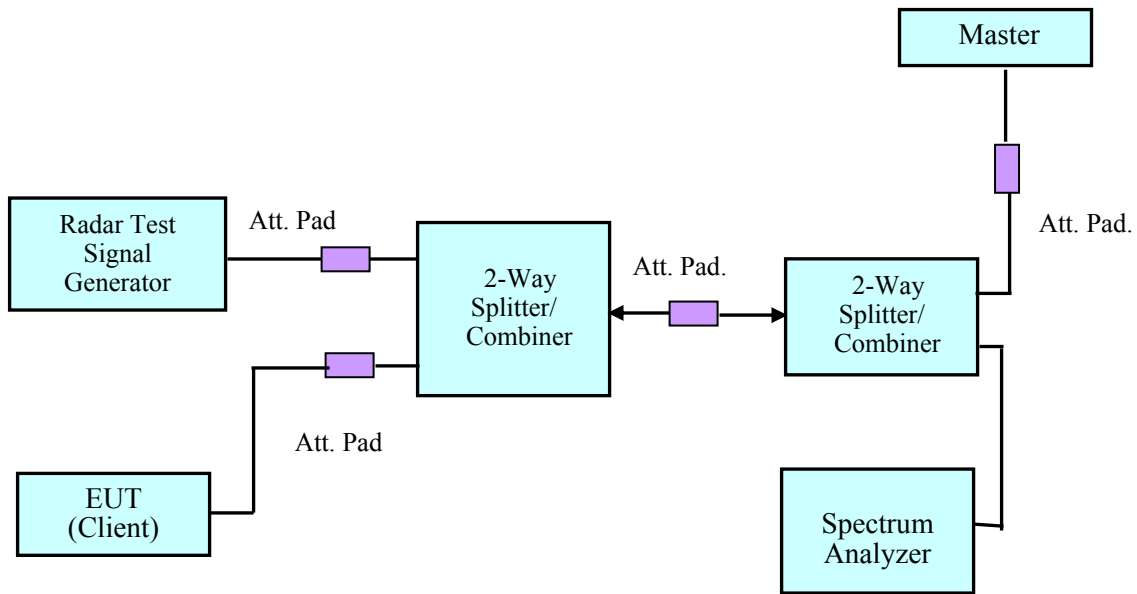

Setup for Client with injection at the Master

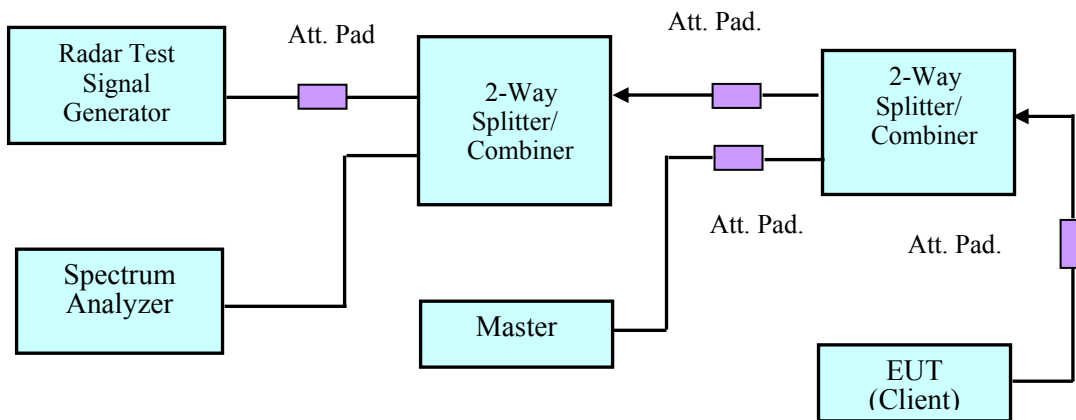

Setup for Client with injection at the Client

3.5 Radiated Method

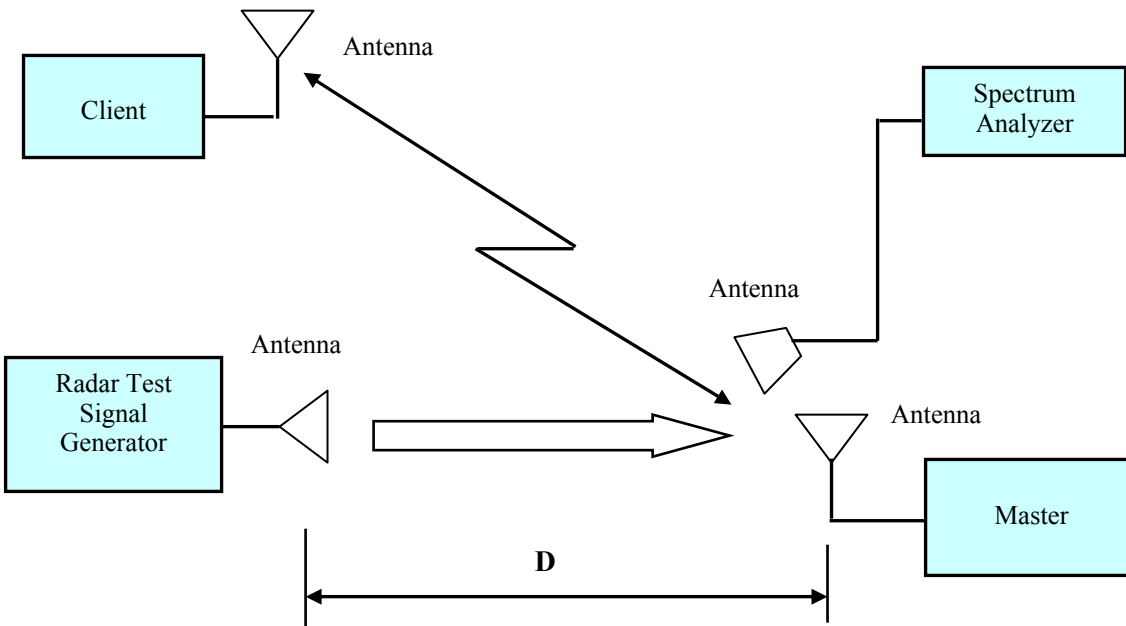

3.6 Test Procedure

A spectrum analyzer is used as a monitor verifies that the EUT status including Channel Closing Transmission Time and Channel Move Time, and does not transmit on a Channel during the Non-Occupancy Period after the diction and Channel move. It is also used to monitor EUT transmissions during the Channel Availability Check Time.

4 SUMMARY OF TEST RESULT

The following result table represents the list of measurements required under the FCC Part15.407 (h) and FCC 06-96.

Items	Description of Test	Result
Detection Bandwidth	UNII Detection Bandwidth	Compliant
Performance Requirements Check	Initial Channel Availability Check Time (CAC)	Compliant
	Radar Burst at the Beginning of the CAC	Compliant
	Radar Burst at the End of the CAC	Compliant
In-Service Monitoring	Channel Move Time	Compliant
	Channel Closing Transmission Time	Compliant
	Non-Occupancy Period	Compliant
Radar Detection	Statistical Performance Check	Compliant

5 TEST RESULTS

5.1 Description of EUT

The EUT operates in 5230-5350 MHz and 5470-5725 MHz range.

The antenna of the EUT 1020e, the gain is 2 dBi (5150-5850 MHz).

The antenna of the EUT 1020i, the gain is 6 dBi (5150-5859 MHz).

The rated output power of EUT is <23 dBm (EIRP), Therefore the required interference threshold level is -62 dBm, after correction for antenna gain and procedure adjustments, the required conducted threshold at antenna port is $-62 + (2) = -60$ dBm.

The calibrated conducted DFS detection threshold level is set to -60 dBm.

WLAN traffic is generated by streaming the video file TestFile.mpg, this file is used by IP and Frame based systems for loading the test channel during the In-service compliance testing of the U-NII device. The file is streamed from the Access Point to the Client in full motion video mode using the media player with the V2.61 Codec package.

Test result show that the EUT requires 21.5 seconds to complete its initial power-up cycle.

5.2 Test Equipment List and Details

Description	Manufacturer	Model Number	Serial Number
NI PXI-1042 8-Slot chassis	National Instruments	PXI-1042	V08X01EE1
Arbitrary Waveform Generator	National Instruments	PXI-5421	N/A
RF Upconverter	National Instruments	PXI-5610	N/A
Upconverter	ASCOR	AS-7206	n/A
Spectrum Analyzer	Agilent	E4440A	MY44303352
Pre-Amplifier	Avantek	2-8 GHz Lab AMP	218
Pre-Amplifier	Ducommun Technologies	ALN-09173030-01	990297-02
Splitter/Combiner	Mini-Circuits	2FSC-2-10G	0349
Splitter/Combiner	Narada	4326B-2	03514
Attenuator	MIDWest	290-30	N/A
Attenuator	Mini-Circuits	BW-S30W2	N/A

Statement of Traceability: **BACL Corp.** attests that all calibrations have been performed per the NVLAP requirements, traceable to the NIST.

5.3 Test Environmental Conditions

Temperature:	20-23 °C
Relative Humidity:	48%- 55%
ATM Pressure:	1015 mbar

Testing performed by Ning Ma on 2011-09-13 to 2011-09-28

5.4 Radar Waveform Calibration

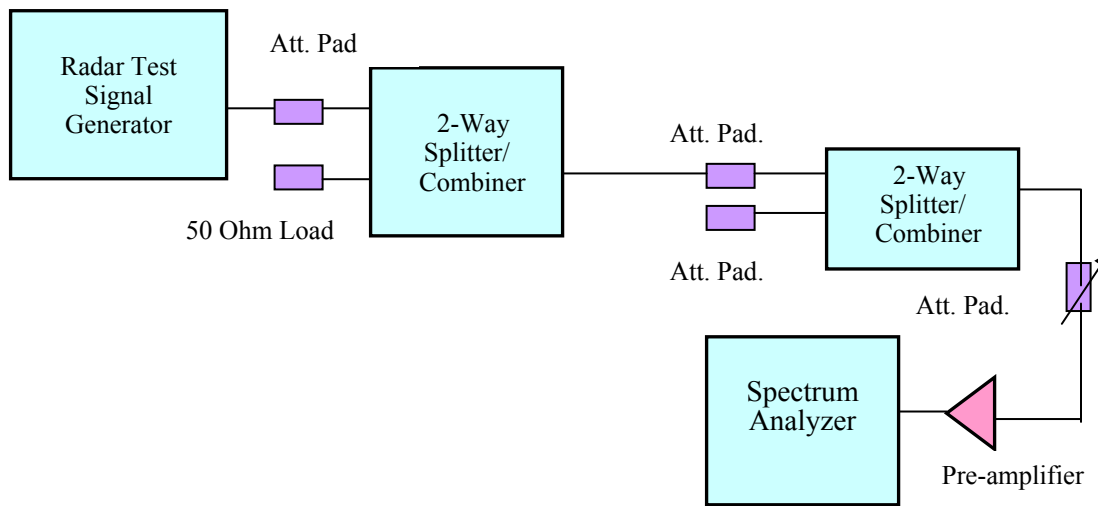

Conducted Calibration Setup Block Diagram

Band edge:

Antenna 1 5580

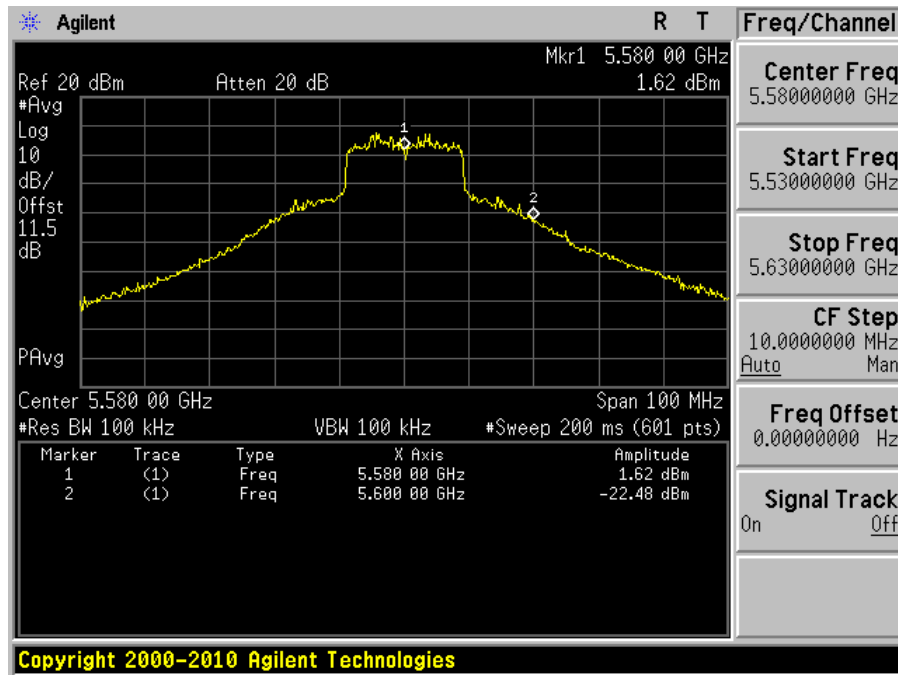

Antenna 2

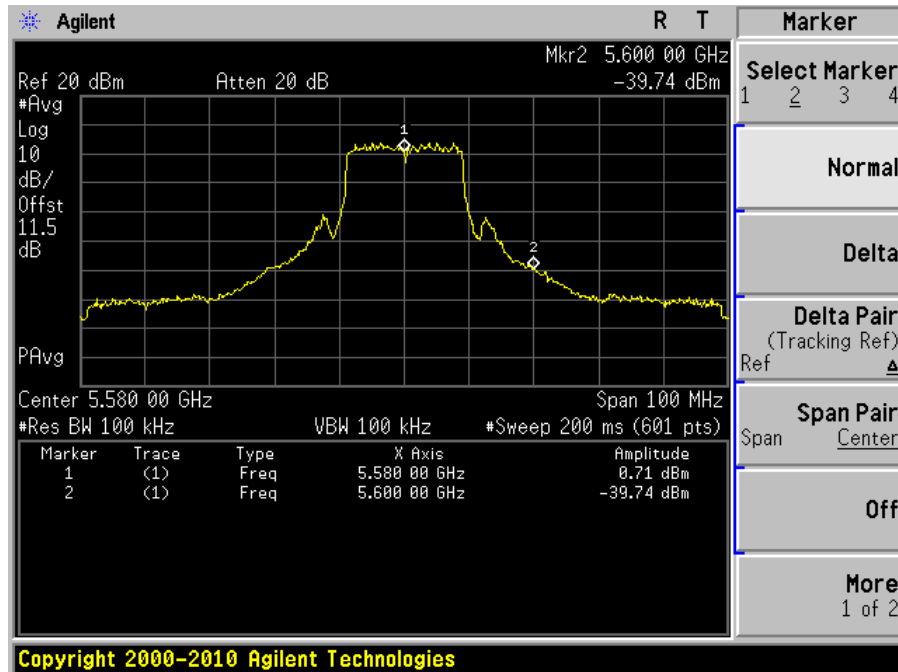

Antenna 1 5670

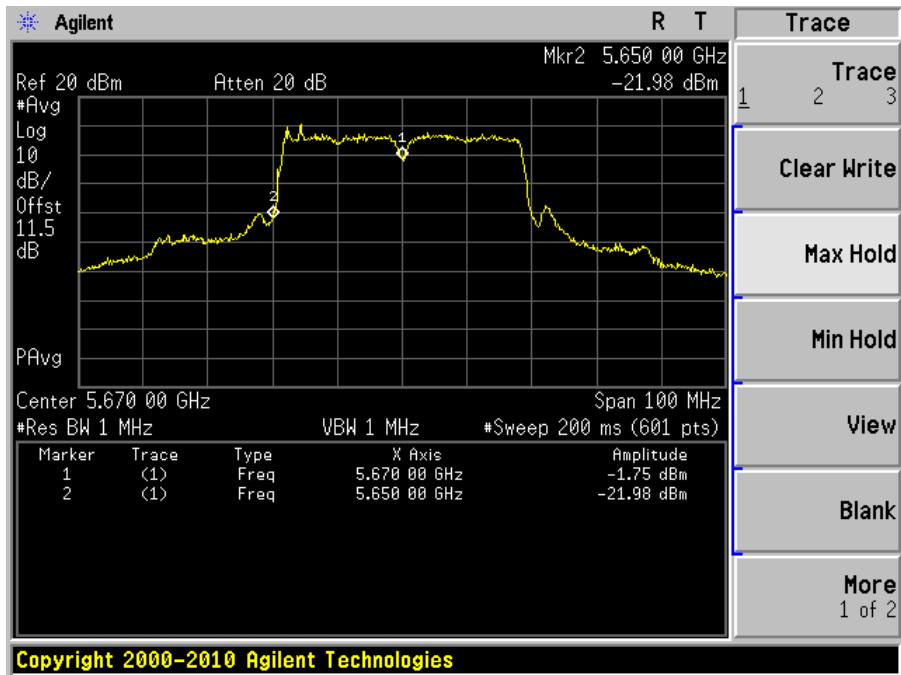

Antenna 2 5670

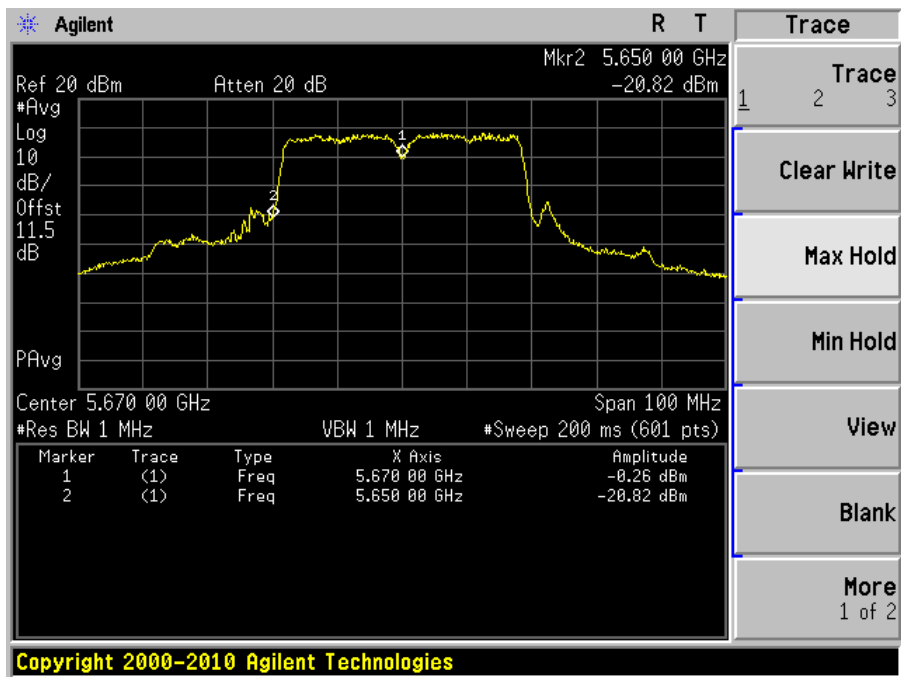

Plots of Radar Waveforms

5280 MHz

Radar Type 1

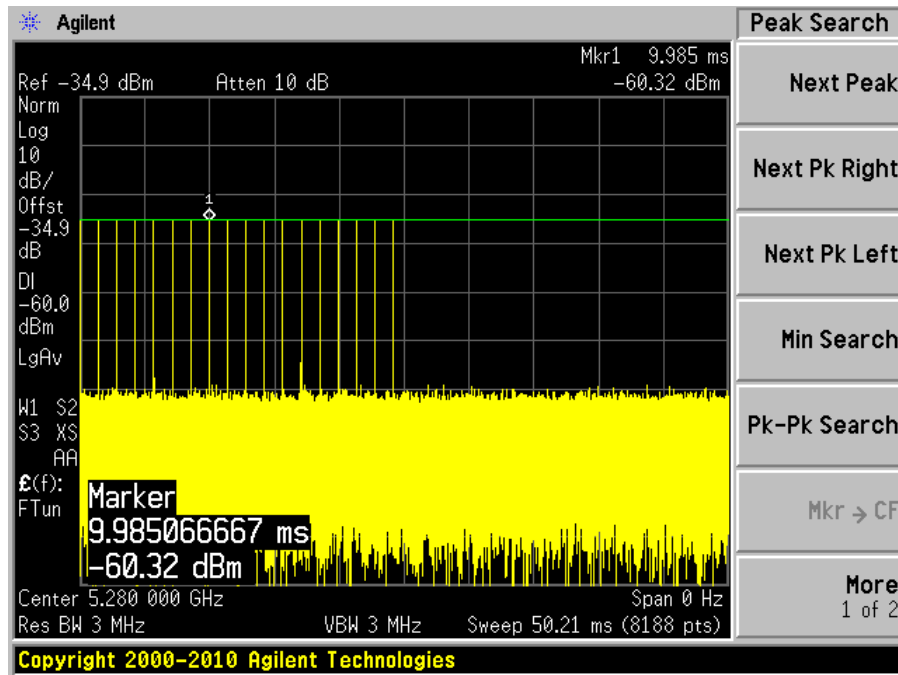

Radar Type 2

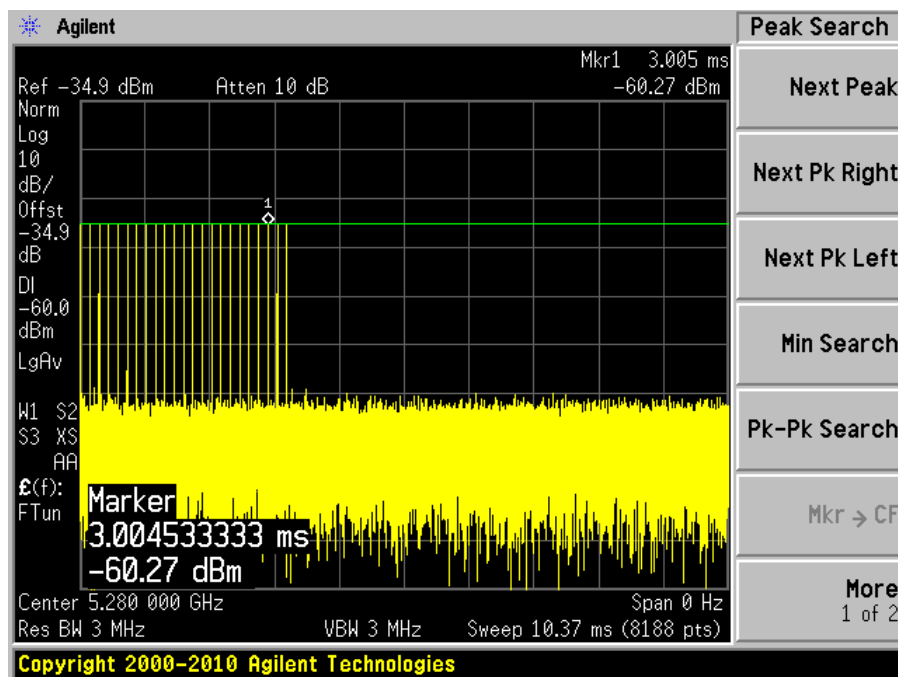

Radar Type 3

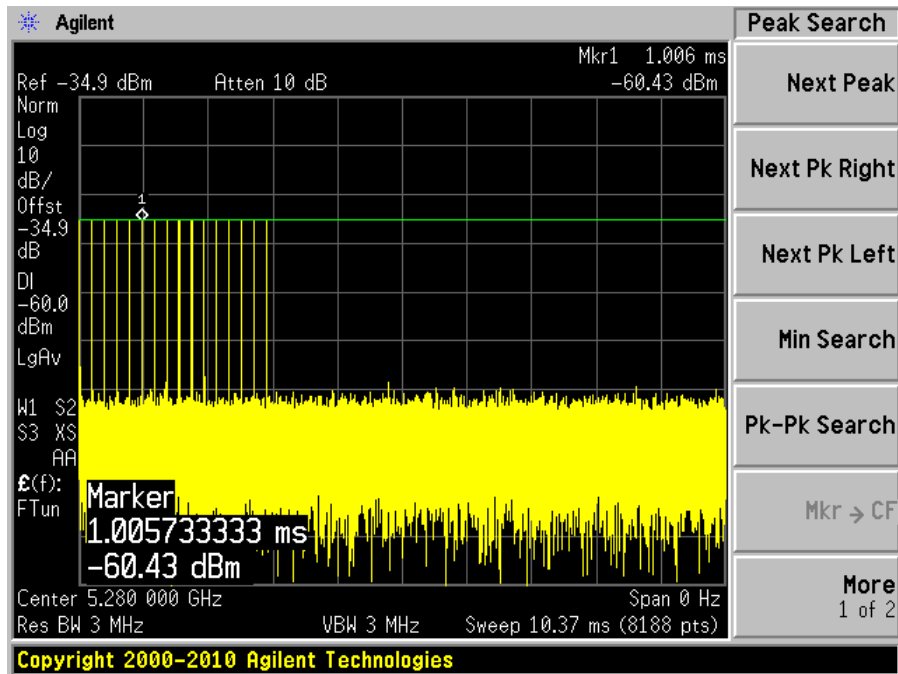

Radar Type 4

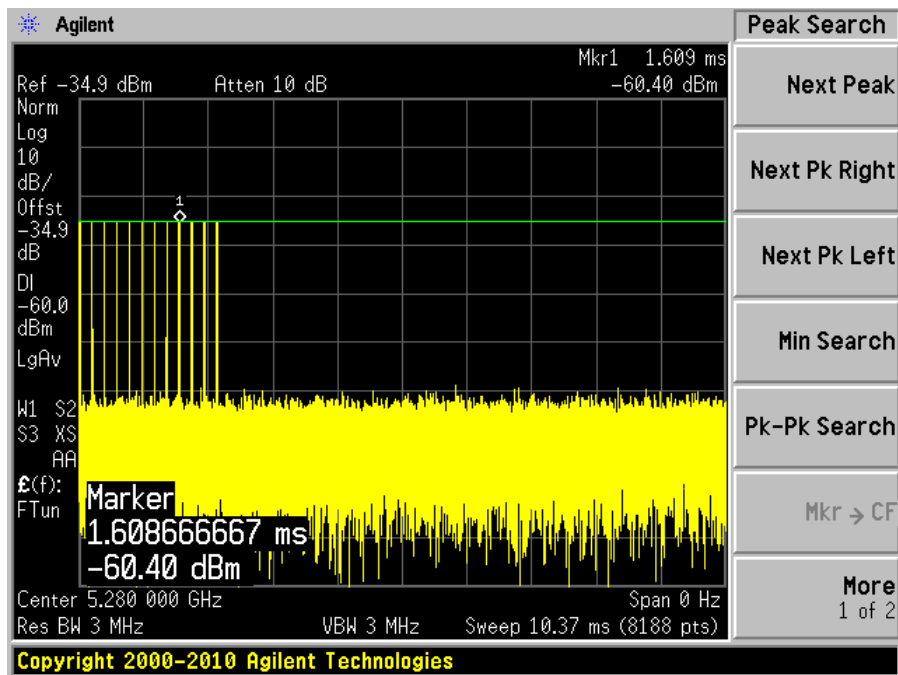

Radar Type 5

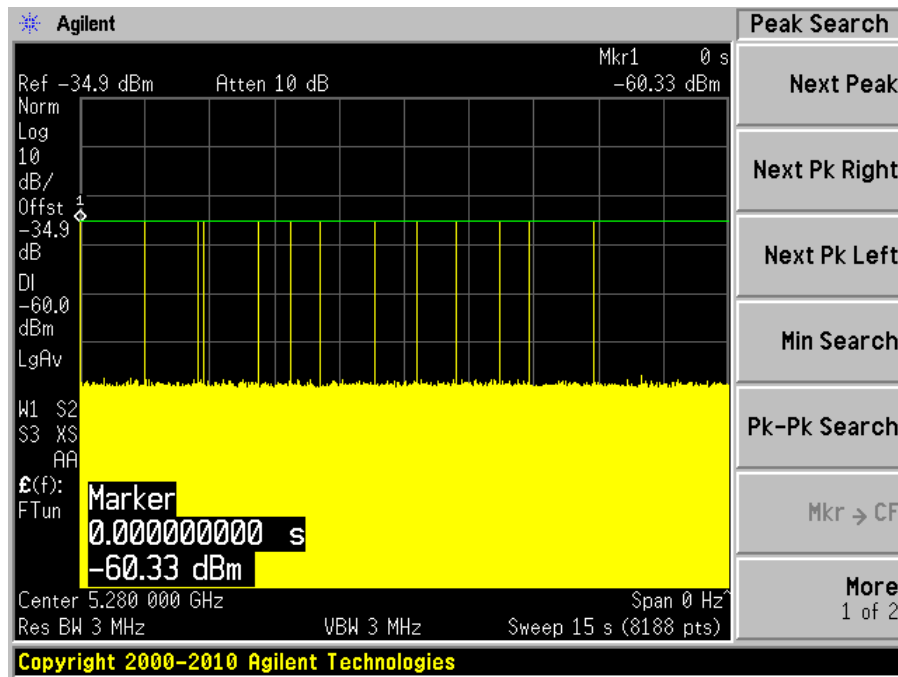

Radar Type 6

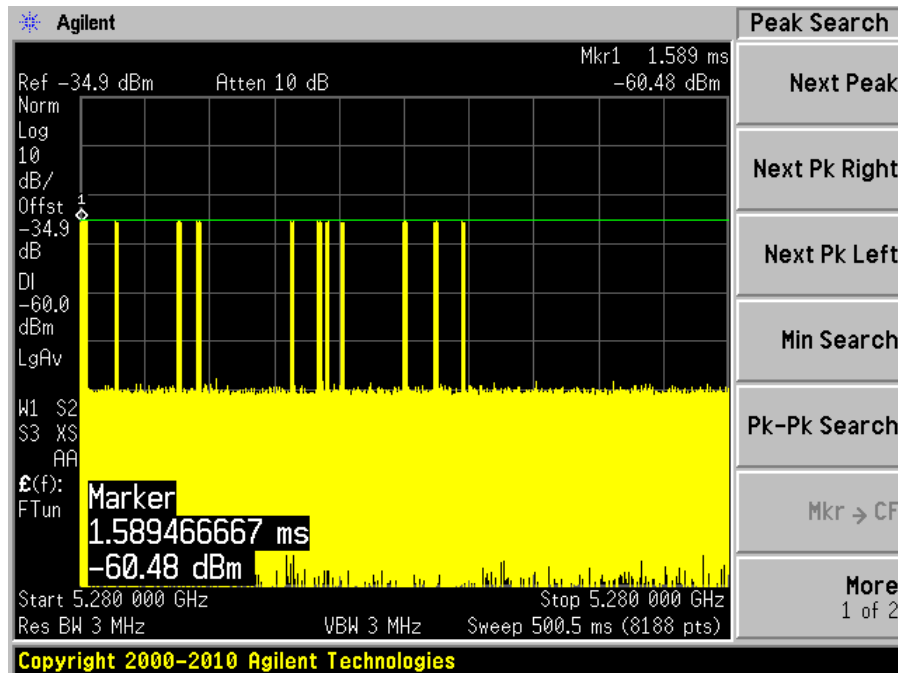

5580 MHz

Radar Type 1

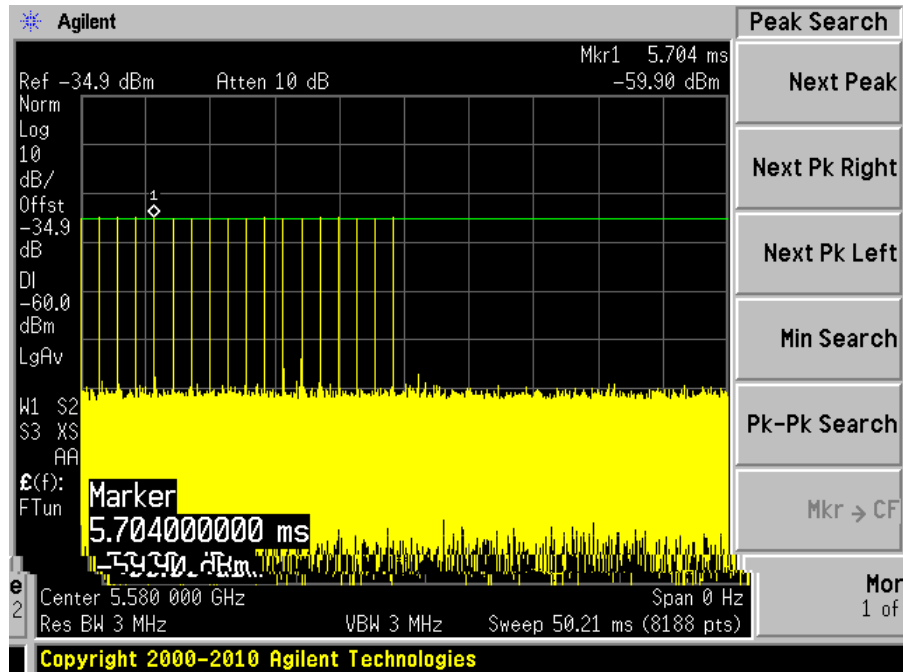

Radar Type 2

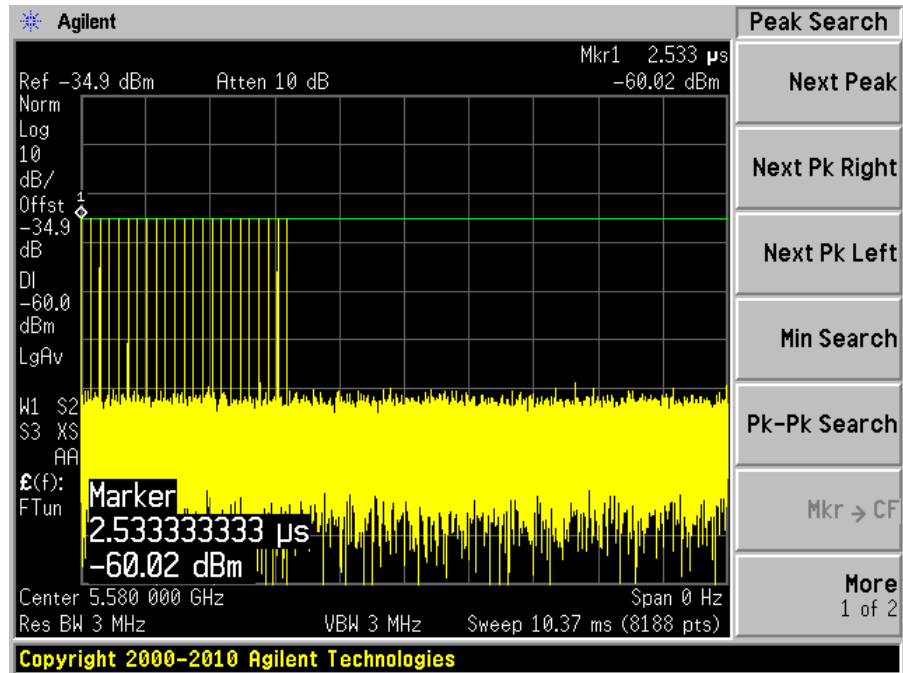

Radar Type 3

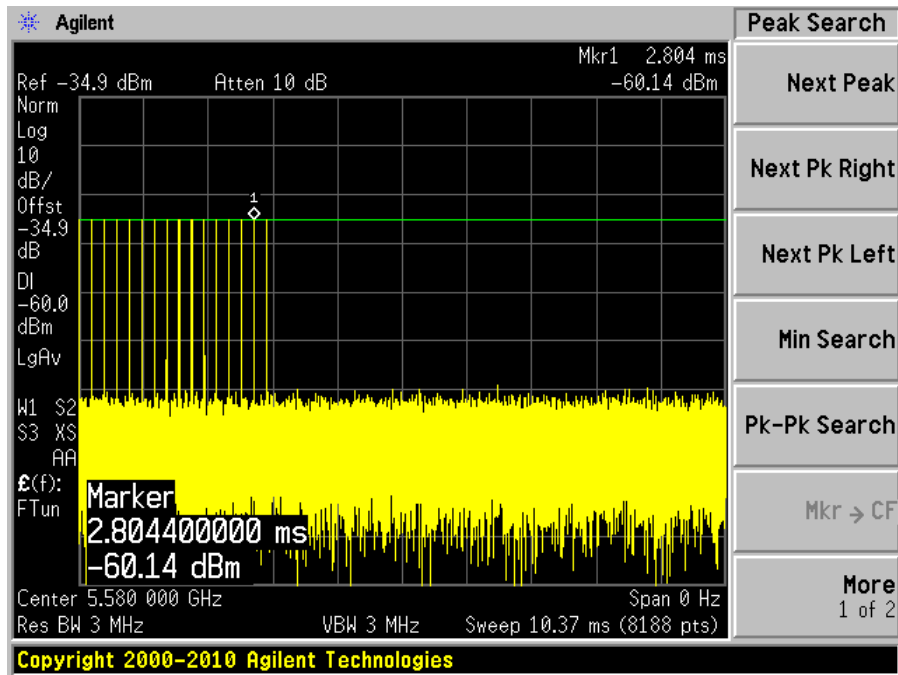

Radar Type 4

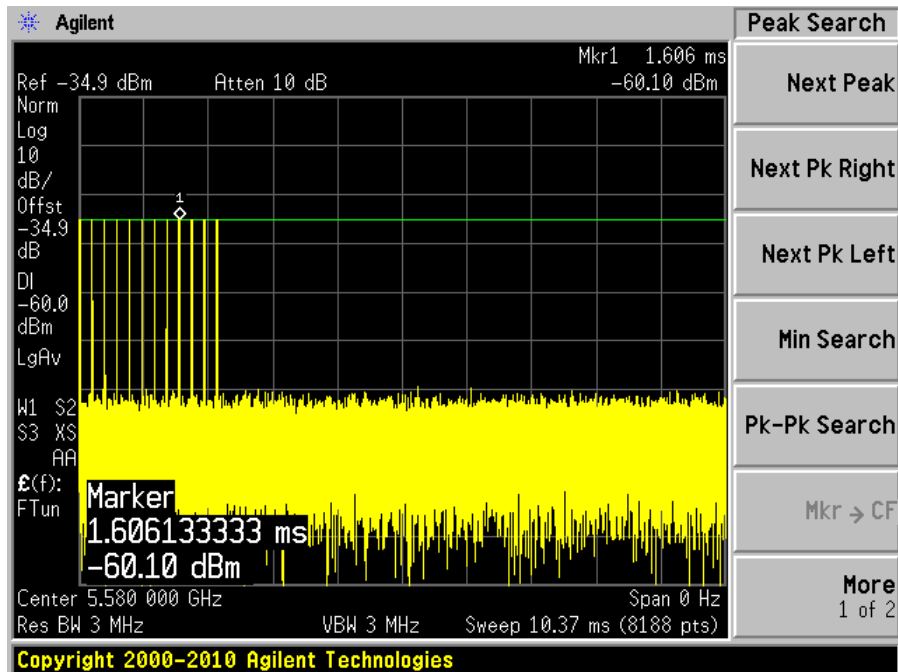

Radar Type 5

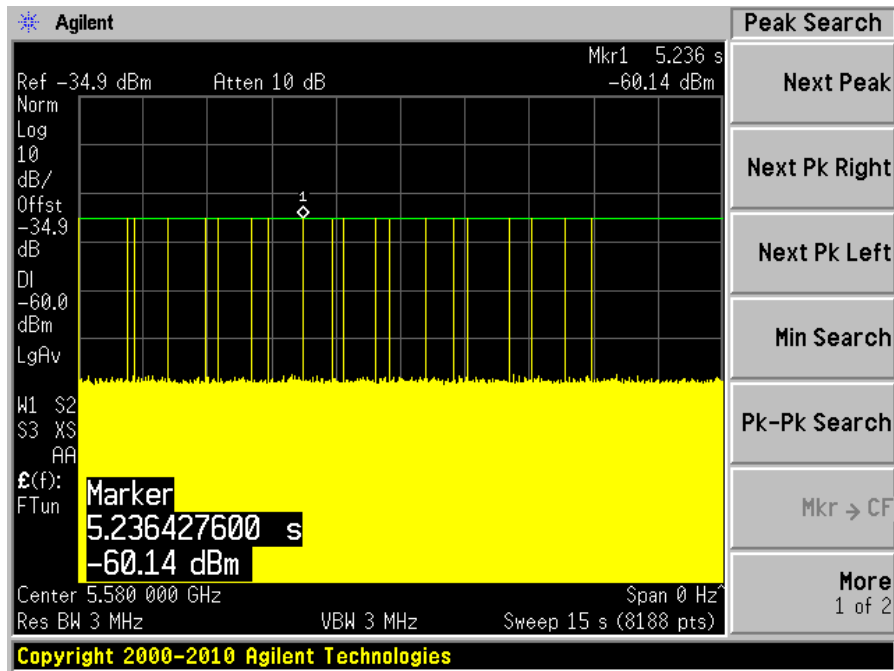

Radar Type 6

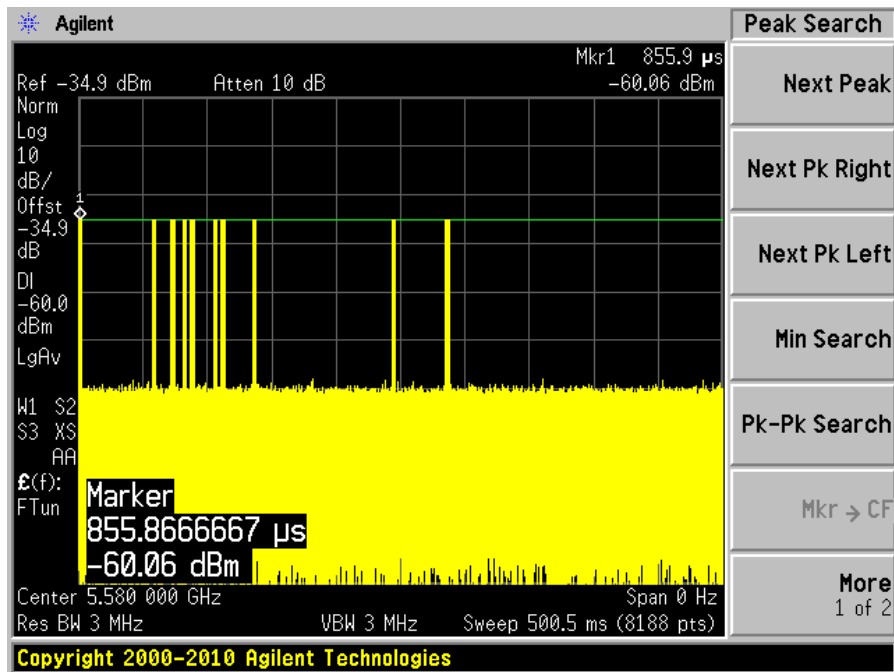

5.5 Channel Availability Check Time (CAC)

Test Procedure

- 1) Measure the initial power-up time of EUT.
- 2) With link established on channel, apply a radar signal within 0~6 seconds after the initial power-up period; monitor the transmissions on channel from the spectrum analyzer.
- 3) Reboot EUT, with a link established on channel, apply a radar signal within 54~60 seconds after the initial power-up period, and monitor the transmission on channel from the spectrum analyzer.

EUT Initial power-up Cycle Time

5280 MHz Bandwidth 20 MHz

EUT initial Power-up cycle (Second)
96

5580 MHz Bandwidth 20 MHz, 5590 MHz Bandwidth 40 MHz and 5600 MHz Bandwidth 20 MHz

EUT initial Power-up cycle (Second)
23

Results:

Timing of Radar Burst	Spectrum Analyzer Display
No Radar Triggered	Transmission begin after power-up cycle +60 seconds CAC
Within 6 seconds of the CAC starting	No transmission
Within the last 6 seconds of the CAC	No transmission

Please refer to the following plots.

5280 MHz Bandwidth 20 MHz – Antenna 1

Plot of without Radar signal applied

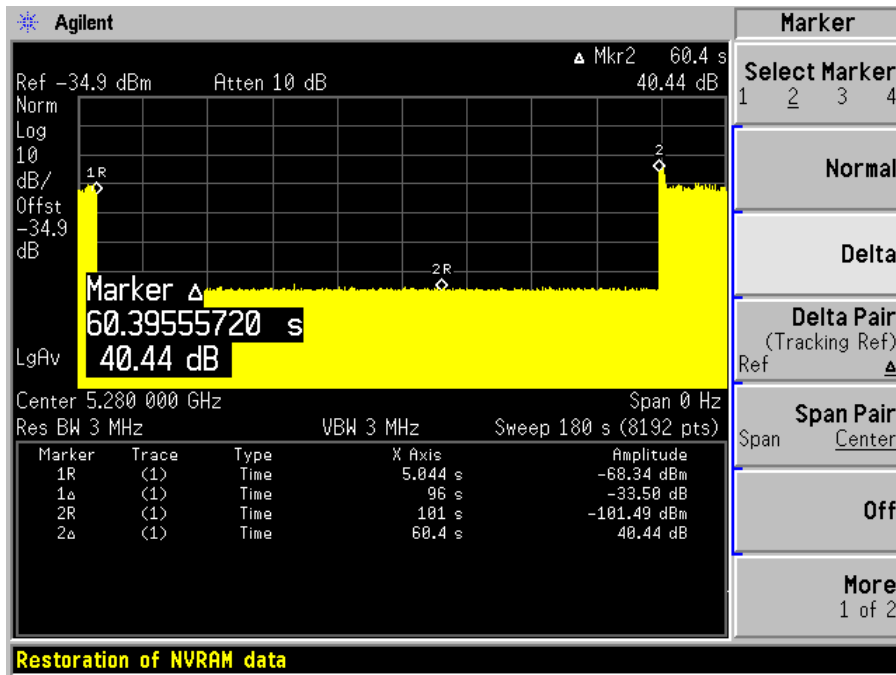

Note: The power-up cycle is 96 seconds

Plot of Radar signal applied within 2 seconds of start of CAC

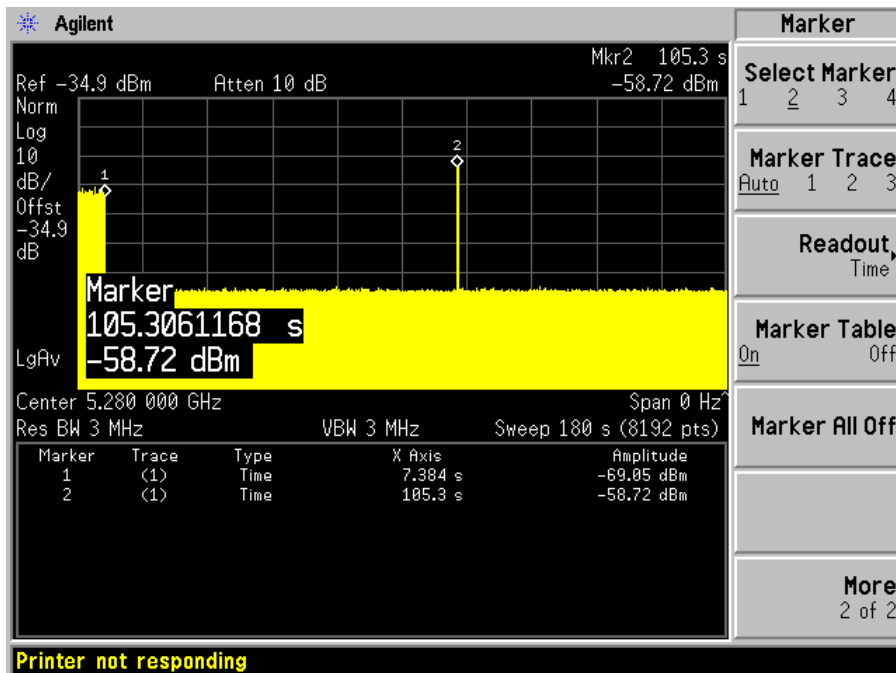

No transmissions found after radar signal applied.

Plot of Radar signal applied at the end of 2 seconds of CAC

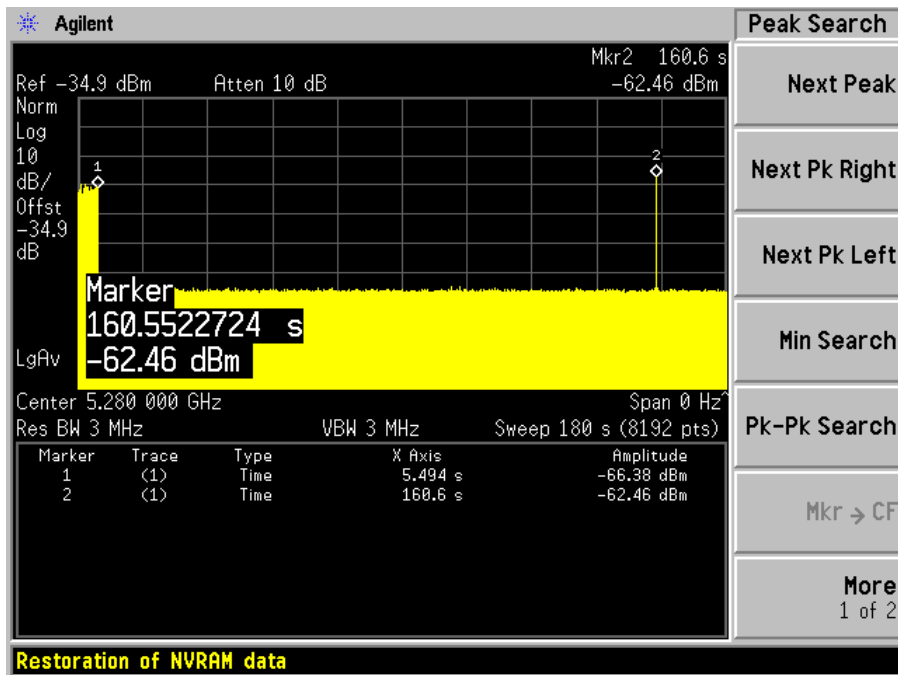

No transmissions found after radar signal applied.

5280 MHz Bandwidth 20 MHz - Antenna 2

Plot of without Radar signal applied

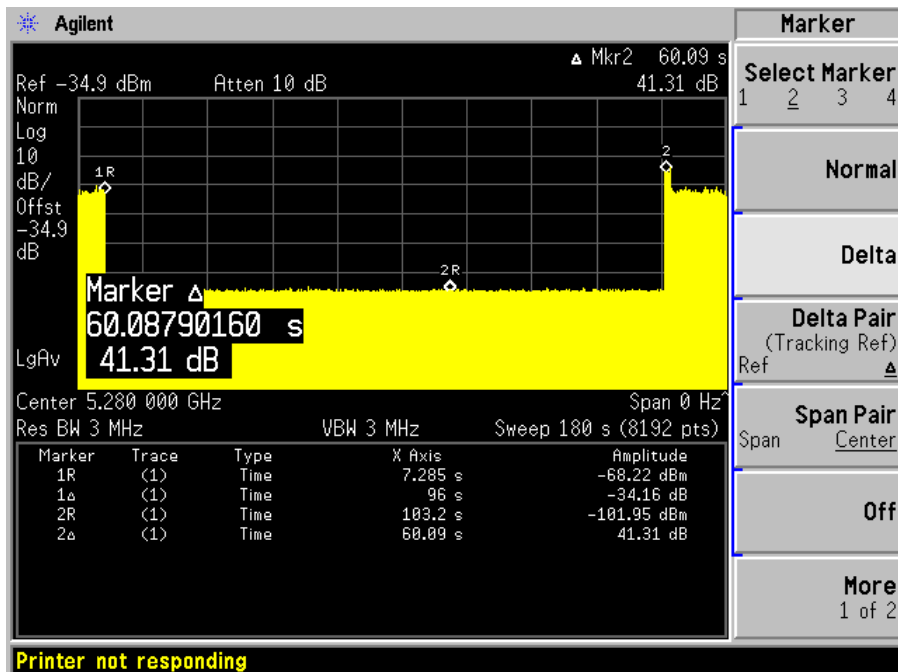

Note: The power-up cycle is 96 seconds

Plot of Radar signal applied within 2 seconds of start of CAC

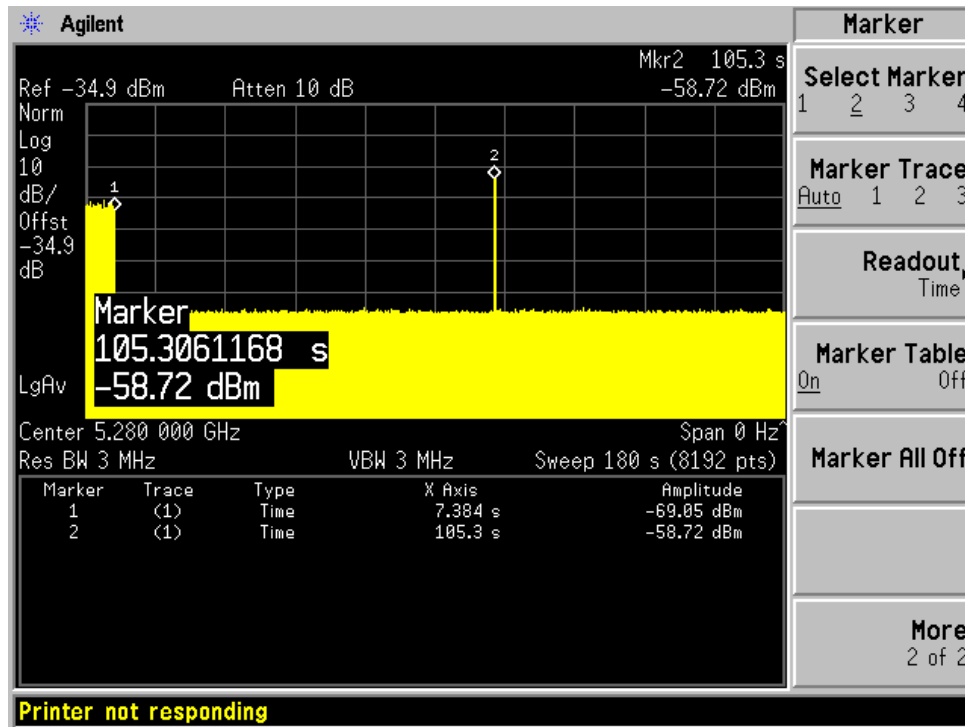

No transmissions found after radar signal applied.

Plot of Radar signal applied at the end of 2 seconds of CAC

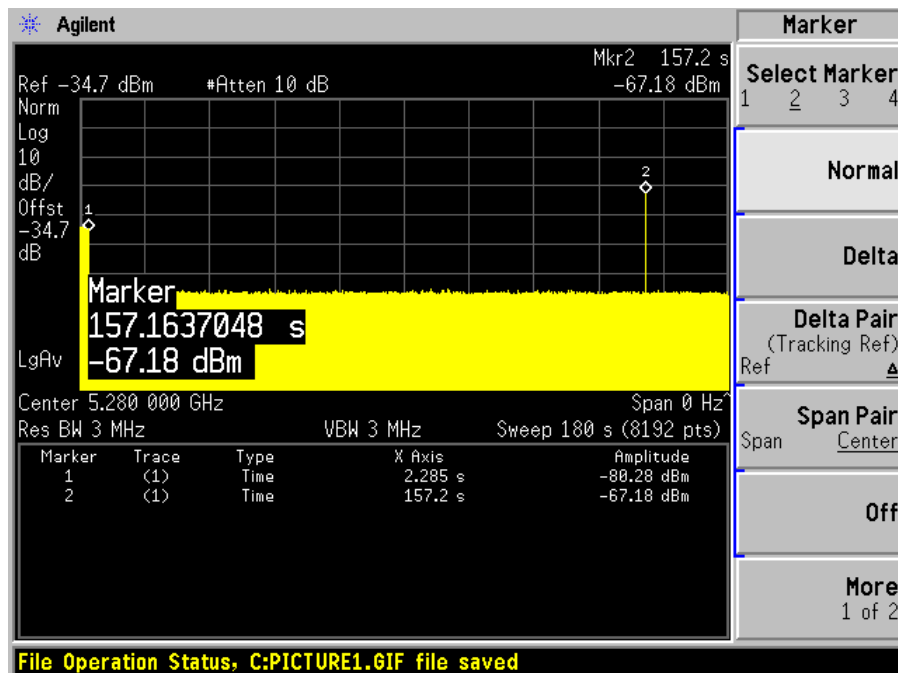

No transmissions found after radar signal applied.

5580 MHz Bandwidth 20 MHz – Antenna 1

Plot of without Radar signal applied

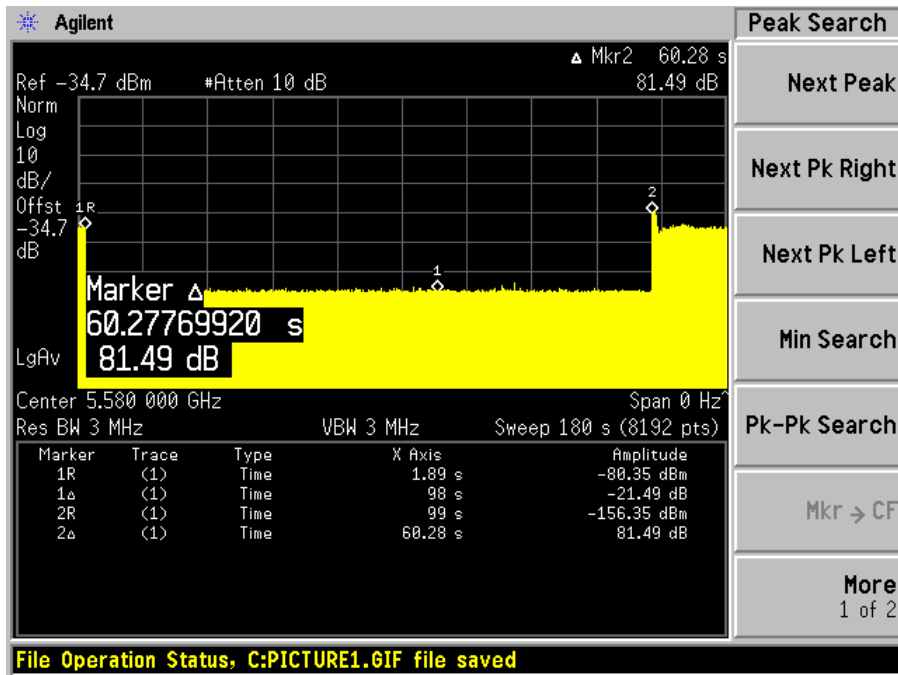

Note: The power-up cycle is 98 seconds

Plot of Radar signal applied within 2 seconds of start of CAC

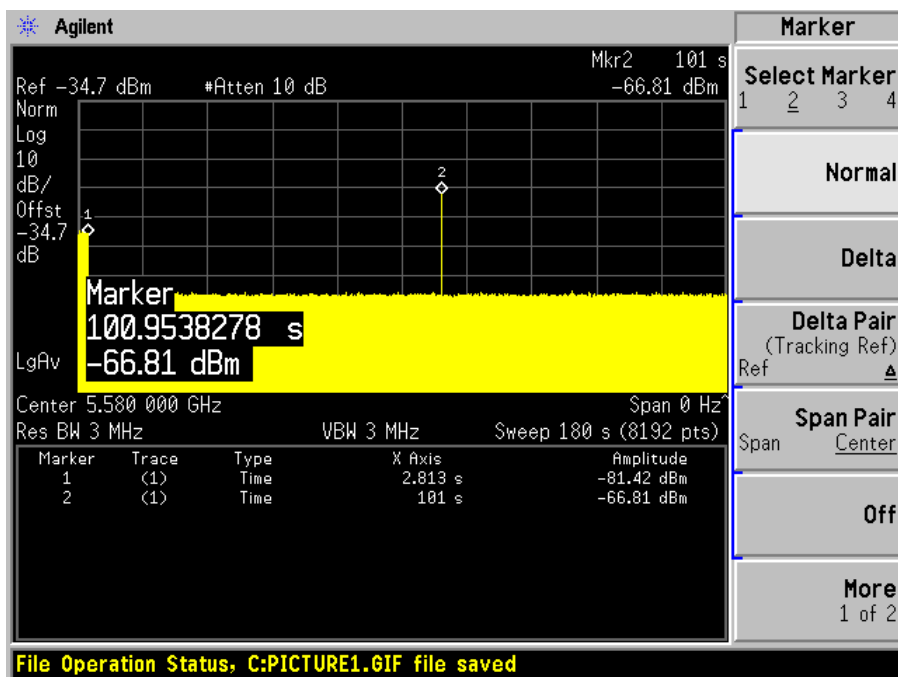

No transmissions found after radar signal applied.

Plot of Radar signal applied at the end of 2 seconds of CAC

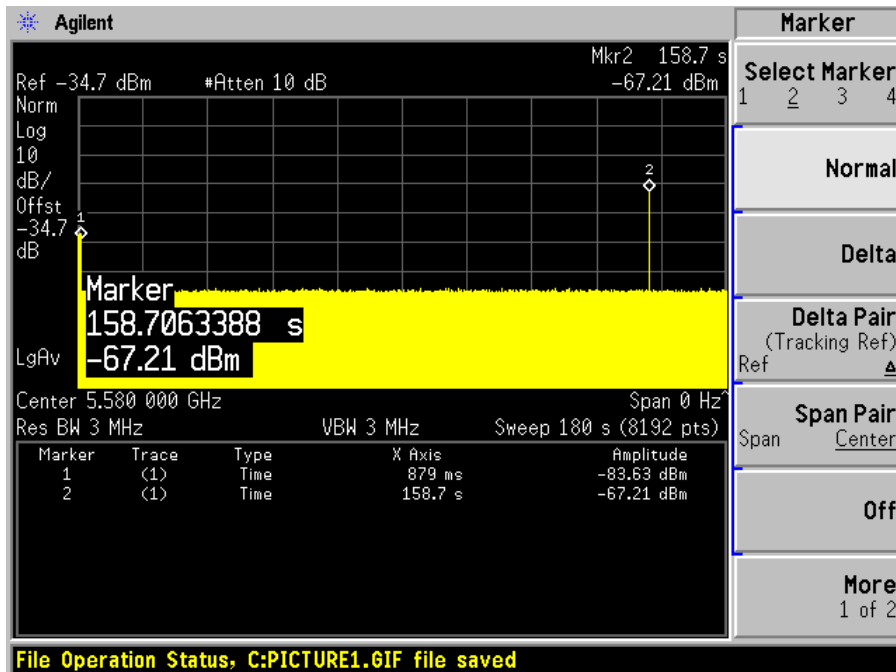

No transmissions found after radar signal applied.

5580 MHz Bandwidth 20 MHz - Antenna 2

Plot of without Radar signal applied

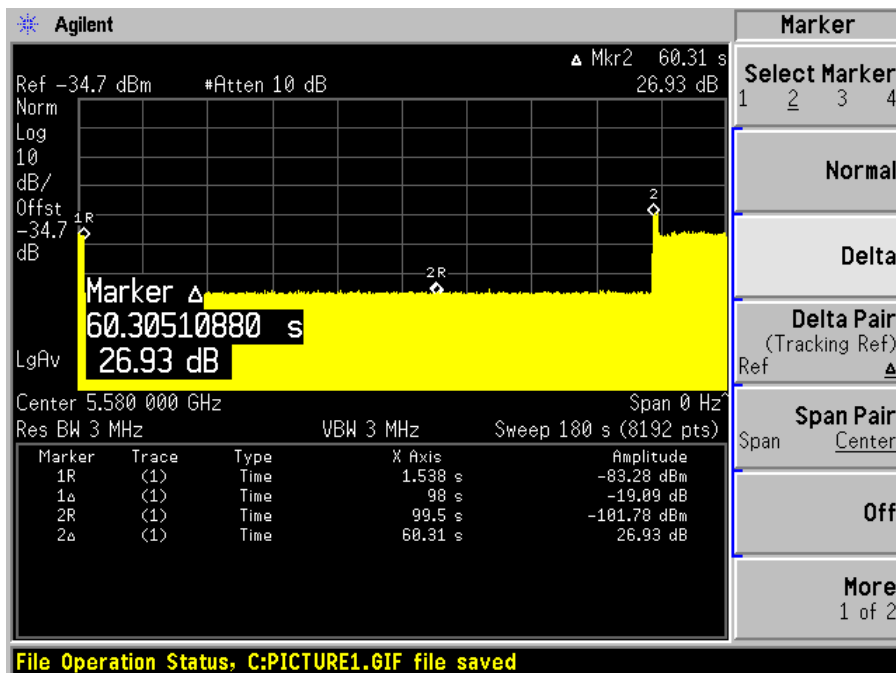

Note: The power-up cycle is 98 seconds

Plot of Radar signal applied within 2 seconds of start of CAC

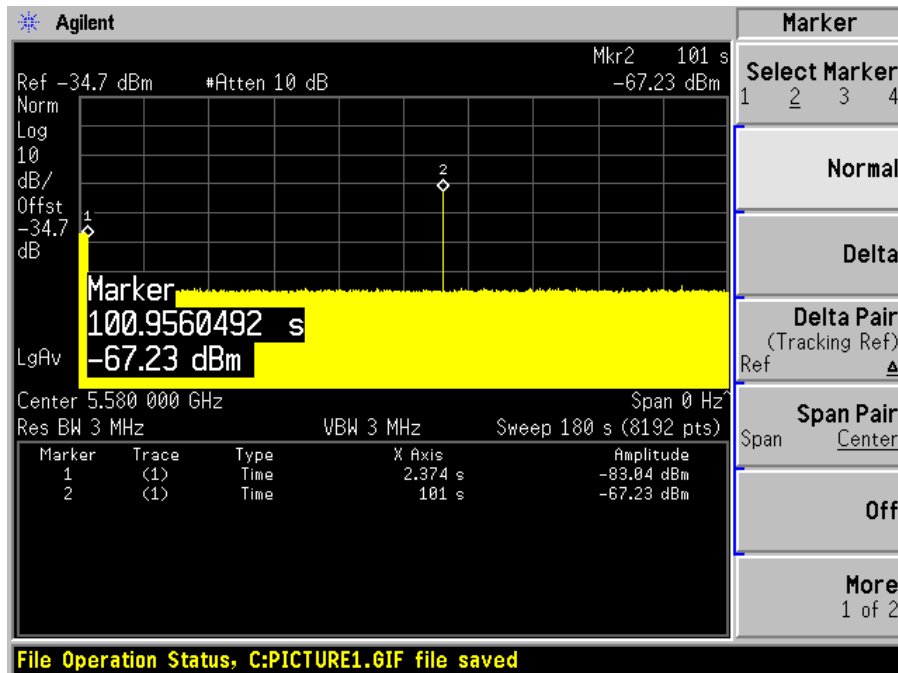

No transmissions found after radar signal applied.

Plot of Radar signal applied at the end of 2 seconds of CAC

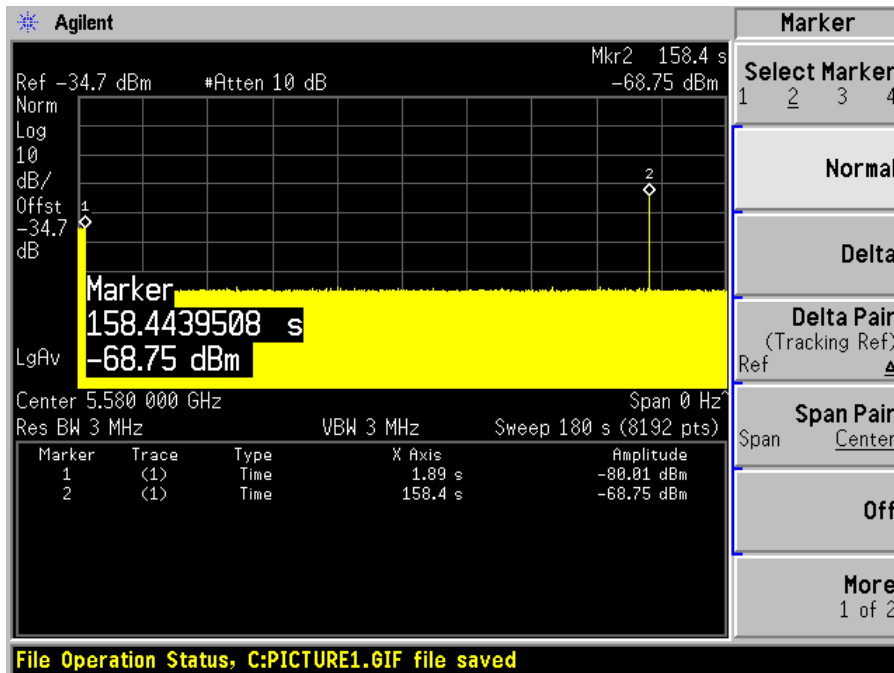

No transmissions found after radar signal applied.

5270 MHz Bandwidth 40 MHz – Antenna 1

Plot of without Radar signal applied

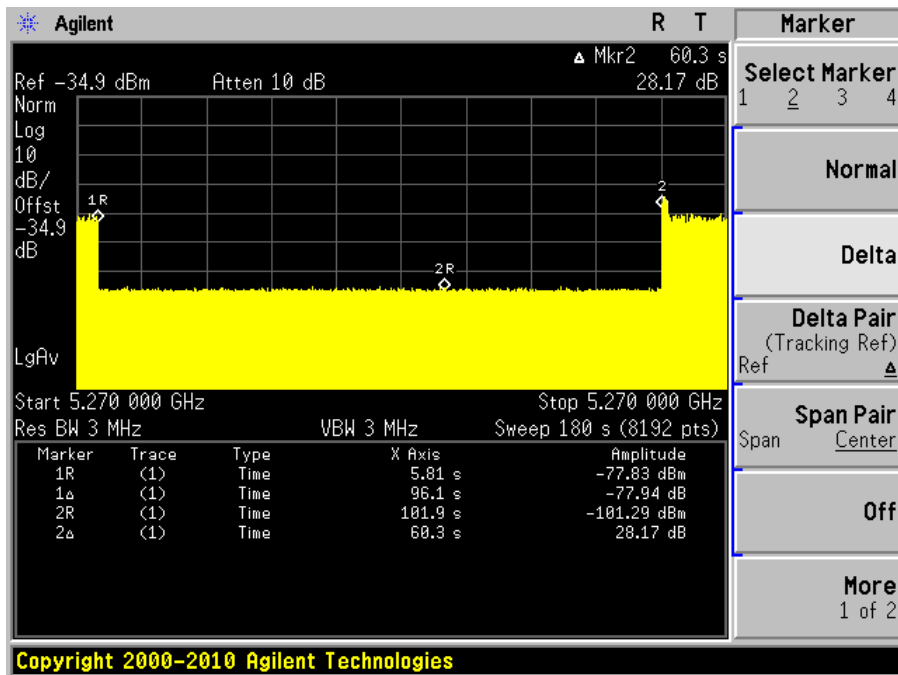

Note: The power-up cycle is 96 seconds

Plot of Radar signal applied within 2 seconds of start of CAC

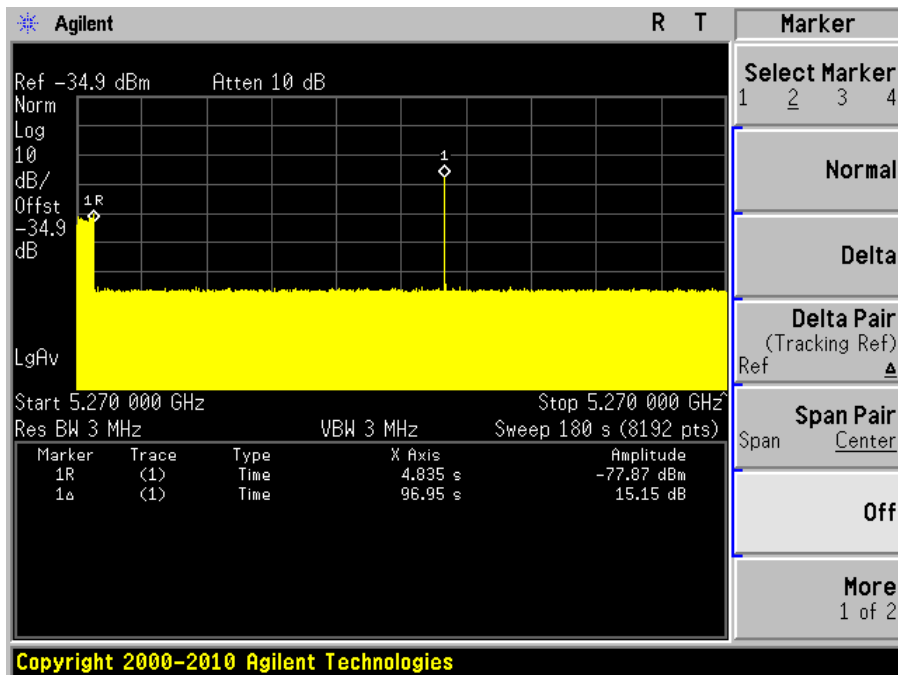

No transmissions found after radar signal applied.

Plot of Radar signal applied at the end of 2 seconds of CAC

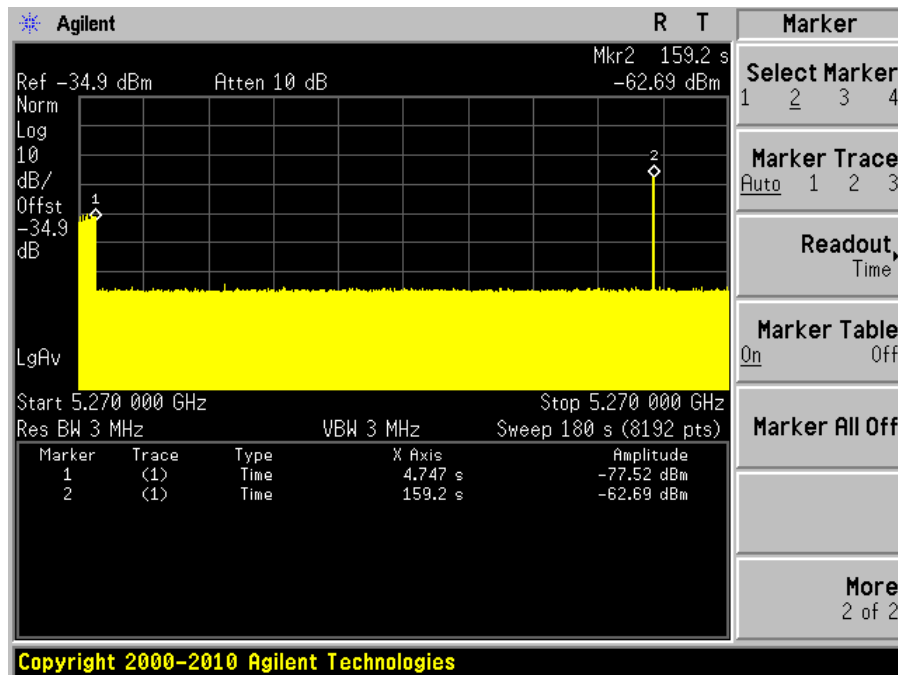

No transmissions found after radar signal applied.

5270 MHz Bandwidth 40 MHz - Antenna 2

Plot of without Radar signal applied

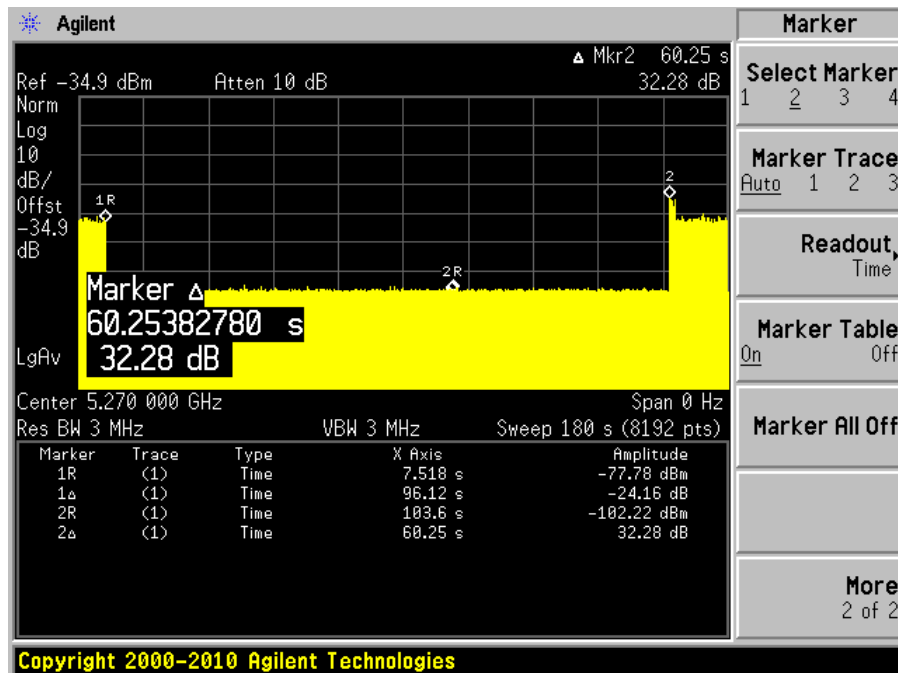

Note: The power-up cycle is 96 seconds

Plot of Radar signal applied within 2 seconds of start of CAC

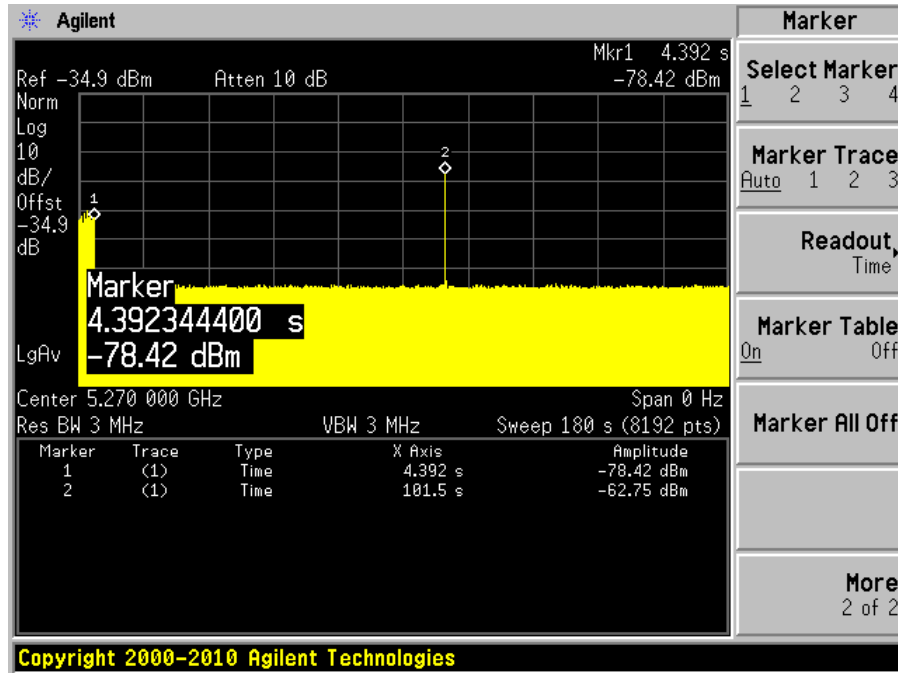

No transmissions found after radar signal applied.

Plot of Radar signal applied at the end of 2 seconds of CAC

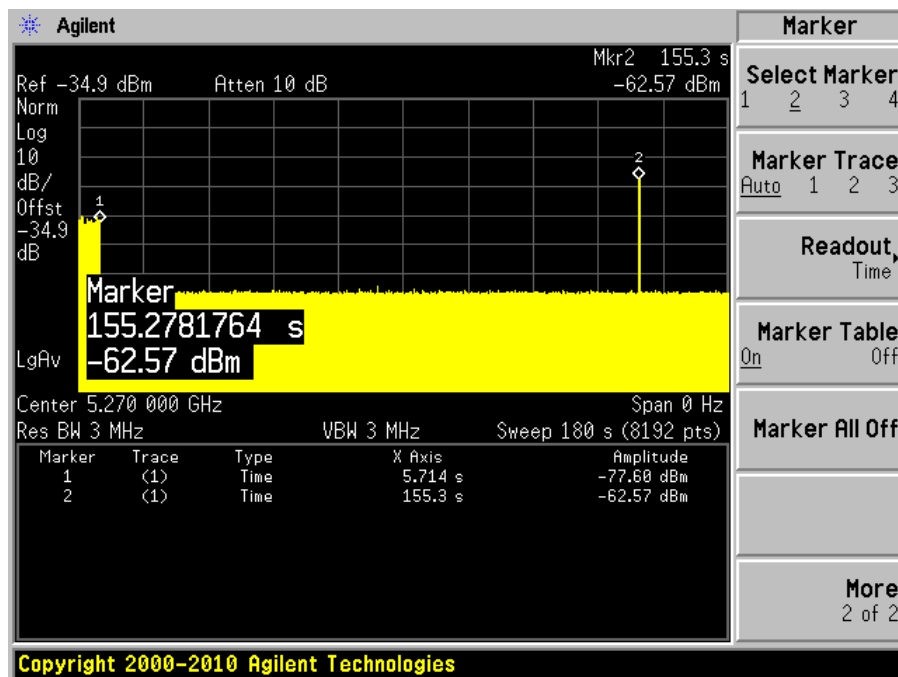

No transmissions found after radar signal applied.

5550 MHz Bandwidth 40 MHz - Antenna 1

Plot of without Radar signal applied

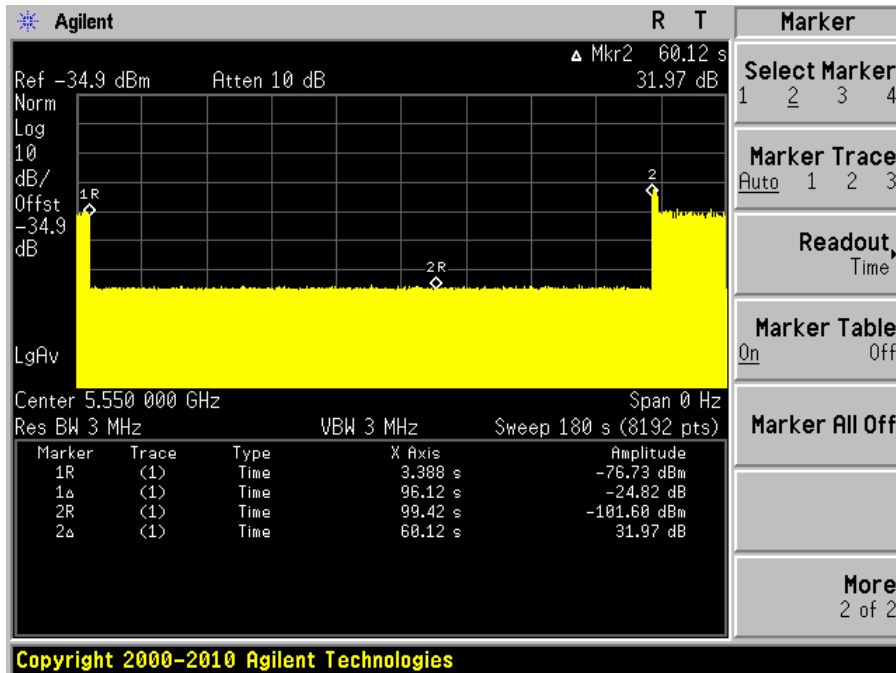

Note: The power-up cycle is 96.1 seconds

Plot of Radar signal applied within 2 seconds of start of CAC

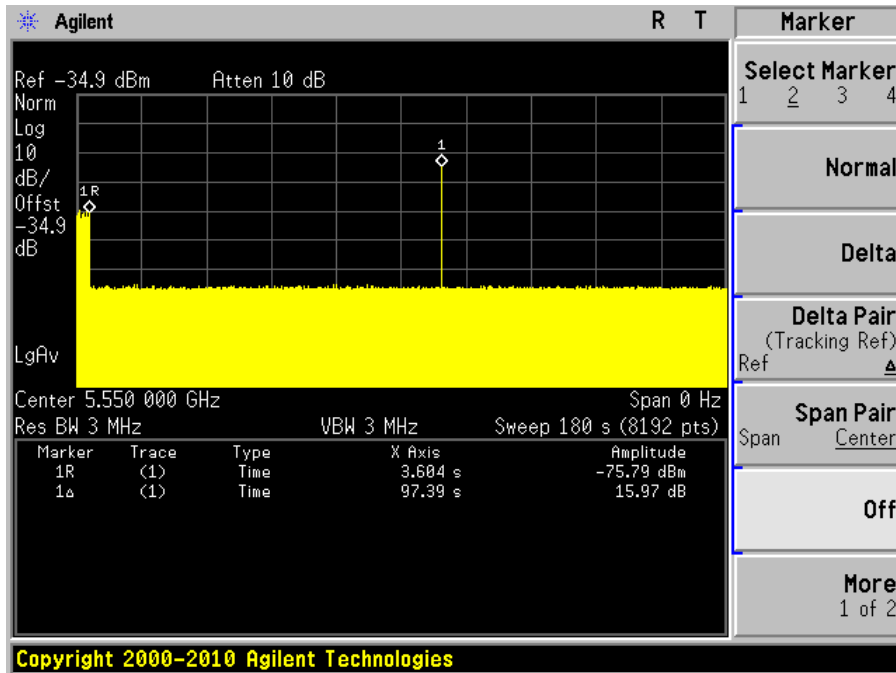

No transmissions found after radar signal applied.

Plot of Radar signal applied at the end of 2 seconds of CAC

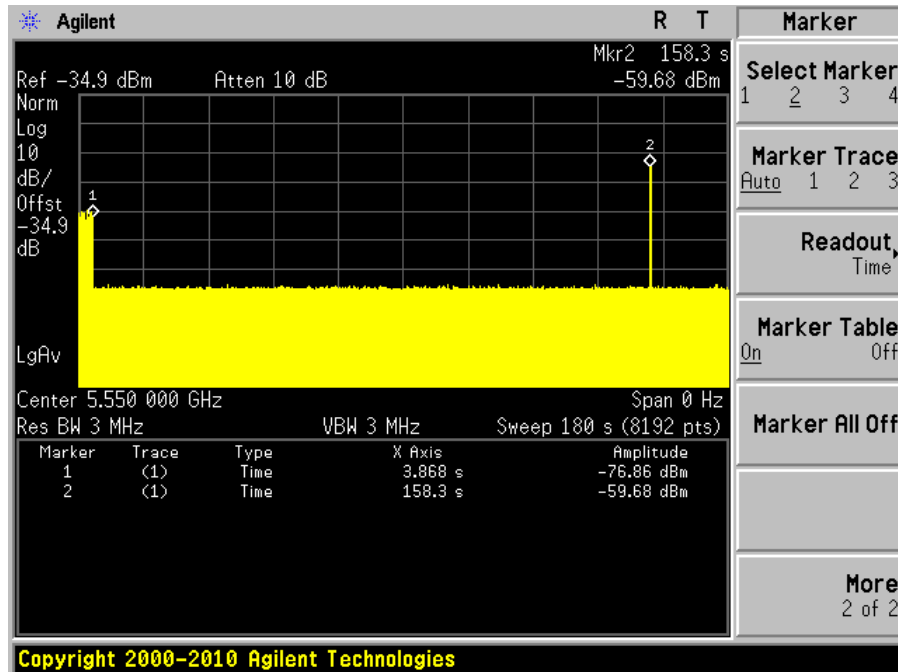

No transmissions found after radar signal applied.

5550 MHz Bandwidth 40 MHz - Antenna 1

Plot of without Radar signal applied

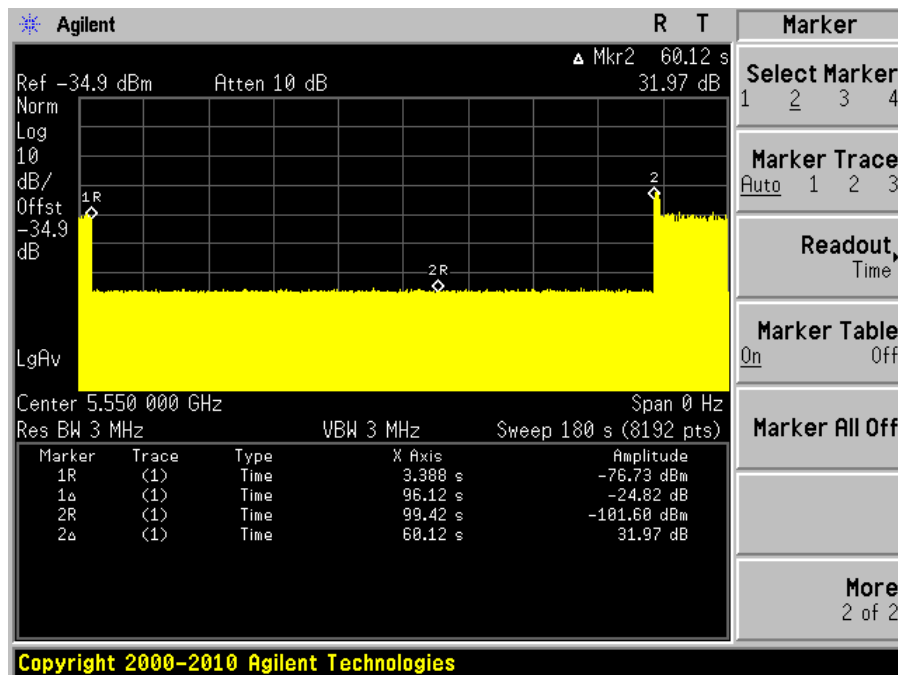

Note: The power-up cycle is 96 seconds

Plot of Radar signal applied within 2 seconds of start of CAC

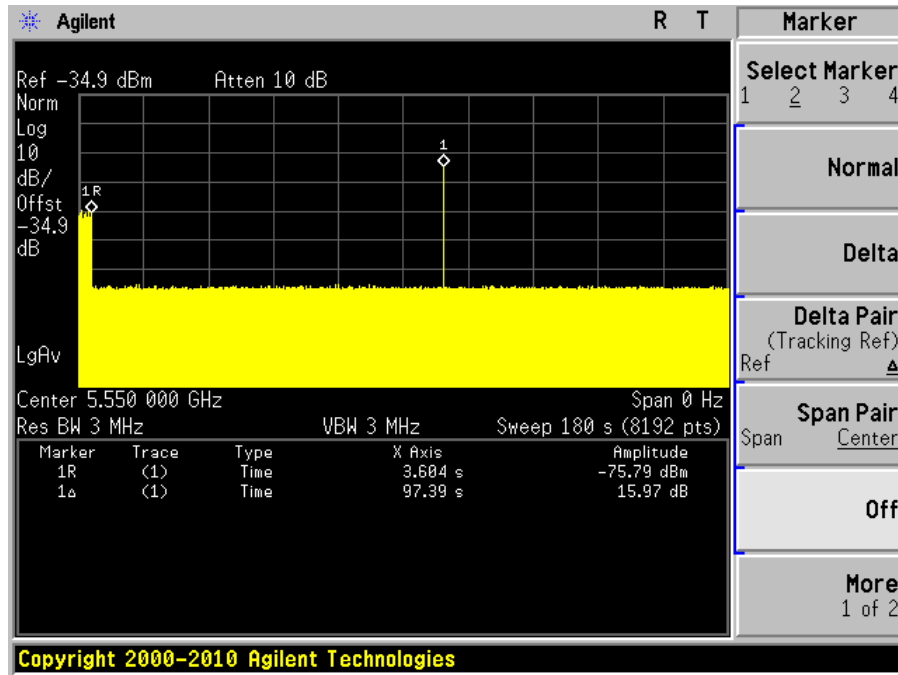

No transmissions found after radar signal applied.

Plot of Radar signal applied at the end of 2 seconds of CAC

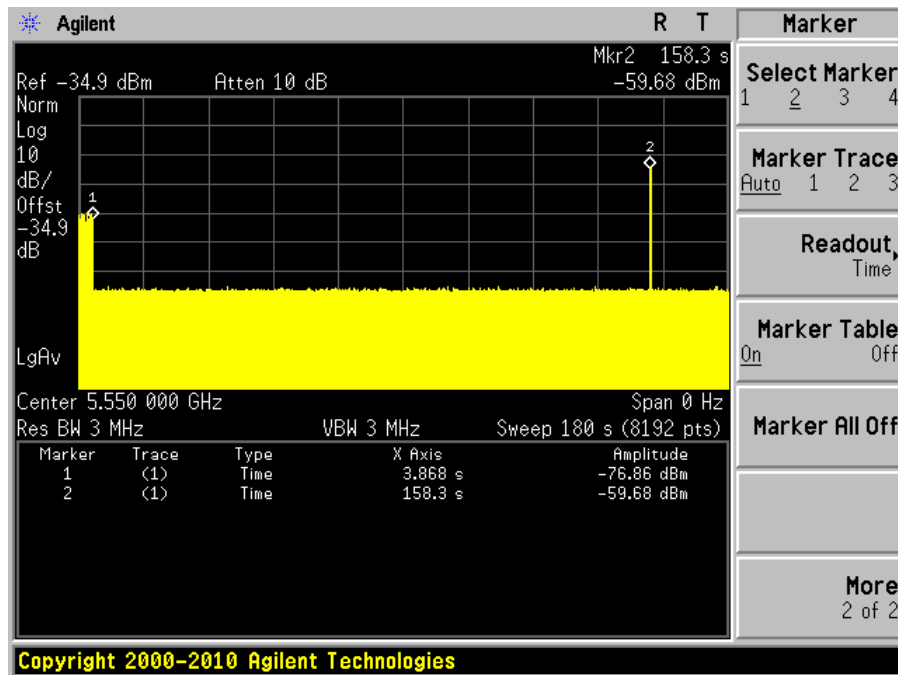

No transmissions found after radar signal applied.

5550 MHz Bandwidth 40 MHz - Antenna 2

Plot of without Radar signal applied

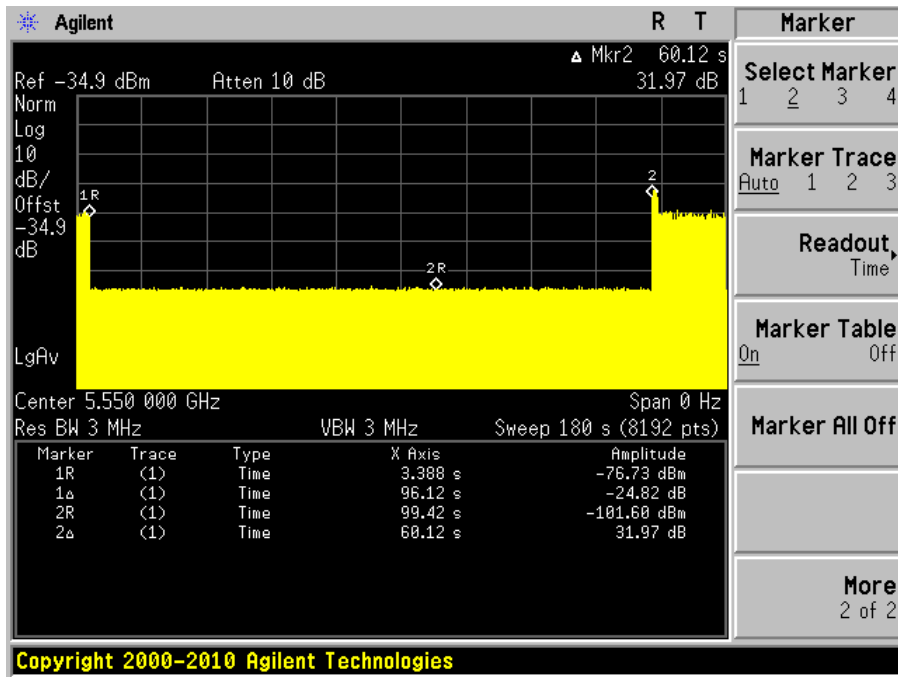

Note: The power-up cycle is 96 seconds

Plot of Radar signal applied within 2 seconds of start of CAC

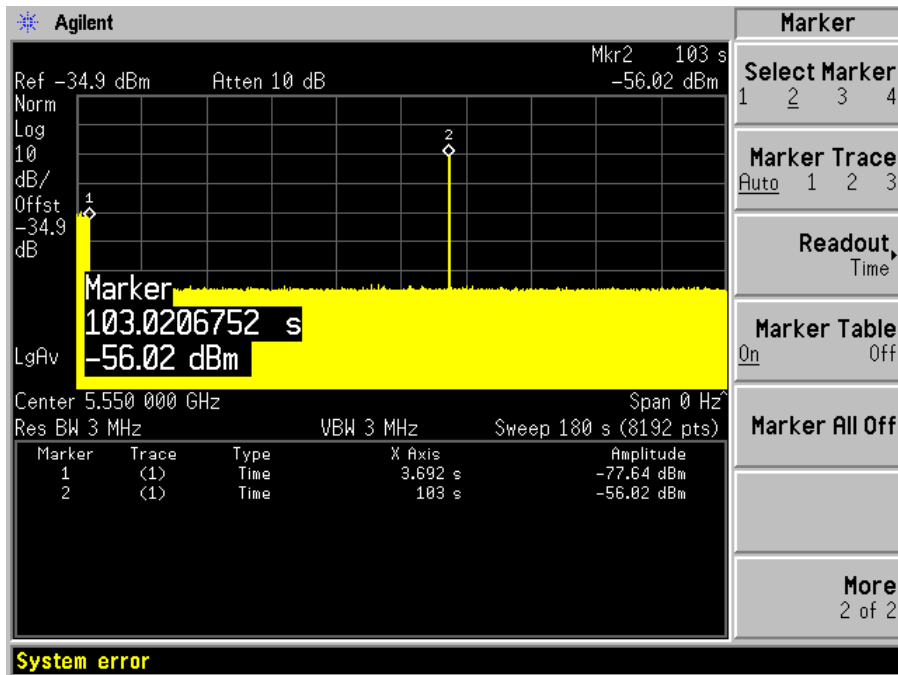

No transmissions found after radar signal applied.

Plot of Radar signal applied at the end of 2 seconds of CAC

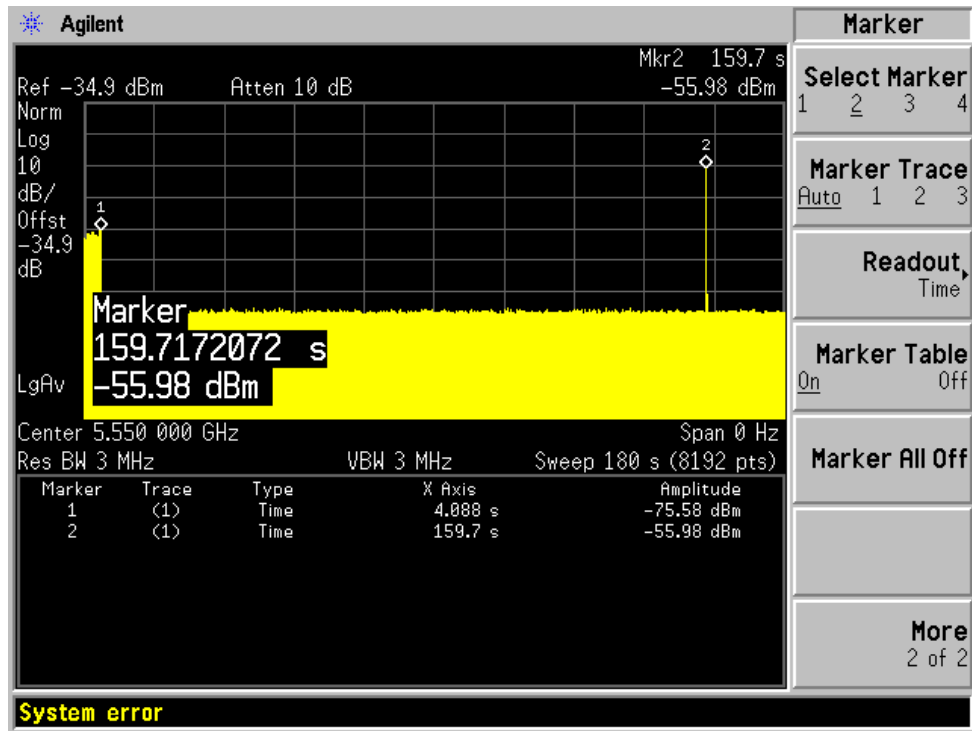

No transmissions found after radar signal applied.

6 CHANNEL MOVE TIME AND CHANNEL CLOSING TRANSMISSION TIME

6.1 Test Procedure

Perform one of the type1 to type 4 short pulse radar waveform, BACL use type 1 radar signal, repeat using a long pulse radar type5 waveform.

The aggregate channel closing transmission time is calculated as follows:

Aggregate Transmission Time = N * Dwell Time

N is the number of spectrum analyzer bins showing a device transmission

Dwell Time is the dwell time per bin (i.e. Dwell Time = S/B, S is the sweep time and B is the number of bin, i.e. 8192)

6.2 Test Results

Antenna 1

Frequency (MHz)	Bandwidth (MHz)	Radar Type	Results
5280	20	Type 1	Compliant
		Type 5	Compliant
5580	20	Type 3	Compliant
		Type 5	Compliant
5270	40	Type 1	Compliant
		Type 5	Compliant
5550	40	Type 1	Compliant
		Type 5	Compliant

Please refer to the following tables and plots.

Antenna 2

Frequency (MHz)	Bandwidth (MHz)	Radar Type	Results
5280	20	Type 1	Compliant
		Type 5	Compliant
5580	20	Type 3	Compliant
		Type 5	Compliant
5270	40	Type 1	Compliant
		Type 5	Compliant
5550	40	Type 1	Compliant
		Type 5	Compliant

Please refer to the following tables and plots.

Antenna 1

5280 MHz Bandwidth 20 MHz

Type 1 radar channel move time result:

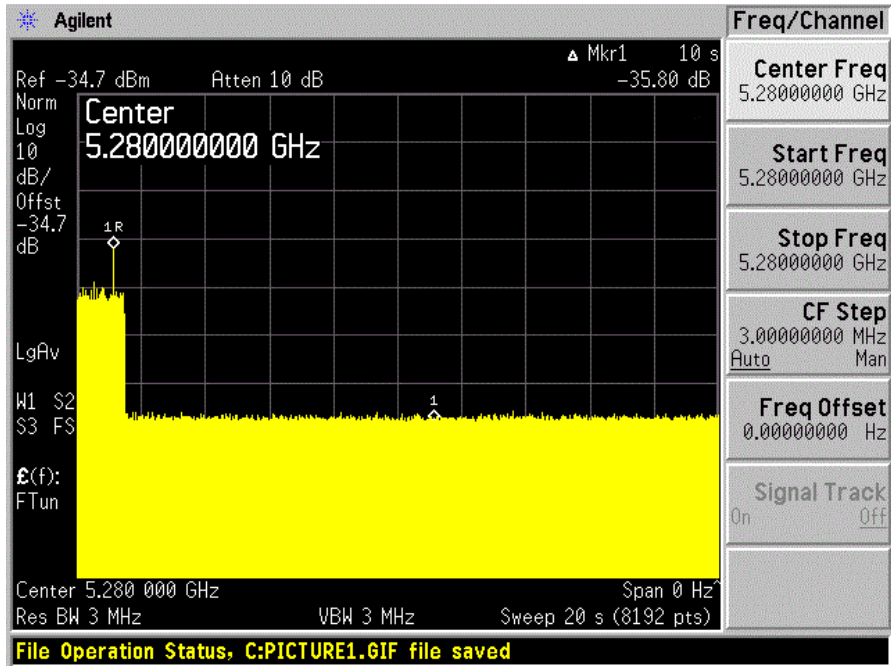

Type1 radar channel closing transmission time result:

Aggregate Transmission Time (ms)	Limit (ms)	Margin (ms)
17.09	60	42.91

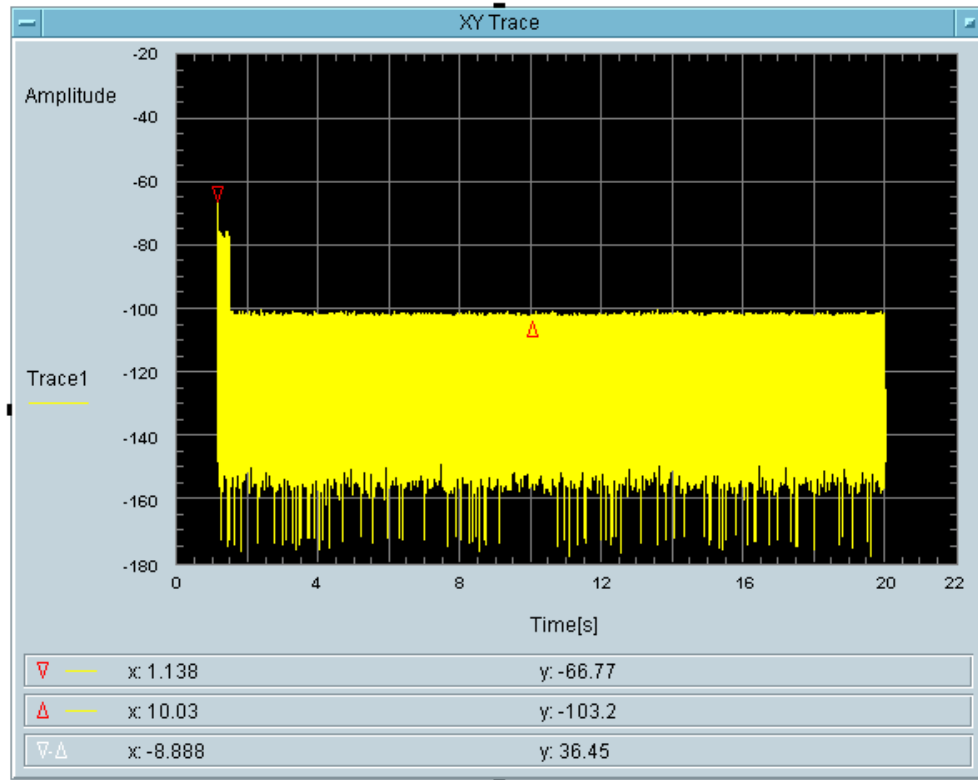

Total On Time [s]
46.39m

Total On Time After Delay [s]
17.09m

Type 5 radar channel move time result:

The traffic ceases period to the end of the radar waveform, therefore it also ceases period to 10 seconds after of the end of the radar waveform.

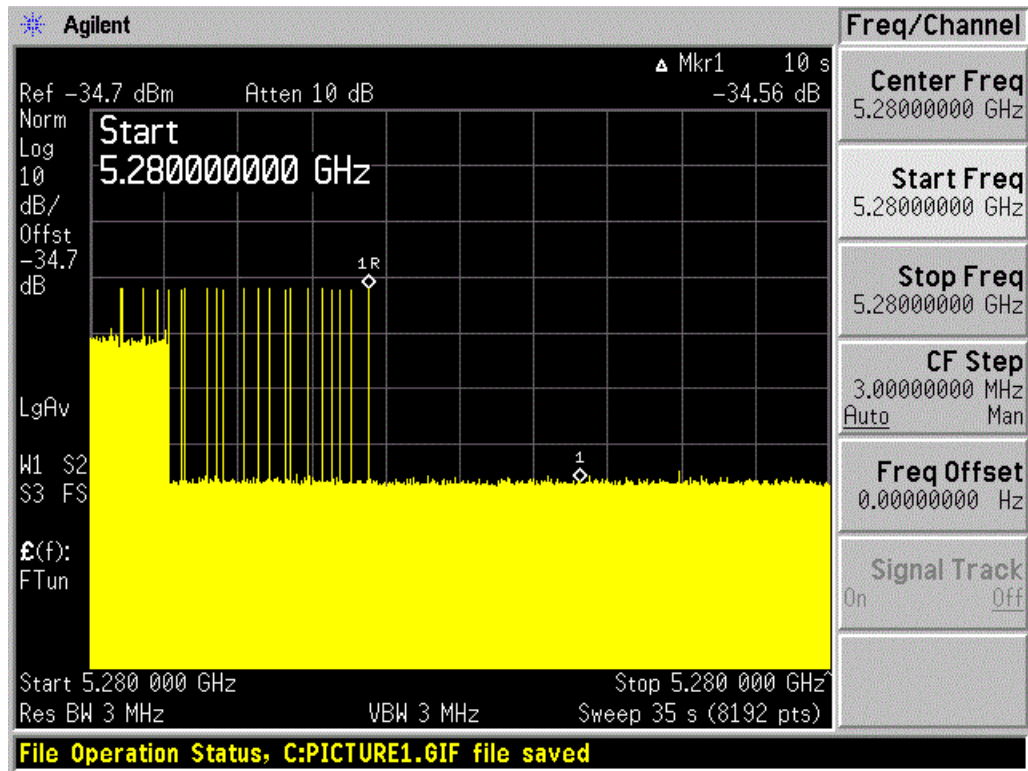

5580 MHz Bandwidth 20 MHz

Type 1 radar channel move time result:

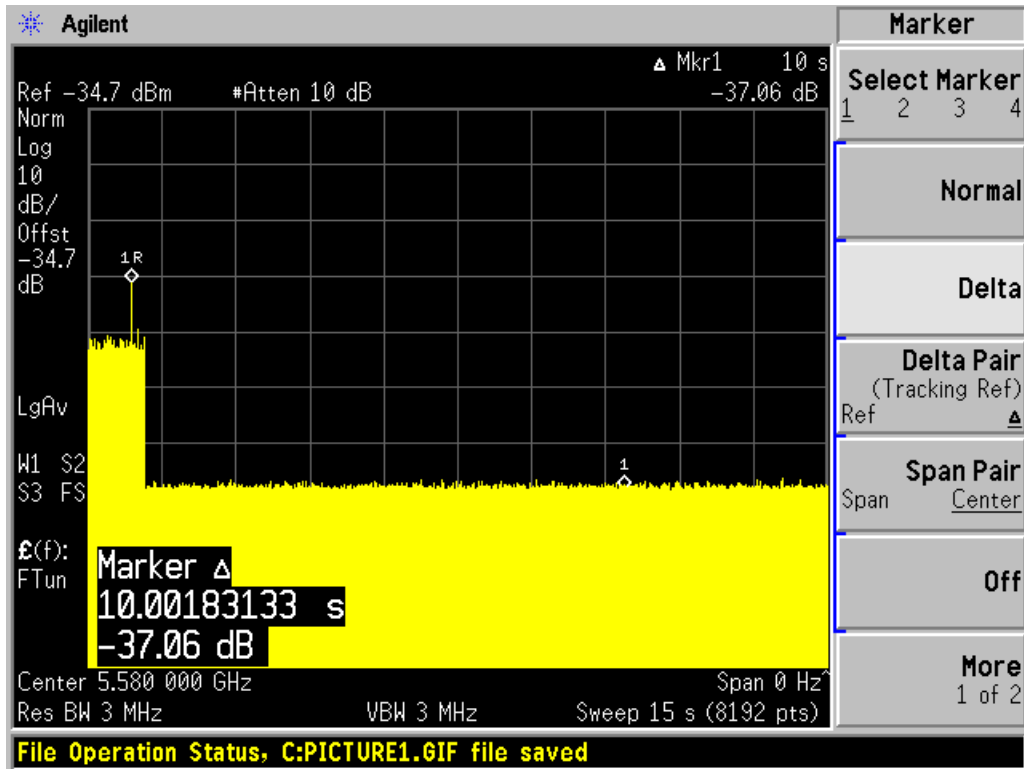

Type I radar channel closing transmission time result:

Aggregate Transmission Time (ms)	Limit (ms)	Margin (ms)
3.662	60	56.338

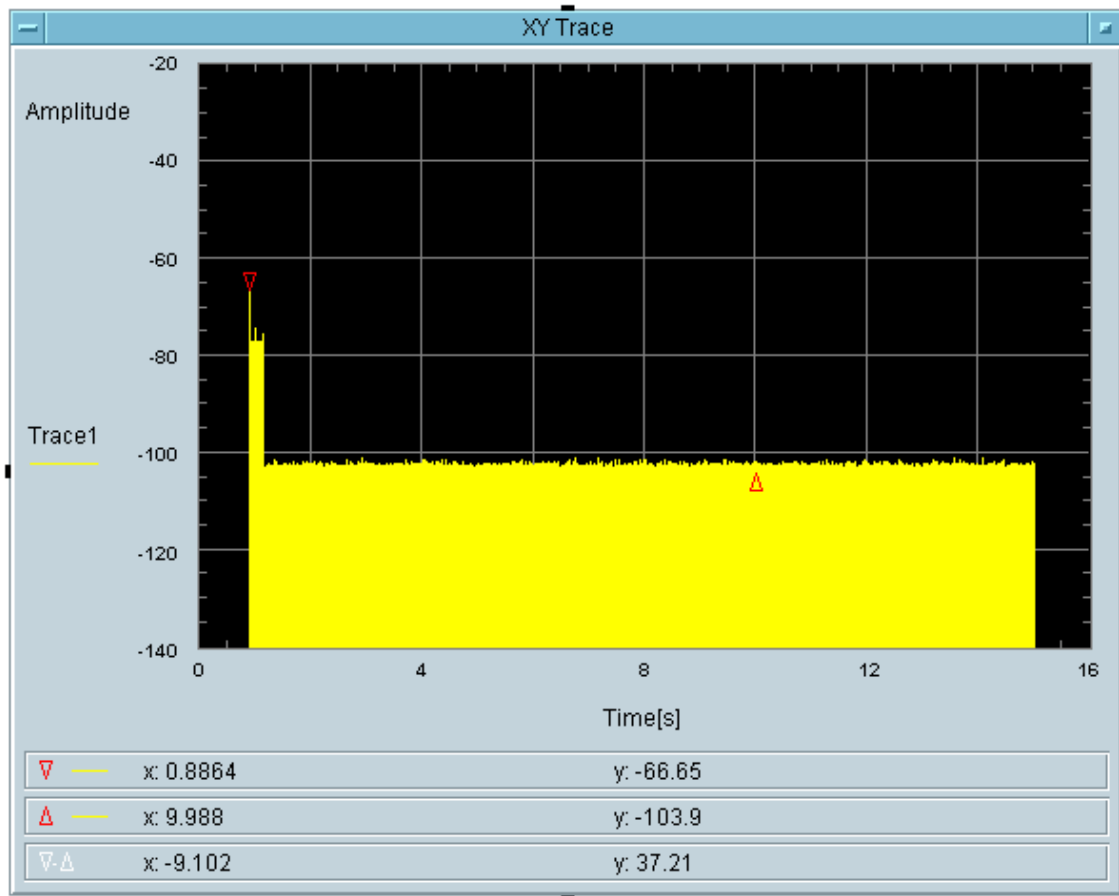

Total On Time [s]
25.64m

Total On Time After Delay [s]
3.662m

Type 5 radar channel move time result:

The traffic ceases period to the end of the radar waveform, therefore it also ceases period to 10 seconds after of the end of the radar waveform.

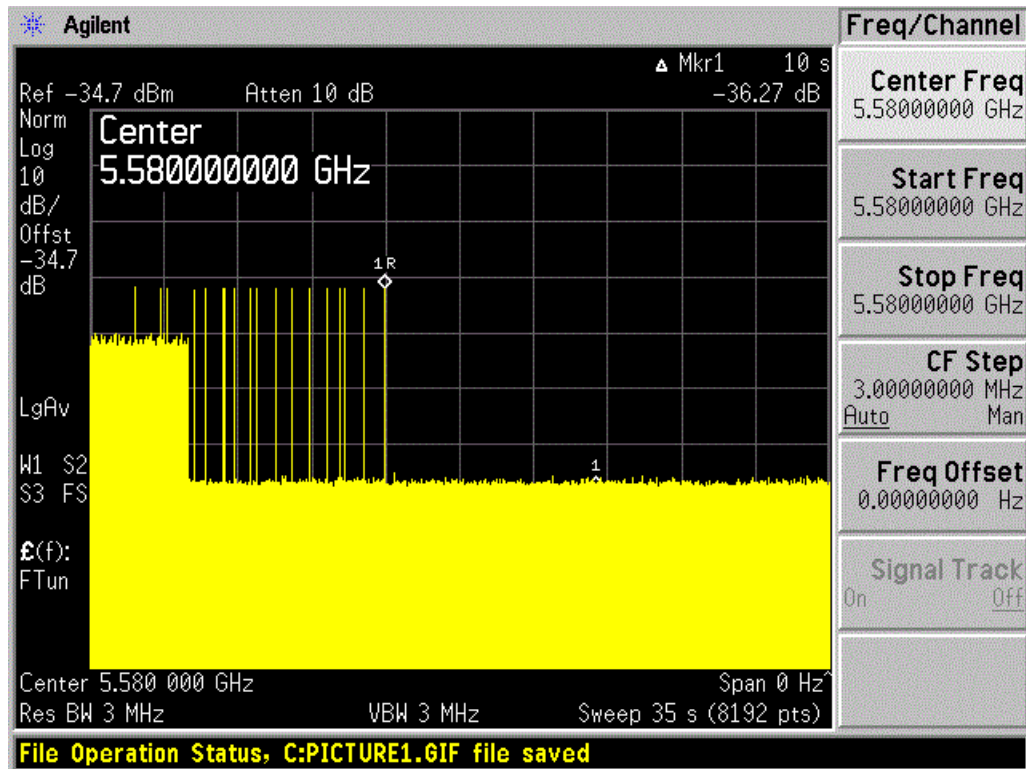

5270 MHz Bandwidth 40 MHz

Type 1 radar channel move time result:

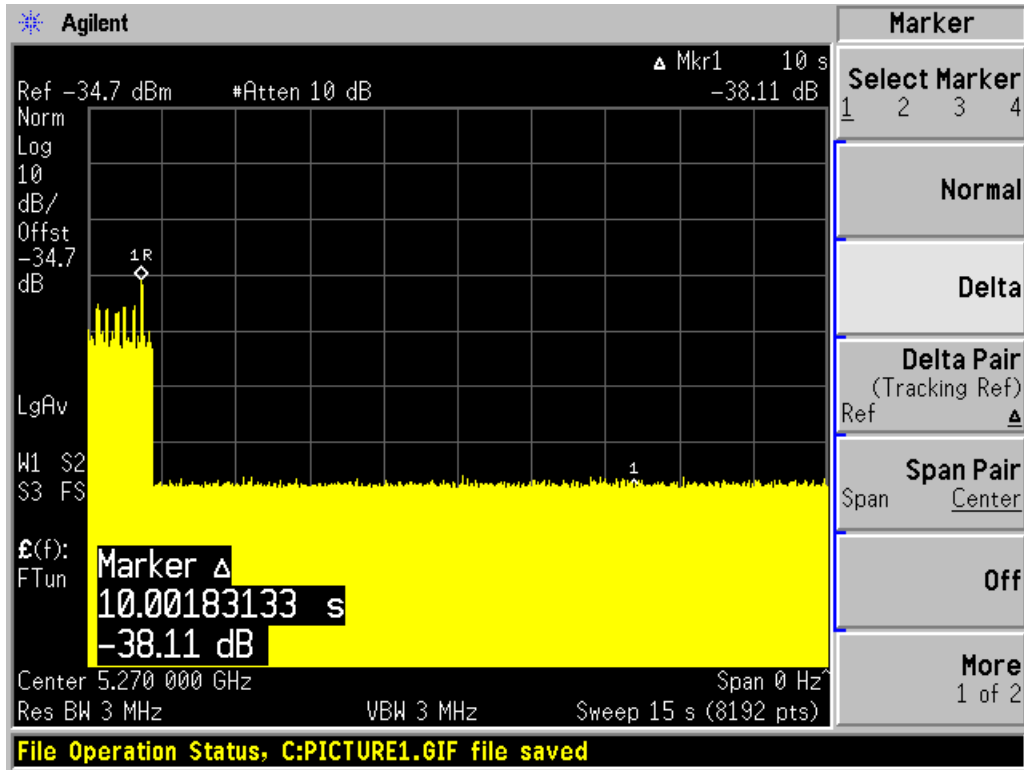

Type1 radar channel closing transmission time result:

Aggregate Transmission Time (ms)	Limit (ms)	Margin (ms)
3.662	60	56.338

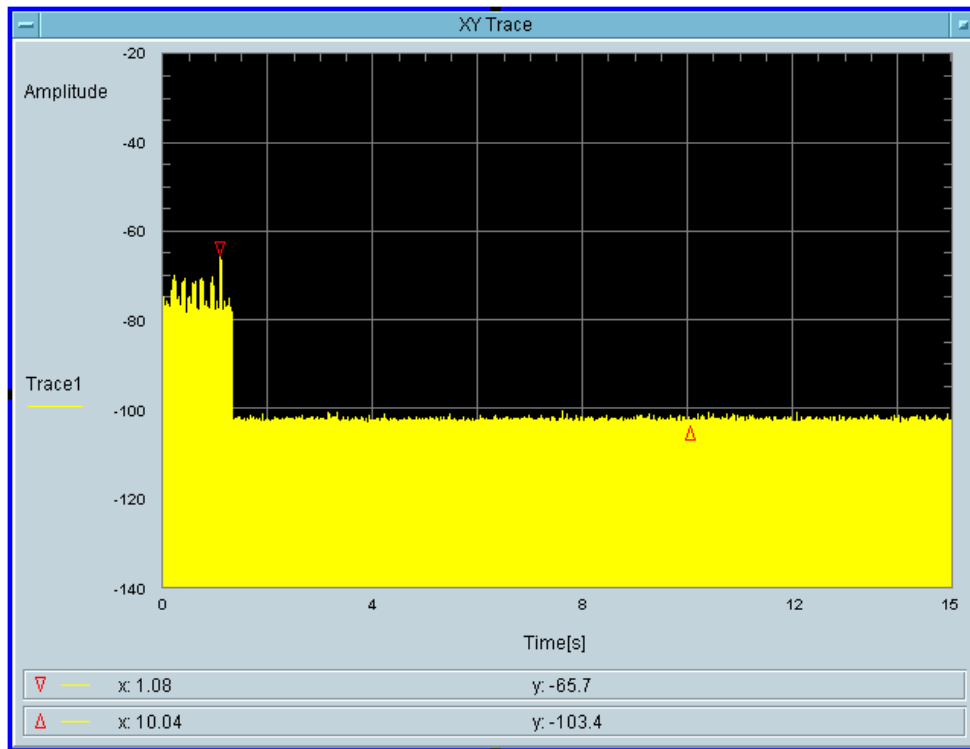

Total On Time [s]
23.8m

Total On Time After Delay [s]
3.662m

Type 5 radar channel move time result:

The traffic ceases period to the end of the radar waveform, therefore it also ceases period to 10 seconds after of the end of the radar waveform.

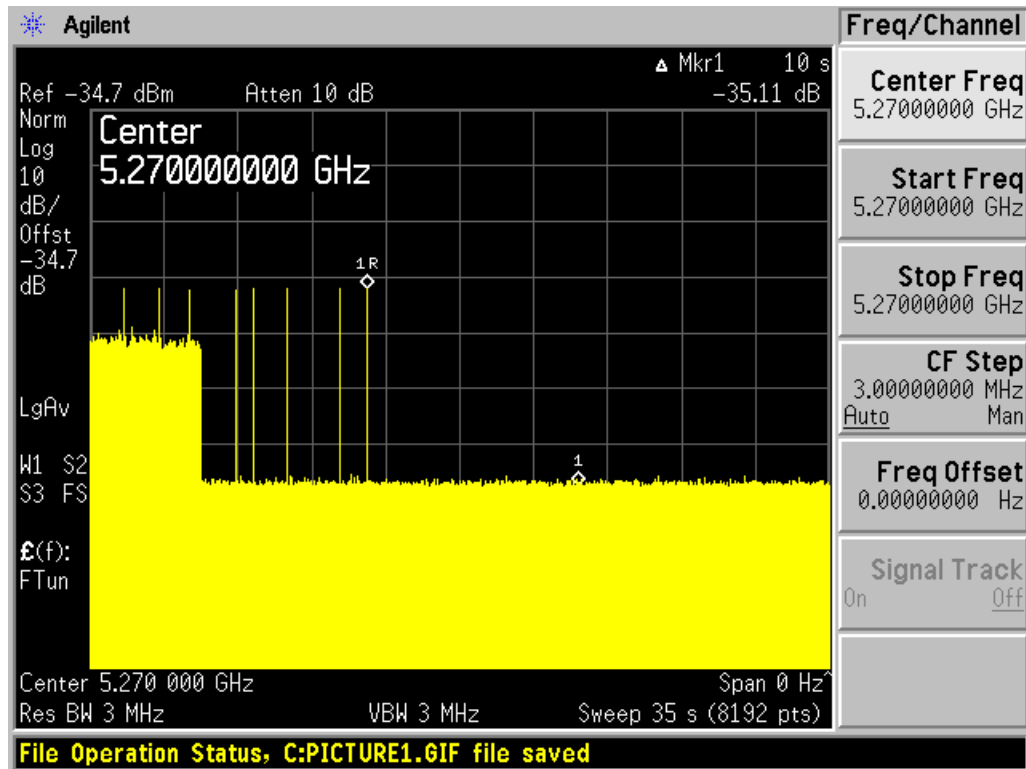

5550 MHz Bandwidth 40 MHz

Type 1 radar channel move time result:

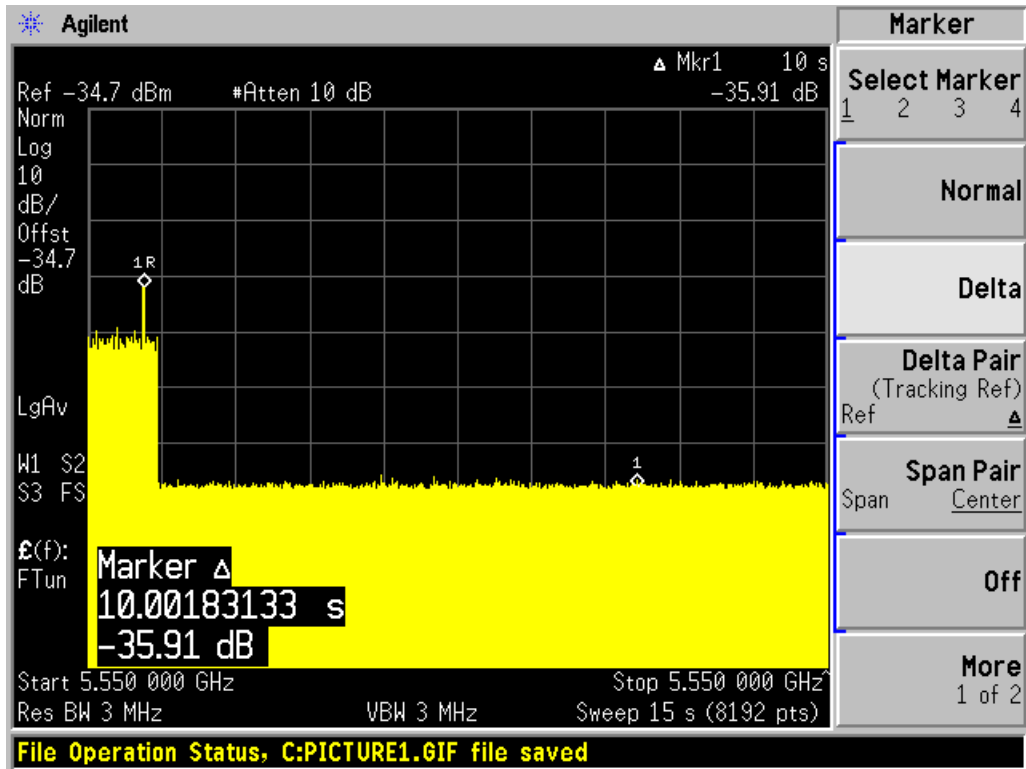

Type1 radar channel closing transmission time result:

Aggregate Transmission Time (ms)	Limit (ms)	Margin (ms)
7.324	60	52.676

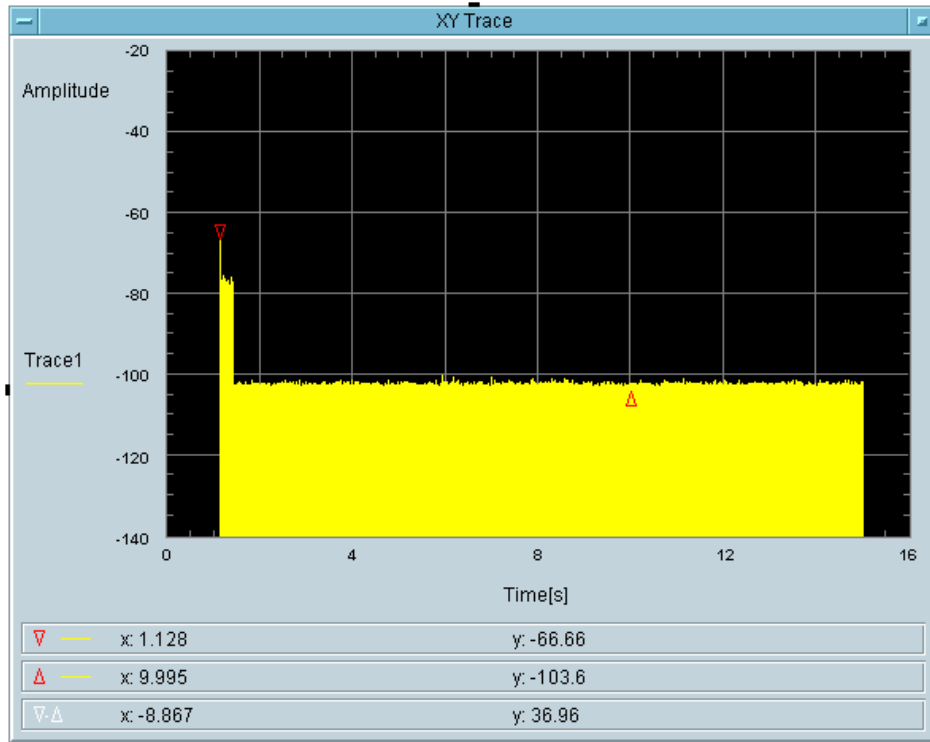

Total On Time [s]
31.13m

Total On Time After Delay [s]
7.324m

Type 5 radar channel move time result:

The traffic ceases period to the end of the radar waveform, therefore it also ceases period to 10 seconds after of the end of the radar waveform.

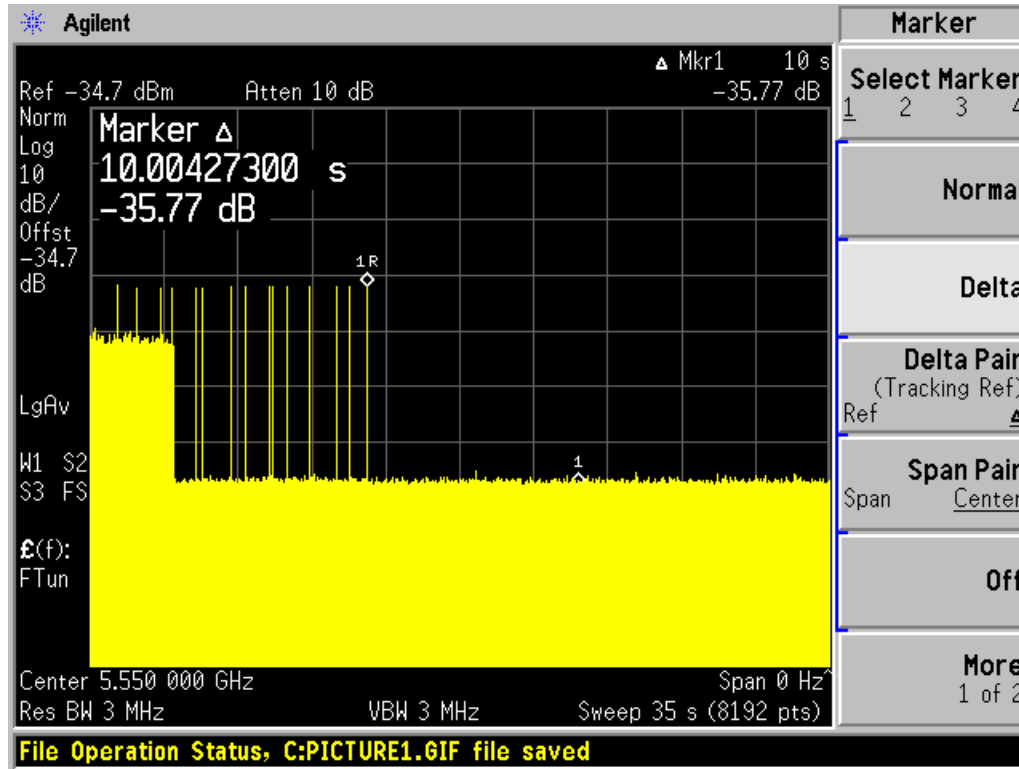

Antenna 2

5280 MHz Bandwidth 20 MHz

Type 1 radar channel move time result:

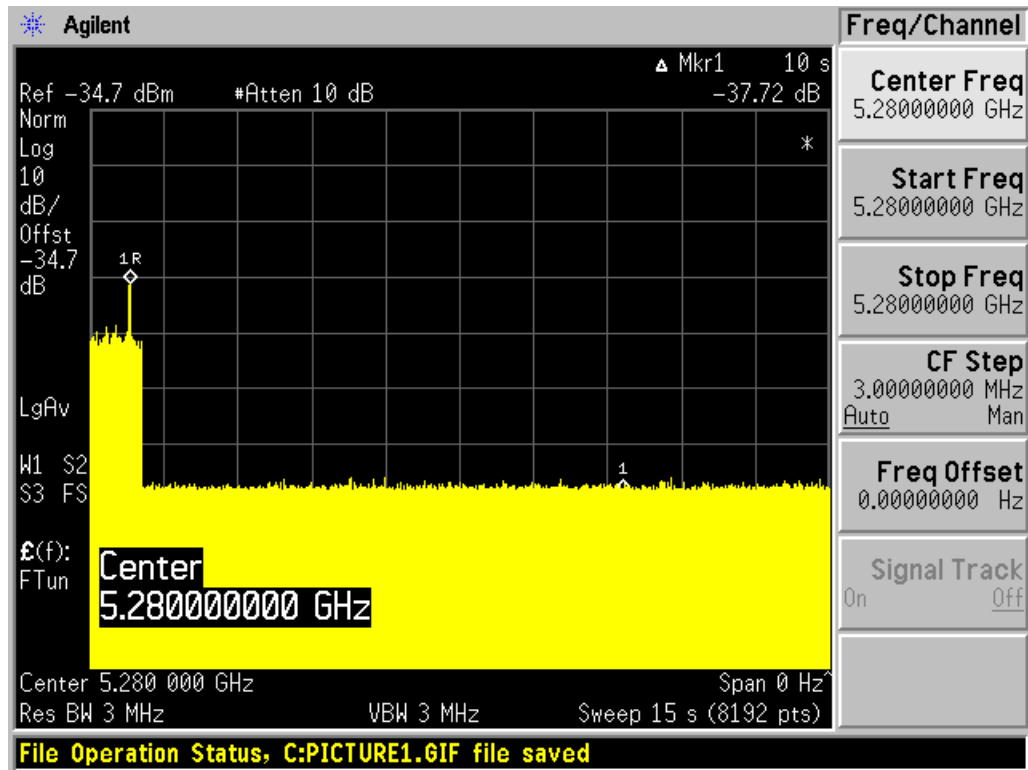

Type1 radar channel closing transmission time result:

Aggregate Transmission Time (ms)	Limit (ms)	Margin (ms)
3.622	60	56.378

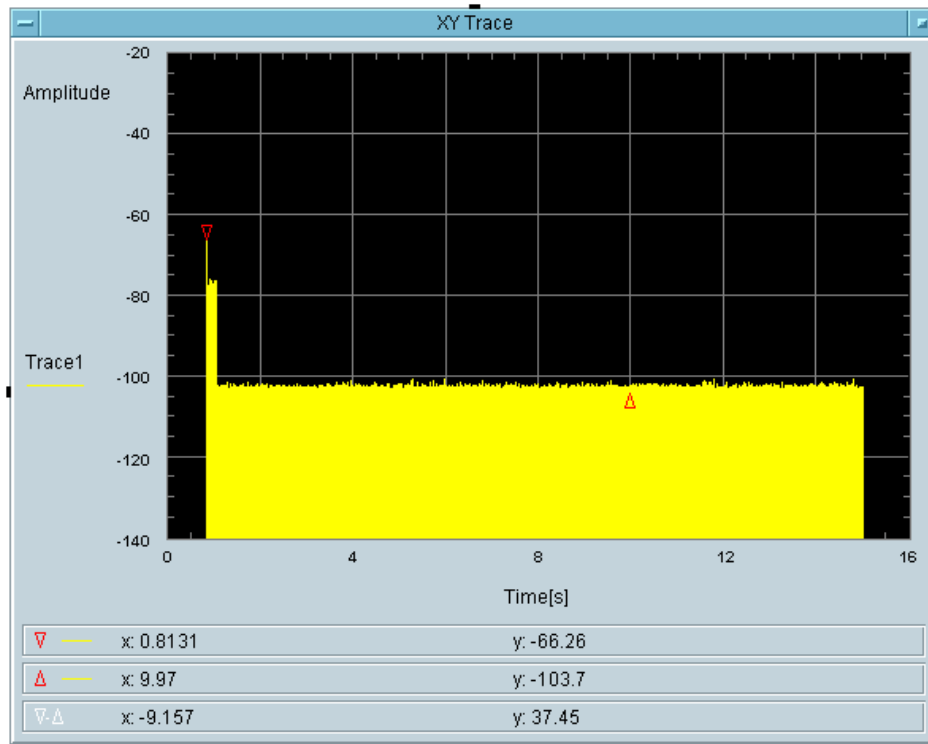

Total On Time [s]
27.47m

Total On Time After Delay [s]
3.662m

Type 5 radar channel move time result:

The traffic ceases period to the end of the radar waveform, therefore it also ceases period to 10 seconds after of the end of the radar waveform.

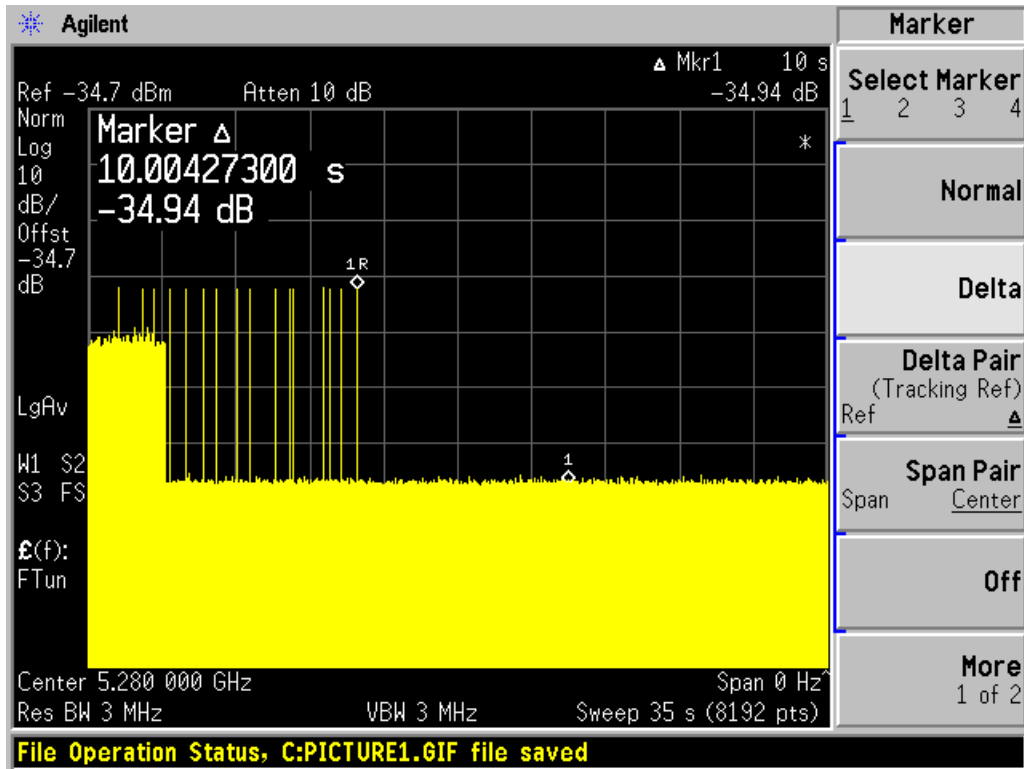

5580 MHz Bandwidth 20 MHz

Type 1 radar channel move time result:

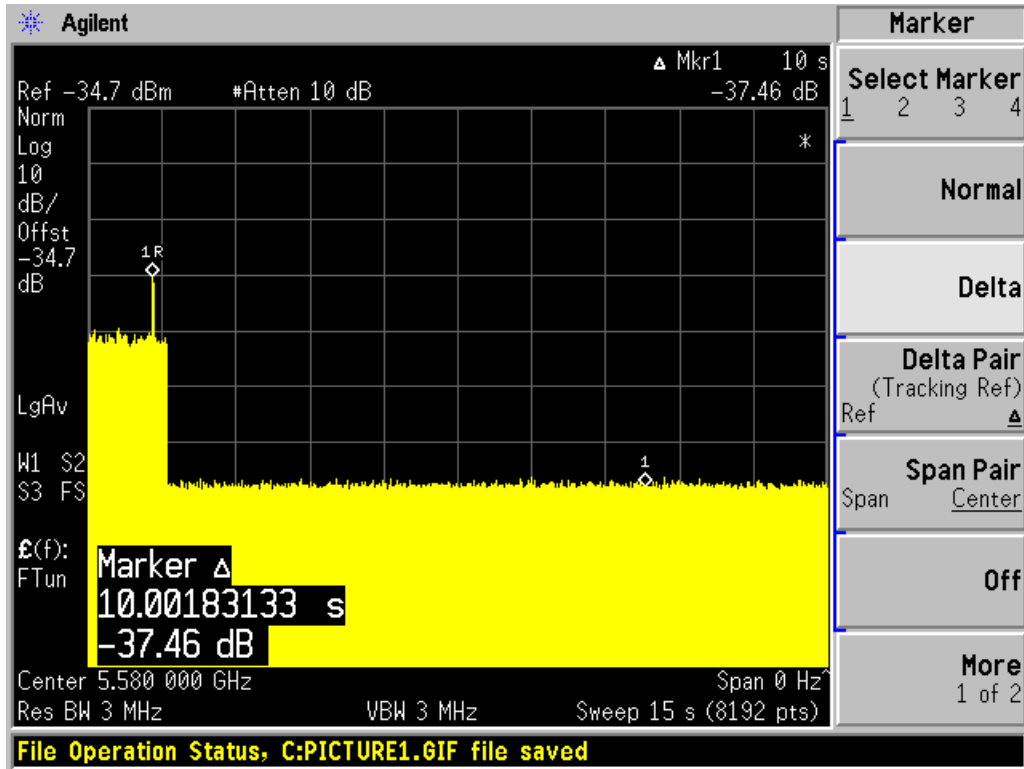

Type1 radar channel closing transmission time result:

Aggregate Transmission Time (ms)	Limit (ms)	Margin (ms)
5.493	60	54.507

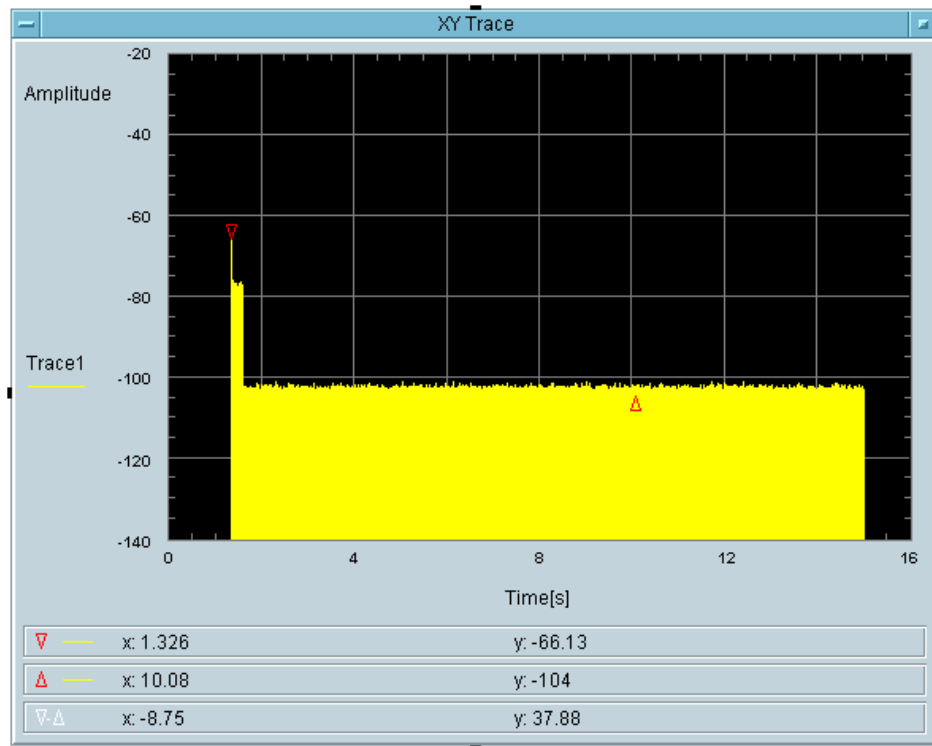

Total On Time [s]
27.47m

Total On Time After Delay [s]
5.493m

Type 5 radar channel move time result:

The traffic ceases period to the end of the radar waveform, therefore it also ceases period to 10 seconds after of the end of the radar waveform.

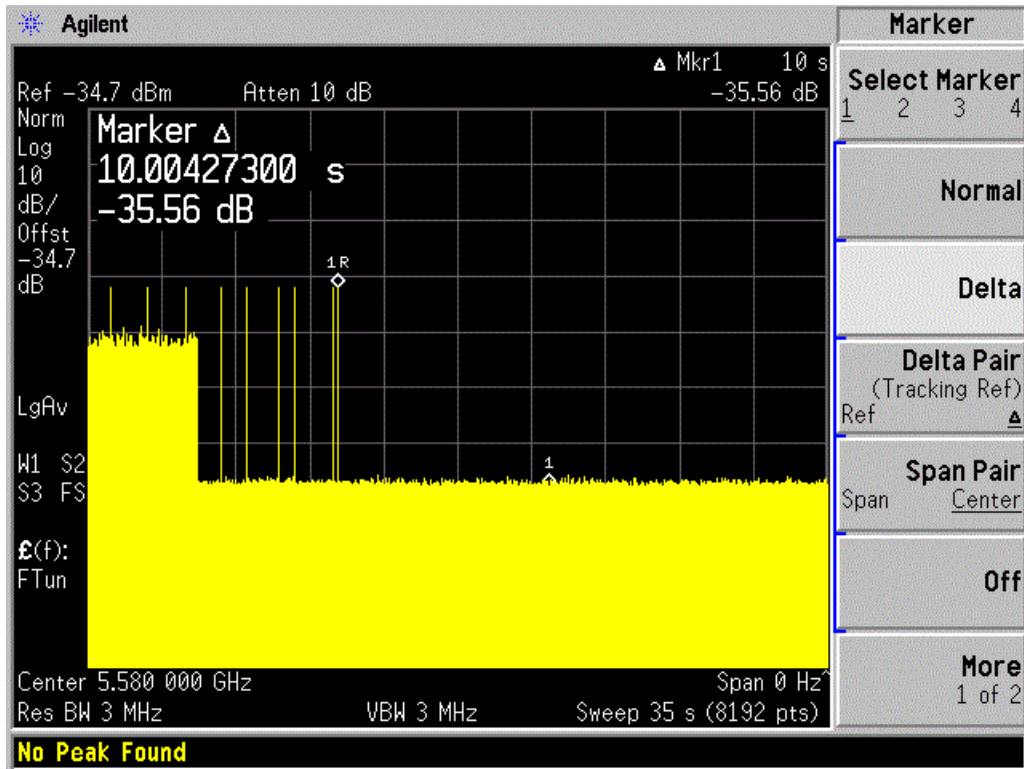

5270 MHz Bandwidth 20 MHz

Type 1 radar channel move time result:

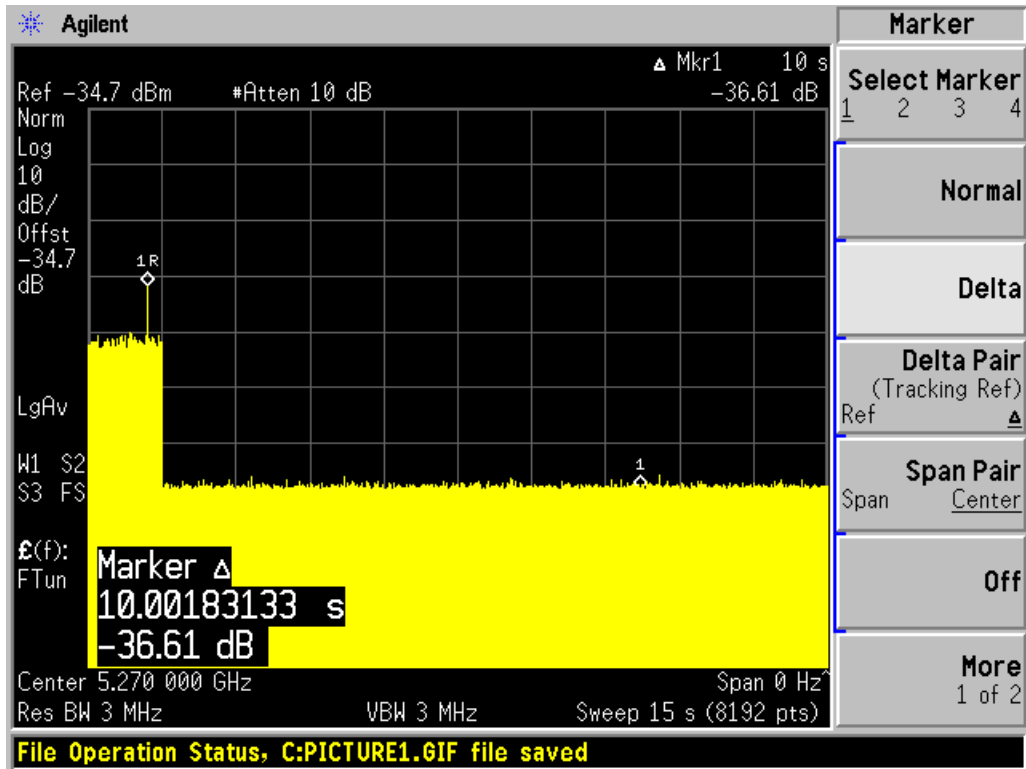

Type1 radar channel closing transmission time result:

Aggregate Transmission Time (ms)	Limit (ms)	Margin (ms)
9.156	60	50.844

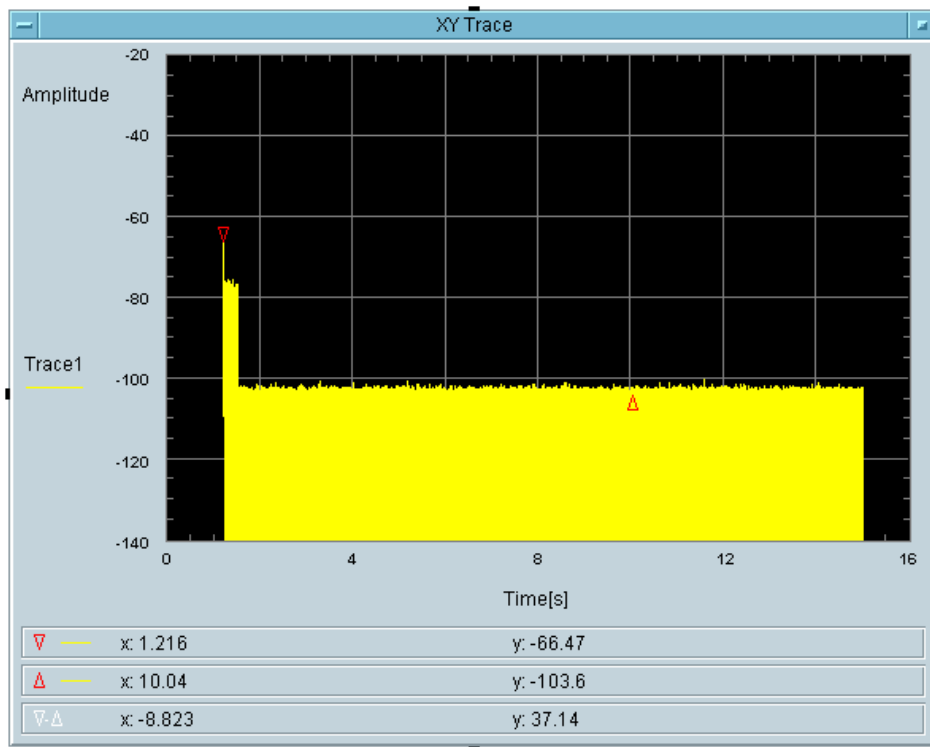

Total On Time [s]
27.47m

Total On Time After Delay [s]
9.156m

Type 5 radar channel move time result:

The traffic ceases period to the end of the radar waveform, therefore it also ceases period to 10 seconds after of the end of the radar waveform.

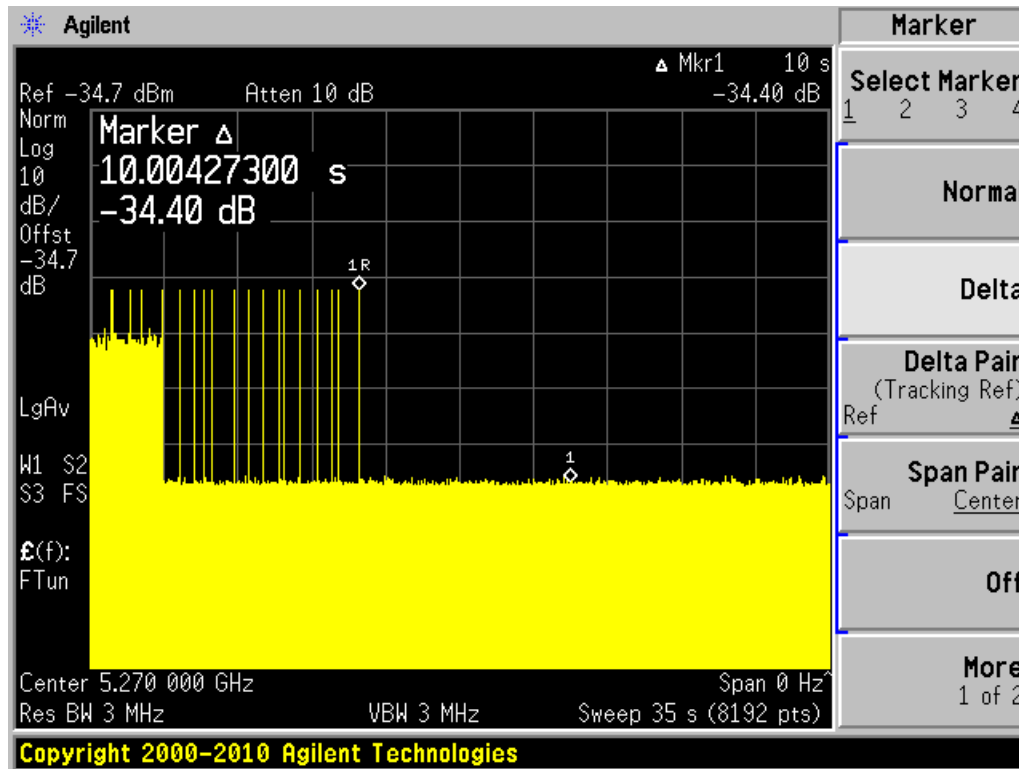

5550 MHz Bandwidth 40 MHz

Type 1 radar channel move time result:

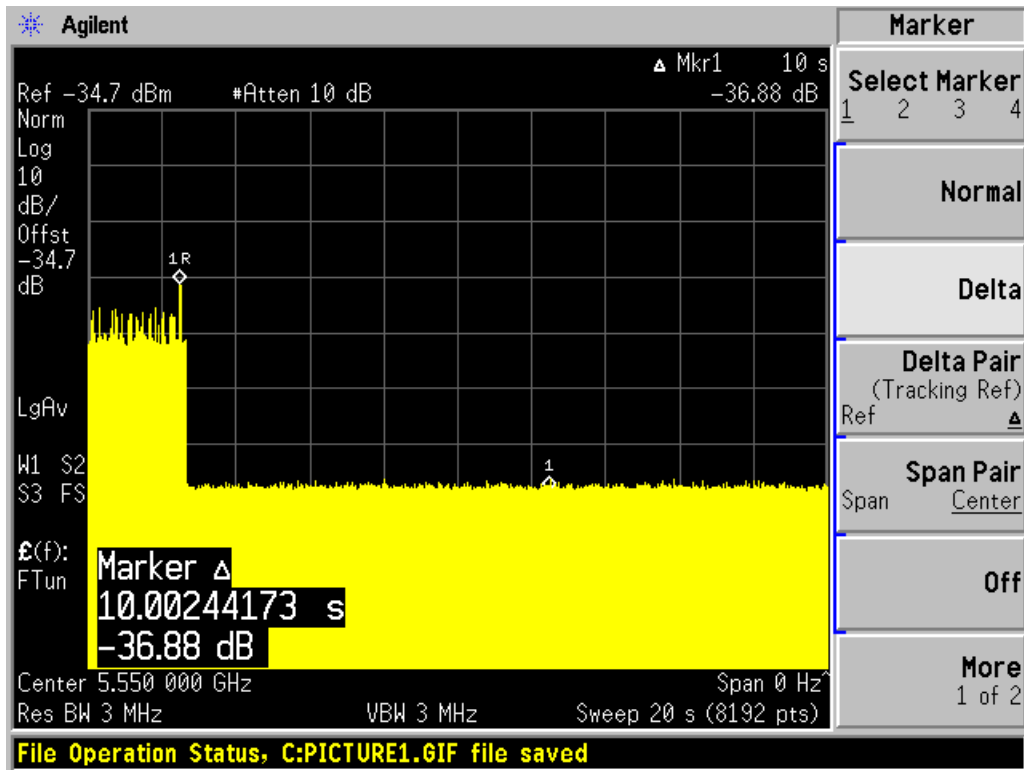

Type1 radar channel closing transmission time result:

Aggregate Transmission Time (ms)	Limit (ms)	Margin (ms)
16.48	60	43.52

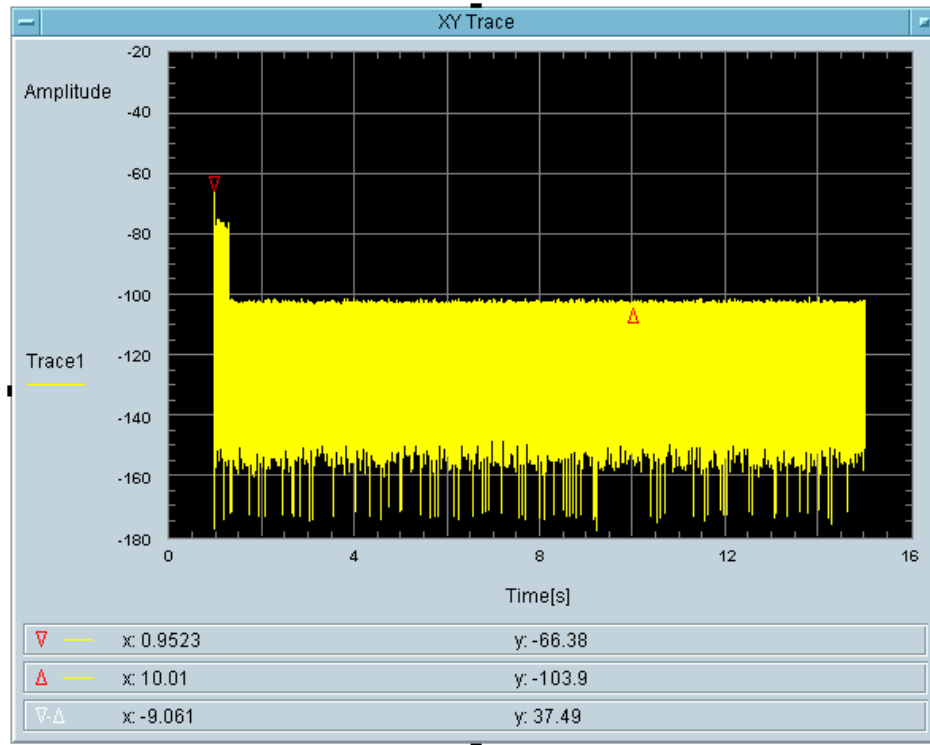

Total On Time [s]
42.12m

Total On Time After Delay [s]
16.48m

Type 5 radar channel move time result:

The traffic ceases period to the end of the radar waveform, therefore it also ceases period to 10 seconds after of the end of the radar waveform.

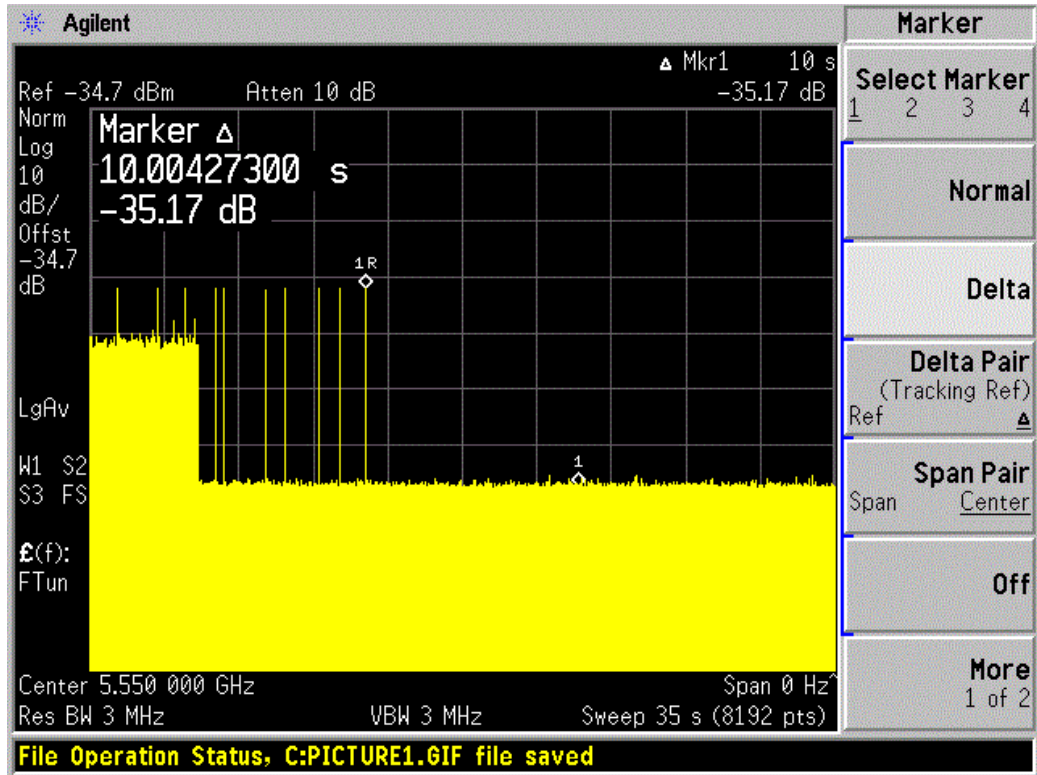

7 NON-OCCUPANCY PERIOD

7.1 Test Procedure

Measure the EUT for more than 30 minutes following the channel close/move time to verify that the EUT does not resume any transmissions on this channel. Provide one plot to demonstrate no transmission on the channel for the non-occupancy period (30 minutes observation time)

7.2 Results

Antenna 1

Frequency (MHz)	Bandwidth (MHz)	Spectrum Analyzer Display
5280	20	No transmission within 30 minutes
5580	20	No transmission within 30 minutes
5270	40	No transmission within 30 minutes
5570	40	No transmission within 30 minutes

Antenna 2

Frequency (MHz)	Bandwidth (MHz)	Spectrum Analyzer Display
5280	20	No transmission within 30 minutes
5580	20	No transmission within 30 minutes
5270	40	No transmission within 30 minutes
5570	40	No transmission within 30 minutes

Please refer to the following plots.

Antenna 1

5280 MHz Bandwidth 20 MHz

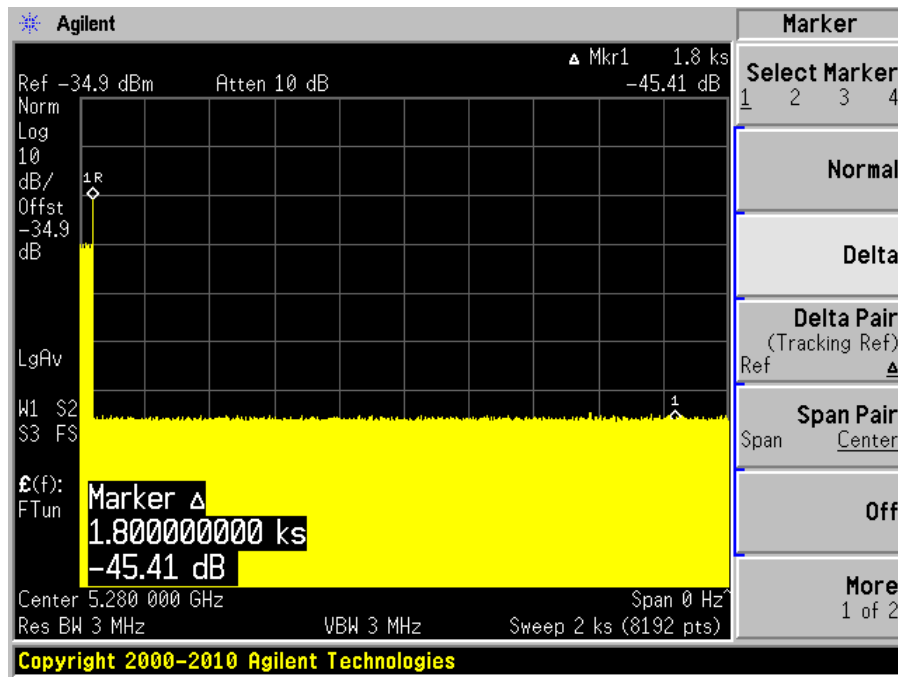

5580 MHz Bandwidth 20 MHz

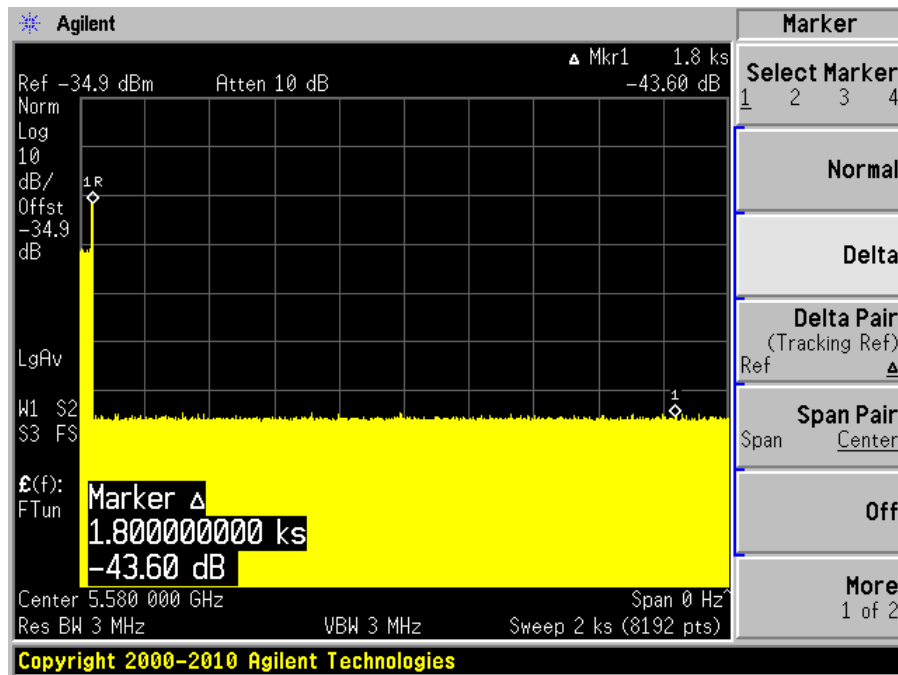

5270 MHz Bandwidth 40 MHz

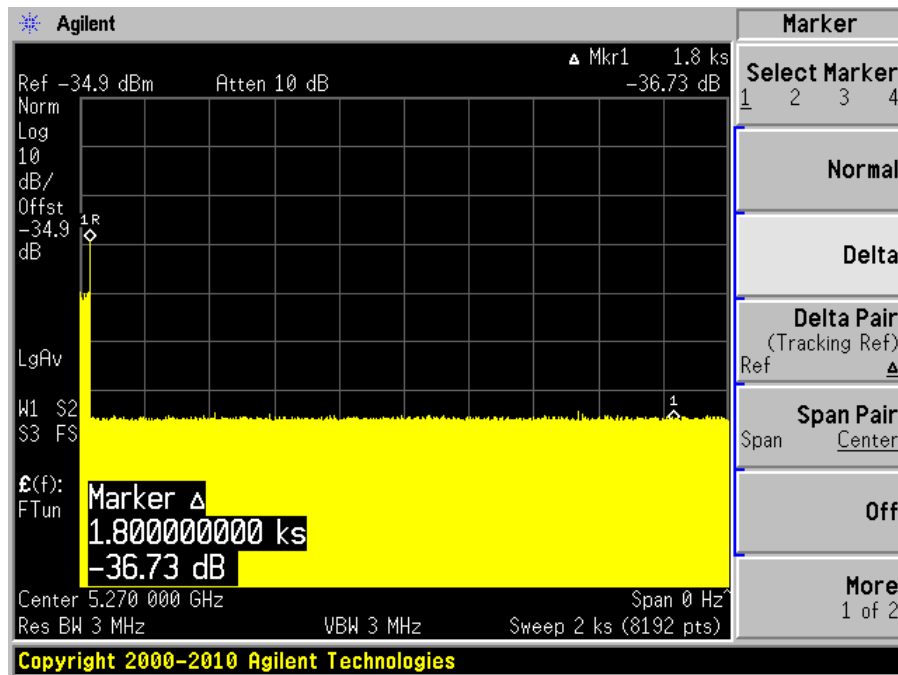

5570 MHz Bandwidth 40 MHz

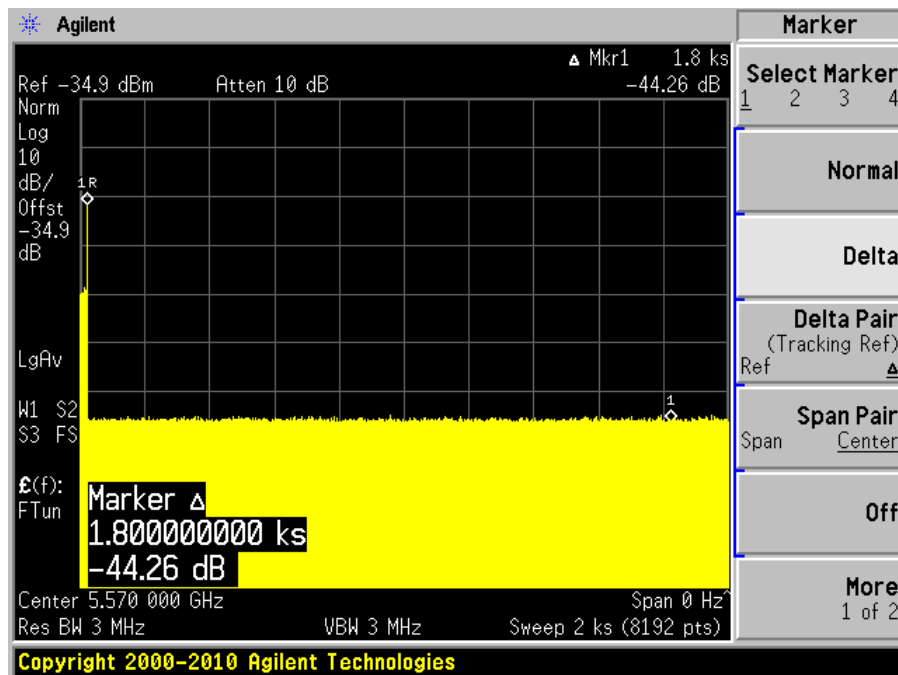

Antenna 2

5280 MHz Bandwidth 20 MHz

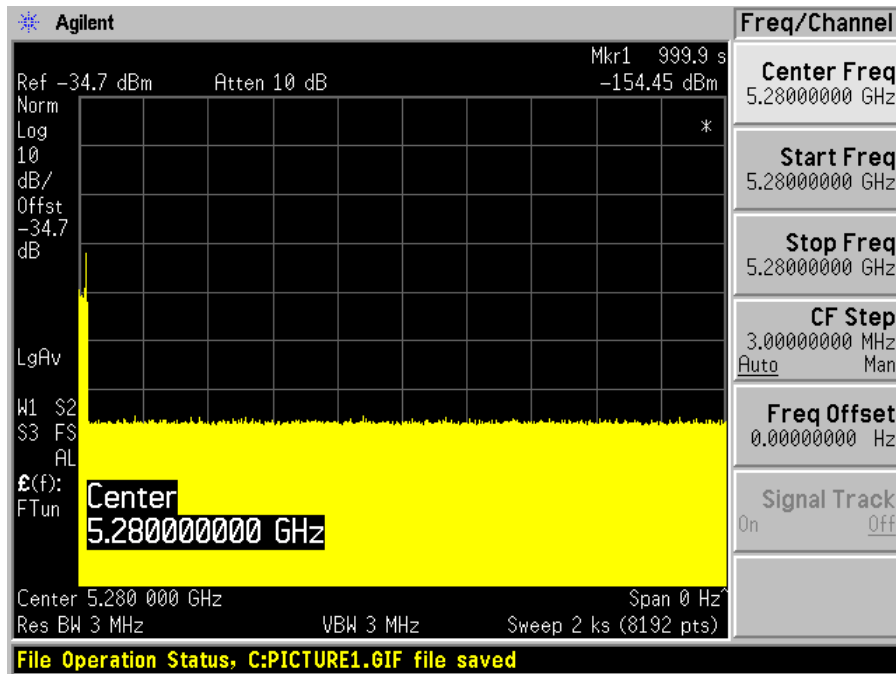

5580 MHz Bandwidth 20 MHz

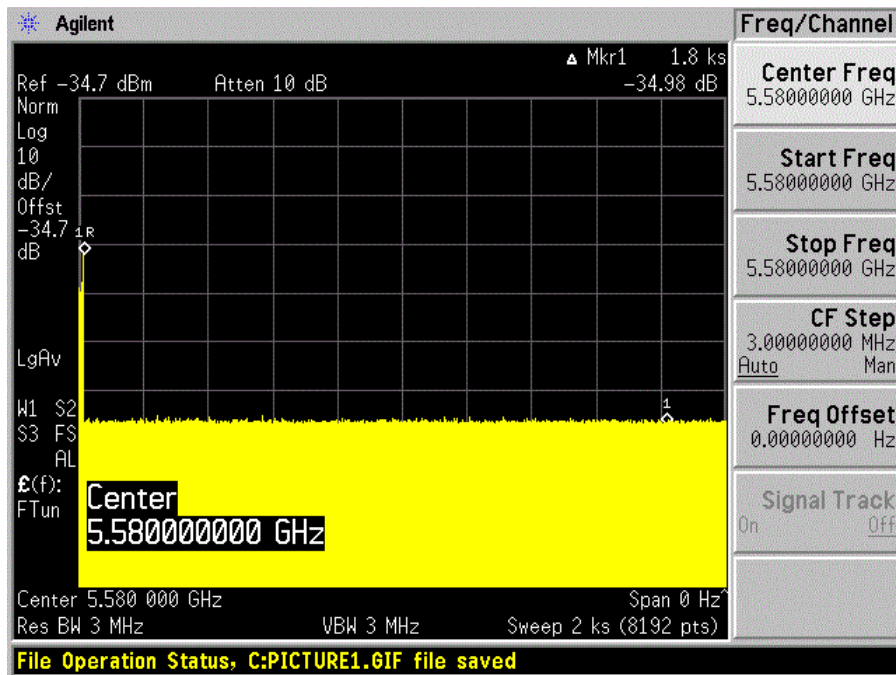

5270 MHz Bandwidth 40 MHz

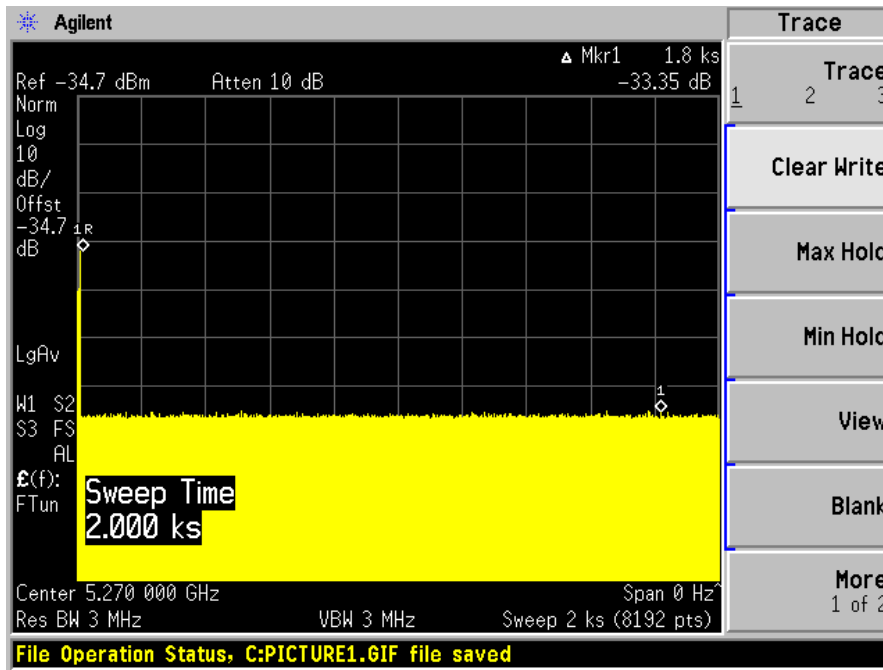

5570 MHz Bandwidth 40 MHz

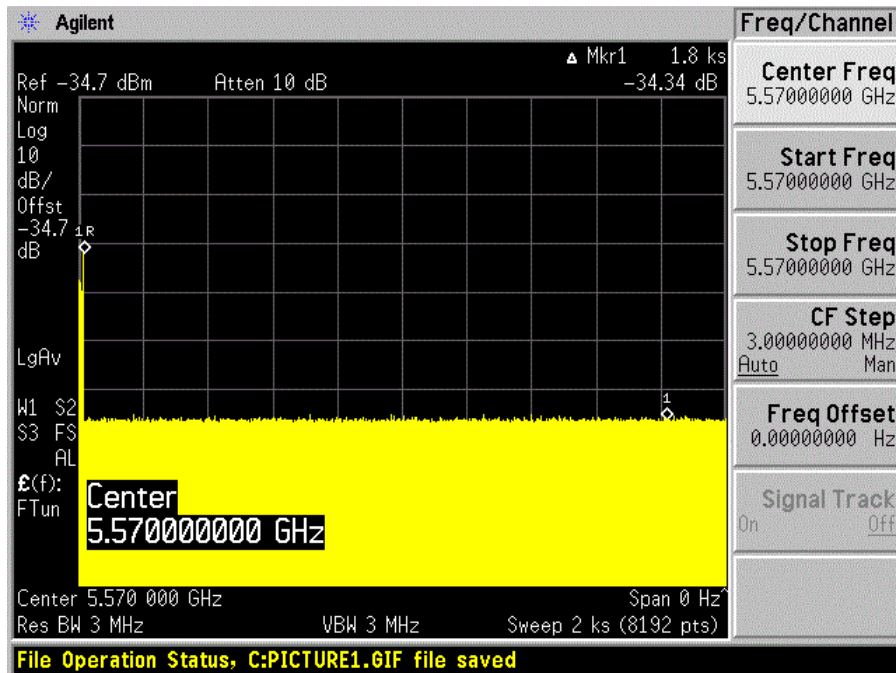

8 DETCETIO BANDWIDTH

8.1 Procedure

Performed with any one of the short pulse radar waveforms (type 1, 2, 3 or 4)

Start with radar generator frequency set to the center of the channel (F_c)

Perform at least 10 trials and confirm at least 90% detected

Increment radar generator frequency by 1 MHz and repeat

Perform at least 10 trials and confirm at least 90% detected

Continue incrementing the radar frequency until detection rate falls below 90%

Starting at $F_c - 1$ MHz, repeat the process, this time decrementing the radar frequency by 1 MHz

F_L is the lowest frequency at which detection was 80% or better

F_H is the highest frequency at which detection was 80% or better

UNII Detection Bandwidth = $F_H - F_L$

8.2 Test Results

Antenna 1

Frequency (MHz)	F_L (MHz)	F_H (MHz)	Detection Bandwidth (MHz)	Minimum Limit	Result
5270	5220	5320	40	80%	Compliance
5280	5260	5300	20	80%	Compliance
5550	5570	5610	40	80%	Compliance
5580	5560	5600	20	80%	Compliance

Antenna 2

Frequency (MHz)	F_L (MHz)	F_H (MHz)	Detection Bandwidth (MHz)	Minimum Limit	Result
5270	5220	5320	40	80%	Compliant
5280	5270	5290	20	80%	Compliant
5550	5570	5610	40	80%	Compliant
5580	5570	5590	20	80%	Compliant

Please refer to the following tables and plots.

Antenna 1:

EUT Frequency = 5270 MHz											
DFS Detection Trials (1 = Detected, Blank = No Detected)											
Radar Frequency (MHz)	1	2	3	4	5	6	7	8	9	10	Detection Rate (%)
5249	0	0	0	0	0	0	0	0	0	0	0 %
5250(F_L)	1	0	1	1	1	1	0	1	1	1	80 %
5252	0	1	1	1	1	1	1	1	1	1	90 %
5254	1	1	1	1	1	1	1	1	1	1	100 %
5256	1	1	1	1	1	1	1	1	1	1	100 %
5258	1	1	1	1	1	1	1	1	1	1	100 %
5260	1	1	1	1	1	1	1	1	1	1	100 %
5262	1	1	1	1	1	1	1	1	1	1	100 %
5264	1	1	1	1	1	1	1	1	1	1	100 %
5266	1	1	1	1	1	1	1	1	1	1	100 %
5268	1	1	1	1	1	1	1	1	1	1	100 %
5270(F _c)	0	1	1	1	1	1	1	1	1	1	90 %
5272	1	1	1	1	1	1	1	1	1	1	100 %
5274	0	1	1	1	1	1	1	1	1	1	90 %
5276	1	1	1	1	1	1	1	1	1	1	100 %
5278	1	1	1	1	1	1	1	1	1	1	100 %
5280	1	1	1	1	1	1	1	1	1	1	100 %
5282	1	1	1	1	1	1	1	1	1	1	100 %
5284	1	1	1	0	1	1	1	1	1	1	90 %
5286	1	1	1	1	1	1	1	1	1	1	100 %
5288	1	1	1	1	1	1	1	1	1	1	100 %
5290(F_H)	1	1	1	1	1	1	1	1	1	1	100 %
5291	0	0	0	0	0	0	0	0	0	0	0 %
Result:	Pass										

EUT Frequency = 5280MHz											
DFS Detection Trials (1 = Detected, Blank = No Detected)											
Radar Frequency (MHz)	1	2	3	4	5	6	7	8	9	10	Detection Rate (%)
5269	0	0	0	0	0	0	0	0	0	0	0%
5270(F_L)	1	1	1	1	1	1	1	1	1	1	90%
5271	1	1	1	1	1	1	1	1	1	1	100 %
5272	1	1	1	1	1	1	1	1	1	1	100 %
5273	1	1	1	1	1	1	1	1	1	1	100 %
5274	0	1	1	1	1	1	1	1	1	1	90 %
5275	1	1	1	1	1	1	1	1	1	1	100 %
5276	1	1	1	1	1	1	1	1	1	1	100 %
5277	1	1	1	1	1	1	1	1	1	1	100 %
5278	1	1	1	1	1	1	1	1	1	1	100 %
5279	1	1	1	1	1	1	1	1	1	1	100 %
5280 (F _c)	1	1	1	1	1	1	1	1	1	1	100 %
5281	1	1	1	1	1	1	1	1	1	1	100 %
5282	1	1	1	1	1	1	1	1	1	1	100 %
5283	1	1	1	1	1	1	1	1	1	1	100 %
5284	1	1	1	1	1	1	1	1	1	1	100 %
5285	1	1	1	1	1	1	1	1	1	1	100 %
5286	1	1	1	1	1	1	1	1	1	1	100 %
5287	1	1	1	1	1	1	1	1	1	1	100 %
5288	1	1	1	1	1	1	1	1	1	1	100 %
5289	1	1	1	1	1	1	1	1	1	1	100 %
5290(F_H)	1	1	1	1	1	1	1	1	1	1	100 %
5291	0	0	0	0	0	0	0	0	0	0	0 %
Result:	Pass										

EUT Frequency = 5550 MHz											
DFS Detection Trials (1 = Detected, Blank = No Detected)											
Radar Frequency (MHz)	1	2	3	4	5	6	7	8	9	10	Detection Rate (%)
5529	0	1	0	0	1	0	1	0	0	0	30%
5530(F_L)	1	1	1	1	1	1	1	1	1	1	100 %
5532	1	1	1	1	1	1	1	1	1	1	100 %
5534	1	1	1	1	1	1	1	1	1	1	100 %
5536	1	1	1	1	1	1	1	1	1	1	100 %
5538	1	1	1	1	1	1	1	1	1	1	100 %
5540	1	1	1	1	1	1	1	1	1	1	100 %
5542	1	1	1	1	1	1	1	1	1	1	100 %
5544	1	1	1	1	1	1	1	1	1	1	100 %
5546	1	1	1	1	1	1	1	1	1	1	100 %
5548	1	1	1	1	1	1	1	1	1	1	100 %
5550 (F _c)	1	1	1	1	1	0	1	1	1	1	90 %
5552	1	1	1	1	1	1	1	1	1	1	100 %
5554	1	1	1	1	1	1	1	1	1	1	100 %
5556	1	1	1	1	1	1	1	1	1	1	100 %
5558	1	1	1	1	1	1	1	1	1	1	100 %
5560	1	1	1	1	1	1	1	1	1	1	100 %
5562	1	1	1	1	1	1	1	1	1	1	100 %
5564	1	1	1	1	1	1	1	1	1	1	100%
5566	1	1	1	1	1	1	1	1	1	1	100 %
5568	1	1	1	1	1	1	1	1	1	1	100 %
5570(F_H)	1	1	1	1	1	1	1	1	1	1	100 %
5571	0	0	0	0	1	0	0	0	0	0	10%
Result:	Pass										

EUT Frequency = 5580MHz											
DFS Detection Trials (1 = Detected, Blank = No Detected)											
Radar Frequency (MHz)	1	2	3	4	5	6	7	8	9	10	Detection Rate (%)
5569	0	0	0	0	0	0	0	0	0	0	0%
5570(F_L)	0	1	1	1	1	1	1	1	1	1	90%
5571	1	1	1	1	1	1	1	1	1	1	100%
5572	0	1	1	1	1	1	1	1	1	1	90%
5573	1	1	1	1	1	1	1	1	1	1	100%
5574	1	1	1	1	1	1	1	1	1	1	100%
5575	1	1	1	1	1	1	1	1	1	1	100%
5576	0	1	1	1	1	1	1	1	1	1	90%
5577	1	1	1	1	1	1	1	1	1	1	100%
5578	1	1	1	1	1	1	1	1	1	1	100%
5579	1	1	1	1	1	1	1	1	1	1	100%
5580 (F _c)	1	1	1	1	1	1	1	1	1	1	100%
5581	1	1	1	1	1	1	1	1	1	1	100%
5582	1	1	1	1	1	1	1	1	1	1	100%
5583	1	1	1	1	1	1	1	1	1	1	100%
5584	1	1	1	1	1	1	1	0	1	1	90%
5585	1	1	1	1	1	1	1	1	1	1	100%
5586	1	1	1	1	1	1	1	1	1	1	100%
5587	1	1	1	1	1	1	1	1	1	1	100%
5588	1	1	1	1	1	1	1	1	1	1	100%
5589	1	1	1	1	1	1	1	1	1	1	100%
5590(F_H)	1	1	1	1	1	1	1	1	1	1	100%
5591	0	0	0	0	0	0	0	0	0	0	0%
Result:	Pass										

Antenna 2:

EUT Frequency = 5270 MHz											
DFS Detection Trials (1 = Detected, Blank = No Detected)											
Radar Frequency (MHz)	1	2	3	4	5	6	7	8	9	10	Detection Rate (%)
5250(F_L)	0	0	0	0	0	0	0	0	0	0	0 %
5252	0	1	1	1	1	1	1	1	1	1	90 %
5254	1	1	1	1	1	1	1	1	1	1	100 %
5256	1	1	1	1	1	1	1	1	1	1	100 %
5258	1	1	1	1	1	1	1	1	1	1	100 %
5260	1	1	1	1	1	1	1	1	1	1	100 %
5262	1	1	1	1	1	1	1	1	1	1	100 %
5264	1	1	1	1	1	1	1	1	1	1	100 %
5266	1	1	1	1	1	1	1	1	1	1	100 %
5268	1	1	1	1	1	1	1	1	1	1	100 %
5270(F_C)	0	1	1	1	1	1	1	1	1	1	90 %
5272	1	1	1	1	1	1	1	1	1	1	100 %
5274	0	1	1	1	1	1	1	1	1	1	90 %
5276	1	1	1	1	1	1	1	1	1	1	100 %
5278	1	1	1	1	1	1	1	1	1	1	100 %
5280	1	1	1	1	1	1	1	1	1	1	100 %
5282	1	1	1	1	1	1	1	1	1	1	100 %
5284	1	1	1	0	1	1	1	1	1	1	90 %
5286	1	1	1	1	1	1	1	1	1	1	100 %
5288	1	1	1	1	1	1	1	1	1	1	100 %
5290(F_H)	1	1	0	1	1	1	1	1	1	1	90 %
5291	0	0	0	0	0	0	0	0	0	0	0 %
Result:	Pass										

EUT Frequency = 5280MHz											
DFS Detection Trials (1 = Detected, Blank = No Detected)											
Radar Frequency (MHz)	1	2	3	4	5	6	7	8	9	10	Detection Rate (%)
5270(F _L)	0	0	0	0	0	0	0	0	0	0	0%
5271	1	1	1	1	1	1	1	1	1	1	100 %
5272	1	1	1	1	1	1	1	1	1	1	100 %
5273	1	1	1	1	1	1	1	1	1	1	100 %
5274	1	1	1	1	1	1	1	1	1	1	100 %
5275	1	1	1	1	1	1	1	1	1	1	100 %
5276	1	1	1	1	1	1	1	1	1	1	100 %
5277	1	1	1	1	1	1	1	1	1	1	100 %
5278	1	1	1	1	1	1	1	1	1	1	100 %
5279	0	1	1	1	1	1	1	1	1	1	90 %
5280 (F _c)	1	1	1	1	1	1	1	1	1	1	100 %
5281	1	1	1	1	1	1	1	1	1	1	100 %
5282	1	1	1	1	1	1	1	1	1	1	100 %
5283	1	1	1	1	1	1	1	1	1	1	100 %
5284	1	1	1	1	1	1	1	1	1	1	100 %
5285	1	1	1	1	1	1	1	1	1	1	100 %
5286	1	1	1	1	1	1	1	1	1	1	100 %
5287	1	1	1	1	1	1	1	1	1	1	100 %
5288	1	1	1	1	1	1	1	1	1	1	100 %
5289	1	1	1	1	1	1	1	1	1	1	100 %
5290(F _H)	0	0	0	0	0	0	0	0	0	0	0 %
5291	0	0	0	0	0	0	0	0	0	0	0 %
Result:	Pass										

EUT Frequency = 5550 MHz											
DFS Detection Trials (1 = Detected, Blank = No Detected)											
Radar Frequency (MHz)	1	2	3	4	5	6	7	8	9	10	Detection Rate (%)
5529	0	0	0	0	0	0	0	0	0	0	0%
5530(F_L)	1	1	1	1	1	1	1	1	1	1	100 %
5532	1	1	1	1	1	1	1	1	1	1	100 %
5534	1	1	1	1	1	1	1	1	1	1	100 %
5536	1	1	1	1	1	1	1	1	1	1	100 %
5538	1	1	1	1	1	1	1	1	1	1	100 %
5540	1	1	1	1	1	1	1	1	1	1	100 %
5542	1	1	1	1	1	1	1	1	1	1	100 %
5544	1	1	1	1	1	1	1	1	1	1	100 %
5546	1	1	1	1	1	1	1	1	1	1	100 %
5548	1	1	1	1	1	1	1	1	1	1	100 %
5550 (F _c)	1	1	1	1	1	0	1	1	1	1	90 %
5552	1	1	1	1	1	1	1	1	1	1	100 %
5554	1	1	1	1	1	1	1	1	1	1	100 %
5556	1	1	1	1	1	1	1	1	1	1	100 %
5558	1	1	1	1	1	1	1	1	1	1	100 %
5560	1	1	1	1	1	1	1	1	1	1	100 %
5562	1	1	1	1	1	1	1	1	1	1	100 %
5564	1	1	1	1	1	1	1	1	1	1	100%
5566	1	1	1	1	1	1	1	1	1	1	100 %
5568	1	1	1	1	1	1	1	1	1	1	100 %
5570(F_H)	0	0	0	0	0	0	0	0	0	0	0 %
Result : Pass											

EUT Frequency = 5580MHz											
DFS Detection Trials (1 = Detected, Blank = No Detected)											
Radar Frequency (MHz)	1	2	3	4	5	6	7	8	9	10	Detection Rate (%)
5570(F_L)	0	0	0	0	0	0	0	0	0	0	0%
5571	1	1	1	1	1	1	1	1	1	1	100 %
5572	1	1	1	1	1	1	1	1	1	1	100 %
5573	1	1	1	1	1	1	1	1	1	1	100 %
5574	1	1	1	1	1	1	1	1	1	1	100 %
5575	1	1	1	1	1	1	1	1	1	1	100 %
5576	1	1	1	1	1	1	1	1	1	1	100 %
5577	1	1	1	1	1	1	1	1	1	1	100 %
5578	1	1	1	1	1	1	1	1	1	1	100 %
5579	0	1	1	1	1	1	1	1	1	1	90 %
5580 (F_c)	1	1	1	1	1	1	1	1	1	1	100 %
5581	1	1	1	1	1	1	1	1	1	1	100 %
5582	1	1	1	1	1	1	1	1	1	1	100 %
5583	1	1	1	1	1	1	1	1	1	1	100 %
5584	1	1	1	1	1	1	1	1	1	1	100 %
5585	1	1	1	1	1	1	1	1	1	1	100 %
5586	1	1	1	1	1	1	1	1	1	1	100 %
5587	1	1	1	1	1	1	1	1	1	1	100 %
5588	1	1	1	1	1	1	1	1	1	1	100 %
5589	1	1	1	1	1	1	1	1	1	1	100 %
5590(F_H)	0	0	0	0	0	0	0	0	0	0	0 %
Result:	Pass										

8.3 Radar Detection

Procedure:

Stream MPEG file from master to slave

Generate radar waveform

Record whether or not the waveform was detected

At least 30 trials are applied for each radar type

For radar types with randomized parameters, each trial uses a unique waveform

Perform with each of the radar types 1-6

Confirm that the detection rate for each radar type meets the minimum requirement

Type 1, 2, 3, 4: 60% each

Type 5: 80%

Type 6: 70%

Confirm that the mean of the rates for radar types 1 through 4 meets the requirement of 80%

$$\text{Detection Ratio} = \frac{\text{Total Waveform Detections}}{\text{Total Waveform Trials}} \times 100$$

Result:

20 MHz

Antenna 1

5270 MHz

Radar Signal Type	Waveform/Trial Number	Detection (%)	Limit (%)	Pass/Fail
Type 1	30	100 %	60%	Pass
Type 2	30	96.7 %	60%	Pass
Type 3	30	100 %	60%	Pass
Type 4	30	100 %	60%	Pass
Type 5	30	80 %	80%	Pass
Type 6	30	93.3 %	70%	Pass

Please refer to the following statistical tables:

Antenna 1**5270 MHz****Table-1 Radar Type 1 Statistical Performance**

Trial #	Fc (MHz)	Pulse/Burst	Pulse Width (µS)	PRI (µs)	Detection (1:yes; 0:no)
1	5270	18	1	1428	1
2	5270	18	1	1428	1
3	5270	18	1	1428	1
4	5270	18	1	1428	1
5	5270	18	1	1428	1
6	5270	18	1	1428	1
7	5270	18	1	1428	1
8	5270	18	1	1428	1
9	5270	18	1	1428	1
10	5270	18	1	1428	1
11	5270	18	1	1428	1
12	5270	18	1	1428	1
13	5270	18	1	1428	1
14	5270	18	1	1428	1
15	5270	18	1	1428	1
16	5270	18	1	1428	1
17	5270	18	1	1428	1
18	5270	18	1	1428	1
19	5270	18	1	1428	1
20	5270	18	1	1428	1
21	5270	18	1	1428	1
22	5270	18	1	1428	1
23	5270	18	1	1428	1
24	5270	18	1	1428	1
25	5270	18	1	1428	1
26	5270	18	1	1428	1
27	5270	18	1	1428	1
28	5270	18	1	1428	1
29	5270	18	1	1428	1
30	5270	18	1	1428	1
Detection Percentage: 100 % (>60%)					

Table-2 Radar Type 2 Statistical Performance

Trial #	Fc (MHz)	Pulse/Burst	Pulse Width (μS)	PRI (μs)	Detection (1:yes; 0:no)
1	5270	29	2.9	190	
2	5270	29	2.4	198	1
3	5270	26	2.4	172	1
4	5270	25	2.0	216	1
5	5270	25	4.6	198	1
6	5270	23	2.6	170	1
7	5270	27	4.3	214	1
8	5270	23	2.0	198	1
9	5270	24	1.8	227	1
10	5270	26	3.7	186	1
11	5270	29	2.3	215	1
12	5270	23	3.5	230	1
13	5270	26	1.3	189	1
14	5270	26	4.8	219	1
15	5270	23	1.5	170	1
16	5270	23	4.3	202	1
17	5270	24	5.0	186	1
18	5270	28	4.4	208	1
19	5270	29	4.1	179	1
20	5270	27	4.5	184	1
21	5270	25	4.7	197	1
22	5270	24	1.8	158	1
23	5270	26	4.2	152	1
24	5270	23	4.5	208	1
25	5270	28	4.2	165	1
26	5270	27	2.7	203	1
27	5270	23	2.6	171	1
28	5270	25	2.6	217	1
29	5270	26	1.3	222	1
30	5270	24	2.8	176	1
Detection Percentage: 96.7 % (>60%)					

Table-3 Radar Type 3 Statistical Performance

Trial #	Fc (MHz)	Pulse/Burst	Pulse Width (μS)	PRI (μs)	Detection (1:yes; 0:no)
1	5270	18	6.7	222	1
2	5270	17	9.4	495	1
3	5270	18	9.6	404	1
4	5270	18	9.2	479	1
5	5270	18	9.7	289	1
6	5270	18	9.9	414	1
7	5270	18	9.2	268	1
8	5270	16	6.8	290	1
9	5270	17	6	408	1
10	5270	17	9.7	323	1
11	5270	16	9.6	251	1
12	5270	18	6.4	327	1
13	5270	16	6.3	240	1
14	5270	17	6.1	238	1
15	5270	18	7.7	326	1
16	5270	16	9.1	306	1
17	5270	16	6.6	378	1
18	5270	18	9.7	239	1
19	5270	17	8.1	460	1
20	5270	18	7.2	484	1
21	5270	18	9.1	321	1
22	5270	16	6.3	276	1
23	5270	16	6.3	229	1
24	5270	17	6.1	318	1
25	5270	18	6.7	304	1
26	5270	17	7.9	497	1
27	5270	16	7	274	1
28	5270	16	8.3	352	1
29	5270	18	10	300	1
30	5270	18	6.4	297	1
Detection Percentage: 100 % (>60%)					

Table-4 Radar Type 4 Statistical Performance

Trial #	Fc (MHz)	Pulse/Burst	Pulse Width (µS)	PRI (µs)	Detection (1:yes; 0:no)
1	5270	14	16.3	299	1
2	5270	15	15.1	456	1
3	5270	16	13.7	382	1
4	5270	16	12	375	1
5	5270	13	19	446	1
6	5270	12	12.5	435	1
7	5270	13	15.2	376	1
8	5270	16	18.7	468	1
9	5270	16	19.2	405	1
10	5270	14	12.6	411	1
11	5270	14	12.2	308	1
12	5270	15	11.8	313	1
13	5270	16	14.3	336	1
14	5270	16	13.5	301	1
15	5270	12	12	248	1
16	5270	15	13.7	216	1
17	5270	12	12.9	285	1
18	5270	15	15.1	388	1
19	5270	14	17.1	285	1
20	5270	16	19.7	374	1
21	5270	15	17.3	371	1
22	5270	16	11.8	302	1
23	5270	12	17.6	219	1
24	5270	13	13.1	426	1
25	5270	14	16.2	438	1
26	5270	15	17.4	306	1
27	5270	12	17.2	478	1
28	5270	15	19.8	329	1
29	5270	12	11.2	307	1
30	5270	12	17.1	379	1
Detection Percentage: 100 % (>60%)					

Table-5 Radar Type 5 Statistical Performance

Bin5 Statistics 1

Trial #	Pulse	Chirp (MHz)	Pulse Width (µS)	Pulse 1-2 spacing (uS)	Pulse 2-3 spacing (uS)	Pulse Start(S)	Detection (1:yes; 0:no)
0	2	8	54.7	1252			0
1	3	12	79.2	1250	1933	1933	
2	2	17	99.9	1880			
3	3	9	91.7	1582	1116	1116	
4	2	9	87	1106			
5	1	19	97.2				
6	2	8	90.8	1161			
7	3	19	50.2	1692	1806	1806	
8	1	6	85.1				
9	2	8	76.5	1570			
10	2	5	50.5	1730			
11	1	17	68.7				
12	1	20	89.4				

Bin5 Statistics 2

Trial #	Pulse	Chirp (MHz)	Pulse Width (µS)	Pulse 1-2 spacing (uS)	Pulse 2-3 spacing (uS)	Pulse Start(S)	Detection (1:yes; 0:no)
0	3	18	97.7	1872	1561	0.064172	1
1	2	16	92.7	1780		1.528326	
2	2	9	81.3	1011		2.729476	
3	2	18	62	1516		3.553	
4	2	15	55.7	1224		4.54604	
5	2	11	77.2	1674		6.101756	
6	1	7	61.9			7.135392	
7	2	10	99.6	1798		7.864731	
8	3	12	72.3	1807	1366	9.800179	
9	3	10	91.1	1100	1512	10.74764	
10	3	19	85.3	1859	1629	11.71869	

Bin5 Statistics 3

Trial #	Pulse	Chirp (MHz)	Pulse Width (µS)	Pulse 1-2 spacing (µS)	Pulse 2-3 spacing (µS)	Pulse Start(S)	Detection (1:yes; 0:no)
0	2	15	57.9	1472		0.02691	1
1	3	15	67.4	1664	1805	1.151699	
2	1	13	51.8			1.342627	
3	2	13	62.1	1397		1.876798	
4	2	14	58.4	1808		2.442159	
5	3	16	55.7	1988	1942	3.170272	
6	3	11	62.8	1008	1201	3.846105	
7	3	10	67.7	1754	1812	4.424064	
8	2	13	70.9	1813		5.164375	
9	3	6	86.9	1641	1435	5.653832	
10	3	18	56.2	1428	1854	6.015709	
11	3	11	60.2	1541	1028	6.934833	
12	2	17	66	1700		7.76972	
13	3	14	75.8	1566	1368	8.383534	
14	2	18	53.2	1951		8.524463	
15	2	6	56.7	1430		9.333011	
16	3	20	63.4	1400	1172	9.70219	
17	2	6	90.8	1320		10.49726	
18	2	6	57.4	1034		10.87439	
19	2	12	85.1	1267		11.44868	

Bin5 Statistics 4

Trial #	Pulse	Chirp (MHz)	Pulse Width (μS)	Pulse 1-2 spacing (uS)	Pulse 2-3 spacing (uS)	Pulse Start(S)	Detection (1:yes; 0:no)
0	1	8	85.4			0.484844	1
1	2	19	85.1	1172		1.380701	
2	2	19	52.8	1638		1.633953	
3	1	6	57.7			2.436987	
4	2	18	74.5	1088		3.830386	
5	1	7	75.7			4.405217	
6	2	16	88.2	1202		4.957233	
7	1	16	92.1			5.837662	
8	2	7	75.9	1165		6.441743	
9	2	17	91.8	1085		7.479112	
10	2	13	85.4	1393		8.446602	
11	1	17	63.6			9.220955	
12	2	13	51.9	1986		10.06307	
13	2	18	65.1	1507		10.80164	
14	2	11	58.2	1151		11.48103	

Bin5 Statistics 5

Trial #	Pulse	Chirp (MHz)	Pulse Width (µS)	Pulse 1-2 spacing (µS)	Pulse 2-3 spacing (µS)	Pulse Start(S)	Detection (1:yes; 0:no)
0	1	6	70.1			0.460184	1
1	3	20	76.1	1750	1295	1.303585	
2	2	6	67.1	1684		2.09342	
3	3	13	94.1	1034	1419	2.58153	
4	1	8	90.3			3.592083	
5	3	6	91.2	1273	1411	4.678849	
6	2	12	69.8	1201		5.503074	
7	3	7	93.6	1938	1353	6.372459	
8	2	8	93.1	1254		6.593913	
9	1	16	88.3			7.303957	
10	2	14	98.7	1347		8.431833	
11	3	5	58.4	1045	1661	9.30152	
12	2	14	93.4	1688		10.3493	
13	2	10	55.8	1393		11.09008	
14	1	12	90.4			11.79293	

Bin5 Statistics 6

Trial #	Pulse	Chirp (MHz)	Pulse Width (µS)	Pulse 1-2 spacing (µS)	Pulse 2-3 spacing (µS)	Pulse Start(S)	Detection (1:yes; 0:no)
0	2	6	81.5	1747		0.371061	0
1	1	13	57.6			1.947696	
2	2	14	54.9	1520		2.626376	
3	3	13	52.3	1634	1498	4.174697	
4	2	14	76.6	1952		5.773904	
5	2	8	67.9	1324		7.015114	
6	2	6	97.9	1947		8.226165	
7	1	13	77.8			9.199996	
8	2	13	51.1	1946		10.27446	
9	3	19	69.4	1099	1069	11.25688	

Bin5 Statistics 7

Trial #	Pulse	Chirp (MHz)	Pulse Width (µS)	Pulse 1-2 spacing (µS)	Pulse 2-3 spacing (µS)	Pulse Start(S)	Detection (1:yes; 0:no)
0	1	16	64.1			0.243593	0
1	3	15	79	1041	1589	1.94944	
2	3	16	70	1124	1401	3.095073	
3	1	12	83			5.247146	
4	3	11	91.5	1888	1714	6.334729	
5	3	18	90.6	1443	1133	7.644543	
6	1	19	89			8.62997	
7	1	7	87.5			10.35205	
8	1	19	79.2			10.80238	

Bin5 Statistics 8

Trial #	Pulse	Chirp (MHz)	Pulse Width (µS)	Pulse 1-2 spacing (µS)	Pulse 2-3 spacing (µS)	Pulse Start(S)	Detection (1:yes; 0:no)
0	2	10	61.3	1773		0.613394	0
1	2	5	96.2	1431		0.825392	
2	1	14	57			1.539965	
3	1	9	74.1			2.114726	
4	1	14	78.7			2.950239	
5	2	18	71.6	1861		3.556105	
6	2	14	56.7	1549		3.982116	
7	3	15	73.4	1426	1808	4.455405	
8	2	11	56.9	1492		5.189498	
9	2	8	53.5	1849		6.052196	
10	3	19	94.6	1274	1779	6.32691	
11	2	5	52.3	1297		7.017316	
12	1	12	65.4			8.039033	
13	2	6	67.8	1348		8.554732	
14	2	14	65.4	1562		9.037159	
15	1	11	53.6			9.653732	
16	2	20	97.8	1394		10.69299	
17	2	19	55.7	1084		11.07757	
18	1	9	54.1			11.43336	

Bin5 Statistics 9

Trial #	Pulse	Chirp (MHz)	Pulse Width (µS)	Pulse 1-2 spacing (uS)	Pulse 2-3 spacing (uS)	Pulse Start(S)	Detection (1:yes; 0:no)
0	3	10	88.8	1074	1974	0.141508	1
1	3	14	78.1	1698	1464	1.001187	
2	2	7	94.2	1969		1.830376	
3	2	10	66.7	1088		2.637034	
4	3	5	70.4	1867	1585	3.531245	
5	3	8	57.2	1901	1391	4.330563	
6	2	10	72.9	1950		5.375644	
7	2	18	96.7	1037		6.041283	
8	1	7	64			6.888013	
9	2	18	86.7	1582		8.545977	
10	2	12	52.4	1914		8.916305	
11	2	7	90.3	1708		9.81291	
12	1	6	93.4			10.33544	
13	1	19	60.5			11.82143	

Bin5 Statistics 10

Trial #	Pulse	Chirp (MHz)	Pulse Width (µS)	Pulse 1-2 spacing (uS)	Pulse 2-3 spacing (uS)	Pulse Start(S)	Detection (1:yes; 0:no)
0	2	5	70.8	1072		0.150494	1
1	1	14	61.7			1.011464	
2	3	13	88.2	1515	1708	2.163621	
3	3	13	94.1	1628	1311	2.977699	
4	3	14	51.1	1866	1635	3.540985	
5	3	15	84.4	1283	1244	4.41495	
6	2	14	87.2	1491		5.430647	
7	1	11	83.8			6.325026	
8	3	9	68.1	1710	1017	6.62242	
9	1	18	77.7			7.280676	
10	2	8	77.2	1445		8.57242	
11	2	8	97.4	1227		9.354087	
12	2	11	78.8	1278		9.769232	
13	2	6	89.6	1016		10.71268	
14	2	16	98.4	1085		11.98039	

Bin5 Statistics 11

Trial #	Pulse	Chirp (MHz)	Pulse Width (µS)	Pulse 1-2 spacing (uS)	Pulse 2-3 spacing (uS)	Pulse Start(S)	Detection (1:yes; 0:no)
0	1	20	58.9			0.474915	1
1	1	18	94.4			1.514963	
2	2	5	63.8	1703		1.840032	
3	1	18	88.4			2.761633	
4	1	15	72			3.389108	
5	3	8	65.1	1394	1484	4.00938	
6	2	7	63.8	1935		5.228441	
7	2	15	71.9	1316		5.659599	
8	1	9	84.7			7.058333	
9	1	10	56.6			7.457492	
10	1	8	70.8			8.096988	
11	2	6	80.3	1706		9.44641	
12	2	6	71.2	1110		10.205	
13	2	8	69.6	1030		10.46089	
14	3	10	55.9	1828	1554	11.59108	

Bin5 Statistics 12

Trial #	Pulse	Chirp (MHz)	Pulse Width (µS)	Pulse 1-2 spacing (uS)	Pulse 2-3 spacing (uS)	Pulse Start(S)	Detection (1:yes; 0:no)
0	3	12	68.3	1302	1497	0.968941	1
1	2	10	58.4	1017		1.697473	
2	2	11	50.4	1244		2.388115	
3	2	10	81.2	1524		4.173742	
4	2	18	60.9	1088		5.111238	
5	2	14	96.8	1802		5.536779	
6	2	10	98.8	1297		7.143946	
7	2	16	60.2	1026		7.898089	
8	1	17	99.8			9.10626	
9	2	8	62.5	1509		10.336	
10	2	12	74.9	1343		11.26751	

Bin5 Statistics 13

Trial #	Pulse	Chirp (MHz)	Pulse Width (μS)	Pulse 1-2 spacing (uS)	Pulse 2-3 spacing (uS)	Pulse Start(S)	Detection (1:yes; 0:no)
0	2	20	77.6	1248		0.28221	1
1	2	16	59.7	1837		2.957368	
2	2	14	79.9	1404		3.131442	
3	1	10	70.6			4.95542	
4	2	10	73.2	1959		6.142558	
5	2	9	56.5	1841		8.305973	
6	1	18	54.3			9.025724	
7	2	8	69.7	1516		10.64139	

Bin5 Statistics 14

Trial #	Pulse	Chirp (MHz)	Pulse Width (μS)	Pulse 1-2 spacing (uS)	Pulse 2-3 spacing (uS)	Pulse Start(S)	Detection (1:yes; 0:no)
0	3	15	75.6	1594	1981	0.371664	1
1	2	18	69.3	1930		1.550847	
2	2	15	86.9	1921		2.286207	
3	3	18	63.8	1205	1709	3.358088	
4	1	10	74.8			3.566996	
5	2	9	90.7	1656		4.375444	
6	2	13	83.7	1527		5.791741	
7	1	15	66.2			6.436092	
8	1	14	93.9			7.027779	
9	2	17	96.8	1999		7.80066	
10	2	13	60.8	1551		9.351169	
11	2	15	91.6	1881		9.982591	
12	3	9	80.1	1026	1055	10.31675	
13	2	19	84.7	1142		11.83006	

Bin5 Statistics 15

Trial #	Pulse	Chirp (MHz)	Pulse Width (µS)	Pulse 1-2 spacing (µS)	Pulse 2-3 spacing (µS)	Pulse Start(S)	Detection (1:yes; 0:no)
0	3	16	93.4	1283	1643	0.100883	1
1	2	14	61.5	1927		1.072181	
2	3	11	98.6	1222	1749	1.759404	
3	2	6	93.7	1364		2.410147	
4	3	17	87.2	1233	1528	3.063906	
5	3	20	82.5	1915	1993	3.633634	
6	1	16	96.8			4.348888	
7	3	9	58.4	1205	1717	5.085092	
8	2	6	82.3	1412		5.812369	
9	2	12	68.4	1442		6.402791	
10	2	10	89.3	1109		7.026421	
11	3	14	77.7	1260	1175	7.345036	
12	2	7	58.9	1824		8.489052	
13	1	11	85.6			9.150336	
14	2	16	68	1159		9.769755	
15	1	13	74			10.21571	
16	2	10	66.4	1234		11.04211	
17	2	12	80.2	1537		11.43485	

Bin5 Statistics 16

Trial #	Pulse	Chirp (MHz)	Pulse Width (µS)	Pulse 1-2 spacing (uS)	Pulse 2-3 spacing (uS)	Pulse Start(S)	Detection (1:yes; 0:no)
0	3	8	60.3	1968	1592	0.227988	1
1	1	13	97.3			1.01423	
2	2	12	92.9	1819		1.526574	
3	2	8	85	1993		1.910209	
4	2	10	58.2	1894		2.656538	
5	2	20	71.7	1772		3.585634	
6	3	14	52.7	1681	1667	4.180127	
7	2	8	52	1627		4.670164	
8	1	18	79			5.384305	
9	1	12	51.7			6.299255	
10	2	19	96.6	1172		6.821693	
11	2	6	66.9	1127		6.972312	
12	2	12	52.4	1753		8.173687	
13	2	10	91.6	1529		8.236001	
14	3	15	84.1	1395	1206	8.90688	
15	2	6	76.5	1293		9.636267	
16	2	8	95.9	1459		10.41852	
17	3	9	71.6	1457	1606	10.98872	
18	2	16	59.8	1661		11.8755	

Bin5 Statistics 17

Trial #	Pulse	Chirp (MHz)	Pulse Width (µS)	Pulse 1-2 spacing (uS)	Pulse 2-3 spacing (uS)	Pulse Start(S)	Detection (1:yes; 0:no)
0	3	15	59.7	1133	1144	0.37903	1
1	3	16	93.6	1449	1848	0.917356	
2	1	11	75			1.494559	
3	2	15	90.5	1189		2.651057	
4	1	7	69.9			2.761014	
5	2	15	54.2	1170		3.672065	
6	2	13	61.4	1808		4.390727	
7	3	17	65.6	1820	1547	5.280114	
8	3	17	69.2	1579	1789	5.937366	
9	1	13	92.8			6.127584	
10	2	18	91.7	1333		7.00299	
11	1	7	97.4			7.570107	
12	1	11	67.4			8.43553	
13	2	12	91.5	1915		9.019889	
14	1	19	55.2			9.844894	
15	3	15	96.3	1652	1569	10.19362	
16	1	16	69.1			10.77356	
17	3	18	89.4	1152	1633	11.64197	

Bin5 Statistics 18

Trial #	Pulse	Chirp (MHz)	Pulse Width (µS)	Pulse 1-2 spacing (uS)	Pulse 2-3 spacing (uS)	Pulse Start(S)	Detection (1:yes; 0:no)
0	2	10	73.7	1586		1.155762	1
1	3	11	75	1355	1008	1.98032	
2	2	7	57	1166		3.051747	
3	3	16	77.8	1770	1394	4.422225	
4	2	10	92.3	1237		5.713222	
5	1	11	89.9			6.530658	
6	2	18	75.7	1202		7.543864	
7	2	18	91.4	1050		9.471612	
8	2	7	83.8	1519		9.814464	
9	2	7	83.9	1452		11.16636	

Bin5 Statistics 19

Trial #	Pulse	Chirp (MHz)	Pulse Width (μS)	Pulse 1-2 spacing (uS)	Pulse 2-3 spacing (uS)	Pulse Start(S)	Detection (1:yes; 0:no)
0	2	17	75.5	1897		0.539596	1
1	3	18	54.3	1567	1445	0.980828	
2	2	16	55.2	1144		1.73495	
3	2	8	93.3	1879		2.153658	
4	2	17	81.8	1306		2.670851	
5	3	19	85.1	1711	1990	3.541687	
6	3	7	91	1828	1019	3.989726	
7	3	17	52.2	1053	1057	4.282467	
8	2	7	52.2	1965		5.389819	
9	2	6	64.1	1394		5.576663	
10	1	17	76.7			6.113901	
11	2	15	95.7	1041		6.902089	
12	1	14	52.2			7.305885	
13	2	14	52.6	1465		7.912144	
14	2	7	73.3	1637		8.442842	
15	3	17	50	1533	1768	9.330777	
16	2	18	93	1936		10.17906	
17	2	17	76.2	1245		10.31371	
18	1	19	53.7			10.882	
19	2	15	83.2	1797		11.93602	

Bin5 Statistics 20

Trial #	Pulse	Chirp (MHz)	Pulse Width (µS)	Pulse 1-2 spacing (uS)	Pulse 2-3 spacing (uS)	Pulse Start(S)	Detection (1:yes; 0:no)
0	1	18	52.1			0.72358	0
1	3	12	55.9	1677	1322	0.843006	
2	2	14	51.3	1545		2.310875	
3	2	8	66.3	1805		2.971591	
4	2	9	99.5	1926		3.549863	
5	2	14	50.3	1483		4.129921	
6	1	18	50.1			5.448646	
7	3	16	68.2	1584	1247	6.231129	
8	1	12	77.8			6.537819	
9	2	11	68.3	1175		7.453137	
10	2	10	87	1339		8.711334	
11	1	12	95.9			8.943314	
12	2	17	62.4	1492		9.916116	
13	2	10	73.5	1687		10.47972	
14	2	17	74.7	1289		11.24015	

Bin5 Statistics 21

Trial #	Pulse	Chirp (MHz)	Pulse Width (µS)	Pulse 1-2 spacing (uS)	Pulse 2-3 spacing (uS)	Pulse Start(S)	Detection (1:yes; 0:no)
0	2	12	57.2	1154		0.206901	1
1	3	15	57.1	1708	1318	0.873572	
2	1	10	80.5			1.816101	
3	3	9	64.3	1599	1450	2.664478	
4	1	8	54.9			3.842923	
5	3	19	66.1	1023	1761	4.975793	
6	1	15	67.8			5.67784	
7	2	16	63.2	1859		6.799467	
8	2	17	89.5	1044		6.929144	
9	2	11	99.4	1152		8.493808	
10	3	9	56.4	1516	1404	9.061922	
11	2	12	62.8	1742		9.436249	
12	1	7	79.2			11.02823	
13	2	6	93.7	1521		11.50591	
0	2	12	57.2	1154		0.206901	

Bin5 Statistics 22

Trial #	Pulse	Chirp (MHz)	Pulse Width (µS)	Pulse 1-2 spacing (µS)	Pulse 2-3 spacing (µS)	Pulse Start(S)	Detection (1:yes; 0:no)
0	2	7	80.7	1788		0.202474	1
1	1	7	75.5			1.311873	
2	2	8	54.9	1852		2.320681	
3	1	15	74.6			4.326587	
4	2	11	63.7	1994		5.439565	
5	2	15	70.1	1434		5.912695	
6	1	16	91.6			7.266286	
7	1	12	83.2			8.171005	
8	3	7	75.6	1962	1567	8.785111	
9	2	18	94	1103		10.36484	
10	2	13	88.9	1226		11.27778	

Bin5 Statistics 23

Trial #	Pulse	Chirp (MHz)	Pulse Width (µS)	Pulse 1-2 spacing (µS)	Pulse 2-3 spacing (µS)	Pulse Start(S)	Detection (1:yes; 0:no)
0	2	5	88.9	1813		0.098313	0
1	2	16	79.3	1503		1.10098	
2	2	11	63.9	1177		2.028313	
3	3	13	93.6	1034	1980	3.014172	
4	2	6	56.8	1651		3.902322	
5	3	13	59.4	1201	1306	5.057332	
6	3	8	58.4	1966	1596	5.877032	
7	2	6	88.8	1795		7.039308	
8	2	11	67.8	1498		7.984115	
9	1	6	61.4			8.384149	
10	3	13	50.2	1468	1243	9.465346	
11	3	10	89.3	1431	1248	10.33042	
12	2	14	72.7	1815		11.11665	

Bin5 Statistics 24

Trial #	Pulse	Chirp (MHz)	Pulse Width (µS)	Pulse 1-2 spacing (µS)	Pulse 2-3 spacing (µS)	Pulse Start(S)	Detection (1:yes; 0:no)
0	3	6	60.8	1353	1163	0.10849	1
1	1	6	97.7			1.876338	
2	1	12	91.8			2.790158	
3	2	19	70.6	1378		3.520917	
4	1	14	80.2			4.015777	
5	1	14	80.2			5.060319	
6	1	14	64.9			6.777693	
7	2	19	89.6	1398		7.085813	
8	3	19	96.2	1641	1250	8.234677	
9	3	18	67.7	1431	1342	9.122645	
10	2	8	72.3	1409		10.68823	
11	2	20	65.7	1189		11.64081	

Bin5 Statistics 25

Trial #	Pulse	Chirp (MHz)	Pulse Width (µS)	Pulse 1-2 spacing (µS)	Pulse 2-3 spacing (µS)	Pulse Start(S)	Detection (1:yes; 0:no)
0	1	14	73.7			0.978874	1
1	2	17	99.9	1598		1.982479	
2	2	8	70.2	1871		3.181431	
3	2	14	56.8	1419		4.712299	
4	3	16	71.1	1193	1711	5.985292	
5	2	13	83.4	1000		7.092418	
6	1	11	88.3			8.145932	
7	3	19	53.3	1809	1189	8.698264	
8	2	10	84.1	1092		10.63527	
9	2	18	57.2	1833		11.42321	

Bin5 Statistics 26

Trial #	Pulse	Chirp (MHz)	Pulse Width (µS)	Pulse 1-2 spacing (uS)	Pulse 2-3 spacing (uS)	Pulse Start(S)	Detection (1:yes; 0:no)
0	2	18	64.4	1855		0.70856	1
1	1	11	68.2			2.002092	
2	3	19	84.9	1596	1464	3.02537	
3	1	20	89.6			4.418815	
4	2	17	63.4	1009		5.822105	
5	3	9	96	1942	1829	6.865348	
6	2	10	92.7	1556		8.021127	
7	2	10	60.4	1829		9.49606	
8	2	19	60.7	1984		10.76079	
9	3	7	71.7	1469	1899	11.69537	

Bin5 Statistics 27

Trial #	Pulse	Chirp (MHz)	Pulse Width (µS)	Pulse 1-2 spacing (uS)	Pulse 2-3 spacing (uS)	Pulse Start(S)	Detection (1:yes; 0:no)
0	2	14	54	1197		0.349903	1
1	1	8	78.9			0.776088	
2	2	13	96	1923		1.73053	
3	2	20	68.3	1953		2.45603	
4	1	8	98.1			2.776823	
5	2	15	79.3	1323		3.336063	
6	2	9	74.6	1648		3.857002	
7	1	12	93.5			4.712266	
8	1	7	70.6			5.424767	
9	2	9	52.4	1925		5.909665	
10	2	13	73.9	1155		6.63023	
11	2	14	60.3	1043		7.148573	
12	1	16	88.2			8.126279	
13	1	7	89.3			8.752431	
14	2	20	85.8	1673		8.916921	
15	2	18	85.6	1293		9.916738	
16	3	6	65.9	1825	1937	10.68978	
17	2	18	81.6	1887		10.91782	
18	2	11	53.5	1963		11.79513	

Bin5 Statistics 28

Trial #	Pulse	Chirp (MHz)	Pulse Width (μS)	Pulse 1-2 spacing (uS)	Pulse 2-3 spacing (uS)	Pulse Start(S)	Detection (1:yes; 0:no)
0	2	18	74.8	1892		0.147238	1
1	2	11	72.3	1846		2.351978	
2	1	6	62.7			3.909188	
3	2	10	56	1684		5.074742	
4	3	13	95.2	1449	1138	5.602172	
5	3	10	59.5	1855	1220	7.016412	
6	2	18	51.2	1762		8.724815	
7	1	16	90			9.479718	
8	1	9	98.2			11.26361	

Bin5 Statistics 29

Trial #	Pulse	Chirp (MHz)	Pulse Width (μS)	Pulse 1-2 spacing (uS)	Pulse 2-3 spacing (uS)	Pulse Start(S)	Detection (1:yes; 0:no)
0	1	15	62.5			0.660377	1
1	1	13	61.2			0.987122	
2	3	19	51.3	1795	1300	2.208575	
3	3	19	57.1	1261	1144	3.430414	
4	3	12	99.1	1987	1632	4.485932	
5	2	6	88.3	1926		4.981818	
6	2	16	71.2	1939		5.570987	
7	1	5	52.6			6.810966	
8	1	17	95.3			7.898758	
9	3	15	89.9	1248	1301	8.344325	
10	3	19	71.1	1223	1653	9.378394	
11	2	18	97.1	1538		10.57249	
12	2	16	56.5	1887		11.53228	

Bin5 Statistics 30

Trial #	Pulse	Chirp (MHz)	Pulse Width (μS)	Pulse 1-2 spacing (uS)	Pulse 2-3 spacing (uS)	Pulse Start(S)	Detection (1:yes; 0:no)
0	2	10	74	1346		0.273622	1
1	3	11	62.7	1913	1557	2.014612	
2	3	16	80.4	1709	1873	2.543208	
3	2	11	74.9	1969		3.379911	
4	3	19	85.1	1691	1394	5.009497	
5	3	16	75.5	1403	1980	6.078011	
6	2	8	98.9	1599		6.619226	
7	2	7	88.2	1375		8.411638	
8	3	19	54.3	1080	1098	9.541978	
9	2	12	53.3	1567		10.83966	
10	2	6	77.2	1405		11.01872	

Table-6 Radar Type 6 Statistical Performance

Trial #	Fc (MHz)	Pulse /Burst	Pulse Width (µS)	PRI (µs)	Detection (1:yes; 0:no)	Hopping Sequence
1	5290	9	1	333	1	5367.0, 5600.0, 5508.0, 5299.0, 5673.0, 5305.0, 5712.0, 5325.0, 5255.0, 5562.0, 5411.0, 5567.0, 5502.0, 5438.0, 5291.0, 5595.0, 5549.0, 5458.0, 5357.0, 5701.0, 5286.0, 5451.0, 5294.0, 5717.0, 5471.0, 5394.0, 5304.0, 5335.0, 5575.0, 5551.0, 5473.0, 5545.0, 5515.0, 5601.0, 5269.0, 5279.0, 5377.0, 5333.0, 5694.0, 5345.0, 5678.0, 5501.0, 5614.0, 5602.0, 5637.0, 5512.0, 5415.0, 5331.0, 5705.0, 5484.0, 5665.0, 5308.0, 5554.0, 5638.0, 5430.0, 5361.0, 5670.0, 5332.0, 5650.0, 5576.0, 5625.0, 5560.0, 5283.0, 5442.0, 5392.0, 5514.0, 5312.0, 5491.0, 5275.0, 5327.0, 5388.0, 5581.0, 5253.0, 5521.0, 5427.0, 5645.0, 5666.0, 5447.0, 5350.0, 5492.0, 5532.0, 5692.0, 5507.0, 5369.0, 5675.0, 5360.0, 5582.0, 5503.0, 5293.0, 5419.0, 5490.0, 5539.0, 5459.0, 5538.0, 5297.0, 5711.0, 5456.0, 5612.0, 5408.0, 5337.0 (number of hits: 10)
2	5290	9	1	333	1	5639.0, 5346.0, 5710.0, 5390.0, 5412.0, 5565.0, 5615.0, 5270.0, 5434.0, 5325.0, 5551.0, 5420.0, 5370.0, 5706.0, 5285.0, 5556.0, 5651.0, 5515.0, 5253.0, 5417.0, 5562.0, 5514.0, 5666.0, 5296.0, 5335.0, 5542.0, 5660.0, 5316.0, 5530.0, 5693.0, 5490.0, 5330.0, 5676.0, 5502.0, 5381.0, 5436.0, 5347.0, 5627.0, 5647.0, 5450.0, 5318.0, 5581.0, 5353.0, 5333.0, 5449.0, 5418.0, 5360.0, 5589.0, 5535.0, 5308.0, 5648.0, 5540.0, 5685.0, 5580.0, 5387.0, 5607.0, 5326.0, 5437.0, 5453.0, 5713.0, 5599.0, 5478.0, 5343.0, 5674.0, 5332.0, 5368.0, 5354.0, 5313.0, 5701.0, 5464.0, 5419.0, 5616.0, 5306.0, 5363.0, 5709.0, 5337.0, 5375.0, 5438.0, 5720.0, 5379.0, 5477.0, 5592.0, 5544.0, 5516.0, 5623.0, 5492.0, 5320.0, 5297.0, 5473.0, 5413.0, 5510.0, 5624.0, 5274.0, 5415.0, 5561.0, 5327.0, 5304.0, 5536.0, 5634.0, 5654.0 (number of hits: 7)
3	5290	9	1	333	1	5570.0, 5587.0, 5586.0, 5275.0, 5488.0, 5251.0, 5301.0, 5640.0, 5391.0, 5713.0, 5608.0, 5461.0, 5311.0, 5537.0, 5356.0, 5310.0, 5604.0, 5417.0, 5658.0, 5703.0, 5376.0, 5302.0, 5478.0, 5404.0, 5462.0, 5606.0, 5323.0, 5308.0, 5333.0, 5412.0, 5675.0, 5616.0, 5540.0, 5469.0, 5365.0, 5696.0, 5439.0, 5465.0, 5505.0, 5266.0, 5454.0, 5541.0, 5701.0, 5279.0, 5383.0, 5499.0, 5659.0, 5332.0, 5486.0, 5294.0, 5449.0, 5657.0, 5599.0, 5309.0, 5409.0, 5536.0, 5556.0, 5401.0, 5434.0, 5642.0,

						5582.0, 5632.0, 5259.0, 5482.0, 5553.0, 5339.0, 5263.0, 5655.0, 5518.0, 5477.0, 5623.0, 5686.0, 5290.0, 5304.0, 5394.0, 5317.0, 5664.0, 5352.0, 5371.0, 5598.0, 5324.0, 5517.0, 5718.0, 5593.0, 5565.0, 5354.0, 5299.0, 5260.0, 5617.0, 5700.0, 5444.0, 5523.0, 5519.0, 5572.0, 5443.0, 5437.0, 5327.0, 5508.0, 5276.0, 5584.0 (number of hits: 10)
4	5290	9	1	333	1	5312.0, 5451.0, 5390.0, 5590.0, 5444.0, 5365.0, 5436.0, 5426.0, 5699.0, 5551.0, 5535.0, 5677.0, 5652.0, 5636.0, 5696.0, 5345.0, 5460.0, 5256.0, 5401.0, 5384.0, 5703.0, 5487.0, 5668.0, 5597.0, 5360.0, 5251.0, 5454.0, 5604.0, 5518.0, 5626.0, 5254.0, 5638.0, 5657.0, 5282.0, 5383.0, 5557.0, 5351.0, 5649.0, 5515.0, 5291.0, 5628.0, 5378.0, 5565.0, 5475.0, 5695.0, 5537.0, 5303.0, 5371.0, 5374.0, 5332.0, 5446.0, 5705.0, 5450.0, 5710.0, 5629.0, 5528.0, 5674.0, 5519.0, 5406.0, 5349.0, 5442.0, 5322.0, 5624.0, 5666.0, 5716.0, 5348.0, 5389.0, 5433.0, 5501.0, 5578.0, 5630.0, 5292.0, 5272.0, 5559.0, 5257.0, 5514.0, 5538.0, 5434.0, 5662.0, 5271.0, 5640.0, 5284.0, 5516.0, 5492.0, 5511.0, 5635.0, 5473.0, 5589.0, 5302.0, 5623.0, 5457.0, 5637.0, 5673.0, 5370.0, 5363.0, 5618.0, 5549.0, 5494.0, 5713.0, 5588.0 (number of hits: 5)
5	5290	9	1	333	1	5483.0, 5310.0, 5646.0, 5474.0, 5707.0, 5654.0, 5536.0, 5371.0, 5285.0, 5665.0, 5355.0, 5442.0, 5342.0, 5655.0, 5472.0, 5387.0, 5517.0, 5715.0, 5345.0, 5452.0, 5689.0, 5357.0, 5539.0, 5548.0, 5366.0, 5485.0, 5312.0, 5545.0, 5521.0, 5519.0, 5307.0, 5612.0, 5567.0, 5296.0, 5356.0, 5343.0, 5587.0, 5286.0, 5325.0, 5275.0, 5385.0, 5690.0, 5566.0, 5470.0, 5570.0, 5709.0, 5490.0, 5487.0, 5579.0, 5426.0, 5673.0, 5626.0, 5590.0, 5324.0, 5259.0, 5535.0, 5520.0, 5569.0, 5268.0, 5423.0, 5497.0, 5639.0, 5551.0, 5437.0, 5553.0, 5713.0, 5434.0, 5308.0, 5685.0, 5398.0, 5401.0, 5425.0, 5288.0, 5251.0, 5450.0, 5320.0, 5537.0, 5350.0, 5415.0, 5338.0, 5593.0, 5505.0, 5501.0, 5400.0, 5468.0, 5658.0, 5607.0, 5304.0, 5250.0, 5404.0, 5448.0, 5720.0, 5257.0, 5696.0, 5610.0, 5631.0, 5647.0, 5467.0, 5449.0, 5652.0 (number of hits: 9)
6	5290	9	1	333	1	5452.0, 5678.0, 5434.0, 5363.0, 5471.0, 5664.0, 5385.0, 5626.0, 5303.0, 5437.0, 5703.0, 5598.0, 5283.0, 5657.0, 5709.0, 5543.0, 5509.0, 5457.0, 5319.0, 5636.0, 5706.0, 5616.0, 5326.0, 5486.0, 5621.0, 5666.0, 5536.0, 5492.0, 5527.0, 5361.0, 5322.0, 5478.0, 5278.0, 5464.0, 5563.0, 5568.0, 5263.0, 5348.0, 5291.0, 5673.0,

						5671.0, 5507.0, 5607.0, 5456.0, 5562.0, 5432.0, 5458.0, 5286.0, 5466.0, 5453.0, 5495.0, 5640.0, 5416.0, 5570.0, 5485.0, 5690.0, 5451.0, 5294.0, 5581.0, 5396.0, 5637.0, 5360.0, 5559.0, 5409.0, 5505.0, 5292.0, 5667.0, 5330.0, 5378.0, 5472.0, 5268.0, 5349.0, 5545.0, 5296.0, 5526.0, 5528.0, 5273.0, 5650.0, 5519.0, 5681.0, 5602.0, 5652.0, 5548.0, 5557.0, 5411.0, 5362.0, 5651.0, 5300.0, 5479.0, 5617.0, 5631.0, 5504.0, 5399.0, 5274.0, 5298.0, 5672.0, 5586.0, 5459.0, 5288.0, 5556.0 (number of hits: 9)
7	5290	9	1	333	1	5344.0, 5498.0, 5320.0, 5721.0, 5553.0, 5256.0, 5449.0, 5338.0, 5501.0, 5346.0, 5377.0, 5679.0, 5613.0, 5555.0, 5513.0, 5378.0, 5529.0, 5356.0, 5414.0, 5680.0, 5688.0, 5543.0, 5286.0, 5362.0, 5710.0, 5671.0, 5364.0, 5323.0, 5528.0, 5636.0, 5551.0, 5406.0, 5496.0, 5325.0, 5479.0, 5599.0, 5442.0, 5404.0, 5556.0, 5557.0, 5668.0, 5489.0, 5567.0, 5455.0, 5502.0, 5436.0, 5295.0, 5581.0, 5408.0, 5647.0, 5381.0, 5673.0, 5672.0, 5568.0, 5631.0, 5355.0, 5322.0, 5474.0, 5706.0, 5400.0, 5523.0, 5308.0, 5340.0, 5585.0, 5635.0, 5301.0, 5388.0, 5574.0, 5652.0, 5260.0, 5379.0, 5423.0, 5500.0, 5285.0, 5428.0, 5469.0, 5302.0, 5623.0, 5624.0, 5527.0, 5583.0, 5369.0, 5444.0, 5307.0, 5577.0, 5530.0, 5621.0, 5592.0, 5626.0, 5405.0, 5450.0, 5650.0, 5349.0, 5533.0, 5690.0, 5434.0, 5717.0, 5250.0, 5418.0, 5440.0 (number of hits: 7)
8	5290	9	1	333	1	5307.0, 5622.0, 5503.0, 5487.0, 5638.0, 5426.0, 5658.0, 5395.0, 5546.0, 5579.0, 5646.0, 5590.0, 5597.0, 5309.0, 5575.0, 5720.0, 5559.0, 5421.0, 5401.0, 5470.0, 5365.0, 5572.0, 5362.0, 5547.0, 5292.0, 5512.0, 5511.0, 5475.0, 5347.0, 5529.0, 5524.0, 5259.0, 5445.0, 5687.0, 5335.0, 5368.0, 5699.0, 5336.0, 5682.0, 5427.0, 5542.0, 5495.0, 5305.0, 5544.0, 5553.0, 5556.0, 5315.0, 5698.0, 5352.0, 5633.0, 5596.0, 5706.0, 5461.0, 5637.0, 5413.0, 5581.0, 5416.0, 5377.0, 5514.0, 5673.0, 5676.0, 5399.0, 5349.0, 5628.0, 5486.0, 5560.0, 5304.0, 5601.0, 5610.0, 5408.0, 5265.0, 5356.0, 5654.0, 5453.0, 5345.0, 5299.0, 5690.0, 5444.0, 5642.0, 5589.0, 5712.0, 5364.0, 5442.0, 5623.0, 5598.0, 5615.0, 5446.0, 5380.0, 5592.0, 5435.0, 5422.0, 5500.0, 5707.0, 5608.0, 5312.0, 5578.0, 5366.0, 5267.0, 5619.0, 5286.0 (number of hits: 8)
9	5290	9	1	333	1	5340.0, 5473.0, 5475.0, 5456.0, 5349.0, 5571.0, 5481.0, 5692.0, 5672.0, 5558.0, 5675.0, 5583.0, 5615.0, 5309.0, 5251.0, 5266.0, 5371.0, 5673.0, 5577.0, 5360.0,

						5334.0, 5436.0, 5527.0, 5460.0, 5376.0, 5531.0, 5377.0, 5489.0, 5274.0, 5380.0, 5439.0, 5276.0, 5352.0, 5612.0, 5501.0, 5637.0, 5657.0, 5265.0, 5707.0, 5290.0, 5422.0, 5414.0, 5697.0, 5668.0, 5645.0, 5631.0, 5491.0, 5472.0, 5347.0, 5480.0, 5397.0, 5400.0, 5357.0, 5304.0, 5648.0, 5517.0, 5407.0, 5295.0, 5702.0, 5294.0, 5415.0, 5459.0, 5538.0, 5470.0, 5369.0, 5322.0, 5367.0, 5560.0, 5389.0, 5390.0, 5579.0, 5450.0, 5649.0, 5518.0, 5709.0, 5298.0, 5540.0, 5661.0, 5273.0, 5255.0, 5267.0, 5287.0, 5487.0, 5388.0, 5614.0, 5442.0, 5611.0, 5606.0, 5271.0, 5419.0, 5375.0, 5317.0, 5586.0, 5325.0, 5676.0, 5417.0, 5324.0, 5656.0, 5434.0, 5529.0 (number of hits: 7)
10	5290	9	1	333	1	5620.0, 5498.0, 5475.0, 5499.0, 5331.0, 5688.0, 5338.0, 5678.0, 5378.0, 5693.0, 5327.0, 5511.0, 5588.0, 5615.0, 5703.0, 5476.0, 5458.0, 5556.0, 5507.0, 5497.0, 5719.0, 5407.0, 5668.0, 5641.0, 5417.0, 5664.0, 5357.0, 5426.0, 5707.0, 5532.0, 5659.0, 5379.0, 5674.0, 5296.0, 5443.0, 5280.0, 5355.0, 5311.0, 5712.0, 5306.0, 5672.0, 5275.0, 5318.0, 5559.0, 5610.0, 5317.0, 5603.0, 5523.0, 5339.0, 5645.0, 5652.0, 5614.0, 5647.0, 5554.0, 5314.0, 5570.0, 5265.0, 5361.0, 5440.0, 5714.0, 5587.0, 5385.0, 5568.0, 5721.0, 5444.0, 5516.0, 5299.0, 5430.0, 5632.0, 5308.0, 5383.0, 5367.0, 5393.0, 5591.0, 5251.0, 5347.0, 5706.0, 5346.0, 5381.0, 5520.0, 5648.0, 5576.0, 5325.0, 5480.0, 5484.0, 5262.0, 5504.0, 5605.0, 5402.0, 5579.0, 5604.0, 5464.0, 5600.0, 5626.0, 5319.0, 5435.0, 5287.0, 5303.0, 5272.0, 5448.0 (number of hits: 8)
11	5290	9	1	333	1	5568.0, 5391.0, 5500.0, 5581.0, 5506.0, 5343.0, 5350.0, 5566.0, 5714.0, 5332.0, 5374.0, 5612.0, 5477.0, 5315.0, 5550.0, 5695.0, 5586.0, 5413.0, 5380.0, 5421.0, 5583.0, 5381.0, 5582.0, 5538.0, 5452.0, 5471.0, 5424.0, 5305.0, 5466.0, 5701.0, 5565.0, 5702.0, 5570.0, 5455.0, 5339.0, 5665.0, 5465.0, 5689.0, 5657.0, 5569.0, 5533.0, 5347.0, 5560.0, 5364.0, 5278.0, 5669.0, 5336.0, 5299.0, 5540.0, 5342.0, 5618.0, 5634.0, 5325.0, 5578.0, 5628.0, 5460.0, 5356.0, 5337.0, 5331.0, 5499.0, 5567.0, 5289.0, 5425.0, 5279.0, 5632.0, 5556.0, 5395.0, 5402.0, 5372.0, 5699.0, 5584.0, 5650.0, 5295.0, 5355.0, 5340.0, 5283.0, 5588.0, 5686.0, 5435.0, 5377.0, 5290.0, 5597.0, 5589.0, 5483.0, 5409.0, 5253.0, 5349.0, 5281.0, 5580.0, 5373.0, 5416.0, 5651.0, 5682.0, 5547.0, 5493.0, 5389.0, 5708.0, 5563.0, 5503.0, 5525.0 (number of hits: 5)

12	5290	9	1	333	1	<p>5385.0, 5613.0, 5450.0, 5346.0, 5264.0, 5453.0, 5531.0, 5343.0, 5433.0, 5495.0, 5535.0, 5275.0, 5671.0, 5310.0, 5550.0, 5611.0, 5574.0, 5530.0, 5261.0, 5705.0, 5662.0, 5403.0, 5255.0, 5410.0, 5577.0, 5409.0, 5359.0, 5718.0, 5695.0, 5678.0, 5389.0, 5715.0, 5428.0, 5379.0, 5690.0, 5607.0, 5497.0, 5628.0, 5624.0, 5474.0, 5612.0, 5554.0, 5476.0, 5558.0, 5263.0, 5268.0, 5331.0, 5456.0, 5494.0, 5291.0, 5650.0, 5253.0, 5637.0, 5700.0, 5569.0, 5649.0, 5693.0, 5642.0, 5256.0, 5444.0, 5525.0, 5377.0, 5374.0, 5408.0, 5698.0, 5666.0, 5668.0, 5506.0, 5416.0, 5380.0, 5492.0, 5469.0, 5561.0, 5585.0, 5646.0, 5505.0, 5339.0, 5641.0, 5709.0, 5484.0, 5296.0, 5300.0, 5477.0, 5598.0, 5370.0, 5647.0, 5721.0, 5354.0, 5460.0, 5630.0, 5415.0, 5713.0, 5659.0, 5521.0, 5270.0, 5257.0, 5548.0, 5515.0, 5566.0, 5498.0 (number of hits: 4)</p>
13	5290	9	1	333	1	<p>5640.0, 5310.0, 5689.0, 5319.0, 5570.0, 5283.0, 5470.0, 5472.0, 5530.0, 5535.0, 5337.0, 5643.0, 5390.0, 5719.0, 5382.0, 5483.0, 5692.0, 5676.0, 5622.0, 5683.0, 5629.0, 5706.0, 5695.0, 5259.0, 5455.0, 5641.0, 5649.0, 5688.0, 5518.0, 5343.0, 5631.0, 5508.0, 5512.0, 5492.0, 5533.0, 5704.0, 5261.0, 5445.0, 5502.0, 5436.0, 5638.0, 5647.0, 5670.0, 5289.0, 5311.0, 5464.0, 5383.0, 5660.0, 5437.0, 5503.0, 5662.0, 5288.0, 5467.0, 5277.0, 5612.0, 5351.0, 5466.0, 5579.0, 5675.0, 5339.0, 5417.0, 5458.0, 5284.0, 5396.0, 5652.0, 5298.0, 5294.0, 5469.0, 5565.0, 5299.0, 5597.0, 5285.0, 5329.0, 5350.0, 5661.0, 5624.0, 5465.0, 5542.0, 5481.0, 5359.0, 5625.0, 5305.0, 5628.0, 5280.0, 5279.0, 5616.0, 5718.0, 5475.0, 5346.0, 5561.0, 5626.0, 5484.0, 5260.0, 5460.0, 5482.0, 5642.0, 5358.0, 5432.0, 5708.0, 5326.0 (number of hits: 9)</p>
14	5290	9	1	333	1	<p>5679.0, 5289.0, 5253.0, 5347.0, 5460.0, 5312.0, 5423.0, 5439.0, 5436.0, 5389.0, 5514.0, 5541.0, 5296.0, 5375.0, 5286.0, 5419.0, 5644.0, 5494.0, 5579.0, 5673.0, 5610.0, 5593.0, 5421.0, 5522.0, 5397.0, 5718.0, 5686.0, 5316.0, 5467.0, 5543.0, 5393.0, 5474.0, 5456.0, 5568.0, 5605.0, 5315.0, 5666.0, 5706.0, 5559.0, 5302.0, 5465.0, 5672.0, 5278.0, 5527.0, 5699.0, 5385.0, 5334.0, 5671.0, 5279.0, 5451.0, 5501.0, 5345.0, 5388.0, 5268.0, 5502.0, 5290.0, 5519.0, 5438.0, 5615.0, 5649.0, 5531.0, 5486.0, 5670.0, 5445.0, 5591.0, 5425.0, 5590.0, 5532.0, 5328.0, 5455.0, 5565.0, 5631.0, 5432.0, 5716.0, 5658.0, 5448.0, 5303.0, 5626.0, 5569.0, 5628.0, 5358.0, 5589.0, 5656.0, 5450.0, 5701.0</p>

						5282.0, 5441.0, 5623.0, 5555.0, 5323.0, 5629.0, 5443.0, 5489.0, 5497.0, 5322.0, 5542.0, 5477.0, 5280.0, 5409.0, 5404.0 (number of hits: 7)
15	5290	9	1	333	1	5354.0, 5689.0, 5618.0, 5610.0, 5337.0, 5666.0, 5292.0, 5304.0, 5692.0, 5341.0, 5531.0, 5601.0, 5660.0, 5536.0, 5625.0, 5306.0, 5675.0, 5434.0, 5586.0, 5418.0, 5456.0, 5297.0, 5629.0, 5496.0, 5650.0, 5663.0, 5630.0, 5384.0, 5435.0, 5657.0, 5508.0, 5560.0, 5584.0, 5714.0, 5369.0, 5548.0, 5519.0, 5396.0, 5569.0, 5300.0, 5319.0, 5441.0, 5479.0, 5361.0, 5490.0, 5558.0, 5528.0, 5404.0, 5590.0, 5417.0, 5326.0, 5620.0, 5589.0, 5542.0, 5295.0, 5669.0, 5549.0, 5599.0, 5571.0, 5265.0, 5632.0, 5511.0, 5424.0, 5442.0, 5298.0, 5484.0, 5392.0, 5702.0, 5271.0, 5677.0, 5425.0, 5305.0, 5409.0, 5504.0, 5523.0, 5509.0, 5623.0, 5447.0, 5401.0, 5383.0, 5313.0, 5433.0, 5682.0, 5705.0, 5459.0, 5312.0, 5643.0, 5671.0, 5269.0, 5613.0, 5389.0, 5272.0, 5680.0, 5316.0, 5388.0, 5537.0, 5695.0, 5525.0, 5594.0, 5458.0 (number of hits: 10)
16	5290	9	1	333	1	5352.0, 5682.0, 5701.0, 5272.0, 5380.0, 5393.0, 5378.0, 5664.0, 5423.0, 5518.0, 5336.0, 5643.0, 5458.0, 5385.0, 5687.0, 5680.0, 5264.0, 5648.0, 5713.0, 5339.0, 5376.0, 5533.0, 5624.0, 5540.0, 5434.0, 5532.0, 5614.0, 5377.0, 5266.0, 5598.0, 5592.0, 5620.0, 5637.0, 5481.0, 5305.0, 5473.0, 5586.0, 5271.0, 5571.0, 5609.0, 5291.0, 5477.0, 5555.0, 5526.0, 5574.0, 5714.0, 5411.0, 5344.0, 5623.0, 5476.0, 5358.0, 5692.0, 5482.0, 5252.0, 5361.0, 5425.0, 5329.0, 5355.0, 5510.0, 5386.0, 5289.0, 5462.0, 5353.0, 5255.0, 5705.0, 5273.0, 5696.0, 5491.0, 5584.0, 5560.0, 5639.0, 5670.0, 5424.0, 5452.0, 5636.0, 5671.0, 5280.0, 5511.0, 5298.0, 5665.0, 5268.0, 5554.0, 5402.0, 5517.0, 5446.0, 5493.0, 5700.0, 5253.0, 5630.0, 5723.0, 5258.0, 5325.0, 5457.0, 5711.0, 5319.0, 5683.0, 5474.0, 5622.0, 5442.0, 5489.0 (number of hits: 4)
17	5290	9	1	333	1	5724.0, 5269.0, 5285.0, 5483.0, 5428.0, 5714.0, 5706.0, 5416.0, 5625.0, 5298.0, 5592.0, 5684.0, 5287.0, 5522.0, 5462.0, 5365.0, 5661.0, 5529.0, 5488.0, 5345.0, 5349.0, 5530.0, 5579.0, 5640.0, 5420.0, 5537.0, 5482.0, 5333.0, 5499.0, 5679.0, 5431.0, 5559.0, 5504.0, 5622.0, 5698.0, 5551.0, 5578.0, 5472.0, 5538.0, 5423.0, 5596.0, 5611.0, 5652.0, 5275.0, 5612.0, 5595.0, 5645.0, 5475.0, 5311.0, 5260.0, 5594.0, 5487.0, 5319.0, 5396.0, 5582.0, 5370.0, 5557.0, 5553.0, 5569.0, 5329.0, 5607.0, 5463.0, 5602.0, 5409.0, 5610.0,

						5354.0, 5347.0, 5337.0, 5507.0, 5408.0, 5615.0, 5373.0, 5605.0, 5350.0, 5403.0, 5276.0, 5571.0, 5360.0, 5495.0, 5361.0, 5425.0, 5465.0, 5291.0, 5284.0, 5419.0, 5623.0, 5654.0, 5253.0, 5509.0, 5352.0, 5455.0, 5328.0, 5281.0, 5315.0, 5629.0, 5438.0, 5636.0, 5566.0, 5670.0, 5514.0 (number of hits: 5)
18	5290	9	1	333	1	5647.0, 5326.0, 5691.0, 5321.0, 5699.0, 5675.0, 5381.0, 5348.0, 5484.0, 5636.0, 5565.0, 5520.0, 5536.0, 5475.0, 5551.0, 5537.0, 5266.0, 5287.0, 5601.0, 5328.0, 5633.0, 5342.0, 5663.0, 5441.0, 5384.0, 5398.0, 5538.0, 5427.0, 5652.0, 5556.0, 5396.0, 5676.0, 5532.0, 5694.0, 5319.0, 5627.0, 5669.0, 5414.0, 5298.0, 5485.0, 5292.0, 5403.0, 5291.0, 5318.0, 5264.0, 5651.0, 5717.0, 5634.0, 5386.0, 5251.0, 5407.0, 5408.0, 5323.0, 5530.0, 5522.0, 5413.0, 5447.0, 5480.0, 5697.0, 5598.0, 5607.0, 5274.0, 5710.0, 5290.0, 5356.0, 5489.0, 5564.0, 5273.0, 5713.0, 5433.0, 5405.0, 5566.0, 5589.0, 5711.0, 5722.0, 5463.0, 5404.0, 5332.0, 5301.0, 5330.0, 5487.0, 5371.0, 5541.0, 5357.0, 5453.0, 5457.0, 5455.0, 5497.0, 5701.0, 5539.0, 5507.0, 5499.0, 5307.0, 5430.0, 5322.0, 5689.0, 5269.0, 5527.0, 5363.0, 5311.0 (number of hits: 8)
19	5290	9	1	333	1	5402.0, 5304.0, 5507.0, 5256.0, 5701.0, 5697.0, 5679.0, 5662.0, 5699.0, 5421.0, 5299.0, 5323.0, 5418.0, 5566.0, 5700.0, 5502.0, 5451.0, 5677.0, 5478.0, 5489.0, 5533.0, 5541.0, 5680.0, 5275.0, 5586.0, 5463.0, 5556.0, 5693.0, 5721.0, 5585.0, 5540.0, 5523.0, 5329.0, 5460.0, 5657.0, 5297.0, 5316.0, 5493.0, 5279.0, 5675.0, 5592.0, 5317.0, 5498.0, 5422.0, 5356.0, 5644.0, 5331.0, 5722.0, 5664.0, 5379.0, 5529.0, 5618.0, 5262.0, 5573.0, 5410.0, 5445.0, 5557.0, 5479.0, 5484.0, 5470.0, 5443.0, 5571.0, 5332.0, 5397.0, 5711.0, 5638.0, 5368.0, 5378.0, 5549.0, 5432.0, 5349.0, 5409.0, 5631.0, 5589.0, 5619.0, 5308.0, 5253.0, 5707.0, 5552.0, 5599.0, 5255.0, 5300.0, 5413.0, 5405.0, 5351.0, 5345.0, 5348.0, 5280.0, 5550.0, 5495.0, 5485.0, 5595.0, 5306.0, 5471.0, 5603.0, 5417.0, 5594.0, 5696.0, 5684.0, 5512.0 (number of hits: 6)
20	5290	9	1	333	1	5541.0, 5272.0, 5593.0, 5699.0, 5369.0, 5471.0, 5581.0, 5326.0, 5454.0, 5307.0, 5452.0, 5645.0, 5715.0, 5435.0, 5566.0, 5289.0, 5281.0, 5279.0, 5601.0, 5578.0, 5540.0, 5488.0, 5529.0, 5430.0, 5403.0, 5268.0, 5671.0, 5329.0, 5704.0, 5672.0, 5595.0, 5316.0, 5458.0, 5648.0, 5324.0, 5505.0, 5425.0, 5481.0, 5297.0, 5469.0, 5678.0, 5683.0, 5357.0, 5383.0, 5397.0,

						5478.0, 5360.0, 5576.0, 5712.0, 5555.0, 5295.0, 5618.0, 5387.0, 5258.0, 5400.0, 5343.0, 5376.0, 5275.0, 5384.0, 5310.0, 5292.0, 5342.0, 5433.0, 5348.0, 5413.0, 5584.0, 5285.0, 5599.0, 5621.0, 5417.0, 5409.0, 5716.0, 5315.0, 5382.0, 5569.0, 5692.0, 5504.0, 5440.0, 5372.0, 5686.0, 5399.0, 5544.0, 5506.0, 5476.0, 5631.0, 5490.0, 5337.0, 5649.0, 5688.0, 5533.0, 5352.0, 5491.0, 5291.0, 5313.0, 5468.0, 5604.0, 5560.0, 5594.0, 5681.0, 5367.0 (number of hits: 9)
21	5290	9	1	333	1	5615.0, 5583.0, 5287.0, 5326.0, 5611.0, 5599.0, 5263.0, 5300.0, 5558.0, 5643.0, 5673.0, 5602.0, 5420.0, 5668.0, 5273.0, 5333.0, 5480.0, 5426.0, 5266.0, 5621.0, 5563.0, 5315.0, 5714.0, 5513.0, 5683.0, 5685.0, 5616.0, 5433.0, 5303.0, 5457.0, 5672.0, 5690.0, 5304.0, 5317.0, 5648.0, 5704.0, 5570.0, 5576.0, 5575.0, 5408.0, 5629.0, 5511.0, 5652.0, 5700.0, 5364.0, 5271.0, 5572.0, 5578.0, 5635.0, 5467.0, 5560.0, 5310.0, 5664.0, 5625.0, 5339.0, 5470.0, 5535.0, 5661.0, 5649.0, 5449.0, 5678.0, 5291.0, 5296.0, 5298.0, 5522.0, 5253.0, 5251.0, 5355.0, 5401.0, 5526.0, 5702.0, 5322.0, 5461.0, 5431.0, 5336.0, 5507.0, 5671.0, 5262.0, 5385.0, 5584.0, 5566.0, 5323.0, 5533.0, 5508.0, 5675.0, 5598.0, 5452.0, 5608.0, 5301.0, 5634.0, 5607.0, 5684.0, 5681.0, 5543.0, 5713.0, 5281.0, 5469.0, 5718.0, 5331.0, 5626.0 (number of hits: 9)
22	5290	9	1	333	1	5602.0, 5619.0, 5385.0, 5425.0, 5681.0, 5558.0, 5471.0, 5434.0, 5556.0, 5406.0, 5664.0, 5297.0, 5356.0, 5475.0, 5440.0, 5283.0, 5525.0, 5301.0, 5443.0, 5327.0, 5515.0, 5285.0, 5633.0, 5299.0, 5308.0, 5591.0, 5490.0, 5436.0, 5275.0, 5348.0, 5625.0, 5437.0, 5458.0, 5457.0, 5587.0, 5622.0, 5320.0, 5715.0, 5336.0, 5700.0, 5278.0, 5516.0, 5543.0, 5274.0, 5479.0, 5415.0, 5713.0, 5663.0, 5676.0, 5259.0, 5505.0, 5472.0, 5485.0, 5426.0, 5379.0, 5574.0, 5650.0, 5629.0, 5630.0, 5414.0, 5641.0, 5613.0, 5365.0, 5667.0, 5649.0, 5492.0, 5354.0, 5451.0, 5523.0, 5699.0, 5476.0, 5265.0, 5573.0, 5634.0, 5305.0, 5646.0, 5566.0, 5280.0, 5577.0, 5688.0, 5639.0, 5657.0, 5380.0, 5696.0, 5282.0, 5658.0, 5716.0, 5589.0, 5638.0, 5628.0, 5391.0, 5460.0, 5448.0, 5659.0, 5701.0, 5480.0, 5424.0, 5604.0, 5454.0, 5318.0 (number of hits: 6)
23	5290	9	1	333	1	5503.0, 5335.0, 5509.0, 5465.0, 5493.0, 5374.0, 5432.0, 5537.0, 5437.0, 5252.0, 5594.0, 5655.0, 5615.0, 5291.0, 5348.0, 5401.0, 5545.0, 5363.0, 5723.0, 5440.0, 5314.0, 5581.0, 5713.0, 5424.0, 5261.0,

						5721.0, 5546.0, 5411.0, 5487.0, 5676.0, 5280.0, 5264.0, 5347.0, 5357.0, 5586.0, 5699.0, 5506.0, 5385.0, 5472.0, 5602.0, 5263.0, 5488.0, 5515.0, 5358.0, 5711.0, 5256.0, 5338.0, 5356.0, 5376.0, 5396.0, 5377.0, 5659.0, 5416.0, 5638.0, 5439.0, 5473.0, 5430.0, 5719.0, 5642.0, 5685.0, 5343.0, 5651.0, 5386.0, 5326.0, 5538.0, 5665.0, 5461.0, 5459.0, 5296.0, 5603.0, 5508.0, 5563.0, 5587.0, 5498.0, 5633.0, 5468.0, 5494.0, 5584.0, 5607.0, 5456.0, 5670.0, 5394.0, 5525.0, 5402.0, 5429.0, 5650.0, 5449.0, 5274.0, 5588.0, 5372.0, 5712.0, 5350.0, 5393.0, 5258.0, 5361.0, 5511.0, 5667.0, 5321.0, 5682.0, 5320.0 (number of hits: 3)
24	5290	9	1	333	1	5356.0, 5436.0, 5561.0, 5530.0, 5717.0, 5677.0, 5547.0, 5393.0, 5537.0, 5417.0, 5290.0, 5595.0, 5399.0, 5685.0, 5289.0, 5692.0, 5577.0, 5474.0, 5308.0, 5490.0, 5596.0, 5380.0, 5295.0, 5329.0, 5712.0, 5454.0, 5267.0, 5251.0, 5504.0, 5491.0, 5511.0, 5638.0, 5687.0, 5716.0, 5706.0, 5326.0, 5305.0, 5557.0, 5388.0, 5492.0, 5583.0, 5587.0, 5421.0, 5381.0, 5585.0, 5541.0, 5293.0, 5642.0, 5518.0, 5262.0, 5698.0, 5416.0, 5646.0, 5339.0, 5255.0, 5302.0, 5489.0, 5415.0, 5643.0, 5699.0, 5271.0, 5336.0, 5570.0, 5513.0, 5372.0, 5313.0, 5479.0, 5648.0, 5688.0, 5468.0, 5543.0, 5711.0, 5682.0, 5444.0, 5310.0, 5622.0, 5419.0, 5346.0, 5389.0, 5270.0, 5679.0, 5520.0, 5414.0, 5456.0, 5294.0, 5472.0, 5516.0, 5469.0, 5581.0, 5540.0, 5299.0, 5598.0, 5708.0, 5358.0, 5713.0, 5347.0, 5439.0, 5693.0, 5552.0, 5286.0 (number of hits: 12)
25	5290	9	1	333	1	5629.0, 5602.0, 5538.0, 5307.0, 5508.0, 5428.0, 5405.0, 5296.0, 5707.0, 5625.0, 5718.0, 5407.0, 5351.0, 5400.0, 5711.0, 5469.0, 5485.0, 5692.0, 5619.0, 5418.0, 5701.0, 5423.0, 5417.0, 5424.0, 5278.0, 5462.0, 5404.0, 5371.0, 5500.0, 5542.0, 5377.0, 5277.0, 5434.0, 5298.0, 5580.0, 5411.0, 5251.0, 5652.0, 5344.0, 5471.0, 5566.0, 5444.0, 5527.0, 5325.0, 5327.0, 5399.0, 5511.0, 5716.0, 5655.0, 5551.0, 5604.0, 5402.0, 5390.0, 5644.0, 5669.0, 5505.0, 5533.0, 5575.0, 5540.0, 5309.0, 5359.0, 5708.0, 5345.0, 5574.0, 5543.0, 5497.0, 5536.0, 5293.0, 5668.0, 5666.0, 5480.0, 5558.0, 5576.0, 5409.0, 5314.0, 5523.0, 5515.0, 5346.0, 5269.0, 5430.0, 5299.0, 5379.0, 5705.0, 5461.0, 5276.0, 5264.0, 5560.0, 5665.0, 5555.0, 5712.0, 5347.0, 5550.0, 5315.0, 5427.0, 5426.0, 5348.0, 5667.0, 5618.0, 5565.0, 5592.0 (number of hits: 7)
26	5290	9	1	333	1	5405.0, 5540.0, 5674.0, 5386.0, 5451.0,

						5583.0, 5619.0, 5483.0, 5480.0, 5719.0, 5321.0, 5496.0, 5638.0, 5340.0, 5327.0, 5585.0, 5568.0, 5524.0, 5270.0, 5362.0, 5707.0, 5525.0, 5285.0, 5689.0, 5536.0, 5694.0, 5648.0, 5513.0, 5713.0, 5559.0, 5326.0, 5645.0, 5709.0, 5363.0, 5315.0, 5440.0, 5621.0, 5528.0, 5564.0, 5518.0, 5606.0, 5282.0, 5693.0, 5696.0, 5308.0, 5571.0, 5655.0, 5339.0, 5611.0, 5508.0, 5371.0, 5372.0, 5469.0, 5348.0, 5625.0, 5367.0, 5273.0, 5468.0, 5311.0, 5333.0, 5424.0, 5491.0, 5498.0, 5515.0, 5351.0, 5617.0, 5720.0, 5533.0, 5449.0, 5428.0, 5417.0, 5557.0, 5309.0, 5510.0, 5312.0, 5721.0, 5556.0, 5305.0, 5505.0, 5716.0, 5593.0, 5271.0, 5616.0, 5325.0, 5488.0, 5671.0, 5464.0, 5347.0, 5432.0, 5676.0, 5566.0, 5547.0, 5365.0, 5368.0, 5319.0, 5450.0, 5681.0, 5276.0, 5635.0, 5380.0 (number of hits: 6)
27	5290	9	1	333	1	5710.0, 5332.0, 5396.0, 5580.0, 5551.0, 5337.0, 5368.0, 5540.0, 5486.0, 5473.0, 5583.0, 5409.0, 5645.0, 5630.0, 5277.0, 5252.0, 5474.0, 5293.0, 5265.0, 5510.0, 5515.0, 5610.0, 5505.0, 5268.0, 5317.0, 5250.0, 5691.0, 5356.0, 5276.0, 5655.0, 5671.0, 5281.0, 5467.0, 5370.0, 5460.0, 5339.0, 5288.0, 5599.0, 5606.0, 5406.0, 5543.0, 5626.0, 5668.0, 5291.0, 5471.0, 5497.0, 5642.0, 5355.0, 5394.0, 5548.0, 5619.0, 5611.0, 5716.0, 5577.0, 5369.0, 5318.0, 5533.0, 5588.0, 5680.0, 5284.0, 5452.0, 5607.0, 5275.0, 5266.0, 5351.0, 5679.0, 5687.0, 5706.0, 5494.0, 5708.0, 5578.0, 5432.0, 5443.0, 5273.0, 5469.0, 5382.0, 5531.0, 5392.0, 5495.0, 5575.0, 5643.0, 5685.0, 5258.0, 5346.0, 5615.0, 5416.0, 5400.0, 5298.0, 5286.0, 5363.0, 5518.0, 5544.0, 5459.0, 5639.0, 5568.0, 5438.0, 5545.0, 5526.0, 5425.0, 5581.0 (number of hits: 5)
28	5290	9	1	333	1	5557.0, 5606.0, 5597.0, 5575.0, 5701.0, 5603.0, 5594.0, 5413.0, 5392.0, 5286.0, 5605.0, 5508.0, 5629.0, 5499.0, 5287.0, 5688.0, 5433.0, 5428.0, 5365.0, 5678.0, 5631.0, 5436.0, 5580.0, 5611.0, 5541.0, 5632.0, 5442.0, 5262.0, 5372.0, 5532.0, 5601.0, 5283.0, 5403.0, 5598.0, 5306.0, 5646.0, 5609.0, 5429.0, 5479.0, 5589.0, 5427.0, 5412.0, 5512.0, 5513.0, 5488.0, 5661.0, 5581.0, 5295.0, 5507.0, 5481.0, 5600.0, 5348.0, 5665.0, 5618.0, 5700.0, 5272.0, 5424.0, 5518.0, 5639.0, 5275.0, 5584.0, 5681.0, 5387.0, 5657.0, 5565.0, 5474.0, 5537.0, 5588.0, 5314.0, 5267.0, 5714.0, 5634.0, 5676.0, 5282.0, 5330.0, 5500.0, 5622.0, 5503.0, 5645.0, 5310.0, 5659.0, 5556.0, 5696.0, 5472.0, 5280.0, 5530.0, 5253.0, 5713.0, 5293.0, 5394.0

						5720.0, 5378.0, 5416.0, 5328.0, 5649.0, 5531.0, 5583.0, 5420.0, 5501.0, 5559.0 (number of hits: 7)
29	5290	9	1	333	1	5586.0, 5264.0, 5389.0, 5546.0, 5333.0, 5490.0, 5334.0, 5483.0, 5497.0, 5578.0, 5695.0, 5533.0, 5279.0, 5562.0, 5503.0, 5336.0, 5462.0, 5436.0, 5433.0, 5413.0, 5256.0, 5457.0, 5343.0, 5298.0, 5418.0, 5551.0, 5582.0, 5420.0, 5458.0, 5701.0, 5452.0, 5707.0, 5676.0, 5412.0, 5631.0, 5547.0, 5438.0, 5369.0, 5678.0, 5529.0, 5463.0, 5455.0, 5338.0, 5575.0, 5403.0, 5290.0, 5661.0, 5710.0, 5642.0, 5697.0, 5376.0, 5718.0, 5486.0, 5266.0, 5504.0, 5708.0, 5620.0, 5423.0, 5271.0, 5505.0, 5374.0, 5460.0, 5324.0, 5656.0, 5390.0, 5410.0, 5261.0, 5303.0, 5280.0, 5628.0, 5430.0, 5391.0, 5527.0, 5444.0, 5655.0, 5665.0, 5681.0, 5705.0, 5636.0, 5694.0, 5615.0, 5543.0, 5507.0, 5654.0, 5641.0, 5255.0, 5577.0, 5350.0, 5561.0, 5540.0, 5265.0, 5652.0, 5311.0, 5622.0, 5309.0, 5692.0, 5451.0, 5536.0, 5589.0, 5362.0 (number of hits: 5)
30	5290	9	1	333	1	5407.0, 5390.0, 5692.0, 5508.0, 5628.0, 5384.0, 5486.0, 5264.0, 5459.0, 5327.0, 5571.0, 5548.0, 5549.0, 5517.0, 5608.0, 5713.0, 5665.0, 5705.0, 5357.0, 5625.0, 5370.0, 5605.0, 5383.0, 5644.0, 5440.0, 5645.0, 5648.0, 5307.0, 5449.0, 5332.0, 5501.0, 5485.0, 5621.0, 5413.0, 5446.0, 5624.0, 5411.0, 5355.0, 5539.0, 5436.0, 5250.0, 5635.0, 5318.0, 5483.0, 5595.0, 5344.0, 5423.0, 5685.0, 5524.0, 5333.0, 5618.0, 5564.0, 5712.0, 5538.0, 5438.0, 5505.0, 5288.0, 5637.0, 5447.0, 5607.0, 5375.0, 5689.0, 5558.0, 5410.0, 5532.0, 5373.0, 5567.0, 5281.0, 5636.0, 5639.0, 5576.0, 5706.0, 5647.0, 5527.0, 5707.0, 5395.0, 5380.0, 5498.0, 5646.0, 5593.0, 5312.0, 5376.0, 5619.0, 5335.0, 5364.0, 5592.0, 5544.0, 5671.0, 5552.0, 5394.0, 5487.0, 5652.0, 5661.0, 5512.0, 5374.0, 5347.0, 5291.0, 5570.0, 5442.0, 5313.0 (number of hits: 5)

5550 MHz

Radar Signal Type	Waveform/Trial Number	Detection (%)	Limit (%)	Pass/Fail
Type 1	30	100 %	60%	Pass
Type 2	30	100 %	60%	Pass
Type 3	30	100 %	60%	Pass
Type 4	30	93.3 %	60%	Pass
Type 5	30	100 %	80%	Pass
Type 6	30	100 %	70%	Pass

Please refer to the following statistical tables:

Table-1 Radar Type 1 Statistical Performance

Trial #	Fc (MHz)	Pulse/Burst	Pulse Width (μS)	PRI (μs)	Detection (1:yes; 0:no)
1	5550	18	1	1428	1
2	5550	18	1	1428	1
3	5550	18	1	1428	1
4	5550	18	1	1428	1
5	5550	18	1	1428	1
6	5550	18	1	1428	1
7	5550	18	1	1428	1
8	5550	18	1	1428	1
9	5550	18	1	1428	1
10	5550	18	1	1428	1
11	5550	18	1	1428	1
12	5550	18	1	1428	1
13	5550	18	1	1428	1
14	5550	18	1	1428	1
15	5550	18	1	1428	1
16	5550	18	1	1428	1
17	5550	18	1	1428	1
18	5550	18	1	1428	1
19	5550	18	1	1428	1
20	5550	18	1	1428	1
21	5550	18	1	1428	1
22	5550	18	1	1428	1
23	5550	18	1	1428	1
24	5550	18	1	1428	1
25	5550	18	1	1428	1
26	5550	18	1	1428	1
27	5550	18	1	1428	1
28	5550	18	1	1428	1
29	5550	18	1	1428	1
30	5550	18	1	1428	1
Detection Percentage: 100 % (>60%)					

Table-2 Radar Type 2 Statistical Performance

Trial #	Fc (MHz)	Pulse/Burst	Pulse Width (μS)	PRI (μs)	Detection (1:yes; 0:no)
1	5550	26	1.1	169	1
2	5550	24	1.3	218	1
3	5550	24	3.1	185	1
4	5550	29	1.6	169	1
5	5550	26	3.6	228	1
6	5550	28	4.5	228	1
7	5550	28	2.4	170	1
8	5550	23	2.5	215	1
9	5550	28	1.8	172	1
10	5550	23	4.1	217	1
11	5550	28	2.2	181	1
12	5550	24	2	179	1
13	5550	23	3.1	171	1
14	5550	26	2.1	187	1
15	5550	25	4.9	160	1
16	5550	25	1.1	220	1
17	5550	24	5	180	1
18	5550	26	3.1	180	1
19	5550	26	2.6	153	1
20	5550	24	1.7	201	1
21	5550	26	4.1	212	1
22	5550	26	3.8	224	1
23	5550	24	2.8	229	1
24	5550	23	2	169	1
25	5550	25	4.2	161	1
26	5550	25	3.6	219	1
27	5550	29	4	164	1
28	5550	25	1.8	157	1
29	5550	23	1.8	221	1
30	5550	23	2.7	172	1
Detection Percentage: 100% (>60%)					

Table-3 Radar Type 3 Statistical Performance

Trial #	Fc (MHz)	Pulse/Burst	Pulse Width (μS)	PRI (μs)	Detection (1:yes; 0:no)
1	5550	18	9.6	417	1
2	5550	17	8.8	250	1
3	5550	17	6.8	358	1
4	5550	18	7.7	311	1
5	5550	18	7.2	305	1
6	5550	16	6.9	477	1
7	5550	16	6.5	263	1
8	5550	16	8.3	260	1
9	5550	17	9.9	383	1
10	5550	17	9.3	457	1
11	5550	16	9.4	379	1
12	5550	16	7	304	1
13	5550	16	8.5	264	1
14	5550	16	6.6	228	1
15	5550	18	7.1	360	1
16	5550	16	8.6	232	1
17	5550	16	9.2	233	1
18	5550	18	7.7	448	1
19	5550	18	9.9	438	1
20	5550	17	7	271	0
21	5550	18	6.2	443	1
22	5550	17	8.6	342	1
23	5550	16	9.1	412	1
24	5550	17	8.1	478	1
25	5550	16	8.4	244	1
26	5550	17	7.1	494	1
27	5550	16	8.5	355	1
28	5550	16	7.9	283	1
29	5550	18	8.6	333	1
30	5550	18	10	493	1
Detection Percentage: 96.7 % (>60%)					

Table-4 Radar Type 4 Statistical Performance

Trial #	Fc (MHz)	Pulse/Burst	Pulse Width (µS)	PRI (µs)	Detection (1:yes; 0:no)
1	5550	13	14.7	282	1
2	5550	12	11.7	224	1
3	5550	14	19.5	322	1
4	5550	12	14.5	254	1
5	5550	15	13	219	1
6	5550	15	18.9	498	1
7	5550	14	11.3	330	1
8	5550	12	19.2	482	1
9	5550	16	13.2	450	1
10	5550	15	18	385	1
11	5550	13	13.7	370	1
12	5550	15	13.6	481	1
13	5550	14	18	224	1
14	5550	14	14.1	472	1
15	5550	16	16.5	377	1
16	5550	16	11.7	476	1
17	5550	12	11.3	473	1
18	5550	16	14.3	247	1
19	5550	13	19.3	473	1
20	5550	12	13.4	390	1
21	5550	15	14.4	432	1
22	5550	13	13.8	468	1
23	5550	16	11.3	329	1
24	5550	13	11.4	206	1
25	5550	14	16.4	241	1
26	5550	12	16.5	413	1
27	5550	12	13.7	391	1
28	5550	16	19	422	1
29	5550	15	13.2	262	1
30	5550	13	17.1	353	1
Detection Percentage: 100 % (>60%)					

Table-5 Radar Type 5 Statistical Performance

Bin5 Statistics 1

Trial #	Pulse	Chirp (MHz)	Pulse Width (μS)	Pulse 1-2 spacing (uS)	Pulse 2-3 spacing (uS)	Pulse Start(S)	Detection (1:yes; 0:no)
0	2	5	87.5	1591		0.362539	0
1	3	19	74.9	1341	1721	1.118776	
2	1	18	72.8			1.881997	
3	3	12	51.9	1585	1677	2.484515	
4	3	13	73	1573	1017	2.732055	
5	1	6	61			3.507908	
6	1	19	62			4.184282	
7	2	18	50.4	1783		5.07885	
8	1	5	90.1			5.672388	
9	3	11	96.2	1117	1323	6.361559	
10	3	17	69.3	1718	1665	7.250771	
11	2	8	84.6	1611		7.45368	
12	2	11	62.3	1041		8.12701	
13	2	10	81.4	1594		8.719677	
14	1	11	72.3			9.995409	
15	3	15	75.1	1236	1947	10.51604	
16	3	10	75.8	1706	1756	11.05392	
17	2	8	86.2	1418		11.73216	

Bin5 Statistics 2

Trial #	Pulse	Chirp (MHz)	Pulse Width (μS)	Pulse 1-2 spacing (uS)	Pulse 2-3 spacing (uS)	Pulse Start(S)	Detection (1:yes; 0:no)
0	3	9	90.2	1113	1799	1.028387	0
1	2	16	89.7	1503		2.146319	
2	3	6	84.9	1718	1811	2.431562	
3	3	8	74.9	1014	1480	4.493057	
4	2	16	72	1979		5.344478	
5	2	19	91.6	1694		6.123479	
6	2	12	71.4	1670		7.577022	
7	2	12	55.3	1105		9.01102	
8	2	10	76.7	1233		10.31375	
9	1	16	78.2			11.15264	

Bin5 Statistics 3

Trial #	Pulse	Chirp (MHz)	Pulse Width (μS)	Pulse 1-2 spacing (uS)	Pulse 2-3 spacing (uS)	Pulse Start(S)	Detection (1:yes; 0:no)
0	2	14	55.9	1386		0.102141	1
1	3	20	82.9	1092	1140	0.771361	
2	2	6	70.1	1171		1.628597	
3	2	5	54.1	1232		2.259757	
4	2	15	85.6	1354		3.11685	
5	3	17	94.5	1565	1207	3.75784	
6	2	19	56.5	1435		4.509568	
7	3	8	83.7	1717	1978	5.074302	
8	3	12	96.5	1459	1529	5.788846	
9	1	13	64.9			6.384231	
10	2	18	91.2	1999		7.056635	
11	3	9	51.2	1885	1288	7.909491	
12	1	12	71			8.149896	
13	2	16	75.7	1240		8.703058	
14	1	9	73.1			9.696749	
15	2	17	54.6	1391		10.30408	
16	2	7	87.2	1703		11.0876	
17	2	17	74.7	1376		11.93459	

Bin5 Statistics 4

Trial #	Pulse	Chirp (MHz)	Pulse Width (μS)	Pulse 1-2 spacing (uS)	Pulse 2-3 spacing (uS)	Pulse Start(S)	Detection (1:yes; 0:no)
0	3	12	71.5	1859	1815	0.886435	1
1	1	7	75			0.92322	
2	2	16	81.1	1518		2.005661	
3	3	18	83.8	1255	1142	2.815328	
4	2	10	84.9	1424		3.801486	
5	3	17	82.6	1025	1764	4.985808	
6	2	15	98.3	1060		5.810764	
7	3	11	98.3	1419	1444	7.215387	
8	1	8	80.5			7.422609	
9	2	13	98.1	1971		9.102879	
10	3	16	79.5	1522	1465	9.625158	
11	1	11	74.6			10.41348	
12	2	16	71.6	1518		11.27372	

Bin5 Statistics 5

Trial #	Pulse	Chirp (MHz)	Pulse Width (µS)	Pulse 1-2 spacing (uS)	Pulse 2-3 spacing (uS)	Pulse Start(S)	Detection (1:yes; 0:no)
0	1	17	68.2			0.009909	1
1	2	12	57.7	1080		1.222722	
2	1	19	89.6			1.801985	
3	2	10	59.1	1075		3.137885	
4	2	8	61.5	1705		4.118437	
5	3	19	73.9	1302	1104	5.014074	
6	2	8	60.5	1868		5.943393	
7	1	18	59.4			6.572142	
8	2	11	90.7	1673		7.498086	
9	2	20	99.5	1857		7.99445	
10	2	6	82.4	1214		8.903369	
11	2	8	84.3	1374		9.888262	
12	2	18	55.4	1193		10.85645	
13	1	10	95			11.74886	

Bin5 Statistics 6

Trial #	Pulse	Chirp (MHz)	Pulse Width (µS)	Pulse 1-2 spacing (uS)	Pulse 2-3 spacing (uS)	Pulse Start(S)	Detection (1:yes; 0:no)
0	3	14	50.2	1859	1549	0.638768	1
1	1	15	98			1.781267	
2	2	14	53.9	1698		2.128382	
3	3	10	73.6	1968	1677	3.151786	
4	2	8	53.8	1122		3.925692	
5	3	12	55.7	1197	1880	4.754364	
6	2	17	60.7	1240		5.98329	
7	2	10	54	1384		7.063929	
8	3	17	75.7	1856	1881	7.680164	
9	2	8	75.8	1955		9.199835	
10	2	13	85	1890		9.723829	
11	2	6	84.4	1175		10.96676	
12	1	10	55.3			11.71423	

Bin5 Statistics 7

Trial #	Pulse	Chirp (MHz)	Pulse Width (µS)	Pulse 1-2 spacing (uS)	Pulse 2-3 spacing (uS)	Pulse Start(S)	Detection (1:yes; 0:no)
0	3	17	55.7	1011	1981	0.349427	1
1	3	6	89.7	1582	1006	1.598333	
2	2	17	75.1	1798		1.837708	
3	2	19	62	1389		2.717751	
4	2	13	53.4	1576		3.806464	
5	3	8	98.5	1230	1390	5.083735	
6	3	19	96.6	1672	1465	5.842756	
7	2	6	54.7	1896		6.087859	
8	2	7	64.7	1789		7.663789	
9	1	16	64.7			7.779575	
10	1	16	59.6			8.88228	
11	2	5	71.8	1499		9.526087	
12	2	13	70	1368		10.36306	
13	1	12	67.6			11.22365	

Bin5 Statistics 8

Trial #	Pulse	Chirp (MHz)	Pulse Width (µS)	Pulse 1-2 spacing (uS)	Pulse 2-3 spacing (uS)	Pulse Start(S)	Detection (1:yes; 0:no)
0	1	18	86.6			0.693252	1
1	2	19	52.2	1562		1.328595	
2	2	9	88.5	1438		2.340461	
3	2	18	87.7	1760		3.365859	
4	2	9	80.8	1332		3.607451	
5	1	10	74			4.30468	
6	3	18	92.9	1291	1913	5.676323	
7	2	17	74.7	1649		6.266309	
8	2	9	91.1	1505		7.063723	
9	1	11	99.2			8.143793	
10	3	16	61.7	1852	1687	9.179713	
11	2	11	99.2	1114		9.956349	
12	3	16	67.2	1993	1910	10.75264	
13	2	7	99.7	1578		11.72864	

Bin5 Statistics 9

Trial #	Pulse	Chirp (MHz)	Pulse Width (μS)	Pulse 1-2 spacing (uS)	Pulse 2-3 spacing (uS)	Pulse Start(S)	Detection (1:yes; 0:no)
0	2	11	93.7	1330		0.17363	0
1	2	5	57.9	1777		1.695173	
2	2	15	99.9	1406		2.760627	
3	3	15	54.2	1483	1554	4.188442	
4	2	8	98.3	1700		5.4822	
5	2	15	75.2	1530		7.538631	
6	1	6	87.4			8.531487	
7	1	14	70.8			10.63392	
8	1	11	80.1			11.20507	

Bin5 Statistics 10

Trial #	Pulse	Chirp (MHz)	Pulse Width (μS)	Pulse 1-2 spacing (uS)	Pulse 2-3 spacing (uS)	Pulse Start(S)	Detection (1:yes; 0:no)
0	3	7	60.2	1428	1786	0.518215	1
1	2	13	93.1	1170		0.915935	
2	2	8	73.8	1431		1.505956	
3	1	12	89.5			2.429194	
4	3	9	64.3	1094	1952	3.248843	
5	3	12	83.5	1056	1144	4.109844	
6	2	20	59.3	1956		4.417343	
7	2	13	87.8	1821		4.952027	
8	3	8	99.3	1748	1967	5.827528	
9	1	7	97.5			6.874667	
10	3	19	56.8	1453	1988	7.343562	
11	2	16	54.3	1042		7.913169	
12	2	17	56.2	1365		8.578858	
13	2	12	60.2	1225		9.761122	
14	3	18	61.9	1839	1987	10.54372	
15	2	11	95.9	1979		11.11604	
16	2	5	55.9	1441		11.29818	

Bin5 Statistics 11

Trial #	Pulse	Chirp (MHz)	Pulse Width (µS)	Pulse 1-2 spacing (µS)	Pulse 2-3 spacing (µS)	Pulse Start(S)	Detection (1:yes; 0:no)
0	1	17	64.2			0.549865	1
1	3	14	99.9	1957	1851	1.077312	
2	2	16	61.6	1293		1.274881	
3	2	6	91.3	1861		2.208764	
4	2	13	87.4	1925		3.102478	
5	3	10	98.9	1939	1352	3.737539	
6	1	16	95.9			3.925006	
7	2	9	73.3	1611		4.785117	
8	2	18	62.4	1504		5.130446	
9	3	7	86.6	1077	1564	5.74079	
10	3	19	85.2	1271	1545	6.42112	
11	2	15	58.5	1516		6.990296	
12	2	18	98.2	1117		7.890478	
13	2	7	93.9	1885		8.752203	
14	2	9	53.7	1001		9.144644	
15	3	16	86	1511	1693	9.704792	
16	2	10	61.1	1323		10.4382	
17	2	18	65.7	1839		10.98665	
18	2	16	69.4	1735		11.95674	

Bin5 Statistics 12

Trial #	Pulse	Chirp (MHz)	Pulse Width (µS)	Pulse 1-2 spacing (uS)	Pulse 2-3 spacing (uS)	Pulse Start(S)	Detection (1:yes; 0:no)
0	3	5	65.6	1273	1020	0.302542	1
1	3	16	77	1063	1701	0.704597	
2	2	17	78.1	1277		1.437034	
3	3	10	65.6	1142	1873	2.403425	
4	2	7	75.9	1063		3.274143	
5	2	8	70.7	1853		3.854547	
6	2	17	90.6	1705		4.290071	
7	2	7	98.1	1804		5.036908	
8	1	13	85.8			5.967539	
9	3	7	88.4	1425	1486	6.139424	
10	1	6	87.8			6.976292	
11	3	10	66.2	1161	1194	7.403315	
12	1	19	66.5			8.146509	
13	3	19	85.2	1972	1587	9.081539	
14	3	19	77.3	1931	1907	9.598337	
15	2	14	64.3	1396		10.42947	
16	1	14	61.3			10.78609	
17	2	16	68	1621		11.43363	

Bin5 Statistics 13

Trial #	Pulse	Chirp (MHz)	Pulse Width (µS)	Pulse 1-2 spacing (uS)	Pulse 2-3 spacing (uS)	Pulse Start(S)	Detection (1:yes; 0:no)
0	1	15	89.6			0.062834	1
1	1	6	94			1.292233	
2	2	16	94.6	1101		2.014245	
3	1	12	54.7			2.983074	
4	1	13	80.8			3.937232	
5	1	6	58.7			4.027195	
6	2	13	69.6	1488		4.824333	
7	1	12	92.2			5.93512	
8	1	20	82.4			6.787358	
9	3	9	87.9	1961	1867	7.599885	
10	3	7	72.3	1185	1564	8.181368	
11	2	13	51.5	1844		9.089876	
12	2	7	78.9	1852		9.966835	
13	2	18	97.6	1756		10.84308	
14	1	19	81.5			11.45806	

Bin5 Statistics 14

Trial #	Pulse	Chirp (MHz)	Pulse Width (µS)	Pulse 1-2 spacing (uS)	Pulse 2-3 spacing (uS)	Pulse Start(S)	Detection (1:yes; 0:no)
0	2	11	62.7	1698		0.506028	0
1	3	10	54.4	1072	1576	1.192012	
2	1	9	64.6			3.078392	
3	1	19	92.2			3.701751	
4	2	13	72.9	1631		5.251437	
5	1	20	75.7			5.940993	
6	1	8	57.3			7.495605	
7	2	5	84.7	1323		7.866419	
8	1	16	83.6			9.378921	
9	2	9	62.9	1861		10.26315	
10	3	9	89.1	1959	1414	11.18055	

Bin5 Statistics 15

Trial #	Pulse	Chirp (MHz)	Pulse Width (µS)	Pulse 1-2 spacing (uS)	Pulse 2-3 spacing (uS)	Pulse Start(S)	Detection (1:yes; 0:no)
0	1	19	50.5			0.566929	1
1	2	15	66.3	1955		0.941109	
2	1	14	61.2			1.695293	
3	2	10	76.2	1653		2.294165	
4	1	8	82.2			2.604893	
5	1	6	58.4			3.520165	
6	2	14	50.3	1882		4.389579	
7	3	11	60.8	1180	1798	4.798793	
8	1	11	74.3			5.069262	
9	2	6	81.3	1054		6.071635	
10	1	16	87.1			6.861636	
11	2	7	79.4	1897		7.078403	
12	3	7	85.9	1575	1196	7.809334	
13	1	18	90.7			8.512029	
14	2	17	61.3	1275		8.857764	
15	1	8	89.5			9.847175	
16	1	11	57.2			10.41457	
17	2	16	81.7	1335		10.92697	
18	1	11	68.4			11.42277	

Bin5 Statistics 16

Trial #	Pulse	Chirp (MHz)	Pulse Width (µS)	Pulse 1-2 spacing (uS)	Pulse 2-3 spacing (uS)	Pulse Start(S)	Detection (1:yes; 0:no)
0	2	13	98.9	1192		0.678051	1
1	1	11	73.8			1.181992	
2	2	13	71.4	1444		1.762429	
3	2	5	97.8	1330		2.885997	
4	2	7	96.8	1979		3.387759	
5	1	7	66.8			4.209928	
6	3	10	61.2	1205	1159	5.130789	
7	2	13	70.4	1661		5.780995	
8	1	6	61			6.313557	
9	2	15	78.3	1830		6.79843	
10	1	7	57			7.758162	
11	2	14	51	1380		8.70882	
12	2	12	58.8	1533		9.22736	
13	1	8	65.3			10.16253	
14	2	13	91.1	1873		11.20222	
15	2	13	77	1168		11.75436	

Bin5 Statistics 17

Trial #	Pulse	Chirp (MHz)	Pulse Width (µS)	Pulse 1-2 spacing (uS)	Pulse 2-3 spacing (uS)	Pulse Start(S)	Detection (1:yes; 0:no)
0	2	17	71.5	1164		0.687343	1
1	2	10	87.6	1785		1.206961	
2	1	18	79.8			3.262484	
3	3	18	74.5	1954	1017	4.251048	
4	2	10	67.7	1714		4.919912	
5	1	15	85.4			5.462214	
6	1	9	93.8			6.999418	
7	3	9	88.6	1558	1549	8.279301	
8	3	11	55.5	1094	1764	9.660114	
9	2	17	85.3	1336		10.13463	
10	2	8	90.2	1792		11.60969	

Bin5 Statistics 18

Trial #	Pulse	Chirp (MHz)	Pulse Width (μS)	Pulse 1-2 spacing (uS)	Pulse 2-3 spacing (uS)	Pulse Start(S)	Detection (1:yes; 0:no)
0	1	17	88.6			0.484247	0
1	2	10	99.6	1152		0.674229	
2	2	13	67.2	1427		1.570337	
3	3	11	96.8	1850	1869	2.28594	
4	2	19	71.5	1869		2.485759	
5	2	11	98.6	1706		3.537628	
6	2	9	92.2	1901		4.117111	
7	3	12	99.9	1915	1701	4.781375	
8	3	13	91.1	1689	1764	4.935302	
9	1	18	88.7			5.457931	
10	2	14	93	1663		6.21956	
11	3	10	70.7	1380	1904	6.990637	
12	3	12	59.5	1279	1614	7.294677	
13	2	6	84.2	1730		8.052894	
14	3	10	53.9	1621	1365	8.926685	
15	2	13	70	1011		9.189152	
16	3	15	50.7	1177	1658	9.773176	
17	3	11	68.1	1238	1582	10.31546	
18	2	7	52	1815		10.8851	
19	2	12	59.8	1116		11.4144	

Bin5 Statistics 19

Trial #	Pulse	Chirp (MHz)	Pulse Width (µS)	Pulse 1-2 spacing (uS)	Pulse 2-3 spacing (uS)	Pulse Start(S)	Detection (1:yes; 0:no)
0	2	20	55.2	1419		0.348057	1
1	3	19	94.3	1953	1765	1.252314	
2	1	14	69.6			1.875878	
3	2	9	51.9	1340		2.303947	
4	1	12	93.5			3.000447	
5	1	18	86.9			4.073611	
6	1	18	92.8			5.163753	
7	1	9	67.1			5.383553	
8	1	9	96.2			6.017362	
9	3	18	71.3	1648	1059	7.203684	
10	2	7	90.2	1585		7.692611	
11	2	7	71.5	1826		8.381383	
12	2	15	86.3	1255		9.6005	
13	1	17	98.7			9.848127	
14	2	12	99.7	1841		10.64415	
15	1	6	84			11.43358	

Bin5 Statistics 20

Trial #	Pulse	Chirp (MHz)	Pulse Width (µS)	Pulse 1-2 spacing (uS)	Pulse 2-3 spacing (uS)	Pulse Start(S)	Detection (1:yes; 0:no)
0	3	10	51	1749	1071	0.138322	1
1	3	14	54.3	1174	1820	1.199301	
2	1	20	66.9			1.550718	
3	2	12	94	1208		2.031385	
4	2	18	50.7	1177		2.751805	
5	2	10	57.8	1519		3.643629	
6	2	17	71.4	1296		4.062861	
7	2	13	63.3	1620		4.919254	
8	2	19	96.1	1541		5.340324	
9	1	14	68.9			6.657664	
10	2	14	86.6	1423		6.763394	
11	1	16	74.1			7.992653	
12	3	16	90.5	1105	1971	8.491859	
13	2	9	89.9	1992		9.162257	
14	2	8	73.9	1981		9.934621	
15	2	18	76.7	1506		10.12337	
16	2	13	58.7	1170		10.69877	
17	2	17	51.1	1434		11.77632	

Bin5 Statistics 21

Trial #	Pulse	Chirp (MHz)	Pulse Width (µS)	Pulse 1-2 spacing (uS)	Pulse 2-3 spacing (uS)	Pulse Start(S)	Detection (1:yes; 0:no)
0	1	7	64.5			1.083903	1
1	2	6	69.6	1456		1.572689	
2	1	18	58			3.641537	
3	3	12	79.4	1938	1297	4.5104	
4	2	6	90.3	1315		5.994499	
5	2	16	96.8	1911		7.226925	
6	2	5	93.3	1503		8.200412	
7	2	15	63.2	1811		10.36479	
8	2	15	80.4	1209		11.28432	

Bin5 Statistics 22

Trial #	Pulse	Chirp (MHz)	Pulse Width (µS)	Pulse 1-2 spacing (uS)	Pulse 2-3 spacing (uS)	Pulse Start(S)	Detection (1:yes; 0:no)
0	3	18	71.2	1896	1176	0.877138	1
1	2	14	83.4	1232		2.395583	
2	2	6	57.1	1308		2.70654	
3	2	15	68.2	1584		4.244027	
4	2	6	65.6	1545		6.44456	
5	2	8	85.1	1288		7.008491	
6	2	13	78.6	1662		8.166006	
7	2	15	78.1	1326		9.929094	
8	3	15	55.1	1883	1785	11.49272	

Bin5 Statistics 23

Trial #	Pulse	Chirp (MHz)	Pulse Width (μS)	Pulse 1-2 spacing (uS)	Pulse 2-3 spacing (uS)	Pulse Start(S)	Detection (1:yes; 0:no)
0	2	18	61.8	1081		0.489065	1
1	1	9	89.2			2.247548	
2	1	11	79.4			3.18933	
3	2	11	54.1	1337		4.105113	
4	3	9	52.4	1266	1818	5.460008	
5	2	8	51.5	1026		7.134208	
6	3	18	51.3	1893	1383	8.081717	
7	2	11	50.5	1815		9.214798	
8	1	9	84			9.849895	
9	2	5	65.3	1800		11.11956	

Bin5 Statistics 24

Trial #	Pulse	Chirp (MHz)	Pulse Width (μS)	Pulse 1-2 spacing (uS)	Pulse 2-3 spacing (uS)	Pulse Start(S)	Detection (1:yes; 0:no)
0	2	6	92.4	1550		0.294171	1
1	2	9	79.5	1463		1.570641	
2	3	5	59.2	1196	1699	2.389153	
3	1	13	77.7			2.777576	
4	1	15	58.1			3.789515	
5	2	18	94.9	1014		5.351571	
6	2	17	50.6	1742		5.626233	
7	2	13	74.6	1985		7.344064	
8	1	14	50.7			7.710375	
9	3	20	85.9	1218	1568	8.866665	
10	2	18	83.2	1846		9.711322	
11	1	12	72.5			10.67771	
12	3	7	75.4	1646	1097	11.43779	

Bin5 Statistics 25

Trial #	Pulse	Chirp (MHz)	Pulse Width (µS)	Pulse 1-2 spacing (uS)	Pulse 2-3 spacing (uS)	Pulse Start(S)	Detection (1:yes; 0:no)
0	2	6	51.9	1612		0.420206	1
1	3	14	83.4	1403	1036	1.277266	
2	2	7	85.3	1488		1.80776	
3	2	17	64.1	1845		2.671277	
4	2	8	79	1164		3.27784	
5	1	20	51.8			4.4449	
6	3	17	52.7	1113	1216	4.889649	
7	1	11	79			5.480592	
8	2	17	53.8	1753		6.397466	
9	3	14	95.9	1110	1311	7.115118	
10	1	10	95.7			7.741169	
11	2	17	74	1145		8.720056	
12	2	14	95.9	1369		9.452754	
13	2	8	66.2	1365		10.11162	
14	2	9	76.5	1916		11.24317	
15	1	13	52.6			11.92286	

Bin5 Statistics 26

Trial #	Pulse	Chirp (MHz)	Pulse Width (µS)	Pulse 1-2 spacing (uS)	Pulse 2-3 spacing (uS)	Pulse Start(S)	Detection (1:yes; 0:no)
0	3	11	80.8	1831	1986	1.233159	1
1	2	6	64.6	1666		2.274086	
2	2	12	77.9	1050		3.601488	
3	2	5	51.1	1497		4.634636	
4	1	18	73.6			7.204514	
5	1	7	98.1			7.507931	
6	2	16	66.5	1644		9.834527	
7	1	5	97.5			11.31759	

Bin5 Statistics 27

Trial #	Pulse	Chirp (MHz)	Pulse Width (μS)	Pulse 1-2 spacing (uS)	Pulse 2-3 spacing (uS)	Pulse Start(S)	Detection (1:yes; 0:no)
0	3	9	95.8	1654	1784	0.668463	0
1	2	9	89.6	1643		1.224305	
2	1	13	74.9			1.967263	
3	3	6	64.4	1666	1418	2.672003	
4	3	9	58.7	1435	1464	3.805987	
5	2	10	64.7	1117		4.003065	
6	3	14	94.9	1960	1892	5.081007	
7	2	17	59.6	1052		5.811512	
8	1	8	82.7			7.117774	
9	3	17	50	1829	1231	7.712912	
10	2	18	77.4	1600		8.568152	
11	2	17	85.5	1940		9.102958	
12	3	7	81.8	1324	1554	9.64832	
13	1	15	74.2			11.19159	
14	2	16	91.3	1167		11.50273	

Bin5 Statistics 28

Trial #	Pulse	Chirp (MHz)	Pulse Width (μS)	Pulse 1-2 spacing (uS)	Pulse 2-3 spacing (uS)	Pulse Start(S)	Detection (1:yes; 0:no)
0	2	9	51.5	1727		0.095597	1
1	2	10	85.3	1947		0.872159	
2	1	11	75.8			1.653394	
3	2	12	87.7	1895		2.239871	
4	3	19	87.5	1453	1902	2.429412	
5	1	18	83.8			3.140792	
6	2	16	97.2	1082		3.742215	
7	3	8	53.3	1126	1471	4.584205	
8	3	20	69.3	1954	1096	5.158882	
9	3	16	64.5	1077	1138	5.885039	
10	2	17	69.1	1071		6.527399	
11	2	11	62.8	1467		6.692485	
12	3	12	55.8	1830	1591	7.61221	
13	1	9	87.8			8.096897	
14	3	16	73.4	1848	1726	8.837984	
15	3	11	89.6	1981	1330	9.030408	
16	2	12	67.8	1299		9.852636	
17	1	6	97.1			10.64263	
18	1	6	63.2			10.86206	
19	2	8	64.4	1520		11.8286	

Bin5 Statistics 29

Trial #	Pulse	Chirp (MHz)	Pulse Width (µS)	Pulse 1-2 spacing (µS)	Pulse 2-3 spacing (µS)	Pulse Start(S)	Detection (1:yes; 0:no)
0	1	10	66.7			0.525723	1
1	2	14	96.2	1923		0.768164	
2	2	14	57.9	1144		2.076753	
3	2	20	79.3	1167		2.782997	
4	2	18	76.2	1651		3.36705	
5	2	16	50	1693		4.015486	
6	2	17	77.1	1576		4.695036	
7	2	7	84	1688		5.2962	
8	2	16	93.1	1667		6.684775	
9	3	9	78.3	1510	1329	7.067485	
10	3	16	59.9	1746	1820	7.857978	
11	3	6	93.4	1147	1927	8.907879	
12	1	16	77.6			9.100434	
13	1	6	81.4			10.42687	
14	1	17	93.6			10.58119	
15	2	12	86.7	1226		11.27168	

Bin5 Statistics 30

Trial #	Pulse	Chirp (MHz)	Pulse Width (µS)	Pulse 1-2 spacing (µS)	Pulse 2-3 spacing (µS)	Pulse Start(S)	Detection (1:yes; 0:no)
0	2	5	89.9	1219		0.883514	1
1	2	13	55.7	1900		1.698928	
2	3	11	77.9	1089	1853	2.881841	
3	1	18	54			3.781008	
4	3	8	90.3	1172	1295	4.441185	
5	2	15	56.5	1695		5.522926	
6	2	12	90	1375		6.916958	
7	3	7	53.5	1998	1783	7.742523	
8	1	14	68.1			8.734773	
9	2	16	76.4	1833		10.09287	
10	1	16	73.2			11.18121	

Table-6 Radar Type 6 Statistical Performance

Trial #	Fc (MHz)	Pulse /Burst	Pulse Width (μS)	PRI (μs)	Detection (1:yes; 0:no)	Hopping Sequence
1	5550	9	1	333	1	5519.0, 5254.0, 5474.0, 5524.0, 5398.0, 5251.0, 5285.0, 5671.0, 5639.0, 5331.0, 5592.0, 5534.0, 5382.0, 5402.0, 5354.0, 5345.0, 5443.0, 5590.0, 5441.0, 5510.0, 5543.0, 5325.0, 5665.0, 5597.0, 5532.0, 5549.0, 5705.0, 5407.0, 5641.0, 5376.0, 5308.0, 5369.0, 5321.0, 5315.0, 5448.0, 5495.0, 5390.0, 5337.0, 5484.0, 5704.0, 5693.0, 5562.0, 5406.0, 5439.0, 5598.0, 5463.0, 5699.0, 5547.0, 5260.0, 5711.0, 5477.0, 5338.0, 5724.0, 5626.0, 5299.0, 5491.0, 5451.0, 5252.0, 5499.0, 5707.0, 5616.0, 5268.0, 5430.0, 5483.0, 5627.0, 5653.0, 5433.0, 5475.0, 5389.0, 5458.0, 5488.0, 5667.0, 5262.0, 5694.0, 5570.0, 5658.0, 5720.0, 5328.0, 5318.0, 5508.0, 5350.0, 5721.0, 5282.0, 5530.0, 5683.0, 5386.0, 5564.0, 5576.0, 5635.0, 5560.0, 5410.0, 5613.0, 5287.0, 5588.0, 5263.0, 5288.0, 5423.0, 5650.0, 5551.0, 5494.0 (number of hits: 5)
2	5550	9	1	333	1	5432.0, 5555.0, 5676.0, 5698.0, 5267.0, 5711.0, 5663.0, 5363.0, 5679.0, 5399.0, 5670.0, 5489.0, 5664.0, 5373.0, 5453.0, 5395.0, 5291.0, 5723.0, 5423.0, 5448.0, 5427.0, 5356.0, 5550.0, 5718.0, 5635.0, 5331.0, 5607.0, 5311.0, 5722.0, 5406.0, 5616.0, 5595.0, 5609.0, 5355.0, 5695.0, 5547.0, 5284.0, 5407.0, 5719.0, 5476.0, 5623.0, 5596.0, 5497.0, 5702.0, 5346.0, 5683.0, 5457.0, 5429.0, 5615.0, 5359.0, 5272.0, 5494.0, 5648.0, 5459.0, 5530.0, 5327.0, 5454.0, 5618.0, 5640.0, 5258.0, 5424.0, 5517.0, 5652.0, 5466.0, 5703.0, 5405.0, 5672.0, 5554.0, 5633.0, 5280.0, 5385.0, 5572.0, 5285.0, 5298.0, 5590.0, 5461.0, 5433.0, 5360.0, 5533.0, 5411.0, 5320.0, 5561.0, 5281.0, 5383.0, 5315.0, 5412.0, 5347.0, 5588.0, 5527.0, 5677.0, 5301.0, 5300.0, 5338.0, 5438.0, 5666.0, 5545.0, 5669.0, 5478.0, 5275.0, 5716.0 (number of hits: 6)
3	5550	9	1	333	1	5581.0, 5623.0, 5625.0, 5361.0, 5723.0, 5517.0, 5526.0, 5344.0, 5516.0, 5636.0, 5275.0, 5380.0, 5698.0, 5476.0, 5466.0, 5257.0, 5368.0, 5515.0, 5411.0, 5585.0, 5276.0, 5620.0, 5574.0, 5612.0, 5256.0, 5439.0, 5261.0, 5646.0, 5301.0, 5492.0, 5543.0, 5597.0, 5442.0, 5342.0, 5266.0, 5513.0, 5675.0, 5402.0, 5464.0, 5338.0, 5309.0, 5341.0, 5649.0, 5401.0, 5606.0, 5634.0, 5305.0, 5674.0, 5493.0, 5271.0, 5438.0, 5444.0, 5708.0, 5631.0, 5712.0, 5511.0, 5470.0, 5419.0, 5315.0, 5665.0,

						5440.0, 5676.0, 5486.0, 5577.0, 5343.0, 5703.0, 5573.0, 5669.0, 5479.0, 5559.0, 5406.0, 5642.0, 5383.0, 5269.0, 5403.0, 5699.0, 5253.0, 5509.0, 5637.0, 5690.0, 5374.0, 5288.0, 5682.0, 5469.0, 5375.0, 5455.0, 5570.0, 5503.0, 5281.0, 5684.0, 5696.0, 5355.0, 5523.0, 5594.0, 5548.0, 5474.0, 5407.0, 5619.0, 5389.0, 5422.0 (number of hits: 4)
4	5550	9	1	333	1	5665.0, 5642.0, 5477.0, 5379.0, 5529.0, 5595.0, 5523.0, 5346.0, 5320.0, 5663.0, 5312.0, 5685.0, 5294.0, 5269.0, 5660.0, 5331.0, 5481.0, 5699.0, 5411.0, 5607.0, 5519.0, 5493.0, 5580.0, 5693.0, 5544.0, 5407.0, 5307.0, 5412.0, 5593.0, 5306.0, 5576.0, 5370.0, 5563.0, 5499.0, 5441.0, 5716.0, 5256.0, 5409.0, 5432.0, 5686.0, 5298.0, 5410.0, 5360.0, 5453.0, 5372.0, 5662.0, 5697.0, 5706.0, 5302.0, 5522.0, 5582.0, 5701.0, 5592.0, 5718.0, 5516.0, 5387.0, 5365.0, 5321.0, 5435.0, 5568.0, 5336.0, 5666.0, 5357.0, 5450.0, 5717.0, 5553.0, 5679.0, 5316.0, 5554.0, 5664.0, 5689.0, 5420.0, 5631.0, 5617.0, 5601.0, 5538.0, 5527.0, 5517.0, 5645.0, 5427.0, 5684.0, 5546.0, 5678.0, 5267.0, 5602.0, 5634.0, 5300.0, 5655.0, 5401.0, 5297.0, 5358.0, 5572.0, 5652.0, 5430.0, 5705.0, 5392.0, 5399.0, 5598.0, 5466.0, 5388.0 (number of hits: 8)
5	5550	9	1	333	1	5519.0, 5583.0, 5571.0, 5336.0, 5663.0, 5682.0, 5358.0, 5314.0, 5490.0, 5263.0, 5590.0, 5430.0, 5576.0, 5431.0, 5643.0, 5537.0, 5470.0, 5632.0, 5561.0, 5460.0, 5412.0, 5299.0, 5563.0, 5592.0, 5711.0, 5645.0, 5693.0, 5253.0, 5497.0, 5328.0, 5283.0, 5451.0, 5521.0, 5376.0, 5339.0, 5579.0, 5262.0, 5694.0, 5313.0, 5437.0, 5671.0, 5707.0, 5634.0, 5303.0, 5650.0, 5302.0, 5619.0, 5382.0, 5288.0, 5311.0, 5720.0, 5648.0, 5535.0, 5256.0, 5254.0, 5368.0, 5362.0, 5326.0, 5699.0, 5675.0, 5429.0, 5546.0, 5349.0, 5404.0, 5436.0, 5547.0, 5498.0, 5250.0, 5689.0, 5258.0, 5714.0, 5637.0, 5513.0, 5559.0, 5664.0, 5320.0, 5597.0, 5507.0, 5341.0, 5552.0, 5611.0, 5627.0, 5678.0, 5344.0, 5396.0, 5508.0, 5301.0, 5357.0, 5434.0, 5631.0, 5439.0, 5447.0, 5347.0, 5418.0, 5491.0, 5310.0, 5386.0, 5324.0, 5540.0, 5423.0 (number of hits: 9)
6	5550	9	1	333	1	5423.0, 5569.0, 5608.0, 5362.0, 5722.0, 5626.0, 5407.0, 5359.0, 5711.0, 5311.0, 5349.0, 5344.0, 5687.0, 5318.0, 5340.0, 5523.0, 5571.0, 5709.0, 5294.0, 5319.0, 5261.0, 5639.0, 5716.0, 5480.0, 5329.0, 5629.0, 5710.0, 5411.0, 5448.0, 5622.0, 5551.0, 5503.0, 5325.0, 5487.0, 5419.0, 5646.0, 5707.0, 5617.0, 5290.0, 5576.0,

						5458.0, 5440.0, 5529.0, 5351.0, 5605.0, 5464.0, 5652.0, 5530.0, 5463.0, 5452.0, 5489.0, 5494.0, 5484.0, 5415.0, 5520.0, 5590.0, 5260.0, 5391.0, 5284.0, 5596.0, 5545.0, 5471.0, 5451.0, 5592.0, 5497.0, 5618.0, 5366.0, 5633.0, 5316.0, 5691.0, 5582.0, 5416.0, 5421.0, 5638.0, 5449.0, 5253.0, 5599.0, 5474.0, 5516.0, 5615.0, 5417.0, 5514.0, 5663.0, 5666.0, 5392.0, 5308.0, 5298.0, 5446.0, 5279.0, 5597.0, 5684.0, 5389.0, 5475.0, 5257.0, 5379.0, 5488.0, 5496.0, 5526.0, 5697.0, 5604.0 (number of hits: 5)
7	5550	9	1	333	1	5427.0, 5417.0, 5343.0, 5655.0, 5478.0, 5713.0, 5384.0, 5541.0, 5364.0, 5333.0, 5695.0, 5604.0, 5553.0, 5423.0, 5552.0, 5322.0, 5595.0, 5481.0, 5425.0, 5626.0, 5486.0, 5633.0, 5465.0, 5504.0, 5436.0, 5328.0, 5440.0, 5394.0, 5611.0, 5484.0, 5579.0, 5605.0, 5298.0, 5588.0, 5719.0, 5290.0, 5514.0, 5658.0, 5557.0, 5578.0, 5251.0, 5652.0, 5554.0, 5310.0, 5309.0, 5723.0, 5542.0, 5257.0, 5550.0, 5342.0, 5370.0, 5591.0, 5428.0, 5482.0, 5277.0, 5491.0, 5357.0, 5530.0, 5497.0, 5386.0, 5283.0, 5635.0, 5360.0, 5538.0, 5344.0, 5563.0, 5560.0, 5382.0, 5356.0, 5683.0, 5515.0, 5354.0, 5346.0, 5441.0, 5643.0, 5619.0, 5437.0, 5583.0, 5555.0, 5377.0, 5544.0, 5434.0, 5455.0, 5546.0, 5373.0, 5449.0, 5629.0, 5523.0, 5654.0, 5529.0, 5503.0, 5534.0, 5378.0, 5391.0, 5720.0, 5684.0, 5456.0, 5295.0, 5587.0, 5299.0 (number of hits: 6)
8	5550	9	1	333	1	5409.0, 5389.0, 5640.0, 5291.0, 5397.0, 5687.0, 5651.0, 5582.0, 5717.0, 5554.0, 5525.0, 5621.0, 5304.0, 5627.0, 5663.0, 5330.0, 5442.0, 5486.0, 5703.0, 5666.0, 5581.0, 5562.0, 5711.0, 5644.0, 5535.0, 5715.0, 5597.0, 5553.0, 5293.0, 5635.0, 5504.0, 5587.0, 5642.0, 5299.0, 5697.0, 5623.0, 5457.0, 5675.0, 5502.0, 5607.0, 5724.0, 5661.0, 5403.0, 5266.0, 5481.0, 5366.0, 5723.0, 5613.0, 5268.0, 5577.0, 5611.0, 5441.0, 5544.0, 5602.0, 5590.0, 5316.0, 5664.0, 5452.0, 5696.0, 5380.0, 5690.0, 5505.0, 5719.0, 5592.0, 5250.0, 5352.0, 5555.0, 5598.0, 5677.0, 5340.0, 5558.0, 5356.0, 5512.0, 5673.0, 5508.0, 5267.0, 5616.0, 5491.0, 5483.0, 5707.0, 5383.0, 5419.0, 5584.0, 5278.0, 5688.0, 5329.0, 5560.0, 5700.0, 5308.0, 5569.0, 5334.0, 5476.0, 5392.0, 5650.0, 5277.0, 5318.0, 5626.0, 5652.0, 5460.0, 5297.0 (number of hits: 6)
9	5550	9	1	333	1	5382.0, 5582.0, 5303.0, 5628.0, 5477.0, 5424.0, 5683.0, 5541.0, 5371.0, 5554.0, 5421.0, 5561.0, 5402.0, 5655.0, 5560.0, 5487.0, 5666.0, 5610.0, 5314.0, 5333.0,

						5352.0, 5276.0, 5621.0, 5646.0, 5700.0, 5309.0, 5476.0, 5339.0, 5720.0, 5405.0, 5320.0, 5479.0, 5635.0, 5311.0, 5456.0, 5313.0, 5406.0, 5681.0, 5414.0, 5268.0, 5686.0, 5719.0, 5717.0, 5525.0, 5386.0, 5349.0, 5362.0, 5632.0, 5574.0, 5345.0, 5331.0, 5703.0, 5454.0, 5497.0, 5439.0, 5300.0, 5412.0, 5429.0, 5707.0, 5596.0, 5550.0, 5292.0, 5505.0, 5315.0, 5327.0, 5385.0, 5462.0, 5455.0, 5297.0, 5394.0, 5492.0, 5669.0, 5463.0, 5400.0, 5498.0, 5480.0, 5503.0, 5559.0, 5708.0, 5595.0, 5542.0, 5679.0, 5266.0, 5698.0, 5257.0, 5537.0, 5491.0, 5619.0, 5712.0, 5466.0, 5325.0, 5323.0, 5675.0, 5441.0, 5378.0, 5370.0, 5255.0, 5521.0, 5416.0, 5290.0 (number of hits: 9)
10	5550	9	1	333	1	5695.0, 5434.0, 5602.0, 5433.0, 5527.0, 5717.0, 5419.0, 5350.0, 5705.0, 5643.0, 5408.0, 5259.0, 5337.0, 5513.0, 5626.0, 5650.0, 5659.0, 5358.0, 5553.0, 5290.0, 5629.0, 5257.0, 5391.0, 5296.0, 5262.0, 5431.0, 5253.0, 5306.0, 5563.0, 5496.0, 5316.0, 5435.0, 5462.0, 5560.0, 5401.0, 5364.0, 5381.0, 5585.0, 5620.0, 5382.0, 5511.0, 5409.0, 5309.0, 5507.0, 5291.0, 5394.0, 5693.0, 5678.0, 5442.0, 5584.0, 5486.0, 5677.0, 5596.0, 5355.0, 5279.0, 5721.0, 5406.0, 5370.0, 5369.0, 5371.0, 5269.0, 5471.0, 5300.0, 5267.0, 5254.0, 5609.0, 5335.0, 5410.0, 5709.0, 5623.0, 5383.0, 5361.0, 5638.0, 5292.0, 5285.0, 5698.0, 5541.0, 5685.0, 5331.0, 5616.0, 5599.0, 5488.0, 5426.0, 5654.0, 5430.0, 5517.0, 5268.0, 5464.0, 5594.0, 5572.0, 5479.0, 5427.0, 5389.0, 5334.0, 5478.0, 5562.0, 5392.0, 5474.0, 5509.0, 5574.0 (number of hits: 8)
11	5550	9	1	333	1	5536.0, 5464.0, 5494.0, 5345.0, 5498.0, 5683.0, 5338.0, 5636.0, 5635.0, 5583.0, 5323.0, 5394.0, 5604.0, 5292.0, 5557.0, 5645.0, 5458.0, 5443.0, 5358.0, 5505.0, 5541.0, 5651.0, 5257.0, 5253.0, 5432.0, 5445.0, 5411.0, 5702.0, 5691.0, 5596.0, 5312.0, 5436.0, 5657.0, 5465.0, 5466.0, 5329.0, 5479.0, 5301.0, 5653.0, 5623.0, 5393.0, 5355.0, 5334.0, 5507.0, 5593.0, 5407.0, 5289.0, 5647.0, 5316.0, 5430.0, 5611.0, 5392.0, 5439.0, 5571.0, 5415.0, 5675.0, 5620.0, 5410.0, 5502.0, 5496.0, 5490.0, 5475.0, 5660.0, 5382.0, 5440.0, 5360.0, 5280.0, 5539.0, 5530.0, 5285.0, 5719.0, 5300.0, 5403.0, 5563.0, 5405.0, 5370.0, 5406.0, 5298.0, 5579.0, 5552.0, 5500.0, 5614.0, 5468.0, 5710.0, 5452.0, 5389.0, 5425.0, 5698.0, 5418.0, 5309.0, 5703.0, 5342.0, 5376.0, 5679.0, 5262.0, 5503.0, 5520.0, 5412.0, 5491.0, 5341.0 (number of hits: 8)

12	5550	9	1	333	1	<p>5362.0, 5690.0, 5370.0, 5518.0, 5371.0, 5545.0, 5386.0, 5397.0, 5641.0, 5452.0, 5338.0, 5425.0, 5541.0, 5390.0, 5530.0, 5456.0, 5633.0, 5488.0, 5266.0, 5446.0, 5694.0, 5686.0, 5608.0, 5438.0, 5596.0, 5278.0, 5537.0, 5707.0, 5382.0, 5520.0, 5586.0, 5689.0, 5688.0, 5254.0, 5680.0, 5572.0, 5490.0, 5480.0, 5533.0, 5410.0, 5621.0, 5703.0, 5350.0, 5676.0, 5400.0, 5575.0, 5658.0, 5624.0, 5369.0, 5450.0, 5333.0, 5305.0, 5313.0, 5617.0, 5297.0, 5535.0, 5384.0, 5433.0, 5364.0, 5544.0, 5524.0, 5407.0, 5687.0, 5628.0, 5600.0, 5618.0, 5404.0, 5678.0, 5671.0, 5420.0, 5360.0, 5357.0, 5519.0, 5341.0, 5692.0, 5587.0, 5650.0, 5330.0, 5299.0, 5620.0, 5329.0, 5589.0, 5708.0, 5664.0, 5722.0, 5585.0, 5412.0, 5660.0, 5550.0, 5387.0, 5508.0, 5424.0, 5644.0, 5583.0, 5447.0, 5348.0, 5648.0, 5430.0, 5584.0, 5434.0</p> <p>(number of hits: 4)</p>
13	5550	9	1	333	1	<p>5527.0, 5283.0, 5353.0, 5448.0, 5630.0, 5517.0, 5546.0, 5563.0, 5658.0, 5261.0, 5513.0, 5342.0, 5378.0, 5712.0, 5433.0, 5257.0, 5686.0, 5534.0, 5622.0, 5440.0, 5603.0, 5591.0, 5335.0, 5703.0, 5467.0, 5339.0, 5637.0, 5613.0, 5662.0, 5539.0, 5401.0, 5430.0, 5548.0, 5256.0, 5456.0, 5426.0, 5714.0, 5332.0, 5282.0, 5412.0, 5480.0, 5483.0, 5641.0, 5701.0, 5414.0, 5717.0, 5499.0, 5476.0, 5594.0, 5275.0, 5465.0, 5454.0, 5561.0, 5370.0, 5280.0, 5544.0, 5606.0, 5344.0, 5535.0, 5360.0, 5640.0, 5345.0, 5473.0, 5325.0, 5646.0, 5303.0, 5437.0, 5653.0, 5405.0, 5442.0, 5584.0, 5705.0, 5655.0, 5621.0, 5693.0, 5609.0, 5404.0, 5581.0, 5346.0, 5497.0, 5272.0, 5696.0, 5434.0, 5682.0, 5505.0, 5589.0, 5338.0, 5706.0, 5253.0, 5495.0, 5423.0, 5583.0, 5330.0, 5314.0, 5255.0, 5599.0, 5265.0, 5397.0, 5287.0, 5723.0</p> <p>(number of hits: 3)</p>
14	5550	9	1	333	1	<p>5647.0, 5511.0, 5354.0, 5595.0, 5352.0, 5401.0, 5539.0, 5717.0, 5519.0, 5605.0, 5632.0, 5638.0, 5568.0, 5388.0, 5698.0, 5660.0, 5548.0, 5516.0, 5346.0, 5567.0, 5480.0, 5664.0, 5700.0, 5577.0, 5584.0, 5446.0, 5253.0, 5313.0, 5538.0, 5299.0, 5716.0, 5674.0, 5356.0, 5410.0, 5442.0, 5306.0, 5505.0, 5374.0, 5461.0, 5606.0, 5671.0, 5467.0, 5525.0, 5623.0, 5712.0, 5552.0, 5267.0, 5600.0, 5261.0, 5570.0, 5530.0, 5676.0, 5650.0, 5588.0, 5427.0, 5488.0, 5684.0, 5695.0, 5387.0, 5520.0, 5533.0, 5537.0, 5274.0, 5325.0, 5396.0, 5563.0, 5282.0, 5262.0, 5661.0, 5314.0, 5455.0, 5634.0, 5663.0, 5720.0, 5615.0, 5385.0, 5308.0, 5368.0, 5376.0, 5361.0, 5581.0, 5470.0, 5639.0, 5493.0, 5690.0,</p>

						5543.0, 5304.0, 5497.0, 5696.0, 5609.0, 5332.0, 5703.0, 5400.0, 5293.0, 5677.0, 5447.0, 5439.0, 5266.0, 5445.0, 5443.0 (number of hits: 7)
15	5550	9	1	333	1	5404.0, 5350.0, 5456.0, 5508.0, 5665.0, 5250.0, 5473.0, 5340.0, 5554.0, 5484.0, 5464.0, 5715.0, 5492.0, 5494.0, 5368.0, 5534.0, 5365.0, 5617.0, 5485.0, 5674.0, 5546.0, 5672.0, 5624.0, 5619.0, 5412.0, 5514.0, 5363.0, 5623.0, 5384.0, 5357.0, 5353.0, 5311.0, 5451.0, 5398.0, 5575.0, 5370.0, 5648.0, 5305.0, 5336.0, 5611.0, 5592.0, 5411.0, 5399.0, 5449.0, 5659.0, 5480.0, 5698.0, 5654.0, 5310.0, 5687.0, 5272.0, 5509.0, 5632.0, 5359.0, 5419.0, 5569.0, 5431.0, 5426.0, 5252.0, 5572.0, 5319.0, 5519.0, 5291.0, 5693.0, 5639.0, 5677.0, 5614.0, 5364.0, 5710.0, 5507.0, 5549.0, 5279.0, 5574.0, 5523.0, 5275.0, 5387.0, 5709.0, 5462.0, 5694.0, 5580.0, 5427.0, 5278.0, 5317.0, 5711.0, 5328.0, 5418.0, 5402.0, 5662.0, 5666.0, 5479.0, 5322.0, 5309.0, 5405.0, 5420.0, 5722.0, 5478.0, 5355.0, 5532.0, 5400.0, 5699.0 (number of hits: 5)
16	5550	9	1	333	1	5480.0, 5274.0, 5549.0, 5577.0, 5680.0, 5465.0, 5494.0, 5308.0, 5333.0, 5610.0, 5440.0, 5669.0, 5281.0, 5483.0, 5641.0, 5395.0, 5346.0, 5263.0, 5466.0, 5488.0, 5700.0, 5468.0, 5686.0, 5398.0, 5317.0, 5272.0, 5696.0, 5443.0, 5644.0, 5307.0, 5556.0, 5334.0, 5356.0, 5392.0, 5531.0, 5379.0, 5413.0, 5501.0, 5291.0, 5639.0, 5351.0, 5687.0, 5325.0, 5566.0, 5625.0, 5667.0, 5660.0, 5370.0, 5590.0, 5504.0, 5362.0, 5402.0, 5527.0, 5721.0, 5434.0, 5265.0, 5678.0, 5369.0, 5657.0, 5685.0, 5372.0, 5616.0, 5585.0, 5393.0, 5408.0, 5542.0, 5419.0, 5598.0, 5453.0, 5521.0, 5574.0, 5676.0, 5526.0, 5451.0, 5397.0, 5292.0, 5722.0, 5267.0, 5653.0, 5620.0, 5617.0, 5724.0, 5623.0, 5516.0, 5335.0, 5435.0, 5456.0, 5471.0, 5343.0, 5713.0, 5296.0, 5671.0, 5511.0, 5424.0, 5293.0, 5659.0, 5473.0, 5279.0, 5689.0, 5309.0 (number of hits: 7)
17	5550	9	1	333	1	5445.0, 5496.0, 5704.0, 5635.0, 5659.0, 5536.0, 5520.0, 5286.0, 5293.0, 5582.0, 5680.0, 5317.0, 5343.0, 5388.0, 5550.0, 5382.0, 5526.0, 5450.0, 5689.0, 5525.0, 5631.0, 5617.0, 5715.0, 5322.0, 5371.0, 5612.0, 5585.0, 5691.0, 5308.0, 5452.0, 5405.0, 5615.0, 5277.0, 5651.0, 5411.0, 5398.0, 5637.0, 5544.0, 5712.0, 5607.0, 5723.0, 5652.0, 5608.0, 5362.0, 5641.0, 5673.0, 5399.0, 5279.0, 5535.0, 5396.0, 5503.0, 5711.0, 5699.0, 5566.0, 5702.0, 5586.0, 5358.0, 5724.0, 5250.0, 5298.0, 5272.0, 5409.0, 5321.0, 5421.0, 5314.0,

						5494.0, 5568.0, 5516.0, 5507.0, 5697.0, 5487.0, 5578.0, 5312.0, 5629.0, 5364.0, 5610.0, 5363.0, 5720.0, 5579.0, 5412.0, 5656.0, 5266.0, 5333.0, 5701.0, 5603.0, 5533.0, 5663.0, 5435.0, 5467.0, 5498.0, 5613.0, 5551.0, 5709.0, 5674.0, 5282.0, 5365.0, 5436.0, 5655.0, 5502.0, 5596.0 (number of hits: 6)
18	5550	9	1	333	1	5446.0, 5669.0, 5460.0, 5547.0, 5497.0, 5396.0, 5476.0, 5611.0, 5539.0, 5273.0, 5545.0, 5422.0, 5696.0, 5399.0, 5481.0, 5591.0, 5484.0, 5601.0, 5529.0, 5662.0, 5649.0, 5256.0, 5593.0, 5688.0, 5604.0, 5561.0, 5618.0, 5425.0, 5409.0, 5710.0, 5490.0, 5532.0, 5419.0, 5309.0, 5379.0, 5458.0, 5267.0, 5305.0, 5465.0, 5578.0, 5719.0, 5680.0, 5573.0, 5670.0, 5563.0, 5302.0, 5451.0, 5385.0, 5562.0, 5667.0, 5284.0, 5507.0, 5441.0, 5520.0, 5260.0, 5709.0, 5315.0, 5259.0, 5362.0, 5661.0, 5590.0, 5586.0, 5502.0, 5350.0, 5325.0, 5322.0, 5672.0, 5366.0, 5400.0, 5472.0, 5526.0, 5527.0, 5665.0, 5467.0, 5654.0, 5659.0, 5388.0, 5700.0, 5407.0, 5598.0, 5564.0, 5635.0, 5622.0, 5505.0, 5420.0, 5387.0, 5522.0, 5493.0, 5548.0, 5511.0, 5365.0, 5317.0, 5698.0, 5299.0, 5650.0, 5430.0, 5612.0, 5492.0, 5714.0, 5469.0 (number of hits: 4)
19	5550	9	1	333	1	5364.0, 5572.0, 5376.0, 5433.0, 5577.0, 5338.0, 5426.0, 5532.0, 5629.0, 5498.0, 5701.0, 5506.0, 5687.0, 5721.0, 5347.0, 5255.0, 5561.0, 5487.0, 5257.0, 5594.0, 5461.0, 5650.0, 5530.0, 5485.0, 5361.0, 5584.0, 5712.0, 5503.0, 5288.0, 5464.0, 5270.0, 5341.0, 5513.0, 5568.0, 5581.0, 5682.0, 5406.0, 5392.0, 5373.0, 5301.0, 5716.0, 5404.0, 5684.0, 5353.0, 5565.0, 5694.0, 5395.0, 5438.0, 5428.0, 5285.0, 5310.0, 5630.0, 5719.0, 5475.0, 5722.0, 5541.0, 5573.0, 5507.0, 5505.0, 5640.0, 5491.0, 5308.0, 5566.0, 5253.0, 5267.0, 5416.0, 5670.0, 5685.0, 5264.0, 5589.0, 5313.0, 5473.0, 5545.0, 5309.0, 5384.0, 5546.0, 5688.0, 5274.0, 5472.0, 5403.0, 5294.0, 5306.0, 5569.0, 5413.0, 5596.0, 5542.0, 5278.0, 5603.0, 5662.0, 5526.0, 5391.0, 5370.0, 5500.0, 5661.0, 5328.0, 5564.0, 5602.0, 5277.0, 5455.0, 5444.0 (number of hits: 9)
20	5550	9	1	333	1	5421.0, 5685.0, 5353.0, 5662.0, 5307.0, 5629.0, 5478.0, 5567.0, 5687.0, 5437.0, 5335.0, 5465.0, 5402.0, 5602.0, 5523.0, 5291.0, 5414.0, 5628.0, 5369.0, 5624.0, 5418.0, 5416.0, 5660.0, 5640.0, 5420.0, 5678.0, 5452.0, 5652.0, 5700.0, 5256.0, 5490.0, 5489.0, 5627.0, 5429.0, 5277.0, 5713.0, 5598.0, 5718.0, 5565.0, 5442.0, 5705.0, 5692.0, 5698.0, 5269.0, 5594.0,

						5599.0, 5340.0, 5444.0, 5439.0, 5673.0, 5688.0, 5535.0, 5508.0, 5536.0, 5691.0, 5706.0, 5714.0, 5667.0, 5591.0, 5573.0, 5499.0, 5362.0, 5632.0, 5633.0, 5666.0, 5337.0, 5703.0, 5298.0, 5472.0, 5318.0, 5527.0, 5516.0, 5367.0, 5600.0, 5656.0, 5398.0, 5356.0, 5622.0, 5374.0, 5381.0, 5639.0, 5553.0, 5411.0, 5435.0, 5387.0, 5322.0, 5648.0, 5719.0, 5424.0, 5423.0, 5525.0, 5486.0, 5488.0, 5710.0, 5254.0, 5552.0, 5390.0, 5382.0, 5299.0, 5351.0 (number of hits: 4)
21	5550	9	1	333	1	5505.0, 5649.0, 5272.0, 5398.0, 5429.0, 5557.0, 5711.0, 5397.0, 5364.0, 5256.0, 5329.0, 5402.0, 5339.0, 5395.0, 5377.0, 5528.0, 5290.0, 5344.0, 5475.0, 5324.0, 5654.0, 5503.0, 5491.0, 5600.0, 5465.0, 5361.0, 5628.0, 5486.0, 5664.0, 5340.0, 5271.0, 5359.0, 5403.0, 5295.0, 5492.0, 5275.0, 5684.0, 5310.0, 5432.0, 5663.0, 5381.0, 5591.0, 5297.0, 5519.0, 5718.0, 5646.0, 5700.0, 5605.0, 5490.0, 5423.0, 5537.0, 5547.0, 5506.0, 5517.0, 5438.0, 5420.0, 5501.0, 5633.0, 5662.0, 5428.0, 5263.0, 5682.0, 5695.0, 5421.0, 5612.0, 5597.0, 5261.0, 5447.0, 5616.0, 5425.0, 5590.0, 5593.0, 5512.0, 5392.0, 5667.0, 5587.0, 5267.0, 5721.0, 5485.0, 5276.0, 5511.0, 5255.0, 5617.0, 5468.0, 5532.0, 5571.0, 5680.0, 5396.0, 5331.0, 5391.0, 5387.0, 5641.0, 5341.0, 5293.0, 5414.0, 5707.0, 5627.0, 5542.0, 5435.0, 5489.0 (number of hits: 5)
22	5550	9	1	333	1	5688.0, 5552.0, 5328.0, 5507.0, 5377.0, 5510.0, 5459.0, 5413.0, 5646.0, 5485.0, 5685.0, 5706.0, 5299.0, 5545.0, 5353.0, 5331.0, 5695.0, 5611.0, 5263.0, 5557.0, 5324.0, 5496.0, 5289.0, 5258.0, 5251.0, 5470.0, 5724.0, 5378.0, 5371.0, 5644.0, 5705.0, 5269.0, 5454.0, 5616.0, 5416.0, 5607.0, 5624.0, 5442.0, 5586.0, 5392.0, 5457.0, 5394.0, 5501.0, 5335.0, 5329.0, 5491.0, 5347.0, 5389.0, 5517.0, 5372.0, 5283.0, 5605.0, 5553.0, 5284.0, 5676.0, 5663.0, 5428.0, 5264.0, 5455.0, 5618.0, 5715.0, 5409.0, 5290.0, 5533.0, 5423.0, 5651.0, 5585.0, 5339.0, 5449.0, 5577.0, 5702.0, 5305.0, 5265.0, 5497.0, 5659.0, 5344.0, 5664.0, 5363.0, 5581.0, 5257.0, 5358.0, 5486.0, 5351.0, 5310.0, 5629.0, 5495.0, 5617.0, 5319.0, 5361.0, 5482.0, 5301.0, 5527.0, 5595.0, 5619.0, 5521.0, 5386.0, 5280.0, 5364.0, 5569.0, 5278.0 (number of hits: 6)
23	5550	9	1	333	1	5643.0, 5549.0, 5399.0, 5318.0, 5449.0, 5303.0, 5579.0, 5661.0, 5516.0, 5308.0, 5364.0, 5573.0, 5287.0, 5351.0, 5671.0, 5711.0, 5272.0, 5261.0, 5333.0, 5476.0, 5283.0, 5654.0, 5582.0, 5692.0, 5565.0,

						5435.0, 5268.0, 5304.0, 5491.0, 5696.0, 5638.0, 5342.0, 5650.0, 5532.0, 5319.0, 5526.0, 5629.0, 5530.0, 5510.0, 5337.0, 5536.0, 5389.0, 5578.0, 5721.0, 5702.0, 5271.0, 5343.0, 5482.0, 5517.0, 5437.0, 5500.0, 5612.0, 5615.0, 5470.0, 5329.0, 5452.0, 5444.0, 5387.0, 5293.0, 5556.0, 5255.0, 5487.0, 5700.0, 5672.0, 5680.0, 5412.0, 5311.0, 5724.0, 5717.0, 5469.0, 5262.0, 5557.0, 5408.0, 5276.0, 5639.0, 5397.0, 5317.0, 5421.0, 5285.0, 5442.0, 5313.0, 5407.0, 5511.0, 5714.0, 5561.0, 5396.0, 5409.0, 5512.0, 5614.0, 5518.0, 5537.0, 5369.0, 5525.0, 5324.0, 5278.0, 5307.0, 5286.0, 5682.0, 5400.0, 5426.0 (number of hits: 10)
24	5550	9	1	333	1	5520.0, 5315.0, 5260.0, 5645.0, 5454.0, 5303.0, 5643.0, 5274.0, 5295.0, 5443.0, 5418.0, 5515.0, 5433.0, 5362.0, 5542.0, 5710.0, 5270.0, 5701.0, 5330.0, 5271.0, 5694.0, 5277.0, 5339.0, 5691.0, 5477.0, 5637.0, 5504.0, 5496.0, 5681.0, 5634.0, 5379.0, 5537.0, 5530.0, 5462.0, 5458.0, 5602.0, 5605.0, 5267.0, 5421.0, 5405.0, 5455.0, 5459.0, 5358.0, 5305.0, 5425.0, 5597.0, 5373.0, 5669.0, 5325.0, 5356.0, 5704.0, 5483.0, 5625.0, 5635.0, 5593.0, 5616.0, 5266.0, 5370.0, 5606.0, 5718.0, 5290.0, 5539.0, 5430.0, 5556.0, 5314.0, 5321.0, 5380.0, 5526.0, 5293.0, 5558.0, 5509.0, 5344.0, 5495.0, 5519.0, 5449.0, 5695.0, 5457.0, 5632.0, 5492.0, 5497.0, 5285.0, 5686.0, 5442.0, 5512.0, 5559.0, 5452.0, 5654.0, 5403.0, 5569.0, 5451.0, 5408.0, 5705.0, 5572.0, 5351.0, 5471.0, 5682.0, 5319.0, 5567.0, 5590.0, 5416.0 (number of hits: 7)
25	5550	9	1	333	1	5401.0, 5368.0, 5463.0, 5722.0, 5616.0, 5473.0, 5610.0, 5695.0, 5275.0, 5583.0, 5559.0, 5480.0, 5351.0, 5295.0, 5449.0, 5451.0, 5560.0, 5623.0, 5377.0, 5372.0, 5453.0, 5529.0, 5281.0, 5283.0, 5342.0, 5413.0, 5385.0, 5338.0, 5430.0, 5412.0, 5421.0, 5569.0, 5253.0, 5680.0, 5577.0, 5671.0, 5358.0, 5715.0, 5329.0, 5646.0, 5626.0, 5686.0, 5395.0, 5465.0, 5470.0, 5707.0, 5292.0, 5388.0, 5310.0, 5386.0, 5494.0, 5265.0, 5499.0, 5437.0, 5256.0, 5396.0, 5467.0, 5701.0, 5365.0, 5517.0, 5479.0, 5581.0, 5717.0, 5485.0, 5579.0, 5611.0, 5697.0, 5564.0, 5613.0, 5503.0, 5497.0, 5400.0, 5482.0, 5553.0, 5255.0, 5460.0, 5426.0, 5606.0, 5307.0, 5293.0, 5536.0, 5673.0, 5622.0, 5486.0, 5442.0, 5321.0, 5513.0, 5472.0, 5478.0, 5565.0, 5639.0, 5682.0, 5721.0, 5387.0, 5593.0, 5716.0, 5690.0, 5648.0, 5433.0, 5603.0 (number of hits: 5)
26	5550	9	1	333	1	5517.0, 5377.0, 5528.0, 5524.0, 5587.0,

						5266.0, 5635.0, 5283.0, 5417.0, 5550.0, 5719.0, 5724.0, 5260.0, 5408.0, 5382.0, 5541.0, 5495.0, 5538.0, 5388.0, 5474.0, 5684.0, 5458.0, 5586.0, 5399.0, 5512.0, 5690.0, 5628.0, 5306.0, 5518.0, 5346.0, 5489.0, 5315.0, 5268.0, 5361.0, 5309.0, 5633.0, 5288.0, 5333.0, 5521.0, 5372.0, 5316.0, 5661.0, 5461.0, 5564.0, 5713.0, 5657.0, 5709.0, 5329.0, 5294.0, 5591.0, 5646.0, 5699.0, 5559.0, 5654.0, 5429.0, 5537.0, 5370.0, 5353.0, 5639.0, 5708.0, 5296.0, 5369.0, 5317.0, 5590.0, 5592.0, 5401.0, 5445.0, 5595.0, 5545.0, 5483.0, 5562.0, 5670.0, 5318.0, 5679.0, 5722.0, 5718.0, 5604.0, 5453.0, 5436.0, 5615.0, 5272.0, 5632.0, 5494.0, 5313.0, 5394.0, 5348.0, 5418.0, 5262.0, 5584.0, 5717.0, 5511.0, 5641.0, 5720.0, 5434.0, 5688.0, 5473.0, 5577.0, 5263.0, 5415.0, 5265.0 (number of hits: 6)
27	5550	9	1	333	1	5644.0, 5257.0, 5277.0, 5600.0, 5574.0, 5484.0, 5698.0, 5435.0, 5515.0, 5513.0, 5432.0, 5645.0, 5328.0, 5602.0, 5631.0, 5288.0, 5386.0, 5400.0, 5650.0, 5556.0, 5297.0, 5706.0, 5302.0, 5612.0, 5490.0, 5577.0, 5711.0, 5253.0, 5654.0, 5250.0, 5368.0, 5616.0, 5709.0, 5700.0, 5573.0, 5348.0, 5684.0, 5520.0, 5342.0, 5641.0, 5689.0, 5443.0, 5613.0, 5425.0, 5509.0, 5699.0, 5463.0, 5649.0, 5647.0, 5300.0, 5562.0, 5456.0, 5554.0, 5430.0, 5517.0, 5405.0, 5652.0, 5696.0, 5304.0, 5419.0, 5503.0, 5472.0, 5535.0, 5450.0, 5614.0, 5265.0, 5298.0, 5547.0, 5424.0, 5564.0, 5691.0, 5493.0, 5258.0, 5344.0, 5483.0, 5695.0, 5384.0, 5720.0, 5383.0, 5522.0, 5660.0, 5286.0, 5380.0, 5703.0, 5715.0, 5431.0, 5642.0, 5481.0, 5416.0, 5387.0, 5392.0, 5523.0, 5485.0, 5569.0, 5605.0, 5292.0, 5385.0, 5630.0, 5471.0, 5271.0 (number of hits: 8)
28	5550	9	1	333	1	5460.0, 5450.0, 5682.0, 5353.0, 5380.0, 5579.0, 5391.0, 5689.0, 5442.0, 5596.0, 5684.0, 5547.0, 5492.0, 5416.0, 5683.0, 5711.0, 5252.0, 5688.0, 5556.0, 5696.0, 5451.0, 5398.0, 5686.0, 5597.0, 5396.0, 5403.0, 5514.0, 5263.0, 5337.0, 5467.0, 5498.0, 5541.0, 5258.0, 5623.0, 5465.0, 5370.0, 5310.0, 5585.0, 5723.0, 5691.0, 5362.0, 5515.0, 5608.0, 5336.0, 5368.0, 5365.0, 5260.0, 5367.0, 5428.0, 5534.0, 5620.0, 5614.0, 5495.0, 5717.0, 5610.0, 5493.0, 5644.0, 5609.0, 5588.0, 5474.0, 5713.0, 5480.0, 5381.0, 5387.0, 5427.0, 5335.0, 5256.0, 5701.0, 5661.0, 5602.0, 5338.0, 5265.0, 5615.0, 5476.0, 5531.0, 5455.0, 5483.0, 5340.0, 5481.0, 5589.0, 5355.0, 5417.0, 5315.0, 5276.0, 5350.0, 5397.0, 5328.0, 5443.0, 5706.0, 5347.0

						5532.0, 5376.0, 5477.0, 5332.0, 5271.0, 5574.0, 5302.0, 5334.0, 5314.0, 5694.0 (number of hits: 3)
29	5550	9	1	333	1	5460.0, 5282.0, 5574.0, 5617.0, 5537.0, 5301.0, 5297.0, 5344.0, 5259.0, 5550.0, 5343.0, 5583.0, 5334.0, 5254.0, 5294.0, 5573.0, 5357.0, 5601.0, 5472.0, 5337.0, 5396.0, 5656.0, 5694.0, 5500.0, 5330.0, 5495.0, 5482.0, 5524.0, 5311.0, 5654.0, 5631.0, 5312.0, 5380.0, 5295.0, 5624.0, 5441.0, 5483.0, 5269.0, 5270.0, 5437.0, 5432.0, 5300.0, 5547.0, 5700.0, 5400.0, 5416.0, 5473.0, 5719.0, 5466.0, 5419.0, 5674.0, 5326.0, 5592.0, 5261.0, 5531.0, 5379.0, 5475.0, 5481.0, 5653.0, 5471.0, 5418.0, 5612.0, 5508.0, 5507.0, 5403.0, 5313.0, 5498.0, 5606.0, 5571.0, 5321.0, 5307.0, 5322.0, 5536.0, 5600.0, 5273.0, 5459.0, 5450.0, 5535.0, 5255.0, 5630.0, 5305.0, 5520.0, 5663.0, 5575.0, 5285.0, 5635.0, 5375.0, 5603.0, 5266.0, 5361.0, 5497.0, 5673.0, 5443.0, 5430.0, 5684.0, 5442.0, 5469.0, 5512.0, 5544.0, 5668.0 (number of hits: 11)
30	5550	9	1	333	1	5341.0, 5576.0, 5606.0, 5517.0, 5513.0, 5449.0, 5588.0, 5609.0, 5569.0, 5404.0, 5687.0, 5481.0, 5673.0, 5266.0, 5391.0, 5321.0, 5345.0, 5460.0, 5553.0, 5617.0, 5369.0, 5533.0, 5485.0, 5367.0, 5412.0, 5521.0, 5386.0, 5515.0, 5254.0, 5567.0, 5474.0, 5421.0, 5276.0, 5307.0, 5398.0, 5334.0, 5580.0, 5563.0, 5392.0, 5648.0, 5409.0, 5715.0, 5473.0, 5583.0, 5626.0, 5604.0, 5380.0, 5355.0, 5271.0, 5342.0, 5259.0, 5327.0, 5502.0, 5269.0, 5656.0, 5333.0, 5385.0, 5418.0, 5506.0, 5282.0, 5406.0, 5516.0, 5354.0, 5664.0, 5344.0, 5622.0, 5698.0, 5525.0, 5353.0, 5431.0, 5552.0, 5547.0, 5458.0, 5582.0, 5275.0, 5650.0, 5376.0, 5352.0, 5681.0, 5400.0, 5591.0, 5305.0, 5493.0, 5286.0, 5267.0, 5335.0, 5692.0, 5470.0, 5313.0, 5402.0, 5408.0, 5360.0, 5382.0, 5283.0, 5378.0, 5570.0, 5459.0, 5324.0, 5585.0, 5488.0 (number of hits: 4)

5280 MHz

Radar Signal Type	Waveform/Trial Number	Detection (%)	Limit (%)	Pass/Fail
Type 1	30	100 %	60%	Pass
Type 2	30	100 %	60%	Pass
Type 3	30	100 %	60%	Pass
Type 4	30	100 %	60%	Pass
Type 5	30	100 %	80%	Pass
Type 6	30	96.7 %	70%	Pass

Please refer to the following statistical tables:

Table-1 Radar Type 1 Statistical Performance

Trial #	Fc (MHz)	Pulse/Burst	Pulse Width (μS)	PRI (μs)	Detection (1:yes; 0:no)
1	5280	18	1	1428	1
2	5280	18	1	1428	1
3	5280	18	1	1428	1
4	5280	18	1	1428	1
5	5280	18	1	1428	1
6	5280	18	1	1428	1
7	5280	18	1	1428	1
8	5280	18	1	1428	1
9	5280	18	1	1428	1
10	5280	18	1	1428	1
11	5280	18	1	1428	1
12	5280	18	1	1428	1
13	5280	18	1	1428	1
14	5280	18	1	1428	1
15	5280	18	1	1428	1
16	5280	18	1	1428	1
17	5280	18	1	1428	1
18	5280	18	1	1428	1
19	5280	18	1	1428	1
20	5280	18	1	1428	1
21	5280	18	1	1428	1
22	5280	18	1	1428	1
23	5280	18	1	1428	1
24	5280	18	1	1428	1
25	5280	18	1	1428	1
26	5280	18	1	1428	1
27	5280	18	1	1428	1
28	5280	18	1	1428	1
29	5280	18	1	1428	1
30	5280	18	1	1428	1
Detection Percentage: 100 % (>60%)					

Table-2 Radar Type 2 Statistical Performance

Trial #	Fc (MHz)	Pulse/Burst	Pulse Width (μS)	PRI (μs)	Detection (1:yes; 0:no)
1	5280	27	4	212	1
2	5280	23	1.6	222	1
3	5280	26	3.3	157	1
4	5280	23	4.2	169	0
5	5280	26	4.3	198	1
6	5280	28	3.2	184	1
7	5280	29	3.7	221	1
8	5280	29	4.6	171	1
9	5280	23	2.5	227	0
10	5280	23	4	193	1
11	5280	24	2.5	187	1
12	5280	26	3.4	151	1
13	5280	27	2.9	184	1
14	5280	29	1.7	215	1
15	5280	24	3.2	162	1
16	5280	25	1.3	208	1
17	5280	28	1.7	166	0
18	5280	25	2.9	195	0
19	5280	29	2.1	168	1
20	5280	27	2.9	157	1
21	5280	25	2.2	225	1
22	5280	23	4.9	160	1
23	5280	29	3.4	206	1
24	5280	25	5	171	1
25	5280	23	4.3	157	1
26	5280	23	3.2	209	1
27	5280	26	2.7	155	1
28	5280	25	1.4	203	1
29	5280	23	4.8	152	1
30	5280	26	3.3	215	1
Detection Percentage: 86.7 % (>60%)					

Table-3 Radar Type 3 Statistical Performance

Trial #	Fc (MHz)	Pulse/Burst	Pulse Width (μS)	PRI (μs)	Detection (1:yes; 0:no)
1	5280	18	10	217	1
2	5280	17	8.4	417	1
3	5280	18	8.4	468	1
4	5280	18	9.1	459	1
5	5280	17	8.2	205	1
6	5280	18	7.3	392	1
7	5280	17	6.1	409	1
8	5280	16	7.4	218	1
9	5280	18	6.1	436	1
10	5280	18	6.6	488	1
11	5280	17	7	299	1
12	5280	16	6.7	315	1
13	5280	17	9.4	410	1
14	5280	16	7.6	214	0
15	5280	17	8	440	1
16	5280	18	6.5	475	1
17	5280	16	9.8	320	1
18	5280	17	6	466	1
19	5280	18	6.3	204	1
20	5280	18	6.3	244	1
21	5280	18	6	413	1
22	5280	17	9.7	331	1
23	5280	16	8.7	320	1
24	5280	18	7.9	202	1
25	5280	16	7.7	286	1
26	5280	16	8.1	276	1
27	5280	16	8.7	269	1
28	5280	17	7	339	1
29	5280	18	7.7	366	1
30	5280	18	6.6	265	0
Detection Percentage: 93.3 % (>60%)					

Table-4 Radar Type 4 Statistical Performance

Trial #	Fc (MHz)	Pulse/Burst	Pulse Width (µS)	PRI (µs)	Detection (1:yes; 0:no)
1	5280	12	11.4	355	0
2	5280	15	14.1	216	1
3	5280	13	14.8	276	1
4	5280	13	19.5	323	1
5	5280	12	11.1	202	1
6	5280	15	14.8	354	1
7	5280	12	14.3	256	1
8	5280	12	13.1	261	1
9	5280	13	17.6	225	1
10	5280	15	18.3	209	1
11	5280	16	18.8	273	1
12	5280	14	14.7	352	1
13	5280	13	13.1	311	1
14	5280	14	12.9	220	1
15	5280	14	14.7	302	1
16	5280	12	18.1	357	1
17	5280	16	15.8	300	1
18	5280	15	13.4	439	1
19	5280	13	17.2	205	1
20	5280	14	11.9	481	1
21	5280	14	14.1	304	1
22	5280	15	15.1	295	1
23	5280	13	12.7	434	1
24	5280	13	19	363	1
25	5280	12	19.6	441	1
26	5280	16	16.9	242	1
27	5280	13	13.8	342	0
28	5280	16	17.1	460	1
29	5280	14	18.6	320	1
30	5280	15	11.9	345	1
Detection Percentage: 93.3 % (>60%)					

Table-5 Radar Type 5 Statistical Performance

Bin5 Statistics 1

Trial #	Pulse	Chirp (MHz)	Pulse Width (μS)	Pulse 1-2 spacing (uS)	Pulse 2-3 spacing (uS)	Pulse Start(S)	Detection (1:yes; 0:no)
0	2	10	83.7	1695		0.080827	1
1	1	13	53.2			1.936119	
2	1	19	86.2			2.95869	
3	1	9	71.1			4.181539	
4	2	18	57	1912		5.170924	
5	2	10	71.9	1728		6.730945	
6	2	6	77.5	1874		7.207939	
7	3	15	54.3	1954	1141	8.631453	
8	1	10	82.3			10.69091	
9	2	10	93.1	1084		11.18833	

Bin5 Statistics 2

Trial #	Pulse	Chirp (MHz)	Pulse Width (μS)	Pulse 1-2 spacing (uS)	Pulse 2-3 spacing (uS)	Pulse Start(S)	Detection (1:yes; 0:no)
0	2	19	57.9	1882		0.145841	1
1	3	19	54.2	1585	1408	0.9246	
2	1	6	78.4			1.575405	
3	2	17	99.4	1092		2.144023	
4	2	18	61.3	1352		2.735644	
5	2	19	52.9	1208		3.507817	
6	3	6	83.4	1375	1216	3.622382	
7	1	10	97.9			4.684592	
8	2	8	56.9	1580		4.865169	
9	1	8	83.2			5.621725	
10	3	6	83.3	1385	1073	6.498814	
11	2	11	97.2	1506		6.719047	
12	1	8	90.1			7.536332	
13	2	18	62.1	1607		7.839243	
14	1	20	52.4			8.88217	
15	1	15	69.4			9.240642	
16	2	18	76.2	1522		10.02092	
17	3	19	92.3	1475	1173	10.20392	
18	2	19	77.6	1055		11.25713	
19	3	13	53	1370	1058	11.86216	

Bin5 Statistics 3

Trial #	Pulse	Chirp (MHz)	Pulse Width (μS)	Pulse 1-2 spacing (uS)	Pulse 2-3 spacing (uS)	Pulse Start(S)	Detection (1:yes; 0:no)
0	2	19	60.8	1779		0.986009	1
1	2	11	74.6	1228		1.743997	
2	1	11	71.6			2.751102	
3	2	8	52.2	1249		4.080143	
4	1	13	65.4			5.717022	
5	2	20	84.6	1586		6.077674	
6	3	8	74.4	1134	1701	7.592399	
7	3	11	79.2	1048	1261	9.193966	
8	2	6	65.3	1998		9.814496	
9	3	8	98.6	1369	1975	11.32232	

Bin5 Statistics 4

Trial #	Pulse	Chirp (MHz)	Pulse Width (μS)	Pulse 1-2 spacing (uS)	Pulse 2-3 spacing (uS)	Pulse Start(S)	Detection (1:yes; 0:no)
0	2	6	64.4	1196		0.347254	1
1	2	9	66	1160		1.457177	
2	3	18	59.2	1843	1192	2.141317	
3	2	12	72.7	1700		2.54566	
4	2	13	84.3	1672		3.781241	
5	2	6	78.1	1389		4.580546	
6	2	7	57.7	1858		4.864946	
7	2	12	75.7	1826		6.02113	
8	2	11	81.3	1798		6.478407	
9	1	7	95.8			7.872359	
10	2	7	92.6	1874		8.134074	
11	2	19	97.5	1261		9.306567	
12	1	13	72.3			9.802549	
13	1	12	87.4			10.7863	
14	3	15	81.3	1557	1935	11.45369	

Bin5 Statistics 5

Trial #	Pulse	Chirp (MHz)	Pulse Width (µS)	Pulse 1-2 spacing (µS)	Pulse 2-3 spacing (µS)	Pulse Start(S)	Detection (1:yes; 0:no)
0	2	5	50.7	1601		0.003312	1
1	3	17	71.4	1826	1500	1.407177	
2	2	18	57.2	1370		1.518171	
3	1	18	69			2.394489	
4	3	14	85.3	1582	1959	3.346234	
5	2	11	96.9	1407		4.384207	
6	1	8	93.1			5.233708	
7	1	10	64.6			5.41851	
8	2	19	84.1	1162		6.105399	
9	2	10	76.8	1213		7.288844	
10	2	8	85.8	1003		7.54627	
11	3	14	51.4	1773	1851	8.412135	
12	1	11	50.8			9.26664	
13	2	9	93.5	1728		10.47154	
14	2	7	85.5	1911		10.80482	
15	1	9	53.7			11.76607	

Bin5 Statistics 6

Trial #	Pulse	Chirp (MHz)	Pulse Width (µS)	Pulse 1-2 spacing (µS)	Pulse 2-3 spacing (µS)	Pulse Start(S)	Detection (1:yes; 0:no)
0	3	16	55.8	1614	1699	0.773487	1
1	1	6	57.7			1.181352	
2	2	6	82.3	1882		2.395783	
3	3	19	73.6	1274	1430	2.575632	
4	3	20	90.1	1872	1198	3.742004	
5	1	18	73.2			4.725481	
6	2	15	78.9	1865		5.936398	
7	1	19	88.1			6.186276	
8	1	9	86.1			7.042976	
9	1	16	82.5			7.756583	
10	2	13	94.6	1668		9.17863	
11	1	9	51			9.933269	
12	1	18	81.9			10.52471	
13	3	18	66.6	1147	1745	11.73211	

Bin5 Statistics 7

Trial #	Pulse	Chirp (MHz)	Pulse Width (µS)	Pulse 1-2 spacing (uS)	Pulse 2-3 spacing (uS)	Pulse Start(S)	Detection (1:yes; 0:no)
0	2	18	68.2	1481		0.053369	1
1	2	9	70.8	1771		1.331214	
2	3	7	62.8	1242	1431	2.293332	
3	1	10	70.6			3.687522	
4	3	17	88.7	1702	1502	4.938871	
5	1	10	90.2			6.039415	
6	2	8	74.2	1946		6.712114	
7	2	8	74.6	1538		8.687436	
8	2	20	92.7	1565		9.09799	
9	2	10	76.8	1452		10.08978	
10	2	13	87	1486		11.91453	
0	2	18	68.2	1481		0.053369	

Bin5 Statistics 8

Trial #	Pulse	Chirp (MHz)	Pulse Width (µS)	Pulse 1-2 spacing (uS)	Pulse 2-3 spacing (uS)	Pulse Start(S)	Detection (1:yes; 0:no)
0	2	13	98.3	1195		0.345108	1
1	3	6	57.4	1718	1334	0.995232	
2	1	19	89.6			1.657963	
3	2	14	87.8	1440		2.555127	
4	2	13	92.6	1105		3.385933	
5	2	12	76.1	1153		3.898533	
6	3	10	89.5	1704	1480	4.565821	
7	2	6	95	1055		5.009653	
8	2	17	59	1205		5.747659	
9	2	12	85.6	1115		6.492252	
10	2	15	69.4	1254		7.471328	
11	1	8	97.8			8.149565	
12	3	6	75.7	1900	1177	8.875157	
13	1	17	66.7			9.80225	
14	2	5	54.4	1467		9.988785	
15	2	18	93.2	1251		10.76748	
16	3	10	54.3	1955	1726	11.77458	

Bin5 Statistics 9

Trial #	Pulse	Chirp (MHz)	Pulse Width (µS)	Pulse 1-2 spacing (µS)	Pulse 2-3 spacing (µS)	Pulse Start(S)	Detection (1:yes; 0:no)
0	3	16	85.5	1132	1611	0.238863	1
1	2	8	86.7	1757		1.490206	
2	2	13	95.5	1380		1.985027	
3	2	9	68.1	1624		2.518499	
4	3	10	60.2	1251	1273	3.837566	
5	1	15	80.9			4.260929	
6	1	6	54.8			5.084505	
7	2	14	94.2	1583		5.780808	
8	2	15	89.9	1506		6.925271	
9	2	10	59.1	1194		7.888243	
10	3	8	67.4	1689	1905	8.098174	
11	1	6	68.4			8.955644	
12	2	6	95.5	1234		10.30361	
13	2	9	59.5	1650		10.79636	
14	2	20	59.7	1236		11.4733	

Bin5 Statistics 10

Trial #	Pulse	Chirp (MHz)	Pulse Width (µS)	Pulse 1-2 spacing (µS)	Pulse 2-3 spacing (µS)	Pulse Start(S)	Detection (1:yes; 0:no)
0	2	19	72.3	1977		0.266574	1
1	2	9	96.7	1997		1.120262	
2	3	7	85.8	1909	1205	1.664413	
3	2	6	87.3	1668		2.674903	
4	3	19	79	1361	1852	3.503296	
5	3	8	96.3	1145	1146	4.021225	
6	2	7	80.8	1081		4.939861	
7	3	12	89.6	1906	1185	5.892966	
8	1	7	68.7			6.278173	
9	1	15	84.2			7.311767	
10	2	5	96.1	1013		7.63115	
11	3	15	80	1776	1941	8.645807	
12	2	19	70.3	1692		9.007898	
13	2	13	70.5	1336		10.13333	
14	2	15	85.3	1660		11.14907	
15	3	5	97.1	1759	1712	11.5736	

Bin5 Statistics 11

Trial #	Pulse	Chirp (MHz)	Pulse Width (µS)	Pulse 1-2 spacing (µS)	Pulse 2-3 spacing (µS)	Pulse Start(S)	Detection (1:yes; 0:no)
0	1	9	58.4			0.729045	0
1	1	15	69.9			0.884907	
2	2	12	79.7	1038		1.747917	
3	1	9	75.9			2.665329	
4	1	17	50.3			3.212772	
5	1	9	84.7			3.960373	
6	1	15	59.1			4.973458	
7	2	15	60.4	1920		5.348022	
8	2	11	91.7	1113		6.693014	
9	2	13	62.1	1903		7.408451	
10	2	13	89.9	1978		8.148668	
11	3	12	95.4	1752	1370	8.689254	
12	1	11	75.2			9.199102	
13	3	15	62.2	1580	1609	9.925373	
14	1	18	75.2			11.00785	
15	2	18	67.3	1881		11.47953	

Bin5 Statistics 12

Trial #	Pulse	Chirp (MHz)	Pulse Width (µS)	Pulse 1-2 spacing (µS)	Pulse 2-3 spacing (µS)	Pulse Start(S)	Detection (1:yes; 0:no)
0	2	19	84.2	1782		0.245353	1
1	2	17	92	1849		1.454146	
2	2	19	61.6	1200		1.527669	
3	3	11	59.3	1776	1724	2.425552	
4	2	9	69.7	1947		3.153585	
5	2	6	58.6	1088		4.226529	
6	3	11	82.1	1562	1482	4.816889	
7	3	15	62.4	1648	1234	5.564186	
8	1	20	63.9			6.669632	
9	3	15	63.6	1353	1575	6.824732	
10	2	9	86.8	1315		7.846792	
11	2	20	65.1	1750		8.905681	
12	2	15	62.2	1296		9.512249	
13	3	12	51	1184	1492	10.07846	
14	2	12	67.9	1911		11.23992	
15	3	11	64.2	1661	1694	11.89597	

Bin5 Statistics 13

Trial #	Pulse	Chirp (MHz)	Pulse Width (µS)	Pulse 1-2 spacing (µS)	Pulse 2-3 spacing (µS)	Pulse Start(S)	Detection (1:yes; 0:no)
0	2	10	77	1927		0.889149	1
1	2	10	72.9	1768		1.889624	
2	2	19	90.9	1597		3.256268	
3	3	17	59.8	1707	1628	3.29957	
4	1	9	71.7			4.839702	
5	2	8	62.5	1012		6.263967	
6	3	13	92.2	1915	1044	6.607079	
7	3	7	86.4	1176	1673	7.799525	
8	2	11	93.7	1179		9.232794	
9	2	9	52.8	1453		10.2408	
10	2	6	93.5	1757		11.02862	

Bin5 Statistics 14

Trial #	Pulse	Chirp (MHz)	Pulse Width (µS)	Pulse 1-2 spacing (µS)	Pulse 2-3 spacing (µS)	Pulse Start(S)	Detection (1:yes; 0:no)
0	2	12	74.6	1584		0.287219	1
1	2	10	76.7	1222		1.836195	
2	2	16	84.2	1680		2.134356	
3	1	10	65.1			3.255966	
4	1	14	52.8			4.5237	
5	2	6	77.3	1455		4.76676	
6	2	16	57.5	1431		6.446476	
7	2	16	58.2	1707		7.116931	
8	2	16	58.4	1611		7.675617	
9	2	6	93.4	1821		8.669447	
10	2	14	60.8	1315		10.04823	
11	1	10	88.8			10.36745	
12	3	15	60.4	1934	1977	11.20306	

Bin5 Statistics 15

Trial #	Pulse	Chirp (MHz)	Pulse Width (µS)	Pulse 1-2 spacing (uS)	Pulse 2-3 spacing (uS)	Pulse Start(S)	Detection (1:yes; 0:no)
0	2	14	61.9	1822		0.67332	1
1	3	19	52.6	1938	1432	1.075366	
2	2	18	65.2	1817		1.673777	
3	2	12	51.4	1221		2.622818	
4	1	7	55.7			2.841524	
5	3	16	69.8	1636	1777	3.845149	
6	1	13	58.3			4.417173	
7	2	14	58.7	1301		5.265015	
8	2	5	97.8	1830		6.108283	
9	1	12	64			6.397363	
10	1	19	97.7			7.662626	
11	2	6	62.2	1903		8.19687	
12	2	6	68.4	1547		8.492971	
13	1	7	60.8			9.288432	
14	1	16	96.2			10.52898	
15	1	5	85.5			10.90119	
16	1	18	75.7			11.80786	

Bin5 Statistics 16

Trial #	Pulse	Chirp (MHz)	Pulse Width (µS)	Pulse 1-2 spacing (uS)	Pulse 2-3 spacing (uS)	Pulse Start(S)	Detection (1:yes; 0:no)
0	3	19	94	1070	1297	0.268322	1
1	1	6	64			1.139209	
2	2	13	73.1	1671		3.091064	
3	1	10	53.4			3.346969	
4	2	11	96.7	1521		5.163528	
5	2	11	94.5	1879		5.939457	
6	1	8	96.6			7.517481	
7	1	6	56.2			7.6426	
8	2	18	67.7	1012		8.870809	
9	1	16	77.1			10.6513	
10	2	14	57.2	1635		11.39809	

Bin5 Statistics 17

Trial #	Pulse	Chirp (MHz)	Pulse Width (µS)	Pulse 1-2 spacing (uS)	Pulse 2-3 spacing (uS)	Pulse Start(S)	Detection (1:yes; 0:no)
0	1	6	90.8			0.990157	1
1	2	18	91.3	1788		1.502905	
2	1	15	96.1			2.463782	
3	3	18	79.1	1100	1109	3.786344	
4	2	7	97	1061		4.76759	
5	1	17	95.1			5.087995	
6	2	11	73.5	1313		6.473492	
7	3	14	85	1042	1278	7.540256	
8	2	6	81.4	1443		8.892608	
9	2	18	99	1489		9.053142	
10	3	11	55.8	1841	1589	10.00683	
11	3	12	93.5	1229	1578	11.55281	

Bin5 Statistics 18

Trial #	Pulse	Chirp (MHz)	Pulse Width (µS)	Pulse 1-2 spacing (uS)	Pulse 2-3 spacing (uS)	Pulse Start(S)	Detection (1:yes; 0:no)
0	3	15	68	1422	1073	0.203247	1
1	1	19	89.8			0.822923	
2	2	15	96	1178		1.685356	
3	3	8	53.2	1412	1345	2.055551	
4	3	7	55.7	1496	1395	2.654748	
5	2	17	75.6	1974		3.447308	
6	3	9	72.5	1853	1189	4.239648	
7	2	15	88.5	1534		4.708005	
8	3	9	93.5	1820	1177	5.493244	
9	1	10	75.7			5.887989	
10	3	13	53.5	1048	1046	6.880047	
11	1	16	83.6			7.251708	
12	1	16	84.6			7.774122	
13	1	18	57.1			8.262144	
14	1	19	94.1			8.880685	
15	2	18	78.2	1970		9.522178	
16	1	11	50			10.53632	
17	3	9	52.7	1709	1019	10.8588	
18	1	14	91.4			11.92899	
0	3	15	68	1422	1073	0.203247	

Bin5 Statistics 19

Trial #	Pulse	Chirp (MHz)	Pulse Width (µS)	Pulse 1-2 spacing (µS)	Pulse 2-3 spacing (µS)	Pulse Start(S)	Detection (1:yes; 0:no)
0	2	19	71.4	1283		0.653229	1
1	2	6	96.5	1835		1.64	
2	2	19	89.3	1143		2.436653	
3	2	10	90.3	1725		3.494389	
4	3	16	99.9	1492	1582	5.040674	
5	2	18	66.5	1639		6.238799	
6	2	7	51	1927		6.938899	
7	2	9	71.8	1831		8.486671	
8	2	20	51.3	1361		9.443717	
9	2	13	90	1485		10.60519	
10	2	20	59	1411		11.518	

Bin5 Statistics 20

Trial #	Pulse	Chirp (MHz)	Pulse Width (µS)	Pulse 1-2 spacing (µS)	Pulse 2-3 spacing (µS)	Pulse Start(S)	Detection (1:yes; 0:no)
0	2	12	86.7	1458		0.406079	1
1	2	12	74.5	1396		0.954657	
2	1	14	89.3			1.805661	
3	2	10	99.1	1987		2.249727	
4	2	15	66.5	1262		3.030542	
5	1	19	99.4			3.68548	
6	2	9	51.8	1208		4.390358	
7	1	17	97.2			5.254204	
8	1	19	88.4			5.88842	
9	3	17	89.3	1529	1295	6.118579	
10	2	7	92.2	1773		6.734208	
11	3	7	59.5	1021	1675	7.433612	
12	1	18	92.9			8.48693	
13	1	15	75.5			8.885805	
14	3	17	91.2	1716	1690	9.770875	
15	2	10	86.9	1675		10.48694	
16	1	10	84.1			11.12985	
17	1	11	93.2			11.52595	

Bin5 Statistics 21

Trial #	Pulse	Chirp (MHz)	Pulse Width (μS)	Pulse 1-2 spacing (uS)	Pulse 2-3 spacing (uS)	Pulse Start(S)	Detection (1:yes; 0:no)
0	3	9	62.5	1060	1494	0.440453	1
1	2	16	91.9	1398		0.839709	
2	3	10	76.6	1965	1883	1.619817	
3	2	19	67.6	1615		2.253118	
4	1	11	87.3			2.64328	
5	3	10	66.6	1890	1827	3.616382	
6	1	20	85.3			4.343088	
7	1	18	80.7			4.551953	
8	2	12	87.8	1936		5.066189	
9	2	15	91.4	1836		6.112925	
10	2	18	63.8	1979		6.609078	
11	1	8	84.4			7.154916	
12	2	16	74	1829		8.063208	
13	2	12	62.8	1714		8.570396	
14	1	7	60.8			8.980453	
15	3	6	90.4	1940	1867	9.77703	
16	1	8	64.7			10.15336	
17	2	6	51.1	1605		10.78717	
18	1	8	62.1			11.66199	

Bin5 Statistics 22

Trial #	Pulse	Chirp (MHz)	Pulse Width (µS)	Pulse 1-2 spacing (µS)	Pulse 2-3 spacing (µS)	Pulse Start(S)	Detection (1:yes; 0:no)
0	1	20	55.1			0.453916	1
1	1	8	54.1			1.422978	
2	3	8	76	1186	1309	1.848464	
3	3	13	74.3	1415	1383	3.374515	
4	2	17	97.1	1475		3.882987	
5	2	17	62.5	1237		4.302974	
6	2	16	63.6	1907		5.844288	
7	2	19	51.2	1163		6.182993	
8	1	14	99.2			7.357134	
9	2	15	50.5	1359		7.789294	
10	1	12	71.8			8.944853	
11	3	12	77.6	1430	1218	9.652362	
12	2	19	54.2	1703		10.41636	
13	2	11	83.5	1333		11.57455	

Bin5 Statistics 23

Trial #	Pulse	Chirp (MHz)	Pulse Width (µS)	Pulse 1-2 spacing (µS)	Pulse 2-3 spacing (µS)	Pulse Start(S)	Detection (1:yes; 0:no)
0	3	10	53.5	1632	1761	0.446165	1
1	2	20	84.6	1950		1.349827	
2	2	11	86.9	1507		2.056069	
3	1	15	96.2			2.754145	
4	3	15	93.9	1360	1402	3.348044	
5	3	11	96.9	1971	1940	3.573241	
6	1	13	96.3			4.454309	
7	3	19	91.5	1477	1900	5.41577	
8	1	10	73.7			6.172761	
9	2	13	66.1	1219		6.578253	
10	3	15	61.8	1257	1655	7.441761	
11	2	14	61.6	1390		8.362886	
12	3	18	64.7	1455	1627	8.958097	
13	3	19	94.1	1031	1527	9.188217	
14	2	6	86.7	1857		10.5068	
15	3	10	98	1154	1859	10.66964	
16	3	15	56	1961	1717	11.67251	
0	3	10	53.5	1632	1761	0.446165	

Bin5 Statistics 24

Trial #	Pulse	Chirp (MHz)	Pulse Width (μS)	Pulse 1-2 spacing (uS)	Pulse 2-3 spacing (uS)	Pulse Start(S)	Detection (1:yes; 0:no)
0	2	19	56.5	1749		0.769279	1
1	3	11	55.1	1668	1816	1.508748	
2	3	16	80.1	1130	1123	3.102108	
3	1	9	91.2			5.284602	
4	2	8	53.4	1947		6.643831	
5	2	15	77.2	1155		7.36049	
6	2	7	56.9	1899		8.212941	
7	2	16	75.2	1077		10.3613	
8	3	17	58.3	1675	1680	11.78929	

Bin5 Statistics 25

Trial #	Pulse	Chirp (MHz)	Pulse Width (μS)	Pulse 1-2 spacing (uS)	Pulse 2-3 spacing (uS)	Pulse Start(S)	Detection (1:yes; 0:no)
0	1	10	88			0.468798	1
1	2	13	92.5	1502		1.063897	
2	2	20	86.6	1308		2.476229	
3	1	17	53.2			3.573303	
4	2	10	52.9	1442		4.315748	
5	3	17	67.6	1512	1661	4.836176	
6	2	5	53.8	1688		5.868988	
7	1	6	87.9			7.160898	
8	2	13	79.6	1206		7.84719	
9	3	15	74.7	1503	1595	8.782054	
10	3	11	54.9	1750	1352	9.353264	
11	2	9	51.7	1586		10.91183	
12	2	8	59.5	1250		11.36882	

Bin5 Statistics 26

Trial #	Pulse	Chirp (MHz)	Pulse Width (μS)	Pulse 1-2 spacing (uS)	Pulse 2-3 spacing (uS)	Pulse Start(S)	Detection (1:yes; 0:no)
0	2	12	95.9	1173		0.706097	1
1	3	15	83.8	1006	1605	0.952847	
2	2	5	79.4	1123		2.332173	
3	1	12	71.8			3.04273	
4	3	13	80.9	1997	1421	4.050199	
5	3	11	69.9	1222	1861	4.792534	
6	3	11	67.5	1463	1857	5.293139	
7	3	20	92.2	1316	1353	6.142554	
8	1	5	55.5			7.262323	
9	1	10	71.8			8.065298	
10	2	19	70.7	1677		9.224773	
11	2	11	52.1	1502		10.15463	
12	2	6	81.9	1921		10.54221	
13	2	17	68.8	1591		11.32391	

Bin5 Statistics 27

Trial #	Pulse	Chirp (MHz)	Pulse Width (μS)	Pulse 1-2 spacing (uS)	Pulse 2-3 spacing (uS)	Pulse Start(S)	Detection (1:yes; 0:no)
0	3	14	62.6	1004	1624	0.344206	1
1	2	18	78.7	1990		2.023207	
2	1	16	51.7			2.747883	
3	2	10	61	1414		3.32401	
4	2	7	81.9	1180		4.835922	
5	3	18	90.4	1857	1775	5.643161	
6	2	10	80.3	1982		6.593518	
7	2	12	90.6	1177		8.592073	
8	1	19	83.7			9.518243	
9	3	14	57.1	1315	1127	10.25176	
10	2	19	76.8	1742		11.21613	
0	3	14	62.6	1004	1624	0.344206	

Bin5 Statistics 28

Trial #	Pulse	Chirp (MHz)	Pulse Width (µS)	Pulse 1-2 spacing (uS)	Pulse 2-3 spacing (uS)	Pulse Start(S)	Detection (1:yes; 0:no)
0	2	14	85.3	1208		1.252349	1
1	3	11	91	1775	1018	2.079064	
2	3	10	91.7	1538	1464	3.579784	
3	1	12	70.3			5.282359	
4	2	15	65.4	1549		6.34531	
5	1	19	71.6			6.748857	
6	2	11	61.8	1197		8.955245	
7	2	17	68.2	1477		10.34809	
8	2	15	71.8	1491		11.10912	

Bin5 Statistics 29

Trial #	Pulse	Chirp (MHz)	Pulse Width (µS)	Pulse 1-2 spacing (uS)	Pulse 2-3 spacing (uS)	Pulse Start(S)	Detection (1:yes; 0:no)
0	3	10	79.5	1221	1794	0.612283	1
1	3	14	81.7	1975	1387	0.814725	
2	2	18	64.6	1256		1.749723	
3	2	13	96.6	1606		2.574953	
4	1	17	55.5			3.195192	
5	3	12	64.4	1960	1020	3.61445	
6	2	8	85.4	1145		4.694039	
7	2	9	58.9	1691		5.274516	
8	3	9	58.9	1276	1608	6.2949	
9	3	7	96.6	1256	1565	6.709622	
10	2	18	92.3	1921		7.294302	
11	2	15	70.1	1932		8.450435	
12	2	14	89.6	1377		8.981104	
13	2	18	88	1331		9.841955	
14	1	18	82			9.913603	
15	2	20	55.2	1243		11.07722	
16	2	17	83.6	1515		11.48381	

Bin5 Statistics 30

Trial #	Pulse	Chirp (MHz)	Pulse Width (μS)	Pulse 1-2 spacing (uS)	Pulse 2-3 spacing (uS)	Pulse Start(S)	Detection (1:yes; 0:no)
0	1	19	55.8			0.524287	1
1	1	7	86.7			1.047645	
2	2	8	62.6	1946		1.831405	
3	3	19	57.1	1545	1374	2.226333	
4	2	15	53.7	1225		3.485348	
5	2	12	55.4	1689		3.573174	
6	2	13	73.5	1085		4.488752	
7	2	12	66.4	1803		5.324407	
8	2	17	76.1	1079		5.647829	
9	2	13	79.9	1080		6.74899	
10	1	16	66.9			7.168387	
11	3	12	65.5	1159	1877	8.091784	
12	3	7	71.9	1176	1197	9.115472	
13	2	19	89.1	1213		9.450809	
14	1	13	67			9.885074	
15	3	7	67.9	1666	1468	10.73634	
16	1	20	97.9			11.81324	

Table-6 Radar Type 6 Statistical Performance

Trial #	Fc (MHz)	Pulse /Burst	Pulse Width (µS)	PRI (µs)	Detection (1:yes; 0:no)	Hopping Sequence
1	5280	9	1	333	1	5616.0, 5695.0, 5278.0, 5456.0, 5398.0, 5523.0, 5528.0, 5346.0, 5504.0, 5327.0, 5513.0, 5485.0, 5338.0, 5552.0, 5477.0, 5627.0, 5667.0, 5697.0, 5698.0, 5715.0, 5600.0, 5668.0, 5518.0, 5648.0, 5529.0, 5372.0, 5645.0, 5691.0, 5432.0, 5439.0, 5612.0, 5331.0, 5716.0, 5351.0, 5318.0, 5566.0, 5394.0, 5279.0, 5479.0, 5623.0, 5348.0, 5298.0, 5416.0, 5454.0, 5689.0, 5615.0, 5604.0, 5656.0, 5685.0, 5321.0, 5340.0, 5303.0, 5433.0, 5660.0, 5423.0, 5618.0, 5487.0, 5509.0, 5389.0, 5573.0, 5281.0, 5273.0, 5540.0, 5651.0, 5413.0, 5274.0, 5705.0, 5548.0, 5360.0, 5478.0, 5335.0, 5336.0, 5617.0, 5633.0, 5553.0, 5436.0, 5492.0, 5565.0, 5418.0, 5551.0, 5653.0, 5272.0, 5469.0, 5536.0, 5367.0, 5448.0, 5639.0, 5435.0, 5579.0, 5652.0, 5425.0, 5484.0, 5550.0, 5584.0, 5721.0, 5415.0, 5379.0, 5589.0, 5682.0, 5400.0 (number of hits: 2)
2	5280	9	1	333	1	5258.0, 5390.0, 5336.0, 5536.0, 5642.0, 5520.0, 5682.0, 5408.0, 5473.0, 5551.0, 5659.0, 5531.0, 5660.0, 5347.0, 5438.0, 5281.0, 5339.0, 5468.0, 5459.0, 5581.0, 5607.0, 5387.0, 5495.0, 5401.0, 5623.0, 5718.0, 5255.0, 5558.0, 5315.0, 5514.0, 5679.0, 5578.0, 5535.0, 5362.0, 5450.0, 5537.0, 5599.0, 5665.0, 5512.0, 5485.0, 5388.0, 5384.0, 5622.0, 5454.0, 5463.0, 5465.0, 5338.0, 5680.0, 5351.0, 5629.0, 5451.0, 5425.0, 5701.0, 5579.0, 5400.0, 5524.0, 5297.0, 5418.0, 5415.0, 5618.0, 5414.0, 5672.0, 5638.0, 5251.0, 5332.0, 5314.0, 5261.0, 5411.0, 5345.0, 5393.0, 5703.0, 5317.0, 5697.0, 5695.0, 5283.0, 5612.0, 5442.0, 5585.0, 5559.0, 5689.0, 5372.0, 5301.0, 5540.0, 5357.0, 5392.0, 5449.0, 5567.0, 5678.0, 5420.0, 5544.0, 5513.0, 5654.0, 5611.0, 5596.0, 5706.0, 5440.0, 5381.0, 5688.0, 5278.0, 5527.0 (number of hits: 3)
3	5280	9	1	333	1	5250.0, 5592.0, 5472.0, 5406.0, 5358.0, 5652.0, 5344.0, 5400.0, 5521.0, 5474.0, 5565.0, 5381.0, 5464.0, 5429.0, 5715.0, 5616.0, 5403.0, 5646.0, 5524.0, 5387.0, 5549.0, 5687.0, 5520.0, 5656.0, 5635.0, 5330.0, 5349.0, 5254.0, 5350.0, 5718.0, 5566.0, 5371.0, 5670.0, 5456.0, 5579.0, 5262.0, 5696.0, 5539.0, 5527.0, 5256.0, 5426.0, 5499.0, 5447.0, 5482.0, 5345.0,

						5673.0, 5586.0, 5278.0, 5440.0, 5575.0, 5388.0, 5304.0, 5471.0, 5369.0, 5325.0, 5284.0, 5334.0, 5587.0, 5286.0, 5415.0, 5515.0, 5380.0, 5518.0, 5291.0, 5627.0, 5255.0, 5570.0, 5573.0, 5390.0, 5513.0, 5425.0, 5323.0, 5414.0, 5270.0, 5675.0, 5654.0, 5514.0, 5401.0, 5663.0, 5341.0, 5545.0, 5294.0, 5454.0, 5469.0, 5572.0, 5554.0, 5333.0, 5497.0, 5684.0, 5485.0, 5475.0, 5689.0, 5619.0, 5582.0, 5537.0, 5509.0, 5463.0, 5506.0, 5373.0, 5630.0 (number of hits: 4)
4	5280	9	1	333	1	5558.0, 5672.0, 5504.0, 5456.0, 5541.0, 5439.0, 5339.0, 5302.0, 5409.0, 5303.0, 5395.0, 5716.0, 5665.0, 5679.0, 5391.0, 5412.0, 5606.0, 5282.0, 5534.0, 5557.0, 5625.0, 5645.0, 5371.0, 5565.0, 5578.0, 5705.0, 5588.0, 5310.0, 5717.0, 5593.0, 5479.0, 5663.0, 5426.0, 5390.0, 5683.0, 5611.0, 5547.0, 5472.0, 5465.0, 5524.0, 5480.0, 5268.0, 5478.0, 5445.0, 5487.0, 5610.0, 5394.0, 5617.0, 5447.0, 5460.0, 5312.0, 5529.0, 5459.0, 5286.0, 5311.0, 5464.0, 5494.0, 5642.0, 5348.0, 5417.0, 5702.0, 5525.0, 5614.0, 5719.0, 5489.0, 5662.0, 5559.0, 5453.0, 5493.0, 5437.0, 5446.0, 5554.0, 5550.0, 5320.0, 5654.0, 5692.0, 5481.0, 5573.0, 5356.0, 5618.0, 5660.0, 5713.0, 5338.0, 5639.0, 5296.0, 5545.0, 5681.0, 5649.0, 5613.0, 5431.0, 5651.0, 5677.0, 5515.0, 5290.0, 5476.0, 5448.0, 5488.0, 5622.0, 5402.0, 5668.0 (number of hits: 8)
5	5280	9	1	333	1	5511.0, 5632.0, 5715.0, 5524.0, 5442.0, 5455.0, 5655.0, 5699.0, 5388.0, 5377.0, 5690.0, 5621.0, 5512.0, 5392.0, 5470.0, 5362.0, 5287.0, 5643.0, 5624.0, 5259.0, 5541.0, 5466.0, 5353.0, 5579.0, 5519.0, 5336.0, 5393.0, 5494.0, 5383.0, 5453.0, 5335.0, 5493.0, 5492.0, 5385.0, 5486.0, 5538.0, 5716.0, 5548.0, 5323.0, 5349.0, 5478.0, 5536.0, 5698.0, 5667.0, 5572.0, 5618.0, 5372.0, 5605.0, 5342.0, 5381.0, 5477.0, 5630.0, 5616.0, 5641.0, 5522.0, 5620.0, 5501.0, 5566.0, 5696.0, 5304.0, 5407.0, 5602.0, 5683.0, 5659.0, 5292.0, 5425.0, 5685.0, 5619.0, 5542.0, 5274.0, 5509.0, 5563.0, 5284.0, 5549.0, 5413.0, 5400.0, 5428.0, 5678.0, 5545.0, 5290.0, 5665.0, 5412.0, 5521.0, 5571.0, 5332.0, 5379.0, 5479.0, 5714.0, 5535.0, 5270.0, 5654.0, 5367.0, 5555.0, 5366.0, 5331.0, 5365.0, 5255.0, 5523.0, 5583.0, 5427.0 (number of hits: 4)
6	5280	9	1	333	1	5493.0, 5333.0, 5418.0, 5432.0, 5487.0, 5417.0, 5314.0, 5692.0, 5284.0, 5268.0,

						5661.0, 5428.0, 5401.0, 5547.0, 5663.0, 5659.0, 5409.0, 5405.0, 5316.0, 5458.0, 5527.0, 5512.0, 5542.0, 5292.0, 5495.0, 5386.0, 5309.0, 5348.0, 5380.0, 5675.0, 5718.0, 5289.0, 5691.0, 5524.0, 5340.0, 5467.0, 5699.0, 5326.0, 5269.0, 5463.0, 5295.0, 5630.0, 5585.0, 5371.0, 5621.0, 5446.0, 5645.0, 5335.0, 5370.0, 5291.0, 5519.0, 5362.0, 5538.0, 5518.0, 5647.0, 5623.0, 5482.0, 5611.0, 5451.0, 5477.0, 5308.0, 5603.0, 5613.0, 5279.0, 5531.0, 5612.0, 5700.0, 5703.0, 5496.0, 5620.0, 5402.0, 5343.0, 5563.0, 5636.0, 5303.0, 5282.0, 5433.0, 5324.0, 5361.0, 5456.0, 5545.0, 5610.0, 5415.0, 5312.0, 5600.0, 5560.0, 5505.0, 5548.0, 5614.0, 5476.0, 5581.0, 5558.0, 5462.0, 5393.0, 5251.0, 5404.0, 5624.0, 5373.0, 5375.0, 5570.0 (number of hits: 9)
7	5280	9	1	333	1	5501.0, 5459.0, 5457.0, 5391.0, 5375.0, 5289.0, 5482.0, 5307.0, 5722.0, 5362.0, 5395.0, 5433.0, 5595.0, 5543.0, 5341.0, 5562.0, 5627.0, 5358.0, 5394.0, 5668.0, 5698.0, 5559.0, 5291.0, 5258.0, 5372.0, 5550.0, 5431.0, 5561.0, 5509.0, 5385.0, 5400.0, 5323.0, 5370.0, 5356.0, 5589.0, 5600.0, 5390.0, 5420.0, 5674.0, 5428.0, 5620.0, 5705.0, 5535.0, 5441.0, 5369.0, 5290.0, 5292.0, 5626.0, 5363.0, 5545.0, 5702.0, 5373.0, 5699.0, 5473.0, 5338.0, 5640.0, 5406.0, 5681.0, 5301.0, 5368.0, 5533.0, 5466.0, 5537.0, 5555.0, 5318.0, 5257.0, 5706.0, 5322.0, 5496.0, 5315.0, 5663.0, 5721.0, 5647.0, 5544.0, 5665.0, 5513.0, 5571.0, 5331.0, 5605.0, 5317.0, 5422.0, 5512.0, 5295.0, 5437.0, 5671.0, 5365.0, 5283.0, 5551.0, 5382.0, 5632.0, 5485.0, 5386.0, 5261.0, 5286.0, 5393.0, 5569.0, 5538.0, 5302.0, 5418.0, 5453.0 (number of hits: 9)
8	5280	9	1	333	1	5522.0, 5677.0, 5446.0, 5390.0, 5538.0, 5455.0, 5707.0, 5619.0, 5662.0, 5543.0, 5587.0, 5560.0, 5369.0, 5252.0, 5348.0, 5675.0, 5712.0, 5361.0, 5318.0, 5466.0, 5652.0, 5336.0, 5709.0, 5438.0, 5520.0, 5293.0, 5498.0, 5555.0, 5551.0, 5304.0, 5328.0, 5534.0, 5660.0, 5515.0, 5644.0, 5526.0, 5381.0, 5406.0, 5639.0, 5263.0, 5352.0, 5388.0, 5545.0, 5282.0, 5542.0, 5358.0, 5341.0, 5679.0, 5532.0, 5676.0, 5530.0, 5325.0, 5383.0, 5408.0, 5364.0, 5384.0, 5616.0, 5255.0, 5673.0, 5603.0, 5423.0, 5393.0, 5256.0, 5686.0, 5715.0, 5371.0, 5470.0, 5436.0, 5636.0, 5394.0, 5488.0, 5711.0, 5547.0, 5625.0, 5289.0, 5378.0, 5415.0, 5525.0, 5503.0, 5464.0,

						5494.0, 5623.0, 5340.0, 5303.0, 5507.0, 5425.0, 5607.0, 5713.0, 5422.0, 5483.0, 5398.0, 5630.0, 5295.0, 5420.0, 5531.0, 5311.0, 5286.0, 5284.0, 5258.0, 5720.0 (number of hits: 7)
9	5280	9	1	333	1	5661.0, 5701.0, 5600.0, 5567.0, 5625.0, 5253.0, 5256.0, 5490.0, 5472.0, 5257.0, 5527.0, 5486.0, 5539.0, 5664.0, 5610.0, 5447.0, 5474.0, 5467.0, 5532.0, 5575.0, 5473.0, 5547.0, 5707.0, 5340.0, 5431.0, 5540.0, 5351.0, 5435.0, 5500.0, 5367.0, 5488.0, 5444.0, 5596.0, 5672.0, 5436.0, 5520.0, 5314.0, 5669.0, 5365.0, 5437.0, 5637.0, 5708.0, 5702.0, 5641.0, 5559.0, 5689.0, 5273.0, 5455.0, 5396.0, 5395.0, 5429.0, 5544.0, 5658.0, 5451.0, 5259.0, 5283.0, 5336.0, 5324.0, 5536.0, 5416.0, 5603.0, 5721.0, 5408.0, 5420.0, 5288.0, 5618.0, 5299.0, 5306.0, 5531.0, 5422.0, 5381.0, 5515.0, 5691.0, 5570.0, 5533.0, 5607.0, 5508.0, 5606.0, 5311.0, 5619.0, 5643.0, 5271.0, 5413.0, 5418.0, 5482.0, 5289.0, 5407.0, 5682.0, 5333.0, 5291.0, 5479.0, 5443.0, 5464.0, 5448.0, 5388.0, 5622.0, 5560.0, 5667.0, 5355.0, 5411.0 (number of hits: 7)
10	5280	9	1	333	1	5697.0, 5669.0, 5657.0, 5376.0, 5484.0, 5290.0, 5498.0, 5700.0, 5366.0, 5537.0, 5608.0, 5518.0, 5466.0, 5450.0, 5642.0, 5551.0, 5318.0, 5688.0, 5541.0, 5454.0, 5370.0, 5613.0, 5644.0, 5399.0, 5559.0, 5405.0, 5413.0, 5495.0, 5395.0, 5508.0, 5540.0, 5723.0, 5574.0, 5402.0, 5486.0, 5312.0, 5661.0, 5668.0, 5309.0, 5479.0, 5288.0, 5330.0, 5387.0, 5473.0, 5721.0, 5401.0, 5465.0, 5396.0, 5414.0, 5322.0, 5406.0, 5528.0, 5259.0, 5577.0, 5641.0, 5385.0, 5719.0, 5506.0, 5571.0, 5629.0, 5426.0, 5512.0, 5296.0, 5580.0, 5635.0, 5349.0, 5598.0, 5600.0, 5444.0, 5595.0, 5471.0, 5411.0, 5499.0, 5604.0, 5542.0, 5485.0, 5443.0, 5372.0, 5494.0, 5654.0, 5710.0, 5556.0, 5254.0, 5561.0, 5720.0, 5409.0, 5329.0, 5323.0, 5392.0, 5659.0, 5350.0, 5546.0, 5522.0, 5679.0, 5573.0, 5563.0, 5715.0, 5614.0, 5334.0, 5539.0 (number of hits: 5)
11	5280	9	1	333	1	5711.0, 5659.0, 5328.0, 5425.0, 5499.0, 5287.0, 5390.0, 5680.0, 5511.0, 5724.0, 5475.0, 5317.0, 5338.0, 5441.0, 5538.0, 5664.0, 5686.0, 5281.0, 5644.0, 5667.0, 5385.0, 5275.0, 5585.0, 5693.0, 5416.0, 5598.0, 5367.0, 5646.0, 5645.0, 5637.0, 5514.0, 5433.0, 5505.0, 5329.0, 5719.0, 5653.0, 5315.0, 5497.0, 5632.0, 5305.0, 5562.0, 5358.0, 5690.0, 5524.0, 5595.0,

						5417.0, 5523.0, 5372.0, 5651.0, 5254.0, 5658.0, 5600.0, 5604.0, 5546.0, 5714.0, 5584.0, 5453.0, 5267.0, 5619.0, 5268.0, 5466.0, 5608.0, 5509.0, 5400.0, 5513.0, 5623.0, 5414.0, 5721.0, 5368.0, 5354.0, 5703.0, 5647.0, 5576.0, 5382.0, 5424.0, 5412.0, 5464.0, 5469.0, 5568.0, 5373.0, 5401.0, 5541.0, 5547.0, 5376.0, 5256.0, 5549.0, 5503.0, 5571.0, 5668.0, 5418.0, 5308.0, 5683.0, 5340.0, 5456.0, 5527.0, 5577.0, 5633.0, 5438.0, 5594.0, 5531.0 (number of hits: 3)
12	5280	9	1	333	1	5399.0, 5613.0, 5344.0, 5635.0, 5449.0, 5674.0, 5489.0, 5379.0, 5412.0, 5447.0, 5507.0, 5649.0, 5557.0, 5278.0, 5541.0, 5657.0, 5605.0, 5508.0, 5370.0, 5646.0, 5683.0, 5639.0, 5299.0, 5586.0, 5523.0, 5504.0, 5669.0, 5558.0, 5678.0, 5626.0, 5479.0, 5596.0, 5482.0, 5574.0, 5397.0, 5476.0, 5483.0, 5400.0, 5655.0, 5711.0, 5259.0, 5494.0, 5446.0, 5481.0, 5581.0, 5645.0, 5276.0, 5383.0, 5421.0, 5392.0, 5361.0, 5295.0, 5296.0, 5281.0, 5485.0, 5676.0, 5408.0, 5527.0, 5279.0, 5528.0, 5273.0, 5437.0, 5424.0, 5687.0, 5463.0, 5420.0, 5445.0, 5395.0, 5614.0, 5690.0, 5298.0, 5349.0, 5652.0, 5411.0, 5402.0, 5529.0, 5599.0, 5500.0, 5440.0, 5453.0, 5670.0, 5257.0, 5716.0, 5717.0, 5561.0, 5707.0, 5351.0, 5317.0, 5372.0, 5343.0, 5480.0, 5612.0, 5459.0, 5570.0, 5712.0, 5318.0, 5387.0, 5417.0, 5425.0, 5326.0 (number of hits: 4)
13	5280	9	1	333	1	5400.0, 5572.0, 5323.0, 5351.0, 5542.0, 5562.0, 5631.0, 5261.0, 5688.0, 5445.0, 5355.0, 5366.0, 5357.0, 5332.0, 5504.0, 5262.0, 5454.0, 5606.0, 5396.0, 5616.0, 5393.0, 5723.0, 5598.0, 5601.0, 5641.0, 5481.0, 5693.0, 5307.0, 5371.0, 5704.0, 5715.0, 5540.0, 5463.0, 5377.0, 5382.0, 5687.0, 5360.0, 5440.0, 5699.0, 5525.0, 5509.0, 5679.0, 5505.0, 5493.0, 5554.0, 5404.0, 5689.0, 5446.0, 5614.0, 5582.0, 5361.0, 5717.0, 5657.0, 5312.0, 5652.0, 5387.0, 5348.0, 5647.0, 5602.0, 5546.0, 5673.0, 5662.0, 5547.0, 5293.0, 5335.0, 5711.0, 5370.0, 5514.0, 5635.0, 5250.0, 5418.0, 5645.0, 5373.0, 5321.0, 5315.0, 5464.0, 5586.0, 5272.0, 5522.0, 5479.0, 5701.0, 5297.0, 5604.0, 5553.0, 5356.0, 5489.0, 5437.0, 5325.0, 5384.0, 5345.0, 5394.0, 5474.0, 5506.0, 5306.0, 5543.0, 5675.0, 5305.0, 5633.0, 5709.0, 5495.0 (number of hits: 6)
14	5280	9	1	333	1	5521.0, 5549.0, 5517.0, 5616.0, 5585.0, 5450.0, 5524.0, 5539.0, 5600.0, 5709.0,

						5604.0, 5431.0, 5350.0, 5366.0, 5493.0, 5340.0, 5571.0, 5511.0, 5353.0, 5285.0, 5274.0, 5348.0, 5473.0, 5280.0, 5426.0, 5592.0, 5311.0, 5325.0, 5508.0, 5453.0, 5580.0, 5307.0, 5575.0, 5394.0, 5538.0, 5510.0, 5413.0, 5317.0, 5577.0, 5279.0, 5649.0, 5589.0, 5638.0, 5468.0, 5271.0, 5425.0, 5388.0, 5302.0, 5455.0, 5599.0, 5613.0, 5266.0, 5641.0, 5272.0, 5342.0, 5596.0, 5344.0, 5548.0, 5560.0, 5405.0, 5323.0, 5568.0, 5563.0, 5398.0, 5416.0, 5265.0, 5381.0, 5375.0, 5542.0, 5386.0, 5314.0, 5496.0, 5601.0, 5677.0, 5534.0, 5299.0, 5553.0, 5364.0, 5262.0, 5718.0, 5527.0, 5408.0, 5415.0, 5642.0, 5438.0, 5635.0, 5612.0, 5460.0, 5449.0, 5576.0, 5622.0, 5400.0, 5273.0, 5572.0, 5678.0, 5631.0, 5706.0, 5526.0, 5255.0, 5514.0 (number of hits: 6)
15	5280	9	1	333	1	5491.0, 5455.0, 5316.0, 5370.0, 5381.0, 5536.0, 5583.0, 5473.0, 5403.0, 5386.0, 5535.0, 5578.0, 5419.0, 5518.0, 5697.0, 5442.0, 5402.0, 5420.0, 5363.0, 5255.0, 5580.0, 5379.0, 5400.0, 5298.0, 5496.0, 5483.0, 5326.0, 5439.0, 5714.0, 5555.0, 5437.0, 5575.0, 5264.0, 5620.0, 5362.0, 5560.0, 5274.0, 5629.0, 5657.0, 5304.0, 5406.0, 5619.0, 5355.0, 5588.0, 5711.0, 5398.0, 5572.0, 5652.0, 5392.0, 5719.0, 5486.0, 5263.0, 5649.0, 5281.0, 5359.0, 5698.0, 5505.0, 5517.0, 5553.0, 5484.0, 5502.0, 5472.0, 5318.0, 5718.0, 5366.0, 5385.0, 5658.0, 5682.0, 5476.0, 5259.0, 5571.0, 5596.0, 5488.0, 5413.0, 5686.0, 5322.0, 5438.0, 5695.0, 5556.0, 5498.0, 5529.0, 5547.0, 5324.0, 5562.0, 5404.0, 5506.0, 5266.0, 5377.0, 5568.0, 5544.0, 5378.0, 5656.0, 5716.0, 5414.0, 5713.0, 5466.0, 5272.0, 5590.0, 5313.0, 5546.0 (number of hits: 3)
16	5280	9	1	333	1	5653.0, 5661.0, 5588.0, 5595.0, 5498.0, 5673.0, 5343.0, 5367.0, 5716.0, 5640.0, 5352.0, 5646.0, 5411.0, 5723.0, 5323.0, 5614.0, 5540.0, 5530.0, 5500.0, 5372.0, 5307.0, 5292.0, 5408.0, 5377.0, 5283.0, 5334.0, 5355.0, 5557.0, 5584.0, 5431.0, 5722.0, 5393.0, 5566.0, 5391.0, 5717.0, 5658.0, 5278.0, 5295.0, 5488.0, 5599.0, 5657.0, 5327.0, 5270.0, 5683.0, 5641.0, 5609.0, 5257.0, 5601.0, 5437.0, 5311.0, 5611.0, 5638.0, 5508.0, 5294.0, 5376.0, 5543.0, 5527.0, 5465.0, 5273.0, 5534.0, 5253.0, 5269.0, 5552.0, 5390.0, 5635.0, 5510.0, 5422.0, 5416.0, 5577.0, 5512.0, 5429.0, 5335.0, 5520.0, 5720.0, 5536.0, 5478.0, 5506.0, 5655.0, 5648.0, 5697.0,

						5483.0, 5410.0, 5346.0, 5296.0, 5714.0, 5684.0, 5703.0, 5382.0, 5569.0, 5688.0, 5351.0, 5387.0, 5398.0, 5564.0, 5362.0, 5282.0, 5669.0, 5592.0, 5459.0, 5297.0 (number of hits: 7)
17	5280	9	1	333	1	5611.0, 5465.0, 5392.0, 5458.0, 5707.0, 5457.0, 5677.0, 5644.0, 5486.0, 5362.0, 5261.0, 5590.0, 5521.0, 5273.0, 5503.0, 5535.0, 5681.0, 5720.0, 5543.0, 5426.0, 5461.0, 5447.0, 5558.0, 5256.0, 5250.0, 5452.0, 5308.0, 5723.0, 5539.0, 5617.0, 5357.0, 5459.0, 5309.0, 5640.0, 5297.0, 5696.0, 5386.0, 5349.0, 5260.0, 5537.0, 5327.0, 5343.0, 5580.0, 5610.0, 5323.0, 5379.0, 5318.0, 5627.0, 5348.0, 5371.0, 5324.0, 5284.0, 5335.0, 5715.0, 5455.0, 5650.0, 5666.0, 5575.0, 5427.0, 5407.0, 5544.0, 5697.0, 5398.0, 5446.0, 5717.0, 5561.0, 5491.0, 5454.0, 5307.0, 5603.0, 5374.0, 5393.0, 5319.0, 5557.0, 5264.0, 5631.0, 5377.0, 5300.0, 5534.0, 5315.0, 5312.0, 5711.0, 5487.0, 5679.0, 5289.0, 5354.0, 5504.0, 5370.0, 5556.0, 5508.0, 5512.0, 5678.0, 5507.0, 5267.0, 5497.0, 5693.0, 5639.0, 5569.0, 5288.0, 5448.0 (number of hits: 8)
18	5280	9	1	333	1	5431.0, 5544.0, 5556.0, 5703.0, 5305.0, 5402.0, 5494.0, 5412.0, 5285.0, 5303.0, 5610.0, 5267.0, 5511.0, 5553.0, 5481.0, 5309.0, 5406.0, 5671.0, 5296.0, 5574.0, 5389.0, 5361.0, 5502.0, 5678.0, 5510.0, 5276.0, 5528.0, 5416.0, 5433.0, 5704.0, 5483.0, 5561.0, 5629.0, 5565.0, 5264.0, 5458.0, 5551.0, 5710.0, 5651.0, 5660.0, 5583.0, 5597.0, 5504.0, 5451.0, 5448.0, 5539.0, 5447.0, 5618.0, 5459.0, 5485.0, 5269.0, 5500.0, 5398.0, 5350.0, 5258.0, 5469.0, 5683.0, 5312.0, 5722.0, 5643.0, 5277.0, 5450.0, 5375.0, 5322.0, 5657.0, 5356.0, 5622.0, 5615.0, 5575.0, 5530.0, 5523.0, 5646.0, 5701.0, 5284.0, 5260.0, 5491.0, 5349.0, 5659.0, 5497.0, 5644.0, 5300.0, 5694.0, 5330.0, 5695.0, 5667.0, 5623.0, 5383.0, 5662.0, 5427.0, 5419.0, 5326.0, 5297.0, 5624.0, 5334.0, 5401.0, 5408.0, 5380.0, 5256.0, 5538.0, 5604.0 (number of hits: 8)
19	5280	9	1	333	1	5309.0, 5579.0, 5362.0, 5614.0, 5626.0, 5451.0, 5482.0, 5424.0, 5532.0, 5515.0, 5713.0, 5570.0, 5319.0, 5661.0, 5317.0, 5505.0, 5584.0, 5558.0, 5369.0, 5366.0, 5494.0, 5632.0, 5488.0, 5645.0, 5677.0, 5529.0, 5653.0, 5684.0, 5681.0, 5427.0, 5468.0, 5429.0, 5382.0, 5668.0, 5358.0, 5378.0, 5452.0, 5493.0, 5504.0, 5282.0, 5613.0, 5609.0, 5629.0, 5313.0, 5400.0,

						5438.0, 5255.0, 5545.0, 5414.0, 5621.0, 5573.0, 5688.0, 5708.0, 5257.0, 5516.0, 5704.0, 5371.0, 5590.0, 5544.0, 5599.0, 5518.0, 5627.0, 5659.0, 5634.0, 5392.0, 5364.0, 5337.0, 5519.0, 5701.0, 5462.0, 5646.0, 5581.0, 5363.0, 5608.0, 5288.0, 5559.0, 5691.0, 5524.0, 5444.0, 5286.0, 5365.0, 5459.0, 5280.0, 5619.0, 5436.0, 5332.0, 5384.0, 5479.0, 5387.0, 5419.0, 5560.0, 5328.0, 5269.0, 5639.0, 5594.0, 5678.0, 5702.0, 5710.0, 5291.0, 5277.0 (number of hits: 5)
20	5280	9	1	333	1	5310.0, 5571.0, 5482.0, 5622.0, 5254.0, 5468.0, 5350.0, 5456.0, 5559.0, 5723.0, 5276.0, 5582.0, 5424.0, 5629.0, 5476.0, 5312.0, 5384.0, 5563.0, 5368.0, 5643.0, 5408.0, 5413.0, 5644.0, 5398.0, 5415.0, 5395.0, 5277.0, 5324.0, 5437.0, 5607.0, 5348.0, 5453.0, 5486.0, 5483.0, 5719.0, 5675.0, 5541.0, 5370.0, 5469.0, 5356.0, 5485.0, 5496.0, 5457.0, 5686.0, 5545.0, 5546.0, 5423.0, 5694.0, 5362.0, 5705.0, 5256.0, 5421.0, 5329.0, 5334.0, 5449.0, 5389.0, 5491.0, 5503.0, 5565.0, 5478.0, 5542.0, 5506.0, 5382.0, 5363.0, 5673.0, 5613.0, 5302.0, 5597.0, 5365.0, 5618.0, 5510.0, 5499.0, 5564.0, 5344.0, 5505.0, 5693.0, 5369.0, 5556.0, 5381.0, 5475.0, 5309.0, 5323.0, 5371.0, 5678.0, 5624.0, 5400.0, 5494.0, 5711.0, 5258.0, 5443.0, 5533.0, 5538.0, 5263.0, 5442.0, 5464.0, 5463.0, 5598.0, 5661.0, 5352.0, 5708.0 (number of hits: 4)
21	5280	9	1	333	1	5663.0, 5391.0, 5437.0, 5718.0, 5701.0, 5703.0, 5616.0, 5573.0, 5561.0, 5528.0, 5347.0, 5595.0, 5592.0, 5350.0, 5394.0, 5566.0, 5408.0, 5710.0, 5555.0, 5337.0, 5666.0, 5390.0, 5479.0, 5682.0, 5273.0, 5285.0, 5530.0, 5589.0, 5612.0, 5539.0, 5668.0, 5363.0, 5463.0, 5274.0, 5278.0, 5490.0, 5290.0, 5438.0, 5655.0, 5523.0, 5387.0, 5477.0, 5593.0, 5433.0, 5443.0, 5321.0, 5557.0, 5482.0, 5484.0, 5493.0, 5594.0, 5609.0, 5478.0, 5524.0, 5635.0, 5250.0, 5534.0, 5711.0, 5267.0, 5516.0, 5471.0, 5697.0, 5492.0, 5532.0, 5619.0, 5309.0, 5567.0, 5352.0, 5326.0, 5404.0, 5636.0, 5340.0, 5540.0, 5627.0, 5322.0, 5660.0, 5289.0, 5590.0, 5545.0, 5402.0, 5702.0, 5714.0, 5648.0, 5546.0, 5325.0, 5596.0, 5639.0, 5560.0, 5574.0, 5657.0, 5588.0, 5400.0, 5417.0, 5434.0, 5488.0, 5483.0, 5295.0, 5468.0, 5472.0, 5496.0 (number of hits: 5)
22	5280	9	1	333	1	5267.0, 5625.0, 5476.0, 5360.0, 5321.0, 5431.0, 5679.0, 5549.0, 5502.0, 5660.0,

						5482.0, 5669.0, 5432.0, 5646.0, 5415.0, 5540.0, 5719.0, 5473.0, 5600.0, 5294.0, 5366.0, 5574.0, 5293.0, 5324.0, 5370.0, 5344.0, 5670.0, 5635.0, 5533.0, 5412.0, 5441.0, 5595.0, 5390.0, 5368.0, 5271.0, 5637.0, 5498.0, 5493.0, 5605.0, 5705.0, 5717.0, 5255.0, 5414.0, 5491.0, 5713.0, 5667.0, 5438.0, 5675.0, 5322.0, 5351.0, 5636.0, 5433.0, 5449.0, 5578.0, 5486.0, 5372.0, 5446.0, 5524.0, 5314.0, 5722.0, 5329.0, 5315.0, 5480.0, 5716.0, 5299.0, 5385.0, 5525.0, 5512.0, 5664.0, 5347.0, 5628.0, 5489.0, 5527.0, 5519.0, 5642.0, 5653.0, 5302.0, 5381.0, 5514.0, 5583.0, 5430.0, 5501.0, 5252.0, 5439.0, 5562.0, 5316.0, 5447.0, 5497.0, 5661.0, 5273.0, 5643.0, 5619.0, 5424.0, 5442.0, 5557.0, 5662.0, 5445.0, 5657.0, 5563.0, 5358.0 (number of hits: 5)
23	5280	9	1	333	1	5462.0, 5497.0, 5484.0, 5317.0, 5266.0, 5447.0, 5565.0, 5554.0, 5315.0, 5361.0, 5448.0, 5701.0, 5602.0, 5589.0, 5603.0, 5615.0, 5407.0, 5564.0, 5382.0, 5429.0, 5253.0, 5473.0, 5305.0, 5444.0, 5657.0, 5402.0, 5276.0, 5378.0, 5418.0, 5601.0, 5537.0, 5526.0, 5672.0, 5323.0, 5262.0, 5477.0, 5570.0, 5369.0, 5677.0, 5637.0, 5375.0, 5621.0, 5585.0, 5541.0, 5515.0, 5426.0, 5517.0, 5451.0, 5357.0, 5583.0, 5414.0, 5303.0, 5368.0, 5401.0, 5273.0, 5434.0, 5519.0, 5277.0, 5606.0, 5498.0, 5690.0, 5287.0, 5512.0, 5342.0, 5446.0, 5628.0, 5424.0, 5640.0, 5490.0, 5625.0, 5711.0, 5666.0, 5449.0, 5263.0, 5309.0, 5656.0, 5670.0, 5619.0, 5706.0, 5516.0, 5364.0, 5362.0, 5492.0, 5373.0, 5351.0, 5588.0, 5409.0, 5599.0, 5321.0, 5650.0, 5328.0, 5483.0, 5529.0, 5302.0, 5504.0, 5713.0, 5395.0, 5433.0, 5500.0, 5687.0 (number of hits: 5)
24	5280	9	1	333	0	5605.0, 5412.0, 5521.0, 5431.0, 5564.0, 5602.0, 5616.0, 5266.0, 5659.0, 5436.0, 5445.0, 5567.0, 5550.0, 5494.0, 5575.0, 5698.0, 5450.0, 5270.0, 5409.0, 5720.0, 5273.0, 5276.0, 5425.0, 5688.0, 5378.0, 5359.0, 5250.0, 5323.0, 5618.0, 5572.0, 5615.0, 5685.0, 5630.0, 5524.0, 5347.0, 5465.0, 5671.0, 5646.0, 5596.0, 5278.0, 5586.0, 5466.0, 5422.0, 5512.0, 5405.0, 5509.0, 5519.0, 5667.0, 5338.0, 5275.0, 5361.0, 5568.0, 5437.0, 5706.0, 5303.0, 5375.0, 5689.0, 5482.0, 5374.0, 5449.0, 5656.0, 5393.0, 5711.0, 5272.0, 5324.0, 5591.0, 5653.0, 5686.0, 5367.0, 5608.0, 5552.0, 5381.0, 5427.0, 5673.0, 5693.0, 5477.0, 5310.0, 5290.0, 5423.0, 5647.0,

						5402.0, 5417.0, 5468.0, 5650.0, 5334.0, 5262.0, 5358.0, 5400.0, 5253.0, 5613.0, 5420.0, 5428.0, 5577.0, 5501.0, 5458.0, 5606.0, 5460.0, 5399.0, 5472.0, 5644.0 (number of hits: 3)
25	5280	9	1	333	1	5668.0, 5533.0, 5252.0, 5309.0, 5471.0, 5429.0, 5286.0, 5350.0, 5609.0, 5660.0, 5592.0, 5326.0, 5291.0, 5320.0, 5264.0, 5619.0, 5714.0, 5671.0, 5393.0, 5384.0, 5310.0, 5504.0, 5494.0, 5468.0, 5653.0, 5464.0, 5685.0, 5293.0, 5452.0, 5538.0, 5525.0, 5481.0, 5657.0, 5285.0, 5554.0, 5386.0, 5598.0, 5256.0, 5687.0, 5705.0, 5353.0, 5456.0, 5579.0, 5521.0, 5358.0, 5560.0, 5585.0, 5274.0, 5635.0, 5679.0, 5654.0, 5363.0, 5422.0, 5713.0, 5526.0, 5265.0, 5697.0, 5301.0, 5717.0, 5484.0, 5633.0, 5531.0, 5542.0, 5480.0, 5425.0, 5314.0, 5530.0, 5372.0, 5357.0, 5403.0, 5387.0, 5624.0, 5343.0, 5580.0, 5575.0, 5409.0, 5675.0, 5700.0, 5297.0, 5304.0, 5546.0, 5255.0, 5318.0, 5278.0, 5618.0, 5410.0, 5458.0, 5499.0, 5298.0, 5467.0, 5489.0, 5544.0, 5678.0, 5349.0, 5330.0, 5415.0, 5315.0, 5442.0, 5639.0, 5632.0 (number of hits: 11)
26	5280	9	1	333	1	5412.0, 5269.0, 5475.0, 5625.0, 5517.0, 5302.0, 5479.0, 5558.0, 5638.0, 5667.0, 5432.0, 5261.0, 5360.0, 5721.0, 5454.0, 5657.0, 5590.0, 5697.0, 5314.0, 5693.0, 5425.0, 5691.0, 5379.0, 5610.0, 5407.0, 5702.0, 5711.0, 5456.0, 5325.0, 5492.0, 5306.0, 5561.0, 5298.0, 5612.0, 5683.0, 5640.0, 5277.0, 5591.0, 5601.0, 5511.0, 5332.0, 5473.0, 5415.0, 5284.0, 5487.0, 5297.0, 5312.0, 5715.0, 5323.0, 5587.0, 5295.0, 5599.0, 5543.0, 5598.0, 5421.0, 5476.0, 5346.0, 5585.0, 5386.0, 5673.0, 5488.0, 5562.0, 5321.0, 5356.0, 5630.0, 5317.0, 5554.0, 5609.0, 5576.0, 5710.0, 5313.0, 5481.0, 5665.0, 5551.0, 5719.0, 5696.0, 5288.0, 5690.0, 5307.0, 5519.0, 5647.0, 5342.0, 5520.0, 5385.0, 5290.0, 5641.0, 5593.0, 5707.0, 5371.0, 5584.0, 5695.0, 5251.0, 5362.0, 5701.0, 5396.0, 5292.0, 5678.0, 5461.0, 5627.0, 5274.0 (number of hits: 12)
27	5280	9	1	333	1	5652.0, 5441.0, 5359.0, 5640.0, 5424.0, 5315.0, 5348.0, 5489.0, 5554.0, 5667.0, 5709.0, 5474.0, 5380.0, 5373.0, 5712.0, 5625.0, 5384.0, 5427.0, 5360.0, 5644.0, 5334.0, 5284.0, 5696.0, 5428.0, 5433.0, 5420.0, 5713.0, 5385.0, 5537.0, 5688.0, 5671.0, 5481.0, 5346.0, 5475.0, 5400.0, 5719.0, 5404.0, 5500.0, 5633.0, 5534.0, 5273.0, 5552.0, 5622.0, 5588.0, 5578.0,

						5609.0, 5689.0, 5448.0, 5437.0, 5498.0, 5294.0, 5403.0, 5507.0, 5453.0, 5256.0, 5525.0, 5701.0, 5639.0, 5612.0, 5337.0, 5326.0, 5362.0, 5413.0, 5300.0, 5418.0, 5634.0, 5290.0, 5325.0, 5387.0, 5610.0, 5536.0, 5656.0, 5298.0, 5257.0, 5604.0, 5446.0, 5381.0, 5347.0, 5365.0, 5608.0, 5683.0, 5590.0, 5378.0, 5292.0, 5651.0, 5277.0, 5687.0, 5568.0, 5630.0, 5390.0, 5313.0, 5263.0, 5662.0, 5556.0, 5597.0, 5562.0, 5461.0, 5327.0, 5472.0, 5350.0 (number of hits: 6)
28	5280	9	1	333	1	5375.0, 5442.0, 5257.0, 5639.0, 5354.0, 5433.0, 5679.0, 5551.0, 5293.0, 5411.0, 5579.0, 5664.0, 5595.0, 5589.0, 5584.0, 5348.0, 5636.0, 5409.0, 5444.0, 5621.0, 5532.0, 5520.0, 5254.0, 5378.0, 5571.0, 5533.0, 5574.0, 5283.0, 5601.0, 5264.0, 5407.0, 5345.0, 5434.0, 5712.0, 5418.0, 5366.0, 5402.0, 5626.0, 5360.0, 5462.0, 5466.0, 5397.0, 5370.0, 5384.0, 5256.0, 5392.0, 5613.0, 5494.0, 5369.0, 5622.0, 5562.0, 5633.0, 5582.0, 5351.0, 5545.0, 5498.0, 5281.0, 5630.0, 5435.0, 5359.0, 5721.0, 5473.0, 5598.0, 5289.0, 5694.0, 5454.0, 5512.0, 5315.0, 5326.0, 5602.0, 5590.0, 5563.0, 5615.0, 5540.0, 5381.0, 5519.0, 5439.0, 5481.0, 5388.0, 5299.0, 5656.0, 5317.0, 5368.0, 5506.0, 5413.0, 5335.0, 5685.0, 5446.0, 5313.0, 5342.0, 5525.0, 5547.0, 5502.0, 5675.0, 5555.0, 5629.0, 5319.0, 5696.0, 5645.0, 5534.0 (number of hits: 4)
29	5280	9	1	333	1	5719.0, 5635.0, 5350.0, 5434.0, 5466.0, 5340.0, 5565.0, 5381.0, 5547.0, 5688.0, 5250.0, 5512.0, 5717.0, 5389.0, 5573.0, 5472.0, 5264.0, 5393.0, 5406.0, 5418.0, 5622.0, 5433.0, 5696.0, 5263.0, 5620.0, 5538.0, 5680.0, 5703.0, 5394.0, 5362.0, 5708.0, 5628.0, 5533.0, 5313.0, 5588.0, 5709.0, 5692.0, 5430.0, 5396.0, 5342.0, 5684.0, 5669.0, 5606.0, 5385.0, 5298.0, 5349.0, 5522.0, 5615.0, 5333.0, 5603.0, 5300.0, 5650.0, 5561.0, 5475.0, 5542.0, 5405.0, 5711.0, 5415.0, 5681.0, 5372.0, 5480.0, 5285.0, 5409.0, 5525.0, 5473.0, 5462.0, 5339.0, 5321.0, 5276.0, 5258.0, 5507.0, 5465.0, 5623.0, 5332.0, 5607.0, 5583.0, 5295.0, 5412.0, 5552.0, 5537.0, 5557.0, 5273.0, 5636.0, 5683.0, 5673.0, 5435.0, 5262.0, 5392.0, 5477.0, 5272.0, 5444.0, 5578.0, 5686.0, 5652.0, 5348.0, 5476.0, 5629.0, 5587.0, 5279.0, 5539.0 (number of hits: 5)
30	5280	9	1	333	1	5646.0, 5338.0, 5685.0, 5512.0, 5656.0, 5638.0, 5435.0, 5421.0, 5643.0, 5366.0,

						5699.0, 5392.0, 5487.0, 5698.0, 5543.0, 5536.0, 5525.0, 5684.0, 5374.0, 5426.0, 5544.0, 5274.0, 5607.0, 5279.0, 5430.0, 5660.0, 5438.0, 5378.0, 5627.0, 5451.0, 5686.0, 5531.0, 5377.0, 5445.0, 5669.0, 5478.0, 5444.0, 5574.0, 5293.0, 5442.0, 5631.0, 5480.0, 5355.0, 5495.0, 5644.0, 5605.0, 5502.0, 5484.0, 5301.0, 5657.0, 5266.0, 5577.0, 5562.0, 5600.0, 5633.0, 5429.0, 5317.0, 5410.0, 5475.0, 5589.0, 5252.0, 5719.0, 5391.0, 5578.0, 5628.0, 5264.0, 5356.0, 5280.0, 5642.0, 5420.0, 5423.0, 5336.0, 5701.0, 5437.0, 5533.0, 5453.0, 5358.0, 5357.0, 5566.0, 5408.0, 5587.0, 5595.0, 5304.0, 5490.0, 5270.0, 5369.0, 5571.0, 5714.0, 5526.0, 5409.0, 5483.0, 5276.0, 5497.0, 5527.0, 5700.0, 5659.0, 5551.0, 5447.0, 5507.0, 5519.0 (number of hits: 3)
--	--	--	--	--	--	---

5580 MHz

Radar Signal Type	Waveform/Trial Number	Detection (%)	Limit (%)	Pass/Fail
Type 1	30	100 %	60%	Pass
Type 2	30	86.7 %	60%	Pass
Type 3	30	100 %	60%	Pass
Type 4	30	100 %	60%	Pass
Type 5	30	100 %	80%	Pass
Type 6	30	100 %	70%	Pass

Please refer to the following statistical tables:

Table-1 Radar Type 1 Statistical Performance

Trial #	Fc (MHz)	Pulse/Burst	Pulse Width (μS)	PRI (μs)	Detection (1:yes; 0:no)
1	5580	18	1	1428	1
2	5580	18	1	1428	1
3	5580	18	1	1428	1
4	5580	18	1	1428	1
5	5580	18	1	1428	1
6	5580	18	1	1428	1
7	5580	18	1	1428	1
8	5580	18	1	1428	1
9	5580	18	1	1428	1
10	5580	18	1	1428	1
11	5580	18	1	1428	1
12	5580	18	1	1428	1
13	5580	18	1	1428	1
14	5580	18	1	1428	1
15	5580	18	1	1428	1
16	5580	18	1	1428	1
17	5580	18	1	1428	1
18	5580	18	1	1428	1
19	5580	18	1	1428	1
20	5580	18	1	1428	1
21	5580	18	1	1428	1
22	5580	18	1	1428	1
23	5580	18	1	1428	1
24	5580	18	1	1428	1
25	5580	18	1	1428	1
26	5580	18	1	1428	1
27	5580	18	1	1428	1
28	5580	18	1	1428	1
29	5580	18	1	1428	1
30	5580	18	1	1428	1
Detection Percentage: 100 % (>60%)					

Table-2 Radar Type 2 Statistical Performance

Trial #	Fc (MHz)	Pulse/Burst	Pulse Width (μS)	PRI (μs)	Detection (1:yes; 0:no)
1	5580	24	3.5	203	1
2	5580	25	5	228	1
3	5580	28	3.5	216	1
4	5580	26	4	154	1
5	5580	26	2.4	212	1
6	5580	24	4.2	230	1
7	5580	29	2.5	164	1
8	5580	29	2.5	176	1
9	5580	27	4.6	180	1
10	5580	26	3.2	214	0
11	5580	28	1.5	160	1
12	5580	23	2.2	175	1
13	5580	28	1.9	158	1
14	5580	28	4.9	196	1
15	5580	29	4.4	177	1
16	5580	24	4.9	202	1
17	5580	25	4.9	171	1
18	5580	26	2.4	158	1
19	5580	27	2.8	160	1
20	5580	24	1.5	173	1
21	5580	26	1	208	1
22	5580	28	1.1	174	1
23	5580	26	4.1	209	1
24	5580	23	3.7	218	1
25	5580	25	2.2	209	1
26	5580	28	4.7	222	1
27	5580	28	1.5	226	1
28	5580	29	3.9	162	1
29	5580	27	2.6	194	1
30	5580	26	1.2	197	1
Detection Percentage: 96.7% (>60%)					

Table-3 Radar Type 3 Statistical Performance

Trial #	Fc (MHz)	Pulse/Burst	Pulse Width (μS)	PRI (μs)	Detection (1:yes; 0:no)
1	5580	17	6.1	333	1
2	5580	17	7.5	286	1
3	5580	16	7.3	263	1
4	5580	16	9.1	390	1
5	5580	17	7.5	315	1
6	5580	16	9.1	240	0
7	5580	17	9.3	265	1
8	5580	18	7.9	448	1
9	5580	16	8.5	316	1
10	5580	17	6.6	477	1
11	5580	18	9.7	485	1
12	5580	16	6.3	262	1
13	5580	16	9.6	250	1
14	5580	18	8.4	376	1
15	5580	16	8.8	317	1
16	5580	18	6.9	297	1
17	5580	18	8.5	256	1
18	5580	16	6.2	315	1
19	5580	18	7.1	286	1
20	5580	16	6.8	302	1
21	5580	17	6	308	1
22	5580	16	8.1	319	1
23	5580	17	8.1	220	0
24	5580	16	6.9	298	1
25	5580	17	9.6	394	1
26	5580	18	9.1	242	0
27	5580	18	9.2	378	1
28	5580	18	6.4	417	1
29	5580	16	7.3	444	1
30	5580	16	6.2	249	1
Detection Percentage: 90.0 % (>60%)					

Table-4 Radar Type 4 Statistical Performance

Trial #	Fc (MHz)	Pulse/Burst	Pulse Width (µS)	PRI (µs)	Detection (1:yes; 0:no)
1	5580	13	19.5	253	1
2	5580	12	13.8	493	1
3	5580	12	11.8	423	1
4	5580	12	19.6	302	1
5	5580	15	15.8	344	1
6	5580	13	12	328	1
7	5580	14	11.5	446	1
8	5580	13	12	454	1
9	5580	14	14.7	313	1
10	5580	16	13.5	398	1
11	5580	14	19.5	393	0
12	5580	13	14	389	1
13	5580	13	14.3	206	0
14	5580	16	16.8	367	1
15	5580	16	16.8	314	1
16	5580	16	13.9	398	1
17	5580	14	15.7	460	1
18	5580	13	18.3	290	1
19	5580	16	14.2	200	0
20	5580	15	17	500	1
21	5580	14	12.4	323	0
22	5580	14	19.6	282	1
23	5580	16	12.9	479	1
24	5580	13	11.2	339	1
25	5580	15	12.7	299	1
26	5580	12	17.2	259	0
27	5580	16	17.3	500	1
28	5580	12	17.8	387	1
29	5580	13	17.2	366	1
30	5580	16	12.8	479	1
Detection Percentage: 100 % (>60%)					

Table-5 Radar Type 5 Statistical Performance

Bin5 Statistics 1

Trial #	Pulse	Chirp (MHz)	Pulse Width (μS)	Pulse 1-2 spacing (uS)	Pulse 2-3 spacing (uS)	Pulse Start(S)	Detection (1:yes; 0:no)
0	2	5	73.4	1975		0.721434	1
1	2	17	63.2	1770		1.335554	
2	1	6	96.7			1.575123	
3	2	6	63.9	1045		2.476077	
4	1	13	50.4			3.184586	
5	3	15	69.4	1530	1371	3.870646	
6	2	13	57.5	1192		4.577593	
7	2	17	82.7	1240		5.746694	
8	1	19	89.9			6.506749	
9	3	13	62.7	1932	1601	7.106147	
10	1	19	66.4			7.922805	
11	2	11	59.7	1856		8.914221	
12	2	16	60.3	1799		9.097432	
13	1	13	73.3			9.95054	
14	2	15	94.9	1183		11.02534	
15	1	7	94.8			11.97446	

Bin5 Statistics 2

Trial #	Pulse	Chirp (MHz)	Pulse Width (μS)	Pulse 1-2 spacing (uS)	Pulse 2-3 spacing (uS)	Pulse Start(S)	Detection (1:yes; 0:no)
0	2	13	58.9	1612		0.543345	1
1	2	19	58	1425		1.107412	
2	1	5	69.2			1.728145	
3	1	13	95.5			2.26313	
4	1	7	95.6			2.744197	
5	2	12	96.8	1854		3.38506	
6	2	7	68.9	1807		4.393244	
7	2	6	96.6	1653		5.020189	
8	2	16	85.7	1183		5.320887	
9	1	18	63.5			5.940693	
10	2	12	73.1	1805		6.700829	
11	3	17	96.5	1770	1768	7.277371	
12	3	19	96.4	1349	1497	7.910365	
13	1	6	89.3			8.823538	
14	1	6	60.2			9.154645	
15	3	7	92.1	1195	1666	9.813398	
16	1	7	73			10.44676	
17	2	20	74.1	1893		10.83793	
18	2	12	76.9	1522		11.65457	

Bin5 Statistics 3

Trial #	Pulse	Chirp (MHz)	Pulse Width (μS)	Pulse 1-2 spacing (uS)	Pulse 2-3 spacing (uS)	Pulse Start(S)	Detection (1:yes; 0:no)
0	2	10	58.3	1805		0.315518	1
1	1	10	72.2			0.884432	
2	2	6	59.3	1036		1.73947	
3	2	15	72.4	1092		2.392808	
4	2	18	51.3	1577		2.637413	
5	2	18	67.5	1866		3.407932	
6	3	8	86.4	1010	1130	4.069918	
7	1	6	63.1			5.006432	
8	3	16	58	1801	1324	5.312545	
9	3	13	58.2	1127	1643	6.304445	
10	2	11	70.8	1444		6.396363	
11	3	11	95.4	1024	1254	7.133425	
12	2	5	94.6	1058		7.699387	
13	1	19	93.8			8.275481	
14	2	18	56.7	1214		9.169718	
15	2	13	86.1	1424		9.664895	
16	2	16	97.1	1298		10.112	
17	1	7	81			10.785	
18	3	9	92.9	1153	1929	11.59523	

Bin5 Statistics 4

Trial #	Pulse	Chirp (MHz)	Pulse Width (µS)	Pulse 1-2 spacing (uS)	Pulse 2-3 spacing (uS)	Pulse Start(S)	Detection (1:yes; 0:no)
0	3	14	93.7	1188	1495	0.482953	1
1	3	11	56.4	1198	1930	0.756527	
2	3	20	73.5	2000	1030	1.215355	
3	2	15	63.4	1312		2.335334	
4	3	9	59.3	1038	1466	2.509687	
5	1	7	60.6			3.374841	
6	2	7	93.9	1744		3.974901	
7	2	7	81.4	1249		4.299921	
8	3	13	72.1	1284	1405	4.963086	
9	3	20	55.4	1676	1016	5.971669	
10	2	6	73	1106		6.342844	
11	2	18	56.2	1060		7.189088	
12	1	10	64			7.372041	
13	1	7	83.8			8.058774	
14	2	9	77	1227		8.441542	
15	3	17	65.7	1608	1587	9.397863	
16	2	8	72.1	1310		9.656985	
17	2	10	52.1	1050		10.5908	
18	3	7	73.8	1605	1772	10.94075	

Bin5 Statistics 5

Trial #	Pulse	Chirp (MHz)	Pulse Width (µS)	Pulse 1-2 spacing (uS)	Pulse 2-3 spacing (uS)	Pulse Start(S)	Detection (1:yes; 0:no)
0	2	15	97.5	1777		0.718264	1
1	2	9	54.8	1729		2.144161	
2	2	16	72.5	1452		2.567228	
3	2	9	75.6	1357		3.897906	
4	1	5	58			4.792651	
5	2	19	93	1452		5.634243	
6	2	11	61	1370		6.668432	
7	2	18	62.4	1291		8.308335	
8	1	16	52.3			9.713388	
9	1	11	93.5			10.47687	
10	3	12	99.5	1002	1796	11.62435	

Bin5 Statistics 6

Trial #	Pulse	Chirp (MHz)	Pulse Width (µS)	Pulse 1-2 spacing (µS)	Pulse 2-3 spacing (µS)	Pulse Start(S)	Detection (1:yes; 0:no)
0	2	19	61.5	1523		0.655295	1
1	2	14	78.1	1715		2.423167	
2	3	13	57.5	1490	1290	3.349361	
3	2	6	52.9	1193		5.002575	
4	1	20	54.6			6.050436	
5	1	6	61.2			7.277236	
6	3	8	89.7	1766	1641	9.250658	
7	3	6	89	1757	1456	10.30188	
8	1	10	65.9			11.71635	

Bin5 Statistics 7

Trial #	Pulse	Chirp (MHz)	Pulse Width (µS)	Pulse 1-2 spacing (µS)	Pulse 2-3 spacing (µS)	Pulse Start(S)	Detection (1:yes; 0:no)
0	1	13	53.5			0.38912	1
1	2	19	94.2	1344		1.155799	
2	3	16	84.8	1807	1895	1.582024	
3	3	6	79.2	1639	1235	2.321256	
4	3	13	94.2	1406	1684	2.819279	
5	1	11	73.7			3.519275	
6	2	16	64.5	1037		4.27417	
7	2	6	57.9	1936		4.574794	
8	1	7	80.1			5.645186	
9	1	6	56.6			6.281873	
10	1	14	53.3			6.568116	
11	1	6	52.2			7.048553	
12	3	17	99.8	1615	1215	8.180043	
13	2	16	73.1	1660		8.750505	
14	1	18	59.1			9.398987	
15	3	11	67.4	1580	1677	9.946861	
16	1	6	97.1			10.6385	
17	1	17	57.5			11.02006	
18	2	18	70.7	1227		11.78858	

Bin5 Statistics 8

Trial #	Pulse	Chirp (MHz)	Pulse Width (μS)	Pulse 1-2 spacing (uS)	Pulse 2-3 spacing (uS)	Pulse Start(S)	Detection (1:yes; 0:no)
0	2	12	86.8	1484		0.195034	1
1	2	10	72.5	1630		1.358585	
2	2	17	95.3	1729		3.083892	
3	2	12	62.5	1842		3.858051	
4	2	17	96.8	1663		4.853836	
5	1	6	82.2			6.497977	
6	3	17	85.9	1739	1324	7.214353	
7	1	16	92.3			8.851462	
8	1	8	56.5			10.54341	
9	1	7	65.4			11.77236	

Bin5 Statistics 9

Trial #	Pulse	Chirp (MHz)	Pulse Width (μS)	Pulse 1-2 spacing (uS)	Pulse 2-3 spacing (uS)	Pulse Start(S)	Detection (1:yes; 0:no)
0	1	10	78.2			1.103447	1
1	3	9	60.5	1052	1498	1.814489	
2	1	8	72.5			3.983121	
3	3	9	54.4	1706	1856	4.901677	
4	1	19	83			5.504238	
5	2	6	60.4	1573		6.965407	
6	3	12	59.2	1278	1931	8.945737	
7	2	13	55	1797		10.37586	
8	3	18	93.6	1783	1603	11.49675	

Bin5 Statistics 10

Trial #	Pulse	Chirp (MHz)	Pulse Width (µS)	Pulse 1-2 spacing (µS)	Pulse 2-3 spacing (µS)	Pulse Start(S)	Detection (1:yes; 0:no)
0	2	16	91.9	1115		0.436279	1
1	2	14	82.1	1043		0.805503	
2	3	18	89.1	1829	1944	1.325114	
3	3	15	58.1	1395	1238	2.13969	
4	2	16	87.2	1297		2.721909	
5	2	16	58.5	1018		3.702663	
6	2	19	70.1	1640		3.863085	
7	2	17	94.7	1250		4.963408	
8	2	8	75.7	1606		5.383646	
9	2	13	94.6	1392		6.196183	
10	2	6	92.1	1878		6.425555	
11	2	18	61	1367		7.367276	
12	3	10	77.8	1570	1893	8.017425	
13	3	17	78.3	1548	1680	8.358649	
14	2	19	53.2	1250		9.461237	
15	1	12	94.1			10.06564	
16	2	15	69.9	1309		10.2131	
17	2	17	54	1481		10.75123	
18	3	10	67	1106	1333	11.87532	

Bin5 Statistics 11

Trial #	Pulse	Chirp (MHz)	Pulse Width (µS)	Pulse 1-2 spacing (µS)	Pulse 2-3 spacing (µS)	Pulse Start(S)	Detection (1:yes; 0:no)
0	2	13	99.1	1736		0.25015	1
1	1	11	92.5			0.936896	
2	3	15	50.1	1045	1091	2.734741	
3	2	12	68.6	1453		3.484193	
4	3	5	93.3	1964	1392	3.979068	
5	1	17	79.6			5.041166	
6	2	6	55.4	1046		5.704777	
7	3	19	86.6	1566	1539	6.635097	
8	2	17	92.4	1477		8.055716	
9	3	18	85.6	1065	1545	8.437071	
10	3	9	51.1	1116	1710	9.605662	
11	2	19	53.9	1232		10.58814	
12	3	10	93.9	1411	1545	11.79646	

Bin5 Statistics 12

Trial #	Pulse	Chirp (MHz)	Pulse Width (µS)	Pulse 1-2 spacing (uS)	Pulse 2-3 spacing (uS)	Pulse Start(S)	Detection (1:yes; 0:no)
0	3	7	91.4	1777	1222	0.57322	1
1	2	6	70	1610		1.378143	
2	1	19	85.2			2.774697	
3	3	19	98.2	1558	1333	3.954709	
4	3	20	99.1	1367	1850	5.024229	
5	1	6	93.1			5.836504	
6	2	18	80.3	1187		7.155882	
7	2	15	89.1	1143		7.885278	
8	3	9	99.4	1257	1429	9.35475	
9	1	13	64.4			10.08511	
10	2	6	86.1	1253		11.38328	

Bin5 Statistics 13

Trial #	Pulse	Chirp (MHz)	Pulse Width (µS)	Pulse 1-2 spacing (uS)	Pulse 2-3 spacing (uS)	Pulse Start(S)	Detection (1:yes; 0:no)
0	2	18	71.9	1146		0.686703	1
1	3	9	69.6	1723	1687	1.074167	
2	2	10	67.5	1415		1.722527	
3	2	16	99.4	1951		2.656395	
4	2	11	64.5	1597		2.879071	
5	2	10	70.7	1597		3.806822	
6	3	14	93.8	1438	1431	4.479505	
7	2	10	64.8	1131		5.046867	
8	2	12	81.7	1791		5.981691	
9	2	11	51.1	1183		6.410135	
10	2	17	61.7	1482		7.514295	
11	3	7	65.9	1021	1138	7.872351	
12	2	5	92.6	1723		9.111835	
13	2	14	91.7	1460		9.186318	
14	3	9	68.3	1085	1426	10.28184	
15	2	20	58.8	1758		11.2392	
16	1	6	86.9			11.47416	

Bin5 Statistics 14

Trial #	Pulse	Chirp (MHz)	Pulse Width (μS)	Pulse 1-2 spacing (uS)	Pulse 2-3 spacing (uS)	Pulse Start(S)	Detection (1:yes; 0:no)
0	2	6	80.4	1211		0.23545	1
1	3	13	91.4	1728	1746	0.72476	
2	3	10	87.7	1085	1602	1.718911	
3	2	13	65.5	1216		2.498929	
4	1	9	50.1			2.892996	
5	1	7	60			3.491029	
6	2	20	79.1	1733		4.179736	
7	1	19	96.8			4.789377	
8	3	17	57.3	1710	1183	5.071345	
9	3	9	70.8	1893	1338	6.183668	
10	2	13	67.1	1854		6.764825	
11	2	10	86	1042		7.263855	
12	1	18	88.2			7.741003	
13	2	15	80.5	1915		8.330148	
14	2	12	60.3	1984		8.921664	
15	1	16	55.5			9.757301	
16	2	16	87.7	1103		10.59322	
17	2	13	94.4	1982		11.12668	
18	2	16	98.3	1393		11.93744	

Bin5 Statistics 15

Trial #	Pulse	Chirp (MHz)	Pulse Width (µS)	Pulse 1-2 spacing (uS)	Pulse 2-3 spacing (uS)	Pulse Start(S)	Detection (1:yes; 0:no)
0	3	8	63.3	1029	1765	0.590446	1
1	2	17	51.8	1127		0.963825	
2	1	12	85.1			1.455862	
3	2	7	97	1073		2.283784	
4	2	10	75.4	1223		3.257588	
5	2	11	68.9	1010		3.560228	
6	1	11	87.7			4.008529	
7	2	13	74.4	1398		5.226623	
8	2	19	81.5	1211		5.359734	
9	1	7	63.7			6.658064	
10	1	15	77.5			7.103512	
11	2	19	62.4	1519		7.544784	
12	2	8	90.2	1144		8.364065	
13	2	5	93.1	1706		9.313175	
14	2	17	86.6	1236		9.435502	
15	3	8	89.8	1984	1098	10.18551	
16	2	7	53.1	1336		11.21697	
17	3	15	52.5	1688	1279	11.42947	

Bin5 Statistics 16

Trial #	Pulse	Chirp (MHz)	Pulse Width (µS)	Pulse 1-2 spacing (uS)	Pulse 2-3 spacing (uS)	Pulse Start(S)	Detection (1:yes; 0:no)
0	2	20	55.3	1329		0.80697	1
1	3	9	86.5	1281	1117	1.26801	
2	3	16	99.3	1503	1291	2.859983	
3	2	10	89.9	1307		3.839226	
4	3	12	55.5	1471	1295	4.374341	
5	2	10	73.1	1073		6.523806	
6	1	20	85.4			6.585454	
7	1	5	96.9			8.615247	
8	1	16	53.1			9.587234	
9	2	15	85.6	1069		10.04275	
10	2	7	78.9	1794		11.66412	

Bin5 Statistics 17

Trial #	Pulse	Chirp (MHz)	Pulse Width (µS)	Pulse 1-2 spacing (µS)	Pulse 2-3 spacing (µS)	Pulse Start(S)	Detection (1:yes; 0:no)
0	1	16	68.5			0.544946	1
1	1	11	66.1			1.214406	
2	2	19	67.7	1294		2.5255	
3	2	19	57.9	1830		3.020803	
4	3	13	78.6	1985	1778	4.284519	
5	1	8	55.6			5.046045	
6	1	15	53.3			5.767254	
7	3	17	80.3	1883	1174	6.598685	
8	2	17	68.8	1198		8.254012	
9	2	12	70.9	1826		8.974877	
10	2	16	55.5	1486		9.863863	
11	1	7	53.9			10.80982	
12	3	13	95	1361	1526	11.92263	

Bin5 Statistics 18

Trial #	Pulse	Chirp (MHz)	Pulse Width (µS)	Pulse 1-2 spacing (µS)	Pulse 2-3 spacing (µS)	Pulse Start(S)	Detection (1:yes; 0:no)
0	2	15	98.9	1471		0.838623	1
1	2	17	55.8	1944		1.508647	
2	2	20	63.2	1469		2.208983	
3	3	6	78.5	1662	1154	3.649718	
4	2	11	51.2	1544		4.486537	
5	2	7	58.5	1152		5.398743	
6	1	10	75.4			6.168868	
7	3	16	95.6	1373	1002	7.110787	
8	2	17	95.4	1390		7.477268	
9	3	15	75.9	1068	1976	8.896788	
10	3	19	75	1309	1304	10.12351	
11	3	9	79.2	1043	1016	10.19472	
12	1	19	69.5			11.86076	

Bin5 Statistics 19

Trial #	Pulse	Chirp (MHz)	Pulse Width (µS)	Pulse 1-2 spacing (uS)	Pulse 2-3 spacing (uS)	Pulse Start(S)	Detection (1:yes; 0:no)
Trial #	Pulse	Chirp (MHz)	Pulse Width (µS)	Pulse 1-2 spacing (uS)	Pulse 2-3 spacing (uS)	Pulse Start(S)	
0	2	16	54.3	1766		0.587944	1
1	3	18	70.6	1758	1821	0.865748	
2	1	11	92.9			1.837877	
3	1	11	80.9			2.445292	
4	2	15	78.7	1130		3.168648	
5	2	7	54	1484		3.531934	
6	3	7	74.9	1731	1600	4.495576	
7	2	6	75.4	1932		5.081229	
8	2	14	62.1	1674		5.967452	
9	2	12	96.4	1799		6.553703	
10	3	17	89	1819	1394	6.859193	
11	1	6	85.5			7.399773	
12	1	18	64.4			8.000606	
13	2	13	56.2	1394		9.24749	
14	1	13	95.4			9.752203	
15	2	10	67.7	1103		10.14488	

Bin5 Statistics 20

Trial #	Pulse	Chirp (MHz)	Pulse Width (µS)	Pulse 1-2 spacing (uS)	Pulse 2-3 spacing (uS)	Pulse Start(S)	Detection (1:yes; 0:no)
0	2	15	76.2	1207		0.796311	1
1	2	16	91.1	1702		1.785519	
2	1	17	52			2.215715	
3	2	18	76.4	1651		2.94325	
4	3	8	69.5	1020	1950	4.013152	
5	2	12	77.8	1536		4.629124	
6	1	11	88.9			5.897796	
7	3	11	57	1411	1054	7.271131	
8	2	17	83	1174		7.582663	
9	2	17	96	1911		8.783406	
10	1	7	74			9.425805	
11	1	17	71.5			11.03495	
12	2	8	87.5	1238		11.37431	

Bin5 Statistics 21

Trial #	Pulse	Chirp (MHz)	Pulse Width (µS)	Pulse 1-2 spacing (uS)	Pulse 2-3 spacing (uS)	Pulse Start(S)	Detection (1:yes; 0:no)
0	2	12	96.8	1909		0.398481	1
1	2	18	80.8	1645		1.109977	
2	1	7	59.5			2.232778	
3	3	16	94.9	1453	1125	3.341678	
4	2	6	84	1773		4.482467	
5	2	6	84.8	1450		5.128233	
6	2	12	87.2	1258		6.490833	
7	2	6	97.7	1003		7.053152	
8	2	14	57.7	1622		8.436622	
9	1	8	76.5			9.546249	
10	2	8	55.3	1558		10.39525	
11	2	17	70.4	1700		11.51435	

Bin5 Statistics 22

Trial #	Pulse	Chirp (MHz)	Pulse Width (µS)	Pulse 1-2 spacing (uS)	Pulse 2-3 spacing (uS)	Pulse Start(S)	Detection (1:yes; 0:no)
0	1	11	51.4			0.547718	1
1	3	18	70.4	1119	1425	1.585266	
2	2	13	82.8	1048		2.926817	
3	2	19	55.5	1884		3.357252	
4	3	19	84.5	1589	1982	4.707486	
5	2	12	56.3	1563		5.436451	
6	2	17	74.8	1905		6.993144	
7	1	10	58.5			7.306044	
8	3	13	68	1882	1971	8.696367	
9	1	9	85.9			9.511168	
10	2	19	78.8	1094		10.25141	
11	3	18	89.7	1690	1462	11.79867	

Bin5 Statistics 23

Trial #	Pulse	Chirp (MHz)	Pulse Width (µS)	Pulse 1-2 spacing (µS)	Pulse 2-3 spacing (µS)	Pulse Start(S)	Detection (1:yes; 0:no)
0	1	11	98.6			0.711851	1
1	2	10	67.6	1879		0.940159	
2	1	18	66.2			2.177944	
3	3	17	60.4	1246	1124	2.279442	
4	2	14	74.7	1677		3.594467	
5	2	10	98.3	1646		4.018407	
6	2	14	88.6	1896		4.957358	
7	1	9	97.7			5.941765	
8	2	9	67.4	1628		6.038643	
9	1	13	70.3			6.838857	
10	1	10	52.4			7.760722	
11	2	14	90.7	1324		8.35136	
12	2	13	93.9	1361		9.536888	
13	2	19	67.2	1514		9.883605	
14	2	13	57	1038		11.06428	
15	2	15	82.6	1153		11.44365	

Bin5 Statistics 24

Trial #	Pulse	Chirp (MHz)	Pulse Width (µS)	Pulse 1-2 spacing (µS)	Pulse 2-3 spacing (µS)	Pulse Start(S)	Detection (1:yes; 0:no)
0	2	9	56.5	1503		0.640652	1
1	1	16	64.2			1.393105	
2	3	20	77.3	1273	1265	2.172339	
3	1	7	63.7			2.294043	
4	3	9	76.5	1726	1541	3.110439	
5	3	12	56.4	1774	1119	4.46426	
6	2	19	88.7	1615		4.942959	
7	1	7	62			5.834178	
8	1	13	71.6			6.590194	
9	1	15	81.3			7.301824	
10	2	14	94.9	1044		7.798493	
11	1	14	75.8			8.405922	
12	1	9	60.4			9.079017	
13	2	14	93.1	1283		10.36245	
14	3	19	98.1	1415	1912	11.02057	
15	2	15	93.2	1738		11.66758	

Bin5 Statistics 25

Trial #	Pulse	Chirp (MHz)	Pulse Width (µS)	Pulse 1-2 spacing (uS)	Pulse 2-3 spacing (uS)	Pulse Start(S)	Detection (1:yes; 0:no)
0	1	19	65.1			0.36868	1
1	2	16	66.4	1733		1.066814	
2	1	19	81			1.781739	
3	2	16	92.9	1969		2.846235	
4	1	20	94.2			3.127672	
5	3	9	92.8	1598	1050	3.904916	
6	2	10	52.9	1884		5.213715	
7	3	19	82.2	1260	1684	5.394452	
8	2	17	98.5	1043		6.615586	
9	2	6	60.8	1678		7.221879	
10	2	10	61	1796		8.225392	
11	1	12	75.9			8.386826	
12	2	13	79.3	1908		9.658422	
13	3	10	84.1	1824	1261	10.18292	
14	3	11	75.5	1097	1812	10.52743	
15	3	15	62.3	1967	1689	11.87031	

Bin5 Statistics 26

Trial #	Pulse	Chirp (MHz)	Pulse Width (µS)	Pulse 1-2 spacing (uS)	Pulse 2-3 spacing (uS)	Pulse Start(S)	Detection (1:yes; 0:no)
0	2	5	52.8	1521		0.449008	1
1	2	18	69.7	1508		1.276255	
2	1	18	53.7			3.335516	
3	2	12	95.1	1031		4.532388	
4	1	19	89.9			5.720413	
5	3	12	56.7	1223	1515	6.126309	
6	2	7	80.3	1854		7.337929	
7	2	11	66.5	1391		9.185408	
8	3	20	90.8	1573	1632	9.977912	
9	2	10	89.2	1427		11.5238	

Bin5 Statistics 27

Trial #	Pulse	Chirp (MHz)	Pulse Width (μS)	Pulse 1-2 spacing (uS)	Pulse 2-3 spacing (uS)	Pulse Start(S)	Detection (1:yes; 0:no)
0	3	9	93.2	1629	1128	0.388728	1
1	2	5	72.4	1073		1.40292	
2	1	19	67.4			2.734934	
3	3	12	57.6	1335	1023	4.239469	
4	2	7	72.8	1482		6.059447	
5	2	19	60.1	1560		7.303623	
6	2	10	85.7	1771		8.751737	
7	1	20	62.5			10.09694	
8	2	6	57	1841		11.67903	
0	3	9	93.2	1629	1128	0.388728	

Bin5 Statistics 28

Trial #	Pulse	Chirp (MHz)	Pulse Width (μS)	Pulse 1-2 spacing (uS)	Pulse 2-3 spacing (uS)	Pulse Start(S)	Detection (1:yes; 0:no)
0	3	18	65.5	1658	1296	1.141902	1
1	1	18	88.7			1.397277	
2	1	15	54.1			2.504103	
3	1	12	86.8			4.772839	
4	1	16	80.8			5.024593	
5	2	11	71	1323		6.843535	
6	2	9	84.4	1805		7.410715	
7	2	20	77.8	1339		9.516868	
8	2	12	89.7	1986		10.15284	
9	3	18	57.3	1237	1779	11.65065	

Bin5 Statistics 29

Trial #	Pulse	Chirp (MHz)	Pulse Width (µS)	Pulse 1-2 spacing (uS)	Pulse 2-3 spacing (uS)	Pulse Start(S)	Detection (1:yes; 0:no)
0	3	10	60.8	1641	1754	0.248876	1
1	1	19	76.4			1.247121	
2	2	16	96.7	1753		2.382737	
3	3	9	67.4	1260	1871	2.759277	
4	2	11	56	1877		3.967623	
5	2	10	62.9	1984		4.521451	
6	1	6	80.9			4.933602	
7	2	10	98.7	1639		5.982609	
8	3	19	94.8	1195	1194	6.505576	
9	3	18	74.8	1063	1469	7.727669	
10	3	20	55.2	1341	1376	8.227328	
11	2	11	85.9	1890		8.863093	
12	3	12	72.3	1990	1855	10.32828	
13	2	11	99.5	1754		11.151	
14	1	9	95.4			11.52009	

Bin5 Statistics 30

Trial #	Pulse	Chirp (MHz)	Pulse Width (µS)	Pulse 1-2 spacing (uS)	Pulse 2-3 spacing (uS)	Pulse Start(S)	Detection (1:yes; 0:no)
0	2	13	74.6	1926		0.164988	1
1	3	20	52.7	1208	1344	1.727709	
2	2	6	70.1	1370		2.405418	
3	1	6	95			3.773045	
4	3	6	51.1	1126	1547	4.747795	
5	2	14	67.7	1871		6.154093	
6	2	6	96.1	1764		7.140644	
7	3	14	56.8	1266	1847	8.380114	
8	2	16	74.6	1045		9.638465	
9	3	7	89.9	1692	1116	10.8629	
10	2	18	84.2	1592		11.33732	

Table-6 Radar Type 6 Statistical Performance

Trial #	Fc (MHz)	Pulse /Burst	Pulse Width (µS)	PRI (µs)	Detection (1:yes; 0:no)	Hopping Sequence
1	5580	9	1	333	1	5514.0, 5563.0, 5576.0, 5376.0, 5718.0, 5461.0, 5636.0, 5401.0, 5468.0, 5415.0, 5700.0, 5282.0, 5268.0, 5454.0, 5567.0, 5302.0, 5689.0, 5420.0, 5367.0, 5396.0, 5719.0, 5645.0, 5345.0, 5404.0, 5492.0, 5692.0, 5447.0, 5717.0, 5283.0, 5528.0, 5544.0, 5524.0, 5287.0, 5498.0, 5677.0, 5306.0, 5695.0, 5676.0, 5354.0, 5276.0, 5437.0, 5495.0, 5254.0, 5584.0, 5509.0, 5292.0, 5348.0, 5270.0, 5627.0, 5560.0, 5436.0, 5515.0, 5290.0, 5547.0, 5456.0, 5513.0, 5446.0, 5662.0, 5378.0, 5304.0, 5295.0, 5687.0, 5675.0, 5666.0, 5669.0, 5351.0, 5416.0, 5703.0, 5632.0, 5285.0, 5511.0, 5690.0, 5674.0, 5668.0, 5496.0, 5586.0, 5539.0, 5502.0, 5333.0, 5459.0, 5371.0, 5536.0, 5683.0, 5252.0, 5671.0, 5533.0, 5673.0, 5356.0, 5510.0, 5602.0, 5352.0, 5310.0, 5569.0, 5667.0, 5654.0, 5440.0, 5488.0, 5387.0, 5375.0, 5527.0 (number of hits: 9)
2	5580	9	1	333	1	5345.0, 5379.0, 5674.0, 5377.0, 5562.0, 5709.0, 5296.0, 5638.0, 5320.0, 5721.0, 5704.0, 5532.0, 5510.0, 5576.0, 5719.0, 5456.0, 5534.0, 5710.0, 5486.0, 5660.0, 5625.0, 5297.0, 5426.0, 5491.0, 5315.0, 5579.0, 5652.0, 5683.0, 5321.0, 5687.0, 5444.0, 5401.0, 5680.0, 5405.0, 5620.0, 5367.0, 5715.0, 5482.0, 5459.0, 5361.0, 5519.0, 5295.0, 5340.0, 5330.0, 5332.0, 5563.0, 5457.0, 5684.0, 5572.0, 5724.0, 5560.0, 5265.0, 5462.0, 5304.0, 5378.0, 5567.0, 5538.0, 5663.0, 5512.0, 5419.0, 5657.0, 5316.0, 5298.0, 5614.0, 5689.0, 5349.0, 5344.0, 5668.0, 5489.0, 5618.0, 5649.0, 5509.0, 5539.0, 5686.0, 5322.0, 5631.0, 5656.0, 5308.0, 5595.0, 5517.0, 5596.0, 5502.0, 5466.0, 5559.0, 5317.0, 5703.0, 5339.0, 5591.0, 5255.0, 5281.0, 5350.0, 5679.0, 5326.0, 5685.0, 5261.0, 5447.0, 5580.0, 5362.0, 5313.0, 5545.0 (number of hits: 7)
3	5580	9	1	333	1	5373.0, 5495.0, 5630.0, 5689.0, 5661.0, 5687.0, 5527.0, 5435.0, 5685.0, 5311.0, 5344.0, 5325.0, 5723.0, 5715.0, 5410.0, 5432.0, 5328.0, 5721.0, 5416.0, 5700.0, 5420.0, 5532.0, 5318.0, 5666.0, 5350.0, 5316.0, 5427.0, 5663.0, 5256.0, 5260.0, 5540.0, 5331.0, 5678.0, 5665.0, 5494.0, 5375.0, 5348.0, 5676.0, 5338.0, 5694.0, 5340.0, 5544.0, 5616.0, 5520.0, 5484.0

						5326.0, 5707.0, 5628.0, 5550.0, 5323.0, 5322.0, 5412.0, 5257.0, 5487.0, 5382.0, 5278.0, 5580.0, 5332.0, 5686.0, 5621.0, 5596.0, 5491.0, 5501.0, 5612.0, 5517.0, 5518.0, 5668.0, 5300.0, 5261.0, 5439.0, 5485.0, 5290.0, 5644.0, 5541.0, 5475.0, 5268.0, 5390.0, 5436.0, 5712.0, 5698.0, 5378.0, 5653.0, 5409.0, 5586.0, 5483.0, 5556.0, 5339.0, 5343.0, 5605.0, 5696.0, 5720.0, 5267.0, 5444.0, 5584.0, 5624.0, 5459.0, 5708.0, 5438.0, 5695.0, 5525.0 (number of hits: 3)
4	5580	9	1	333	1	5632.0, 5670.0, 5541.0, 5540.0, 5276.0, 5703.0, 5710.0, 5320.0, 5674.0, 5707.0, 5443.0, 5481.0, 5641.0, 5497.0, 5432.0, 5478.0, 5292.0, 5691.0, 5650.0, 5604.0, 5630.0, 5698.0, 5686.0, 5347.0, 5343.0, 5407.0, 5386.0, 5285.0, 5452.0, 5354.0, 5371.0, 5461.0, 5501.0, 5373.0, 5284.0, 5289.0, 5428.0, 5563.0, 5627.0, 5508.0, 5283.0, 5318.0, 5504.0, 5639.0, 5575.0, 5440.0, 5253.0, 5309.0, 5647.0, 5704.0, 5643.0, 5515.0, 5718.0, 5334.0, 5687.0, 5413.0, 5554.0, 5418.0, 5507.0, 5544.0, 5706.0, 5419.0, 5360.0, 5430.0, 5564.0, 5545.0, 5254.0, 5623.0, 5593.0, 5695.0, 5460.0, 5342.0, 5705.0, 5344.0, 5398.0, 5666.0, 5712.0, 5291.0, 5580.0, 5348.0, 5467.0, 5665.0, 5701.0, 5663.0, 5470.0, 5268.0, 5573.0, 5303.0, 5468.0, 5353.0, 5361.0, 5304.0, 5682.0, 5378.0, 5377.0, 5408.0, 5716.0, 5400.0, 5453.0, 5429.0 (number of hits: 7)
5	5580	9	1	333	1	5425.0, 5693.0, 5603.0, 5252.0, 5510.0, 5671.0, 5290.0, 5686.0, 5467.0, 5702.0, 5345.0, 5321.0, 5254.0, 5519.0, 5711.0, 5648.0, 5433.0, 5676.0, 5397.0, 5500.0, 5487.0, 5313.0, 5444.0, 5718.0, 5366.0, 5555.0, 5664.0, 5580.0, 5303.0, 5482.0, 5632.0, 5550.0, 5497.0, 5556.0, 5575.0, 5612.0, 5530.0, 5505.0, 5338.0, 5649.0, 5466.0, 5484.0, 5447.0, 5565.0, 5545.0, 5255.0, 5361.0, 5349.0, 5600.0, 5589.0, 5491.0, 5663.0, 5560.0, 5346.0, 5353.0, 5722.0, 5311.0, 5516.0, 5282.0, 5317.0, 5432.0, 5435.0, 5641.0, 5307.0, 5701.0, 5343.0, 5449.0, 5655.0, 5292.0, 5316.0, 5380.0, 5567.0, 5659.0, 5660.0, 5670.0, 5532.0, 5599.0, 5314.0, 5605.0, 5452.0, 5678.0, 5454.0, 5501.0, 5403.0, 5520.0, 5717.0, 5563.0, 5614.0, 5324.0, 5645.0, 5633.0, 5389.0, 5618.0, 5348.0, 5439.0, 5527.0, 5286.0, 5703.0, 5498.0, 5647.0 (number of hits: 8)
6	5580	9	1	333	1	5340.0, 5425.0, 5264.0, 5585.0, 5713.0, 5593.0, 5323.0, 5286.0, 5471.0, 5406.0,

						5348.0, 5538.0, 5539.0, 5337.0, 5655.0, 5377.0, 5327.0, 5536.0, 5514.0, 5550.0, 5651.0, 5552.0, 5521.0, 5375.0, 5280.0, 5378.0, 5486.0, 5463.0, 5494.0, 5604.0, 5705.0, 5597.0, 5619.0, 5714.0, 5370.0, 5483.0, 5488.0, 5346.0, 5326.0, 5523.0, 5622.0, 5697.0, 5560.0, 5440.0, 5444.0, 5654.0, 5610.0, 5324.0, 5554.0, 5530.0, 5302.0, 5580.0, 5591.0, 5485.0, 5598.0, 5589.0, 5663.0, 5462.0, 5665.0, 5489.0, 5541.0, 5404.0, 5292.0, 5344.0, 5266.0, 5499.0, 5517.0, 5284.0, 5449.0, 5581.0, 5405.0, 5319.0, 5686.0, 5373.0, 5256.0, 5426.0, 5334.0, 5367.0, 5349.0, 5398.0, 5365.0, 5357.0, 5500.0, 5625.0, 5532.0, 5707.0, 5694.0, 5387.0, 5559.0, 5261.0, 5600.0, 5584.0, 5338.0, 5268.0, 5389.0, 5527.0, 5364.0, 5620.0, 5615.0, 5562.0 (number of hits: 3)
7	5580	9	1	333	1	5442.0, 5621.0, 5597.0, 5276.0, 5348.0, 5720.0, 5483.0, 5268.0, 5488.0, 5652.0, 5418.0, 5357.0, 5287.0, 5367.0, 5430.0, 5684.0, 5571.0, 5560.0, 5682.0, 5640.0, 5649.0, 5601.0, 5261.0, 5388.0, 5422.0, 5637.0, 5347.0, 5592.0, 5509.0, 5718.0, 5578.0, 5662.0, 5311.0, 5468.0, 5495.0, 5498.0, 5449.0, 5520.0, 5516.0, 5305.0, 5320.0, 5278.0, 5309.0, 5580.0, 5677.0, 5568.0, 5704.0, 5558.0, 5340.0, 5667.0, 5355.0, 5627.0, 5659.0, 5368.0, 5405.0, 5494.0, 5310.0, 5279.0, 5440.0, 5330.0, 5699.0, 5263.0, 5588.0, 5485.0, 5472.0, 5288.0, 5492.0, 5695.0, 5337.0, 5270.0, 5554.0, 5470.0, 5322.0, 5373.0, 5469.0, 5536.0, 5289.0, 5262.0, 5625.0, 5564.0, 5254.0, 5672.0, 5605.0, 5665.0, 5420.0, 5623.0, 5466.0, 5481.0, 5410.0, 5723.0, 5324.0, 5490.0, 5683.0, 5345.0, 5255.0, 5271.0, 5502.0, 5395.0, 5501.0, 5626.0 (number of hits: 7)
8	5580	9	1	333	1	5398.0, 5300.0, 5410.0, 5443.0, 5452.0, 5709.0, 5317.0, 5428.0, 5381.0, 5571.0, 5658.0, 5408.0, 5688.0, 5480.0, 5273.0, 5373.0, 5672.0, 5277.0, 5594.0, 5353.0, 5338.0, 5501.0, 5551.0, 5703.0, 5671.0, 5516.0, 5659.0, 5282.0, 5686.0, 5441.0, 5687.0, 5662.0, 5401.0, 5460.0, 5419.0, 5476.0, 5581.0, 5562.0, 5320.0, 5335.0, 5318.0, 5677.0, 5291.0, 5609.0, 5555.0, 5392.0, 5422.0, 5369.0, 5604.0, 5669.0, 5402.0, 5534.0, 5340.0, 5566.0, 5539.0, 5505.0, 5472.0, 5573.0, 5312.0, 5615.0, 5724.0, 5266.0, 5556.0, 5463.0, 5513.0, 5268.0, 5550.0, 5553.0, 5510.0, 5323.0, 5385.0, 5559.0, 5614.0, 5618.0, 5546.0, 5284.0, 5632.0, 5694.0, 5322.0, 5440.0,

						5294.0, 5652.0, 5280.0, 5267.0, 5272.0, 5445.0, 5493.0, 5301.0, 5713.0, 5469.0, 5309.0, 5372.0, 5542.0, 5321.0, 5332.0, 5396.0, 5327.0, 5624.0, 5631.0, 5417.0 (number of hits: 6)
9	5580	9	1	333	1	5704.0, 5260.0, 5338.0, 5336.0, 5266.0, 5424.0, 5562.0, 5295.0, 5406.0, 5437.0, 5304.0, 5307.0, 5290.0, 5575.0, 5465.0, 5381.0, 5663.0, 5319.0, 5709.0, 5251.0, 5628.0, 5313.0, 5690.0, 5329.0, 5707.0, 5350.0, 5405.0, 5453.0, 5544.0, 5463.0, 5265.0, 5719.0, 5328.0, 5583.0, 5361.0, 5259.0, 5540.0, 5673.0, 5511.0, 5592.0, 5371.0, 5476.0, 5635.0, 5520.0, 5426.0, 5312.0, 5691.0, 5377.0, 5275.0, 5538.0, 5623.0, 5596.0, 5708.0, 5654.0, 5398.0, 5348.0, 5569.0, 5624.0, 5433.0, 5423.0, 5451.0, 5494.0, 5296.0, 5289.0, 5457.0, 5291.0, 5261.0, 5565.0, 5274.0, 5404.0, 5531.0, 5545.0, 5436.0, 5354.0, 5509.0, 5314.0, 5524.0, 5506.0, 5525.0, 5287.0, 5344.0, 5720.0, 5652.0, 5347.0, 5386.0, 5431.0, 5276.0, 5337.0, 5253.0, 5413.0, 5697.0, 5372.0, 5297.0, 5250.0, 5407.0, 5278.0, 5282.0, 5483.0, 5542.0, 5452.0 (number of hits: 12)
10	5580	9	1	333	1	5699.0, 5572.0, 5389.0, 5347.0, 5310.0, 5545.0, 5533.0, 5415.0, 5493.0, 5430.0, 5396.0, 5424.0, 5508.0, 5314.0, 5290.0, 5714.0, 5698.0, 5428.0, 5618.0, 5419.0, 5669.0, 5477.0, 5666.0, 5476.0, 5557.0, 5292.0, 5295.0, 5619.0, 5412.0, 5531.0, 5583.0, 5610.0, 5686.0, 5705.0, 5417.0, 5440.0, 5664.0, 5579.0, 5569.0, 5706.0, 5267.0, 5512.0, 5274.0, 5464.0, 5271.0, 5327.0, 5547.0, 5712.0, 5375.0, 5520.0, 5541.0, 5723.0, 5443.0, 5259.0, 5481.0, 5365.0, 5561.0, 5340.0, 5334.0, 5343.0, 5336.0, 5536.0, 5683.0, 5528.0, 5354.0, 5420.0, 5671.0, 5640.0, 5603.0, 5538.0, 5268.0, 5655.0, 5309.0, 5435.0, 5521.0, 5613.0, 5497.0, 5703.0, 5523.0, 5628.0, 5426.0, 5370.0, 5307.0, 5594.0, 5500.0, 5589.0, 5356.0, 5715.0, 5648.0, 5491.0, 5544.0, 5465.0, 5591.0, 5492.0, 5601.0, 5614.0, 5262.0, 5421.0, 5596.0, 5559.0 (number of hits: 7)
11	5580	9	1	333	1	5645.0, 5261.0, 5426.0, 5396.0, 5328.0, 5498.0, 5706.0, 5365.0, 5364.0, 5457.0, 5308.0, 5339.0, 5525.0, 5450.0, 5370.0, 5309.0, 5441.0, 5495.0, 5658.0, 5260.0, 5279.0, 5638.0, 5401.0, 5502.0, 5417.0, 5358.0, 5577.0, 5296.0, 5416.0, 5593.0, 5485.0, 5714.0, 5433.0, 5258.0, 5466.0, 5675.0, 5565.0, 5467.0, 5619.0, 5410.0, 5409.0, 5541.0, 5589.0, 5514.0, 5695.0,

						5704.0, 5472.0, 5376.0, 5352.0, 5362.0, 5596.0, 5335.0, 5332.0, 5499.0, 5528.0, 5711.0, 5484.0, 5286.0, 5692.0, 5425.0, 5329.0, 5683.0, 5696.0, 5270.0, 5437.0, 5290.0, 5690.0, 5267.0, 5315.0, 5251.0, 5289.0, 5670.0, 5363.0, 5538.0, 5387.0, 5344.0, 5256.0, 5327.0, 5360.0, 5452.0, 5581.0, 5620.0, 5515.0, 5431.0, 5694.0, 5612.0, 5561.0, 5288.0, 5639.0, 5420.0, 5584.0, 5576.0, 5526.0, 5701.0, 5508.0, 5440.0, 5413.0, 5382.0, 5544.0, 5293.0 (number of hits: 8)
12	5580	9	1	333	1	5500.0, 5430.0, 5702.0, 5421.0, 5542.0, 5322.0, 5383.0, 5405.0, 5711.0, 5600.0, 5663.0, 5299.0, 5250.0, 5273.0, 5352.0, 5493.0, 5402.0, 5684.0, 5269.0, 5530.0, 5407.0, 5370.0, 5708.0, 5356.0, 5687.0, 5410.0, 5257.0, 5506.0, 5386.0, 5572.0, 5446.0, 5699.0, 5578.0, 5368.0, 5705.0, 5690.0, 5478.0, 5373.0, 5399.0, 5587.0, 5254.0, 5586.0, 5576.0, 5623.0, 5528.0, 5260.0, 5559.0, 5720.0, 5261.0, 5389.0, 5610.0, 5256.0, 5445.0, 5538.0, 5525.0, 5448.0, 5387.0, 5602.0, 5679.0, 5503.0, 5712.0, 5604.0, 5426.0, 5291.0, 5343.0, 5419.0, 5377.0, 5296.0, 5560.0, 5513.0, 5541.0, 5577.0, 5384.0, 5333.0, 5354.0, 5555.0, 5681.0, 5529.0, 5326.0, 5593.0, 5496.0, 5592.0, 5328.0, 5519.0, 5680.0, 5501.0, 5482.0, 5295.0, 5710.0, 5302.0, 5314.0, 5566.0, 5271.0, 5279.0, 5583.0, 5463.0, 5512.0, 5365.0, 5565.0, 5533.0 (number of hits: 6)
13	5580	9	1	333	1	5698.0, 5690.0, 5259.0, 5537.0, 5376.0, 5336.0, 5313.0, 5417.0, 5693.0, 5668.0, 5323.0, 5278.0, 5492.0, 5565.0, 5523.0, 5319.0, 5284.0, 5418.0, 5676.0, 5683.0, 5344.0, 5553.0, 5462.0, 5318.0, 5637.0, 5262.0, 5255.0, 5427.0, 5379.0, 5562.0, 5594.0, 5316.0, 5468.0, 5480.0, 5630.0, 5612.0, 5334.0, 5341.0, 5415.0, 5584.0, 5689.0, 5600.0, 5526.0, 5607.0, 5558.0, 5550.0, 5385.0, 5302.0, 5442.0, 5291.0, 5270.0, 5586.0, 5544.0, 5360.0, 5662.0, 5300.0, 5469.0, 5381.0, 5395.0, 5585.0, 5611.0, 5649.0, 5261.0, 5279.0, 5305.0, 5312.0, 5631.0, 5554.0, 5353.0, 5650.0, 5617.0, 5405.0, 5490.0, 5640.0, 5375.0, 5723.0, 5628.0, 5322.0, 5489.0, 5406.0, 5409.0, 5674.0, 5722.0, 5540.0, 5675.0, 5419.0, 5350.0, 5264.0, 5545.0, 5651.0, 5587.0, 5477.0, 5423.0, 5671.0, 5485.0, 5414.0, 5501.0, 5704.0, 5453.0, 5514.0 (number of hits: 6)
14	5580	9	1	333	1	5518.0, 5711.0, 5703.0, 5443.0, 5582.0, 5536.0, 5488.0, 5451.0, 5555.0, 5311.0,

						5547.0, 5321.0, 5548.0, 5425.0, 5252.0, 5676.0, 5334.0, 5680.0, 5545.0, 5278.0, 5601.0, 5336.0, 5628.0, 5294.0, 5353.0, 5480.0, 5562.0, 5531.0, 5517.0, 5709.0, 5720.0, 5492.0, 5537.0, 5342.0, 5527.0, 5309.0, 5581.0, 5297.0, 5363.0, 5421.0, 5686.0, 5442.0, 5437.0, 5351.0, 5549.0, 5463.0, 5611.0, 5623.0, 5415.0, 5502.0, 5532.0, 5412.0, 5714.0, 5461.0, 5263.0, 5544.0, 5479.0, 5646.0, 5675.0, 5377.0, 5511.0, 5571.0, 5489.0, 5583.0, 5559.0, 5483.0, 5695.0, 5462.0, 5448.0, 5690.0, 5371.0, 5280.0, 5281.0, 5478.0, 5274.0, 5509.0, 5663.0, 5679.0, 5487.0, 5430.0, 5440.0, 5689.0, 5329.0, 5627.0, 5588.0, 5253.0, 5458.0, 5696.0, 5319.0, 5469.0, 5595.0, 5331.0, 5420.0, 5697.0, 5700.0, 5379.0, 5573.0, 5551.0, 5667.0, 5652.0 (number of hits: 4)
15	5580	9	1	333	1	5518.0, 5688.0, 5460.0, 5676.0, 5605.0, 5465.0, 5509.0, 5544.0, 5484.0, 5658.0, 5315.0, 5372.0, 5378.0, 5429.0, 5580.0, 5380.0, 5385.0, 5516.0, 5322.0, 5508.0, 5608.0, 5390.0, 5360.0, 5368.0, 5520.0, 5286.0, 5300.0, 5254.0, 5568.0, 5470.0, 5582.0, 5406.0, 5535.0, 5317.0, 5321.0, 5495.0, 5680.0, 5625.0, 5501.0, 5724.0, 5282.0, 5455.0, 5471.0, 5525.0, 5411.0, 5268.0, 5290.0, 5573.0, 5394.0, 5438.0, 5448.0, 5379.0, 5492.0, 5709.0, 5356.0, 5422.0, 5488.0, 5281.0, 5665.0, 5700.0, 5712.0, 5497.0, 5565.0, 5316.0, 5427.0, 5642.0, 5312.0, 5652.0, 5293.0, 5367.0, 5388.0, 5417.0, 5333.0, 5351.0, 5552.0, 5623.0, 5340.0, 5590.0, 5489.0, 5505.0, 5539.0, 5480.0, 5396.0, 5689.0, 5354.0, 5477.0, 5644.0, 5413.0, 5640.0, 5373.0, 5553.0, 5512.0, 5291.0, 5696.0, 5387.0, 5415.0, 5328.0, 5718.0, 5289.0, 5337.0 (number of hits: 7)
16	5580	9	1	333	1	5574.0, 5375.0, 5701.0, 5697.0, 5576.0, 5599.0, 5439.0, 5356.0, 5571.0, 5512.0, 5454.0, 5657.0, 5524.0, 5609.0, 5653.0, 5635.0, 5695.0, 5425.0, 5506.0, 5602.0, 5529.0, 5662.0, 5545.0, 5335.0, 5706.0, 5719.0, 5559.0, 5521.0, 5383.0, 5702.0, 5398.0, 5409.0, 5716.0, 5336.0, 5645.0, 5544.0, 5714.0, 5570.0, 5552.0, 5417.0, 5514.0, 5250.0, 5519.0, 5504.0, 5532.0, 5619.0, 5269.0, 5703.0, 5575.0, 5577.0, 5525.0, 5550.0, 5354.0, 5637.0, 5452.0, 5491.0, 5424.0, 5490.0, 5395.0, 5414.0, 5324.0, 5446.0, 5410.0, 5510.0, 5360.0, 5407.0, 5520.0, 5605.0, 5513.0, 5565.0, 5305.0, 5717.0, 5408.0, 5445.0, 5539.0, 5436.0, 5631.0, 5492.0, 5639.0, 5295.0,

						5363.0, 5698.0, 5376.0, 5306.0, 5459.0, 5628.0, 5290.0, 5465.0, 5318.0, 5622.0, 5287.0, 5654.0, 5499.0, 5382.0, 5646.0, 5678.0, 5314.0, 5388.0, 5309.0, 5642.0 (number of hits: 7)
17	5580	9	1	333	1	5673.0, 5311.0, 5402.0, 5632.0, 5303.0, 5674.0, 5483.0, 5285.0, 5393.0, 5304.0, 5267.0, 5681.0, 5528.0, 5475.0, 5423.0, 5272.0, 5289.0, 5382.0, 5281.0, 5346.0, 5534.0, 5536.0, 5454.0, 5474.0, 5276.0, 5543.0, 5652.0, 5345.0, 5594.0, 5671.0, 5503.0, 5334.0, 5344.0, 5547.0, 5410.0, 5396.0, 5301.0, 5331.0, 5515.0, 5651.0, 5631.0, 5280.0, 5315.0, 5268.0, 5256.0, 5262.0, 5375.0, 5485.0, 5377.0, 5532.0, 5602.0, 5323.0, 5507.0, 5432.0, 5692.0, 5343.0, 5562.0, 5638.0, 5265.0, 5348.0, 5404.0, 5488.0, 5720.0, 5464.0, 5286.0, 5589.0, 5623.0, 5526.0, 5663.0, 5718.0, 5672.0, 5656.0, 5542.0, 5643.0, 5584.0, 5463.0, 5682.0, 5327.0, 5551.0, 5713.0, 5299.0, 5709.0, 5469.0, 5436.0, 5277.0, 5283.0, 5264.0, 5383.0, 5516.0, 5428.0, 5405.0, 5704.0, 5545.0, 5339.0, 5644.0, 5293.0, 5617.0, 5373.0, 5449.0, 5627.0 (number of hits: 9)
18	5580	9	1	333		
19	5580	9	1	333	1	5600.0, 5657.0, 5520.0, 5651.0, 5543.0, 5533.0, 5647.0, 5350.0, 5524.0, 5332.0, 5400.0, 5717.0, 5546.0, 5277.0, 5266.0, 5561.0, 5441.0, 5409.0, 5643.0, 5649.0, 5458.0, 5527.0, 5590.0, 5658.0, 5668.0, 5439.0, 5445.0, 5679.0, 5664.0, 5428.0, 5582.0, 5414.0, 5288.0, 5484.0, 5282.0, 5530.0, 5612.0, 5252.0, 5709.0, 5479.0, 5551.0, 5682.0, 5380.0, 5426.0, 5710.0, 5494.0, 5267.0, 5560.0, 5355.0, 5349.0, 5636.0, 5358.0, 5345.0, 5364.0, 5531.0, 5306.0, 5335.0, 5541.0, 5557.0, 5719.0, 5576.0, 5563.0, 5670.0, 5678.0, 5521.0, 5328.0, 5331.0, 5402.0, 5671.0, 5433.0, 5638.0, 5272.0, 5317.0, 5650.0, 5614.0, 5516.0, 5490.0, 5607.0, 5311.0, 5377.0, 5663.0, 5469.0, 5374.0, 5628.0, 5571.0, 5384.0, 5462.0, 5587.0, 5456.0, 5584.0, 5601.0, 5368.0, 5574.0, 5659.0, 5304.0, 5577.0, 5487.0, 5684.0, 5630.0, 5579.0 (number of hits: 4)
20	5580	9	1	333	1	5510.0, 5356.0, 5349.0, 5408.0, 5369.0, 5670.0, 5505.0, 5311.0, 5718.0, 5479.0, 5575.0, 5668.0, 5462.0, 5424.0, 5421.0, 5429.0, 5545.0, 5625.0, 5260.0, 5633.0, 5355.0, 5691.0, 5548.0, 5463.0, 5377.0, 5537.0, 5367.0, 5259.0, 5584.0, 5645.0, 5694.0, 5671.0, 5630.0, 5490.0, 5528.0, 5278.0, 5461.0, 5297.0, 5396.0, 5302.0,

						5543.0, 5686.0, 5552.0, 5387.0, 5436.0, 5492.0, 5440.0, 5409.0, 5403.0, 5678.0, 5476.0, 5357.0, 5683.0, 5503.0, 5544.0, 5596.0, 5669.0, 5374.0, 5301.0, 5473.0, 5657.0, 5475.0, 5370.0, 5418.0, 5306.0, 5606.0, 5448.0, 5375.0, 5680.0, 5459.0, 5426.0, 5460.0, 5650.0, 5516.0, 5250.0, 5603.0, 5702.0, 5532.0, 5561.0, 5675.0, 5624.0, 5517.0, 5707.0, 5456.0, 5458.0, 5676.0, 5340.0, 5337.0, 5457.0, 5638.0, 5509.0, 5338.0, 5333.0, 5317.0, 5389.0, 5520.0, 5719.0, 5567.0, 5611.0, 5432.0 (number of hits: 5)
21	5580	9	1	333	1	5558.0, 5678.0, 5688.0, 5306.0, 5327.0, 5521.0, 5272.0, 5666.0, 5277.0, 5659.0, 5604.0, 5652.0, 5557.0, 5328.0, 5334.0, 5451.0, 5598.0, 5437.0, 5567.0, 5431.0, 5509.0, 5525.0, 5425.0, 5291.0, 5584.0, 5523.0, 5581.0, 5281.0, 5442.0, 5316.0, 5570.0, 5473.0, 5314.0, 5494.0, 5692.0, 5481.0, 5356.0, 5456.0, 5513.0, 5663.0, 5614.0, 5563.0, 5300.0, 5290.0, 5419.0, 5700.0, 5470.0, 5637.0, 5573.0, 5365.0, 5585.0, 5539.0, 5569.0, 5550.0, 5638.0, 5655.0, 5537.0, 5341.0, 5676.0, 5273.0, 5690.0, 5388.0, 5552.0, 5683.0, 5617.0, 5331.0, 5630.0, 5592.0, 5612.0, 5427.0, 5366.0, 5287.0, 5579.0, 5383.0, 5501.0, 5315.0, 5403.0, 5498.0, 5452.0, 5359.0, 5467.0, 5489.0, 5422.0, 5718.0, 5397.0, 5485.0, 5257.0, 5320.0, 5648.0, 5336.0, 5632.0, 5410.0, 5421.0, 5680.0, 5326.0, 5474.0, 5338.0, 5313.0, 5713.0, 5576.0 (number of hits: 7)
22	5580	9	1	333	1	5324.0, 5554.0, 5436.0, 5349.0, 5499.0, 5628.0, 5678.0, 5408.0, 5402.0, 5582.0, 5271.0, 5610.0, 5435.0, 5604.0, 5515.0, 5670.0, 5657.0, 5659.0, 5631.0, 5442.0, 5340.0, 5570.0, 5658.0, 5306.0, 5519.0, 5551.0, 5491.0, 5297.0, 5705.0, 5724.0, 5476.0, 5500.0, 5443.0, 5605.0, 5294.0, 5641.0, 5702.0, 5356.0, 5614.0, 5376.0, 5650.0, 5417.0, 5625.0, 5298.0, 5630.0, 5498.0, 5669.0, 5562.0, 5666.0, 5645.0, 5646.0, 5287.0, 5328.0, 5606.0, 5416.0, 5712.0, 5662.0, 5552.0, 5672.0, 5516.0, 5337.0, 5293.0, 5388.0, 5318.0, 5569.0, 5599.0, 5653.0, 5373.0, 5343.0, 5344.0, 5543.0, 5466.0, 5432.0, 5330.0, 5329.0, 5652.0, 5485.0, 5488.0, 5394.0, 5310.0, 5399.0, 5275.0, 5331.0, 5699.0, 5397.0, 5446.0, 5472.0, 5632.0, 5590.0, 5587.0, 5664.0, 5463.0, 5479.0, 5497.0, 5509.0, 5459.0, 5600.0, 5538.0, 5263.0, 5573.0 (number of hits: 7)
23	5580	9	1	333	1	5697.0, 5680.0, 5716.0, 5722.0, 5598.0,

						5617.0, 5669.0, 5462.0, 5308.0, 5530.0, 5613.0, 5686.0, 5404.0, 5586.0, 5501.0, 5360.0, 5443.0, 5685.0, 5591.0, 5477.0, 5684.0, 5378.0, 5455.0, 5402.0, 5273.0, 5491.0, 5294.0, 5543.0, 5600.0, 5317.0, 5289.0, 5382.0, 5587.0, 5481.0, 5341.0, 5257.0, 5636.0, 5260.0, 5639.0, 5572.0, 5550.0, 5354.0, 5413.0, 5295.0, 5448.0, 5303.0, 5653.0, 5375.0, 5688.0, 5615.0, 5363.0, 5315.0, 5489.0, 5498.0, 5436.0, 5632.0, 5325.0, 5346.0, 5687.0, 5626.0, 5495.0, 5625.0, 5329.0, 5337.0, 5383.0, 5446.0, 5400.0, 5599.0, 5296.0, 5340.0, 5557.0, 5422.0, 5635.0, 5466.0, 5428.0, 5464.0, 5417.0, 5717.0, 5365.0, 5597.0, 5689.0, 5638.0, 5607.0, 5350.0, 5318.0, 5523.0, 5666.0, 5271.0, 5497.0, 5324.0, 5290.0, 5321.0, 5367.0, 5490.0, 5522.0, 5493.0, 5648.0, 5555.0, 5611.0, 5547.0 (number of hits: 7)
24	5580	9	1	333	1	5344.0, 5454.0, 5270.0, 5342.0, 5628.0, 5414.0, 5572.0, 5397.0, 5318.0, 5382.0, 5346.0, 5564.0, 5376.0, 5617.0, 5483.0, 5662.0, 5288.0, 5425.0, 5722.0, 5347.0, 5335.0, 5314.0, 5530.0, 5379.0, 5390.0, 5515.0, 5567.0, 5517.0, 5656.0, 5477.0, 5691.0, 5387.0, 5505.0, 5692.0, 5671.0, 5482.0, 5449.0, 5406.0, 5493.0, 5426.0, 5640.0, 5484.0, 5511.0, 5281.0, 5498.0, 5534.0, 5632.0, 5402.0, 5308.0, 5659.0, 5261.0, 5593.0, 5690.0, 5612.0, 5358.0, 5711.0, 5600.0, 5305.0, 5310.0, 5549.0, 5345.0, 5400.0, 5445.0, 5324.0, 5304.0, 5670.0, 5259.0, 5525.0, 5623.0, 5325.0, 5686.0, 5513.0, 5351.0, 5372.0, 5557.0, 5652.0, 5389.0, 5321.0, 5503.0, 5713.0, 5576.0, 5408.0, 5599.0, 5328.0, 5681.0, 5250.0, 5695.0, 5710.0, 5629.0, 5682.0, 5323.0, 5436.0, 5510.0, 5302.0, 5594.0, 5422.0, 5399.0, 5367.0, 5272.0, 5334.0 (number of hits: 7)
25	5580	9	1	333	1	5424.0, 5523.0, 5367.0, 5438.0, 5676.0, 5688.0, 5667.0, 5617.0, 5362.0, 5505.0, 5565.0, 5704.0, 5399.0, 5369.0, 5641.0, 5572.0, 5689.0, 5286.0, 5558.0, 5522.0, 5294.0, 5519.0, 5269.0, 5540.0, 5588.0, 5702.0, 5531.0, 5658.0, 5304.0, 5335.0, 5493.0, 5648.0, 5631.0, 5703.0, 5309.0, 5322.0, 5272.0, 5459.0, 5400.0, 5635.0, 5552.0, 5619.0, 5376.0, 5680.0, 5569.0, 5439.0, 5458.0, 5422.0, 5517.0, 5629.0, 5311.0, 5418.0, 5564.0, 5373.0, 5411.0, 5391.0, 5546.0, 5415.0, 5633.0, 5334.0, 5640.0, 5305.0, 5478.0, 5339.0, 5650.0, 5532.0, 5340.0, 5537.0, 5293.0, 5321.0, 5345.0, 5331.0, 5723.0, 5475.0, 5604.0,

						5465.0, 5276.0, 5296.0, 5653.0, 5590.0, 5638.0, 5468.0, 5620.0, 5349.0, 5577.0, 5447.0, 5656.0, 5615.0, 5490.0, 5573.0, 5352.0, 5583.0, 5433.0, 5539.0, 5492.0, 5332.0, 5696.0, 5521.0, 5397.0, 5642.0 (number of hits: 8)
26	5580	9	1	333	1	5442.0, 5686.0, 5619.0, 5706.0, 5270.0, 5638.0, 5508.0, 5499.0, 5634.0, 5419.0, 5349.0, 5381.0, 5462.0, 5324.0, 5539.0, 5694.0, 5357.0, 5677.0, 5452.0, 5356.0, 5519.0, 5313.0, 5629.0, 5385.0, 5595.0, 5541.0, 5513.0, 5353.0, 5527.0, 5626.0, 5316.0, 5293.0, 5322.0, 5505.0, 5300.0, 5426.0, 5503.0, 5504.0, 5466.0, 5625.0, 5476.0, 5312.0, 5363.0, 5604.0, 5612.0, 5526.0, 5435.0, 5305.0, 5382.0, 5398.0, 5710.0, 5608.0, 5346.0, 5665.0, 5409.0, 5388.0, 5470.0, 5454.0, 5384.0, 5402.0, 5491.0, 5386.0, 5550.0, 5554.0, 5708.0, 5336.0, 5321.0, 5264.0, 5537.0, 5436.0, 5716.0, 5379.0, 5374.0, 5639.0, 5563.0, 5637.0, 5609.0, 5530.0, 5696.0, 5267.0, 5684.0, 5715.0, 5252.0, 5532.0, 5274.0, 5471.0, 5318.0, 5689.0, 5603.0, 5641.0, 5453.0, 5459.0, 5533.0, 5358.0, 5500.0, 5512.0, 5549.0, 5709.0, 5597.0, 5422.0 (number of hits: 5)
27	5580	9	1	333	1	5473.0, 5551.0, 5622.0, 5582.0, 5361.0, 5516.0, 5454.0, 5356.0, 5518.0, 5667.0, 5577.0, 5654.0, 5479.0, 5642.0, 5554.0, 5513.0, 5365.0, 5533.0, 5302.0, 5425.0, 5378.0, 5711.0, 5521.0, 5276.0, 5272.0, 5633.0, 5609.0, 5530.0, 5671.0, 5547.0, 5387.0, 5434.0, 5345.0, 5611.0, 5268.0, 5632.0, 5364.0, 5639.0, 5372.0, 5498.0, 5389.0, 5618.0, 5487.0, 5703.0, 5494.0, 5680.0, 5451.0, 5541.0, 5610.0, 5672.0, 5560.0, 5467.0, 5638.0, 5485.0, 5289.0, 5312.0, 5537.0, 5574.0, 5476.0, 5520.0, 5522.0, 5489.0, 5349.0, 5506.0, 5692.0, 5532.0, 5575.0, 5347.0, 5501.0, 5371.0, 5658.0, 5657.0, 5616.0, 5409.0, 5338.0, 5472.0, 5442.0, 5311.0, 5517.0, 5625.0, 5620.0, 5693.0, 5602.0, 5444.0, 5406.0, 5304.0, 5700.0, 5709.0, 5696.0, 5469.0, 5335.0, 5341.0, 5567.0, 5377.0, 5412.0, 5457.0, 5455.0, 5650.0, 5261.0, 5408.0 (number of hits: 5)
28	5580	9	1	333	1	5321.0, 5355.0, 5296.0, 5439.0, 5532.0, 5361.0, 5322.0, 5348.0, 5455.0, 5641.0, 5722.0, 5498.0, 5524.0, 5422.0, 5576.0, 5698.0, 5660.0, 5367.0, 5354.0, 5425.0, 5626.0, 5360.0, 5501.0, 5408.0, 5542.0, 5333.0, 5690.0, 5412.0, 5519.0, 5320.0, 5717.0, 5349.0, 5285.0, 5621.0, 5710.0, 5700.0, 5298.0, 5628.0, 5688.0, 5685.0,

						5279.0, 5670.0, 5692.0, 5586.0, 5463.0, 5559.0, 5539.0, 5356.0, 5625.0, 5372.0, 5517.0, 5314.0, 5282.0, 5481.0, 5306.0, 5370.0, 5399.0, 5318.0, 5396.0, 5514.0, 5301.0, 5472.0, 5304.0, 5606.0, 5668.0, 5332.0, 5508.0, 5287.0, 5652.0, 5302.0, 5564.0, 5573.0, 5627.0, 5631.0, 5597.0, 5459.0, 5462.0, 5578.0, 5502.0, 5486.0, 5704.0, 5658.0, 5432.0, 5364.0, 5634.0, 5430.0, 5456.0, 5433.0, 5387.0, 5531.0, 5256.0, 5338.0, 5262.0, 5376.0, 5290.0, 5614.0, 5397.0, 5682.0, 5316.0, 5400.0 (number of hits: 10)
29	5580	9	1	333	1	5253.0, 5493.0, 5650.0, 5483.0, 5467.0, 5281.0, 5275.0, 5289.0, 5455.0, 5413.0, 5719.0, 5341.0, 5574.0, 5499.0, 5436.0, 5439.0, 5266.0, 5678.0, 5251.0, 5452.0, 5585.0, 5502.0, 5406.0, 5300.0, 5459.0, 5518.0, 5357.0, 5345.0, 5320.0, 5409.0, 5288.0, 5655.0, 5322.0, 5490.0, 5398.0, 5324.0, 5669.0, 5566.0, 5670.0, 5296.0, 5584.0, 5371.0, 5364.0, 5611.0, 5264.0, 5535.0, 5539.0, 5628.0, 5570.0, 5687.0, 5359.0, 5675.0, 5354.0, 5385.0, 5714.0, 5474.0, 5306.0, 5636.0, 5442.0, 5410.0, 5449.0, 5335.0, 5473.0, 5487.0, 5294.0, 5591.0, 5722.0, 5567.0, 5577.0, 5373.0, 5330.0, 5676.0, 5333.0, 5604.0, 5547.0, 5589.0, 5497.0, 5372.0, 5261.0, 5425.0, 5256.0, 5560.0, 5355.0, 5407.0, 5368.0, 5704.0, 5469.0, 5471.0, 5374.0, 5408.0, 5259.0, 5528.0, 5656.0, 5358.0, 5505.0, 5428.0, 5383.0, 5351.0, 5587.0, 5453.0 (number of hits: 6)
30	5580	9	1	333	1	5511.0, 5678.0, 5543.0, 5692.0, 5351.0, 5404.0, 5298.0, 5684.0, 5391.0, 5388.0, 5675.0, 5279.0, 5628.0, 5374.0, 5680.0, 5275.0, 5431.0, 5357.0, 5596.0, 5544.0, 5719.0, 5712.0, 5326.0, 5399.0, 5586.0, 5360.0, 5293.0, 5548.0, 5706.0, 5429.0, 5310.0, 5282.0, 5713.0, 5330.0, 5396.0, 5556.0, 5373.0, 5499.0, 5540.0, 5674.0, 5553.0, 5480.0, 5648.0, 5617.0, 5268.0, 5607.0, 5272.0, 5416.0, 5699.0, 5390.0, 5546.0, 5490.0, 5403.0, 5677.0, 5265.0, 5359.0, 5346.0, 5333.0, 5343.0, 5577.0, 5584.0, 5484.0, 5525.0, 5486.0, 5258.0, 5614.0, 5377.0, 5430.0, 5653.0, 5335.0, 5602.0, 5660.0, 5618.0, 5523.0, 5554.0, 5259.0, 5472.0, 5527.0, 5654.0, 5369.0, 5419.0, 5334.0, 5435.0, 5516.0, 5715.0, 5338.0, 5658.0, 5464.0, 5353.0, 5681.0, 5458.0, 5613.0, 5591.0, 5518.0, 5250.0, 5687.0, 5564.0, 5481.0, 5313.0, 5382.0 (number of hits: 4)

20 MHz**Antenna 2****5270 MHz**

Radar Signal Type	Waveform/Trial Number	Detection (%)	Limit (%)	Pass/Fail
Type 1	30	96.7 %	60%	Pass
Type 2	30	93.3 %	60%	Pass
Type 3	30	100 %	60%	Pass
Type 4	30	100 %	60%	Pass
Type 5	30	83.3 %	80%	Pass
Type 6	30	93.3 %	70%	Pass

Please refer to the following statistical tables:

Antenna 2**5270 MHz****Table-1 Radar Type 1 Statistical Performance**

Trial #	Fc (MHz)	Pulse/Burst	Pulse Width (μS)	PRI (μs)	Detection (1:yes; 0:no)
1	5270	18	1	1428	1
2	5270	18	1	1428	1
3	5270	18	1	1428	1
4	5270	18	1	1428	1
5	5270	18	1	1428	1
6	5270	18	1	1428	1
7	5270	18	1	1428	1
8	5270	18	1	1428	1
9	5270	18	1	1428	1
10	5270	18	1	1428	1
11	5270	18	1	1428	1
12	5270	18	1	1428	1
13	5270	18	1	1428	1
14	5270	18	1	1428	0
15	5270	18	1	1428	1
16	5270	18	1	1428	1
17	5270	18	1	1428	1
18	5270	18	1	1428	1
19	5270	18	1	1428	1
20	5270	18	1	1428	1
21	5270	18	1	1428	1
22	5270	18	1	1428	1
23	5270	18	1	1428	1
24	5270	18	1	1428	1
25	5270	18	1	1428	1
26	5270	18	1	1428	1
27	5270	18	1	1428	1
28	5270	18	1	1428	1
29	5270	18	1	1428	1
30	5270	18	1	1428	1
Detection Percentage: 96.7 % (>60%)					

Table-2 Radar Type 2 Statistical Performance

Trial #	Fc (MHz)	Pulse/Burst	Pulse Width (μS)	PRI (μs)	Detection (1:yes; 0:no)
1	5270	29	2.9	190	0
2	5270	29	2.4	198	1
3	5270	26	2.4	172	1
4	5270	25	2.0	216	1
5	5270	25	4.6	198	1
6	5270	23	2.6	170	1
7	5270	27	4.3	214	1
8	5270	23	2.0	198	1
9	5270	24	1.8	227	1
10	5270	26	3.7	186	1
11	5270	29	2.3	215	1
12	5270	23	3.5	230	1
13	5270	26	1.3	189	1
14	5270	26	4.8	219	1
15	5270	23	1.5	170	1
16	5270	23	4.3	202	1
17	5270	24	5.0	186	1
18	5270	28	4.4	208	1
19	5270	29	4.1	179	1
20	5270	27	4.5	184	1
21	5270	25	4.7	197	1
22	5270	24	1.8	158	1
23	5270	26	4.2	152	1
24	5270	23	4.5	208	1
25	5270	28	4.2	165	1
26	5270	27	2.7	203	1
27	5270	23	2.6	171	1
28	5270	25	2.6	217	1
29	5270	26	1.3	222	1
30	5270	24	2.8	176	1
Detection Percentage: 93.3 % (>60%)					

Table-3 Radar Type 3 Statistical Performance

Trial #	Fc (MHz)	Pulse/Burst	Pulse Width (μS)	PRI (μs)	Detection (1:yes; 0:no)
1	5270	17	7.4	396	1
2	5270	18	6.3	404	1
3	5270	18	10	313	1
4	5270	18	6.4	356	1
5	5270	18	8.4	288	1
6	5270	16	8.6	325	1
7	5270	17	9.7	336	1
8	5270	17	8.6	215	1
9	5270	17	7	361	1
10	5270	17	7.7	365	1
11	5270	17	9.4	253	1
12	5270	18	8	219	1
13	5270	17	9.9	203	1
14	5270	16	6.5	336	1
15	5270	17	9.8	357	1
16	5270	18	8.3	425	1
17	5270	16	8.2	369	1
18	5270	17	10	236	1
19	5270	16	9.7	426	1
20	5270	17	9.7	436	1
21	5270	17	7.3	327	1
22	5270	17	8.4	365	1
23	5270	17	9.4	330	1
24	5270	16	6.4	280	1
25	5270	18	9.9	287	1
26	5270	18	8.6	411	1
27	5270	17	8.9	472	1
28	5270	17	6	259	1
29	5270	16	7.9	495	1
30	5270	17	6.1	351	1
Detection Percentage: 100 % (>60%)					

Table-4 Radar Type 4 Statistical Performance

Trial #	Fc (MHz)	Pulse/Burst	Pulse Width (μS)	PRI (μs)	Detection (1:yes; 0:no)
1	5270	12	18.2	460	1
2	5270	16	18	319	1
3	5270	14	14.5	410	1
4	5270	16	12.3	295	1
5	5270	14	15.8	458	1
6	5270	15	11.3	401	1
7	5270	16	17.4	498	1
8	5270	12	14.4	404	1
9	5270	13	12	345	1
10	5270	16	17.9	302	1
11	5270	16	11.9	304	1
12	5270	15	12.9	386	1
13	5270	14	16.3	487	1
14	5270	15	13.8	342	1
15	5270	13	12.9	381	1
16	5270	14	17.8	425	1
17	5270	12	16.7	385	1
18	5270	14	18.9	447	1
19	5270	12	19.6	442	1
20	5270	13	14.7	332	1
21	5270	15	17.5	278	1
22	5270	14	12	265	1
23	5270	13	17.5	494	1
24	5270	14	14	351	1
25	5270	15	16.3	386	1
26	5270	15	17.4	319	1
27	5270	15	11.7	488	1
28	5270	15	18.4	238	1
29	5270	14	19.6	255	1
30	5270	12	17.6	457	1
Detection Percentage: 100 % (>60%)					

Table-5 Radar Type 5 Statistical Performance

Bin5 Statistics 1

Trial #	Pulse	Chirp (MHz)	Pulse Width (μS)	Pulse 1-2 spacing (uS)	Pulse 2-3 spacing (uS)	Pulse Start(S)	Detection (1:yes; 0:no)
0	2	7	91.8	1202		0.156392	0
1	3	18	83.6	1079	1708	1.503751	
2	2	9	96.7	1125		2.398119	
3	2	14	50.9	1960		3.763378	
4	1	12	63.9			4.821633	
5	3	18	90.6	1101	1870	5.157229	
6	1	12	78.3			6.977139	
7	1	13	95.6			7.286232	
8	2	15	64.4	1806		8.885247	
9	1	15	88			9.050839	
10	3	13	81	1349	1438	10.37466	
11	2	18	85.5	1726		11.61025	

Bin5 Statistics 2

Trial #	Pulse	Chirp (MHz)	Pulse Width (μS)	Pulse 1-2 spacing (uS)	Pulse 2-3 spacing (uS)	Pulse Start(S)	Detection (1:yes; 0:no)
0	1	16	96.6			0.675452	1
1	2	10	63.1	1259		1.412429	
2	1	6	90.2			2.744302	
3	2	8	71.2	1749		3.603297	
4	1	16	92.3			5.241944	
5	2	12	61.8	1774		5.729367	
6	2	17	55.7	1270		7.601932	
7	3	5	57.1	1619	1892	8.184038	
8	2	6	96.3	1015		9.545028	
9	2	18	60.8	1402		10.79664	
10	1	5	82.5			11.97156	

Bin5 Statistics 3

Trial #	Pulse	Chirp (MHz)	Pulse Width (µS)	Pulse 1-2 spacing (uS)	Pulse 2-3 spacing (uS)	Pulse Start(S)	Detection (1:yes; 0:no)
0	1	10	73.8			0.207781	1
1	2	7	88.1	1038		0.919956	
2	3	9	53.1	1250	1893	1.656451	
3	1	11	97.2			2.480853	
4	3	19	56.2	1619	1219	3.441426	
5	2	11	53.2	1284		4.454284	
6	3	17	56	1256	1271	5.195119	
7	3	19	67	1420	1730	5.852925	
8	2	11	55.8	1052		6.717437	
9	2	10	98.9	1061		6.775295	
10	2	7	80.7	1700		7.79098	
11	2	19	65.2	1533		8.968444	
12	2	11	91	1823		9.16429	
13	2	5	85.5	1497		10.31845	
14	2	19	90.7	1822		10.53811	
15	1	17	88.1			11.95545	

Bin5 Statistics 4

Trial #	Pulse	Chirp (MHz)	Pulse Width (µS)	Pulse 1-2 spacing (uS)	Pulse 2-3 spacing (uS)	Pulse Start(S)	Detection (1:yes; 0:no)
0	2	16	57.1	1505		0.051621	1
1	2	7	66.5	1928		1.439005	
2	2	6	57.4	1505		1.731835	
3	2	15	76.4	1440		2.533793	
4	3	8	52	1973	1367	3.670364	
5	2	16	99.4	1970		4.045773	
6	1	10	66.2			5.438623	
7	1	10	55.3			6.177893	
8	1	16	74.3			6.406841	
9	2	15	58.2	1692		7.978875	
10	2	10	91.9	1348		8.122229	
11	2	13	54.7	1550		9.560836	
12	2	8	69.4	1723		10.30677	
13	3	9	51.1	1976	1010	11.02024	
14	2	14	86.1	1397		11.7685	

Bin5 Statistics 5

Trial #	Pulse	Chirp (MHz)	Pulse Width (µS)	Pulse 1-2 spacing (µS)	Pulse 2-3 spacing (µS)	Pulse Start(S)	Detection (1:yes; 0:no)
0	1	14	60.9			0.1357	1
1	2	18	64.6	1357		1.273159	
2	2	16	83.4	1722		1.742249	
3	2	19	93.5	1657		2.414006	
4	3	8	87.2	1023	1445	2.976903	
5	3	11	99.8	1894	1146	3.776227	
6	3	12	54.5	1974	1945	4.342696	
7	2	17	71.5	1290		5.174835	
8	3	18	70.8	1635	1840	5.459696	
9	2	15	61.1	1362		6.53035	
10	3	19	90.8	1165	1286	7.179388	
11	2	9	93.3	1232		7.463867	
12	2	15	75.3	1971		8.564698	
13	2	17	74.5	1044		9.21068	
14	1	16	58.6			9.971772	
15	1	8	85.7			10.27923	
16	2	9	84.8	1246		11.01738	
17	3	19	93.3	1778	1515	11.56758	

Bin5 Statistics 6

Trial #	Pulse	Chirp (MHz)	Pulse Width (µS)	Pulse 1-2 spacing (µS)	Pulse 2-3 spacing (µS)	Pulse Start(S)	Detection (1:yes; 0:no)
0	3	10	59.1	1144	1717	0.709109	0
1	3	15	71.1	1051	1039	1.853843	
2	2	5	66	1241		3.115284	
3	2	6	74.9	1260		4.724177	
4	1	16	52.5			4.917408	
5	1	18	77.5			6.798252	
6	1	14	57.7			7.262141	
7	1	18	50.4			9.247554	
8	2	19	58.5	1158		10.68887	
9	3	9	73.9	1772	1598	11.5753	

Bin5 Statistics 7

Trial #	Pulse	Chirp (MHz)	Pulse Width (µS)	Pulse 1-2 spacing (µS)	Pulse 2-3 spacing (µS)	Pulse Start(S)	Detection (1:yes; 0:no)
0	1	19	92.9			0.204923	0
1	2	15	61.3	1373		1.49125	
2	3	17	88	1492	1661	3.21104	
3	1	10	98.3			4.560092	
4	1	16	80			5.467928	
5	1	9	93.5			7.186279	
6	3	6	57.5	1469	1762	8.303643	
7	2	14	94.5	1483		8.607015	
8	2	12	58	1039		10.73113	
9	1	8	93.5			10.81613	

Bin5 Statistics 8

Trial #	Pulse	Chirp (MHz)	Pulse Width (µS)	Pulse 1-2 spacing (µS)	Pulse 2-3 spacing (µS)	Pulse Start(S)	Detection (1:yes; 0:no)
0	1	19	66.5			0.749261	0
1	1	19	70.6			2.353339	
2	1	14	73.5			4.059776	
3	2	13	98.8	1212		5.786688	
4	3	11	97.3	1700	1699	7.490899	
5	3	7	95.6	1901	1845	7.555894	
6	3	18	59.3	1649	1224	10.44528	
7	3	17	80.9	1462	1674	11.03886	

Bin5 Statistics 9

Trial #	Pulse	Chirp (MHz)	Pulse Width (µS)	Pulse 1-2 spacing (µS)	Pulse 2-3 spacing (µS)	Pulse Start(S)	Detection (1:yes; 0:no)
0	2	8	76	1856		1.066903	1
1	2	14	59.3	1254		1.98573	
2	3	16	69.6	1640	1122	3.244708	
3	3	11	63.5	1607	1089	4.154983	
4	2	12	57.4	1421		4.954642	
5	1	13	51.7			6.302494	
6	2	15	89.3	1315		8.07924	
7	3	16	73.5	1913	1189	8.41233	
8	2	15	52.3	1781		10.56939	
9	1	13	51.9			11.54692	

Bin5 Statistics 10

Trial #	Pulse	Chirp (MHz)	Pulse Width (µS)	Pulse 1-2 spacing (uS)	Pulse 2-3 spacing (uS)	Pulse Start(S)	Detection (1:yes; 0:no)
0	1	12	50.4			0.234697	1
1	2	9	81.3	1068		1.42179	
2	1	19	56.3			2.017471	
3	3	19	85.8	1602	1028	2.504278	
4	1	8	71.2			3.650199	
5	2	16	81.6	1466		4.177997	
6	3	6	70.3	1101	1805	5.17311	
7	3	15	65	1168	1205	5.888359	
8	1	15	83.1			6.99703	
9	2	9	77.9	1924		7.656298	
10	2	8	67.1	1377		8.604067	
11	1	10	83.2			9.554568	
12	2	5	69.4	1465		9.631755	
13	2	10	70	1949		10.55517	
14	2	20	75.1	1592		11.25526	

Bin5 Statistics 11

Trial #	Pulse	Chirp (MHz)	Pulse Width (µS)	Pulse 1-2 spacing (uS)	Pulse 2-3 spacing (uS)	Pulse Start(S)	Detection (1:yes; 0:no)
0	1	12	56			0.618134	1
1	2	11	66.7	1640		1.534056	
2	3	17	97.1	1116	1680	1.634309	
3	3	14	93.3	1813	1201	3.046037	
4	1	17	64.3			3.971846	
5	2	17	77.1	1035		4.675412	
6	3	19	58.8	1276	1460	4.973417	
7	1	8	83.3			5.730712	
8	1	11	82.1			6.984761	
9	3	8	92.3	1528	1813	7.251155	
10	3	18	83.3	1324	1636	8.344245	
11	1	14	56.7			9.339627	
12	2	18	94.5	1539		10.38846	
13	2	8	96.9	1907		10.75992	
14	3	14	60.9	1948	1164	11.39857	

Bin5 Statistics 12

Trial #	Pulse	Chirp (MHz)	Pulse Width (μS)	Pulse 1-2 spacing (uS)	Pulse 2-3 spacing (uS)	Pulse Start(S)	Detection (1:yes; 0:no)
0	2	16	94.8	1919		0.076028	1
1	3	15	67.5	1530	1544	1.200222	
2	1	13	99.7			2.978041	
3	3	19	75.2	1887	1714	4.136346	
4	2	9	82.9	1312		5.634684	
5	2	18	72.4	1764		6.173755	
6	3	18	77.5	1324	1446	7.947161	
7	3	5	63.1	1275	1255	8.798892	
8	1	14	59.2			9.882356	
9	2	15	93.8	1545		11.45449	

Bin5 Statistics 13

Trial #	Pulse	Chirp (MHz)	Pulse Width (μS)	Pulse 1-2 spacing (uS)	Pulse 2-3 spacing (uS)	Pulse Start(S)	Detection (1:yes; 0:no)
0	1	7	79.8			0.181782	1
1	3	10	68.4	1910	1877	1.501876	
2	1	14	55.8			2.666584	
3	2	12	57.3	1304		3.908986	
4	2	6	84.3	1824		4.38817	
5	1	5	55.8			5.79543	
6	3	15	70.1	1454	1599	7.207133	
7	3	11	98.9	1429	1564	7.903126	
8	3	16	100	1951	1538	9.492573	
9	2	9	50.9	2000		10.14293	
10	3	16	68.5	1671	1906	11.25423	

Bin5 Statistics 14

Trial #	Pulse	Chirp (MHz)	Pulse Width (µS)	Pulse 1-2 spacing (uS)	Pulse 2-3 spacing (uS)	Pulse Start(S)	Detection (1:yes; 0:no)
0	2	15	87.3	1244		0.178385	1
1	1	14	80.3			1.012555	
2	1	7	67.1			1.897463	
3	1	9	98.8			2.633533	
4	2	6	66.3	1733		3.036696	
5	1	10	98.7			3.343477	
6	2	17	68	1752		4.076398	
7	2	12	56.8	1528		5.326183	
8	1	11	70.8			5.95068	
9	3	15	64.8	1053	1625	6.287182	
10	1	11	78.1			6.72651	
11	2	10	54	1056		7.827562	
12	3	6	63.8	1353	1256	8.532538	
13	2	19	84.3	1321		9.096759	
14	2	7	97.7	1128		9.963968	
15	1	7	59.8			10.48176	
16	2	12	66.2	1113		10.8959	
17	1	5	80.1			11.74764	

Bin5 Statistics 15

Trial #	Pulse	Chirp (MHz)	Pulse Width (µS)	Pulse 1-2 spacing (uS)	Pulse 2-3 spacing (uS)	Pulse Start(S)	Detection (1:yes; 0:no)
0	1	20	57.8			0.557417	1
1	2	12	80.3	1666		1.538149	
2	1	17	93.5			2.58365	
3	1	11	52.9			3.361412	
4	2	19	96.1	1317		5.123376	
5	3	8	83.2	1329	1162	6.503342	
6	2	8	59.3	1225		7.373443	
7	2	13	79.4	1223		8.593843	
8	2	19	92	1830		9.637595	
9	3	7	70.1	1384	1068	10.52302	
10	3	14	58.1	1645	1216	11.83044	

Bin5 Statistics 16

Trial #	Pulse	Chirp (MHz)	Pulse Width (µS)	Pulse 1-2 spacing (µS)	Pulse 2-3 spacing (µS)	Pulse Start(S)	Detection (1:yes; 0:no)
0	3	5	60.7	1151	1894	0.555163	1
1	1	6	88			1.43678	
2	3	12	99.7	1857	1533	2.562707	
3	1	11	64.1			4.355586	
4	2	14	79.2	1040		5.302056	
5	2	13	62.8	1005		5.497313	
6	1	18	71.6			6.595714	
7	3	17	81.1	1109	1925	8.241592	
8	2	10	66.5	1657		9.118227	
9	2	13	87.1	1019		10.20468	
10	1	9	72			11.36496	

Bin5 Statistics 17

Trial #	Pulse	Chirp (MHz)	Pulse Width (µS)	Pulse 1-2 spacing (µS)	Pulse 2-3 spacing (µS)	Pulse Start(S)	Detection (1:yes; 0:no)
0	3	10	55.3	1296	1026	0.381238	1
1	2	5	72.1	1978		1.195386	
2	1	13	53.6			2.435901	
3	3	17	68	1592	1970	3.053242	
4	2	11	81	1809		3.789559	
5	3	8	66	1750	1239	4.577307	
6	1	9	70.7			5.254718	
7	2	14	91.9	1075		6.197171	
8	2	16	53.7	1181		6.98552	
9	2	8	91.8	1581		8.24695	
10	1	14	72.5			8.776104	
11	3	6	77.9	1098	1435	9.856903	
12	1	7	96.8			11.11948	
13	3	9	64.3	1360	1878	11.5557	

Bin5 Statistics 18

Trial #	Pulse	Chirp (MHz)	Pulse Width (µS)	Pulse 1-2 spacing (uS)	Pulse 2-3 spacing (uS)	Pulse Start(S)	Detection (1:yes; 0:no)
0	3	10	64.7	1064	1387	1.13358	1
1	2	10	70.8	1765		1.896357	
2	2	15	87.6	1542		3.359708	
3	3	11	97.2	1018	1940	4.249141	
4	1	7	75.7			5.550901	
5	2	11	93.6	1982		7.803176	
6	2	8	77.7	1236		8.304491	
7	3	9	95.4	1698	1768	10.44851	
8	2	15	91.6	1859		11.24338	

Bin5 Statistics 19

Trial #	Pulse	Chirp (MHz)	Pulse Width (µS)	Pulse 1-2 spacing (uS)	Pulse 2-3 spacing (uS)	Pulse Start(S)	Detection (1:yes; 0:no)
0	1	12	51.7			0.432821	1
1	3	8	54.4	1888	1788	1.627401	
2	2	19	84.9	1535		3.149224	
3	2	8	83.6	1805		4.257159	
4	2	9	89.4	1295		5.198464	
5	2	13	58.3	1152		5.573731	
6	2	7	58.8	1797		7.166685	
7	1	15	71.9			8.666607	
8	2	7	73.2	1133		9.217091	
9	3	14	55.9	1562	1579	9.938773	
10	1	17	59.1			11.60094	

Bin5 Statistics 20

Trial #	Pulse	Chirp (MHz)	Pulse Width (µS)	Pulse 1-2 spacing (µS)	Pulse 2-3 spacing (µS)	Pulse Start(S)	Detection (1:yes; 0:no)
0	1	20	68.1			0.706908	0
1	3	14	88	1264	1149	0.752802	
2	2	12	83.2	1676		1.523828	
3	3	9	57.7	1308	1739	2.790104	
4	2	8	60.1	1127		3.619753	
5	3	6	97.4	1456	1483	4.339004	
6	2	7	98	1277		5.06919	
7	3	14	76.1	1040	1090	5.986715	
8	3	18	68.4	1699	1352	6.284946	
9	1	10	50.9			7.090921	
10	1	20	99.7			8.157926	
11	3	16	86.3	1445	1773	8.859705	
12	2	7	68.5	1746		9.367762	
13	2	12	59.3	1205		10.37778	
14	3	10	74.1	1386	1816	11.03819	
15	2	12	64.1	1772		11.82131	

Bin5 Statistics 21

Trial #	Pulse	Chirp (MHz)	Pulse Width (µS)	Pulse 1-2 spacing (µS)	Pulse 2-3 spacing (µS)	Pulse Start(S)	Detection (1:yes; 0:no)
0	2	18	68.5	1148		0.519711	1
1	2	18	56.2	1488		1.767167	
2	1	9	50.7			3.276811	
3	1	16	63.8			3.650978	
4	3	11	64.7	1199	1979	5.345284	
5	1	16	90.3			6.722661	
6	1	18	89.5			7.592812	
7	2	18	69.3	1085		8.649231	
8	2	13	57.6	1931		10.08126	
9	3	10	67.2	1419	1750	11.01657	

Bin5 Statistics 22

Trial #	Pulse	Chirp (MHz)	Pulse Width (μS)	Pulse 1-2 spacing (uS)	Pulse 2-3 spacing (uS)	Pulse Start(S)	Detection (1:yes; 0:no)
0	2	14	77.4	1129		0.159064	1
1	3	17	62	1669	1465	1.379135	
2	1	12	78			2.980271	
3	2	17	67.2	1746		4.574279	
4	3	6	76.8	1145	1628	5.74868	
5	2	14	92.4	1214		6.415951	
6	2	17	56.3	1293		8.268952	
7	1	10	70.2			9.544168	
8	3	9	78.6	1513	1225	10.45508	
9	3	9	90.3	1836	1172	10.92681	

Bin5 Statistics 23

Trial #	Pulse	Chirp (MHz)	Pulse Width (μS)	Pulse 1-2 spacing (uS)	Pulse 2-3 spacing (uS)	Pulse Start(S)	Detection (1:yes; 0:no)
0	3	10	92	1467	1008	0.467654	0
1	3	18	93.2	1727	1886	1.12184	
2	3	16	66.4	1857	1772	1.944988	
3	2	19	58.4	1398		3.548039	
4	3	12	86.8	1926	1242	4.310013	
5	1	12	69.4			5.461797	
6	2	18	59.5	1449		5.950899	
7	2	17	75.5	1672		7.375645	
8	2	8	72.8	1164		7.946294	
9	2	10	55.6	1053		8.60773	
10	1	7	52.8			9.590184	
11	3	9	93	1382	1371	10.1697	
12	3	6	76	1860	1121	11.74203	

Bin5 Statistics 24

Trial #	Pulse	Chirp (MHz)	Pulse Width (μS)	Pulse 1-2 spacing (uS)	Pulse 2-3 spacing (uS)	Pulse Start(S)	Detection (1:yes; 0:no)
0	2	10	85.4	1900		0.255544	1
1	2	9	68.6	1081		0.803688	
2	3	18	91.1	1148	1619	1.400929	
3	3	13	61.9	1828	1801	2.030761	
4	1	10	76.2			3.292658	
5	3	19	78.2	1957	1175	3.701682	
6	2	8	50.9	1760		4.190795	
7	2	9	98.9	1538		5.190306	
8	2	12	53.6	1316		5.956618	
9	2	7	95.6	1117		6.31793	
10	3	14	81.8	1005	1681	7.184694	
11	3	17	82.1	1717	1735	7.447043	
12	2	6	64.4	1542		8.496956	
13	2	6	87	1682		9.045393	
14	2	11	58.4	1426		9.882089	
15	2	11	86.9	1995		10.53461	
16	1	20	63.8			10.83593	
17	1	19	67.9			11.95681	

Bin5 Statistics 25

Trial #	Pulse	Chirp (MHz)	Pulse Width (µS)	Pulse 1-2 spacing (uS)	Pulse 2-3 spacing (uS)	Pulse Start(S)	Detection (1:yes; 0:no)
0	1	18	71.6			0.591837	1
1	2	9	58.9	1674		0.929816	
2	3	5	66.9	1246	1394	1.880283	
3	1	7	60.3			2.141171	
4	2	8	79.3	1738		3.143781	
5	2	17	91.2	1466		3.409343	
6	2	5	87.7	1660		4.162251	
7	2	14	99.9	1139		4.986646	
8	2	14	65.6	1236		5.427118	
9	3	18	71.3	1382	1375	5.810732	
10	2	16	87.4	1531		6.793711	
11	2	10	94.9	1985		7.168696	
12	2	11	81	1116		7.914329	
13	1	19	55.3			8.725471	
14	1	12	70.8			9.045362	
15	1	15	59.6			9.483872	
16	1	13	78.2			10.39118	
17	1	15	72			11.28962	
18	3	7	94.9	1762	1598	11.67871	

Bin5 Statistics 26

Trial #	Pulse	Chirp (MHz)	Pulse Width (µS)	Pulse 1-2 spacing (uS)	Pulse 2-3 spacing (uS)	Pulse Start(S)	Detection (1:yes; 0:no)
0	3	11	56.9	1500	1594	0.422035	1
1	3	18	93.2	1254	1032	1.113541	
2	3	7	94.8	1298	1932	2.023647	
3	3	12	93.8	1115	1774	2.950831	
4	1	18	91.3			3.552522	
5	2	20	56.6	1524		4.295797	
6	1	12	92.7			4.816634	
7	1	9	63.7			6.042341	
8	1	6	89.9			6.664266	
9	1	11	96.9			7.989704	
10	3	14	98.9	1325	1272	8.55524	
11	2	14	63.2	1088		9.511023	
12	3	9	58.9	1832	1420	9.671738	
13	2	16	71.7	1670		10.40149	
14	3	15	81.7	1024	1572	11.76582	

Bin5 Statistics 27

Trial #	Pulse	Chirp (MHz)	Pulse Width (μS)	Pulse 1-2 spacing (uS)	Pulse 2-3 spacing (uS)	Pulse Start(S)	Detection (1:yes; 0:no)
0	3	11	70.1	1323	1150	0.5199	1
1	2	19	56.5	1110		0.793588	
2	1	16	96.3			1.465574	
3	2	12	79.8	1896		1.950489	
4	3	9	95.2	1467	1536	2.508908	
5	2	13	78	1877		3.595198	
6	2	16	58.4	1759		3.94556	
7	2	11	85	1956		4.399696	
8	3	12	63.7	1605	1245	4.898851	
9	2	15	78.1	1892		5.784475	
10	1	11	98.3			6.458594	
11	2	12	67.5	1424		6.638191	
12	2	12	69	1648		7.651555	
13	3	14	98.8	1989	1445	7.854724	
14	2	10	58.4	1311		8.536957	
15	2	9	50.5	1201		9.585926	
16	3	11	51.6	1619	1805	9.814686	
17	2	11	91.8	1876		10.47038	
18	2	15	84.1	1430		11.34918	
19	2	20	87.7	1844		11.83622	

Bin5 Statistics 28

Trial #	Pulse	Chirp (MHz)	Pulse Width (µS)	Pulse 1-2 spacing (uS)	Pulse 2-3 spacing (uS)	Pulse Start(S)	Detection (1:yes; 0:no)
0	3	8	58.1	1991	1167	0.060873	1
1	2	11	68	1899		1.093482	
2	2	10	53.2	1747		1.51071	
3	3	18	81.3	1564	1645	2.080642	
4	2	6	56	1785		2.694719	
5	2	14	62.6	1894		3.942873	
6	1	19	51.1			4.188315	
7	1	20	80.8			4.759043	
8	2	20	97.5	1499		5.712449	
9	2	13	50.3	1565		6.156499	
10	2	13	84.5	1499		7.042553	
11	3	12	66.3	1645	1974	7.524031	
12	1	11	86.8			8.26249	
13	2	6	62.7	1400		9.08789	
14	2	6	51.2	1309		9.654549	
15	2	6	70.2	1531		10.50237	
16	1	13	50.1			10.74144	
17	1	7	53.7			11.52599	

Bin5 Statistics 29

Trial #	Pulse	Chirp (MHz)	Pulse Width (µS)	Pulse 1-2 spacing (uS)	Pulse 2-3 spacing (uS)	Pulse Start(S)	Detection (1:yes; 0:no)
0	3	17	99.9	1579	1812	0.255537	1
1	2	17	52.4	1612		1.29343	
2	2	11	86.3	1089		1.766714	
3	3	9	70.8	1224	1054	2.847732	
4	2	19	72.2	1496		4.089993	
5	3	8	81.7	1529	1817	4.494277	
6	2	13	57.8	1875		5.907271	
7	2	17	94	1062		6.164885	
8	2	8	97.9	1085		7.115081	
9	3	13	76.2	1965	1602	8.231298	
10	2	17	53.2	1081		9.121017	
11	2	6	99.2	1950		9.699423	
12	2	17	67.4	1557		10.57306	
13	2	19	86	1426		11.168	

Bin5 Statistics 30

Trial #	Pulse	Chirp (MHz)	Pulse Width (μS)	Pulse 1-2 spacing (uS)	Pulse 2-3 spacing (uS)	Pulse Start(S)	Detection (1:yes; 0:no)
0	1	12	85			0.9338	1
1	1	12	55.5			1.361447	
2	2	5	73.1	1722		2.873894	
3	1	12	99.7			3.408727	
4	1	20	97.1			4.84973	
5	2	13	89.8	1825		5.144095	
6	2	13	89.8	1362		6.635485	
7	3	12	78.4	1748	1330	7.723339	
8	1	17	91.6			8.00822	
9	1	10	80.4			9.257948	
10	2	19	55.9	1339		10.41697	
11	1	10	59.4			11.27223	

Table-6 Radar Type 6 Statistical Performance

Trial #	Fc (MHz)	Pulse /Burst	Pulse Width (µS)	PRI (µs)	Detection (1:yes; 0:no)	Hopping Sequence
1	5270	9	1	333	1	5684.0, 5402.0, 5358.0, 5550.0, 5537.0, 5672.0, 5259.0, 5311.0, 5546.0, 5272.0, 5606.0, 5471.0, 5565.0, 5345.0, 5441.0, 5346.0, 5389.0, 5656.0, 5418.0, 5302.0, 5673.0, 5460.0, 5299.0, 5713.0, 5531.0, 5327.0, 5597.0, 5485.0, 5716.0, 5281.0, 5636.0, 5528.0, 5265.0, 5567.0, 5508.0, 5283.0, 5364.0, 5700.0, 5361.0, 5688.0, 5660.0, 5511.0, 5506.0, 5655.0, 5696.0, 5641.0, 5503.0, 5489.0, 5393.0, 5293.0, 5436.0, 5376.0, 5486.0, 5348.0, 5357.0, 5474.0, 5298.0, 5544.0, 5440.0, 5450.0, 5430.0, 5702.0, 5549.0, 5318.0, 5495.0, 5724.0, 5722.0, 5548.0, 5322.0, 5444.0, 5448.0, 5604.0, 5367.0, 5267.0, 5547.0, 5375.0, 5530.0, 5652.0, 5617.0, 5413.0, 5612.0, 5337.0, 5427.0, 5646.0, 5386.0, 5295.0, 5321.0, 5334.0, 5369.0, 5335.0, 5354.0, 5477.0, 5690.0, 5482.0, 5420.0, 5315.0, 5331.0, 5443.0, 5541.0, 5573.0 (number of hits: 6)
2	5270	9	1	333	1	5279.0, 5385.0, 5500.0, 5603.0, 5398.0, 5559.0, 5684.0, 5316.0, 5322.0, 5569.0, 5610.0, 5286.0, 5445.0, 5329.0, 5393.0, 5522.0, 5518.0, 5456.0, 5366.0, 5264.0, 5489.0, 5560.0, 5579.0, 5694.0, 5418.0, 5458.0, 5630.0, 5293.0, 5562.0, 5435.0, 5375.0, 5276.0, 5291.0, 5677.0, 5320.0, 5623.0, 5601.0, 5364.0, 5468.0, 5716.0, 5628.0, 5338.0, 5552.0, 5280.0, 5277.0, 5701.0, 5365.0, 5568.0, 5434.0, 5648.0, 5369.0, 5420.0, 5387.0, 5306.0, 5638.0, 5343.0, 5258.0, 5425.0, 5384.0, 5336.0, 5658.0, 5578.0, 5693.0, 5363.0, 5259.0, 5368.0, 5399.0, 5433.0, 5476.0, 5323.0, 5351.0, 5650.0, 5308.0, 5467.0, 5281.0, 5534.0, 5544.0, 5707.0, 5402.0, 5551.0, 5672.0, 5525.0, 5573.0, 5715.0, 5722.0, 5480.0, 5482.0, 5498.0, 5695.0, 5614.0, 5371.0, 5382.0, 5325.0, 5374.0, 5414.0, 5632.0, 5543.0, 5622.0, 5580.0, 5667.0 (number of hits: 5)
3	5270	9	1	333	1	5391.0, 5288.0, 5483.0, 5597.0, 5430.0, 5351.0, 5537.0, 5333.0, 5403.0, 5603.0, 5541.0, 5569.0, 5567.0, 5649.0, 5471.0, 5580.0, 5401.0, 5312.0, 5355.0, 5721.0, 5616.0, 5317.0, 5719.0, 5579.0, 5691.0, 5462.0, 5631.0, 5534.0, 5449.0, 5645.0, 5438.0, 5298.0, 5398.0, 5542.0, 5425.0, 5311.0, 5559.0, 5348.0, 5481.0, 5396.0, 5689.0, 5587.0, 5577.0, 5485.0, 5250.0

						5572.0, 5444.0, 5709.0, 5291.0, 5335.0, 5344.0, 5260.0, 5334.0, 5255.0, 5475.0, 5491.0, 5697.0, 5538.0, 5283.0, 5571.0, 5503.0, 5400.0, 5613.0, 5410.0, 5637.0, 5710.0, 5404.0, 5589.0, 5617.0, 5517.0, 5360.0, 5339.0, 5508.0, 5543.0, 5536.0, 5435.0, 5480.0, 5686.0, 5700.0, 5519.0, 5254.0, 5399.0, 5570.0, 5343.0, 5433.0, 5664.0, 5531.0, 5520.0, 5673.0, 5627.0, 5675.0, 5427.0, 5633.0, 5303.0, 5347.0, 5646.0, 5629.0, 5656.0, 5264.0, 5679.0 (number of hits: 6)
4	5270	9	1	333	1	5332.0, 5569.0, 5362.0, 5320.0, 5371.0, 5297.0, 5695.0, 5337.0, 5677.0, 5349.0, 5674.0, 5316.0, 5697.0, 5716.0, 5610.0, 5350.0, 5468.0, 5548.0, 5663.0, 5710.0, 5512.0, 5454.0, 5429.0, 5281.0, 5491.0, 5370.0, 5409.0, 5502.0, 5498.0, 5340.0, 5321.0, 5705.0, 5369.0, 5539.0, 5672.0, 5535.0, 5600.0, 5335.0, 5310.0, 5330.0, 5687.0, 5430.0, 5279.0, 5268.0, 5579.0, 5619.0, 5722.0, 5563.0, 5696.0, 5555.0, 5590.0, 5392.0, 5578.0, 5415.0, 5723.0, 5380.0, 5621.0, 5550.0, 5462.0, 5388.0, 5471.0, 5625.0, 5668.0, 5717.0, 5466.0, 5561.0, 5558.0, 5361.0, 5589.0, 5659.0, 5601.0, 5278.0, 5363.0, 5334.0, 5593.0, 5493.0, 5300.0, 5707.0, 5267.0, 5400.0, 5260.0, 5292.0, 5553.0, 5389.0, 5372.0, 5288.0, 5671.0, 5629.0, 5526.0, 5549.0, 5446.0, 5421.0, 5720.0, 5676.0, 5406.0, 5262.0, 5581.0, 5485.0, 5311.0, 5509.0 (number of hits: 6)
5	5270	9	1	333	1	5276.0, 5266.0, 5714.0, 5265.0, 5277.0, 5685.0, 5470.0, 5623.0, 5331.0, 5606.0, 5484.0, 5399.0, 5362.0, 5511.0, 5364.0, 5369.0, 5335.0, 5697.0, 5646.0, 5506.0, 5440.0, 5639.0, 5703.0, 5515.0, 5706.0, 5667.0, 5661.0, 5516.0, 5552.0, 5541.0, 5602.0, 5261.0, 5391.0, 5421.0, 5415.0, 5624.0, 5382.0, 5311.0, 5483.0, 5527.0, 5463.0, 5285.0, 5327.0, 5665.0, 5425.0, 5310.0, 5615.0, 5715.0, 5663.0, 5403.0, 5441.0, 5316.0, 5550.0, 5420.0, 5326.0, 5600.0, 5414.0, 5412.0, 5379.0, 5656.0, 5657.0, 5614.0, 5498.0, 5294.0, 5592.0, 5330.0, 5432.0, 5536.0, 5297.0, 5378.0, 5487.0, 5573.0, 5627.0, 5568.0, 5278.0, 5398.0, 5321.0, 5260.0, 5501.0, 5619.0, 5272.0, 5597.0, 5322.0, 5638.0, 5473.0, 5718.0, 5374.0, 5302.0, 5539.0, 5476.0, 5339.0, 5365.0, 5402.0, 5372.0, 5342.0, 5439.0, 5540.0, 5416.0, 5367.0, 5561.0 (number of hits: 6)
6	5270	9	1	333	1	5387.0, 5687.0, 5290.0, 5628.0, 5443.0, 5422.0, 5507.0, 5506.0, 5521.0, 5263.0,

						5657.0, 5609.0, 5540.0, 5321.0, 5377.0, 5526.0, 5401.0, 5510.0, 5595.0, 5577.0, 5354.0, 5693.0, 5542.0, 5705.0, 5533.0, 5362.0, 5578.0, 5493.0, 5583.0, 5569.0, 5445.0, 5365.0, 5634.0, 5289.0, 5528.0, 5393.0, 5596.0, 5488.0, 5314.0, 5504.0, 5503.0, 5673.0, 5450.0, 5390.0, 5474.0, 5313.0, 5568.0, 5405.0, 5651.0, 5556.0, 5723.0, 5293.0, 5389.0, 5283.0, 5395.0, 5379.0, 5295.0, 5437.0, 5460.0, 5553.0, 5582.0, 5487.0, 5498.0, 5512.0, 5472.0, 5638.0, 5357.0, 5695.0, 5326.0, 5719.0, 5409.0, 5449.0, 5692.0, 5624.0, 5384.0, 5663.0, 5345.0, 5469.0, 5299.0, 5710.0, 5696.0, 5281.0, 5551.0, 5305.0, 5714.0, 5407.0, 5602.0, 5415.0, 5373.0, 5627.0, 5592.0, 5330.0, 5567.0, 5501.0, 5486.0, 5633.0, 5545.0, 5647.0, 5402.0, 5264.0 (number of hits: 8)
7	5270	9	1	333	1	5512.0, 5377.0, 5460.0, 5634.0, 5464.0, 5378.0, 5382.0, 5492.0, 5617.0, 5515.0, 5342.0, 5632.0, 5690.0, 5359.0, 5287.0, 5580.0, 5421.0, 5279.0, 5517.0, 5318.0, 5471.0, 5347.0, 5516.0, 5525.0, 5712.0, 5462.0, 5488.0, 5540.0, 5620.0, 5275.0, 5647.0, 5669.0, 5569.0, 5500.0, 5296.0, 5480.0, 5413.0, 5389.0, 5467.0, 5642.0, 5533.0, 5403.0, 5564.0, 5631.0, 5281.0, 5681.0, 5529.0, 5561.0, 5333.0, 5584.0, 5621.0, 5602.0, 5476.0, 5374.0, 5508.0, 5288.0, 5556.0, 5693.0, 5677.0, 5700.0, 5538.0, 5299.0, 5695.0, 5672.0, 5305.0, 5465.0, 5458.0, 5350.0, 5292.0, 5616.0, 5582.0, 5309.0, 5509.0, 5393.0, 5346.0, 5412.0, 5576.0, 5534.0, 5343.0, 5575.0, 5437.0, 5600.0, 5678.0, 5658.0, 5568.0, 5651.0, 5457.0, 5591.0, 5388.0, 5272.0, 5293.0, 5680.0, 5439.0, 5623.0, 5676.0, 5257.0, 5266.0, 5523.0, 5336.0, 5718.0 (number of hits: 8)
8	5270	9	1	333	1	5680.0, 5335.0, 5301.0, 5616.0, 5336.0, 5720.0, 5498.0, 5434.0, 5547.0, 5266.0, 5598.0, 5306.0, 5342.0, 5653.0, 5488.0, 5651.0, 5592.0, 5665.0, 5452.0, 5549.0, 5414.0, 5406.0, 5591.0, 5325.0, 5418.0, 5512.0, 5634.0, 5695.0, 5357.0, 5648.0, 5723.0, 5626.0, 5269.0, 5519.0, 5635.0, 5630.0, 5639.0, 5256.0, 5539.0, 5522.0, 5550.0, 5717.0, 5274.0, 5540.0, 5605.0, 5701.0, 5714.0, 5596.0, 5360.0, 5363.0, 5273.0, 5604.0, 5468.0, 5446.0, 5531.0, 5683.0, 5297.0, 5613.0, 5415.0, 5687.0, 5559.0, 5417.0, 5296.0, 5610.0, 5703.0, 5685.0, 5355.0, 5343.0, 5284.0, 5387.0, 5608.0, 5663.0, 5535.0, 5612.0, 5712.0, 5367.0, 5377.0, 5403.0, 5309.0, 5350.0

						5286.0, 5265.0, 5358.0, 5599.0, 5278.0, 5459.0, 5500.0, 5276.0, 5586.0, 5664.0, 5545.0, 5411.0, 5396.0, 5320.0, 5511.0, 5642.0, 5329.0, 5369.0, 5696.0, 5475.0 (number of hits: 6)
9	5270	9	1	333	1	5445.0, 5386.0, 5416.0, 5341.0, 5587.0, 5290.0, 5592.0, 5421.0, 5615.0, 5452.0, 5473.0, 5574.0, 5513.0, 5251.0, 5455.0, 5557.0, 5567.0, 5552.0, 5537.0, 5387.0, 5332.0, 5595.0, 5318.0, 5414.0, 5433.0, 5699.0, 5677.0, 5454.0, 5428.0, 5580.0, 5352.0, 5610.0, 5323.0, 5328.0, 5466.0, 5441.0, 5409.0, 5576.0, 5367.0, 5378.0, 5630.0, 5503.0, 5519.0, 5624.0, 5496.0, 5410.0, 5598.0, 5304.0, 5384.0, 5481.0, 5486.0, 5423.0, 5628.0, 5377.0, 5491.0, 5637.0, 5364.0, 5594.0, 5488.0, 5313.0, 5408.0, 5526.0, 5259.0, 5480.0, 5622.0, 5412.0, 5674.0, 5392.0, 5419.0, 5562.0, 5431.0, 5712.0, 5265.0, 5450.0, 5287.0, 5541.0, 5447.0, 5459.0, 5310.0, 5564.0, 5634.0, 5342.0, 5573.0, 5294.0, 5517.0, 5613.0, 5499.0, 5253.0, 5572.0, 5444.0, 5331.0, 5667.0, 5301.0, 5515.0, 5681.0, 5420.0, 5603.0, 5532.0, 5345.0, 5493.0 (number of hits: 7)
10	5270	9	1	333	1	5260.0, 5460.0, 5327.0, 5462.0, 5678.0, 5523.0, 5401.0, 5514.0, 5671.0, 5508.0, 5722.0, 5450.0, 5580.0, 5359.0, 5316.0, 5256.0, 5507.0, 5488.0, 5459.0, 5586.0, 5431.0, 5563.0, 5426.0, 5577.0, 5660.0, 5479.0, 5658.0, 5596.0, 5377.0, 5657.0, 5711.0, 5295.0, 5368.0, 5597.0, 5551.0, 5539.0, 5404.0, 5423.0, 5443.0, 5512.0, 5314.0, 5258.0, 5471.0, 5719.0, 5440.0, 5302.0, 5624.0, 5278.0, 5497.0, 5491.0, 5259.0, 5625.0, 5280.0, 5412.0, 5442.0, 5318.0, 5672.0, 5355.0, 5599.0, 5331.0, 5618.0, 5560.0, 5458.0, 5701.0, 5406.0, 5326.0, 5373.0, 5592.0, 5699.0, 5264.0, 5449.0, 5433.0, 5513.0, 5505.0, 5415.0, 5461.0, 5292.0, 5315.0, 5419.0, 5649.0, 5645.0, 5452.0, 5626.0, 5272.0, 5427.0, 5500.0, 5694.0, 5595.0, 5528.0, 5492.0, 5338.0, 5481.0, 5251.0, 5388.0, 5361.0, 5294.0, 5487.0, 5543.0, 5313.0, 5534.0 (number of hits: 6)
11	5270	9	1	333	1	5302.0, 5583.0, 5313.0, 5534.0, 5717.0, 5413.0, 5499.0, 5528.0, 5509.0, 5469.0, 5401.0, 5355.0, 5368.0, 5450.0, 5435.0, 5398.0, 5448.0, 5478.0, 5559.0, 5603.0, 5688.0, 5581.0, 5388.0, 5642.0, 5359.0, 5669.0, 5438.0, 5609.0, 5683.0, 5387.0, 5402.0, 5672.0, 5590.0, 5643.0, 5586.0, 5639.0, 5295.0, 5486.0, 5691.0, 5615.0, 5412.0, 5510.0, 5516.0, 5377.0, 5461.0,

						5407.0, 5547.0, 5529.0, 5677.0, 5337.0, 5292.0, 5434.0, 5298.0, 5314.0, 5423.0, 5465.0, 5453.0, 5565.0, 5389.0, 5275.0, 5692.0, 5346.0, 5400.0, 5393.0, 5721.0, 5695.0, 5616.0, 5375.0, 5341.0, 5618.0, 5403.0, 5549.0, 5390.0, 5354.0, 5422.0, 5378.0, 5253.0, 5254.0, 5268.0, 5635.0, 5455.0, 5610.0, 5620.0, 5556.0, 5500.0, 5710.0, 5332.0, 5711.0, 5371.0, 5535.0, 5324.0, 5328.0, 5638.0, 5344.0, 5538.0, 5276.0, 5329.0, 5322.0, 5514.0, 5612.0 (number of hits: 6)
12	5270	9	1	333	1	5631.0, 5544.0, 5385.0, 5402.0, 5362.0, 5256.0, 5531.0, 5516.0, 5374.0, 5662.0, 5359.0, 5290.0, 5572.0, 5259.0, 5658.0, 5648.0, 5423.0, 5558.0, 5576.0, 5463.0, 5303.0, 5441.0, 5482.0, 5559.0, 5517.0, 5484.0, 5714.0, 5481.0, 5535.0, 5497.0, 5472.0, 5420.0, 5294.0, 5400.0, 5612.0, 5655.0, 5411.0, 5705.0, 5670.0, 5661.0, 5540.0, 5649.0, 5350.0, 5645.0, 5305.0, 5505.0, 5617.0, 5508.0, 5512.0, 5651.0, 5520.0, 5261.0, 5518.0, 5480.0, 5724.0, 5642.0, 5701.0, 5561.0, 5581.0, 5590.0, 5447.0, 5344.0, 5555.0, 5355.0, 5352.0, 5528.0, 5629.0, 5427.0, 5474.0, 5371.0, 5660.0, 5266.0, 5566.0, 5426.0, 5666.0, 5488.0, 5401.0, 5297.0, 5394.0, 5285.0, 5550.0, 5689.0, 5281.0, 5386.0, 5257.0, 5440.0, 5478.0, 5393.0, 5446.0, 5390.0, 5716.0, 5445.0, 5392.0, 5650.0, 5549.0, 5338.0, 5432.0, 5677.0, 5503.0, 5399.0 (number of hits: 6)
13	5270	9	1	333	1	5681.0, 5529.0, 5392.0, 5385.0, 5423.0, 5427.0, 5254.0, 5271.0, 5435.0, 5561.0, 5445.0, 5711.0, 5386.0, 5671.0, 5326.0, 5491.0, 5577.0, 5447.0, 5446.0, 5357.0, 5630.0, 5369.0, 5422.0, 5687.0, 5367.0, 5407.0, 5441.0, 5657.0, 5706.0, 5592.0, 5629.0, 5380.0, 5484.0, 5256.0, 5261.0, 5485.0, 5715.0, 5376.0, 5431.0, 5525.0, 5444.0, 5321.0, 5371.0, 5308.0, 5350.0, 5477.0, 5615.0, 5595.0, 5507.0, 5375.0, 5404.0, 5517.0, 5362.0, 5625.0, 5387.0, 5582.0, 5684.0, 5396.0, 5265.0, 5287.0, 5251.0, 5656.0, 5501.0, 5604.0, 5650.0, 5641.0, 5424.0, 5639.0, 5332.0, 5647.0, 5520.0, 5537.0, 5538.0, 5588.0, 5453.0, 5644.0, 5259.0, 5474.0, 5594.0, 5661.0, 5345.0, 5522.0, 5601.0, 5700.0, 5597.0, 5550.0, 5398.0, 5674.0, 5567.0, 5333.0, 5406.0, 5665.0, 5388.0, 5257.0, 5258.0, 5703.0, 5642.0, 5544.0, 5497.0, 5476.0 (number of hits: 2)
14	5270	9	1	333	1	5580.0, 5274.0, 5493.0, 5566.0, 5293.0, 5331.0, 5615.0, 5468.0, 5622.0, 5340.0,

						5558.0, 5368.0, 5388.0, 5373.0, 5606.0, 5482.0, 5362.0, 5252.0, 5510.0, 5251.0, 5419.0, 5300.0, 5551.0, 5335.0, 5576.0, 5278.0, 5425.0, 5680.0, 5296.0, 5648.0, 5332.0, 5304.0, 5506.0, 5267.0, 5283.0, 5392.0, 5657.0, 5444.0, 5344.0, 5561.0, 5277.0, 5722.0, 5369.0, 5400.0, 5361.0, 5502.0, 5664.0, 5646.0, 5265.0, 5692.0, 5390.0, 5497.0, 5528.0, 5411.0, 5605.0, 5403.0, 5262.0, 5465.0, 5436.0, 5408.0, 5668.0, 5507.0, 5694.0, 5508.0, 5342.0, 5533.0, 5433.0, 5542.0, 5346.0, 5593.0, 5578.0, 5720.0, 5721.0, 5364.0, 5292.0, 5426.0, 5250.0, 5307.0, 5695.0, 5423.0, 5634.0, 5375.0, 5581.0, 5318.0, 5594.0, 5412.0, 5345.0, 5539.0, 5710.0, 5556.0, 5550.0, 5453.0, 5560.0, 5381.0, 5575.0, 5601.0, 5608.0, 5511.0, 5409.0, 5500.0 (number of hits: 6)
15	5270	9	1	333	1	5604.0, 5462.0, 5455.0, 5284.0, 5569.0, 5389.0, 5434.0, 5368.0, 5351.0, 5646.0, 5329.0, 5348.0, 5469.0, 5588.0, 5331.0, 5699.0, 5722.0, 5529.0, 5710.0, 5257.0, 5619.0, 5276.0, 5513.0, 5266.0, 5465.0, 5464.0, 5676.0, 5541.0, 5695.0, 5642.0, 5589.0, 5622.0, 5707.0, 5253.0, 5354.0, 5632.0, 5580.0, 5624.0, 5508.0, 5321.0, 5504.0, 5303.0, 5609.0, 5600.0, 5486.0, 5514.0, 5383.0, 5308.0, 5599.0, 5712.0, 5307.0, 5314.0, 5553.0, 5660.0, 5394.0, 5311.0, 5346.0, 5551.0, 5428.0, 5561.0, 5411.0, 5620.0, 5659.0, 5503.0, 5403.0, 5373.0, 5559.0, 5323.0, 5666.0, 5545.0, 5596.0, 5409.0, 5418.0, 5720.0, 5705.0, 5572.0, 5367.0, 5587.0, 5379.0, 5424.0, 5524.0, 5324.0, 5298.0, 5718.0, 5414.0, 5467.0, 5326.0, 5542.0, 5606.0, 5487.0, 5478.0, 5319.0, 5520.0, 5679.0, 5334.0, 5425.0, 5480.0, 5563.0, 5322.0, 5437.0 (number of hits: 6)
16	5270	9	1	333	1	5561.0, 5488.0, 5309.0, 5263.0, 5450.0, 5529.0, 5722.0, 5357.0, 5253.0, 5613.0, 5639.0, 5609.0, 5560.0, 5468.0, 5479.0, 5544.0, 5545.0, 5689.0, 5461.0, 5640.0, 5687.0, 5269.0, 5714.0, 5587.0, 5388.0, 5420.0, 5682.0, 5341.0, 5702.0, 5567.0, 5482.0, 5426.0, 5286.0, 5395.0, 5668.0, 5641.0, 5394.0, 5645.0, 5316.0, 5713.0, 5352.0, 5610.0, 5584.0, 5604.0, 5469.0, 5397.0, 5492.0, 5462.0, 5402.0, 5291.0, 5636.0, 5676.0, 5268.0, 5435.0, 5697.0, 5256.0, 5699.0, 5548.0, 5375.0, 5577.0, 5601.0, 5399.0, 5355.0, 5596.0, 5260.0, 5630.0, 5327.0, 5573.0, 5320.0, 5369.0, 5405.0, 5721.0, 5304.0, 5724.0, 5559.0, 5638.0, 5595.0, 5404.0, 5693.0, 5431.0

						5646.0, 5588.0, 5261.0, 5423.0, 5475.0, 5717.0, 5705.0, 5343.0, 5704.0, 5598.0, 5258.0, 5428.0, 5382.0, 5642.0, 5410.0, 5516.0, 5454.0, 5436.0, 5528.0, 5259.0 (number of hits: 4)
17	5270	9	1	333	1	5390.0, 5256.0, 5668.0, 5695.0, 5691.0, 5493.0, 5305.0, 5306.0, 5699.0, 5624.0, 5707.0, 5320.0, 5394.0, 5532.0, 5584.0, 5535.0, 5547.0, 5580.0, 5664.0, 5272.0, 5527.0, 5641.0, 5392.0, 5322.0, 5675.0, 5349.0, 5504.0, 5576.0, 5503.0, 5531.0, 5646.0, 5309.0, 5393.0, 5569.0, 5262.0, 5341.0, 5376.0, 5574.0, 5501.0, 5435.0, 5670.0, 5347.0, 5452.0, 5653.0, 5263.0, 5686.0, 5461.0, 5346.0, 5565.0, 5592.0, 5332.0, 5472.0, 5453.0, 5679.0, 5397.0, 5372.0, 5336.0, 5563.0, 5317.0, 5698.0, 5312.0, 5361.0, 5502.0, 5297.0, 5465.0, 5446.0, 5721.0, 5486.0, 5676.0, 5559.0, 5524.0, 5417.0, 5638.0, 5447.0, 5625.0, 5713.0, 5391.0, 5560.0, 5333.0, 5433.0, 5348.0, 5605.0, 5440.0, 5714.0, 5254.0, 5546.0, 5456.0, 5513.0, 5597.0, 5412.0, 5549.0, 5562.0, 5515.0, 5528.0, 5687.0, 5568.0, 5438.0, 5409.0, 5252.0, 5567.0 (number of hits: 5)
18	5270	9	1	333	1	5712.0, 5434.0, 5497.0, 5302.0, 5551.0, 5453.0, 5507.0, 5380.0, 5573.0, 5308.0, 5363.0, 5405.0, 5704.0, 5392.0, 5722.0, 5640.0, 5352.0, 5422.0, 5398.0, 5340.0, 5314.0, 5533.0, 5681.0, 5474.0, 5309.0, 5633.0, 5253.0, 5530.0, 5506.0, 5601.0, 5412.0, 5546.0, 5452.0, 5345.0, 5562.0, 5442.0, 5473.0, 5342.0, 5675.0, 5255.0, 5283.0, 5273.0, 5280.0, 5659.0, 5275.0, 5481.0, 5542.0, 5499.0, 5622.0, 5391.0, 5656.0, 5326.0, 5566.0, 5466.0, 5652.0, 5580.0, 5329.0, 5723.0, 5287.0, 5476.0, 5609.0, 5448.0, 5344.0, 5290.0, 5636.0, 5532.0, 5705.0, 5587.0, 5356.0, 5332.0, 5443.0, 5272.0, 5508.0, 5634.0, 5393.0, 5539.0, 5679.0, 5552.0, 5297.0, 5522.0, 5524.0, 5610.0, 5525.0, 5321.0, 5529.0, 5527.0, 5582.0, 5339.0, 5325.0, 5373.0, 5394.0, 5289.0, 5616.0, 5374.0, 5401.0, 5611.0, 5578.0, 5372.0, 5513.0, 5554.0 (number of hits: 8)
19	5270	9	1	333	1	5600.0, 5569.0, 5492.0, 5622.0, 5621.0, 5357.0, 5332.0, 5303.0, 5564.0, 5649.0, 5591.0, 5261.0, 5642.0, 5614.0, 5535.0, 5602.0, 5495.0, 5625.0, 5367.0, 5576.0, 5533.0, 5630.0, 5464.0, 5456.0, 5628.0, 5326.0, 5520.0, 5420.0, 5339.0, 5468.0, 5578.0, 5411.0, 5547.0, 5258.0, 5677.0, 5360.0, 5616.0, 5583.0, 5631.0, 5451.0, 5294.0, 5471.0, 5661.0, 5295.0, 5518.0,

						5706.0, 5644.0, 5686.0, 5283.0, 5401.0, 5570.0, 5262.0, 5693.0, 5366.0, 5517.0, 5548.0, 5485.0, 5565.0, 5487.0, 5534.0, 5634.0, 5377.0, 5462.0, 5298.0, 5504.0, 5460.0, 5568.0, 5486.0, 5455.0, 5426.0, 5514.0, 5396.0, 5263.0, 5398.0, 5507.0, 5648.0, 5430.0, 5717.0, 5539.0, 5472.0, 5494.0, 5601.0, 5655.0, 5683.0, 5433.0, 5637.0, 5550.0, 5501.0, 5432.0, 5624.0, 5647.0, 5383.0, 5273.0, 5325.0, 5688.0, 5440.0, 5354.0, 5546.0, 5640.0, 5553.0 (number of hits: 4)
20	5270	9	1	333	1	5287.0, 5439.0, 5275.0, 5574.0, 5639.0, 5519.0, 5308.0, 5654.0, 5668.0, 5645.0, 5555.0, 5558.0, 5330.0, 5341.0, 5680.0, 5468.0, 5658.0, 5402.0, 5416.0, 5585.0, 5631.0, 5695.0, 5411.0, 5607.0, 5524.0, 5284.0, 5546.0, 5632.0, 5481.0, 5327.0, 5624.0, 5609.0, 5583.0, 5464.0, 5557.0, 5259.0, 5478.0, 5376.0, 5575.0, 5413.0, 5595.0, 5403.0, 5657.0, 5569.0, 5687.0, 5296.0, 5651.0, 5491.0, 5443.0, 5387.0, 5285.0, 5563.0, 5272.0, 5357.0, 5613.0, 5323.0, 5666.0, 5681.0, 5392.0, 5626.0, 5505.0, 5442.0, 5567.0, 5518.0, 5422.0, 5257.0, 5301.0, 5670.0, 5691.0, 5582.0, 5303.0, 5665.0, 5484.0, 5671.0, 5310.0, 5699.0, 5647.0, 5453.0, 5619.0, 5495.0, 5261.0, 5382.0, 5345.0, 5267.0, 5298.0, 5471.0, 5581.0, 5597.0, 5650.0, 5269.0, 5307.0, 5300.0, 5544.0, 5396.0, 5698.0, 5331.0, 5576.0, 5676.0, 5264.0, 5682.0 (number of hits: 10)
21	5270	9	1	333	1	5721.0, 5615.0, 5354.0, 5585.0, 5489.0, 5272.0, 5649.0, 5403.0, 5455.0, 5712.0, 5340.0, 5308.0, 5682.0, 5641.0, 5690.0, 5616.0, 5481.0, 5413.0, 5281.0, 5274.0, 5344.0, 5515.0, 5516.0, 5265.0, 5546.0, 5253.0, 5258.0, 5693.0, 5575.0, 5607.0, 5355.0, 5557.0, 5572.0, 5473.0, 5267.0, 5366.0, 5488.0, 5583.0, 5667.0, 5513.0, 5421.0, 5506.0, 5547.0, 5672.0, 5600.0, 5588.0, 5341.0, 5324.0, 5598.0, 5284.0, 5276.0, 5580.0, 5715.0, 5268.0, 5587.0, 5624.0, 5663.0, 5566.0, 5432.0, 5441.0, 5350.0, 5555.0, 5670.0, 5312.0, 5404.0, 5508.0, 5452.0, 5484.0, 5539.0, 5665.0, 5621.0, 5677.0, 5625.0, 5472.0, 5304.0, 5335.0, 5553.0, 5321.0, 5499.0, 5699.0, 5383.0, 5494.0, 5293.0, 5707.0, 5530.0, 5537.0, 5687.0, 5611.0, 5710.0, 5535.0, 5322.0, 5408.0, 5381.0, 5471.0, 5618.0, 5533.0, 5640.0, 5718.0, 5697.0, 5380.0 (number of hits: 4)
22	5270	9	1	333	1	5305.0, 5561.0, 5439.0, 5363.0, 5252.0, 5250.0, 5598.0, 5658.0, 5302.0, 5621.0,

						5320.0, 5447.0, 5280.0, 5275.0, 5356.0, 5408.0, 5642.0, 5409.0, 5375.0, 5664.0, 5523.0, 5460.0, 5612.0, 5687.0, 5381.0, 5649.0, 5323.0, 5656.0, 5629.0, 5494.0, 5633.0, 5515.0, 5448.0, 5701.0, 5537.0, 5693.0, 5360.0, 5493.0, 5457.0, 5703.0, 5299.0, 5265.0, 5442.0, 5548.0, 5270.0, 5723.0, 5312.0, 5291.0, 5404.0, 5338.0, 5613.0, 5593.0, 5307.0, 5720.0, 5467.0, 5347.0, 5560.0, 5544.0, 5484.0, 5430.0, 5516.0, 5418.0, 5603.0, 5352.0, 5521.0, 5522.0, 5343.0, 5635.0, 5567.0, 5597.0, 5417.0, 5552.0, 5402.0, 5676.0, 5557.0, 5433.0, 5503.0, 5541.0, 5716.0, 5668.0, 5486.0, 5645.0, 5634.0, 5712.0, 5387.0, 5569.0, 5542.0, 5665.0, 5294.0, 5394.0, 5392.0, 5263.0, 5682.0, 5681.0, 5536.0, 5562.0, 5568.0, 5594.0, 5370.0, 5326.0 (number of hits: 7)
23	5270	9	1	333	1	5320.0, 5278.0, 5317.0, 5453.0, 5463.0, 5538.0, 5578.0, 5607.0, 5500.0, 5534.0, 5676.0, 5549.0, 5502.0, 5684.0, 5361.0, 5619.0, 5551.0, 5616.0, 5409.0, 5541.0, 5264.0, 5567.0, 5343.0, 5381.0, 5595.0, 5312.0, 5387.0, 5493.0, 5393.0, 5477.0, 5705.0, 5255.0, 5397.0, 5650.0, 5694.0, 5327.0, 5436.0, 5424.0, 5716.0, 5491.0, 5626.0, 5604.0, 5544.0, 5359.0, 5352.0, 5503.0, 5484.0, 5647.0, 5514.0, 5507.0, 5618.0, 5704.0, 5455.0, 5703.0, 5537.0, 5483.0, 5659.0, 5577.0, 5368.0, 5665.0, 5553.0, 5442.0, 5583.0, 5296.0, 5460.0, 5321.0, 5685.0, 5306.0, 5431.0, 5479.0, 5532.0, 5598.0, 5273.0, 5588.0, 5270.0, 5515.0, 5652.0, 5717.0, 5269.0, 5417.0, 5441.0, 5589.0, 5259.0, 5720.0, 5712.0, 5300.0, 5462.0, 5288.0, 5427.0, 5445.0, 5638.0, 5655.0, 5689.0, 5569.0, 5263.0, 5291.0, 5581.0, 5466.0, 5523.0, 5423.0 (number of hits: 6)
24	5270	9	1	333	1	5283.0, 5715.0, 5509.0, 5636.0, 5678.0, 5333.0, 5383.0, 5259.0, 5484.0, 5683.0, 5696.0, 5351.0, 5520.0, 5664.0, 5265.0, 5479.0, 5572.0, 5645.0, 5409.0, 5661.0, 5538.0, 5612.0, 5719.0, 5315.0, 5311.0, 5261.0, 5702.0, 5304.0, 5490.0, 5375.0, 5298.0, 5586.0, 5396.0, 5305.0, 5653.0, 5486.0, 5675.0, 5377.0, 5421.0, 5415.0, 5721.0, 5553.0, 5418.0, 5397.0, 5492.0, 5602.0, 5630.0, 5536.0, 5401.0, 5654.0, 5364.0, 5495.0, 5528.0, 5272.0, 5578.0, 5323.0, 5296.0, 5302.0, 5545.0, 5267.0, 5450.0, 5650.0, 5472.0, 5250.0, 5644.0, 5583.0, 5425.0, 5314.0, 5512.0, 5395.0, 5443.0, 5378.0, 5376.0, 5457.0, 5496.0, 5488.0, 5522.0, 5614.0, 5343.0, 5568.0

						5624.0, 5428.0, 5404.0, 5660.0, 5340.0, 5394.0, 5276.0, 5611.0, 5318.0, 5277.0, 5483.0, 5347.0, 5432.0, 5429.0, 5381.0, 5717.0, 5665.0, 5266.0, 5326.0, 5447.0 (number of hits: 7)
25	5270	9	1	333	1	5298.0, 5673.0, 5509.0, 5526.0, 5373.0, 5543.0, 5487.0, 5485.0, 5378.0, 5687.0, 5305.0, 5641.0, 5523.0, 5434.0, 5301.0, 5720.0, 5292.0, 5672.0, 5557.0, 5718.0, 5593.0, 5361.0, 5706.0, 5690.0, 5277.0, 5715.0, 5637.0, 5273.0, 5674.0, 5520.0, 5537.0, 5484.0, 5504.0, 5451.0, 5412.0, 5473.0, 5267.0, 5337.0, 5569.0, 5446.0, 5578.0, 5581.0, 5514.0, 5527.0, 5508.0, 5577.0, 5257.0, 5431.0, 5590.0, 5424.0, 5419.0, 5318.0, 5374.0, 5323.0, 5360.0, 5385.0, 5605.0, 5541.0, 5413.0, 5589.0, 5562.0, 5701.0, 5406.0, 5545.0, 5369.0, 5340.0, 5666.0, 5679.0, 5383.0, 5436.0, 5612.0, 5645.0, 5600.0, 5638.0, 5696.0, 5489.0, 5464.0, 5435.0, 5698.0, 5552.0, 5712.0, 5426.0, 5602.0, 5272.0, 5461.0, 5714.0, 5601.0, 5359.0, 5268.0, 5286.0, 5629.0, 5291.0, 5392.0, 5513.0, 5532.0, 5333.0, 5539.0, 5568.0, 5300.0, 5618.0 (number of hits: 7)
26	5270	9	1	333	1	5601.0, 5533.0, 5684.0, 5668.0, 5290.0, 5365.0, 5469.0, 5464.0, 5540.0, 5325.0, 5465.0, 5560.0, 5302.0, 5634.0, 5613.0, 5471.0, 5380.0, 5477.0, 5549.0, 5398.0, 5489.0, 5535.0, 5708.0, 5702.0, 5309.0, 5288.0, 5614.0, 5297.0, 5413.0, 5501.0, 5460.0, 5619.0, 5701.0, 5694.0, 5354.0, 5675.0, 5631.0, 5628.0, 5505.0, 5330.0, 5615.0, 5576.0, 5711.0, 5657.0, 5503.0, 5451.0, 5679.0, 5582.0, 5351.0, 5407.0, 5658.0, 5307.0, 5606.0, 5681.0, 5300.0, 5689.0, 5356.0, 5444.0, 5642.0, 5429.0, 5511.0, 5530.0, 5467.0, 5335.0, 5682.0, 5273.0, 5318.0, 5599.0, 5507.0, 5382.0, 5426.0, 5295.0, 5294.0, 5491.0, 5481.0, 5581.0, 5504.0, 5519.0, 5456.0, 5306.0, 5458.0, 5612.0, 5542.0, 5371.0, 5643.0, 5404.0, 5611.0, 5602.0, 5434.0, 5394.0, 5336.0, 5323.0, 5473.0, 5409.0, 5285.0, 5488.0, 5257.0, 5254.0, 5405.0, 5446.0 (number of hits: 11)
27	5270	9	1	333	1	5710.0, 5399.0, 5643.0, 5448.0, 5298.0, 5659.0, 5690.0, 5670.0, 5414.0, 5657.0, 5366.0, 5330.0, 5484.0, 5308.0, 5392.0, 5341.0, 5515.0, 5581.0, 5481.0, 5591.0, 5389.0, 5673.0, 5403.0, 5336.0, 5609.0, 5717.0, 5631.0, 5558.0, 5713.0, 5361.0, 5601.0, 5565.0, 5526.0, 5319.0, 5444.0, 5555.0, 5617.0, 5344.0, 5375.0, 5687.0, 5719.0, 5608.0, 5711.0, 5519.0, 5490.0,

						5421.0, 5456.0, 5512.0, 5430.0, 5551.0, 5505.0, 5270.0, 5479.0, 5644.0, 5691.0, 5575.0, 5637.0, 5257.0, 5332.0, 5356.0, 5669.0, 5432.0, 5321.0, 5594.0, 5294.0, 5492.0, 5627.0, 5408.0, 5443.0, 5493.0, 5477.0, 5412.0, 5466.0, 5706.0, 5689.0, 5641.0, 5662.0, 5540.0, 5373.0, 5678.0, 5402.0, 5586.0, 5663.0, 5474.0, 5426.0, 5449.0, 5682.0, 5554.0, 5716.0, 5566.0, 5264.0, 5499.0, 5603.0, 5295.0, 5380.0, 5364.0, 5315.0, 5483.0, 5424.0, 5707.0 (number of hits: 4)
28	5270	9	1	333	1	5535.0, 5313.0, 5251.0, 5563.0, 5413.0, 5284.0, 5522.0, 5438.0, 5419.0, 5322.0, 5282.0, 5341.0, 5268.0, 5303.0, 5272.0, 5407.0, 5575.0, 5607.0, 5326.0, 5573.0, 5339.0, 5605.0, 5286.0, 5448.0, 5664.0, 5265.0, 5484.0, 5289.0, 5420.0, 5531.0, 5270.0, 5549.0, 5623.0, 5386.0, 5384.0, 5305.0, 5324.0, 5383.0, 5475.0, 5261.0, 5584.0, 5271.0, 5370.0, 5691.0, 5422.0, 5456.0, 5589.0, 5304.0, 5570.0, 5685.0, 5632.0, 5256.0, 5530.0, 5409.0, 5464.0, 5269.0, 5649.0, 5536.0, 5443.0, 5399.0, 5351.0, 5344.0, 5650.0, 5532.0, 5626.0, 5526.0, 5703.0, 5264.0, 5483.0, 5529.0, 5625.0, 5503.0, 5263.0, 5709.0, 5427.0, 5693.0, 5406.0, 5655.0, 5653.0, 5252.0, 5586.0, 5325.0, 5364.0, 5634.0, 5266.0, 5250.0, 5428.0, 5278.0, 5348.0, 5671.0, 5491.0, 5487.0, 5705.0, 5556.0, 5673.0, 5447.0, 5467.0, 5648.0, 5515.0, 5701.0 (number of hits: 6)
29	5270	9	1	333	1	5257.0, 5382.0, 5260.0, 5619.0, 5459.0, 5585.0, 5306.0, 5440.0, 5513.0, 5547.0, 5268.0, 5720.0, 5615.0, 5357.0, 5461.0, 5691.0, 5668.0, 5300.0, 5496.0, 5673.0, 5468.0, 5467.0, 5602.0, 5470.0, 5624.0, 5472.0, 5348.0, 5271.0, 5281.0, 5618.0, 5336.0, 5707.0, 5711.0, 5675.0, 5409.0, 5342.0, 5344.0, 5377.0, 5609.0, 5621.0, 5559.0, 5262.0, 5410.0, 5286.0, 5605.0, 5412.0, 5578.0, 5660.0, 5302.0, 5669.0, 5408.0, 5573.0, 5630.0, 5456.0, 5495.0, 5390.0, 5663.0, 5393.0, 5439.0, 5696.0, 5534.0, 5540.0, 5415.0, 5479.0, 5455.0, 5512.0, 5259.0, 5258.0, 5714.0, 5506.0, 5391.0, 5592.0, 5687.0, 5628.0, 5474.0, 5642.0, 5367.0, 5374.0, 5276.0, 5685.0, 5531.0, 5469.0, 5387.0, 5503.0, 5550.0, 5308.0, 5310.0, 5671.0, 5606.0, 5670.0, 5378.0, 5617.0, 5497.0, 5541.0, 5594.0, 5288.0, 5326.0, 5273.0, 5692.0, 5423.0 (number of hits: 7)
30	5270	9	1	333	1	5435.0, 5320.0, 5701.0, 5345.0, 5276.0, 5608.0, 5691.0, 5431.0, 5542.0, 5556.0,

						5379.0, 5653.0, 5281.0, 5629.0, 5408.0, 5473.0, 5522.0, 5677.0, 5588.0, 5593.0, 5562.0, 5511.0, 5577.0, 5688.0, 5332.0, 5496.0, 5521.0, 5668.0, 5483.0, 5623.0, 5606.0, 5286.0, 5693.0, 5392.0, 5704.0, 5644.0, 5694.0, 5324.0, 5399.0, 5462.0, 5510.0, 5619.0, 5502.0, 5335.0, 5432.0, 5648.0, 5724.0, 5284.0, 5386.0, 5308.0, 5288.0, 5570.0, 5712.0, 5456.0, 5261.0, 5490.0, 5508.0, 5303.0, 5546.0, 5602.0, 5405.0, 5662.0, 5552.0, 5325.0, 5441.0, 5275.0, 5624.0, 5273.0, 5390.0, 5516.0, 5574.0, 5440.0, 5300.0, 5263.0, 5430.0, 5421.0, 5289.0, 5402.0, 5427.0, 5658.0, 5721.0, 5594.0, 5459.0, 5258.0, 5321.0, 5404.0, 5501.0, 5339.0, 5341.0, 5520.0, 5523.0, 5700.0, 5356.0, 5383.0, 5259.0, 5611.0, 5626.0, 5554.0, 5333.0, 5309.0 (number of hits: 7)
--	--	--	--	--	--	---

5550 MHz

Radar Signal Type	Waveform/Trial Number	Detection (%)	Limit (%)	Pass/Fail
Type 1	30	100 %	60%	Pass
Type 2	30	100 %	60%	Pass
Type 3	30	100 %	60%	Pass
Type 4	30	100 %	60%	Pass
Type 5	30	80 %	80%	Pass
Type 6	30	100 %	70%	Pass

Please refer to the following statistical tables:

Table-1 Radar Type 1 Statistical Performance

Trial #	Fc (MHz)	Pulse/Burst	Pulse Width (μS)	PRI (μs)	Detection (1:yes; 0:no)
1	5550	18	1	1428	1
2	5550	18	1	1428	1
3	5550	18	1	1428	1
4	5550	18	1	1428	1
5	5550	18	1	1428	1
6	5550	18	1	1428	1
7	5550	18	1	1428	1
8	5550	18	1	1428	1
9	5550	18	1	1428	1
10	5550	18	1	1428	1
11	5550	18	1	1428	1
12	5550	18	1	1428	1
13	5550	18	1	1428	1
14	5550	18	1	1428	1
15	5550	18	1	1428	1
16	5550	18	1	1428	1
17	5550	18	1	1428	1
18	5550	18	1	1428	1
19	5550	18	1	1428	1
20	5550	18	1	1428	1
21	5550	18	1	1428	1
22	5550	18	1	1428	1
23	5550	18	1	1428	1
24	5550	18	1	1428	1
25	5550	18	1	1428	1
26	5550	18	1	1428	1
27	5550	18	1	1428	1
28	5550	18	1	1428	1
29	5550	18	1	1428	1
30	5550	18	1	1428	1
Detection Percentage: 100 % (>60%)					

Table-2 Radar Type 2 Statistical Performance

Trial #	Fc (MHz)	Pulse/Burst	Pulse Width (μS)	PRI (μs)	Detection (1:yes; 0:no)
1	5550	29	4.4	174	1
2	5550	26	1.2	183	1
3	5550	28	4.3	205	1
4	5550	29	5	192	1
5	5550	28	3.7	181	1
6	5550	27	4.4	160	1
7	5550	29	3.8	205	1
8	5550	27	1.4	221	1
9	5550	24	3.6	150	1
10	5550	29	4	219	1
11	5550	25	2.4	229	1
12	5550	27	4.7	221	1
13	5550	24	4.3	211	1
14	5550	28	2.1	183	1
15	5550	24	4	179	1
16	5550	24	1.4	203	1
17	5550	27	5	201	1
18	5550	29	2.3	152	1
19	5550	28	1.9	181	1
20	5550	29	4.2	222	1
21	5550	26	3	211	1
22	5550	28	4.9	161	1
23	5550	25	2.1	195	1
24	5550	25	4.2	165	1
25	5550	25	1.5	169	1
26	5550	24	4.6	167	1
27	5550	23	4.9	220	1
28	5550	24	2.5	200	1
29	5550	28	1.9	172	1
30	5550	26	3.9	183	1
Detection Percentage: 100% (>60%)					

Table-3 Radar Type 3 Statistical Performance

Trial #	Fc (MHz)	Pulse/Burst	Pulse Width (μS)	PRI (μs)	Detection (1:yes; 0:no)
1	5550	16	7.8	366	1
2	5550	18	8.7	224	1
3	5550	16	8.2	216	1
4	5550	17	6.1	202	1
5	5550	17	7.9	260	1
6	5550	16	7.3	266	1
7	5550	17	8.1	396	1
8	5550	17	6.2	418	1
9	5550	17	7.3	412	1
10	5550	16	6.9	259	1
11	5550	18	6.3	376	1
12	5550	18	7.8	385	1
13	5550	17	8.5	207	1
14	5550	16	8.1	420	1
15	5550	17	7.2	294	1
16	5550	18	8.1	370	1
17	5550	16	7.3	230	1
18	5550	17	7.1	485	1
19	5550	16	7.7	461	1
20	5550	16	6.3	322	1
21	5550	17	9.8	278	1
22	5550	17	9.2	407	1
23	5550	16	7.3	453	1
24	5550	17	8.6	495	1
25	5550	16	8.1	327	1
26	5550	18	9.4	251	1
27	5550	18	8.1	321	1
28	5550	16	7.9	314	1
29	5550	17	9.5	355	1
30	5550	18	8.3	412	1
Detection Percentage: 100 % (>60%)					

Table-4 Radar Type 4 Statistical Performance

Trial #	Fc (MHz)	Pulse/Burst	Pulse Width (μS)	PRI (μs)	Detection (1:yes; 0:no)
1	5550	12	17.2	307	1
2	5550	15	17.1	479	1
3	5550	16	19.8	360	1
4	5550	12	15.4	436	1
5	5550	13	11.8	357	1
6	5550	14	13.1	332	1
7	5550	12	18.3	360	1
8	5550	15	13.3	253	1
9	5550	16	17.9	422	1
10	5550	14	18.6	294	1
11	5550	14	14.8	253	1
12	5550	15	14.2	488	1
13	5550	15	18.1	302	1
14	5550	13	15.4	434	1
15	5550	12	11.8	311	1
16	5550	15	14.5	228	1
17	5550	13	15.4	497	1
18	5550	13	14.5	417	1
19	5550	14	14.2	469	1
20	5550	13	14.8	343	1
21	5550	16	12.9	431	1
22	5550	13	11	482	1
23	5550	15	14.3	464	1
24	5550	13	16.9	487	1
25	5550	13	15.6	278	1
26	5550	14	15.5	321	1
27	5550	15	15.8	367	1
28	5550	12	14	432	1
29	5550	16	17.1	211	1
30	5550	16	13.5	320	1
Detection Percentage: 100 % (>60%)					

Table-5 Radar Type 5 Statistical Performance

Bin5 Statistics 1

Trial #	Pulse	Chirp (MHz)	Pulse Width (μS)	Pulse 1-2 spacing (uS)	Pulse 2-3 spacing (uS)	Pulse Start(S)	Detection (1:yes; 0:no)
0	2	18	83.9	1486		0.718182	0
1	2	18	51.4	1963		1.165698	
2	1	14	81.7			2.335385	
3	2	8	64.9	1169		3.534667	
4	2	16	91.1	1767		4.988369	
5	1	7	62.5			5.684995	
6	3	12	97.4	1643	1885	6.471384	
7	1	7	76.8			7.871792	
8	1	17	82.8			8.351937	
9	1	12	60.3			9.170633	
10	3	5	67.2	1906	1345	10.81718	
11	2	6	82.9	1371		11.78489	

Bin5 Statistics 2

Trial #	Pulse	Chirp (MHz)	Pulse Width (μS)	Pulse 1-2 spacing (uS)	Pulse 2-3 spacing (uS)	Pulse Start(S)	Detection (1:yes; 0:no)
0	1	17	91.1			0.665632	1
1	2	11	85.4	1928		1.577273	
2	1	8	62.1			2.781197	
3	1	8	88.9			3.490839	
4	3	11	93.2	1815	1619	4.658097	
5	2	17	92.3	1925		5.541832	
6	2	19	86.1	1507		6.024544	
7	2	17	83	1880		7.487594	
8	3	7	54.3	1148	1007	8.626006	
9	3	15	69.3	1640	1822	9.120558	
10	1	18	55.9			10.32351	
11	1	7	98.6			11.07042	

Bin5 Statistics 3

Trial #	Pulse	Chirp (MHz)	Pulse Width (μS)	Pulse 1-2 spacing (uS)	Pulse 2-3 spacing (uS)	Pulse Start(S)	Detection (1:yes; 0:no)
0	1	13	50.5			0.409417	1
1	1	6	73.3			1.613876	
2	2	17	79.6	1999		2.448238	
3	3	13	68.8	1022	1629	3.680768	
4	3	10	55.3	1832	1372	4.11139	
5	2	15	52.7	1804		5.045093	
6	3	11	84.5	1771	1487	6.415686	
7	2	11	74.5	1377		7.253779	
8	2	12	50.7	1440		8.240085	
9	2	9	81.2	1339		8.617883	
10	2	14	67.9	1422		9.330026	
11	2	6	92.3	1675		10.29136	
12	2	16	76	1688		11.41194	

Bin5 Statistics 4

Trial #	Pulse	Chirp (MHz)	Pulse Width (μS)	Pulse 1-2 spacing (uS)	Pulse 2-3 spacing (uS)	Pulse Start(S)	Detection (1:yes; 0:no)
0	3	5	53.9	1260	1773	0.432772	1
1	2	12	54.8	1160		1.31236	
2	1	9	95			2.631965	
3	2	19	93.8	1282		3.669527	
4	2	19	95.3	1517		4.861666	
5	2	6	92.3	1913		6.161616	
6	2	20	55.8	1524		7.482809	
7	2	10	60.4	1124		8.498732	
8	3	8	59.3	1908	1790	10.46627	
9	3	13	75.1	1982	1575	11.86971	

Bin5 Statistics 5

Trial #	Pulse	Chirp (MHz)	Pulse Width (µS)	Pulse 1-2 spacing (uS)	Pulse 2-3 spacing (uS)	Pulse Start(S)	Detection (1:yes; 0:no)
0	3	20	51.7	1272	1875	0.811854	1
1	2	12	58.8	1685		2.37223	
2	2	12	69.6	1440		3.238428	
3	2	13	75.1	1894		4.101758	
4	3	10	79.8	1180	1757	5.310592	
5	1	18	61			7.09465	
6	2	16	74	1989		7.908183	
7	3	8	61.6	1919	1460	8.791697	
8	2	13	96.7	1896		10.75709	
9	2	17	71.3	1150		11.84248	

Bin5 Statistics 6

Trial #	Pulse	Chirp (MHz)	Pulse Width (µS)	Pulse 1-2 spacing (uS)	Pulse 2-3 spacing (uS)	Pulse Start(S)	Detection (1:yes; 0:no)
0	2	16	91.7	1378		0.510943	1
1	3	11	70.1	1681	1869	1.365452	
2	2	16	90.3	1331		1.541915	
3	2	9	61.5	1864		2.564887	
4	3	8	89.5	1643	1220	2.905928	
5	1	17	62.8			3.965751	
6	2	14	80.8	1387		4.750522	
7	1	10	93.1			5.062766	
8	2	9	68.8	1967		5.694753	
9	3	7	86.5	1912	1048	6.789056	
10	1	5	94.4			7.542443	
11	2	15	92.7	1359		8.183823	
12	1	13	67.9			8.70116	
13	2	13	57.1	1549		9.715245	
14	3	12	83.1	1110	1338	10.34776	
15	1	12	90.6			11.20237	
16	3	14	88.1	1158	1841	11.46622	

Bin5 Statistics 7

Trial #	Pulse	Chirp (MHz)	Pulse Width (µS)	Pulse 1-2 spacing (µS)	Pulse 2-3 spacing (µS)	Pulse Start(S)	Detection (1:yes; 0:no)
0	2	15	93.5	1599		0.333469	1
1	2	9	86	1728		1.009564	
2	3	15	50.9	1516	1221	1.933186	
3	2	13	84.9	1111		2.727087	
4	3	15	55.9	1662	1401	3.490615	
5	2	11	59	1810		4.598618	
6	3	12	68.9	1814	1175	5.605118	
7	3	9	53	1002	1491	6.424686	
8	3	8	93.1	1029	1313	7.384984	
9	2	7	99.9	1034		8.2315	
10	2	10	73.7	1530		8.988039	
11	3	8	75.7	1896	1844	9.692763	
12	1	19	56.1			10.48032	
13	2	10	62.6	1279		11.83019	

Bin5 Statistics 8

Trial #	Pulse	Chirp (MHz)	Pulse Width (µS)	Pulse 1-2 spacing (µS)	Pulse 2-3 spacing (µS)	Pulse Start(S)	Detection (1:yes; 0:no)
0	1	19	98			0.752112	1
1	1	15	57.8			1.547976	
2	3	16	61.3	1822	1944	2.719375	
3	2	19	59.4	1761		3.334894	
4	2	8	59.8	1701		3.917911	
5	2	16	82.3	1187		4.734468	
6	2	12	77.2	1991		5.997623	
7	1	17	73.3			7.181162	
8	2	14	56.6	1928		7.867233	
9	2	5	58	1109		8.565553	
10	2	8	51	1484		10.14678	
11	2	9	82.5	1275		10.2506	
12	3	8	70.6	1287	1152	11.56334	

Bin5 Statistics 9

Trial #	Pulse	Chirp (MHz)	Pulse Width (μS)	Pulse 1-2 spacing (uS)	Pulse 2-3 spacing (uS)	Pulse Start(S)	Detection (1:yes; 0:no)
0	2	18	71.5	1231		0.491219	1
1	1	12	54			0.899625	
2	2	19	89	1766		1.335045	
3	2	8	51.4	1153		1.912265	
4	3	18	58.3	1822	1900	2.872493	
5	2	9	54.1	1282		3.277909	
6	2	18	55.2	1200		3.811059	
7	2	6	67.7	1980		4.807156	
8	3	17	63.2	1936	1290	5.560169	
9	3	9	89.3	1532	1855	6.136608	
10	1	15	50.4			6.796698	
11	1	19	53.9			7.340719	
12	2	15	73.3	1667		7.656291	
13	1	15	61.9			8.534864	
14	2	9	66.6	1776		9.144826	
15	1	12	74.9			9.960131	
16	2	7	69.1	1545		10.229	
17	3	13	80	1174	1517	11.31365	
18	3	8	68.6	1973	1931	11.52976	

Bin5 Statistics 10

Trial #	Pulse	Chirp (MHz)	Pulse Width (µS)	Pulse 1-2 spacing (uS)	Pulse 2-3 spacing (uS)	Pulse Start(S)	Detection (1:yes; 0:no)
0	1	13	61.4			0.159504	1
1	2	9	89.7	1695		1.227269	
2	2	7	77.8	1846		1.949657	
3	3	16	66.1	1121	1433	2.914953	
4	1	20	61.6			3.665563	
5	2	5	83.3	1800		3.768289	
6	2	11	56.2	1558		4.936346	
7	2	17	94.4	1836		5.333475	
8	1	11	91.1			6.334973	
9	2	17	81.2	1607		6.971157	
10	2	20	65.6	1690		8.11132	
11	2	6	89.4	1857		8.463229	
12	2	6	96.2	1856		9.143963	
13	2	5	78.3	1931		10.09853	
14	3	16	85.3	1429	1318	10.62157	
15	1	15	89.7			11.70419	

Bin5 Statistics 11

Trial #	Pulse	Chirp (MHz)	Pulse Width (µS)	Pulse 1-2 spacing (uS)	Pulse 2-3 spacing (uS)	Pulse Start(S)	Detection (1:yes; 0:no)
0	2	5	98.4	1628		0.089973	1
1	2	19	70.2	1911		1.956727	
2	1	11	76.2			2.657725	
3	3	19	50.5	1337	1975	3.690105	
4	3	13	75	1256	1438	4.34823	
5	1	18	70.6			5.501846	
6	2	7	99.1	1628		6.555557	
7	2	14	61.4	1040		7.849259	
8	2	19	71.3	1469		8.984922	
9	2	18	92	1480		9.928598	
10	2	17	54.4	1967		10.60798	
11	2	7	93.3	1845		11.95706	

Bin5 Statistics 12

Trial #	Pulse	Chirp (MHz)	Pulse Width (μS)	Pulse 1-2 spacing (uS)	Pulse 2-3 spacing (uS)	Pulse Start(S)	Detection (1:yes; 0:no)
0	2	12	88.8	1007		0.200289	0
1	1	8	96.7			1.110957	
2	2	13	70.5	1336		1.842952	
3	2	7	70.9	1396		2.309834	
4	2	7	62.7	1895		3.069525	
5	2	14	66.4	1997		4.342883	
6	2	6	85.2	1691		4.93688	
7	2	9	55.5	1655		5.6916	
8	1	10	65.7			6.519137	
9	3	16	84.2	1810	1460	6.883015	
10	2	14	62	1412		7.56703	
11	1	14	67.1			8.744045	
12	2	13	87.2	1687		9.262399	
13	2	17	55.3	1813		10.19142	
14	1	18	75.7			10.71443	
15	2	7	62.4	1603		11.77166	

Bin5 Statistics 13

Trial #	Pulse	Chirp (MHz)	Pulse Width (μS)	Pulse 1-2 spacing (uS)	Pulse 2-3 spacing (uS)	Pulse Start(S)	Detection (1:yes; 0:no)
0	1	8	72.6			0.970915	1
1	2	12	76.3	1892		1.588028	
2	2	20	76.1	1472		2.74638	
3	2	11	92.5	1764		4.080833	
4	2	11	76.2	1574		4.625723	
5	3	15	71.8	1849	1515	6.062896	
6	2	10	92.4	1527		6.598676	
7	2	9	84.5	1792		8.28437	
8	1	14	70.2			9.027755	
9	3	11	90.2	1786	1301	10.20786	
10	2	9	59.3	1117		11.46496	

Bin5 Statistics 14

Trial #	Pulse	Chirp (MHz)	Pulse Width (μS)	Pulse 1-2 spacing (uS)	Pulse 2-3 spacing (uS)	Pulse Start(S)	Detection (1:yes; 0:no)
0	1	11	72.1			0.241973	1
1	1	8	94.7			1.024858	
2	3	13	64.8	1990	1484	2.236159	
3	2	10	70.7	1846		3.117999	
4	1	7	89.2			3.625319	
5	2	12	76.3	1350		4.750647	
6	2	16	55.9	1519		5.656575	
7	2	6	55.4	1078		6.830871	
8	3	7	75.7	1462	1633	6.902163	
9	2	16	93.4	1747		7.860687	
10	2	14	89.3	1687		9.233234	
11	2	11	57	1286		9.459361	
12	2	10	91.7	1128		10.6552	
13	2	16	69.5	1869		11.82143	

Bin5 Statistics 15

Trial #	Pulse	Chirp (MHz)	Pulse Width (μS)	Pulse 1-2 spacing (uS)	Pulse 2-3 spacing (uS)	Pulse Start(S)	Detection (1:yes; 0:no)
0	2	13	58.5	1356		0.266409	1
1	2	6	75.6	1388		1.378005	
2	2	8	59.6	1672		2.517527	
3	2	7	63.1	1917		2.867729	
4	1	15	94.5			3.992968	
5	2	11	62.5	1489		4.691425	
6	3	11	55.2	1912	1135	5.940363	
7	3	9	82.4	1988	1125	6.753177	
8	2	19	52.5	1681		8.125705	
9	1	14	59			8.567286	
10	2	6	52	1446		9.473015	
11	2	12	56.9	1412		11.06677	
12	3	16	71.6	1832	1817	11.77133	

Bin5 Statistics 16

Trial #	Pulse	Chirp (MHz)	Pulse Width (µS)	Pulse 1-2 spacing (uS)	Pulse 2-3 spacing (uS)	Pulse Start(S)	Detection (1:yes; 0:no)
0	1	15	63.5			0.536447	1
1	1	6	89.2			0.735145	
2	3	8	76.9	1895	1796	1.847322	
3	1	19	84.8			2.2433	
4	3	18	91	1953	1376	2.971067	
5	2	9	87.5	1896		3.811742	
6	3	15	71.9	1943	1840	4.545358	
7	2	16	51.1	1551		5.183939	
8	1	13	56.1			5.649606	
9	2	9	73.8	1558		6.095666	
10	3	6	63.3	1290	1171	7.078542	
11	3	15	68	1059	1106	7.432124	
12	3	9	76.5	1431	1517	8.301432	
13	1	13	77.7			9.057603	
14	1	14	59.3			9.684966	
15	2	15	74.6	1525		10.44124	
16	2	8	69.3	1397		10.8022	
17	2	13	98.5	1945		11.4089	

Bin5 Statistics 17

Trial #	Pulse	Chirp (MHz)	Pulse Width (µS)	Pulse 1-2 spacing (uS)	Pulse 2-3 spacing (uS)	Pulse Start(S)	Detection (1:yes; 0:no)
0	2	11	57	1630		0.146589	1
1	2	14	70.6	1520		2.344922	
2	1	13	98.3			2.501395	
3	3	15	64.8	1205	1790	4.4758	
4	3	12	87.4	1163	1564	5.76706	
5	3	18	54.4	1671	1272	6.570773	
6	3	18	56.7	1932	1062	7.332595	
7	2	6	69.3	1285		8.687458	
8	2	8	70	1700		10.03504	
9	1	17	71.5			11.34672	

Bin5 Statistics 18

Trial #	Pulse	Chirp (MHz)	Pulse Width (μS)	Pulse 1-2 spacing (uS)	Pulse 2-3 spacing (uS)	Pulse Start(S)	Detection (1:yes; 0:no)
0	2	17	82.8	1409		0.326537	1
1	3	13	81.2	1203	1956	1.701206	
2	2	11	57	1434		2.88122	
3	2	18	85.4	1912		3.583236	
4	1	15	82.7			4.065957	
5	2	5	61.3	1693		5.816816	
6	2	12	84.5	1290		6.530896	
7	3	12	92.3	1369	1207	7.399115	
8	2	7	75.4	1096		8.018947	
9	1	16	92.2			9.449473	
10	2	9	56.2	1369		10.65091	
11	2	12	61.6	1955		11.35932	

Bin5 Statistics 19

Trial #	Pulse	Chirp (MHz)	Pulse Width (μS)	Pulse 1-2 spacing (uS)	Pulse 2-3 spacing (uS)	Pulse Start(S)	Detection (1:yes; 0:no)
0	1	12	75.4			0.611527	1
1	1	20	54.3			1.353034	
2	2	18	91	1683		2.285473	
3	1	8	74.4			2.64561	
4	2	10	91	1296		4.244896	
5	2	6	75.9	1064		4.989112	
6	3	8	54.8	1356	1536	5.19718	
7	1	5	72.8			6.128498	
8	3	16	95.3	1649	1314	7.312276	
9	3	11	85.6	1589	1707	8.26429	
10	1	12	88.6			9.074597	
11	3	9	75.1	1873	1110	9.894736	
12	1	7	69.1			10.53189	
13	1	8	99.7			11.95879	

Bin5 Statistics 20

Trial #	Pulse	Chirp (MHz)	Pulse Width (µS)	Pulse 1-2 spacing (uS)	Pulse 2-3 spacing (uS)	Pulse Start(S)	Detection (1:yes; 0:no)
0	1	7	86.6			0.895697	0
1	3	8	62	1553	1894	1.400874	
2	2	5	77	1908		2.151683	
3	3	19	87.3	1677	1740	3.635129	
4	3	16	95.1	1048	1089	3.886618	
5	2	18	95.5	1325		4.737255	
6	2	19	59.3	1373		5.749034	
7	1	15	99.1			6.726302	
8	3	9	95.2	1700	1942	7.393651	
9	2	18	57.7	1199		8.553639	
10	2	19	95.8	1290		10.02338	
11	2	9	76.7	1761		10.45749	
12	2	8	85.8	1973		11.52105	

Bin5 Statistics 21

Trial #	Pulse	Chirp (MHz)	Pulse Width (µS)	Pulse 1-2 spacing (uS)	Pulse 2-3 spacing (uS)	Pulse Start(S)	Detection (1:yes; 0:no)
0	3	14	90.5	1206	1631	0.18104	1
1	1	15	68.5			2.652335	
2	2	17	65.5	1710		2.781008	
3	2	10	73.4	1685		5.277695	
4	3	14	74.6	1579	1579	5.730194	
5	1	16	80.7			6.833458	
6	1	15	61.7			8.127214	
7	2	18	56.9	1133		10.04638	
8	2	16	66.9	1781		11.34109	

Bin5 Statistics 22

Trial #	Pulse	Chirp (MHz)	Pulse Width (μS)	Pulse 1-2 spacing (uS)	Pulse 2-3 spacing (uS)	Pulse Start(S)	Detection (1:yes; 0:no)
0	1	18	91.3			1.124136	1
1	2	10	84.5	1606		1.218214	
2	1	16	91			3.009707	
3	2	11	87.1	1575		3.816658	
4	1	13	96.6			5.855779	
5	3	14	62.2	1487	1705	7.058146	
6	1	16	82.9			7.417818	
7	3	12	51.6	1070	1429	8.664035	
8	1	19	65.2			10.00938	
9	1	8	77.7			11.25828	

Bin5 Statistics 23

Trial #	Pulse	Chirp (MHz)	Pulse Width (μS)	Pulse 1-2 spacing (uS)	Pulse 2-3 spacing (uS)	Pulse Start(S)	Detection (1:yes; 0:no)
0	1	20	86.1			0.841793	0
1	2	11	52.5	1335		0.867466	
2	3	10	95.7	1058	1401	1.916548	
3	2	7	60.1	1814		2.736509	
4	3	7	68.5	1073	1362	3.732951	
5	2	10	50.9	1898		5.126441	
6	3	18	82.2	1463	1708	5.702399	
7	1	17	57.1			6.302473	
8	1	11	53.3			7.509284	
9	3	8	67.5	1557	1064	8.050446	
10	1	18	75.3			8.961571	
11	2	16	63.2	1418		9.5777	
12	2	11	83.5	1247		10.9302	
13	2	15	87.1	1630		11.60872	

Bin5 Statistics 24

Trial #	Pulse	Chirp (MHz)	Pulse Width (µS)	Pulse 1-2 spacing (uS)	Pulse 2-3 spacing (uS)	Pulse Start(S)	Detection (1:yes; 0:no)
0	2	20	63.1	1304		0.70163	1
1	3	9	58.1	1552	1080	2.003213	
2	1	19	50.1			3.389893	
3	2	20	78.3	1193		4.845207	
4	2	14	71.1	1629		7.200209	
5	2	7	82	1019		7.766489	
6	1	6	78.3			9.428754	
7	1	9	54.6			11.58406	

Bin5 Statistics 25

Trial #	Pulse	Chirp (MHz)	Pulse Width (µS)	Pulse 1-2 spacing (uS)	Pulse 2-3 spacing (uS)	Pulse Start(S)	Detection (1:yes; 0:no)
0	1	13	81.7			0.58049	1
1	3	19	68.8	1948	1982	1.04531	
2	2	12	99.4	1750		2.220207	
3	3	17	94.2	1652	1073	2.345027	
4	1	9	56.6			3.272423	
5	2	8	64	1489		4.401073	
6	2	10	63.7	1728		5.199363	
7	2	9	96.9	1589		5.737982	
8	2	13	69.6	1782		6.703888	
9	2	7	51.8	1737		7.194415	
10	2	6	98.7	1777		7.746467	
11	3	6	86.2	1847	1317	8.431415	
12	2	6	58.3	1386		9.307061	
13	3	12	59.9	1731	1874	10.28319	
14	3	17	64.5	1113	1035	11.2334	
15	2	13	95.7	1620		11.79577	

Bin5 Statistics 26

Trial #	Pulse	Chirp (MHz)	Pulse Width (µS)	Pulse 1-2 spacing (µS)	Pulse 2-3 spacing (µS)	Pulse Start(S)	Detection (1:yes; 0:no)
0	2	10	82	1793		0.1205	0
1	1	12	58.6			0.891887	
2	1	16	94.9			1.420998	
3	3	18	77.7	1120	1839	2.324384	
4	2	14	56.2	1649		3.087125	
5	2	10	64	1262		3.623227	
6	2	17	51.7	1871		4.532071	
7	2	18	71	1521		5.007966	
8	3	8	97.8	1949	1451	6.154959	
9	2	17	97	1333		6.640913	
10	3	13	95.4	1690	1854	7.127001	
11	3	15	51.5	1009	1288	8.223017	
12	1	12	67.7			9.164058	
13	2	17	81.6	1667		9.338181	
14	1	14	87			9.898665	
15	2	16	70.8	1897		10.67837	
16	1	7	64.5			11.97722	

Bin5 Statistics 27

Trial #	Pulse	Chirp (MHz)	Pulse Width (µS)	Pulse 1-2 spacing (µS)	Pulse 2-3 spacing (µS)	Pulse Start(S)	Detection (1:yes; 0:no)
0	3	15	68.4	1613	1341	0.96949	1
1	2	14	75.8	1343		1.903279	
2	1	19	52.1			2.238759	
3	2	18	86.3	1821		3.120255	
4	2	7	64.9	1569		4.571701	
5	2	17	99.9	1676		5.675524	
6	1	8	86.5			6.555676	
7	1	11	66.9			7.780756	
8	1	16	64.5			8.338882	
9	1	15	59.1			9.644413	
10	2	14	51.1	1762		10.59586	
11	3	18	65.8	1028	1017	11.80765	

Bin5 Statistics 28

Trial #	Pulse	Chirp (MHz)	Pulse Width (µS)	Pulse 1-2 spacing (uS)	Pulse 2-3 spacing (uS)	Pulse Start(S)	Detection (1:yes; 0:no)
0	2	9	67.8	1110		0.288406	1
1	1	7	79.4			2.242863	
2	3	10	68.7	1141	1882	2.722276	
3	2	7	95.3	1505		5.004514	
4	3	12	88	1947	1676	5.815111	
5	2	12	97.4	1496		6.957945	
6	2	15	80.6	1516		8.400222	
7	2	17	66.8	1662		9.789895	
8	2	5	91.3	1546		11.60725	

Bin5 Statistics 29

Trial #	Pulse	Chirp (MHz)	Pulse Width (µS)	Pulse 1-2 spacing (uS)	Pulse 2-3 spacing (uS)	Pulse Start(S)	Detection (1:yes; 0:no)
0	2	17	72.1	1229		0.812592	1
1	3	11	77.8	1806	1953	1.229802	
2	2	13	78.3	1748		1.901566	
3	3	6	79.3	1460	1324	2.78155	
4	1	12	66.6			3.71772	
5	2	19	85.6	1149		4.867712	
6	2	14	73.8	1704		6.311386	
7	3	20	94.8	1161	1534	7.363903	
8	2	8	54.4	1908		8.145406	
9	1	17	88.3			8.749901	
10	2	12	65.7	1134		9.989714	
11	3	20	97.9	1575	1023	10.86322	
12	2	13	82.6	1630		11.08543	

Bin5 Statistics 30

Trial #	Pulse	Chirp (MHz)	Pulse Width (μS)	Pulse 1-2 spacing (uS)	Pulse 2-3 spacing (uS)	Pulse Start(S)	Detection (1:yes; 0:no)
0	1	5	56.3			0.358286	0
1	3	14	67.5	1899	1823	1.355093	
2	3	8	95	1417	1970	1.477036	
3	2	13	93.3	1953		2.312588	
4	2	19	81.5	1660		2.956469	
5	1	16	55			4.225032	
6	2	11	90.9	1277		4.34134	
7	1	6	85.1			5.607625	
8	3	15	62.3	1523	1753	6.198374	
9	2	18	55.2	1437		6.953741	
10	2	6	81.5	1331		7.611158	
11	3	16	89.9	1698	1327	8.056947	
12	1	19	85.2			8.601866	
13	1	13	58.1			9.528605	
14	1	18	82.5			10.3778	
15	2	7	88.9	1134		11.16895	
16	2	16	82.4	1758		11.96869	

Table-6 Radar Type 6 Statistical Performance

Trial #	Fc (MHz)	Pulse /Burst	Pulse Width (µS)	PRI (µs)	Detection (1:yes; 0:no)	Hopping Sequence
1	5550	9	1	333	1	5251.0, 5541.0, 5713.0, 5503.0, 5598.0, 5604.0, 5444.0, 5360.0, 5592.0, 5483.0, 5561.0, 5577.0, 5301.0, 5519.0, 5550.0, 5506.0, 5330.0, 5431.0, 5610.0, 5458.0, 5594.0, 5258.0, 5626.0, 5490.0, 5723.0, 5342.0, 5306.0, 5383.0, 5270.0, 5568.0, 5352.0, 5308.0, 5422.0, 5322.0, 5334.0, 5651.0, 5265.0, 5463.0, 5288.0, 5357.0, 5612.0, 5450.0, 5523.0, 5445.0, 5378.0, 5476.0, 5325.0, 5679.0, 5321.0, 5492.0, 5254.0, 5632.0, 5700.0, 5681.0, 5564.0, 5671.0, 5353.0, 5385.0, 5530.0, 5329.0, 5556.0, 5662.0, 5485.0, 5645.0, 5438.0, 5504.0, 5668.0, 5374.0, 5619.0, 5574.0, 5582.0, 5477.0, 5428.0, 5278.0, 5449.0, 5472.0, 5412.0, 5318.0, 5394.0, 5381.0, 5648.0, 5465.0, 5512.0, 5356.0, 5548.0, 5341.0, 5667.0, 5676.0, 5543.0, 5324.0, 5508.0, 5328.0, 5526.0, 5398.0, 5390.0, 5720.0, 5606.0, 5658.0, 5421.0, 5571.0 (number of hits: 4)
2	5550	9	1	333	1	5463.0, 5490.0, 5530.0, 5469.0, 5468.0, 5614.0, 5310.0, 5545.0, 5672.0, 5676.0, 5475.0, 5338.0, 5403.0, 5440.0, 5698.0, 5623.0, 5505.0, 5480.0, 5345.0, 5585.0, 5313.0, 5717.0, 5607.0, 5513.0, 5281.0, 5384.0, 5253.0, 5259.0, 5565.0, 5393.0, 5351.0, 5660.0, 5343.0, 5549.0, 5524.0, 5482.0, 5539.0, 5374.0, 5478.0, 5323.0, 5576.0, 5594.0, 5584.0, 5449.0, 5562.0, 5625.0, 5608.0, 5694.0, 5635.0, 5701.0, 5516.0, 5455.0, 5444.0, 5448.0, 5542.0, 5271.0, 5251.0, 5274.0, 5286.0, 5291.0, 5340.0, 5628.0, 5509.0, 5707.0, 5683.0, 5420.0, 5337.0, 5699.0, 5312.0, 5447.0, 5561.0, 5397.0, 5362.0, 5579.0, 5715.0, 5616.0, 5391.0, 5560.0, 5620.0, 5555.0, 5461.0, 5610.0, 5622.0, 5718.0, 5369.0, 5598.0, 5503.0, 5321.0, 5677.0, 5667.0, 5543.0, 5615.0, 5566.0, 5593.0, 5657.0, 5405.0, 5573.0, 5515.0, 5404.0, 5472.0 (number of hits: 5)
3	5550	9	1	333	1	5332.0, 5398.0, 5412.0, 5517.0, 5691.0, 5587.0, 5679.0, 5327.0, 5588.0, 5326.0, 5578.0, 5463.0, 5392.0, 5431.0, 5427.0, 5351.0, 5522.0, 5295.0, 5651.0, 5386.0, 5700.0, 5596.0, 5552.0, 5283.0, 5273.0, 5566.0, 5454.0, 5721.0, 5516.0, 5430.0, 5675.0, 5413.0, 5417.0, 5528.0, 5613.0, 5250.0, 5462.0, 5620.0, 5276.0, 5603.0, 5476.0, 5502.0, 5499.0, 5532.0, 5280.0

						5380.0, 5324.0, 5376.0, 5583.0, 5262.0, 5316.0, 5668.0, 5408.0, 5697.0, 5265.0, 5641.0, 5716.0, 5605.0, 5508.0, 5638.0, 5707.0, 5567.0, 5346.0, 5591.0, 5575.0, 5510.0, 5362.0, 5645.0, 5429.0, 5428.0, 5402.0, 5618.0, 5626.0, 5555.0, 5500.0, 5448.0, 5699.0, 5497.0, 5701.0, 5311.0, 5654.0, 5446.0, 5407.0, 5323.0, 5719.0, 5308.0, 5653.0, 5584.0, 5409.0, 5382.0, 5661.0, 5533.0, 5496.0, 5456.0, 5470.0, 5340.0, 5688.0, 5363.0, 5475.0, 5687.0 (number of hits: 3)
4	5550	9	1	333	1	5585.0, 5477.0, 5438.0, 5453.0, 5687.0, 5454.0, 5598.0, 5553.0, 5332.0, 5372.0, 5619.0, 5484.0, 5539.0, 5515.0, 5478.0, 5647.0, 5533.0, 5671.0, 5644.0, 5560.0, 5388.0, 5555.0, 5274.0, 5319.0, 5425.0, 5497.0, 5547.0, 5420.0, 5602.0, 5440.0, 5367.0, 5289.0, 5589.0, 5356.0, 5586.0, 5465.0, 5291.0, 5335.0, 5300.0, 5564.0, 5266.0, 5536.0, 5531.0, 5369.0, 5651.0, 5527.0, 5328.0, 5657.0, 5629.0, 5285.0, 5600.0, 5401.0, 5480.0, 5513.0, 5614.0, 5416.0, 5546.0, 5639.0, 5353.0, 5715.0, 5346.0, 5721.0, 5405.0, 5587.0, 5475.0, 5409.0, 5441.0, 5524.0, 5703.0, 5292.0, 5295.0, 5659.0, 5481.0, 5426.0, 5597.0, 5511.0, 5708.0, 5411.0, 5251.0, 5665.0, 5611.0, 5376.0, 5273.0, 5430.0, 5608.0, 5645.0, 5528.0, 5400.0, 5433.0, 5437.0, 5496.0, 5402.0, 5476.0, 5435.0, 5593.0, 5461.0, 5344.0, 5660.0, 5711.0, 5337.0 (number of hits: 6)
5	5550	9	1	333	1	5510.0, 5547.0, 5262.0, 5544.0, 5580.0, 5505.0, 5396.0, 5454.0, 5661.0, 5626.0, 5645.0, 5584.0, 5466.0, 5660.0, 5500.0, 5373.0, 5697.0, 5264.0, 5288.0, 5413.0, 5371.0, 5434.0, 5310.0, 5292.0, 5610.0, 5380.0, 5515.0, 5663.0, 5509.0, 5253.0, 5694.0, 5289.0, 5307.0, 5381.0, 5550.0, 5535.0, 5620.0, 5573.0, 5529.0, 5712.0, 5557.0, 5718.0, 5476.0, 5602.0, 5430.0, 5641.0, 5311.0, 5546.0, 5559.0, 5341.0, 5628.0, 5486.0, 5723.0, 5468.0, 5492.0, 5331.0, 5489.0, 5462.0, 5460.0, 5497.0, 5309.0, 5499.0, 5521.0, 5395.0, 5394.0, 5431.0, 5551.0, 5538.0, 5315.0, 5713.0, 5501.0, 5408.0, 5439.0, 5507.0, 5698.0, 5658.0, 5543.0, 5681.0, 5438.0, 5457.0, 5532.0, 5357.0, 5646.0, 5451.0, 5360.0, 5585.0, 5676.0, 5376.0, 5473.0, 5675.0, 5683.0, 5591.0, 5334.0, 5287.0, 5654.0, 5345.0, 5575.0, 5630.0, 5491.0, 5383.0 (number of hits: 8)
6	5550	9	1	333	1	5709.0, 5540.0, 5399.0, 5514.0, 5453.0, 5269.0, 5621.0, 5563.0, 5363.0, 5371.0,

						5310.0, 5306.0, 5322.0, 5641.0, 5261.0, 5706.0, 5302.0, 5391.0, 5597.0, 5273.0, 5610.0, 5340.0, 5435.0, 5603.0, 5590.0, 5304.0, 5365.0, 5560.0, 5707.0, 5559.0, 5498.0, 5619.0, 5374.0, 5552.0, 5344.0, 5476.0, 5410.0, 5265.0, 5684.0, 5441.0, 5323.0, 5704.0, 5359.0, 5576.0, 5573.0, 5501.0, 5413.0, 5445.0, 5259.0, 5660.0, 5484.0, 5555.0, 5442.0, 5338.0, 5412.0, 5495.0, 5262.0, 5372.0, 5631.0, 5309.0, 5578.0, 5690.0, 5460.0, 5421.0, 5270.0, 5356.0, 5301.0, 5481.0, 5275.0, 5596.0, 5361.0, 5592.0, 5714.0, 5362.0, 5341.0, 5468.0, 5637.0, 5618.0, 5428.0, 5523.0, 5305.0, 5316.0, 5721.0, 5416.0, 5633.0, 5387.0, 5705.0, 5666.0, 5335.0, 5485.0, 5319.0, 5352.0, 5266.0, 5547.0, 5710.0, 5324.0, 5386.0, 5411.0, 5642.0, 5327.0 (number of hits: 7)
7	5550	9	1	333	1	5637.0, 5606.0, 5448.0, 5502.0, 5517.0, 5602.0, 5539.0, 5510.0, 5550.0, 5322.0, 5584.0, 5589.0, 5560.0, 5595.0, 5717.0, 5406.0, 5604.0, 5364.0, 5403.0, 5603.0, 5501.0, 5390.0, 5449.0, 5709.0, 5425.0, 5326.0, 5643.0, 5623.0, 5523.0, 5251.0, 5263.0, 5690.0, 5304.0, 5431.0, 5252.0, 5707.0, 5281.0, 5385.0, 5557.0, 5704.0, 5370.0, 5384.0, 5475.0, 5569.0, 5270.0, 5462.0, 5253.0, 5492.0, 5379.0, 5487.0, 5480.0, 5533.0, 5393.0, 5374.0, 5689.0, 5616.0, 5660.0, 5614.0, 5276.0, 5715.0, 5655.0, 5633.0, 5297.0, 5360.0, 5559.0, 5442.0, 5301.0, 5357.0, 5455.0, 5405.0, 5271.0, 5647.0, 5333.0, 5586.0, 5567.0, 5453.0, 5465.0, 5290.0, 5259.0, 5578.0, 5311.0, 5615.0, 5408.0, 5435.0, 5277.0, 5629.0, 5344.0, 5580.0, 5625.0, 5283.0, 5568.0, 5496.0, 5666.0, 5416.0, 5427.0, 5553.0, 5532.0, 5545.0, 5548.0, 5551.0 (number of hits: 5)
8	5550	9	1	333	1	5355.0, 5359.0, 5630.0, 5276.0, 5606.0, 5590.0, 5384.0, 5558.0, 5549.0, 5493.0, 5463.0, 5422.0, 5516.0, 5328.0, 5482.0, 5326.0, 5681.0, 5434.0, 5441.0, 5502.0, 5428.0, 5310.0, 5689.0, 5388.0, 5404.0, 5416.0, 5580.0, 5459.0, 5530.0, 5297.0, 5628.0, 5392.0, 5340.0, 5634.0, 5521.0, 5718.0, 5296.0, 5451.0, 5474.0, 5387.0, 5373.0, 5708.0, 5611.0, 5613.0, 5624.0, 5547.0, 5423.0, 5667.0, 5406.0, 5564.0, 5707.0, 5595.0, 5456.0, 5605.0, 5478.0, 5665.0, 5557.0, 5671.0, 5332.0, 5522.0, 5429.0, 5490.0, 5483.0, 5264.0, 5437.0, 5654.0, 5619.0, 5653.0, 5369.0, 5596.0, 5385.0, 5711.0, 5351.0, 5669.0, 5349.0, 5488.0, 5271.0, 5523.0, 5257.0, 5546.0

						5670.0, 5582.0, 5323.0, 5617.0, 5341.0, 5587.0, 5485.0, 5570.0, 5409.0, 5466.0, 5632.0, 5716.0, 5578.0, 5645.0, 5391.0, 5525.0, 5331.0, 5709.0, 5675.0, 5378.0 (number of hits: 3)
9	5550	9	1	333	1	5634.0, 5519.0, 5496.0, 5464.0, 5619.0, 5555.0, 5513.0, 5258.0, 5486.0, 5601.0, 5393.0, 5668.0, 5546.0, 5451.0, 5563.0, 5667.0, 5436.0, 5438.0, 5455.0, 5317.0, 5627.0, 5392.0, 5669.0, 5253.0, 5505.0, 5292.0, 5390.0, 5620.0, 5545.0, 5675.0, 5447.0, 5320.0, 5586.0, 5599.0, 5402.0, 5401.0, 5284.0, 5493.0, 5351.0, 5701.0, 5395.0, 5290.0, 5384.0, 5329.0, 5481.0, 5276.0, 5492.0, 5271.0, 5571.0, 5689.0, 5508.0, 5289.0, 5670.0, 5286.0, 5418.0, 5435.0, 5702.0, 5550.0, 5542.0, 5357.0, 5547.0, 5699.0, 5346.0, 5674.0, 5416.0, 5358.0, 5594.0, 5501.0, 5612.0, 5559.0, 5408.0, 5666.0, 5589.0, 5314.0, 5645.0, 5263.0, 5562.0, 5461.0, 5533.0, 5539.0, 5560.0, 5420.0, 5389.0, 5655.0, 5495.0, 5503.0, 5339.0, 5600.0, 5341.0, 5327.0, 5500.0, 5370.0, 5548.0, 5661.0, 5688.0, 5302.0, 5387.0, 5427.0, 5680.0, 5633.0 (number of hits: 6)
10	5550	9	1	333	1	5393.0, 5648.0, 5380.0, 5573.0, 5317.0, 5420.0, 5680.0, 5413.0, 5373.0, 5265.0, 5508.0, 5698.0, 5396.0, 5509.0, 5623.0, 5457.0, 5377.0, 5495.0, 5427.0, 5274.0, 5501.0, 5581.0, 5552.0, 5340.0, 5342.0, 5255.0, 5444.0, 5306.0, 5463.0, 5589.0, 5336.0, 5424.0, 5321.0, 5356.0, 5676.0, 5541.0, 5498.0, 5535.0, 5372.0, 5338.0, 5647.0, 5662.0, 5558.0, 5586.0, 5332.0, 5469.0, 5638.0, 5297.0, 5477.0, 5375.0, 5421.0, 5722.0, 5689.0, 5530.0, 5545.0, 5370.0, 5435.0, 5333.0, 5316.0, 5392.0, 5346.0, 5292.0, 5633.0, 5528.0, 5290.0, 5416.0, 5276.0, 5695.0, 5635.0, 5559.0, 5289.0, 5537.0, 5628.0, 5513.0, 5400.0, 5601.0, 5308.0, 5281.0, 5627.0, 5485.0, 5448.0, 5398.0, 5347.0, 5410.0, 5524.0, 5295.0, 5557.0, 5561.0, 5619.0, 5353.0, 5594.0, 5678.0, 5376.0, 5708.0, 5492.0, 5539.0, 5531.0, 5472.0, 5690.0, 5397.0 (number of hits: 7)
11	5550	9	1	333	1	5425.0, 5255.0, 5541.0, 5513.0, 5367.0, 5682.0, 5669.0, 5702.0, 5437.0, 5417.0, 5325.0, 5355.0, 5327.0, 5657.0, 5366.0, 5596.0, 5443.0, 5305.0, 5616.0, 5622.0, 5279.0, 5563.0, 5638.0, 5393.0, 5342.0, 5307.0, 5474.0, 5252.0, 5462.0, 5572.0, 5381.0, 5540.0, 5335.0, 5569.0, 5352.0, 5434.0, 5605.0, 5504.0, 5704.0, 5615.0, 5603.0, 5322.0, 5589.0, 5595.0, 5274.0,

						5720.0, 5368.0, 5641.0, 5654.0, 5271.0, 5332.0, 5613.0, 5675.0, 5348.0, 5407.0, 5608.0, 5356.0, 5403.0, 5480.0, 5701.0, 5543.0, 5709.0, 5694.0, 5716.0, 5722.0, 5577.0, 5712.0, 5562.0, 5382.0, 5705.0, 5261.0, 5650.0, 5625.0, 5297.0, 5293.0, 5267.0, 5685.0, 5648.0, 5257.0, 5635.0, 5521.0, 5703.0, 5557.0, 5477.0, 5446.0, 5386.0, 5624.0, 5488.0, 5581.0, 5273.0, 5500.0, 5448.0, 5486.0, 5442.0, 5415.0, 5435.0, 5686.0, 5292.0, 5661.0, 5630.0 (number of hits: 5)
12	5550	9	1	333	1	5299.0, 5500.0, 5642.0, 5510.0, 5269.0, 5256.0, 5466.0, 5626.0, 5572.0, 5415.0, 5542.0, 5609.0, 5367.0, 5580.0, 5271.0, 5337.0, 5592.0, 5441.0, 5696.0, 5587.0, 5455.0, 5280.0, 5563.0, 5495.0, 5513.0, 5319.0, 5562.0, 5359.0, 5714.0, 5278.0, 5699.0, 5635.0, 5430.0, 5435.0, 5504.0, 5323.0, 5368.0, 5461.0, 5482.0, 5648.0, 5251.0, 5284.0, 5701.0, 5440.0, 5605.0, 5470.0, 5436.0, 5659.0, 5426.0, 5679.0, 5374.0, 5639.0, 5402.0, 5611.0, 5464.0, 5599.0, 5487.0, 5711.0, 5704.0, 5693.0, 5499.0, 5556.0, 5602.0, 5325.0, 5687.0, 5603.0, 5264.0, 5686.0, 5554.0, 5723.0, 5363.0, 5558.0, 5406.0, 5539.0, 5631.0, 5718.0, 5322.0, 5425.0, 5652.0, 5507.0, 5456.0, 5596.0, 5544.0, 5384.0, 5321.0, 5416.0, 5494.0, 5480.0, 5258.0, 5388.0, 5348.0, 5454.0, 5506.0, 5712.0, 5490.0, 5329.0, 5429.0, 5310.0, 5474.0, 5437.0 (number of hits: 2)
13	5550	9	1	333	1	5686.0, 5399.0, 5563.0, 5271.0, 5653.0, 5290.0, 5537.0, 5648.0, 5295.0, 5392.0, 5357.0, 5460.0, 5712.0, 5668.0, 5600.0, 5471.0, 5449.0, 5720.0, 5337.0, 5635.0, 5509.0, 5562.0, 5395.0, 5366.0, 5602.0, 5614.0, 5470.0, 5416.0, 5678.0, 5461.0, 5476.0, 5660.0, 5718.0, 5383.0, 5282.0, 5555.0, 5330.0, 5456.0, 5279.0, 5353.0, 5650.0, 5285.0, 5296.0, 5420.0, 5548.0, 5717.0, 5401.0, 5623.0, 5382.0, 5274.0, 5634.0, 5619.0, 5448.0, 5464.0, 5546.0, 5288.0, 5404.0, 5406.0, 5494.0, 5637.0, 5398.0, 5610.0, 5477.0, 5441.0, 5320.0, 5670.0, 5640.0, 5586.0, 5525.0, 5620.0, 5500.0, 5415.0, 5618.0, 5646.0, 5663.0, 5687.0, 5644.0, 5672.0, 5583.0, 5331.0, 5318.0, 5455.0, 5591.0, 5542.0, 5682.0, 5307.0, 5447.0, 5277.0, 5599.0, 5450.0, 5628.0, 5501.0, 5552.0, 5388.0, 5432.0, 5701.0, 5359.0, 5709.0, 5520.0, 5355.0 (number of hits: 6)
14	5550	9	1	333	1	5306.0, 5489.0, 5595.0, 5586.0, 5418.0, 5412.0, 5587.0, 5362.0, 5491.0, 5605.0,

						<p>5507.0, 5267.0, 5543.0, 5394.0, 5335.0, 5617.0, 5282.0, 5441.0, 5304.0, 5424.0, 5541.0, 5470.0, 5504.0, 5577.0, 5653.0, 5461.0, 5671.0, 5642.0, 5544.0, 5565.0, 5275.0, 5317.0, 5691.0, 5364.0, 5560.0, 5345.0, 5667.0, 5526.0, 5534.0, 5400.0, 5305.0, 5676.0, 5602.0, 5597.0, 5554.0, 5564.0, 5716.0, 5338.0, 5258.0, 5590.0, 5647.0, 5409.0, 5446.0, 5524.0, 5429.0, 5715.0, 5719.0, 5694.0, 5677.0, 5668.0, 5657.0, 5269.0, 5277.0, 5459.0, 5289.0, 5550.0, 5406.0, 5615.0, 5374.0, 5434.0, 5366.0, 5625.0, 5410.0, 5505.0, 5566.0, 5530.0, 5367.0, 5273.0, 5390.0, 5252.0, 5423.0, 5561.0, 5546.0, 5278.0, 5583.0, 5324.0, 5397.0, 5360.0, 5604.0, 5291.0, 5700.0, 5690.0, 5547.0, 5591.0, 5320.0, 5687.0, 5471.0, 5431.0, 5708.0, 5309.0</p> <p>(number of hits: 6)</p>
15	5550	9	1	333	1	<p>5255.0, 5308.0, 5624.0, 5299.0, 5387.0, 5605.0, 5701.0, 5301.0, 5672.0, 5376.0, 5567.0, 5274.0, 5676.0, 5610.0, 5719.0, 5469.0, 5498.0, 5627.0, 5586.0, 5318.0, 5483.0, 5688.0, 5612.0, 5340.0, 5490.0, 5581.0, 5420.0, 5282.0, 5625.0, 5569.0, 5503.0, 5523.0, 5568.0, 5516.0, 5593.0, 5262.0, 5636.0, 5710.0, 5596.0, 5418.0, 5460.0, 5683.0, 5528.0, 5669.0, 5425.0, 5405.0, 5555.0, 5629.0, 5633.0, 5616.0, 5664.0, 5364.0, 5543.0, 5699.0, 5296.0, 5357.0, 5579.0, 5339.0, 5427.0, 5538.0, 5584.0, 5575.0, 5487.0, 5650.0, 5377.0, 5251.0, 5606.0, 5369.0, 5573.0, 5545.0, 5342.0, 5520.0, 5453.0, 5493.0, 5506.0, 5396.0, 5265.0, 5410.0, 5634.0, 5530.0, 5392.0, 5441.0, 5648.0, 5450.0, 5415.0, 5509.0, 5366.0, 5685.0, 5345.0, 5712.0, 5690.0, 5350.0, 5373.0, 5696.0, 5651.0, 5393.0, 5426.0, 5698.0, 5329.0, 5678.0</p> <p>(number of hits: 4)</p>
16	5550	9	1	333	1	<p>5616.0, 5535.0, 5692.0, 5571.0, 5298.0, 5446.0, 5525.0, 5395.0, 5302.0, 5709.0, 5650.0, 5569.0, 5538.0, 5272.0, 5332.0, 5579.0, 5556.0, 5566.0, 5257.0, 5507.0, 5685.0, 5526.0, 5386.0, 5409.0, 5632.0, 5317.0, 5523.0, 5596.0, 5377.0, 5280.0, 5255.0, 5445.0, 5262.0, 5609.0, 5278.0, 5648.0, 5587.0, 5394.0, 5558.0, 5573.0, 5429.0, 5662.0, 5471.0, 5328.0, 5595.0, 5268.0, 5479.0, 5362.0, 5696.0, 5477.0, 5570.0, 5550.0, 5404.0, 5294.0, 5680.0, 5355.0, 5628.0, 5334.0, 5450.0, 5627.0, 5668.0, 5412.0, 5427.0, 5630.0, 5500.0, 5670.0, 5443.0, 5481.0, 5622.0, 5387.0, 5592.0, 5684.0, 5306.0, 5666.0, 5557.0, 5383.0, 5667.0, 5330.0, 5390.0, 5366.0,</p>

						5589.0, 5456.0, 5719.0, 5655.0, 5358.0, 5714.0, 5475.0, 5467.0, 5353.0, 5453.0, 5348.0, 5554.0, 5560.0, 5326.0, 5344.0, 5585.0, 5663.0, 5623.0, 5614.0, 5701.0 (number of hits: 4)
17	5550	9	1	333	1	5705.0, 5440.0, 5388.0, 5421.0, 5266.0, 5533.0, 5674.0, 5578.0, 5716.0, 5427.0, 5499.0, 5564.0, 5590.0, 5444.0, 5715.0, 5313.0, 5507.0, 5543.0, 5645.0, 5493.0, 5535.0, 5694.0, 5567.0, 5495.0, 5471.0, 5608.0, 5692.0, 5508.0, 5465.0, 5528.0, 5351.0, 5491.0, 5391.0, 5379.0, 5353.0, 5277.0, 5479.0, 5485.0, 5453.0, 5579.0, 5611.0, 5514.0, 5375.0, 5684.0, 5338.0, 5339.0, 5637.0, 5332.0, 5583.0, 5426.0, 5702.0, 5617.0, 5263.0, 5554.0, 5700.0, 5272.0, 5442.0, 5560.0, 5668.0, 5373.0, 5592.0, 5708.0, 5670.0, 5365.0, 5302.0, 5614.0, 5330.0, 5281.0, 5636.0, 5480.0, 5565.0, 5690.0, 5355.0, 5346.0, 5326.0, 5470.0, 5359.0, 5691.0, 5672.0, 5497.0, 5680.0, 5262.0, 5582.0, 5622.0, 5698.0, 5558.0, 5481.0, 5555.0, 5258.0, 5552.0, 5619.0, 5371.0, 5658.0, 5713.0, 5398.0, 5665.0, 5687.0, 5527.0, 5500.0, 5644.0 (number of hits: 2)
18	5550	9	1	333	1	5434.0, 5647.0, 5665.0, 5311.0, 5533.0, 5299.0, 5445.0, 5514.0, 5319.0, 5641.0, 5651.0, 5485.0, 5368.0, 5630.0, 5628.0, 5715.0, 5717.0, 5394.0, 5369.0, 5648.0, 5504.0, 5428.0, 5704.0, 5484.0, 5623.0, 5595.0, 5359.0, 5539.0, 5621.0, 5317.0, 5440.0, 5361.0, 5463.0, 5407.0, 5502.0, 5322.0, 5499.0, 5551.0, 5385.0, 5410.0, 5599.0, 5702.0, 5626.0, 5550.0, 5386.0, 5262.0, 5505.0, 5517.0, 5510.0, 5301.0, 5275.0, 5675.0, 5590.0, 5389.0, 5427.0, 5287.0, 5711.0, 5679.0, 5346.0, 5469.0, 5355.0, 5561.0, 5695.0, 5617.0, 5341.0, 5607.0, 5672.0, 5689.0, 5597.0, 5433.0, 5395.0, 5376.0, 5699.0, 5690.0, 5417.0, 5497.0, 5642.0, 5692.0, 5564.0, 5494.0, 5584.0, 5384.0, 5396.0, 5401.0, 5656.0, 5697.0, 5431.0, 5452.0, 5405.0, 5500.0, 5611.0, 5420.0, 5448.0, 5254.0, 5567.0, 5524.0, 5273.0, 5483.0, 5291.0, 5269.0 (number of hits: 5)
19	5550	9	1	333	1	5307.0, 5262.0, 5341.0, 5272.0, 5609.0, 5654.0, 5371.0, 5376.0, 5658.0, 5466.0, 5478.0, 5435.0, 5490.0, 5572.0, 5719.0, 5335.0, 5605.0, 5613.0, 5462.0, 5396.0, 5687.0, 5280.0, 5686.0, 5526.0, 5323.0, 5592.0, 5707.0, 5367.0, 5620.0, 5671.0, 5670.0, 5299.0, 5525.0, 5362.0, 5668.0, 5616.0, 5381.0, 5477.0, 5454.0, 5276.0, 5496.0, 5563.0, 5439.0, 5418.0, 5311.0,

						5648.0, 5607.0, 5666.0, 5556.0, 5546.0, 5306.0, 5406.0, 5452.0, 5578.0, 5681.0, 5579.0, 5354.0, 5305.0, 5393.0, 5417.0, 5493.0, 5587.0, 5271.0, 5325.0, 5562.0, 5251.0, 5343.0, 5408.0, 5570.0, 5383.0, 5292.0, 5547.0, 5332.0, 5457.0, 5268.0, 5253.0, 5285.0, 5695.0, 5630.0, 5290.0, 5348.0, 5349.0, 5274.0, 5318.0, 5685.0, 5482.0, 5676.0, 5652.0, 5387.0, 5395.0, 5531.0, 5548.0, 5491.0, 5412.0, 5629.0, 5480.0, 5431.0, 5514.0, 5680.0, 5372.0 (number of hits: 8)
20	5550	9	1	333	1	5349.0, 5526.0, 5513.0, 5436.0, 5434.0, 5695.0, 5465.0, 5305.0, 5296.0, 5404.0, 5346.0, 5375.0, 5600.0, 5719.0, 5594.0, 5710.0, 5421.0, 5515.0, 5275.0, 5623.0, 5546.0, 5470.0, 5715.0, 5607.0, 5643.0, 5512.0, 5370.0, 5591.0, 5268.0, 5330.0, 5448.0, 5661.0, 5267.0, 5302.0, 5431.0, 5395.0, 5680.0, 5543.0, 5502.0, 5426.0, 5501.0, 5518.0, 5388.0, 5380.0, 5456.0, 5615.0, 5467.0, 5418.0, 5723.0, 5721.0, 5565.0, 5331.0, 5260.0, 5691.0, 5365.0, 5614.0, 5347.0, 5479.0, 5558.0, 5693.0, 5559.0, 5544.0, 5313.0, 5311.0, 5630.0, 5345.0, 5316.0, 5326.0, 5686.0, 5604.0, 5578.0, 5509.0, 5295.0, 5579.0, 5361.0, 5369.0, 5499.0, 5466.0, 5353.0, 5314.0, 5658.0, 5517.0, 5409.0, 5665.0, 5635.0, 5412.0, 5714.0, 5299.0, 5632.0, 5485.0, 5454.0, 5323.0, 5376.0, 5563.0, 5497.0, 5524.0, 5722.0, 5596.0, 5650.0, 5420.0 (number of hits: 8)
21	5550	9	1	333	1	5703.0, 5675.0, 5649.0, 5595.0, 5613.0, 5677.0, 5471.0, 5333.0, 5624.0, 5458.0, 5403.0, 5394.0, 5632.0, 5513.0, 5483.0, 5662.0, 5583.0, 5694.0, 5425.0, 5581.0, 5572.0, 5292.0, 5539.0, 5380.0, 5340.0, 5551.0, 5526.0, 5491.0, 5618.0, 5509.0, 5518.0, 5440.0, 5297.0, 5346.0, 5501.0, 5503.0, 5689.0, 5482.0, 5524.0, 5281.0, 5704.0, 5681.0, 5548.0, 5540.0, 5287.0, 5659.0, 5446.0, 5463.0, 5635.0, 5302.0, 5409.0, 5307.0, 5347.0, 5306.0, 5323.0, 5396.0, 5321.0, 5424.0, 5699.0, 5284.0, 5579.0, 5322.0, 5674.0, 5498.0, 5360.0, 5378.0, 5584.0, 5691.0, 5493.0, 5646.0, 5341.0, 5387.0, 5388.0, 5661.0, 5478.0, 5342.0, 5567.0, 5448.0, 5591.0, 5414.0, 5298.0, 5486.0, 5428.0, 5295.0, 5508.0, 5706.0, 5690.0, 5479.0, 5545.0, 5544.0, 5519.0, 5406.0, 5315.0, 5502.0, 5370.0, 5313.0, 5331.0, 5277.0, 5514.0, 5280.0 (number of hits: 9)
22	5550	9	1	333	1	5562.0, 5582.0, 5394.0, 5706.0, 5722.0, 5321.0, 5279.0, 5354.0, 5327.0, 5473.0,

						5555.0, 5536.0, 5567.0, 5655.0, 5586.0, 5470.0, 5620.0, 5563.0, 5502.0, 5535.0, 5652.0, 5721.0, 5323.0, 5259.0, 5383.0, 5682.0, 5605.0, 5603.0, 5382.0, 5672.0, 5637.0, 5435.0, 5256.0, 5302.0, 5338.0, 5572.0, 5485.0, 5289.0, 5677.0, 5634.0, 5389.0, 5629.0, 5627.0, 5293.0, 5469.0, 5428.0, 5418.0, 5547.0, 5271.0, 5471.0, 5644.0, 5303.0, 5447.0, 5398.0, 5351.0, 5560.0, 5290.0, 5531.0, 5515.0, 5611.0, 5254.0, 5334.0, 5299.0, 5476.0, 5568.0, 5270.0, 5492.0, 5318.0, 5459.0, 5529.0, 5691.0, 5443.0, 5444.0, 5272.0, 5689.0, 5521.0, 5594.0, 5404.0, 5378.0, 5345.0, 5508.0, 5617.0, 5665.0, 5362.0, 5452.0, 5585.0, 5292.0, 5509.0, 5283.0, 5336.0, 5285.0, 5701.0, 5514.0, 5457.0, 5510.0, 5524.0, 5403.0, 5528.0, 5683.0, 5599.0 (number of hits: 8)
23	5550	9	1	333	1	5405.0, 5651.0, 5415.0, 5288.0, 5437.0, 5318.0, 5502.0, 5262.0, 5463.0, 5591.0, 5640.0, 5258.0, 5660.0, 5665.0, 5615.0, 5261.0, 5530.0, 5689.0, 5697.0, 5265.0, 5592.0, 5724.0, 5624.0, 5622.0, 5321.0, 5337.0, 5307.0, 5289.0, 5583.0, 5538.0, 5722.0, 5413.0, 5396.0, 5469.0, 5505.0, 5531.0, 5422.0, 5568.0, 5567.0, 5503.0, 5548.0, 5395.0, 5478.0, 5677.0, 5357.0, 5710.0, 5481.0, 5657.0, 5362.0, 5701.0, 5589.0, 5551.0, 5705.0, 5480.0, 5599.0, 5378.0, 5630.0, 5613.0, 5344.0, 5666.0, 5379.0, 5688.0, 5483.0, 5253.0, 5618.0, 5278.0, 5431.0, 5269.0, 5363.0, 5419.0, 5365.0, 5579.0, 5342.0, 5435.0, 5355.0, 5494.0, 5394.0, 5381.0, 5440.0, 5384.0, 5259.0, 5545.0, 5484.0, 5400.0, 5668.0, 5473.0, 5392.0, 5623.0, 5672.0, 5411.0, 5627.0, 5351.0, 5662.0, 5594.0, 5571.0, 5479.0, 5285.0, 5676.0, 5716.0, 5577.0 (number of hits: 4)
24	5550	9	1	333	1	5508.0, 5473.0, 5388.0, 5390.0, 5658.0, 5359.0, 5541.0, 5701.0, 5649.0, 5479.0, 5616.0, 5280.0, 5343.0, 5412.0, 5422.0, 5284.0, 5625.0, 5663.0, 5403.0, 5376.0, 5409.0, 5470.0, 5683.0, 5484.0, 5551.0, 5448.0, 5398.0, 5607.0, 5578.0, 5497.0, 5550.0, 5256.0, 5270.0, 5253.0, 5709.0, 5402.0, 5351.0, 5318.0, 5600.0, 5604.0, 5346.0, 5360.0, 5411.0, 5560.0, 5254.0, 5436.0, 5480.0, 5392.0, 5703.0, 5296.0, 5264.0, 5307.0, 5496.0, 5372.0, 5344.0, 5656.0, 5558.0, 5498.0, 5389.0, 5668.0, 5373.0, 5417.0, 5382.0, 5574.0, 5563.0, 5538.0, 5524.0, 5618.0, 5665.0, 5621.0, 5659.0, 5641.0, 5364.0, 5549.0, 5528.0, 5322.0, 5724.0, 5610.0, 5593.0, 5706.0,

						5418.0, 5680.0, 5400.0, 5599.0, 5679.0, 5294.0, 5459.0, 5391.0, 5666.0, 5674.0, 5464.0, 5285.0, 5327.0, 5647.0, 5597.0, 5716.0, 5455.0, 5347.0, 5677.0, 5535.0 (number of hits: 4)
25	5550	9	1	333	1	5408.0, 5559.0, 5591.0, 5288.0, 5609.0, 5275.0, 5379.0, 5633.0, 5537.0, 5450.0, 5645.0, 5511.0, 5554.0, 5253.0, 5653.0, 5413.0, 5525.0, 5621.0, 5376.0, 5418.0, 5307.0, 5542.0, 5423.0, 5330.0, 5578.0, 5388.0, 5556.0, 5536.0, 5372.0, 5250.0, 5558.0, 5311.0, 5268.0, 5368.0, 5369.0, 5497.0, 5347.0, 5251.0, 5367.0, 5468.0, 5676.0, 5496.0, 5711.0, 5283.0, 5293.0, 5431.0, 5417.0, 5508.0, 5472.0, 5338.0, 5524.0, 5407.0, 5449.0, 5527.0, 5465.0, 5380.0, 5613.0, 5396.0, 5535.0, 5302.0, 5612.0, 5487.0, 5334.0, 5646.0, 5585.0, 5433.0, 5481.0, 5686.0, 5625.0, 5383.0, 5622.0, 5661.0, 5337.0, 5589.0, 5700.0, 5565.0, 5429.0, 5267.0, 5315.0, 5395.0, 5308.0, 5278.0, 5318.0, 5534.0, 5657.0, 5692.0, 5499.0, 5280.0, 5602.0, 5264.0, 5297.0, 5557.0, 5455.0, 5615.0, 5263.0, 5411.0, 5281.0, 5579.0, 5309.0, 5254.0 (number of hits: 8)
26	5550	9	1	333	1	5714.0, 5382.0, 5308.0, 5493.0, 5624.0, 5684.0, 5469.0, 5267.0, 5404.0, 5330.0, 5407.0, 5569.0, 5506.0, 5434.0, 5557.0, 5650.0, 5490.0, 5387.0, 5322.0, 5492.0, 5521.0, 5562.0, 5475.0, 5549.0, 5548.0, 5602.0, 5574.0, 5705.0, 5405.0, 5325.0, 5606.0, 5341.0, 5575.0, 5384.0, 5394.0, 5411.0, 5459.0, 5529.0, 5352.0, 5351.0, 5576.0, 5314.0, 5682.0, 5596.0, 5438.0, 5320.0, 5520.0, 5464.0, 5296.0, 5428.0, 5544.0, 5577.0, 5600.0, 5514.0, 5690.0, 5693.0, 5377.0, 5636.0, 5704.0, 5631.0, 5555.0, 5431.0, 5418.0, 5511.0, 5343.0, 5523.0, 5611.0, 5414.0, 5265.0, 5485.0, 5403.0, 5271.0, 5677.0, 5254.0, 5298.0, 5515.0, 5324.0, 5336.0, 5452.0, 5502.0, 5370.0, 5701.0, 5295.0, 5392.0, 5598.0, 5337.0, 5688.0, 5597.0, 5415.0, 5356.0, 5565.0, 5675.0, 5468.0, 5470.0, 5427.0, 5489.0, 5479.0, 5528.0, 5303.0, 5293.0 (number of hits: 7)
27	5550	9	1	333	1	5600.0, 5533.0, 5438.0, 5467.0, 5683.0, 5607.0, 5475.0, 5494.0, 5573.0, 5495.0, 5331.0, 5370.0, 5255.0, 5390.0, 5447.0, 5584.0, 5279.0, 5351.0, 5627.0, 5432.0, 5481.0, 5586.0, 5408.0, 5409.0, 5318.0, 5426.0, 5665.0, 5673.0, 5300.0, 5579.0, 5485.0, 5678.0, 5261.0, 5484.0, 5535.0, 5278.0, 5521.0, 5284.0, 5281.0, 5301.0, 5358.0, 5333.0, 5363.0, 5277.0, 5671.0,

						5633.0, 5561.0, 5581.0, 5304.0, 5570.0, 5341.0, 5593.0, 5282.0, 5436.0, 5687.0, 5466.0, 5682.0, 5397.0, 5394.0, 5702.0, 5487.0, 5354.0, 5468.0, 5452.0, 5619.0, 5291.0, 5557.0, 5567.0, 5410.0, 5251.0, 5667.0, 5504.0, 5383.0, 5294.0, 5662.0, 5266.0, 5565.0, 5605.0, 5415.0, 5623.0, 5387.0, 5275.0, 5433.0, 5511.0, 5440.0, 5608.0, 5642.0, 5334.0, 5347.0, 5626.0, 5386.0, 5500.0, 5413.0, 5258.0, 5648.0, 5260.0, 5257.0, 5391.0, 5497.0, 5364.0 (number of hits: 5)
28	5550	9	1	333	1	5617.0, 5558.0, 5412.0, 5468.0, 5369.0, 5597.0, 5660.0, 5359.0, 5582.0, 5362.0, 5324.0, 5591.0, 5289.0, 5535.0, 5525.0, 5487.0, 5531.0, 5510.0, 5515.0, 5703.0, 5620.0, 5540.0, 5658.0, 5323.0, 5417.0, 5467.0, 5460.0, 5339.0, 5276.0, 5291.0, 5678.0, 5264.0, 5716.0, 5593.0, 5293.0, 5583.0, 5715.0, 5685.0, 5552.0, 5612.0, 5533.0, 5654.0, 5572.0, 5392.0, 5262.0, 5422.0, 5321.0, 5423.0, 5363.0, 5288.0, 5425.0, 5407.0, 5723.0, 5516.0, 5601.0, 5305.0, 5295.0, 5632.0, 5680.0, 5347.0, 5672.0, 5604.0, 5429.0, 5330.0, 5602.0, 5374.0, 5712.0, 5681.0, 5469.0, 5372.0, 5360.0, 5650.0, 5257.0, 5492.0, 5391.0, 5341.0, 5574.0, 5695.0, 5630.0, 5334.0, 5707.0, 5404.0, 5693.0, 5696.0, 5704.0, 5367.0, 5285.0, 5456.0, 5480.0, 5426.0, 5652.0, 5410.0, 5624.0, 5373.0, 5296.0, 5639.0, 5520.0, 5421.0, 5308.0, 5633.0 (number of hits: 9)
29	5550	9	1	333	1	5591.0, 5506.0, 5330.0, 5625.0, 5545.0, 5627.0, 5296.0, 5513.0, 5581.0, 5332.0, 5422.0, 5569.0, 5323.0, 5622.0, 5452.0, 5535.0, 5687.0, 5406.0, 5686.0, 5637.0, 5491.0, 5566.0, 5351.0, 5414.0, 5576.0, 5605.0, 5685.0, 5485.0, 5298.0, 5689.0, 5609.0, 5387.0, 5334.0, 5475.0, 5555.0, 5557.0, 5268.0, 5354.0, 5377.0, 5260.0, 5644.0, 5667.0, 5705.0, 5724.0, 5305.0, 5645.0, 5559.0, 5461.0, 5673.0, 5458.0, 5610.0, 5325.0, 5641.0, 5285.0, 5420.0, 5621.0, 5694.0, 5257.0, 5706.0, 5353.0, 5651.0, 5528.0, 5356.0, 5633.0, 5639.0, 5708.0, 5372.0, 5655.0, 5481.0, 5340.0, 5252.0, 5348.0, 5517.0, 5543.0, 5415.0, 5571.0, 5536.0, 5640.0, 5402.0, 5677.0, 5558.0, 5547.0, 5428.0, 5444.0, 5556.0, 5647.0, 5586.0, 5273.0, 5642.0, 5322.0, 5329.0, 5580.0, 5346.0, 5507.0, 5583.0, 5585.0, 5598.0, 5540.0, 5575.0, 5408.0 (number of hits: 4)
30	5550	9	1	333	1	5267.0, 5637.0, 5418.0, 5523.0, 5312.0, 5575.0, 5454.0, 5573.0, 5673.0, 5280.0,

						5487.0, 5662.0, 5318.0, 5362.0, 5440.0, 5672.0, 5295.0, 5664.0, 5370.0, 5679.0, 5715.0, 5265.0, 5435.0, 5421.0, 5582.0, 5324.0, 5641.0, 5700.0, 5512.0, 5281.0, 5689.0, 5692.0, 5319.0, 5394.0, 5583.0, 5366.0, 5492.0, 5612.0, 5642.0, 5623.0, 5297.0, 5704.0, 5263.0, 5250.0, 5585.0, 5522.0, 5476.0, 5475.0, 5405.0, 5507.0, 5416.0, 5313.0, 5430.0, 5321.0, 5385.0, 5310.0, 5592.0, 5711.0, 5290.0, 5676.0, 5693.0, 5404.0, 5262.0, 5542.0, 5270.0, 5325.0, 5518.0, 5722.0, 5547.0, 5431.0, 5465.0, 5358.0, 5638.0, 5605.0, 5300.0, 5338.0, 5399.0, 5626.0, 5428.0, 5552.0, 5283.0, 5301.0, 5608.0, 5291.0, 5425.0, 5530.0, 5705.0, 5377.0, 5703.0, 5695.0, 5646.0, 5468.0, 5561.0, 5617.0, 5345.0, 5331.0, 5622.0, 5396.0, 5606.0, 5682.0 (number of hits: 9)
--	--	--	--	--	--	---

5280 MHz

Radar Signal Type	Waveform/Trial Number	Detection (%)	Limit (%)	Pass/Fail
Type 1	30	100 %	60%	Pass
Type 2	30	93.3 %	60%	Pass
Type 3	30	83.3 %	60%	Pass
Type 4	30	96.7 %	60%	Pass
Type 5	30	100 %	80%	Pass
Type 6	30	93.3 %	70%	Pass

Please refer to the following statistical tables:

Table-1 Radar Type 1 Statistical Performance

Trial #	Fc (MHz)	Pulse/Burst	Pulse Width (μS)	PRI (μs)	Detection (1:yes; 0:no)
1	5280	18	1	1428	1
2	5280	18	1	1428	1
3	5280	18	1	1428	1
4	5280	18	1	1428	1
5	5280	18	1	1428	1
6	5280	18	1	1428	1
7	5280	18	1	1428	1
8	5280	18	1	1428	1
9	5280	18	1	1428	1
10	5280	18	1	1428	1
11	5280	18	1	1428	1
12	5280	18	1	1428	1
13	5280	18	1	1428	1
14	5280	18	1	1428	1
15	5280	18	1	1428	1
16	5280	18	1	1428	1
17	5280	18	1	1428	1
18	5280	18	1	1428	1
19	5280	18	1	1428	1
20	5280	18	1	1428	1
21	5280	18	1	1428	1
22	5280	18	1	1428	1
23	5280	18	1	1428	1
24	5280	18	1	1428	1
25	5280	18	1	1428	1
26	5280	18	1	1428	1
27	5280	18	1	1428	1
28	5280	18	1	1428	1
29	5280	18	1	1428	1
30	5280	18	1	1428	1
Detection Percentage: 100 % (>60%)					

Table-2 Radar Type 2 Statistical Performance

Trial #	Fc (MHz)	Pulse/Burst	Pulse Width (μS)	PRI (μs)	Detection (1:yes; 0:no)
1	5280	29	3	220	1
2	5280	29	1	151	1
3	5280	28	2.1	152	1
4	5280	29	3.5	177	1
5	5280	29	2.7	165	1
6	5280	24	2.1	155	1
7	5280	23	4.6	185	1
8	5280	27	4.1	184	1
9	5280	29	3.9	229	1
10	5280	25	1	226	1
11	5280	28	1.4	189	1
12	5280	26	3	203	1
13	5280	29	4.8	226	1
14	5280	24	1.5	190	1
15	5280	27	1.2	190	1
16	5280	29	1.1	159	1
17	5280	26	3.8	214	0
18	5280	27	1.8	184	1
19	5280	25	2.6	192	1
20	5280	24	2	220	1
21	5280	29	3.3	150	1
22	5280	23	2.1	167	1
23	5280	23	4.9	192	1
24	5280	23	2.8	230	1
25	5280	25	3.9	201	0
26	5280	26	3.2	190	1
27	5280	26	1.4	222	1
28	5280	25	2.9	229	1
29	5280	28	2.7	176	1
30	5280	27	2.9	196	1
Detection Percentage: 93.3 % (>60%)					

Table-3 Radar Type 3 Statistical Performance

Trial #	Fc (MHz)	Pulse/Burst	Pulse Width (µS)	PRI (µs)	Detection (1:yes; 0:no)
1	5280	17	7.3	218	1
2	5280	16	6.6	306	1
3	5280	17	6.3	483	0
4	5280	16	9.6	261	1
5	5280	18	9.9	327	1
6	5280	18	9.9	329	0
7	5280	18	7.9	397	1
8	5280	18	8.9	201	0
9	5280	16	6.6	205	1
10	5280	16	6.2	383	1
11	5280	16	9	498	1
12	5280	16	8.1	493	1
13	5280	18	9.1	262	1
14	5280	17	8.4	259	0
15	5280	18	7.8	422	1
16	5280	16	7.1	213	1
17	5280	17	9.4	468	1
18	5280	16	6.1	426	1
19	5280	17	8.5	465	1
20	5280	18	7	207	1
21	5280	17	6.8	495	1
22	5280	18	7.3	325	1
23	5280	17	9.3	442	1
24	5280	18	9	244	1
25	5280	17	7	248	1
26	5280	17	8.2	210	1
27	5280	18	9.5	425	0
28	5280	17	9	202	1
29	5280	18	7.6	313	1
30	5280	17	6.8	497	1
Detection Percentage: 83.3 % (>60%)					

Table-4 Radar Type 4 Statistical Performance

Trial #	Fc (MHz)	Pulse/Burst	Pulse Width (μS)	PRI (μs)	Detection (1:yes; 0:no)
1	5280	12	11.9	312	1
2	5280	12	11.6	333	1
3	5280	14	19.1	388	1
4	5280	14	15.4	343	1
5	5280	14	15.9	397	1
6	5280	14	17	313	1
7	5280	16	15.1	279	1
8	5280	15	18.4	250	1
9	5280	14	16.4	334	1
10	5280	13	17.2	400	1
11	5280	14	13.1	428	1
12	5280	15	14.6	327	1
13	5280	16	15	445	1
14	5280	16	16.8	280	1
15	5280	12	17.4	227	0
16	5280	14	14.1	365	1
17	5280	12	12.9	260	1
18	5280	13	16.3	493	1
19	5280	13	13.8	229	1
20	5280	14	15.9	208	1
21	5280	14	15	436	1
22	5280	16	12.3	492	1
23	5280	12	16.2	421	1
24	5280	13	13.6	213	1
25	5280	14	11.3	273	1
26	5280	16	15.1	312	1
27	5280	14	15.3	344	1
28	5280	13	15.5	243	1
29	5280	13	18.5	231	1
30	5280	12	18.4	268	1
Detection Percentage: 96.7 % (>60%)					

Table-5 Radar Type 5 Statistical Performance

Bin5 Statistics 1

Trial #	Pulse	Chirp (MHz)	Pulse Width (μS)	Pulse 1-2 spacing (uS)	Pulse 2-3 spacing (uS)	Pulse Start(S)	Detection (1:yes; 0:no)
0	2	9	95.9	1945		0.159992	1
1	1	10	96.8			1.507253	
2	2	18	52.9	1183		3.590325	
3	3	17	94.4	1878	1650	4.985699	
4	2	15	83.7	1539		6.565268	
5	2	15	52.3	1885		7.932822	
6	1	16	93.9			9.269866	
7	1	7	99.9			10.59813	
8	1	7	52.6			11.93967	

Bin5 Statistics 2

Trial #	Pulse	Chirp (MHz)	Pulse Width (μS)	Pulse 1-2 spacing (uS)	Pulse 2-3 spacing (uS)	Pulse Start(S)	Detection (1:yes; 0:no)
0	1	17	91.1			0.654924	1
1	1	18	56.9			2.518427	
2	2	11	63.8	1579		3.700384	
3	2	6	66.8	1904		5.108453	
4	1	19	94.5			5.551392	
5	2	11	70.6	1976		7.534001	
6	3	17	83.6	1398	1172	9.026908	
7	1	13	72.8			10.20621	
8	2	6	70.5	1776		11.61292	

Bin5 Statistics 3

Trial #	Pulse	Chirp (MHz)	Pulse Width (µS)	Pulse 1-2 spacing (uS)	Pulse 2-3 spacing (uS)	Pulse Start(S)	Detection (1:yes; 0:no)
0	2	20	77.1	1526		0.138069	1
1	3	18	51.9	1584	1183	1.470029	
2	1	17	95			1.60801	
3	3	18	66.8	1029	1325	2.826312	
4	2	8	60.7	1041		3.055456	
5	3	10	87.9	1745	1907	3.932194	
6	3	9	58.6	1744	1684	4.984678	
7	2	5	93.4	1089		5.695808	
8	1	7	89			6.205287	
9	2	18	64.5	1557		7.350718	
10	1	16	54.4			7.597086	
11	2	8	76.6	1277		8.631468	
12	1	5	71.6			9.741427	
13	2	10	99.9	1091		9.819239	
14	2	17	57.6	1449		10.52224	
15	3	6	50.9	1298	1205	11.53972	

Bin5 Statistics 4

Trial #	Pulse	Chirp (MHz)	Pulse Width (µS)	Pulse 1-2 spacing (uS)	Pulse 2-3 spacing (uS)	Pulse Start(S)	Detection (1:yes; 0:no)
0	3	11	74.6	1146	1301	0.657932	1
1	2	8	75.2	1310		0.793569	
2	2	17	92.5	1717		1.546632	
3	3	18	62.8	1798	1032	2.990109	
4	3	11	91	1002	1535	3.217412	
5	2	11	70	1100		4.214716	
6	3	6	83.4	1422	1646	4.863755	
7	2	9	80.6	1391		5.32082	
8	2	19	92.2	1314		6.409354	
9	3	14	89.7	1280	1157	7.029434	
10	3	12	55.1	1499	1804	7.838802	
11	3	9	75.1	1076	1106	8.724613	
12	1	16	85.2			9.101302	
13	1	7	76.3			10.20262	
14	2	12	75.7	1522		11.06703	
15	2	9	79.9	1843		11.33169	

Bin5 Statistics 5

Trial #	Pulse	Chirp (MHz)	Pulse Width (µS)	Pulse 1-2 spacing (µS)	Pulse 2-3 spacing (µS)	Pulse Start(S)	Detection (1:yes; 0:no)
0	3	12	88.2	1057	1697	0.240625	1
1	2	15	87.9	1001		1.704452	
2	2	15	55.7	1834		2.610851	
3	2	8	87.8	1820		3.979579	
4	2	14	53.1	1679		5.079469	
5	1	6	76.1			5.580267	
6	3	16	59.3	1229	1198	7.08365	
7	1	11	98.2			8.291781	
8	2	20	66.6	1122		9.588828	
9	3	18	62.2	1451	1912	10.87061	
10	1	7	50.3			11.84933	

Bin5 Statistics 6

Trial #	Pulse	Chirp (MHz)	Pulse Width (µS)	Pulse 1-2 spacing (µS)	Pulse 2-3 spacing (µS)	Pulse Start(S)	Detection (1:yes; 0:no)
0	2	17	83.2	1120		0.34609	1
1	3	9	81.3	1509	1533	1.025862	
2	3	7	83.6	1418	1698	1.774852	
3	2	18	94.2	1132		2.961326	
4	2	15	83.5	1382		3.483999	
5	1	11	95.4			4.027858	
6	2	15	64.8	1142		4.532981	
7	1	13	67.3			5.989741	
8	2	13	70.7	1891		6.638559	
9	2	5	86.8	1188		6.79679	
10	1	19	93.4			8.053464	
11	3	12	71.8	1841	1331	8.552523	
12	3	18	54.9	1260	1263	9.718363	
13	2	5	85.3	1635		10.2956	
14	2	20	87.8	1039		10.70754	
15	2	7	75.5	1368		11.63087	

Bin5 Statistics 7

Trial #	Pulse	Chirp (MHz)	Pulse Width (µS)	Pulse 1-2 spacing (uS)	Pulse 2-3 spacing (uS)	Pulse Start(S)	Detection (1:yes; 0:no)
0	2	17	93.2	1519		0.748638	1
1	1	8	97.5			1.330902	
2	2	7	50.8	1529		2.478635	
3	2	16	59.2	1274		3.70352	
4	2	14	84.2	1483		5.890565	
5	2	18	85.7	1280		6.482584	
6	2	20	79.2	1636		8.08233	
7	1	12	66.6			8.526803	
8	2	16	82.5	1353		10.78988	
9	2	19	65.3	1925		11.12223	

Bin5 Statistics 8

Trial #	Pulse	Chirp (MHz)	Pulse Width (µS)	Pulse 1-2 spacing (uS)	Pulse 2-3 spacing (uS)	Pulse Start(S)	Detection (1:yes; 0:no)
0	3	9	71.9	1211	1837	0.149186	1
1	2	6	66.1	1765		1.382356	
2	3	16	63.3	1183	1764	2.638076	
3	2	11	94.7	1134		3.643155	
4	1	8	65.5			5.257461	
5	3	12	85	1704	1558	6.118611	
6	2	8	64.9	1850		7.05951	
7	2	18	61.9	1348		8.017441	
8	2	19	72.7	1297		8.956632	
9	2	13	87.7	1811		10.04298	
10	2	6	81.6	1740		11.0238	

Bin5 Statistics 9

Trial #	Pulse	Chirp (MHz)	Pulse Width (µS)	Pulse 1-2 spacing (uS)	Pulse 2-3 spacing (uS)	Pulse Start(S)	Detection (1:yes; 0:no)
0	1	7	79.9			0.155582	1
1	1	18	57.8			1.262253	
2	2	11	75.9	1284		1.961492	
3	3	6	89.7	1056	1316	3.02885	
4	2	20	95.1	1558		3.732285	
5	1	5	93.3			4.535136	
6	1	8	65.8			4.860837	
7	3	11	89.5	1882	1352	6.137555	
8	3	10	56.1	1216	1859	6.776995	
9	2	10	84.6	1797		7.657722	
10	3	10	69.8	1636	1581	8.720396	
11	1	8	65.3			8.982931	
12	2	15	72.3	1476		10.10541	
13	2	14	58.3	1444		10.62651	
14	3	14	63	1229	1041	11.91501	

Bin5 Statistics 10

Trial #	Pulse	Chirp (MHz)	Pulse Width (µS)	Pulse 1-2 spacing (uS)	Pulse 2-3 spacing (uS)	Pulse Start(S)	Detection (1:yes; 0:no)
0	3	16	63.1	1422	1358	0.06145	1
1	2	7	54.3	1571		1.576048	
2	2	15	74.8	1263		1.932534	
3	2	12	72.3	1314		2.761447	
4	2	16	67.3	1819		3.503404	
5	2	15	61.8	1458		4.028043	
6	2	11	52.5	1882		4.830776	
7	2	9	90.3	1428		5.856188	
8	2	9	68.5	1746		6.841069	
9	1	9	58.2			7.400357	
10	1	5	53.9			8.600692	
11	1	19	59.8			9.098535	
12	1	11	67.2			9.705194	
13	2	15	55.2	1676		11.15714	
14	2	16	51.9	1636		11.48998	

Bin5 Statistics 11

Trial #	Pulse	Chirp (MHz)	Pulse Width (μS)	Pulse 1-2 spacing (uS)	Pulse 2-3 spacing (uS)	Pulse Start(S)	Detection (1:yes; 0:no)
0	1	14	83.9			0.177286	1
1	1	9	60.3			1.426425	
2	1	11	65.3			3.185265	
3	1	9	97.8			4.218112	
4	3	13	74.8	1410	1927	4.871134	
5	3	7	99.2	1933	1979	6.848894	
6	2	6	70.1	1967		8.280398	
7	2	10	57	1716		8.786253	
8	3	5	99.8	1709	1560	10.38422	
9	1	16	68.6			11.86913	

Bin5 Statistics 12

Trial #	Pulse	Chirp (MHz)	Pulse Width (μS)	Pulse 1-2 spacing (uS)	Pulse 2-3 spacing (uS)	Pulse Start(S)	Detection (1:yes; 0:no)
0	2	18	56.4	1497		0.714475	1
1	1	16	81.7			1.048004	
2	3	13	87.6	1689	1354	2.4862	
3	2	19	91	1869		3.073671	
4	3	15	72.3	1153	1280	3.458809	
5	3	13	66.1	1048	1748	4.38279	
6	2	13	92.5	1173		5.891606	
7	2	5	58	1233		6.094746	
8	3	18	83.2	1026	1114	7.546156	
9	1	10	60.4			7.810911	
10	2	8	61.6	1061		9.381633	
11	2	13	91.9	1742		10.17136	
12	2	5	70.8	1990		10.74333	
13	1	11	68.3			11.17318	

Bin5 Statistics 13

Trial #	Pulse	Chirp (MHz)	Pulse Width (µS)	Pulse 1-2 spacing (µS)	Pulse 2-3 spacing (µS)	Pulse Start(S)	Detection (1:yes; 0:no)
0	3	6	74.6	1699	1320	0.190207	1
1	1	18	77.1			0.845572	
2	2	9	95.5	1673		1.731416	
3	3	18	90.7	1799	1346	2.383705	
4	2	12	52.4	1857		3.18107	
5	2	16	85.6	1844		4.315549	
6	2	13	70.1	1595		4.957543	
7	2	8	58.5	1067		5.506421	
8	3	11	54.7	1165	1745	6.006102	
9	3	10	97.9	1114	1800	6.91797	
10	2	9	66	1002		8.230162	
11	1	5	92			8.450695	
12	3	18	53.7	1501	1511	9.722931	
13	2	17	86.6	1912		9.81363	
14	2	18	98.4	1215		10.99807	
15	2	18	65.9	1499		11.90653	

Bin5 Statistics 14

Trial #	Pulse	Chirp (MHz)	Pulse Width (µS)	Pulse 1-2 spacing (µS)	Pulse 2-3 spacing (µS)	Pulse Start(S)	Detection (1:yes; 0:no)
0	3	10	55.4	1751	1029	0.196418	1
1	2	5	71.9	1835		0.908502	
2	3	16	74.8	1069	1642	2.067731	
3	1	5	99.8			2.743995	
4	1	11	98.5			3.518524	
5	3	7	75	1872	1258	3.866128	
6	3	17	91.3	1581	1200	5.233744	
7	1	8	76.2			5.931495	
8	2	8	55.2	1082		6.49017	
9	2	14	88.4	1763		7.05693	
10	2	14	53.1	1508		7.856396	
11	1	14	94.2			8.571306	
12	3	17	87.8	1154	1708	9.665914	
13	3	6	65.7	1785	1793	10.32791	
14	1	14	74.3			11.01737	
15	2	20	77.4	1155		11.96175	

Bin5 Statistics 15

Trial #	Pulse	Chirp (MHz)	Pulse Width (µS)	Pulse 1-2 spacing (uS)	Pulse 2-3 spacing (uS)	Pulse Start(S)	Detection (1:yes; 0:no)
0	1	7	92.4			0.148347	1
1	2	8	50.4	1280		1.479802	
2	1	10	79.7			2.656635	
3	2	11	82.8	1596		4.334505	
4	2	10	92.6	1108		4.541005	
5	1	6	69.5			5.474557	
6	1	18	67.1			6.834076	
7	3	8	57	1536	1654	8.385418	
8	2	6	71.6	1736		8.736311	
9	3	7	89.6	1886	1912	10.19738	
10	2	11	95.8	1385		11.51206	

Bin5 Statistics 16

Trial #	Pulse	Chirp (MHz)	Pulse Width (µS)	Pulse 1-2 spacing (uS)	Pulse 2-3 spacing (uS)	Pulse Start(S)	Detection (1:yes; 0:no)
0	2	16	88.3	1451		0.380154	1
1	1	11	56.7			1.624869	
2	3	11	70.4	1135	1706	2.748231	
3	3	20	85.8	1730	1033	3.668636	
4	3	14	67.1	1157	1098	4.383247	
5	2	12	96.8	1359		6.391867	
6	2	19	53	1709		7.208733	
7	1	18	55.8			8.683885	
8	3	17	52.2	1585	1496	9.591751	
9	2	7	79.8	1719		10.72762	
10	2	9	77.8	1200		11.92872	

Bin5 Statistics 17

Trial #	Pulse	Chirp (MHz)	Pulse Width (µS)	Pulse 1-2 spacing (µS)	Pulse 2-3 spacing (µS)	Pulse Start(S)	Detection (1:yes; 0:no)
0	1	8	89.8			0.11005	1
1	2	14	50.6	1196		1.099197	
2	1	9	86.7			1.391729	
3	2	9	96.7	1835		1.95609	
4	3	8	54.2	1957	1139	2.784249	
5	2	16	52.3	1134		3.234804	
6	2	13	66.7	1875		3.93453	
7	2	12	61.2	1977		4.514379	
8	1	7	75.5			5.005532	
9	3	5	95.8	1891	1466	5.956188	
10	3	19	60.1	1322	1811	6.151293	
11	2	13	85.3	1200		7.141875	
12	2	10	62	1041		7.341552	
13	3	7	51.5	1565	1709	8.071205	
14	2	5	65.3	1534		8.583761	
15	1	7	76.2			9.484845	
16	2	7	56.4	1851		9.810805	
17	2	14	66.5	1906		10.48852	
18	1	16	57.8			11.14001	
19	2	8	67.5	1535		11.80393	

Bin5 Statistics 18

Trial #	Pulse	Chirp (MHz)	Pulse Width (µS)	Pulse 1-2 spacing (uS)	Pulse 2-3 spacing (uS)	Pulse Start(S)	Detection (1:yes; 0:no)
0	2	5	58.5	1875		0.171841	1
1	3	17	96.3	1084	1280	1.509049	
2	2	8	84.7	1693		2.175146	
3	3	11	52.1	1407	1842	2.400482	
4	2	13	58.2	1065		3.398752	
5	3	19	85.7	1403	1929	4.315181	
6	3	20	88.4	1876	1050	5.487351	
7	2	18	91	1687		5.844626	
8	1	13	90.8			6.921017	
9	2	12	77.7	1513		7.722227	
10	2	10	65.9	1497		8.430545	
11	1	10	53.6			9.180931	
12	1	5	85.1			9.855273	
13	1	8	55.8			11.08544	
14	2	10	56.2	1096		11.81455	

Bin5 Statistics 19

Trial #	Pulse	Chirp (MHz)	Pulse Width (µS)	Pulse 1-2 spacing (uS)	Pulse 2-3 spacing (uS)	Pulse Start(S)	Detection (1:yes; 0:no)
0	2	14	53	1446		0.148943	1
1	2	7	88.3	1139		1.218605	
2	3	11	98.7	1794	1962	2.80718	
3	1	17	52.8			4.286129	
4	2	19	95.7	1649		4.598694	
5	3	11	85.1	1316	1869	6.271446	
6	2	9	64.3	1785		7.455715	
7	2	10	67.2	1502		8.252894	
8	2	10	73.7	1765		8.857978	
9	2	19	74.4	1432		10.59967	
10	2	6	70.7	1273		11.66311	

Bin5 Statistics 20

Trial #	Pulse	Chirp (MHz)	Pulse Width (µS)	Pulse 1-2 spacing (uS)	Pulse 2-3 spacing (uS)	Pulse Start(S)	Detection (1:yes; 0:no)
0	2	17	96.8	1433		0.260538	1
1	2	17	65.1	1762		2.157429	
2	3	20	69.6	1491	1686	3.043226	
3	2	12	75.1	1985		4.114457	
4	1	16	79.3			5.396392	
5	3	18	83.6	1709	1495	6.019435	
6	2	16	50.5	1421		6.626015	
7	1	11	95.7			7.872952	
8	1	12	67.8			9.270558	
9	2	8	64.1	1938		10.38513	
10	1	17	84			11.32571	

Bin5 Statistics 21

Trial #	Pulse	Chirp (MHz)	Pulse Width (µS)	Pulse 1-2 spacing (uS)	Pulse 2-3 spacing (uS)	Pulse Start(S)	Detection (1:yes; 0:no)
0	3	13	63.7	1646	1101	0.456804	1
1	3	14	52.4	1688	1245	2.510041	
2	2	12	94.6	1913		3.533221	
3	1	16	93.4			4.227231	
4	1	10	87.2			5.505426	
5	1	9	58.9			7.928327	
6	2	6	94	1439		8.314758	
7	2	14	55.8	1910		9.833046	
8	3	13	74.2	1351	1530	11.31304	

Bin5 Statistics 22

Trial #	Pulse	Chirp (MHz)	Pulse Width (µS)	Pulse 1-2 spacing (uS)	Pulse 2-3 spacing (uS)	Pulse Start(S)	Detection (1:yes; 0:no)
0	1	18	97.3			0.342732	1
1	2	20	53.7	1006		0.707473	
2	2	19	51.6	1744		1.874445	
3	1	20	87.1			2.380541	
4	2	10	57.8	1626		3.215636	
5	2	19	54.7	1383		3.788617	
6	2	8	66.8	1089		4.33529	
7	3	14	92.6	1252	1019	5.311321	
8	2	19	81.8	1232		5.428312	
9	2	19	79.2	1491		6.459735	
10	2	18	50.9	1443		6.679214	
11	2	14	56.3	1313		7.889717	
12	2	10	52.3	1775		8.515511	
13	3	18	57.5	1470	1780	8.862158	
14	2	5	96	1969		9.797883	
15	2	14	68.2	1631		10.22317	
16	3	9	93.3	1236	1941	11.24994	
17	2	17	52.3	1566		11.64881	

Bin5 Statistics 23

Trial #	Pulse	Chirp (MHz)	Pulse Width (µS)	Pulse 1-2 spacing (uS)	Pulse 2-3 spacing (uS)	Pulse Start(S)	Detection (1:yes; 0:no)
0	3	17	86.9	1678	1059	0.47188	1
1	1	12	54.5			2.320719	
2	2	19	52.8	1558		2.721757	
3	2	13	62	1165		5.293493	
4	2	10	59.5	1940		5.860738	
5	3	13	69.1	1724	1178	7.016311	
6	1	13	96.2			8.901844	
7	2	5	74.2	1811		10.40524	
8	2	13	61.5	1225		10.90054	

Bin5 Statistics 24

Trial #	Pulse	Chirp (MHz)	Pulse Width (µS)	Pulse 1-2 spacing (µS)	Pulse 2-3 spacing (µS)	Pulse Start(S)	Detection (1:yes; 0:no)
0	2	7	57.8	1835		0.9866	1
1	2	5	85.8	1114		1.228094	
2	3	11	60.6	1261	1752	2.485616	
3	2	15	77.5	1720		3.739967	
4	3	5	97	1369	1834	4.348049	
5	1	15	80			5.664173	
6	2	9	99.4	1572		6.876556	
7	2	12	83.5	1552		7.960014	
8	3	11	54	1577	1179	8.140579	
9	2	5	77.4	1520		9.418903	
10	1	20	88.9			10.00747	
11	3	13	81.2	1001	1751	11.91976	

Bin5 Statistics 25

Trial #	Pulse	Chirp (MHz)	Pulse Width (µS)	Pulse 1-2 spacing (µS)	Pulse 2-3 spacing (µS)	Pulse Start(S)	Detection (1:yes; 0:no)
0	2	14	63.5	1449		0.094445	1
1	2	6	53.3	1545		0.926563	
2	3	17	75.3	1737	1551	1.412245	
3	2	19	84	1469		2.247191	
4	2	11	64.3	1273		2.676015	
5	2	13	51.1	1820		3.420827	
6	2	14	91.7	1939		3.798935	
7	3	8	61.9	1625	1638	4.725507	
8	2	13	82.8	1455		4.814757	
9	2	9	84.2	1715		5.403846	
10	3	20	60	1594	1772	6.248026	
11	2	6	82.3	1455		6.709045	
12	2	7	64.3	1583		7.541348	
13	1	6	50.5			8.347709	
14	3	17	58.3	1887	1862	8.6474	
15	2	13	60.9	1843		9.00268	
16	2	18	91.5	1957		9.776957	
17	2	20	79.9	1606		10.34415	
18	1	5	78			10.99419	
19	1	15	74.4			11.65499	

Bin5 Statistics 26

Trial #	Pulse	Chirp (MHz)	Pulse Width (µS)	Pulse 1-2 spacing (µS)	Pulse 2-3 spacing (µS)	Pulse Start(S)	Detection (1:yes; 0:no)
0	2	7	85.3	1055		0.357701	0
1	2	7	73.8	1285		1.682867	
2	2	8	70.2	1068		3.730837	
3	1	11	96.8			4.439435	
4	1	14	99.5			6.560357	
5	2	12	62.2	1083		7.383385	
6	1	10	64.8			9.016434	
7	3	6	85.9	1283	1426	10.22661	
8	3	8	71.3	1005	1089	10.74984	

Bin5 Statistics 27

Trial #	Pulse	Chirp (MHz)	Pulse Width (µS)	Pulse 1-2 spacing (µS)	Pulse 2-3 spacing (µS)	Pulse Start(S)	Detection (1:yes; 0:no)
0	3	6	72.3	1809	1856	0.154324	1
1	2	11	86.4	1140		1.150393	
2	3	6	66.7	1630	1732	1.364684	
3	3	11	68.3	1388	1890	2.11258	
4	2	6	64.1	1955		2.991337	
5	2	17	55.7	1106		3.342214	
6	3	12	74	1056	1124	4.124406	
7	2	19	55.2	1172		4.569802	
8	2	9	66.4	1127		5.050176	
9	2	19	74.6	1681		5.529327	
10	1	12	96.8			6.219245	
11	1	17	82.1			6.875639	
12	2	10	99.3	1162		7.663907	
13	2	16	58.6	1023		7.930043	
14	2	19	94.1	1308		8.49164	
15	3	19	91.7	1656	1603	9.302021	
16	2	11	84.9	1065		9.922799	
17	2	13	71.7	1225		10.23273	
18	2	17	88.4	1463		11.08815	
19	1	18	96.9			11.91368	

Bin5 Statistics 28

Trial #	Pulse	Chirp (MHz)	Pulse Width (µS)	Pulse 1-2 spacing (µS)	Pulse 2-3 spacing (µS)	Pulse Start(S)	Detection (1:yes; 0:no)
0	2	8	79.9	1944		0.687606	1
1	2	17	84.3	1990		1.57854	
2	1	7	76.1			3.119067	
3	2	18	93.7	1575		3.428048	
4	1	12	58			4.955507	
5	1	13	86.3			6.254648	
6	2	8	88.4	1101		6.776586	
7	2	10	75.4	1936		8.288261	
8	3	7	76.5	1332	1269	8.918249	
9	3	6	55.6	1582	1715	10.19381	
10	2	10	60.2	1918		11.27739	

Bin5 Statistics 29

Trial #	Pulse	Chirp (MHz)	Pulse Width (µS)	Pulse 1-2 spacing (µS)	Pulse 2-3 spacing (µS)	Pulse Start(S)	Detection (1:yes; 0:no)
0	2	18	63.6	1050		0.237821	1
1	3	9	72.4	1518	1005	1.245165	
2	1	6	92.4			2.592772	
3	3	17	98.7	1253	1070	4.124384	
4	1	9	99.2			4.892944	
5	2	18	81.7	1766		5.575502	
6	2	16	77.2	1705		7.430368	
7	1	11	80.3			8.562158	
8	2	17	81.2	1577		9.730993	
9	2	10	98.7	1059		9.884286	
10	3	19	98.2	1611	1465	11.56855	

Bin5 Statistics 30

Trial #	Pulse	Chirp (MHz)	Pulse Width (μS)	Pulse 1-2 spacing (uS)	Pulse 2-3 spacing (uS)	Pulse Start(S)	Detection (1:yes; 0:no)
0	1	8	57.6			0.164803	1
1	1	7	89.8			1.728997	
2	2	17	73.1	1621		2.584805	
3	2	18	77	1892		3.619633	
4	2	7	96.2	1474		4.971645	
5	2	11	71.3	1318		5.521371	
6	3	11	58.4	1803	1085	6.226027	
7	1	12	71.1			7.851172	
8	3	8	79.4	1721	1640	8.620048	
9	2	5	75.9	1729		9.256461	
10	1	13	85.6			10.73663	
11	2	15	56.5	1688		11.54367	

Table-6 Radar Type 6 Statistical Performance

Trial #	Fc (MHz)	Pulse /Burst	Pulse Width (µS)	PRI (µs)	Detection (1:yes; 0:no)	Hopping Sequence
1	5280	9	1	333	1	5299.0, 5292.0, 5281.0, 5342.0, 5421.0, 5303.0, 5298.0, 5419.0, 5550.0, 5402.0, 5586.0, 5291.0, 5470.0, 5435.0, 5277.0, 5304.0, 5478.0, 5620.0, 5622.0, 5266.0, 5385.0, 5366.0, 5456.0, 5313.0, 5472.0, 5459.0, 5722.0, 5592.0, 5493.0, 5491.0, 5608.0, 5273.0, 5363.0, 5597.0, 5488.0, 5599.0, 5596.0, 5712.0, 5696.0, 5508.0, 5695.0, 5322.0, 5379.0, 5276.0, 5707.0, 5718.0, 5309.0, 5558.0, 5283.0, 5556.0, 5411.0, 5305.0, 5604.0, 5315.0, 5403.0, 5570.0, 5675.0, 5475.0, 5691.0, 5671.0, 5282.0, 5412.0, 5589.0, 5489.0, 5335.0, 5663.0, 5580.0, 5614.0, 5372.0, 5348.0, 5593.0, 5618.0, 5354.0, 5428.0, 5288.0, 5449.0, 5543.0, 5262.0, 5646.0, 5352.0, 5607.0, 5458.0, 5437.0, 5661.0, 5539.0, 5290.0, 5358.0, 5511.0, 5680.0, 5338.0, 5396.0, 5487.0, 5434.0, 5546.0, 5340.0, 5571.0, 5573.0, 5553.0, 5426.0, 5584.0 (number of hits: 11)
2	5280	9	1	333	1	5486.0, 5574.0, 5297.0, 5383.0, 5276.0, 5457.0, 5597.0, 5260.0, 5344.0, 5328.0, 5481.0, 5711.0, 5545.0, 5558.0, 5477.0, 5668.0, 5356.0, 5656.0, 5510.0, 5446.0, 5600.0, 5431.0, 5672.0, 5324.0, 5595.0, 5372.0, 5439.0, 5353.0, 5573.0, 5661.0, 5697.0, 5455.0, 5550.0, 5274.0, 5369.0, 5352.0, 5451.0, 5298.0, 5580.0, 5375.0, 5592.0, 5506.0, 5588.0, 5321.0, 5254.0, 5404.0, 5335.0, 5287.0, 5670.0, 5386.0, 5460.0, 5608.0, 5570.0, 5718.0, 5710.0, 5722.0, 5323.0, 5709.0, 5373.0, 5589.0, 5385.0, 5556.0, 5442.0, 5619.0, 5309.0, 5293.0, 5717.0, 5294.0, 5586.0, 5724.0, 5541.0, 5468.0, 5332.0, 5362.0, 5419.0, 5682.0, 5433.0, 5425.0, 5435.0, 5333.0, 5658.0, 5601.0, 5503.0, 5410.0, 5547.0, 5483.0, 5561.0, 5514.0, 5614.0, 5559.0, 5448.0, 5585.0, 5700.0, 5409.0, 5513.0, 5408.0, 5472.0, 5415.0, 5318.0, 5282.0 (number of hits: 6)
3	5280	9	1	333	1	5502.0, 5331.0, 5611.0, 5388.0, 5340.0, 5654.0, 5306.0, 5266.0, 5450.0, 5633.0, 5444.0, 5469.0, 5622.0, 5681.0, 5382.0, 5276.0, 5642.0, 5652.0, 5474.0, 5664.0, 5311.0, 5669.0, 5363.0, 5335.0, 5480.0, 5441.0, 5634.0, 5608.0, 5545.0, 5348.0, 5442.0, 5324.0, 5505.0, 5569.0, 5316.0, 5631.0, 5376.0, 5619.0, 5328.0, 5567.0, 5481.0, 5665.0, 5290.0, 5423.0, 5424.0, 5715.0, 5603.0, 5561.0, 5317.0, 5304.0, 5391.0, 5360.0, 5518.0, 5670.0, 5717.0, 5663.0, 5666.0, 5491.0, 5421.0, 5560.0

						5496.0, 5295.0, 5723.0, 5542.0, 5521.0, 5547.0, 5407.0, 5471.0, 5540.0, 5597.0, 5565.0, 5583.0, 5558.0, 5325.0, 5691.0, 5430.0, 5620.0, 5536.0, 5510.0, 5262.0, 5483.0, 5571.0, 5259.0, 5410.0, 5351.0, 5705.0, 5350.0, 5352.0, 5429.0, 5528.0, 5722.0, 5525.0, 5339.0, 5326.0, 5453.0, 5519.0, 5657.0, 5710.0, 5445.0, 5479.0 (number of hits: 5)
4	5280	9	1	333	1	5631.0, 5602.0, 5596.0, 5603.0, 5705.0, 5715.0, 5650.0, 5598.0, 5527.0, 5716.0, 5675.0, 5306.0, 5559.0, 5431.0, 5428.0, 5445.0, 5413.0, 5308.0, 5483.0, 5680.0, 5338.0, 5593.0, 5545.0, 5660.0, 5472.0, 5679.0, 5665.0, 5606.0, 5321.0, 5336.0, 5625.0, 5471.0, 5489.0, 5689.0, 5376.0, 5398.0, 5429.0, 5385.0, 5600.0, 5672.0, 5362.0, 5420.0, 5594.0, 5592.0, 5695.0, 5540.0, 5618.0, 5554.0, 5326.0, 5479.0, 5269.0, 5491.0, 5379.0, 5406.0, 5263.0, 5501.0, 5497.0, 5347.0, 5492.0, 5671.0, 5599.0, 5524.0, 5496.0, 5273.0, 5267.0, 5427.0, 5612.0, 5529.0, 5298.0, 5558.0, 5311.0, 5710.0, 5691.0, 5610.0, 5604.0, 5386.0, 5677.0, 5328.0, 5624.0, 5550.0, 5688.0, 5694.0, 5275.0, 5515.0, 5410.0, 5412.0, 5337.0, 5388.0, 5461.0, 5426.0, 5711.0, 5315.0, 5409.0, 5635.0, 5358.0, 5568.0, 5608.0, 5318.0, 5272.0, 5331.0 (number of hits: 4)
5	5280	9	1	333	1	5633.0, 5272.0, 5572.0, 5653.0, 5643.0, 5274.0, 5464.0, 5390.0, 5518.0, 5615.0, 5543.0, 5553.0, 5691.0, 5490.0, 5410.0, 5524.0, 5290.0, 5567.0, 5417.0, 5552.0, 5533.0, 5285.0, 5508.0, 5265.0, 5322.0, 5486.0, 5716.0, 5268.0, 5613.0, 5324.0, 5472.0, 5346.0, 5690.0, 5291.0, 5585.0, 5697.0, 5392.0, 5621.0, 5641.0, 5310.0, 5670.0, 5507.0, 5648.0, 5314.0, 5476.0, 5683.0, 5696.0, 5279.0, 5642.0, 5652.0, 5699.0, 5707.0, 5685.0, 5388.0, 5289.0, 5331.0, 5379.0, 5378.0, 5596.0, 5435.0, 5539.0, 5306.0, 5688.0, 5680.0, 5694.0, 5527.0, 5660.0, 5599.0, 5620.0, 5434.0, 5326.0, 5445.0, 5270.0, 5684.0, 5395.0, 5587.0, 5619.0, 5340.0, 5252.0, 5498.0, 5628.0, 5556.0, 5352.0, 5309.0, 5588.0, 5580.0, 5297.0, 5368.0, 5492.0, 5669.0, 5630.0, 5271.0, 5363.0, 5548.0, 5421.0, 5280.0, 5475.0, 5276.0, 5466.0, 5635.0 (number of hits: 9)
6	5280	9	1	333	1	5322.0, 5307.0, 5580.0, 5444.0, 5370.0, 5549.0, 5709.0, 5335.0, 5605.0, 5306.0, 5288.0, 5443.0, 5664.0, 5314.0, 5665.0, 5266.0, 5563.0, 5522.0, 5568.0, 5402.0, 5412.0, 5282.0, 5524.0, 5637.0, 5350.0, 5575.0, 5619.0, 5660.0, 5603.0, 5623.0, 5336.0, 5391.0, 5656.0, 5401.0, 5502.0, 5343.0, 5411.0, 5615.0, 5658.0, 5531.0,

						5326.0, 5423.0, 5441.0, 5645.0, 5498.0, 5463.0, 5482.0, 5250.0, 5363.0, 5346.0, 5347.0, 5680.0, 5590.0, 5555.0, 5480.0, 5504.0, 5327.0, 5279.0, 5548.0, 5301.0, 5459.0, 5349.0, 5399.0, 5651.0, 5666.0, 5506.0, 5458.0, 5574.0, 5464.0, 5713.0, 5532.0, 5488.0, 5567.0, 5512.0, 5364.0, 5576.0, 5318.0, 5295.0, 5525.0, 5540.0, 5263.0, 5435.0, 5650.0, 5617.0, 5678.0, 5310.0, 5379.0, 5716.0, 5419.0, 5300.0, 5330.0, 5710.0, 5627.0, 5717.0, 5626.0, 5573.0, 5383.0, 5687.0, 5642.0, 5652.0 (number of hits: 8)
7	5280	9	1	333	1	5370.0, 5451.0, 5356.0, 5566.0, 5303.0, 5602.0, 5486.0, 5355.0, 5670.0, 5616.0, 5446.0, 5598.0, 5334.0, 5296.0, 5590.0, 5671.0, 5394.0, 5481.0, 5661.0, 5411.0, 5532.0, 5501.0, 5585.0, 5368.0, 5307.0, 5703.0, 5443.0, 5473.0, 5580.0, 5299.0, 5262.0, 5531.0, 5453.0, 5289.0, 5445.0, 5494.0, 5250.0, 5305.0, 5706.0, 5691.0, 5465.0, 5301.0, 5615.0, 5298.0, 5539.0, 5491.0, 5498.0, 5398.0, 5679.0, 5306.0, 5698.0, 5270.0, 5452.0, 5651.0, 5617.0, 5680.0, 5419.0, 5693.0, 5258.0, 5659.0, 5373.0, 5268.0, 5406.0, 5711.0, 5707.0, 5317.0, 5593.0, 5470.0, 5492.0, 5335.0, 5378.0, 5712.0, 5382.0, 5479.0, 5358.0, 5586.0, 5657.0, 5713.0, 5489.0, 5294.0, 5600.0, 5266.0, 5371.0, 5571.0, 5390.0, 5352.0, 5533.0, 5623.0, 5312.0, 5512.0, 5425.0, 5357.0, 5574.0, 5276.0, 5658.0, 5500.0, 5332.0, 5359.0, 5666.0, 5495.0 (number of hits: 11)
8	5280	9	1	333	1	5262.0, 5431.0, 5388.0, 5292.0, 5704.0, 5455.0, 5273.0, 5325.0, 5600.0, 5281.0, 5444.0, 5674.0, 5261.0, 5630.0, 5404.0, 5681.0, 5709.0, 5486.0, 5472.0, 5697.0, 5689.0, 5286.0, 5495.0, 5251.0, 5541.0, 5485.0, 5613.0, 5561.0, 5610.0, 5311.0, 5531.0, 5676.0, 5546.0, 5698.0, 5711.0, 5634.0, 5599.0, 5713.0, 5328.0, 5347.0, 5530.0, 5381.0, 5391.0, 5572.0, 5362.0, 5365.0, 5465.0, 5414.0, 5315.0, 5396.0, 5550.0, 5648.0, 5289.0, 5296.0, 5511.0, 5441.0, 5316.0, 5323.0, 5521.0, 5369.0, 5401.0, 5569.0, 5409.0, 5517.0, 5702.0, 5678.0, 5256.0, 5309.0, 5618.0, 5442.0, 5669.0, 5287.0, 5425.0, 5644.0, 5645.0, 5480.0, 5690.0, 5605.0, 5297.0, 5426.0, 5571.0, 5430.0, 5471.0, 5269.0, 5370.0, 5529.0, 5597.0, 5255.0, 5400.0, 5411.0, 5447.0, 5368.0, 5272.0, 5502.0, 5717.0, 5410.0, 5624.0, 5467.0, 5403.0, 5588.0 (number of hits: 8)
9	5280	9	1	333	1	5476.0, 5477.0, 5714.0, 5678.0, 5605.0, 5592.0, 5546.0, 5624.0, 5391.0, 5562.0, 5286.0, 5625.0, 5399.0, 5478.0, 5564.0, 5370.0, 5676.0, 5526.0, 5285.0, 5257.0,

						5588.0, 5645.0, 5445.0, 5415.0, 5667.0, 5513.0, 5682.0, 5615.0, 5580.0, 5574.0, 5706.0, 5338.0, 5472.0, 5424.0, 5366.0, 5599.0, 5464.0, 5379.0, 5273.0, 5333.0, 5355.0, 5558.0, 5377.0, 5689.0, 5715.0, 5713.0, 5356.0, 5549.0, 5485.0, 5438.0, 5405.0, 5669.0, 5450.0, 5316.0, 5346.0, 5511.0, 5266.0, 5551.0, 5480.0, 5453.0, 5253.0, 5422.0, 5716.0, 5681.0, 5528.0, 5319.0, 5416.0, 5589.0, 5439.0, 5612.0, 5579.0, 5602.0, 5375.0, 5530.0, 5310.0, 5704.0, 5411.0, 5360.0, 5305.0, 5565.0, 5636.0, 5491.0, 5542.0, 5392.0, 5701.0, 5358.0, 5642.0, 5606.0, 5675.0, 5709.0, 5571.0, 5431.0, 5406.0, 5322.0, 5692.0, 5708.0, 5722.0, 5679.0, 5471.0, 5440.0 (number of hits: 4)
10	5280	9	1	333	1	5405.0, 5539.0, 5325.0, 5534.0, 5294.0, 5548.0, 5328.0, 5590.0, 5698.0, 5470.0, 5289.0, 5690.0, 5724.0, 5479.0, 5632.0, 5480.0, 5711.0, 5437.0, 5624.0, 5630.0, 5263.0, 5355.0, 5288.0, 5320.0, 5691.0, 5417.0, 5535.0, 5667.0, 5628.0, 5296.0, 5626.0, 5580.0, 5525.0, 5606.0, 5395.0, 5332.0, 5281.0, 5306.0, 5317.0, 5394.0, 5436.0, 5569.0, 5641.0, 5366.0, 5309.0, 5491.0, 5285.0, 5571.0, 5579.0, 5566.0, 5547.0, 5451.0, 5365.0, 5388.0, 5679.0, 5544.0, 5314.0, 5673.0, 5468.0, 5492.0, 5364.0, 5599.0, 5677.0, 5621.0, 5713.0, 5346.0, 5701.0, 5657.0, 5336.0, 5518.0, 5558.0, 5420.0, 5592.0, 5669.0, 5383.0, 5378.0, 5373.0, 5683.0, 5648.0, 5347.0, 5507.0, 5703.0, 5352.0, 5714.0, 5487.0, 5382.0, 5368.0, 5333.0, 5644.0, 5675.0, 5392.0, 5646.0, 5717.0, 5484.0, 5452.0, 5517.0, 5559.0, 5334.0, 5350.0, 5384.0 (number of hits: 8)
11	5280	9	1	333	1	5416.0, 5715.0, 5505.0, 5345.0, 5647.0, 5379.0, 5471.0, 5270.0, 5323.0, 5601.0, 5316.0, 5470.0, 5613.0, 5481.0, 5721.0, 5403.0, 5254.0, 5714.0, 5592.0, 5654.0, 5480.0, 5456.0, 5392.0, 5286.0, 5706.0, 5689.0, 5578.0, 5485.0, 5610.0, 5322.0, 5550.0, 5604.0, 5616.0, 5488.0, 5455.0, 5409.0, 5594.0, 5692.0, 5389.0, 5598.0, 5376.0, 5371.0, 5258.0, 5705.0, 5476.0, 5529.0, 5447.0, 5678.0, 5360.0, 5487.0, 5421.0, 5579.0, 5642.0, 5268.0, 5439.0, 5344.0, 5355.0, 5538.0, 5313.0, 5673.0, 5548.0, 5288.0, 5372.0, 5377.0, 5614.0, 5410.0, 5326.0, 5542.0, 5401.0, 5707.0, 5315.0, 5451.0, 5449.0, 5466.0, 5627.0, 5432.0, 5300.0, 5328.0, 5382.0, 5318.0, 5419.0, 5648.0, 5674.0, 5664.0, 5599.0, 5645.0, 5658.0, 5496.0, 5615.0, 5319.0, 5369.0, 5283.0, 5346.0, 5634.0, 5390.0, 5337.0, 5584.0, 5581.0, 5351.0, 5274.0 (number of hits: 4)

12	5280	9	1	333	1	5482.0, 5442.0, 5313.0, 5286.0, 5253.0, 5456.0, 5573.0, 5675.0, 5552.0, 5312.0, 5372.0, 5401.0, 5575.0, 5665.0, 5272.0, 5689.0, 5518.0, 5591.0, 5593.0, 5255.0, 5652.0, 5325.0, 5269.0, 5638.0, 5275.0, 5611.0, 5405.0, 5608.0, 5308.0, 5451.0, 5310.0, 5285.0, 5559.0, 5305.0, 5615.0, 5536.0, 5586.0, 5643.0, 5295.0, 5664.0, 5368.0, 5539.0, 5293.0, 5589.0, 5563.0, 5540.0, 5630.0, 5547.0, 5334.0, 5504.0, 5568.0, 5497.0, 5646.0, 5502.0, 5348.0, 5543.0, 5498.0, 5604.0, 5574.0, 5388.0, 5344.0, 5535.0, 5549.0, 5590.0, 5526.0, 5685.0, 5339.0, 5711.0, 5691.0, 5321.0, 5633.0, 5417.0, 5421.0, 5397.0, 5570.0, 5279.0, 5601.0, 5294.0, 5578.0, 5542.0, 5514.0, 5406.0, 5618.0, 5474.0, 5338.0, 5672.0, 5278.0, 5366.0, 5376.0, 5399.0, 5470.0, 5431.0, 5274.0, 5471.0, 5347.0, 5724.0, 5677.0, 5389.0, 5718.0, 5336.0 (number of hits: 10)
13	5280	9	1	333	1	5471.0, 5444.0, 5574.0, 5536.0, 5286.0, 5430.0, 5513.0, 5339.0, 5699.0, 5564.0, 5299.0, 5279.0, 5695.0, 5498.0, 5573.0, 5499.0, 5631.0, 5354.0, 5724.0, 5269.0, 5570.0, 5327.0, 5716.0, 5429.0, 5458.0, 5514.0, 5633.0, 5571.0, 5516.0, 5422.0, 5461.0, 5408.0, 5527.0, 5502.0, 5434.0, 5720.0, 5637.0, 5528.0, 5668.0, 5376.0, 5642.0, 5615.0, 5380.0, 5414.0, 5284.0, 5653.0, 5722.0, 5350.0, 5293.0, 5268.0, 5601.0, 5331.0, 5539.0, 5258.0, 5504.0, 5603.0, 5641.0, 5423.0, 5302.0, 5479.0, 5308.0, 5317.0, 5696.0, 5315.0, 5693.0, 5671.0, 5658.0, 5466.0, 5665.0, 5475.0, 5264.0, 5359.0, 5712.0, 5599.0, 5587.0, 5507.0, 5505.0, 5340.0, 5467.0, 5407.0, 5335.0, 5713.0, 5600.0, 5676.0, 5446.0, 5254.0, 5652.0, 5687.0, 5398.0, 5272.0, 5644.0, 5395.0, 5684.0, 5546.0, 5524.0, 5700.0, 5648.0, 5261.0, 5538.0, 5657.0 (number of hits: 5)
14	5280	9	1	333	1	5530.0, 5521.0, 5717.0, 5452.0, 5376.0, 5414.0, 5592.0, 5714.0, 5606.0, 5559.0, 5316.0, 5360.0, 5647.0, 5644.0, 5348.0, 5617.0, 5548.0, 5367.0, 5331.0, 5456.0, 5323.0, 5255.0, 5283.0, 5250.0, 5696.0, 5289.0, 5328.0, 5665.0, 5543.0, 5405.0, 5677.0, 5415.0, 5364.0, 5680.0, 5337.0, 5324.0, 5258.0, 5259.0, 5343.0, 5682.0, 5468.0, 5500.0, 5295.0, 5368.0, 5645.0, 5516.0, 5671.0, 5651.0, 5254.0, 5547.0, 5432.0, 5613.0, 5567.0, 5638.0, 5267.0, 5642.0, 5309.0, 5588.0, 5685.0, 5366.0, 5542.0, 5715.0, 5447.0, 5565.0, 5504.0, 5573.0, 5649.0, 5519.0, 5698.0, 5342.0, 5350.0, 5604.0, 5526.0, 5344.0, 5497.0, 5402.0, 5382.0, 5260.0, 5541.0, 5510.0, 5694.0, 5277.0, 5674.0, 5486.0, 5266.0

						5353.0, 5670.0, 5459.0, 5393.0, 5498.0, 5386.0, 5287.0, 5556.0, 5373.0, 5652.0, 5676.0, 5278.0, 5464.0, 5446.0, 5646.0 (number of hits: 4)
15	5280	9	1	333	1	5311.0, 5522.0, 5585.0, 5372.0, 5539.0, 5448.0, 5467.0, 5487.0, 5670.0, 5558.0, 5325.0, 5594.0, 5526.0, 5546.0, 5638.0, 5454.0, 5329.0, 5341.0, 5589.0, 5322.0, 5516.0, 5281.0, 5280.0, 5651.0, 5627.0, 5658.0, 5423.0, 5445.0, 5643.0, 5501.0, 5387.0, 5491.0, 5503.0, 5686.0, 5534.0, 5413.0, 5607.0, 5580.0, 5507.0, 5479.0, 5361.0, 5462.0, 5634.0, 5282.0, 5532.0, 5615.0, 5674.0, 5574.0, 5363.0, 5656.0, 5514.0, 5577.0, 5681.0, 5451.0, 5560.0, 5569.0, 5350.0, 5609.0, 5266.0, 5373.0, 5505.0, 5695.0, 5666.0, 5513.0, 5394.0, 5586.0, 5425.0, 5253.0, 5274.0, 5605.0, 5456.0, 5470.0, 5419.0, 5284.0, 5579.0, 5500.0, 5287.0, 5364.0, 5366.0, 5439.0, 5581.0, 5259.0, 5536.0, 5291.0, 5545.0, 5646.0, 5420.0, 5484.0, 5637.0, 5633.0, 5409.0, 5663.0, 5407.0, 5320.0, 5604.0, 5668.0, 5502.0, 5621.0, 5326.0, 5588.0 (number of hits: 3)
16	5280	9	1	333	1	5279.0, 5375.0, 5477.0, 5365.0, 5292.0, 5253.0, 5713.0, 5487.0, 5380.0, 5446.0, 5632.0, 5540.0, 5607.0, 5437.0, 5655.0, 5673.0, 5506.0, 5523.0, 5703.0, 5411.0, 5274.0, 5472.0, 5454.0, 5415.0, 5441.0, 5463.0, 5406.0, 5658.0, 5474.0, 5340.0, 5318.0, 5378.0, 5428.0, 5541.0, 5631.0, 5515.0, 5424.0, 5657.0, 5585.0, 5574.0, 5394.0, 5685.0, 5626.0, 5357.0, 5561.0, 5720.0, 5661.0, 5271.0, 5608.0, 5680.0, 5407.0, 5356.0, 5471.0, 5667.0, 5604.0, 5273.0, 5402.0, 5501.0, 5596.0, 5346.0, 5286.0, 5706.0, 5530.0, 5382.0, 5319.0, 5647.0, 5373.0, 5707.0, 5503.0, 5479.0, 5284.0, 5296.0, 5715.0, 5268.0, 5537.0, 5583.0, 5671.0, 5668.0, 5254.0, 5306.0, 5636.0, 5482.0, 5531.0, 5311.0, 5491.0, 5368.0, 5498.0, 5272.0, 5666.0, 5545.0, 5650.0, 5476.0, 5505.0, 5558.0, 5511.0, 5559.0, 5295.0, 5519.0, 5333.0, 5590.0 (number of hits: 6)
17	5280	9	1	333	1	
18	5280	9	1	333	1	
19	5280	9	1	333	1	5273.0, 5654.0, 5669.0, 5571.0, 5416.0, 5262.0, 5658.0, 5691.0, 5611.0, 5336.0, 5293.0, 5627.0, 5709.0, 5439.0, 5521.0, 5442.0, 5354.0, 5294.0, 5557.0, 5286.0, 5614.0, 5569.0, 5545.0, 5405.0, 5340.0, 5639.0, 5582.0, 5411.0, 5575.0, 5362.0, 5478.0, 5578.0, 5278.0, 5608.0, 5591.0, 5495.0, 5660.0, 5428.0, 5385.0, 5693.0, 5699.0, 5714.0, 5635.0, 5695.0, 5544.0, 5422.0, 5328.0, 5674.0, 5409.0, 5704.0,

						5559.0, 5532.0, 5565.0, 5325.0, 5717.0, 5506.0, 5462.0, 5268.0, 5696.0, 5634.0, 5255.0, 5261.0, 5683.0, 5679.0, 5586.0, 5318.0, 5481.0, 5387.0, 5426.0, 5491.0, 5700.0, 5288.0, 5417.0, 5472.0, 5435.0, 5456.0, 5531.0, 5510.0, 5703.0, 5618.0, 5402.0, 5641.0, 5486.0, 5583.0, 5466.0, 5269.0, 5713.0, 5433.0, 5512.0, 5274.0, 5568.0, 5546.0, 5607.0, 5724.0, 5394.0, 5355.0, 5254.0, 5446.0, 5427.0, 5353.0 (number of hits: 4)
20	5280	9	1	333	1	5584.0, 5355.0, 5255.0, 5700.0, 5612.0, 5327.0, 5264.0, 5421.0, 5439.0, 5385.0, 5665.0, 5350.0, 5347.0, 5438.0, 5678.0, 5577.0, 5274.0, 5519.0, 5363.0, 5401.0, 5495.0, 5339.0, 5394.0, 5687.0, 5372.0, 5550.0, 5602.0, 5518.0, 5533.0, 5525.0, 5511.0, 5334.0, 5630.0, 5723.0, 5521.0, 5624.0, 5343.0, 5504.0, 5284.0, 5270.0, 5478.0, 5650.0, 5398.0, 5679.0, 5463.0, 5298.0, 5546.0, 5456.0, 5542.0, 5322.0, 5720.0, 5252.0, 5404.0, 5471.0, 5534.0, 5459.0, 5488.0, 5517.0, 5393.0, 5356.0, 5698.0, 5673.0, 5427.0, 5669.0, 5267.0, 5376.0, 5560.0, 5354.0, 5589.0, 5596.0, 5557.0, 5345.0, 5672.0, 5371.0, 5621.0, 5593.0, 5414.0, 5586.0, 5676.0, 5688.0, 5562.0, 5508.0, 5337.0, 5666.0, 5373.0, 5506.0, 5395.0, 5645.0, 5303.0, 5620.0, 5505.0, 5499.0, 5418.0, 5590.0, 5402.0, 5302.0, 5308.0, 5342.0, 5468.0, 5276.0 (number of hits: 4)
21	5280	9	1	333	1	5589.0, 5539.0, 5313.0, 5395.0, 5380.0, 5483.0, 5623.0, 5317.0, 5466.0, 5351.0, 5276.0, 5617.0, 5448.0, 5311.0, 5533.0, 5440.0, 5603.0, 5597.0, 5538.0, 5347.0, 5333.0, 5694.0, 5562.0, 5526.0, 5253.0, 5528.0, 5631.0, 5678.0, 5517.0, 5376.0, 5525.0, 5649.0, 5423.0, 5463.0, 5544.0, 5300.0, 5669.0, 5620.0, 5618.0, 5591.0, 5576.0, 5667.0, 5607.0, 5706.0, 5293.0, 5372.0, 5407.0, 5633.0, 5710.0, 5410.0, 5650.0, 5277.0, 5546.0, 5480.0, 5424.0, 5524.0, 5693.0, 5416.0, 5319.0, 5355.0, 5393.0, 5702.0, 5434.0, 5314.0, 5442.0, 5684.0, 5366.0, 5685.0, 5381.0, 5321.0, 5707.0, 5289.0, 5495.0, 5433.0, 5401.0, 5323.0, 5297.0, 5488.0, 5352.0, 5648.0, 5471.0, 5575.0, 5508.0, 5409.0, 5659.0, 5658.0, 5704.0, 5474.0, 5462.0, 5370.0, 5697.0, 5283.0, 5532.0, 5571.0, 5305.0, 5552.0, 5489.0, 5452.0, 5651.0, 5696.0 (number of hits: 8)
22	5280	9	1	333	1	5402.0, 5526.0, 5605.0, 5627.0, 5329.0, 5272.0, 5591.0, 5603.0, 5375.0, 5385.0, 5648.0, 5424.0, 5547.0, 5322.0, 5600.0, 5309.0, 5703.0, 5653.0, 5303.0, 5643.0, 5571.0, 5585.0, 5587.0, 5583.0, 5625.0, 5631.0, 5501.0, 5540.0, 5650.0, 5601.0,

						5566.0, 5357.0, 5411.0, 5449.0, 5342.0, 5404.0, 5416.0, 5606.0, 5372.0, 5433.0, 5663.0, 5536.0, 5451.0, 5496.0, 5560.0, 5302.0, 5708.0, 5488.0, 5360.0, 5656.0, 5389.0, 5266.0, 5450.0, 5621.0, 5721.0, 5622.0, 5678.0, 5300.0, 5388.0, 5283.0, 5581.0, 5686.0, 5286.0, 5438.0, 5417.0, 5335.0, 5307.0, 5530.0, 5370.0, 5353.0, 5444.0, 5394.0, 5630.0, 5285.0, 5548.0, 5446.0, 5367.0, 5511.0, 5697.0, 5478.0, 5717.0, 5386.0, 5435.0, 5612.0, 5346.0, 5475.0, 5429.0, 5675.0, 5611.0, 5575.0, 5672.0, 5319.0, 5358.0, 5549.0, 5384.0, 5351.0, 5569.0, 5434.0, 5523.0, 5393.0 (number of hits: 7)
23	5280	9	1	333	1	5492.0, 5407.0, 5381.0, 5298.0, 5524.0, 5317.0, 5637.0, 5264.0, 5318.0, 5611.0, 5366.0, 5379.0, 5447.0, 5473.0, 5535.0, 5501.0, 5682.0, 5544.0, 5652.0, 5292.0, 5395.0, 5674.0, 5702.0, 5718.0, 5453.0, 5277.0, 5626.0, 5346.0, 5394.0, 5551.0, 5311.0, 5696.0, 5514.0, 5464.0, 5444.0, 5402.0, 5482.0, 5547.0, 5650.0, 5625.0, 5570.0, 5657.0, 5666.0, 5533.0, 5489.0, 5646.0, 5410.0, 5377.0, 5465.0, 5660.0, 5716.0, 5486.0, 5436.0, 5413.0, 5325.0, 5546.0, 5423.0, 5587.0, 5406.0, 5655.0, 5327.0, 5360.0, 5539.0, 5398.0, 5338.0, 5467.0, 5427.0, 5574.0, 5461.0, 5690.0, 5416.0, 5449.0, 5302.0, 5301.0, 5382.0, 5345.0, 5552.0, 5693.0, 5306.0, 5385.0, 5279.0, 5399.0, 5392.0, 5548.0, 5662.0, 5577.0, 5290.0, 5370.0, 5694.0, 5362.0, 5314.0, 5687.0, 5493.0, 5503.0, 5376.0, 5319.0, 5303.0, 5573.0, 5265.0, 5389.0 (number of hits: 9)
24	5280	9	1	333	0	5715.0, 5290.0, 5269.0, 5718.0, 5456.0, 5285.0, 5322.0, 5452.0, 5477.0, 5317.0, 5703.0, 5284.0, 5490.0, 5486.0, 5709.0, 5292.0, 5595.0, 5711.0, 5347.0, 5394.0, 5690.0, 5571.0, 5531.0, 5689.0, 5638.0, 5567.0, 5633.0, 5600.0, 5506.0, 5653.0, 5591.0, 5542.0, 5644.0, 5596.0, 5293.0, 5504.0, 5694.0, 5664.0, 5488.0, 5562.0, 5563.0, 5495.0, 5307.0, 5513.0, 5295.0, 5698.0, 5424.0, 5281.0, 5503.0, 5654.0, 5388.0, 5354.0, 5420.0, 5678.0, 5265.0, 5251.0, 5702.0, 5377.0, 5676.0, 5498.0, 5390.0, 5339.0, 5299.0, 5291.0, 5358.0, 5364.0, 5431.0, 5359.0, 5697.0, 5367.0, 5518.0, 5407.0, 5617.0, 5555.0, 5598.0, 5722.0, 5492.0, 5448.0, 5538.0, 5517.0, 5303.0, 5376.0, 5712.0, 5719.0, 5280.0, 5670.0, 5482.0, 5632.0, 5289.0, 5625.0, 5696.0, 5371.0, 5577.0, 5507.0, 5592.0, 5554.0, 5646.0, 5473.0, 5419.0, 5429.0 (number of hits: 10)
25	5280	9	1	333	1	5322.0, 5480.0, 5355.0, 5258.0, 5681.0, 5507.0, 5303.0, 5541.0, 5388.0, 5523.0,

						5364.0, 5350.0, 5272.0, 5566.0, 5309.0, 5340.0, 5536.0, 5442.0, 5305.0, 5313.0, 5636.0, 5678.0, 5336.0, 5609.0, 5630.0, 5620.0, 5482.0, 5601.0, 5441.0, 5693.0, 5677.0, 5462.0, 5437.0, 5533.0, 5356.0, 5627.0, 5348.0, 5694.0, 5349.0, 5682.0, 5664.0, 5308.0, 5573.0, 5475.0, 5318.0, 5397.0, 5383.0, 5522.0, 5414.0, 5585.0, 5472.0, 5579.0, 5270.0, 5417.0, 5430.0, 5294.0, 5487.0, 5543.0, 5649.0, 5374.0, 5659.0, 5448.0, 5545.0, 5547.0, 5321.0, 5508.0, 5666.0, 5558.0, 5461.0, 5512.0, 5597.0, 5702.0, 5295.0, 5411.0, 5346.0, 5394.0, 5556.0, 5683.0, 5496.0, 5398.0, 5550.0, 5623.0, 5580.0, 5661.0, 5302.0, 5298.0, 5362.0, 5532.0, 5553.0, 5503.0, 5274.0, 5517.0, 5528.0, 5453.0, 5408.0, 5722.0, 5478.0, 5399.0, 5402.0, 5707.0 (number of hits: 9)
26	5280	9	1	333	1	5539.0, 5556.0, 5529.0, 5612.0, 5626.0, 5393.0, 5471.0, 5704.0, 5722.0, 5275.0, 5655.0, 5293.0, 5474.0, 5473.0, 5642.0, 5515.0, 5564.0, 5690.0, 5384.0, 5306.0, 5440.0, 5300.0, 5527.0, 5326.0, 5433.0, 5336.0, 5418.0, 5631.0, 5717.0, 5478.0, 5687.0, 5623.0, 5272.0, 5296.0, 5446.0, 5268.0, 5679.0, 5662.0, 5715.0, 5516.0, 5460.0, 5289.0, 5624.0, 5410.0, 5570.0, 5512.0, 5348.0, 5276.0, 5723.0, 5490.0, 5533.0, 5695.0, 5716.0, 5421.0, 5697.0, 5706.0, 5479.0, 5495.0, 5404.0, 5640.0, 5592.0, 5585.0, 5650.0, 5261.0, 5466.0, 5696.0, 5552.0, 5469.0, 5308.0, 5267.0, 5274.0, 5620.0, 5480.0, 5463.0, 5358.0, 5520.0, 5357.0, 5545.0, 5703.0, 5494.0, 5324.0, 5648.0, 5256.0, 5416.0, 5532.0, 5599.0, 5656.0, 5487.0, 5396.0, 5505.0, 5331.0, 5524.0, 5635.0, 5680.0, 5337.0, 5574.0, 5519.0, 5294.0, 5456.0, 5453.0 (number of hits: 7)
27	5280	9	1	333	1	5678.0, 5340.0, 5519.0, 5688.0, 5318.0, 5359.0, 5707.0, 5342.0, 5593.0, 5677.0, 5310.0, 5513.0, 5417.0, 5648.0, 5484.0, 5487.0, 5333.0, 5281.0, 5409.0, 5718.0, 5560.0, 5465.0, 5273.0, 5553.0, 5712.0, 5369.0, 5443.0, 5594.0, 5512.0, 5415.0, 5514.0, 5462.0, 5628.0, 5308.0, 5682.0, 5523.0, 5422.0, 5437.0, 5252.0, 5561.0, 5356.0, 5348.0, 5698.0, 5461.0, 5503.0, 5490.0, 5617.0, 5601.0, 5578.0, 5673.0, 5511.0, 5473.0, 5396.0, 5644.0, 5694.0, 5717.0, 5463.0, 5307.0, 5686.0, 5622.0, 5697.0, 5271.0, 5439.0, 5313.0, 5364.0, 5609.0, 5558.0, 5412.0, 5372.0, 5545.0, 5255.0, 5426.0, 5351.0, 5655.0, 5381.0, 5538.0, 5684.0, 5455.0, 5567.0, 5481.0, 5636.0, 5685.0, 5674.0, 5695.0, 5602.0, 5660.0, 5703.0, 5393.0, 5716.0, 5675.0, 5534.0, 5499.0, 5403.0, 5507.0, 5297.0,

						5284.0, 5517.0, 5573.0, 5625.0, 5469.0 (number of hits: 5)
28	5280	9	1	333	1	5688.0, 5690.0, 5297.0, 5601.0, 5346.0, 5276.0, 5305.0, 5570.0, 5450.0, 5380.0, 5333.0, 5406.0, 5360.0, 5427.0, 5687.0, 5278.0, 5313.0, 5422.0, 5638.0, 5496.0, 5354.0, 5539.0, 5302.0, 5507.0, 5263.0, 5522.0, 5320.0, 5711.0, 5449.0, 5574.0, 5389.0, 5670.0, 5720.0, 5300.0, 5694.0, 5619.0, 5288.0, 5705.0, 5550.0, 5661.0, 5413.0, 5292.0, 5356.0, 5631.0, 5518.0, 5666.0, 5652.0, 5606.0, 5558.0, 5463.0, 5505.0, 5284.0, 5611.0, 5409.0, 5289.0, 5559.0, 5339.0, 5598.0, 5480.0, 5722.0, 5390.0, 5395.0, 5474.0, 5454.0, 5691.0, 5572.0, 5312.0, 5577.0, 5468.0, 5431.0, 5394.0, 5426.0, 5593.0, 5633.0, 5381.0, 5405.0, 5656.0, 5648.0, 5411.0, 5398.0, 5270.0, 5369.0, 5452.0, 5372.0, 5703.0, 5613.0, 5712.0, 5571.0, 5560.0, 5609.0, 5514.0, 5671.0, 5327.0, 5254.0, 5716.0, 5579.0, 5719.0, 5258.0, 5640.0, 5523.0 (number of hits: 9)
29	5280	9	1	333	1	5482.0, 5573.0, 5385.0, 5519.0, 5652.0, 5386.0, 5376.0, 5441.0, 5623.0, 5566.0, 5382.0, 5587.0, 5681.0, 5317.0, 5444.0, 5613.0, 5525.0, 5529.0, 5358.0, 5593.0, 5353.0, 5434.0, 5356.0, 5475.0, 5553.0, 5310.0, 5546.0, 5496.0, 5460.0, 5457.0, 5512.0, 5665.0, 5472.0, 5498.0, 5550.0, 5714.0, 5423.0, 5644.0, 5491.0, 5259.0, 5480.0, 5395.0, 5642.0, 5583.0, 5351.0, 5578.0, 5336.0, 5690.0, 5343.0, 5555.0, 5420.0, 5364.0, 5515.0, 5590.0, 5610.0, 5370.0, 5468.0, 5510.0, 5517.0, 5497.0, 5389.0, 5398.0, 5479.0, 5534.0, 5359.0, 5505.0, 5598.0, 5284.0, 5640.0, 5599.0, 5346.0, 5658.0, 5462.0, 5562.0, 5645.0, 5507.0, 5636.0, 5707.0, 5514.0, 5701.0, 5638.0, 5404.0, 5648.0, 5341.0, 5484.0, 5670.0, 5453.0, 5478.0, 5654.0, 5695.0, 5437.0, 5381.0, 5528.0, 5594.0, 5685.0, 5265.0, 5408.0, 5378.0, 5254.0, 5432.0 (number of hits: 1)
30	5280	9	1	333	1	5327.0, 5488.0, 5634.0, 5404.0, 5699.0, 5689.0, 5619.0, 5458.0, 5629.0, 5417.0, 5670.0, 5346.0, 5567.0, 5656.0, 5379.0, 5381.0, 5262.0, 5691.0, 5581.0, 5368.0, 5674.0, 5604.0, 5252.0, 5583.0, 5387.0, 5255.0, 5385.0, 5259.0, 5460.0, 5334.0, 5545.0, 5423.0, 5428.0, 5299.0, 5328.0, 5335.0, 5294.0, 5627.0, 5392.0, 5684.0, 5566.0, 5493.0, 5497.0, 5649.0, 5263.0, 5534.0, 5472.0, 5375.0, 5673.0, 5528.0, 5618.0, 5585.0, 5316.0, 5637.0, 5364.0, 5394.0, 5416.0, 5607.0, 5366.0, 5707.0, 5265.0, 5438.0, 5524.0, 5652.0, 5455.0, 5329.0, 5321.0, 5325.0, 5433.0, 5440.0, 5642.0, 5570.0, 5356.0, 5393.0, 5411.0,

						5620.0, 5713.0, 5267.0, 5605.0, 5535.0, 5632.0, 5591.0, 5539.0, 5659.0, 5569.0, 5516.0, 5473.0, 5456.0, 5628.0, 5612.0, 5298.0, 5454.0, 5594.0, 5658.0, 5449.0, 5720.0, 5439.0, 5304.0, 5370.0, 5510.0 (number of hits: 4)
--	--	--	--	--	--	--

5580 MHz

Radar Signal Type	Waveform/Trial Number	Detection (%)	Limit (%)	Pass/Fail
Type 1	30	100 %	60%	Pass
Type 2	30	93.3 %	60%	Pass
Type 3	30	83.3 %	60%	Pass
Type 4	30	83.3 %	60%	Pass
Type 5	30	96.7 %	80%	Pass
Type 6	30	96.7 %	70%	Pass

Please refer to the following statistical tables:

Table-1 Radar Type 1 Statistical Performance

Trial #	Fc (MHz)	Pulse/Burst	Pulse Width (μS)	PRI (μs)	Detection (1:yes; 0:no)
1	5580	18	1	1428	1
2	5580	18	1	1428	1
3	5580	18	1	1428	1
4	5580	18	1	1428	1
5	5580	18	1	1428	1
6	5580	18	1	1428	1
7	5580	18	1	1428	1
8	5580	18	1	1428	1
9	5580	18	1	1428	1
10	5580	18	1	1428	1
11	5580	18	1	1428	1
12	5580	18	1	1428	1
13	5580	18	1	1428	1
14	5580	18	1	1428	1
15	5580	18	1	1428	1
16	5580	18	1	1428	1
17	5580	18	1	1428	1
18	5580	18	1	1428	1
19	5580	18	1	1428	1
20	5580	18	1	1428	1
21	5580	18	1	1428	1
22	5580	18	1	1428	1
23	5580	18	1	1428	1
24	5580	18	1	1428	1
25	5580	18	1	1428	1
26	5580	18	1	1428	1
27	5580	18	1	1428	1
28	5580	18	1	1428	1
29	5580	18	1	1428	1
30	5580	18	1	1428	1
Detection Percentage: 100 % (>60%)					

Table-2 Radar Type 2 Statistical Performance

Trial #	Fc (MHz)	Pulse/Burst	Pulse Width (µS)	PRI (µs)	Detection (1:yes; 0:no)
1	5580	29	4.3	153	1
2	5580	23	1.9	167	1
3	5580	25	4.4	158	1
4	5580	27	4.9	197	1
5	5580	24	2.2	193	1
6	5580	29	3	201	
7	5580	24	2.6	167	1
8	5580	28	3.2	230	1
9	5580	27	1.9	223	1
10	5580	26	5	151	1
11	5580	23	2.1	164	1
12	5580	23	2	207	1
13	5580	24	3.7	172	1
14	5580	29	1.7	217	1
15	5580	25	1.1	166	1
16	5580	26	1.5	223	1
17	5580	28	3	176	1
18	5580	29	4.9	229	1
19	5580	28	1.2	181	1
20	5580	28	4.3	154	1
21	5580	25	1.6	165	1
22	5580	26	2.6	160	1
23	5580	26	1	159	1
24	5580	23	2.4	201	
25	5580	25	3	161	1
26	5580	27	1	226	1
27	5580	24	3.7	188	1
28	5580	29	4.9	205	1
29	5580	29	2.1	155	1
30	5580	26	1.2	210	1
Detection Percentage: 93.3 % (>60%)					

Table-3 Radar Type 3 Statistical Performance

Trial #	Fc (MHz)	Pulse/Burst	Pulse Width (μS)	PRI (μs)	Detection (1:yes; 0:no)
1	5580	16	6.1	376	1
2	5580	16	7	324	1
3	5580	16	6	367	1
4	5580	17	7.3	207	0
5	5580	16	6.4	424	1
6	5580	17	9.1	437	1
7	5580	16	7	375	1
8	5580	16	8.8	441	1
9	5580	17	9.8	458	1
10	5580	18	9	412	1
11	5580	18	8.6	306	1
12	5580	18	8.1	289	1
13	5580	17	9.9	300	1
14	5580	17	6	204	0
15	5580	17	8.6	452	1
16	5580	17	7.7	230	0
17	5580	16	7.1	436	1
18	5580	18	7.5	334	1
19	5580	16	8.1	315	1
20	5580	18	9.7	443	1
21	5580	18	7.8	393	0
22	5580	16	8.4	445	1
23	5580	16	9.3	258	1
24	5580	16	9.1	379	1
25	5580	18	9.8	404	1
26	5580	16	8.7	480	1
27	5580	16	7.5	315	1
28	5580	18	6.6	268	1
29	5580	16	9.2	227	0
30	5580	17	7.2	349	1
Detection Percentage: 83.3 % (>60%)					

Table-4 Radar Type 4 Statistical Performance

Trial #	Fc (MHz)	Pulse/Burst	Pulse Width (µS)	PRI (µs)	Detection (1:yes; 0:no)
1	5580	15	14.2	213	0
2	5580	12	17	211	0
3	5580	13	15.2	333	1
4	5580	12	19.6	490	1
5	5580	12	15.3	346	1
6	5580	14	13.3	299	1
7	5580	13	13.9	354	1
8	5580	13	11.3	433	1
9	5580	14	14.6	314	1
10	5580	12	17.3	224	0
11	5580	13	17.6	483	0
12	5580	12	12.2	418	1
13	5580	16	16.5	404	1
14	5580	15	11.1	267	1
15	5580	16	15.2	497	1
16	5580	16	16.3	296	1
17	5580	13	19.2	454	1
18	5580	12	11.1	232	0
19	5580	14	11.8	486	1
20	5580	13	18.5	268	1
21	5580	16	18.9	458	1
22	5580	13	13.5	327	1
23	5580	14	15.2	447	1
24	5580	13	11.3	491	1
25	5580	12	15	403	1
26	5580	15	13.2	398	1
27	5580	16	17	356	1
28	5580	12	12.9	304	1
29	5580	15	11.7	319	1
30	5580	12	18.3	382	1
Detection Percentage: 83.3 % (>60%)					

Table-5 Radar Type 5 Statistical Performance

Bin5 Statistics 1

Trial #	Pulse	Chirp (MHz)	Pulse Width (μS)	Pulse 1-2 spacing (uS)	Pulse 2-3 spacing (uS)	Pulse Start(S)	Detection (1:yes; 0:no)
0	1	7	70.6			0.652457	1
1	2	9	71.3	1995		0.910797	
2	1	11	51.9			1.760821	
3	1	17	62.7			2.265865	
4	1	6	76.9			3.254518	
5	3	5	54	1389	1012	3.681228	
6	1	5	80.2			4.570456	
7	2	6	52	1496		4.976448	
8	2	7	55.8	1277		5.788277	
9	3	15	63.5	1048	1736	6.364477	
10	2	10	91.5	1626		7.072334	
11	2	12	98.7	1094		8.092793	
12	2	13	92.6	1052		8.780277	
13	1	10	93.2			9.748417	
14	2	9	92.4	1823		10.15981	
15	2	13	95.7	1604		10.86494	
16	1	13	53.9			11.98934	

Bin5 Statistics 2

Trial #	Pulse	Chirp (MHz)	Pulse Width (μS)	Pulse 1-2 spacing (uS)	Pulse 2-3 spacing (uS)	Pulse Start(S)	Detection (1:yes; 0:no)
0	2	9	65.2	1233		0.144703	1
1	2	14	70.5	1802		1.133582	
2	2	17	77.5	1529		1.704245	
3	2	9	89.6	1065		2.186638	
4	3	9	98.8	1156	1681	2.859368	
5	2	12	70.2	1187		3.578296	
6	2	15	61.5	1021		4.014361	
7	3	8	70.5	1585	1977	4.746902	
8	3	17	75	1877	1976	5.859826	
9	2	11	98.9	1052		6.132234	
10	2	19	82.9	1828		7.186561	
11	2	10	77.6	1144		7.98047	
12	3	18	80.2	1554	1007	8.110965	
13	3	5	83.5	1145	1645	9.27541	
14	1	15	84.6			9.555022	
15	2	13	90.7	1989		10.13339	
16	2	14	85.8	1696		11.15605	
17	3	18	84.3	1265	1799	11.59255	

Bin5 Statistics 3

Trial #	Pulse	Chirp (MHz)	Pulse Width (µS)	Pulse 1-2 spacing (µS)	Pulse 2-3 spacing (µS)	Pulse Start(S)	Detection (1:yes; 0:no)
0	3	14	63.6	1719	1846	0.506142	1
1	2	9	74.9	1753		1.29966	
2	3	11	61.9	1379	1973	2.333944	
3	2	15	73.3	1406		3.1963	
4	2	13	65.5	1195		4.175629	
5	2	18	64.2	1553		4.867988	
6	1	16	86.1			5.851608	
7	3	20	67.6	1097	1615	6.079738	
8	2	14	85.5	1266		7.09002	
9	2	10	63.8	1778		8.462335	
10	1	6	68.6			9.105887	
11	2	14	70.1	1045		10.17437	
12	3	13	84	1223	1356	10.60565	
13	2	11	73.1	1134		11.91073	

Bin5 Statistics 4

Trial #	Pulse	Chirp (MHz)	Pulse Width (µS)	Pulse 1-2 spacing (µS)	Pulse 2-3 spacing (µS)	Pulse Start(S)	Detection (1:yes; 0:no)
0	3	13	78.5	1863	1455	0.302389	1
1	3	8	90.4	1969	1355	0.824383	
2	2	12	78.1	1669		1.34884	
3	2	8	83.2	1789		2.245966	
4	3	19	90.8	1983	1018	3.219835	
5	2	16	75.2	1641		3.539395	
6	2	14	100	1786		4.201504	
7	1	11	54.5			5.190355	
8	2	10	61.3	1833		5.650015	
9	3	19	84.6	1037	1868	6.57115	
10	1	18	54.8			7.022656	
11	3	8	74.6	1936	1366	7.94372	
12	1	19	98.8			8.026993	
13	3	6	58.5	1696	1188	8.730296	
14	1	11	73.7			9.66827	
15	1	17	70.9			10.57695	
16	3	10	63.1	1625	1883	11.08474	
17	1	19	74.9			11.73854	

Bin5 Statistics 5

Trial #	Pulse	Chirp (MHz)	Pulse Width (µS)	Pulse 1-2 spacing (uS)	Pulse 2-3 spacing (uS)	Pulse Start(S)	Detection (1:yes; 0:no)
0	2	9	81.7	1618		0.698653	1
1	2	18	52.1	1723		2.143747	
2	2	19	78.9	1507		2.94773	
3	3	7	59.9	1818	1464	3.382163	
4	2	6	67	1593		4.900384	
5	2	12	93.1	1763		6.207272	
6	3	19	57.4	1195	1113	7.545813	
7	2	20	73.7	1124		8.374554	
8	3	7	96.2	1188	1570	8.864781	
9	3	17	69.5	1023	1631	10.01243	
10	2	9	69.8	1452		10.9928	

Bin5 Statistics 6

Trial #	Pulse	Chirp (MHz)	Pulse Width (µS)	Pulse 1-2 spacing (uS)	Pulse 2-3 spacing (uS)	Pulse Start(S)	Detection (1:yes; 0:no)
0	3	18	63.9	1016	1691	0.781591	1
1	3	10	73.4	1058	1898	1.05506	
2	3	11	64.8	1761	1485	2.155984	
3	3	5	75.8	1829	1822	2.792466	
4	1	13	98.8			3.601849	
5	1	13	59.4			4.503975	
6	2	6	90.2	1312		5.307009	
7	1	19	59.9			6.251721	
8	1	18	81.9			7.18886	
9	2	7	64.9	1970		7.529643	
10	2	10	91.4	1581		8.303832	
11	1	15	74.1			9.481227	
12	2	7	85.3	1274		9.816059	
13	3	12	84	1212	1637	10.8627	
14	2	17	96.5	1794		11.20559	

Bin5 Statistics 7

Trial #	Pulse	Chirp (MHz)	Pulse Width (µS)	Pulse 1-2 spacing (uS)	Pulse 2-3 spacing (uS)	Pulse Start(S)	Detection (1:yes; 0:no)
0	3	11	73.1	1580	1206	0.469937	1
1	2	14	86.2	1020		2.061374	
2	3	8	50.6	1941	1776	3.550028	
3	3	13	65	1742	1586	4.16073	
4	3	17	65	1950	1120	4.861505	
5	2	17	55.1	1447		7.132977	
6	3	12	59.1	1580	1531	7.628822	
7	3	11	71.8	1011	1750	9.211576	
8	1	17	96.6			9.888081	
9	3	16	62	1301	1533	10.87784	

Bin5 Statistics 8

Trial #	Pulse	Chirp (MHz)	Pulse Width (µS)	Pulse 1-2 spacing (uS)	Pulse 2-3 spacing (uS)	Pulse Start(S)	Detection (1:yes; 0:no)
0	2	18	84.9	1869		0.131063	0
1	2	5	79.7	1295		0.827204	
2	3	19	72.7	1184	1750	1.623476	
3	3	12	77.2	1873	1221	2.3771	
4	3	13	96.1	1596	1491	3.301409	
5	2	9	74.4	1067		3.628834	
6	2	18	64.2	1973		4.61676	
7	1	20	93.1			5.374435	
8	2	9	91.4	1289		5.867634	
9	3	9	81.4	1570	1958	7.044412	
10	1	12	87.3			7.493553	
11	2	7	71.6	1638		8.446933	
12	2	13	87.7	1577		9.117524	
13	2	8	94.5	1918		9.518141	
14	2	13	94.3	1999		10.06088	
15	1	16	96.6			10.67731	
16	2	12	65.2	1198		11.63342	

Bin5 Statistics 9

Trial #	Pulse	Chirp (MHz)	Pulse Width (µS)	Pulse 1-2 spacing (µS)	Pulse 2-3 spacing (µS)	Pulse Start(S)	Detection (1:yes; 0:no)
0	1	6	56.7			0.322699	1
1	1	20	75.6			0.919301	
2	3	20	73.9	1951	1077	1.380382	
3	3	8	98.9	1916	1483	1.81955	
4	2	9	70.4	1872		2.724697	
5	2	8	72.4	1529		3.149971	
6	2	12	70.3	1762		4.108264	
7	2	18	74.9	1470		4.69805	
8	2	19	85.7	1656		4.82725	
9	1	19	50.6			5.429374	
10	1	10	76.6			6.560113	
11	2	11	89.3	1174		6.996364	
12	3	15	73.9	1129	1302	7.663272	
13	1	16	97.9			8.039399	
14	3	13	88.2	1280	1852	8.990328	
15	3	14	69.5	1020	1547	9.130541	
16	2	15	97.8	1081		10.19387	
17	2	5	86.6	1201		10.48624	
18	2	18	78.4	1858		11.35777	
19	3	10	94.5	1984	1203	11.92984	

Bin5 Statistics 10

Trial #	Pulse	Chirp (MHz)	Pulse Width (μS)	Pulse 1-2 spacing (uS)	Pulse 2-3 spacing (uS)	Pulse Start(S)	Detection (1:yes; 0:no)
0	1	9	79.1			0.361576	1
1	2	18	71.6	1188		1.487285	
2	1	13	66.4			1.788138	
3	2	10	79.2	1056		2.671017	
4	3	19	93.6	1537	1101	3.641692	
5	3	7	78.3	1220	1899	3.986025	
6	3	7	72.1	1801	1848	5.224929	
7	1	6	67.1			5.777917	
8	2	8	94.2	1594		6.744021	
9	1	9	95.1			6.834498	
10	2	18	54.4	1966		7.963751	
11	2	15	77.1	1143		8.472377	
12	3	13	51.2	1257	1040	9.195758	
13	3	13	74.4	1410	1049	9.777775	
14	2	17	61.7	1251		11.08763	
15	2	13	87.7	1825		11.80192	

Bin5 Statistics 11

Trial #	Pulse	Chirp (MHz)	Pulse Width (μS)	Pulse 1-2 spacing (uS)	Pulse 2-3 spacing (uS)	Pulse Start(S)	Detection (1:yes; 0:no)
0	2	8	77.8	1233		0.283005	1
1	2	12	81.2	1297		0.868606	
2	2	13	56.5	1896		1.567232	
3	1	8	81.7			2.262833	
4	3	17	73.5	1235	1780	2.912781	
5	3	18	51.5	1848	1129	3.380663	
6	2	15	77.7	1679		3.927394	
7	2	18	50	1380		4.465803	
8	2	9	100	1047		5.456273	
9	3	17	51.2	1912	1328	6.272688	
10	1	17	68.2			6.435781	
11	1	18	62.4			7.493931	
12	2	9	82.4	1583		8.026444	
13	1	8	88.7			8.456956	
14	1	6	79.4			9.408312	
15	1	17	75.3			9.965491	
16	1	13	73.1			10.67618	
17	2	19	85.9	1026		11.25016	
18	2	18	67.4	1275		11.81606	

Bin5 Statistics 12

Trial #	Pulse	Chirp (MHz)	Pulse Width (µS)	Pulse 1-2 spacing (uS)	Pulse 2-3 spacing (uS)	Pulse Start(S)	Detection (1:yes; 0:no)
0	1	16	59.6			0.597619	1
1	2	18	99.2	1381		1.387209	
2	2	20	99.5	1948		2.053042	
3	2	9	82	1058		2.349208	
4	1	17	83.9			3.160121	
5	1	12	94.3			3.598027	
6	1	18	56.3			4.478661	
7	2	17	58.7	1650		5.270193	
8	2	16	65	1845		6.20612	
9	2	13	57.2	1228		6.573517	
10	2	9	71.7	1606		7.281561	
11	2	9	67	1600		7.988301	
12	2	13	71	1646		8.688899	
13	3	13	53	1683	1083	9.667008	
14	1	6	80			10.10746	
15	3	16	86.2	1375	1542	11.08302	
16	2	8	61.6	1003		11.99345	

Bin5 Statistics 13

Trial #	Pulse	Chirp (MHz)	Pulse Width (µS)	Pulse 1-2 spacing (uS)	Pulse 2-3 spacing (uS)	Pulse Start(S)	Detection (1:yes; 0:no)
0	3	17	89.8	1627	1968	0.02034	1
1	1	18	68.5			2.376207	
2	2	11	77.6	1421		2.635679	
3	2	11	64.6	1122		4.722176	
4	2	6	60.2	1416		5.639237	
5	2	13	51.1	1312		6.771056	
6	3	17	76.4	1715	1409	7.357865	
7	3	19	74.7	1106	1357	8.812734	
8	1	8	98			9.721608	
9	3	19	92.2	1420	1940	10.95664	

Bin5 Statistics 14

Trial #	Pulse	Chirp (MHz)	Pulse Width (μS)	Pulse 1-2 spacing (uS)	Pulse 2-3 spacing (uS)	Pulse Start(S)	Detection (1:yes; 0:no)
0	3	15	63.4	1153	1530	0.141303	1
1	3	17	60.1	1026	1538	0.765073	
2	3	11	77.8	1695	1765	1.512991	
3	3	13	53.3	1642	1901	2.11065	
4	3	20	77.5	1423	1743	3.128483	
5	3	15	70.7	1629	1291	3.569877	
6	3	7	86.2	1773	1636	4.044765	
7	3	9	64.5	1469	1640	4.7573	
8	2	12	57	1849		5.355561	
9	3	15	62.5	1087	1797	6.096174	
10	3	16	64.2	1785	1083	6.562421	
11	1	7	80.4			7.059765	
12	3	15	86.6	1978	1205	8.042854	
13	2	9	73.4	1647		8.37085	
14	3	12	97.7	1355	1028	8.982185	
15	3	15	70.1	1422	1542	9.697006	
16	1	9	50			10.26524	
17	2	17	90.5	1051		10.84116	
18	1	8	84.3			11.40359	

Bin5 Statistics 15

Trial #	Pulse	Chirp (MHz)	Pulse Width (µS)	Pulse 1-2 spacing (µS)	Pulse 2-3 spacing (µS)	Pulse Start(S)	Detection (1:yes; 0:no)
0	2	11	91	1448		0.408849	1
1	1	10	65.4			1.531292	
2	3	19	97.6	1426	1989	1.882363	
3	3	13	84.9	1458	1457	3.285985	
4	2	7	57.8	1132		4.215347	
5	2	15	77.1	1029		5.2366	
6	3	15	62	1589	1116	5.68415	
7	1	8	98.8			6.703772	
8	1	11	52			7.746995	
9	3	13	50.2	1055	1932	9.147455	
10	2	8	73.2	1780		9.841547	
11	3	15	69.4	1208	1369	10.7456	
12	1	10	80.9			11.30727	

Bin5 Statistics 16

Trial #	Pulse	Chirp (MHz)	Pulse Width (µS)	Pulse 1-2 spacing (µS)	Pulse 2-3 spacing (µS)	Pulse Start(S)	Detection (1:yes; 0:no)
0	3	11	93.7	1963	1208	0.334937	1
1	2	14	67	1940		0.994796	
2	2	7	61.3	1287		1.745096	
3	3	15	57.5	1949	1626	2.15949	
4	2	6	50.2	1762		2.917759	
5	1	10	65.5			3.923722	
6	1	19	55.3			4.186105	
7	1	10	61.5			5.017573	
8	1	18	86.6			5.857867	
9	2	15	58.7	1981		6.1881	
10	2	19	52.2	1921		6.668285	
11	1	10	62.1			7.774651	
12	2	17	51.9	1427		8.022357	
13	3	11	78.9	1600	1633	8.755575	
14	2	14	56	1052		9.752613	
15	2	9	98.1	1690		10.42488	
16	2	13	58.1	1804		11.15257	
17	2	16	65.5	1426		11.99	

Bin5 Statistics 17

Trial #	Pulse	Chirp (MHz)	Pulse Width (µS)	Pulse 1-2 spacing (uS)	Pulse 2-3 spacing (uS)	Pulse Start(S)	Detection (1:yes; 0:no)
0	2	8	50.9	1338		0.079862	1
1	2	11	86.7	1826		0.914661	
2	2	18	69.2	1833		1.878849	
3	1	12	63.2			2.401044	
4	1	7	65.2			2.70583	
5	2	6	56	1086		3.848725	
6	1	15	98			4.564424	
7	2	13	67.5	1748		4.963398	
8	1	8	79.6			5.576306	
9	1	16	87			6.389062	
10	2	20	66.9	1940		7.136365	
11	3	9	59.2	1120	1336	7.415846	
12	3	9	59.9	1855	1217	8.520947	
13	1	12	91.5			8.687871	
14	1	15	96.7			9.92992	
15	3	20	60.8	1713	1843	10.64645	
16	2	18	95.9	1134		10.93371	
17	3	9	76.5	1689	1331	11.69878	

Bin5 Statistics 18

Trial #	Pulse	Chirp (MHz)	Pulse Width (µS)	Pulse 1-2 spacing (uS)	Pulse 2-3 spacing (uS)	Pulse Start(S)	Detection (1:yes; 0:no)
0	2	10	50.9	1404		1.038388	1
1	2	11	94.8	1155		1.321204	
2	2	7	77.2	1455		3.000825	
3	1	6	73.6			3.892164	
4	2	7	93.8	1792		5.933645	
5	2	14	94.7	1777		6.719893	
6	3	7	89.4	1600	1522	7.693987	
7	2	15	51.6	1751		8.957943	
8	2	6	59.2	1608		9.61451	
9	2	9	77.3	1117		11.8486	

Bin5 Statistics 19

Trial #	Pulse	Chirp (MHz)	Pulse Width (μS)	Pulse 1-2 spacing (uS)	Pulse 2-3 spacing (uS)	Pulse Start(S)	Detection (1:yes; 0:no)
Trial #	Pulse	Chirp (MHz)	Pulse Width (μS)	Pulse 1-2 spacing (uS)	Pulse 2-3 spacing (uS)	Pulse Start(S)	1
0	1	19	75.4			0.238759	
1	3	8	57.5	1222	1217	0.873455	
2	2	16	71.3	1661		2.30233	
3	2	13	68.4	1709		2.643904	
4	1	18	93.2			3.646246	
5	2	6	73.8	1315		4.506646	
6	2	19	83.7	1028		4.859564	
7	1	6	97.3			5.777049	
8	2	8	63.8	1794		6.521716	
9	3	16	86.8	1019	1973	7.940438	
10	2	19	52	1621		8.237317	
11	1	6	67			8.841234	
12	1	8	55.5			9.789303	
13	3	11	83.6	1525	1223	11.00933	
14	3	9	83.7	1179	1679	11.201	

Bin5 Statistics 20

Trial #	Pulse	Chirp (MHz)	Pulse Width (μS)	Pulse 1-2 spacing (uS)	Pulse 2-3 spacing (uS)	Pulse Start(S)	Detection (1:yes; 0:no)
Trial #	Pulse	Chirp (MHz)	Pulse Width (μS)	Pulse 1-2 spacing (uS)	Pulse 2-3 spacing (uS)	Pulse Start(S)	1
0	2	9	53.6	1483		0.238441	
1	2	5	97.2	1626		1.372169	
2	1	15	91.4			1.898359	
3	1	18	65.8			3.055399	
4	3	7	85.7	1834	1581	4.157777	
5	2	6	99.2	1415		4.699965	
6	3	13	57.9	1213	1165	5.654117	
7	2	14	56	1269		6.058069	
8	1	12	88.8			7.654448	
9	1	12	64.7			8.411164	
10	3	20	62.1	1828	1880	8.721025	
11	1	10	91.4			9.761743	
12	2	18	85.6	1658		10.46896	
13	2	14	75.2	1342		11.61596	

Bin5 Statistics 21

Trial #	Pulse	Chirp (MHz)	Pulse Width (µS)	Pulse 1-2 spacing (uS)	Pulse 2-3 spacing (uS)	Pulse Start(S)	Detection (1:yes; 0:no)
0	3	8	69.1	1992	1699	0.175454	1
1	2	19	77.6	1350		0.910419	
2	2	19	83.3	1706		1.381216	
3	2	18	91.6	1149		2.45295	
4	2	12	60.8	1624		2.573487	
5	2	13	91.8	1825		3.694519	
6	3	8	86.6	1280	1981	4.032083	
7	3	19	98.1	1588	1038	4.644805	
8	1	18	50.4			5.32435	
9	2	16	79.3	1474		6.034085	
10	2	8	71.1	1990		6.840691	
11	3	20	68.6	1021	1296	6.972951	
12	2	11	52.8	1467		8.016202	
13	2	19	60.8	1027		8.331812	
14	2	6	86.1	1850		9.451051	
15	1	16	76.8			10.0888	
16	3	14	84.6	1577	1154	10.57034	
17	1	19	58.6			10.88662	
18	2	11	51.9	1979		11.55976	

Bin5 Statistics 22

Trial #	Pulse	Chirp (MHz)	Pulse Width (µS)	Pulse 1-2 spacing (uS)	Pulse 2-3 spacing (uS)	Pulse Start(S)	Detection (1:yes; 0:no)
0	1	18	99.1			0.474268	1
1	2	11	85.6	1592		1.347503	
2	3	12	91.3	1508	1718	2.106265	
3	2	7	98	1693		2.76298	
4	2	10	56.4	1153		4.228326	
5	3	13	80	1425	1042	5.005874	
6	2	10	67.6	1260		5.520875	
7	2	9	75.9	1226		6.442979	
8	1	9	90.5			7.361051	
9	2	10	59.8	1547		8.341414	
10	1	11	61			8.635366	
11	1	19	71.5			9.843687	
12	3	17	54.8	1807	1822	10.60478	
13	2	19	99	1562		11.6548	

Bin5 Statistics 23

Trial #	Pulse	Chirp (MHz)	Pulse Width (µS)	Pulse 1-2 spacing (uS)	Pulse 2-3 spacing (uS)	Pulse Start(S)	Detection (1:yes; 0:no)
0	2	9	95.7	1576		0.116148	1
1	2	11	99.2	1739		1.772977	
2	3	16	69.4	1338	1431	2.096812	
3	2	7	72.6	1094		3.075382	
4	3	17	97.6	1140	1342	4.367307	
5	1	19	64.3			5.477419	
6	3	15	50.5	1986	1802	6.732996	
7	1	16	73.7			7.056061	
8	2	9	78.2	1510		8.863976	
9	3	8	71.5	1675	1845	9.657306	
10	2	10	51.6	1852		10.74331	
11	3	18	67.1	1180	1429	11.66163	

Bin5 Statistics 24

Trial #	Pulse	Chirp (MHz)	Pulse Width (µS)	Pulse 1-2 spacing (uS)	Pulse 2-3 spacing (uS)	Pulse Start(S)	Detection (1:yes; 0:no)
0	1	13	50.5			0.368877	1
1	1	9	51.8			1.361037	
2	2	6	63.3	1090		1.780343	
3	1	12	84.2			2.727677	
4	3	16	83.8	1738	1835	3.552114	
5	2	6	82.1	1113		4.307166	
6	2	13	58.2	1850		5.217673	
7	2	16	72.7	1461		5.917937	
8	2	20	91.6	1906		6.661243	
9	2	12	75.5	1002		7.54129	
10	1	19	86.5			8.789587	
11	2	8	69.9	1286		9.301338	
12	2	20	65.9	1967		10.08075	
13	2	13	65.4	1691		10.59323	
14	2	7	89.6	1135		11.27122	

Bin5 Statistics 25

Trial #	Pulse	Chirp (MHz)	Pulse Width (µS)	Pulse 1-2 spacing (uS)	Pulse 2-3 spacing (uS)	Pulse Start(S)	Detection (1:yes; 0:no)
0	2	11	69.7	1713		0.192225	1
1	2	14	69.3	1346		0.863303	
2	2	15	56.5	1467		1.738094	
3	2	17	74.2	1082		2.40078	
4	3	13	97.1	1457	1045	3.090248	
5	2	5	79.5	1611		3.684491	
6	1	14	99.2			4.309014	
7	2	11	90.3	1539		5.325215	
8	3	15	99.3	1192	1981	5.668499	
9	1	19	76.7			6.439949	
10	3	14	77.1	1572	1536	7.289114	
11	1	16	61.8			8.342177	
12	3	6	64.7	1949	1284	8.813694	
13	2	8	76.1	1609		9.353171	
14	2	6	77.9	1317		10.07417	
15	2	12	98.2	1393		10.82168	
16	2	7	57.6	1763		11.78411	

Bin5 Statistics 26

Trial #	Pulse	Chirp (MHz)	Pulse Width (µS)	Pulse 1-2 spacing (uS)	Pulse 2-3 spacing (uS)	Pulse Start(S)	Detection (1:yes; 0:no)
0	2	13	57.4	1039		0.82421	1
1	1	7	73.5			1.686873	
2	3	10	78	1591	1055	2.109923	
3	2	7	96.2	1480		2.975147	
4	2	7	61.1	1552		3.790736	
5	3	15	97.4	1087	1288	4.707891	
6	3	16	70.5	1855	1181	5.364353	
7	3	7	69.3	1371	1487	6.082728	
8	2	8	75.8	1916		6.97234	
9	3	17	78.1	1098	1663	7.957836	
10	1	16	92.9			8.699079	
11	2	14	55.6	1139		10.0963	
12	1	14	99.3			10.3785	
13	2	17	72	1536		11.37886	

Bin5 Statistics 27

Trial #	Pulse	Chirp (MHz)	Pulse Width (µS)	Pulse 1-2 spacing (uS)	Pulse 2-3 spacing (uS)	Pulse Start(S)	Detection (1:yes; 0:no)
0	2	6	54.6	1077		0.544844	1
1	2	16	77.2	1800		1.670236	
2	1	7	88.2			2.888348	
3	2	19	80.7	1691		3.140265	
4	2	15	84	1072		4.788491	
5	1	15	64.3			5.948825	
6	1	7	54.4			6.591875	
7	3	13	91.8	1886	1641	7.508995	
8	2	18	58.4	1661		8.328712	
9	2	17	65.4	1912		9.158467	
10	3	20	87.3	1411	1448	10.05175	
11	2	20	70.6	1955		11.30702	

Bin5 Statistics 28

Trial #	Pulse	Chirp (MHz)	Pulse Width (µS)	Pulse 1-2 spacing (uS)	Pulse 2-3 spacing (uS)	Pulse Start(S)	Detection (1:yes; 0:no)
0	2	20	59.9	1558		0.17794	1
1	2	11	60.2	1608		1.08861	
2	3	8	74.3	1603	1481	1.910631	
3	1	10	51.4			2.312675	
4	3	16	63	1035	1449	3.011195	
5	2	17	92.3	1621		3.518133	
6	2	8	63.8	1640		4.153486	
7	3	18	62.7	1765	1928	5.111009	
8	2	15	95.2	1542		5.395737	
9	1	15	98.3			6.032572	
10	3	15	97.9	1876	1208	7.049798	
11	3	15	62.7	1900	1934	7.640418	
12	2	11	66.9	1834		8.12382	
13	2	12	76.4	1828		8.899854	
14	2	17	86.7	1269		9.811055	
15	2	7	83.3	1587		10.44917	
16	2	13	50.2	1987		10.67856	
17	2	13	69.4	1973		11.35004	

Bin5 Statistics 29

Trial #	Pulse	Chirp (MHz)	Pulse Width (µS)	Pulse 1-2 spacing (uS)	Pulse 2-3 spacing (uS)	Pulse Start(S)	Detection (1:yes; 0:no)
0	2	18	59.5	1457		0.914711	1
1	1	17	91.9			1.282411	
2	2	16	94.5	1864		2.645393	
3	3	8	77.7	1658	1746	4.27895	
4	2	12	74.7	1664		5.069423	
5	3	18	73.9	1866	1379	6.062795	
6	3	15	67.9	1664	1577	8.364106	
7	2	9	70.5	1750		9.225168	
8	1	15	78.2			9.604806	
9	3	5	80.6	1955	1154	11.52863	

Bin5 Statistics 30

Trial #	Pulse	Chirp (MHz)	Pulse Width (µS)	Pulse 1-2 spacing (uS)	Pulse 2-3 spacing (uS)	Pulse Start(S)	Detection (1:yes; 0:no)
0	2	10	68.3	1330		0.1472	1
1	1	13	89.7			1.832648	
2	1	17	56.4			3.221818	
3	3	12	82.4	1834	1915	3.306415	
4	1	15	99			4.892827	
5	2	8	90.8	1599		6.035987	
6	3	7	95.3	1236	1738	7.08645	
7	1	17	67.8			8.593833	
8	2	13	94	1157		9.451083	
9	2	12	93.9	1145		10.53588	
10	2	10	98.1	1418		11.44275	

Table-6 Radar Type 6 Statistical Performance

Trial #	Fc (MHz)	Pulse /Burst	Pulse Width (µS)	PRI (µs)	Detection (1:yes; 0:no)	Hopping Sequence
1	5580	9	1	333	1	5685.0, 5254.0, 5573.0, 5477.0, 5468.0, 5718.0, 5467.0, 5719.0, 5308.0, 5419.0, 5571.0, 5676.0, 5505.0, 5338.0, 5663.0, 5347.0, 5350.0, 5420.0, 5423.0, 5385.0, 5452.0, 5461.0, 5662.0, 5672.0, 5602.0, 5572.0, 5361.0, 5394.0, 5541.0, 5294.0, 5545.0, 5679.0, 5675.0, 5331.0, 5253.0, 5690.0, 5428.0, 5466.0, 5333.0, 5316.0, 5563.0, 5587.0, 5561.0, 5627.0, 5310.0, 5661.0, 5276.0, 5392.0, 5529.0, 5724.0, 5589.0, 5504.0, 5489.0, 5527.0, 5343.0, 5518.0, 5575.0, 5555.0, 5447.0, 5706.0, 5319.0, 5326.0, 5645.0, 5409.0, 5588.0, 5445.0, 5299.0, 5317.0, 5417.0, 5604.0, 5622.0, 5444.0, 5540.0, 5413.0, 5598.0, 5567.0, 5434.0, 5495.0, 5399.0, 5493.0, 5584.0, 5270.0, 5278.0, 5633.0, 5252.0, 5658.0, 5565.0, 5640.0, 5280.0, 5443.0, 5669.0, 5507.0, 5490.0, 5513.0, 5648.0, 5367.0, 5416.0, 5569.0, 5393.0, 5426.0 (number of hits: 4)
2	5580	9	1	333	1	5369.0, 5403.0, 5447.0, 5294.0, 5304.0, 5701.0, 5284.0, 5303.0, 5572.0, 5592.0, 5549.0, 5629.0, 5330.0, 5388.0, 5616.0, 5614.0, 5456.0, 5395.0, 5558.0, 5286.0, 5476.0, 5278.0, 5418.0, 5424.0, 5619.0, 5636.0, 5250.0, 5339.0, 5307.0, 5475.0, 5328.0, 5488.0, 5577.0, 5580.0, 5349.0, 5589.0, 5707.0, 5254.0, 5269.0, 5601.0, 5723.0, 5259.0, 5718.0, 5329.0, 5613.0, 5351.0, 5620.0, 5305.0, 5434.0, 5669.0, 5640.0, 5699.0, 5574.0, 5564.0, 5562.0, 5693.0, 5668.0, 5535.0, 5512.0, 5444.0, 5298.0, 5517.0, 5367.0, 5419.0, 5662.0, 5505.0, 5374.0, 5631.0, 5555.0, 5566.0, 5697.0, 5496.0, 5607.0, 5274.0, 5317.0, 5519.0, 5509.0, 5478.0, 5428.0, 5283.0, 5501.0, 5433.0, 5510.0, 5717.0, 5479.0, 5541.0, 5602.0, 5492.0, 5526.0, 5491.0, 5638.0, 5277.0, 5652.0, 5453.0, 5711.0, 5536.0, 5705.0, 5468.0, 5467.0, 5348.0 (number of hits: 7)
3	5580	9	1	333	1	5724.0, 5372.0, 5293.0, 5290.0, 5580.0, 5552.0, 5298.0, 5384.0, 5562.0, 5597.0, 5607.0, 5435.0, 5574.0, 5354.0, 5527.0, 5669.0, 5429.0, 5601.0, 5715.0, 5624.0, 5411.0, 5376.0, 5716.0, 5687.0, 5396.0, 5496.0, 5345.0, 5252.0, 5364.0, 5316.0, 5312.0, 5420.0, 5688.0, 5531.0, 5706.0, 5412.0, 5556.0, 5483.0, 5710.0, 5522.0, 5478.0, 5482.0, 5318.0, 5277.0, 5260.0, 5696.0, 5505.0, 5528.0, 5488.0, 5647.0, 5653.0, 5481.0, 5673.0, 5664.0, 5436.0, 5279.0, 5334.0, 5430.0, 5672.0, 5453.0

						5547.0, 5276.0, 5282.0, 5329.0, 5684.0, 5571.0, 5264.0, 5305.0, 5331.0, 5359.0, 5596.0, 5703.0, 5714.0, 5283.0, 5257.0, 5457.0, 5361.0, 5702.0, 5404.0, 5575.0, 5380.0, 5526.0, 5685.0, 5425.0, 5616.0, 5431.0, 5390.0, 5521.0, 5485.0, 5530.0, 5378.0, 5622.0, 5272.0, 5473.0, 5524.0, 5273.0, 5281.0, 5518.0, 5605.0, 5721.0 (number of hits: 5)
4	5580	9	1	333	1	5330.0, 5293.0, 5713.0, 5312.0, 5554.0, 5403.0, 5487.0, 5537.0, 5359.0, 5412.0, 5316.0, 5339.0, 5568.0, 5553.0, 5541.0, 5561.0, 5676.0, 5390.0, 5695.0, 5265.0, 5498.0, 5616.0, 5599.0, 5623.0, 5317.0, 5543.0, 5533.0, 5456.0, 5266.0, 5291.0, 5674.0, 5531.0, 5546.0, 5283.0, 5625.0, 5656.0, 5583.0, 5392.0, 5254.0, 5685.0, 5336.0, 5638.0, 5421.0, 5405.0, 5323.0, 5340.0, 5597.0, 5366.0, 5344.0, 5430.0, 5408.0, 5514.0, 5665.0, 5350.0, 5433.0, 5621.0, 5694.0, 5357.0, 5385.0, 5388.0, 5382.0, 5670.0, 5693.0, 5253.0, 5334.0, 5333.0, 5458.0, 5558.0, 5562.0, 5463.0, 5578.0, 5645.0, 5310.0, 5526.0, 5338.0, 5614.0, 5292.0, 5321.0, 5490.0, 5468.0, 5365.0, 5579.0, 5586.0, 5329.0, 5492.0, 5389.0, 5277.0, 5691.0, 5349.0, 5633.0, 5407.0, 5574.0, 5309.0, 5689.0, 5263.0, 5657.0, 5711.0, 5469.0, 5610.0, 5276.0 (number of hits: 6)
5	5580	9	1	333	1	5567.0, 5332.0, 5508.0, 5537.0, 5646.0, 5432.0, 5533.0, 5556.0, 5549.0, 5597.0, 5644.0, 5443.0, 5497.0, 5554.0, 5361.0, 5362.0, 5322.0, 5446.0, 5470.0, 5464.0, 5542.0, 5658.0, 5417.0, 5555.0, 5385.0, 5499.0, 5488.0, 5366.0, 5642.0, 5400.0, 5667.0, 5413.0, 5524.0, 5588.0, 5713.0, 5589.0, 5552.0, 5282.0, 5584.0, 5595.0, 5680.0, 5723.0, 5435.0, 5534.0, 5679.0, 5442.0, 5356.0, 5353.0, 5600.0, 5643.0, 5358.0, 5419.0, 5452.0, 5539.0, 5694.0, 5641.0, 5510.0, 5289.0, 5458.0, 5261.0, 5676.0, 5393.0, 5670.0, 5373.0, 5392.0, 5447.0, 5293.0, 5338.0, 5259.0, 5666.0, 5664.0, 5303.0, 5635.0, 5456.0, 5507.0, 5340.0, 5709.0, 5531.0, 5648.0, 5299.0, 5287.0, 5315.0, 5653.0, 5298.0, 5577.0, 5518.0, 5309.0, 5712.0, 5457.0, 5562.0, 5581.0, 5305.0, 5285.0, 5270.0, 5310.0, 5272.0, 5621.0, 5308.0, 5484.0, 5582.0 (number of hits: 11)
6	5580	9	1	333	1	5457.0, 5417.0, 5263.0, 5662.0, 5316.0, 5275.0, 5671.0, 5302.0, 5465.0, 5255.0, 5369.0, 5361.0, 5711.0, 5413.0, 5627.0, 5476.0, 5565.0, 5376.0, 5483.0, 5303.0, 5540.0, 5273.0, 5643.0, 5283.0, 5425.0, 5309.0, 5251.0, 5685.0, 5282.0, 5687.0, 5563.0, 5441.0, 5682.0, 5423.0, 5614.0, 5624.0, 5284.0, 5334.0, 5511.0, 5513.0,

						5705.0, 5620.0, 5290.0, 5359.0, 5583.0, 5454.0, 5301.0, 5512.0, 5553.0, 5456.0, 5382.0, 5402.0, 5679.0, 5649.0, 5670.0, 5615.0, 5420.0, 5592.0, 5265.0, 5419.0, 5489.0, 5405.0, 5617.0, 5521.0, 5450.0, 5398.0, 5323.0, 5658.0, 5421.0, 5503.0, 5418.0, 5631.0, 5518.0, 5407.0, 5686.0, 5326.0, 5558.0, 5680.0, 5488.0, 5640.0, 5504.0, 5331.0, 5252.0, 5468.0, 5280.0, 5470.0, 5710.0, 5604.0, 5531.0, 5655.0, 5637.0, 5636.0, 5444.0, 5625.0, 5546.0, 5524.0, 5618.0, 5650.0, 5321.0, 5490.0 (number of hits: 5)
7	5580	9	1	333	1	5385.0, 5470.0, 5431.0, 5712.0, 5326.0, 5605.0, 5383.0, 5654.0, 5429.0, 5594.0, 5378.0, 5530.0, 5289.0, 5475.0, 5284.0, 5396.0, 5630.0, 5255.0, 5395.0, 5416.0, 5368.0, 5506.0, 5296.0, 5344.0, 5495.0, 5418.0, 5400.0, 5591.0, 5628.0, 5324.0, 5656.0, 5351.0, 5382.0, 5421.0, 5565.0, 5665.0, 5397.0, 5391.0, 5704.0, 5328.0, 5583.0, 5388.0, 5424.0, 5285.0, 5701.0, 5599.0, 5413.0, 5536.0, 5609.0, 5464.0, 5415.0, 5451.0, 5455.0, 5352.0, 5432.0, 5544.0, 5317.0, 5252.0, 5375.0, 5343.0, 5685.0, 5496.0, 5321.0, 5461.0, 5652.0, 5547.0, 5483.0, 5505.0, 5471.0, 5525.0, 5460.0, 5596.0, 5354.0, 5639.0, 5721.0, 5350.0, 5723.0, 5687.0, 5280.0, 5574.0, 5376.0, 5448.0, 5634.0, 5341.0, 5309.0, 5298.0, 5625.0, 5282.0, 5427.0, 5632.0, 5693.0, 5374.0, 5585.0, 5299.0, 5435.0, 5545.0, 5308.0, 5688.0, 5369.0, 5433.0 (number of hits: 7)
8	5580	9	1	333	1	5320.0, 5663.0, 5424.0, 5315.0, 5587.0, 5708.0, 5356.0, 5625.0, 5546.0, 5577.0, 5537.0, 5647.0, 5598.0, 5491.0, 5521.0, 5312.0, 5687.0, 5363.0, 5322.0, 5691.0, 5279.0, 5475.0, 5453.0, 5707.0, 5342.0, 5410.0, 5622.0, 5379.0, 5407.0, 5390.0, 5366.0, 5260.0, 5277.0, 5522.0, 5596.0, 5426.0, 5438.0, 5573.0, 5332.0, 5419.0, 5489.0, 5459.0, 5711.0, 5458.0, 5602.0, 5679.0, 5702.0, 5516.0, 5466.0, 5654.0, 5502.0, 5308.0, 5658.0, 5472.0, 5650.0, 5623.0, 5651.0, 5311.0, 5439.0, 5697.0, 5561.0, 5474.0, 5680.0, 5319.0, 5553.0, 5262.0, 5642.0, 5603.0, 5618.0, 5720.0, 5548.0, 5325.0, 5289.0, 5391.0, 5704.0, 5296.0, 5259.0, 5302.0, 5341.0, 5444.0, 5566.0, 5665.0, 5575.0, 5671.0, 5585.0, 5523.0, 5468.0, 5559.0, 5673.0, 5276.0, 5431.0, 5352.0, 5507.0, 5399.0, 5721.0, 5304.0, 5395.0, 5290.0, 5539.0, 5674.0 (number of hits: 8)
9	5580	9	1	333	1	5566.0, 5549.0, 5528.0, 5425.0, 5430.0, 5325.0, 5295.0, 5353.0, 5613.0, 5626.0, 5620.0, 5276.0, 5722.0, 5259.0, 5556.0, 5635.0, 5582.0, 5262.0, 5457.0, 5438.0,

						5503.0, 5558.0, 5547.0, 5597.0, 5698.0, 5296.0, 5282.0, 5410.0, 5407.0, 5363.0, 5266.0, 5562.0, 5394.0, 5488.0, 5351.0, 5253.0, 5459.0, 5641.0, 5649.0, 5530.0, 5577.0, 5643.0, 5298.0, 5513.0, 5571.0, 5713.0, 5694.0, 5456.0, 5290.0, 5573.0, 5637.0, 5473.0, 5360.0, 5619.0, 5399.0, 5458.0, 5700.0, 5412.0, 5470.0, 5502.0, 5543.0, 5355.0, 5271.0, 5317.0, 5354.0, 5441.0, 5375.0, 5374.0, 5551.0, 5630.0, 5640.0, 5480.0, 5512.0, 5701.0, 5250.0, 5434.0, 5712.0, 5367.0, 5618.0, 5533.0, 5435.0, 5624.0, 5550.0, 5648.0, 5585.0, 5474.0, 5251.0, 5600.0, 5707.0, 5264.0, 5705.0, 5487.0, 5350.0, 5673.0, 5527.0, 5352.0, 5616.0, 5669.0, 5538.0, 5330.0 (number of hits: 4)
10	5580	9	1	333	1	5631.0, 5290.0, 5324.0, 5321.0, 5305.0, 5410.0, 5353.0, 5418.0, 5652.0, 5609.0, 5469.0, 5517.0, 5297.0, 5468.0, 5433.0, 5483.0, 5312.0, 5544.0, 5596.0, 5583.0, 5603.0, 5315.0, 5653.0, 5559.0, 5543.0, 5620.0, 5291.0, 5589.0, 5430.0, 5644.0, 5636.0, 5576.0, 5260.0, 5356.0, 5685.0, 5413.0, 5590.0, 5704.0, 5329.0, 5380.0, 5351.0, 5673.0, 5598.0, 5370.0, 5618.0, 5707.0, 5252.0, 5354.0, 5322.0, 5461.0, 5396.0, 5579.0, 5323.0, 5365.0, 5445.0, 5511.0, 5604.0, 5663.0, 5467.0, 5573.0, 5270.0, 5422.0, 5316.0, 5564.0, 5475.0, 5400.0, 5258.0, 5376.0, 5364.0, 5405.0, 5417.0, 5703.0, 5288.0, 5720.0, 5284.0, 5612.0, 5676.0, 5385.0, 5455.0, 5293.0, 5568.0, 5327.0, 5494.0, 5440.0, 5434.0, 5554.0, 5428.0, 5700.0, 5662.0, 5686.0, 5325.0, 5296.0, 5518.0, 5654.0, 5337.0, 5666.0, 5672.0, 5513.0, 5272.0, 5332.0 (number of hits: 8)
11	5580	9	1	333	1	5537.0, 5411.0, 5255.0, 5644.0, 5585.0, 5653.0, 5443.0, 5490.0, 5554.0, 5591.0, 5272.0, 5433.0, 5707.0, 5525.0, 5596.0, 5689.0, 5639.0, 5714.0, 5674.0, 5377.0, 5260.0, 5615.0, 5418.0, 5436.0, 5340.0, 5665.0, 5621.0, 5556.0, 5333.0, 5325.0, 5617.0, 5305.0, 5487.0, 5492.0, 5427.0, 5302.0, 5463.0, 5598.0, 5277.0, 5317.0, 5466.0, 5285.0, 5581.0, 5539.0, 5720.0, 5336.0, 5320.0, 5685.0, 5493.0, 5254.0, 5566.0, 5278.0, 5622.0, 5474.0, 5287.0, 5594.0, 5308.0, 5491.0, 5667.0, 5376.0, 5523.0, 5592.0, 5298.0, 5330.0, 5290.0, 5394.0, 5437.0, 5382.0, 5319.0, 5499.0, 5273.0, 5575.0, 5434.0, 5442.0, 5454.0, 5438.0, 5562.0, 5647.0, 5508.0, 5311.0, 5362.0, 5328.0, 5690.0, 5284.0, 5407.0, 5713.0, 5421.0, 5607.0, 5380.0, 5664.0, 5692.0, 5520.0, 5501.0, 5658.0, 5313.0, 5456.0, 5458.0, 5606.0, 5584.0, 5453.0 (number of hits: 9)

12	5580	9	1	333	1	<p>5487.0, 5515.0, 5526.0, 5424.0, 5400.0, 5340.0, 5622.0, 5413.0, 5484.0, 5281.0, 5288.0, 5336.0, 5490.0, 5493.0, 5407.0, 5473.0, 5601.0, 5322.0, 5608.0, 5633.0, 5674.0, 5641.0, 5619.0, 5369.0, 5362.0, 5467.0, 5348.0, 5724.0, 5694.0, 5384.0, 5481.0, 5589.0, 5539.0, 5436.0, 5651.0, 5356.0, 5538.0, 5558.0, 5709.0, 5459.0, 5477.0, 5692.0, 5326.0, 5365.0, 5275.0, 5339.0, 5451.0, 5638.0, 5494.0, 5642.0, 5282.0, 5352.0, 5617.0, 5664.0, 5476.0, 5700.0, 5510.0, 5705.0, 5620.0, 5504.0, 5574.0, 5297.0, 5372.0, 5656.0, 5331.0, 5578.0, 5347.0, 5420.0, 5587.0, 5579.0, 5564.0, 5518.0, 5444.0, 5543.0, 5701.0, 5317.0, 5631.0, 5598.0, 5720.0, 5376.0, 5565.0, 5357.0, 5320.0, 5315.0, 5683.0, 5268.0, 5349.0, 5379.0, 5722.0, 5581.0, 5648.0, 5662.0, 5486.0, 5254.0, 5462.0, 5499.0, 5299.0, 5274.0, 5660.0, 5623.0 (number of hits: 3)</p>
13	5580	9	1	333	1	<p>5637.0, 5451.0, 5292.0, 5486.0, 5620.0, 5474.0, 5599.0, 5395.0, 5555.0, 5318.0, 5563.0, 5659.0, 5485.0, 5665.0, 5323.0, 5594.0, 5360.0, 5685.0, 5528.0, 5488.0, 5614.0, 5500.0, 5667.0, 5430.0, 5511.0, 5326.0, 5483.0, 5507.0, 5512.0, 5694.0, 5402.0, 5464.0, 5387.0, 5256.0, 5505.0, 5253.0, 5450.0, 5426.0, 5628.0, 5403.0, 5419.0, 5302.0, 5492.0, 5605.0, 5699.0, 5484.0, 5432.0, 5278.0, 5269.0, 5261.0, 5593.0, 5390.0, 5328.0, 5653.0, 5463.0, 5646.0, 5429.0, 5696.0, 5621.0, 5576.0, 5618.0, 5254.0, 5359.0, 5506.0, 5625.0, 5439.0, 5549.0, 5607.0, 5314.0, 5251.0, 5502.0, 5283.0, 5423.0, 5684.0, 5644.0, 5435.0, 5655.0, 5472.0, 5315.0, 5350.0, 5527.0, 5571.0, 5265.0, 5619.0, 5361.0, 5633.0, 5368.0, 5588.0, 5671.0, 5397.0, 5307.0, 5703.0, 5327.0, 5287.0, 5660.0, 5412.0, 5530.0, 5339.0, 5417.0, 5271.0 (number of hits: 5)</p>
14	5580	9	1	333	1	<p>5250.0, 5561.0, 5494.0, 5394.0, 5491.0, 5357.0, 5320.0, 5563.0, 5295.0, 5376.0, 5672.0, 5375.0, 5438.0, 5693.0, 5493.0, 5522.0, 5404.0, 5682.0, 5416.0, 5495.0, 5267.0, 5692.0, 5415.0, 5463.0, 5711.0, 5360.0, 5310.0, 5285.0, 5355.0, 5449.0, 5322.0, 5602.0, 5318.0, 5261.0, 5704.0, 5392.0, 5551.0, 5533.0, 5334.0, 5557.0, 5526.0, 5661.0, 5385.0, 5683.0, 5331.0, 5698.0, 5326.0, 5300.0, 5265.0, 5552.0, 5566.0, 5410.0, 5705.0, 5702.0, 5545.0, 5687.0, 5715.0, 5429.0, 5584.0, 5531.0, 5359.0, 5596.0, 5312.0, 5391.0, 5587.0, 5481.0, 5347.0, 5340.0, 5270.0, 5418.0, 5403.0, 5253.0, 5406.0, 5361.0, 5330.0, 5517.0, 5291.0, 5447.0, 5485.0, 5701.0, 5577.0, 5645.0, 5605.0, 5642.0, 5317.0,</p>

						5643.0, 5390.0, 5512.0, 5539.0, 5507.0, 5411.0, 5571.0, 5426.0, 5296.0, 5688.0, 5611.0, 5460.0, 5650.0, 5266.0, 5324.0 (number of hits: 7)
15	5580	9	1	333	1	5632.0, 5542.0, 5285.0, 5287.0, 5326.0, 5384.0, 5378.0, 5687.0, 5670.0, 5263.0, 5559.0, 5602.0, 5566.0, 5411.0, 5524.0, 5293.0, 5455.0, 5610.0, 5664.0, 5690.0, 5274.0, 5547.0, 5339.0, 5359.0, 5476.0, 5676.0, 5365.0, 5607.0, 5646.0, 5299.0, 5681.0, 5495.0, 5654.0, 5462.0, 5713.0, 5540.0, 5474.0, 5604.0, 5551.0, 5307.0, 5603.0, 5461.0, 5413.0, 5368.0, 5591.0, 5696.0, 5640.0, 5501.0, 5620.0, 5549.0, 5614.0, 5497.0, 5579.0, 5369.0, 5438.0, 5452.0, 5429.0, 5555.0, 5439.0, 5716.0, 5389.0, 5417.0, 5422.0, 5258.0, 5448.0, 5572.0, 5502.0, 5668.0, 5711.0, 5440.0, 5356.0, 5450.0, 5545.0, 5667.0, 5276.0, 5325.0, 5449.0, 5446.0, 5649.0, 5569.0, 5500.0, 5600.0, 5509.0, 5498.0, 5680.0, 5475.0, 5349.0, 5445.0, 5376.0, 5485.0, 5595.0, 5637.0, 5374.0, 5641.0, 5320.0, 5507.0, 5251.0, 5459.0, 5360.0, 5642.0 (number of hits: 5)
16	5580	9	1	333	1	5497.0, 5258.0, 5401.0, 5351.0, 5607.0, 5664.0, 5701.0, 5341.0, 5485.0, 5435.0, 5474.0, 5481.0, 5279.0, 5703.0, 5434.0, 5381.0, 5270.0, 5418.0, 5598.0, 5570.0, 5587.0, 5674.0, 5525.0, 5502.0, 5359.0, 5281.0, 5589.0, 5633.0, 5414.0, 5688.0, 5438.0, 5634.0, 5326.0, 5569.0, 5407.0, 5377.0, 5347.0, 5515.0, 5536.0, 5582.0, 5529.0, 5462.0, 5471.0, 5466.0, 5575.0, 5321.0, 5397.0, 5699.0, 5498.0, 5533.0, 5432.0, 5628.0, 5282.0, 5620.0, 5518.0, 5681.0, 5460.0, 5335.0, 5349.0, 5385.0, 5679.0, 5680.0, 5323.0, 5617.0, 5277.0, 5324.0, 5344.0, 5293.0, 5638.0, 5698.0, 5409.0, 5506.0, 5482.0, 5656.0, 5531.0, 5705.0, 5426.0, 5337.0, 5486.0, 5561.0, 5350.0, 5417.0, 5645.0, 5675.0, 5273.0, 5309.0, 5469.0, 5640.0, 5678.0, 5697.0, 5327.0, 5644.0, 5478.0, 5551.0, 5660.0, 5354.0, 5564.0, 5325.0, 5549.0, 5379.0 (number of hits: 2)
17	5580	9	1	333	1	5584.0, 5716.0, 5645.0, 5478.0, 5602.0, 5330.0, 5460.0, 5560.0, 5496.0, 5357.0, 5426.0, 5481.0, 5669.0, 5518.0, 5557.0, 5530.0, 5352.0, 5295.0, 5501.0, 5627.0, 5364.0, 5474.0, 5493.0, 5641.0, 5510.0, 5667.0, 5301.0, 5407.0, 5327.0, 5282.0, 5335.0, 5538.0, 5450.0, 5278.0, 5480.0, 5577.0, 5640.0, 5583.0, 5568.0, 5632.0, 5349.0, 5644.0, 5498.0, 5486.0, 5284.0, 5663.0, 5634.0, 5264.0, 5443.0, 5658.0, 5320.0, 5637.0, 5348.0, 5680.0, 5500.0, 5403.0, 5508.0, 5504.0, 5599.0, 5372.0, 5388.0, 5694.0, 5261.0, 5643.0, 5709.0,

						5650.0, 5614.0, 5706.0, 5502.0, 5467.0, 5546.0, 5367.0, 5294.0, 5642.0, 5720.0, 5458.0, 5303.0, 5258.0, 5516.0, 5588.0, 5628.0, 5595.0, 5399.0, 5515.0, 5629.0, 5522.0, 5306.0, 5255.0, 5615.0, 5411.0, 5534.0, 5293.0, 5431.0, 5286.0, 5465.0, 5370.0, 5275.0, 5292.0, 5362.0, 5717.0 (number of hits: 8)
18	5580	9	1	333		5647.0, 5453.0, 5285.0, 5670.0, 5492.0, 5627.0, 5411.0, 5615.0, 5439.0, 5604.0, 5330.0, 5463.0, 5256.0, 5488.0, 5533.0, 5659.0, 5642.0, 5270.0, 5523.0, 5717.0, 5473.0, 5710.0, 5447.0, 5441.0, 5581.0, 5644.0, 5457.0, 5663.0, 5261.0, 5309.0, 5691.0, 5370.0, 5594.0, 5445.0, 5548.0, 5658.0, 5656.0, 5720.0, 5333.0, 5458.0, 5490.0, 5661.0, 5593.0, 5715.0, 5579.0, 5592.0, 5572.0, 5673.0, 5369.0, 5536.0, 5633.0, 5635.0, 5318.0, 5682.0, 5484.0, 5257.0, 5556.0, 5314.0, 5629.0, 5489.0, 5338.0, 5679.0, 5560.0, 5678.0, 5646.0, 5396.0, 5311.0, 5346.0, 5401.0, 5320.0, 5540.0, 5460.0, 5624.0, 5645.0, 5349.0, 5649.0, 5558.0, 5512.0, 5413.0, 5616.0, 5386.0, 5326.0, 5689.0, 5508.0, 5541.0, 5567.0, 5368.0, 5714.0, 5609.0, 5344.0, 5406.0, 5639.0, 5680.0, 5648.0, 5259.0, 5713.0, 5345.0, 5262.0, 5336.0, 5498.0 (number of hits: 4)
19	5580	9	1	333	1	5268.0, 5532.0, 5363.0, 5659.0, 5377.0, 5340.0, 5525.0, 5678.0, 5605.0, 5485.0, 5553.0, 5305.0, 5504.0, 5573.0, 5534.0, 5612.0, 5550.0, 5642.0, 5600.0, 5445.0, 5402.0, 5265.0, 5533.0, 5624.0, 5618.0, 5627.0, 5427.0, 5511.0, 5524.0, 5548.0, 5454.0, 5271.0, 5562.0, 5468.0, 5580.0, 5723.0, 5333.0, 5707.0, 5329.0, 5374.0, 5352.0, 5679.0, 5501.0, 5509.0, 5560.0, 5448.0, 5472.0, 5439.0, 5508.0, 5413.0, 5602.0, 5704.0, 5544.0, 5646.0, 5660.0, 5713.0, 5387.0, 5648.0, 5441.0, 5267.0, 5555.0, 5685.0, 5378.0, 5517.0, 5336.0, 5542.0, 5287.0, 5382.0, 5653.0, 5689.0, 5321.0, 5610.0, 5703.0, 5415.0, 5495.0, 5259.0, 5631.0, 5294.0, 5574.0, 5452.0, 5636.0, 5398.0, 5293.0, 5431.0, 5651.0, 5526.0, 5266.0, 5608.0, 5487.0, 5488.0, 5458.0, 5392.0, 5721.0, 5719.0, 5449.0, 5292.0, 5383.0, 5401.0, 5252.0, 5617.0 (number of hits: 5)
20	5580	9	1	333	1	5581.0, 5541.0, 5331.0, 5700.0, 5500.0, 5424.0, 5502.0, 5562.0, 5519.0, 5413.0, 5482.0, 5689.0, 5484.0, 5608.0, 5513.0, 5388.0, 5337.0, 5468.0, 5598.0, 5667.0, 5572.0, 5434.0, 5578.0, 5599.0, 5595.0, 5585.0, 5573.0, 5638.0, 5473.0, 5618.0, 5563.0, 5259.0, 5370.0, 5327.0, 5707.0, 5516.0, 5462.0, 5615.0, 5661.0, 5514.0, 5497.0, 5703.0, 5546.0, 5659.0, 5549.0,

						5254.0, 5611.0, 5620.0, 5355.0, 5686.0, 5283.0, 5252.0, 5657.0, 5290.0, 5445.0, 5448.0, 5672.0, 5299.0, 5609.0, 5436.0, 5345.0, 5372.0, 5673.0, 5663.0, 5367.0, 5260.0, 5486.0, 5324.0, 5358.0, 5273.0, 5631.0, 5559.0, 5603.0, 5651.0, 5523.0, 5430.0, 5682.0, 5481.0, 5381.0, 5591.0, 5257.0, 5694.0, 5251.0, 5386.0, 5520.0, 5588.0, 5442.0, 5632.0, 5476.0, 5313.0, 5493.0, 5646.0, 5351.0, 5390.0, 5649.0, 5528.0, 5268.0, 5560.0, 5396.0, 5428.0 (number of hits: 3)
21	5580	9	1	333	1	5301.0, 5714.0, 5357.0, 5538.0, 5677.0, 5477.0, 5472.0, 5263.0, 5459.0, 5359.0, 5607.0, 5434.0, 5464.0, 5497.0, 5281.0, 5679.0, 5439.0, 5626.0, 5693.0, 5575.0, 5561.0, 5457.0, 5678.0, 5545.0, 5283.0, 5470.0, 5552.0, 5448.0, 5610.0, 5452.0, 5318.0, 5675.0, 5342.0, 5395.0, 5264.0, 5381.0, 5593.0, 5644.0, 5694.0, 5527.0, 5684.0, 5377.0, 5303.0, 5579.0, 5508.0, 5408.0, 5409.0, 5253.0, 5473.0, 5432.0, 5479.0, 5328.0, 5504.0, 5680.0, 5293.0, 5621.0, 5424.0, 5363.0, 5351.0, 5474.0, 5695.0, 5524.0, 5449.0, 5636.0, 5688.0, 5259.0, 5310.0, 5430.0, 5535.0, 5598.0, 5532.0, 5463.0, 5516.0, 5634.0, 5322.0, 5708.0, 5488.0, 5294.0, 5343.0, 5368.0, 5615.0, 5658.0, 5612.0, 5458.0, 5645.0, 5686.0, 5414.0, 5315.0, 5664.0, 5499.0, 5355.0, 5528.0, 5562.0, 5618.0, 5506.0, 5608.0, 5551.0, 5347.0, 5285.0, 5346.0 (number of hits: 6)
22	5580	9	1	333	1	
23	5580	9	1	333	1	5664.0, 5679.0, 5341.0, 5443.0, 5595.0, 5601.0, 5714.0, 5258.0, 5333.0, 5336.0, 5368.0, 5480.0, 5427.0, 5389.0, 5645.0, 5695.0, 5308.0, 5338.0, 5435.0, 5398.0, 5524.0, 5444.0, 5461.0, 5488.0, 5418.0, 5252.0, 5491.0, 5325.0, 5703.0, 5412.0, 5687.0, 5652.0, 5700.0, 5661.0, 5549.0, 5673.0, 5606.0, 5383.0, 5292.0, 5620.0, 5550.0, 5715.0, 5533.0, 5270.0, 5557.0, 5402.0, 5655.0, 5613.0, 5519.0, 5536.0, 5448.0, 5592.0, 5318.0, 5497.0, 5643.0, 5560.0, 5636.0, 5456.0, 5315.0, 5683.0, 5298.0, 5360.0, 5322.0, 5460.0, 5319.0, 5711.0, 5454.0, 5329.0, 5457.0, 5697.0, 5365.0, 5545.0, 5392.0, 5447.0, 5376.0, 5691.0, 5563.0, 5408.0, 5362.0, 5372.0, 5633.0, 5281.0, 5569.0, 5302.0, 5621.0, 5458.0, 5698.0, 5466.0, 5387.0, 5421.0, 5273.0, 5665.0, 5288.0, 5323.0, 5406.0, 5526.0, 5476.0, 5357.0, 5478.0, 5339.0 (number of hits: 5)
24	5580	9	1	333	1	5631.0, 5378.0, 5596.0, 5578.0, 5281.0, 5545.0, 5552.0, 5332.0, 5466.0, 5581.0, 5295.0, 5338.0, 5337.0, 5554.0, 5448.0,

						5484.0, 5442.0, 5380.0, 5627.0, 5315.0, 5286.0, 5397.0, 5651.0, 5434.0, 5670.0, 5310.0, 5635.0, 5650.0, 5304.0, 5333.0, 5345.0, 5683.0, 5393.0, 5691.0, 5349.0, 5458.0, 5657.0, 5634.0, 5678.0, 5460.0, 5564.0, 5251.0, 5391.0, 5512.0, 5366.0, 5598.0, 5638.0, 5461.0, 5707.0, 5499.0, 5276.0, 5667.0, 5296.0, 5431.0, 5405.0, 5455.0, 5544.0, 5383.0, 5367.0, 5501.0, 5293.0, 5686.0, 5589.0, 5379.0, 5388.0, 5424.0, 5339.0, 5500.0, 5363.0, 5389.0, 5272.0, 5392.0, 5473.0, 5400.0, 5343.0, 5619.0, 5518.0, 5409.0, 5282.0, 5254.0, 5521.0, 5680.0, 5427.0, 5534.0, 5523.0, 5566.0, 5428.0, 5351.0, 5335.0, 5292.0, 5649.0, 5632.0, 5348.0, 5600.0, 5528.0, 5621.0, 5658.0, 5329.0, 5516.0, 5637.0 (number of hits: 7)
25	5580	9	1	333	1	5353.0, 5673.0, 5523.0, 5679.0, 5532.0, 5573.0, 5695.0, 5292.0, 5438.0, 5582.0, 5544.0, 5261.0, 5641.0, 5666.0, 5490.0, 5406.0, 5672.0, 5488.0, 5259.0, 5492.0, 5276.0, 5277.0, 5554.0, 5441.0, 5619.0, 5514.0, 5283.0, 5426.0, 5589.0, 5638.0, 5399.0, 5400.0, 5354.0, 5700.0, 5275.0, 5255.0, 5615.0, 5560.0, 5465.0, 5635.0, 5680.0, 5262.0, 5545.0, 5376.0, 5516.0, 5356.0, 5549.0, 5704.0, 5387.0, 5667.0, 5640.0, 5417.0, 5308.0, 5423.0, 5541.0, 5634.0, 5462.0, 5557.0, 5585.0, 5345.0, 5696.0, 5552.0, 5471.0, 5580.0, 5577.0, 5528.0, 5270.0, 5653.0, 5480.0, 5705.0, 5397.0, 5305.0, 5583.0, 5273.0, 5335.0, 5402.0, 5691.0, 5697.0, 5331.0, 5312.0, 5613.0, 5503.0, 5265.0, 5302.0, 5694.0, 5509.0, 5403.0, 5290.0, 5636.0, 5723.0, 5437.0, 5624.0, 5315.0, 5332.0, 5407.0, 5595.0, 5685.0, 5713.0, 5388.0, 5281.0 (number of hits: 6)
26	5580	9	1	333	1	5531.0, 5601.0, 5438.0, 5690.0, 5564.0, 5355.0, 5633.0, 5606.0, 5336.0, 5658.0, 5467.0, 5556.0, 5372.0, 5416.0, 5592.0, 5428.0, 5425.0, 5460.0, 5537.0, 5596.0, 5283.0, 5677.0, 5523.0, 5508.0, 5558.0, 5329.0, 5424.0, 5458.0, 5453.0, 5332.0, 5405.0, 5337.0, 5391.0, 5300.0, 5648.0, 5291.0, 5600.0, 5341.0, 5431.0, 5445.0, 5566.0, 5605.0, 5693.0, 5345.0, 5613.0, 5374.0, 5611.0, 5664.0, 5645.0, 5618.0, 5671.0, 5604.0, 5707.0, 5617.0, 5521.0, 5709.0, 5691.0, 5268.0, 5393.0, 5706.0, 5583.0, 5377.0, 5599.0, 5277.0, 5507.0, 5676.0, 5533.0, 5722.0, 5252.0, 5426.0, 5640.0, 5494.0, 5446.0, 5687.0, 5584.0, 5401.0, 5450.0, 5411.0, 5457.0, 5639.0, 5302.0, 5562.0, 5661.0, 5565.0, 5465.0, 5644.0, 5697.0, 5287.0, 5371.0, 5419.0, 5396.0, 5309.0, 5307.0, 5591.0, 5320.0, 5509.0, 5578.0, 5575.0, 5497.0, 5473.0

						(number of hits: 6)
27	5580	9	1	333	1	5660.0, 5260.0, 5290.0, 5664.0, 5316.0, 5444.0, 5440.0, 5595.0, 5366.0, 5392.0, 5478.0, 5604.0, 5410.0, 5405.0, 5557.0, 5535.0, 5383.0, 5468.0, 5704.0, 5322.0, 5505.0, 5484.0, 5559.0, 5421.0, 5337.0, 5706.0, 5705.0, 5695.0, 5268.0, 5476.0, 5655.0, 5672.0, 5313.0, 5497.0, 5518.0, 5654.0, 5454.0, 5582.0, 5452.0, 5327.0, 5723.0, 5378.0, 5388.0, 5638.0, 5382.0, 5261.0, 5414.0, 5608.0, 5686.0, 5721.0, 5352.0, 5436.0, 5500.0, 5411.0, 5573.0, 5460.0, 5279.0, 5349.0, 5371.0, 5364.0, 5619.0, 5286.0, 5346.0, 5565.0, 5687.0, 5712.0, 5265.0, 5362.0, 5692.0, 5311.0, 5380.0, 5634.0, 5519.0, 5699.0, 5502.0, 5529.0, 5384.0, 5710.0, 5584.0, 5503.0, 5395.0, 5581.0, 5659.0, 5453.0, 5697.0, 5457.0, 5438.0, 5563.0, 5668.0, 5335.0, 5343.0, 5338.0, 5585.0, 5325.0, 5255.0, 5263.0, 5601.0, 5572.0, 5575.0, 5379.0
						(number of hits: 4)
28	5580	9	1	333	1	5489.0, 5528.0, 5420.0, 5344.0, 5695.0, 5503.0, 5428.0, 5500.0, 5293.0, 5392.0, 5660.0, 5335.0, 5410.0, 5626.0, 5442.0, 5629.0, 5467.0, 5364.0, 5281.0, 5620.0, 5492.0, 5310.0, 5508.0, 5681.0, 5315.0, 5549.0, 5303.0, 5288.0, 5535.0, 5323.0, 5391.0, 5413.0, 5698.0, 5518.0, 5429.0, 5544.0, 5406.0, 5462.0, 5540.0, 5417.0, 5478.0, 5412.0, 5512.0, 5437.0, 5669.0, 5632.0, 5313.0, 5400.0, 5459.0, 5381.0, 5317.0, 5556.0, 5271.0, 5390.0, 5644.0, 5483.0, 5673.0, 5671.0, 5299.0, 5411.0, 5648.0, 5475.0, 5539.0, 5325.0, 5415.0, 5623.0, 5520.0, 5314.0, 5597.0, 5603.0, 5554.0, 5683.0, 5651.0, 5453.0, 5479.0, 5309.0, 5598.0, 5399.0, 5664.0, 5517.0, 5504.0, 5451.0, 5440.0, 5273.0, 5599.0, 5367.0, 5548.0, 5345.0, 5426.0, 5547.0, 5446.0, 5519.0, 5575.0, 5502.0, 5589.0, 5425.0, 5387.0, 5717.0, 5527.0, 5450.0
						(number of hits: 8)
29	5580	9	1	333	1	5484.0, 5255.0, 5289.0, 5387.0, 5506.0, 5276.0, 5512.0, 5497.0, 5647.0, 5481.0, 5282.0, 5268.0, 5695.0, 5608.0, 5542.0, 5321.0, 5589.0, 5599.0, 5334.0, 5361.0, 5611.0, 5283.0, 5271.0, 5522.0, 5577.0, 5549.0, 5713.0, 5420.0, 5362.0, 5254.0, 5447.0, 5460.0, 5478.0, 5291.0, 5613.0, 5605.0, 5639.0, 5409.0, 5554.0, 5454.0, 5531.0, 5679.0, 5286.0, 5442.0, 5419.0, 5561.0, 5509.0, 5459.0, 5281.0, 5525.0, 5473.0, 5382.0, 5568.0, 5406.0, 5640.0, 5530.0, 5634.0, 5346.0, 5360.0, 5471.0, 5644.0, 5307.0, 5670.0, 5538.0, 5671.0, 5501.0, 5498.0, 5519.0, 5523.0, 5474.0, 5413.0, 5511.0, 5645.0, 5357.0, 5546.0

						5551.0, 5606.0, 5592.0, 5676.0, 5524.0, 5461.0, 5424.0, 5468.0, 5304.0, 5428.0, 5322.0, 5370.0, 5445.0, 5571.0, 5256.0, 5349.0, 5529.0, 5287.0, 5583.0, 5518.0, 5711.0, 5341.0, 5677.0, 5391.0, 5277.0 (number of hits: 6)
30	5580	9	1	333	1	5282.0, 5657.0, 5411.0, 5458.0, 5582.0, 5647.0, 5513.0, 5404.0, 5636.0, 5397.0, 5672.0, 5565.0, 5285.0, 5463.0, 5682.0, 5518.0, 5575.0, 5692.0, 5555.0, 5294.0, 5709.0, 5491.0, 5361.0, 5330.0, 5407.0, 5475.0, 5685.0, 5351.0, 5645.0, 5497.0, 5277.0, 5368.0, 5329.0, 5600.0, 5409.0, 5494.0, 5367.0, 5304.0, 5574.0, 5648.0, 5543.0, 5272.0, 5716.0, 5523.0, 5516.0, 5572.0, 5280.0, 5601.0, 5496.0, 5265.0, 5391.0, 5629.0, 5452.0, 5652.0, 5346.0, 5311.0, 5599.0, 5339.0, 5350.0, 5258.0, 5587.0, 5612.0, 5666.0, 5515.0, 5501.0, 5550.0, 5360.0, 5670.0, 5289.0, 5579.0, 5659.0, 5400.0, 5626.0, 5334.0, 5691.0, 5618.0, 5305.0, 5358.0, 5570.0, 5651.0, 5429.0, 5357.0, 5553.0, 5503.0, 5597.0, 5254.0, 5438.0, 5487.0, 5650.0, 5578.0, 5620.0, 5566.0, 5352.0, 5290.0, 5706.0, 5348.0, 5366.0, 5399.0, 5317.0, 5372.0 (number of hits: 7)

9 APPENDIX A - TEST SETUP PHOTOGRAPHS

9.1 DFS Test Setup View



10 APPENDIX B - EUT PHOTOGRAPHS

10.1 EUT AP1020i- Top View



10.2 EUT 1020i-Bottom View



10.3 EUT AP1020i- Cover off View

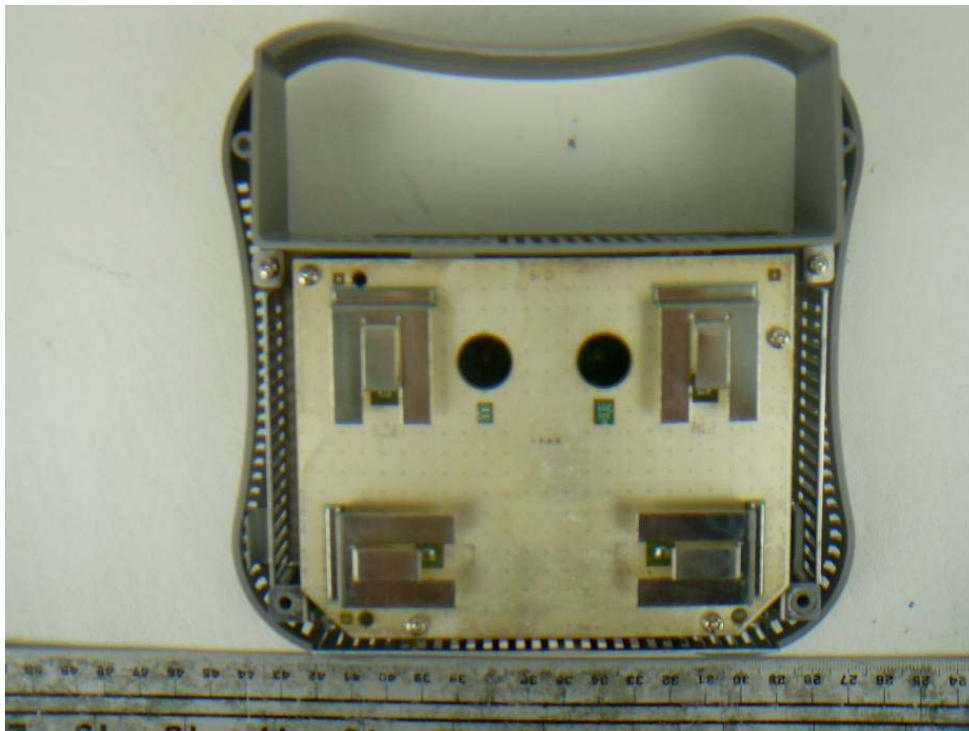

10.4 EUT AP1020i –Board Top View

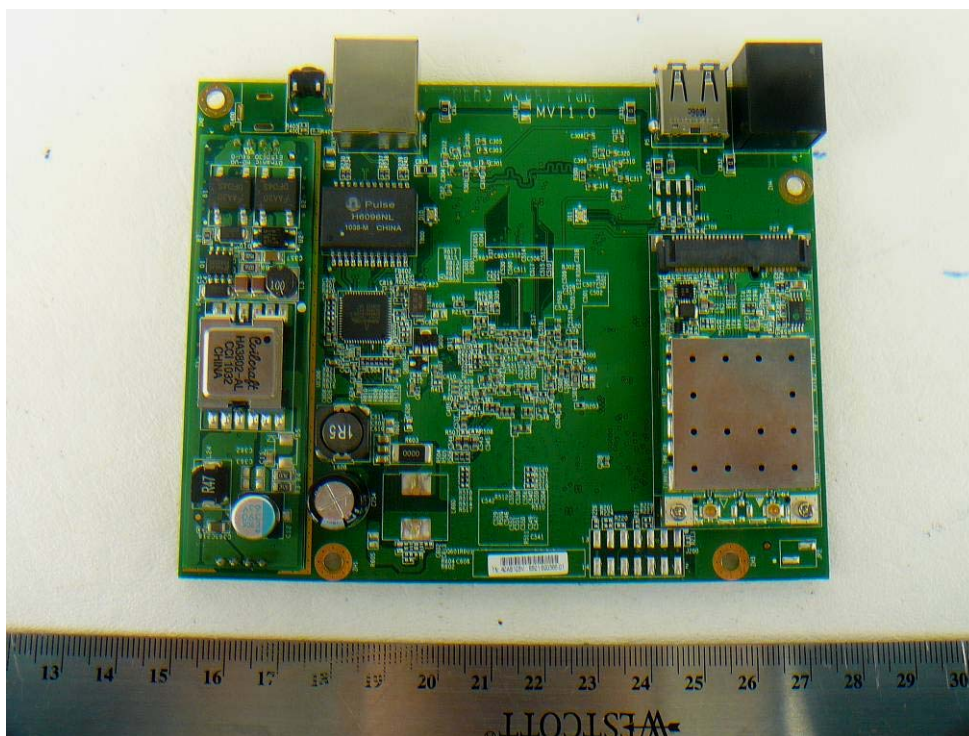

10.5 EUT AP1020i –Board Back View

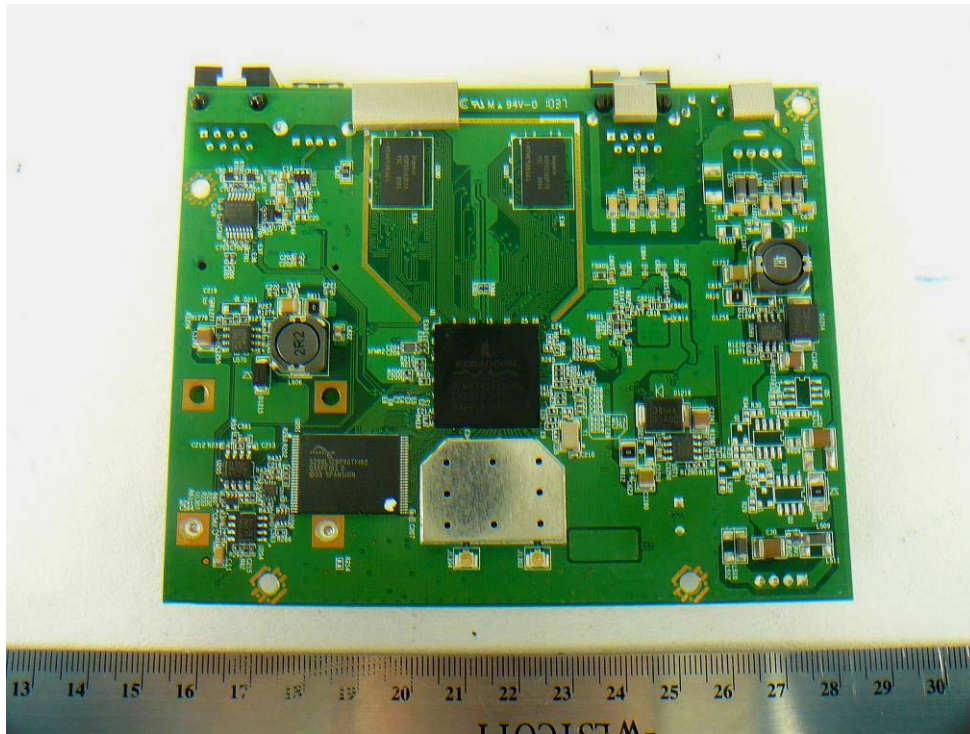

10.6 EUT – Adapter for POE



10.7 EUT AP1020e- Top View

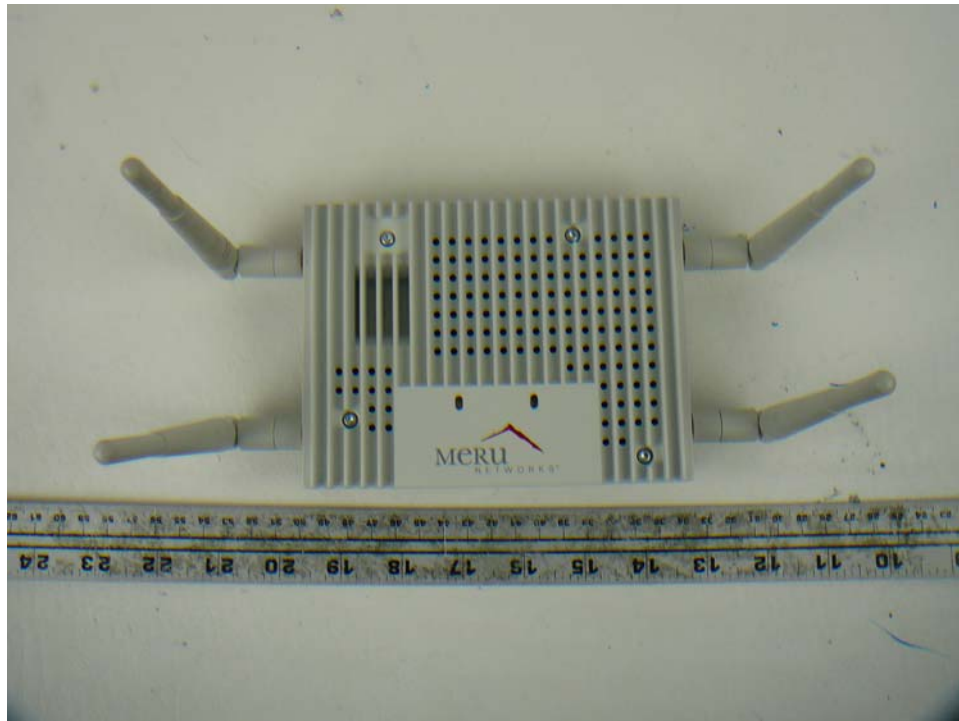

10.8 EUT 1020e-Bottom View

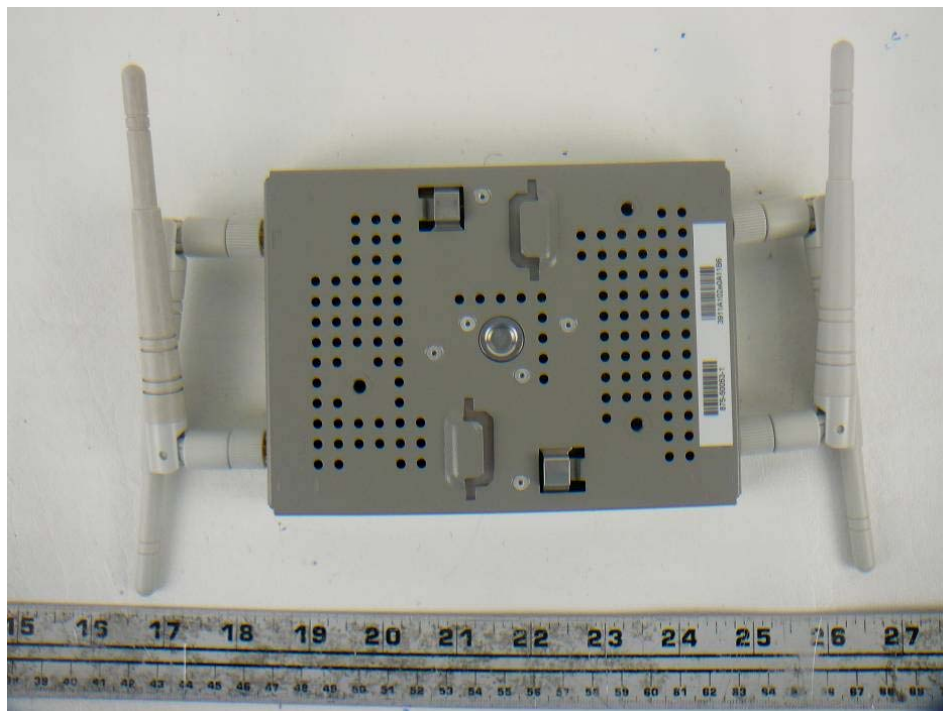

10.9 EUT AP1020e - Cover off View

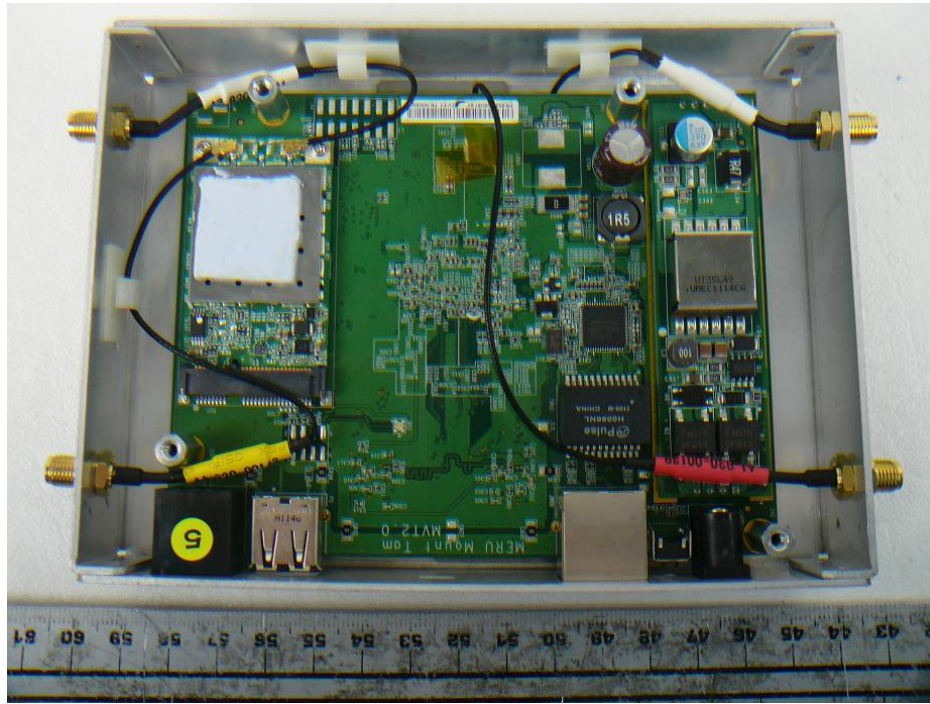

10.10 EUT AP1020e – Board Top View

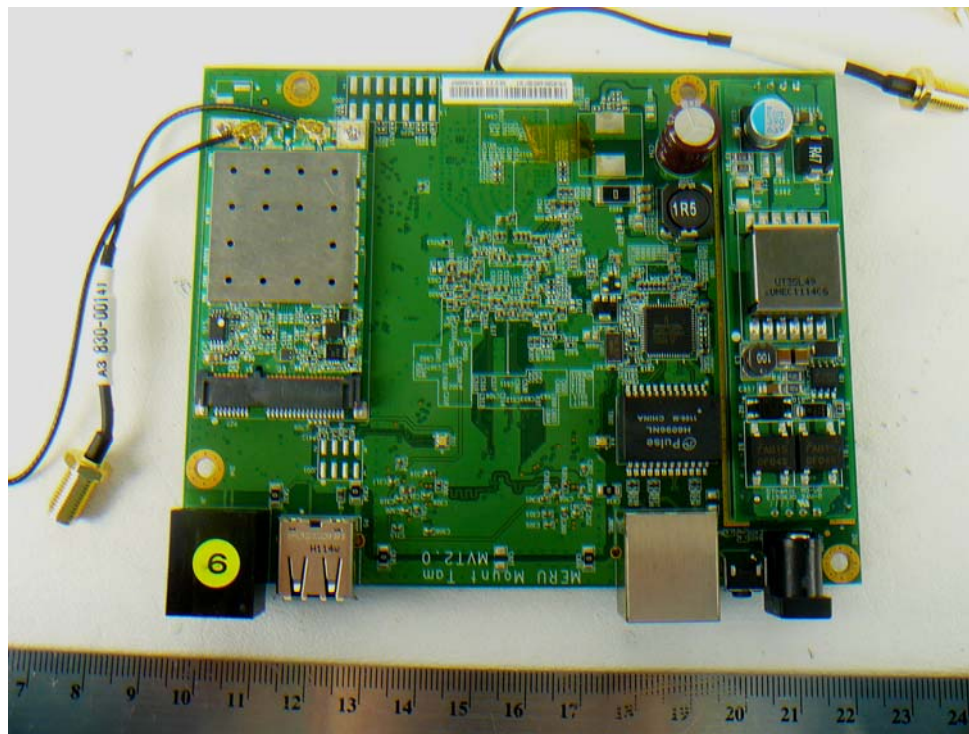

10.11 EUT AP1020e –Board Back View

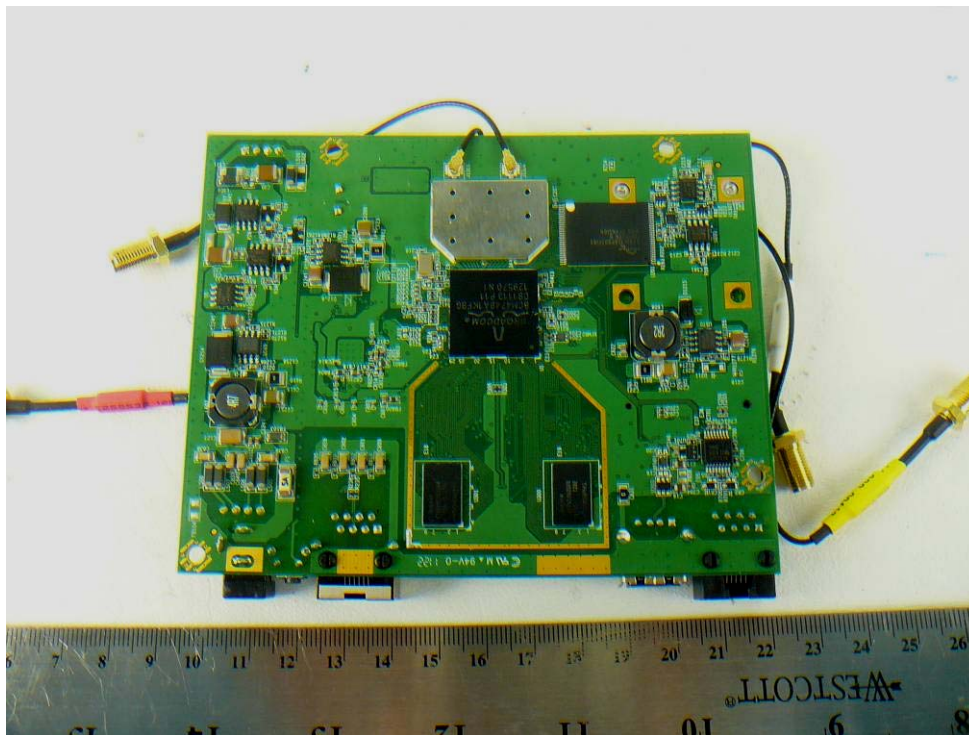

10.12 EUT AP1020e Antenna

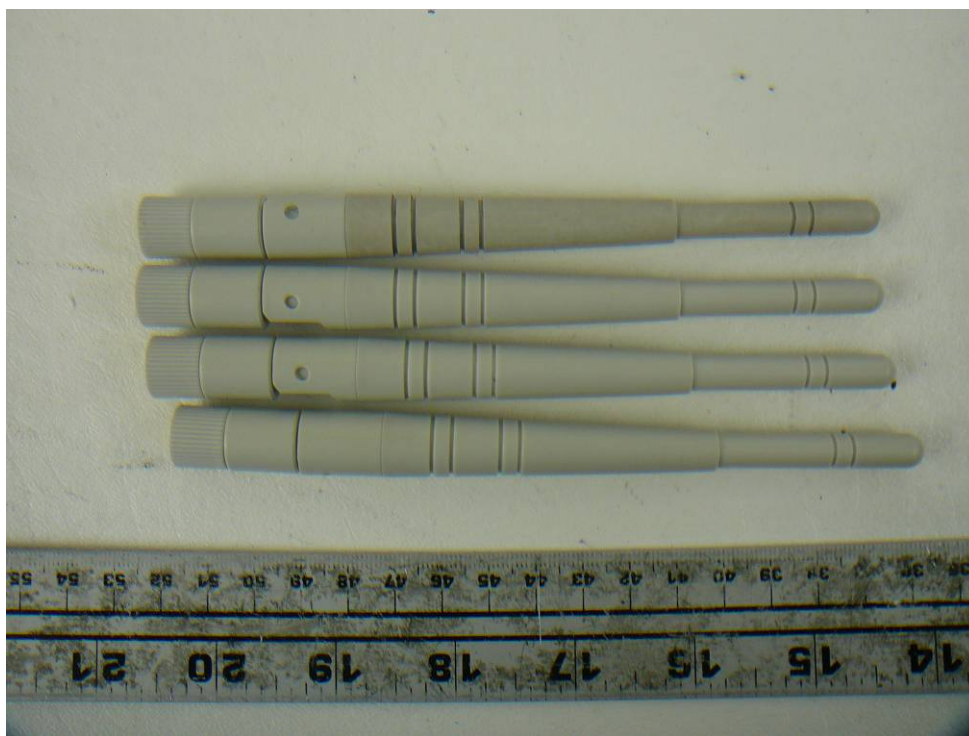

--- END OF REPORT ---