

FCC 47 CFR PART 15 SUBPART C

RF Test Report

Applicant : NETSCOUT Systems Inc.
Product Type : NETSCOUT 802.11ac Network USB Adapter
Trade Name : NETSCOUT
Model Number : D1080-Z1
Applicable Standard : FCC 47 CFR PART 15 SUBPART C
ANSI C63.10:2013
Receive Date : Mar. 17, 2016
Test Period : Apr. 06 ~ Jul. 06, 2016
Issue Date : Jul. 06, 2017

Issue by

A Test Lab Techno Corp.
No. 140-1, Changan Street, Bade District,
Taoyuan City 33465, Taiwan (R.O.C)
Tel : +886-3-2710188 / Fax : +886-3-2710190



Taiwan Accreditation Eoundation accreditation number: 1330
Test Firm MRA designation number: TW0010

Note: This report shall not be reproduced except in full, without the written approval of A Test Lab Techno Corp. This document may be altered or revised by A Test Lab Techno Corp. personnel only, and shall be noted in the revision section of the document. The client should not use it to claim product endorsement by TAF, or any government agencies. The test results in the report only apply to the tested sample.



Revision History

Rev.	Issue Date	Revisions	Revised By
00	Jun. 07, 2017	Initial Issue	Nina Lin
01	Jul. 06, 2017	Revised report information.	Nina Lin



Verification of Compliance

Issued Date: Jul. 06, 2017

Applicant : NETSCOUT Systems Inc.
Product Type : NETSCOUT 802.11ac Network USB Adapter
Trade Name : NETSCOUT
Model Number : D1080-Z1
FCC ID : RD7-USB11AC
EUT Rated Voltage : DC 5V, 900mA
Test Voltage : 120 Vac / 60 Hz
Applicable Standard : FCC 47 CFR PART 15 SUBPART C
ANSI C63.10:2013
Test Result : Complied
Performing Lab. : A Test Lab Techno Corp.

No. 140-1, Changan Street, Bade District,
Taoyuan City 33465, Taiwan (R.O.C)
Tel : +886-3-2710188 / Fax : +886-3-2710190



Taiwan Accreditation Foundation accreditation number: 1330
<http://www.atl-lab.com.tw/e-index.htm>

A Test Lab Techno Corp. tested the above equipment in accordance with the requirements set forth in the above standards. All indications of Pass/Fail in this report are opinions expressed by A Test Lab Techno Corp. based on interpretations and/or observations of test results. Measurement Uncertainties were not taken into account and are published for informational purposes only. The test results show that the equipment tested is capable of demonstrating compliance with the requirements as documented in this report.

Approved By : Fly Lu Reviewed By : Eric Ou Yang
(Manager) (Fly Lu) (Testing Engineer) (Eric Ou Yang)



TABLE OF CONTENTS

1	General Information	6
2	EUT Description	7
3	Test Methodology	8
3.1.	Mode of Operation	8
3.2.	EUT Exercise Software	12
3.3.	Configuration of Test System Details	13
3.4.	Test Site Environment	13
4	AC Power Line Conducted Emission Measurement	14
4.1.	Limit	14
4.2.	Test Instruments	14
4.3.	Test Setup	14
4.4.	Test Procedure	15
4.5.	Test Result	16
5	Radiated Emission Measurement	18
5.1.	Limit	18
5.2.	Test Instruments	18
5.3.	Setup	19
5.4.	Test Procedure	21
5.5.	Test Result	23
6	Maximum Conducted Output Power Measurement	59
6.1.	Limit	59
6.2.	Test Setup	59
6.3.	Test Instruments	59
6.4.	Test Procedure	59
6.5.	Test Result	60
7	6dB RF Bandwidth Measurement	65
7.1.	Limit	65
7.2.	Test Setup	65
7.3.	Test Instruments	65
7.4.	Test Procedure	65
7.5.	Test Result	66
7.6.	Test Graphs	67



- 8 Maximum Power Density Measurement75**
 - 8.1. Limit.....75
 - 8.2. Test Setup75
 - 8.3. Test Instruments75
 - 8.4. Test Procedure76
 - 8.5. Test Result.....77
 - 8.6. Test Graphs78
- 9 Out of Band Conducted Emissions Measurement86**
 - 9.1. Limit.....86
 - 9.2. Test Setup86
 - 9.3. Test Instruments86
 - 9.4. Test Procedure86
 - 9.5. Test Graphs87
- 10 Antenna Measurement111**
 - 10.1.Limit..... 111
 - 10.2.Antenna Description 111
 - 10.3.Directiona Gain Calculated 111



1 General Information

1.1 Summary of Test Result

Standard	Item	Result	Remark
15.247			
15.207	AC Power Conducted Emission	PASS	-----
Standard	Item	Result	Remark
15.247			
15.247(d)	Transmitter Radiated Emissions	PASS	-----
15.247(b)(3)	Max. Output Power	PASS	-----
15.247(a)(2)	6dB RF Bandwidth	PASS	-----
15.247(e)	Power Spectral Density	PASS	-----
15.247(d)	Out of Band Conducted Spurious Emission	PASS	-----
15.203	Antenna Requirement	PASS	-----

The test results of this report relate only to the tested sample(s) identified in this report. Manufacturer or whom it may concern should recognize the pass or fail of the test result.

1.2 Measurement Uncertainty

Test Item	Frequency Range	Uncertainty (dB)
Conducted Emission	9kHz ~ 150KHz	2.7
	150kHz ~ 30MHz	2.7
Radiated Emission	9kHz ~ 30MHz	1.7
	30MHz ~ 1000MHz	5.7
	1000MHz ~ 18000MHz	5.5
	18000MHz ~ 26500MHz	4.8
	26500MHz ~ 40000MHz	4.8
Conducted Output Power	+0.27 dB / -0.28 dB	
RF Bandwidth	4.96%	
Power Spectral Density	+0.71 dB / -0.77 dB	



2 EUT Description

Applicant	NETSCOUT Systems Inc. 310 Littleton Road, Westford, Massachusetts, 01886-4105, United States				
Manufacturer	EDIMAX TECHNOLOGY CO. LTD. No.278, Xinhua 1st Road, Neihu Dist, Taipei City, Taiwan (R.O.C.)				
Product Type	NETSCOUT 802.11ac Network USB Adapter				
Trade Name	NETSCOUT				
Model Number	D1080-Z1				
FCC ID	RD7-USB11AC				
Operate Freq. Band	Frequency Range (MHz)	Modulation		Channel Bandwidth	Data Rate 400 GI (ns)
IEEE 802.11b	2412 ~ 2462	DSSS		20MHz	Up to 11Mbps
IEEE 802.11g	2412 ~ 2462	OFDM (64QAM)		20MHz	Up to 54Mbps
IEEE 802.11n 2.4GHz 20MHz	2412 ~ 2462	OFDM (256QAM)		20MHz	Up to 260.1Mbps
IEEE 802.11n 2.4GHz 40MHz	2422 ~ 2452	OFDM (256QAM)		40MHz	Up to 600Mbps
Antenna information	ANT	Trade Name	Model Number	Type	Max. Gain (dBi)
	ANT-0	LYNwave	ALU150-222030	PIFA antenna	4.84
	ANT-1	LYNwave	ALA110-221020-056010	PCB antenna	3.41
	ANT-2	LYNwave	ALU150-222030	PIFA antenna	3.59
Antenna Delivery	See section 3.1				

Frequency Band	Max. RF Output Power (W)
IEEE 802.11b	0.100
IEEE 802.11g	0.073
IEEE 802.11n 2.4GHz 20MHz	0.078
IEEE 802.11n 2.4GHz 40MHz	0.067

3 Test Methodology

3.1. Mode of Operation

Decision of Test ATL has verified the construction and function in typical operation. All the test modes were carried out with the EUT in normal operation, which was shown in this test report and defined as:

Test Mode
Mode 1: Continuous TX mode
Mode 2: IEEE 802.11b TX mode
Mode 3: IEEE 802.11g TX mode
Mode 4: IEEE 802.11n 2.4GHz 20MHz TX mode
Mode 5: IEEE 802.11n 2.4GHz 40MHz TX mode

Software used to control the EUT for staying in continuous transmitting mode was programmed.

After verification, all tests were carried out with the worst case test modes as shown below except radiated spurious emission below 1GHz and power line conducted emissions below 30MHz, which worst case was in TX mode only.

By preliminary testing and verifying three axis (X, Y and Z) position of EUT transmitted status, it was found that "X axis" position was the worst, then the final test was executed the worst condition and test data were recorded in this report.

Test Mode	ANT-0	ANT-1	ANT-2	ANT-0+1+2
Mode 2: IEEE 802.11b link mode	V			
Mode 3: IEEE 802.11g link mode	V			
Mode 4: IEEE 802.11n 2.4GHz 20MHz link mode	V	V	V	V
Mode 5: IEEE 802.11n 2.4GHz 40MHz link mode	V	V	V	V

Test Mode	Antenna Delivery	Test Channel	Data Rate 800GI (ns)
Mode 2: IEEE 802.11b link mode	1TX / 1RX	1, 6, 11	1
Mode 3: IEEE 802.11g link mode	1TX / 1RX	1, 6, 11	6
Mode 4: IEEE 802.11n 2.4GHz 20MHz link mode	3TX / 3RX (MIMO)	1, 6, 11	19.5
Mode 5: IEEE 802.11n 2.4GHz 40MHz link mode	3TX / 3RX (MIMO)	3, 6, 9	40.5

Duty cycle

Test Mode	Frequency (MHz)	on time (ms)	on+off time (ms)	Duty cycle	Duty Factor (dB)	1/T Minimum VBW (kHz)
Mode 2: IEEE 802.11b link mode	2412.0	8.210	8.250	0.995	0.021	0.010
Mode 3: IEEE 802.11g link mode	2412.0	1.374	1.410	0.974	0.112	0.728
Mode 4: IEEE 802.11n 2.4GHz 20MHz link mode	2412.0	0.480	0.519	0.925	0.339	2.083
Mode 5: IEEE 802.11n 2.4GHz 40MHz link mode	2422.0	0.258	0.304	0.849	0.713	3.876



Duty Cycle Graphs

Mode 2: IEEE 802.11b link mode

On time

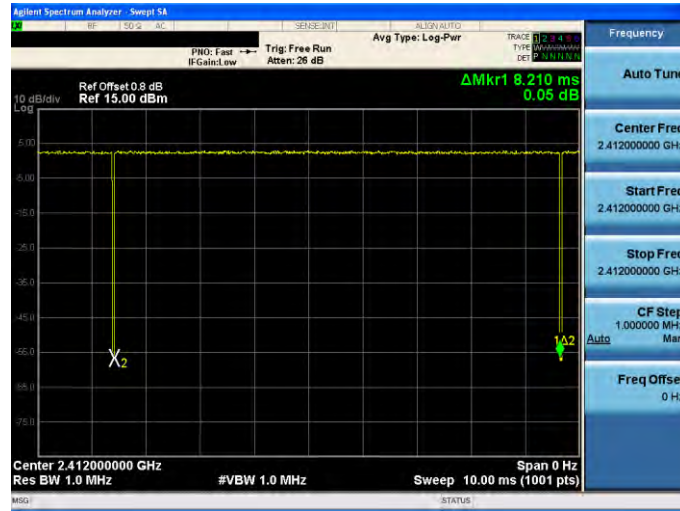

On+off time

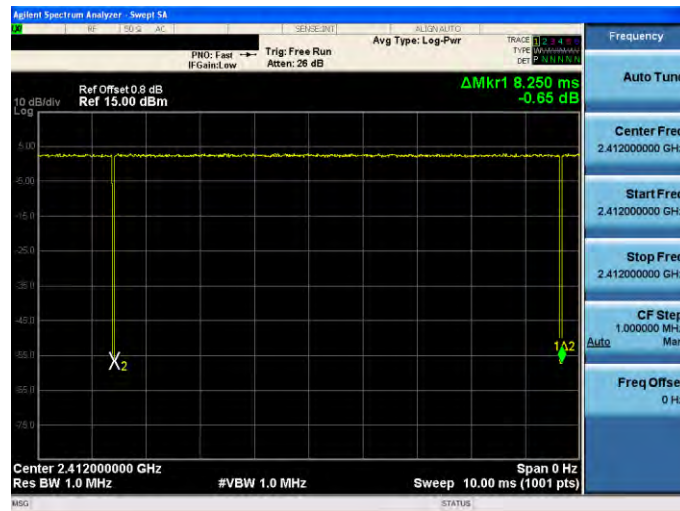



Mode 3: IEEE 802.11g Mode

On time

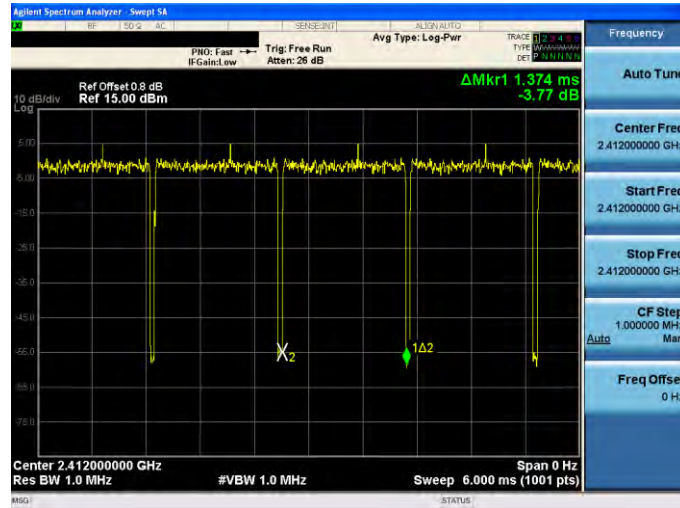

On+off time

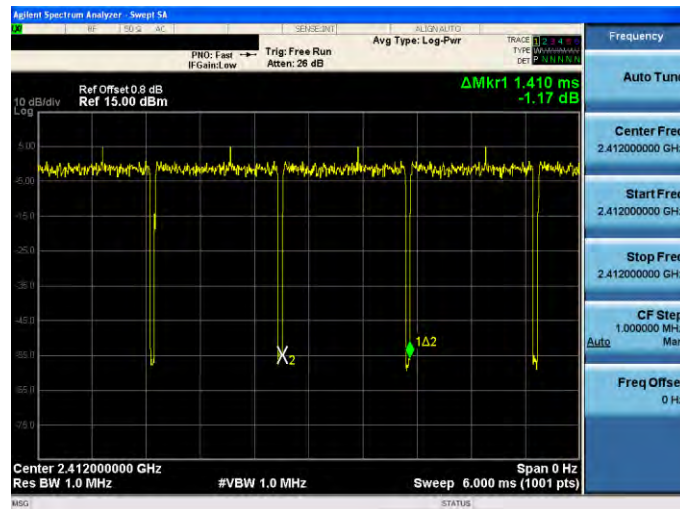



Mode 4: IEEE 802.11n 2.4GHz 20MHz Mode

On time

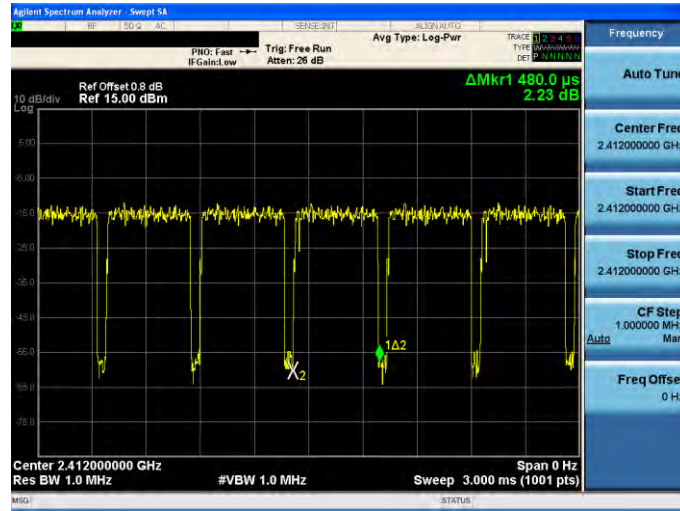

On+off time

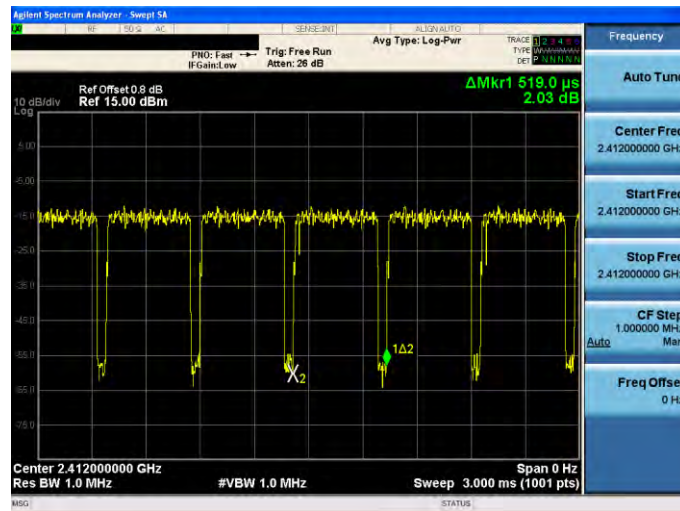

Mode 5: IEEE 802.11n 2.4GHz 40MHz Mode	
On time	
On+off time	

3.2. EUT Exercise Software

1.	Setup the EUT shown on 3.3.
2.	Turn on the power of all equipment.
3.	Turn Wi-Fi function link to AP
4.	EUT run test program.

Measurement Software	
1	EZ-EMC Ver. ATL-03A1-1
2	EZ-EMC Ver ATL-ITC-3A1-1

3.3. Configuration of Test System Details

Conducted Emissions

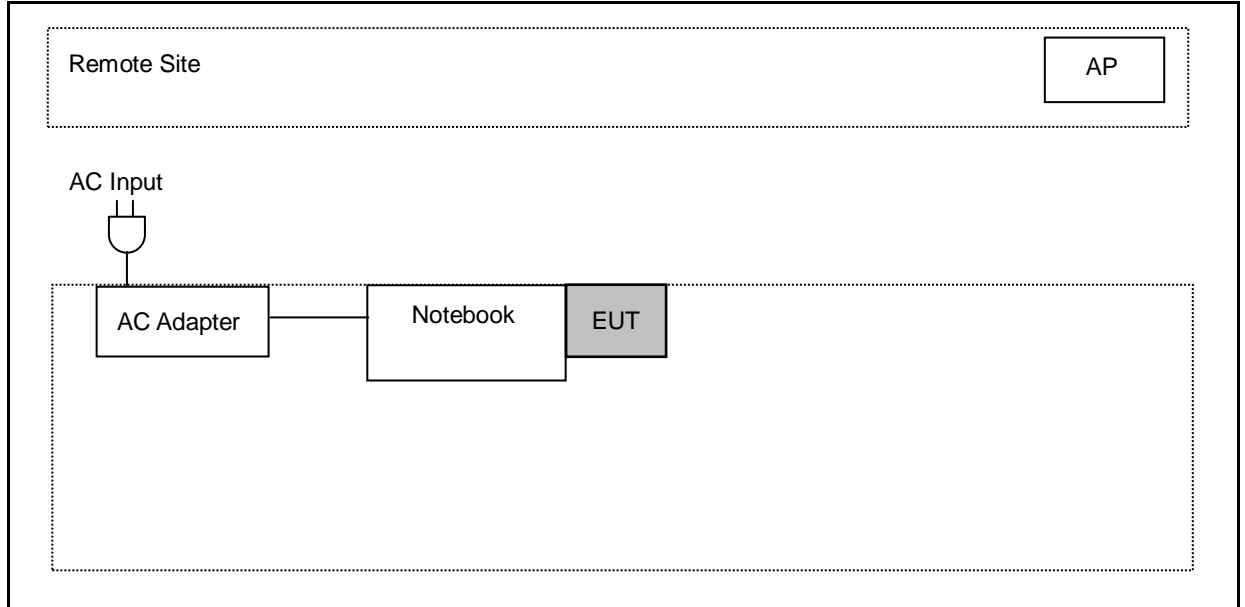

Radiated Emissions

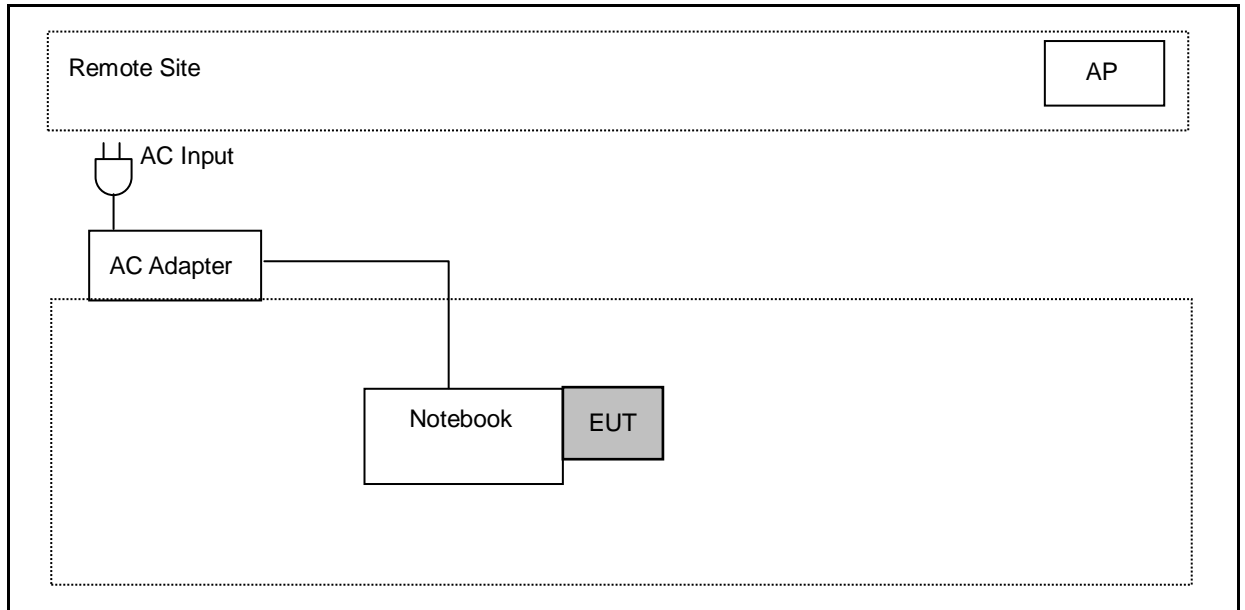

3.4. Test Site Environment

Items	Required (IEC 60068-1)	Actual
Temperature (°C)	15-35	26
Humidity (%RH)	25-75	60
Barometric pressure (mbar)	860-1060	950

4 AC Power Line Conducted Emission Measurement

4.1. Limit

Frequency (MHz)	Quasi-peak	Average
0.15 - 0.5	66 to 56	56 to 46
0.50 - 5.0	56	46
5.0 - 30.0	60	50

4.2. Test Instruments

Describe	Manufacturer	Model Number	Serial Number	Cal. Date	Cal. Period
Test Receiver	R&S	ESCI	100367	06/25/2015	1 year
LISN	R&S	ENV216	101040	03/15/2016	1 year
LISN	R&S	ENV216	101041	03/07/2016	1 year
RF Cable	Woken	00100D1380194M	TE-02-02	06/26/2015	1 year
Test Site	ATL	TE02	TE02	N.C.R.	-----

Note: N.C.R. = No Calibration Request.

4.3. Test Setup

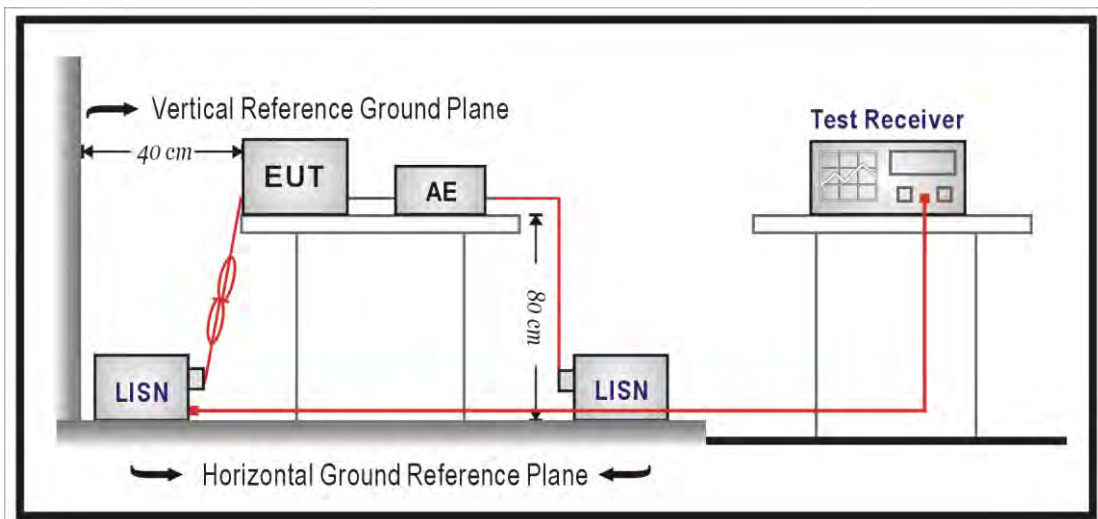

4.4. Test Procedure

The EUT and simulators are connected to the main power through a line impedance stabilization network (L.I.S.N.). This provides a $50\Omega // 50\mu\text{H}$ coupling impedance for the measuring equipment. The peripheral devices are also connected to the main power through a LISN that provides a $50\Omega // 50\mu\text{H}$ coupling impedance with 50ohm termination.

Tabletop device shall be placed on a non-conducting platform, of nominal size 1 m by 1.5 m, raised 80 cm above the reference ground plane. The wall of screened room shall be located 40cm to the rear of the EUT. Other surfaces of tabletop or floor standing EUT shall be at least 80cm from any other ground conducting surface including one or more LISNs. For floor-standing device shall be placed under the EUT with a 12mm insulating material.

Conducted emissions were investigated over the frequency range from 0.15 MHz to 30 MHz using a resolution bandwidth of 9 kHz. The equipment under test (EUT) shall be meet the limits in section 4.1, as applicable, including the average limit and the quasi-peak limit when using respectively, an average detector and quasi-peak detector measured in accordance with the methods described of related standard. When all of peak value were complied with quasi-peak and average limit from 150kHz to 30MHz then quasi-peak and average measurement was unnecessary.

The AMN shall be placed 0,8 m from the boundary of the unit under test and bonded to a ground reference plane for AMNs mounted on top of the ground reference plane. This distance is between the closest points of the AMN and the EUT. All other units of the EUT and associated equipment shall be at least 0,8 m from the AMN. If the mains power cable is longer than 1m then the cable shall be folded back and forth at the centre of the lead to form a bundle no longer than 0.4m. All of interconnecting cables that hang closer than 40cm to the ground plane shall be folded back and forth in the center forming a bundle 30 cm to 40 cm long. All of EUT and AE shall be separate place more than 0.1m. All 50 Ω ports of the LISN shall be resistively terminated into 50 Ω loads when not connected to the measuring instrument.

If the reading of the measuring receiver shows fluctuations close to the limit, the reading shall be observed for at least 15 s at each measurement frequency; the higher reading shall be recorded with the exception of any brief isolated high reading which shall be ignored.



4.5. Test Result

Standard:	FCC Part 15C	Line:	L1
Test item:	Conducted Emission	Power:	AC 120V/60Hz
Model Number:	D1080-Z1	Temp.(°C)/Hum.(%RH):	26(°C)/60%RH
Mode:	Mode 1	Date:	05/04/2016
		Test By:	Eric Ou Yang
Description:			

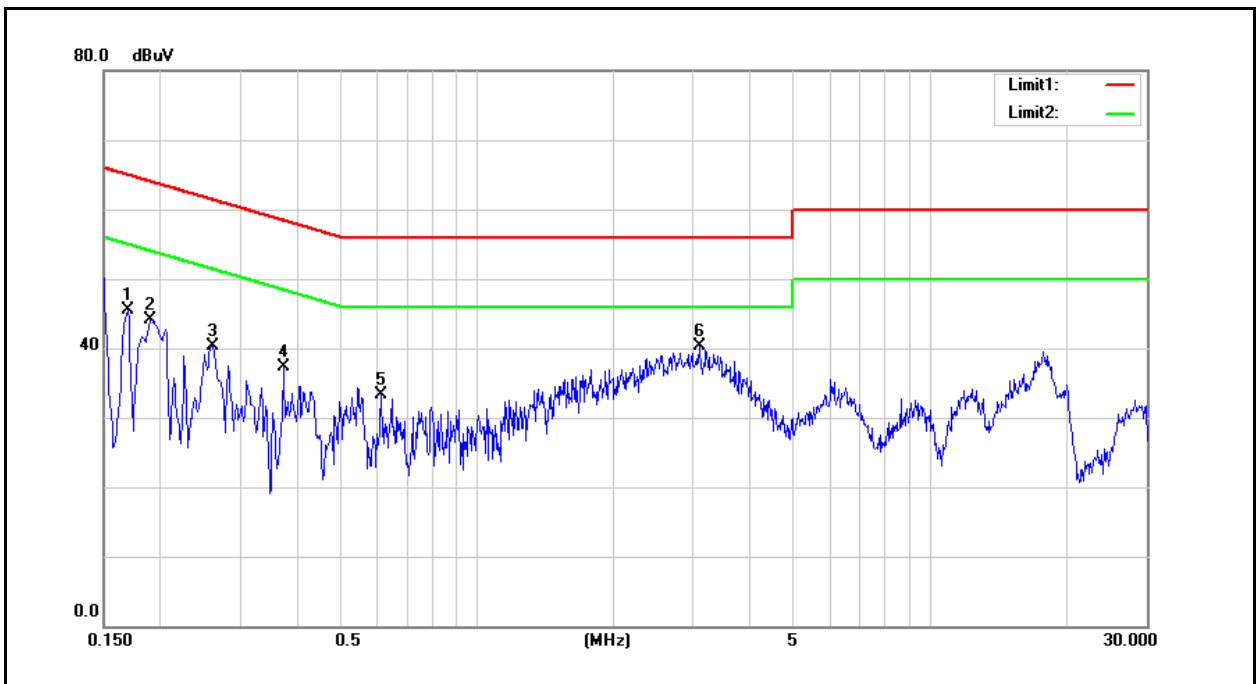

No.	Frequency (MHz)	QP reading (dBuV)	AVG reading (dBuV)	Correction factor (dB)	QP result (dBuV)	AVG result (dBuV)	QP limit (dBuV)	AVG limit (dBuV)	QP margin (dB)	AVG margin (dB)	Remark
1	0.1700	28.57	10.64	9.60	38.17	20.24	64.96	54.96	-26.79	-34.72	Pass
2	0.1900	34.20	29.34	9.59	43.79	38.93	64.04	54.04	-20.25	-15.11	Pass
3	0.2620	28.94	20.31	9.60	38.54	29.91	61.37	51.37	-22.83	-21.46	Pass
4	0.3740	21.82	10.32	9.60	31.42	19.92	58.41	48.41	-26.99	-28.49	Pass
5	0.6140	19.88	11.82	9.61	29.49	21.43	56.00	46.00	-26.51	-24.57	Pass
6	3.0980	25.80	18.03	9.73	35.53	27.76	56.00	46.00	-20.47	-18.24	Pass

Note: 1. Result (dBuV) = Correction factor (dB) + Reading(dBuV).

2. Correction factor (dB) = Cable loss (dB) + L.I.S.N. factor (dB).



Standard:	FCC Part 15C	Line:	N
Test item:	Conducted Emission	Power:	AC 120V/60Hz
Model Number:	D1080-Z1	Temp.(°C)/Hum.(%RH):	26(°C)/60%RH
Mode:	Mode 1	Date:	05/04/2016
		Test By:	Eric Ou Yang
Description:			

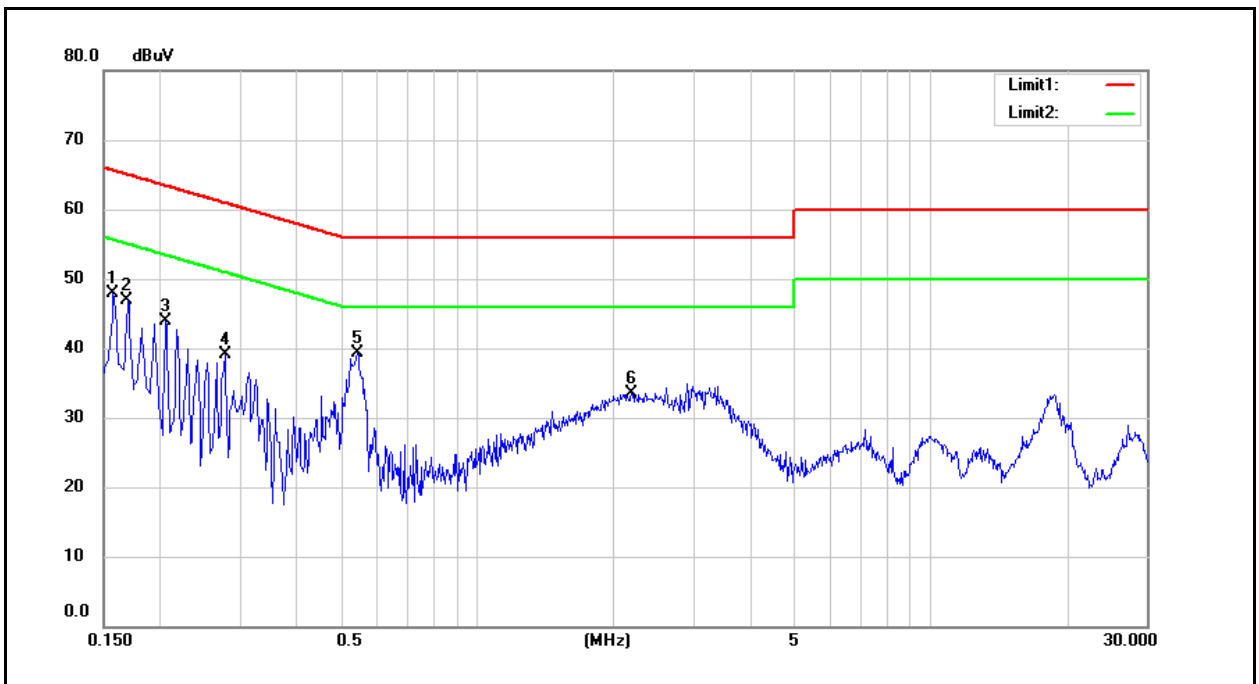

No.	Frequency (MHz)	QP reading (dBuV)	AVG reading (dBuV)	Correction factor (dB)	QP result (dBuV)	AVG result (dBuV)	QP limit (dBuV)	AVG limit (dBuV)	QP margin (dB)	AVG margin (dB)	Remark
1	0.1580	35.27	22.91	9.59	44.86	32.50	65.57	55.57	-20.71	-23.07	Pass
2	0.1700	34.04	21.05	9.59	43.63	30.64	64.96	54.96	-21.33	-24.32	Pass
3	0.2060	27.44	14.11	9.58	37.02	23.69	63.37	53.37	-26.35	-29.68	Pass
4	0.2780	23.02	12.56	9.59	32.61	22.15	60.88	50.88	-28.27	-28.73	Pass
5	0.5460	27.67	20.10	9.60	37.27	29.70	56.00	46.00	-18.73	-16.30	Pass
6	2.1940	21.46	15.37	9.69	31.15	25.06	56.00	46.00	-24.85	-20.94	Pass

Note: 1. Result (dBuV) = Correction factor (dB) + Reading(dBuV).

2. Correction factor (dB) = Cable loss (dB) + L.I.S.N. factor (dB).



5 Radiated Emission Measurement

5.1. Limit

According to §15.209(a), except as provided elsewhere in this subpart, the emissions from an intentional radiator shall not exceed the field strength levels specified in the following table:

Frequency (MHz)	Field Strength ($\mu\text{V}/\text{m}$ at meter)	Measurement Distance (meters)
0.009 – 0.490	2400 / F (kHz)	300
0.490 – 1.705	24000 / F (kHz)	30
1.705 – 30.0	30	30
30 - 88	100**	3
88-216	150**	3
216-960	200**	3
Above 960	500	3

** Except as provided in paragraph (g), fundamental emissions from intentional radiators operating under this Section shall not be located in the frequency bands 54-72 MHz, 76-88 MHz, 174-216 MHz or 470-806 MHz. However, operation within these frequency bands is permitted under other sections of this Part, e.g., Sections 15.231 and 15.241.

5.2. Test Instruments

3 Meter Chamber					
Equipment	Manufacturer	Model Number	Serial Number	Cal. Date	Cal. Period
RF Pre-selector	Agilent	N9039A	MY46520256	01/08/2016	1 year
Spectrum Analyzer	Agilent	E4446A	MY46180578	01/08/2016	1 year
Pre Amplifier	Agilent	8449B	3008A02237	10/07/2015	1 year
Pre Amplifier	Agilent	8447D	2944A11119	01/11/2016	1 year
Broadband Antenna	Schwarzbeck	VULB9168	416	09/25/2015	1 year
Horn Antenna (1~18GHz)	SCHWARZBECK MESS-ELEKTRONIK	BBHA9120D	9120D-550	06/12/2015	1 year
Horn Antenna (18~40GHz)	ETS	3116	86467	09/01/2015	1 year
Loop Antenna	COM-POWER CORPORATION	AL-130	121014	02/01/2016	1 year
Microwave Cable	EMCI	EMC102-KM-KM-14000	151001	10/15/2015	1 year
Microwave Cable	EMCI	EMC-104-SM-SM-14000	140202	10/15/2015	1 year
Microwave Cable	EMCI	EMC104-SM-SM-600	140301	10/15/2015	1 year
Test Site	ATL	TE01	888001	08/27/2015	1 year

Note: N.C.R. = No Calibration Request.

5.3. Setup

9kHz ~ 30MHz

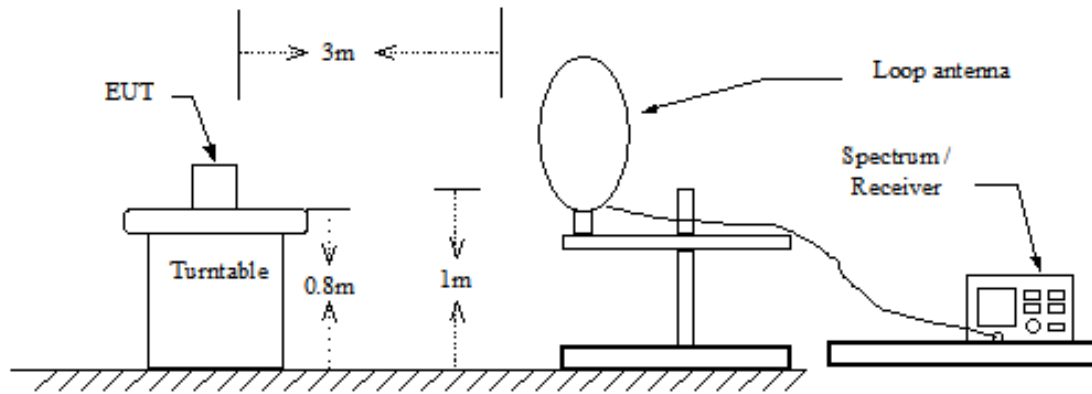

Below 1GHz

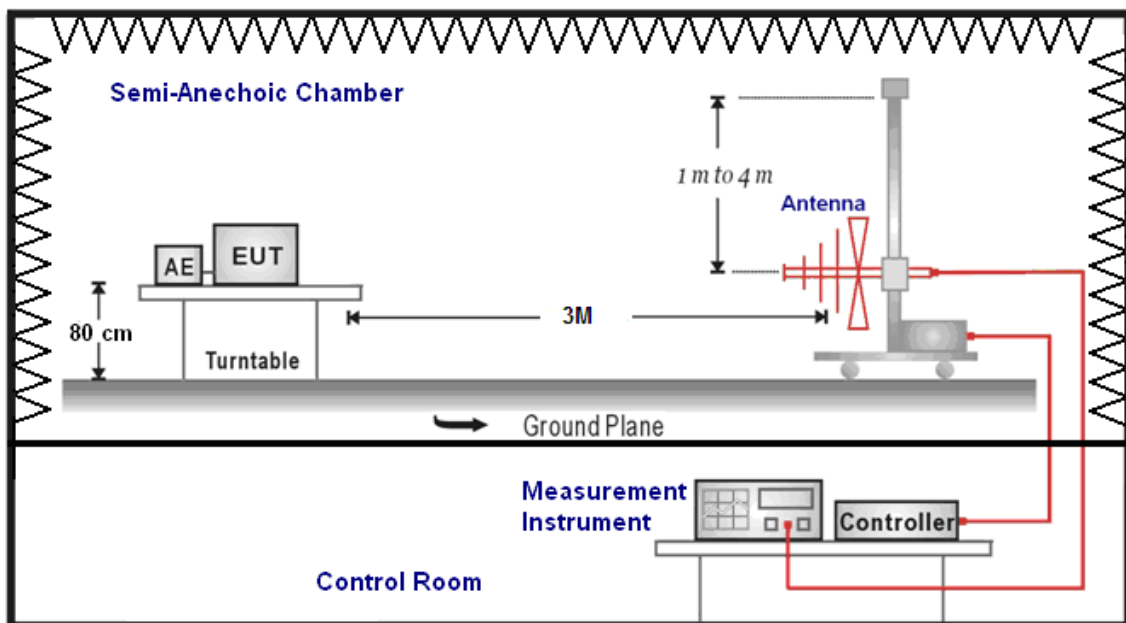

Above 1GHz

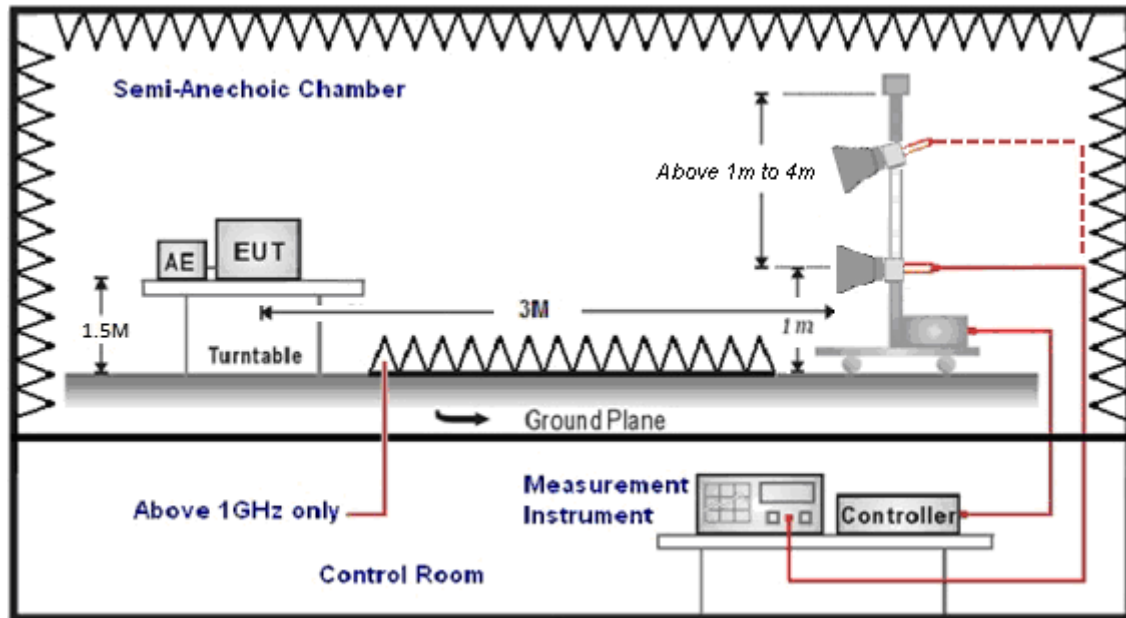



5.4. Test Procedure

Final radiation measurements were made on a three-meter, Semi Anechoic Chamber. The EUT system was placed on a nonconductive turntable which is 0.8 or 1.5 meters height (below 1GHz use 0.8m turntable / above 1GHz use 1.5m turntable), top surface 1.0 x 1.5 meter. The spectrum was examined from 250 MHz to 2.5 GHz in order to cover the whole spectrum below 10th harmonic which could generate from the EUT. During the test, EUT was set to transmit continuously & Measurements spectrum range from 9 kHz to 26.5 GHz is investigated.

For measurements below 1 GHz the resolution bandwidth is set to 100 kHz for peak detection measurements or 120 kHz for quasi-peak detection measurements. Peak detection is used unless otherwise noted as quasi-peak.

For measurements above 1 GHz the resolution bandwidth is set to 1 MHz, and then the video bandwidth is set to 1 MHz for peak measurements and 10 Hz for average measurements when Duty cycle >0.98 / $1/T$ for average measurements when Duty cycle <0.98 . A nonconductive material surrounded the EUT to supporting the EUT for standing on three orthogonal planes. At each condition, the EUT was rotated 360 degrees, and the antenna was raised and lowered from one to four meters to find the maximum emission levels. Measurements were taken using both horizontal and vertical antenna polarization.

SCHWARZBECK MESS-ELEKTRONIK Biconilog Antenna at 3 Meter and the SCHWARZBECK Double Ridged Guide Antenna was used in frequencies 1 –26.5 GHz at a distance of 3 meter. The antenna at an angle toward the source of the emission. All test results were extrapolated to equivalent signal at 3 meters utilizing an inverse linear distance extrapolation Factor (20dB/decade).

For testing above 1GHz, the emission level of the EUT in peak mode was 20dB lower than average limit (that means the emission level in peak mode also complies with the limit in average mode), then testing will be stopped and peak values of EUT will be reported, otherwise, the emissions will be measured in average mode again and reported.

Appropriate preamplifiers were used for improving sensitivity and precautions were taken to avoid overloading or desensitizing the spectrum analyzer. No post – detector video filters were used in the test.

The spectrum analyzer's 6 dB bandwidth was set to 1 MHz, and the analyzer was operated in the peak detection mode, for frequencies both below and up 1 GHz. The average levels were obtained by subtracting the duty cycle correction factor from the peak readings.

The following procedures were used to convert the emission levels measured in decibels referenced to 1 microvolt (dBuV) into field intensity in micro volts per meter (uV/m).

The actual field intensity in decibels referenced to 1 microvolt in to field intensity in micro volts per meter (dBuV/m).



The actual field intensity in referenced to 1 microvolt per meter (dBuV/m) is determined by algebraically adding the measured reading in dBuV, the antenna factor (dB), and cable loss (dB) and Subtracting the gain of preamplifier (dB) is auto calculate in spectrum analyzer.

(1) $\text{Amplitude (dBuV/m)} = \text{FI (dBuV)} + \text{AF (dBuV)} + \text{CL (dBuV)} - \text{Gain (dB)}$

FI= Reading of the field intensity.

AF= Antenna factor.

CL= Cable loss.

P.S Amplitude is auto calculate in spectrum analyzer.

(2) $\text{Actual Amplitude (dBuV/m)} = \text{Amplitude (dBuV)} - \text{Dis(dB)}$

The FCC specified emission limits were calculated according the EUT operating frequency and by following linear interpolation equations:

(a) For fundamental frequency : Transmitter Output < +30dBm

(b) For spurious frequency : Spurious emission limits = fundamental emission limit /10

Data of measurement within this frequency range without mark in the table above means the reading of emissions are attenuated more than 20dB below the permissible limits or the field strength is too small to be measured.



5.5. Test Result

Below 1GHz

Standard:		FCC Part 15C		Test Distance:		3m	
Test item:		Radiated Emission		Power:		AC 120V/60Hz	
Model Number:		D1080-Z1		Temp.(°C)/Hum.(%RH):		26(°C)/60%RH	
Mode:		Mode 1		Date:		04/06/2016	
				Test By:		Eric Ou Yang	
Frequency (MHz)	Reading (dBuV)	Correct Factor (dB/m)	Result (dBuV/m)	Limit (dBuV/m)	Margin (dB)	Remark	Ant.Polar. H / V
173.5000	25.65	-6.10	19.55	43.50	-23.95	QP	H
293.5000	29.40	-4.09	25.31	46.00	-20.69	QP	H
466.0000	26.08	-0.28	25.80	46.00	-20.20	QP	H
580.0000	25.66	1.97	27.63	46.00	-18.37	QP	H
715.0000	26.22	4.76	30.98	46.00	-15.02	QP	H
831.0000	24.57	6.92	31.49	46.00	-14.51	QP	H
168.0000	28.23	-5.73	22.50	43.50	-21.00	QP	V
224.5000	28.60	-8.01	20.59	46.00	-25.41	QP	V
380.5000	25.90	-2.45	23.45	46.00	-22.55	QP	V
469.0000	27.05	-0.23	26.82	46.00	-19.18	QP	V
586.5000	25.46	2.16	27.62	46.00	-18.38	QP	V
828.0000	24.62	6.87	31.49	46.00	-14.51	QP	V

Note:1.Result (dBuV) = Correction factor (dB) + Reading(dBuV).

2.Correction factor (dB/m) = Antenna Factor (dB/m) + Cable loss (dB) – Pre-Amplifier gain (dB).

3.No emission found between lowest internal used/generated frequencies to 30MHz (9 kHz~30MHz).



Above 1GHz

Standard:	FCC Part 15C	Test Distance:	3m				
Test item:	Radiated Emission	Power:	AC 120V/60Hz				
Model Number:	D1080-Z1	Temp.(°C)/Hum.(%RH):	26(°C)/60%RH				
Mode:	Mode 2	Date:	04/07/2016				
Frequency:	2412MHz	Test By:	Eric Ou Yang				
Frequency (MHz)	Reading (dBuV)	Correct Factor (dB/m)	Result (dBuV/m)	Limit (dBuV/m)	Margin (dB)	Remark	Ant.Polar. H / V
4824.000	58.25	-7.90	50.35	74.00	-23.65	peak	H
4824.000	55.46	-7.90	47.56	74.00	-26.44	peak	V

Standard:	FCC Part 15C	Test Distance:	3m				
Test item:	Radiated Emission	Power:	AC 120V/60Hz				
Model Number:	D1080-Z1	Temp.(°C)/Hum.(%RH):	26(°C)/60%RH				
Mode:	Mode 2	Date:	04/07/2016				
Frequency:	2437MHz	Test By:	Eric Ou Yang				
Frequency (MHz)	Reading (dBuV)	Correct Factor (dB/m)	Result (dBuV/m)	Limit (dBuV/m)	Margin (dB)	Remark	Ant.Polar. H / V
4874.000	65.84	-7.75	58.09	74.00	-15.91	peak	H
4874.000	60.72	-7.75	52.97	54.00	-1.03	AVG	H
4874.000	59.56	-7.75	51.81	74.00	-22.19	peak	V
7311.000	55.42	-0.79	54.63	74.00	-19.37	peak	V
7311.000	50.19	-0.79	49.40	54.00	-4.60	AVG	V

Note:1.Result (dBuV) = Correction factor (dB) + Reading(dBuV).

2.Correction factor (dB/m) = Antenna Factor (dB/m) + Cable loss (dB) – Pre-Amplifier gain (dB).



Standard:	FCC Part 15C			Test Distance:	3m		
Test item:	Radiated Emission			Power:	AC 120V/60Hz		
Model Number:	D1080-Z1			Temp.(°C)/Hum.(%RH):	26(°C)/60%RH		
Mode:	Mode 2			Date:	04/07/2016		
Frequency:	2462MHz			Test By:	Eric Ou Yang		
Frequency (MHz)	Reading (dBuV)	Correct Factor (dB/m)	Result (dBuV/m)	Limit (dBuV/m)	Margin (dB)	Remark	Ant.Polar. H / V
4924.000	60.93	-7.59	53.34	74.00	-20.66	peak	H
4924.000	57.85	-7.59	50.26	54.00	-3.74	AVG	H
4924.000	55.07	-7.59	47.48	74.00	-26.52	peak	V

Standard:	FCC Part 15C			Test Distance:	3m		
Test item:	Radiated Emission			Power:	AC 120V/60Hz		
Model Number:	D1080-Z1			Temp.(°C)/Hum.(%RH):	26(°C)/60%RH		
Mode:	Mode 3			Date:	04/07/2016		
Frequency:	2412MHz			Test By:	Eric Ou Yang		
Frequency (MHz)	Reading (dBuV)	Correct Factor (dB/m)	Result (dBuV/m)	Limit (dBuV/m)	Margin (dB)	Remark	Ant.Polar. H / V
4824.000	52.74	-7.90	44.84	74.00	-29.16	peak	H
4824.000	52.22	-7.90	44.32	74.00	-29.68	peak	V

Note:1.Result (dBuV) = Correction factor (dB) + Reading(dBuV).

2.Correction factor (dB/m) = Antenna Factor (dB/m) + Cable loss (dB) – Pre-Amplifier gain (dB).



Standard:	FCC Part 15C	Test Distance:	3m				
Test item:	Radiated Emission	Power:	AC 120V/60Hz				
Model Number:	D1080-Z1	Temp.(°C)/Hum.(%RH):	26(°C)/60%RH				
Mode:	Mode 3	Date:	04/07/2016				
Frequency:	2437MHz	Test By:	Eric Ou Yang				
Frequency (MHz)	Reading (dBuV)	Correct Factor (dB/m)	Result (dBuV/m)	Limit (dBuV/m)	Margin (dB)	Remark	Ant.Polar. H / V
4874.000	54.63	-7.75	46.88	74.00	-27.12	peak	H
4874.000	52.62	-7.75	44.87	74.00	-29.13	peak	V

Standard:	FCC Part 15C	Test Distance:	3m				
Test item:	Radiated Emission	Power:	AC 120V/60Hz				
Model Number:	D1080-Z1	Temp.(°C)/Hum.(%RH):	26(°C)/60%RH				
Mode:	Mode 3	Date:	04/07/2016				
Frequency:	2462MHz	Test By:	Eric Ou Yang				
Frequency (MHz)	Reading (dBuV)	Correct Factor (dB/m)	Result (dBuV/m)	Limit (dBuV/m)	Margin (dB)	Remark	Ant.Polar. H / V
4924.000	50.82	-7.59	43.23	74.00	-30.77	peak	H
4924.000	50.14	-7.59	42.55	74.00	-31.45	peak	V

Note:1.Result (dBuV) = Correction factor (dB) + Reading(dBuV).

2.Correction factor (dB/m) = Antenna Factor (dB/m) + Cable loss (dB) – Pre-Amplifier gain (dB).



Standard: FCC Part 15C		Test Distance: 3m					
Test item: Radiated Emission		Power: AC 120V/60Hz					
Model Number: D1080-Z1		Temp.(°C)/Hum.(%RH): 26(°C)/60%RH					
Mode: Mode 4		Date: 04/07/2016					
Frequency: 2412MHz		Test By: Eric Ou Yang					
Frequency (MHz)	Reading (dBuV)	Correct Factor (dB/m)	Result (dBuV/m)	Limit (dBuV/m)	Margin (dB)	Remark	Ant.Polar. H / V
4824.000	53.95	-7.90	46.05	74.00	-27.95	peak	H
4824.000	52.88	-7.90	44.98	74.00	-29.02	peak	V

Standard: FCC Part 15C		Test Distance: 3m					
Test item: Radiated Emission		Power: AC 120V/60Hz					
Model Number: D1080-Z1		Temp.(°C)/Hum.(%RH): 26(°C)/60%RH					
Mode: Mode 4		Date: 04/07/2016					
Frequency: 2437MHz		Test By: Eric Ou Yang					
Frequency (MHz)	Reading (dBuV)	Correct Factor (dB/m)	Result (dBuV/m)	Limit (dBuV/m)	Margin (dB)	Remark	Ant.Polar. H / V
4874.000	56.66	-7.75	48.91	74.00	-25.09	peak	H
4874.000	53.02	-7.75	45.27	74.00	-28.73	peak	V

Note:1.Result (dBuV) = Correction factor (dB) + Reading(dBuV).

2.Correction factor (dB/m) = Antenna Factor (dB/m) + Cable loss (dB) – Pre-Amplifier gain (dB).



Standard:	FCC Part 15C	Test Distance:	3m				
Test item:	Radiated Emission	Power:	AC 120V/60Hz				
Model Number:	D1080-Z1	Temp.(°C)/Hum.(%RH):	26(°C)/60%RH				
Mode:	Mode 4	Date:	04/07/2016				
Frequency:	2462MHz	Test By:	Eric Ou Yang				
Frequency (MHz)	Reading (dBuV)	Correct Factor (dB/m)	Result (dBuV/m)	Limit (dBuV/m)	Margin (dB)	Remark	Ant.Polar. H / V
4924.000	51.75	-7.59	44.16	74.00	-29.84	peak	H
4924.000	51.75	-7.59	44.16	74.00	-29.84	peak	V

Standard:	FCC Part 15C	Test Distance:	3m				
Test item:	Radiated Emission	Power:	AC 120V/60Hz				
Model Number:	D1080-Z1	Temp.(°C)/Hum.(%RH):	26(°C)/60%RH				
Mode:	Mode 5	Date:	04/07/2016				
Frequency:	2422MHz	Test By:	Eric Ou Yang				
Frequency (MHz)	Reading (dBuV)	Correct Factor (dB/m)	Result (dBuV/m)	Limit (dBuV/m)	Margin (dB)	Remark	Ant.Polar. H / V
4844.000	52.09	-7.83	44.26	74.00	-29.74	peak	H
4844.000	50.56	-7.83	42.73	74.00	-31.27	peak	V

Note:1.Result (dBuV) = Correction factor (dB) + Reading(dBuV).

2.Correction factor (dB/m) = Antenna Factor (dB/m) + Cable loss (dB) – Pre-Amplifier gain (dB).



Standard: FCC Part 15C		Test Distance: 3m					
Test item: Radiated Emission		Power: AC 120V/60Hz					
Model Number: D1080-Z1		Temp.(°C)/Hum.(%RH): 26(°C)/60%RH					
Mode: Mode 5		Date: 04/07/2016					
Frequency: 2437MHz		Test By: Eric Ou Yang					
Frequency (MHz)	Reading (dBuV)	Correct Factor (dB/m)	Result (dBuV/m)	Limit (dBuV/m)	Margin (dB)	Remark	Ant.Polar. H / V
4874.000	57.07	-7.75	49.32	74.00	-24.68	peak	H
4874.000	49.74	-7.75	41.99	74.00	-32.01	peak	V

Standard: FCC Part 15C		Test Distance: 3m					
Test item: Radiated Emission		Power: AC 120V/60Hz					
Model Number: D1080-Z1		Temp.(°C)/Hum.(%RH): 26(°C)/60%RH					
Mode: Mode 5		Date: 04/07/2016					
Frequency: 2452MHz		Test By: Eric Ou Yang					
Frequency (MHz)	Reading (dBuV)	Correct Factor (dB/m)	Result (dBuV/m)	Limit (dBuV/m)	Margin (dB)	Remark	Ant.Polar. H / V
4904.000	50.97	-7.65	43.32	74.00	-30.68	peak	H
4904.000	53.01	-7.65	45.36	74.00	-28.64	peak	V

Note:1.Result (dBuV) = Correction factor (dB) + Reading(dBuV).

2.Correction factor (dB/m) = Antenna Factor (dB/m) + Cable loss (dB) – Pre-Amplifier gain (dB).



Band Edge

Standard:	FCC Part 15C	Test Distance:	3m
Test item:	Band edge	Power:	AC 110V/60Hz
Frequency:	2412MHz	Temp.(°C)/Hum.(%RH):	26(°C)/60%RH
Mode:	Mode 2	Date:	04/06/2016
Ant.Polar.:	Horizontal		

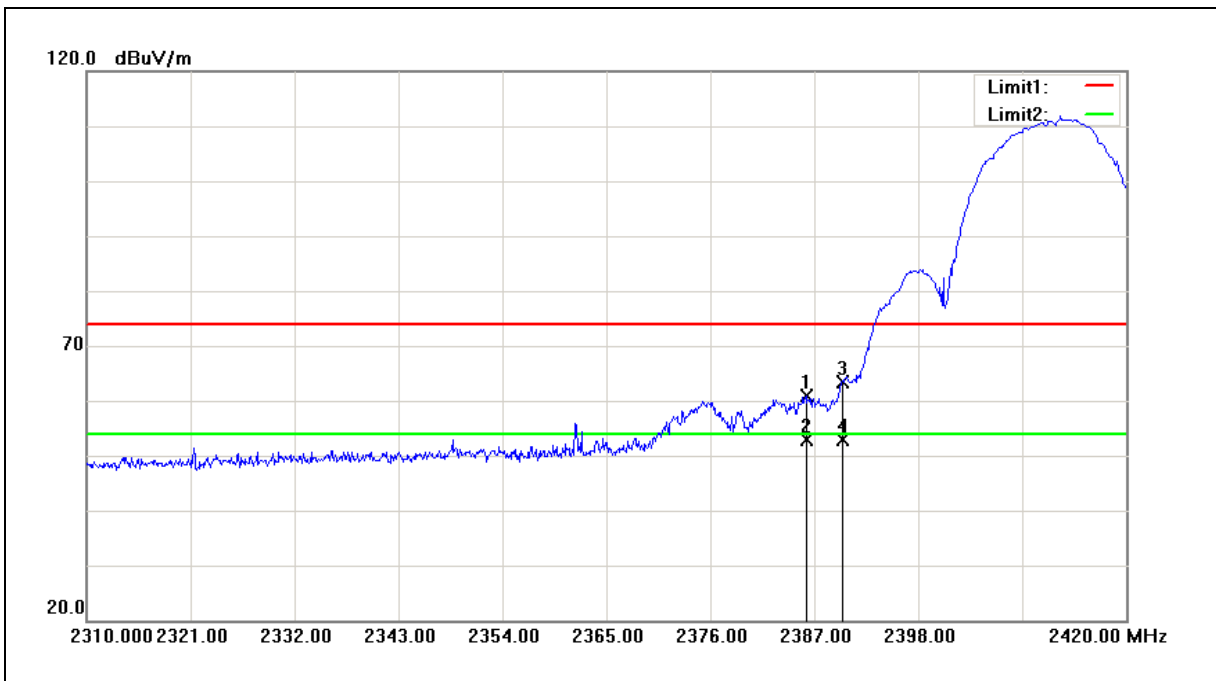

No.	Frequency (MHz)	Reading (dBuV)	Correct Factor (dB/m)	Result (dBuV/m)	Limit (dBuV/m)	Margin (dB)	Remark
1	2386.120	61.16	-0.35	60.81	74.00	-13.19	peak
2	2386.120	53.26	-0.35	52.91	54.00	-1.09	AVG
3	2390.000	63.66	-0.33	63.33	74.00	-10.67	peak
4	2390.000	53.28	-0.33	52.95	54.00	-1.05	AVG

Note:1.Result (dBuV/m) = Correct Factor (dB/m) + Reading(dBuV).

2.Correction factor (dB/m) = Antenna Factor (dB/m) + Cable loss (dB) – Pre-Amplifier gain (dB).

3. When the peak results are less than average limit, so not need to evaluate the average.



Standard:	FCC Part 15C	Test Distance:	3m
Test item:	Band edge	Power:	AC 110V/60Hz
Frequency:	2412MHz	Temp.(°C)/Hum.(%RH):	26(°C)/60%RH
Mode:	Mode 2	Date:	04/06/2016
Ant.Polar.:	Vertical		

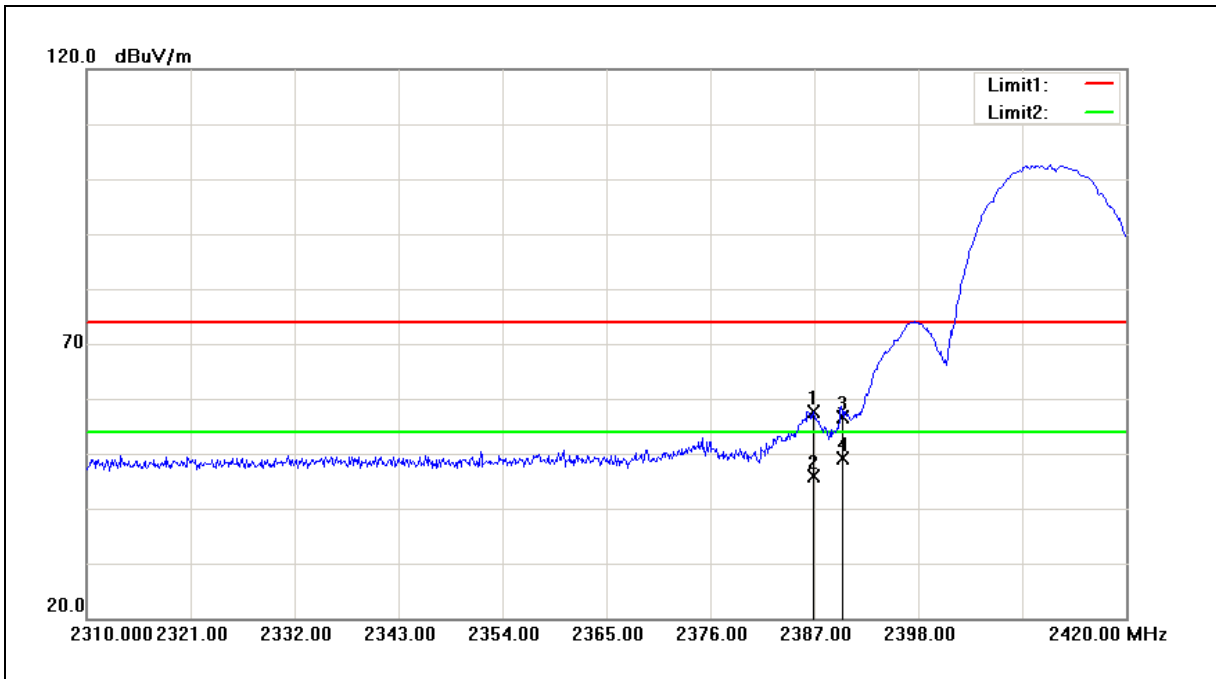

No.	Frequency (MHz)	Reading (dBuV)	Correct Factor (dB/m)	Result (dBuV/m)	Limit (dBuV/m)	Margin (dB)	Remark
1	2386.890	57.97	-0.33	57.64	74.00	-16.36	peak
2	2386.890	46.17	-0.33	45.84	54.00	-8.16	AVG
3	2390.000	56.94	-0.33	56.61	74.00	-17.39	peak
4	2390.000	49.38	-0.33	49.05	54.00	-4.95	AVG

Note:1.Result (dBuV/m) = Correct Factor (dB/m) + Reading(dBuV).

2.Correction factor (dB/m) = Antenna Factor (dB/m) + Cable loss (dB) – Pre-Amplifier gain (dB).

3. When the peak results are less than average limit, so not need to evaluate the average.



Standard:	FCC Part 15C	Test Distance:	3m
Test item:	Band edge	Power:	AC 110V/60Hz
Frequency:	2437MHz	Temp.(°C)/Hum.(%RH):	26(°C)/60%RH
Mode:	Mode 2	Date:	04/06/2016
Ant.Polar.:	Horizontal		

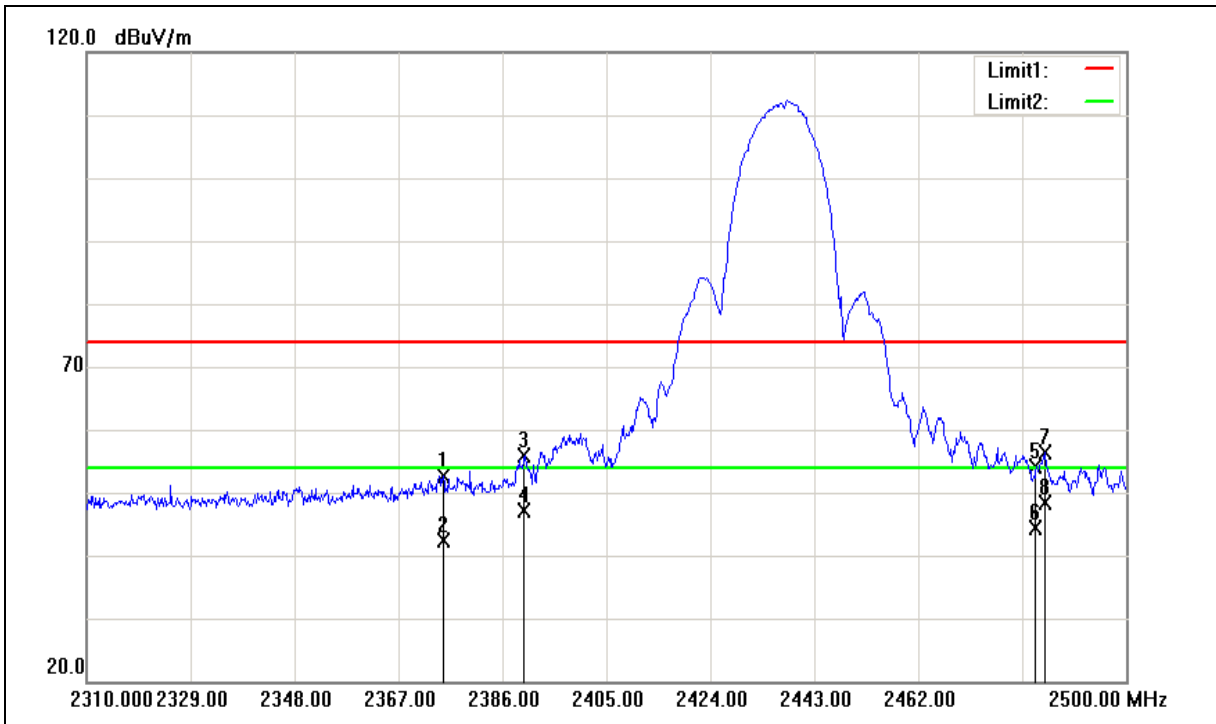



Standard:	FCC Part 15C	Test Distance:	3m
Test item:	Band edge	Power:	AC 110V/60Hz
Frequency:	2437MHz	Temp.(°C)/Hum.(%RH):	26(°C)/60%RH
Mode:	Mode 2	Date:	04/06/2016
Ant.Polar.:	Horizontal		

No.	Frequency (MHz)	Reading (dBuV)	Correct Factor (dB/m)	Result (dBuV/m)	Limit (dBuV/m)	Margin (dB)	Remark
1	2375.170	53.00	-0.38	52.62	74.00	-21.38	peak
2	2375.170	42.71	-0.38	42.33	54.00	-11.67	AVG
3	2390.000	56.27	-0.33	55.94	74.00	-18.06	peak
4	2390.000	47.51	-0.33	47.18	54.00	-6.82	AVG
5	2483.500	54.13	0.03	54.16	74.00	-19.84	peak
6	2483.500	44.34	0.03	44.37	54.00	-9.63	AVG
7	2485.180	56.28	0.03	56.31	74.00	-17.69	peak
8	2485.180	48.43	0.03	48.46	54.00	-5.54	AVG

Note:1.Result (dBuV/m) = Correct Factor (dB/m) + Reading(dBuV).

2.Correction factor (dB/m) = Antenna Factor (dB/m) + Cable loss (dB) – Pre-Amplifier gain (dB).

3. When the peak results are less than average limit, so not need to evaluate the average.



Standard:	FCC Part 15C	Test Distance:	3m
Test item:	Band edge	Power:	AC 110V/60Hz
Frequency:	2437MHz	Temp.(°C)/Hum.(%RH):	26(°C)/60%RH
Mode:	Mode 2	Date:	04/06/2016
Ant.Polar.:	Vertical		

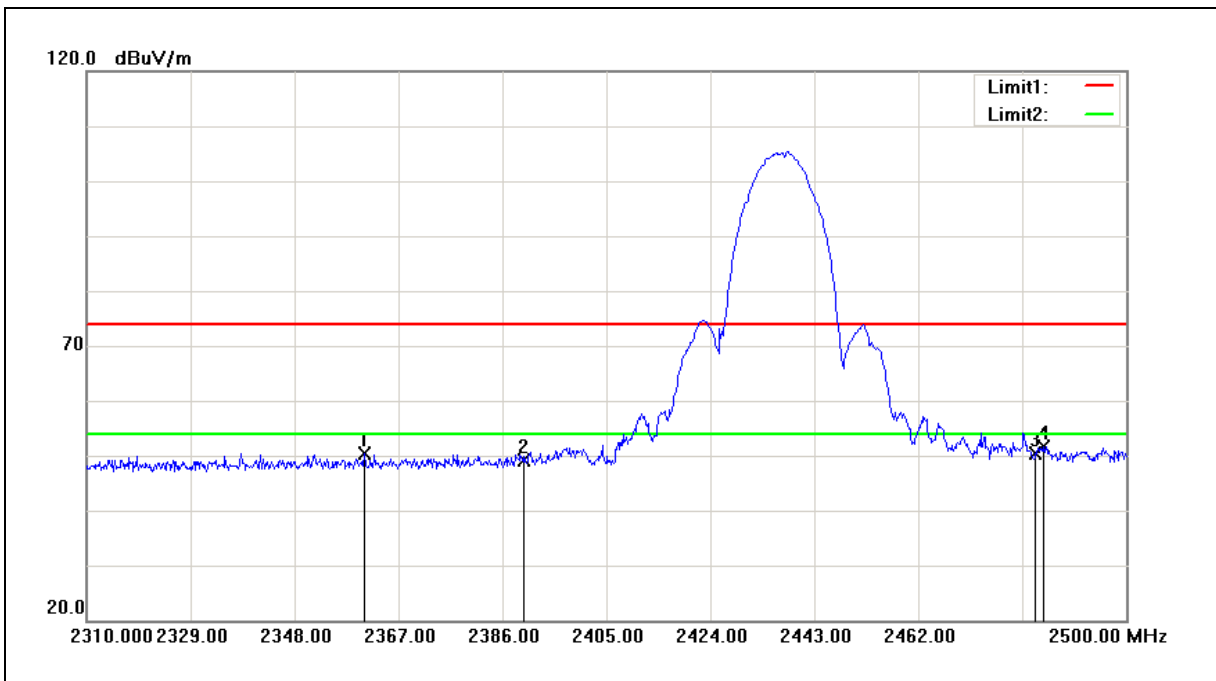

No.	Frequency (MHz)	Reading (dBuV)	Correct Factor (dB/m)	Result (dBuV/m)	Limit (dBuV/m)	Margin (dB)	Remark
1	2360.730	50.89	-0.44	50.45	74.00	-23.55	peak
2	2390.000	49.52	-0.33	49.19	74.00	-24.81	peak
3	2483.500	50.40	0.03	50.43	74.00	-23.57	peak
4	2484.800	51.61	0.03	51.64	74.00	-22.36	peak

Note:1.Result (dBuV/m) = Correct Factor (dB/m) + Reading(dBuV).

2.Correction factor (dB/m) = Antenna Factor (dB/m) + Cable loss (dB) – Pre-Amplifier gain (dB).

3. When the peak results are less than average limit, so not need to evaluate the average.



Standard:	FCC Part 15C	Test Distance:	3m
Test item:	Band edge	Power:	AC 110V/60Hz
Frequency:	2462MHz	Temp.(°C)/Hum.(%RH):	26(°C)/60%RH
Mode:	Mode 2	Date:	04/06/2016
Ant.Polar.:	Horizontal		

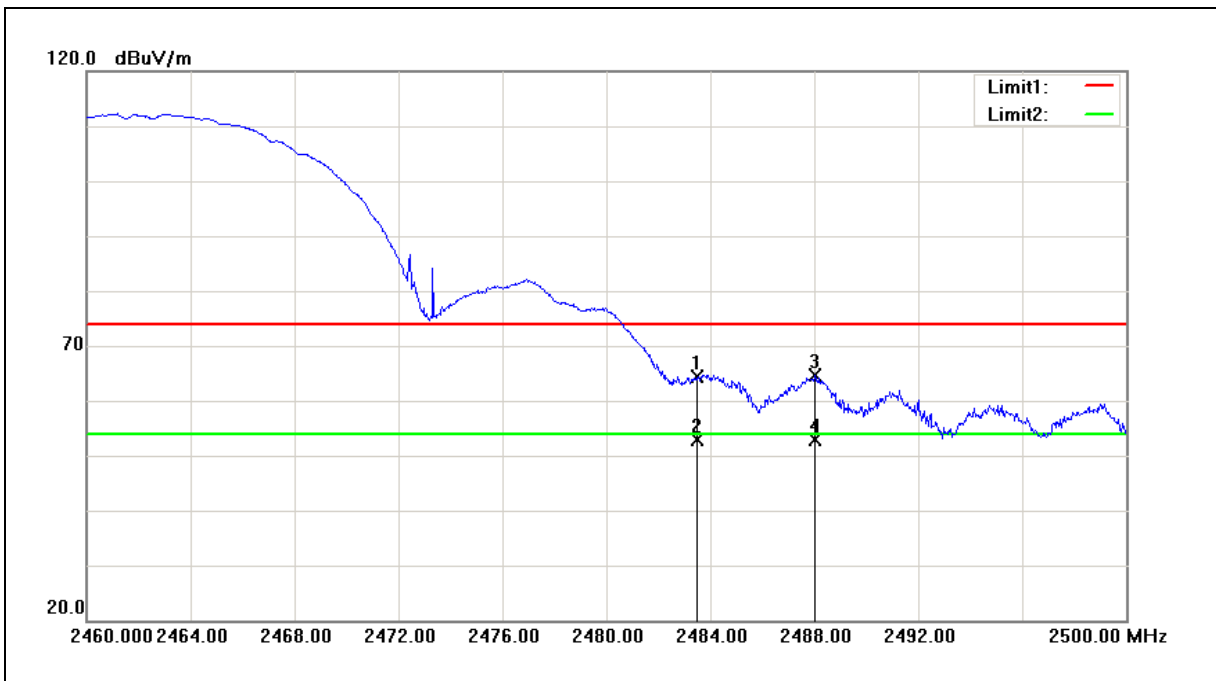

No.	Frequency (MHz)	Reading (dBuV)	Correct Factor (dB/m)	Result (dBuV/m)	Limit (dBuV/m)	Margin (dB)	Remark
1	2483.500	64.35	0.03	64.38	74.00	-9.62	peak
2	2483.500	52.78	0.03	52.81	54.00	-1.19	AVG
3	2488.040	64.49	0.04	64.53	74.00	-9.47	peak
4	2488.040	52.93	0.04	52.97	54.00	-1.03	AVG

- Note:1.Result (dBuV/m) = Correct Factor (dB/m) + Reading(dBuV).
- 2.Correction factor (dB/m) = Antenna Factor (dB/m) + Cable loss (dB) – Pre-Amplifier gain (dB).
3. When the peak results are less than average limit, so not need to evaluate the average.



Standard:	FCC Part 15C	Test Distance:	3m
Test item:	Band edge	Power:	AC 110V/60Hz
Frequency:	2462MHz	Temp.(°C)/Hum.(%RH):	26(°C)/60%RH
Mode:	Mode 2	Date:	04/06/2016
Ant.Polar.:	Vertical		

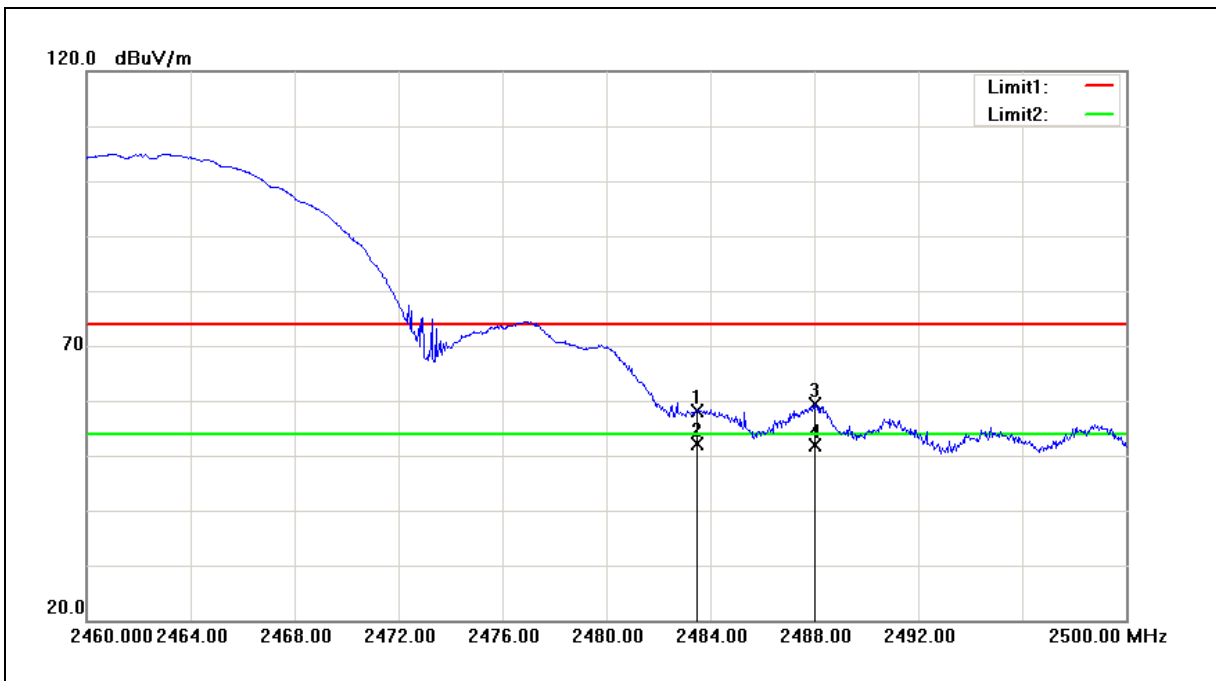

No.	Frequency (MHz)	Reading (dBuV)	Correct Factor (dB/m)	Result (dBuV/m)	Limit (dBuV/m)	Margin (dB)	Remark
1	2483.500	58.15	0.03	58.18	74.00	-15.82	peak
2	2483.500	52.05	0.03	52.08	54.00	-1.92	AVG
3	2488.000	59.38	0.04	59.42	74.00	-14.58	peak
4	2488.000	51.90	0.04	51.94	54.00	-2.06	AVG

- Note:1.Result (dBuV/m) = Correct Factor (dB/m) + Reading(dBuV).
- 2.Correction factor (dB/m) = Antenna Factor (dB/m) + Cable loss (dB) – Pre-Amplifier gain (dB).
3. When the peak results are less than average limit, so not need to evaluate the average.



Standard:	FCC Part 15C	Test Distance:	3m
Test item:	Band edge	Power:	AC 110V/60Hz
Frequency:	2412MHz	Temp.(°C)/Hum.(%RH):	26(°C)/60%RH
Mode:	Mode 3	Date:	04/06/2016
Ant.Polar.:	Horizontal		

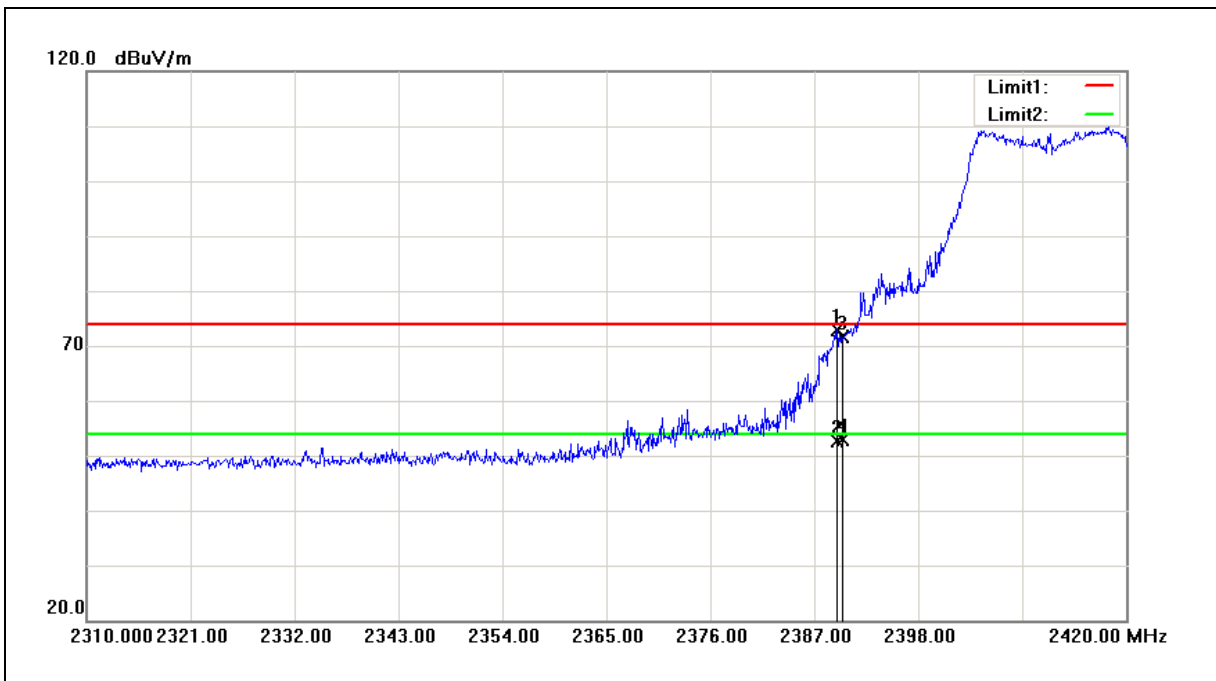

No.	Frequency (MHz)	Reading (dBuV)	Correct Factor (dB/m)	Result (dBuV/m)	Limit (dBuV/m)	Margin (dB)	Remark
1	2389.420	73.33	-0.33	73.00	74.00	-1.00	peak
2	2389.420	53.06	-0.33	52.73	54.00	-1.27	AVG
3	2390.000	71.92	-0.33	71.59	74.00	-2.41	peak
4	2390.000	53.21	-0.33	52.88	54.00	-1.12	AVG

Note:1.Result (dBuV/m) = Correct Factor (dB/m) + Reading(dBuV).

2.Correction factor (dB/m) = Antenna Factor (dB/m) + Cable loss (dB) – Pre-Amplifier gain (dB).

3. When the peak results are less than average limit, so not need to evaluate the average.



Standard:	FCC Part 15C	Test Distance:	3m
Test item:	Band edge	Power:	AC 110V/60Hz
Frequency:	2412MHz	Temp.(°C)/Hum.(%RH):	26(°C)/60%RH
Mode:	Mode 3	Date:	04/06/2016
Ant.Polar.:	Vertical		

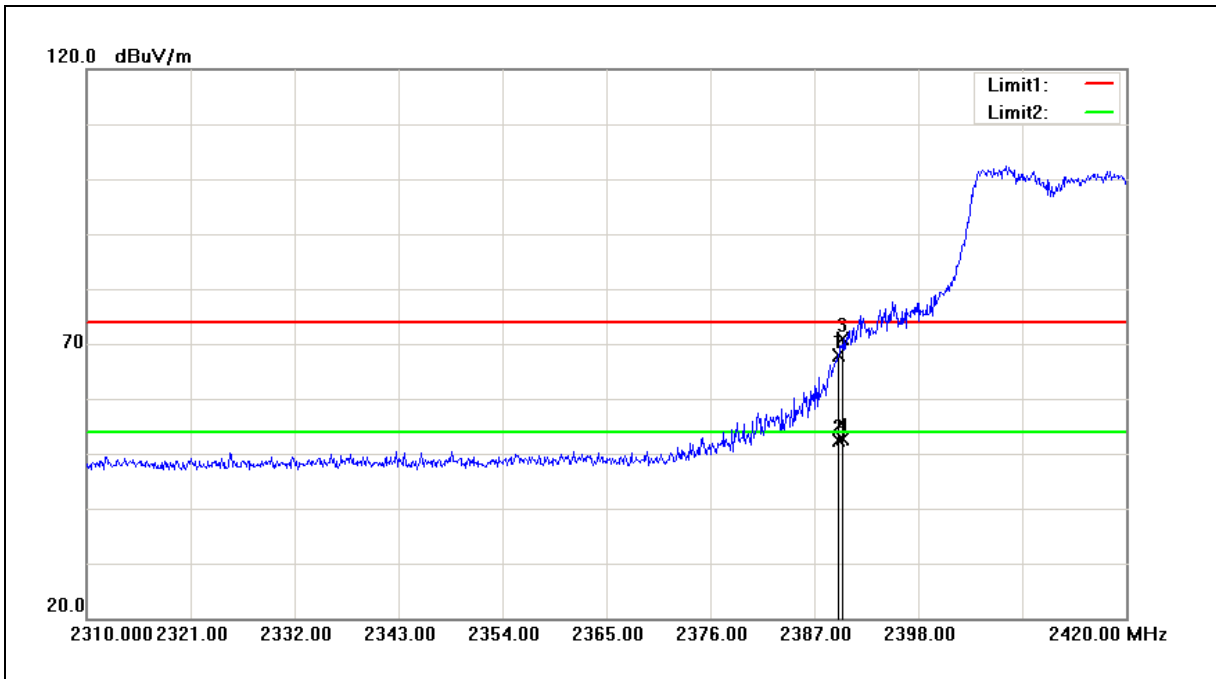

No.	Frequency (MHz)	Reading (dBuV)	Correct Factor (dB/m)	Result (dBuV/m)	Limit (dBuV/m)	Margin (dB)	Remark
1	2389.530	68.29	-0.33	67.96	74.00	-6.04	peak
2	2389.530	52.74	-0.33	52.41	54.00	-1.59	AVG
3	2390.000	71.25	-0.33	70.92	74.00	-3.08	peak
4	2390.000	52.88	-0.33	52.55	54.00	-1.45	AVG

- Note:1.Result (dBuV/m) = Correct Factor (dB/m) + Reading(dBuV).
 2.Correction factor (dB/m) = Antenna Factor (dB/m) + Cable loss (dB) – Pre-Amplifier gain (dB).
 3. When the peak results are less than average limit, so not need to evaluate the average.



Standard:	FCC Part 15C	Test Distance:	3m
Test item:	Band edge	Power:	AC 110V/60Hz
Frequency:	2437MHz	Temp.(°C)/Hum.(%RH):	26(°C)/60%RH
Mode:	Mode 3	Date:	04/06/2016
Ant.Polar.:	Horizontal		

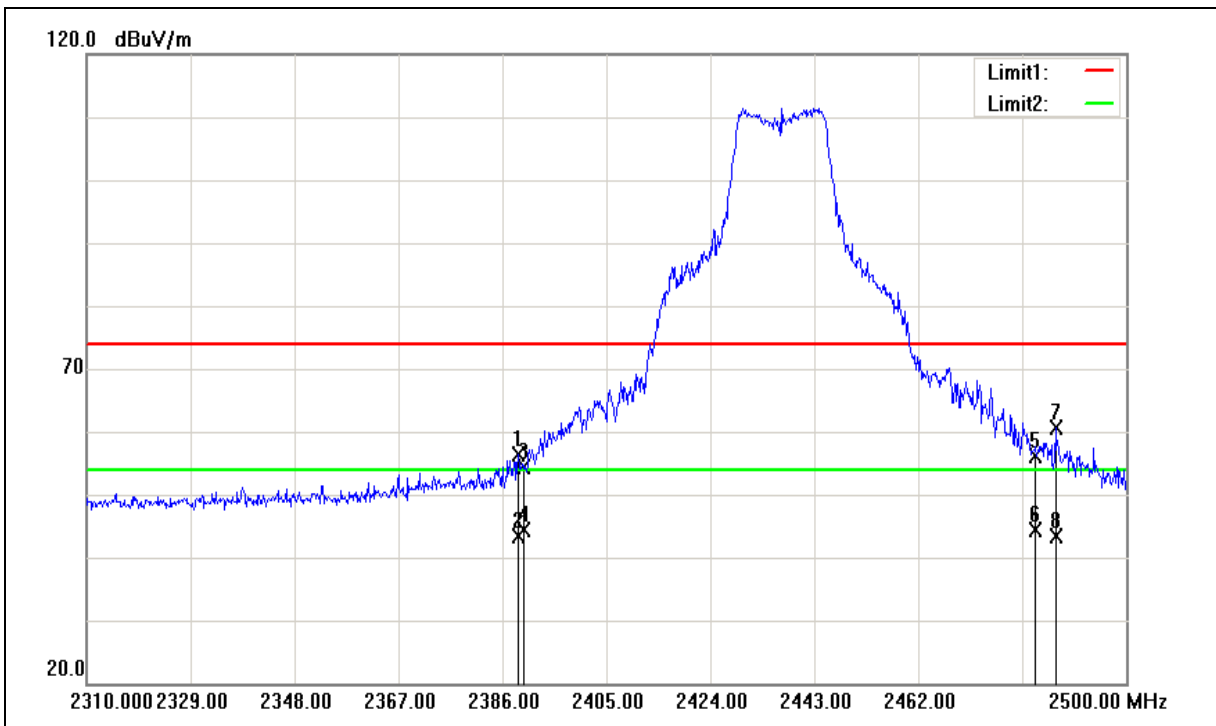



Standard:	FCC Part 15C	Test Distance:	3m
Test item:	Band edge	Power:	AC 110V/60Hz
Frequency:	2437MHz	Temp.(°C)/Hum.(%RH):	26(°C)/60%RH
Mode:	Mode 3	Date:	04/06/2016
Ant.Polar.:	Horizontal		

No.	Frequency (MHz)	Reading (dBuV)	Correct Factor (dB/m)	Result (dBuV/m)	Limit (dBuV/m)	Margin (dB)	Remark
1	2388.850	56.78	-0.33	56.45	74.00	-17.55	peak
2	2388.850	43.63	-0.33	43.30	54.00	-10.70	AVG
3	2390.000	54.61	-0.33	54.28	74.00	-19.72	peak
4	2390.000	44.66	-0.33	44.33	54.00	-9.67	AVG
5	2483.500	56.10	0.03	56.13	74.00	-17.87	peak
6	2483.500	44.23	0.03	44.26	54.00	-9.74	AVG
7	2487.080	60.56	0.04	60.60	74.00	-13.40	peak
8	2487.080	43.45	0.04	43.49	54.00	-10.51	AVG

Note:1.Result (dBuV/m) = Correct Factor (dB/m) + Reading(dBuV).

2. Correction factor (dB/m) = Antenna Factor (dB/m) + Cable loss (dB) – Pre-Amplifier gain (dB).

3. When the peak results are less than average limit, so not need to evaluate the average.

Standard:	FCC Part 15C	Test Distance:	3m
Test item:	Band edge	Power:	AC 110V/60Hz
Frequency:	2437MHz	Temp.(°C)/Hum.(%RH):	26(°C)/60%RH
Mode:	Mode 3	Date:	04/06/2016
Ant.Polar.:	Vertical		

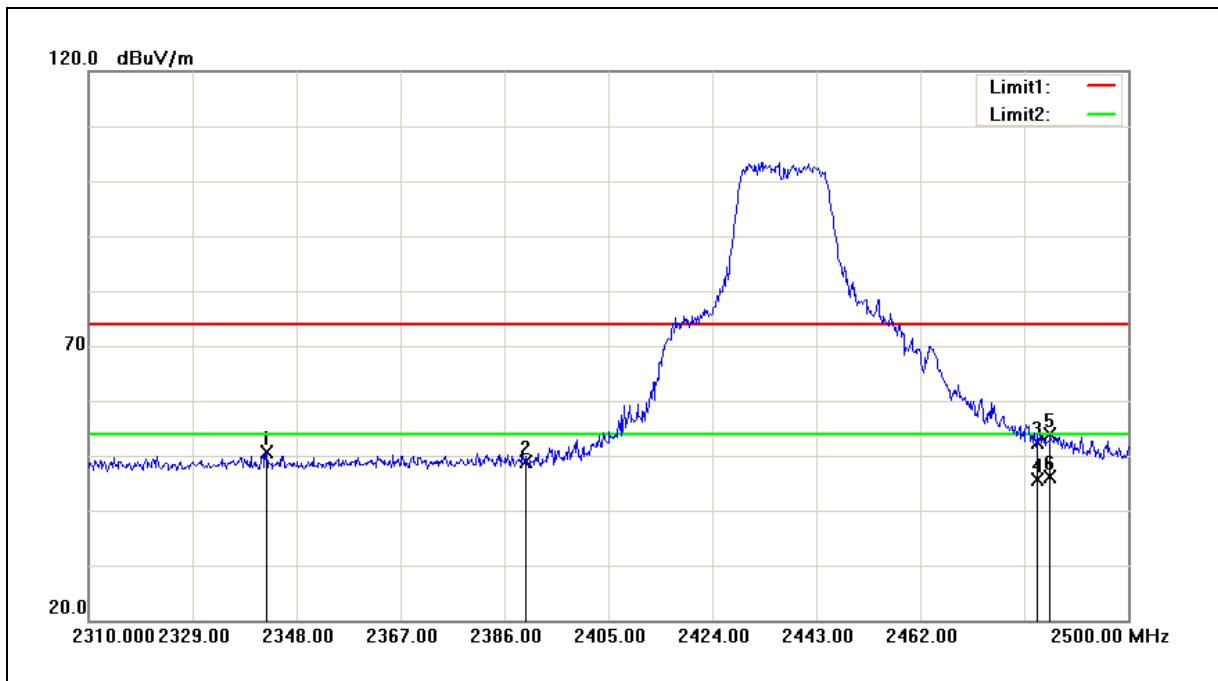

No.	Frequency (MHz)	Reading (dBuV)	Correct Factor (dB/m)	Result (dBuV/m)	Limit (dBuV/m)	Margin (dB)	Remark
1	2342.490	51.02	-0.51	50.51	74.00	-23.49	peak
2	2390.000	49.19	-0.33	48.86	74.00	-25.14	peak
3	2483.500	52.39	0.03	52.42	74.00	-21.58	peak
4	2483.500	45.56	0.03	45.59	54.00	-8.41	AVG
5	2485.750	53.87	0.03	53.90	74.00	-20.10	peak
6	2485.750	46.18	0.03	46.21	54.00	-7.79	AVG

Note:1.Result (dBuV/m) = Correct Factor (dB/m) + Reading(dBuV).

2.Correction factor (dB/m) = Antenna Factor (dB/m) + Cable loss (dB) – Pre-Amplifier gain (dB).

3. When the peak results are less than average limit, so not need to evaluate the average.



Standard:	FCC Part 15C	Test Distance:	3m
Test item:	Band edge	Power:	AC 110V/60Hz
Frequency:	2462MHz	Temp.(°C)/Hum.(%RH):	26(°C)/60%RH
Mode:	Mode 3	Date:	04/06/2016
Ant.Polar.:	Horizontal		

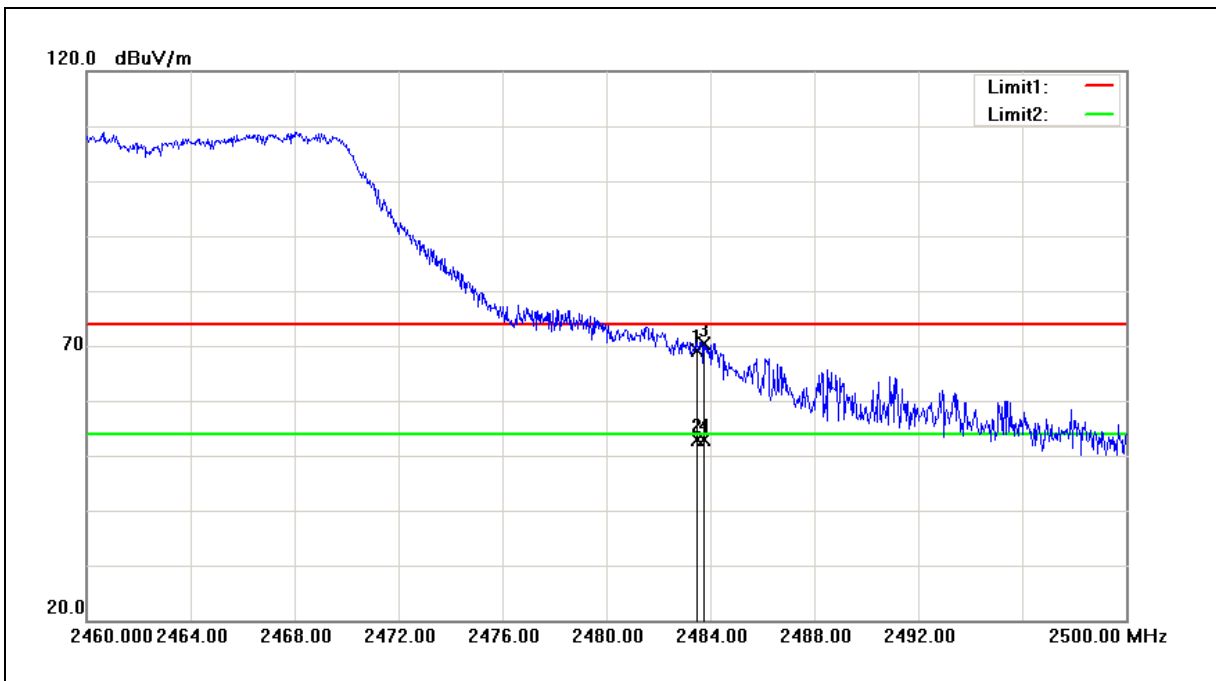

No.	Frequency (MHz)	Reading (dBuV)	Correct Factor (dB/m)	Result (dBuV/m)	Limit (dBuV/m)	Margin (dB)	Remark
1	2483.500	69.15	0.03	69.18	74.00	-4.82	peak
2	2483.500	52.94	0.03	52.97	54.00	-1.03	AVG
3	2483.760	70.44	0.03	70.47	74.00	-3.53	peak
4	2483.760	52.86	0.03	52.89	54.00	-1.11	AVG

Note:1.Result (dBuV/m) = Correct Factor (dB/m) + Reading(dBuV).

2.Correction factor (dB/m) = Antenna Factor (dB/m) + Cable loss (dB) – Pre-Amplifier gain (dB).

3. When the peak results are less than average limit, so not need to evaluate the average.



Standard:	FCC Part 15C	Test Distance:	3m
Test item:	Band edge	Power:	AC 110V/60Hz
Frequency:	2462MHz	Temp.(°C)/Hum.(%RH):	26(°C)/60%RH
Mode:	Mode 3	Date:	04/06/2016
Ant.Polar.:	Vertical		

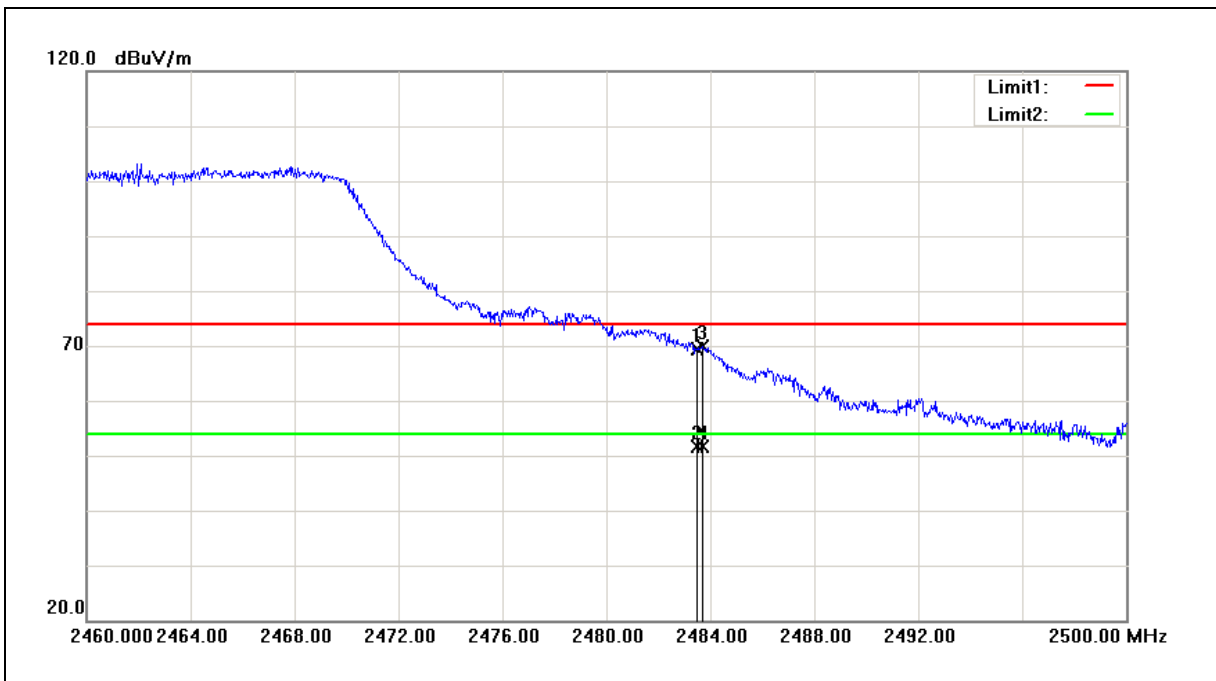

No.	Frequency (MHz)	Reading (dBuV)	Correct Factor (dB/m)	Result (dBuV/m)	Limit (dBuV/m)	Margin (dB)	Remark
1	2483.500	69.23	0.03	69.26	74.00	-4.74	peak
2	2483.500	51.63	0.03	51.66	54.00	-2.34	AVG
3	2483.680	69.73	0.03	69.76	74.00	-4.24	peak
4	2483.680	51.54	0.03	51.57	54.00	-2.43	AVG

- Note:1.Result (dBuV/m) = Correct Factor (dB/m) + Reading(dBuV).
- 2.Correction factor (dB/m) = Antenna Factor (dB/m) + Cable loss (dB) – Pre-Amplifier gain (dB).
3. When the peak results are less than average limit, so not need to evaluate the average.



Standard:	FCC Part 15C	Test Distance:	3m
Test item:	Band edge	Power:	AC 110V/60Hz
Frequency:	2412MHz	Temp.(°C)/Hum.(%RH):	26(°C)/60%RH
Mode:	Mode 4	Date:	04/06/2016
Ant.Polar.:	Horizontal		

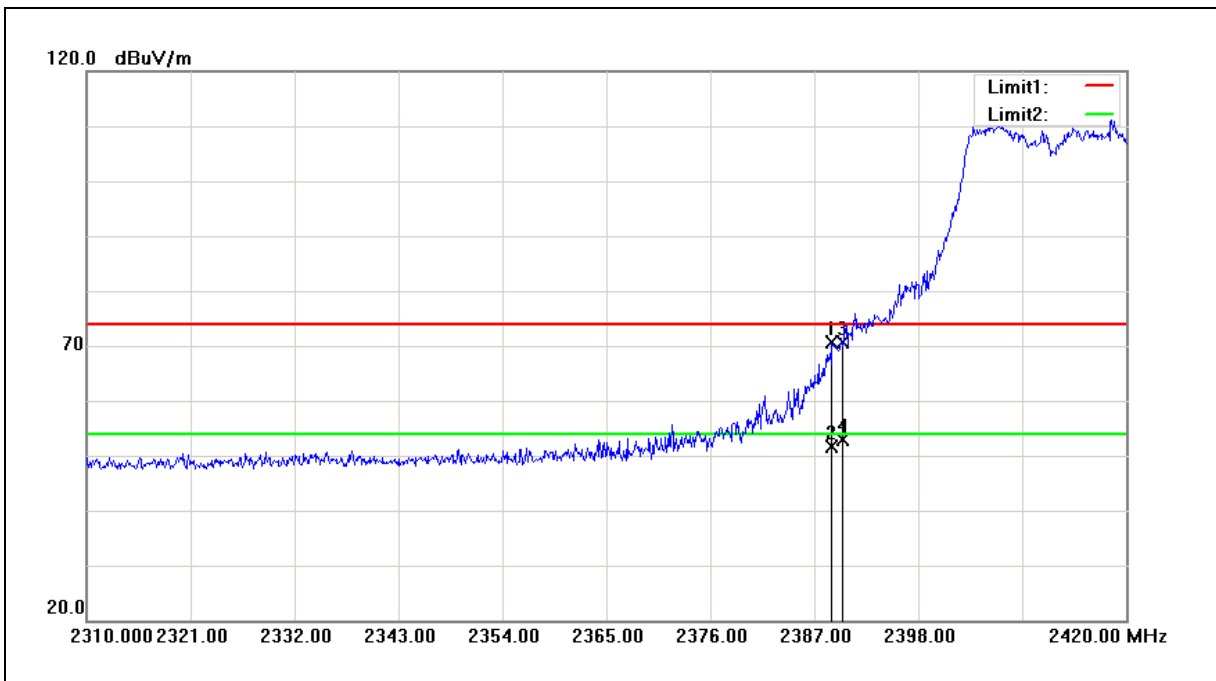

No.	Frequency (MHz)	Reading (dBuV)	Correct Factor (dB/m)	Result (dBuV/m)	Limit (dBuV/m)	Margin (dB)	Remark
1	2388.870	71.05	-0.33	70.72	74.00	-3.28	peak
2	2388.870	52.01	-0.33	51.68	54.00	-2.32	AVG
3	2390.000	71.06	-0.33	70.73	74.00	-3.27	peak
4	2390.000	53.20	-0.33	52.87	54.00	-1.13	AVG

- Note:1.Result (dBuV/m) = Correct Factor (dB/m) + Reading(dBuV).
- 2.Correction factor (dB/m) = Antenna Factor (dB/m) + Cable loss (dB) – Pre-Amplifier gain (dB).
3. When the peak results are less than average limit, so not need to evaluate the average.



Standard:	FCC Part 15C	Test Distance:	3m
Test item:	Band edge	Power:	AC 110V/60Hz
Frequency:	2412MHz	Temp.(°C)/Hum.(%RH):	26(°C)/60%RH
Mode:	Mode 4	Date:	04/06/2016
Ant.Polar.:	Vertical		

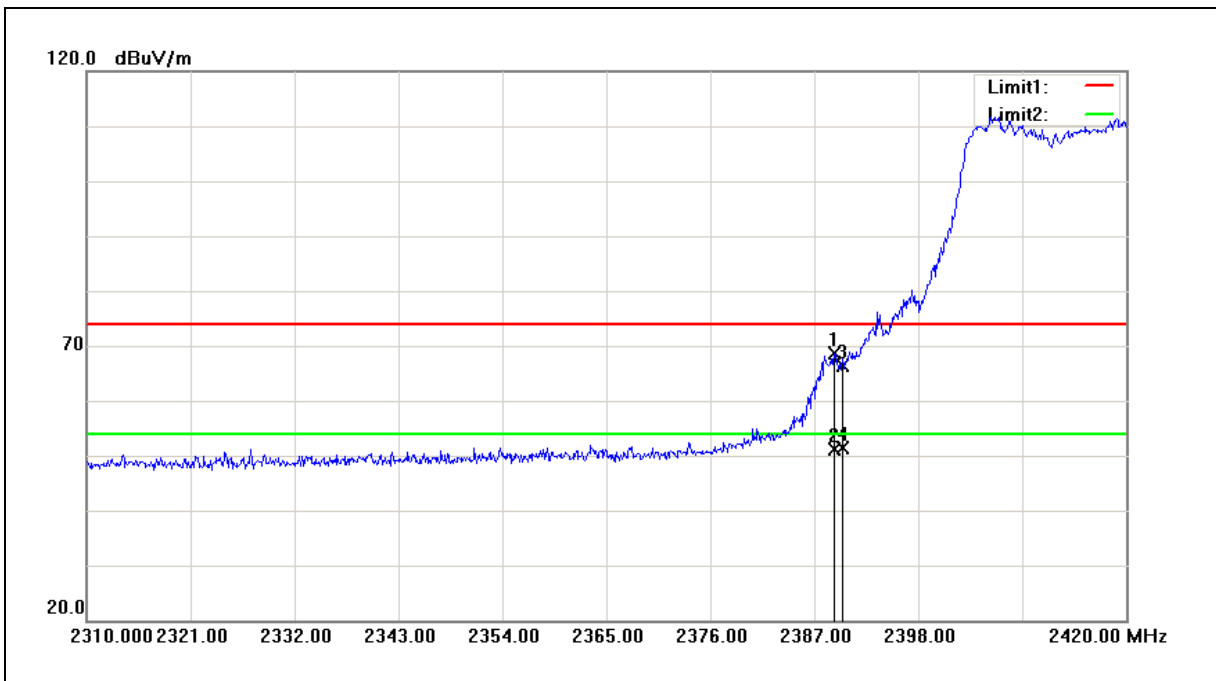

No.	Frequency (MHz)	Reading (dBuV)	Correct Factor (dB/m)	Result (dBuV/m)	Limit (dBuV/m)	Margin (dB)	Remark
1	2389.090	69.03	-0.33	68.70	74.00	-5.30	peak
2	2389.090	51.57	-0.33	51.24	54.00	-2.76	AVG
3	2390.000	66.77	-0.33	66.44	74.00	-7.56	peak
4	2390.000	51.66	-0.33	51.33	54.00	-2.67	AVG

- Note:1.Result (dBuV/m) = Correct Factor (dB/m) + Reading(dBuV).
- 2.Correction factor (dB/m) = Antenna Factor (dB/m) + Cable loss (dB) – Pre-Amplifier gain (dB).
3. When the peak results are less than average limit, so not need to evaluate the average.



Standard:	FCC Part 15C	Test Distance:	3m
Test item:	Band edge	Power:	AC 110V/60Hz
Frequency:	2437MHz	Temp.(°C)/Hum.(%RH):	26(°C)/60%RH
Mode:	Mode 4	Date:	04/06/2016
Ant.Polar.:	Horizontal		

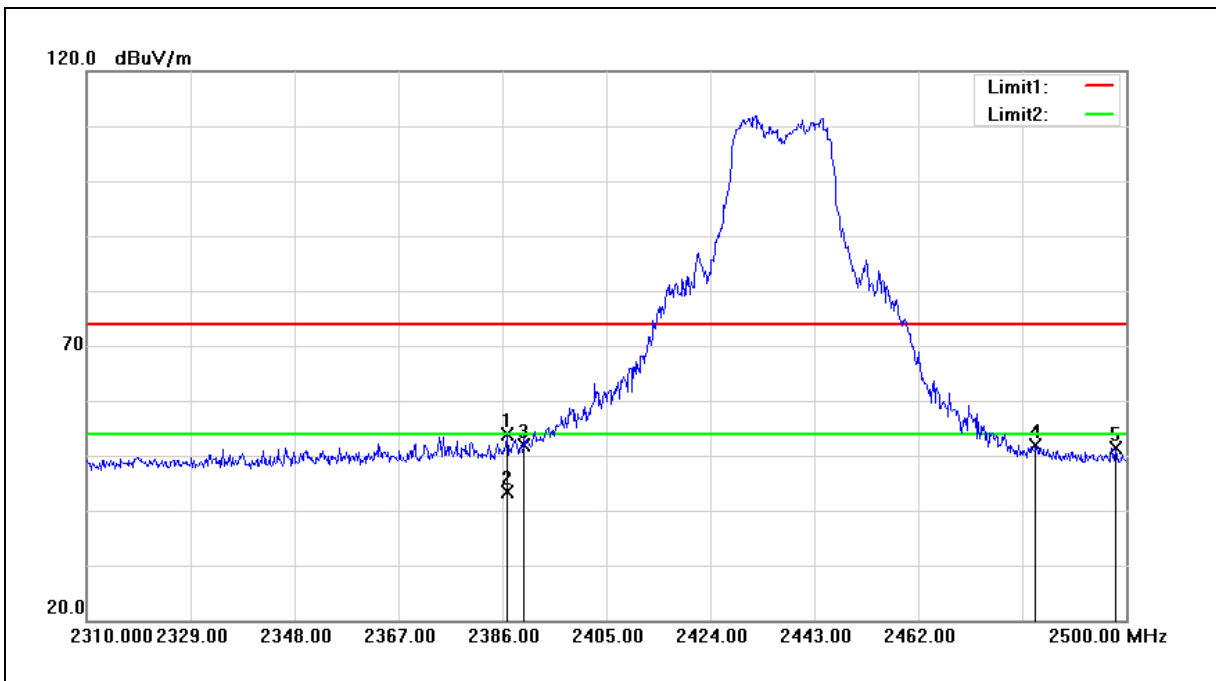

No.	Frequency (MHz)	Reading (dBuV)	Correct Factor (dB/m)	Result (dBuV/m)	Limit (dBuV/m)	Margin (dB)	Remark
1	2386.950	54.14	-0.33	53.81	74.00	-20.19	peak
2	2386.950	43.61	-0.33	43.28	54.00	-10.72	AVG
3	2390.000	52.28	-0.33	51.95	74.00	-22.05	peak
4	2483.500	51.88	0.03	51.91	74.00	-22.09	peak
5	2498.100	51.39	0.09	51.48	74.00	-22.52	peak

Note:1.Result (dBuV/m) = Correct Factor (dB/m) + Reading(dBuV).

2.Correction factor (dB/m) = Antenna Factor (dB/m) + Cable loss (dB) – Pre-Amplifier gain (dB).

3. When the peak results are less than average limit, so not need to evaluate the average.



Standard:	FCC Part 15C	Test Distance:	3m
Test item:	Band edge	Power:	AC 110V/60Hz
Frequency:	2437MHz	Temp.(°C)/Hum.(%RH):	26(°C)/60%RH
Mode:	Mode 4	Date:	04/06/2016
Ant.Polar.:	Vertical		

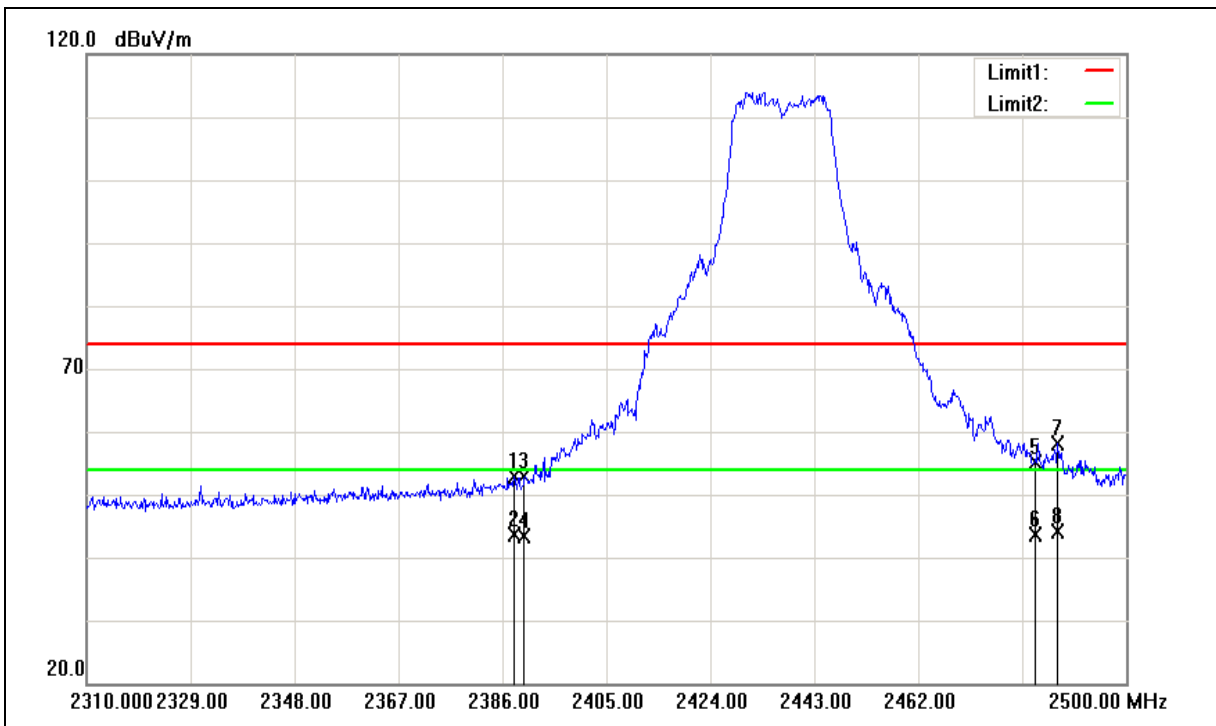



Standard:	FCC Part 15C	Test Distance:	3m
Test item:	Band edge	Power:	AC 110V/60Hz
Frequency:	2437MHz	Temp.(°C)/Hum.(%RH):	26(°C)/60%RH
Mode:	Mode 4	Date:	04/06/2016
Ant.Polar.:	Vertical		

No.	Frequency (MHz)	Reading (dBuV)	Correct Factor (dB/m)	Result (dBuV/m)	Limit (dBuV/m)	Margin (dB)	Remark
1	2388.090	53.24	-0.33	52.91	74.00	-21.09	peak
2	2388.090	43.88	-0.33	43.55	54.00	-10.45	AVG
3	2390.000	53.13	-0.33	52.80	74.00	-21.20	peak
4	2390.000	43.62	-0.33	43.29	54.00	-10.71	AVG
5	2483.500	55.00	0.03	55.03	74.00	-18.97	peak
6	2483.500	43.70	0.03	43.73	54.00	-10.27	AVG
7	2487.460	58.06	0.04	58.10	74.00	-15.90	peak
8	2487.460	44.18	0.04	44.22	54.00	-9.78	AVG

Note:1.Result (dBuV/m) = Correct Factor (dB/m) + Reading(dBuV).

2.Correction factor (dB/m) = Antenna Factor (dB/m) + Cable loss (dB) – Pre-Amplifier gain (dB).

3. When the peak results are less than average limit, so not need to evaluate the average.



Standard:	FCC Part 15C	Test Distance:	3m
Test item:	Band edge	Power:	AC 110V/60Hz
Frequency:	2462MHz	Temp.(°C)/Hum.(%RH):	26(°C)/60%RH
Mode:	Mode 4	Date:	04/06/2016
Ant.Polar.:	Horizontal		

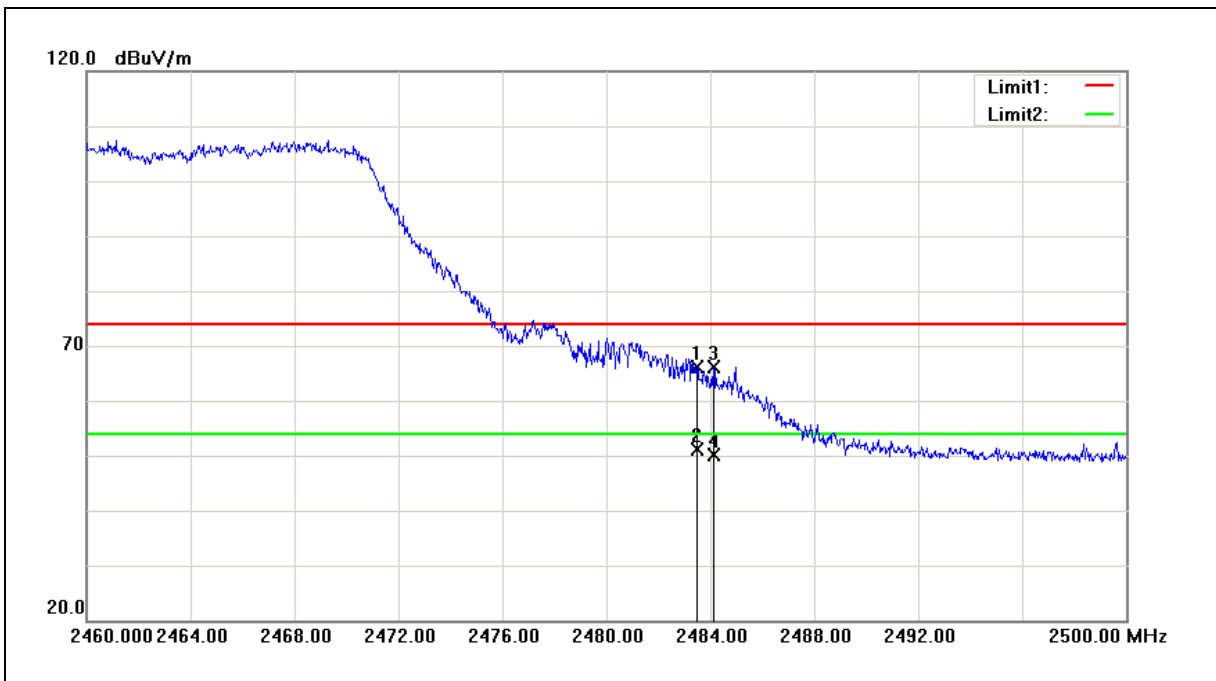

No.	Frequency (MHz)	Reading (dBuV)	Correct Factor (dB/m)	Result (dBuV/m)	Limit (dBuV/m)	Margin (dB)	Remark
1	2483.500	66.13	0.03	66.16	74.00	-7.84	peak
2	2483.500	51.11	0.03	51.14	54.00	-2.86	AVG
3	2484.120	66.11	0.03	66.14	74.00	-7.86	peak
4	2484.120	50.16	0.03	50.19	54.00	-3.81	AVG

- Note:1.Result (dBuV/m) = Correct Factor (dB/m) + Reading(dBuV).
- 2.Correction factor (dB/m) = Antenna Factor (dB/m) + Cable loss (dB) – Pre-Amplifier gain (dB).
3. When the peak results are less than average limit, so not need to evaluate the average.



Standard:	FCC Part 15C	Test Distance:	3m
Test item:	Band edge	Power:	AC 110V/60Hz
Frequency:	2462MHz	Temp.(°C)/Hum.(%RH):	26(°C)/60%RH
Mode:	Mode 4	Date:	04/06/2016
Ant.Polar.:	Vertical		

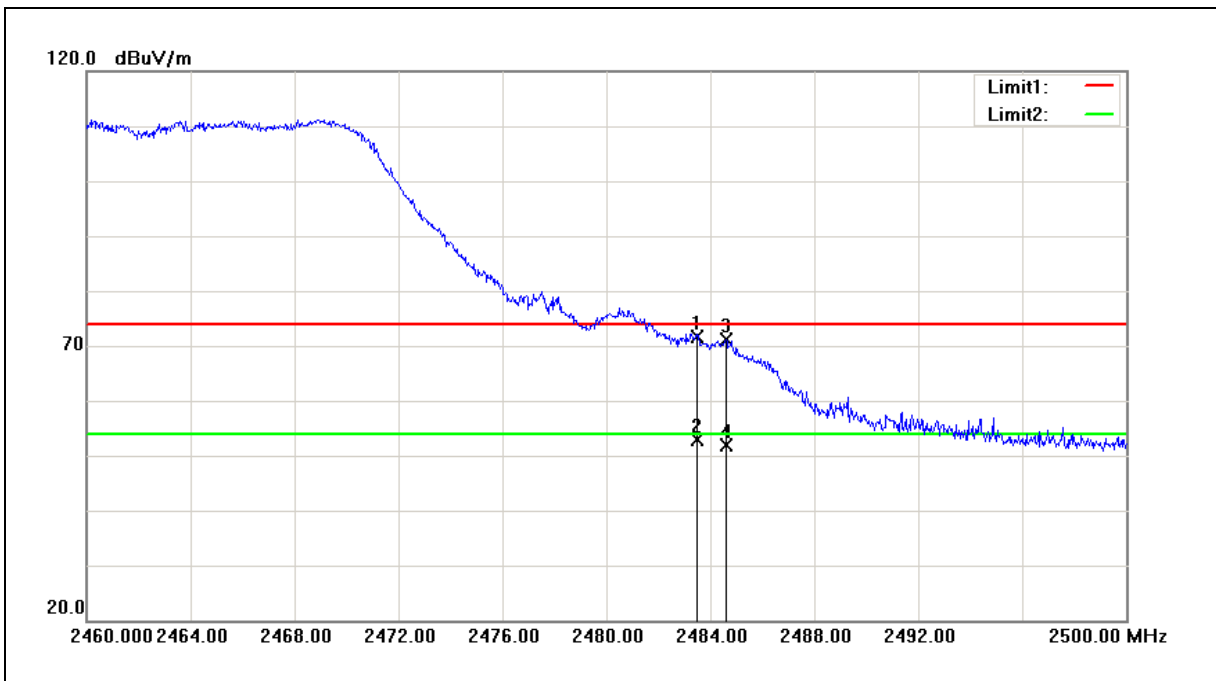

No.	Frequency (MHz)	Reading (dBuV)	Correct Factor (dB/m)	Result (dBuV/m)	Limit (dBuV/m)	Margin (dB)	Remark
1	2483.500	71.71	0.03	71.74	74.00	-2.26	peak
2	2483.500	52.90	0.03	52.93	54.00	-1.07	AVG
3	2484.600	71.04	0.03	71.07	74.00	-2.93	peak
4	2484.600	51.73	0.03	51.76	54.00	-2.24	AVG

Note:1.Result (dBuV/m) = Correct Factor (dB/m) + Reading(dBuV).

2.Correction factor (dB/m) = Antenna Factor (dB/m) + Cable loss (dB) – Pre-Amplifier gain (dB).

3. When the peak results are less than average limit, so not need to evaluate the average.



Standard:	FCC Part 15C	Test Distance:	3m
Test item:	Band edge	Power:	AC 110V/60Hz
Frequency:	2422MHz	Temp.(°C)/Hum.(%RH):	26(°C)/60%RH
Mode:	Mode 5	Date:	04/06/2016
Ant.Polar.:	Horizontal		

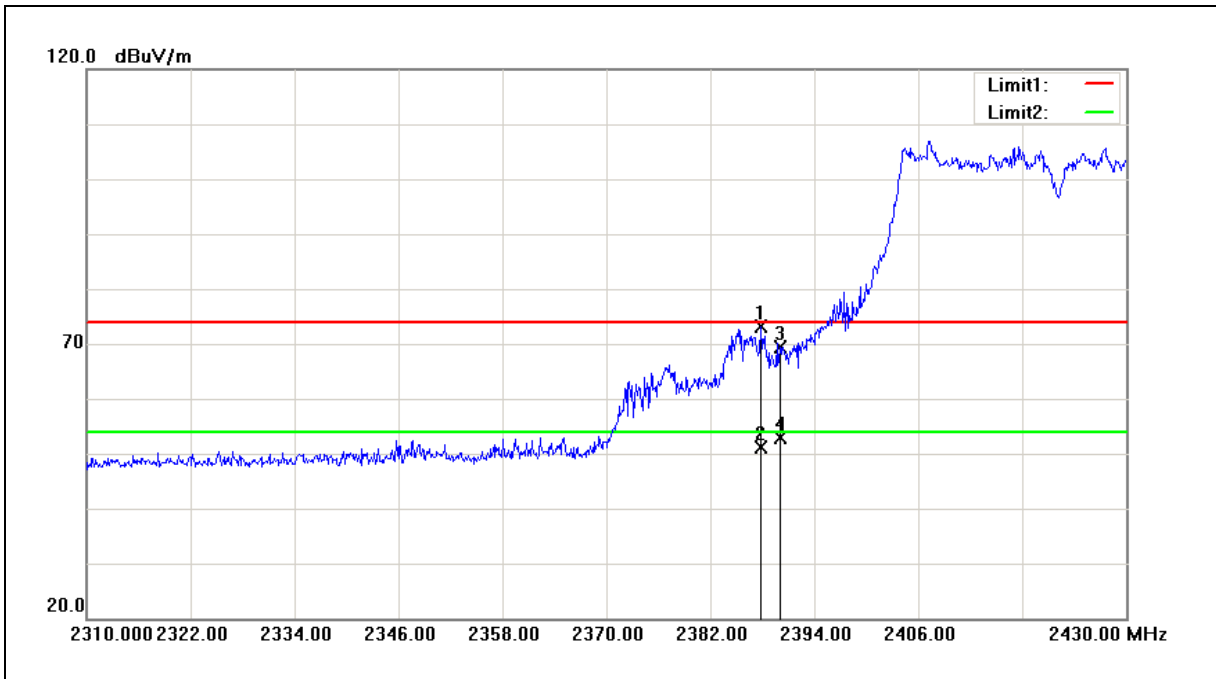

No.	Frequency (MHz)	Reading (dBuV)	Correct Factor (dB/m)	Result (dBuV/m)	Limit (dBuV/m)	Margin (dB)	Remark
1	2387.880	73.38	-0.33	73.05	74.00	-0.95	peak
2	2387.880	51.49	-0.33	51.16	54.00	-2.84	AVG
3	2390.000	69.81	-0.33	69.48	74.00	-4.52	peak
4	2390.000	53.27	-0.33	52.94	54.00	-1.06	AVG

Note:1.Result (dBuV/m) = Correct Factor (dB/m) + Reading(dBuV).

2.Correction factor (dB/m) = Antenna Factor (dB/m) + Cable loss (dB) – Pre-Amplifier gain (dB).

3. When the peak results are less than average limit, so not need to evaluate the average.



Standard:	FCC Part 15C	Test Distance:	3m
Test item:	Band edge	Power:	AC 110V/60Hz
Frequency:	2422MHz	Temp.(°C)/Hum.(%RH):	26(°C)/60%RH
Mode:	Mode 5	Date:	04/06/2016
Ant.Polar.:	Vertical		

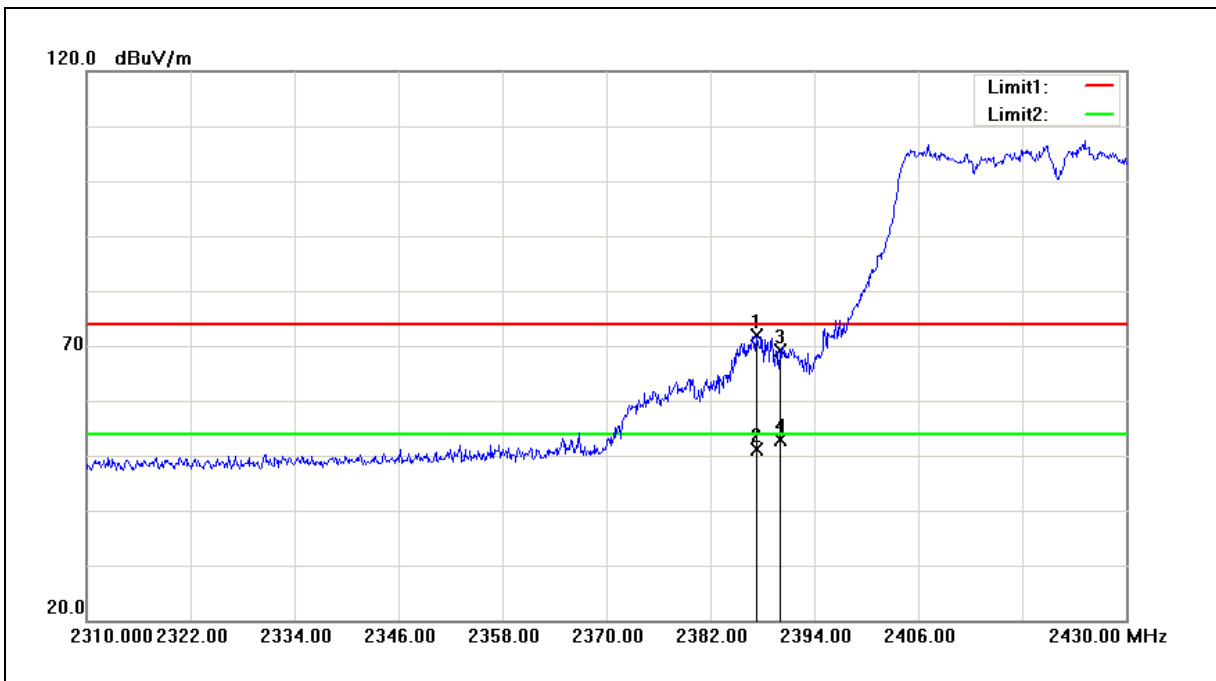

No.	Frequency (MHz)	Reading (dBuV)	Correct Factor (dB/m)	Result (dBuV/m)	Limit (dBuV/m)	Margin (dB)	Remark
1	2387.280	72.29	-0.33	71.96	74.00	-2.04	peak
2	2387.280	51.35	-0.33	51.02	54.00	-2.98	AVG
3	2390.000	69.53	-0.33	69.20	74.00	-4.80	peak
4	2390.000	53.19	-0.33	52.86	54.00	-1.14	AVG

Note:1.Result (dBuV/m) = Correct Factor (dB/m) + Reading(dBuV).

2.Correction factor (dB/m) = Antenna Factor (dB/m) + Cable loss (dB) – Pre-Amplifier gain (dB).

3. When the peak results are less than average limit, so not need to evaluate the average.



Standard:	FCC Part 15C	Test Distance:	3m
Test item:	Band edge	Power:	AC 110V/60Hz
Frequency:	2437MHz	Temp.(°C)/Hum.(%RH):	26(°C)/60%RH
Mode:	Mode 5	Date:	04/06/2016
Ant.Polar.:	Horizontal		

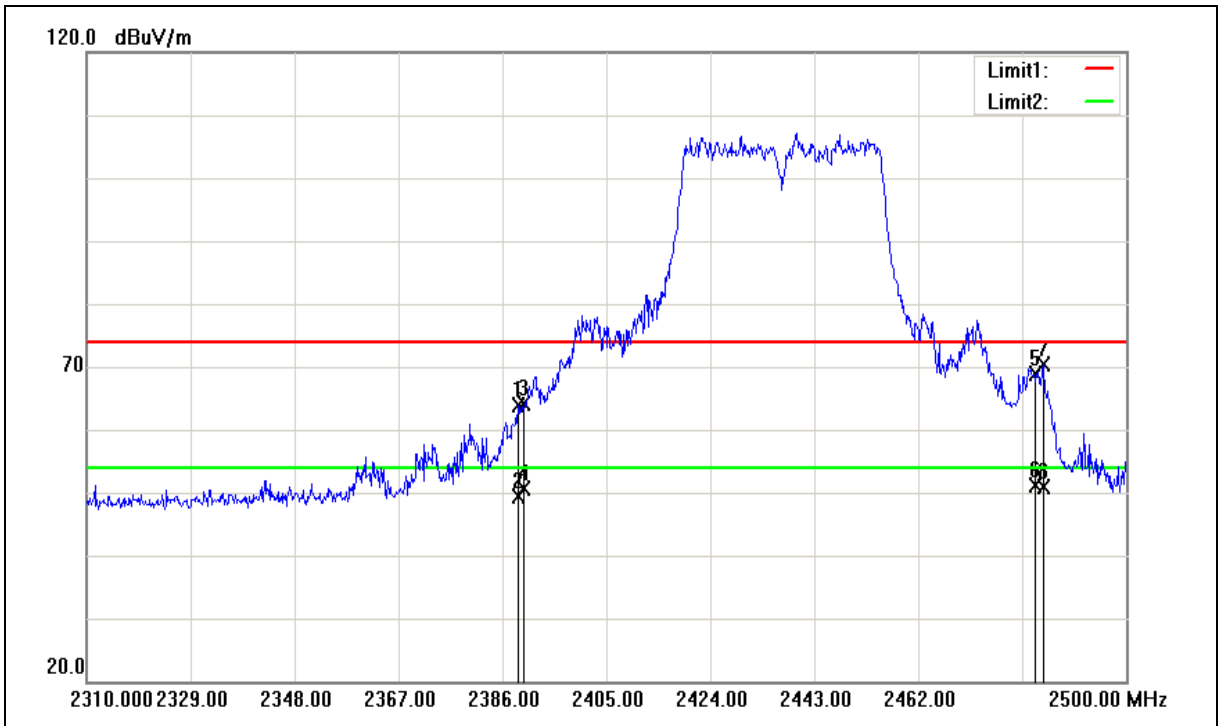



Standard:	FCC Part 15C	Test Distance:	3m
Test item:	Band edge	Power:	AC 110V/60Hz
Frequency:	2437MHz	Temp.(°C)/Hum.(%RH):	26(°C)/60%RH
Mode:	Mode 5	Date:	04/06/2016
Ant.Polar.:	Horizontal		

No.	Frequency (MHz)	Reading (dBuV)	Correct Factor (dB/m)	Result (dBuV/m)	Limit (dBuV/m)	Margin (dB)	Remark
1	2388.850	64.28	-0.33	63.95	74.00	-10.05	peak
2	2388.850	49.62	-0.33	49.29	54.00	-4.71	AVG
3	2390.000	64.39	-0.33	64.06	74.00	-9.94	peak
4	2390.000	50.85	-0.33	50.52	54.00	-3.48	AVG
5	2483.500	68.84	0.03	68.87	74.00	-5.13	peak
6	2483.500	51.06	0.03	51.09	54.00	-2.91	AVG
7	2484.800	70.24	0.03	70.27	74.00	-3.73	peak
8	2484.800	50.90	0.03	50.93	54.00	-3.07	AVG

Note:1.Result (dBuV/m) = Correct Factor (dB/m) + Reading(dBuV).

2.Correction factor (dB/m) = Antenna Factor (dB/m) + Cable loss (dB) – Pre-Amplifier gain (dB).

3. When the peak results are less than average limit, so not need to evaluate the average.



Standard:	FCC Part 15C	Test Distance:	3m
Test item:	Band edge	Power:	AC 110V/60Hz
Frequency:	2437MHz	Temp.(°C)/Hum.(%RH):	26(°C)/60%RH
Mode:	Mode 5	Date:	04/06/2016
Ant.Polar.:	Vertical		

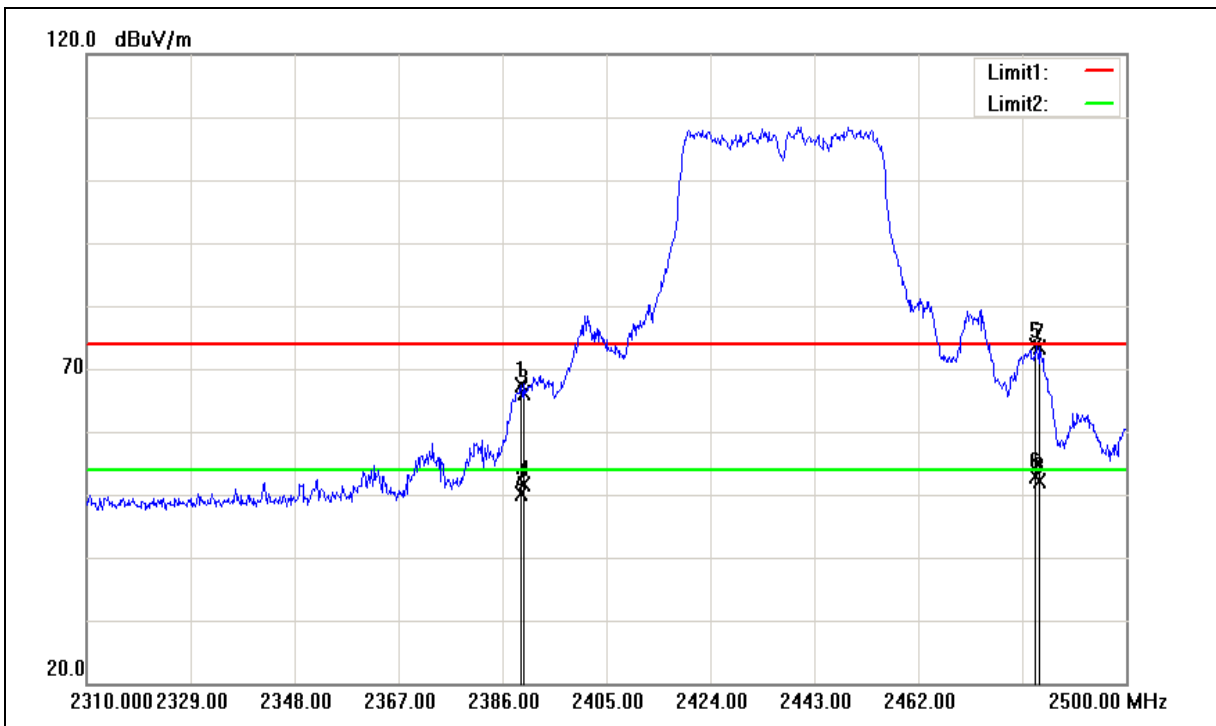



Standard:	FCC Part 15C	Test Distance:	3m
Test item:	Band edge	Power:	AC 110V/60Hz
Frequency:	2437MHz	Temp.(°C)/Hum.(%RH):	26(°C)/60%RH
Mode:	Mode 5	Date:	04/06/2016
Ant.Polar.:	Vertical		

No.	Frequency (MHz)	Reading (dBuV)	Correct Factor (dB/m)	Result (dBuV/m)	Limit (dBuV/m)	Margin (dB)	Remark
1	2389.420	67.60	-0.33	67.27	74.00	-6.73	peak
2	2389.420	50.58	-0.33	50.25	54.00	-3.75	AVG
3	2390.000	66.54	-0.33	66.21	74.00	-7.79	peak
4	2390.000	51.90	-0.33	51.57	54.00	-2.43	AVG
5	2483.500	73.54	0.03	73.57	74.00	-0.43	peak
6	2483.500	52.84	0.03	52.87	54.00	-1.13	AVG
7	2484.040	73.37	0.03	73.40	74.00	-0.60	peak
8	2484.040	52.06	0.03	52.09	54.00	-1.91	AVG

Note:1.Result (dBuV/m) = Correct Factor (dB/m) + Reading(dBuV).

2.Correction factor (dB/m) = Antenna Factor (dB/m) + Cable loss (dB) – Pre-Amplifier gain (dB).

3. When the peak results are less than average limit, so not need to evaluate the average.



Standard:	FCC Part 15C	Test Distance:	3m
Test item:	Band edge	Power:	AC 110V/60Hz
Frequency:	2452MHz	Temp.(°C)/Hum.(%RH):	26(°C)/60%RH
Mode:	Mode 5	Date:	04/06/2016
Ant.Polar.:	Horizontal		

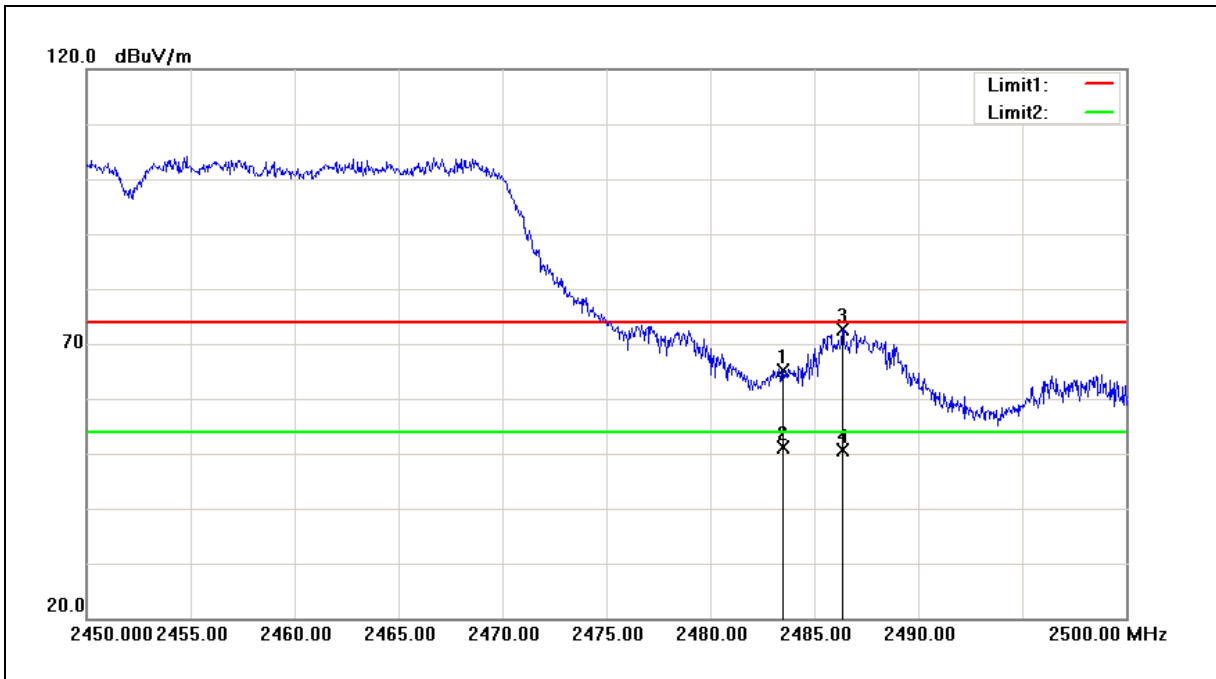

No.	Frequency (MHz)	Reading (dBuV)	Correct Factor (dB/m)	Result (dBuV/m)	Limit (dBuV/m)	Margin (dB)	Remark
1	2483.500	65.05	0.03	65.08	74.00	-8.92	peak
2	2483.500	51.13	0.03	51.16	54.00	-2.84	AVG
3	2486.350	72.70	0.03	72.73	74.00	-1.27	peak
4	2486.350	50.64	0.03	50.67	54.00	-3.33	AVG

- Note:1.Result (dBuV/m) = Correct Factor (dB/m) + Reading(dBuV).
- 2.Correction factor (dB/m) = Antenna Factor (dB/m) + Cable loss (dB) – Pre-Amplifier gain (dB).
3. When the peak results are less than average limit, so not need to evaluate the average.



Standard:	FCC Part 15C	Test Distance:	3m
Test item:	Band edge	Power:	AC 110V/60Hz
Frequency:	2452MHz	Temp.(°C)/Hum.(%RH):	26(°C)/60%RH
Mode:	Mode 5	Date:	04/06/2016
Ant.Polar.:	Vertical		

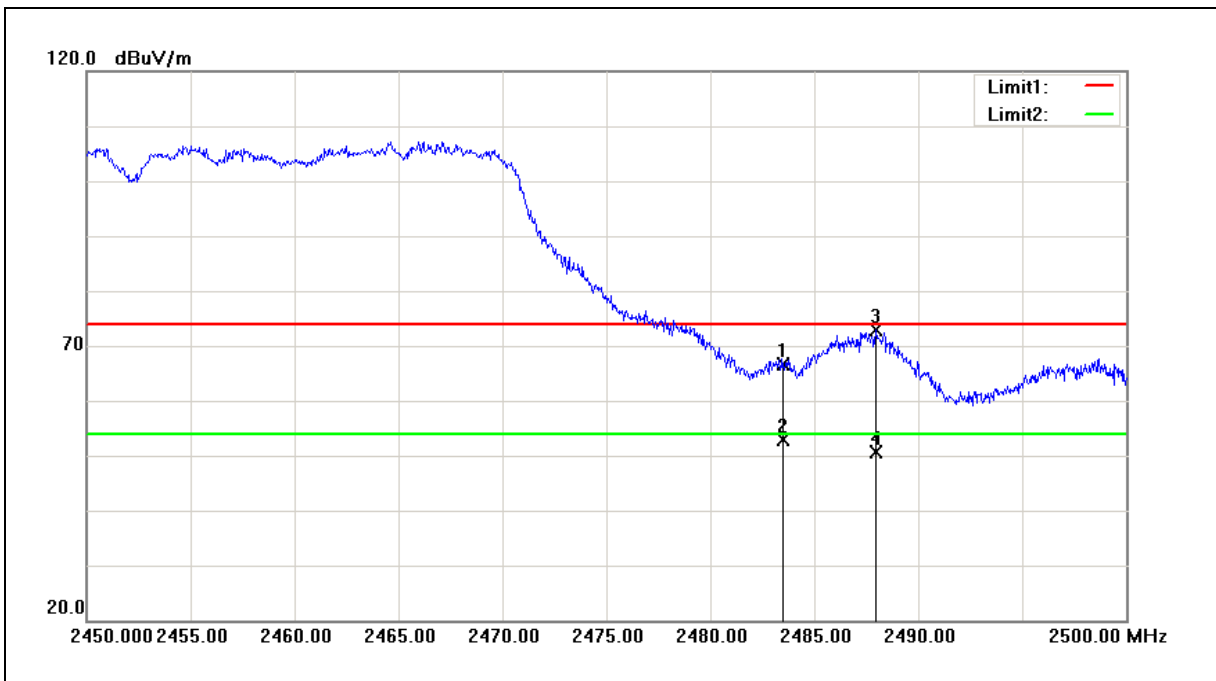

No.	Frequency (MHz)	Reading (dBuV)	Correct Factor (dB/m)	Result (dBuV/m)	Limit (dBuV/m)	Margin (dB)	Remark
1	2483.500	66.66	0.03	66.69	74.00	-7.31	peak
2	2483.500	52.95	0.03	52.98	54.00	-1.02	AVG
3	2487.950	72.81	0.04	72.85	74.00	-1.15	peak
4	2487.950	50.62	0.04	50.66	54.00	-3.34	AVG

Note:1.Result (dBuV/m) = Correct Factor (dB/m) + Reading(dBuV).

2.Correction factor (dB/m) = Antenna Factor (dB/m) + Cable loss (dB) – Pre-Amplifier gain (dB).

3. When the peak results are less than average limit, so not need to evaluate the average.

6 Maximum Conducted Output Power Measurement

6.1. Limit

For systems using digital modulation in the 2400-2483.5MHz, the limit for maximum output power is 30dBm.

And According to 15.247 (b), if transmitting antennas of directional gain greater than 6 dBi are used, the power shall be reduced by the amount in dB that the directional gain of the antenna exceeds 6dBi.

- * SISO mode ANT-0 : Max. Gain = 4.84 dBi < 6dBi.
- SISO mode ANT-1 : Max. Gain = 3.41 dBi < 6dBi.
- SISO mode ANT-2 : Max. Gain = 3.59 dBi < 6dBi.
- * MIMO mode : Directional Gain = $10 \cdot \log\{[10^{G1/20} + 10^{G2/20} + \dots + 10^{Gn/20}]^2 / NANT\}$ = 8.74 dBi > 6dBi
- * MIMO mode power limit shall be reduced = 30 - 2.74 = 27.26 dBm

6.2. Test Setup

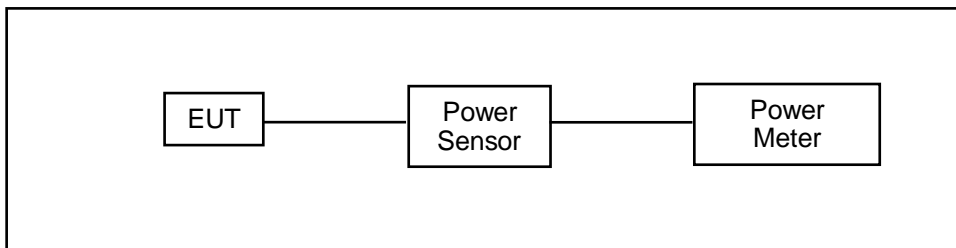

6.3. Test Instruments

Equipment	Manufacturer	Model Number	Serial Number	Cal. Date	Cal. Period
Power Sensor	Anritsu	MA2411B	1126022	08/24/2015	1 year
Power Meter	Anritsu	ML2495A	1135009	08/24/2015	1 year
Microwave Cable	EMCI	EMC104-SM-SM-1500	140303	02/23/2016	1 year
Test Site	ATL	TE05	TE05	N.C.R.	-----

Note: N.C.R. = No Calibration Request.

6.4. Test Procedure

The tests below are run with the EUT's transmitter set at high power in TX mode. The EUT is needed to force selection of output power level and channel number. While testing, EUT was set to transmit continuously. Remove the Subjective device's antenna and connect the RF output port to power sensor.



6.5. Test Result

Model Number	D1080-Z1				
Test Item	Maximum Conducted Output Power				
Date of Test	04/06/2016				
ANT-0					
Test Mode	Frequency (MHz)	Data Rate	Average Output Power		
			Measurement Results		Limit
			dBm	W	dBm
Mode 2	2412	1M	18.88	0.077	< 30
	2437		19.95	0.099	< 30
	2462		19.99	0.100	< 30
	2437	2M	19.94	0.099	< 30
	2437	5.5M	19.92	0.098	< 30
	2437	11M	19.91	0.098	< 30
Mode 3	2412	6M	17.52	0.056	< 30
	2437		18.18	0.066	< 30
	2462		18.63	0.073	< 30
	2437	9M	18.17	0.066	< 30
	2437	12M	18.16	0.065	< 30
	2437	18M	18.14	0.065	< 30
	2437	24M	18.13	0.065	< 30
	2437	36M	18.12	0.065	< 30
	2437	48M	18.10	0.065	< 30
	2437	54M	18.08	0.064	< 30

Note: The relevant measured result has the offset with cable loss already.



Model Number	D1080-Z1				
Test Item	Maximum Conducted Output Power				
Date of Test	04/06/2016				
ANT-0					
Test Mode	Frequency (MHz)	Data Rate	Average Output Power		
			Measurement Results		Limit
			dBm	W	dBm
Mode 4	2412	19.5M	14.76	0.030	< 30
	2437		15.12	0.033	< 30
	2462		15.01	0.032	< 30
	2437	39M	15.10	0.032	< 30
	2437	58.5M	15.09	0.032	< 30
	2437	78M	15.07	0.032	< 30
	2437	117M	15.04	0.032	< 30
	2437	156M	15.01	0.032	< 30
	2437	175.5M	14.97	0.031	< 30
	2437	195M	14.95	0.031	< 30
	2437	234M	14.92	0.031	< 30
Mode 5	2422	40.5M	14.34	0.027	< 30
	2437		14.64	0.029	< 30
	2452		14.57	0.029	< 30
	2437	81M	14.62	0.029	< 30
	2437	121.5M	14.59	0.029	< 30
	2437	162M	14.56	0.029	< 30
	2437	243M	14.53	0.028	< 30
	2437	324M	14.51	0.028	< 30
	2437	364.5M	14.48	0.028	< 30
	2437	135M	14.45	0.028	< 30
	2437	486M	14.43	0.028	< 30
	2437	540M	14.41	0.028	< 30

Note: The relevant measured result has the offset with cable loss already.



Model Number	D1080-Z1				
Test Item	Maximum Conducted Output Power				
Date of Test	04/06/2016				
ANT-1					
Test Mode	Frequency (MHz)	Data Rate	Average Output Power		
			Measurement Results		Limit
			dBm	W	dBm
Mode 4	2412	19.5M	10.32	0.011	< 30
	2437		10.92	0.012	< 30
	2462		10.69	0.012	< 30
	2437	39M	10.87	0.012	< 30
	2437	58.5M	10.85	0.012	< 30
	2437	78M	10.83	0.012	< 30
	2437	117M	10.80	0.012	< 30
	2437	156M	10.78	0.012	< 30
	2437	175.5M	10.75	0.012	< 30
	2437	195M	10.72	0.012	< 30
	2437	234M	10.70	0.012	< 30
Mode 5	2422	40.5M	9.68	0.009	< 30
	2437		9.48	0.009	< 30
	2452		9.69	0.009	< 30
	2437	81M	9.46	0.009	< 30
	2437	121.5M	9.43	0.009	< 30
	2437	162M	9.41	0.009	< 30
	2437	243M	9.38	0.009	< 30
	2437	324M	9.36	0.009	< 30
	2437	364.5M	9.33	0.009	< 30
	2437	135M	9.31	0.009	< 30
	2437	486M	9.27	0.008	< 30
	2437	540M	9.24	0.008	< 30

Note: The relevant measured result has the offset with cable loss already.



Model Number	D1080-Z1				
Test Item	Maximum Conducted Output Power				
Date of Test	04/06/2016				
ANT-2					
Test Mode	Frequency (MHz)	Data Rate	Average Output Power		
			Measurement Results		Limit
			dBm	W	dBm
Mode 4	2412	19.5M	14.94	0.031	< 30
	2437		15.26	0.034	< 30
	2462		15.15	0.033	< 30
	2437	39M	15.24	0.033	< 30
	2437	58.5M	15.21	0.033	< 30
	2437	78M	15.18	0.033	< 30
	2437	117M	15.16	0.033	< 30
	2437	156M	15.14	0.033	< 30
	2437	175.5M	15.11	0.032	< 30
	2437	195M	15.09	0.032	< 30
	2437	234M	15.06	0.032	< 30
Mode 5	2422	40.5M	14.44	0.028	< 30
	2437		14.68	0.029	< 30
	2452		14.65	0.029	< 30
	2437	81M	14.65	0.029	< 30
	2437	121.5M	14.63	0.029	< 30
	2437	162M	14.61	0.029	< 30
	2437	243M	14.58	0.029	< 30
	2437	324M	14.56	0.029	< 30
	2437	364.5M	14.53	0.028	< 30
	2437	135M	14.52	0.028	< 30
	2437	486M	14.49	0.028	< 30
	2437	540M	14.47	0.028	< 30

Note: The relevant measured result has the offset with cable loss already.



Model Number	D1080-Z1				
Test Item	Maximum Conducted Output Power				
Date of Test	04/06/2016				
ANT-0+1+2					
Test Mode	Frequency (MHz)	Data Rate	Average Output Power		
			Measurement Results		Limit
			dBm	W	dBm
Mode 4	2412	19.5M	18.57	0.072	< 27.26
	2437		18.95	0.078	< 27.26
	2462		18.82	0.076	< 27.26
	2437	39M	18.92	0.078	< 27.26
	2437	58.5M	18.90	0.078	< 27.26
	2437	78M	18.88	0.077	< 27.26
	2437	117M	18.85	0.077	< 27.26
	2437	156M	18.83	0.076	< 27.26
	2437	175.5M	18.79	0.076	< 27.26
	2437	195M	18.77	0.075	< 27.26
	2437	234M	18.74	0.075	< 27.26
Mode 5	2422	40.5M	18.08	0.064	< 27.26
	2437		18.28	0.067	< 27.26
	2452		18.27	0.067	< 27.26
	2437	81M	18.26	0.067	< 27.26
	2437	121.5M	18.23	0.067	< 27.26
	2437	162M	18.21	0.066	< 27.26
	2437	243M	18.18	0.066	< 27.26
	2437	324M	18.16	0.065	< 27.26
	2437	364.5M	18.13	0.065	< 27.26
	2437	135M	18.11	0.065	< 27.26
	2437	486M	18.08	0.064	< 27.26
	2437	540M	18.06	0.064	< 27.26

Note: The relevant measured result has the offset with cable loss already.

7 6dB RF Bandwidth Measurement

7.1. Limit

6dB RF Bandwidth: Systems using digital modulation techniques may operate in the 2400–2483.5 MHz bands. The minimum 6 dB band-width shall be at least 500 kHz.

7.2. Test Setup

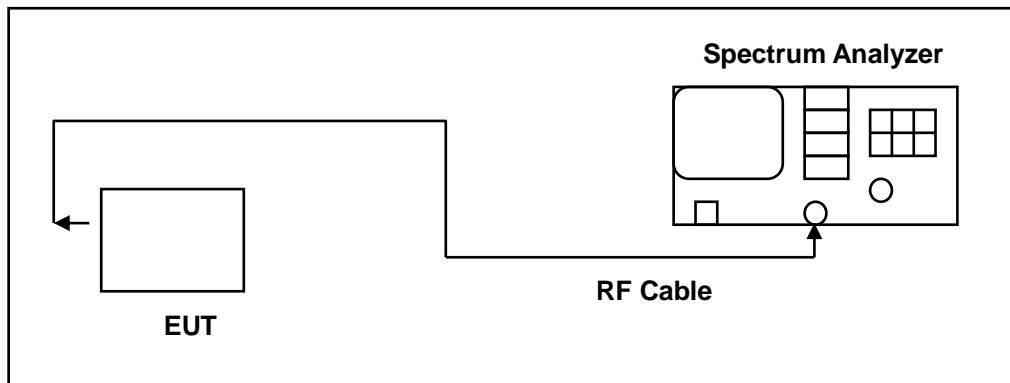

7.3. Test Instruments

Equipment	Manufacturer	Model Number	Serial Number	Cal. Date	Cal. Period
Spectrum Analyzer	Agilent	E4445A	MY45300744	12/15/2015	1 year
Microwave Cable	EMCI	EMC104-SM-SM-1500	140303	02/23/2016	1 year
Test Site	ATL	TE05	TE05	N.C.R.	-----

Note: N.C.R. = No Calibration Request.

7.4. Test Procedure

The EUT tested to DTS test procedure of KDB558074D01 for compliance to FCC 47CFR 15.247 requirements.

6dB RF Bandwidth: The antenna port of the EUT was connected to the input of a spectrum analyzer. Analyzer RBW was set to 100 kHz. For each RF output channel investigated, the spectrum analyzer center frequency was set to the channel carrier. A peak output reading was taken, a DISPLAY line was drawn 6 dB lower than peak level. The 6 dB bandwidth was determined from where the channel output spectrum intersected the display line.

The test was performed at 3 channels (Channel low, middle, high)



7.5. Test Result

Model Number	D1080-Z1				
Test Item	6dB RF Bandwidth				
Date of Test	05/05/2016				
Test Mode	Frequency (MHz)	Measurement (kHz)			Limit (kHz)
		ANT-0	ANT-1	ANT-2	
Mode 2	2412	10060	---	---	> 500
	2437	10080	---	---	> 500
	2462	10060	---	---	> 500
Mode 3	2412	16360	---	---	> 500
	2437	16350	---	---	> 500
	2462	16360	---	---	> 500
Mode 4	2412	17570	17590	17590	> 500
	2437	17560	17590	17580	> 500
	2462	17560	17580	17580	> 500
Mode 5	2422	36270	36280	36340	> 500
	2437	36280	36300	36300	> 500
	2452	36290	36320	36340	> 500

7.6. Test Graphs

Mode 2: IEEE 802.11b link mode_ANT-0	
2412 MHz	<p>Agilent Spectrum Analyzer - Occupied BW</p> <p>Center Freq: 2.412000000 GHz Trig: Free Run #Atten: 20 dB</p> <p>Radio Std: None Radio Device: BTS</p> <p>10 dB/div Ref 20.00 dBm</p> <p>Center: 2.412 GHz #Res BW 100 kHz #VBW 300 kHz Span 30 MHz Sweep 3.733 ms</p> <p>Occupied Bandwidth 15.574 MHz Total Power 30.4 dBm</p> <p>Transmit Freq Error 52.673 kHz OBW Power 99.00 %</p> <p>x dB Bandwidth 10.06 MHz x dB -6.00 dB</p>
2437 MHz	<p>Agilent Spectrum Analyzer - Occupied BW</p> <p>Center Freq: 2.437000000 GHz Trig: Free Run #Atten: 20 dB</p> <p>Radio Std: None Radio Device: BTS</p> <p>10 dB/div Ref 20.00 dBm</p> <p>Center: 2.437 GHz #Res BW 100 kHz #VBW 300 kHz Span 30 MHz Sweep 3.733 ms</p> <p>Occupied Bandwidth 15.755 MHz Total Power 30.2 dBm</p> <p>Transmit Freq Error -19.163 kHz OBW Power 99.00 %</p> <p>x dB Bandwidth 10.08 MHz x dB -6.00 dB</p>
2462 MHz	<p>Agilent Spectrum Analyzer - Occupied BW</p> <p>Center Freq: 2.462000000 GHz Trig: Free Run #Atten: 20 dB</p> <p>Radio Std: None Radio Device: BTS</p> <p>10 dB/div Ref 20.00 dBm</p> <p>Center: 2.462 GHz #Res BW 100 kHz #VBW 300 kHz Span 30 MHz Sweep 3.733 ms</p> <p>Occupied Bandwidth 15.790 MHz Total Power 30.7 dBm</p> <p>Transmit Freq Error -22.297 kHz OBW Power 99.00 %</p> <p>x dB Bandwidth 10.06 MHz x dB -6.00 dB</p>



Mode 3: IEEE 802.11g link mode_ANT-0

2412 MHz

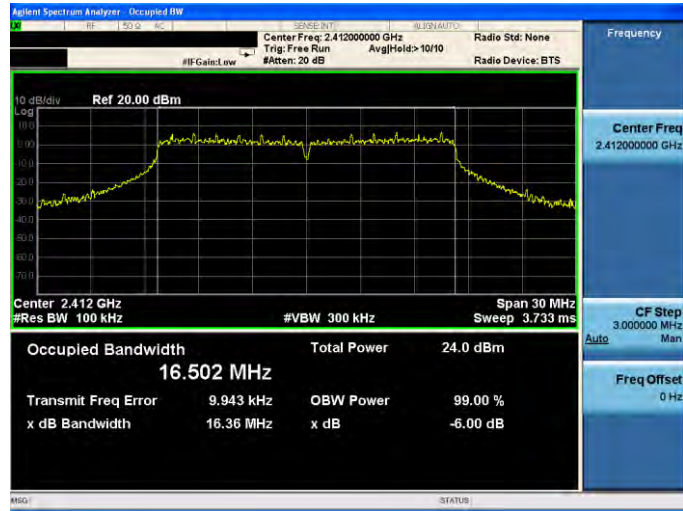

2437 MHz

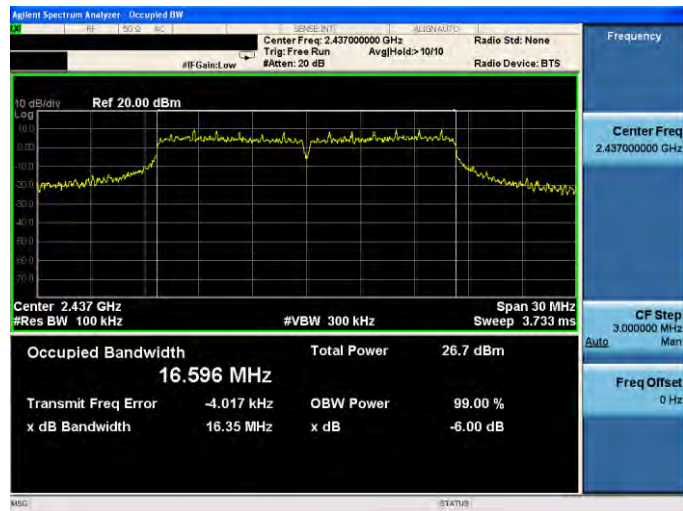

2462 MHz

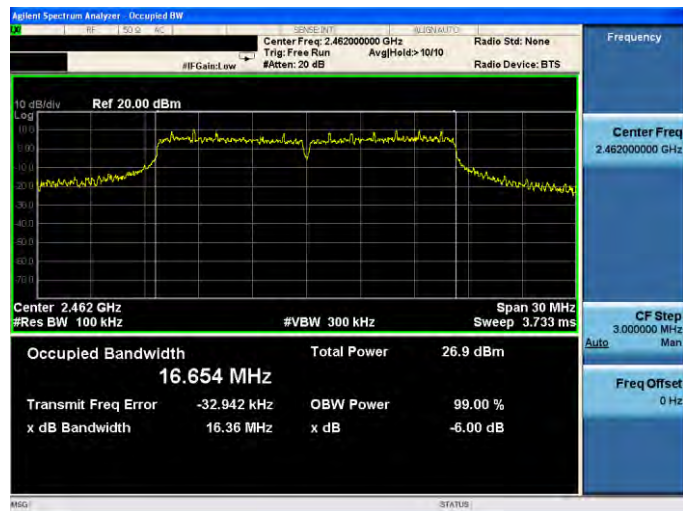



Mode 4: IEEE 802.11n 2.4GHz 20MHz link mode_ANT-0

2412 MHz

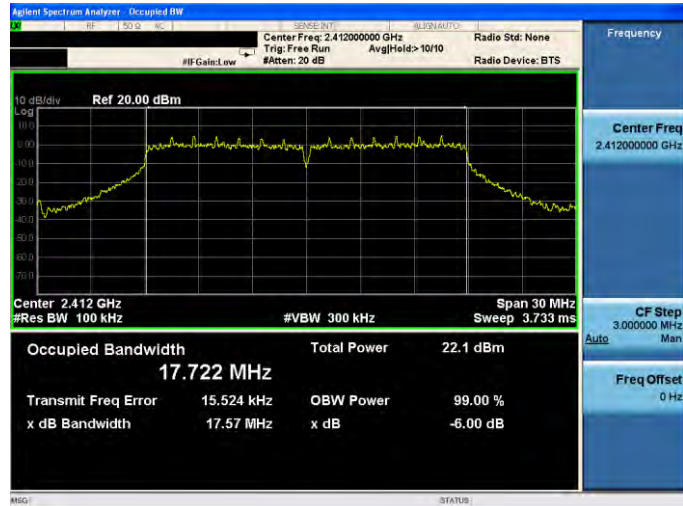

2437 MHz

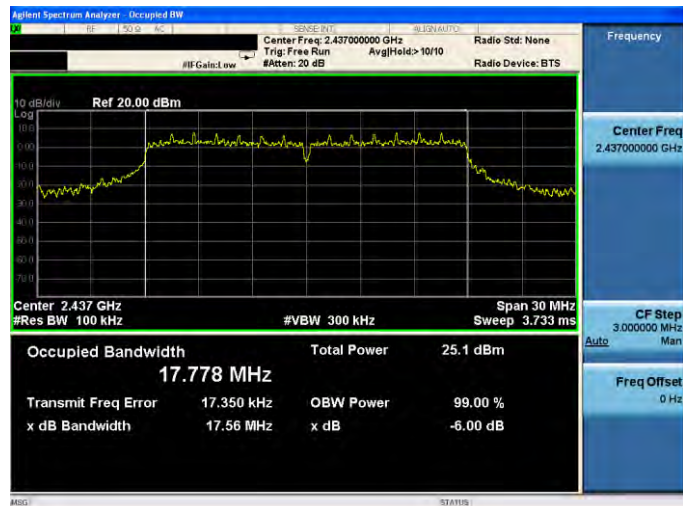

2462 MHz

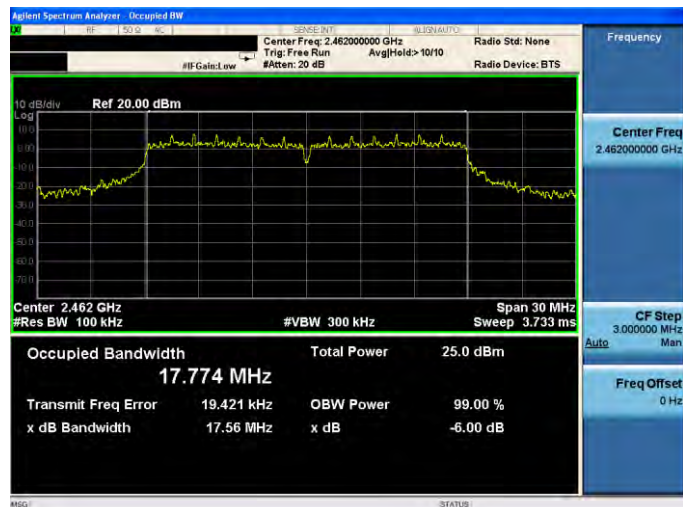



Mode 5: IEEE 802.11n 2.4GHz 40MHz link mode_ANT-0

2422 MHz



2437 MHz



2452 MHz

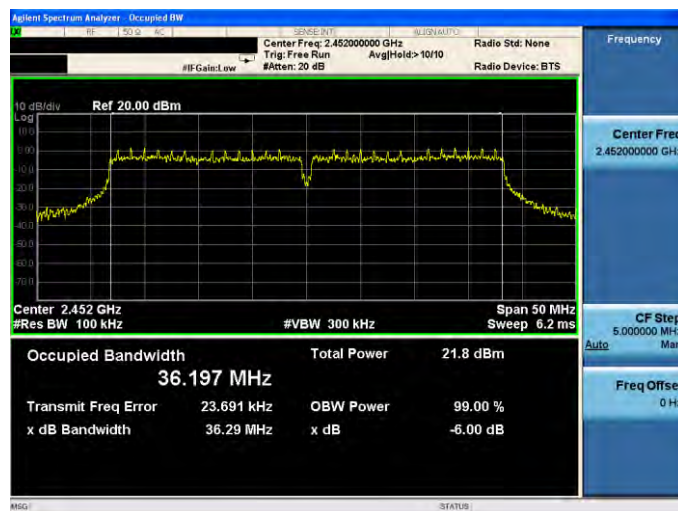



Mode 4: IEEE 802.11n 2.4GHz 20MHz link mode_ANT-1

2412 MHz

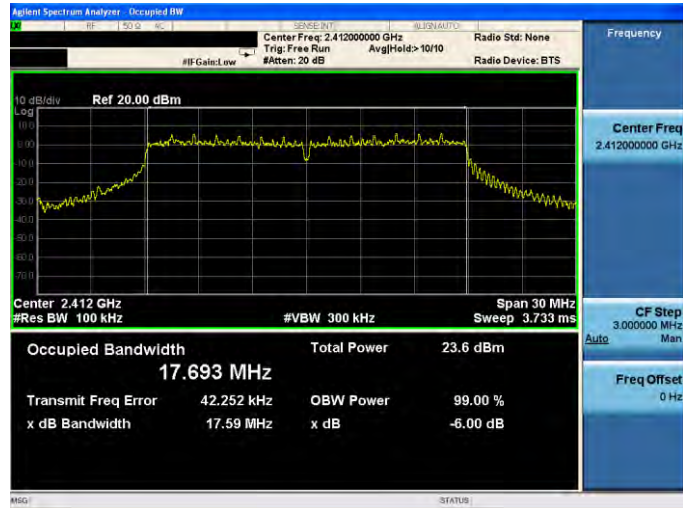

2437 MHz



2462 MHz

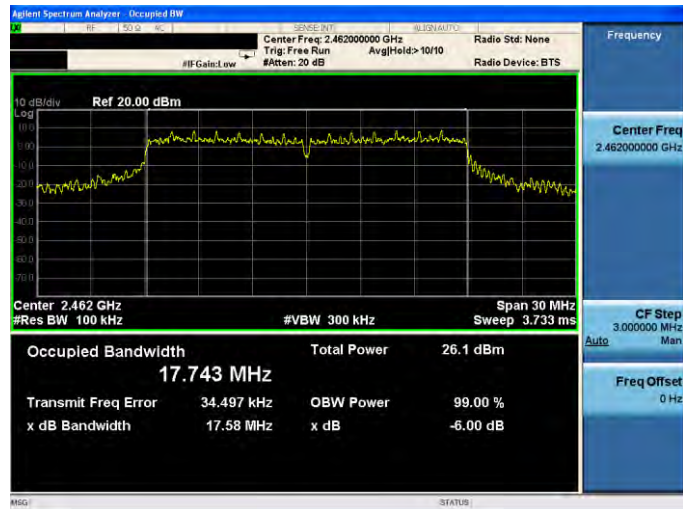



Mode 5: IEEE 802.11n 2.4GHz 40MHz link mode_ANT-1

2422 MHz

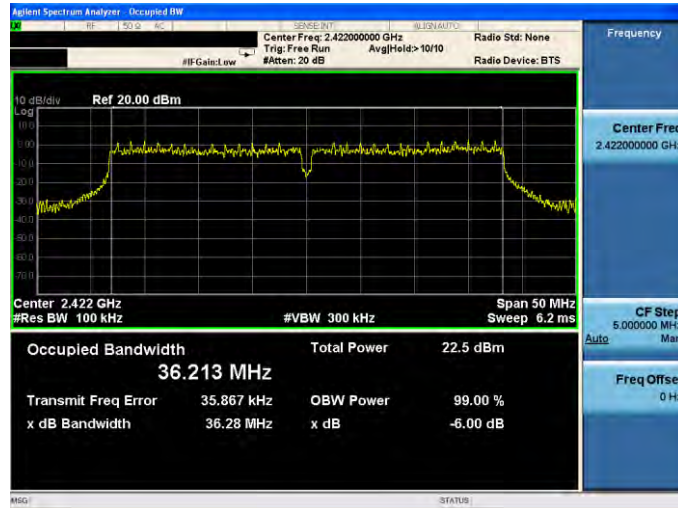

2437 MHz



2452 MHz

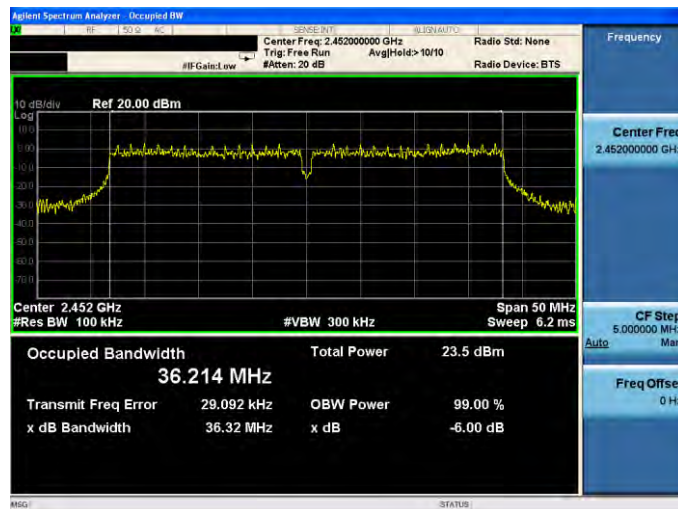



Mode 4: IEEE 802.11n 2.4GHz 20MHz link mode_ANT-2

2412 MHz



2437 MHz



2462 MHz

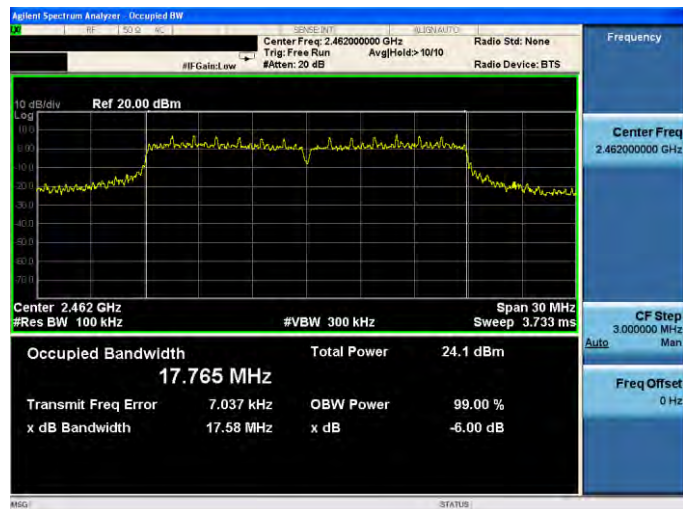



Mode 5: IEEE 802.11n 2.4GHz 40MHz link mode_ANT-2

2422 MHz



2437 MHz



2452 MHz

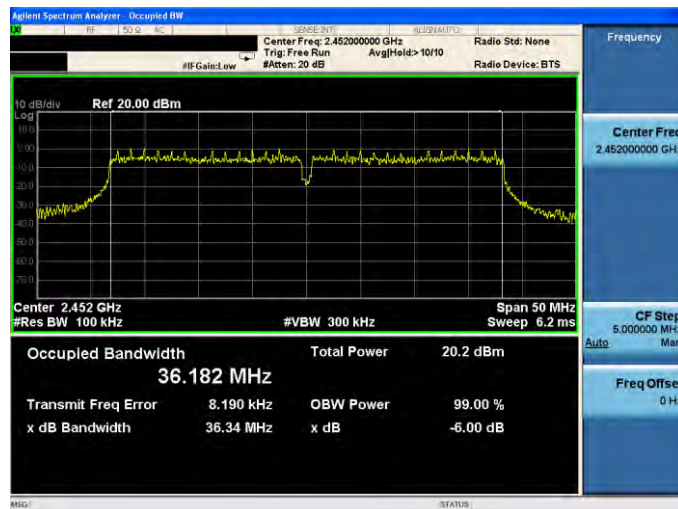

8 Maximum Power Density Measurement

8.1. Limit

For digitally modulated systems, the power spectral density conducted from the intentional radiator to the antenna shall not be greater than 8 dBm in any 3 kHz band during any time interval of continuous transmission.

And According to 15.247 (b), if transmitting antennas of directional gain greater than 6 dBi are used, the power shall be reduced by the amount in dB that the directional gain of the antenna exceeds 6dBi.

- * SISO mode ANT-0 : Max. Gain = 4.84 dBi < 6dBi.
- SISO mode ANT-1 : Max. Gain = 3.41 dBi < 6dBi.
- SISO mode ANT-2 : Max. Gain = 3.59 dBi < 6dBi.
- * MIMO mode : Directional Gain = $10 \cdot \log\{[10^{(G1/20)} + 10^{(G2/20)} + \dots + 10^{(Gn/20)}]^2 / NANT\}$ = 8.74 dBi > 6dBi
- * MIMO mode power limit shall be reduced = 8 - 2.74 = 5.26 dBm/3KHz.

8.2. Test Setup

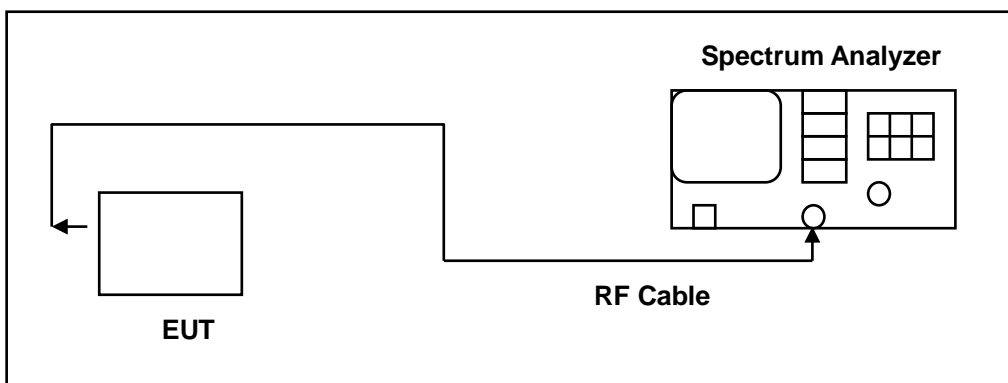

8.3. Test Instruments

Equipment	Manufacturer	Model Number	Serial Number	Cal. Date	Cal. Period
Spectrum Analyzer	Agilent	E4445A	MY45300744	12/15/2015	1 year
Microwave Cable	EMCI	EMC104-SM-SM-1500	140303	02/23/2016	1 year
Test Site	ATL	TE05	TE05	N.C.R.	-----

Note: N.C.R. = No Calibration Request.



8.4. Test Procedure

The EUT tested to DTS test procedure of KDB558074D01 for compliance to FCC 47CFR 15.247 requirements.

1. Set analyzer center frequency to DTS channel center frequency.
2. Set the span to 1.5 times the DTS bandwidth.
3. Set the RBW to: $3 \text{ kHz} \leq \text{RBW} \leq 100 \text{ kHz}$.
4. Set the VBW $\geq 3 \times \text{RBW}$.
5. Detector = peak.
6. Sweep time = auto couple.
7. Trace mode = max hold.
8. Allow trace to fully stabilize.
9. Use the peak marker function to determine the maximum amplitude level within the RBW.
10. If measured value exceeds limit, reduce RBW (no less than 3 kHz) and repeat.



8.5. Test Result



Model Number	D1080-Z1				
Test Item	Maximum Power Density				
Date of Test	04/06/2016				
Test Mode	Frequency (MHz)	Measurement (dBm/3KHz)			Limit (dBm/3KHz)
		ANT-0	ANT-1	ANT-2	
Mode 2	2412	-1.272	---	---	< 8
	2437	-0.243	---	---	< 8
	2462	0.029	---	---	< 8
Mode 3	2412	-6.896	---	---	< 8
	2437	-6.385	---	---	< 8
	2462	-5.512	---	---	< 8
Mode 4	2412	-11.997	-17.379	-10.151	< 8
	2437	-11.301	-17.437	-9.910	< 8
	2462	-11.034	-17.931	-10.199	< 8
Mode 5	2422	-14.191	-20.486	-14.151	< 8
	2437	-14.581	-19.614	-14.465	< 8
	2452	-14.321	-20.199	-14.575	< 8

Model Number	D1080-Z1			
Test Item	Maximum Power Density			
Date of Test	04/06/2016			
Test Mode	Frequency (MHz)	Measurement (dBm/3KHz)		Limit (dBm/3KHz)
		ANT-0+1+2		
Mode 4	2412	-7.496		< 5.26
	2437	-7.116		< 5.26
	2462	-7.202		< 5.26
Mode 5	2422	-10.681		< 5.26
	2437	-10.887		< 5.26
	2452	-10.894		< 5.26



8.6. Test Graphs

Mode 2: IEEE 802.11b link mode_ANT-0

2412 MHz	
2437 MHz	
2462 MHz	



Mode 3: IEEE 802.11g link mode_ANT-0

2412 MHz

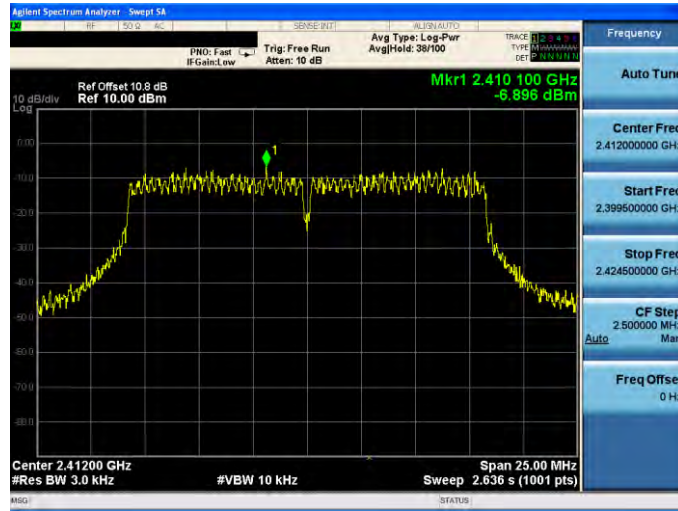

2437 MHz

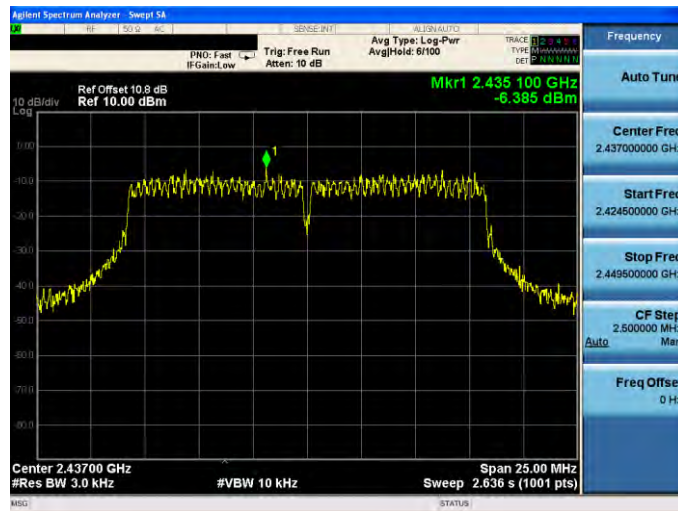

2462 MHz

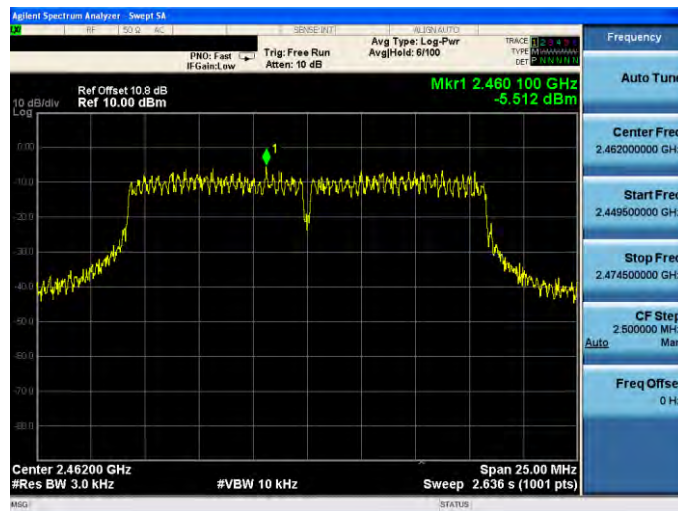



Mode 4: IEEE 802.11n 2.4GHz 20MHz link mode_ANT-0

2412 MHz

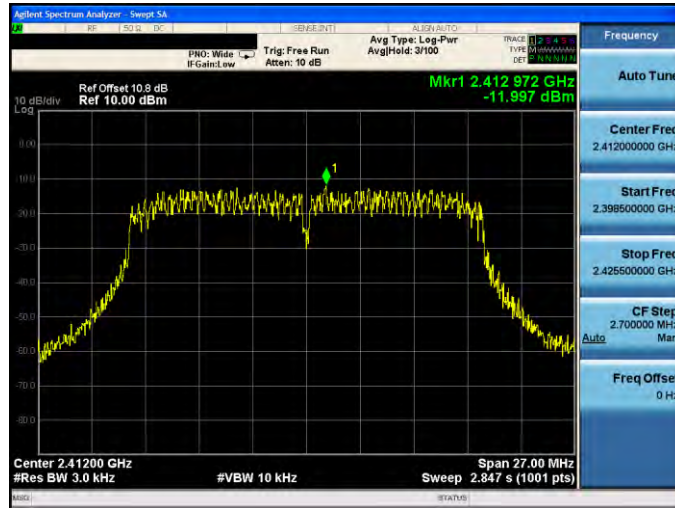

2437 MHz

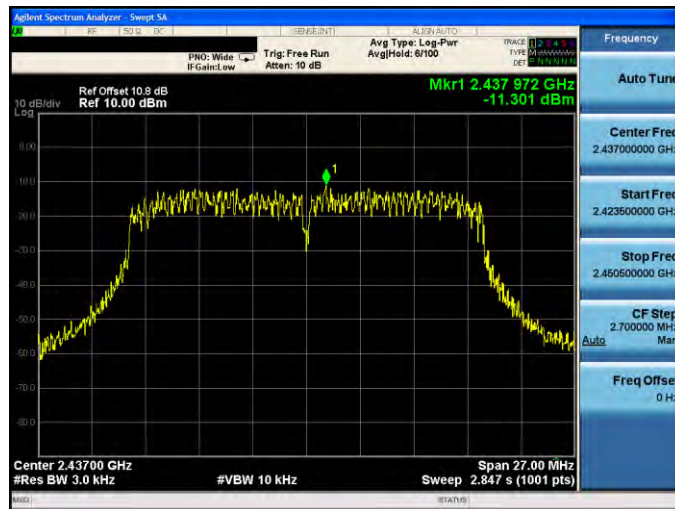

2462 MHz

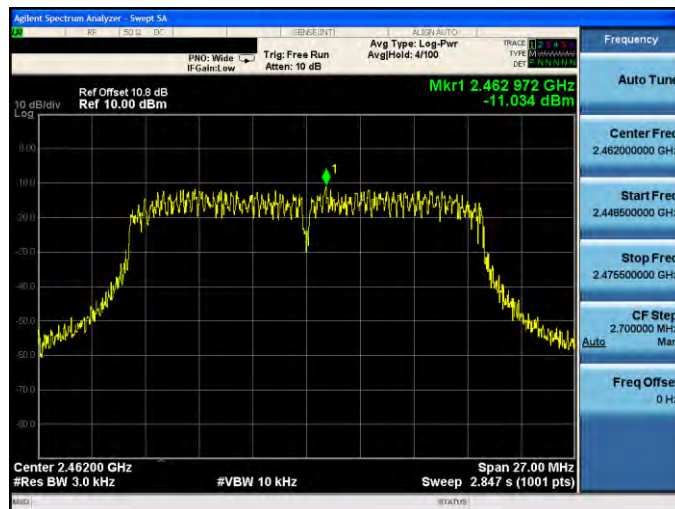



Mode 5: IEEE 802.11n 2.4GHz 40MHz link mode_ANT-0

2422 MHz

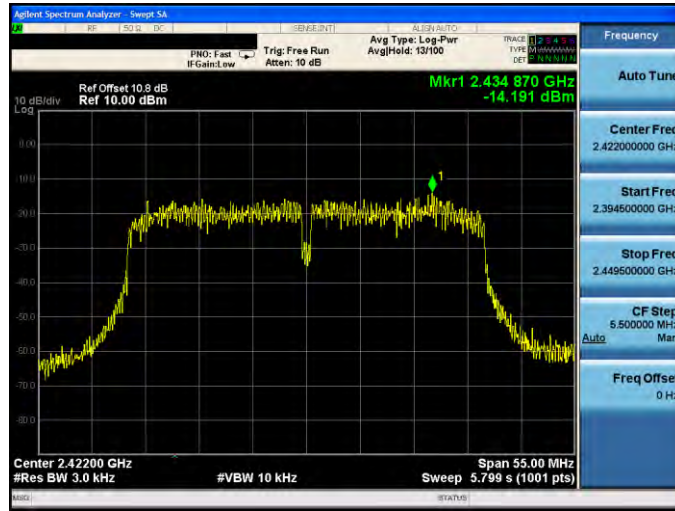

2437 MHz

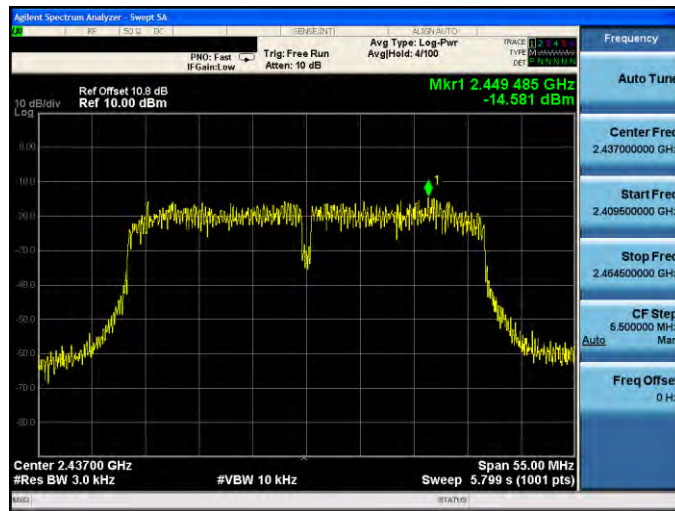

2452 MHz

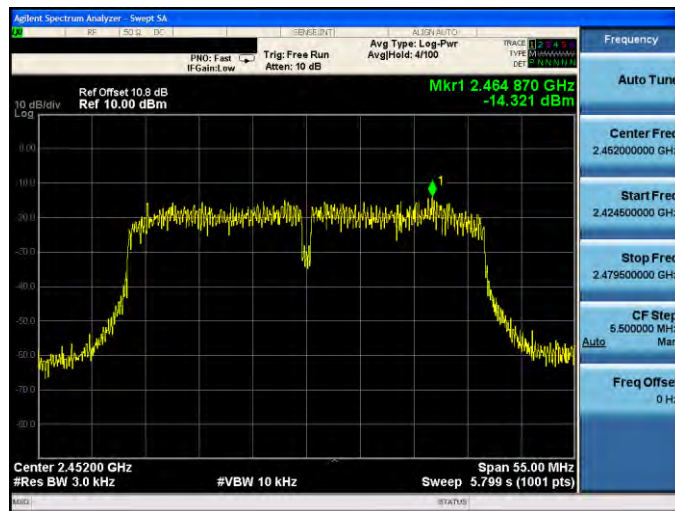



Mode 4: IEEE 802.11n 2.4GHz 20MHz link mode_ANT-1

2412 MHz

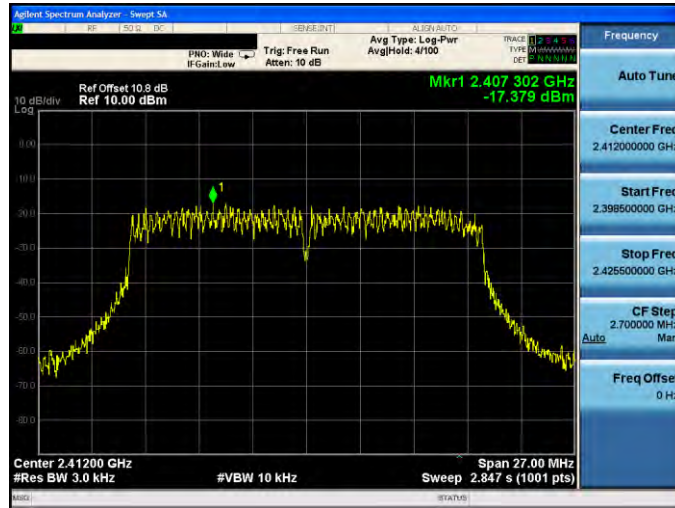

2437 MHz

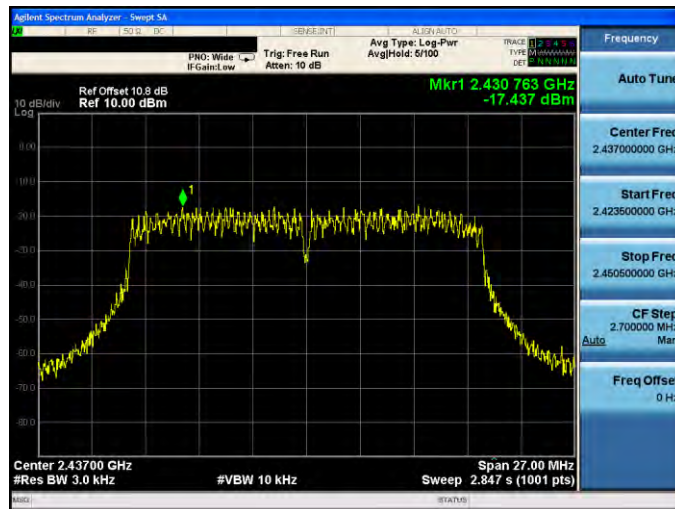

2462 MHz

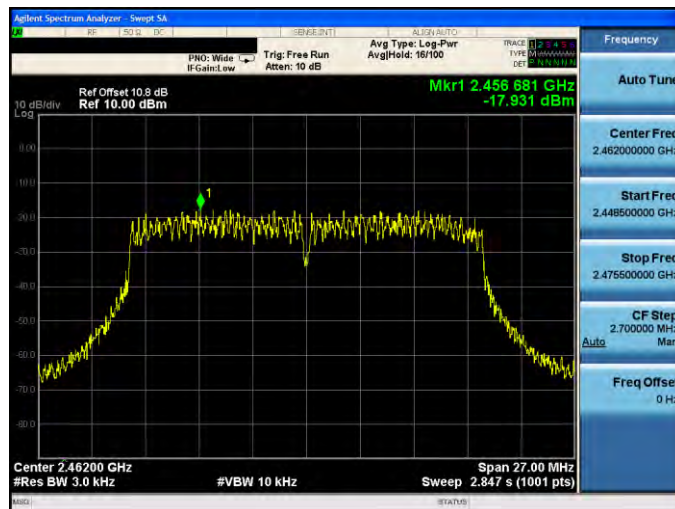



Mode 5: IEEE 802.11n 2.4GHz 40MHz link mode_ANT-1

2422 MHz

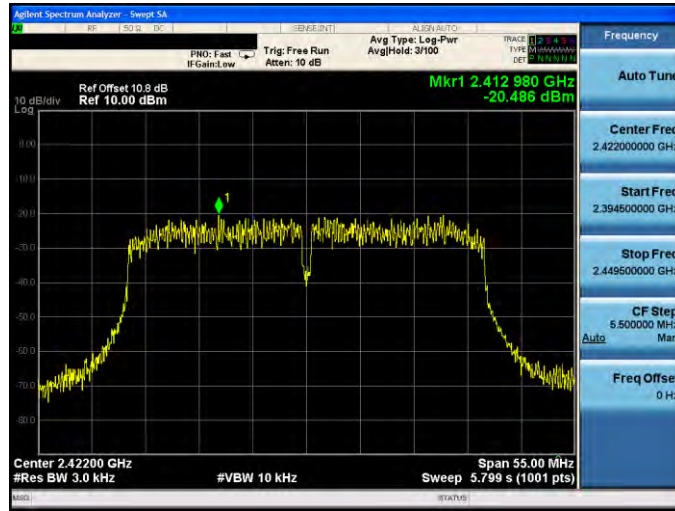

2437 MHz

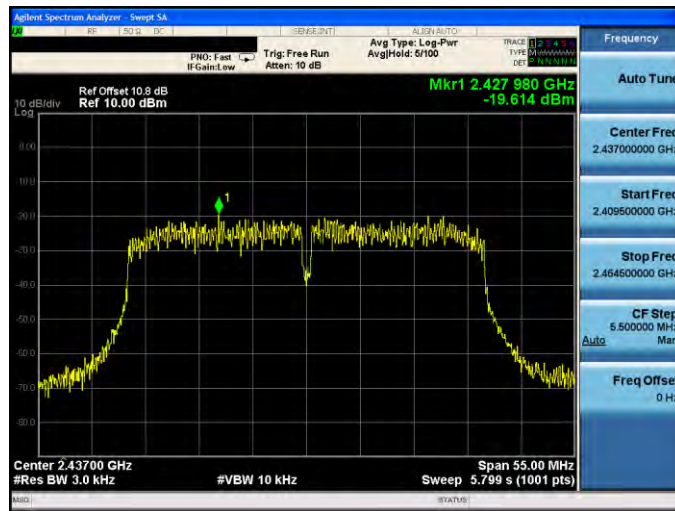

2452 MHz

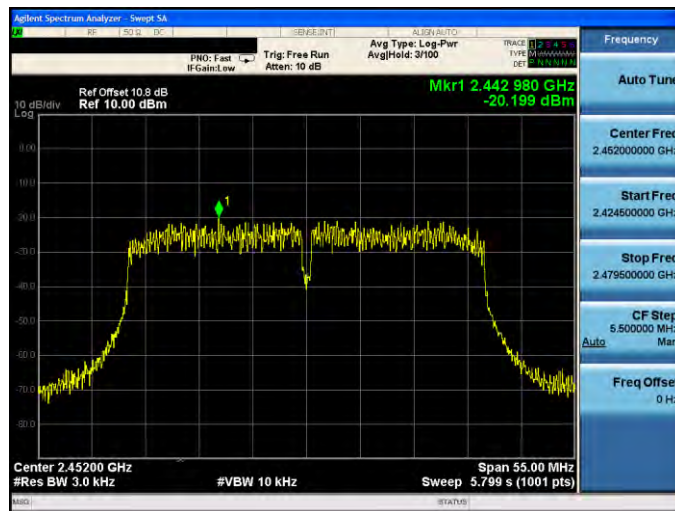



Mode 4: IEEE 802.11n 2.4GHz 20MHz link mode_ANT-2

2412 MHz

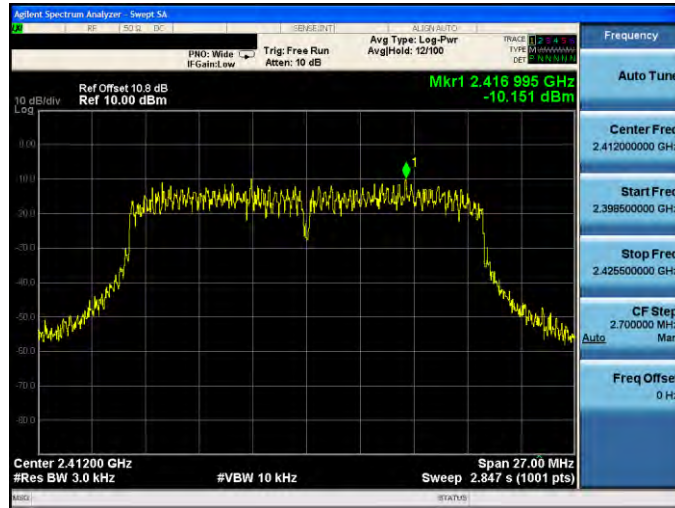

2437 MHz

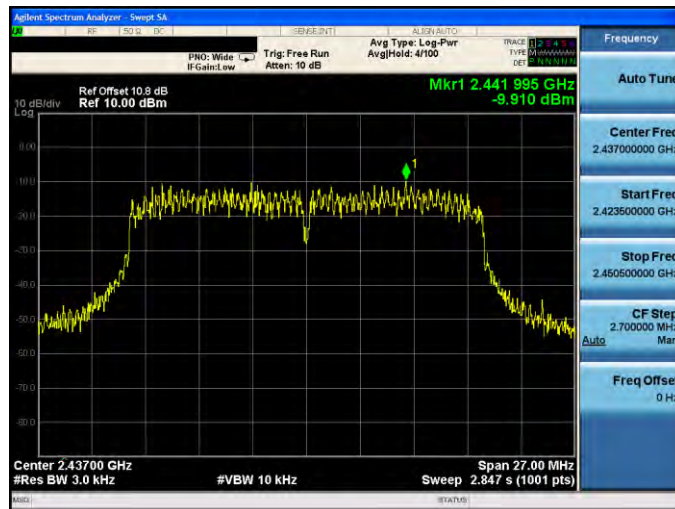

2462 MHz

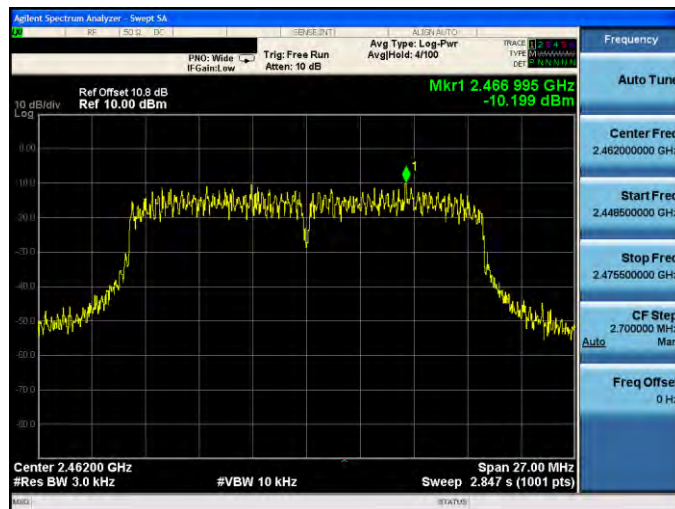



Mode 5: IEEE 802.11n 2.4GHz 40MHz link mode_ANT-2

2422 MHz

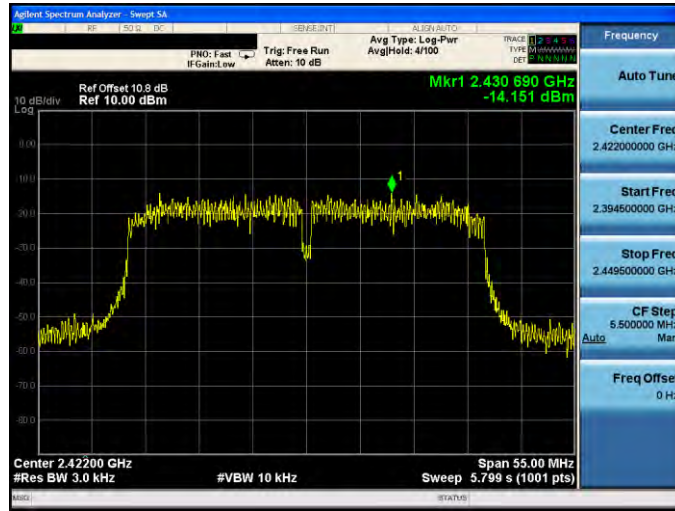

2437 MHz

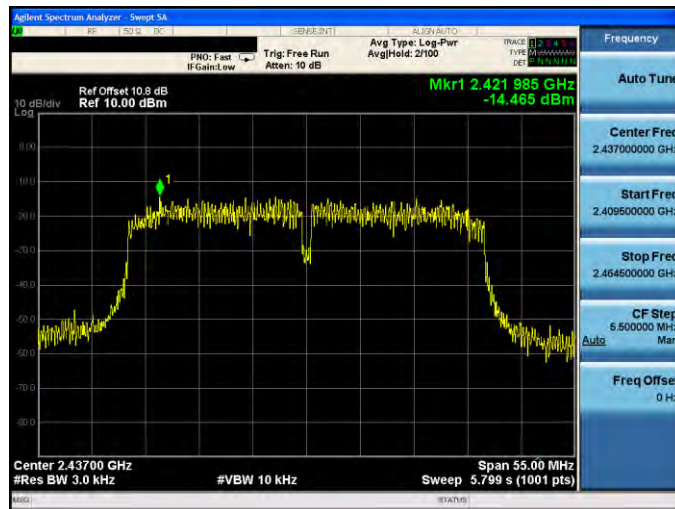

2452 MHz

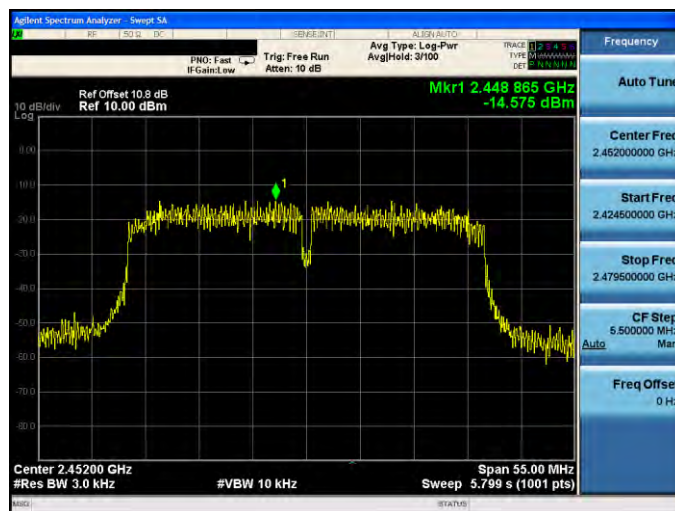

9 Out of Band Conducted Emissions Measurement

9.1. Limit

In any 100 kHz bandwidth outside the frequency band in which the spread spectrum or digitally modulated intentional radiator is operating, the radio frequency power that is produced by the intentional radiator shall be at least 30 dB below that in the 100 kHz bandwidth within the band that contains the highest level of the desired power

9.2. Test Setup

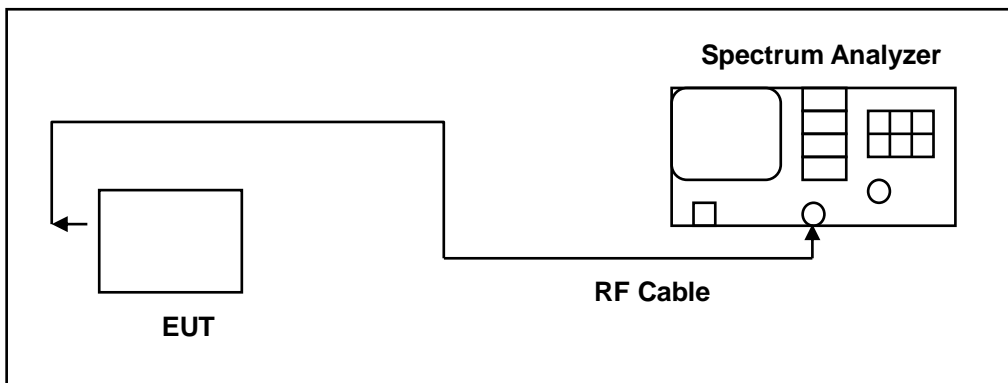

9.3. Test Instruments

Equipment	Manufacturer	Model Number	Serial Number	Cal. Date	Cal. Period
Spectrum Analyzer	Agilent	E4445A	MY45300744	12/15/2015	1 year
Spectrum Analyzer	Agilent	E4408B	MY45107753	07/27/2015	1 year
Microwave Cable	EMCI	EMC104-SM-SM-1500	140303	02/23/2016	1 year
Test Site	ATL	TE05	TE05	N.C.R.	-----

Note: N.C.R. = No Calibration Request.

9.4. Test Procedure

In any 100 kHz bandwidth outside the EUT pass band, the RF power produced by the modulation products of the spreading sequence, the information sequence, and the carrier frequency shall be at least 30 dB below that of the maximum in-band 100 kHz emission, antenna output of the EUT was coupled directly to spectrum analyzer; if an external attenuator and/or cable was used, these losses are compensated for with the analyzer OFFSET function.

All other types of emissions from the EUT shall meet the general limits for radiated frequencies outside the pass band.



The test was performed at 3 channels.



9.5. Test Graphs

Reference level

Mode 2: IEEE 802.11b link mode_ANT-0

2412 MHz	
2437 MHz	
2462 MHz	



Mode 3: IEEE 802.11g link mode_ANT-0

2412 MHz

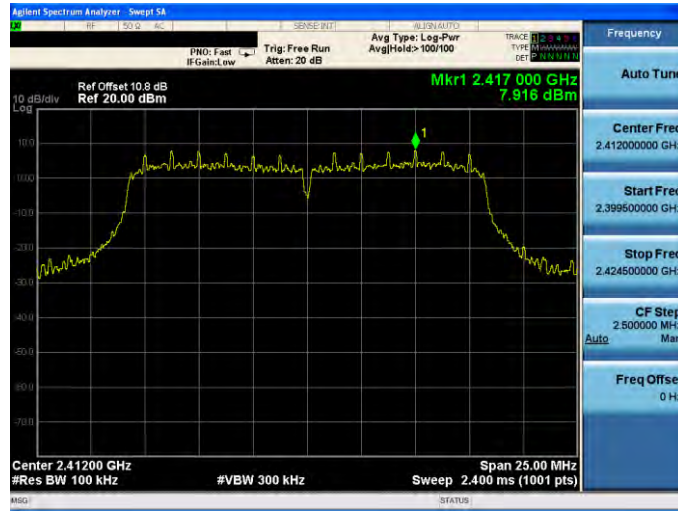

2437 MHz

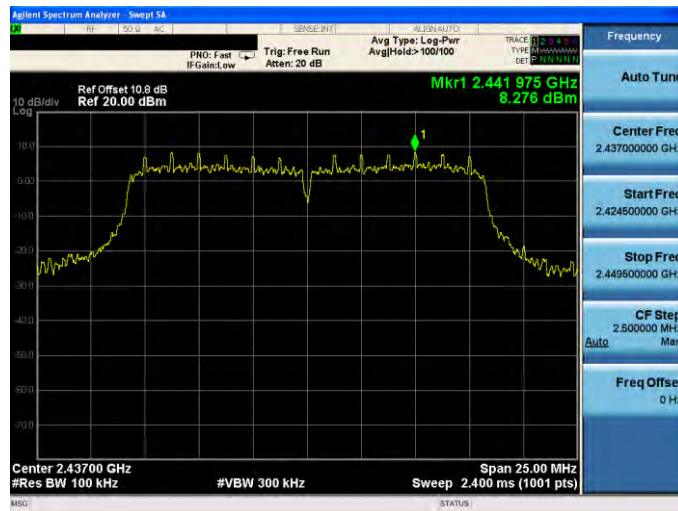

2462 MHz





Mode 4: IEEE 802.11n 2.4GHz 20MHz link mode_ANT-0

2412 MHz

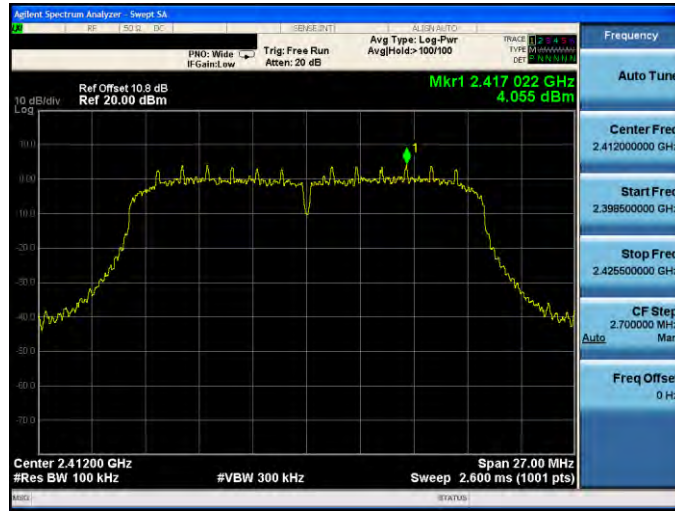

2437 MHz



2462 MHz

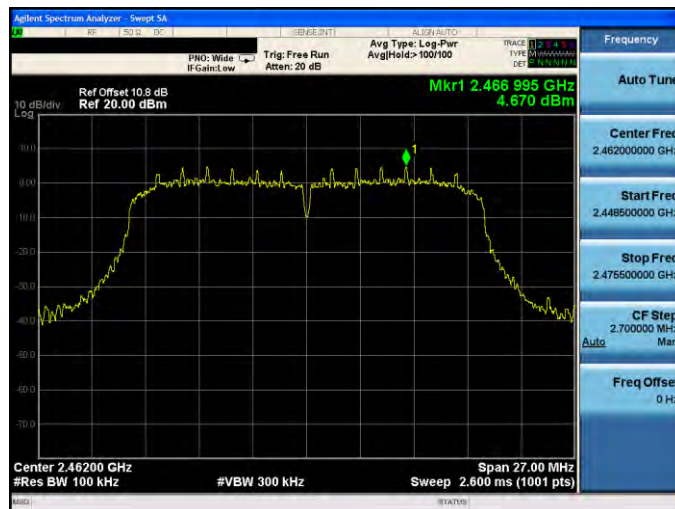



Mode 5: IEEE 802.11n 2.4GHz 40MHz link mode_ANT-0

2422 MHz

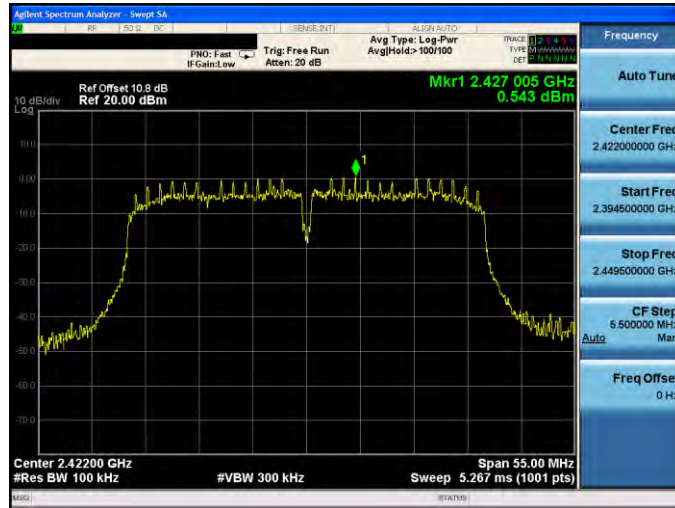

2437 MHz

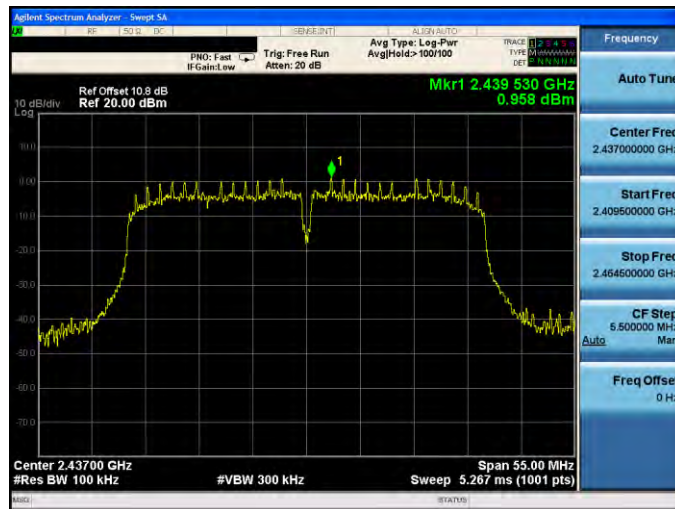

2452 MHz

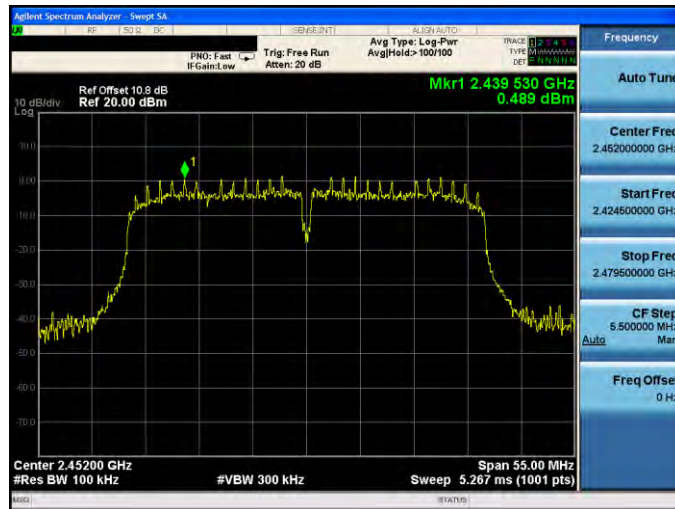



Mode 4: IEEE 802.11n 2.4GHz 20MHz link mode_ANT-1

2412 MHz

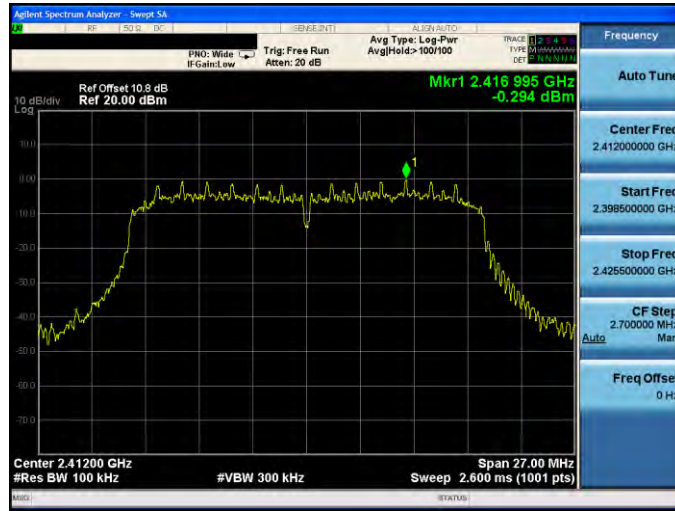

2437 MHz



2462 MHz





Mode 5: IEEE 802.11n 2.4GHz 40MHz link mode_ANT-1

2422 MHz

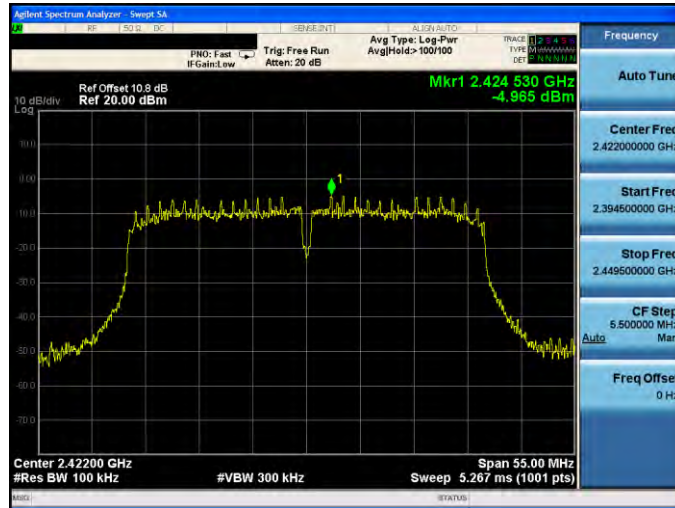

2437 MHz

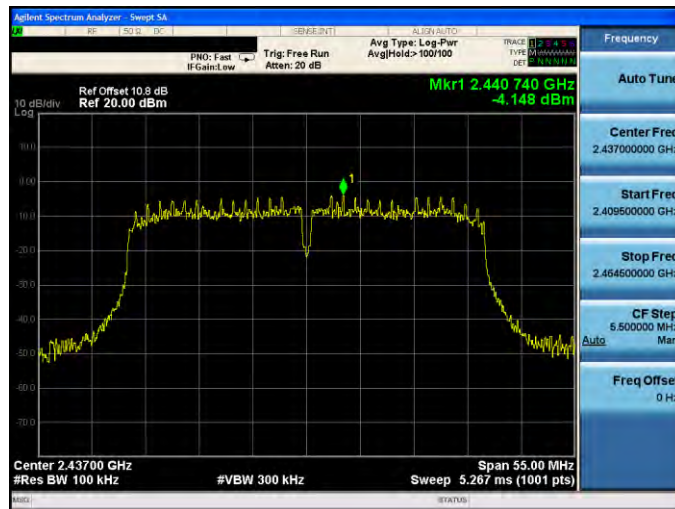

2452 MHz

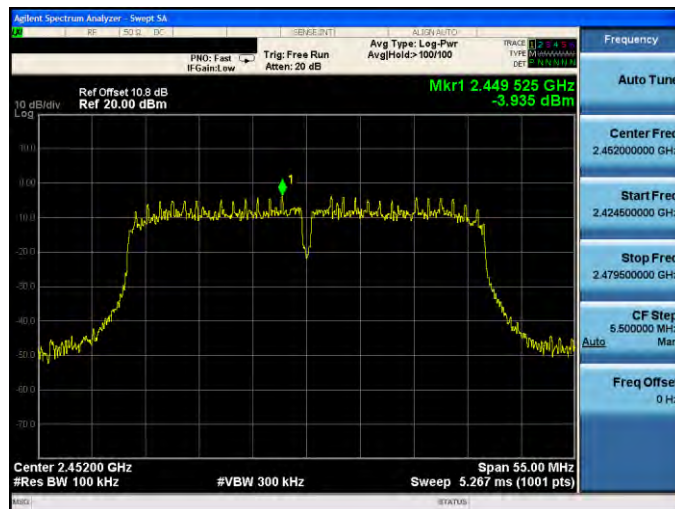



Mode 4: IEEE 802.11n 2.4GHz 20MHz link mode_ANT-2

2412 MHz

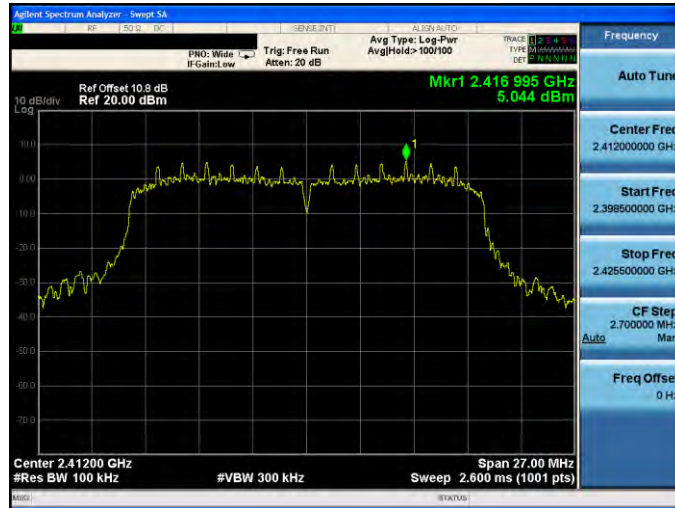

2437 MHz



2462 MHz





Mode 5: IEEE 802.11n 2.4GHz 40MHz link mode_ANT-2

2422 MHz

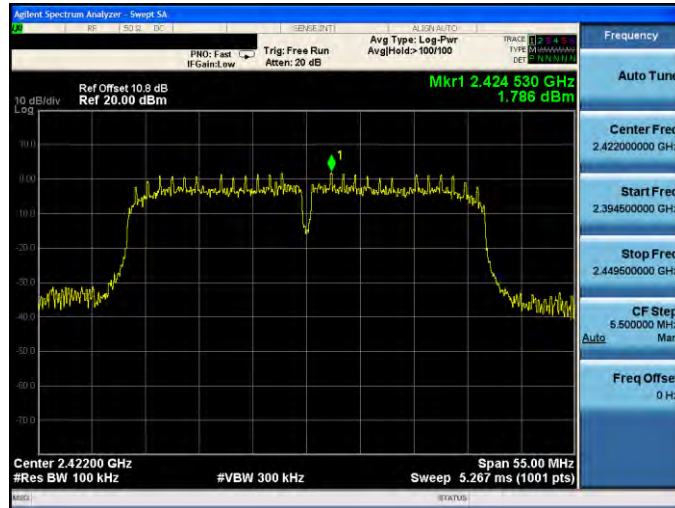

2437 MHz

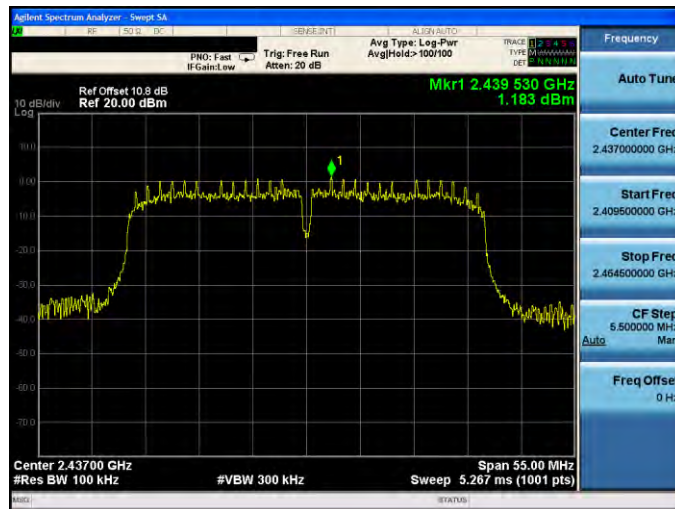

2452 MHz

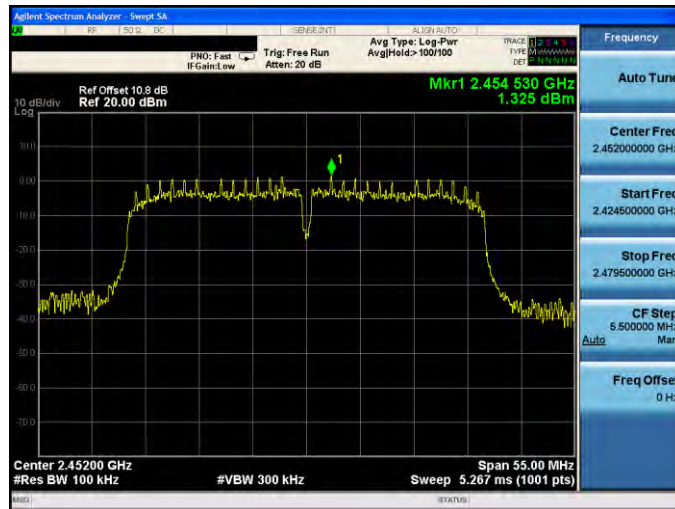



Out of Band Conducted Emissions

Mode 2: IEEE 802.11b link mode_ANT-0

2412 MHz

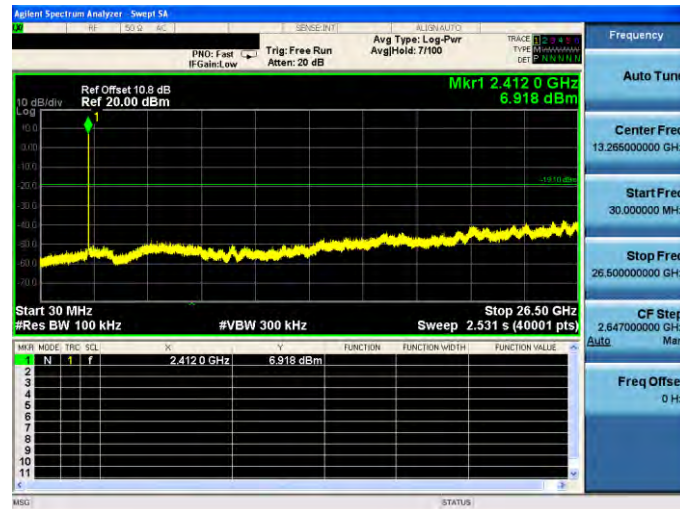

2437 MHz

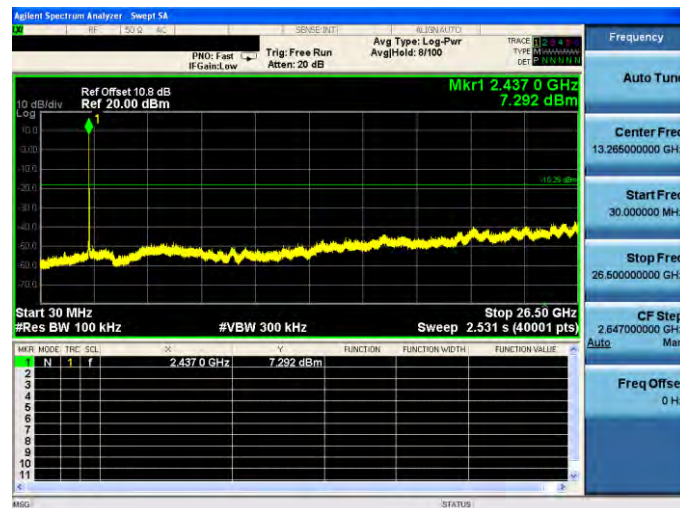

2462 MHz

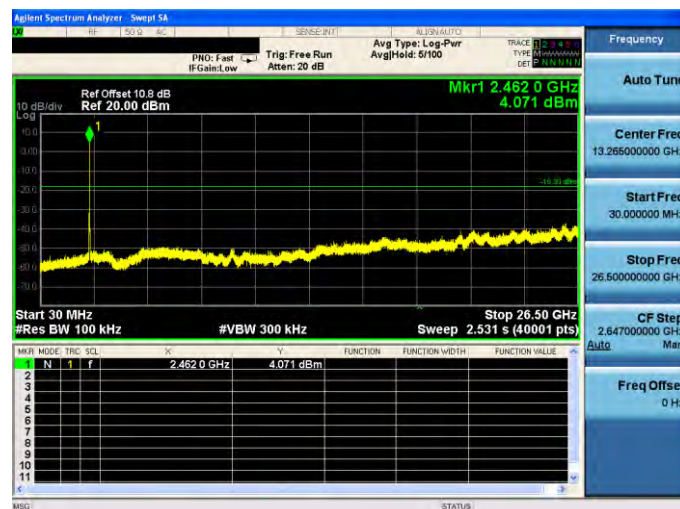



Mode 3: IEEE 802.11g link mode_ANT-0

2412 MHz

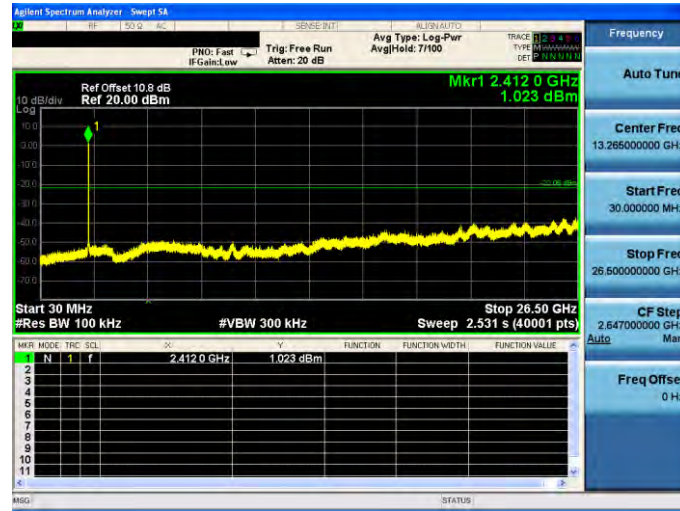

2437 MHz

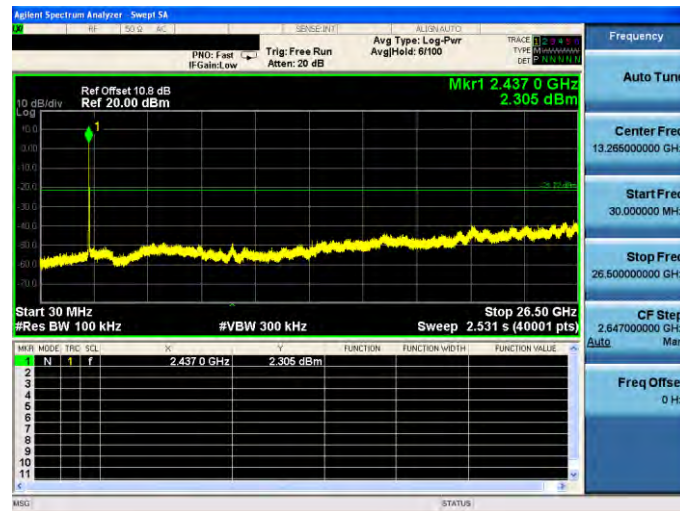

2462 MHz

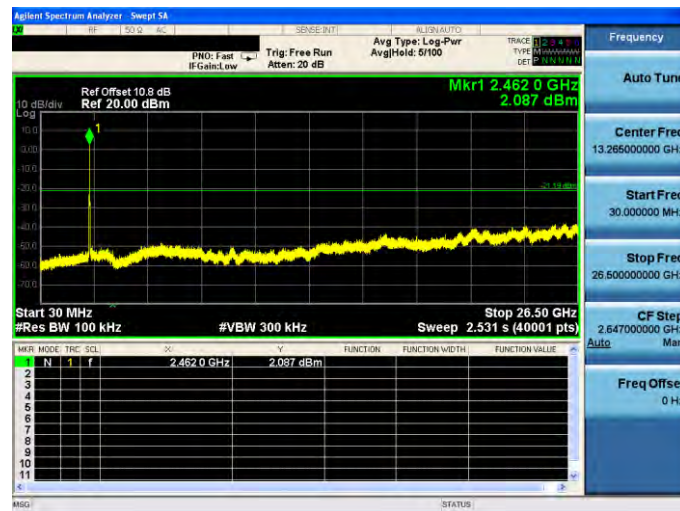



Mode 4: IEEE 802.11n 2.4GHz 20MHz link mode_ANT-0

2412 MHz

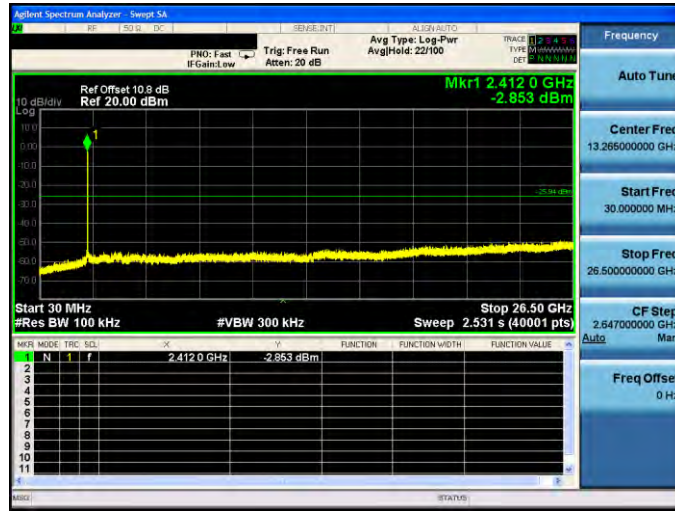

2437 MHz

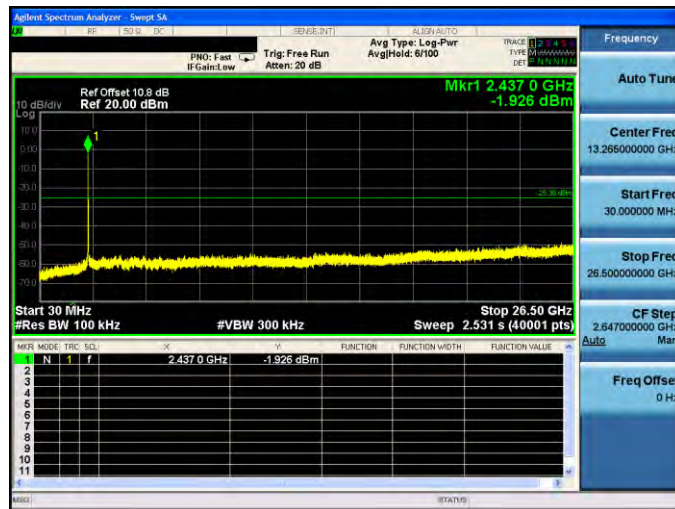

2462 MHz

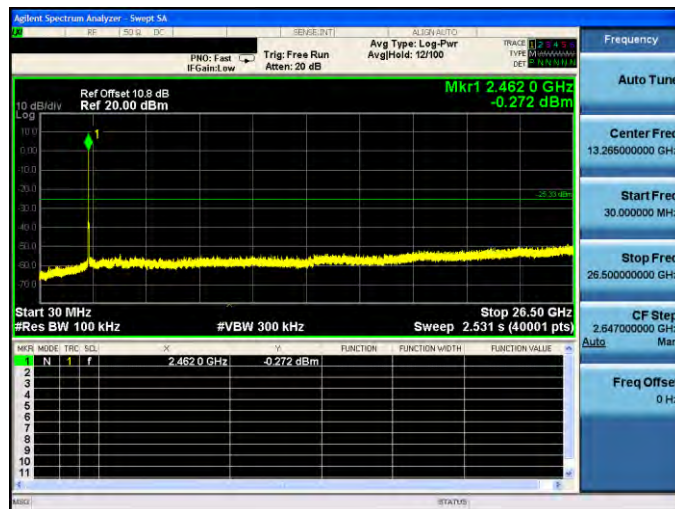



Mode 5: IEEE 802.11n 2.4GHz 40MHz link mode_ANT-0

2422 MHz

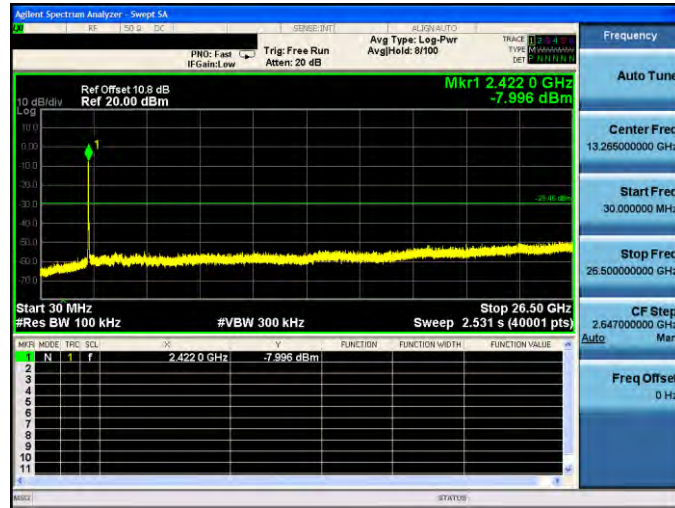

2437 MHz

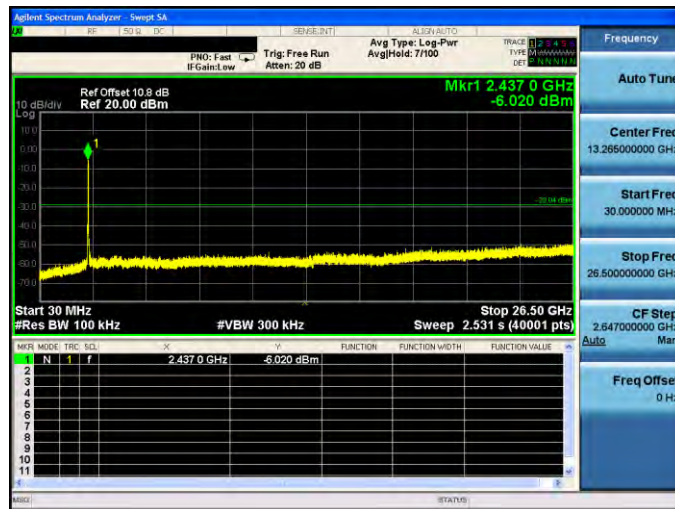

2452 MHz

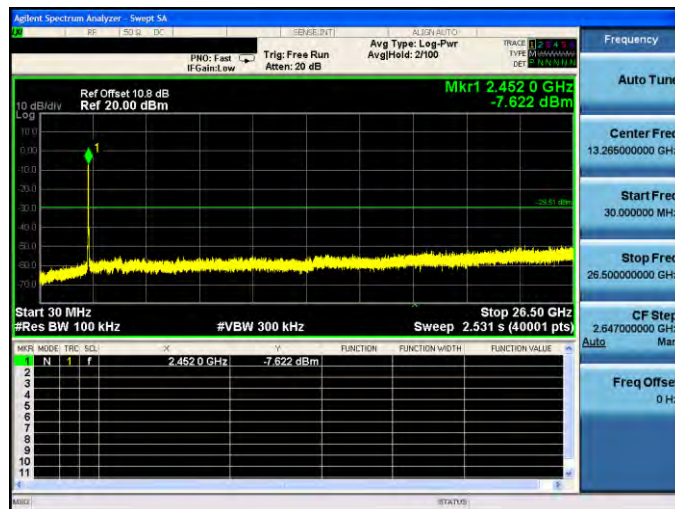



Mode 4: IEEE 802.11n 2.4GHz 20MHz link mode_ANT-1

2412 MHz

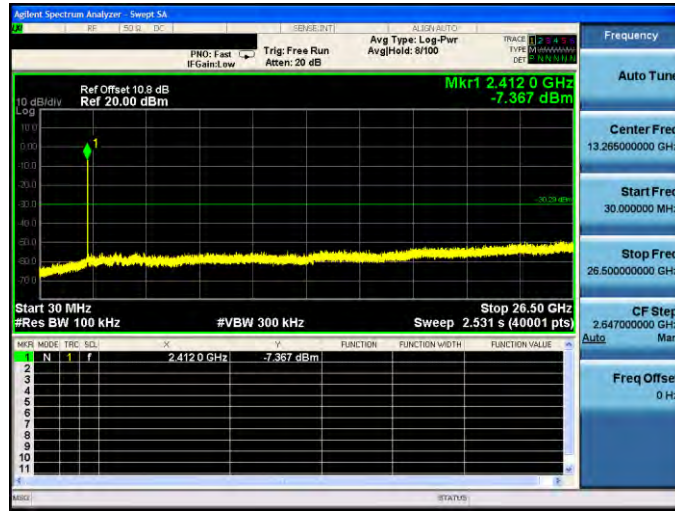

2437 MHz

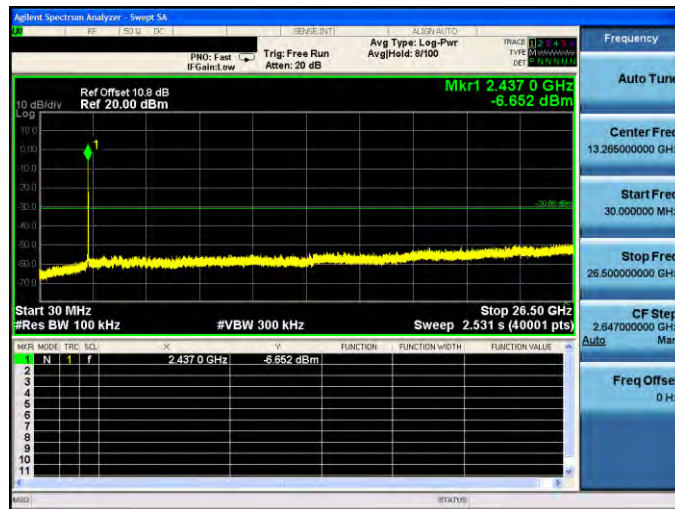

2462 MHz

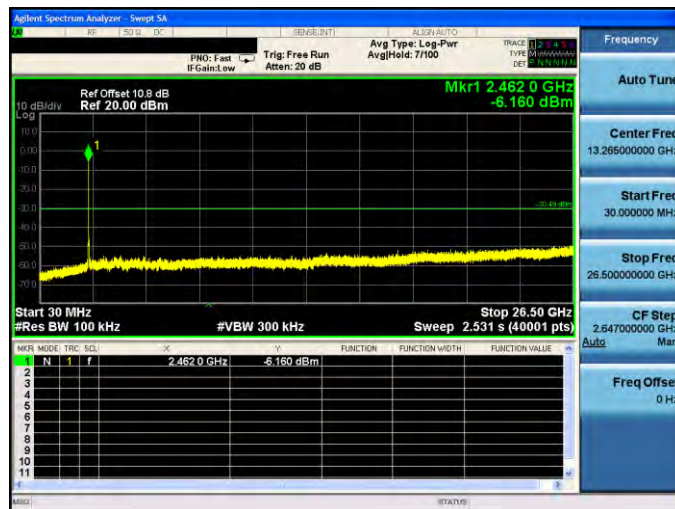



Mode 5: IEEE 802.11n 2.4GHz 40MHz link mode_ANT-1

2422 MHz

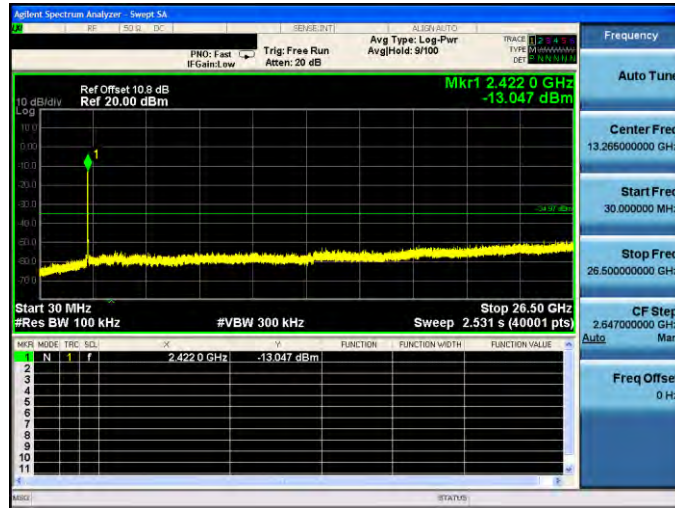

2437 MHz

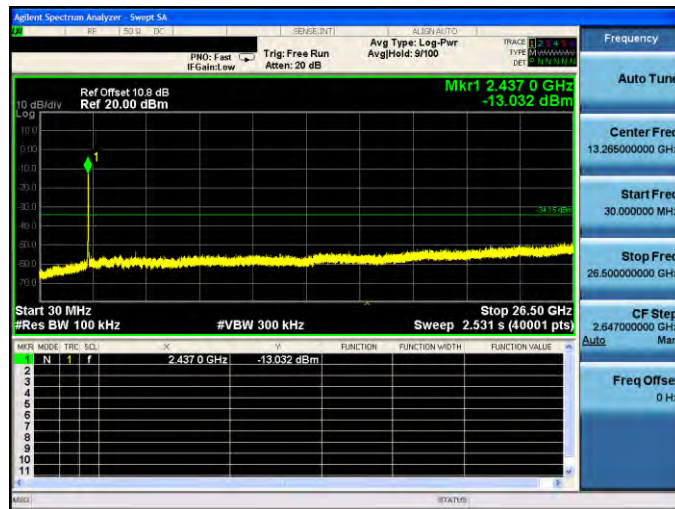

2452 MHz

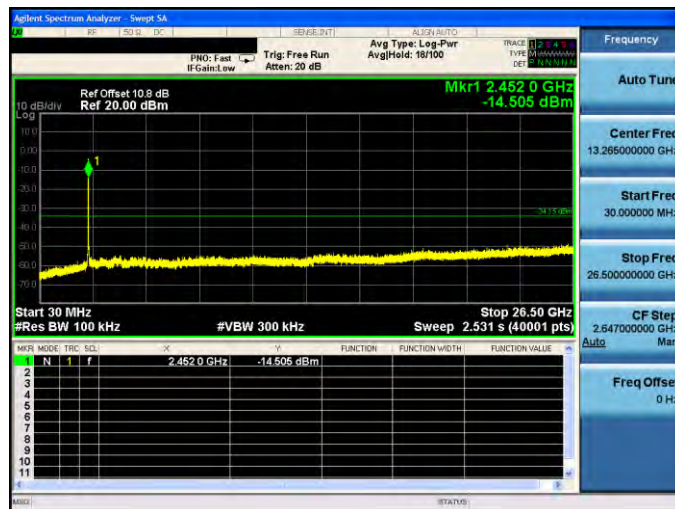



Mode 4: IEEE 802.11n 2.4GHz 20MHz link mode_ANT-2

2412 MHz

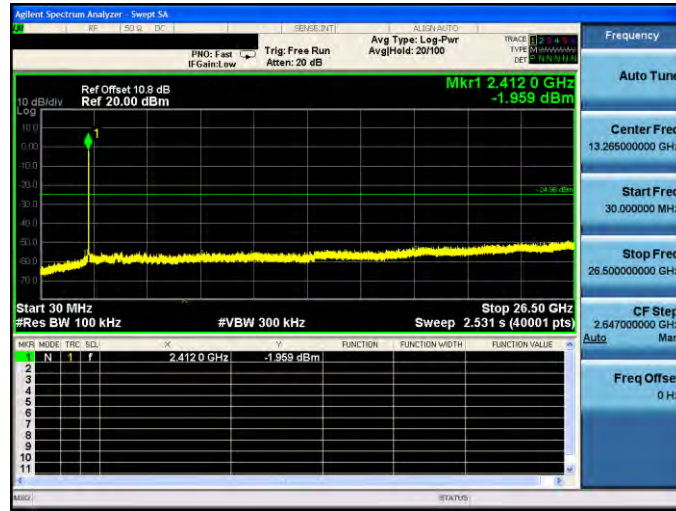

2437 MHz

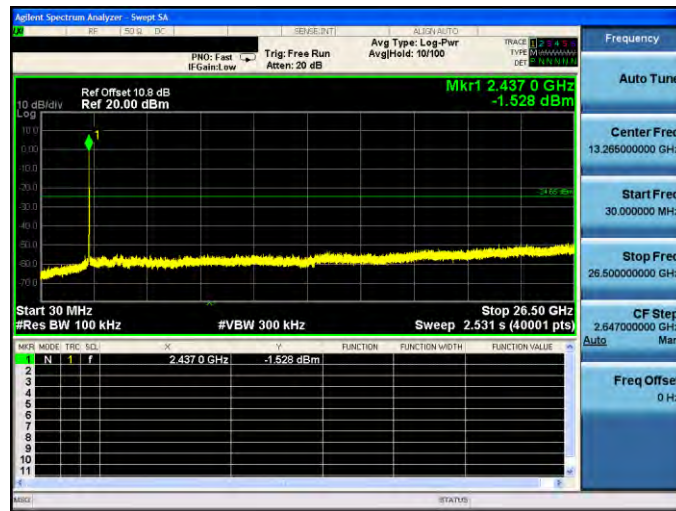

2462 MHz

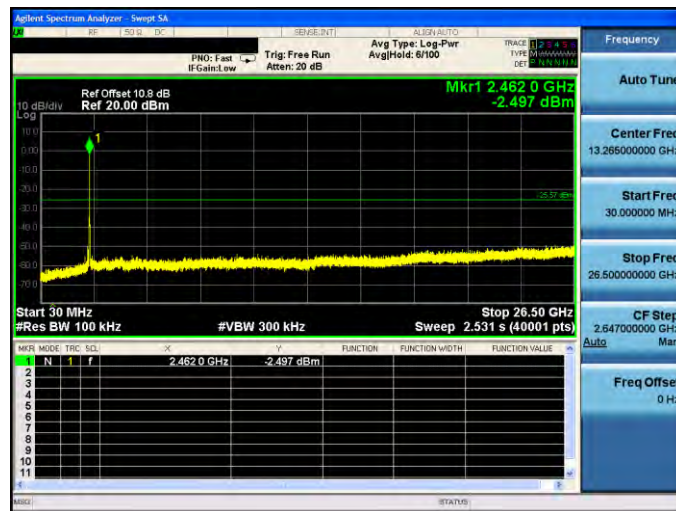



Mode 5: IEEE 802.11n 2.4GHz 40MHz link mode_ANT-2

2422 MHz

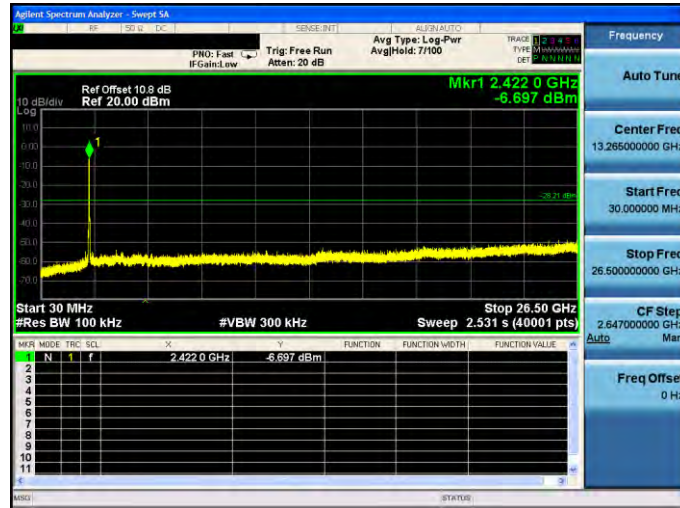

2437 MHz

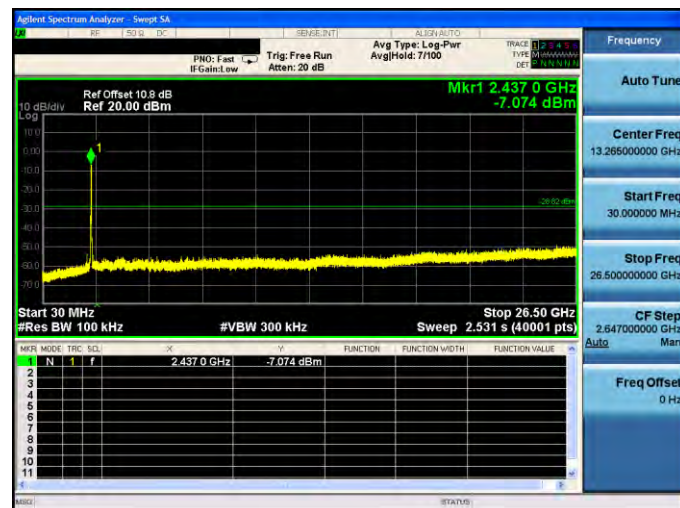

2452 MHz

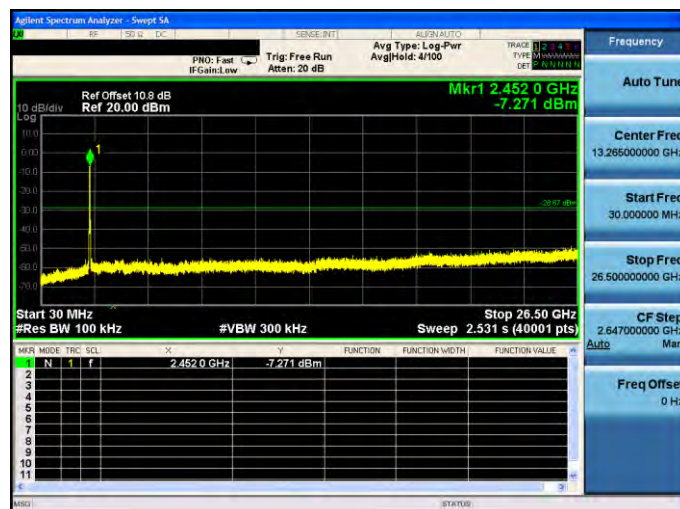



Conducted Band Edge

Mode 2: IEEE 802.11b link mode_ANT-0

2412 MHz

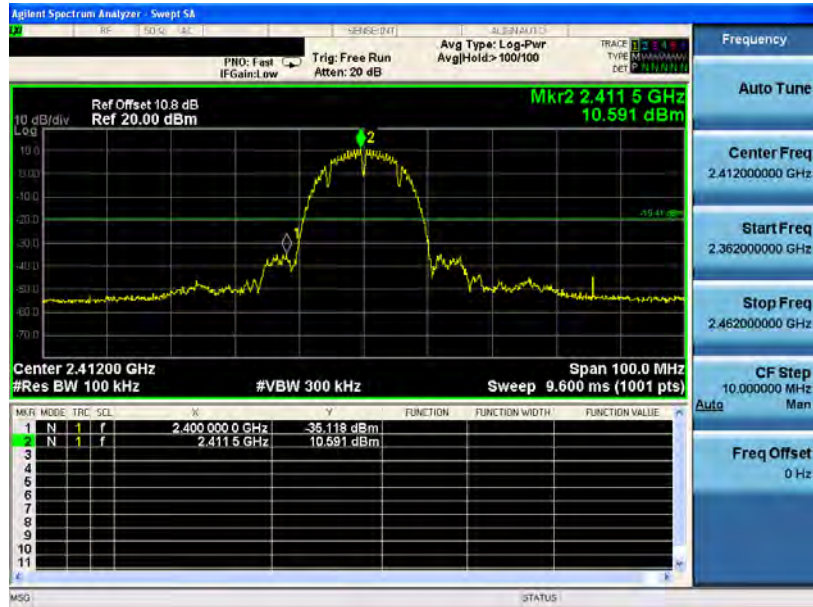

2462 MHz

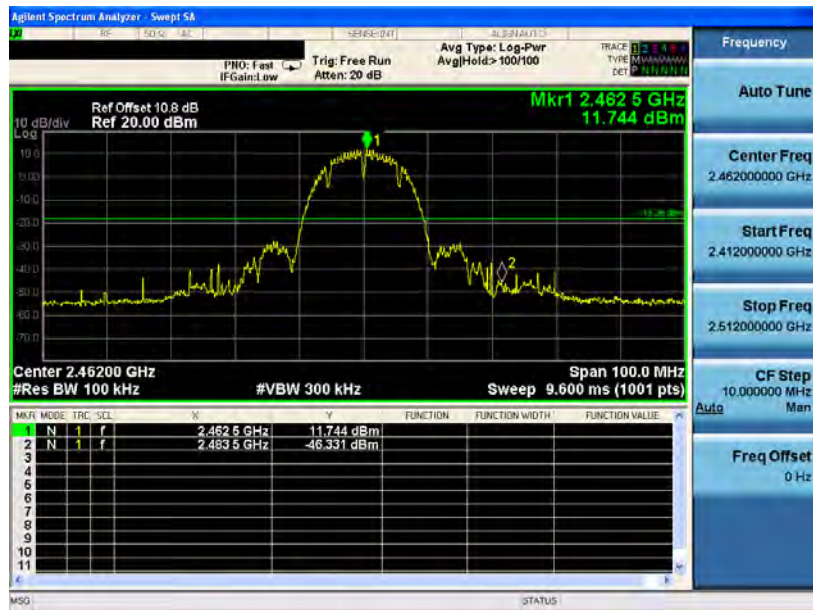



Mode 3: IEEE 802.11g link mode_ANT-0

2412 MHz

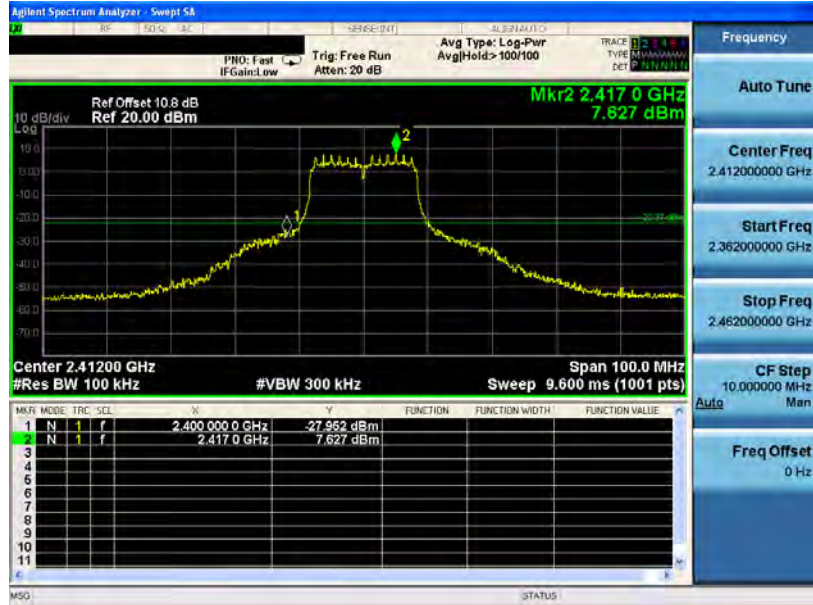

2462 MHz

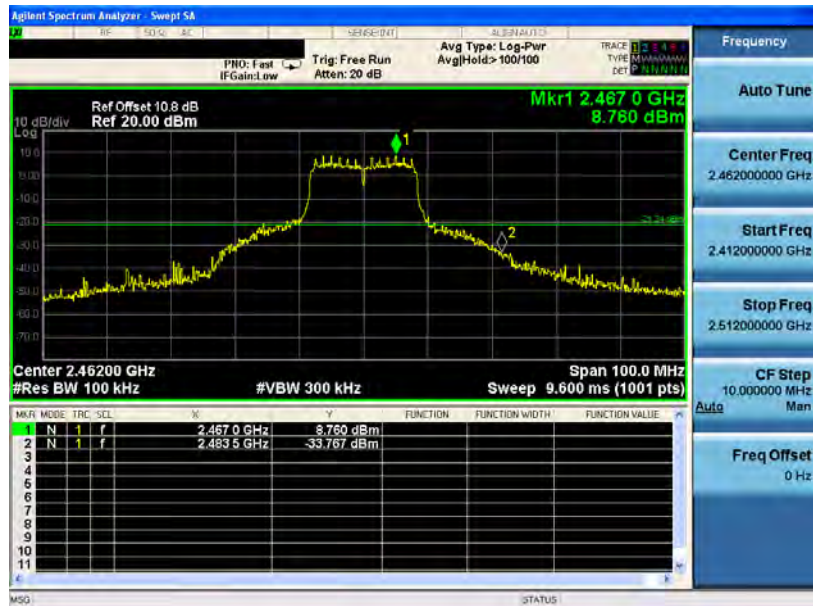



Mode 4: IEEE 802.11n 2.4GHz 20MHz link mode_ANT-0

2412 MHz

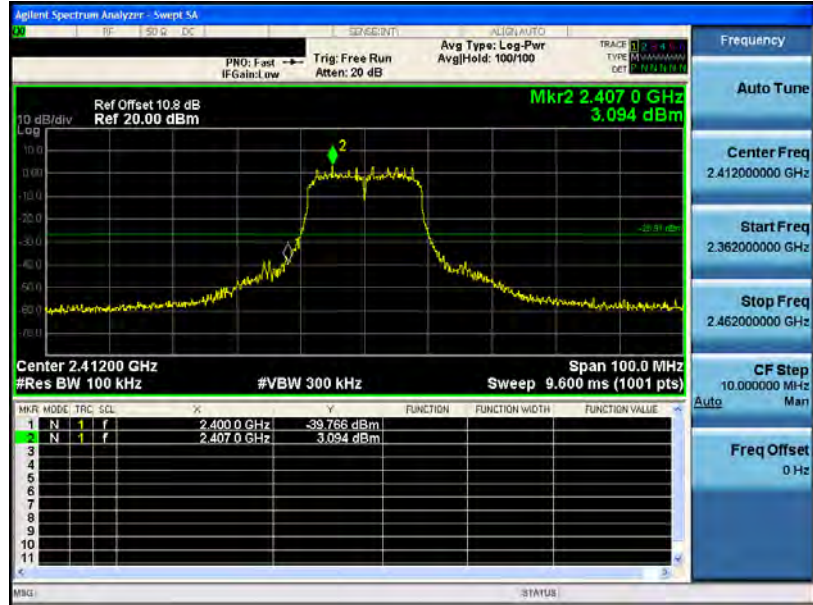

2462 MHz

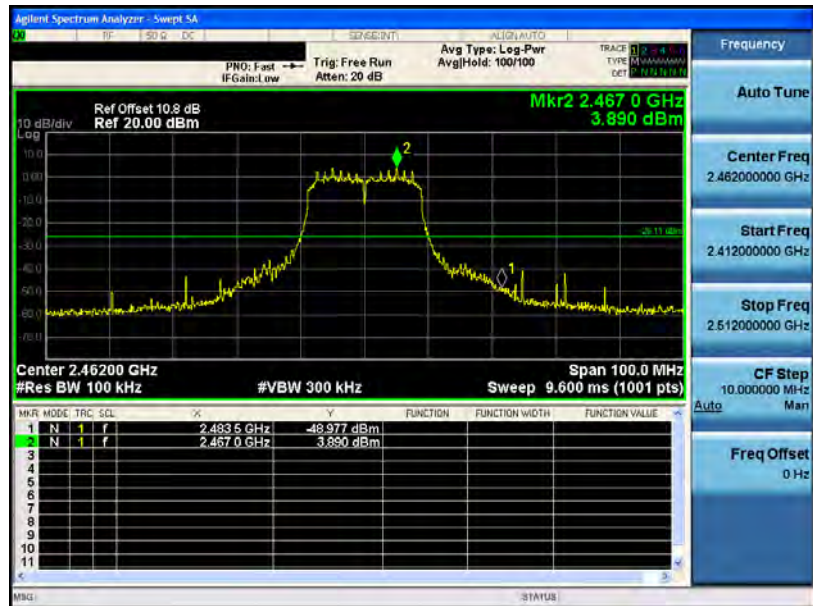



Mode 5: IEEE 802.11n 2.4GHz 40MHz link mode_ANT-0

2422 MHz

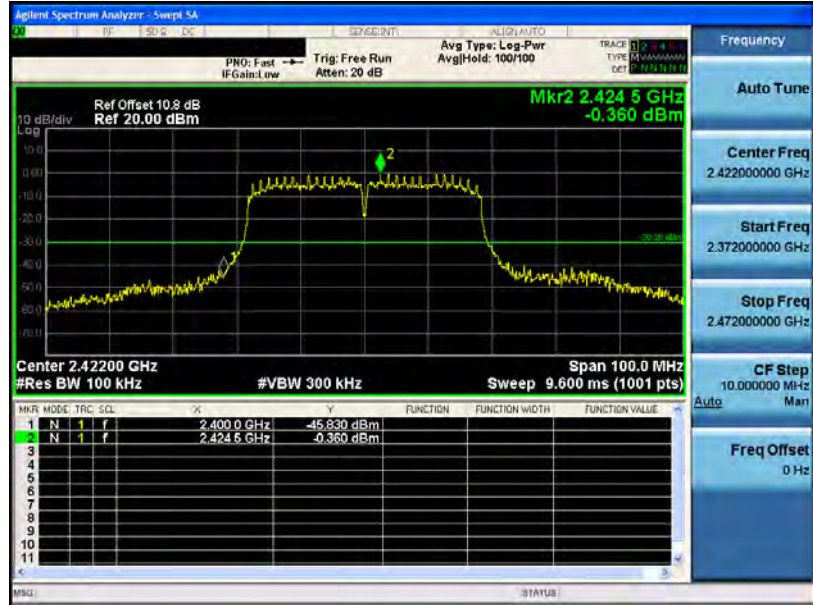

2452 MHz

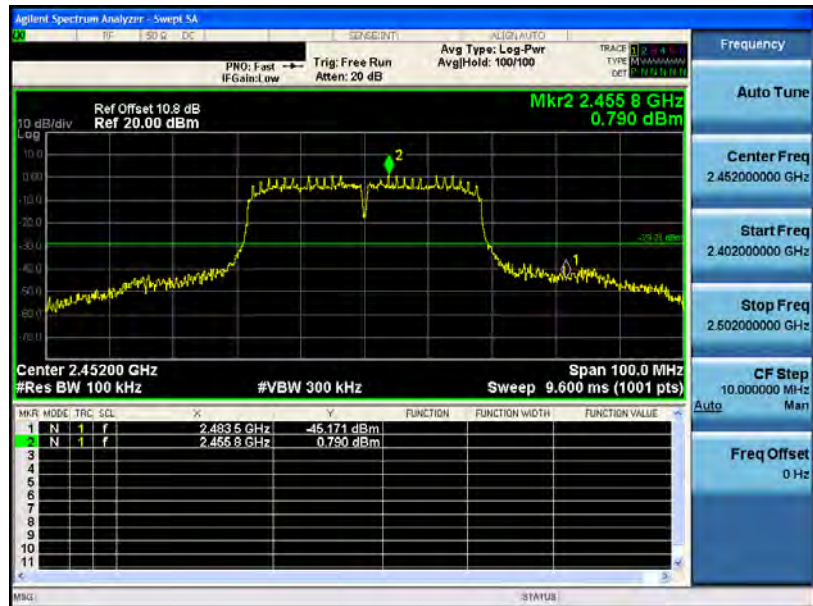

Mode 4: IEEE 802.11n 2.4GHz 20MHz link mode_ANT-1

2412 MHz

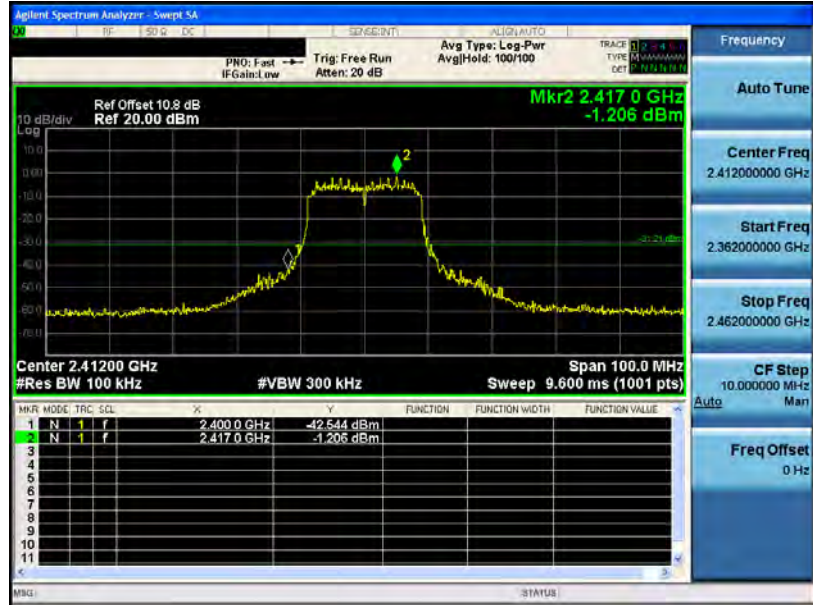

2462 MHz

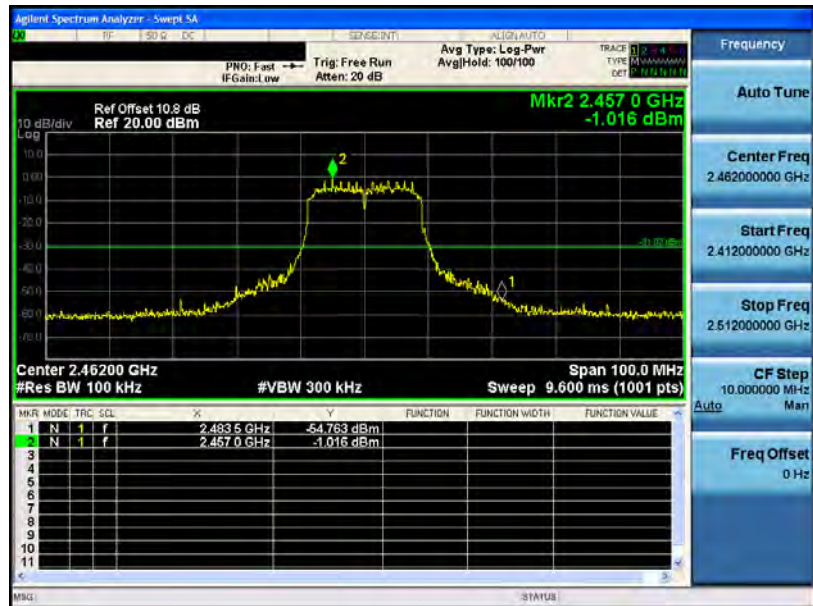



Mode 5: IEEE 802.11n 2.4GHz 40MHz link mode_ANT-1

2422 MHz

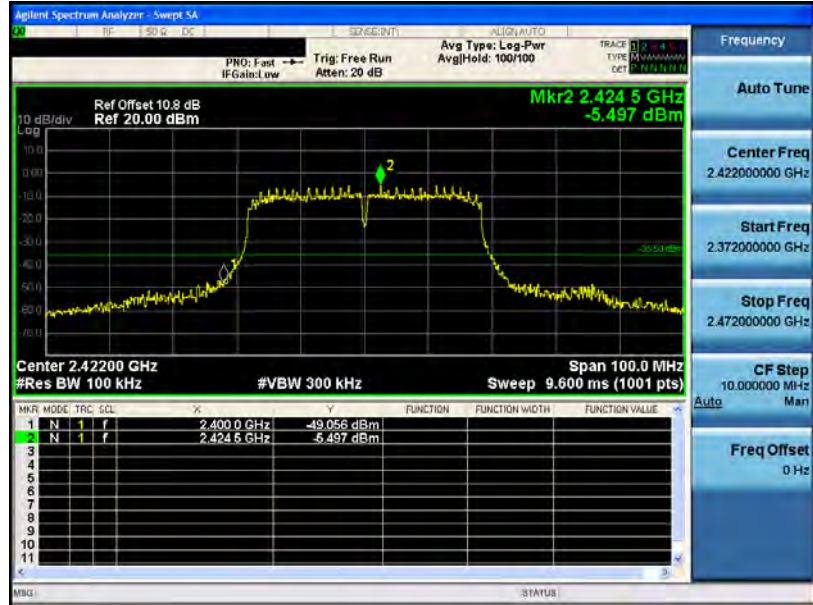

2452 MHz

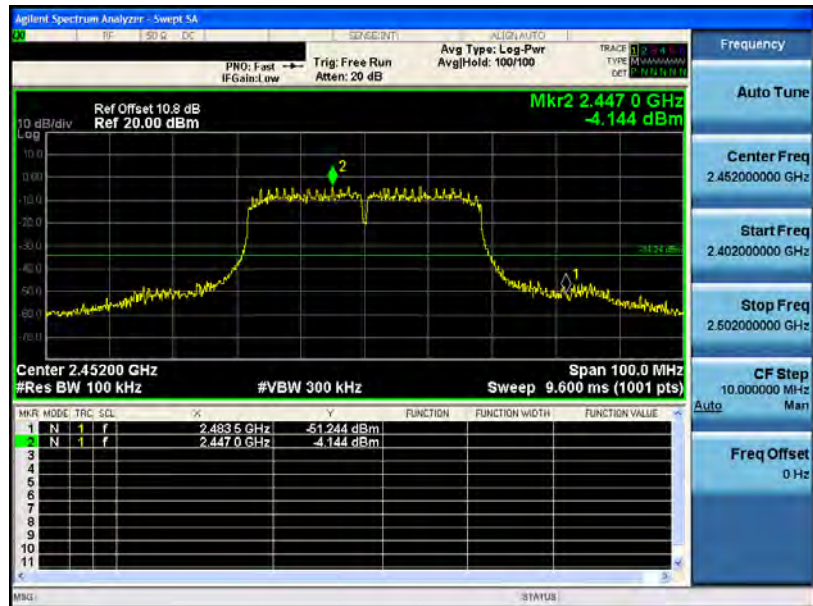

Mode 4: IEEE 802.11n 2.4GHz 20MHz link mode_ANT-2

2412 MHz

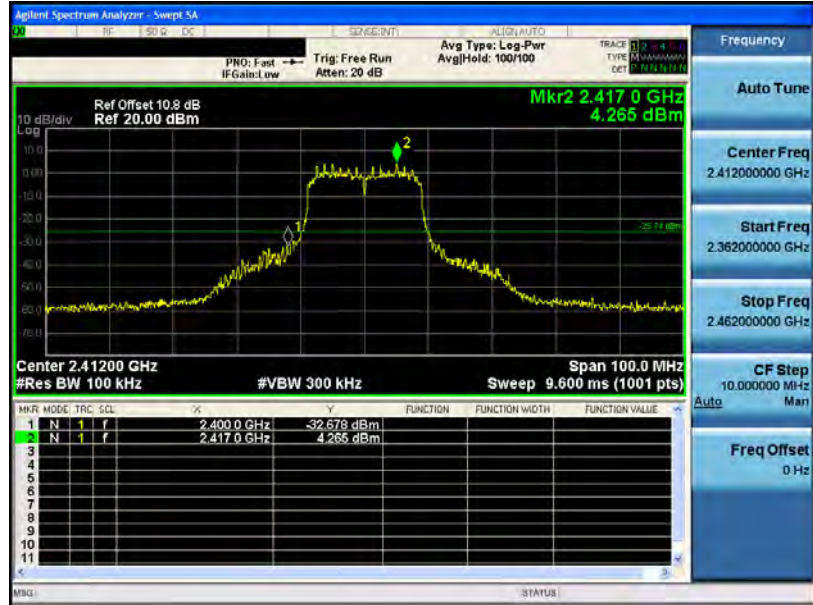

2462 MHz

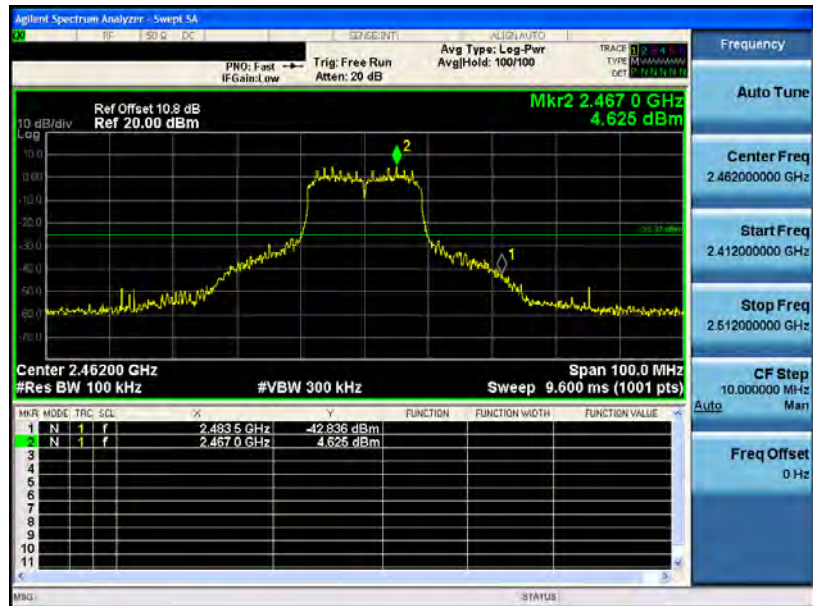



Mode 5: IEEE 802.11n 2.4GHz 40MHz link mode_ANT-2

2422 MHz



2452 MHz





10 Antenna Measurement

10.1.Limit

For intentional device, according to 15.203, an intentional radiator shall be designed to ensure that no antenna other than that furnished by the responsible party shall be used with the device.

And According to 15.247 (b), if transmitting antennas of directional gain greater than 6 dBi are used, the power shall be reduced by the amount in dB that the directional gain of the antenna exceeds 6dBi.

10.2.Antenna Description

See section 2 – antenna information.

10.3.Directiona Gain Calculated

Directional Gain = $10 \cdot \log\{[10^{(G1/20)} + 10^{(G2/20)} + \dots + 10^{(Gn/20)}]^2 / NANT\} = 8.74 \text{ dBi} > 6\text{dBi}$

Operate Freq. Band	Directional Gain (dBi)
IEEE 802.11n 2.4GHz 20MHz	8.74
IEEE 802.11n 2.4GHz 40MHz	8.74