



## FCC TEST REPORT (15.247)

**REPORT NO.:** RF940629L08  
**MODEL NO.:** A5020  
**RECEIVED:** Jul. 14, 2005  
**TESTED:** Jul. 14 ~ Aug. 20, 2005  
**ISSUED:** Aug. 26, 2005

**APPLICANT:** AirMagnet, Inc.

**ADDRESS:** 1325 Chesapeake Terrace, Sunnyvale, CA  
94089 U.S.A.

**ISSUED BY:** Advance Data Technology Corporation

**LAB ADDRESS:** No. 47, 14<sup>th</sup> Ling, Chia Pau Tsuen, Lin Kou  
Hsiang 244, Taipei Hsien, Taiwan, R.O.C.

**TEST LOCATION:** No. 19, Hwa Ya 2<sup>nd</sup> Rd., Wen Hwa Tsuen, Kwei  
Shan Hsiang, Taoyuan Hsien 333, Taiwan,  
R.O.C.

This test report consists of 170 pages in total. It may be duplicated completely for legal use with the approval of the applicant. It should not be reproduced except in full, without the written approval of our laboratory. The client should not use it to claim product endorsement by CNLA, A2LA or any government agencies. The test results in the report only apply to the tested sample.



0528  
ILAC MRA



No. 2177-01



## Table of Contents

|        |   |    |
|--------|---|----|
| 1.     | CERTIFICATION .....   | 6  |
| 2.     | SUMMARY OF TEST RESULTS .....                               | 7  |
| 2.1    | MEASUREMENT UNCERTAINTY .....                               | 8  |
| 3.     | GENERAL INFORMATION .....                                   | 9  |
| 3.1    | GENERAL DESCRIPTION OF EUT .....                            | 9  |
| 3.2    | DESCRIPTION OF TEST MODES .....                             | 11 |
| 3.2.1  | CONFIGURATION OF SYSTEM UNDER TEST .....                    | 12 |
| 3.2.2  | TEST MODE APPLICABILITY AND TESTED CHANNEL DETAIL .....     | 13 |
| 3.3    | GENERAL DESCRIPTION OF APPLIED STANDARDS .....              | 16 |
| 3.4    | DESCRIPTION OF SUPPORT UNITS.....                           | 16 |
| 4.     | TEST TYPES AND RESULTS (802.11b & g 2412~2462MHz BAND)..... | 17 |
| 4.1    | CONDUCTED EMISSION MEASUREMENT .....                        | 17 |
| 4.1.1  | LIMITS OF CONDUCTED EMISSION MEASUREMENT .....              | 17 |
| 4.1.2  | TEST INSTRUMENTS.....                                       | 17 |
| 4.1.3  | TEST PROCEDURES .....                                       | 18 |
| 4.1.4  | DEVIATION FROM TEST STANDARD .....                          | 18 |
| 4.1.5  | TEST SETUP .....  | 19 |
| 4.1.6  | EUT OPERATING CONDITIONS .....                              | 19 |
| 4.1.7  | TEST RESULTS .....  | 20 |
| 4.2    | RADIATED EMISSION MEASUREMENT .....                         | 38 |
| 4.2.1  | LIMITS OF RADIATED EMISSION MEASUREMENT.....                | 38 |
| 4.2.2  | TEST INSTRUMENTS.....                                       | 39 |
| 4.2.3  | TEST PROCEDURES .....                                       | 40 |
| 4.2.4  | DEVIATION FROM TEST STANDARD .....                          | 40 |
| 4.2.5  | TEST SETUP .....  | 41 |
| 4.2.6  | EUT OPERATING CONDITIONS .....                              | 41 |
| 4.2.7  | TEST RESULTS_ ANTENNA SAA05-22063A (BELOW 1GHz TEST) .....  | 42 |
| 4.2.8  | TEST RESULTS_ ANTENNA SDW0939A1 (BELOW 1GHz TEST) .....     | 45 |
| 4.2.9  | TEST RESULTS_ ANTENNA SAA05-22056A (BELOW 1GHz TEST).....   | 48 |
| 4.2.10 | TEST RESULTS_ ANTENNA SAA05-22063A (ABOVE 1GHz TEST).....   | 51 |
| 4.2.11 | TEST RESULTS_ ANTENNA SDW0939A1 (ABOVE 1GHz TEST).....      | 57 |
| 4.2.12 | TEST RESULTS_ ANTENNA SAA05-22056A (ABOVE 1GHz TEST).....   | 63 |
| 4.3    | 6dB BANDWIDTH MEASUREMENT .....                             | 69 |
| 4.3.1  | LIMITS OF 6dB BANDWIDTH MEASUREMENT .....                   | 69 |
| 4.3.2  | TEST INSTRUMENTS.....                                       | 69 |
| 4.3.3  | TEST PROCEDURE.....   | 70 |
| 4.3.4  | DEVIATION FROM TEST STANDARD .....                          | 70 |
| 4.3.5  | TEST SETUP .....  | 70 |



|       |   |     |
|-------|---|-----|
| 4.3.6 | EUT OPERATING CONDITIONS .....                          | 70  |
| 4.3.7 | TEST RESULTS .....                                      | 71  |
| 4.4   | MAXIMUM PEAK OUTPUT POWER.....                          | 77  |
| 4.4.1 | LIMITS OF MAXIMUM PEAK OUTPUT POWER MEASUREMENT .....   | 77  |
| 4.4.2 | INSTRUMENTS.....  | 77  |
| 4.4.1 | TEST PROCEDURES .....                                   | 78  |
| 4.4.2 | DEVIATION FROM TEST STANDARD .....                      | 78  |
| 4.4.3 | TEST SETUP .....  | 78  |
| 4.4.4 | EUT OPERATING CONDITIONS .....                          | 78  |
| 4.4.3 | TEST RESULTS .....                                      | 79  |
| 4.5   | POWER SPECTRAL DENSITY MEASUREMENT.....                 | 80  |
| 4.5.1 | LIMITS OF POWER SPECTRAL DENSITY MEASUREMENT.....       | 80  |
| 4.5.2 | TEST INSTRUMENTS.....                                   | 80  |
| 4.5.3 | TEST PROCEDURE.....                                     | 81  |
| 4.5.4 | DEVIATION FROM TEST STANDARD .....                      | 81  |
| 4.5.5 | TEST SETUP .....  | 81  |
| 4.5.6 | EUT OPERATING CONDITION.....                            | 81  |
| 4.5.7 | TEST RESULTS .....                                      | 82  |
| 4.6   | BAND EDGES MEASUREMENT.....                             | 88  |
| 4.6.1 | LIMITS OF BAND EDGES MEASUREMENT .....                  | 88  |
| 4.6.2 | TEST INSTRUMENTS.....                                   | 88  |
| 4.6.3 | TEST PROCEDURE.....                                     | 88  |
| 4.6.4 | DEVIATION FROM TEST STANDARD .....                      | 88  |
| 4.6.5 | EUT OPERATING CONDITION.....                            | 88  |
| 4.6.6 | TEST RESULTS .....                                      | 89  |
| 4.7   | ANTENNA REQUIREMENT .....                               | 101 |
| 4.7.1 | STANDARD APPLICABLE.....                                | 101 |
| 4.7.2 | ANTENNA CONNECTED CONSTRUCTION.....                     | 101 |
| 5.    | TEST TYPES AND RESULTS (802.11a 5725~5850MHz BAND)..... | 102 |
| 5.1   | CONDUCTED EMISSION MEASUREMENT .....                    | 102 |
| 5.1.1 | LIMITS OF CONDUCTED EMISSION MEASUREMENT .....          | 102 |
| 5.1.2 | TEST INSTRUMENTS.....                                   | 102 |
| 5.1.3 | TEST PROCEDURES .....                                   | 103 |
| 5.1.4 | DEVIATION FROM TEST STANDARD .....                      | 103 |
| 5.1.5 | TEST SETUP .....  | 104 |
| 5.1.6 | EUT OPERATING CONDITIONS .....                          | 104 |
| 5.1.7 | TEST RESULTS .....                                      | 105 |
| 5.2   | RADIATED EMISSION MEASUREMENT .....                     | 111 |
| 5.2.1 | LIMITS OF RADIATED EMISSION MEASUREMENT.....            | 111 |
| 5.2.2 | TEST INSTRUMENTS.....                                   | 112 |
| 5.2.3 | TEST PROCEDURES .....                                   | 113 |



5.2.4 DEVIATION FROM TEST STANDARD ..... 113

5.2.5 TEST SETUP ..... 114

5.2.6 EUT OPERATING CONDITIONS ..... 114

5.2.7 TEST RESULTS\_ ANTENNA SAA05-22063A (BELOW 1GHz TEST) ..... 115

5.2.8 TEST RESULTS\_ ANTENNA SDW0939A1 (BELOW 1GHz TEST) ..... 118

5.2.9 TEST RESULTS\_ ANTENNA SAA05-22056A (BELOW 1GHz TEST) ..... 121

5.2.10 TEST RESULTS\_ ANTENNA SAA05-22063A (ABOVE 1GHz TEST) ..... 124

5.2.11 TEST RESULTS\_ ANTENNA SDW0939A1 (ABOVE 1GHz TEST) ..... 127

5.2.12 TEST RESULTS\_ ANTENNA SAA05-22056A (ABOVE 1GHz TEST) ..... 130

5.3 6dB BANDWIDTH MEASUREMENT ..... 133

5.3.1 LIMITS OF 6dB BANDWIDTH MEASUREMENT ..... 133

5.3.2 TEST INSTRUMENTS ..... 133

5.3.3 TEST PROCEDURE ..... 134

5.3.4 DEVIATION FROM TEST STANDARD ..... 134

5.3.5 TEST SETUP ..... 134

5.3.6 EUT OPERATING CONDITIONS ..... 134

5.3.7 TEST RESULTS ..... 135

5.4 MAXIMUM PEAK OUTPUT POWER ..... 138

5.4.1 LIMITS OF MAXIMUM PEAK OUTPUT POWER MEASUREMENT ..... 138

5.4.2 INSTRUMENTS ..... 138

5.4.3 TEST PROCEDURES ..... 139

5.4.4 DEVIATION FROM TEST STANDARD ..... 139

5.4.5 TEST SETUP ..... 139

5.4.6 EUT OPERATING CONDITIONS ..... 139

5.4.7 TEST RESULTS ..... 140

5.5 POWER SPECTRAL DENSITY MEASUREMENT ..... 141

5.5.1 LIMITS OF POWER SPECTRAL DENSITY MEASUREMENT ..... 141

5.5.2 TEST INSTRUMENTS ..... 141

5.5.3 TEST PROCEDURE ..... 142

5.5.4 DEVIATION FROM TEST STANDARD ..... 142

5.5.5 TEST SETUP ..... 142

5.5.6 EUT OPERATING CONDITION ..... 142

5.5.7 TEST RESULTS ..... 143

5.6 BAND EDGES MEASUREMENT ..... 146

5.6.1 LIMITS OF BAND EDGES MEASUREMENT ..... 146

5.6.2 TEST INSTRUMENTS ..... 146

5.6.3 TEST PROCEDURE ..... 146

5.6.4 DEVIATION FROM TEST STANDARD ..... 146

5.6.5 EUT OPERATING CONDITION ..... 147

5.6.6 TEST RESULTS ..... 147

5.7 ANTENNA REQUIREMENT ..... 151



5.7.1 STANDARD APPLICABLE..... 151  
5.7.2 ANTENNA CONNECTED CONSTRUCTION..... 151  
6. PHOTOGRAPHS OF THE TEST CONFIGURATION..... 152  
7. INFORMATION ON THE TESTING LABORATORIES ..... 170



## 1. CERTIFICATION

**PRODUCT:** AirMagnet SmartEdge Sensor  
**MODEL:** A5020  
**BRAND:** AirMagnet  
**APPLICANT:** AirMagnet, Inc.  
**TESTED:** Jul. 14 ~ Aug. 20, 2005  
**TEST SAMPLE:** ENGINEERING SAMPLE  
**STANDARDS:** FCC Part 15, Subpart C (Section 15.247),  
ANSI C63.4-2003

The above equipment has been tested by **Advance Data Technology Corporation**, and found compliance with the requirement of the above standards. The test record, data evaluation & Equipment Under Test (EUT) configurations represented herein are true and accurate accounts of the measurements of the sample's EMC characteristics under the conditions specified in this report.

**PREPARED BY** : Rennie Wang , **DATE:** Aug. 26, 2005  
Rennie Wang

**TECHNICAL ACCEPTANCE** : Gary Chang , **DATE:** Aug. 26, 2005  
Responsible for RF Gary Chang

**APPROVED BY** : Cody Chang , **DATE:** Aug. 26, 2005  
Cody Chang / Deputy Manager

## 2. SUMMARY OF TEST RESULTS

The EUT has been tested according to the following specifications:

| <b>APPLIED STANDARD: FCC Part 15, Subpart C (Section 15.247)</b> |  |               |   |
|--|--|---------------|---|
| <b>Standard Section</b>  | <b>Test Type and Limit</b>   | <b>Result</b> | <b>Remark</b>   |
| 15.207   | AC Power Conducted Emission  | PASS          | Meet the requirement of limit.<br>Minimum passing margin is -11.06dB at 18.488MHz |
| 15.247(a)(2)   | Spectrum Bandwidth of a Direct Sequence Spread Spectrum System<br>Limit: min. 500kHz   | PASS          | Meet the requirement of limit.  |
| 15.247(b)  | Maximum Peak Output Power<br>Limit: max. 30dBm   | PASS          | Meet the requirement of limit.  |
| 15.247(d)  | Radiated Emissions<br>Limit: Table 15.209  | PASS          | Meet the requirement of limit.<br>Minimum passing margin is -1.03dB at 667.60MHz  |
| 15.247(e)  | Power Spectral Density<br>Limit: max. 8dBm   | PASS          | Meet the requirement of limit.  |
| 15.247(d)  | Band Edge Measurement<br>Limit: 20dB less than the peak value of fundamental frequency | PASS          | Meet the requirement of limit.  |

## 2.1 MEASUREMENT UNCERTAINTY

Where relevant, the following measurement uncertainty levels have been estimated for tests performed on the EUT as specified in CISPR 16-4:

| Measurement         | Frequency        | Uncertainty |
|---------------------|------------------|-------------|
| Conducted emissions | 9kHz ~ 30MHz     | 2.44 dB     |
| Radiated emissions  | 30MHz ~ 200MHz   | 3.73 dB     |
|                     | 200MHz ~ 1000MHz | 3.74 dB     |
|                     | 1GHz ~ 18GHz     | 2.20 dB     |
|                     | 18GHz ~ 40GHz    | 1.88 dB     |

This uncertainty represents an expanded uncertainty expressed at approximately the 95% confidence level using a coverage factor of  $k=2$ .





### 3. GENERAL INFORMATION

#### 3.1 GENERAL DESCRIPTION OF EUT

|                              |   |
|------------------------------|---|
| <b>EUT</b>                   | AirMagnet SmartEdge Sensor  |
| <b>MODEL NO.</b>             | A5020   |
| <b>POWER SUPPLY</b>          | 48Vdc from POE<br>12Vdc from AC adapter   |
| <b>MODULATION TYPE</b>       | CCK, DQPSK, DBPSK for DSSS<br>64QAM, 16QAM, QPSK, BPSK for OFDM                                     |
| <b>MODULATION TECHNOLOGY</b> | DSSS, OFDM  |
| <b>TRANSFER RATE</b>         | 802.11b: 11/5.5/2/1Mbps<br>802.11g: 54/48/36/24/18/12/9/6Mbps<br>802.11a: 54/48/36/24/18/12/9/6Mbps |
| <b>FREQUENCY RANGE</b>       | 802.11b & 802.11g: 2.412 ~ 2.462GHz<br>802.11a: 5.150 ~ 5.350GHz and 5.725 ~ 5.850GHz               |
| <b>NUMBER OF CHANNEL</b>     | 802.11b & 802.11g: 11<br>802.11a: 13  |
| <b>CHANNEL SPACING</b>       | 802.11b & 802.11g: 5MHz<br>802.11a: 20MHz   |
| <b>OUTPUT POWER</b>          | 51.168mW for 2.412 ~ 2.462GHz<br>14.421mW for 5.150 ~ 5.350GHz<br>32.137mW for 5.725 ~ 5.850GHz     |
| <b>ANTENNA TYPE</b>          | Refer to Note 2 as below  |
| <b>DATA CABLE</b>            | NA  |
| <b>I/O PORTS</b>             | RJ45, RS232   |
| <b>ASSOCIATED DEVICES</b>    | NA  |

**NOTE:**

- The EUT was operated with the following POE and adapters:

| POE               |   |
|-------------------|---|
| <b>BRAND</b>      | PowerDsine 3001                         |
| <b>MODEL</b>      | PD-3001/AC                              |
| <b>INPUT</b>      | 100-250Vac, 50-60Hz, 0.5A               |
| <b>OUTPUT</b>     | 48Vdc, 0.35A                            |
| <b>POWER LINE</b> | AC 1.2m non-shielded cable without core |

| Adapter 1         |   |
|-------------------|---|
| <b>BRAND</b>      | ENG                                     |
| <b>MODEL</b>      | 57-12-1500                              |
| <b>INPUT</b>      | 120Vac, 60Hz, 32W                       |
| <b>OUTPUT</b>     | 12Vdc, 1500mA                           |
| <b>POWER LINE</b> | DC 1.8m non-shielded cable without core |



| Adapter 2         |  |
|-------------------|--|
| <b>BRAND</b>      | FAIRWAY  |
| <b>MODEL</b>      | VE20-120   |
| <b>INPUT</b>      | 120-240Vac, 50-60Hz, 1A  |
| <b>OUTPUT</b>     | 12Vdc, 1.66A   |
| <b>POWER LINE</b> | DC 1.6m non-shielded cable without core<br>AC 1.5m non-shielded cable without core |

2. The following antennas were provided to this EUT.

| Antenna Type                       | Antenna      | Gain (dBi) |      | Antenna connector |
|------------------------------------|--------------|------------|------|-------------------|
|                                    |              | 2.4G       | 5G   |                   |
| Dual-Band Omni-Directional Antenna | SAA05-22063A | 5          | 7    | RP TNC Plug       |
| Dual Band Dipole Antenna           | SDW0939A1    | 2.05       | 2.27 | RP-TNC(M)         |
| Dual-Band Directional Antenna      | SAA05-22056A | 6          | 8    | RP TNC Plug       |

- The EUT operates in both the 5GHz and 2.4GHz Bands and compatibility with 802.11a and 802.11b, 802.11g technology.
- The above EUT information was declared by the manufacturer and for more detailed features description, please refer to the manufacturer's specifications or User's Manual.



### 3.2 DESCRIPTION OF TEST MODES

Operated in 2400 ~ 2483.5MHz band:

For 802.11b/g: Eleven channels are provided to this EUT.

| Channel | Frequency | Channel | Frequency |
|---------|-----------|---------|-----------|
| 1       | 2412 MHz  | 7       | 2442 MHz  |
| 2       | 2417 MHz  | 8       | 2447 MHz  |
| 3       | 2422 MHz  | 9       | 2452 MHz  |
| 4       | 2427 MHz  | 10      | 2457 MHz  |
| 5       | 2432 MHz  | 11      | 2462 MHz  |
| 6       | 2437 MHz  |         |           |

Operated in 5725 ~ 5850MHz band:

For 802.11a: Five channels are provided to this EUT.

| Channel | Frequency |
|---------|-----------|
| 1       | 5745 MHz  |
| 2       | 5765 MHz  |
| 3       | 5785 MHz  |
| 4       | 5805 MHz  |
| 5       | 5825 MHz  |

### 3.2.1 CONFIGURATION OF SYSTEM UNDER TEST

#### (Power from POE)

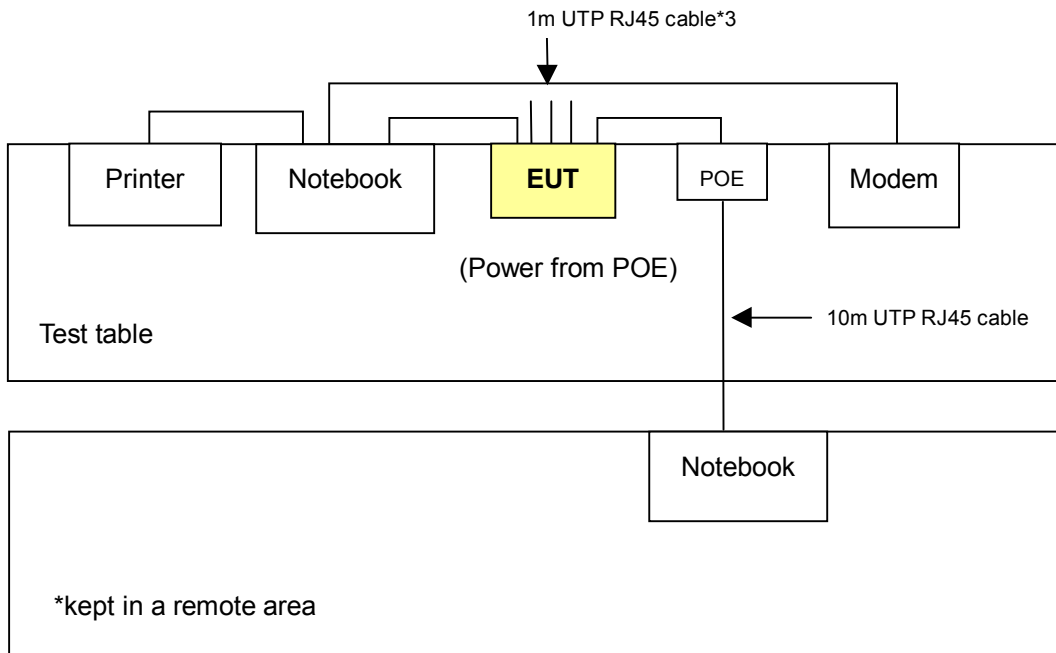

#### (Power from AC adapter)

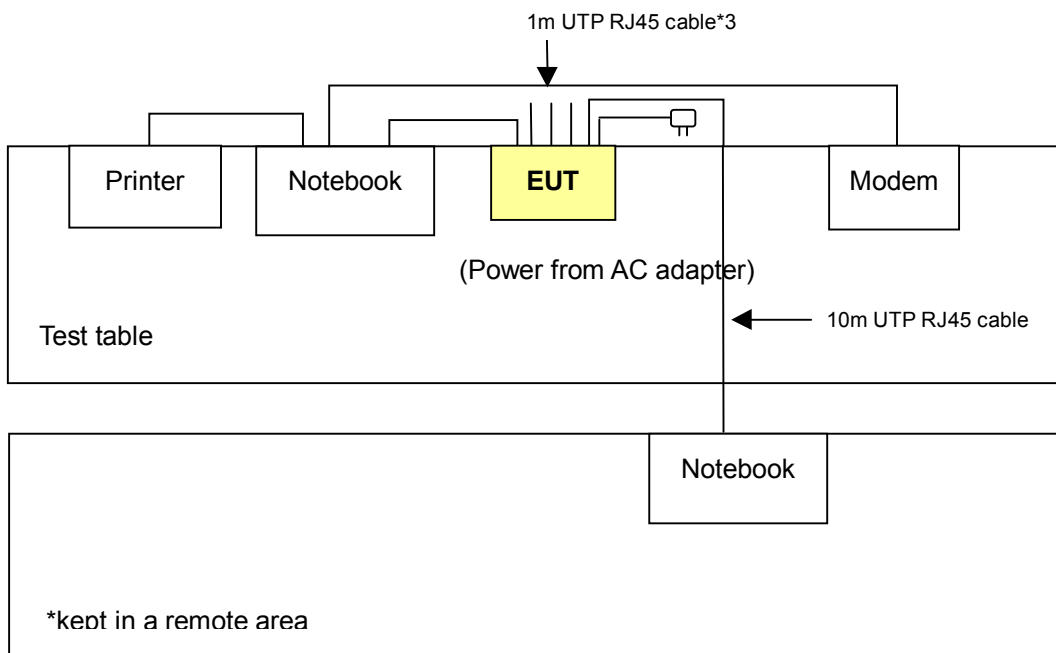



### 3.2.2 TEST MODE APPLICABILITY AND TESTED CHANNEL DETAIL

| EUT configure mode | Applicable to |       |       |      | Description  |
|--------------------|---------------|-------|-------|------|--|
|                    | PLC           | RE<1G | RE≥1G | APCM |  |
| A1                 | -             | √     | -     | -    | Power from POE (PD-3001/AC) with Antenna SAA05-22063A        |
| A2                 | -             | √     | -     | -    | Power from POE (PD-3001/AC) with Antenna SDW0939A1           |
| A3                 | √             | √     | -     | -    | Power from POE (PD-3001/AC) with Antenna SAA05-22056A        |
| B1                 | -             | √     | -     | -    | Power from AC Adapter (57-12-1500) with Antenna SAA05-22063A |
| B2                 | -             | √     | -     | -    | Power from AC Adapter (57-12-1500) with Antenna SDW0939A1    |
| B3                 | √             | √     | -     | -    | Power from AC Adapter (57-12-1500) with Antenna SAA05-22056A |
| C1                 | -             | √     | √     | -    | Power from AC Adapter (VE20-120) with Antenna SAA05-22063A   |
| C2                 | -             | √     | √     | -    | Power from AC Adapter (VE20-120) with Antenna SDW0939A1      |
| C3                 | √             | √     | √     | √    | Power from AC Adapter (VE20-120) with Antenna SAA05-22056A   |

Where PLC: Power Line Conducted Emission RE<1G RE: Radiated Emission below 1GHz  
 RE≥1G: Radiated Emission above 1GHz APCM: Antenna Port Conducted Measurement  
 "-": No effect

#### **Power Line Conducted Emission Test:**

- Pre-Scan has been conducted to determine the worst-case mode from all possible combinations between available modulations, data rates and antenna ports (if EUT with antenna diversity architecture).
- Following channel(s) was (were) selected for the final test as listed below.

| EUT configure mode | Mode    | Available Channel | Tested Channel | Modulation Technology | Modulation Type | Data Rate (Mbps) |
|--------------------|---------|-------------------|----------------|-----------------------|-----------------|------------------|
| A3                 | 802.11g | 1 to 11           | 1, 6, 11       | OFDM                  | BPSK            | 6                |
| B3                 | 802.11g | 1 to 11           | 1, 6, 11       | OFDM                  | BPSK            | 6                |
| C3                 | 802.11g | 1 to 11           | 1, 6, 11       | OFDM                  | BPSK            | 6                |
| A3                 | 802.11a | 1 to 5            | 3              | OFDM                  | BPSK            | 6                |
| B3                 | 802.11a | 1 to 5            | 3              | OFDM                  | BPSK            | 6                |
| C3                 | 802.11a | 1 to 5            | 3              | OFDM                  | BPSK            | 6                |



**Radiated Emission Test (Below 1 GHz):**

- Pre-Scan has been conducted to determine the worst-case mode from all possible combinations between available modulations, data rates and antenna ports (if EUT with antenna diversity architecture).
- Following channel(s) was (were) selected for the final test as listed below.

| EUT configure mode | Mode    | Available Channel | Tested Channel | Modulation Technology | Modulation Type | Data Rate (Mbps) |
|--------------------|---------|-------------------|----------------|-----------------------|-----------------|------------------|
| A1 ~ A3            | 802.11g | 1 to 11           | 11             | OFDM                  | BPSK            | 6                |
| B1 ~ B3            | 802.11g | 1 to 11           | 11             | OFDM                  | BPSK            | 6                |
| C1 ~ C3            | 802.11g | 1 to 11           | 11             | OFDM                  | BPSK            | 6                |
| A1 ~ A3            | 802.11a | 1 to 5            | 3              | OFDM                  | BPSK            | 6                |
| B1 ~ B3            | 802.11a | 1 to 5            | 3              | OFDM                  | BPSK            | 6                |
| C1 ~ C3            | 802.11a | 1 to 5            | 3              | OFDM                  | BPSK            | 6                |

**Radiated Emission Test (Above 1 GHz):**

- Pre-Scan has been conducted to determine the worst-case mode from all possible combinations between available modulations, data rates and antenna ports (if EUT with antenna diversity architecture).
- Following channel(s) was (were) selected for the final test as listed below.

| EUT configure mode | Mode    | Available Channel | Tested Channel | Modulation Technology | Modulation Type | Data Rate (Mbps) |
|--------------------|---------|-------------------|----------------|-----------------------|-----------------|------------------|
| C1 ~ C3            | 802.11b | 1 to 11           | 1, 6, 11       | DSSS                  | CCK             | 11               |
| C1 ~ C3            | 802.11g | 1 to 11           | 1, 6, 11       | OFDM                  | BPSK            | 6                |
| C1 ~ C3            | 802.11a | 1 to 5            | 1, 3, 5        | OFDM                  | BPSK            | 6                |

**Bandedge Measurement:**

- Pre-Scan has been conducted to determine the worst-case mode from all possible combinations between available modulations, data rates and antenna ports (if EUT with antenna diversity architecture).
- Following channel(s) was (were) selected for the final test as listed below.

| Mode    | Available Channel | Tested Channel | Modulation Technology | Modulation Type | Data Rate (Mbps) |
|---------|-------------------|----------------|-----------------------|-----------------|------------------|
| 802.11b | 1 to 11           | 1, 11          | DSSS                  | CCK             | 11               |
| 802.11g | 1 to 11           | 1, 11          | OFDM                  | BPSK            | 6                |
| 802.11a | 1 to 5            | 1, 5           | OFDM                  | BPSK            | 6                |

**Antenna Port Conducted Measurement:**

- Pre-Scan has been conducted to determine the worst-case mode from all possible combinations between available modulations, data rates and antenna ports (if EUT with antenna diversity architecture).
- Following channel(s) was (were) selected for the final test as listed below.

| Mode    | Available Channel | Tested Channel | Modulation Technology | Modulation Type | Data Rate (Mbps) |
|---------|-------------------|----------------|-----------------------|-----------------|------------------|
| 802.11b | 1 to 11           | 1, 6, 11       | DSSS                  | CCK             | 11               |
| 802.11g | 1 to 11           | 1, 6, 11       | OFDM                  | BPSK            | 6                |
| 802.11a | 1 to 5            | 1, 3, 5        | OFDM                  | BPSK            | 6                |



### 3.3 GENERAL DESCRIPTION OF APPLIED STANDARDS

The EUT is a AirMagnet SmartEdge Sensor. According to the specifications of the manufacturer, it must comply with the requirements of the following standards:

#### FCC Part 15, Subpart C. (15.247)

#### ANSI C63.4-2003

All test items have been performed and recorded as per the above standards.

**NOTE:** The EUT is also considered as a kind of computer peripheral, because the connection to computer is necessary for typical use. It has been verified to comply with the requirements of FCC Part 15, Subpart B, Class B (DoC). The test report has been issued separately.

### 3.4 DESCRIPTION OF SUPPORT UNITS

The EUT has been tested as an independent unit together with other necessary accessories or support units. The following support units or accessories were used to form a representative test configuration during the tests.

| NO. | PRODUCT           | BRAND | MODEL NO. | SERIAL NO.  | FCC ID           |
|-----|-------------------|-------|-----------|-------------|------------------|
| 1   | NOTEBOOK COMPUTER | DELL  | PP05L     | 12130898320 | E2K24CLNS        |
| 2   | PRINTER           | EPSON | LQ-300+   | DCGY047265  | FCC DoC Approved |
| 3   | MODEM             | ACEEX | 1414V/3   | 0401008248  | IFAXDM1414       |
| 4   | NOTEBOOK COMPUTER | DELL  | PP05L     | 20838027664 | E2K24CLNS        |

| NO. | SIGNAL CABLE DESCRIPTION OF THE ABOVE SUPPORT UNITS |
|-----|---|
| 1   | NA  |
| 2   | 1.2m shielded cable                                 |
| 3   | 1.2m shielded cable                                 |
| 4   | NA  |

**NOTE:** All power cords of the above support units are non shielded (1.8m).





## 4. TEST TYPES AND RESULTS (802.11b & g 2412~2462MHz Band)

### 4.1 CONDUCTED EMISSION MEASUREMENT

#### 4.1.1 LIMITS OF CONDUCTED EMISSION MEASUREMENT

| FREQUENCY OF EMISSION (MHz) | CONDUCTED LIMIT (dB $\mu$ V) |          |
|-----------------------------|------------------------------|----------|
|                             | Quasi-peak                   | Average  |
| 0.15-0.5                    | 66 to 56                     | 56 to 46 |
| 0.5-5                       | 56                           | 46       |
| 5-30                        | 60                           | 50       |

- NOTE:**
1. The lower limit shall apply at the transition frequencies.
  2. The limit decreases in line with the logarithm of the frequency in the range of 0.15 to 0.50 MHz.
  3. All emanations from a class A/B digital device or system, including any network of conductors and apparatus connected thereto, shall not exceed the level of field strengths specified above.

#### 4.1.2 TEST INSTRUMENTS

| DESCRIPTION & MANUFACTURER       | MODEL NO.   | SERIAL NO.     | CALIBRATED UNTIL |
|----------------------------------|-------------|----------------|------------------|
| Test Receiver<br>ROHDE & SCHWARZ | ESCS30      | 100288         | Nov. 06, 2005    |
| RF signal cable<br>Woken         | 5D-FB       | Cable-HyC02-01 | Jan. 09, 2006    |
| LISN<br>ROHDE & SCHWARZ          | ESH2-Z5     | 100100         | Jan. 20, 2006    |
| LISN<br>ROHDE & SCHWARZ          | ESH3-Z5     | 100311         | Jan. 20, 2006    |
| Software<br>ADT                  | ADT_Cond_V3 | NA             | NA               |

- NOTE:**
1. The calibration interval of the above test instruments is 12 months and the calibrations are traceable to NML/ROC and NIST/USA.
  2. The test was performed in HwaYa Shielded Room 3.
  3. The VCCI Site Registration No. is C-2047.



#### 4.1.3 TEST PROCEDURES

- a. The EUT was placed 0.4 meters from the conducting wall of the shielded room with EUT being connected to the power mains through a line impedance stabilization network (LISN). Other support units were connected to the power mains through another LISN. The two LISNs provide 50 ohm/ 50uH of coupling impedance for the measuring instrument.
- b. Both lines of the power mains connected to the EUT were checked for maximum conducted interference.
- c. The frequency range from 150kHz to 30MHz was searched. Emission levels under (Limit - 20dB) was not recorded.

#### 4.1.4 DEVIATION FROM TEST STANDARD

No deviation

#### 4.1.5 TEST SETUP

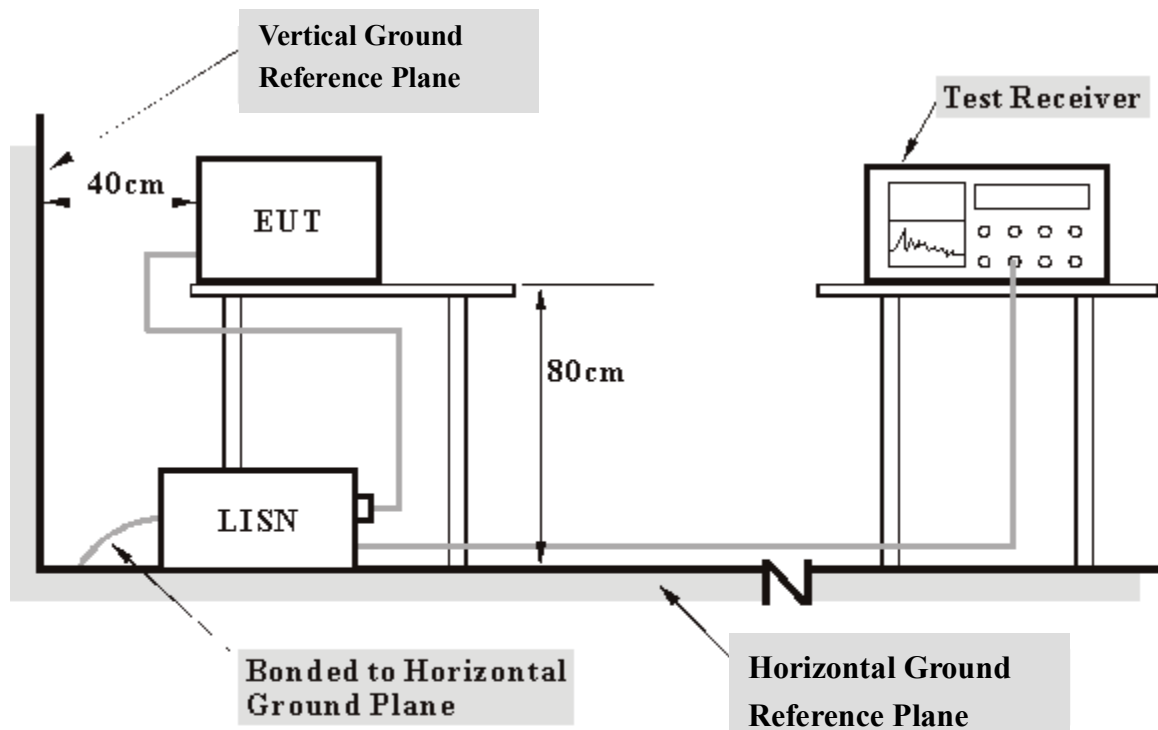

- Note:**
1. Support units were connected to second LISN.
  2. Both of LISNs (AMN) 80 cm from EUT and at the least 80 cm from other units and other metal planes support units.

For the actual test configuration, please refer to the related item – Photographs of the Test Configuration.

#### 4.1.6 EUT OPERATING CONDITIONS

- a. Connected the EUT to notebook via an RJ45 cable and placed on a testing table.
- b. The notebook ran a test program (provided by manufacturer) to enable all functions under transmission/receiving condition continuously at specific channel frequency.
- c. The notebook system sent "H" messages to its screen.
- d. The notebook system sent "H" messages to modem.
- e. The notebook system sent "H" messages to printer and the printer prints them on paper.
- f. Step c ~ e was repeated.



### 4.1.7 TEST RESULTS

#### Conducted Worst-Case Data (Power from POE)

|                        |                            |                                 |                         |
|------------------------|----------------------------|---------------------------------|-------------------------|
| <b>EUT</b>             | AirMagnet SmartEdge Sensor | <b>MEASUREMENT DETAIL</b>       |                         |
| <b>MODEL</b>           | A5020                      | <b>PHASE</b>                    | Line 1                  |
| <b>CHANNEL</b>         | Channel 1                  | <b>6dB BANDWIDTH</b>            | 9 kHz                   |
| <b>MODULATION TYPE</b> | BPSK                       | <b>ENVIRONMENTAL CONDITIONS</b> | 25deg. C, 65%RH, 985hPa |
| <b>TRANSFER RATE</b>   | 6Mbps                      | <b>INPUT POWER (SYSTEM)</b>     | 120Vac, 60 Hz           |
| <b>TEST MODE</b>       | A3                         | <b>TESTED BY</b>                | William Chien           |

| No | Freq. [MHz] | Corr. Factor (dB) | Reading Value [dB (uV)] |       | Emission Level [dB (uV)] |       | Limit [dB (uV)] |       | Margin (dB) |       |
|----|-------------|-------------------|-------------------------|-------|--------------------------|-------|-----------------|-------|-------------|-------|
|    |             |                   | Q.P.                    | AV.   | Q.P.                     | AV.   | Q.P.            | AV.   | Q.P.        | AV.   |
|    |             |                   | 1                       | 0.170 | 0.11                     | 46.32 | -               | 46.43 | -           | 64.98 |
| 2  | 0.259       | 0.11              | 36.19                   | -     | 36.30                    | -     | 61.45           | 51.45 | -25.15      | -     |
| 3  | 1.121       | 0.23              | 24.10                   | -     | 24.33                    | -     | 56.00           | 46.00 | -31.67      | -     |
| 4  | 4.570       | 0.30              | 30.12                   | -     | 30.42                    | -     | 56.00           | 46.00 | -25.58      | -     |
| 5  | 18.914      | 0.89              | 45.02                   | -     | 45.91                    | -     | 60.00           | 50.00 | -14.09      | -     |
| 6  | 25.875      | 1.42              | 44.64                   | -     | 46.06                    | -     | 60.00           | 50.00 | -13.94      | -     |

- REMARKS:**
1. Q.P. and AV. are abbreviations of quasi-peak and average individually.
  2. "-": The Quasi-peak reading value also meets average limit and measurement with the average detector is unnecessary.
  3. The emission levels of other frequencies were very low against the limit.
  4. Margin value = Emission level - Limit value
  5. Correction factor = Insertion loss + Cable loss
  6. Emission Level = Correction Factor + Reading Value.

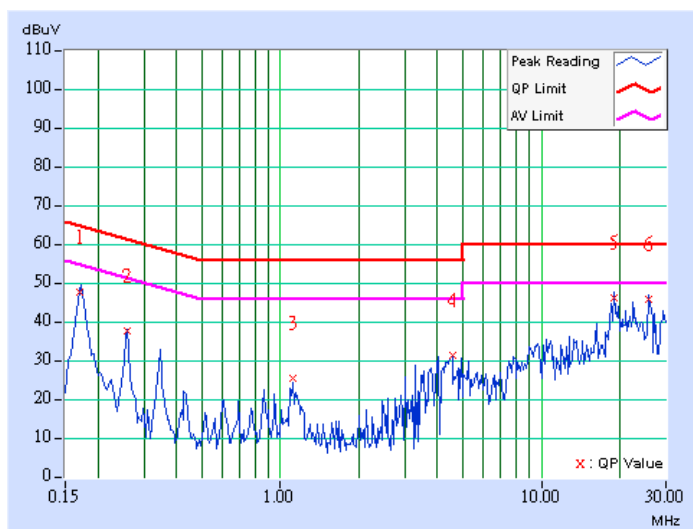



|                        |                            |                                 |                         |
|------------------------|----------------------------|---------------------------------|-------------------------|
| <b>EUT</b>             | AirMagnet SmartEdge Sensor | <b>MEASUREMENT DETAIL</b>       |                         |
| <b>MODEL</b>           | A5020                      | <b>PHASE</b>                    | Line 2                  |
| <b>CHANNEL</b>         | Channel 1                  | <b>6dB BANDWIDTH</b>            | 9 kHz                   |
| <b>MODULATION TYPE</b> | BPSK                       | <b>ENVIRONMENTAL CONDITIONS</b> | 25deg. C, 65%RH, 985hPa |
| <b>TRANSFER RATE</b>   | 6Mbps                      | <b>INPUT POWER (SYSTEM)</b>     | 120Vac, 60 Hz           |
| <b>TEST MODE</b>       | A3                         | <b>TESTED BY</b>                | William Chien           |

| No | Freq.<br>[MHz] | Corr.<br>Factor<br>(dB) | Reading Value |     | Emission Level |     | Limit     |       | Margin |     |
|----|----------------|-------------------------|---------------|-----|----------------|-----|-----------|-------|--------|-----|
|    |                |                         | [dB (uV)]     |     | [dB (uV)]      |     | [dB (uV)] |       | (dB)   |     |
|    |                |                         | Q.P.          | AV. | Q.P.           | AV. | Q.P.      | AV.   | Q.P.   | AV. |
| 1  | 0.173          | 0.11                    | 49.88         | -   | 49.99          | -   | 64.79     | 54.79 | -14.81 | -   |
| 2  | 0.259          | 0.11                    | 37.16         | -   | 37.27          | -   | 61.45     | 51.45 | -24.18 | -   |
| 3  | 0.861          | 0.20                    | 29.27         | -   | 29.47          | -   | 56.00     | 46.00 | -26.53 | -   |
| 4  | 4.223          | 0.30                    | 33.21         | -   | 33.51          | -   | 56.00     | 46.00 | -22.49 | -   |
| 5  | 11.459         | 0.57                    | 42.81         | -   | 43.38          | -   | 60.00     | 50.00 | -16.62 | -   |
| 6  | 18.922         | 0.91                    | 47.09         | -   | 48.00          | -   | 60.00     | 50.00 | -12.00 | -   |

- REMARKS:**
1. Q.P. and AV. are abbreviations of quasi-peak and average individually.
  2. "-": The Quasi-peak reading value also meets average limit and measurement with the average detector is unnecessary.
  3. The emission levels of other frequencies were very low against the limit.
  4. Margin value = Emission level - Limit value
  5. Correction factor = Insertion loss + Cable loss
  6. Emission Level = Correction Factor + Reading Value.

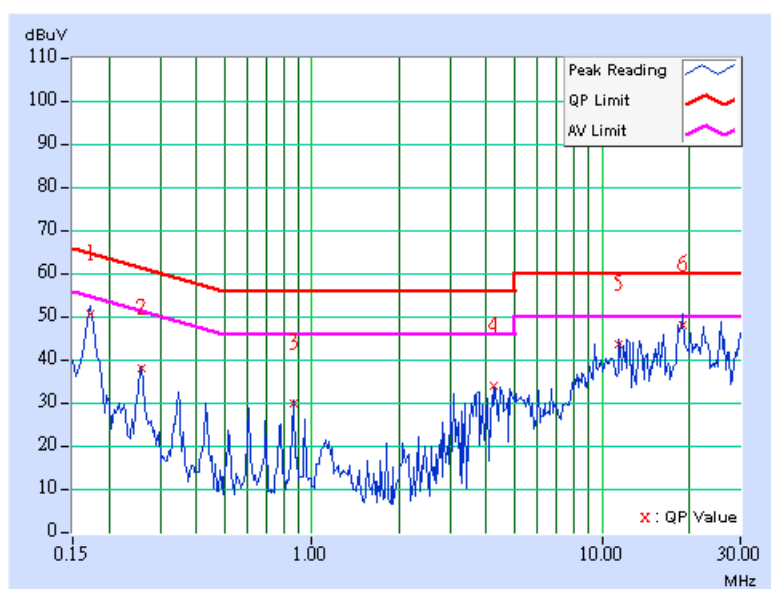



|                        |                            |                                 |                         |
|------------------------|----------------------------|---------------------------------|-------------------------|
| <b>EUT</b>             | AirMagnet SmartEdge Sensor | <b>MEASUREMENT DETAIL</b>       |                         |
| <b>MODEL</b>           | A5020                      | <b>PHASE</b>                    | Line 1                  |
| <b>CHANNEL</b>         | Channel 6                  | <b>6dB BANDWIDTH</b>            | 9 kHz                   |
| <b>MODULATION TYPE</b> | BPSK                       | <b>ENVIRONMENTAL CONDITIONS</b> | 25deg. C, 65%RH, 985hPa |
| <b>TRANSFER RATE</b>   | 6Mbps                      | <b>INPUT POWER (SYSTEM)</b>     | 120Vac, 60 Hz           |
| <b>TEST MODE</b>       | A3                         | <b>TESTED BY</b>                | William Chien           |

| No       | Freq.<br>[MHz] | Corr.<br>Factor<br>(dB) | Reading Value |     | Emission Level |     | Limit        |              | Margin        |     |
|----------|----------------|-------------------------|---------------|-----|----------------|-----|--------------|--------------|---------------|-----|
|          |                |                         | [dB (uV)]     |     | [dB (uV)]      |     | [dB (uV)]    |              | (dB)          |     |
|          |                |                         | Q.P.          | AV. | Q.P.           | AV. | Q.P.         | AV.          | Q.P.          | AV. |
| 1        | 0.173          | 0.11                    | 47.71         | -   | 47.82          | -   | 64.79        | 54.79        | -16.98        | -   |
| 2        | 0.259          | 0.11                    | 36.00         | -   | 36.11          | -   | 61.45        | 51.45        | -25.34        | -   |
| 3        | 0.345          | 0.12                    | 30.73         | -   | 30.85          | -   | 59.07        | 49.07        | -28.23        | -   |
| 4        | 1.121          | 0.23                    | 24.18         | -   | 24.41          | -   | 56.00        | 46.00        | -31.59        | -   |
| 5        | 4.660          | 0.31                    | 29.14         | -   | 29.45          | -   | 56.00        | 46.00        | -26.55        | -   |
| <b>6</b> | <b>18.488</b>  | <b>0.85</b>             | <b>48.09</b>  | -   | <b>48.94</b>   | -   | <b>60.00</b> | <b>50.00</b> | <b>-11.06</b> | -   |

- REMARKS:**
1. Q.P. and AV. are abbreviations of quasi-peak and average individually.
  2. "-": The Quasi-peak reading value also meets average limit and measurement with the average detector is unnecessary.
  3. The emission levels of other frequencies were very low against the limit.
  4. Margin value = Emission level - Limit value
  5. Correction factor = Insertion loss + Cable loss
  6. Emission Level = Correction Factor + Reading Value.

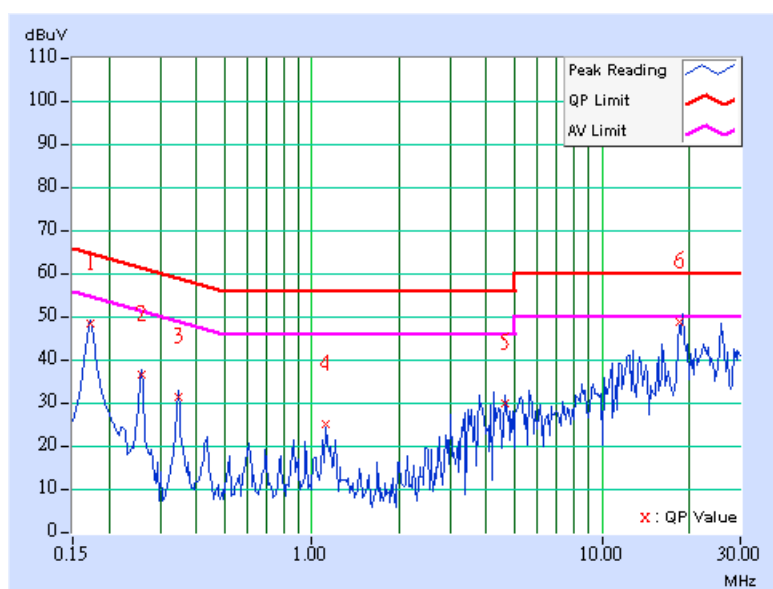



|                        |                            |                                 |                         |
|------------------------|----------------------------|---------------------------------|-------------------------|
| <b>EUT</b>             | AirMagnet SmartEdge Sensor | <b>MEASUREMENT DETAIL</b>       |                         |
| <b>MODEL</b>           | A5020                      | <b>PHASE</b>                    | Line 2                  |
| <b>CHANNEL</b>         | Channel 6                  | <b>6dB BANDWIDTH</b>            | 9 kHz                   |
| <b>MODULATION TYPE</b> | BPSK                       | <b>ENVIRONMENTAL CONDITIONS</b> | 25deg. C, 65%RH, 985hPa |
| <b>TRANSFER RATE</b>   | 6Mbps                      | <b>INPUT POWER (SYSTEM)</b>     | 120Vac, 60 Hz           |
| <b>TEST MODE</b>       | A3                         | <b>TESTED BY</b>                | William Chien           |

| No | Freq. [MHz] | Corr. Factor (dB) | Reading Value [dB (uV)] |       | Emission Level [dB (uV)] |       | Limit [dB (uV)] |       | Margin (dB) |       |
|----|-------------|-------------------|-------------------------|-------|--------------------------|-------|-----------------|-------|-------------|-------|
|    |             |                   | Q.P.                    | AV.   | Q.P.                     | AV.   | Q.P.            | AV.   | Q.P.        | AV.   |
|    |             |                   | 1                       | 0.170 | 0.11                     | 42.35 | -               | 42.46 | -           | 64.98 |
| 2  | 0.259       | 0.11              | 34.46                   | -     | 34.57                    | -     | 61.45           | 51.45 | -26.88      | -     |
| 3  | 0.865       | 0.21              | 25.22                   | -     | 25.43                    | -     | 56.00           | 46.00 | -30.57      | -     |
| 4  | 4.145       | 0.30              | 30.35                   | -     | 30.65                    | -     | 56.00           | 46.00 | -25.35      | -     |
| 5  | 10.793      | 0.56              | 38.40                   | -     | 38.96                    | -     | 60.00           | 50.00 | -21.04      | -     |
| 6  | 18.485      | 0.88              | 47.49                   | -     | 48.37                    | -     | 60.00           | 50.00 | -11.63      | -     |

- REMARKS:**
1. Q.P. and AV. are abbreviations of quasi-peak and average individually.
  2. "-": The Quasi-peak reading value also meets average limit and measurement with the average detector is unnecessary.
  3. The emission levels of other frequencies were very low against the limit.
  4. Margin value = Emission level - Limit value
  5. Correction factor = Insertion loss + Cable loss
  6. Emission Level = Correction Factor + Reading Value.

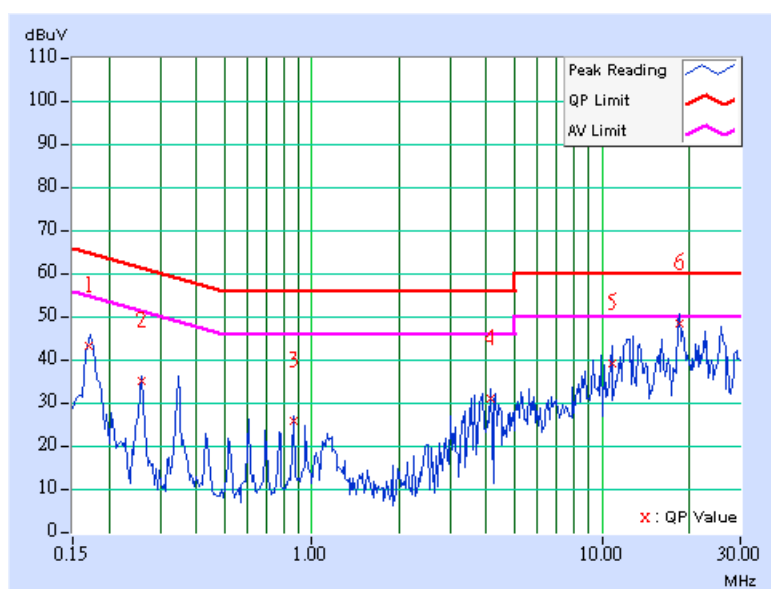



|                        |                            |                                 |                         |
|------------------------|----------------------------|---------------------------------|-------------------------|
| <b>EUT</b>             | AirMagnet SmartEdge Sensor | <b>MEASUREMENT DETAIL</b>       |                         |
| <b>MODEL</b>           | A5020                      | <b>PHASE</b>                    | Line 1                  |
| <b>CHANNEL</b>         | Channel 11                 | <b>6dB BANDWIDTH</b>            | 9 kHz                   |
| <b>MODULATION TYPE</b> | BPSK                       | <b>ENVIRONMENTAL CONDITIONS</b> | 25deg. C, 65%RH, 985hPa |
| <b>TRANSFER RATE</b>   | 6Mbps                      | <b>INPUT POWER (SYSTEM)</b>     | 120Vac, 60 Hz           |
| <b>TEST MODE</b>       | A3                         | <b>TESTED BY</b>                | William Chien           |

| No | Freq. [MHz] | Corr. Factor (dB) | Reading Value [dB (uV)] |       | Emission Level [dB (uV)] |       | Limit [dB (uV)] |       | Margin (dB) |       |
|----|-------------|-------------------|-------------------------|-------|--------------------------|-------|-----------------|-------|-------------|-------|
|    |             |                   | Q.P.                    | AV.   | Q.P.                     | AV.   | Q.P.            | AV.   | Q.P.        | AV.   |
|    |             |                   | 1                       | 0.170 | 0.11                     | 44.46 | -               | 44.57 | -           | 64.98 |
| 2  | 0.259       | 0.11              | 35.75                   | -     | 35.86                    | -     | 61.45           | 51.45 | -25.59      | -     |
| 3  | 1.117       | 0.23              | 23.06                   | -     | 23.29                    | -     | 56.00           | 46.00 | -32.71      | -     |
| 4  | 3.805       | 0.29              | 30.84                   | -     | 31.13                    | -     | 56.00           | 46.00 | -24.87      | -     |
| 5  | 9.938       | 0.44              | 25.37                   | -     | 25.81                    | -     | 60.00           | 50.00 | -34.19      | -     |
| 6  | 25.691      | 1.40              | 43.01                   | -     | 44.41                    | -     | 60.00           | 50.00 | -15.59      | -     |

- REMARKS:**
1. Q.P. and AV. are abbreviations of quasi-peak and average individually.
  2. "-": The Quasi-peak reading value also meets average limit and measurement with the average detector is unnecessary.
  3. The emission levels of other frequencies were very low against the limit.
  4. Margin value = Emission level - Limit value
  5. Correction factor = Insertion loss + Cable loss
  6. Emission Level = Correction Factor + Reading Value.

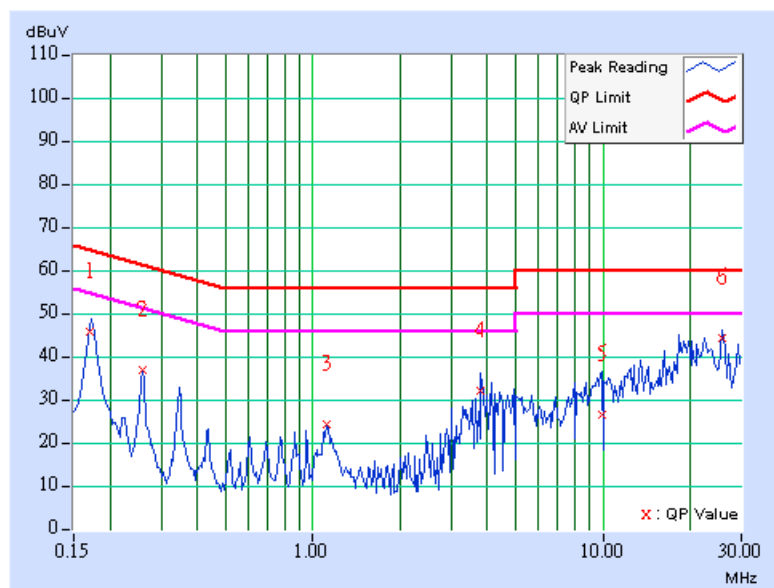





|                        |                            |                                 |                         |
|------------------------|----------------------------|---------------------------------|-------------------------|
| <b>EUT</b>             | AirMagnet SmartEdge Sensor | <b>MEASUREMENT DETAIL</b>       |                         |
| <b>MODEL</b>           | A5020                      | <b>PHASE</b>                    | Line 2                  |
| <b>CHANNEL</b>         | Channel 11                 | <b>6dB BANDWIDTH</b>            | 9 kHz                   |
| <b>MODULATION TYPE</b> | BPSK                       | <b>ENVIRONMENTAL CONDITIONS</b> | 25deg. C, 65%RH, 985hPa |
| <b>TRANSFER RATE</b>   | 6Mbps                      | <b>INPUT POWER (SYSTEM)</b>     | 120Vac, 60 Hz           |
| <b>TEST MODE</b>       | A3                         | <b>TESTED BY</b>                | William Chien           |

| No | Freq.<br>[MHz] | Corr.<br>Factor<br>(dB) | Reading Value |     | Emission Level |     | Limit     |       | Margin |     |
|----|----------------|-------------------------|---------------|-----|----------------|-----|-----------|-------|--------|-----|
|    |                |                         | [dB (uV)]     |     | [dB (uV)]      |     | [dB (uV)] |       | (dB)   |     |
|    |                |                         | Q.P.          | AV. | Q.P.           | AV. | Q.P.      | AV.   | Q.P.   | AV. |
| 1  | 0.170          | 0.11                    | 42.13         | -   | 42.24          | -   | 64.98     | 54.98 | -22.75 | -   |
| 2  | 0.259          | 0.11                    | 34.46         | -   | 34.57          | -   | 61.45     | 51.45 | -26.88 | -   |
| 3  | 0.865          | 0.21                    | 25.05         | -   | 25.26          | -   | 56.00     | 46.00 | -30.74 | -   |
| 4  | 3.715          | 0.28                    | 28.51         | -   | 28.79          | -   | 56.00     | 46.00 | -27.21 | -   |
| 5  | 12.199         | 0.59                    | 40.97         | -   | 41.56          | -   | 60.00     | 50.00 | -18.44 | -   |
| 6  | 18.922         | 0.91                    | 46.16         | -   | 47.07          | -   | 60.00     | 50.00 | -12.93 | -   |

- REMARKS:**
1. Q.P. and AV. are abbreviations of quasi-peak and average individually.
  2. "-": The Quasi-peak reading value also meets average limit and measurement with the average detector is unnecessary.
  3. The emission levels of other frequencies were very low against the limit.
  4. Margin value = Emission level - Limit value
  5. Correction factor = Insertion loss + Cable loss
  6. Emission Level = Correction Factor + Reading Value.

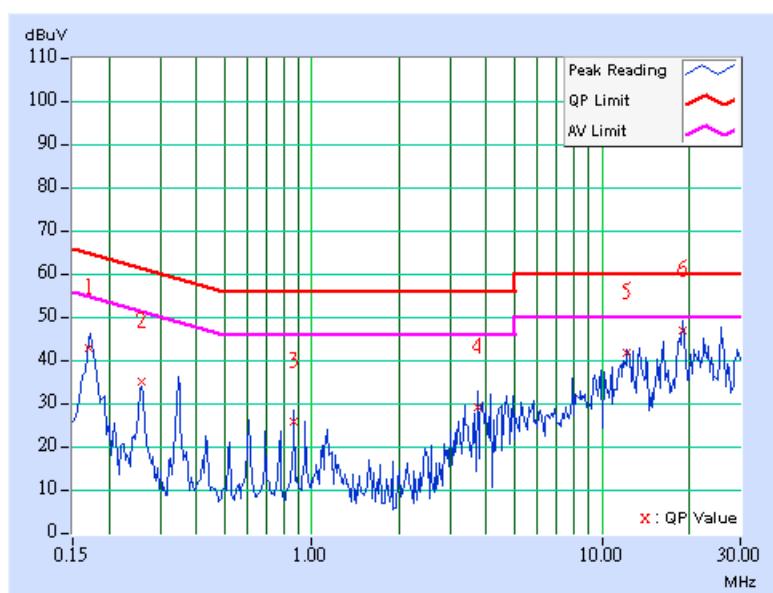



**Conducted Worst-Case Data (Power from AC adapter\_57-12-1500)**

|                        |                            |                                 |                         |
|------------------------|----------------------------|---------------------------------|-------------------------|
| <b>EUT</b>             | AirMagnet SmartEdge Sensor | <b>MEASUREMENT DETAIL</b>       |                         |
| <b>MODEL</b>           | A5020                      | <b>PHASE</b>                    | Line 1                  |
| <b>CHANNEL</b>         | Channel 1                  | <b>6dB BANDWIDTH</b>            | 9 kHz                   |
| <b>MODULATION TYPE</b> | BPSK                       | <b>ENVIRONMENTAL CONDITIONS</b> | 25deg. C, 65%RH, 985hPa |
| <b>TRANSFER RATE</b>   | 6Mbps                      | <b>INPUT POWER (SYSTEM)</b>     | 120Vac, 60 Hz           |
| <b>TEST MODE</b>       | B3                         | <b>TESTED BY</b>                | William Chien           |

| No | Freq. [MHz] | Corr. Factor (dB) | Reading Value [dB (uV)] |       | Emission Level [dB (uV)] |       | Limit [dB (uV)] |       | Margin (dB) |       |
|----|-------------|-------------------|-------------------------|-------|--------------------------|-------|-----------------|-------|-------------|-------|
|    |             |                   | Q.P.                    | AV.   | Q.P.                     | AV.   | Q.P.            | AV.   | Q.P.        | AV.   |
|    |             |                   | 1                       | 0.181 | 0.10                     | 50.07 | -               | 50.17 | -           | 64.43 |
| 2  | 0.240       | 0.10              | 47.91                   | -     | 48.01                    | -     | 62.10           | 52.10 | -14.09      | -     |
| 3  | 0.576       | 0.13              | 40.79                   | -     | 40.92                    | -     | 56.00           | 46.00 | -15.08      | -     |
| 4  | 0.959       | 0.19              | 27.15                   | -     | 27.34                    | -     | 56.00           | 46.00 | -28.66      | -     |
| 5  | 8.527       | 0.28              | 13.17                   | -     | 13.45                    | -     | 60.00           | 50.00 | -46.55      | -     |
| 6  | 17.652      | 0.61              | 8.33                    | -     | 8.94                     | -     | 60.00           | 50.00 | -51.06      | -     |

- REMARKS:**
1. Q.P. and AV. are abbreviations of quasi-peak and average individually.
  2. "-": The Quasi-peak reading value also meets average limit and measurement with the average detector is unnecessary.
  3. The emission levels of other frequencies were very low against the limit.
  4. Margin value = Emission level - Limit value
  5. Correction factor = Insertion loss + Cable loss
  6. Emission Level = Correction Factor + Reading Value.

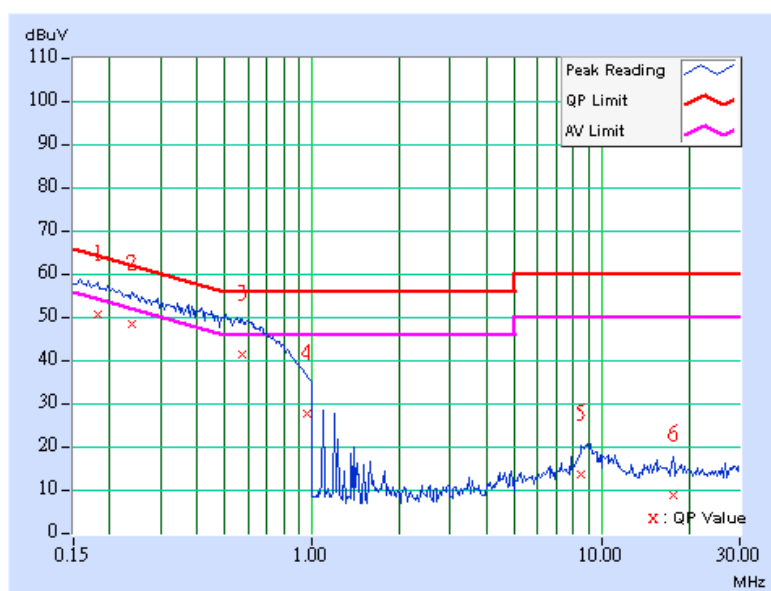



|                        |                            |                                 |                         |
|------------------------|----------------------------|---------------------------------|-------------------------|
| <b>EUT</b>             | AirMagnet SmartEdge Sensor | <b>MEASUREMENT DETAIL</b>       |                         |
| <b>MODEL</b>           | A5020                      | <b>PHASE</b>                    | Line 2                  |
| <b>CHANNEL</b>         | Channel 1                  | <b>6dB BANDWIDTH</b>            | 9 kHz                   |
| <b>MODULATION TYPE</b> | BPSK                       | <b>ENVIRONMENTAL CONDITIONS</b> | 25deg. C, 65%RH, 985hPa |
| <b>TRANSFER RATE</b>   | 6Mbps                      | <b>INPUT POWER (SYSTEM)</b>     | 120Vac, 60 Hz           |
| <b>TEST MODE</b>       | B3                         | <b>TESTED BY</b>                | William Chien           |

| No | Freq.<br>[MHz] | Corr.<br>Factor<br>(dB) | Reading Value |     | Emission Level |     | Limit     |       | Margin |     |
|----|----------------|-------------------------|---------------|-----|----------------|-----|-----------|-------|--------|-----|
|    |                |                         | [dB (uV)]     |     | [dB (uV)]      |     | [dB (uV)] |       | (dB)   |     |
|    |                |                         | Q.P.          | AV. | Q.P.           | AV. | Q.P.      | AV.   | Q.P.   | AV. |
| 1  | 0.189          | 0.10                    | 49.80         | -   | 49.90          | -   | 64.08     | 54.08 | -14.18 | -   |
| 2  | 0.474          | 0.11                    | 42.52         | -   | 42.63          | -   | 56.44     | 46.44 | -13.81 | -   |
| 3  | 0.638          | 0.14                    | 38.81         | -   | 38.95          | -   | 56.00     | 46.00 | -17.05 | -   |
| 4  | 1.016          | 0.20                    | 25.12         | -   | 25.32          | -   | 56.00     | 46.00 | -30.68 | -   |
| 5  | 8.957          | 0.37                    | 17.25         | -   | 17.62          | -   | 60.00     | 50.00 | -42.38 | -   |
| 6  | 20.500         | 0.82                    | 15.78         | -   | 16.60          | -   | 60.00     | 50.00 | -43.40 | -   |

- REMARKS:**
1. Q.P. and AV. are abbreviations of quasi-peak and average individually.
  2. "-": The Quasi-peak reading value also meets average limit and measurement with the average detector is unnecessary.
  3. The emission levels of other frequencies were very low against the limit.
  4. Margin value = Emission level - Limit value
  5. Correction factor = Insertion loss + Cable loss
  6. Emission Level = Correction Factor + Reading Value.

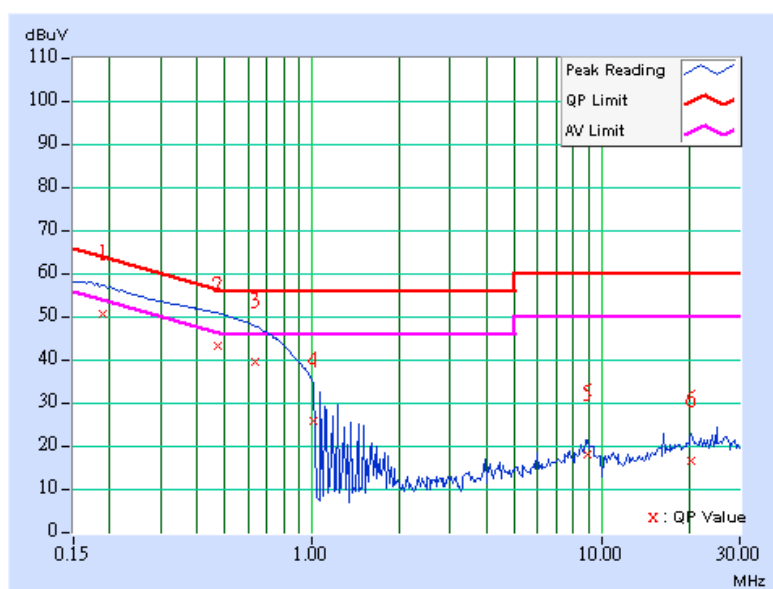



|                        |                            |                                 |                         |
|------------------------|----------------------------|---------------------------------|-------------------------|
| <b>EUT</b>             | AirMagnet SmartEdge Sensor | <b>MEASUREMENT DETAIL</b>       |                         |
| <b>MODEL</b>           | A5020                      | <b>PHASE</b>                    | Line 1                  |
| <b>CHANNEL</b>         | Channel 6                  | <b>6dB BANDWIDTH</b>            | 9 kHz                   |
| <b>MODULATION TYPE</b> | BPSK                       | <b>ENVIRONMENTAL CONDITIONS</b> | 25deg. C, 65%RH, 985hPa |
| <b>TRANSFER RATE</b>   | 6Mbps                      | <b>INPUT POWER (SYSTEM)</b>     | 120Vac, 60 Hz           |
| <b>TEST MODE</b>       | B3                         | <b>TESTED BY</b>                | William Chien           |

| No | Freq. [MHz] | Corr. Factor (dB) | Reading Value [dB (uV)] |       | Emission Level [dB (uV)] |       | Limit [dB (uV)] |       | Margin (dB) |       |
|----|-------------|-------------------|-------------------------|-------|--------------------------|-------|-----------------|-------|-------------|-------|
|    |             |                   | Q.P.                    | AV.   | Q.P.                     | AV.   | Q.P.            | AV.   | Q.P.        | AV.   |
|    |             |                   | 1                       | 0.255 | 0.10                     | 47.24 | -               | 47.34 | -           | 61.58 |
| 2  | 0.463       | 0.11              | 42.86                   | -     | 42.97                    | -     | 56.65           | 46.65 | -13.68      | -     |
| 3  | 0.654       | 0.14              | 39.67                   | -     | 39.81                    | -     | 56.00           | 46.00 | -16.19      | -     |
| 4  | 0.982       | 0.20              | 25.62                   | -     | 25.82                    | -     | 56.00           | 46.00 | -30.18      | -     |
| 5  | 8.719       | 0.28              | 17.03                   | -     | 17.31                    | -     | 60.00           | 50.00 | -42.69      | -     |
| 6  | 14.883      | 0.40              | 10.77                   | -     | 11.17                    | -     | 60.00           | 50.00 | -48.83      | -     |

- REMARKS:**
1. Q.P. and AV. are abbreviations of quasi-peak and average individually.
  2. "-": The Quasi-peak reading value also meets average limit and measurement with the average detector is unnecessary.
  3. The emission levels of other frequencies were very low against the limit.
  4. Margin value = Emission level - Limit value
  5. Correction factor = Insertion loss + Cable loss
  6. Emission Level = Correction Factor + Reading Value.

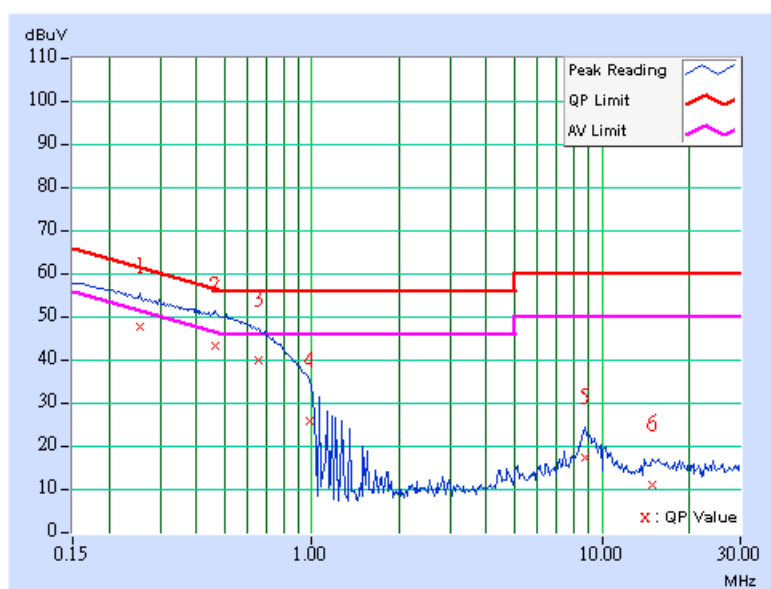



|                        |                            |                                 |                         |
|------------------------|----------------------------|---------------------------------|-------------------------|
| <b>EUT</b>             | AirMagnet SmartEdge Sensor | <b>MEASUREMENT DETAIL</b>       |                         |
| <b>MODEL</b>           | A5020                      | <b>PHASE</b>                    | Line 2                  |
| <b>CHANNEL</b>         | Channel 6                  | <b>6dB BANDWIDTH</b>            | 9 kHz                   |
| <b>MODULATION TYPE</b> | BPSK                       | <b>ENVIRONMENTAL CONDITIONS</b> | 25deg. C, 65%RH, 985hPa |
| <b>TRANSFER RATE</b>   | 6Mbps                      | <b>INPUT POWER (SYSTEM)</b>     | 120Vac, 60 Hz           |
| <b>TEST MODE</b>       | B3                         | <b>TESTED BY</b>                | William Chien           |

| No | Freq.<br>[MHz] | Corr.<br>Factor<br>(dB) | Reading Value |     | Emission Level |     | Limit     |       | Margin |     |
|----|----------------|-------------------------|---------------|-----|----------------|-----|-----------|-------|--------|-----|
|    |                |                         | [dB (uV)]     |     | [dB (uV)]      |     | [dB (uV)] |       | (dB)   |     |
|    |                |                         | Q.P.          | AV. | Q.P.           | AV. | Q.P.      | AV.   | Q.P.   | AV. |
| 1  | 0.224          | 0.10                    | 47.99         | -   | 48.09          | -   | 62.66     | 52.66 | -14.57 | -   |
| 2  | 0.365          | 0.10                    | 44.21         | -   | 44.31          | -   | 58.62     | 48.62 | -14.31 | -   |
| 3  | 0.474          | 0.11                    | 43.01         | -   | 43.12          | -   | 56.44     | 46.44 | -13.32 | -   |
| 4  | 1.004          | 0.20                    | 24.92         | -   | 25.12          | -   | 56.00     | 46.00 | -30.88 | -   |
| 5  | 9.020          | 0.37                    | 17.58         | -   | 17.95          | -   | 60.00     | 50.00 | -42.05 | -   |
| 6  | 20.113         | 0.80                    | 15.42         | -   | 16.22          | -   | 60.00     | 50.00 | -43.78 | -   |

- REMARKS:**
1. Q.P. and AV. are abbreviations of quasi-peak and average individually.
  2. "-": The Quasi-peak reading value also meets average limit and measurement with the average detector is unnecessary.
  3. The emission levels of other frequencies were very low against the limit.
  4. Margin value = Emission level - Limit value
  5. Correction factor = Insertion loss + Cable loss
  6. Emission Level = Correction Factor + Reading Value.

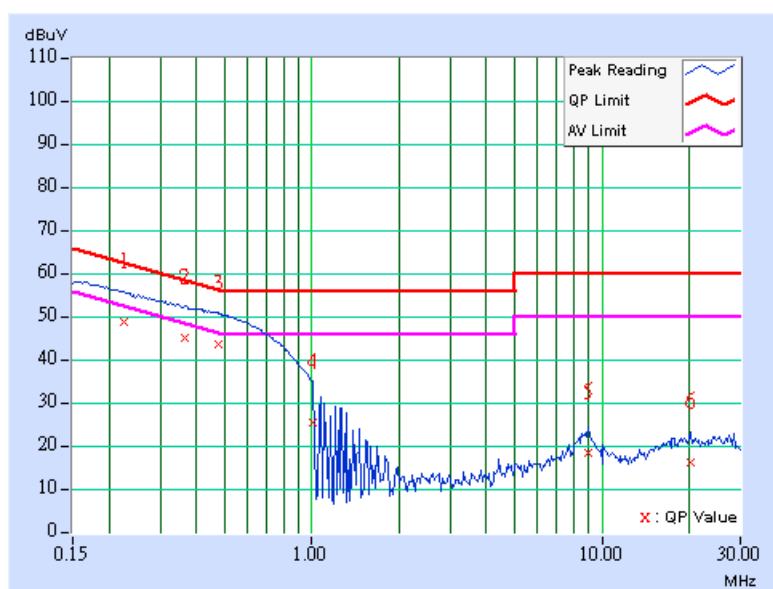



|                        |                            |                                 |                         |
|------------------------|----------------------------|---------------------------------|-------------------------|
| <b>EUT</b>             | AirMagnet SmartEdge Sensor | <b>MEASUREMENT DETAIL</b>       |                         |
| <b>MODEL</b>           | A5020                      | <b>PHASE</b>                    | Line 1                  |
| <b>CHANNEL</b>         | Channel 11                 | <b>6dB BANDWIDTH</b>            | 9 kHz                   |
| <b>MODULATION TYPE</b> | BPSK                       | <b>ENVIRONMENTAL CONDITIONS</b> | 25deg. C, 65%RH, 985hPa |
| <b>TRANSFER RATE</b>   | 6Mbps                      | <b>INPUT POWER (SYSTEM)</b>     | 120Vac, 60 Hz           |
| <b>TEST MODE</b>       | B3                         | <b>TESTED BY</b>                | William Chien           |

| No | Freq. [MHz] | Corr. Factor (dB) | Reading Value [dB (uV)] |       | Emission Level [dB (uV)] |       | Limit [dB (uV)] |       | Margin (dB) |       |
|----|-------------|-------------------|-------------------------|-------|--------------------------|-------|-----------------|-------|-------------|-------|
|    |             |                   | Q.P.                    | AV.   | Q.P.                     | AV.   | Q.P.            | AV.   | Q.P.        | AV.   |
|    |             |                   | 1                       | 0.216 | 0.10                     | 48.50 | -               | 48.60 | -           | 62.96 |
| 2  | 0.443       | 0.11              | 43.20                   | -     | 43.31                    | -     | 57.01           | 47.01 | -13.70      | -     |
| 3  | 0.517       | 0.12              | 42.96                   | -     | 43.08                    | -     | 56.00           | 46.00 | -12.92      | -     |
| 4  | 0.986       | 0.20              | 25.47                   | -     | 25.67                    | -     | 56.00           | 46.00 | -30.33      | -     |
| 5  | 8.734       | 0.28              | 16.32                   | -     | 16.60                    | -     | 60.00           | 50.00 | -43.40      | -     |
| 6  | 14.055      | 0.38              | 9.94                    | -     | 10.32                    | -     | 60.00           | 50.00 | -49.68      | -     |

- REMARKS:**
1. Q.P. and AV. are abbreviations of quasi-peak and average individually.
  2. "-": The Quasi-peak reading value also meets average limit and measurement with the average detector is unnecessary.
  3. The emission levels of other frequencies were very low against the limit.
  4. Margin value = Emission level - Limit value
  5. Correction factor = Insertion loss + Cable loss
  6. Emission Level = Correction Factor + Reading Value.

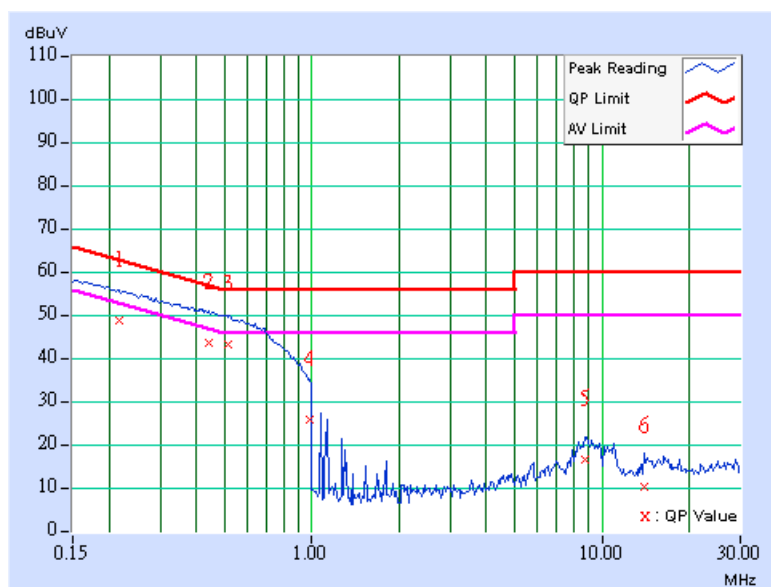



|                        |                            |                                 |                         |
|------------------------|----------------------------|---------------------------------|-------------------------|
| <b>EUT</b>             | AirMagnet SmartEdge Sensor | <b>MEASUREMENT DETAIL</b>       |                         |
| <b>MODEL</b>           | A5020                      | <b>PHASE</b>                    | Line 2                  |
| <b>CHANNEL</b>         | Channel 11                 | <b>6dB BANDWIDTH</b>            | 9 kHz                   |
| <b>MODULATION TYPE</b> | BPSK                       | <b>ENVIRONMENTAL CONDITIONS</b> | 25deg. C, 65%RH, 985hPa |
| <b>TRANSFER RATE</b>   | 6Mbps                      | <b>INPUT POWER (SYSTEM)</b>     | 120Vac, 60 Hz           |
| <b>TEST MODE</b>       | B3                         | <b>TESTED BY</b>                | William Chien           |

| No | Freq.<br>[MHz] | Corr.<br>Factor<br>(dB) | Reading Value |     | Emission Level |     | Limit     |       | Margin |     |
|----|----------------|-------------------------|---------------|-----|----------------|-----|-----------|-------|--------|-----|
|    |                |                         | [dB (uV)]     |     | [dB (uV)]      |     | [dB (uV)] |       | (dB)   |     |
|    |                |                         | Q.P.          | AV. | Q.P.           | AV. | Q.P.      | AV.   | Q.P.   | AV. |
| 1  | 0.252          | 0.10                    | 46.97         | -   | 47.07          | -   | 61.71     | 51.71 | -14.64 | -   |
| 2  | 0.466          | 0.11                    | 43.13         | -   | 43.24          | -   | 56.58     | 46.58 | -13.34 | -   |
| 3  | 0.580          | 0.13                    | 41.23         | -   | 41.36          | -   | 56.00     | 46.00 | -14.64 | -   |
| 4  | 0.966          | 0.19                    | 26.38         | -   | 26.57          | -   | 56.00     | 46.00 | -29.43 | -   |
| 5  | 9.098          | 0.37                    | 17.76         | -   | 18.13          | -   | 60.00     | 50.00 | -41.87 | -   |
| 6  | 20.410         | 0.82                    | 17.01         | -   | 17.83          | -   | 60.00     | 50.00 | -42.17 | -   |

- REMARKS:**
1. Q.P. and AV. are abbreviations of quasi-peak and average individually.
  2. "-": The Quasi-peak reading value also meets average limit and measurement with the average detector is unnecessary.
  3. The emission levels of other frequencies were very low against the limit.
  4. Margin value = Emission level - Limit value
  5. Correction factor = Insertion loss + Cable loss
  6. Emission Level = Correction Factor + Reading Value.

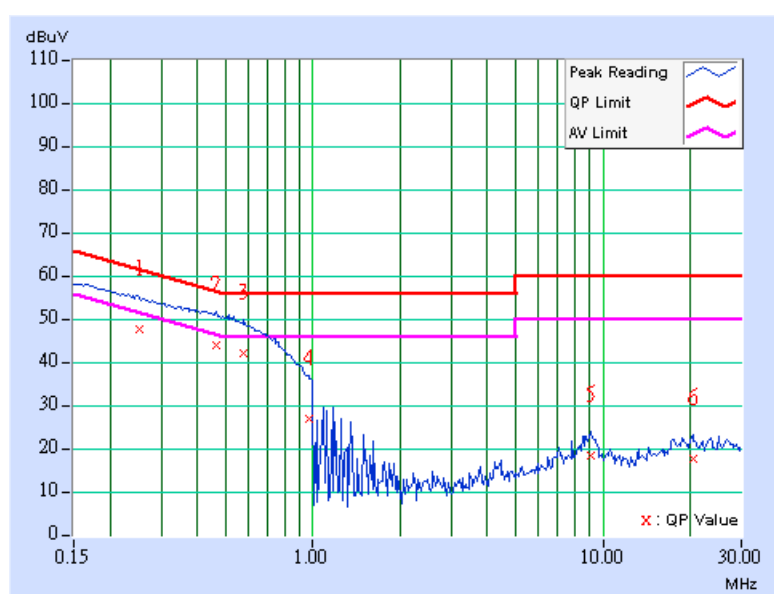



**Conducted Worst-Case Data (Power from AC adapter\_VE20-120)**

|                        |                            |                                 |                         |
|------------------------|----------------------------|---------------------------------|-------------------------|
| <b>EUT</b>             | AirMagnet SmartEdge Sensor | <b>MEASUREMENT DETAIL</b>       |                         |
| <b>MODEL</b>           | A5020                      | <b>PHASE</b>                    | Line 1                  |
| <b>CHANNEL</b>         | Channel 1                  | <b>6dB BANDWIDTH</b>            | 9 kHz                   |
| <b>MODULATION TYPE</b> | BPSK                       | <b>ENVIRONMENTAL CONDITIONS</b> | 25deg. C, 65%RH, 985hPa |
| <b>TRANSFER RATE</b>   | 6Mbps                      | <b>INPUT POWER (SYSTEM)</b>     | 120Vac, 60 Hz           |
| <b>TEST MODE</b>       | C3                         | <b>TESTED BY</b>                | William Chien           |

| No | Freq. [MHz] | Corr. Factor (dB) | Reading Value [dB (uV)] |       | Emission Level [dB (uV)] |       | Limit [dB (uV)] |       | Margin (dB) |       |
|----|-------------|-------------------|-------------------------|-------|--------------------------|-------|-----------------|-------|-------------|-------|
|    |             |                   | Q.P.                    | AV.   | Q.P.                     | AV.   | Q.P.            | AV.   | Q.P.        | AV.   |
|    |             |                   | 1                       | 0.154 | 0.11                     | 42.99 | -               | 43.10 | -           | 65.79 |
| 2  | 0.353       | 0.12              | 32.20                   | -     | 32.32                    | -     | 58.89           | 48.89 | -26.57      | -     |
| 3  | 0.642       | 0.16              | 32.74                   | -     | 32.90                    | -     | 56.00           | 46.00 | -23.10      | -     |
| 4  | 2.027       | 0.25              | 30.90                   | -     | 31.15                    | -     | 56.00           | 46.00 | -24.85      | -     |
| 5  | 10.242      | 0.45              | 37.17                   | -     | 37.62                    | -     | 60.00           | 50.00 | -22.38      | -     |
| 6  | 20.258      | 1.00              | 42.64                   | -     | 43.64                    | -     | 60.00           | 50.00 | -16.36      | -     |

- REMARKS:**
1. Q.P. and AV. are abbreviations of quasi-peak and average individually.
  2. "-": The Quasi-peak reading value also meets average limit and measurement with the average detector is unnecessary.
  3. The emission levels of other frequencies were very low against the limit.
  4. Margin value = Emission level - Limit value
  5. Correction factor = Insertion loss + Cable loss
  6. Emission Level = Correction Factor + Reading Value.

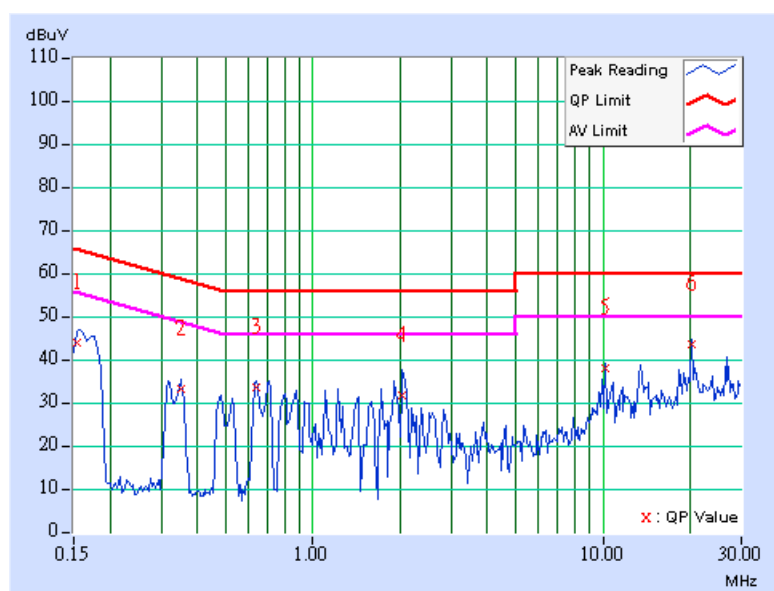





|                        |                            |                                 |                         |
|------------------------|----------------------------|---------------------------------|-------------------------|
| <b>EUT</b>             | AirMagnet SmartEdge Sensor | <b>MEASUREMENT DETAIL</b>       |                         |
| <b>MODEL</b>           | A5020                      | <b>PHASE</b>                    | Line 2                  |
| <b>CHANNEL</b>         | Channel 1                  | <b>6dB BANDWIDTH</b>            | 9 kHz                   |
| <b>MODULATION TYPE</b> | BPSK                       | <b>ENVIRONMENTAL CONDITIONS</b> | 25deg. C, 65%RH, 985hPa |
| <b>TRANSFER RATE</b>   | 6Mbps                      | <b>INPUT POWER (SYSTEM)</b>     | 120Vac, 60 Hz           |
| <b>TEST MODE</b>       | C3                         | <b>TESTED BY</b>                | William Chien           |

| No | Freq. [MHz] | Corr. Factor (dB) | Reading Value [dB (uV)] |       | Emission Level [dB (uV)] |       | Limit [dB (uV)] |       | Margin (dB) |       |
|----|-------------|-------------------|-------------------------|-------|--------------------------|-------|-----------------|-------|-------------|-------|
|    |             |                   | Q.P.                    | AV.   | Q.P.                     | AV.   | Q.P.            | AV.   | Q.P.        | AV.   |
|    |             |                   | 1                       | 0.162 | 0.11                     | 43.69 | -               | 43.80 | -           | 65.38 |
| 2  | 0.349       | 0.12              | 31.16                   | -     | 31.28                    | -     | 58.98           | 48.98 | -27.70      | -     |
| 3  | 0.642       | 0.16              | 32.65                   | -     | 32.81                    | -     | 56.00           | 46.00 | -23.19      | -     |
| 4  | 2.051       | 0.25              | 34.84                   | -     | 35.09                    | -     | 56.00           | 46.00 | -20.91      | -     |
| 5  | 10.246      | 0.55              | 36.87                   | -     | 37.42                    | -     | 60.00           | 50.00 | -22.58      | -     |
| 6  | 20.258      | 0.99              | 42.48                   | -     | 43.47                    | -     | 60.00           | 50.00 | -16.53      | -     |

- REMARKS:**
1. Q.P. and AV. are abbreviations of quasi-peak and average individually.
  2. "-": The Quasi-peak reading value also meets average limit and measurement with the average detector is unnecessary.
  3. The emission levels of other frequencies were very low against the limit.
  4. Margin value = Emission level - Limit value
  5. Correction factor = Insertion loss + Cable loss
  6. Emission Level = Correction Factor + Reading Value.

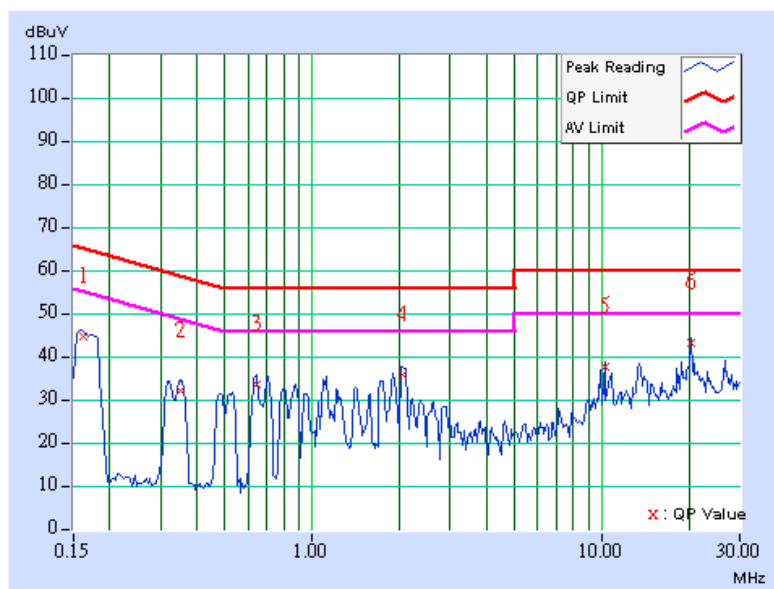



|                        |                            |                                 |                         |
|------------------------|----------------------------|---------------------------------|-------------------------|
| <b>EUT</b>             | AirMagnet SmartEdge Sensor | <b>MEASUREMENT DETAIL</b>       |                         |
| <b>MODEL</b>           | A5020                      | <b>PHASE</b>                    | Line 1                  |
| <b>CHANNEL</b>         | Channel 6                  | <b>6dB BANDWIDTH</b>            | 9 kHz                   |
| <b>MODULATION TYPE</b> | BPSK                       | <b>ENVIRONMENTAL CONDITIONS</b> | 25deg. C, 65%RH, 985hPa |
| <b>TRANSFER RATE</b>   | 6Mbps                      | <b>INPUT POWER (SYSTEM)</b>     | 120Vac, 60 Hz           |
| <b>TEST MODE</b>       | C3                         | <b>TESTED BY</b>                | William Chien           |

| No | Freq.<br>[MHz] | Corr.<br>Factor<br>(dB) | Reading Value |     | Emission Level |     | Limit     |       | Margin |     |
|----|----------------|-------------------------|---------------|-----|----------------|-----|-----------|-------|--------|-----|
|    |                |                         | [dB (uV)]     |     | [dB (uV)]      |     | [dB (uV)] |       | (dB)   |     |
|    |                |                         | Q.P.          | AV. | Q.P.           | AV. | Q.P.      | AV.   | Q.P.   | AV. |
| 1  | 0.158          | 0.11                    | 45.45         | -   | 45.56          | -   | 65.58     | 55.58 | -20.02 | -   |
| 2  | 0.349          | 0.12                    | 32.87         | -   | 32.99          | -   | 58.98     | 48.98 | -25.99 | -   |
| 3  | 0.642          | 0.16                    | 33.77         | -   | 33.93          | -   | 56.00     | 46.00 | -22.07 | -   |
| 4  | 2.094          | 0.25                    | 31.06         | -   | 31.31          | -   | 56.00     | 46.00 | -24.69 | -   |
| 5  | 10.059         | 0.44                    | 35.94         | -   | 36.38          | -   | 60.00     | 50.00 | -23.62 | -   |
| 6  | 20.258         | 1.00                    | 42.32         | -   | 43.32          | -   | 60.00     | 50.00 | -16.68 | -   |

- REMARKS:**
1. Q.P. and AV. are abbreviations of quasi-peak and average individually.
  2. "-": The Quasi-peak reading value also meets average limit and measurement with the average detector is unnecessary.
  3. The emission levels of other frequencies were very low against the limit.
  4. Margin value = Emission level - Limit value
  5. Correction factor = Insertion loss + Cable loss
  6. Emission Level = Correction Factor + Reading Value.

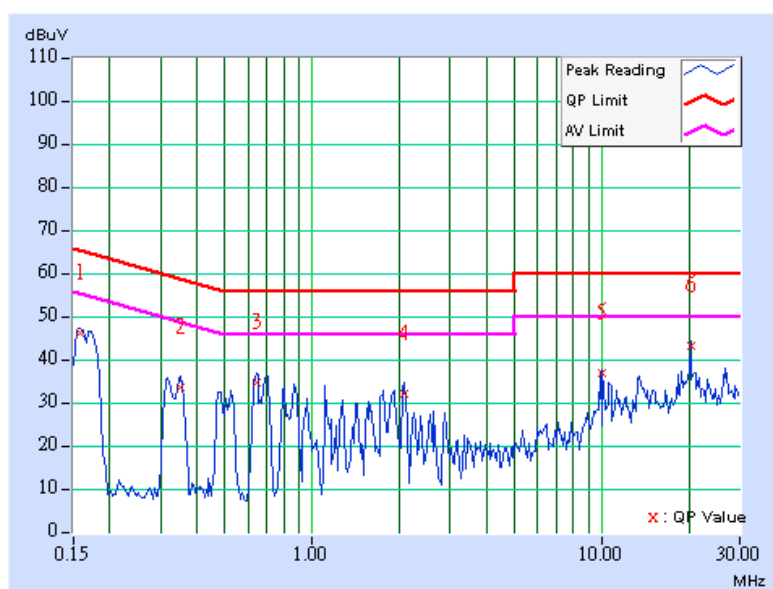



|                        |                            |                                 |                         |
|------------------------|----------------------------|---------------------------------|-------------------------|
| <b>EUT</b>             | AirMagnet SmartEdge Sensor | <b>MEASUREMENT DETAIL</b>       |                         |
| <b>MODEL</b>           | A5020                      | <b>PHASE</b>                    | Line 2                  |
| <b>CHANNEL</b>         | Channel 6                  | <b>6dB BANDWIDTH</b>            | 9 kHz                   |
| <b>MODULATION TYPE</b> | BPSK                       | <b>ENVIRONMENTAL CONDITIONS</b> | 25deg. C, 65%RH, 985hPa |
| <b>TRANSFER RATE</b>   | 6Mbps                      | <b>INPUT POWER (SYSTEM)</b>     | 120Vac, 60 Hz           |
| <b>TEST MODE</b>       | C3                         | <b>TESTED BY</b>                | William Chien           |

| No | Freq. [MHz] | Corr. Factor (dB) | Reading Value [dB (uV)] |       | Emission Level [dB (uV)] |       | Limit [dB (uV)] |       | Margin (dB) |       |
|----|-------------|-------------------|-------------------------|-------|--------------------------|-------|-----------------|-------|-------------|-------|
|    |             |                   | Q.P.                    | AV.   | Q.P.                     | AV.   | Q.P.            | AV.   | Q.P.        | AV.   |
|    |             |                   | 1                       | 0.158 | 0.11                     | 44.87 | -               | 44.98 | -           | 65.58 |
| 2  | 0.357       | 0.12              | 29.54                   | -     | 29.66                    | -     | 58.80           | 48.80 | -29.14      | -     |
| 3  | 0.634       | 0.16              | 34.70                   | -     | 34.86                    | -     | 56.00           | 46.00 | -21.14      | -     |
| 4  | 1.121       | 0.23              | 33.18                   | -     | 33.41                    | -     | 56.00           | 46.00 | -22.59      | -     |
| 5  | 10.059      | 0.54              | 36.16                   | -     | 36.70                    | -     | 60.00           | 50.00 | -23.30      | -     |
| 6  | 20.258      | 0.99              | 42.07                   | -     | 43.06                    | -     | 60.00           | 50.00 | -16.94      | -     |

- REMARKS:**
1. Q.P. and AV. are abbreviations of quasi-peak and average individually.
  2. "-": The Quasi-peak reading value also meets average limit and measurement with the average detector is unnecessary.
  3. The emission levels of other frequencies were very low against the limit.
  4. Margin value = Emission level - Limit value
  5. Correction factor = Insertion loss + Cable loss
  6. Emission Level = Correction Factor + Reading Value.

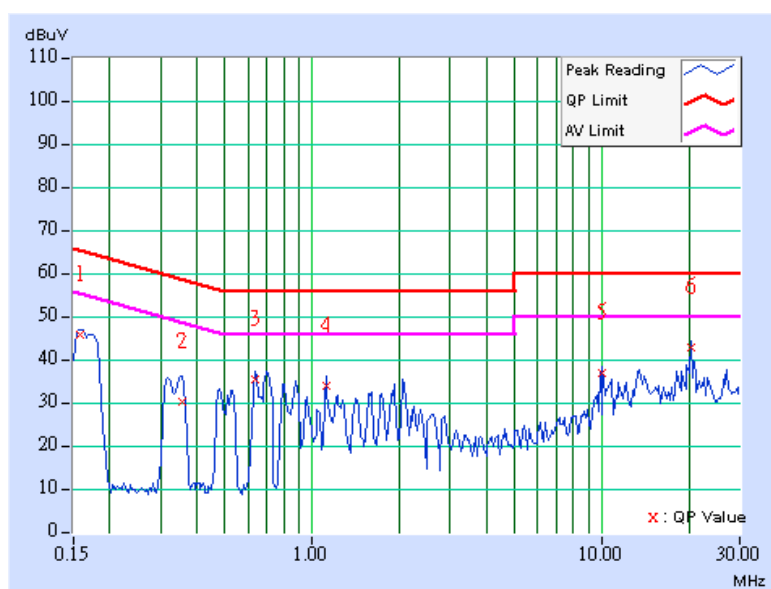



|                        |                            |                                 |                         |
|------------------------|----------------------------|---------------------------------|-------------------------|
| <b>EUT</b>             | AirMagnet SmartEdge Sensor | <b>MEASUREMENT DETAIL</b>       |                         |
| <b>MODEL</b>           | A5020                      | <b>PHASE</b>                    | Line 1                  |
| <b>CHANNEL</b>         | Channel 11                 | <b>6dB BANDWIDTH</b>            | 9 kHz                   |
| <b>MODULATION TYPE</b> | BPSK                       | <b>ENVIRONMENTAL CONDITIONS</b> | 25deg. C, 65%RH, 985hPa |
| <b>TRANSFER RATE</b>   | 6Mbps                      | <b>INPUT POWER (SYSTEM)</b>     | 120Vac, 60 Hz           |
| <b>TEST MODE</b>       | C3                         | <b>TESTED BY</b>                | William Chien           |

| No | Freq.<br>[MHz] | Corr.<br>Factor<br>(dB) | Reading Value<br>[dB (uV)] |       | Emission Level<br>[dB (uV)] |       | Limit<br>[dB (uV)] |       | Margin<br>(dB) |        |
|----|----------------|-------------------------|----------------------------|-------|-----------------------------|-------|--------------------|-------|----------------|--------|
|    |                |                         | Q.P.                       | AV.   | Q.P.                        | AV.   | Q.P.               | AV.   | Q.P.           | AV.    |
|    | 1              | 0.158                   | 0.11                       | 45.37 | -                           | 45.48 | -                  | 65.58 | 55.58          | -20.10 |
| 2  | 0.353          | 0.12                    | 32.75                      | -     | 32.87                       | -     | 58.89              | 48.89 | -26.02         | -      |
| 3  | 0.634          | 0.16                    | 34.28                      | -     | 34.44                       | -     | 56.00              | 46.00 | -21.56         | -      |
| 4  | 2.031          | 0.25                    | 31.00                      | -     | 31.25                       | -     | 56.00              | 46.00 | -24.75         | -      |
| 5  | 10.063         | 0.44                    | 36.06                      | -     | 36.50                       | -     | 60.00              | 50.00 | -23.50         | -      |
| 6  | 20.258         | 1.00                    | 42.34                      | -     | 43.34                       | -     | 60.00              | 50.00 | -16.66         | -      |

- REMARKS:**
1. Q.P. and AV. are abbreviations of quasi-peak and average individually.
  2. "-": The Quasi-peak reading value also meets average limit and measurement with the average detector is unnecessary.
  3. The emission levels of other frequencies were very low against the limit.
  4. Margin value = Emission level - Limit value
  5. Correction factor = Insertion loss + Cable loss
  6. Emission Level = Correction Factor + Reading Value.

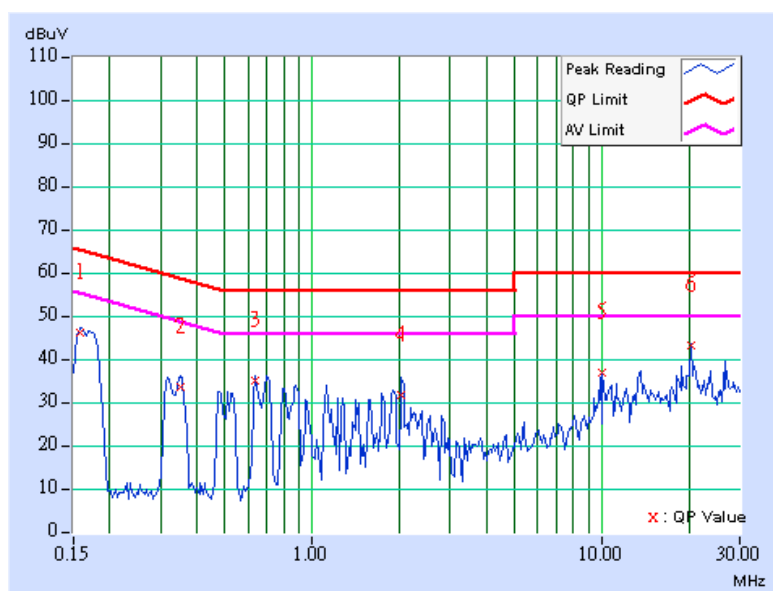



|                        |                            |                                 |                         |
|------------------------|----------------------------|---------------------------------|-------------------------|
| <b>EUT</b>             | AirMagnet SmartEdge Sensor | <b>MEASUREMENT DETAIL</b>       |                         |
| <b>MODEL</b>           | A5020                      | <b>PHASE</b>                    | Line 2                  |
| <b>CHANNEL</b>         | Channel 11                 | <b>6dB BANDWIDTH</b>            | 9 kHz                   |
| <b>MODULATION TYPE</b> | BPSK                       | <b>ENVIRONMENTAL CONDITIONS</b> | 25deg. C, 65%RH, 985hPa |
| <b>TRANSFER RATE</b>   | 6Mbps                      | <b>INPUT POWER (SYSTEM)</b>     | 120Vac, 60 Hz           |
| <b>TEST MODE</b>       | C3                         | <b>TESTED BY</b>                | William Chien           |

| No | Freq.<br>[MHz] | Corr.<br>Factor<br>(dB) | Reading Value |     | Emission Level |     | Limit     |       | Margin |     |
|----|----------------|-------------------------|---------------|-----|----------------|-----|-----------|-------|--------|-----|
|    |                |                         | [dB (uV)]     |     | [dB (uV)]      |     | [dB (uV)] |       | (dB)   |     |
|    |                |                         | Q.P.          | AV. | Q.P.           | AV. | Q.P.      | AV.   | Q.P.   | AV. |
| 1  | 0.162          | 0.11                    | 44.06         | -   | 44.17          | -   | 65.38     | 55.38 | -21.21 | -   |
| 2  | 0.353          | 0.12                    | 31.32         | -   | 31.44          | -   | 58.89     | 48.89 | -27.45 | -   |
| 3  | 0.630          | 0.16                    | 31.63         | -   | 31.79          | -   | 56.00     | 46.00 | -24.21 | -   |
| 4  | 2.086          | 0.25                    | 31.77         | -   | 32.02          | -   | 56.00     | 46.00 | -23.98 | -   |
| 5  | 13.418         | 0.62                    | 35.61         | -   | 36.23          | -   | 60.00     | 50.00 | -23.77 | -   |
| 6  | 20.320         | 0.99                    | 39.86         | -   | 40.85          | -   | 60.00     | 50.00 | -19.15 | -   |

- REMARKS:**
1. Q.P. and AV. are abbreviations of quasi-peak and average individually.
  2. "-": The Quasi-peak reading value also meets average limit and measurement with the average detector is unnecessary.
  3. The emission levels of other frequencies were very low against the limit.
  4. Margin value = Emission level - Limit value
  5. Correction factor = Insertion loss + Cable loss
  6. Emission Level = Correction Factor + Reading Value.

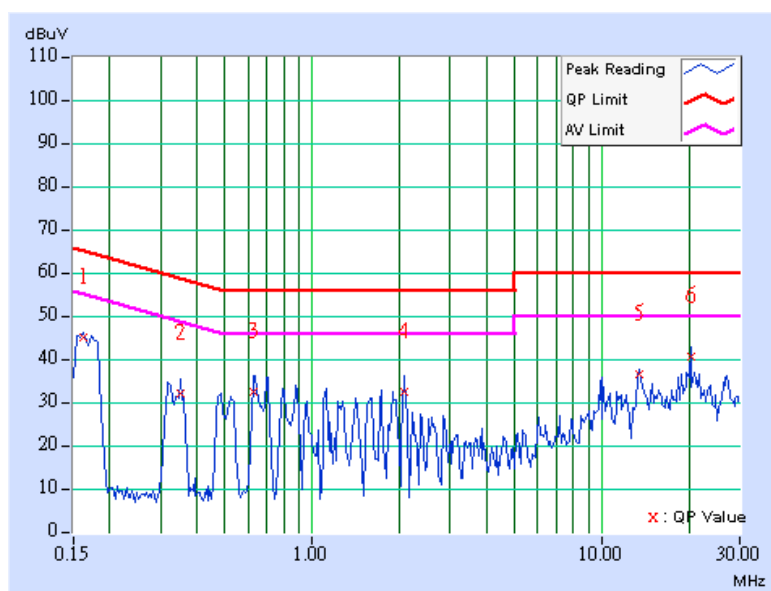



## 4.2 RADIATED EMISSION MEASUREMENT

### 4.2.1 LIMITS OF RADIATED EMISSION MEASUREMENT

Emissions radiated outside of the specified bands, shall be according to the general radiated limits in 15.209 as following:

| Frequencies (MHz) | Field strength (microvolts/meter) | Measurement distance (meters) |
|-------------------|-----------------------------------|-------------------------------|
| 0.009-0.490       | 2400/F(kHz)                       | 300                           |
| 0.490-1.705       | 24000/F(kHz)                      | 30                            |
| 1.705-30.0        | 30                                | 30                            |
| 30-88             | 100                               | 3                             |
| 88-216            | 150                               | 3                             |
| 216-960           | 200                               | 3                             |
| Above 960         | 500                               | 3                             |

**NOTE:**

1. The lower limit shall apply at the transition frequencies.
2. Emission level (dBuV/m) = 20 log Emission level (uV/m).
3. As shown in 15.35(b), for frequencies above 1000MHz, the field strength limits are based on average detector, however, the peak field strength of any emission shall not exceed the maximum permitted average limits, specified above by more than 20dB under any condition of modulation.



## 4.2.2 TEST INSTRUMENTS

| DESCRIPTION & MANUFACTURER              | MODEL NO.          | SERIAL NO.   | CALIBRATED UNTIL |
|---|--------------------|--------------|------------------|
| Test Receiver<br>ROHDE & SCHWARZ        | ESI7               | 838496/016   | Jan. 07, 2006    |
| Spectrum Analyzer<br>ROHDE & SCHWARZ    | FSP40              | 100041       | Nov. 29, 2005    |
| BILOG Antenna<br>SCHWARZBECK            | VULB9168           | 9168-155     | Jan. 22, 2006    |
| HORN Antenna<br>SCHWARZBECK             | BBHA 9120D         | 9120D-404    | Jan. 05, 2006    |
| HORN Antenna<br>SCHWARZBECK             | BBHA 9170          | BBHA 9170242 | Jan. 23, 2006    |
| Preamplifier<br>Agilent                 | 8447D              | 2944A10631   | Nov. 17, 2005    |
| Preamplifier<br>Agilent                 | 8449B              | 3008A01960   | Nov. 14, 2005    |
| RF signal cable<br>HUBER+SUHNNER        | SUCOFLEX 104       | 219272/4     | Jan. 26, 2006    |
| RF signal cable<br>HUBER+SUHNNER        | SUCOFLEX 104       | 219275/4     | Jan. 26, 2006    |
| Software<br>ADT.                        | ADT_Radiated_V5.14 | NA           | NA               |
| Antenna Tower<br>inn-co GmbH            | MA 4000            | 010303       | NA               |
| Antenna Tower Controller<br>inn-co GmbH | CO2000             | 019303       | NA               |
| Turn Table<br>ADT.                      | TT100.             | TT93021704   | NA               |
| Turn Table Controller<br>ADT.           | SC100.             | SC93021704   | NA               |

- NOTE:**
1. The calibration interval of the above test instruments is 12 months and the calibrations are traceable to NML/ROC and NIST/USA.
  2. The test was performed in HwaYa Chamber 3.
  3. The horn antenna and HP preamplifier (model: 8449B) are used only for the measurement of emission frequency above 1GHz if tested.
  4. The IC Site Registration No. is IC4924-4.



#### 4.2.3 TEST PROCEDURES

- a. The EUT was placed on the top of a rotating table 0.8 meters above the ground at a 3 meter semi-anechoic chamber. The table was rotated 360 degrees to determine the position of the highest radiation.
- b. The EUT was set 3 meters away from the interference-receiving antenna, which was mounted on the top of a variable-height antenna tower.
- c. The antenna is a broadband antenna, and its height is varied from one meter to four meters above the ground to determine the maximum value of the field strength. Both horizontal and vertical polarizations of the antenna are set to make the measurement.
- d. For each suspected emission, the EUT was arranged to its worst case and then the antenna was tuned to heights from 1 meter to 4 meters and the rotatable table was turned from 0 degrees to 360 degrees to find the maximum reading.
- e. The test-receiver system was set to Peak Detect Function and Specified Bandwidth with Maximum Hold Mode.
- f. If the emission level of the EUT in peak mode was lower than the limit specified, then testing could be stopped and the peak values of the EUT would be reported. Otherwise the emissions would be re-tested one by one using peak, quasi-peak or average method as specified and then reported in a data sheet.

**NOTE:**

1. The resolution bandwidth and video bandwidth of test receiver/spectrum analyzer is 120kHz for Quasi-peak detection at frequency below 1GHz.
2. The resolution bandwidth and video bandwidth of test receiver/spectrum analyzer is 1 MHz for Peak detection (PK) at frequency above 1GHz.
3. The resolution bandwidth of test receiver/spectrum analyzer is 1 MHz and the video bandwidth is 1 kHz for Average detection (AV) at frequency above 1GHz.

#### 4.2.4 DEVIATION FROM TEST STANDARD

No deviation



### 4.2.5 TEST SETUP

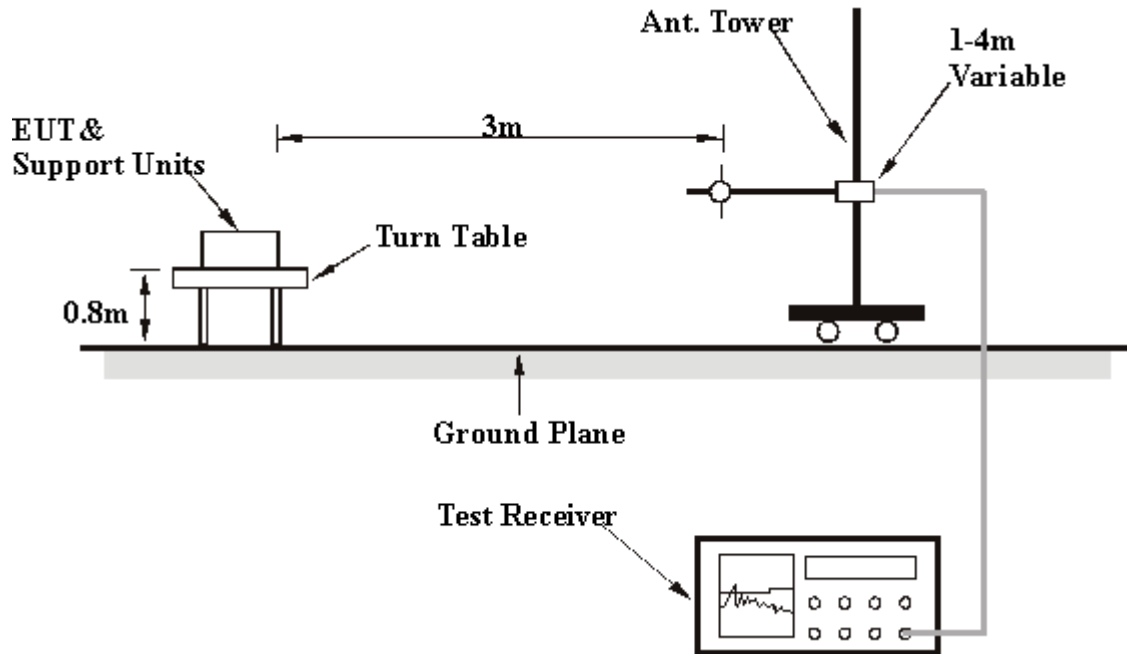

For the actual test configuration, please refer to the related item – Photographs of the Test Configuration.

### 4.2.6 EUT OPERATING CONDITIONS

Same as 4.1.6



4.2.7 TEST RESULTS\_ANTENNA SAA05-22063A (BELOW 1GHz TEST)

Below 1GHz Worst-Case Data (Power from POE)

|                        |                            |                                 |                         |
|------------------------|----------------------------|---------------------------------|-------------------------|
| <b>EUT</b>             | AirMagnet SmartEdge Sensor | <b>MEASUREMENT DETAIL</b>       |                         |
| <b>MODEL</b>           | A5020                      | <b>FREQUENCY RANGE</b>          | Below 1000MHz           |
| <b>CHANNEL</b>         | Channel 11                 | <b>DETECTOR FUNCTION</b>        | Quasi-Peak              |
| <b>MODULATION TYPE</b> | BPSK                       | <b>ENVIRONMENTAL CONDITIONS</b> | 24deg. C, 64%RH, 991hPa |
| <b>TRANSFER RATE</b>   | 6Mbps                      | <b>INPUT POWER (SYSTEM)</b>     | 120Vac, 60 Hz           |
| <b>TEST MODE</b>       | A1                         | <b>TESTED BY</b>                | Brad Wu                 |

| ANTENNA POLARITY & TEST DISTANCE: HORIZONTAL AT 3 M |             |                         |                |             |                    |                      |                  |                          |
|---|-------------|-------------------------|----------------|-------------|--------------------|----------------------|------------------|--------------------------|
| No.   | Freq. (MHz) | Emission Level (dBuV/m) | Limit (dBuV/m) | Margin (dB) | Antenna Height (m) | Table Angle (Degree) | Raw Value (dBuV) | Correction Factor (dB/m) |
| 1   | 51.38       | 34.03 QP                | 40.00          | -5.97       | 1.50 H             | 88                   | 19.56            | 14.46                    |
| 2   | 199.12      | 34.44 QP                | 43.50          | -9.06       | 1.00 H             | 232                  | 23.09            | 11.34                    |
| 3   | 399.34      | 40.41 QP                | 46.00          | -5.59       | 1.00 H             | 94                   | 23.70            | 16.71                    |
| 4   | 667.60      | 44.76 QP                | 46.00          | -1.24       | 2.00 H             | 190                  | 23.10            | 21.66                    |
| 5   | 799.78      | 37.65 QP                | 46.00          | -8.35       | 1.00 H             | 235                  | 14.19            | 23.46                    |
| 6   | 933.91      | 40.78 QP                | 46.00          | -5.22       | 1.00 H             | 220                  | 15.62            | 25.16                    |

| ANTENNA POLARITY & TEST DISTANCE: VERTICAL AT 3 M |             |                         |                |             |                    |                      |                  |                          |
|---|-------------|-------------------------|----------------|-------------|--------------------|----------------------|------------------|--------------------------|
| No.   | Freq. (MHz) | Emission Level (dBuV/m) | Limit (dBuV/m) | Margin (dB) | Antenna Height (m) | Table Angle (Degree) | Raw Value (dBuV) | Correction Factor (dB/m) |
| 1   | 37.78       | 37.67 QP                | 40.00          | -2.33       | 1.00 V             | 181                  | 22.70            | 14.96                    |
| 2   | 199.12      | 35.86 QP                | 43.50          | -7.64       | 2.00 V             | 271                  | 24.52            | 11.34                    |
| 3   | 399.34      | 37.91 QP                | 46.00          | -8.09       | 1.00 V             | 241                  | 21.20            | 16.71                    |
| 4   | 533.47      | 40.73 QP                | 46.00          | -5.27       | 1.00 V             | 208                  | 21.56            | 19.17                    |
| 5   | 667.60      | 44.59 QP                | 46.00          | -1.41       | 1.50 V             | 196                  | 22.93            | 21.66                    |
| 6   | 933.91      | 39.91 QP                | 46.00          | -6.09       | 1.00 V             | 115                  | 14.75            | 25.16                    |

- REMARKS:**
1. Emission level(dBuV/m)=Raw Value(dBuV) + Correction Factor(dB/m)
  2. Correction Factor(dB/m) = Antenna Factor (dB/m) + Cable Factor (dB)
  3. The other emission levels were very low against the limit.
  4. Margin value = Emission level – Limit value

**Below 1GHz Worst-Case Data (Power from AC adapter\_57-12-1500)**

|                        |                            |                                 |                         |
|------------------------|----------------------------|---------------------------------|-------------------------|
| <b>EUT</b>             | AirMagnet SmartEdge Sensor | <b>MEASUREMENT DETAIL</b>       |                         |
| <b>MODEL</b>           | A5020                      | <b>FREQUENCY RANGE</b>          | Below 1000MHz           |
| <b>CHANNEL</b>         | Channel 11                 | <b>DETECTOR FUNCTION</b>        | Quasi-Peak              |
| <b>MODULATION TYPE</b> | BPSK                       | <b>ENVIRONMENTAL CONDITIONS</b> | 24deg. C, 64%RH, 991hPa |
| <b>TRANSFER RATE</b>   | 6Mbps                      | <b>INPUT POWER (SYSTEM)</b>     | 120Vac, 60 Hz           |
| <b>TEST MODE</b>       | B1                         | <b>TESTED BY</b>                | Brad Wu                 |

**ANTENNA POLARITY & TEST DISTANCE: HORIZONTAL AT 3 M**

| No. | Freq. (MHz) | Emission Level (dBuV/m) | Limit (dBuV/m) | Margin (dB) | Antenna Height (m) | Table Angle (Degree) | Raw Value (dBuV) | Correction Factor (dB/m) |
|-----|-------------|-------------------------|----------------|-------------|--------------------|----------------------|------------------|--------------------------|
| 1   | 53.33       | 33.60 QP                | 40.00          | -6.40       | 1.00 H             | 61                   | 19.33            | 14.27                    |
| 2   | 133.03      | 34.97 QP                | 43.50          | -8.53       | 2.00 H             | 154                  | 21.08            | 13.89                    |
| 3   | 300.20      | 39.58 QP                | 46.00          | -6.42       | 1.00 H             | 136                  | 25.16            | 14.41                    |
| 4   | 667.60      | 44.18 QP                | 46.00          | -1.82       | 2.00 H             | 205                  | 22.52            | 21.66                    |
| 5   | 799.78      | 42.01 QP                | 46.00          | -3.99       | 1.00 H             | 142                  | 18.55            | 23.46                    |
| 6   | 933.91      | 41.49 QP                | 46.00          | -4.51       | 2.00 H             | 178                  | 16.32            | 25.16                    |

**ANTENNA POLARITY & TEST DISTANCE: VERTICAL AT 3 M**

| No. | Freq. (MHz) | Emission Level (dBuV/m) | Limit (dBuV/m) | Margin (dB) | Antenna Height (m) | Table Angle (Degree) | Raw Value (dBuV) | Correction Factor (dB/m) |
|-----|-------------|-------------------------|----------------|-------------|--------------------|----------------------|------------------|--------------------------|
| 1   | 31.94       | 38.68 QP                | 40.00          | -1.32       | 1.25 V             | 157                  | 24.67            | 14.01                    |
| 2   | 399.34      | 41.71 QP                | 46.00          | -4.29       | 1.00 V             | 181                  | 24.99            | 16.71                    |
| 3   | 533.47      | 42.61 QP                | 46.00          | -3.39       | 1.00 V             | 178                  | 23.44            | 19.17                    |
| 4   | 667.60      | 44.44 QP                | 46.00          | -1.56       | 1.50 V             | 154                  | 22.78            | 21.66                    |
| 5   | 799.78      | 38.21 QP                | 46.00          | -7.79       | 1.00 V             | 115                  | 14.75            | 23.46                    |
| 6   | 933.91      | 39.43 QP                | 46.00          | -6.57       | 2.00 V             | 145                  | 14.26            | 25.16                    |

- REMARKS:**
1. Emission level(dBuV/m)=Raw Value(dBuV) + Correction Factor(dB/m)
  2. Correction Factor(dB/m) = Antenna Factor (dB/m) + Cable Factor (dB)
  3. The other emission levels were very low against the limit.
  4. Margin value = Emission level – Limit value



### Below 1GHz Worst-Case Data (Power from AC adapter\_VE20-120)

|                        |                            |                                 |                         |
|------------------------|----------------------------|---------------------------------|-------------------------|
| <b>EUT</b>             | AirMagnet SmartEdge Sensor | <b>MEASUREMENT DETAIL</b>       |                         |
| <b>MODEL</b>           | A5020                      | <b>FREQUENCY RANGE</b>          | Below 1000MHz           |
| <b>CHANNEL</b>         | Channel 11                 | <b>DETECTOR FUNCTION</b>        | Quasi-Peak              |
| <b>MODULATION TYPE</b> | BPSK                       | <b>ENVIRONMENTAL CONDITIONS</b> | 24deg. C, 64%RH, 991hPa |
| <b>TRANSFER RATE</b>   | 6Mbps                      | <b>INPUT POWER (SYSTEM)</b>     | 120Vac, 60 Hz           |
| <b>TEST MODE</b>       | C1                         | <b>TESTED BY</b>                | Brad Wu                 |

#### ANTENNA POLARITY & TEST DISTANCE: HORIZONTAL AT 3 M

| No. | Freq. (MHz) | Emission Level (dBuV/m) | Limit (dBuV/m) | Margin (dB) | Antenna Height (m) | Table Angle (Degree) | Raw Value (dBuV) | Correction Factor (dB/m) |
|-----|-------------|-------------------------|----------------|-------------|--------------------|----------------------|------------------|--------------------------|
| 1   | 199.12      | 35.00 QP                | 43.50          | -8.50       | 1.00 H             | 235                  | 23.66            | 11.34                    |
| 2   | 232.16      | 36.83 QP                | 46.00          | -9.17       | 1.00 H             | 103                  | 24.35            | 12.48                    |
| 3   | 399.34      | 40.22 QP                | 46.00          | -5.78       | 1.00 H             | 106                  | 23.50            | 16.71                    |
| 4   | 667.60      | 43.14 QP                | 46.00          | -2.86       | 1.50 H             | 154                  | 21.48            | 21.66                    |
| 5   | 799.78      | 36.90 QP                | 46.00          | -9.10       | 1.00 H             | 226                  | 13.44            | 23.46                    |
| 6   | 933.91      | 41.28 QP                | 46.00          | -4.72       | 2.00 H             | 223                  | 16.12            | 25.16                    |

#### ANTENNA POLARITY & TEST DISTANCE: VERTICAL AT 3 M

| No. | Freq. (MHz) | Emission Level (dBuV/m) | Limit (dBuV/m) | Margin (dB) | Antenna Height (m) | Table Angle (Degree) | Raw Value (dBuV) | Correction Factor (dB/m) |
|-----|-------------|-------------------------|----------------|-------------|--------------------|----------------------|------------------|--------------------------|
| 1   | 37.78       | 38.14 QP                | 40.00          | -1.86       | 2.00 V             | 136                  | 23.18            | 14.96                    |
| 2   | 199.12      | 36.09 QP                | 43.50          | -7.41       | 1.00 V             | 274                  | 24.75            | 11.34                    |
| 3   | 399.34      | 38.23 QP                | 46.00          | -7.77       | 1.00 V             | 235                  | 21.52            | 16.71                    |
| 4   | 533.47      | 41.05 QP                | 46.00          | -4.95       | 1.00 V             | 211                  | 21.88            | 19.17                    |
| 5   | 667.60      | 44.53 QP                | 46.00          | -1.47       | 1.50 V             | 196                  | 22.87            | 21.66                    |
| 6   | 933.91      | 40.34 QP                | 46.00          | -5.66       | 1.00 V             | 112                  | 15.17            | 25.16                    |

- REMARKS:**
1. Emission level(dBuV/m)=Raw Value(dBuV) + Correction Factor(dB/m)
  2. Correction Factor(dB/m) = Antenna Factor (dB/m) + Cable Factor (dB)
  3. The other emission levels were very low against the limit.
  4. Margin value = Emission level – Limit value



4.2.8 TEST RESULTS\_ ANTENNA SDW0939A1 (BELOW 1GHz TEST)

Below 1GHz Worst-Case Data (Power from POE)

|                        |                            |                                 |                         |
|------------------------|----------------------------|---------------------------------|-------------------------|
| <b>EUT</b>             | AirMagnet SmartEdge Sensor | <b>MEASUREMENT DETAIL</b>       |                         |
| <b>MODEL</b>           | A5020                      | <b>FREQUENCY RANGE</b>          | Below 1000MHz           |
| <b>CHANNEL</b>         | Channel 11                 | <b>DETECTOR FUNCTION</b>        | Quasi-Peak              |
| <b>MODULATION TYPE</b> | BPSK                       | <b>ENVIRONMENTAL CONDITIONS</b> | 24deg. C, 64%RH, 991hPa |
| <b>TRANSFER RATE</b>   | 6Mbps                      | <b>INPUT POWER (SYSTEM)</b>     | 120Vac, 60 Hz           |
| <b>TEST MODE</b>       | A2                         | <b>TESTED BY</b>                | Brad Wu                 |

| ANTENNA POLARITY & TEST DISTANCE: HORIZONTAL AT 3 M |             |                         |                |             |                    |                      |                  |                          |
|---|-------------|-------------------------|----------------|-------------|--------------------|----------------------|------------------|--------------------------|
| No.   | Freq. (MHz) | Emission Level (dBuV/m) | Limit (dBuV/m) | Margin (dB) | Antenna Height (m) | Table Angle (Degree) | Raw Value (dBuV) | Correction Factor (dB/m) |
| 1   | 199.12      | 34.53 QP                | 43.50          | -8.97       | 1.00 H             | 256                  | 23.19            | 11.34                    |
| 2   | 232.16      | 36.48 QP                | 46.00          | -9.52       | 1.25 H             | 106                  | 24.00            | 12.48                    |
| 3   | 399.34      | 40.38 QP                | 46.00          | -5.62       | 1.00 H             | 97                   | 23.66            | 16.71                    |
| 4   | 667.60      | 43.30 QP                | 46.00          | -2.70       | 1.00 H             | 154                  | 21.64            | 21.66                    |
| 5   | 799.78      | 36.76 QP                | 46.00          | -9.24       | 1.50 H             | 145                  | 13.30            | 23.46                    |
| 6   | 933.91      | 41.07 QP                | 46.00          | -4.93       | 1.00 H             | 223                  | 15.91            | 25.16                    |

| ANTENNA POLARITY & TEST DISTANCE: VERTICAL AT 3 M |             |                         |                |             |                    |                      |                  |                          |
|---|-------------|-------------------------|----------------|-------------|--------------------|----------------------|------------------|--------------------------|
| No.   | Freq. (MHz) | Emission Level (dBuV/m) | Limit (dBuV/m) | Margin (dB) | Antenna Height (m) | Table Angle (Degree) | Raw Value (dBuV) | Correction Factor (dB/m) |
| 1   | 37.78       | 38.11 QP                | 40.00          | -1.89       | 1.25 V             | 172                  | 23.15            | 14.96                    |
| 2   | 199.12      | 35.75 QP                | 43.50          | -7.75       | 1.00 V             | 292                  | 24.41            | 11.34                    |
| 3   | 399.34      | 38.33 QP                | 46.00          | -7.67       | 1.00 V             | 244                  | 21.62            | 16.71                    |
| 4   | 533.47      | 40.97 QP                | 46.00          | -5.03       | 1.00 V             | 202                  | 21.80            | 19.17                    |
| 5   | 667.60      | 44.16 QP                | 46.00          | -1.84       | 1.50 V             | 196                  | 22.50            | 21.66                    |
| 6   | 933.91      | 40.30 QP                | 46.00          | -5.70       | 1.00 V             | 112                  | 15.13            | 25.16                    |

- REMARKS:**
1. Emission level(dBuV/m)=Raw Value(dBuV) + Correction Factor(dB/m)
  2. Correction Factor(dB/m) = Antenna Factor (dB/m) + Cable Factor (dB)
  3. The other emission levels were very low against the limit.
  4. Margin value = Emission level – Limit value



**Below 1GHz Worst-Case Data (Power from AC adapter\_57-12-1500)**

|                        |                            |                                 |                         |
|------------------------|----------------------------|---------------------------------|-------------------------|
| <b>EUT</b>             | AirMagnet SmartEdge Sensor | <b>MEASUREMENT DETAIL</b>       |                         |
| <b>MODEL</b>           | A5020                      | <b>FREQUENCY RANGE</b>          | Below 1000MHz           |
| <b>CHANNEL</b>         | Channel 11                 | <b>DETECTOR FUNCTION</b>        | Quasi-Peak              |
| <b>MODULATION TYPE</b> | BPSK                       | <b>ENVIRONMENTAL CONDITIONS</b> | 24deg. C, 64%RH, 991hPa |
| <b>TRANSFER RATE</b>   | 6Mbps                      | <b>INPUT POWER (SYSTEM)</b>     | 120Vac, 60 Hz           |
| <b>TEST MODE</b>       | <b>B2</b>                  | <b>TESTED BY</b>                | Brad Wu                 |

**ANTENNA POLARITY & TEST DISTANCE: HORIZONTAL AT 3 M**

| No. | Freq. (MHz) | Emission Level (dBuV/m) | Limit (dBuV/m) | Margin (dB) | Antenna Height (m) | Table Angle (Degree) | Raw Value (dBuV) | Correction Factor (dB/m) |
|-----|-------------|-------------------------|----------------|-------------|--------------------|----------------------|------------------|--------------------------|
| 1   | 300.20      | 36.35 QP                | 46.00          | -9.65       | 1.00 H             | 142                  | 21.94            | 14.41                    |
| 2   | 399.34      | 39.01 QP                | 46.00          | -6.99       | 1.00 H             | 205                  | 22.30            | 16.71                    |
| 3   | 533.47      | 41.93 QP                | 46.00          | -4.07       | 2.00 H             | 355                  | 22.76            | 19.17                    |
| 4   | 667.60      | 44.46 QP                | 46.00          | -1.54       | 2.00 H             | 202                  | 22.80            | 21.66                    |
| 5   | 799.78      | 40.39 QP                | 46.00          | -5.61       | 1.00 H             | 154                  | 16.93            | 23.46                    |
| 6   | 933.91      | 42.50 QP                | 46.00          | -3.50       | 1.50 H             | 184                  | 17.34            | 25.16                    |

**ANTENNA POLARITY & TEST DISTANCE: VERTICAL AT 3 M**

| No. | Freq. (MHz) | Emission Level (dBuV/m) | Limit (dBuV/m) | Margin (dB) | Antenna Height (m) | Table Angle (Degree) | Raw Value (dBuV) | Correction Factor (dB/m) |
|-----|-------------|-------------------------|----------------|-------------|--------------------|----------------------|------------------|--------------------------|
| 1   | 31.94       | 38.36 QP                | 40.00          | -1.64       | 1.00 V             | 229                  | 24.35            | 14.01                    |
| 2   | 199.12      | 35.54 QP                | 43.50          | -7.96       | 1.00 V             | 172                  | 24.20            | 11.34                    |
| 3   | 399.34      | 41.50 QP                | 46.00          | -4.50       | 1.50 V             | 244                  | 24.78            | 16.71                    |
| 4   | 533.47      | 40.37 QP                | 46.00          | -5.63       | 1.00 V             | 250                  | 21.20            | 19.17                    |
| 5   | 667.60      | 44.13 QP                | 46.00          | -1.87       | 1.50 V             | 232                  | 22.47            | 21.66                    |
| 6   | 933.91      | 40.40 QP                | 46.00          | -5.60       | 1.00 V             | 226                  | 15.24            | 25.16                    |

- REMARKS:**
1. Emission level(dBuV/m)=Raw Value(dBuV) + Correction Factor(dB/m)
  2. Correction Factor(dB/m) = Antenna Factor (dB/m) + Cable Factor (dB)
  3. The other emission levels were very low against the limit.
  4. Margin value = Emission level – Limit value

**Below 1GHz Worst-Case Data (Power from AC adapter\_VE20-120)**

|                        |                            |                                 |                         |
|------------------------|----------------------------|---------------------------------|-------------------------|
| <b>EUT</b>             | AirMagnet SmartEdge Sensor | <b>MEASUREMENT DETAIL</b>       |                         |
| <b>MODEL</b>           | A5020                      | <b>FREQUENCY RANGE</b>          | Below 1000MHz           |
| <b>CHANNEL</b>         | Channel 11                 | <b>DETECTOR FUNCTION</b>        | Quasi-Peak              |
| <b>MODULATION TYPE</b> | BPSK                       | <b>ENVIRONMENTAL CONDITIONS</b> | 24deg. C, 64%RH, 991hPa |
| <b>TRANSFER RATE</b>   | 6Mbps                      | <b>INPUT POWER (SYSTEM)</b>     | 120Vac, 60 Hz           |
| <b>TEST MODE</b>       | C2                         | <b>TESTED BY</b>                | Brad Wu                 |

**ANTENNA POLARITY & TEST DISTANCE: HORIZONTAL AT 3 M**

| No. | Freq. (MHz) | Emission Level (dBuV/m) | Limit (dBuV/m) | Margin (dB) | Antenna Height (m) | Table Angle (Degree) | Raw Value (dBuV) | Correction Factor (dB/m) |
|-----|-------------|-------------------------|----------------|-------------|--------------------|----------------------|------------------|--------------------------|
| 1   | 39.72       | 30.38 QP                | 40.00          | -9.62       | 1.00 H             | 148                  | 15.12            | 15.26                    |
| 2   | 199.12      | 34.48 QP                | 43.50          | -9.02       | 1.50 H             | 247                  | 23.14            | 11.34                    |
| 3   | 232.16      | 36.64 QP                | 46.00          | -9.36       | 1.00 H             | 112                  | 24.16            | 12.48                    |
| 4   | 399.34      | 40.25 QP                | 46.00          | -5.75       | 1.00 H             | 97                   | 23.54            | 16.71                    |
| 5   | 667.60      | 43.42 QP                | 46.00          | -2.58       | 1.00 H             | 157                  | 21.76            | 21.66                    |
| 6   | 933.91      | 41.12 QP                | 46.00          | -4.88       | 2.00 H             | 106                  | 15.96            | 25.16                    |

**ANTENNA POLARITY & TEST DISTANCE: VERTICAL AT 3 M**

| No. | Freq. (MHz) | Emission Level (dBuV/m) | Limit (dBuV/m) | Margin (dB) | Antenna Height (m) | Table Angle (Degree) | Raw Value (dBuV) | Correction Factor (dB/m) |
|-----|-------------|-------------------------|----------------|-------------|--------------------|----------------------|------------------|--------------------------|
| 1   | 37.78       | 37.08 QP                | 40.00          | -2.92       | 1.00 V             | 64                   | 22.12            | 14.96                    |
| 2   | 199.12      | 36.22 QP                | 43.50          | -7.28       | 1.50 V             | 259                  | 24.88            | 11.34                    |
| 3   | 399.34      | 37.88 QP                | 46.00          | -8.12       | 1.00 V             | 232                  | 21.16            | 16.71                    |
| 4   | 533.47      | 40.76 QP                | 46.00          | -5.24       | 1.00 V             | 208                  | 21.59            | 19.17                    |
| 5   | 667.60      | 44.25 QP                | 46.00          | -1.75       | 1.50 V             | 193                  | 22.59            | 21.66                    |
| 6   | 933.91      | 39.95 QP                | 46.00          | -6.05       | 1.00 V             | 112                  | 14.78            | 25.16                    |

- REMARKS:**
1. Emission level(dBuV/m)=Raw Value(dBuV) + Correction Factor(dB/m)
  2. Correction Factor(dB/m) = Antenna Factor (dB/m) + Cable Factor (dB)
  3. The other emission levels were very low against the limit.
  4. Margin value = Emission level – Limit value

## 4.2.9 TEST RESULTS\_ ANTENNA SAA05-22056A (BELOW 1GHz TEST)

## Below 1GHz Worst-Case Data (Power from POE)

|                        |                            |                                 |                         |
|------------------------|----------------------------|---------------------------------|-------------------------|
| <b>EUT</b>             | AirMagnet SmartEdge Sensor | <b>MEASUREMENT DETAIL</b>       |                         |
| <b>MODEL</b>           | A5020                      | <b>FREQUENCY RANGE</b>          | Below 1000MHz           |
| <b>CHANNEL</b>         | Channel 11                 | <b>DETECTOR FUNCTION</b>        | Quasi-Peak              |
| <b>MODULATION TYPE</b> | BPSK                       | <b>ENVIRONMENTAL CONDITIONS</b> | 24deg. C, 64%RH, 991hPa |
| <b>TRANSFER RATE</b>   | 6Mbps                      | <b>INPUT POWER (SYSTEM)</b>     | 120Vac, 60 Hz           |
| <b>TEST MODE</b>       | A3                         | <b>TESTED BY</b>                | Brad Wu                 |

**ANTENNA POLARITY & TEST DISTANCE: HORIZONTAL AT 3 M**

| No. | Freq. (MHz) | Emission Level (dBuV/m) | Limit (dBuV/m) | Margin (dB) | Antenna Height (m) | Table Angle (Degree) | Raw Value (dBuV) | Correction Factor (dB/m) |
|-----|-------------|-------------------------|----------------|-------------|--------------------|----------------------|------------------|--------------------------|
| 1   | 39.72       | 31.37 QP                | 40.00          | -8.63       | 1.00 H             | 217                  | 16.11            | 15.26                    |
| 2   | 199.12      | 34.97 QP                | 43.50          | -8.53       | 1.50 H             | 235                  | 23.63            | 11.34                    |
| 3   | 232.16      | 37.26 QP                | 46.00          | -8.74       | 1.00 H             | 115                  | 24.78            | 12.48                    |
| 4   | 399.34      | 40.23 QP                | 46.00          | -5.77       | 1.00 H             | 97                   | 23.51            | 16.71                    |
| 5   | 667.60      | 44.48 QP                | 46.00          | -1.52       | 2.00 H             | 187                  | 22.82            | 21.66                    |
| 6   | 933.91      | 40.82 QP                | 46.00          | -5.18       | 1.00 H             | 103                  | 15.66            | 25.16                    |

**ANTENNA POLARITY & TEST DISTANCE: VERTICAL AT 3 M**

| No. | Freq. (MHz) | Emission Level (dBuV/m) | Limit (dBuV/m) | Margin (dB) | Antenna Height (m) | Table Angle (Degree) | Raw Value (dBuV) | Correction Factor (dB/m) |
|-----|-------------|-------------------------|----------------|-------------|--------------------|----------------------|------------------|--------------------------|
| 1   | 37.78       | 37.91 QP                | 40.00          | -2.09       | 2.00 V             | 181                  | 22.95            | 14.96                    |
| 2   | 166.07      | 36.49 QP                | 43.50          | -7.01       | 1.00 V             | 334                  | 22.17            | 14.32                    |
| 3   | 399.34      | 38.31 QP                | 46.00          | -7.69       | 1.00 V             | 241                  | 21.60            | 16.71                    |
| 4   | 533.47      | 41.32 QP                | 46.00          | -4.68       | 1.00 V             | 205                  | 22.16            | 19.17                    |
| 5   | 667.60      | 44.12 QP                | 46.00          | -1.88       | 1.50 V             | 277                  | 22.46            | 21.66                    |
| 6   | 933.91      | 39.68 QP                | 46.00          | -6.32       | 1.00 V             | 112                  | 14.51            | 25.16                    |

- REMARKS:**
1. Emission level(dBuV/m)=Raw Value(dBuV) + Correction Factor(dB/m)
  2. Correction Factor(dB/m) = Antenna Factor (dB/m) + Cable Factor (dB)
  3. The other emission levels were very low against the limit.
  4. Margin value = Emission level – Limit value





**Below 1GHz Worst-Case Data (Power from AC adapter\_57-12-1500)**

|                        |                            |                                 |                         |
|------------------------|----------------------------|---------------------------------|-------------------------|
| <b>EUT</b>             | AirMagnet SmartEdge Sensor | <b>MEASUREMENT DETAIL</b>       |                         |
| <b>MODEL</b>           | A5020                      | <b>FREQUENCY RANGE</b>          | Below 1000MHz           |
| <b>CHANNEL</b>         | Channel 11                 | <b>DETECTOR FUNCTION</b>        | Quasi-Peak              |
| <b>MODULATION TYPE</b> | BPSK                       | <b>ENVIRONMENTAL CONDITIONS</b> | 24deg. C, 64%RH, 991hPa |
| <b>TRANSFER RATE</b>   | 6Mbps                      | <b>INPUT POWER (SYSTEM)</b>     | 120Vac, 60 Hz           |
| <b>TEST MODE</b>       | <b>B3</b>                  | <b>TESTED BY</b>                | Brad Wu                 |

| <b>ANTENNA POLARITY &amp; TEST DISTANCE: HORIZONTAL AT 3 M</b> |             |                         |                |             |                    |                      |                  |                          |
|--|-------------|-------------------------|----------------|-------------|--------------------|----------------------|------------------|--------------------------|
| No.  | Freq. (MHz) | Emission Level (dBuV/m) | Limit (dBuV/m) | Margin (dB) | Antenna Height (m) | Table Angle (Degree) | Raw Value (dBuV) | Correction Factor (dB/m) |
| 1  | 300.20      | 37.21 QP                | 46.00          | -8.79       | 1.25 H             | 130                  | 22.80            | 14.41                    |
| 2  | 399.34      | 38.17 QP                | 46.00          | -7.83       | 1.00 H             | 199                  | 21.45            | 16.71                    |
| 3  | 533.47      | 41.73 QP                | 46.00          | -4.27       | 2.00 H             | 343                  | 22.56            | 19.17                    |
| 4  | 667.60      | 44.76 QP                | 46.00          | -1.24       | 2.00 H             | 202                  | 23.10            | 21.66                    |
| 5  | 799.78      | 39.26 QP                | 46.00          | -6.74       | 1.00 H             | 157                  | 15.81            | 23.46                    |
| 6  | 933.91      | 40.40 QP                | 46.00          | -5.60       | 2.00 H             | 208                  | 15.24            | 25.16                    |

| <b>ANTENNA POLARITY &amp; TEST DISTANCE: VERTICAL AT 3 M</b> |             |                         |                |             |                    |                      |                  |                          |
|--|-------------|-------------------------|----------------|-------------|--------------------|----------------------|------------------|--------------------------|
| No.  | Freq. (MHz) | Emission Level (dBuV/m) | Limit (dBuV/m) | Margin (dB) | Antenna Height (m) | Table Angle (Degree) | Raw Value (dBuV) | Correction Factor (dB/m) |
| 1  | 31.94       | 38.43 QP                | 40.00          | -1.57       | 1.25 V             | 226                  | 24.42            | 14.01                    |
| 2  | 199.12      | 35.97 QP                | 43.50          | -7.53       | 1.00 V             | 178                  | 24.63            | 11.34                    |
| 3  | 399.34      | 41.12 QP                | 46.00          | -4.88       | 1.00 V             | 244                  | 24.41            | 16.71                    |
| 4  | 533.47      | 38.88 QP                | 46.00          | -7.12       | 1.50 V             | 262                  | 19.71            | 19.17                    |
| 5  | 667.60      | 44.83 QP                | 46.00          | -1.17       | 1.00 V             | 268                  | 23.17            | 21.66                    |
| 6  | 933.91      | 39.75 QP                | 46.00          | -6.25       | 2.00 V             | 181                  | 14.59            | 25.16                    |

- REMARKS:**
1. Emission level(dBuV/m)=Raw Value(dBuV) + Correction Factor(dB/m)
  2. Correction Factor(dB/m) = Antenna Factor (dB/m) + Cable Factor (dB)
  3. The other emission levels were very low against the limit.
  4. Margin value = Emission level – Limit value



### Below 1GHz Worst-Case Data (Power from AC adapter\_VE20-120)

|                 |                            |                          |                         |
|-----------------|----------------------------|--------------------------|-------------------------|
| EUT             | AirMagnet SmartEdge Sensor | MEASUREMENT DETAIL       |                         |
| MODEL           | A5020                      | FREQUENCY RANGE          | Below 1000MHz           |
| CHANNEL         | Channel 11                 | DETECTOR FUNCTION        | Quasi-Peak              |
| MODULATION TYPE | BPSK                       | ENVIRONMENTAL CONDITIONS | 24deg. C, 64%RH, 991hPa |
| TRANSFER RATE   | 6Mbps                      | INPUT POWER (SYSTEM)     | 120Vac, 60 Hz           |
| TEST MODE       | C3                         | TESTED BY                | Brad Wu                 |

#### ANTENNA POLARITY & TEST DISTANCE: HORIZONTAL AT 3 M

| No. | Freq. (MHz)   | Emission Level (dBuV/m) | Limit (dBuV/m) | Margin (dB)  | Antenna Height (m) | Table Angle (Degree) | Raw Value (dBuV) | Correction Factor (dB/m) |
|-----|---------------|-------------------------|----------------|--------------|--------------------|----------------------|------------------|--------------------------|
| 1   | 37.78         | 32.62 QP                | 40.00          | -7.38        | 1.25 H             | 103                  | 17.66            | 14.96                    |
| 2   | 166.07        | 35.81 QP                | 43.50          | -7.69        | 1.00 H             | 109                  | 21.49            | 14.32                    |
| 3   | 399.34        | 39.90 QP                | 46.00          | -6.10        | 1.00 H             | 103                  | 23.19            | 16.71                    |
| 4   | 533.47        | 38.35 QP                | 46.00          | -7.65        | 2.00 H             | 286                  | 19.18            | 19.17                    |
| 5   | <b>667.60</b> | <b>44.97 QP</b>         | <b>46.00</b>   | <b>-1.03</b> | <b>2.00 H</b>      | <b>202</b>           | <b>23.31</b>     | <b>21.66</b>             |
| 6   | 933.91        | 40.84 QP                | 46.00          | -5.16        | 1.00 H             | 106                  | 15.67            | 25.16                    |

#### ANTENNA POLARITY & TEST DISTANCE: VERTICAL AT 3 M

| No. | Freq. (MHz) | Emission Level (dBuV/m) | Limit (dBuV/m) | Margin (dB) | Antenna Height (m) | Table Angle (Degree) | Raw Value (dBuV) | Correction Factor (dB/m) |
|-----|-------------|-------------------------|----------------|-------------|--------------------|----------------------|------------------|--------------------------|
| 1   | 37.78       | 38.37 QP                | 40.00          | -1.63       | 2.00 V             | 157                  | 23.41            | 14.96                    |
| 2   | 199.12      | 35.95 QP                | 43.50          | -7.55       | 1.00 V             | 301                  | 24.61            | 11.34                    |
| 3   | 399.34      | 38.35 QP                | 46.00          | -7.65       | 1.00 V             | 232                  | 21.63            | 16.71                    |
| 4   | 533.47      | 40.93 QP                | 46.00          | -5.07       | 1.00 V             | 205                  | 21.77            | 19.17                    |
| 5   | 667.60      | 44.73 QP                | 46.00          | -1.27       | 1.50 V             | 196                  | 23.07            | 21.66                    |
| 6   | 933.91      | 39.87 QP                | 46.00          | -6.13       | 1.00 V             | 109                  | 14.71            | 25.16                    |

- REMARKS:**
1. Emission level(dBuV/m)=Raw Value(dBuV) + Correction Factor(dB/m)
  2. Correction Factor(dB/m) = Antenna Factor (dB/m) + Cable Factor (dB)
  3. The other emission levels were very low against the limit.
  4. Margin value = Emission level – Limit value

## 4.2.10 TEST RESULTS\_ANTENNA SAA05-22063A (ABOVE 1GHz TEST)

## 802.11b DSSS modulation

|                 |                            |                          |                            |
|-----------------|----------------------------|--------------------------|----------------------------|
| EUT             | AirMagnet SmartEdge Sensor | MEASUREMENT DETAIL       |                            |
| MODEL           | A5020                      | FREQUENCY RANGE          | 1 ~ 25GHz                  |
| CHANNEL         | Channel 1                  | DETECTOR FUNCTION        | Peak(PK)<br>Average (AV)   |
| MODULATION TYPE | CCK                        | ENVIRONMENTAL CONDITIONS | 24deg. C, 64%RH,<br>985hPa |
| TRANSFER RATE   | 11Mbps                     | INPUT POWER (SYSTEM)     | 120Vac, 60 Hz              |
| TEST MODE       | CI                         | TESTED BY                | Brad Wu                    |

## ANTENNA POLARITY &amp; TEST DISTANCE: HORIZONTAL AT 3 M

| No. | Freq. (MHz) | Emission Level (dBuV/m) | Limit (dBuV/m) | Margin (dB) | Antenna Height (m) | Table Angle (Degree) | Raw Value (dBuV) | Correction Factor (dB/m) |
|-----|-------------|-------------------------|----------------|-------------|--------------------|----------------------|------------------|--------------------------|
| 1   | 1066.00     | 43.12 PK                | 74.00          | -30.88      | 1.02 H             | 19                   | 15.57            | 27.55                    |
| 2   | 2390.00     | 42.55 PK                | 74.00          | -31.45      | 1.30 H             | 66                   | 10.68            | 31.87                    |
| 3   | *2412.00    | 99.95 PK                |                |             | 1.30 H             | 66                   | 67.99            | 31.96                    |
| 3   | *2412.00    | 91.79 AV                |                |             | 1.30 H             | 66                   | 59.83            | 31.96                    |
| 4   | 4824.00     | 47.61 PK                | 74.00          | -26.39      | 1.00 H             | 210                  | 9.78             | 37.83                    |

## ANTENNA POLARITY &amp; TEST DISTANCE: VERTICAL AT 3 M

| No. | Freq. (MHz) | Emission Level (dBuV/m) | Limit (dBuV/m) | Margin (dB) | Antenna Height (m) | Table Angle (Degree) | Raw Value (dBuV) | Correction Factor (dB/m) |
|-----|-------------|-------------------------|----------------|-------------|--------------------|----------------------|------------------|--------------------------|
| 1   | 1066.00     | 45.17 PK                | 74.00          | -28.83      | 1.01 V             | 211                  | 17.62            | 27.55                    |
| 2   | 2320.00     | 61.34 PK                | 74.00          | -12.66      | 1.00 V             | 352                  | 29.73            | 31.61                    |
| 2   | 2320.00     | 51.28 AV                | 54.00          | -2.72       | 1.00 V             | 352                  | 19.67            | 31.61                    |
| 3   | 2390.00     | 57.20 PK                | 74.00          | -16.80      | 1.20 V             | 347                  | 25.33            | 31.87                    |
| 3   | 2390.00     | 48.97 AV                | 54.00          | -5.03       | 1.20 V             | 347                  | 17.10            | 31.87                    |
| 4   | *2412.00    | 114.60 PK               |                |             | 1.20 V             | 347                  | 82.64            | 31.96                    |
| 4   | *2412.00    | 106.37 AV               |                |             | 1.20 V             | 347                  | 74.41            | 31.96                    |
| 5   | 4824.00     | 57.53 PK                | 74.00          | -16.47      | 1.06 V             | 7                    | 19.70            | 37.83                    |
| 5   | 4824.00     | 46.85 AV                | 54.00          | -7.15       | 1.06 V             | 7                    | 9.02             | 37.83                    |

- REMARKS:**
1. Emission level(dBuV/m)=Raw Value(dBuV) + Correction Factor(dB/m)
  2. Correction Factor(dB/m) = Antenna Factor (dB/m) + Cable Factor (dB)
  3. The other emission levels were very low against the limit.
  4. Margin value = Emission level – Limit value.
  5. The limit value is defined as per 15.247
  6. “ \* “ : Fundamental frequency

|                        |                            |                                 |                            |
|------------------------|----------------------------|---------------------------------|----------------------------|
| <b>EUT</b>             | AirMagnet SmartEdge Sensor | <b>MEASUREMENT DETAIL</b>       |                            |
| <b>MODEL</b>           | A5020                      | <b>FREQUENCY RANGE</b>          | 1 ~ 25GHz                  |
| <b>CHANNEL</b>         | Channel 6                  | <b>DETECTOR FUNCTION</b>        | Peak(PK)<br>Average (AV)   |
| <b>MODULATION TYPE</b> | CCK                        | <b>ENVIRONMENTAL CONDITIONS</b> | 24deg. C, 64%RH,<br>985hPa |
| <b>TRANSFER RATE</b>   | 11Mbps                     | <b>INPUT POWER (SYSTEM)</b>     | 120Vac, 60 Hz              |
| <b>TEST MODE</b>       | CI                         | <b>TESTED BY</b>                | Brad Wu                    |

#### ANTENNA POLARITY & TEST DISTANCE: HORIZONTAL AT 3 M

| No. | Freq. (MHz) | Emission Level (dBuV/m) | Limit (dBuV/m) | Margin (dB) | Antenna Height (m) | Table Angle (Degree) | Raw Value (dBuV) | Correction Factor (dB/m) |
|-----|-------------|-------------------------|----------------|-------------|--------------------|----------------------|------------------|--------------------------|
| 1   | 1066.00     | 44.22 PK                | 74.00          | -29.78      | 1.00 H             | 29                   | 16.67            | 27.55                    |
| 2   | *2437.00    | 99.72 PK                |                |             | 1.28 H             | 72                   | 67.66            | 32.06                    |
| 2   | *2437.00    | 91.54 AV                |                |             | 1.28 H             | 72                   | 59.48            | 32.06                    |
| 3   | 4874.00     | 47.06 PK                | 74.00          | -26.94      | 1.03 H             | 225                  | 9.08             | 37.98                    |

#### ANTENNA POLARITY & TEST DISTANCE: VERTICAL AT 3 M

| No. | Freq. (MHz) | Emission Level (dBuV/m) | Limit (dBuV/m) | Margin (dB) | Antenna Height (m) | Table Angle (Degree) | Raw Value (dBuV) | Correction Factor (dB/m) |
|-----|-------------|-------------------------|----------------|-------------|--------------------|----------------------|------------------|--------------------------|
| 1   | 1066.00     | 45.24 PK                | 74.00          | -28.76      | 1.00 V             | 215                  | 17.69            | 27.55                    |
| 2   | 2320.00     | 61.30 PK                | 74.00          | -12.70      | 1.02 V             | 358                  | 29.69            | 31.61                    |
| 2   | 2320.00     | 51.24 AV                | 54.00          | -2.76       | 1.02 V             | 358                  | 19.63            | 31.61                    |
| 3   | *2437.00    | 114.32 PK               |                |             | 1.14 V             | 0                    | 82.26            | 32.06                    |
| 3   | *2437.00    | 105.97 AV               |                |             | 1.14 V             | 0                    | 73.91            | 32.06                    |
| 4   | 4874.00     | 57.69 PK                | 74.00          | -16.31      | 1.02 V             | 11                   | 19.71            | 37.98                    |
| 4   | 4874.00     | 46.93 AV                | 54.00          | -7.07       | 1.02 V             | 11                   | 8.95             | 37.98                    |

- REMARKS:**
1. Emission level(dBuV/m)=Raw Value(dBuV) + Correction Factor(dB/m)
  2. Correction Factor(dB/m) = Antenna Factor (dB/m) + Cable Factor (dB)
  3. The other emission levels were very low against the limit.
  4. Margin value = Emission level – Limit value.
  5. The limit value is defined as per 15.247
  6. “ \* “ : Fundamental frequency



|                        |                            |                                 |                            |
|------------------------|----------------------------|---------------------------------|----------------------------|
| <b>EUT</b>             | AirMagnet SmartEdge Sensor | <b>MEASUREMENT DETAIL</b>       |                            |
| <b>MODEL</b>           | A5020                      | <b>FREQUENCY RANGE</b>          | 1 ~ 25GHz                  |
| <b>CHANNEL</b>         | Channel 11                 | <b>DETECTOR FUNCTION</b>        | Peak(PK)<br>Average (AV)   |
| <b>MODULATION TYPE</b> | CCK                        | <b>ENVIRONMENTAL CONDITIONS</b> | 24deg. C, 64%RH,<br>985hPa |
| <b>TRANSFER RATE</b>   | 11Mbps                     | <b>INPUT POWER (SYSTEM)</b>     | 120Vac, 60 Hz              |
| <b>TEST MODE</b>       | CI                         | <b>TESTED BY</b>                | Brad Wu                    |

| <b>ANTENNA POLARITY &amp; TEST DISTANCE: HORIZONTAL AT 3 M</b> |             |                         |                |             |                    |                      |                  |                          |
|--|-------------|-------------------------|----------------|-------------|--------------------|----------------------|------------------|--------------------------|
| No.  | Freq. (MHz) | Emission Level (dBuV/m) | Limit (dBuV/m) | Margin (dB) | Antenna Height (m) | Table Angle (Degree) | Raw Value (dBuV) | Correction Factor (dB/m) |
| 1  | 1066.00     | 44.09 PK                | 74.00          | -29.91      | 1.01 H             | 34                   | 16.54            | 27.55                    |
| 2  | *2462.00    | 99.65 PK                |                |             | 1.25 H             | 81                   | 67.49            | 32.16                    |
| 2  | *2462.00    | 91.36 AV                |                |             | 1.25 H             | 81                   | 59.20            | 32.16                    |
| 3  | 2483.50     | 40.10 PK                | 74.00          | -33.90      | 1.25 H             | 81                   | 7.86             | 32.24                    |
| 4  | 4924.00     | 47.11 PK                | 74.00          | -26.89      | 1.04 H             | 217                  | 8.97             | 38.14                    |

| <b>ANTENNA POLARITY &amp; TEST DISTANCE: VERTICAL AT 3 M</b> |             |                         |                |             |                    |                      |                  |                          |
|--|-------------|-------------------------|----------------|-------------|--------------------|----------------------|------------------|--------------------------|
| No.  | Freq. (MHz) | Emission Level (dBuV/m) | Limit (dBuV/m) | Margin (dB) | Antenna Height (m) | Table Angle (Degree) | Raw Value (dBuV) | Correction Factor (dB/m) |
| 1  | 1066.00     | 45.07 PK                | 74.00          | -28.93      | 1.09 V             | 241                  | 17.52            | 27.55                    |
| 2  | 2320.00     | 61.27 PK                | 74.00          | -12.73      | 1.02 V             | 359                  | 29.66            | 31.61                    |
| 2  | 2320.00     | 51.19 AV                | 54.00          | -2.81       | 1.02 V             | 359                  | 19.58            | 31.61                    |
| 3  | *2462.00    | 114.29 PK               |                |             | 1.18 V             | 357                  | 82.13            | 32.16                    |
| 3  | *2462.00    | 105.92 AV               |                |             | 1.18 V             | 357                  | 73.76            | 32.16                    |
| 4  | 2483.50     | 54.74 PK                | 74.00          | -19.26      | 1.18 V             | 357                  | 22.50            | 32.24                    |
| 4  | 2483.50     | 46.37 AV                | 54.00          | -7.63       | 1.18 V             | 357                  | 14.13            | 32.24                    |
| 5  | 4924.00     | 57.51 PK                | 74.00          | -16.49      | 1.05 V             | 11                   | 19.37            | 38.14                    |
| 5  | 4924.00     | 46.82 AV                | 54.00          | -7.18       | 1.05 V             | 11                   | 8.68             | 38.14                    |

- REMARKS:**
1. Emission level(dBuV/m)=Raw Value(dBuV) + Correction Factor(dB/m)
  2. Correction Factor(dB/m) = Antenna Factor (dB/m) + Cable Factor (dB)
  3. The other emission levels were very low against the limit.
  4. Margin value = Emission level – Limit value.
  5. The limit value is defined as per 15.247
  6. “ \* “ : Fundamental frequency



**802.11g OFDM modulation**

|                        |                            |                                 |                            |
|------------------------|----------------------------|---------------------------------|----------------------------|
| <b>EUT</b>             | AirMagnet SmartEdge Sensor | <b>MEASUREMENT DETAIL</b>       |                            |
| <b>MODEL</b>           | A5020                      | <b>FREQUENCY RANGE</b>          | 1 ~ 25GHz                  |
| <b>CHANNEL</b>         | Channel 1                  | <b>DETECTOR FUNCTION</b>        | Peak(PK)<br>Average (AV)   |
| <b>MODULATION TYPE</b> | BPSK                       | <b>ENVIRONMENTAL CONDITIONS</b> | 24deg. C, 64%RH,<br>985hPa |
| <b>TRANSFER RATE</b>   | 6Mbps                      | <b>INPUT POWER (SYSTEM)</b>     | 120Vac, 60 Hz              |
| <b>TEST MODE</b>       | CI                         | <b>TESTED BY</b>                | Brad Wu                    |

| <b>ANTENNA POLARITY &amp; TEST DISTANCE: HORIZONTAL AT 3 M</b> |             |                         |                |             |                    |                      |                  |                          |
|--|-------------|-------------------------|----------------|-------------|--------------------|----------------------|------------------|--------------------------|
| No.  | Freq. (MHz) | Emission Level (dBuV/m) | Limit (dBuV/m) | Margin (dB) | Antenna Height (m) | Table Angle (Degree) | Raw Value (dBuV) | Correction Factor (dB/m) |
| 1  | 1066.00     | 44.87 PK                | 74.00          | -29.13      | 1.09 H             | 237                  | 17.32            | 27.55                    |
| 2  | 2390.00     | 43.89 PK                | 74.00          | -30.11      | 1.98 H             | 276                  | 12.02            | 31.87                    |
| 3  | *2412.00    | 94.57 PK                |                |             | 1.98 H             | 276                  | 62.61            | 31.96                    |
| 3  | *2412.00    | 84.36 AV                |                |             | 1.98 H             | 276                  | 52.40            | 31.96                    |
| 4  | 4824.00     | 47.96 PK                | 74.00          | -26.04      | 1.03 H             | 279                  | 10.13            | 37.83                    |

| <b>ANTENNA POLARITY &amp; TEST DISTANCE: VERTICAL AT 3 M</b> |             |                         |                |             |                    |                      |                  |                          |
|--|-------------|-------------------------|----------------|-------------|--------------------|----------------------|------------------|--------------------------|
| No.  | Freq. (MHz) | Emission Level (dBuV/m) | Limit (dBuV/m) | Margin (dB) | Antenna Height (m) | Table Angle (Degree) | Raw Value (dBuV) | Correction Factor (dB/m) |
| 1  | 1066.00     | 45.83 PK                | 74.00          | -28.17      | 1.01 V             | 289                  | 18.28            | 27.55                    |
| 2  | 2320.00     | 61.97 PK                | 74.00          | -12.03      | 1.00 V             | 235                  | 30.36            | 31.61                    |
| 2  | 2320.00     | 51.67 AV                | 54.00          | -2.33       | 1.00 V             | 235                  | 20.06            | 31.61                    |
| 3  | 2390.00     | 56.48 PK                | 74.00          | -17.52      | 1.00 V             | 37                   | 24.61            | 31.87                    |
| 3  | 2390.00     | 46.45 AV                | 54.00          | -7.55       | 1.00 V             | 37                   | 14.58            | 31.87                    |
| 4  | *2412.00    | 107.16 PK               |                |             | 1.00 V             | 37                   | 75.20            | 31.96                    |
| 4  | *2412.00    | 97.13 AV                |                |             | 1.00 V             | 37                   | 65.17            | 31.96                    |
| 5  | 4824.00     | 48.56 PK                | 74.00          | -25.44      | 1.05 V             | 243                  | 10.73            | 37.83                    |

- REMARKS:**
1. Emission level(dBuV/m)=Raw Value(dBuV) + Correction Factor(dB/m)
  2. Correction Factor(dB/m) = Antenna Factor (dB/m) + Cable Factor (dB)
  3. The other emission levels were very low against the limit.
  4. Margin value = Emission level – Limit value.
  5. The limit value is defined as per 15.247
  6. “ \* “ : Fundamental frequency

|                        |                            |                                 |                            |
|------------------------|----------------------------|---------------------------------|----------------------------|
| <b>EUT</b>             | AirMagnet SmartEdge Sensor | <b>MEASUREMENT DETAIL</b>       |                            |
| <b>MODEL</b>           | A5020                      | <b>FREQUENCY RANGE</b>          | 1 ~ 25GHz                  |
| <b>CHANNEL</b>         | Channel 6                  | <b>DETECTOR FUNCTION</b>        | Peak(PK)<br>Average (AV)   |
| <b>MODULATION TYPE</b> | BPSK                       | <b>ENVIRONMENTAL CONDITIONS</b> | 24deg. C, 64%RH,<br>985hPa |
| <b>TRANSFER RATE</b>   | 6Mbps                      | <b>INPUT POWER (SYSTEM)</b>     | 120Vac, 60 Hz              |
| <b>TEST MODE</b>       | CI                         | <b>TESTED BY</b>                | Brad Wu                    |

### ANTENNA POLARITY & TEST DISTANCE: HORIZONTAL AT 3 M

| No. | Freq. (MHz) | Emission Level (dBuV/m) | Limit (dBuV/m) | Margin (dB) | Antenna Height (m) | Table Angle (Degree) | Raw Value (dBuV) | Correction Factor (dB/m) |
|-----|-------------|-------------------------|----------------|-------------|--------------------|----------------------|------------------|--------------------------|
| 1   | 1066.00     | 45.07 PK                | 74.00          | -28.93      | 1.12 H             | 241                  | 17.52            | 27.55                    |
| 2   | *2437.00    | 93.61 PK                |                |             | 1.96 H             | 277                  | 61.55            | 32.06                    |
| 2   | *2437.00    | 83.42 AV                |                |             | 1.96 H             | 277                  | 51.36            | 32.06                    |
| 3   | 4874.00     | 47.52 PK                | 74.00          | -26.48      | 1.03 H             | 217                  | 9.54             | 37.98                    |

### ANTENNA POLARITY & TEST DISTANCE: VERTICAL AT 3 M

| No. | Freq. (MHz) | Emission Level (dBuV/m) | Limit (dBuV/m) | Margin (dB) | Antenna Height (m) | Table Angle (Degree) | Raw Value (dBuV) | Correction Factor (dB/m) |
|-----|-------------|-------------------------|----------------|-------------|--------------------|----------------------|------------------|--------------------------|
| 1   | 1066.00     | 46.89 PK                | 74.00          | -27.11      | 1.12 V             | 195                  | 19.34            | 27.55                    |
| 2   | 2320.00     | 61.89 PK                | 74.00          | -12.11      | 1.06 V             | 215                  | 30.28            | 31.61                    |
| 2   | 2320.00     | 51.58 AV                | 54.00          | -2.42       | 1.06 V             | 215                  | 19.97            | 31.61                    |
| 3   | *2437.00    | 106.08 PK               |                |             | 1.00 V             | 40                   | 74.02            | 32.06                    |
| 3   | *2437.00    | 96.29 AV                |                |             | 1.00 V             | 40                   | 64.23            | 32.06                    |
| 4   | 4874.00     | 48.36 PK                | 74.00          | -25.64      | 1.01 V             | 251                  | 10.38            | 37.98                    |

- REMARKS:**
1. Emission level(dBuV/m)=Raw Value(dBuV) + Correction Factor(dB/m)
  2. Correction Factor(dB/m) = Antenna Factor (dB/m) + Cable Factor (dB)
  3. The other emission levels were very low against the limit.
  4. Margin value = Emission level – Limit value.
  5. The limit value is defined as per 15.247
  6. “ \* “ : Fundamental frequency

|                        |                            |                                 |                            |
|------------------------|----------------------------|---------------------------------|----------------------------|
| <b>EUT</b>             | AirMagnet SmartEdge Sensor | <b>MEASUREMENT DETAIL</b>       |                            |
| <b>MODEL</b>           | A5020                      | <b>FREQUENCY RANGE</b>          | 1 ~ 25GHz                  |
| <b>CHANNEL</b>         | Channel 11                 | <b>DETECTOR FUNCTION</b>        | Peak(PK)<br>Average (AV)   |
| <b>MODULATION TYPE</b> | BPSK                       | <b>ENVIRONMENTAL CONDITIONS</b> | 24deg. C, 64%RH,<br>985hPa |
| <b>TRANSFER RATE</b>   | 6Mbps                      | <b>INPUT POWER (SYSTEM)</b>     | 120Vac, 60 Hz              |
| <b>TEST MODE</b>       | CI                         | <b>TESTED BY</b>                | Brad Wu                    |

#### ANTENNA POLARITY & TEST DISTANCE: HORIZONTAL AT 3 M

| No. | Freq. (MHz) | Emission Level (dBuV/m) | Limit (dBuV/m) | Margin (dB) | Antenna Height (m) | Table Angle (Degree) | Raw Value (dBuV) | Correction Factor (dB/m) |
|-----|-------------|-------------------------|----------------|-------------|--------------------|----------------------|------------------|--------------------------|
| 1   | 1066.00     | 44.63 PK                | 74.00          | -29.37      | 1.12 H             | 87                   | 17.08            | 27.55                    |
| 2   | *2462.00    | 94.65 PK                |                |             | 1.90 H             | 265                  | 62.49            | 32.16                    |
| 2   | *2462.00    | 84.44 AV                |                |             | 1.90 H             | 265                  | 52.28            | 32.16                    |
| 3   | 2483.50     | 41.82 PK                | 74.00          | -32.18      | 1.90 H             | 265                  | 9.58             | 32.24                    |
| 4   | 4924.00     | 47.75 PK                | 74.00          | -26.25      | 1.03 H             | 237                  | 9.61             | 38.14                    |

#### ANTENNA POLARITY & TEST DISTANCE: VERTICAL AT 3 M

| No. | Freq. (MHz) | Emission Level (dBuV/m) | Limit (dBuV/m) | Margin (dB) | Antenna Height (m) | Table Angle (Degree) | Raw Value (dBuV) | Correction Factor (dB/m) |
|-----|-------------|-------------------------|----------------|-------------|--------------------|----------------------|------------------|--------------------------|
| 1   | 1066.00     | 45.74 PK                | 74.00          | -28.26      | 1.00 V             | 235                  | 18.19            | 27.55                    |
| 2   | 2320.00     | 61.86 PK                | 74.00          | -12.14      | 1.02 V             | 252                  | 30.25            | 31.61                    |
| 2   | 2320.00     | 51.53 AV                | 54.00          | -2.47       | 1.02 V             | 252                  | 19.92            | 31.61                    |
| 3   | *2462.00    | 106.11 PK               |                |             | 1.01 V             | 43                   | 73.95            | 32.16                    |
| 3   | *2462.00    | 96.32 AV                |                |             | 1.01 V             | 43                   | 64.16            | 32.16                    |
| 4   | 2483.50     | 53.32 PK                | 74.00          | -20.68      | 1.01 V             | 43                   | 21.08            | 32.24                    |
| 4   | 2483.50     | 43.53 AV                | 54.00          | -10.47      | 1.01 V             | 43                   | 11.29            | 32.24                    |
| 5   | 4924.00     | 48.22 PK                | 74.00          | -25.78      | 1.01 V             | 290                  | 10.08            | 38.14                    |

- REMARKS:**
1. Emission level(dBuV/m)=Raw Value(dBuV) + Correction Factor(dB/m)
  2. Correction Factor(dB/m) = Antenna Factor (dB/m) + Cable Factor (dB)
  3. The other emission levels were very low against the limit.
  4. Margin value = Emission level – Limit value.
  5. The limit value is defined as per 15.247
  6. “ \* “ : Fundamental frequency



## 4.2.11 TEST RESULTS\_ ANTENNA SDW0939A1 (ABOVE 1GHz TEST)

## 802.11b DSSS modulation

|                 |                            |                          |                            |
|-----------------|----------------------------|--------------------------|----------------------------|
| EUT             | AirMagnet SmartEdge Sensor | MEASUREMENT DETAIL       |                            |
| MODEL           | A5020                      | FREQUENCY RANGE          | 1 ~ 25GHz                  |
| CHANNEL         | Channel 1                  | DETECTOR FUNCTION        | Peak(PK)<br>Average (AV)   |
| MODULATION TYPE | CCK                        | ENVIRONMENTAL CONDITIONS | 24deg. C, 64%RH,<br>985hPa |
| TRANSFER RATE   | 11Mbps                     | INPUT POWER (SYSTEM)     | 120Vac, 60 Hz              |
| TEST MODE       | C2                         | TESTED BY                | Brad Wu                    |

| ANTENNA POLARITY & TEST DISTANCE: HORIZONTAL AT 3 M |             |                         |                |             |                    |                      |                  |                          |
|---|-------------|-------------------------|----------------|-------------|--------------------|----------------------|------------------|--------------------------|
| No.   | Freq. (MHz) | Emission Level (dBuV/m) | Limit (dBuV/m) | Margin (dB) | Antenna Height (m) | Table Angle (Degree) | Raw Value (dBuV) | Correction Factor (dB/m) |
| 1   | 1066.00     | 43.27 PK                | 74.00          | -30.73      | 1.01 H             | 211                  | 15.72            | 27.55                    |
| 2   | 2390.00     | 46.50 PK                | 74.00          | -27.50      | 1.41 H             | 237                  | 14.63            | 31.87                    |
| 3   | *2412.00    | 101.21 PK               |                |             | 1.41 H             | 237                  | 69.25            | 31.96                    |
| 3   | *2412.00    | 93.02 AV                |                |             | 1.41 H             | 237                  | 61.06            | 31.96                    |
| 4   | 4824.00     | 48.31 PK                | 74.00          | -25.69      | 1.08 H             | 156                  | 10.48            | 37.83                    |
| 4   | 4824.00     | 37.87 AV                | 54.00          | -16.13      | 1.08 H             | 156                  | 0.04             | 37.83                    |

| ANTENNA POLARITY & TEST DISTANCE: VERTICAL AT 3 M |             |                         |                |             |                    |                      |                  |                          |
|---|-------------|-------------------------|----------------|-------------|--------------------|----------------------|------------------|--------------------------|
| No.   | Freq. (MHz) | Emission Level (dBuV/m) | Limit (dBuV/m) | Margin (dB) | Antenna Height (m) | Table Angle (Degree) | Raw Value (dBuV) | Correction Factor (dB/m) |
| 1   | 1066.00     | 44.75 PK                | 74.00          | -29.25      | 1.01 V             | 123                  | 17.20            | 27.55                    |
| 2   | 2390.00     | 57.72 PK                | 74.00          | -16.28      | 1.03 V             | 170                  | 25.85            | 31.87                    |
| 2   | 2390.00     | 49.49 AV                | 54.00          | -4.51       | 1.03 V             | 170                  | 17.62            | 31.87                    |
| 3   | *2412.00    | 112.43 PK               |                |             | 1.03 V             | 170                  | 80.47            | 31.96                    |
| 3   | *2412.00    | 104.20 AV               |                |             | 1.03 V             | 170                  | 72.24            | 31.96                    |
| 4   | 4824.00     | 55.96 PK                | 74.00          | -18.04      | 1.07 V             | 182                  | 18.13            | 37.83                    |
| 4   | 4824.00     | 47.43 AV                | 54.00          | -6.57       | 1.07 V             | 182                  | 9.60             | 37.83                    |

- REMARKS:**
1. Emission level(dBuV/m)=Raw Value(dBuV) + Correction Factor(dB/m)
  2. Correction Factor(dB/m) = Antenna Factor (dB/m) + Cable Factor (dB)
  3. The other emission levels were very low against the limit.
  4. Margin value = Emission level – Limit value.
  5. The limit value is defined as per 15.247
  6. " \* " : Fundamental frequency

|                        |                            |                                 |                            |
|------------------------|----------------------------|---------------------------------|----------------------------|
| <b>EUT</b>             | AirMagnet SmartEdge Sensor | <b>MEASUREMENT DETAIL</b>       |                            |
| <b>MODEL</b>           | A5020                      | <b>FREQUENCY RANGE</b>          | 1 ~ 25GHz                  |
| <b>CHANNEL</b>         | Channel 6                  | <b>DETECTOR FUNCTION</b>        | Peak(PK)<br>Average (AV)   |
| <b>MODULATION TYPE</b> | CCK                        | <b>ENVIRONMENTAL CONDITIONS</b> | 24deg. C, 64%RH,<br>985hPa |
| <b>TRANSFER RATE</b>   | 11Mbps                     | <b>INPUT POWER (SYSTEM)</b>     | 120Vac, 60 Hz              |
| <b>TEST MODE</b>       | <b>C2</b>                  | <b>TESTED BY</b>                | Brad Wu                    |

#### ANTENNA POLARITY & TEST DISTANCE: HORIZONTAL AT 3 M

| No. | Freq. (MHz) | Emission Level (dBuV/m) | Limit (dBuV/m) | Margin (dB) | Antenna Height (m) | Table Angle (Degree) | Raw Value (dBuV) | Correction Factor (dB/m) |
|-----|-------------|-------------------------|----------------|-------------|--------------------|----------------------|------------------|--------------------------|
| 1   | 1066.00     | 43.87 PK                | 74.00          | -30.13      | 1.02 H             | 155                  | 16.32            | 27.55                    |
| 2   | *2437.00    | 101.08 PK               |                |             | 1.38 H             | 233                  | 69.02            | 32.06                    |
| 2   | *2437.00    | 92.87 AV                |                |             | 1.38 H             | 233                  | 60.81            | 32.06                    |
| 3   | 4874.00     | 48.65 PK                | 74.00          | -25.35      | 1.04 H             | 115                  | 10.67            | 37.98                    |

#### ANTENNA POLARITY & TEST DISTANCE: VERTICAL AT 3 M

| No. | Freq. (MHz) | Emission Level (dBuV/m) | Limit (dBuV/m) | Margin (dB) | Antenna Height (m) | Table Angle (Degree) | Raw Value (dBuV) | Correction Factor (dB/m) |
|-----|-------------|-------------------------|----------------|-------------|--------------------|----------------------|------------------|--------------------------|
| 1   | 1066.00     | 44.61 PK                | 74.00          | -29.39      | 1.06 V             | 153                  | 17.06            | 27.55                    |
| 2   | *2437.00    | 112.28 PK               |                |             | 1.00 V             | 170                  | 80.22            | 32.06                    |
| 2   | *2437.00    | 104.10 AV               |                |             | 1.00 V             | 170                  | 72.04            | 32.06                    |
| 3   | 4874.00     | 55.87 PK                | 74.00          | -18.13      | 1.00 V             | 159                  | 17.89            | 37.98                    |
| 3   | 4874.00     | 47.21 AV                | 54.00          | -6.79       | 1.00 V             | 159                  | 9.23             | 37.98                    |

- REMARKS:**
1. Emission level(dBuV/m)=Raw Value(dBuV) + Correction Factor(dB/m)
  2. Correction Factor(dB/m) = Antenna Factor (dB/m) + Cable Factor (dB)
  3. The other emission levels were very low against the limit.
  4. Margin value = Emission level – Limit value.
  5. The limit value is defined as per 15.247
  6. “ \* “ : Fundamental frequency



|                        |                            |                                 |                            |
|------------------------|----------------------------|---------------------------------|----------------------------|
| <b>EUT</b>             | AirMagnet SmartEdge Sensor | <b>MEASUREMENT DETAIL</b>       |                            |
| <b>MODEL</b>           | A5020                      | <b>FREQUENCY RANGE</b>          | 1 ~ 25GHz                  |
| <b>CHANNEL</b>         | Channel 11                 | <b>DETECTOR FUNCTION</b>        | Peak(PK)<br>Average (AV)   |
| <b>MODULATION TYPE</b> | CCK                        | <b>ENVIRONMENTAL CONDITIONS</b> | 24deg. C, 64%RH,<br>985hPa |
| <b>TRANSFER RATE</b>   | 11Mbps                     | <b>INPUT POWER (SYSTEM)</b>     | 120Vac, 60 Hz              |
| <b>TEST MODE</b>       | <b>C2</b>                  | <b>TESTED BY</b>                | Brad Wu                    |

#### ANTENNA POLARITY & TEST DISTANCE: HORIZONTAL AT 3 M

| No. | Freq. (MHz) | Emission Level (dBuV/m) | Limit (dBuV/m) | Margin (dB) | Antenna Height (m) | Table Angle (Degree) | Raw Value (dBuV) | Correction Factor (dB/m) |
|-----|-------------|-------------------------|----------------|-------------|--------------------|----------------------|------------------|--------------------------|
| 1   | 1066.00     | 43.28 PK                | 74.00          | -30.72      | 1.06 H             | 84                   | 15.73            | 27.55                    |
| 2   | *2462.00    | 101.19 PK               |                |             | 1.38 H             | 241                  | 69.03            | 32.16                    |
| 2   | *2462.00    | 93.00 AV                |                |             | 1.38 H             | 241                  | 60.84            | 32.16                    |
| 3   | 2483.50     | 44.50 PK                | 74.00          | -29.50      | 1.38 H             | 241                  | 12.26            | 32.24                    |
| 4   | 4924.00     | 48.27 PK                | 74.00          | -25.73      | 1.00 H             | 132                  | 10.13            | 38.14                    |

#### ANTENNA POLARITY & TEST DISTANCE: VERTICAL AT 3 M

| No. | Freq. (MHz) | Emission Level (dBuV/m) | Limit (dBuV/m) | Margin (dB) | Antenna Height (m) | Table Angle (Degree) | Raw Value (dBuV) | Correction Factor (dB/m) |
|-----|-------------|-------------------------|----------------|-------------|--------------------|----------------------|------------------|--------------------------|
| 1   | 1066.00     | 44.82 PK                | 74.00          | -29.18      | 1.06 V             | 210                  | 17.27            | 27.55                    |
| 2   | *2462.00    | 112.35 PK               |                |             | 1.00 V             | 172                  | 80.19            | 32.16                    |
| 2   | *2462.00    | 104.22 AV               |                |             | 1.00 V             | 172                  | 72.06            | 32.16                    |
| 3   | 2483.50     | 55.66 PK                | 74.00          | -18.34      | 1.00 V             | 172                  | 23.42            | 32.24                    |
| 3   | 2483.50     | 47.53 AV                | 54.00          | -6.47       | 1.00 V             | 172                  | 15.29            | 32.24                    |
| 4   | 4924.00     | 55.72 PK                | 74.00          | -18.28      | 1.02 V             | 149                  | 17.58            | 38.14                    |
| 4   | 4924.00     | 47.31 AV                | 54.00          | -6.69       | 1.02 V             | 149                  | 9.17             | 38.14                    |

- REMARKS:**
1. Emission level(dBuV/m)=Raw Value(dBuV) + Correction Factor(dB/m)
  2. Correction Factor(dB/m) = Antenna Factor (dB/m) + Cable Factor (dB)
  3. The other emission levels were very low against the limit.
  4. Margin value = Emission level – Limit value.
  5. The limit value is defined as per 15.247
  6. “ \* “ : Fundamental frequency

## 802.11g OFDM modulation

|                 |                            |                          |                            |
|-----------------|----------------------------|--------------------------|----------------------------|
| EUT             | AirMagnet SmartEdge Sensor | MEASUREMENT DETAIL       |                            |
| MODEL           | A5020                      | FREQUENCY RANGE          | 1 ~ 25GHz                  |
| CHANNEL         | Channel 1                  | DETECTOR FUNCTION        | Peak(PK)<br>Average (AV)   |
| MODULATION TYPE | BPSK                       | ENVIRONMENTAL CONDITIONS | 24deg. C, 64%RH,<br>985hPa |
| TRANSFER RATE   | 6Mbps                      | INPUT POWER (SYSTEM)     | 120Vac, 60 Hz              |
| TEST MODE       | C2                         | TESTED BY                | Brad Wu                    |

## ANTENNA POLARITY &amp; TEST DISTANCE: HORIZONTAL AT 3 M

| No. | Freq. (MHz) | Emission Level (dBuV/m) | Limit (dBuV/m) | Margin (dB) | Antenna Height (m) | Table Angle (Degree) | Raw Value (dBuV) | Correction Factor (dB/m) |
|-----|-------------|-------------------------|----------------|-------------|--------------------|----------------------|------------------|--------------------------|
| 1   | 1066.00     | 41.42 PK                | 74.00          | -32.58      | 1.00 H             | 183                  | 13.87            | 27.55                    |
| 1   | 1066.00     | 35.85 AV                | 54.00          | -18.15      | 1.00 H             | 183                  | 8.30             | 27.55                    |
| 2   | 2390.00     | 42.04 PK                | 74.00          | -31.96      | 1.00 H             | 143                  | 10.17            | 31.87                    |
| 3   | *2412.00    | 89.94 PK                |                |             | 1.00 H             | 143                  | 57.98            | 31.96                    |
| 3   | *2412.00    | 80.29 AV                |                |             | 1.00 H             | 143                  | 48.33            | 31.96                    |
| 4   | 4824.00     | 48.88 PK                | 74.00          | -25.12      | 1.06 H             | 107                  | 11.05            | 37.83                    |
| 4   | 4824.00     | 35.36 AV                | 54.00          | -18.64      | 1.06 H             | 107                  | -2.47            | 37.83                    |

## ANTENNA POLARITY &amp; TEST DISTANCE: VERTICAL AT 3 M

| No. | Freq. (MHz) | Emission Level (dBuV/m) | Limit (dBuV/m) | Margin (dB) | Antenna Height (m) | Table Angle (Degree) | Raw Value (dBuV) | Correction Factor (dB/m) |
|-----|-------------|-------------------------|----------------|-------------|--------------------|----------------------|------------------|--------------------------|
| 1   | 1066.00     | 44.61 PK                | 74.00          | -29.39      | 1.17 V             | 51                   | 17.06            | 27.55                    |
| 1   | 1066.00     | 39.36 AV                | 54.00          | -14.64      | 1.17 V             | 51                   | 11.81            | 27.55                    |
| 2   | 2320.00     | 58.86 PK                | 74.00          | -15.14      | 1.03 V             | 172                  | 27.25            | 31.61                    |
| 2   | 2320.00     | 48.99 AV                | 54.00          | -5.01       | 1.03 V             | 172                  | 17.38            | 31.61                    |
| 3   | 2390.00     | 57.29 PK                | 74.00          | -16.71      | 1.03 V             | 172                  | 25.42            | 31.87                    |
| 3   | 2390.00     | 47.32 AV                | 54.00          | -6.68       | 1.03 V             | 172                  | 15.45            | 31.87                    |
| 4   | *2412.00    | 105.19 PK               |                |             | 1.03 V             | 172                  | 73.23            | 31.96                    |
| 4   | *2412.00    | 95.22 AV                |                |             | 1.03 V             | 172                  | 63.26            | 31.96                    |
| 5   | 2480.00     | 60.63 PK                | 74.00          | -13.37      | 1.00 V             | 169                  | 28.40            | 32.23                    |
| 5   | 2480.00     | 51.29 AV                | 54.00          | -2.71       | 1.00 V             | 169                  | 19.06            | 32.23                    |
| 6   | 4824.00     | 49.56 PK                | 74.00          | -24.44      | 1.02 V             | 213                  | 11.73            | 37.83                    |
| 6   | 4824.00     | 35.47 AV                | 54.00          | -18.53      | 1.02 V             | 213                  | -2.36            | 37.83                    |

- REMARKS:**
1. Emission level(dBuV/m)=Raw Value(dBuV) + Correction Factor(dB/m)
  2. Correction Factor(dB/m) = Antenna Factor (dB/m) + Cable Factor (dB)
  3. The other emission levels were very low against the limit.
  4. Margin value = Emission level – Limit value.
  5. The limit value is defined as per 15.247
  6. “ \* “ : Fundamental frequency



|                        |                            |                                 |                            |
|------------------------|----------------------------|---------------------------------|----------------------------|
| <b>EUT</b>             | AirMagnet SmartEdge Sensor | <b>MEASUREMENT DETAIL</b>       |                            |
| <b>MODEL</b>           | A5020                      | <b>FREQUENCY RANGE</b>          | 1 ~ 25GHz                  |
| <b>CHANNEL</b>         | Channel 6                  | <b>DETECTOR FUNCTION</b>        | Peak(PK)<br>Average (AV)   |
| <b>MODULATION TYPE</b> | BPSK                       | <b>ENVIRONMENTAL CONDITIONS</b> | 24deg. C, 64%RH,<br>985hPa |
| <b>TRANSFER RATE</b>   | 6Mbps                      | <b>INPUT POWER (SYSTEM)</b>     | 120Vac, 60 Hz              |
| <b>TEST MODE</b>       | C2                         | <b>TESTED BY</b>                | Brad Wu                    |

| <b>ANTENNA POLARITY &amp; TEST DISTANCE: HORIZONTAL AT 3 M</b> |             |                         |                |             |                    |                      |                  |                          |
|--|-------------|-------------------------|----------------|-------------|--------------------|----------------------|------------------|--------------------------|
| No.  | Freq. (MHz) | Emission Level (dBuV/m) | Limit (dBuV/m) | Margin (dB) | Antenna Height (m) | Table Angle (Degree) | Raw Value (dBuV) | Correction Factor (dB/m) |
| 1  | 1066.00     | 42.81 PK                | 74.00          | -31.19      | 1.05 H             | 217                  | 15.26            | 27.55                    |
| 2  | *2437.00    | 89.95 PK                |                |             | 1.28 H             | 130                  | 57.89            | 32.06                    |
| 2  | *2437.00    | 80.29 AV                |                |             | 1.28 H             | 130                  | 48.23            | 32.06                    |
| 3  | 4874.00     | 48.75 PK                | 74.00          | -25.25      | 1.03 H             | 100                  | 10.77            | 37.98                    |

| <b>ANTENNA POLARITY &amp; TEST DISTANCE: VERTICAL AT 3 M</b> |             |                         |                |             |                    |                      |                  |                          |
|--|-------------|-------------------------|----------------|-------------|--------------------|----------------------|------------------|--------------------------|
| No.  | Freq. (MHz) | Emission Level (dBuV/m) | Limit (dBuV/m) | Margin (dB) | Antenna Height (m) | Table Angle (Degree) | Raw Value (dBuV) | Correction Factor (dB/m) |
| 1  | 1066.00     | 44.76 PK                | 74.00          | -29.24      | 1.15 V             | 66                   | 17.21            | 27.55                    |
| 2  | *2437.00    | 104.65 PK               |                |             | 1.00 V             | 167                  | 72.59            | 32.06                    |
| 2  | *2437.00    | 95.16 AV                |                |             | 1.00 V             | 167                  | 63.10            | 32.06                    |
| 3  | 4874.00     | 49.27 PK                | 74.00          | -24.73      | 1.08 V             | 174                  | 11.29            | 37.98                    |

- REMARKS:**
1. Emission level(dBuV/m)=Raw Value(dBuV) + Correction Factor(dB/m)
  2. Correction Factor(dB/m) = Antenna Factor (dB/m) + Cable Factor (dB)
  3. The other emission levels were very low against the limit.
  4. Margin value = Emission level – Limit value.
  5. The limit value is defined as per 15.247
  6. “ \* “ : Fundamental frequency

|                        |                            |                                 |                            |
|------------------------|----------------------------|---------------------------------|----------------------------|
| <b>EUT</b>             | AirMagnet SmartEdge Sensor | <b>MEASUREMENT DETAIL</b>       |                            |
| <b>MODEL</b>           | A5020                      | <b>FREQUENCY RANGE</b>          | 1 ~ 25GHz                  |
| <b>CHANNEL</b>         | Channel 11                 | <b>DETECTOR FUNCTION</b>        | Peak(PK)<br>Average (AV)   |
| <b>MODULATION TYPE</b> | BPSK                       | <b>ENVIRONMENTAL CONDITIONS</b> | 24deg. C, 64%RH,<br>985hPa |
| <b>TRANSFER RATE</b>   | 6Mbps                      | <b>INPUT POWER (SYSTEM)</b>     | 120Vac, 60 Hz              |
| <b>TEST MODE</b>       | C2                         | <b>TESTED BY</b>                | Brad Wu                    |

### ANTENNA POLARITY & TEST DISTANCE: HORIZONTAL AT 3 M

| No. | Freq. (MHz) | Emission Level (dBuV/m) | Limit (dBuV/m) | Margin (dB) | Antenna Height (m) | Table Angle (Degree) | Raw Value (dBuV) | Correction Factor (dB/m) |
|-----|-------------|-------------------------|----------------|-------------|--------------------|----------------------|------------------|--------------------------|
| 1   | 1066.00     | 42.38 PK                | 74.00          | -31.62      | 1.05 H             | 146                  | 14.83            | 27.55                    |
| 2   | *2462.00    | 89.81 PK                |                |             | 1.01 H             | 144                  | 57.65            | 32.16                    |
| 2   | *2462.00    | 80.18 AV                |                |             | 1.01 H             | 144                  | 48.02            | 32.16                    |
| 3   | 2483.50     | 40.21 PK                | 74.00          | -33.79      | 1.01 H             | 144                  | 7.97             | 32.24                    |
| 4   | 4924.00     | 48.71 PK                | 74.00          | -25.29      | 1.01 H             | 129                  | 10.57            | 38.14                    |

### ANTENNA POLARITY & TEST DISTANCE: VERTICAL AT 3 M

| No. | Freq. (MHz) | Emission Level (dBuV/m) | Limit (dBuV/m) | Margin (dB) | Antenna Height (m) | Table Angle (Degree) | Raw Value (dBuV) | Correction Factor (dB/m) |
|-----|-------------|-------------------------|----------------|-------------|--------------------|----------------------|------------------|--------------------------|
| 1   | 1066.00     | 45.21 PK                | 74.00          | -28.79      | 1.01 V             | 304                  | 17.66            | 27.55                    |
| 2   | 2400.00     | 61.14 PK                | 74.00          | -12.86      | 1.00 V             | 173                  | 29.23            | 31.91                    |
| 2   | 2400.00     | 51.67 AV                | 54.00          | -2.33       | 1.00 V             | 173                  | 19.76            | 31.91                    |
| 3   | *2462.00    | 104.77 PK               |                |             | 1.00 V             | 173                  | 72.61            | 32.16                    |
| 3   | *2462.00    | 94.86 AV                |                |             | 1.00 V             | 173                  | 62.70            | 32.16                    |
| 4   | 2483.50     | 55.17 PK                | 74.00          | -18.83      | 1.00 V             | 173                  | 22.93            | 32.24                    |
| 4   | 2483.50     | 45.26 AV                | 54.00          | -8.74       | 1.00 V             | 173                  | 13.02            | 32.24                    |
| 5   | 4924.00     | 49.26 PK                | 74.00          | -24.74      | 1.02 V             | 240                  | 11.12            | 38.14                    |

- REMARKS:**
1. Emission level(dBuV/m)=Raw Value(dBuV) + Correction Factor(dB/m)
  2. Correction Factor(dB/m) = Antenna Factor (dB/m) + Cable Factor (dB)
  3. The other emission levels were very low against the limit.
  4. Margin value = Emission level – Limit value.
  5. The limit value is defined as per 15.247
  6. “ \* “ : Fundamental frequency



4.2.12 TEST RESULTS\_ ANTENNA SAA05-22056A (ABOVE 1GHz TEST)

802.11b DSSS modulation

|                        |                            |                                 |                            |
|------------------------|----------------------------|---------------------------------|----------------------------|
| <b>EUT</b>             | AirMagnet SmartEdge Sensor | <b>MEASUREMENT DETAIL</b>       |                            |
| <b>MODEL</b>           | A5020                      | <b>FREQUENCY RANGE</b>          | 1 ~ 25GHz                  |
| <b>CHANNEL</b>         | Channel 1                  | <b>DETECTOR FUNCTION</b>        | Peak(PK)<br>Average (AV)   |
| <b>MODULATION TYPE</b> | CCK                        | <b>ENVIRONMENTAL CONDITIONS</b> | 24deg. C, 64%RH,<br>985hPa |
| <b>TRANSFER RATE</b>   | 11Mbps                     | <b>INPUT POWER (SYSTEM)</b>     | 120Vac, 60 Hz              |
| <b>TEST MODE</b>       | C3                         | <b>TESTED BY</b>                | Brad Wu                    |

| ANTENNA POLARITY & TEST DISTANCE: HORIZONTAL AT 3 M |             |                         |                |             |                    |                      |                  |                          |
|---|-------------|-------------------------|----------------|-------------|--------------------|----------------------|------------------|--------------------------|
| No.   | Freq. (MHz) | Emission Level (dBuV/m) | Limit (dBuV/m) | Margin (dB) | Antenna Height (m) | Table Angle (Degree) | Raw Value (dBuV) | Correction Factor (dB/m) |
| 1   | 1066.00     | 43.62 PK                | 74.00          | -30.38      | 1.00 H             | 13                   | 16.07            | 27.55                    |
| 2   | 2390.00     | 47.65 PK                | 74.00          | -26.35      | 1.31 H             | 276                  | 15.78            | 31.87                    |
| 3   | *2412.00    | 102.75 PK               |                |             | 1.31 H             | 276                  | 70.79            | 31.96                    |
| 3   | *2412.00    | 94.63 AV                |                |             | 1.31 H             | 276                  | 62.67            | 31.96                    |
| 4   | 4824.00     | 48.38 PK                | 74.00          | -25.62      | 1.01 H             | 215                  | 10.55            | 37.83                    |
| 4   | 4824.00     | 36.10 AV                | 54.00          | -17.90      | 1.01 H             | 215                  | -1.73            | 37.83                    |

| ANTENNA POLARITY & TEST DISTANCE: VERTICAL AT 3 M |             |                         |                |             |                    |                      |                  |                          |
|---|-------------|-------------------------|----------------|-------------|--------------------|----------------------|------------------|--------------------------|
| No.   | Freq. (MHz) | Emission Level (dBuV/m) | Limit (dBuV/m) | Margin (dB) | Antenna Height (m) | Table Angle (Degree) | Raw Value (dBuV) | Correction Factor (dB/m) |
| 1   | 1066.00     | 45.79 PK                | 74.00          | -28.21      | 1.03 V             | 214                  | 18.24            | 27.55                    |
| 2   | 2320.00     | 62.38 PK                | 74.00          | -11.62      | 1.03 V             | 214                  | 30.77            | 31.61                    |
| 2   | 2320.00     | 52.37 AV                | 54.00          | -1.63       | 1.03 V             | 214                  | 20.76            | 31.61                    |
| 3   | 2390.00     | 60.92 PK                | 74.00          | -13.08      | 1.04 V             | 358                  | 29.05            | 31.87                    |
| 3   | 2390.00     | 52.74 AV                | 54.00          | -1.26       | 1.04 V             | 358                  | 20.87            | 31.87                    |
| 4   | *2412.00    | 115.52 PK               |                |             | 1.04 V             | 358                  | 83.56            | 31.96                    |
| 4   | *2412.00    | 107.34 AV               |                |             | 1.04 V             | 358                  | 75.38            | 31.96                    |
| 5   | 4824.00     | 58.86 PK                | 74.00          | -15.14      | 1.03 V             | 6                    | 21.03            | 37.83                    |
| 5   | 4824.00     | 48.07 AV                | 54.00          | -5.93       | 1.03 V             | 6                    | 10.24            | 37.83                    |

- REMARKS:**
1. Emission level(dBuV/m)=Raw Value(dBuV) + Correction Factor(dB/m)
  2. Correction Factor(dB/m) = Antenna Factor (dB/m) + Cable Factor (dB)
  3. The other emission levels were very low against the limit.
  4. Margin value = Emission level – Limit value.
  5. The limit value is defined as per 15.247
  6. “ \* “ : Fundamental frequency

|                        |                            |                                 |                            |
|------------------------|----------------------------|---------------------------------|----------------------------|
| <b>EUT</b>             | AirMagnet SmartEdge Sensor | <b>MEASUREMENT DETAIL</b>       |                            |
| <b>MODEL</b>           | A5020                      | <b>FREQUENCY RANGE</b>          | 1 ~ 25GHz                  |
| <b>CHANNEL</b>         | Channel 6                  | <b>DETECTOR FUNCTION</b>        | Peak(PK)<br>Average (AV)   |
| <b>MODULATION TYPE</b> | CCK                        | <b>ENVIRONMENTAL CONDITIONS</b> | 24deg. C, 64%RH,<br>985hPa |
| <b>TRANSFER RATE</b>   | 11Mbps                     | <b>INPUT POWER (SYSTEM)</b>     | 120Vac, 60 Hz              |
| <b>TEST MODE</b>       | <b>C3</b>                  | <b>TESTED BY</b>                | Brad Wu                    |

#### ANTENNA POLARITY & TEST DISTANCE: HORIZONTAL AT 3 M

| No. | Freq. (MHz) | Emission Level (dBuV/m) | Limit (dBuV/m) | Margin (dB) | Antenna Height (m) | Table Angle (Degree) | Raw Value (dBuV) | Correction Factor (dB/m) |
|-----|-------------|-------------------------|----------------|-------------|--------------------|----------------------|------------------|--------------------------|
| 1   | 1066.00     | 44.07 PK                | 74.00          | -29.93      | 1.01 H             | 335                  | 16.52            | 27.55                    |
| 2   | *2437.00    | 102.21 PK               |                |             | 1.30 H             | 277                  | 70.15            | 32.06                    |
| 2   | *2437.00    | 94.16 AV                |                |             | 1.30 H             | 277                  | 62.10            | 32.06                    |
| 3   | 4874.00     | 47.87 PK                | 74.00          | -26.13      | 1.00 H             | 206                  | 9.89             | 37.98                    |

#### ANTENNA POLARITY & TEST DISTANCE: VERTICAL AT 3 M

| No. | Freq. (MHz) | Emission Level (dBuV/m) | Limit (dBuV/m) | Margin (dB) | Antenna Height (m) | Table Angle (Degree) | Raw Value (dBuV) | Correction Factor (dB/m) |
|-----|-------------|-------------------------|----------------|-------------|--------------------|----------------------|------------------|--------------------------|
| 1   | 1066.00     | 46.21 PK                | 74.00          | -27.79      | 1.02 V             | 231                  | 18.66            | 27.55                    |
| 2   | 2320.00     | 62.47 PK                | 74.00          | -11.53      | 1.08 V             | 259                  | 30.86            | 31.61                    |
| 2   | 2320.00     | 52.44 AV                | 54.00          | -1.56       | 1.08 V             | 259                  | 20.83            | 31.61                    |
| 3   | *2437.00    | 115.45 PK               |                |             | 1.04 V             | 359                  | 83.39            | 32.06                    |
| 3   | *2437.00    | 107.18 AV               |                |             | 1.04 V             | 359                  | 75.12            | 32.06                    |
| 4   | 4874.00     | 58.26 PK                | 74.00          | -15.74      | 1.00 V             | 9                    | 20.28            | 37.98                    |
| 4   | 4874.00     | 47.71 AV                | 54.00          | -6.29       | 1.00 V             | 9                    | 9.73             | 37.98                    |

- REMARKS:**
1. Emission level(dBuV/m)=Raw Value(dBuV) + Correction Factor(dB/m)
  2. Correction Factor(dB/m) = Antenna Factor (dB/m) + Cable Factor (dB)
  3. The other emission levels were very low against the limit.
  4. Margin value = Emission level – Limit value.
  5. The limit value is defined as per 15.247
  6. “ \* “ : Fundamental frequency





|                        |                            |                                 |                            |
|------------------------|----------------------------|---------------------------------|----------------------------|
| <b>EUT</b>             | AirMagnet SmartEdge Sensor | <b>MEASUREMENT DETAIL</b>       |                            |
| <b>MODEL</b>           | A5020                      | <b>FREQUENCY RANGE</b>          | 1 ~ 25GHz                  |
| <b>CHANNEL</b>         | Channel 11                 | <b>DETECTOR FUNCTION</b>        | Peak(PK)<br>Average (AV)   |
| <b>MODULATION TYPE</b> | CCK                        | <b>ENVIRONMENTAL CONDITIONS</b> | 24deg. C, 64%RH,<br>985hPa |
| <b>TRANSFER RATE</b>   | 11Mbps                     | <b>INPUT POWER (SYSTEM)</b>     | 120Vac, 60 Hz              |
| <b>TEST MODE</b>       | <b>C3</b>                  | <b>TESTED BY</b>                | Brad Wu                    |

| <b>ANTENNA POLARITY &amp; TEST DISTANCE: HORIZONTAL AT 3 M</b> |             |                         |                |             |                    |                      |                  |                          |
|--|-------------|-------------------------|----------------|-------------|--------------------|----------------------|------------------|--------------------------|
| No.  | Freq. (MHz) | Emission Level (dBuV/m) | Limit (dBuV/m) | Margin (dB) | Antenna Height (m) | Table Angle (Degree) | Raw Value (dBuV) | Correction Factor (dB/m) |
| 1  | 1066.00     | 44.37 PK                | 74.00          | -29.63      | 1.03 H             | 217                  | 16.82            | 27.55                    |
| 2  | *2462.00    | 102.56 PK               |                |             | 1.32 H             | 277                  | 70.40            | 32.16                    |
| 2  | *2462.00    | 94.52 AV                |                |             | 1.32 H             | 277                  | 62.36            | 32.16                    |
| 3  | 2483.50     | 43.96 PK                | 74.00          | -30.04      | 1.32 H             | 277                  | 11.72            | 32.24                    |
| 4  | 4924.00     | 48.61 PK                | 74.00          | -25.39      | 1.03 H             | 217                  | 10.47            | 38.14                    |

| <b>ANTENNA POLARITY &amp; TEST DISTANCE: VERTICAL AT 3 M</b> |             |                         |                |             |                    |                      |                  |                          |
|--|-------------|-------------------------|----------------|-------------|--------------------|----------------------|------------------|--------------------------|
| No.  | Freq. (MHz) | Emission Level (dBuV/m) | Limit (dBuV/m) | Margin (dB) | Antenna Height (m) | Table Angle (Degree) | Raw Value (dBuV) | Correction Factor (dB/m) |
| 1  | 1066.00     | 46.65 PK                | 74.00          | -27.35      | 1.00 V             | 217                  | 19.10            | 27.55                    |
| 2  | 2320.00     | 62.51 PK                | 74.00          | -11.49      | 1.06 V             | 261                  | 30.90            | 31.61                    |
| 2  | 2320.00     | 52.47 AV                | 54.00          | -1.53       | 1.06 V             | 261                  | 20.86            | 31.61                    |
| 3  | *2462.00    | 115.76 PK               |                |             | 1.00 V             | 356                  | 83.60            | 32.16                    |
| 3  | *2462.00    | 107.50 AV               |                |             | 1.00 V             | 356                  | 75.34            | 32.16                    |
| 4  | 2483.50     | 58.16 PK                | 74.00          | -15.84      | 1.00 V             | 356                  | 25.92            | 32.24                    |
| 4  | 2483.50     | 49.90 AV                | 54.00          | -4.10       | 1.00 V             | 356                  | 17.66            | 32.24                    |
| 5  | 4924.00     | 58.62 PK                | 74.00          | -15.38      | 1.02 V             | 21                   | 20.48            | 38.14                    |
| 5  | 4924.00     | 48.04 AV                | 54.00          | -5.96       | 1.02 V             | 21                   | 9.90             | 38.14                    |

- REMARKS:**
1. Emission level(dBuV/m)=Raw Value(dBuV) + Correction Factor(dB/m)
  2. Correction Factor(dB/m) = Antenna Factor (dB/m) + Cable Factor (dB)
  3. The other emission levels were very low against the limit.
  4. Margin value = Emission level – Limit value.
  5. The limit value is defined as per 15.247
  6. “ \* “ : Fundamental frequency



## 802.11g OFDM modulation

|                        |                            |                                 |                            |
|------------------------|----------------------------|---------------------------------|----------------------------|
| <b>EUT</b>             | AirMagnet SmartEdge Sensor | <b>MEASUREMENT DETAIL</b>       |                            |
| <b>MODEL</b>           | A5020                      | <b>FREQUENCY RANGE</b>          | 1 ~ 25GHz                  |
| <b>CHANNEL</b>         | Channel 1                  | <b>DETECTOR FUNCTION</b>        | Peak(PK)<br>Average (AV)   |
| <b>MODULATION TYPE</b> | BPSK                       | <b>ENVIRONMENTAL CONDITIONS</b> | 24deg. C, 64%RH,<br>985hPa |
| <b>TRANSFER RATE</b>   | 6Mbps                      | <b>INPUT POWER (SYSTEM)</b>     | 120Vac, 60 Hz              |
| <b>TEST MODE</b>       | C3                         | <b>TESTED BY</b>                | Brad Wu                    |

**ANTENNA POLARITY & TEST DISTANCE: HORIZONTAL AT 3 M**

| No. | Freq. (MHz) | Emission Level (dBuV/m) | Limit (dBuV/m) | Margin (dB) | Antenna Height (m) | Table Angle (Degree) | Raw Value (dBuV) | Correction Factor (dB/m) |
|-----|-------------|-------------------------|----------------|-------------|--------------------|----------------------|------------------|--------------------------|
| 1   | 1066.00     | 44.22 PK                | 74.00          | -29.78      | 1.10 H             | 279                  | 16.67            | 27.55                    |
| 2   | 2390.00     | 51.38 PK                | 74.00          | -22.62      | 1.16 H             | 203                  | 19.51            | 31.87                    |
| 2   | 2390.00     | 41.02 AV                | 54.00          | -12.98      | 1.16 H             | 203                  | 9.15             | 31.87                    |
| 3   | *2412.00    | 97.47 PK                |                |             | 1.16 H             | 203                  | 65.51            | 31.96                    |
| 3   | *2412.00    | 87.11 AV                |                |             | 1.16 H             | 203                  | 55.15            | 31.96                    |
| 4   | 4824.00     | 48.87 PK                | 74.00          | -25.13      | 1.00 H             | 295                  | 11.04            | 37.83                    |

**ANTENNA POLARITY & TEST DISTANCE: VERTICAL AT 3 M**

| No. | Freq. (MHz) | Emission Level (dBuV/m) | Limit (dBuV/m) | Margin (dB) | Antenna Height (m) | Table Angle (Degree) | Raw Value (dBuV) | Correction Factor (dB/m) |
|-----|-------------|-------------------------|----------------|-------------|--------------------|----------------------|------------------|--------------------------|
| 1   | 1066.00     | 46.27 PK                | 74.00          | -27.73      | 1.03 V             | 329                  | 18.72            | 27.55                    |
| 2   | 2320.00     | 62.40 PK                | 74.00          | -11.60      | 1.15 V             | 342                  | 30.79            | 31.61                    |
| 2   | 2320.00     | 52.31 AV                | 54.00          | -1.69       | 1.15 V             | 342                  | 20.70            | 31.61                    |
| 3   | 2390.00     | 62.37 PK                | 74.00          | -11.63      | 1.07 V             | 351                  | 30.50            | 31.87                    |
| 3   | 2390.00     | 52.47 AV                | 54.00          | -1.53       | 1.07 V             | 351                  | 20.60            | 31.87                    |
| 4   | *2412.00    | 108.76 PK               |                |             | 1.07 V             | 351                  | 76.80            | 31.96                    |
| 4   | *2412.00    | 98.86 AV                |                |             | 1.07 V             | 351                  | 66.90            | 31.96                    |
| 5   | 4824.00     | 48.73 PK                | 74.00          | -25.27      | 1.06 V             | 225                  | 10.90            | 37.83                    |

- REMARKS:**
1. Emission level(dBuV/m)=Raw Value(dBuV) + Correction Factor(dB/m)
  2. Correction Factor(dB/m) = Antenna Factor (dB/m) + Cable Factor (dB)
  3. The other emission levels were very low against the limit.
  4. Margin value = Emission level – Limit value.
  5. The limit value is defined as per 15.247
  6. “ \* “ : Fundamental frequency



|                        |                            |                                 |                            |
|------------------------|----------------------------|---------------------------------|----------------------------|
| <b>EUT</b>             | AirMagnet SmartEdge Sensor | <b>MEASUREMENT DETAIL</b>       |                            |
| <b>MODEL</b>           | A5020                      | <b>FREQUENCY RANGE</b>          | 1 ~ 25GHz                  |
| <b>CHANNEL</b>         | Channel 6                  | <b>DETECTOR FUNCTION</b>        | Peak(PK)<br>Average (AV)   |
| <b>MODULATION TYPE</b> | BPSK                       | <b>ENVIRONMENTAL CONDITIONS</b> | 24deg. C, 64%RH,<br>985hPa |
| <b>TRANSFER RATE</b>   | 6Mbps                      | <b>INPUT POWER (SYSTEM)</b>     | 120Vac, 60 Hz              |
| <b>TEST MODE</b>       | C3                         | <b>TESTED BY</b>                | Brad Wu                    |

| <b>ANTENNA POLARITY &amp; TEST DISTANCE: HORIZONTAL AT 3 M</b> |             |                         |                |             |                    |                      |                  |                          |
|--|-------------|-------------------------|----------------|-------------|--------------------|----------------------|------------------|--------------------------|
| No.  | Freq. (MHz) | Emission Level (dBuV/m) | Limit (dBuV/m) | Margin (dB) | Antenna Height (m) | Table Angle (Degree) | Raw Value (dBuV) | Correction Factor (dB/m) |
| 1  | 1066.00     | 44.76 PK                | 74.00          | -29.24      | 1.06 H             | 253                  | 17.21            | 27.55                    |
| 2  | *2437.00    | 97.29 PK                |                |             | 1.15 H             | 206                  | 65.23            | 32.06                    |
| 2  | *2437.00    | 87.03 AV                |                |             | 1.15 H             | 206                  | 54.97            | 32.06                    |
| 3  | 4874.00     | 48.26 PK                | 74.00          | -25.74      | 1.10 H             | 216                  | 10.28            | 37.98                    |

| <b>ANTENNA POLARITY &amp; TEST DISTANCE: VERTICAL AT 3 M</b> |             |                         |                |             |                    |                      |                  |                          |
|--|-------------|-------------------------|----------------|-------------|--------------------|----------------------|------------------|--------------------------|
| No.  | Freq. (MHz) | Emission Level (dBuV/m) | Limit (dBuV/m) | Margin (dB) | Antenna Height (m) | Table Angle (Degree) | Raw Value (dBuV) | Correction Factor (dB/m) |
| 1  | 1066.00     | 46.28 PK                | 74.00          | -27.72      | 1.02 V             | 213                  | 18.73            | 27.55                    |
| 2  | 2320.00     | 62.31 PK                | 74.00          | -11.69      | 1.10 V             | 329                  | 30.70            | 31.61                    |
| 2  | 2320.00     | 52.27 AV                | 54.00          | -1.73       | 1.10 V             | 329                  | 20.66            | 31.61                    |
| 3  | *2437.00    | 108.23 PK               |                |             | 1.08 V             | 350                  | 76.17            | 32.06                    |
| 3  | *2437.00    | 98.30 AV                |                |             | 1.08 V             | 350                  | 66.24            | 32.06                    |
| 4  | 4874.00     | 48.92 PK                | 74.00          | -25.08      | 1.10 V             | 132                  | 10.94            | 37.98                    |

- REMARKS:**
1. Emission level(dBuV/m)=Raw Value(dBuV) + Correction Factor(dB/m)
  2. Correction Factor(dB/m) = Antenna Factor (dB/m) + Cable Factor (dB)
  3. The other emission levels were very low against the limit.
  4. Margin value = Emission level – Limit value.
  5. The limit value is defined as per 15.247
  6. “ \* “ : Fundamental frequency

|                        |                            |                                 |                            |
|------------------------|----------------------------|---------------------------------|----------------------------|
| <b>EUT</b>             | AirMagnet SmartEdge Sensor | <b>MEASUREMENT DETAIL</b>       |                            |
| <b>MODEL</b>           | A5020                      | <b>FREQUENCY RANGE</b>          | 1 ~ 25GHz                  |
| <b>CHANNEL</b>         | Channel 11                 | <b>DETECTOR FUNCTION</b>        | Peak(PK)<br>Average (AV)   |
| <b>MODULATION TYPE</b> | BPSK                       | <b>ENVIRONMENTAL CONDITIONS</b> | 24deg. C, 64%RH,<br>985hPa |
| <b>TRANSFER RATE</b>   | 6Mbps                      | <b>INPUT POWER (SYSTEM)</b>     | 120Vac, 60 Hz              |
| <b>TEST MODE</b>       | C3                         | <b>TESTED BY</b>                | Brad Wu                    |

### ANTENNA POLARITY & TEST DISTANCE: HORIZONTAL AT 3 M

| No. | Freq. (MHz) | Emission Level (dBuV/m) | Limit (dBuV/m) | Margin (dB) | Antenna Height (m) | Table Angle (Degree) | Raw Value (dBuV) | Correction Factor (dB/m) |
|-----|-------------|-------------------------|----------------|-------------|--------------------|----------------------|------------------|--------------------------|
| 1   | 1066.00     | 43.67 PK                | 74.00          | -30.33      | 1.09 H             | 254                  | 16.12            | 27.55                    |
| 2   | *2462.00    | 97.84 PK                |                |             | 1.17 H             | 204                  | 65.68            | 32.16                    |
| 2   | *2462.00    | 87.57 AV                |                |             | 1.17 H             | 204                  | 55.41            | 32.16                    |
| 3   | 2483.50     | 48.73 PK                | 74.00          | -25.27      | 1.17 H             | 204                  | 16.49            | 32.24                    |
| 4   | 4924.00     | 47.96 PK                | 74.00          | -26.04      | 1.12 H             | 213                  | 9.82             | 38.14                    |

### ANTENNA POLARITY & TEST DISTANCE: VERTICAL AT 3 M

| No. | Freq. (MHz) | Emission Level (dBuV/m) | Limit (dBuV/m) | Margin (dB) | Antenna Height (m) | Table Angle (Degree) | Raw Value (dBuV) | Correction Factor (dB/m) |
|-----|-------------|-------------------------|----------------|-------------|--------------------|----------------------|------------------|--------------------------|
| 1   | 1066.00     | 46.27 PK                | 74.00          | -27.73      | 1.09 V             | 57                   | 18.72            | 27.55                    |
| 2   | 2320.00     | 62.73 PK                | 74.00          | -11.27      | 1.11 V             | 347                  | 31.12            | 31.61                    |
| 2   | 2320.00     | 52.63 AV                | 54.00          | -1.37       | 1.11 V             | 347                  | 21.02            | 31.61                    |
| 3   | *2462.00    | 108.59 PK               |                |             | 1.07 V             | 357                  | 76.43            | 32.16                    |
| 3   | *2462.00    | 98.47 AV                |                |             | 1.07 V             | 357                  | 66.31            | 32.16                    |
| 4   | 2483.50     | 59.48 PK                | 74.00          | -14.52      | 1.07 V             | 357                  | 27.24            | 32.24                    |
| 4   | 2483.50     | 49.36 AV                | 54.00          | -4.64       | 1.07 V             | 357                  | 17.12            | 32.24                    |
| 5   | 4924.00     | 48.62 PK                | 74.00          | -25.38      | 1.07 V             | 142                  | 10.49            | 38.14                    |
| 5   | 4924.00     | 36.10 AV                | 54.00          | -17.90      | 1.07 V             | 142                  | -2.03            | 38.14                    |

- REMARKS:**
1. Emission level(dBuV/m)=Raw Value(dBuV) + Correction Factor(dB/m)
  2. Correction Factor(dB/m) = Antenna Factor (dB/m) + Cable Factor (dB)
  3. The other emission levels were very low against the limit.
  4. Margin value = Emission level – Limit value.
  5. The limit value is defined as per 15.247
  6. “ \* “ : Fundamental frequency



### 4.3 6dB BANDWIDTH MEASUREMENT

#### 4.3.1 LIMITS OF 6dB BANDWIDTH MEASUREMENT

The minimum of 6dB Bandwidth Measurement is 0.5 MHz.

#### 4.3.2 TEST INSTRUMENTS

| Description & Manufacturer | Model No. | Serial No. | Calibrated Until |
|----------------------------|-----------|------------|------------------|
| SPECTRUM ANALYZER          | FSEK 30   | 100049     | Aug. 14, 2006    |

**NOTE:** The calibration interval of the above test instruments is 12 months and the calibrations are traceable to NML/ROC and NIST/USA.

#### 4.3.3 TEST PROCEDURE

The transmitter output was connected to the spectrum analyzer through an attenuator. The bandwidth of the fundamental frequency was measured by spectrum analyzer with 100kHz RBW and 100kHz VBW. The 6dB bandwidth is defined as the total spectrum the power of which is higher than peak power minus 6dB.

#### 4.3.4 DEVIATION FROM TEST STANDARD

No deviation

#### 4.3.5 TEST SETUP

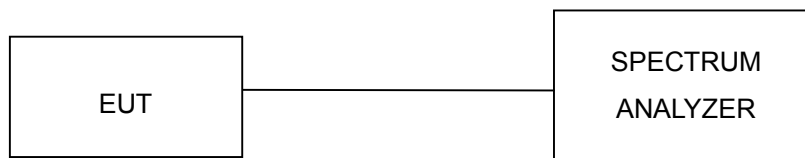

#### 4.3.6 EUT OPERATING CONDITIONS

The software provided by client to enable the EUT under transmission condition continuously at lowest, middle and highest channel frequencies individually.



4.3.7 TEST RESULTS

802.11b DSSS modulation

|                             |                            |                                 |                        |
|-----------------------------|----------------------------|---------------------------------|------------------------|
| <b>EUT</b>                  | AirMagnet SmartEdge Sensor | <b>MODEL</b>                    | A5020                  |
| <b>MODULATION TYPE</b>      | CCK                        | <b>TRANSFER RATE</b>            | 11Mbps                 |
| <b>INPUT POWER (SYSTEM)</b> | 120Vac, 60 Hz              | <b>ENVIRONMENTAL CONDITIONS</b> | 23deg.C, 60%RH, 985hPa |
| <b>TESTED BY</b>            | Gary Chang                 |                                 |                        |

| CHANNEL | CHANNEL FREQUENCY (MHz) | 6dB BANDWIDTH (MHz) | MINIMUM LIMIT (MHz) | PASS/FAIL |
|---------|-------------------------|---------------------|---------------------|-----------|
| 1       | 2412                    | 11.52               | 0.5                 | PASS      |
| 6       | 2437                    | 11.00               | 0.5                 | PASS      |
| 11      | 2462                    | 11.56               | 0.5                 | PASS      |



CH 1

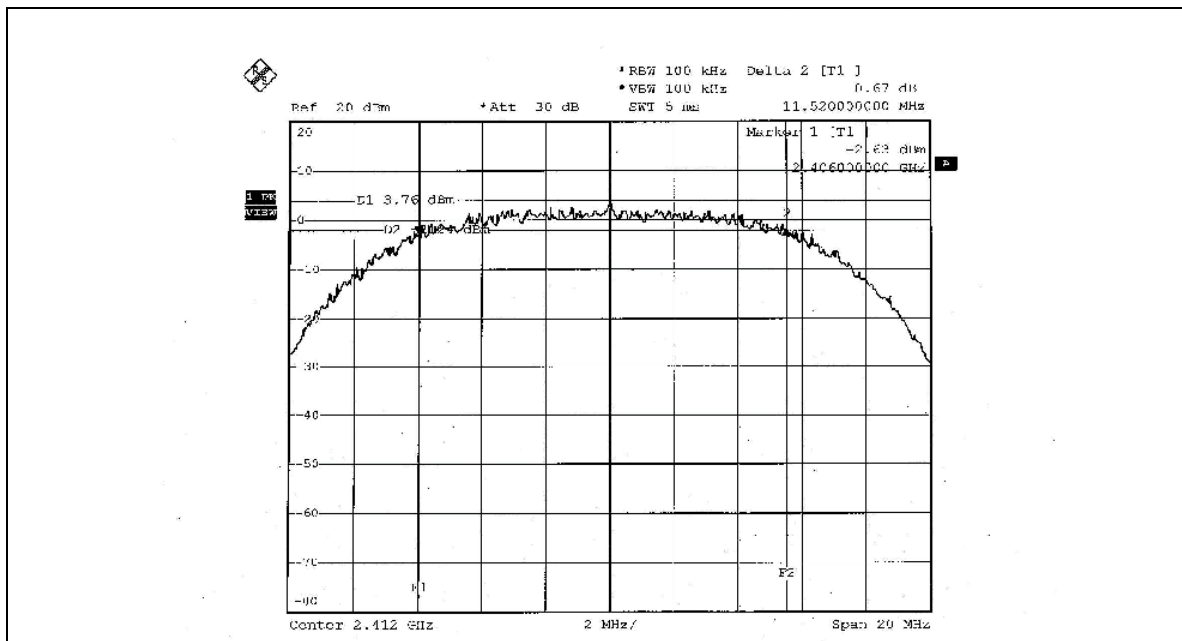

CH 6

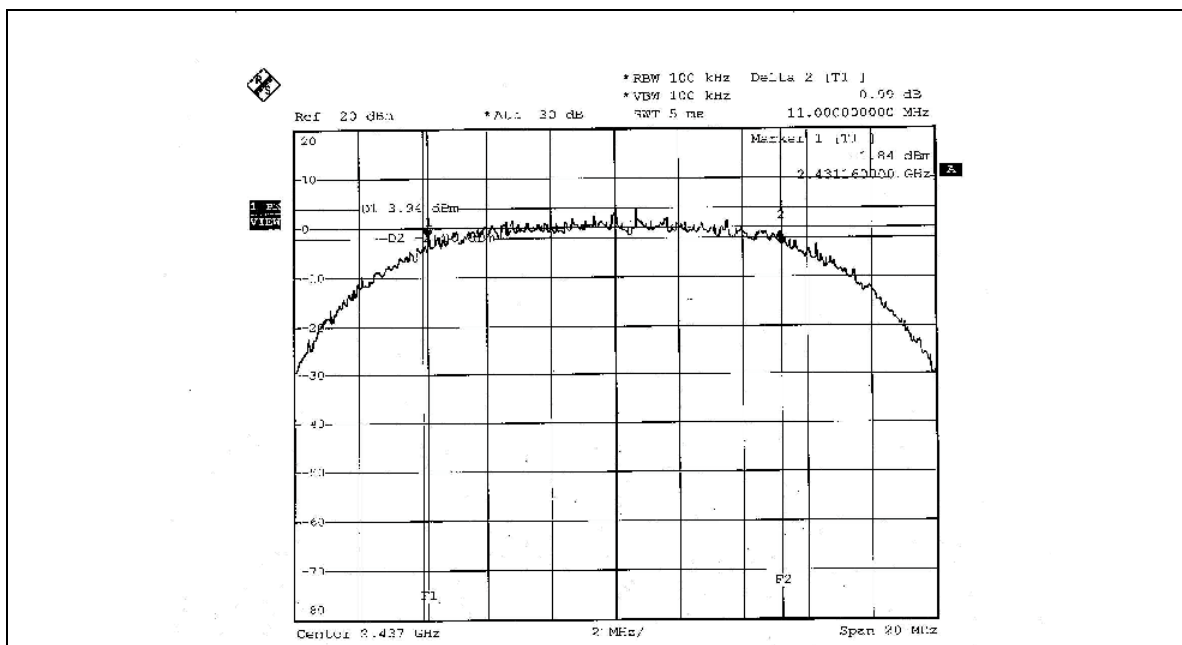





CH 11

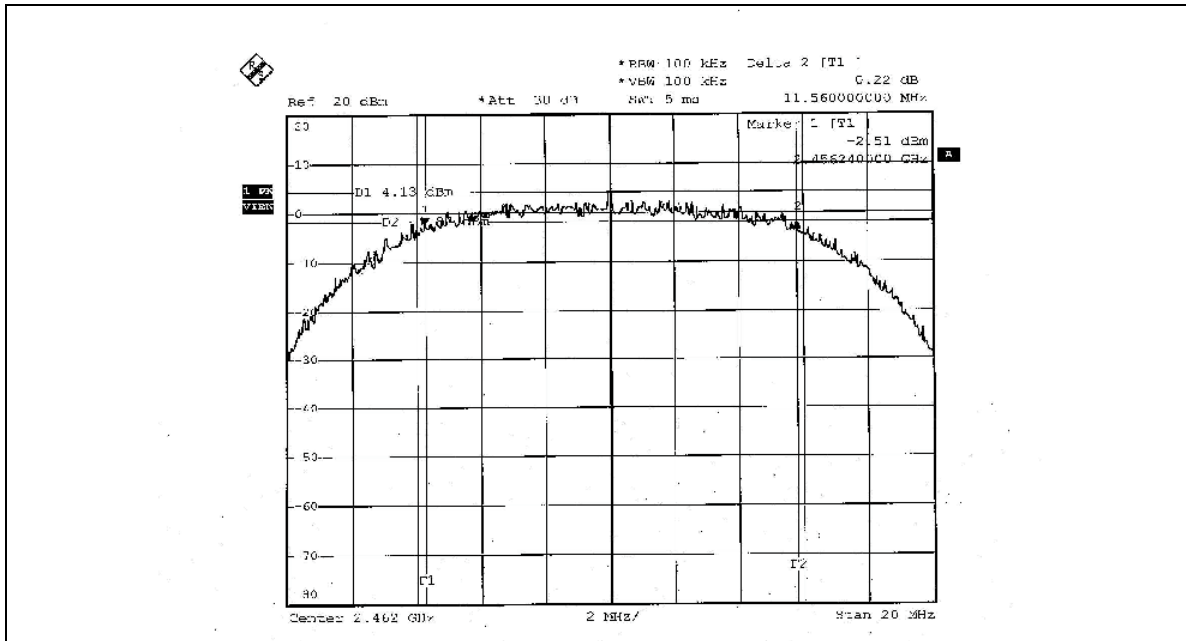



**802.11g OFDM modulation**

|                             |                            |                                 |                        |
|-----------------------------|----------------------------|---------------------------------|------------------------|
| <b>EUT</b>                  | AirMagnet SmartEdge Sensor | <b>MODEL</b>                    | A5020                  |
| <b>MODULATION TYPE</b>      | BPSK                       | <b>TRANSFER RATE</b>            | 6Mbps                  |
| <b>INPUT POWER (SYSTEM)</b> | 120Vac, 60 Hz              | <b>ENVIRONMENTAL CONDITIONS</b> | 23deg.C, 60%RH, 985hPa |
| <b>TESTED BY</b>            | Gary Chang                 |                                 |                        |

| <b>CHANNEL</b> | <b>CHANNEL FREQUENCY (MHz)</b> | <b>6dB BANDWIDTH (MHz)</b> | <b>MINIMUM LIMIT (MHz)</b> | <b>PASS/FAIL</b> |
|----------------|--------------------------------|----------------------------|----------------------------|------------------|
| 1              | 2412                           | 16.44                      | 0.5                        | PASS             |
| 6              | 2437                           | 16.40                      | 0.5                        | PASS             |
| 11             | 2462                           | 16.40                      | 0.5                        | PASS             |



CH 1

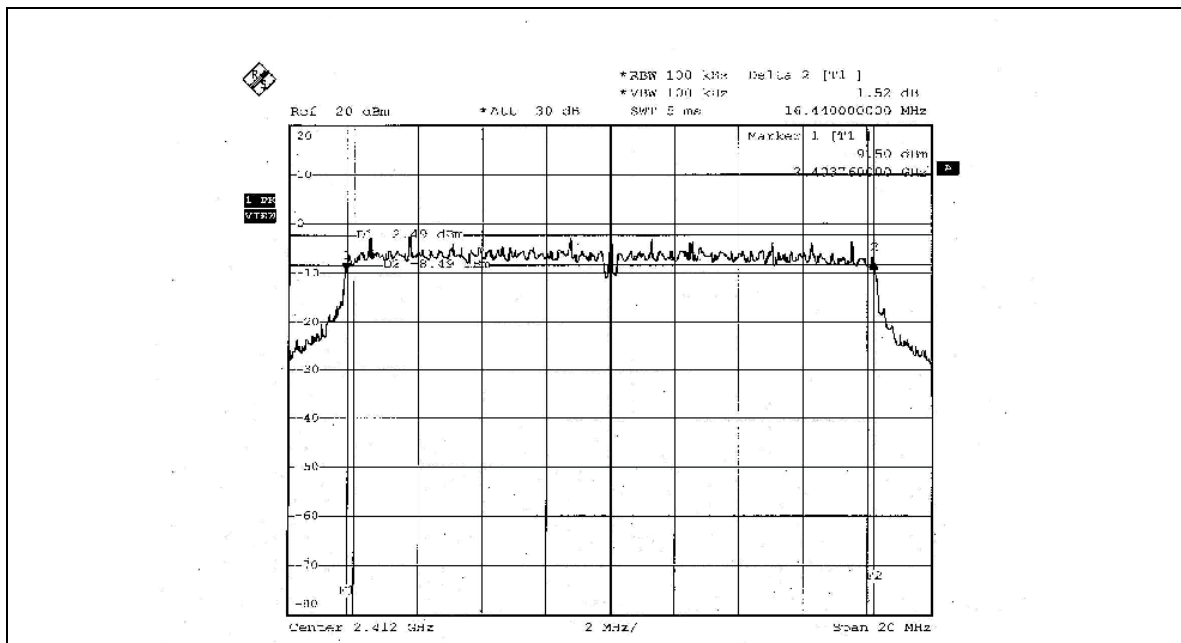

CH 6

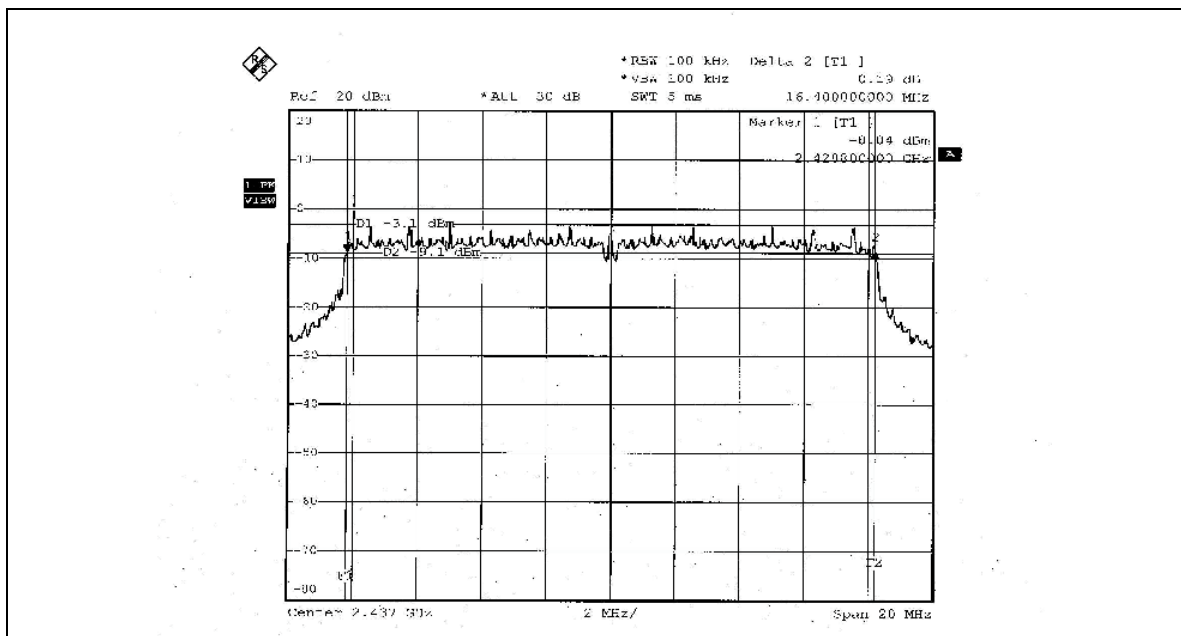



CH 11

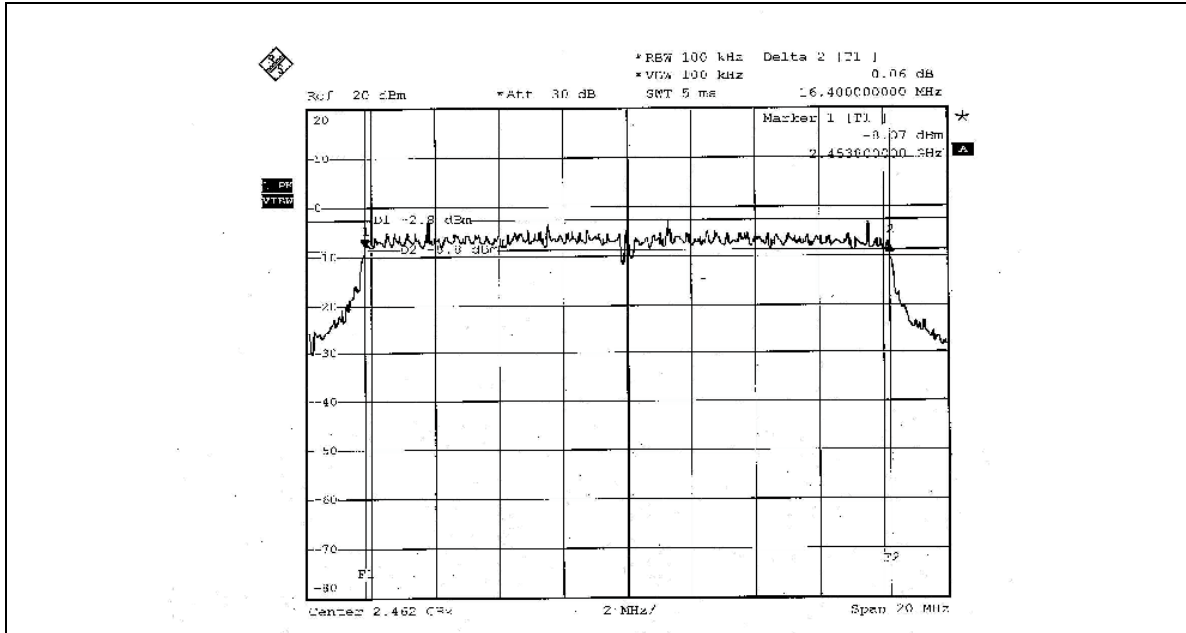



#### 4.4 MAXIMUM PEAK OUTPUT POWER

##### 4.4.1 LIMITS OF MAXIMUM PEAK OUTPUT POWER MEASUREMENT

The Maximum Peak Output Power Measurement is 30dBm.

##### 4.4.2 INSTRUMENTS

| Description & Manufacturer | Model No. | Serial No. | Calibrated Until |
|----------------------------|-----------|------------|------------------|
| R&S SPECTRUM ANALYZER      | FSEK30    | 100049     | Aug. 14, 2006    |
| AGILENT SIGNAL GENERATOR   | E8257C    | MY43320668 | Dec. 31, 2005    |
| TEKTRONIX OSCILLOSCOPE     | TDS 1012  | C019167    | Feb. 01, 2006    |
| NARDA DETECTOR             | 4503A     | FSCM99899  | NA               |

**NOTE:**

The calibration interval of the above test instruments is 12 months and the calibrations are traceable to NML/ROC and NIST/USA.



#### 4.4.1 TEST PROCEDURES

1. A detector was used on the output port of the EUT. An oscilloscope was used to read the response of the detector.
2. Replaced the EUT by the signal generator. The center frequency of the S.G was adjusted to the center frequency of the measured channel.
3. Adjusted the power to have the same reading on oscilloscope. Record the power level.

#### 4.4.2 DEVIATION FROM TEST STANDARD

No deviation

#### 4.4.3 TEST SETUP



#### 4.4.4 EUT OPERATING CONDITIONS

Same as Item 4.3.6

## 4.4.3 TEST RESULTS

## 802.11b DSSS modulation

|                             |                            |                                 |                        |
|-----------------------------|----------------------------|---------------------------------|------------------------|
| <b>EUT</b>                  | AirMagnet SmartEdge Sensor | <b>MODEL</b>                    | A5020                  |
| <b>MODULATION TYPE</b>      | CCK                        | <b>TRANSFER RATE</b>            | 11Mbps                 |
| <b>INPUT POWER (SYSTEM)</b> | 120Vac, 60 Hz              | <b>ENVIRONMENTAL CONDITIONS</b> | 23deg.C, 60%RH, 985hPa |
| <b>TESTED BY</b>            | Gary Chang                 |                                 |                        |

| CHANNEL | CHANNEL FREQUENCY (MHz) | PEAK POWER OUTPUT (mW) | PEAK POWER OUTPUT (dBm) | PEAK POWER LIMIT (dBm) | PASS/FAIL |
|---------|-------------------------|------------------------|-------------------------|------------------------|-----------|
| 1       | 2412                    | 50.186                 | 17.06                   | 30                     | PASS      |
| 6       | 2437                    | 51.168                 | 17.09                   | 30                     | PASS      |
| 11      | 2462                    | 50.350                 | 17.02                   | 30                     | PASS      |

## 802.11g OFDM modulation

|                             |                            |                                 |                        |
|-----------------------------|----------------------------|---------------------------------|------------------------|
| <b>EUT</b>                  | AirMagnet SmartEdge Sensor | <b>MODEL</b>                    | A5020                  |
| <b>MODULATION TYPE</b>      | BPSK                       | <b>TRANSFER RATE</b>            | 6Mbps                  |
| <b>INPUT POWER (SYSTEM)</b> | 120Vac, 60 Hz              | <b>ENVIRONMENTAL CONDITIONS</b> | 23deg.C, 60%RH, 985hPa |
| <b>TESTED BY</b>            | Gary Chang                 |                                 |                        |

| CHANNEL | CHANNEL FREQUENCY (MHz) | PEAK POWER OUTPUT (mW) | PEAK POWER OUTPUT (dBm) | PEAK POWER LIMIT (dBm) | PASS/FAIL |
|---------|-------------------------|------------------------|-------------------------|------------------------|-----------|
| 1       | 2412                    | 25.293                 | 14.03                   | 30                     | PASS      |
| 6       | 2437                    | 25.586                 | 14.08                   | 30                     | PASS      |
| 11      | 2462                    | 25.410                 | 14.05                   | 30                     | PASS      |



## 4.5 POWER SPECTRAL DENSITY MEASUREMENT

### 4.5.1 LIMITS OF POWER SPECTRAL DENSITY MEASUREMENT

The Maximum of Power Spectral Density Measurement is 8dBm.

### 4.5.2 TEST INSTRUMENTS

| Description & Manufacturer | Model No. | Serial No. | Calibrated Until |
|----------------------------|-----------|------------|------------------|
| R&S SPECTRUM ANALYZER      | FSEK30    | 100049     | Aug. 14, 2006    |

**NOTE:**

The calibration interval of the above test instruments is 12 months and the calibrations are traceable to NML/ROC and NIST/USA.



#### 4.5.3 TEST PROCEDURE

The transmitter output was connected to the spectrum analyzer through an attenuator, the bandwidth of the fundamental frequency was measured with the spectrum analyzer using 3kHz RBW and 30kHz VBW, set sweep time = span/3kHz. The power spectral density was measured and recorded.

The sweep time is allowed to be longer than span/3kHz for a full response of the mixer in the spectrum analyzer.

#### 4.5.4 DEVIATION FROM TEST STANDARD

No deviation

#### 4.5.5 TEST SETUP

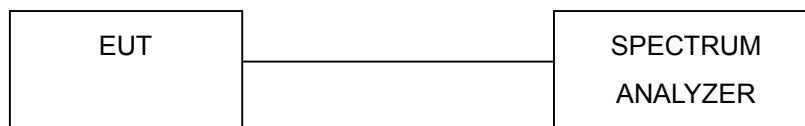

#### 4.5.6 EUT OPERATING CONDITION

Same as Item 4.3.6

## 4.5.7 TEST RESULTS

## 802.11b DSSS modulation

|                             |                            |                                 |                        |
|-----------------------------|----------------------------|---------------------------------|------------------------|
| <b>EUT</b>                  | AirMagnet SmartEdge Sensor | <b>MODEL</b>                    | A5020                  |
| <b>MODULATION TYPE</b>      | CCK                        | <b>TRANSFER RATE</b>            | 11Mbps                 |
| <b>INPUT POWER (SYSTEM)</b> | 120Vac, 60 Hz              | <b>ENVIRONMENTAL CONDITIONS</b> | 23deg.C, 60%RH, 985hPa |
| <b>TESTED BY</b>            | Gary Chang                 |                                 |                        |

| CHANNEL | CHANNEL FREQUENCY (MHz ) | RF POWER LEVEL IN 3kHz BW (dBm) | MAXIMUM LIMIT (dBm) | PASS/FAIL |
|---------|--------------------------|---------------------------------|---------------------|-----------|
| 1       | 2412                     | -2.33                           | 8                   | PASS      |
| 6       | 2437                     | -2.94                           | 8                   | PASS      |
| 11      | 2462                     | -2.67                           | 8                   | PASS      |



CH 1

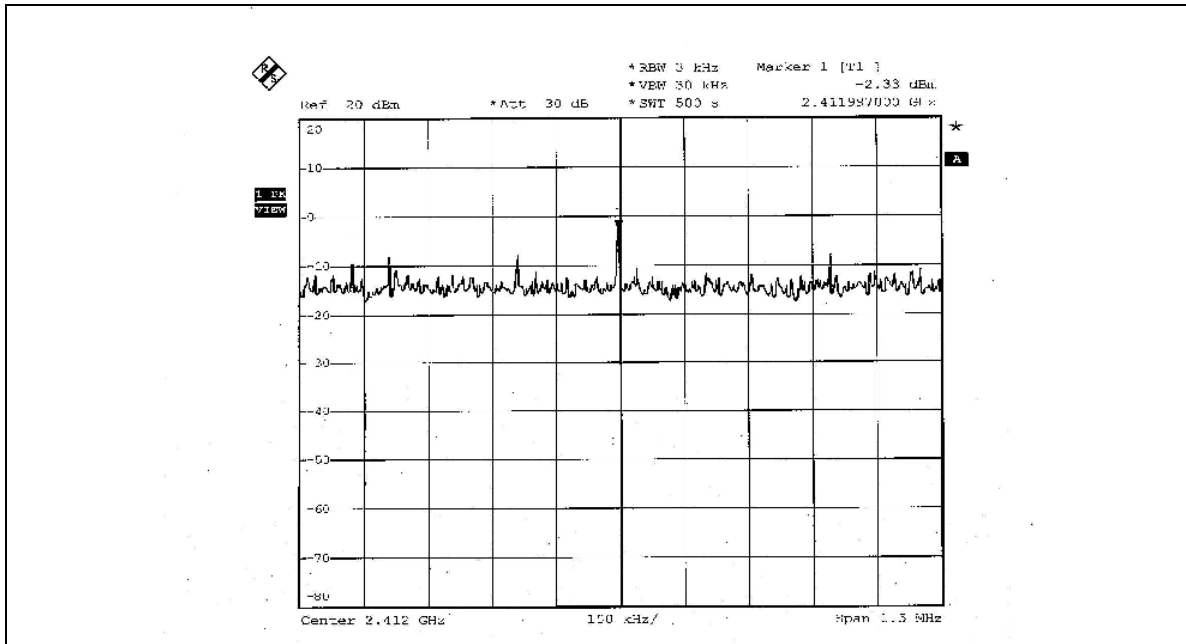

CH 6

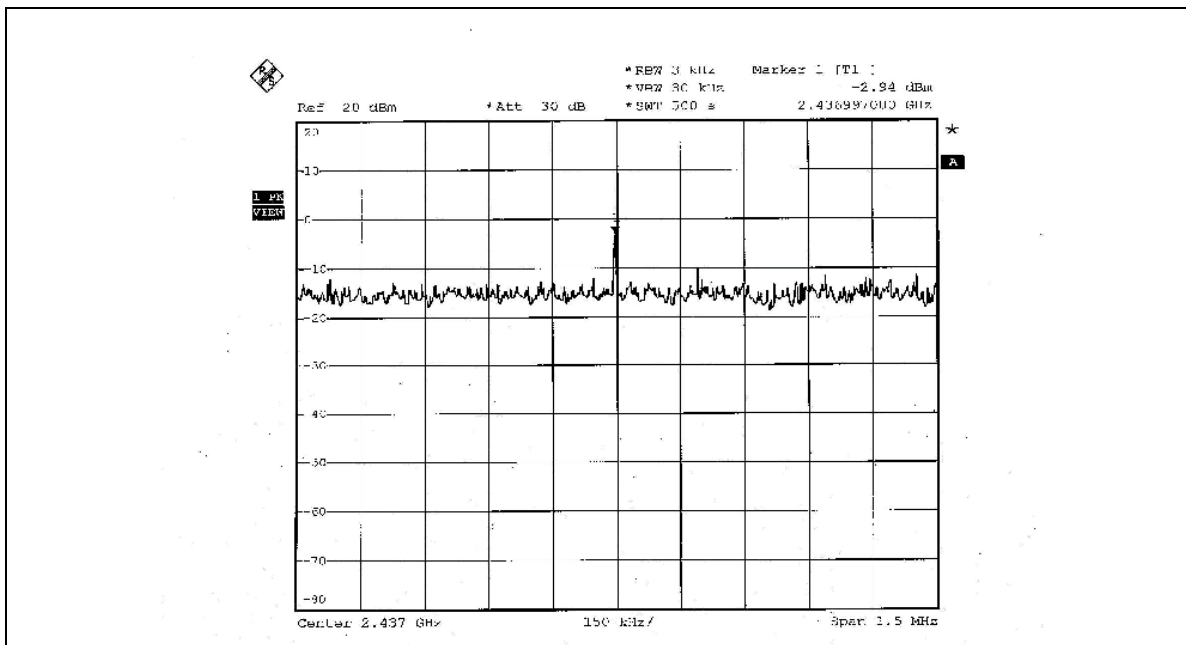



CH 11

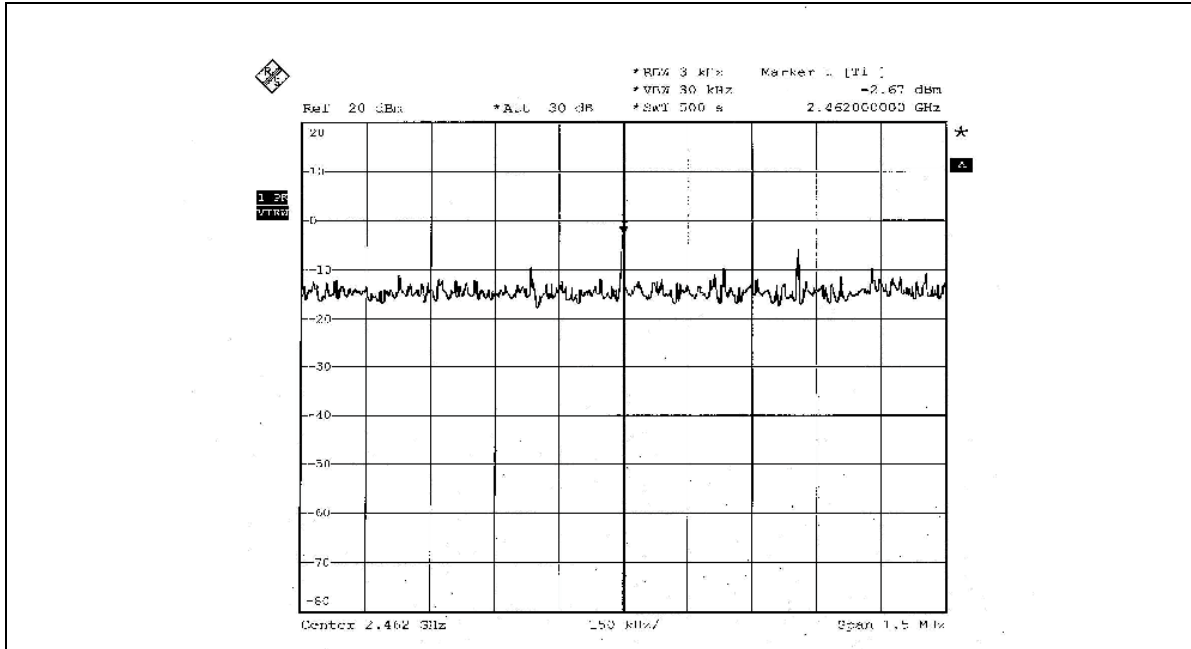



### 802.11g OFDM modulation

|                             |                            |                                 |                        |
|-----------------------------|----------------------------|---------------------------------|------------------------|
| <b>EUT</b>                  | AirMagnet SmartEdge Sensor | <b>MODEL</b>                    | A5020                  |
| <b>MODULATION TYPE</b>      | BPSK                       | <b>TRANSFER RATE</b>            | 6Mbps                  |
| <b>INPUT POWER (SYSTEM)</b> | 120Vac, 60 Hz              | <b>ENVIRONMENTAL CONDITIONS</b> | 23deg.C, 60%RH, 985hPa |
| <b>TESTED BY</b>            | Gary Chang                 |                                 |                        |

| CHANNEL | CHANNEL FREQUENCY (MHz ) | RF POWER LEVEL IN 3kHz BW (dBm) | MAXIMUM LIMIT (dBm) | PASS/FAIL |
|---------|--------------------------|---------------------------------|---------------------|-----------|
| 1       | 2412                     | -5.58                           | 8                   | PASS      |
| 6       | 2437                     | -5.81                           | 8                   | PASS      |
| 11      | 2462                     | -5.98                           | 8                   | PASS      |



CH 1

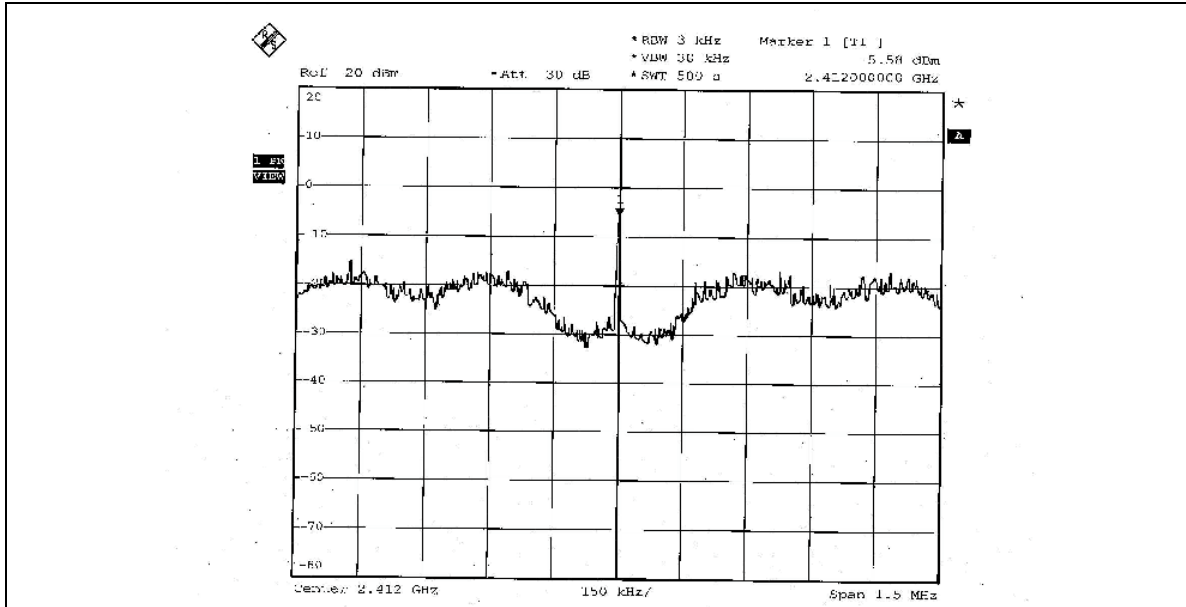

CH 6

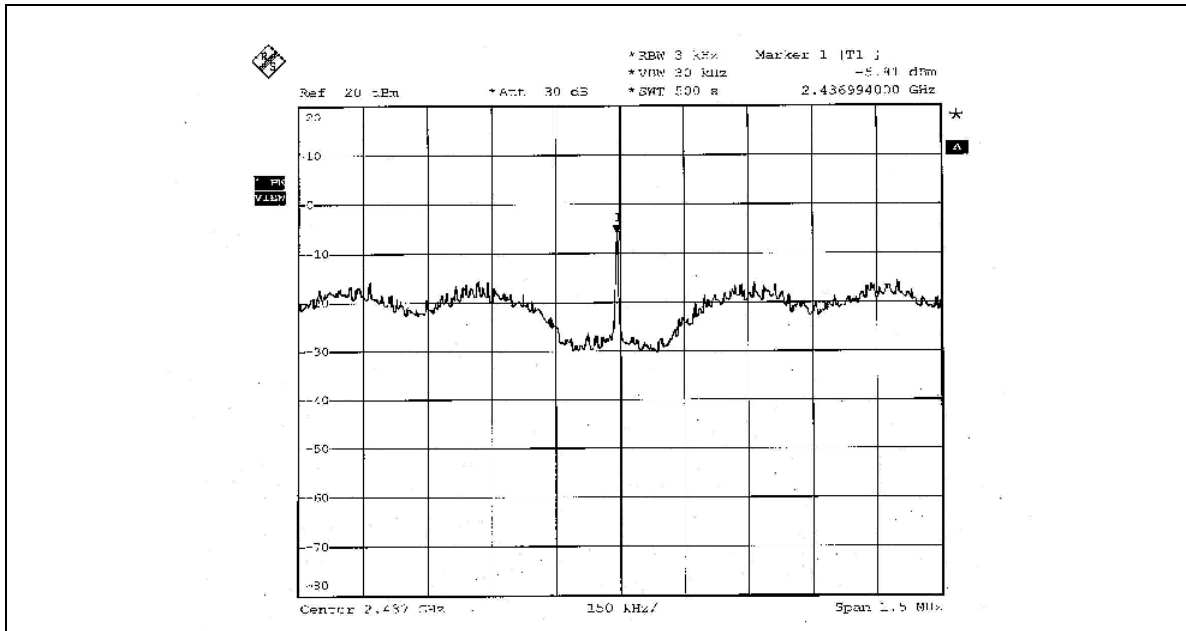



CH 11

