



Test report No:  
2250816R-HP-US-P01V03

## SAR TEST REPORT

Product	Touch All In One Computer
Product Name / Model No.	Elo
Trademark	ESY1514
FCC ID	RBWESY14SV
IC	10757B-ESY14SV
Applicant's name / address	Elo Touch Solutions, Inc 670 N. McCarthy Blvd., Suite 100, Milpitas, CA 95035, USA.
Test method requested, standard	FCC KDB Publication 248227 D01v02r02 FCC KDB Publication 447498 D01v06 FCC KDB Publication 865664 D01v01r04 IEEE Std. 1528-2013 FCC 47CFR §2.1093 ANSI C95.1-2005 RSS 102: Issue 5
Maximum SAR	ESY1514: Standalone SAR 1.193W/kg; Simultaneous SAR 1.350W/kg
Verdict Summary	IN COMPLIANCE
Tested by (name / position & signature)	Tim Cao/Project Engineer  <i>Tim Cao</i>
Approved by (name / position & signature)	Jack Zhang/ Manager  <i>Jack Zhang</i>
Date of issue	2022-09-16
Report template No	Template_FCC SAR-RF-V1.0

---

FCC Designation Number	CN1199
ISED CAB identifier	CN0040

## INDEX

	Page
<b>COMPETENCES AND GUARANTEES</b> .....	<b>5</b>
<b>GENERAL CONDITIONS</b> .....	<b>5</b>
<b>ENVIRONMENTAL CONDITIONS</b> .....	<b>6</b>
<b>POSSIBLE TEST CASE VERDICTS</b> .....	<b>6</b>
<b>DOCUMENT HISTORY</b> .....	<b>7</b>
<b>REMARKS AND COMMENTS</b> .....	<b>7</b>
<b>1 GENERAL INFORMATION</b> .....	<b>8</b>
1.1 GENERAL DESCRIPTION OF THE ITEM(S) .....	8
1.2 ANTENNA INFORMATION .....	10
<b>2 SAR MEASUREMENT SYSTEM</b> .....	<b>13</b>
2.1 DASYS SYSTEM DESCRIPTION.....	13
2.1.1 Applications .....	14
2.1.2 Area Scans .....	14
2.1.3 Zoom Scan (Cube Scan Averaging).....	14
2.1.4 Uncertainty of Inter-/Extrapolation and Averaging.....	15
2.2 DASYS E-FIELD PROBE .....	16
2.3 BOUNDARY DETECTION UNIT AND PROBE MOUNTING DEVICE .....	17
2.4 DATA ACQUISITION ELECTRONICS (DAE) AND MEASUREMENT SERVER.....	17
2.5 ROBOT.....	18
2.6 LIGHT BEAM UNIT .....	18
2.7 DEVICE HOLDER .....	19
2.8 SAM TWIN PHANTOM .....	20
SAM TWIN PHANTOM.....	20
ELI PHANTOM .....	20
<b>3 TISSUE SIMULATING LIQUID</b> .....	<b>21</b>
3.1 THE COMPOSITION OF THE TISSUE SIMULATING LIQUID .....	21
3.2 TISSUE CALIBRATION RESULT.....	22
3.3 TISSUE DIELECTRIC PARAMETERS FOR HEAD AND BODY PHANTOMS .....	25
<b>4 SAR MEASUREMENT PROCEDURE</b> .....	<b>26</b>
4.1 SAR SYSTEM VALIDATION .....	26
4.1.1 Validation Dipoles .....	26

---

4.1.2.	Validation Result .....	27
4.2	SAR MEASUREMENT PROCEDURE .....	28
<b>5</b>	<b>SAR EXPOSURE LIMITS .....</b>	<b>29</b>
<b>6</b>	<b>TEST EQUIPMENT LIST .....</b>	<b>30</b>
<b>7</b>	<b>MEASUREMENT UNCERTAINTY .....</b>	<b>31</b>
<b>8</b>	<b>POWER TEST RESULTS .....</b>	<b>33</b>
<b>9</b>	<b>SAR TEST RESULTS.....</b>	<b>49</b>
9.1	STANDALONE SAR .....	49
9.2	TEST POSITION AND CONFIGURATION .....	53
9.3	SAR TEST EXCLUSIONS APPLIED .....	54
9.4	SIMULTANEOUS TRANSMISSION ANALYSIS .....	55
<b>APPENDIX A.</b>	<b>SAR VALIDATION DATA .....</b>	<b>56</b>
<b>APPENDIX B.</b>	<b>SAR TEST DATA.....</b>	<b>60</b>
<b>APPENDIX C.</b>	<b>PROBE CALIBRATION DATA.....</b>	<b>65</b>
<b>DIPOLE CALIBRATION DATA .....</b>		<b>74</b>
<b>APPENDIX E.</b>	<b>DAE CALIBRATION DATA .....</b>	<b>88</b>

## COMPETENCES AND GUARANTEES

DEKRA is a testing laboratory competent to carry out the tests described in this report.

In order to assure the traceability to other national and international laboratories, DEKRA has a calibration and maintenance program for its measurement equipment.

DEKRA guarantees the reliability of the data presented in this report, which is the result of the measurements and the tests performed to the item under test on the date and under the conditions stated in the report and it is based on the knowledge and technical facilities available at DEKRA at the time of performance of the test.

DEKRA is liable to the client for the maintenance of the confidentiality of all information related to the item under test and the results of the test.

The results presented in this Test Report apply only to the particular item under test established in this document.

**IMPORTANT:** No parts of this report may be reproduced or quoted out of context, in any form or by any means, except in full, without the previous written permission of DEKRA.

## GENERAL CONDITIONS

Test Location	No. 99, Hongye Road, Suzhou Industrial Park Suzhou, 215006, P.R. China
Date(receive sample)	May. 30, 2022
Date (start test)	May. 31, 2022
Date (finish test)	Aug. 08, 2022

1. This report is only referred to the item that has undergone the test.
2. This report does not constitute or imply on its own an approval of the product by the Certification Bodies or Competent Authorities.
3. This document is only valid if complete; no partial reproduction can be made without previous written permission of DEKRA.
4. This test report cannot be used partially or in full for publicity and/or promotional purposes without previous written permission of DEKRA.

## ENVIRONMENTAL CONDITIONS

The climatic conditions during the tests are within the limits specified by the manufacturer for the operation of the EUT and the test equipment. The climatic conditions during the tests were within the following limits:

Ambient temperature	18 °C – 25 °C
Relative Humidity air	30% - 60%

If explicitly required in the basic standard or applied product / product family standard the climatic values are recorded and documented separately in this test report.

## POSSIBLE TEST CASE VERDICTS

Test case does not apply to test object	N/A
Test object does meet requirement	P (Pass) / PASS
Test object does not meet requirement	F (Fail) / FAIL
Not measured	N/M

## DOCUMENT HISTORY

Report No.	Version	Description	Issued Date
2250816R-HP-US-P01V03	V1.0	Initial issue of report.	2022-09-16

## REMARKS AND COMMENTS

1. The equipment under test (EUT) does meet the essential requirements of the stated standard(s)/test(s).
2. These test results on a sample of the device are for the purpose of demonstrating Compliance with FCC Part 2.1093.
3. The measurement result is considered in conformance with the requirement if it is within the prescribed limit, It is not necessary to account the uncertainty associated with the measurement result.
4. The test results presented in this report relate only to the object tested.
5. The test report shall not be reproduced without the written approval of DEKRA Testing and Certification (Suzhou) Co., Ltd.
6. This report will not be used for social proof function in China market.
7. DEKRA declines any responsibility with the following test data provided by customer that may affect the validity of result:
  - Chapter 1.1 General Description of the Item(s);
  - Chapter 1.2 Antenna Information.

# 1 General Information

## 1.1 General Description of the Item(s)

Product Name	Touch All In One Computer					
Model No.	ESY15I4					
HVIN	ESYI4SV					
Hardware Version	R05					
Software Version	Android 10					
FCC ID	RBWESYI4SV					
IC	10757B-ESYI4SV					
Manufacturer	Elo Touch Solutions, Inc					
Manufacturer Address	670 N. McCarthy Blvd., Suite 100, Milpitas, CA 95035, USA.					
EUT Voltage	19 Vdc and POE 44-57V for ESY10I4, ESY15I4, ESY22I4, ESY15I4-C					
Frequency Range	For 2.4GHz Band 802.11b/g/n(20MHz): 2400~2483.5MHz					
Channel Number	For 2.4GHz Band 802.11b/g/n(20MHz): 11					
Type of Modulation	802.11b: DSSS-DBPSK, DQPSK, CCK 802.11g/n: OFDM-BPSK, QPSK, 16QAM, 64QAM					
Data Rate	802.11b: 1/2/5.5/11 Mbps 802.11g: 6/9/12/18/24/36/48/54 Mbps 802.11n: up to 144.4 Mbps					
Frequency Range	5GHz Band					
Type of Modulation	OFDM-BPSK, QPSK, 16QAM, 64QAM, 256QAM					
Data Rate	802.11a: 6/9/12/18/24/36/48/54Mbps 802.11n: up to 300Mbps 802.11ac: up to 866.6Mbps					
Channel Control	Auto					
Transmit modes	<input checked="" type="checkbox"/>	802.11a	<input checked="" type="checkbox"/>	802.11n(20MHz)	<input checked="" type="checkbox"/>	802.11n(40MHz)
	<input checked="" type="checkbox"/>	802.11ac(20MHz)	<input checked="" type="checkbox"/>	802.11ac(40MHz)	<input checked="" type="checkbox"/>	802.11ac(80MHz)
Support Bands	<input type="checkbox"/>	5150MHz~5250MHz	<input type="checkbox"/>	Outdoor AP		
	<input type="checkbox"/>		<input type="checkbox"/>	Indoor AP		
	<input type="checkbox"/>		<input type="checkbox"/>	Fixed point-to-point AP		
	<input checked="" type="checkbox"/>		<input checked="" type="checkbox"/>	Mobile and Portable Client		
	<input checked="" type="checkbox"/>	5250MHz~5350MHz				
	<input checked="" type="checkbox"/>	5470MHz~5725MHz for FCC	<input checked="" type="checkbox"/>	With TDWR Channels		
			<input type="checkbox"/>	Without TDWR Channels		



	<input checked="" type="checkbox"/>	5470MHz~5600MHz and 5600MHz~5650MHz for ISED
	<input checked="" type="checkbox"/>	5725MHz~5850MHz

Wireless specification	Bluetooth					
Bluetooth Specification	V3.0					
Frequency Range	2400~2483.5MHz					
Type of Modulation	GFSK					
PHYs	<input checked="" type="checkbox"/>	GFSK	<input checked="" type="checkbox"/>	Pi/4 DQPSK	<input checked="" type="checkbox"/>	8DPSK
Data Rate	<input checked="" type="checkbox"/>	1Mbit/s	<input checked="" type="checkbox"/>	2Mbit/s	<input checked="" type="checkbox"/>	3Mbit/s
Number of channel	79					
Wireless specification	Bluetooth 5.0					
Frequency Range	2400~2483.5MHz					
Type of Modulation	GFSK					
PHYs	<input checked="" type="checkbox"/>	LE 1M	<input checked="" type="checkbox"/>	LE 2M	<input type="checkbox"/>	LE Coded S=2/8
Data Rate	<input checked="" type="checkbox"/>	1Mbit/s	<input checked="" type="checkbox"/>	2Mbit/s	<input type="checkbox"/>	500/125 Kbit/s
Number of channel	40					
Temperature Range	0°C~40°C					

## 1.2 Antenna Information

### WLAN Antenna

#### 2.4GHz

Antenna model / type number .....	N/A		
Antenna serial number .....	N/A		
Antenna Delivery .....	<input checked="" type="checkbox"/>	1TX + 1RX	
	<input checked="" type="checkbox"/>	2TX + 2RX	
	<input type="checkbox"/>	Others:.....	
Antenna technology .....	<input checked="" type="checkbox"/>	SISO	
	<input checked="" type="checkbox"/>	MIMO	<input checked="" type="checkbox"/> CDD
			<input type="checkbox"/> Beam-forming
Antenna Type.....	<input type="checkbox"/>	External	<input type="checkbox"/> Dipole
			<input type="checkbox"/> Sectorized
	<input checked="" type="checkbox"/>	Internal	<input checked="" type="checkbox"/> PIFA
			<input type="checkbox"/> PCB
			<input type="checkbox"/> Metal Antenna
			<input type="checkbox"/> Others:.....

**5GHz**

Antenna model / type number .. :	N/A		
Antenna serial number .....	N/A		
Antenna Delivery .....	<input checked="" type="checkbox"/>	1TX + 1RX	
	<input checked="" type="checkbox"/>	2TX + 2RX	
	<input type="checkbox"/>	Others:.....	
Antenna technology .....	<input checked="" type="checkbox"/>	SISO	
	<input checked="" type="checkbox"/>	MIMO	<input checked="" type="checkbox"/> CDD
			<input type="checkbox"/> Beam-forming
Antenna Type .....	<input type="checkbox"/>	External	<input type="checkbox"/> Dipole
			<input type="checkbox"/> Sectorized
	<input checked="" type="checkbox"/>	Internal	<input checked="" type="checkbox"/> PIFA
			<input type="checkbox"/> PCB
			<input type="checkbox"/> Metal Antenna
		<input type="checkbox"/> Others.....	

### Antenna Location Map

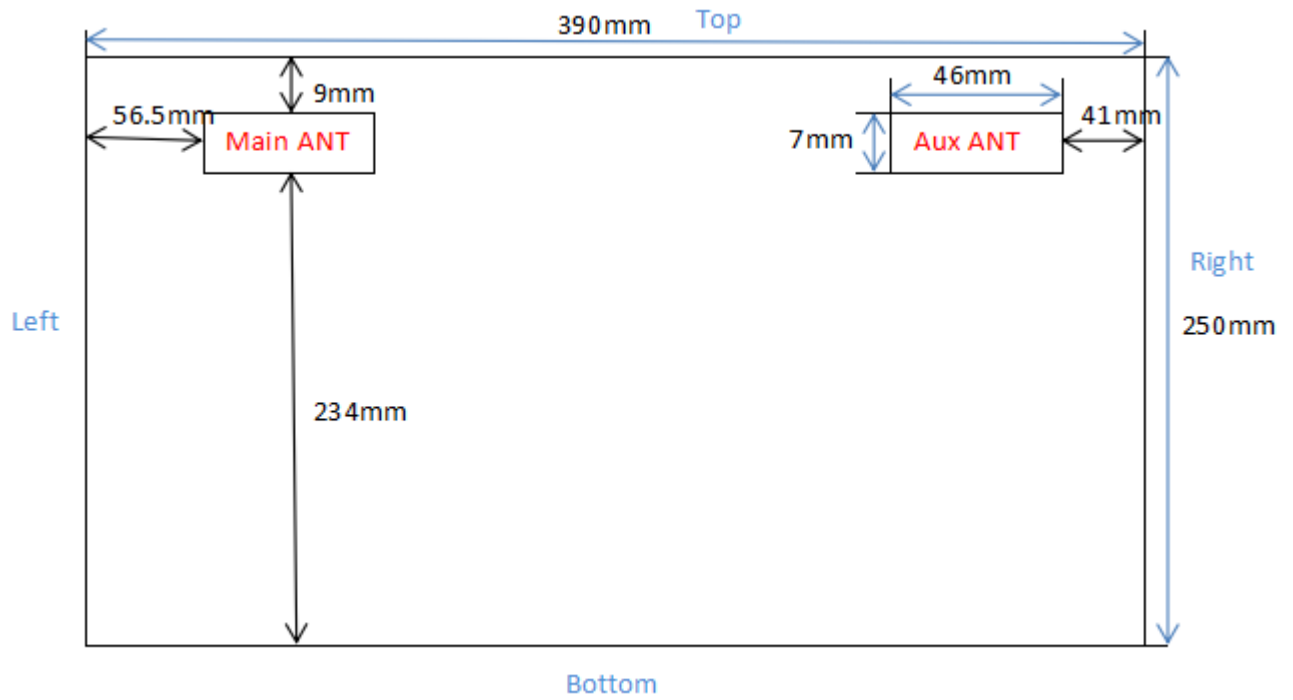

## 2 SAR MEASUREMENT SYSTEM

### 2.1 DASY5 System Description

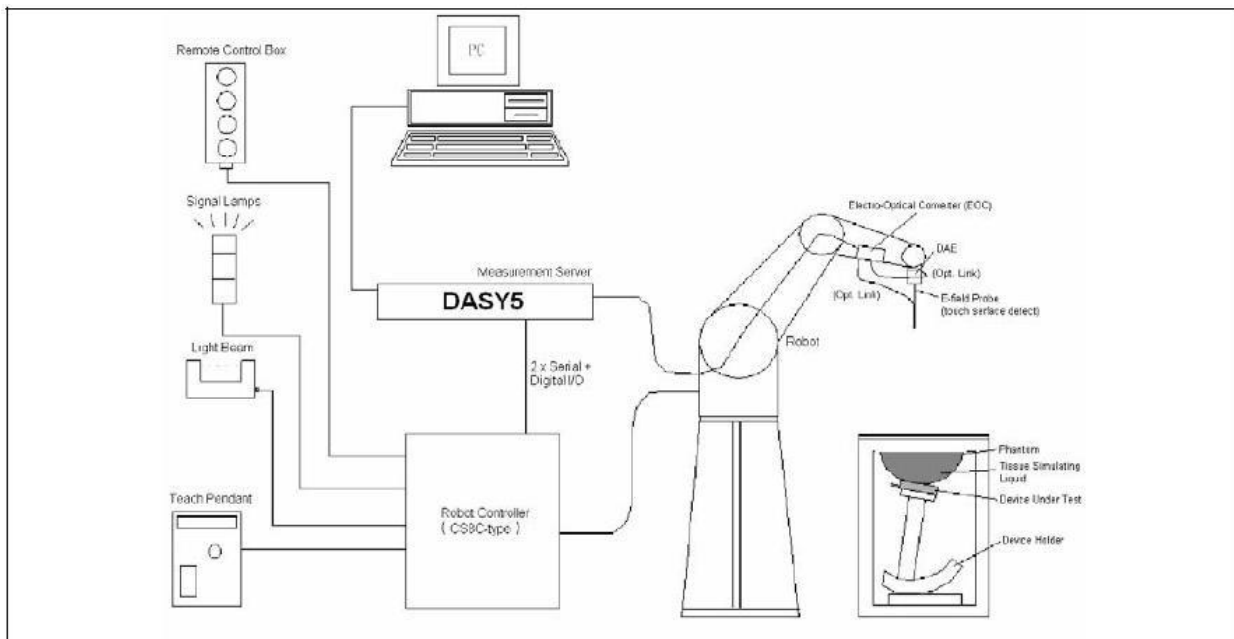

The DASY5 system for performing compliance tests consists of the following items:

1. A standard high precision 6-axis robot with controller, teach pendant and software. An arm extension for accommodating the data acquisition electronics (DAE).
2. A data acquisition electronics (DAE) which performs the signal amplification, signal multiplexing, AD-conversion, offset measurements, mechanical surface detection, collision detection, etc. The unit is battery powered with standard or rechargeable batteries. The signal is optically transmitted to the EOC.
3. The Electro-optical converter (EOC) performs the conversion from optical to electrical signals for the digital communication to the DAE. To use optical surface detection, a special version of the EOC is required. The EOC signal is transmitted to the measurement server.
4. The Light Beam used is for probe alignment. This improves the (absolute) accuracy of the probe positioning.
5. A computer running WinXP and the DASY5 software.
6. Remote control and teach pendant as well as additional circuitry for robot safety such as warning lamps, etc.
7. The phantom, the device holder and other accessories according to the targeted measurement.

### **2.1.1. Applications**

Predefined procedures and evaluations for automated compliance testing with all worldwide standards, e.g., IEEE 1528, OET 65, IEC 62209-1, IEC 62209-2, EN 50360, EN 50383, EN62311 and others.

### **2.1.2. Area Scans**

Area scans are defined prior to the measurement process being executed with a user defined variable spacing between each measurement point (integral) allowing low uncertainty measurements to be conducted. Scans defined for FCC applications utilize a 10mm<sup>2</sup> step integral, with 1mm interpolation used to locate the peak SAR area used for zoom scan assessments.

When an Area Scan has measured all reachable points, it computes the field maxima found in the scanned area, within a range of the global maximum. The range (in dB) is specified in the standards for compliance testing. For example, a 2 dB range is required in IEEE 1528-2003 and IEC 62209 standards, whereby 3 dB is a requirement when compliance is assessed in accordance with the ARIB standard (Japan).

### **2.1.3. Zoom Scan (Cube Scan Averaging)**

Zoom Scans are used to assess the peak spatial SAR values within a cubic averaging volume containing 1 g and 10 g of simulated tissue. A density of 1000 kg/m<sup>3</sup> is used to represent the head and body tissue density and not the phantom liquid density, in order to be consistent with the definition of the liquid dielectric properties, i.e. the side length of the 1 g cube is 10mm, with the side length of the 10 g cube 21,5mm.

The zoom scan integer steps can be user defined so as to reduce uncertainty, but normal practice for typical test applications utilize a physical step of 7x7x7 (5mmx5mmx5mm) providing a volume of 30mm in the X & Y axis, and 30mm in the Z axis.

#### 2.1.4. Uncertainty of Inter-/Extrapolation and Averaging

In order to evaluate the uncertainty of the interpolation, extrapolation and averaged SAR calculation algorithms of the Postprocessor, DASYS5 allows the generation of measurement grids which are artificially predefined by analytically based test functions. Therefore, the grids of area scans and zoom scans can be filled with uncertainty test data, according to the SAR benchmark functions of IEEE 1528. The three analytical functions shown in equations as below are used to describe the possible range of the expected SAR distributions for the tested handsets. The field gradients are covered by the spatially flat distribution f1, the spatially steep distribution f3 and f2 accounts for H-field cancellation on the phantom/tissue surface.

$$f_1(x, y, z) = Ae^{-\frac{z}{2a}} \cos^2 \left( \frac{\pi \sqrt{x'^2 + y'^2}}{2 \cdot 5a} \right)$$

$$f_2(x, y, z) = Ae^{-\frac{z}{a}} \frac{a^2}{a^2 + x'^2} \left( 3 - e^{-\frac{2z}{a}} \right) \cos^2 \left( \frac{\pi y'}{2 \cdot 3a} \right)$$

$$f_3(x, y, z) = A \frac{a^2}{\frac{a^2}{4} + x'^2 + y'^2} \left( e^{-\frac{2z}{a}} + \frac{a^2}{2(a + 2z)^2} \right)$$

## 2.2 DASYS E-Field Probe

The SAR measurement is conducted with the dosimetric probe manufactured by SPEAG. The probe is specially designed and calibrated for use in liquid with high permittivity. The dosimetric probe has special calibration in liquid at different frequency.

SPEAG conducts the probe calibration in compliance with international and national standards (e.g. IEEE 1528, EN 62209-1, IEC 62209, etc.) under ISO 17025. The calibration data are in Appendix D.

<b>Model</b>	EX3DV4	
<b>Construction</b>	Symmetrical design with triangular core Built-in shielding against static charges PEEK enclosure material (resistant to organic solvents, e.g., DGBE)	
<b>Frequency</b>	10 MHz to 6 GHz Linearity: $\pm 0.2$ dB (30 MHz to 6 GHz)	
<b>Directivity</b>	$\pm 0.3$ dB in HSL (rotation around probe axis) $\pm 0.5$ dB in tissue material (rotation normal to probe axis)	
<b>Dynamic Range</b>	10 $\mu$ W/g to 100 mW/g Linearity: $\pm 0.2$ dB (noise: typically $< 1$ $\mu$ W/g)	
<b>Dimensions</b>	Overall length: 330 mm (Tip: 20 mm) Tip diameter: 2.5 mm (Body: 12 mm) Typical distance from probe tip to dipole centers: 1 mm	
<b>Application</b>	High precision dosimetric measurements in any exposure scenario (e.g., very strong gradient fields). Only probe which enables compliance testing for frequencies up to 6 GHz with precision of better 30%.	



## 2.3 Boundary Detection Unit and Probe Mounting Device

The DASY probes use a precise connector and an additional holder for the probe, consisting of a plastic tube and a flexible silicon ring to center the probe. The connector at the DAE is flexibly mounted and held in the default position with magnets and springs. Two switching systems in the connector mount detect frontal and lateral probe collisions and trigger the necessary software response.



## 2.4 DATA Acquisition Electronics (DAE) and Measurement Server

The data acquisition electronics (DAE) consists of a highly sensitive electrometer-grade preamplifier with auto-zeroing, a channel and gain-switching multiplexer, a fast 16 bit AD-converter and a command decoder and control logic unit.

Transmission to the measurement server is accomplished through an optical downlink for data and status information as well as an optical uplink for commands and the clock.

The input impedance of the DAE4 is 200M Ohm; the inputs are symmetrical and floating. Common mode rejection is above 80dB.



The DASY5 measurement server is based on a PC/104 CPU board with a 400MHz intel ULV Celeron, 128MB chipdisk and 128MB RAM. The necessary circuits for communication with the DAE electronics box, as well as the 16 bit AD converter system for optical detection and digital I/O interface are contained on the DASY5 I/O board, which is directly connected to the PC/104 bus of the CPU board.



## 2.5 Robot

The DASY5 system uses the high precision robots TX90 XL type out of the newer series from Stäubli SA (France). For the 6-axis controller DASY5 system, the CS8C robot controller version from Stäubli is used.

The XL robot series have many features that are important for our application:

- High precision (repeatability 0.02 mm)
- High reliability (industrial design)
- Jerk-free straight movements
- Low ELF interference (the closed metallic construction shields against motor control fields)
- 6-axis controller



## 2.6 Light Beam Unit

The light beam switch allows automatic "tooling" of the probe. During the process, the actual position of the probe tip with respect to the robot arm is measured, as well as the probe length and the horizontal probe offset. The software then corrects all movements, such that the robot coordinates are valid for the probe tip.

The repeatability of this process is better than 0.1 mm. If a position has been taught with an aligned probe, the same position will be reached with another aligned probe within 0.1 mm, even if the other probe has different dimensions. During probe rotations, the probe tip will keep its actual position.



## 2.7 Device Holder

The DASY5 device holder is designed to cope with different positions given in the standard. It has two scales for the device rotation (with respect to the body axis) and the device inclination (with respect to the line between the ear reference points). The rotation center for both scales is the ear reference point (EPR).

Thus the device needs no repositioning when changing the angles.

The DASY5 device holder has been made out of low-loss POM material having the following dielectric parameters: relative permittivity  $\epsilon_r = 3$  and loss tangent  $\delta = 0.02$ . The amount of dielectric material has been reduced in the closest vicinity of the device, since measurements have suggested that the influence of the clamp on the test results could thus be lowered.



The extension is lightweight and made of POM, acrylic glass and foam. It fits easily on the upper part of the mounting device in place of the phone positioned. The extension is fully compatible with the SAM Twin and ELI phantoms.

The DASY5 device holder has been made out of low-loss POM material having the following dielectric parameters: relative permittivity  $\epsilon_r = 3$  and loss tangent  $\delta = 0.02$ . The amount of dielectric material has been reduced in the closest vicinity of the device, since measurements have suggested that the influence of the clamp on the test results could thus be lowered.



## 2.8 SAM Twin Phantom

### SAM Twin Phantom

The SAM twin phantom is a fiberglass shell phantom with 2mm shell thickness (except the ear region where shell thickness increases to 6mm). It has three measurement areas:

- Left head
- Right head
- Flat phantom

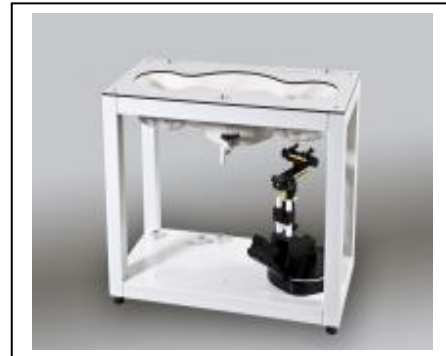

The bottom plate contains three pair of bolts for locking the device holder. The device holder positions are adjusted to the standard measurement positions in the three sections. A white cover is provided to tap the phantom during off-periods to prevent water evaporation and changes in the liquid parameters. On the phantom top, three reference markers are provided to identify the phantom position with respect to the robot.

### ELI Phantom

The SAM phantom is a fiberglass shell phantom with 2mm shell thickness. It has one measurement areas:

- ELI phantom



The ELI phantom is intended for compliance testing of handheld and body-mounted wireless devices in the frequency range of 30 MHz to 6 GHz. ELI4 is fully compatible with standard and all known tissue simulating liquids.

### 3 TISSUE SIMULATING LIQUID

#### 3.1 The composition of the tissue simulating liquid

INGREDIENT (% Weight)	2450MHz Body	5250MHz Body	5600MHz Body	5750MHz Body
Water	73.2	75.68	75.68	75.68
Salt	0.04	0.43	0.43	0.43
Sugar	0.00	0.00	0.00	0.00
HEC	0.00	0.00	0.00	0.00
Preventol	0.00	0.00	0.00	0.00
DGBE	26.76	4.42	4.42	4.42
Triton X-100	0.00	19.47	19.47	19.47

### 3.2 Tissue Calibration Result

The dielectric parameters of the liquids were verified prior to the SAR evaluation using DASY5 Dielectric Probe Kit and Agilent Vector Network Analyzer E5071C

Head Tissue Simulant Measurement				
Frequency [MHz]	Description	Dielectric Parameters		Tissue Temp. [°C]
		$\epsilon_r$	$\sigma$ [s/m]	
2450 MHz	Reference result ± 5% window	39.2 37.24 to 41.16	1.80 1.71 to 1.89	N/A
	08-05-2022	39.068	1.876	21.0
5250 MHz	Reference result ± 5% window	35.94 34.14 to 37.74	4.69 4.46 to 4.92	N/A
	08-05-2022	36.729	4.626	21.0
5600 MHz	Reference result ± 5% window	35.53 33.75 to 37.31	4.93 4.68 to 5.18	N/A
	08-05-2022	35.928	5.110	21.0
5750 MHz	Reference result ± 5% window	35.36 33.59 to 37.13	5.04 4.79 to 5.29	N/A
	08-05-2022	35.624	5.216	21.0

### Head Tissue Simulant Measurement (Test Data: 08-03-2022)

Frequency [MHz]	Dielectric Parameters						Tissue Temp. [°C]
	Permittivity $\epsilon_r$	Conductivity $\sigma$	Permittivity Target $\epsilon_r$	Conductivity Target $\sigma$	Delta ( $\epsilon_r$ ) %	Delta ( $\sigma$ ) %	
2402	39.149	1.801	39.29	1.76	-0.38	2.33	21.0
2412	39.100	1.812	39.27	1.77	-0.51	2.37	21.0
2437	38.998	1.841	38.46	1.79	1.29	2.85	21.0
2441	38.976	1.845	39.22	1.79	-0.57	3.07	21.0
2462	38.895	1.872	39.18	1.81	-0.78	3.43	21.0
2480	38.814	1.893	39.15	1.83	-0.98	3.44	21.0
5220	36.619	4.615	36.47	4.72	0.33	-2.22	21.0
5260	36.566	4.656	36.39	4.76	0.46	-2.18	21.0
5320	36.477	4.717	36.30	4.78	0.49	-1.32	21.0
5500	36.232	4.898	35.63	4.97	1.78	-1.45	21.0
5580	36.114	4.982	35.53	5.05	1.73	-1.35	21.0
5700	35.942	5.112	35.40	5.17	1.53	-1.12	21.0
5745	35.780	5.243	35.36	5.22	1.07	0.44	21.0
5785	35.882	5.160	35.32	5.26	1.65	-1.90	21.0
5825	35.835	5.200	35.28	5.30	1.52	-1.89	21.0

**Note:**

- The delta ( $\epsilon_r$ ) and ( $\sigma$ ) are within  $\pm 5\%$ , delta SAR value was not calculated in this report.
- As per IEC 62209-2 Annex F, the SAR correction factor is given by:

$$\Delta \text{SAR} = c_\epsilon \Delta \epsilon_r + c_\sigma \Delta \sigma$$

For the 1g average SAR  $C_\epsilon$  and  $C_\sigma$  are given by:

$$C_\epsilon = -7.854 \times 10^{-4} f^3 + 9.402 \times 10^{-3} f^2 - 2.742 \times 10^{-2} f - 0.2026$$

$$C_\sigma = 9.804 \times 10^{-3} f^3 - 8.661 \times 10^{-2} f^2 + 2.981 \times 10^{-2} f + 0.7829$$

Where f is the frequency in GHz.

Head Tissue Simulant Measurement (Test Data: 08-01-2022)						
Frequency [MHz]	Dielectric Parameters					Tissue Temp. [°C]
	Delta ( $\epsilon_r$ ) %	Delta ( $\sigma$ ) %	C $\epsilon$	C $\sigma$	Delta SAR%	
2402	-0.38	2.33	-0.23	0.49	1.23	21.0
2412	-0.51	2.37	-0.23	0.49	1.27	21.0
2437	1.29	2.85	-0.22	0.48	1.09	21.0
2441	-0.57	3.07	-0.22	0.48	1.61	21.0
2462	-0.78	3.43	-0.22	0.48	1.81	21.0
2480	-0.98	3.44	-0.22	0.47	1.85	21.0
5220	0.33	-2.22	-0.20	-0.03	0.01	21.0
5260	0.46	-2.18	-0.20	-0.03	0.03	21.0
5320	0.49	-1.32	-0.20	-0.03	0.05	21.0
5500	1.78	-1.45	-0.20	-0.04	0.29	21.0
5580	1.73	-1.35	-0.20	-0.04	0.29	21.0
5700	1.53	-1.12	-0.20	-0.05	0.25	21.0
5745	1.07	0.44	-0.20	-0.05	0.23	21.0
5785	1.65	-1.90	-0.20	-0.05	0.24	21.0
5825	1.52	-1.89	-0.20	-0.04	0.22	21.0

Note: The  $\Delta$ SAR refers to the percent change in SAR relative to the percent change in dielectric properties versus the target values. A negative  $\Delta$ SAR would translate to a lower measured SAR value than what would be measured if using dielectric properties equal to the target values. A positive  $\Delta$ SAR would translate to a higher measured SAR value than what would be measured if using dielectric properties equal to the target values. SAR correction shall not be made when the  $\Delta$ SAR has a positive sign to provide a conservative SAR value. The SAR is only corrected when  $\Delta$ SAR has a negative sign.



### 3.3 Tissue Dielectric Parameters for Head and Body Phantoms

The head tissue dielectric parameters recommended by the IEEE SCC-34/SC-2 in P1528 have been incorporated in the following table. These head parameters are derived from planar layer models simulating the highest expected SAR for the dielectric properties and tissue thickness variations in a human head. Other head and body tissue parameters that have not been specified in P1528 are derived from the tissue dielectric parameters computed from the 4-Cole-Cole equations described in Reference [12] and extrapolated according to the head parameters specified in P1528.

Target Frequency (MHz)	Head	
	$\epsilon_r$	$\sigma$ (S/m)
150	52.3	0.76
300	45.3	0.87
450	43.5	0.87
835	41.5	0.90
900	41.5	0.97
915	41.5	0.98
1450	40.5	1.20
1610	40.3	1.29
1800 – 2000	40.0	1.40
2450	<b>39.2</b>	<b>1.80</b>
4000	37.4	3.43
5200	<b>36.0</b>	<b>4.66</b>
5800	<b>35.3</b>	<b>5.07</b>

( $\epsilon_r$  = relative permittivity,  $\sigma$  = conductivity and  $\rho = 1000 \text{ kg/m}^3$ )

## 4 SAR MEASUREMENT PROCEDURE

### 4.1 SAR System Validation

#### 4.1.1. Validation Dipoles

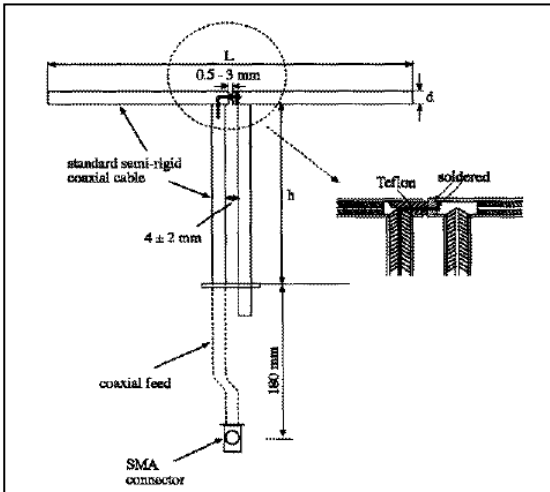

The dipoles used is based on the IEEE-1528 standard, and is complied with mechanical and electrical specifications in line with the requirements of both IEEE and FCC Supplement C. the table below provides details for the mechanical and electrical specifications for the dipoles.

Frequency	L (mm)	h (mm)	d (mm)
2450MHz	53.5	30.4	3.6
5250MHz	20.6	14.2	3.6
5600MHz	20.6	14.2	3.6
5750MHz	20.6	14.2	3.6

#### 4.1.2. Validation Result

System Performance Check at 2450MHz, 5250MHz, 5600MHz and 5750MHz				
Frequency [MHz]	Description	SAR [w/kg] 1g	SAR [w/kg] 10g	Tissue Temp. [°C]
2450 MHz	Reference result ± 10% window	51.2 46.08 to 56.32	23.6 21.24 to 25.96	N/A
	08-05-2022	51.60	24.08	21.0
5250 MHz	Reference result ± 10% window	75.5 67.95 to 83.05	21.6 19.44 to 23.76	N/A
	08-05-2022	82.50	22.80	21.0
5600 MHz	Reference result ± 10% window	79.7 71.73 to 87.67	23.0 20.7 to 25.3	N/A
	08-05-2022	83.10	23.80	21.0
5750 MHz	Reference result ± 10% window	78.6 70.74 to 86.46	22.4 20.16 to 24.64	N/A
	08-05-2022	80.50	22.40	21.0

Note: All SAR values are normalized to 1W forward power.

## 4.2 SAR Measurement Procedure

The DASY 5 calculates SAR using the following equation,

$$SAR = \frac{\sigma |E|^2}{\rho}$$

$\sigma$ : represents the simulated tissue conductivity

$\rho$ : represents the tissue density

The EUT is set to transmit at the required power in line with product specification, at each frequency relating to the LOW, MID, and HIGH channel settings.

Pre-scans are made on the device to establish the location for the transmitting antenna, using a large area scan in either air or tissue simulation fluid.

The EUT is placed against the Universal Phantom where the maximum area scan dimensions are larger than the physical size of the resonating antenna. When the scan size is not large enough to cover the peak SAR distribution, it is modified by either extending the area scan size in both the X and Y directions, or the device is shifted within the predefined area.

The area scan is then run to establish the peak SAR location (interpolated resolution set at  $1\text{mm}^2$ ) which is then used to orient the center of the zoom scan. The zoom scan is then executed and the 1g and 10g averages are derived from the zoom scan volume (interpolated resolution set at  $1\text{mm}^3$ ).

## 5 SAR EXPOSURE LIMITS

SAR assessments have been made in line with the requirements of IEEE-1528, FCC Supplement C, and comply with ANSI/IEEE C95.1-1992 “Uncontrolled Environments” limits. These limits apply to a location which is deemed as “Uncontrolled Environment” which can be described as a situation where the general public may be exposed to an RF source with no prior knowledge or control over their exposure.

### Limits for General Population/Uncontrolled Exposure (W/kg)

Type Exposure	Uncontrolled Environment Limit
Spatial Peak SAR (1g cube tissue for brain or body)	<b>1.60 W/kg</b>
Spatial Average SAR (whole body)	<b>0.08 W/kg</b>
Spatial Peak SAR (10g for hands, feet, ankles and wrist)	<b>4.00 W/kg</b>

## 6 TEST EQUIPMENT LIST

Instrument	Manufacturer	Model No.	Serial No.	Cali. Due Date
Stäubli Robot TX60L	Stäubli	TX60L	F10/5C90A1/A/01	N/A
Controller	Stäubli	SP1	S-0034	N/A
Dipole Validation Kits	Speag	D2450V2	938	2025.03.31
Dipole Validation Kits	Speag	D5GHzV2	1078	2025.03.27
SAM Twin Phantom	Speag	SAM	TP-1561/1562	N/A
Device Holder	Speag	SD 000 H01 HA	N/A	N/A
Data Acquisition Electronic	Speag	DAE4	1220	2023.03.23
E-Field Probe	Speag	EX3DV4	3710	2023.4.17
SAR Software	Speag	DASY5	V5.2 Build 162	N/A
Power Amplifier	Mini-Circuit	ZVA-183-S+	N657400950	N/A
Directional Coupler	Agilent	778D	20160	N/A
Vector Network	Agilent	E5071C	MY46103316	2022.10.26
Signal Generator	Agilent	E4438C	MY45092174	2023.06.30
Spectrum Analyzer	Agilent	N9010A	MY48030494	2023.06.30
Temperature/Humidity Meter	RTS	RTS-8S	RF02	2023.03.09
Temperature Meter	Dretec	O-274	RF-001	2022.11.23

## 7 MEASUREMENT UNCERTAINTY

DASY5 Uncertainty according to IEEE std. 1528-2013								
Measurement uncertainty for 300 MHz to 3 GHz averaged over 1 gram / 10 gram.								
Error Description	Uncert. value	Prob. Dist.	Div.	(ci) 1g	(ci) 10g	Std. Unc.(1g)	Std. Unc.(10g)	(vi) $v_{eff}$
<b>Measurement System</b>								
Probe Calibration	±6.0%	N	1	1	1	±6.0%	±6.0%	∞
Axial Isotropy	±4.7%	R	$\sqrt{3}$	0.7	0.7	±1.9%	±1.9%	∞
Hemispherical Isotropy	±9.6%	R	$\sqrt{3}$	0.7	0.7	±3.9%	±3.9%	∞
Boundary Effects	±1.0%	R	$\sqrt{3}$	1	1	±0.6%	±0.6%	∞
Linearity	±4.7%	R	$\sqrt{3}$	1	1	±2.7%	±2.7%	∞
System Detection Limits	±1.0%	R	$\sqrt{3}$	1	1	±0.6%	±0.6%	∞
Readout Electronics	±0.3%	N	1	1	1	±0.3%	±0.3%	∞
Response Time	±0.8%	R	$\sqrt{3}$	1	1	±0.5%	±0.5%	∞
Integration Time	±2.6%	R	$\sqrt{3}$	1	1	±1.5%	±1.5%	∞
RF Ambient Noise	±3.0%	R	$\sqrt{3}$	1	1	±1.7%	±1.7%	∞
RF Ambient Reflections	±3.0%	R	$\sqrt{3}$	1	1	±1.7%	±1.7%	∞
Probe Positioner	±0.4%	R	$\sqrt{3}$	1	1	±0.2%	±0.2%	∞
Probe Positioning	±2.9%	R	$\sqrt{3}$	1	1	±1.7%	±1.7%	∞
Max. SAR Eval.	±1.0%	R	$\sqrt{3}$	1	1	±0.6%	±0.6%	∞
<b>Test Sample Related</b>								
Device Positioning	±2.9%	N	1	1	1	±2.9%	±2.9%	145
Device Holder	±3.6%	N	1	1	1	±3.6%	±3.6%	5
Power Drift	±5.0%	R	$\sqrt{3}$	1	1	±2.9%	±2.9%	∞
<b>Phantom and Setup</b>								
Phantom Uncertainty	±4.0%	R	$\sqrt{3}$	1	1	±2.3%	±2.3%	∞
Liquid Conductivity (target)	±5.0%	R	$\sqrt{3}$	0.64	0.43	±1.8%	±1.2%	∞
Liquid Conductivity (meas.)	±2.5%	N	1	0.64	0.43	±1.6%	±1.1%	∞
Liquid Permittivity (target)	±5.0%	R	$\sqrt{3}$	0.6	0.49	±1.7%	±1.4%	∞
Liquid Permittivity (meas.)	±2.5%	N	1	0.6	0.49	±1.5%	±1.2%	∞
<b>Combined Std. Uncertainty</b>						±11.0%	±10.8%	387
<b>Expanded STD Uncertainty</b>						±22.0%	±21.5%	

DASY5 Uncertainty according to IEEE std. 1528-2013								
Measurement uncertainty for 3 GHz to 6 GHz averaged over 1 gram / 10 gram.								
Error Description	Uncert. value	Prob. Dist.	Div.	(c <sub>i</sub> ) 1g	(c <sub>i</sub> ) 10g	Std. Unc. (1g)	Std. Unc. (10g)	(v <sub>i</sub> ) V <sub>eff</sub>
<b>Measurement System</b>								
Probe Calibration	±6.55%	N	1	1	1	±6.55%	±6.55%	∞
Axial Isotropy	±4.7%	R	$\sqrt{3}$	0.7	0.7	±1.9%	±1.9%	∞
Hemispherical Isotropy	±9.6%	R	$\sqrt{3}$	0.7	0.7	±3.9%	±3.9%	∞
Boundary Effects	±2.0%	R	$\sqrt{3}$	1	1	±1.2%	±1.2%	∞
Linearity	±4.7%	R	$\sqrt{3}$	1	1	±2.7%	±2.7%	∞
System Detection Limits	±1.0%	R	$\sqrt{3}$	1	1	±0.6%	±0.6%	∞
Readout Electronics	±0.3%	N	1	1	1	±0.3%	±0.3%	∞
Response Time	±0.8%	R	$\sqrt{3}$	1	1	±0.5%	±0.5%	∞
Integration Time	±2.6%	R	$\sqrt{3}$	1	1	±1.5%	±1.5%	∞
RF Ambient Noise	±3.0%	R	$\sqrt{3}$	1	1	±1.7%	±1.7%	∞
RF Ambient Reflections	±3.0%	R	$\sqrt{3}$	1	1	±1.7%	±1.7%	∞
Probe Positioner	±0.8%	R	$\sqrt{3}$	1	1	±0.5%	±0.5%	∞
Probe Positioning	±9.9%	R	$\sqrt{3}$	1	1	±5.7%	±5.7%	∞
Max. SAR Eval.	±4.0%	R	$\sqrt{3}$	1	1	±2.3%	±2.3%	∞
<b>Test Sample Related</b>								
Device Positioning	±2.9%	N	1	1	1	±2.9%	±2.9%	145
Device Holder	±3.6%	N	1	1	1	±3.6%	±3.6%	5
Power Drift	±5.0%	R	$\sqrt{3}$	1	1	±2.9%	±2.9%	∞
<b>Phantom and Setup</b>								
Phantom Uncertainty	±4.0%	R	$\sqrt{3}$	1	1	±2.3%	±2.3%	∞
Liquid Conductivity (target)	±5.0%	R	$\sqrt{3}$	0.64	0.43	±1.8%	±1.2%	∞
Liquid Conductivity (meas.)	±2.5%	N	1	0.64	0.43	±1.6%	±1.1%	∞
Liquid Permittivity (target)	±5.0%	R	$\sqrt{3}$	0.6	0.49	±1.7%	±1.4%	∞
Liquid Permittivity (meas.)	±2.5%	N	1	0.6	0.49	±1.5%	±1.2%	∞
<b>Combined Std. Uncertainty</b>						±12.8%	±12.6%	330
<b>Expanded STD Uncertainty</b>						±25.6%	±25.2%	



## 8 POWER TEST RESULTS

### 2.4GHz:

#### SISO:

Mode	Channel	Test Frequency (MHz)	Conducted Power Output (dBm)		Tune up Power Output (dBm)		Tune up Factor		Result
			Ant 1	Ant 2	Ant 1	Ant 2	Ant 1	Ant 2	
802.11b	01	2412	17.69	17.51	18.00	18.00	1.074	1.119	Pass
	06	2437	17.89	17.69	18.00	18.00	1.026	1.074	Pass
	11	2462	17.88	17.65	18.00	18.00	1.028	1.084	Pass
802.11g	01	2412	18.66	18.39	19.00	19.00	1.081	1.151	Pass
	06	2437	18.72	18.45	19.00	19.00	1.067	1.135	Pass
	11	2462	18.65	18.33	19.00	19.00	1.084	1.167	Pass
802.11n	01	2412	18.65	18.39	19.00	19.00	1.084	1.151	Pass
	06	2437	18.56	18.29	19.00	19.00	1.107	1.178	Pass
	11	2462	18.28	18.96	19.00	19.00	1.180	1.009	Pass

**MIMO**

Mode	Channel	Test Frequency (MHz)	Conducted Power Output (dBm)	Tune up Power Output (dBm)	Tune up Factor	Result
802.11g	01	2412	21.82	22.00	1.042	Pass
	06	2437	21.86	22.00	1.033	Pass
	11	2462	21.65	22.00	1.084	Pass
802.11n	01	2412	21.75	22.00	1.059	Pass
	06	2437	21.69	22.00	1.074	Pass
	11	2462	21.45	22.00	1.135	Pass

**5GHz 802.11a:****SISO:**

Channel	Test Frequency (MHz)	Conducted Power Output (dBm)		Tune up Power Output (dBm)		Tune up Factor		Result
		Ant 1	Ant 2	Ant 1	Ant 2	Ant 1	Ant 2	
36	5180	14.15	13.26	14.50	13.50	1.084	1.057	Pass
44	5220	14.19	13.31	14.50	13.50	1.074	1.045	Pass
48	5240	14.18	13.28	14.50	13.50	1.076	1.052	Pass
52	5260	14.21	13.34	14.50	13.50	1.069	1.038	Pass
60	5300	14.22	13.29	14.50	13.50	1.067	1.050	Pass
64	5320	14.24	13.32	14.50	13.50	1.062	1.042	Pass
100	5500	12.21	11.32	12.50	11.50	1.069	1.042	Pass
116	5580	12.23	11.39	12.50	11.50	1.064	1.026	Pass
140	5700	12.24	11.41	12.50	11.50	1.062	1.021	Pass
149	5745	11.69	10.88	12.00	11.00	1.074	1.028	Pass
157	5785	11.75	10.90	12.00	11.00	1.059	1.023	Pass
165	5825	11.72	10.92	12.00	11.00	1.067	1.019	Pass

**MIMO**

Channel	Test Frequency (MHz)	Conducted Power Output (dBm)	Tune up Power Output (dBm)	Tune up Factor	Result
36	5180	16.77	17.50	1.183	Pass
44	5220	16.76	17.50	1.186	Pass
48	5240	16.82	17.50	1.169	Pass
52	5260	16.82	17.50	1.169	Pass
60	5300	16.82	17.50	1.169	Pass
64	5320	16.81	17.50	1.172	Pass
100	5500	14.25	15.50	1.334	Pass
116	5580	14.80	15.50	1.175	Pass
140	5700	14.84	15.50	1.164	Pass
149	5745	14.28	15.50	1.324	Pass
157	5785	14.31	15.50	1.315	Pass
165	5825	14.30	15.50	1.318	Pass

**5GHz 802.11n(20MHz):****SISO:**

Channel	Test Frequency (MHz)	Conducted Power Output (dBm)		Tune up Power Output (dBm)		Tune up Factor		Result
		Ant 1	Ant 2	Ant 1	Ant 2	Ant 1	Ant 2	
36	5180	14.49	13.56	15.00	14.00	1.125	1.107	Pass
44	5220	14.51	13.58	15.00	14.00	1.119	1.102	Pass
48	5240	14.54	13.54	15.00	14.00	1.112	1.112	Pass
52	5260	14.47	13.60	15.00	14.00	1.130	1.096	Pass
60	5300	14.45	13.55	15.00	14.00	1.135	1.109	Pass
64	5320	14.44	13.53	15.00	14.00	1.138	1.114	Pass
100	5500	12.58	11.48	13.00	12.00	1.102	1.127	Pass
116	5580	12.62	11.45	13.00	12.00	1.091	1.135	Pass
140	5700	12.65	11.47	13.00	12.00	1.084	1.130	Pass
149	5745	12.15	10.98	12.50	11.50	1.084	1.127	Pass
157	5785	12.16	10.95	12.50	11.50	1.081	1.135	Pass
165	5825	12.19	10.92	12.50	11.50	1.074	1.143	Pass

**MIMO**

Channel	Test Frequency (MHz)	Conducted Power Output (dBm)	Tune up Power Output (dBm)	Tune up Factor	Result
36	5180	17.11	18.00	1.227	Pass
44	5220	17.14	18.00	1.219	Pass
48	5240	17.09	18.00	1.233	Pass
52	5260	17.07	18.00	1.239	Pass
60	5300	17.06	18.00	1.242	Pass
64	5320	17.03	18.00	1.250	Pass
100	5500	15.01	16.00	1.256	Pass
116	5580	15.08	16.00	1.236	Pass
140	5700	15.12	16.00	1.225	Pass
149	5745	14.64	15.50	1.219	Pass
157	5785	14.71	15.50	1.199	Pass
165	5825	14.66	15.50	1.213	Pass

**5GHz 802.11n(40MHz):**

**SISO:**

Channel	Test Frequency (MHz)	Conducted Power Output (dBm)		Tune up Power Output (dBm)		Tune up Factor		Result
		Ant 1	Ant 2	Ant 1	Ant 2	Ant 1	Ant 2	
38	5190	14.28	13.36	14.50	13.50	1.052	1.033	Pass
46	5230	14.31	13.34	14.50	13.50	1.045	1.038	Pass
54	5270	14.35	13.39	14.50	13.50	1.035	1.026	Pass
62	5310	14.32	13.41	14.50	13.50	1.042	1.021	Pass
102	5510	12.28	11.41	12.50	11.50	1.052	1.021	Pass
118	5590	12.31	11.39	12.50	11.50	1.045	1.026	Pass
134	5670	12.35	11.45	12.50	11.50	1.035	1.012	Pass
151	5755	11.83	10.88	12.00	11.00	1.040	1.028	Pass
159	5795	11.87	10.91	12.00	11.00	1.030	1.021	Pass

**MIMO**

Channel	Test Frequency (MHz)	Conducted Power Output (dBm)	Tune up Power Output (dBm)	Tune up Factor	Result
38	5190	16.93	17.50	1.140	Pass
46	5230	16.91	17.50	1.146	Pass
54	5270	16.88	17.50	1.153	Pass
62	5310	16.87	17.50	1.156	Pass
102	5510	14.92	15.50	1.143	Pass
118	5590	14.92	15.50	1.143	Pass
134	5670	14.91	15.50	1.146	Pass
151	5755	14.39	15.00	1.151	Pass
159	5795	14.42	15.00	1.143	Pass



**5GHz 802.11ac(20MHz):****SISO:**

Channel	Test Frequency (MHz)	Conducted Power Output (dBm)		Tune up Power Output (dBm)		Tune up Factor		Result
		Ant 1	Ant 2	Ant 1	Ant 2	Ant 1	Ant 2	
36	5180	14.18	13.26	14.50	13.50	1.076	1.057	Pass
44	5220	14.21	13.28	14.50	13.50	1.069	1.052	Pass
48	5240	14.23	13.29	14.50	13.50	1.064	1.050	Pass
52	5260	14.19	13.32	14.50	13.50	1.074	1.042	Pass
60	5300	14.16	13.33	14.50	13.50	1.081	1.040	Pass
64	5320	14.12	13.35	14.50	13.50	1.091	1.035	Pass
100	5500	12.25	11.31	12.50	11.50	1.059	1.045	Pass
116	5580	12.21	11.35	12.50	11.50	1.069	1.035	Pass
140	5700	12.25	11.34	12.50	11.50	1.059	1.038	Pass
149	5745	11.72	10.82	12.00	11.00	1.067	1.042	Pass
157	5785	11.69	10.84	12.00	11.00	1.074	1.038	Pass
165	5825	11.75	10.80	12.00	11.00	1.059	1.047	Pass

**MIMO**

Channel	Test Frequency (MHz)	Conducted Power Output (dBm)	Tune up Power Output (dBm)	Tune up Factor	Result
36	5180	16.83	17.50	1.167	Pass
44	5220	16.83	17.50	1.167	Pass
48	5240	16.85	17.50	1.161	Pass
52	5260	16.85	17.50	1.161	Pass
60	5300	16.83	17.50	1.167	Pass
64	5320	16.81	17.50	1.172	Pass
100	5500	14.85	15.50	1.161	Pass
116	5580	14.86	15.50	1.159	Pass
140	5700	14.83	15.50	1.167	Pass
149	5745	14.29	15.00	1.178	Pass
157	5785	14.28	15.00	1.180	Pass
165	5825	14.33	15.00	1.167	Pass

**5GHz 802.11ac(40MHz):****SISO:**

Channel	Test Frequency (MHz)	Conducted Power Output (dBm)		Tune up Power Output (dBm)		Tune up Factor		Result
		Ant 1	Ant 2	Ant 1	Ant 2	Ant 1	Ant 2	
38	5190	14.05	13.11	14.50	13.50	1.109	1.094	Pass
46	5230	14.12	13.14	14.50	13.50	1.091	1.086	Pass
54	5270	14.02	13.09	14.50	13.50	1.117	1.099	Pass
62	5310	14.12	13.15	14.50	13.50	1.091	1.084	Pass
102	5510	12.15	11.04	12.50	11.50	1.084	1.112	Pass
118	5590	12.09	11.02	12.50	11.50	1.099	1.117	Pass
134	5670	12.12	11.08	12.50	11.50	1.091	1.102	Pass
151	5755	11.55	10.64	12.00	11.00	1.109	1.086	Pass
159	5795	11.57	10.66	12.00	11.00	1.104	1.081	Pass

**MIMO**

Channel	Test Frequency (MHz)	Conducted Power Output (dBm)	Tune up Power Output (dBm)	Tune up Factor	Result
38	5190	16.62	17.50	1.225	Pass
46	5230	16.65	17.50	1.216	Pass
54	5270	16.59	17.50	1.233	Pass
62	5310	16.65	17.50	1.216	Pass
102	5510	14.62	15.50	1.225	Pass
118	5590	14.59	15.50	1.233	Pass
134	5670	14.65	15.50	1.216	Pass
151	5755	14.11	15.00	1.227	Pass
159	5795	14.11	15.00	1.227	Pass

**5GHz 802.11ac(80MHz):**

**SISO:**

Channel	Test Frequency (MHz)	Conducted Power Output (dBm)		Tune up Power Output (dBm)		Tune up Factor		Result
		Ant 1	Ant 2	Ant 1	Ant 2	Ant 1	Ant 2	
42	5210	13.81	12.87	14.00	13.00	1.045	1.030	Pass
58	5290	13.83	12.91	14.00	13.00	1.040	1.021	Pass
106	5530	11.78	10.81	12.00	11.00	1.052	1.045	Pass
155	5775	11.32	10.29	11.50	10.50	1.042	1.050	Pass

**MIMO**

Channel	Test Frequency (MHz)	Conducted Power Output (dBm)	Tune up Power Output (dBm)	Tune up Factor	Result
42	5210	16.37	17.00	1.156	Pass
58	5290	16.42	17.00	1.143	Pass
106	5530	14.57	15.00	1.104	Pass
155	5775	14.04	14.50	1.112	Pass

## Bluetooth

Mode	Channel	Test Frequency (MHz)	Conducted Power Output (dBm)	Tune up Power Output (dBm)	Tune up Factor	Result
GFSK	00	2402	1.35	2.00	1.161	Pass
	39	2441	1.58	2.00	1.102	Pass
	78	2480	1.34	2.00	1.164	Pass
Pi/4 DQPSK	00	2402	4.32	5.00	1.169	Pass
	39	2441	3.83	5.00	1.309	Pass
	78	2480	4.33	5.00	1.167	Pass
8DPSK	00	2402	4.35	5.00	1.161	Pass
	39	2441	3.94	5.00	1.276	Pass
	78	2480	4.43	5.00	1.140	Pass
LE 1M	00	2402	5.85	6.00	1.035	Pass
	19	2440	5.27	6.00	1.183	Pass
	39	2480	4.53	6.00	1.403	Pass
LE 2M	00	2402	5.51	6.00	1.119	Pass
	19	2440	4.84	6.00	1.306	Pass
	39	2480	4.12	6.00	1.542	Pass

**DUTY CYCLE**

Test Mode	Tx On (ms)	Tx Off (ms)	Duty Cycle (%)	Duty Cycle Factor
2.4GHz 802.11b	N/A	N/A	100.00	1.00
2.4GHz 802.11g	N/A	N/A	100.00	1.00
2.4GHz 802.11n(20MHz)	N/A	N/A	100.00	1.00
5GHz 802.11a	2.044	0.049	97.70	1.02
5GHz 802.11n(20MHz)	2.044	0.049	97.70	1.02
5GHz 802.11n(40MHz)	0.612	0.144	80.90	1.24
5GHz 802.11ac(20MHz)	2.044	0.049	97.70	1.02
5GHz 802.11ac(40MHz)	0.612	0.144	80.90	1.24
5GHz 802.11ac(80MHz)	0.288	0.052	68.20	1.47
Bluetooth3.0(DH5)	2.22	1.53	59.20	1.69
Bluetooth5.0(BLE)	380	250	60.32	1.66

Note: We evaluated all models and only represented the worst data.



## 9 SAR TEST RESULTS

### 9.1 Standalone SAR

SAR MEASUREMENT							
Ambient Temperature (°C) : 21.5 ±2				Relative Humidity (%) : 52			
Liquid Temperature (°C) : 21.0 ±2				Depth of Liquid (cm):>15			
Product:Touch All in One Computer_Test distance: 0mm							
Test Position	Test Mode	Frequency		Antenna	Power Drift (<±0.2)	SAR 1g (W/kg)	Limit (W/kg)
		Channel	MHz				
WLAN2.4G Body SAR							
Top	802.11b	6	2437	Main	0.01	0.344	1.6
Left	802.11b	6	2437	Main	0.05	0.023	1.6
Top	802.11b	6	2437	Aux	0.13	0.316	1.6
Right	802.11b	6	2437	Aux	0.02	0.026	1.6
Top	802.11g	6	2437	Mimo	0.19	0.452	1.6
Top	802.11g	1	2412	Mimo	0.15	0.449	1.6
Top	802.11g	11	2462	Mimo	-0.01	0.476	1.6
Bluetooth Body SAR							
Top	DH5	0	2402	Aux	0.02	0.080	1.6
Top	DH5	39	2441	Aux	-0.12	0.045	1.6
Top	DH5	78	2480	Aux	0.03	0.061	1.6
WLAN5G Body SAR							
Top	802.11n(20MHz)	52	5260	Mimo	0.01	0.763	1.6
Right	802.11n(20MHz)	52	5260	Mimo	0.12	0.243	1.6
Left	802.11n(20MHz)	52	5260	Mimo	0.04	0.294	1.6
Top	802.11n(20MHz)	44	5220	Mimo	-0.11	0.746	1.6
Top	802.11n(20MHz)	64	5320	Mimo	0.08	0.782	1.6
* Top	802.11n(20MHz)	100	5500	Mimo	0.18	0.931	1.6

Top	802.11n(20MHz)	100	5500	Mimo	0.11	0.901	1.6
* Top	802.11n(20MHz)	116	5580	Mimo	-0.09	0.929	1.6
Top	802.11n(20MHz)	116	5580	Mimo	0.01	0.897	1.6
Top	802.11n(20MHz)	140	5700	Mimo	0.03	0.782	1.6
Top	802.11n(20MHz)	165	5825	Mimo	0.16	0.320	1.6
Top	802.11n(20MHz)	149	5745	Mimo	-0.12	0.282	1.6
Top	802.11n(20MHz)	157	5785	Mimo	0.09	0.294	1.6

SAR MEASUREMENT								
Ambient Temperature (°C) : 21.5 ±2					Relative Humidity (%): 52			
Liquid Temperature (°C) : 21.0 ±2					Depth of Liquid (cm):>15			
Product: Touch All One Computer								
Test Position	Test Mode	Frequency		Antenna	Scaled Factor	Duty Factor	Reported SAR 1g (W/kg)	Limit (W/kg)
		Channel	MHz					
WLAN2.4G Body SAR								
Top	802.11b	6	2437	Main	1.026	1.00	0.353	1.6
Left	802.11b	6	2437	Main	1.026	1.00	0.024	1.6
Top	802.11b	6	2437	Aux	1.074	1.00	0.339	1.6
Right	802.11b	6	2437	Aux	1.074	1.00	0.028	1.6
Top	802.11g	6	2437	Mimo	1.033	1.00	0.467	1.6
Top	802.11g	1	2412	Mimo	1.042	1.00	0.468	1.6
Top	802.11g	11	2462	Mimo	1.084	1.00	<b>0.516</b>	1.6
Bluetooth Body SAR								
Top	DH5	0	2402	Aux	1.161	1.69	<b>0.157</b>	1.6
Top	DH5	39	2441	Aux	1.276	1.69	0.097	1.6
Top	DH5	78	2480	Aux	1.140	1.69	0.118	1.6
WLAN5G Body SAR								
Top	802.11n(20MHz)	52	5260	Mimo	1.239	1.02	0.964	1.6
Right	802.11n(20MHz)	52	5260	Mimo	1.239	1.02	0.307	1.6
Left	802.11n(20MHz)	52	5260	Mimo	1.239	1.02	0.372	1.6
Top	802.11n(20MHz)	44	5220	Mimo	1.219	1.02	0.928	1.6
Top	802.11n(20MHz)	64	5320	Mimo	1.250	1.02	0.997	1.6
* Top	802.11n(20MHz)	100	5500	Mimo	1.256	1.02	<b>1.193</b>	1.6
Top	802.11n(20MHz)	100	5500	Mimo	1.256	1.02	1.154	1.6
* Top	802.11n(20MHz)	116	5580	Mimo	1.236	1.02	1.171	1.6
Top	802.11n(20MHz)	116	5580	Mimo	1.236	1.02	1.131	1.6
Top	802.11n(20MHz)	140	5700	Mimo	1.225	1.02	0.977	1.6
Top	802.11n(20MHz)	165	5825	Mimo	1.213	1.02	0.396	1.6

Top	802.11n(20MHz)	149	5745	Mimo	1.219	1.02	0.351	1.6
Top	802.11n(20MHz)	157	5785	Mimo	1.199	1.02	0.360	1.6

Note:

1: \* - repeated at the highest measured SAR according to the FCC KDB 865664

2: When the reported SAR of the initial test position is > 0.4 W/kg, on the highest maximum output power channel, until the reported SAR is ≤ 0.8 W/kg or all required test positions are tested.

3: For all positions/configurations tested using the initial test position and subsequent test positions, when the reported SAR is > 0.8 W/kg, SAR is measured for these test positions/configurations on the subsequent next highest measured output power channel(s) until the reported SAR is ≤ 1.2 W/kg or all required channels are tested.

4: Per NOTICE 2012-DRS0529, the SAR need to calculated only when the  $\Delta$ SAR is a negative value.

5: Reference standard KDB447498 D04 formula calculation In SISO mode, some test surfaces meet the exemption requirements. For example, when the Main antenna is used, Bottom and Right meet the exemption requirements, and when the Aux antenna is used, Bottom and Left meet the exemption requirements.

6: All test positions were evaluated and only the worst positions were represented.

7: Since the back of the product needs to be connected to the adapter, the product will not touch the back during normal use, so there is no need to test.

## 9.2 Test position and configuration

1. Liquid tissue depth was at least 15.0 cm for all frequencies.
2. The manufacturer has confirmed that the device(s) tested have the same physical, mechanical and thermal characteristics and are within operational tolerances expected for production units.
3. SAR results were scaled to the maximum allowed power to demonstrate compliance per FCC KDB Publication 447498 D01v06.

### 9.3 SAR Test Exclusions Applied

#### Wi-Fi/Bluetooth

Per FCC KDB 447498 D01v06, the SAR exclusion threshold for distances<50mm is defined by the following equation:

$$\frac{\text{Max Power of Channel (mW)}}{\text{Test Separation Dist (mm)}} * \sqrt{\text{Frequency(GHz)}} \leq 3.0$$

Per FCC KDB 447498 D01v06, the SAR exclusion threshold for distances>50mm is defined by the following equation:

$$\frac{[\text{Power allowed at numeric threshold for 50 mm in step 1}] + (\text{Test separation distance} - 50 \text{ mm}) (\text{Frequency(MHz)/150}] \text{ mW}}{\text{Test Separation Dist (mm)}} * \sqrt{\text{Frequency(GHz)}}$$

#### The distance exclusion threshold per output power:

Exposure Position	Wireless Interface	2.4GHz WLAN ANT Main	2.4GHz WLAN ANT Aux	2.4GHz WLAN ANT Mimo	5GHz WLAN ANT Main	5GHz WLAN ANT Aux	5GHz WLAN ANT Mimo
	Calculated Frequency	2462MHz	2462MHz	2462MHz	5825MHz	5825MHz	5825MHz
	Maximum power (dBm)	19	19	22	15	14	18
	Maximum rated power(mW)	79.0	79.0	158.0	32.0	25.0	63.0
Top	Separation distance(mm)	5.0	5.0	5.0	5.0	5.0	5.0
	exclusion threshold	24.8	24.8	49.6	15.5	12.1	30.4
	Testing required?	Yes	Yes	Yes	Yes	Yes	Yes
Right	Separation distance(mm)	287.5	41.0	41.0	287.5	41.0	41.0
	exclusion threshold	2471.0	3.0	6.1	2437.0	1.5	3.7
	Testing required?	No	Yes	Yes	No	No	Yes
Left	Separation distance(mm)	56.5	303.0	56.5	56.5	303.0	56.5
	exclusion threshold	161.0	2626.0	161.0	127.0	2592.0	127.0
	Testing required?	No	No	No	No	No	No

## 9.4 Simultaneous Transmission Analysis

### Simultaneous Transmission Scenario with Bluetooth

Simult Tx	Configuration	2.4G WLAN SAR (W/kg)	BT SAR (W/kg)	2.4G+BT SAR (W/kg)
Body	ESY15I4-C	0.516	0.157	0.673
Simult Tx	Configuration	5G WLAN SAR (W/kg)	BT SAR (W/kg)	5G+BT SAR (W/kg)
Body	ESY15I4-C	1.193	0.157	1.350

## Appendix A. SAR Validation Data

Date:8/5/2022

Test Laboratory: DEKRA Lab

System Check Head 2450MHz

**DUT: Dipole 2450 MHz D2450V2; Type: D2450V2**

Communication System: UID 0, CW; Communication System Band: D2450(2450MHz); Duty Cycle: 1:1;

Frequency: 2450 MHz; Medium parameters used (interpolated):  $f = 2450$  MHz;  $\sigma = 1.876$  S/m;  $\epsilon_r = 39.068$ ;

$\rho = 1000$  kg/m<sup>3</sup>; Phantom section: Flat Section; Input Power=250mW

Ambient temperature (°C): 21.5, Liquid temperature (°C): 21.0

DASY5 Configuration:

- Probe: EX3DV4 - SN3710; ConvF(7.39, 7.39, 7.39); Calibrated: 4/18/2022
- Sensor-Surface: 4mm (Mechanical Surface Detection)
- Electronics: DAE4 Sn1220; Calibrated: 3/24/2022
- Phantom: ELI1; Type: QDOVA002AA; Serial: TP:2106
- Measurement SW: DASY52, Version 52.10 (4); SEMCAD X Version 14.6.14 (7483)

**System Check Head 2450MHz/Area Scan (9x9x1):** Measurement grid: dx=12mm, dy=12mm

Maximum value of SAR (measured) = 14.6 W/kg

**System Check Head 2450MHz/Zoom Scan (7x7x8)/Cube 0:** Measurement grid: dx=5mm, dy=5mm, dz=5mm

Reference Value = 59.38 V/m; Power Drift = 0.12 dB

Peak SAR (extrapolated) = 27.0 W/kg

**SAR(1 g) = 12.9 W/kg; SAR(10 g) = 6.02 W/kg**

Maximum value of SAR (measured) = 14.5 W/kg

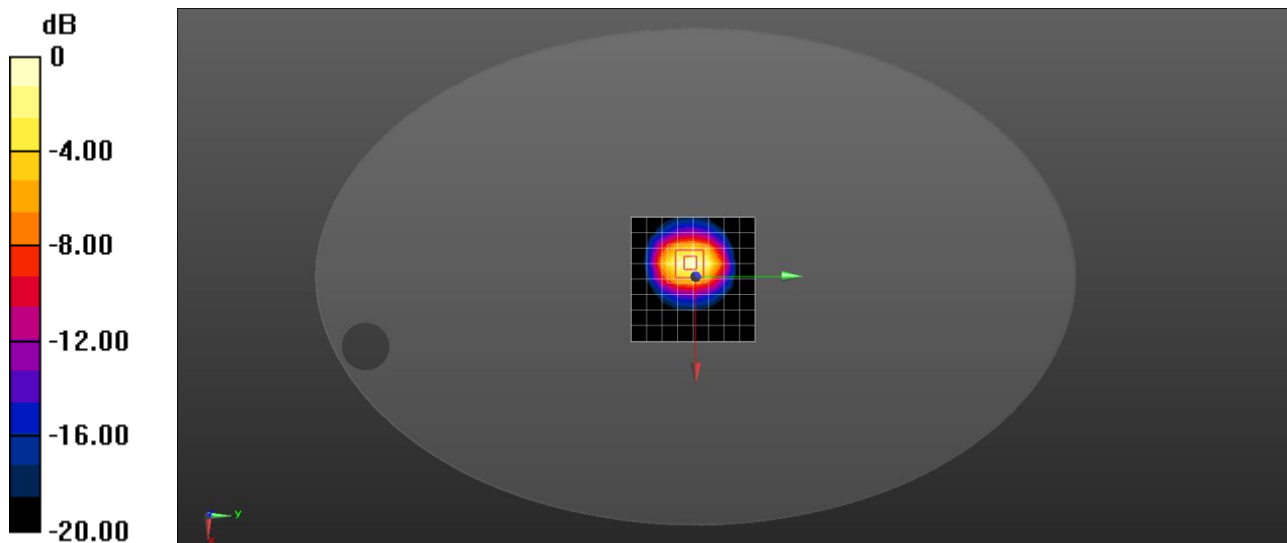

0 dB = 14.5 W/kg = 11.61 dBW/kg



Date:8/5/2022

Test Laboratory: DEKRA Lab

System Check Head 5250MHz

**DUT: Dipole D5GHzV2; Type: D5GHzV2**

Communication System: UID 0, CW (0); Communication System Band: 5GHz(5000.0-6000.0MHz); Duty

Cycle: 1:1; Frequency: 5250 MHz; Medium parameters used (interpolated):  $f = 5250$  MHz;  $\sigma = 4.626$  S/m;

$\epsilon_r = 36.729$ ;  $\rho = 1000$  kg/m<sup>3</sup>; Phantom section: Flat Section; Input Power=100mW

Ambient temperature (°C): 21.5, Liquid temperature (°C): 21.0

DASY5 Configuration:

- Probe: EX3DV4 - SN3710; ConvF(5.4, 5.4, 5.4); Calibrated: 4/18/2022
- Sensor-Surface: 4mm (Mechanical Surface Detection), Sensor-Surface: 1.4mm (Mechanical Surface Detection)
- Electronics: DAE4 Sn1220; Calibrated: 3/24/2022
- Phantom: ELI1; Type: QDOVA002AA; Serial: TP:2106
- Measurement SW: DASY52, Version 52.10 (4); SEMCAD X Version 14.6.14 (7483)

**System Check Head 5250MHz/Area Scan (11x11x1):** Measurement grid: dx=10mm, dy=10mm

Maximum value of SAR (measured) = 7.81 W/kg

**System Check Head 5250MHz/Zoom Scan (8x8x7)/Cube 0:** Measurement grid: dx=4mm, dy=4mm, dz=1.4mm

Reference Value = 37.30 V/m; Power Drift = 0.17 dB

Peak SAR (extrapolated) = 32.4 W/kg

**SAR(1 g) = 8.25 W/kg; SAR(10 g) = 2.28 W/kg**

Maximum value of SAR (measured) = 19.8 W/kg

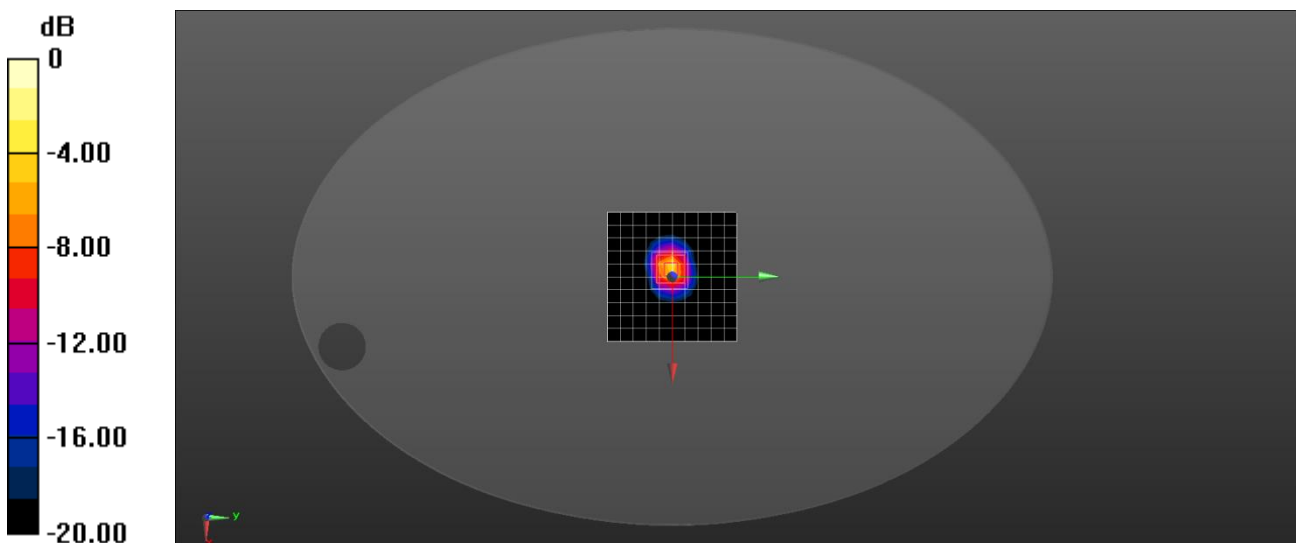

0 dB = 19.8 W/kg = 12.97 dBW/kg

Date:8/5/2022

Test Laboratory: DEKRA Lab

System Check Head 5600MHz

**DUT: Dipole D5GHzV2; Type: D5GHzV2**

Communication System: UID 0, CW (0); Communication System Band: 5GHz(5000.0-6000.0MHz); Duty Cycle: 1:1; Frequency: 5600 MHz; Medium parameters used:  $f = 5600$  MHz;  $\sigma = 5.11$  S/m;  $\epsilon r = 35.928$ ;  $\rho = 1000$  kg/m<sup>3</sup>; Phantom section: Flat Section; Input Power=100mW

Ambient temperature (°C): 21.5, Liquid temperature (°C): 21.0

DASY5 Configuration:

- Probe: EX3DV4 - SN3710; ConvF(4.85, 4.85, 4.85); Calibrated: 4/18/2022
- Sensor-Surface: 4mm (Mechanical Surface Detection), Sensor-Surface: 1.4mm (Mechanical Surface Detection)
- Electronics: DAE4 Sn1220; Calibrated: 3/24/2022
- Phantom: ELI1; Type: QDOVA002AA; Serial: TP:2106
- Measurement SW: DASY52, Version 52.10 (4); SEMCAD X Version 14.6.14 (7483)

**System Check Head 5600MHz/Area Scan (10x10x1):** Measurement grid: dx=10mm, dy=10mm

Maximum value of SAR (measured) = 7.84 W/kg

**System Check Head 5600MHz/Zoom Scan (8x8x7)/Cube 0:** Measurement grid: dx=4mm, dy=4mm, dz=1.4mm

Reference Value = 34.84 V/m; Power Drift = 0.02 dB

Peak SAR (extrapolated) = 33.5 W/kg

**SAR(1 g) = 8.31 W/kg; SAR(10 g) = 2.38 W/kg**

Maximum value of SAR (measured) = 20.5 W/kg

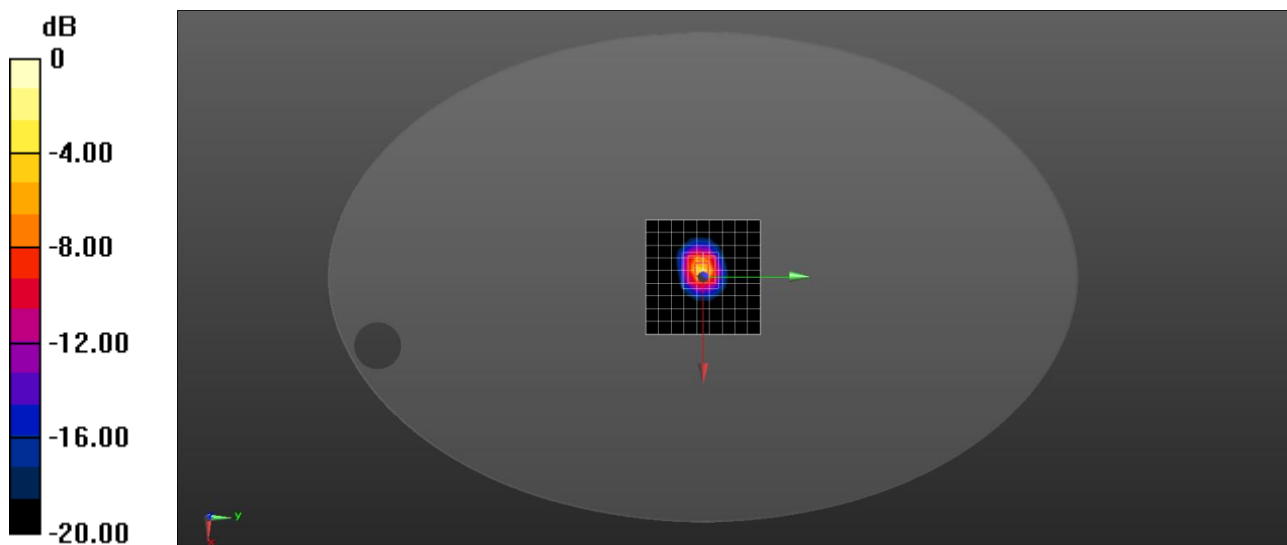

0 dB = 20.5 W/kg = 13.12 dBW/kg

Date:8/5/2022

Test Laboratory: DEKRA Lab

System Check Head 5750MHz

**DUT: Dipole D5GHzV2; Type: D5GHzV2**

Communication System: UID 0, CW (0); Communication System Band: 5GHz(5000.0-6000.0MHz); Duty Cycle: 1:1; Frequency: 5750 MHz; Medium parameters used:  $f = 5750$  MHz;  $\sigma = 5.216$  S/m;  $\epsilon_r = 35.624$ ;  $\rho = 1000$  kg/m<sup>3</sup>; Phantom section: Flat Section ; Input Power=100mW

Ambient temperature (°C): 21.5, Liquid temperature (°C): 21.0

DASY5 Configuration:

- Probe: EX3DV4 - SN3710; ConvF(4.88, 4.88, 4.88); Calibrated: 4/18/2022
- Sensor-Surface: 4mm (Mechanical Surface Detection), Sensor-Surface: 1.4mm (Mechanical Surface Detection)
- Electronics: DAE4 Sn1220; Calibrated: 3/24/2022
- Phantom: ELI1; Type: QDOVA002AA; Serial: TP:2106
- Measurement SW: DASY52, Version 52.10 (4); SEMCAD X Version 14.6.14 (7483)

**System Check Head 5750MHz/Area Scan (10x10x1):** Measurement grid: dx=10mm, dy=10mm

Maximum value of SAR (measured) = 7.80 W/kg

**System Check Head 5750MHz/Zoom Scan (8x8x7)/Cube 0:** Measurement grid: dx=4mm, dy=4mm, dz=1.4mm

Reference Value = 34.73 V/m; Power Drift = 0.02 dB

Peak SAR (extrapolated) = 33.3 W/kg

**SAR(1 g) = 8.07 W/kg; SAR(10 g) = 2.24 W/kg**

Maximum value of SAR (measured) = 20.4 W/kg

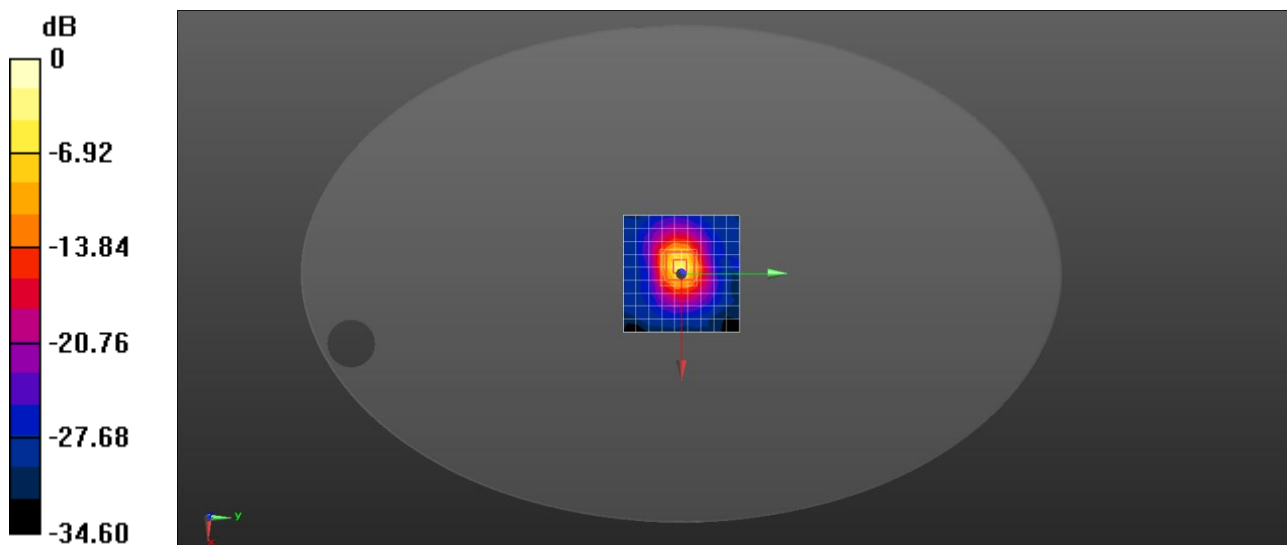

0 dB = 20.4 W/kg = 13.10 dBW/kg

## Appendix B. SAR Test Data

Date:8/5/2022

Test Laboratory: DEKRA Lab

WLAN2.4G 802.11g(20MHz) CH11 2462MHz MIMO Top

**DUT: Elo PAD; Type: ESY1514**

Communication System: UID 0, Wi-Fi (0); Communication System Band: 802.11g; Duty Cycle: 1:1; Frequency: 2462 MHz; Medium parameters used:  $f = 2462$  MHz;  $\sigma = 1.891$  S/m;  $\epsilon r = 39.009$ ;  $\rho = 1000$  kg/m<sup>3</sup> ;

Phantom section: Flat Section ; Input Power=250mW

Ambient temperature (°C): 21.5, Liquid temperature (°C): 21.0

DASY5 Configuration:

- Probe: EX3DV4 - SN3710; ConvF(7.39, 7.39, 7.39); Calibrated: 4/18/2022
- Sensor-Surface: 4mm (Mechanical Surface Detection)
- Electronics: DAE4 Sn1220; Calibrated: 3/24/2022
- Phantom: ELI1; Type: QDOVA002AA; Serial: TP:2106
- Measurement SW: DASY52, Version 52.10 (4); SEMCAD X Version 14.6.14 (7483)

**WLAN2.4G 802.11g(20MHz) CH11 2462MHz MIMO Top/Area Scan (8x36x1):** Measurement grid: dx=12mm, dy=12mm

Maximum value of SAR (measured) = 0.379 W/kg

**WLAN2.4G 802.11g(20MHz) CH11 2462MHz MIMO Top/Zoom Scan (7x7x5)/Cube 0:** Measurement grid: dx=5mm, dy=5mm, dz=4mm

Reference Value = 0.7350 V/m; Power Drift = -0.01 dB

Peak SAR (extrapolated) = 0.958 W/kg

**SAR(1 g) = 0.476 W/kg; SAR(10 g) = 0.212 W/kg**

Maximum value of SAR (measured) = 0.539 W/kg

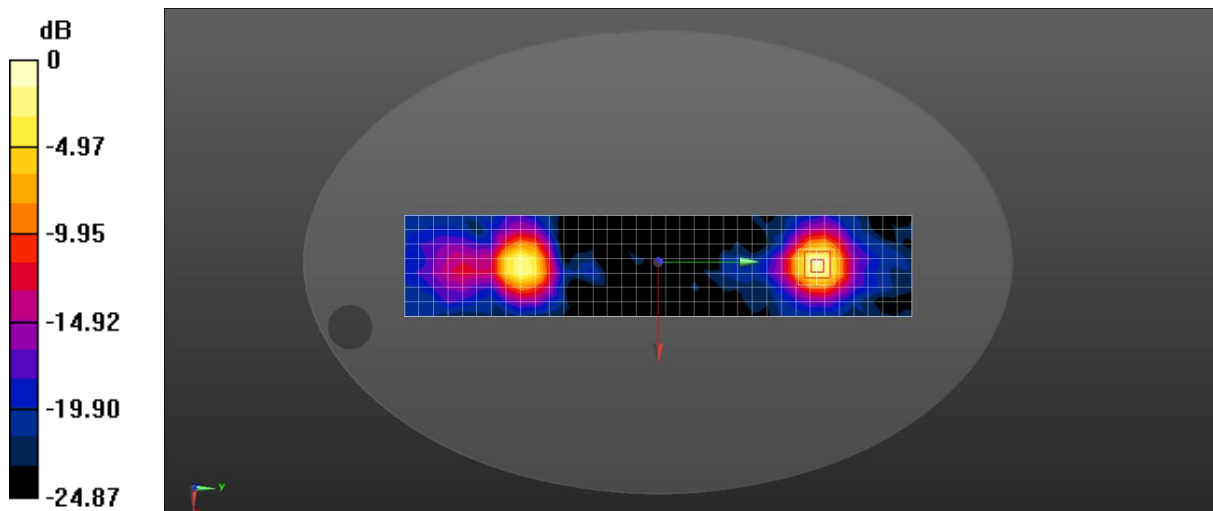

0 dB = 0.539 W/kg = -2.68 dBW/kg

Date: 8/5/2022

Test Laboratory: DEKRA Lab

BLE CH00 2402MHz Top

**DUT: Elo PAD; Type: ESY1514**

Communication System: UID 0, Bluetooth (0); Communication System Band: BLE; Duty Cycle: 1:1;

Frequency: 2402 MHz; Medium parameters used (interpolated):  $f = 2402$  MHz;  $\sigma = 1.769$  S/m;  $\epsilon_r = 40.089$ ;  $\rho = 1000$  kg/m<sup>3</sup> ; Phantom section: Flat Section ; Input Power=250mW

Ambient temperature (°C): 21.5, Liquid temperature (°C): 21.0

DASY5 Configuration:

- Probe: EX3DV4 - SN3710; ConvF(7.39, 7.39, 7.39) ; Calibrated: 4/18/2022
- Sensor-Surface: 4mm (Mechanical Surface Detection)
- Electronics: DAE4 Sn1220; Calibrated: 3/24/2022
- Phantom: ELI1; Type: QDOVA002AA; Serial: TP:2106
- Measurement SW: DASY52, Version 52.10 (4); SEMCAD X Version 14.6.14 (7483)

**CH00/Area Scan (11x12x1):** Measurement grid: dx=12mm, dy=12mm

Maximum value of SAR (measured) = 0.0796 W/kg

**CH00/Zoom Scan (7x7x5)/Cube 0:** Measurement grid: dx=5mm, dy=5mm, dz=4mm

Reference Value = 6.124 V/m; Power Drift = 0.02 dB

Peak SAR (extrapolated) = 0.193 W/kg

**SAR(1 g) = 0.080 W/kg; SAR(10 g) = 0.037 W/kg**

Maximum value of SAR (measured) = 0.0867 W/kg

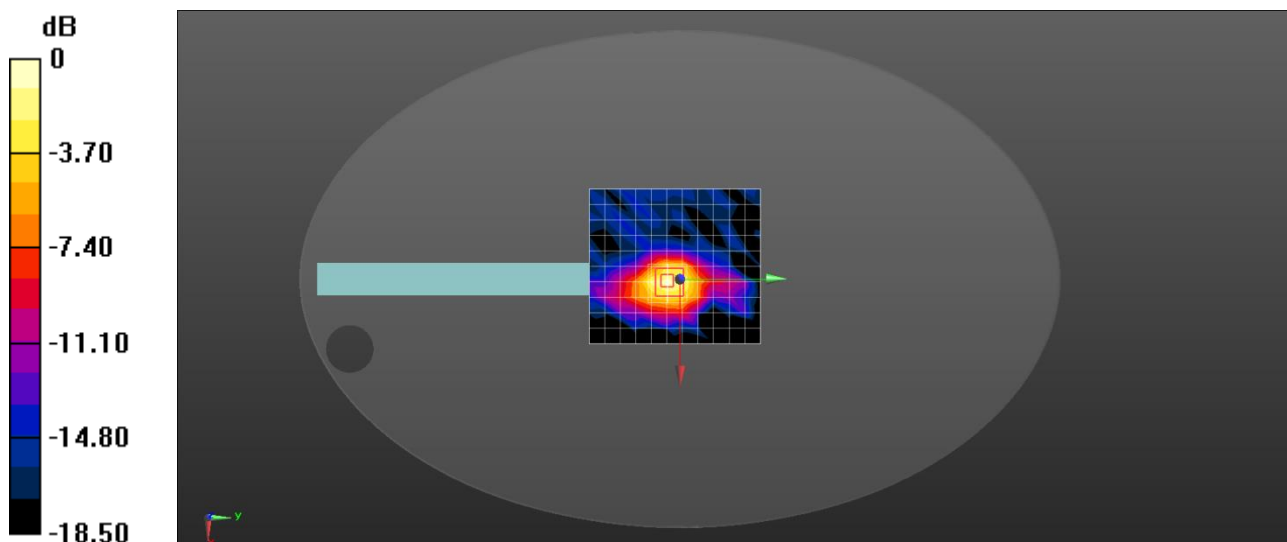

0 dB = 0.0867 W/kg = -10.62 dBW/kg

Date:8/5/2022

Test Laboratory: DEKRA Lab

WLAN5G 802.11n(20MHz) CH64 5320MHz MIMO Top

**DUT: Elo PAD; Type: ESY1514**

Communication System: UID 0, CW (0); Communication System Band: 5GHz(5000.0-6000.0MHz); Duty

Cycle: 1:1.0; Frequency: 5320 MHz; Medium parameters used:  $f = 5320$  MHz;  $\sigma = 4.705$  S/m;  $\epsilon r = 36.571$ ;

$\rho = 1000$  kg/m<sup>3</sup>; Phantom section: Flat Section

Ambient temperature (°C): 21.5, Liquid temperature (°C): 21.0

DASY5 Configuration:

- Probe: EX3DV4 - SN3710; ConvF(5.4, 5.4, 5.4) ; Calibrated: 4/18/2022
- Sensor-Surface: 2mm (Mechanical Surface Detection)
- Electronics: DAE4 Sn1220; Calibrated: 3/24/2022
- Phantom: ELI1; Type: QDOVA002AA; Serial: TP:2106
- Measurement SW: DASY52, Version 52.10 (4); SEMCAD X Version 14.6.14 (7483)

**WLAN5G 802.11n(20MHz) CH64 5320MHz MIMO Top/Area Scan (10x43x1):** Measurement grid: dx=10mm, dy=10mm

Maximum value of SAR (measured) = 1.61 W/kg

**WLAN5G 802.11n(20MHz) CH64 5320MHz MIMO Top/Zoom Scan (8x8x12)/Cube 0:** Measurement grid: dx=4mm, dy=4mm, dz=2mm

Reference Value = 0.7340 V/m; Power Drift = 0.08 dB

Peak SAR (extrapolated) = 3.31 W/kg

**SAR(1 g) = 0.782 W/kg; SAR(10 g) = 0.285 W/kg**

Maximum value of SAR (measured) = 1.61 W/kg

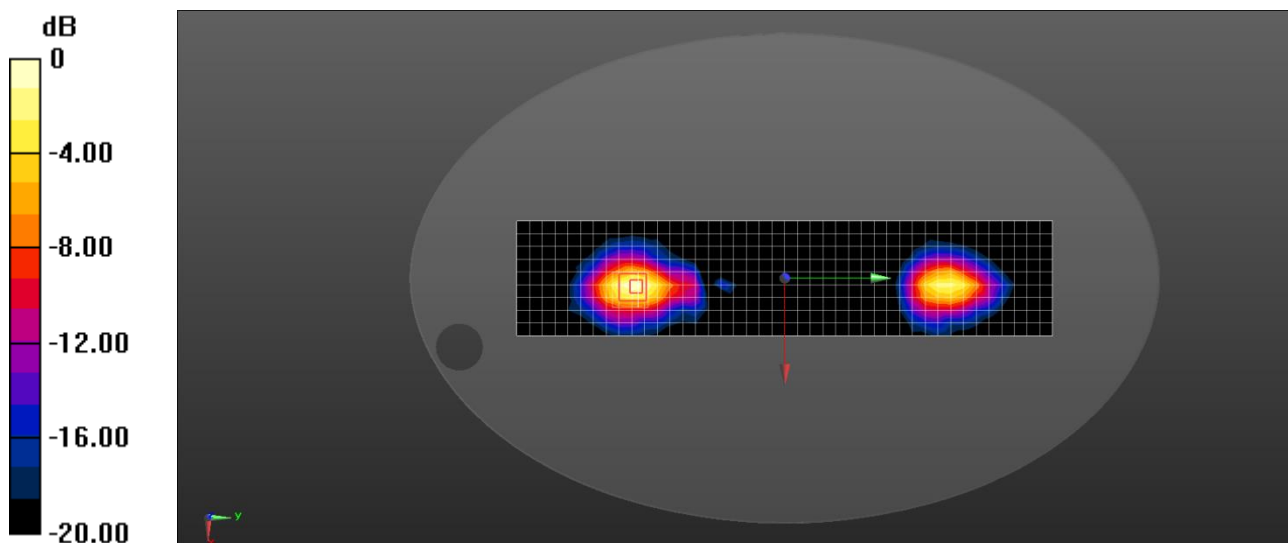

0 dB = 1.61 W/kg = 2.07 dBW/kg

Date:8/5/2022

Test Laboratory: DEKRA Lab

WLAN5G 802.11n(20MHz) CH100 5500MHz MIMO Top

**DUT: Elo PAD; Type: ESY15I4**

Communication System: UID 0, CW (0); Communication System Band: 5GHz(5000.0-6000.0MHz); Duty Cycle: 1:1.0; Frequency: 5500 MHz; Medium parameters used:  $f = 5500$  MHz;  $\sigma = 4.913$  S/m;  $\epsilon r = 36.173$ ;  $\rho = 1000$  kg/m<sup>3</sup>; Phantom section: Flat Section

Ambient temperature (°C): 21.5, Liquid temperature (°C): 21.0

DASY5 Configuration:

- Probe: EX3DV4 - SN3710; ConvF(4.85, 4.85, 4.85); Calibrated: 4/18/2022
- Sensor-Surface: 2mm (Mechanical Surface Detection)
- Electronics: DAE4 Sn1220; Calibrated: 3/24/2022
- Phantom: ELI1; Type: QDOVA002AA; Serial: TP:2106
- Measurement SW: DASY52, Version 52.10 (4); SEMCAD X Version 14.6.14 (7483)

**WLAN5G 802.11n(20MHz) CH100 5500MHz MIMO Top/Area Scan (10x43x1):** Measurement grid:

dx=10mm, dy=10mm

Maximum value of SAR (measured) = 1.77 W/kg

**WLAN5G 802.11n(20MHz) CH100 5500MHz MIMO Top/Zoom Scan (8x8x12)/Cube 0:** Measurement grid:

dx=4mm, dy=4mm, dz=2mm

Reference Value = 0.7270 V/m; Power Drift =0.18 dB

Peak SAR (extrapolated) = 3.75 W/kg

**SAR(1 g) = 0.931 W/kg; SAR(10 g) = 0.332 W/kg**

Maximum value of SAR (measured) = 1.91 W/kg

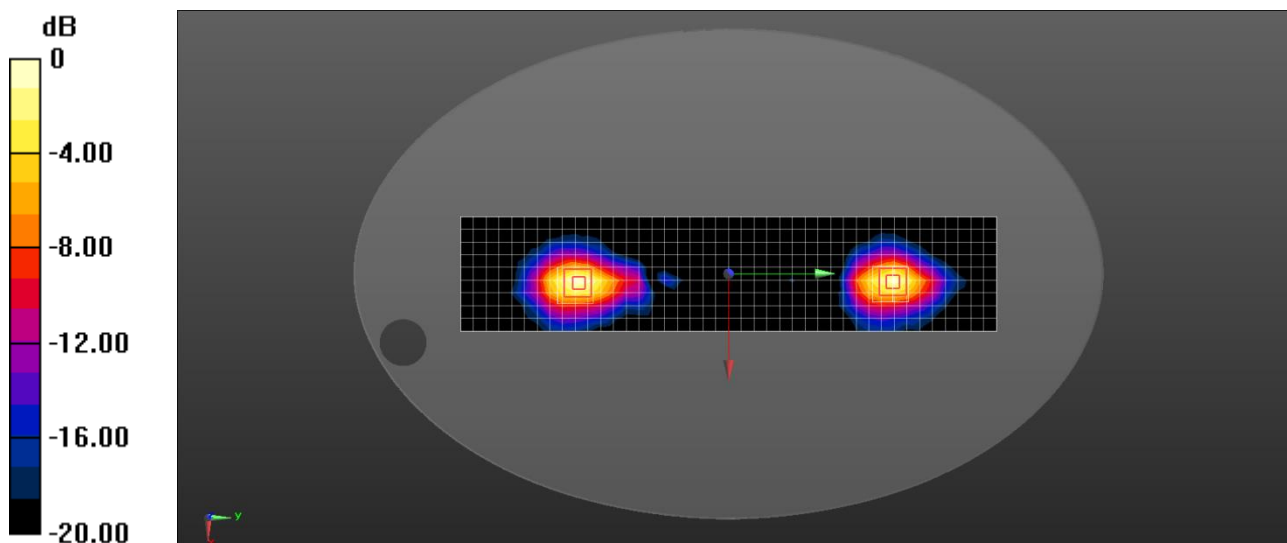

0 dB = 1.76 W/kg = 2.46 dBW/kg

Date:8/5/2022

Test Laboratory: DEKRA Lab

WLAN5G 802.11n(20MHz) CH165 5825MHz MIMO Top

**DUT: Elo PAD; Type: ESY1514**

Communication System: UID 0, CW (0); Communication System Band: 5GHz(5000.0-6000.0MHz); Duty Cycle: 1:1.0; Frequency: 5825 MHz; Medium parameters used (interpolated):  $f = 5825$  MHz;  $\sigma = 5.303$  S/m;  $\epsilon_r = 35.467$ ;  $\rho = 1000$  kg/m<sup>3</sup>; Phantom section: Flat Section

Ambient temperature (°C): 21.5, Liquid temperature (°C): 21.0

DASY5 Configuration:

- Probe: EX3DV4 - SN3710; ConvF(4.88, 4.88, 4.88); Calibrated: 4/18/2022
- Sensor-Surface: 2mm (Mechanical Surface Detection)
- Electronics: DAE4 Sn1220; Calibrated: 3/24/2022
- Phantom: ELI1; Type: QDOVA002AA; Serial: TP:2106
- Measurement SW: DASY52, Version 52.10 (4); SEMCAD X Version 14.6.14 (7483)

**WLAN5G 802.11n(20MHz) CH165 5825MHz MIMO Top/Area Scan (10x43x1):** Measurement grid:

dx=10mm, dy=10mm

**WLAN5G 802.11n(20MHz) CH165 5825MHz MIMO Top/Zoom Scan (8x8x12)/Cube 0:** Measurement grid:

dx=4mm, dy=4mm, dz=2mm

Reference Value = 0.8430 V/m; Power Drift = 0.16 dB

Peak SAR (extrapolated) = 1.31 W/kg

**SAR(1 g) = 0.320 W/kg; SAR(10 g) = 0.111 W/kg**

Maximum value of SAR (measured) = 0.595 W/kg

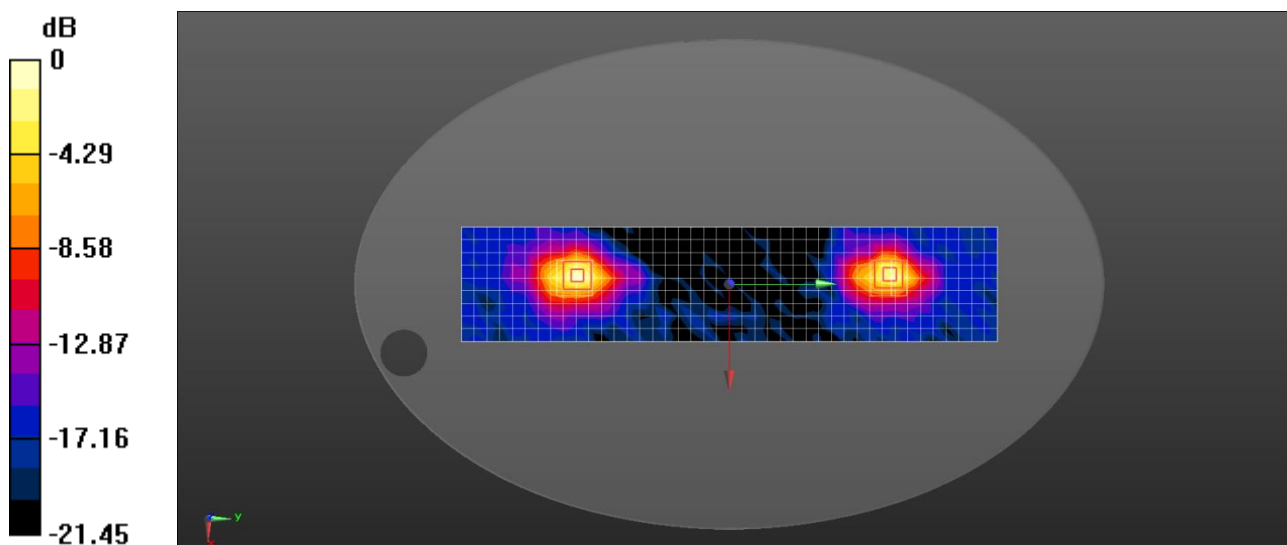

0 dB = 0.595 W/kg = -2.25 dBW/kg



### Appendix C. Probe Calibration Data



Add: No.52 HuaYuanBei Road, Haidian District, Beijing, 100191, China  
 Tel: +86-10-62304633-2512 Fax: +86-10-62304633-2504  
 E-mail: cttl@chinattl.com Http://www.chinattl.cn



中国认可  
 国际互认  
 校准  
**CAICT**  
 CALIBRATION  
 CNAS L0570

Client **Dekra-CN**

Certificate No: **Z22-60083**

## CALIBRATION CERTIFICATE

Object **EX3DV4 - SN : 3710**

Calibration Procedure(s) **FF-Z11-004-02  
 Calibration Procedures for Dosimetric E-field Probes**

Calibration date: **April 18, 2022**

This calibration Certificate documents the traceability to national standards, which realize the physical units of measurements(SI). The measurements and the uncertainties with confidence probability are given on the following pages and are part of the certificate.

All calibrations have been conducted in the closed laboratory facility: environment temperature(22±3)°C and humidity<70%.

Calibration Equipment used (M&TE critical for calibration)

Primary Standards	ID #	Cal Date(Calibrated by, Certificate No.)	Scheduled Calibration
Power Meter NRP2	101919	15-Jun-21(CTTL, No.J21X04466)	Jun-22
Power sensor NRP-Z91	101547	15-Jun-21(CTTL, No.J21X04466)	Jun-22
Power sensor NRP-Z91	101548	15-Jun-21(CTTL, No.J21X04466)	Jun-22
Reference 10dBAttenuator	18N50W-10dB	20-Jan-21(CTTL, No.J21X00486)	Jan-23
Reference 20dBAttenuator	18N50W-20dB	20-Jan-21(CTTL, No.J21X00485)	Jan-23
Reference Probe EX3DV4	SN 7307	26-May-21(SPEAG, No.EX3-7307_May21)	May-22
Reference Probe EX3DV4	SN 7464	26-Jan-22(SPEAG, No.EX3-7464_Jan22)	Jan-23
DAE4	SN 1555	20-Aug-21(SPEAG, No.DAE4-1555_Aug21/2)	Aug-22
Secondary Standards	ID #	Cal Date(Calibrated by, Certificate No.)	Scheduled Calibration
SignalGenerator MG3700A	6201052605	16-Jun-21(CTTL, No.J21X04467)	Jun-22
Network Analyzer E5071C	MY46110673	14-Jan-22(CTTL, No.J22X00406)	Jan-23

	Name	Function	Signature
Calibrated by:	Yu Zongying	SAR Test Engineer	
Reviewed by:	Lin Hao	SAR Test Engineer	
Approved by:	Qi Dianyuan	SAR Project Leader	

Issued: April 19, 2022

This calibration certificate shall not be reproduced except in full without written approval of the laboratory.



In Collaboration with  
**s p e a g**  
CALIBRATION LABORATORY



Add: No.52 HuaYuanBei Road, Haidian District, Beijing, 100191, China  
Tel: +86-10-62304633-2512 Fax: +86-10-62304633-2504  
E-mail: cttl@chinattl.com [Http://www.chinattl.cn](http://www.chinattl.cn)

**Glossary:**

TSL	tissue simulating liquid
NORM <sub>x,y,z</sub>	sensitivity in free space
ConvF	sensitivity in TSL / NORM <sub>x,y,z</sub>
DCP	diode compression point
CF	crest factor (1/duty_cycle) of the RF signal
A,B,C,D	modulation dependent linearization parameters
Polarization Φ	Φ rotation around probe axis
Polarization θ	θ rotation around an axis that is in the plane normal to probe axis (at measurement center), i θ=0 is normal to probe axis

Connector Angle information used in DASYS system to align probe sensor X to the robot coordinate system

**Calibration is Performed According to the Following Standards:**

- a) IEEE Std 1528-2013, "IEEE Recommended Practice for Determining the Peak Spatial-Averaged Specific Absorption Rate (SAR) in the Human Head from Wireless Communications Devices: Measurement Techniques", June 2013
- b) IEC 62209-1, "Measurement procedure for the assessment of Specific Absorption Rate (SAR) from hand-held and body-mounted devices used next to the ear (frequency range of 300 MHz to 6 GHz)", July 2016
- c) IEC 62209-2, "Procedure to determine the Specific Absorption Rate (SAR) for wireless communication devices used in close proximity to the human body (frequency range of 30 MHz to 6 GHz)", March 2010
- d) KDB 865664, "SAR Measurement Requirements for 100 MHz to 6 GHz"

**Methods Applied and Interpretation of Parameters:**

- **NORM<sub>x,y,z</sub>:** Assessed for E-field polarization θ=0 (f≤900MHz in TEM-cell; f>1800MHz: waveguide). NORM<sub>x,y,z</sub> are only intermediate values, i.e., the uncertainties of NORM<sub>x,y,z</sub> does not effect the E<sup>2</sup>-field uncertainty inside TSL (see below ConvF).
- **NORM(f)<sub>x,y,z</sub> = NORM<sub>x,y,z</sub>\* frequency\_response** (see Frequency Response Chart). This linearization is implemented in DASYS4 software versions later than 4.2. The uncertainty of the frequency response is included in the stated uncertainty of ConvF.
- **DCP<sub>x,y,z</sub>:** DCP are numerical linearization parameters assessed based on the data of power sweep (no uncertainty required). DCP does not depend on frequency nor media.
- **PAR:** PAR is the Peak to Average Ratio that is not calibrated but determined based on the signal characteristics.
- **A<sub>x,y,z</sub>; B<sub>x,y,z</sub>; C<sub>x,y,z</sub>; VR<sub>x,y,z</sub>; A,B,C** are numerical linearization parameters assessed based on the data of power sweep for specific modulation signal. The parameters do not depend on frequency nor media. VR is the maximum calibration range expressed in RMS voltage across the diode.
- **ConvF and Boundary Effect Parameters:** Assessed in flat phantom using E-field (or Temperature Transfer Standard for f≤800MHz) and inside waveguide using analytical field distributions based on power measurements for f >800MHz. The same setups are used for assessment of the parameters applied for boundary compensation (alpha, depth) of which typical uncertainty valued are given. These parameters are used in DASYS4 software to improve probe accuracy close to the boundary. The sensitivity in TSL corresponds to NORM<sub>x,y,z</sub>\* ConvF whereby the uncertainty corresponds to that given for ConvF. A frequency dependent ConvF is used in DASYS version 4.4 and higher which allows extending the validity from ±50MHz to ±100MHz.
- **Spherical isotropy (3D deviation from isotropy):** in a field of low gradients realized using a flat phantom exposed by a patch antenna.
- **Sensor Offset:** The sensor offset corresponds to the offset of virtual measurement center from the probe tip (on probe axis). No tolerance required.
- **Connector Angle:** The angle is assessed using the information gained by determining the NORM<sub>x</sub> (no uncertainty required).



In Collaboration with  
**s p e a g**  
CALIBRATION LABORATORY

Add: No.52 HuaYuanBei Road, Haidian District, Beijing, 100191, China  
Tel: +86-10-62304633-2512 Fax: +86-10-62304633-2504  
E-mail: cttl@chinattl.com [Http://www.chinattl.cn](http://www.chinattl.cn)



## DASY/EASY – Parameters of Probe: EX3DV4 – SN:3710

### Basic Calibration Parameters

	Sensor X	Sensor Y	Sensor Z	Unc (k=2)
Norm( $\mu\text{V}/(\text{V}/\text{m})^2$ ) <sup>A</sup>	0.37	0.41	0.49	±10.0%
DCP(mV) <sup>B</sup>	101.9	102.3	102.5	

### Modulation Calibration Parameters

UID	Communication System Name		A dB	B dB $\sqrt{\mu\text{V}}$	C	D dB	VR mV	Unc <sup>E</sup> (k=2)
0	CW	X	0.0	0.0	1.0	0.00	140.6	±2.1%
		Y	0.0	0.0	1.0		148.8	
		Z	0.0	0.0	1.0		170.6	

The reported uncertainty of measurement is stated as the standard uncertainty of Measurement multiplied by the coverage factor  $k=2$ , which for a normal distribution Corresponds to a coverage probability of approximately 95%.

<sup>A</sup> The uncertainties of Norm X, Y, Z do not affect the E<sup>2</sup>-field uncertainty inside TSL (see Page 4).

<sup>B</sup> Numerical linearization parameter: uncertainty not required.

<sup>E</sup> Uncertainty is determined using the max. deviation from linear response applying rectangular distribution and is expressed for the square of the field value.



Add: No.52 HuaYuanBei Road, Haidian District, Beijing, 100191, China  
 Tel: +86-10-62304633-2512 Fax: +86-10-62304633-2504  
 E-mail: cttl@chinattl.com [Http://www.chinattl.cn](http://www.chinattl.cn)



## DASY/EASY – Parameters of Probe: EX3DV4 – SN:3710

### Calibration Parameter Determined in Head Tissue Simulating Media

f [MHz] <sup>C</sup>	Relative Permittivity <sup>F</sup>	Conductivity (S/m) <sup>F</sup>	ConvF X	ConvF Y	ConvF Z	Alpha <sup>G</sup>	Depth <sup>G</sup> (mm)	Unct. (k=2)
750	41.9	0.89	9.60	9.60	9.60	0.17	1.28	±12.1%
835	41.5	0.90	9.31	9.31	9.31	0.15	1.41	±12.1%
900	41.5	0.97	9.30	9.30	9.30	0.17	1.27	±12.1%
1810	40.0	1.40	7.90	7.90	7.90	0.30	0.93	±12.1%
1900	40.0	1.40	7.80	7.80	7.80	0.32	0.94	±12.1%
2300	39.5	1.67	7.66	7.66	7.66	0.57	0.71	±12.1%
2450	39.2	1.80	7.39	7.39	7.39	0.61	0.69	±12.1%
2600	39.0	1.96	7.18	7.18	7.18	0.53	0.76	±12.1%
3300	38.2	2.71	7.00	7.00	7.00	0.43	0.93	±13.3%
3500	37.9	2.91	6.78	6.78	6.78	0.45	0.98	±13.3%
3700	37.7	3.12	6.49	6.49	6.49	0.42	1.02	±13.3%
3900	37.5	3.32	6.55	6.55	6.55	0.35	1.35	±13.3%
4100	37.2	3.53	6.53	6.53	6.53	0.40	1.15	±13.3%
4200	37.1	3.63	6.44	6.44	6.44	0.40	1.25	±13.3%
4400	36.9	3.84	6.34	6.34	6.34	0.40	1.25	±13.3%
4600	36.7	4.04	6.23	6.23	6.23	0.45	1.25	±13.3%
4800	36.4	4.25	6.18	6.18	6.18	0.45	1.30	±13.3%
4950	36.3	4.40	5.87	5.87	5.87	0.45	1.30	±13.3%
5250	35.9	4.71	5.40	5.40	5.40	0.45	1.30	±13.3%
5600	35.5	5.07	4.85	4.85	4.85	0.55	1.20	±13.3%
5750	35.4	5.22	4.88	4.88	4.88	0.55	1.20	±13.3%

<sup>C</sup> Frequency validity above 300 MHz of ±100MHz only applies for DASY v4.4 and higher (Page 2), else it is restricted to ±50MHz. The uncertainty is the RSS of ConvF uncertainty at calibration frequency and the uncertainty for the indicated frequency band. Frequency validity below 300 MHz is ± 10, 25, 40, 50 and 70 MHz for ConvF assessments at 30, 64, 128, 150 and 220 MHz respectively. Above 5 GHz frequency validity can be extended to ± 110 MHz.

<sup>F</sup> At frequency below 3 GHz, the validity of tissue parameters ( $\epsilon$  and  $\sigma$ ) can be relaxed to ±10% if liquid compensation formula is applied to measured SAR values. At frequencies above 3 GHz, the validity of tissue parameters ( $\epsilon$  and  $\sigma$ ) is restricted to ±5%. The uncertainty is the RSS of the ConvF uncertainty for indicated target tissue parameters.

<sup>G</sup> Alpha/Depth are determined during calibration. SPEAG warrants that the remaining deviation due to the boundary effect after compensation is always less than ± 1% for frequencies below 3 GHz and below ± 2% for the frequencies between 3-6 GHz at any distance larger than half the probe tip diameter from the boundary.



In Collaboration with  
**s p e a g**  
CALIBRATION LABORATORY



Add: No.52 HuaYuanBei Road, Haidian District, Beijing, 100191, China  
Tel: +86-10-62304633-2512 Fax: +86-10-62304633-2504  
E-mail: [ctl@chinattl.com](mailto:ctl@chinattl.com) [Http://www.chinattl.cn](http://www.chinattl.cn)

### Frequency Response of E-Field (TEM-Cell: ifi110 EXX, Waveguide: R22)

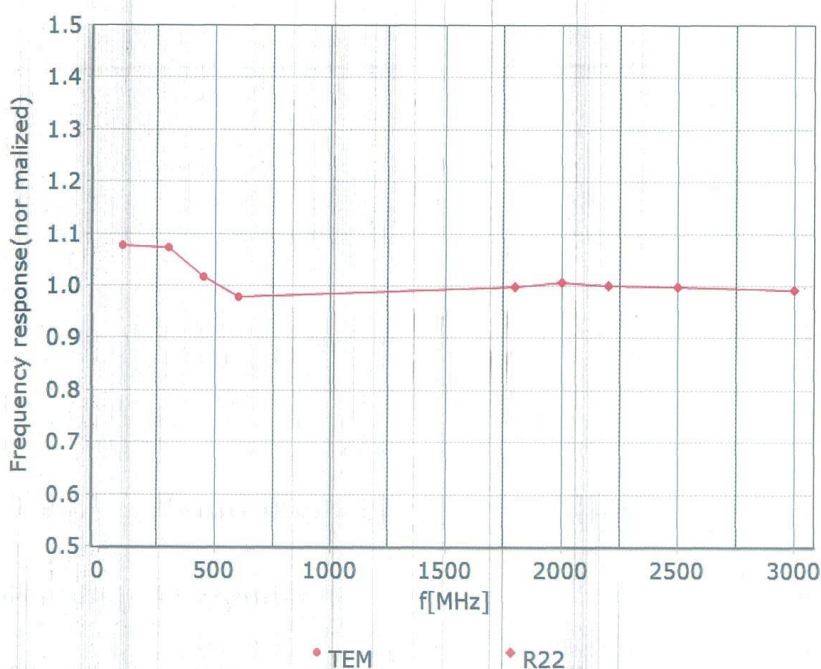

Uncertainty of Frequency Response of E-field:  $\pm 7.4\%$  ( $k=2$ )



Add: No.52 HuaYuanBei Road, Haidian District, Beijing, 100191, China  
 Tel: +86-10-62304633-2512 Fax: +86-10-62304633-2504  
 E-mail: cttl@chinattl.com [Http://www.chinattl.cn](http://www.chinattl.cn)

### Receiving Pattern ( $\Phi$ ), $\theta=0^\circ$

f=600 MHz, TEM

f=1800 MHz, R22

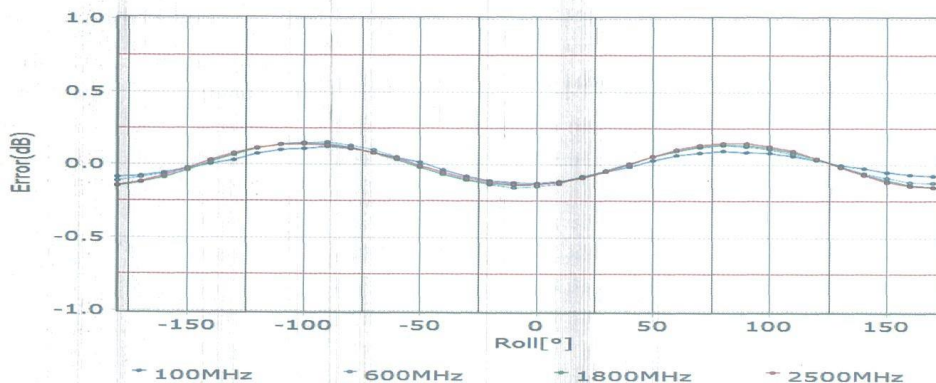
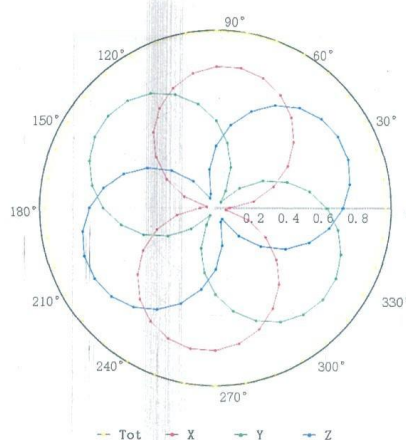
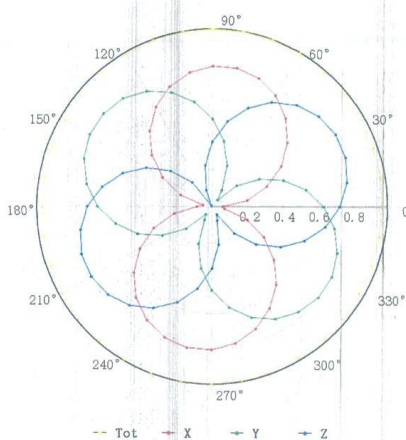

Uncertainty of Axial Isotropy Assessment:  $\pm 1.2\%$  ( $k=2$ )

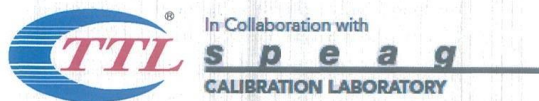

Add: No.52 HuaYuanBei Road, Haidian District, Beijing, 100191, China  
 Tel: +86-10-62304633-2512 Fax: +86-10-62304633-2504  
 E-mail: cttl@chinattl.com [Http://www.chinattl.cn](http://www.chinattl.cn)

### Dynamic Range f(SAR<sub>head</sub>) (TEM cell, f = 900 MHz)

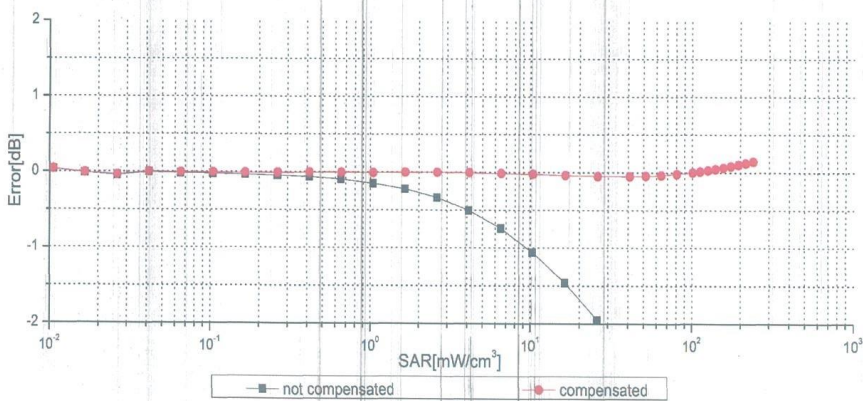
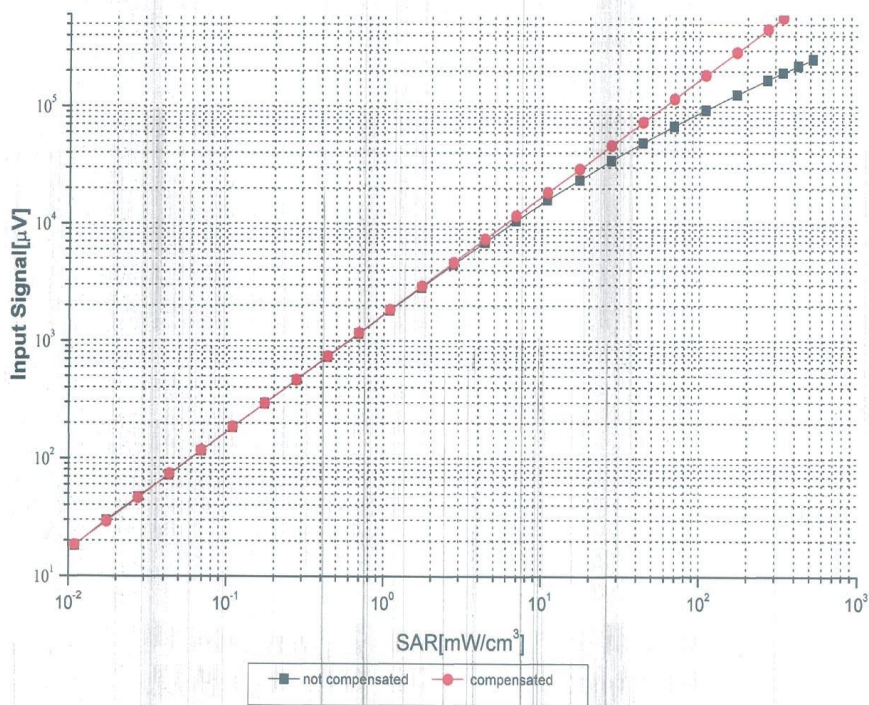

Uncertainty of Linearity Assessment: ±0.9% (k=2)

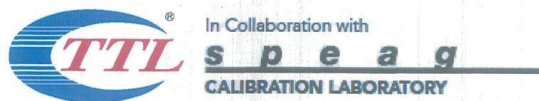

Add: No.52 HuaYuanBei Road, Haidian District, Beijing, 100191, China  
 Tel: +86-10-62304633-2512 Fax: +86-10-62304633-2504  
 E-mail: cttl@chinattl.com [Http://www.chinattl.cn](http://www.chinattl.cn)



### Conversion Factor Assessment

f=750 MHz,WGLS R9(H\_convF)

f=1810 MHz,WGLS R22(H\_convF)

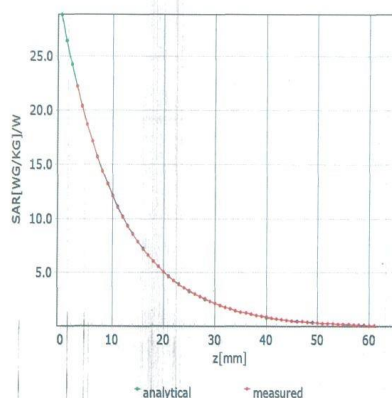
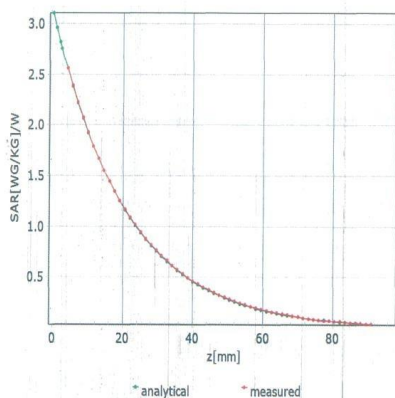

### Deviation from Isotropy in Liquid

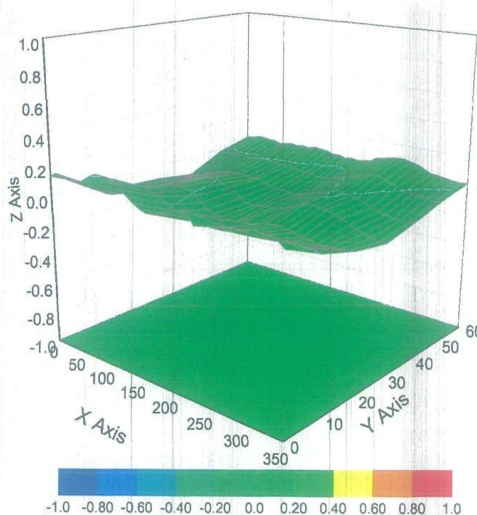

Uncertainty of Spherical Isotropy Assessment: ±3.2% (k=2)



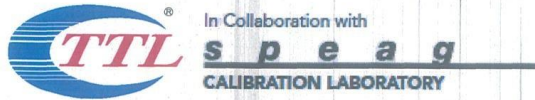

Add: No.52 HuaYuanBei Road, Haidian District, Beijing, 100191, China  
 Tel: +86-10-62304633-2512 Fax: +86-10-62304633-2504  
 E-mail: [ctl@chinattl.com](mailto:ctl@chinattl.com) [Http://www.chinattl.cn](http://www.chinattl.cn)



## DASY/EASY – Parameters of Probe: EX3DV4 – SN:3710

### Other Probe Parameters

Sensor Arrangement	Triangular
Connector Angle (°)	81.3
Mechanical Surface Detection Mode	enabled
Optical Surface Detection Mode	disable
Probe Overall Length	337mm
Probe Body Diameter	10mm
Tip Length	9mm
Tip Diameter	2.5mm
Probe Tip to Sensor X Calibration Point	1mm
Probe Tip to Sensor Y Calibration Point	1mm
Probe Tip to Sensor Z Calibration Point	1mm
Recommended Measurement Distance from Surface	1.4mm

## Dipole Calibration Data



Add: No.52 HuaYuanBei Road, Haidian District, Beijing, 100191  
 Tel: +86-10-62304633-2512 Fax: +86-10-62304633-2504  
 E-mail: cttl@chinattl.com Http://www.chinattl.cn



中国认可  
 国际互认  
 校准  
 CALIBRATION  
 CNAS L0570



Client **Dekra-CN**

Certificate No: **Z22-60089**

CALIBRATION CERTIFICATE			
Object	D2450V2 - SN: 839		
Calibration Procedure(s)	FF-Z11-003-01 Calibration Procedures for dipole validation kits		
Calibration date:	April 1, 2022		
<p>This calibration Certificate documents the traceability to national standards, which realize the physical units of measurements (SI). The measurements and the uncertainties with confidence probability are given on the following pages and are part of the certificate.</p> <p>All calibrations have been conducted in the closed laboratory facility: environment temperature (22±3)°C and humidity&lt;70%.</p> <p>Calibration Equipment used (M&amp;TE critical for calibration)</p>			
Primary Standards	ID #	Cal Date (Calibrated by, Certificate No.)	Scheduled Calibration
Power Meter NRP2	106277	24-Sep-21 (CTTL, No.J21X08326)	Sep-22
Power sensor NRP8S	104291	24-Sep-21 (CTTL, No.J21X08326)	Sep-22
Reference Probe EX3DV4	SN 7307	26-May-21(SPEAG,No.EX3-7307_May21)	May-22
DAE4	SN 1556	12-Jan-22(CTTL-SPEAG,No.Z22-60007)	Jan-23
Secondary Standards	ID #	Cal Date (Calibrated by, Certificate No.)	Scheduled Calibration
Signal Generator E4438C	MY49071430	13-Jan-22 (CTTL, No. J22X00409)	Jan-23
Network Analyzer E5071C	MY46110673	14-Jan-22 (CTTL, No.J22X00406)	Jan-23
Calibrated by:	Name Zhao Jing	Function SAR Test Engineer	Signature 
Reviewed by:	Name Lin Hao	Function SAR Test Engineer	Signature 
Approved by:	Name Qi Dianyuan	Function SAR Project Leader	Signature 
			Issued: April 6, 2022
This calibration certificate shall not be reproduced except in full without written approval of the laboratory.			



Add: No.52 HuaYuanBei Road, Haidian District, Beijing, 100191, China  
Tel: +86-10-62304633-2079 Fax: +86-10-62304633-2504  
E-mail: cttl@chinattl.com http://www.chinattl.cn



**Glossary:**

TSL tissue simulating liquid  
ConvF sensitivity in TSL / NORM<sub>x,y,z</sub>  
N/A not applicable or not measured

**Calibration is Performed According to the Following Standards:**

- a) IEC/IEEE 62209-1528, "Measurement Procedure for The Assessment of Specific Absorption Rate of Human Exposure to Radio Frequency Fields from Hand-held and Body-mounted Wireless Communication Devices- Part 1528: Human Models, Instrumentation and Procedures (Frequency range of 4 MHz to 10 GHz)", October 2020
- b) KDB 865664, "SAR Measurement Requirements for 100 MHz to 6 GHz"

**Additional Documentation:**

- c) DASY4/5 System Handbook

**Methods Applied and Interpretation of Parameters:**

- *Measurement Conditions:* Further details are available from the Validation Report at the end of the certificate. All figures stated in the certificate are valid at the frequency indicated.
- *Antenna Parameters with TSL:* The dipole is mounted with the spacer to position its feed point exactly below the center marking of the flat phantom section, with the arms oriented parallel to the body axis.
- *Feed Point Impedance and Return Loss:* These parameters are measured with the dipole positioned under the liquid filled phantom. The impedance stated is transformed from the measurement at the SMA connector to the feed point. The Return Loss ensures low reflected power. No uncertainty required.
- *Electrical Delay:* One-way delay between the SMA connector and the antenna feed point. No uncertainty required.
- *SAR measured:* SAR measured at the stated antenna input power.
- *SAR normalized:* SAR as measured, normalized to an input power of 1 W at the antenna connector.
- *SAR for nominal TSL parameters:* The measured TSL parameters are used to calculate the nominal SAR result.

The reported uncertainty of measurement is stated as the standard uncertainty of Measurement multiplied by the coverage factor  $k=2$ , which for a normal distribution corresponds to a coverage probability of approximately 95%.