



Dynamic Frequency Selection (DFS) Test Report

Product Name : Touch All In One Computer
Model No. : ESY10I4, ESY15I4, ESY15I4-C,
ESY22I4
FCC ID : RBWESYI4SV
IC : 10757B-ESYI4SV

Applicant : Elo Touch Solutions, Inc
Address : 670 N. McCarthy Blvd., Suite 100, Milpitas, CA
95035, USA

Date of Receipt : May. 30, 2022
Test Date : May. 31, 2022 ~ Jul. 15, 2022
Issued Date : Sep.16, 2022
Report No. : 2250816R-RF-US-P08V01
Report Version : V1.0

The test results presented in this report relate only to the object tested.

The measurement result is considered in conformance with the requirement if it is within the prescribed limit, It is not necessary to account the uncertainty associated with the measurement result.

This report shall not be reproduced, except in full, without the written approval of DEKRA Testing and Certification (Suzhou) Co., Ltd.

This report is not used for social proof in China (or Mainland China) market.

DFS Test Report

Issued Date: Sep.16, 2022

Report No. : 2250816R-RF-US-P08V01

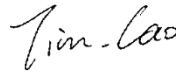

Product Name : Touch All In One Computer
 Applicant : Elo Touch Solutions, Inc
 Address : 670 N. McCarthy Blvd., Suite 100, Milpitas, CA 95035, USA.
 Manufacturer : Elo Touch Solutions, Inc
 Address : 670 N. McCarthy Blvd., Suite 100, Milpitas, CA 95035, USA.
 Model No. : ESY10I4, ESY15I4, ESY15I4-C, ESY22I4
 Trademark : Elo
 Applicable Standard : RSS-Gen Issue 5; RSS-247 Issue 2
 FCC CFR Title 47 Part 15 Subpart E
 KDB 905462 D02 v02; KDB 905462 D03 v01r02
 Test Result : Pass
 Performed Location : DEKRA Testing & Certification (Suzhou) Co., Ltd.
 No.99 Hongye Rd., Suzhou Industrial Park, Suzhou, 215006,
 Jiangsu, China
 TEL: +86-512-6251-5088 / FAX: +86-512-6251-5098
 FCC Designation Number: CN1199
 ISED CAB identifier: CN0040
 Operation Mode : Master device
 Slaver device with radar detection function
 Slaver device without radar detection function

Documented By : 

 (Project Engineer: Tim Cao)

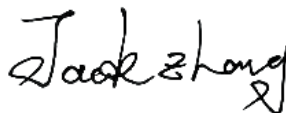
Approved By : 

 (Supervisor: Jack Zhang)

TABLE OF CONTENTS

Description	Page
1. GENERAL INFORMATION	4
1.1. EUT Description	4
1.2. Antenna information	6
1.3. UNII Device Description	8
1.4. Test Equipment.....	9
1.5. Test Setup	9
1.6. Limits	11
1.7. Client Device requireiment	17
1.8. Radar Waveform Calibration	18
1.9. Radar Waveform Calibration Result	19
2. Channel Move Time and Channel Closing Transmission Time	23
2.1. Test Procedure	23
2.2. Test Requirement	23
2.3. Uncertainty	23
2.4. Test Result of Channel Move Time and Channel Closing Transmission Time.....	24

1. GENERAL INFORMATION

1.1. EUT Description

Product Name	Touch All In One Computer					
Model No.	ESY10I4, ESY15I4, ESY15I4-C, ESY22I4					
HVIN. :	ESYI4SV					
EUT Voltage	19 Vdc and POE 44-57V for ESY10I4, ESY15I4, ESY22I4 19 Vdc for ESY15I4-C					
Type of Modulation	OFDM-BPSK, QPSK, 16QAM, 64QAM, 256QAM					
Data Rate	802.11a: 6/9/12/18/24/36/48/54Mbps					
	802.11n: up to 300Mbps					
	802.11ac: up to 866.6Mbps					
Channel Control	Auto					
Transmit modes	<input checked="" type="checkbox"/>	802.11a	<input checked="" type="checkbox"/>	802.11n(20MHz)	<input checked="" type="checkbox"/>	802.11n(40MHz)
	<input checked="" type="checkbox"/>	802.11ac(20MHz)	<input checked="" type="checkbox"/>	802.11ac(40MHz)	<input checked="" type="checkbox"/>	802.11ac(80MHz)
Support Bands	<input checked="" type="checkbox"/>	5150MHz~5250MHz	<input type="checkbox"/>	Outdoor AP		
			<input type="checkbox"/>	Indoor AP		
			<input type="checkbox"/>	Fixed point-to-point AP		
			<input type="checkbox"/>	Fixed point-to-Multi point AP		
			<input checked="" type="checkbox"/>	Mobile and Portable Client		
	<input checked="" type="checkbox"/>	5250MHz~5350MHz				
	<input checked="" type="checkbox"/>	5470MHz~5725MHz for FCC	<input checked="" type="checkbox"/>	With TDWR Channels		
			<input type="checkbox"/>	Without TDWR Channels		
<input checked="" type="checkbox"/>	5470MHz~5600MHz, 5650MHz~5725MHz for ISED					
<input checked="" type="checkbox"/>	5725MHz~5850MHz					
Master						
Product Name	Wireless-AX6000 Dual Band Gigabit Router					
Model No.	RT-AX88U					
FCC ID	MSQ-RTAXHP00					

Model and /or type reference	Hardware Version	Software Version
ESY10I4	R05	Android 10
ESY15I4	R05	Android 10
ESY22I4	R05	Android 10
ESY15I4-C	R04	Android 10

Note1: The four models have the same circuit and layout, the difference is the size and antenna, the ESY10I4 is 10.1 inches, the ESY15I4 is 15.6 inches, the ESY15I4-C is 15.6 inches, and the ESY22I4 is 21.5 inches.

Note2: Model ESY22I4 is evaluated for conducted test items; ESY10I4, ESY15I4, ESY15I4-C, ESY22I4 is evaluated for radiated test items and conducted emission, shown in the report is the worst data of four models.

1.2. Antenna information

Antenna model / type number .. :		N/A	
Antenna serial number		N/A	
Antenna Delivery		<input checked="" type="checkbox"/>	1TX + 1RX
		<input checked="" type="checkbox"/>	2TX + 2RX
		<input type="checkbox"/>	Others:.....
Antenna technology		<input checked="" type="checkbox"/>	SISO
		<input checked="" type="checkbox"/>	MIMO
		<input checked="" type="checkbox"/>	CDD
Antenna Type.....		<input type="checkbox"/>	External
		<input type="checkbox"/>	Dipole
		<input type="checkbox"/>	Sectorized
		<input checked="" type="checkbox"/>	Internal
		<input checked="" type="checkbox"/>	PIFA
		<input type="checkbox"/>	PCB
		<input type="checkbox"/>	Metal Antenna
		<input type="checkbox"/>	Others.....
SISO	Antenna 1 Gain	1.26 dBi for ESY10I4 2.9 dBi for ESY15I4 2.8 dBi for ESY15I4-C 2.73 dBi for ESY22I4	
	Antenna 2 Gain.....	1.61 dBi for ESY10I4 2.69 dBi for ESY15I4 2.7 dBi for ESY15I4-C 2.91 dBi for ESY22I4	
CDD		1.61 dBi for Power; 4.62 dBi for PSD for ESY10I4 2.9 dBi for Power; 5.91 dBi for PSD for ESY15I4 2.8 dBi for Power; 5.81 dBi for PSD for ESY15I4 2.91 dBi for Power; 5.92 dBi for PSD for ESY22I4	

Working Frequency of Each Channel:

802.11a/n/ac(20MHz) Working Frequency of Each Channel:							
Channel	Frequency	Channel	Frequency	Channel	Frequency	Channel	Frequency
36	5180 MHz	40	5200 MHz	44	5220 MHz	48	5240 MHz
52	5260MHz	56	5280 MHz	60	5300 MHz	64	5320 MHz
100	5500MHz	104	5520 MHz	108	5540 MHz	112	5550 MHz
116	5580MHz	120	5600MHz	124	5620MHz	128	5640MHz
132	5660 MHz	136	5680 MHz	140	5700 MHz	149	5745 MHz
153	5765 MHz	157	5785 MHz	161	5805 MHz	165	5825MHz
802.11n/ac(40MHz) Working Frequency of Each Channel:							
Channel	Frequency	Channel	Frequency	Channel	Frequency	Channel	Frequency
38	5190 MHz	46	5230 MHz	54	5270 MHz	62	5310 MHz
102	5510 MHz	110	5550 MHz	118	5590 MHz	126	5630 MHz
134	5670 MHz	151	5755 MHz	159	5795 MHz	N/A	N/A
802.11ac(80MHz) Working Frequency of Each Channel:							
Channel	Frequency	Channel	Frequency	Channel	Frequency	Channel	Frequency
42	5210 MHz	58	5290 MHz	106	5530MHz	122	5610 MHz
155	5775 MHz	N/A	N/A	N/A	N/A	N/A	N/A

Note1: For ISED, 5600MHz ~ 5650MHz can't be used.

1.3. UNII Device Description

The UUT operates in the following band:

1. 5250-5350 MHz
2. 5470-5725 MHz for FCC, 5470-5600 MHz and 5650-5725 MHz for ISSED

The UUT is a Client Device that does not have radar detection capability and ad-hoc function. The highest gain antenna assembly utilized with the EUT has a maximum gain of 1.68dBi in 5GHz frequency band. The 50-ohm Tx/Rx antenna port is connected to the test system to perform conducted tests. TPC is not required since the maximum EIRP is less than 500mW (27dBm).

The UUT utilizes 802.11a/n/ac IP based architecture. Three nominal channel bandwidths, 20 MHz, 40MHz and 80MHz are implemented.

WLAN traffic is generated by streaming the video file "TestFile.mp2" from the Master device to the Slave device in full motion video mode using the "Nero Show Time 3" with the V3.0.1.3 Codec package.

The master device is an ASUS 802.11a/b/g/n/ac/ax Access Point. The ASUS Access Point FCC ID: MSQ-RTAXHP00

The UUT is a client device without radar detection therefore the interference threshold level is not required.

Statement: Information regarding the parameters of the detected Radar Waveforms is not available to the end user.

1.4. Test Equipment

Dynamic Frequency Selection (DFS) / TR-8

Instrument	Manufacturer	Type No.	Serial No	Cal. Due Date
Spectrum Analyzer	Agilent	N9010A	MY48030494	2022.12.14
ESG Vector Signal Generator	Agilent	E4438C	MY49070163	2023.06.30

Instrument	Manufacturer	Type No.	Serial No
Splitter/Combiner (Qty: 2)	Mini-Circuits	ZAPD-50W 4.2-6.0 GHz	NN256400424
Splitter/Combiner (Qty: 2)	MCLI	PS3-7	4463/4464
ATT (Qty: 1)	Mini-Circuits	VAT-30+	30912
Laptop PC	Asus	N80V	8BN0AS226971468
RF Cable (Qty: 6)	Mini-Circuits	N/A	DFS-1~6

Software	Manufacturer	Function
N7607C	Keysight	Radar Signal Generation Software
DFS Tool	Agilent	DFS Test Software

1.5. Test Setup

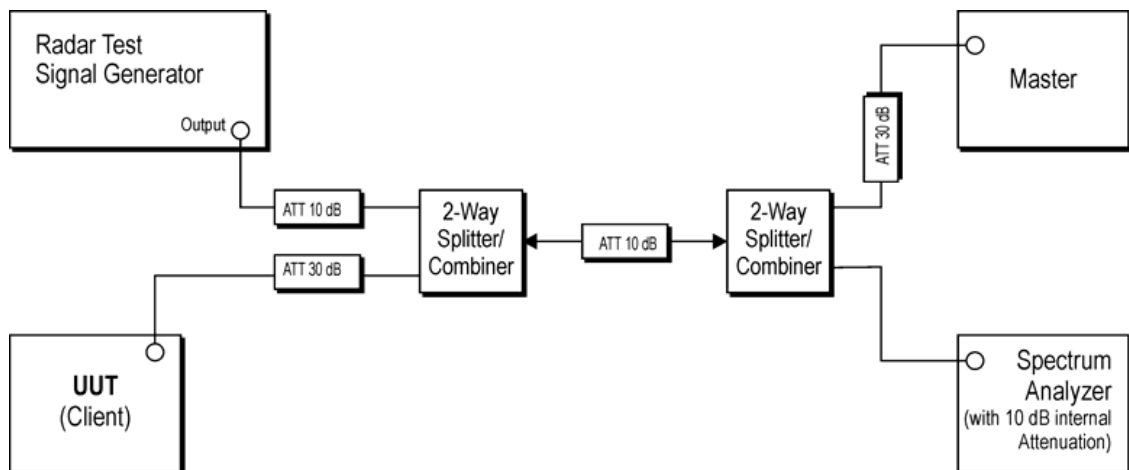

DFS Set-up Photo: Slave and Spectrum Analyzer



1.6. Limits

According to §15.407(h), 905462 D02 UNII DFS Compliance Procedures New Rules v01, 905462 D03 UNII Clients Without Radar Detection New Rules v01r02 and FCC 14-30 APPENDIX “COMPLIANCE MEASUREMENT PROCEDURES FOR UNLICENSED NATIONAL INFORMATION INFRASTRUCTURE DEVICES OPERATING IN THE 5250-5350 MHz AND 5470-5725MHz BANDS INCORPORATING DYNAMIC FREQUENCY SELECTION”.

Applicability of DFS requirements prior to use of a channel

Requirement	Operational Mode		
	Master	Client (without radar detection)	Client (with radar detection)
Non-Occupancy Period	Yes	Not Required	Yes
DFS Detection Threshold	Yes	Not Required	Yes
Channel Availability Check Time	Yes	Not Required	Not Required
U-NII Detection Bandwidth	Yes	Not Required	Yes

Applicability of DFS requirements during normal operation

Requirement	Operational Mode	
	Master or Client (with radar detection)	Client (without radar detection)
DFS Detection Threshold	Yes	Not Required
Channel Closing Transmission Time	Yes	Yes
Channel Move Time	Yes	Yes
U-NII Detection Bandwidth	Yes	Not required

Additional requirements for devices with multiple bandwidth modes	Master Device or Client with Radar Detection	Client (without radar detection)
U-NII Detection Bandwidth and Statistical Performance Check	All BW modes must be tested	Not required
Channel Move Time and Channel Closing Transmission Time	Test using widest BW mode available	Test using the widest BW mode available for the link
All other tests	Any single BW mode	Not required
<p>Note: Frequencies selected for statistical performance check (Section 7.8.4) should include several frequencies within the radar detection bandwidth and frequencies near the edge of the radar detection bandwidth. For 802.11 devices it is suggested to select frequencies in all 20 MHz channel blocks and a null frequencies between the bonded 20 MHz channel blocks.</p>		

DFS Detection Thresholds for Master Devices and Client Devices With Radar Detection

Maximum Transmit Power	Value (see note)
EIRP ≥ 200 milliwatt	-64 dBm
EIRP < 200 milliwatt and power spectral density < 10 dBm/MHz	-62 dBm
EIRP < 200 milliwatt that do not meet the power spectral density requirement	-62 dBm
<p>Note 1: This is the level at the input of the receiver assuming a 0 dBi receive antenna.</p> <p>Note 2: Throughout these test procedures an additional 1 dB has been added to the amplitude of the test transmission waveforms to account for variations in measurement equipment. This will ensure that the test signal is at or above the detection threshold level to trigger a DFS response.</p> <p>Note3: EIRP is based on the highest antenna gain. For MIMO devices refer to KDB Publication 662911 D01.</p>	

DFS Response requirement values

Parameter	Value
Non-Occupancy Period	Minimum 30 minutes
Channel Availability Check Time	60 Seconds
Channel Move Time	10 Seconds (See Note1)
Channel Closing Transmission Time	200 milliseconds + an aggregate of 60 milliseconds over remaining 10 second period. (See Notes 1 and 2)
U-NII Detection Bandwidth	Minimum 100% of the U-NII 99% transmission power bandwidth. See Note 3.
<p>Note 1: Channel Move Time and the Channel Closing Transmission Time should be performed with Radar Type 0. The measurement timing begins at the end of the Radar Type 0 burst.</p> <p>Note 2: The Channel Closing Transmission Time is comprised of 200 milliseconds starting at the beginning of the Channel Move Time plus any additional intermittent control signals required to facilitate a Channel move (an aggregate of 60 milliseconds) during the remainder of the 10 second period. The aggregate duration of control signals will not count quiet periods in between transmissions.</p> <p>Note 3: During the U-NII Detection Bandwidth detection test, radar type 0 should be used. For each frequency step the minimum percentage of detection is 90 percent. Measurements are performed with no data traffic.</p>	

Short Pulse Radar Test Waveforms

Table 5 – Short Pulse Radar Test Waveforms

Radar Type	Pulse Width (μsec)	PRI (μsec)	Number of Pulses	Minimum Percentage of Successful Detection	Minimum Number of Trials
0	1	1428	18	See Note 1	See Note 1
1	1	Test A: 15 unique PRI values randomly selected from the list of 23 PRI values in Table 5a	Roundup $\left\{ \left(\frac{1}{360} \right) \cdot \left(\frac{19 \cdot 10^6}{PRI_{\mu sec}} \right) \right\}$	60%	30
		Test B: 15 unique PRI values randomly selected within the range of 518-3066 μ sec, with a minimum increment of 1 μ sec, excluding PRI values selected in Test A			
2	1-5	150-230	23-29	60%	30
3	6-10	200-500	16-18	60%	30
4	11-20	200-500	12-16	60%	30
Aggregate (Radar Types 1-4)				80%	120
Note 1: Short Pulse Radar Type 0 should be used for the detection bandwidth test, channel move time, and channel closing time tests.					

A minimum of 30 unique waveforms are required for each of the Short Pulse Radar Types 2 through 4. If more than 30 waveforms are used for Short Pulse Radar Types 2 through 4, then each additional waveform must also be unique and not repeated from the previous waveforms. If more than 30 waveforms are used for Short Pulse Radar Type 1, then each additional waveform is generated with Test B and must also be unique and not repeated from the previous waveforms in Tests A or B.

For example if in Short Pulse Radar Type 1 Test B a PRI of 3066 usec is selected, the number of

pulses would be = Roundup $\left\{ \left(\frac{1}{360} \right) \cdot \left(\frac{19 \cdot 10^6}{3066} \right) \right\} = \text{Roundup}\{17.2\} = 18.$

Table 5a - Pulse Repetition Intervals Values for Test A

Pulse Repetition Frequency Number	Pulse Repetition Frequency (Pulses Per Second)	Pulse Repetition Interval (Microseconds)
1	1930.5	518
2	1858.7	538
3	1792.1	558
4	1730.1	578
5	1672.2	598
6	1618.1	618
7	1567.4	638
8	1519.8	658
9	1474.9	678
10	1432.7	698
11	1392.8	718
12	1355	738
13	1319.3	758
14	1285.3	778
15	1253.1	798
16	1222.5	818
17	1193.3	838
18	1165.6	858
19	1139	878
20	1113.6	898
21	1089.3	918
22	1066.1	938
23	326.2	3066

The aggregate is the average of the percentage of successful detections of Short Pulse Radar Types 1-4.

Long Pulse Radar Test Signal

Radar Waveform	Bursts	Pulses Per Burst	Pulse Width (μsec)	Chirp Width (MHz)	PRI (μsec)	Minimum Percentage of Successful Detection	Minimum Trials
5	8-20	1-3	50-100	5-20	1000-2000	80%	30

The parameters for this waveform are randomly chosen. Thirty unique waveforms are required for the long pulse radar test signal. If more than 30 waveforms are used for the long pulse radar test signal, then each additional waveform must also be unique and not repeated from the previous waveforms.

Frequency Hopping Radar Test Signal

Radar Waveform	Pulse Width (μsec)	PRI (μsec)	Hopping Sequence Length (msec)	Pulses Per Hop	Hopping Rate (kHz)	Minimum Percentage of Successful Detection	Minimum Trials
6	1	333	300	9	0.333	70%	30

For the Frequency Hopping Radar Type, the same *Burst* parameters are used for each waveform. The hopping sequence is different for each waveform and a 100-length segment is selected from the hopping sequence defined by the following algorithm:

The first frequency in a hopping sequence is selected randomly from the group of 475 integer frequencies from 5250 – 5724 MHz. Next, the frequency that was just chosen is removed from the group and a frequency is randomly selected from the remaining 474 frequencies in the group. This process continues until all 475 frequencies are chosen for the set. For selection of a random frequency, the frequencies remaining within the group are always treated as equally likely.

1.7. Client Device requirement

- a) A Client Device will not transmit before having received appropriate control signals from a Master Device.
- b) A Client Device will stop all its transmissions whenever instructed by a Master Device to which it is associated and will meet the Channel Move Time and Channel Closing Transmission Time requirements. The Client Device will not resume any transmissions until it has again received control signals from a Master Device.
- c) If a Client Device is performing In-Service Monitoring and detects a Radar Waveform above the DFS Detection Threshold, it will inform the Master Device. This is equivalent to the Master Device detecting the Radar Waveform and d) through f) of section 5.1.1 apply.
- d) Irrespective of Client Device or Master Device detection the Channel Move Time and Channel Closing Transmission Time requirements remain the same.
- e) The client test frequency must be monitored to ensure no transmission of any type has occurred for 30 minutes. Note: If the client moves with the master, the device is considered compliant if nothing appears in the client non-occupancy period test. For devices that shut down (rather than moving channels), no beacons should appear.

1.8. Radar Waveform Calibration

The following equipment setup was used to calibrate the conducted radar waveform. A spectrum analyzer was used to establish the test signal level for each radar type. During this process there were replace 50ohm terminal from master and client device and no transmissions by either the master or client device. The spectrum analyzer was switched to the zero span (time domain) at the frequency of the radar waveform generator. Peak detection was utilized. The spectrum analyzer resolution bandwidth (RBW) and video bandwidth (VBW) were set to 3MHz and 3 MHz.

The signal generator amplitude was set so that the power level measured at the spectrum analyzer was -61dBm due to the interference threshold level is not required.

Conducted Calibration Setup

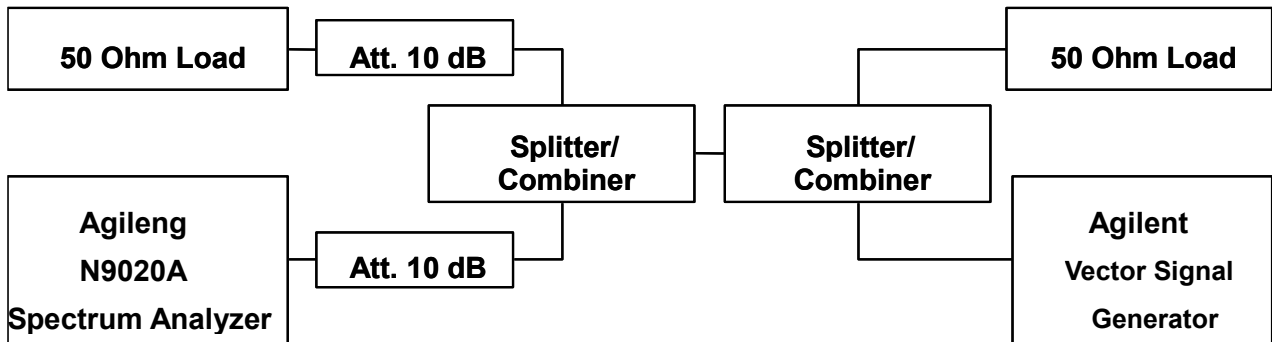

1.9. Radar Waveform Calibration Result

11ac80 CH106 5530MHz Radar Type 0 Calibration Plot

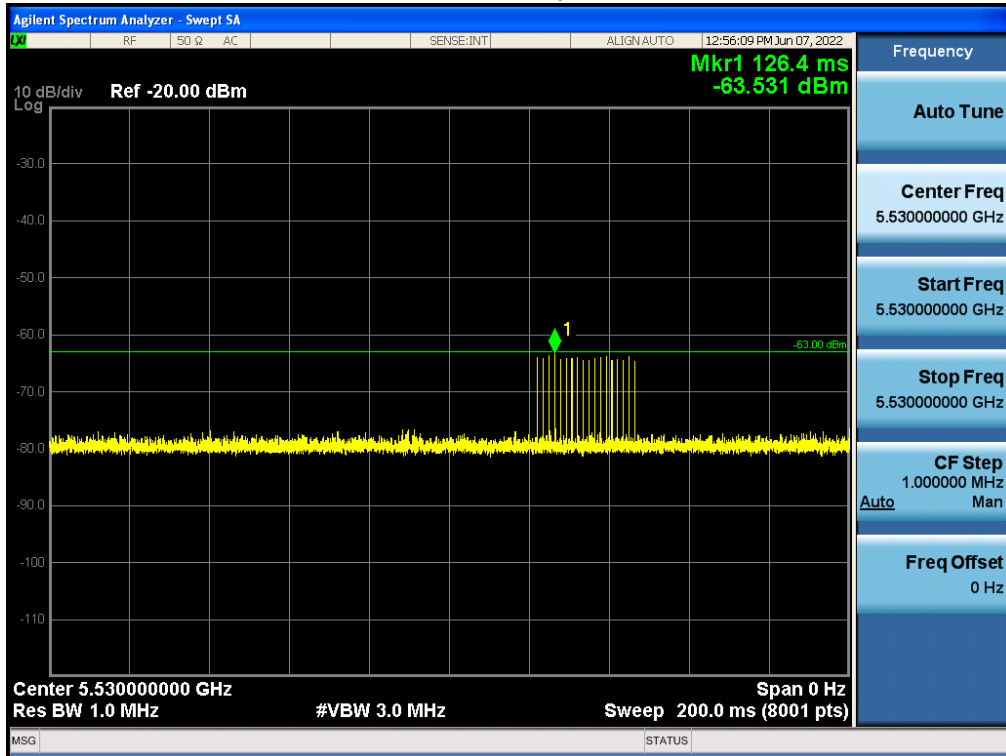

11ac80 CH106 5530MHz Radar Type 1 Calibration Plot

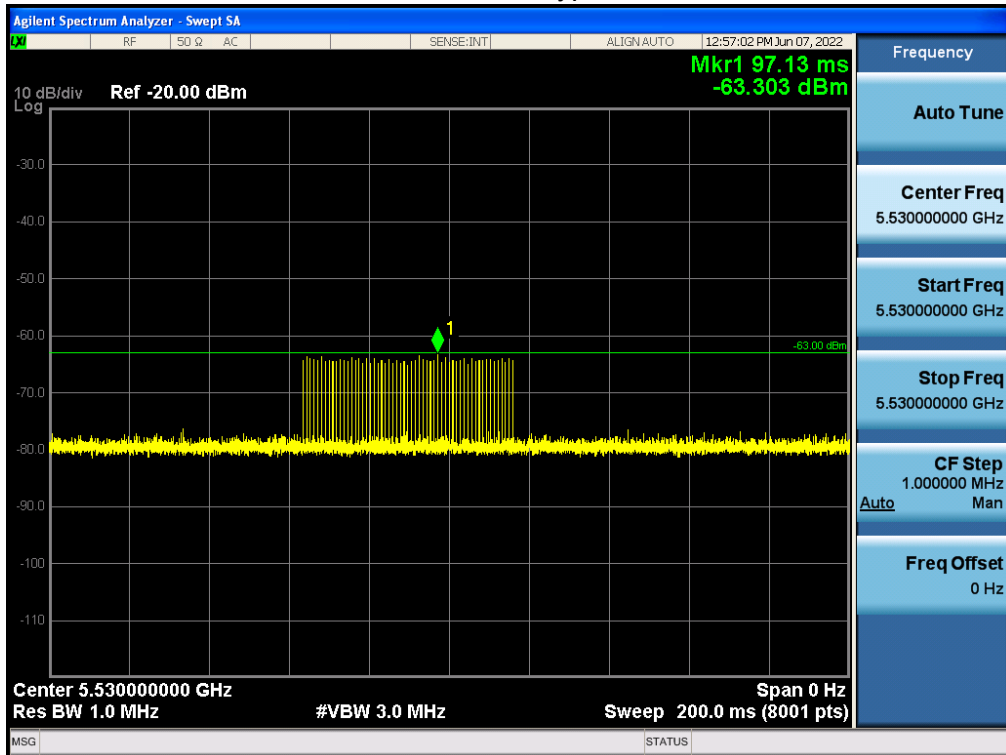

11ac80 CH106 5530MHz Radar Type 2 Calibration Plot

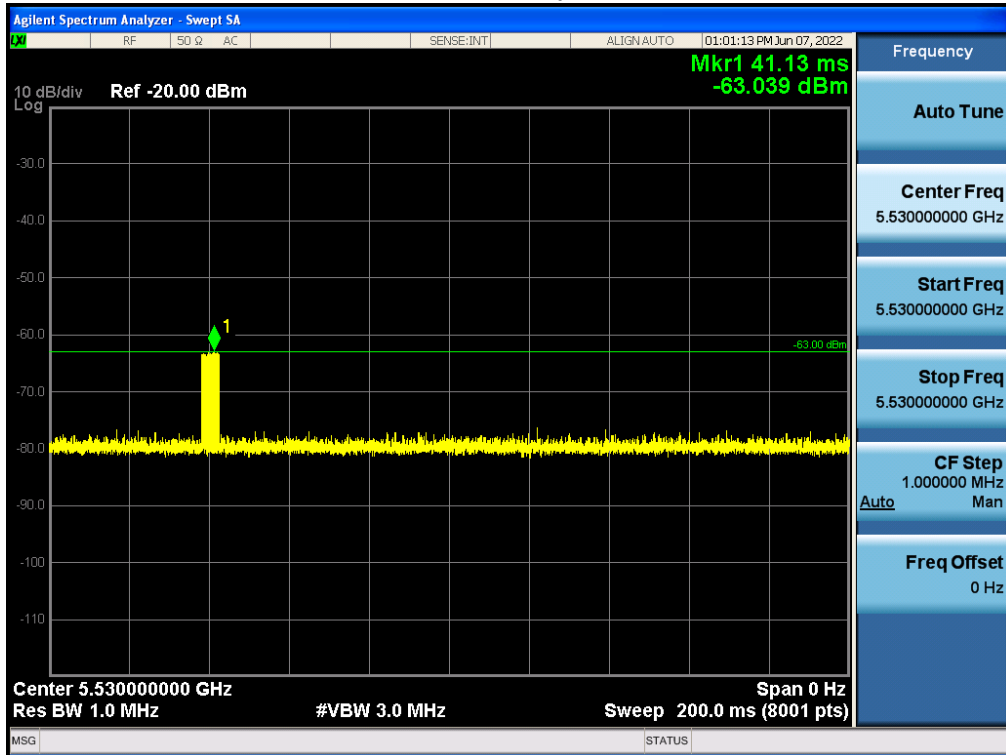

11ac80 CH106 5530MHz Radar Type 3 Calibration Plot

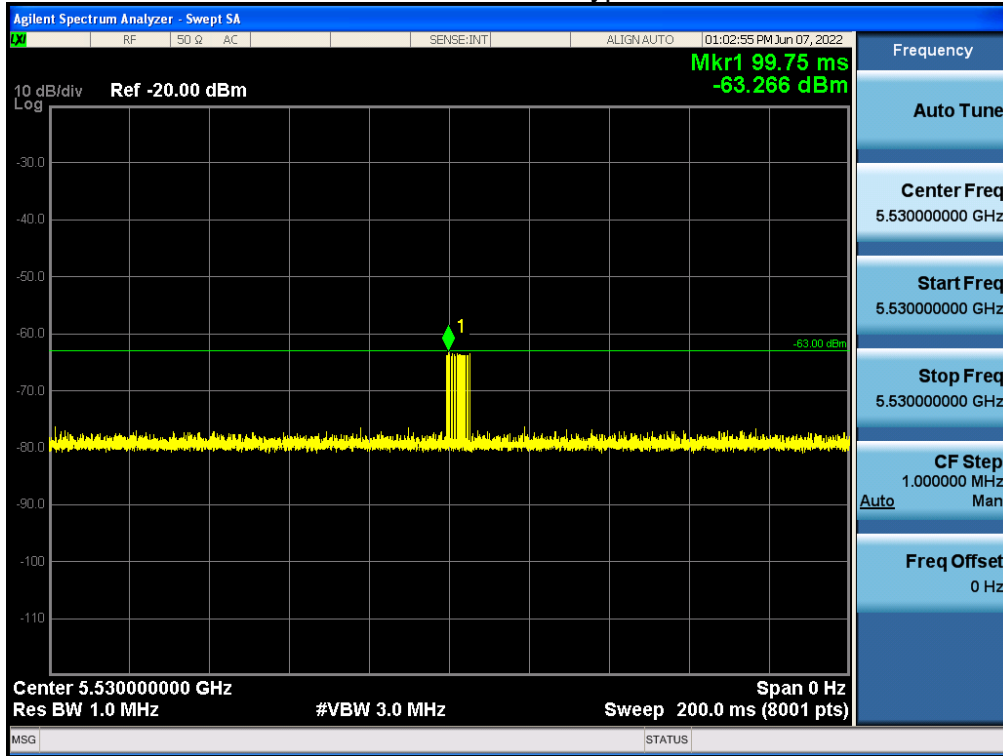

11ac80 CH106 5530MHz Radar Type 4 Calibration Plot

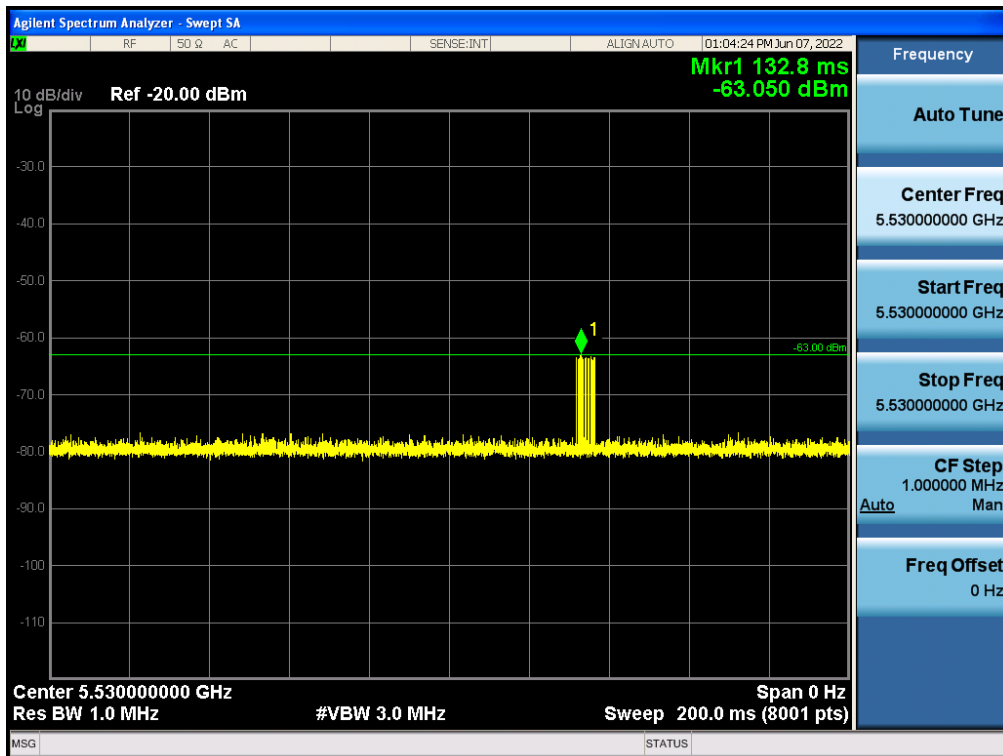

11ac80 CH106 5530MHz Radar Type 5 Calibration Plot

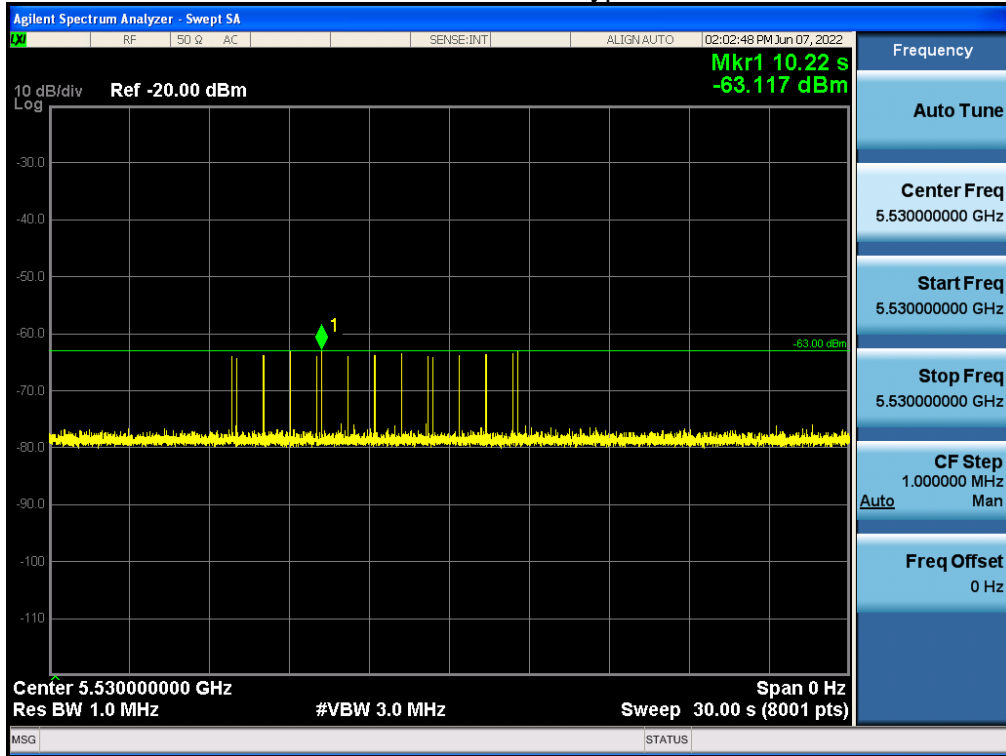

11ac80 CH106 5530MHz Radar Type 6 Calibration Plot

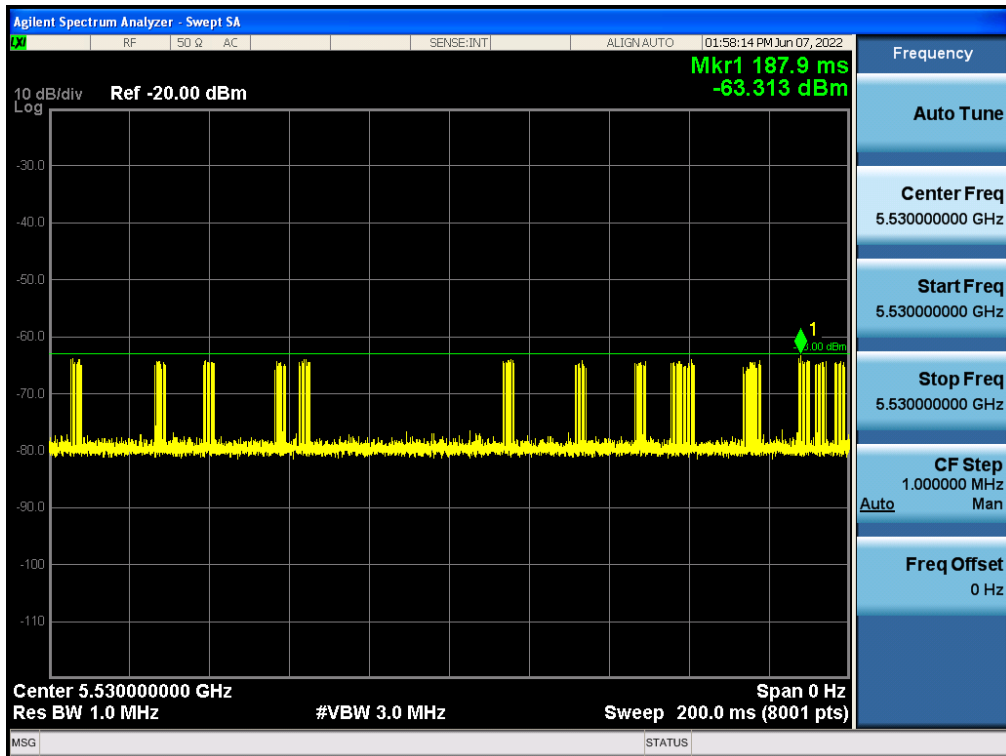

2. Channel Move Time and Channel Closing Transmission Time

2.1. Test Procedure

These tests define how the following DFS parameters are verified during In-Service Monitoring; Channel Closing Transmission Time and Channel Move Time.

The steps below define the procedure to determine the above mentioned parameters when a radar burst with a level -61dBm is generated on the operating channel of the U-NII device.

A U-NII device operating as a Client device will associate with the Master device at 5500MHz.

During the in-service monitoring detection probability and channel moving tests the system was configured with a streaming video file from the master device (sourced by the PC connected to the master device via an Ethernet interface) to the client device. The streamed file was the “FCC” test file and the client device was using Media Player Classic as required by FCC Part 15 Subpart E.

Observe the transmissions of the EUT at the end of the radar burst on the operating channel for duration greater than 10 seconds. Measure and record the transmissions from the spectrum analyzer during the observation time (Channel Move Time). Compare the channel move time and channel closing transmission time results to the limits defined in the DFS Response requirement values table.

2.2. Test Requirement

Parameter	Value
Channel Move Time	10 Seconds
Channel Closing Transmission Time	200 milliseconds + approx. 60 milliseconds over remaining 10 seconds period

2.3. Uncertainty

± 1ms.

2.4. Test Result of Channel Move Time and Channel Closing Transmission Time

5530MHz. (802.11ac80MHz)

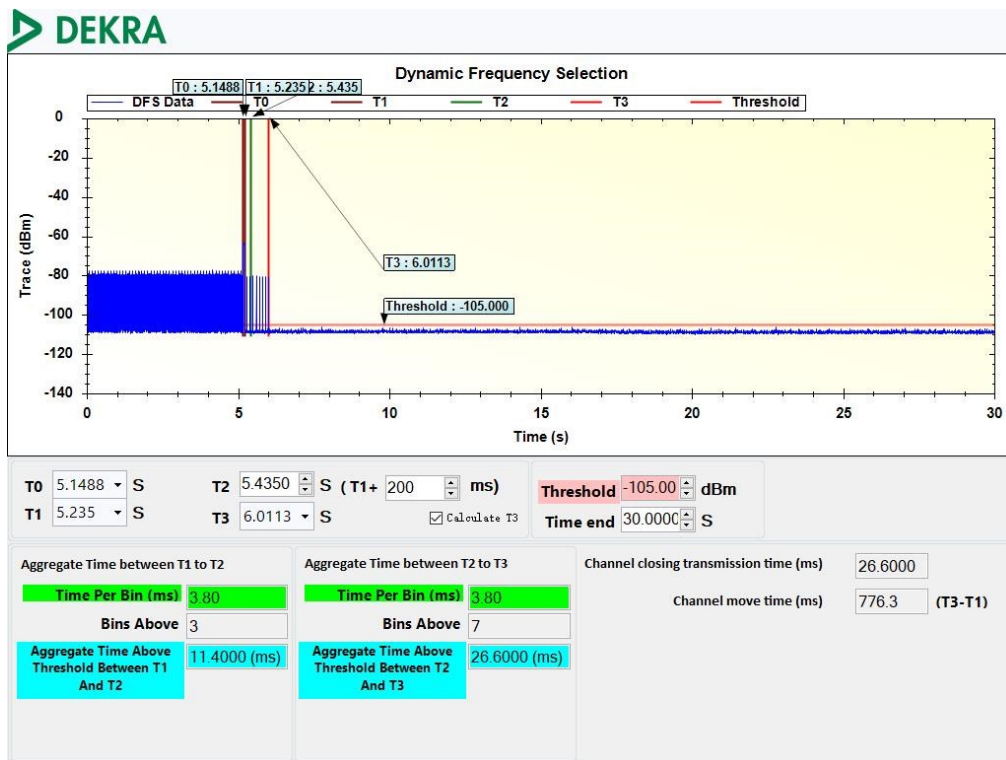

Test Item	Limit	Results
Channel Move Time	10 s	Pass
Channel Closing Transmission Time	200ms + an aggregate of 60ms over remaining 10 second period.	Pass

The End