



Test report No:
2250816R-RF-US-P06V01

FCC & ISSED TEST REPORT

Product Name	Touch All In One Computer
Trademark	Elo
Model and /or type reference	ESY10I4, ESY15I4, ESY22I4, ESY15I4-C
FCC ID	RBWESYI4SV
IC	10757B-ESYI4SV
Applicant's name / address	Elo Touch Solutions, Inc 670 N. McCarthy Blvd., Suite 100, Milpitas, CA 95035, USA.
Test method requested, standard	FCC CFR Title 47 Part 15 Subpart C Section 15.247 ANSI C63.10: 2013 KDB 558074 D01v05r02 KDB 662911 D01 Multiple Transmitter Output v02r01 RSS-Gen Issue 5 /RSS-247 Issue 2
Verdict Summary	IN COMPLIANCE
Tested By (name / position & signature)	Tim Cao/Project Engineer 
Approved by (name / position & signature)	Jack Zhang/ Manager 
Date of issue	2022-09-16
Report Version	V1.0
Report template No	Template_FCC Part 15C-RF-V1.0

INDEX

	page
Competences and Guarantees.....	4
General conditions.....	4
Environmental conditions.....	4
Possible test case verdicts.....	5
Abbreviations.....	5
Document History.....	6
Remarks and Comments.....	6
Used Equipment.....	7
Uncertainty.....	9
1 General Information.....	10
1.1 General Description of the Item(s).....	10
1.2 Antenna Information.....	11
1.3 Test Data Rate.....	12
1.4 Channel List.....	12
2 Description of Test Setup.....	13
2.1 Operating mode(s) used for tests.....	13
2.2 Accessories Information.....	13
2.3 Support / Auxiliary equipment / unit / Test software for the EUT.....	13
2.4 Test Configuration / Block diagram used for tests.....	14
2.5 Testing process.....	15
3 Verdict summary section.....	16
3.1 Standards.....	16
3.2 Overview of results.....	17
3.3 Test Facility.....	18
4 Test Results.....	19
4.1 AC Power Line Conducted Emission.....	19
4.1.1 Limit.....	19
4.1.2 Test Setup.....	19
4.1.3 Test Procedure.....	19
4.1.4 Test Data.....	20
4.2 Emissions in restricted frequency bands.....	22
4.2.1 Limit.....	22
4.2.2 Test Setup.....	24
4.2.3 Test Procedure.....	25

4.2.4	Test Data	26
4.3	Emissions in non-restricted frequency band.....	48
4.3.1	Limit	48
4.3.2	Test Setup.....	48
4.3.3	Test Procedure.....	48
4.3.4	Test Data	49
4.4	Duty cycle	52
4.4.1	Limit	52
4.4.2	Test Setup.....	52
4.4.3	Test Procedure.....	52
4.4.4	Test Data	53
4.5	Radiated Emission Band Edge	54
4.5.1	Limit	54
4.5.2	Test Setup.....	54
4.5.3	Test Procedure.....	55
4.5.4	Test Data	56
4.6	DTS Bandwidth	128
4.6.1	Limit	128
4.6.2	Test Setup.....	128
4.6.3	Test Procedure.....	128
4.6.4	Test Data	129
4.7	Fundamental emission output power	130
4.7.1	Limit	130
4.7.2	Test Setup.....	130
4.7.3	Test Procedure.....	131
4.7.4	Test Data	133
4.8	Power Density.....	142
4.8.1	Limit:	142
4.8.2	Test Setup.....	142
4.8.3	Test Procedure.....	142
4.8.4	Test Data	144
4.9	Antenna Requirement	145
4.9.1	Limit:	145
4.9.2	Antenna Connector Construction:.....	145
5	Test setup photo and EUT Photo	146

COMPETENCES AND GUARANTEES

DEKRA is a testing laboratory competent to carry out the tests described in this report.

In order to assure the traceability to other national and international laboratories, DEKRA has a calibration and maintenance program for its measurement equipment.

DEKRA guarantees the reliability of the data presented in this report, which is the result of the measurements and the tests performed to the item under test on the date and under the conditions stated in the report and it is based on the knowledge and technical facilities available at DEKRA at the time of performance of the test.

DEKRA is liable to the client for the maintenance of the confidentiality of all information related to the item under test and the results of the test.

The results presented in this Test Report apply only to the particular item under test established in this document.

IMPORTANT: No parts of this report may be reproduced or quoted out of context, in any form or by any means, except in full, without the previous written permission of DEKRA.

GENERAL CONDITIONS

Test Location	No. 99, Hongye Road, Suzhou Industrial Park Suzhou, 215006, P.R. China
Date(receive sample)	May. 30, 2022
Date (start test)	May. 31, 2022
Date (finish test)	Jul. 15, 2022

1. This report is only referred to the item that has undergone the test.
2. This report does not constitute or imply on its own an approval of the product by the Certification Bodies or Competent Authorities.
3. This document is only valid if complete; no partial reproduction can be made without previous written permission of DEKRA.
4. This test report cannot be used partially or in full for publicity and/or promotional purposes without previous written permission of DEKRA.
5. The 2.4G WLAN part of AirEngine6761-21T is exactly the same as AirEngine5761-11, so we only verified the power and AC Power Line Conducted Emission, and other data are quoted from AirEngine5761-11.

ENVIRONMENTAL CONDITIONS

The climatic conditions during the tests are within the limits specified by the manufacturer for the operation of the EUT and the test equipment. The climatic conditions during the tests were within the following limits:

Ambient temperature	15 °C – 35 °C
Relative Humidity air	30% - 60%

If explicitly required in the basic standard or applied product / product family standard the climatic values are recorded and documented separately in this test report.

POSSIBLE TEST CASE VERDICTS

Test case does not apply to test object	N/A
Test object does meet requirement	P (Pass) / PASS
Test object does not meet requirement	F (Fail) / FAIL
Not measured	N/M

ABBREVIATIONS

For the purposes of the present document, the following abbreviations apply:

EUT	: Equipment Under Test
QP	: Quasi-Peak
CAV	: CISPR Average
AV	: Average
CDN	: Coupling Decoupling Network
SAC	: Semi-Anechoic Chamber
OATS	: Open Area Test Site
BW	: Bandwidth
AM	: Amplitude Modulation
PM	: Pulse Modulation
HCP	: Horizontal Coupling Plane
VCP	: Vertical Coupling Plane
U_N	: Nominal voltage
T_x	: Transmitter
R_x	: Receiver
N/A	: Not Applicable
N/M	: Not Measured

DOCUMENT HISTORY

Report No.	Version	Description	Issued Date
2250816R-RF-US-P06V01	V1.0	Initial issue of report.	2022-09-16

REMARKS AND COMMENTS

- The equipment under test (EUT) does meet the essential requirements of the stated standard(s)/test(s).
- These test results on a sample of the device are for the purpose of demonstrating Compliance with Part 15 Subpart C Paragraph 15.247, RSS-Gen Issue 5, RSS-247 Issue 2.
- The measurement result is considered in conformance with the requirement if it is within the prescribed limit, It is not necessary to account the uncertainty associated with the measurement result.
- The test results presented in this report relate only to the object tested.
- The test report shall not be reproduced without the written approval of DEKRA Testing and Certification (Suzhou) Co., Ltd.
- This report will not be used for social proof function in China market.
- DEKRA declines any responsibility with the following test data provided by customer that may affect the validity of result:
 - Chapter 1.1 General Description of the Item(s);
 - Chapter 1.2 Antenna Informaion;
 - Chapter 1.3 Test Data Rate;
 - Chapter 1.4 Channel List;
- Four models have the same circuit and layout, the difference is the size and antenna, ESY10I4 is 10.1 inch, ESY15I4 is 15.6 inch, ESY15I4-C is 15.6 inch, ESY22I4 is 21.5 inch, model ESY22I4 is evaluated for conducted test items; ESY10I4, ESY15I4, ESY22I4, ESY15I4-C is evaluated for radiated test items and conducted emission, shown in the repot is the worst data of four models.

USED EQUIPMENT

AC Power Line Conducted Emission / TR1

Instrument	Manufacturer	Model No.	Serial No.	Cal. Date	Next Cal. Date
EMI Test Receiver	R&S	ESCI	100726	2021.10.30	2022.10.29
Two-Line V-Network	R&S	ENV216	101044	2022.03.12	2023.03.11
50ohm Termination	SHX	TF2	7081403	2021.09.04	2022.09.03
50ohm Coaxial Switch	Anritsu	MP59B	6200464462	N/A	N/A
Temperature/Humidity Meter	RTS	RTS-8S	TR1-TH	2022.07.07	2023.07.06
Dekra test software	Dekra	-	-	-	-

Emissions in non-restricted frequency bands/ Occupied Bandwidth/ Fundamental emission output power/ Power Spectral Density/Band Edge/ TR8

Instrument	Manufacturer	Model No.	Serial No.	Cal. Date	Next Cal. Date
Spectrum Analyzer	Agilent	N9010A	MY48030494	2021.12.15	2022.12.14
EXA Spectrum Analyzer	Keysight	N9010A	MY55370495	2021.08.12	2022.08.11
MXA Signal Analyzer	Keysight	N9020A	MY56060147	2022.07.14	2023.07.13
4TX MIMO Power Sensor	Keysight	X8750A	MY59400102	2022.03.16	2023.03.15
Coaxial Cable	Woken	N/A	N/A	2022.01.18	2023.01.17
Temperature/Humidity Meter	RTS	RTS-8S	RF08	2022.07.07	2023.07.06

Radiated Emission(30MHz-1GHz) / AC3

Instrument	Manufacturer	Model No.	Serial No.	Cal. Date	Next Cal. Date
EMI Test Receiver	R&S	ESCI	100176	2021.08.15	2022.08.14
Loop Antenna	R&S	HFH2-Z2	833799/003	2022.04.15	2023.04.14
Bilog Antenna	Teseq GmbH	CBL6112D	27613	2021.08.23	2022.08.22
Coaxial Cable	Huber+Suhner	RG 214	AC3-C	2022.03.30	2023.03.29
Temperature/Humidity Meter	RTS	RTS-8S	AC3-TH	2022.07.07	2023.07.06
Dekra test software	Dekra	-	-	-	-

Radiated Emission(1GHz-40GHz) / AC5

Instrument	Manufacturer	Model No.	Serial No.	Cal. Date	Next Cal. Date
EXA Spectrum Analyzer	Keysight	N9010A	MY55370495	2021.08.12	2022.08.11
Amplifier	SKET	LNPA_0118G-45	SK2021041201	2022.04.15	2023.04.14
Preamplifier	EMCI	EMC184045SE	980263	2022.05.21	2023.05.20
DRG Horn Antenna	ETS-Lindgren	3117	00167055	2021.08.23	2022.08.22
Broad-Band Horn Antenna	Schwarzbeck	BBHA9170	294	2022.05.19	2023.05.18
Coaxial Cable	Huber+Suhner	SUCOFLEX 106	AC5-C2	2022.05.22	2023.05.21
Coaxial Cable	ROSENBERGER	LA1-C011-2000/3000	AC5-40G	2022.03.21	2023.03.20
High-Pass Filter	Wainwright	WHKX3.0/18G-12SS	AC5&AC6	2022.06.07	2023.06.06
Temperature/Humidity Meter	RTS	RTS-8S	AC5-TH	2022.07.07	2023.07.06
Dekra test software	Dekra	-	-	-	-

UNCERTAINTY

Uncertainties have been calculated according to the DEKRA internal document. The reported expanded uncertainties are based on a standard uncertainty multiplied by a coverage factor of $k=2$, providing a level of confidence of approximately 95%.

Test item	Uncertainty
AC Power Line Conducted Emission	± 2.92 dB
Peak Power Output	± 1.13 dB
Radiated Emission(30MHz~1GHz)	Horizontal: 30MHz~200MHz: 4.60 dB 200MHz~1GHz: 4.10 dB Vertical: 30MHz~200MHz: 4.80 dB 200MHz~1GHz: 4.10 dB
Radiated Emission(1GHz~40GHz)	Horizontal: 1GHz~18GHz: 5.00 dB Vertical: 1GHz~18GHz: 4.80 dB Horizontal: 18GHz~40GHz: 4.70 dB Vertical: 18GHz~40GHz: 4.60 dB
RF antenna conducted test	± 1.13 dB
Radiated Emission Band Edge	± 5.00 dB
DTS Bandwidth	± 279 Hz
Occupied Bandwidth	± 279 Hz
Power Density	± 1.13 dB

1 GENERAL INFORMATION

1.1 General Description of the Item(s)

Product Name..... :	Touch All In One Computer
Model No. :	ESY10I4, ESY15I4, ESY22I4, ESY15I4-C
HVIN..... :	ESYI4SV
FCC ID..... :	RBWESYI4SV
IC..... :	10757B-ESYI4SV
Manufacturer..... :	Elo Touch Solutions, Inc
Manufacturer Address..... :	670 N. McCarthy Blvd., Suite 100, Milpitas, CA 95035, USA.
Model Differences	Four models have the same circuit and layout, the difference is the size and antenna, ESY10I4 is 10.1 inch, ESY15I4 is 15.6 inch, ESY15I4-C is 15.6 inch, ESY22I4 is 21.5 inch

Model and /or type reference	Hardware Version	Software Version
ESY10I4	R05	Android 10
ESY15I4	R05	Android 10
ESY22I4	R05	Android 10
ESY15I4-C	R04	Android 10

Wireless specification..... :	WIFI
Operating frequency range(s)..... :	2400~2483.5MHz
Type of modulation..... :	802.11b: DSSS-DBPSK, DQPSK, CCK 802.11g/n: OFDM-BPSK, QPSK, 16QAM, 64QAM
Number of channel..... :	802.11b/g/n (20MHz) : 11
Data Rate	802.11b: 1/2/5.5/11 Mbps 802.11g: 6/9/12/18/24/36/48/54 Mbps 802.11n: up to 144.4 Mbps

Rated power supply	Voltage and Frequency	
	<input type="checkbox"/>	AC: 220 – 240 V, 50/60 Hz
	<input type="checkbox"/>	AC: 110 – 130 Vac, 50/60 Hz
	<input checked="" type="checkbox"/>	19 Vdc and POE 44-57V for ESY10I4, ESY15I4, ESY22I4, 19 Vdc for ESY15I4-C
	<input type="checkbox"/>	Battery:

1.2 Antenna Information

Antenna model / type number.....:	N/A		
Antenna serial number	N/A		
Antenna Delivery	<input checked="" type="checkbox"/>	1TX + 1RX	
	<input checked="" type="checkbox"/>	2TX + 2RX	
	<input type="checkbox"/>	Others:.....	
Antenna technology.....:	<input checked="" type="checkbox"/>	SISO	
	<input checked="" type="checkbox"/>	MIMO	<input checked="" type="checkbox"/> CDD
			<input type="checkbox"/> Beam-forming
Antenna Type.....:	<input type="checkbox"/>	External	<input type="checkbox"/> Dipole
			<input type="checkbox"/> Sectorized
	<input checked="" type="checkbox"/>	Internal	<input checked="" type="checkbox"/> PIFA
			<input type="checkbox"/> PCB
			<input type="checkbox"/> Metal Monopole Antenna
			<input type="checkbox"/> Ceramic chip
			<input type="checkbox"/> Others.....
Antenna Gain	SISO:	Antenna1	1.16 dBi for ESY10I4 2.34 dBi for ESY15I4 2.72 dBi for ESY15I4-C 2.18 dBi for ESY22I4
		Antenna2	1.66 dBi for ESY10I4 1.98 dBi for ESY15I4 2.76 dBi for ESY15I4-C 2.9 dBi for ESY22I4
	CDD:	1.66 dBi for Power; 3.67 dBi for PSD for ESY10I4 2.34 dBi for Power; 5.35 dBi for PSD for ESY15I4 2.79 dBi for Power; 5.80 dBi for PSD for ESY15I4-C 2.9 dBi for Power; 5.91 dBi for PSD for ESY22I4	

1.3 Test Data Rate

Note: The test rate is the lowest rate of 802.11b/g/n(20MHz)

1.4 Channel List

IEEE 802.11b/g & IEEE 802.11n (20MHz)

Working Frequency of Each Channel							
Channel	Frequency	Channel	Frequency	Channel	Frequency	Channel	Frequency
1	2412 MHz	2	2417 MHz	3	2422 MHz	4	2427 MHz
5	2432 MHz	6	2437 MHz	7	2442 MHz	8	2447 MHz
9	2452 MHz	10	2457 MHz	11	2462 MHz	-	-

Note: The General Description of the Item, antenna information, Test Data Rate and Channel List in clause 1 are provided and confirmed by the client.

2 DESCRIPTION OF TEST SETUP

2.1 Operating mode(s) used for tests

During the tests the following operating mode(s) has(have) been used.

Test Mode	Mode 1: Transmit by 802.11b
	Mode 2: Transmit by 802.11g
	Mode 3: Transmit by 802.11n(20MHz)

2.2 Accessories Information

Accessories Information	Brand/model name	Cable		
		Length used during test [m]	Attached during test	Shielded
USB Cable	N/A	10	<input checked="" type="checkbox"/>	<input checked="" type="checkbox"/>
USB Cable	N/A	0.5	<input checked="" type="checkbox"/>	<input checked="" type="checkbox"/>

2.3 Support / Auxiliary equipment / unit / Test software for the EUT

The EUT has been tested with the following auxiliary equipment / unit / software:

Auxiliary equipment	Type / Version	Manufacturer	Supplied by
Notebook	Think pad x220	Lenovo	Adapter
software	Type / Version	Manufacturer	Supplied by
N/A	N/A	N/A	N/A

2.4 Test Configuration / Block diagram used for tests

The following test setup / configuration / block diagram has been used during the tests:

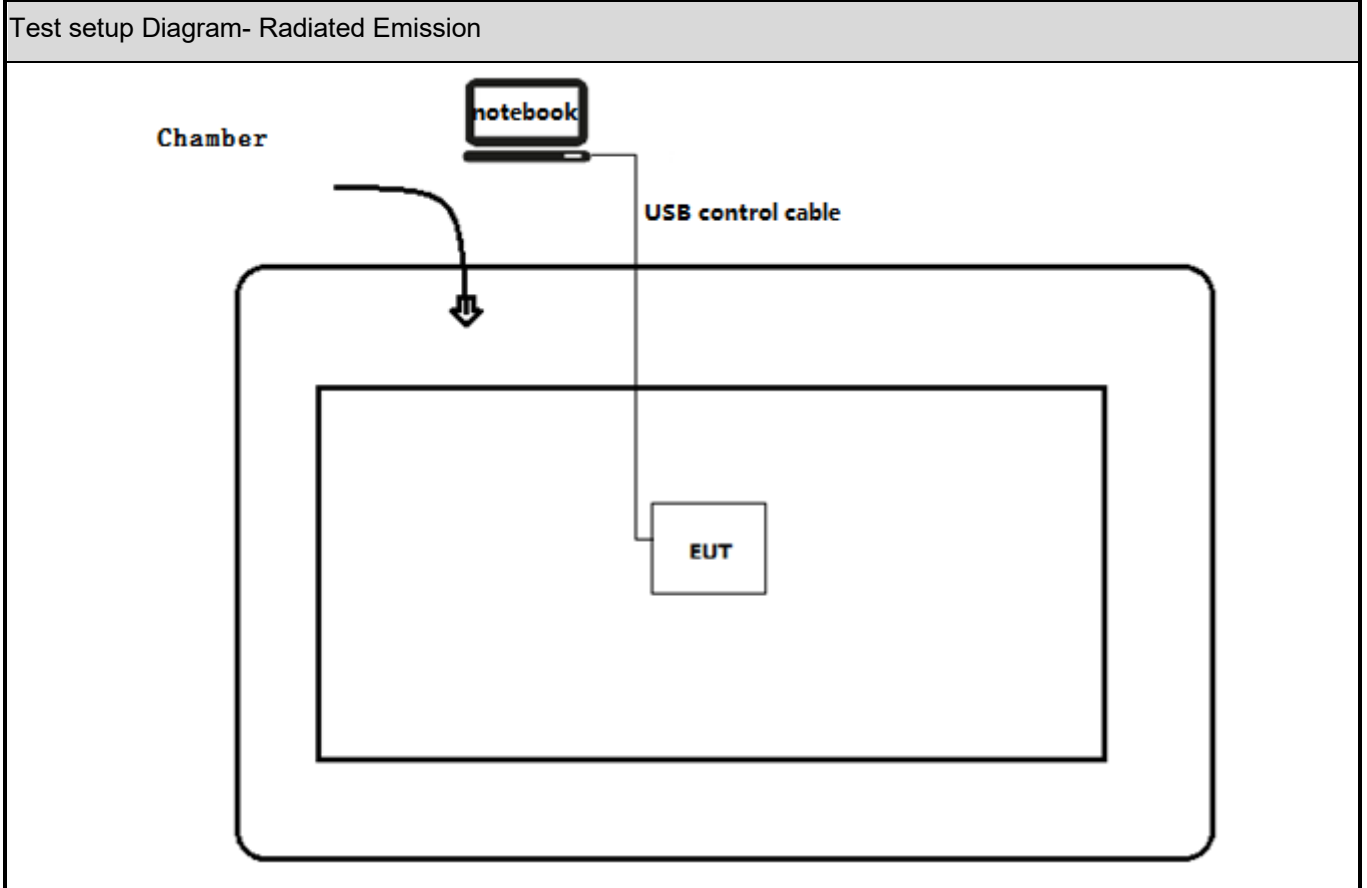
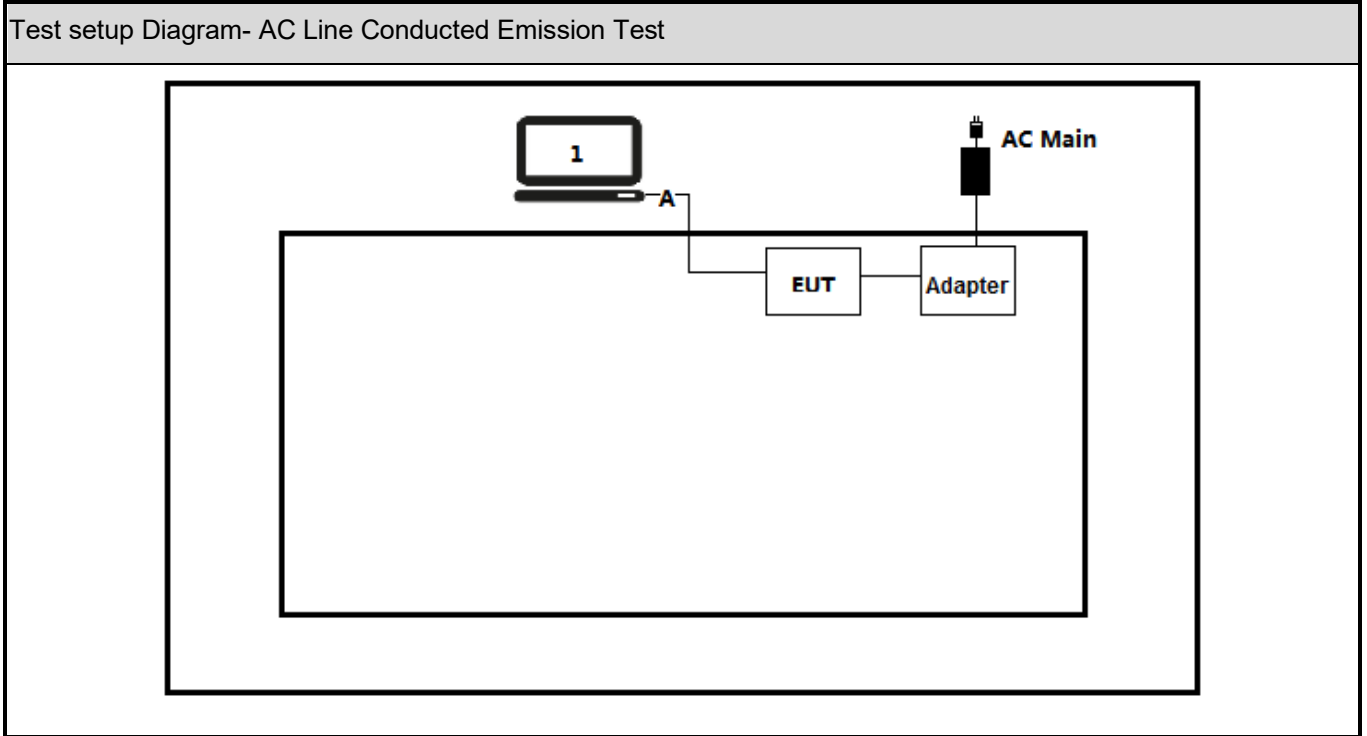

2.5 Testing process

1	Setup the EUT and simulators as shown on above.
2	Turn on the power of equipment.
3	Run the ADB command.
4	Select the transmission mode and test channel, then start test.

3 VERDICT SUMMARY SECTION

This chapter presents an overview of standards and results. Refer to the next chapters for details of measured test results and applied test levels.

3.1 Standards

Standard	Year	Description
FCC CFR Title 47 Part 15 Subpart C Section 15.247	2020	Operation within the bands 902–928 MHz, 2400–2483.5 MHz, and 5725–5850 MHz.
ANSI C63.10	2013	American National Standard of Procedures for Compliance Testing of Unlicensed Wireless Devices
KDB 558074 D01V05r02	2019	Guidance for performing compliance measurements on Digital Transmission System (DTS) operating under section 15.247
RSS-Gen Issue 5 Amendment 2	2021	General Requirements for Compliance of Radio Apparatus
RSS-247 Issue 2	2017	Digital Transmission Systems (DTSS), Frequency Hopping Systems (FHSs) and Licence-Exempt Local Area Network (LE-LAN) Devices

3.2 Overview of results

For FCC

Requirement – Test case	Basic standard(s)	Verdict	Remark
AC Power Line Conducted Emission	FCC 15.207	PASS	---
Emissions in restricted frequency bands	FCC 15.247(b)(3)	PASS	---
Duty cycle	ANSI C63.10:2013	PASS	---
Emissions in non-restricted frequency bands	FCC 15.247(d), FCC 15.209	PASS	---
Band Edge	FCC 15.247(d)	PASS	---
Fundamental emission output power	FCC 15.247(d), FCC 15.209	PASS	---
DTS Bandwidth	FCC 15.247(a)(2)	PASS	---
Power Spectral Density	FCC 15.247(e)	PASS	---
Antenna Requirement	FCC 15.203	PASS	---

For ISED

Requirement – Test case	Basic standard(s)	Verdict	Remark
AC Power Line Conducted Emission	RSS-Gen Issue 5 Section 8.8	PASS	---
Emissions in restricted frequency bands	RSS-Gen Issue 5 Section 8.9	PASS	---
Duty cycle	ANSI C63.10:2013	PASS	---
Emissions in non-restricted frequency bands	RSS-247 Issue 2 Section 5.5	PASS	---
Band Edge	RSS-Gen Issue 5 Section 8.10	PASS	---
Fundamental emission output power	RSS-247 Issue 2 Section 5.4(d)	PASS	---
DTS Bandwidth	RSS-Gen Issue 5 Section 6.7	PASS	---
Power Spectral Density	RSS-247 Issue 2 Section 5.2(b)	PASS	---
Antenna Requirement	RSS-Gen Issue 5 Section 6.8	PASS	---

3.3 Test Facility

USA	:	FCC Designation Number: CN1199
CA	:	ISED CAB identifier: CN0040

4 TEST RESULTS

4.1 AC Power Line Conducted Emission	VERDICT: PASS
---------------------------------------------	----------------------

4.1.1 Limit		
Standard	FCC Part 15 Subpart C Paragraph 15.207	
Frequency range [MHz]	Limit: QP [dB(μV) ¹]	Limit: AV [dB(μV) ¹]
0,15 - 0,50	66 - 56 ²⁾	56 - 46 ²⁾
0,50 - 5,0	56	46
5,0 - 30	60	50
¹⁾ At the transition frequency, the lower limit applies. ²⁾ The limit decreases linearly with the logarithm of the frequency.		

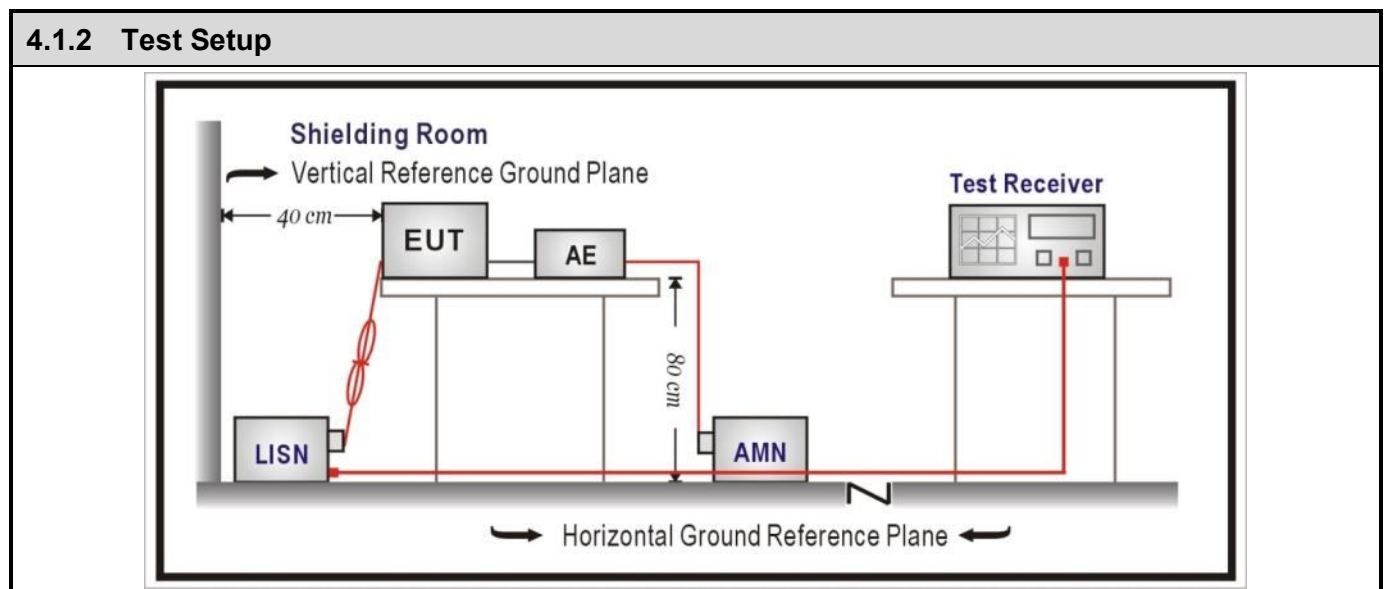

4.1.3 Test Procedure			
	References Rule	Chapter	Item
<input checked="" type="checkbox"/>	ANSI C63.10-2013	6.2	Standard test method for ac power-line conducted emissions from unlicensed wireless devices

4.1.4 Test Data

Profile: 2250816R	Page No.: 65
Engineer: YuLiu	
Site: TR1	Time: 2022/06/20 - 22:40
Limit: FCC_Part15.207_CE_AC Power_ClassB	Margin: 0
Probe: ENV216_101190(0.009-30MHz)	Polarity: Line
EUT: TOUCH ALL IN ONE COMPUTER	Power: AC 120V/60Hz
Note: Mode1	

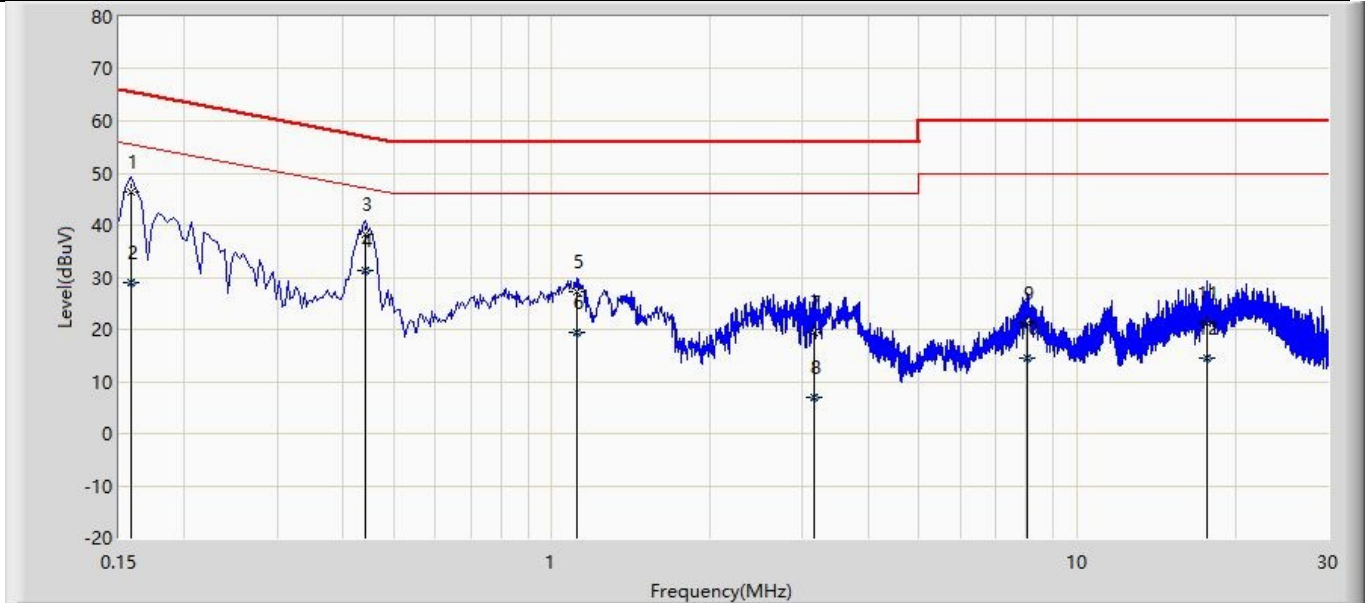

No	Mark	Frequency (MHz)	Measure Level (dBuV)	Reading Level (dBuV)	Over Limit (dB)	Limit (dBuV)	Probe (dB)	Cable (dB)	Amp (dB)	Type
1		0.158	46.485	36.905	-19.084	65.568	9.552	0.028	0.000	QP
2		0.158	28.943	19.364	-26.625	55.568	9.552	0.028	0.000	AV
3		0.442	38.292	28.676	-18.732	57.024	9.576	0.040	0.000	QP
4	*	0.442	31.320	21.704	-15.705	47.024	9.576	0.040	0.000	AV
5		1.114	27.182	17.534	-28.818	56.000	9.590	0.058	0.000	QP
6		1.114	19.354	9.706	-26.646	46.000	9.590	0.058	0.000	AV
7		3.162	19.440	9.712	-36.560	56.000	9.621	0.107	0.000	QP
8		3.162	6.960	-2.768	-39.040	46.000	9.621	0.107	0.000	AV
9		8.042	21.070	11.127	-38.930	60.000	9.764	0.180	0.000	QP
10		8.042	14.527	4.583	-35.473	50.000	9.764	0.180	0.000	AV
11		17.634	21.303	11.117	-38.697	60.000	9.917	0.269	0.000	QP
12		17.634	14.357	4.171	-35.643	50.000	9.917	0.269	0.000	AV

Profile: 2250816R	Page No.: 66
Engineer: YuLiu	
Site: TR1	Time: 2022/06/20 - 22:43
Limit: FCC_Part15.207_CE_AC Power_ClassB	Margin: 0
Probe: ENV216_101190(0.009-30MHz)	Polarity: Neutral
EUT: TOUCH ALL IN ONE COMPUTER	Power: AC 120V/60Hz
Note: Mode1	

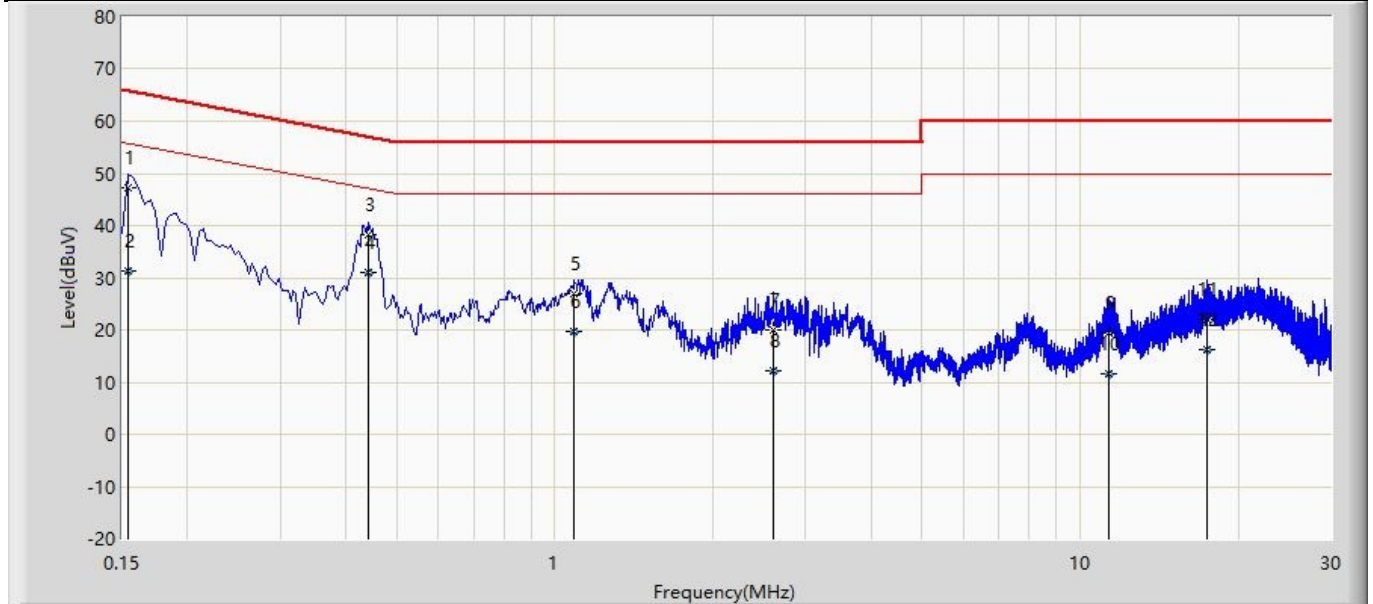

No	Mark	Frequency (MHz)	Measure Level (dBuV)	Reading Level (dBuV)	Over Limit (dB)	Limit (dBuV)	Probe (dB)	Cable (dB)	Amp (dB)	Type
1		0.154	47.372	37.804	-18.409	65.781	9.540	0.028	0.000	QP
2		0.154	31.354	21.786	-24.428	55.781	9.540	0.028	0.000	AV
3		0.442	38.239	28.624	-18.786	57.024	9.574	0.040	0.000	QP
4	*	0.442	31.127	21.512	-15.898	47.024	9.574	0.040	0.000	AV
5		1.090	26.939	17.288	-29.061	56.000	9.590	0.061	0.000	QP
6		1.090	19.786	10.136	-26.214	46.000	9.590	0.061	0.000	AV
7		2.606	20.021	10.320	-35.979	56.000	9.604	0.097	0.000	QP
8		2.606	12.250	2.549	-33.750	46.000	9.604	0.097	0.000	AV
9		11.346	19.438	9.390	-40.562	60.000	9.834	0.214	0.000	QP
10		11.346	11.635	1.587	-38.365	50.000	9.834	0.214	0.000	AV
11		17.422	22.099	11.893	-37.901	60.000	9.939	0.268	0.000	QP
12		17.422	16.122	5.915	-33.878	50.000	9.939	0.268	0.000	AV

4.2 Emissions in restricted frequency bands	VERDICT: PASS
----------------------------------------------------	----------------------

4.2.1 Limit			
Standard		FCC Part 15 Subpart C Paragraph 15.205; 15.209	
Restricted Bands of operation for FCC			
Frequency (MHz)	Frequency (MHz)	Frequency (MHz)	Frequency (GHz)
0.090 – 0.110	16.42 – 16.423	399.9 – 410	4.5 – 5.15
0.495 – 0.505	16.69475 – 16.69525	608 – 614	5.35 – 5.46
2.1735 – 2.1905	16.80425 – 16.80475	960 – 1240	7.25 – 7.75
4.125 – 4.128	25.5 – 25.67	1300 – 1427	8.025 – 8.5
4.17725 – 4.17775	37.5 – 38.25	1435 – 1626.5	9.0 – 9.2
4.20725 – 4.20775	73 – 74.6	1645.5 – 1646.5	9.3 – 9.5
6.215 – 6.218	74.8 – 75.2	1660 – 1710	10.6 – 12.7
6.26775 – 6.26825	108 – 121.94	1718.8 – 1722.2	13.25 – 13.4
6.31175 – 6.31225	123 – 138	2200 – 2300	14.47 – 14.5
8.291 – 8.294	149.9 – 150.05	2310 – 2390	15.35 – 16.2
8.362 – 8.366	156.52475 – 156.52525	2483.5 – 2500	17.7 – 21.4
8.37625 – 8.38675	156.7 – 156.9	2690 – 2900	22.01 – 23.12
8.81425 – 8.81475	162.0125 – 167.17	3260 – 3267	23.6 – 24.0
12.29 – 12.293	167.72 – 173.2	3332 – 3339	31.2 – 31.8
12.51975 – 12.52025	240 – 285	3345.8 – 3358	36.43 – 36.5
12.57675 – 12.57725	322 – 335.4	3600 – 4400	Above 38.6
13.36 – 13.41	--	--	--
Restricted Band Emissions Limit			
Frequency (MHz)	Field strength (µV/m)	Field strength (dBµV/m)	Measurement distance (m)
0.009 - 0.49	2400/F(kHz)	48.5 – 13.8	300 _(Note 1)
0.49 - 1.705	24000/F(kHz)	33.8 - 23	30 _(Note 1)
1.705 - 30	30	29.5	30 _(Note 1)
30 - 88	100	40	3 _(Note 2)
88 - 216	150	43.5	3 _(Note 2)
216 - 960	200	46	3 _(Note 2)
Above 960	500	54	3 _(Note 2)
<p>Note 1: At frequencies below 30 MHz, measurements may be performed at a distance closer than that specified in the regulations; however, an attempt should be made to avoid making measurements in the near field. Pending the development of an appropriate measurement procedure for measurements performed below 30 MHz, when performing measurements at a closer distance than specified, the results shall be extrapolated to the specified distance by either making measurements at a minimum of two distances on at least one radial to determine the proper extrapolation factor or by using the square of an inverse linear distance extrapolation factor (40 dB/decade).</p> <p>Note 2: At frequencies at or above 30 MHz, measurements may be performed at a distance other than what is specified provided: measurements are not made in the near field except where it can be shown that near field measurements are appropriate due to the characteristics of the device; and it can be demonstrated that the signal levels needed to be measured at the distance employed can be detected by the measurement equipment. Measurements shall not be performed at a distance greater than 30 meters unless it can be further demonstrated</p>			

that measurements at a distance of 30 meters or less are impractical. When performing measurements at a distance other than that specified, the results shall be extrapolated to the specified distance using an extrapolation factor of 20 dB/decade (inverse linear-distance for field strength measurements; inverse-linear-distance-squared for power density measurements).

4.2.2 Test Setup

Below 30MHz Test Setup:

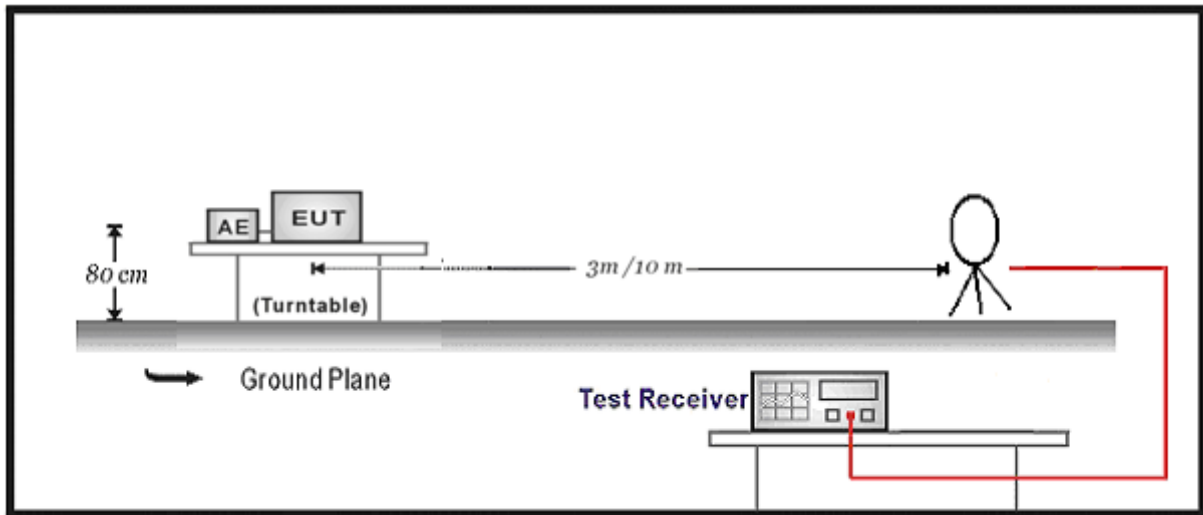

30MHz-1GHz Test Setup:

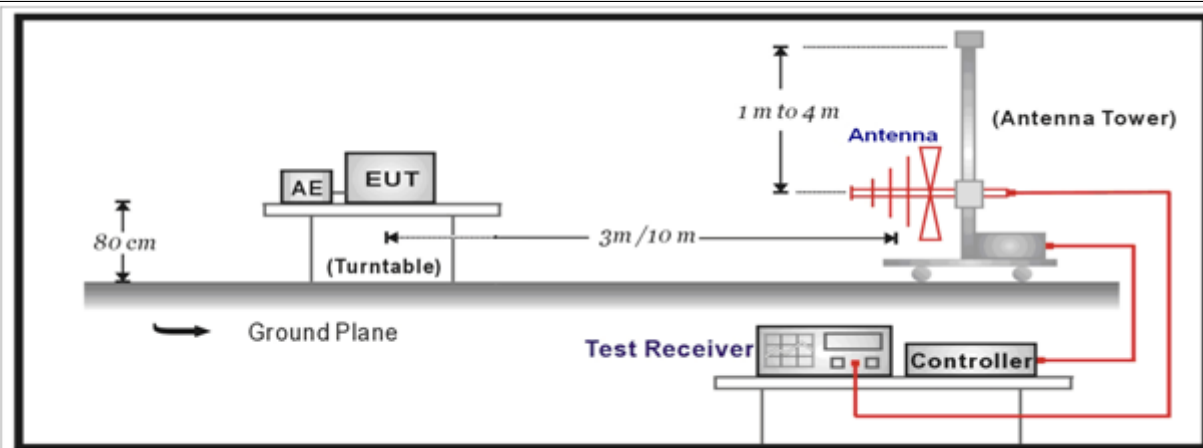

Above 1GHz Test Setup:

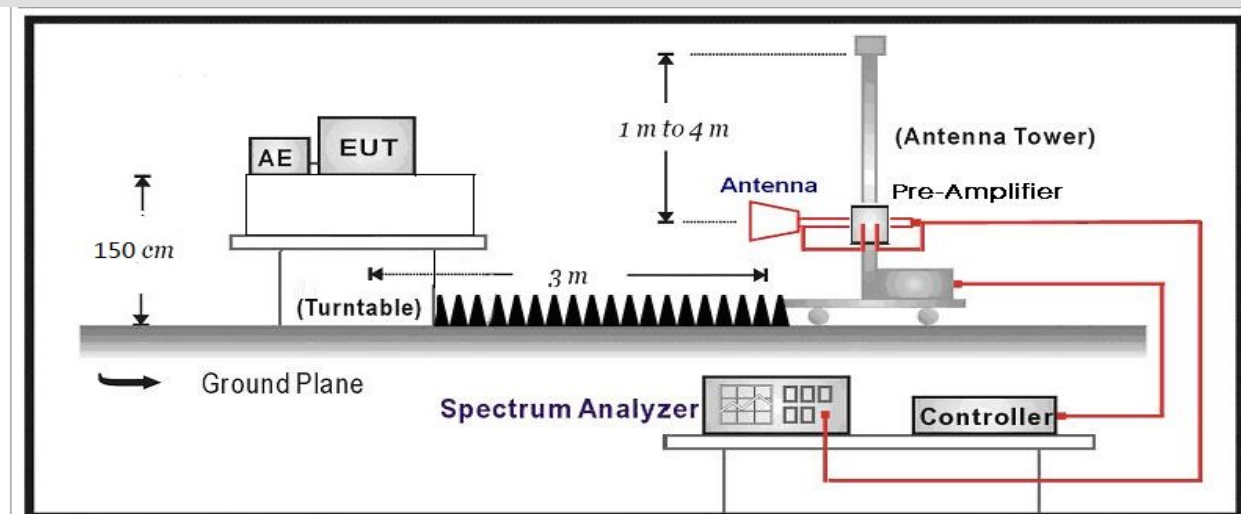

4.2.3 Test Procedure			
	References Rule	Chapter	Description
<input checked="" type="checkbox"/>	ANSI C63.10	11.12	Emissions in restricted frequency bands
	<input checked="" type="checkbox"/> ANSI C63.10	11.12.1	Radiated emission measurements
	<input checked="" type="checkbox"/> ANSI C63.10	6.3	Radiated spurious emission test
	<input checked="" type="checkbox"/> ANSI C63.10	6.4	Radiated emissions from unlicensed wireless devices below 30 MHz
	<input checked="" type="checkbox"/> ANSI C63.10	6.5	Radiated emissions from unlicensed wireless devices in the frequency range of 30 MHz to 1000 MHz
	<input checked="" type="checkbox"/> ANSI C63.10	6.6	Radiated emissions from unlicensed wireless devices above 1 GHz
	<input type="checkbox"/> ANSI C63.10	11.12.2	Antenna-port conducted measurements
	<input type="checkbox"/> ANSI C63.10	11.12.2.3	Quasi-peak measurement procedure
	<input type="checkbox"/> ANSI C63.10	11.12.2.4	Peak power measurement procedure
	<input type="checkbox"/> ANSI C63.10	11.12.2.5	Average power measurement procedures
	<input type="checkbox"/> ANSI C63.10	11.12.2.5.1	Trace averaging with continuous EUT transmission at full power
	<input type="checkbox"/> ANSI C63.10	11.12.2.5.2	Trace averaging across ON and OFF times of the EUT transmissions followed by duty cycle correction
	<input type="checkbox"/> ANSI C63.10	11.12.2.5.3	Reduced VBW averaging across ON and OFF times of the EUT transmissions with max hold

4.2.4 Test Data

Profile: 2250816R	Page No.: 19
Engineer: Yu Liu	
Site: AC5	Time: 2022/06/16 - 22:15
Limit: FCC_Part15.209_RE(3m)	Margin: 0
Probe: HORN_3117_00167055(1-18GHZ)	Polarity: Horizontal
EUT: Touch All In One Computer	Power: AC 120V/60Hz
Note: Mode 1:Transmit at 2412MHz by 11b	

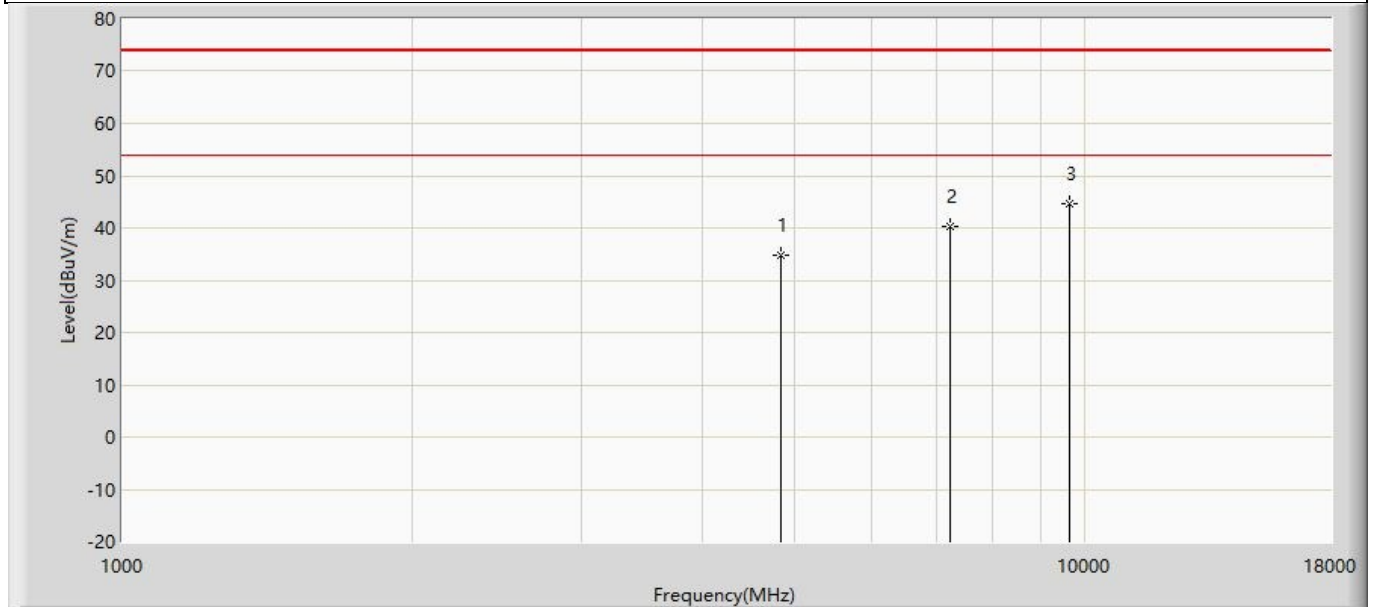

No	Mark	Frequency (MHz)	Measure Level (dBuV/m)	Reading Level (dBuV)	Over Limit (dB)	Limit (dBuV/m)	Factor (dB)	Type
1		4824.000	34.831	49.505	-39.169	74.000	-14.674	PK
2		7236.000	40.181	48.575	-33.819	74.000	-8.394	PK
3	*	9648.000	44.673	49.718	-29.327	74.000	-5.045	PK

Profile: 2250816R	Page No.: 20
Engineer: Yu Liu	
Site: AC5	Time: 2022/06/16 - 22:15
Limit: FCC_Part15.209_RE(3m)	Margin: 0
Probe: HORN_3117_00167055(1-18GHZ)	Polarity: Vertical
EUT: Touch All In One Computer	Power: AC 120V/60Hz
Note: Mode 1:Transmit at 2412MHz by 11b	

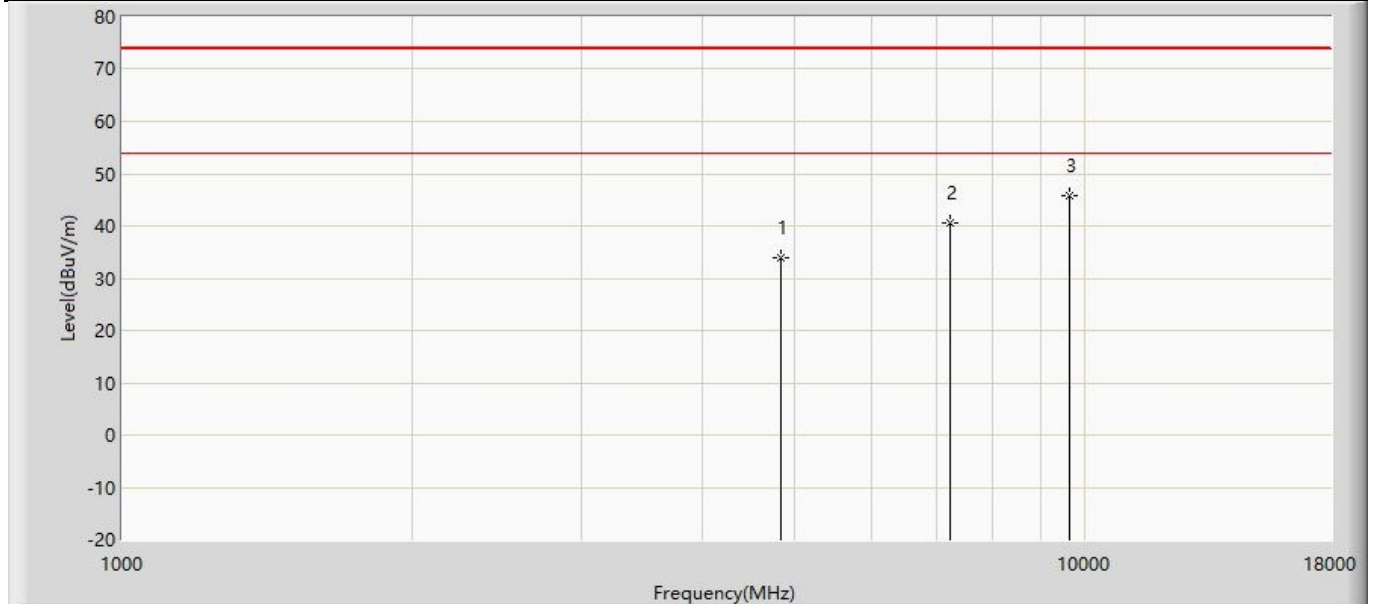

No	Mark	Frequency (MHz)	Measure Level (dBuV/m)	Reading Level (dBuV)	Over Limit (dB)	Limit (dBuV/m)	Factor (dB)	Type
1		4824.000	34.051	48.725	-39.949	74.000	-14.674	PK
2		7236.000	40.630	49.024	-33.370	74.000	-8.394	PK
3	*	9648.000	45.744	50.789	-28.256	74.000	-5.045	PK

Profile: 2250816R	Page No.: 21
Engineer: Yu Liu	
Site: AC5	Time: 2022/06/16 - 22:15
Limit: FCC_Part15.209_RE(3m)	Margin: 0
Probe: HORN_3117_00167055(1-18GHZ)	Polarity: Horizontal
EUT: Touch All In One Computer	Power: AC 120V/60Hz
Note: Mode 1:Transmit at 2437MHz by 11b	

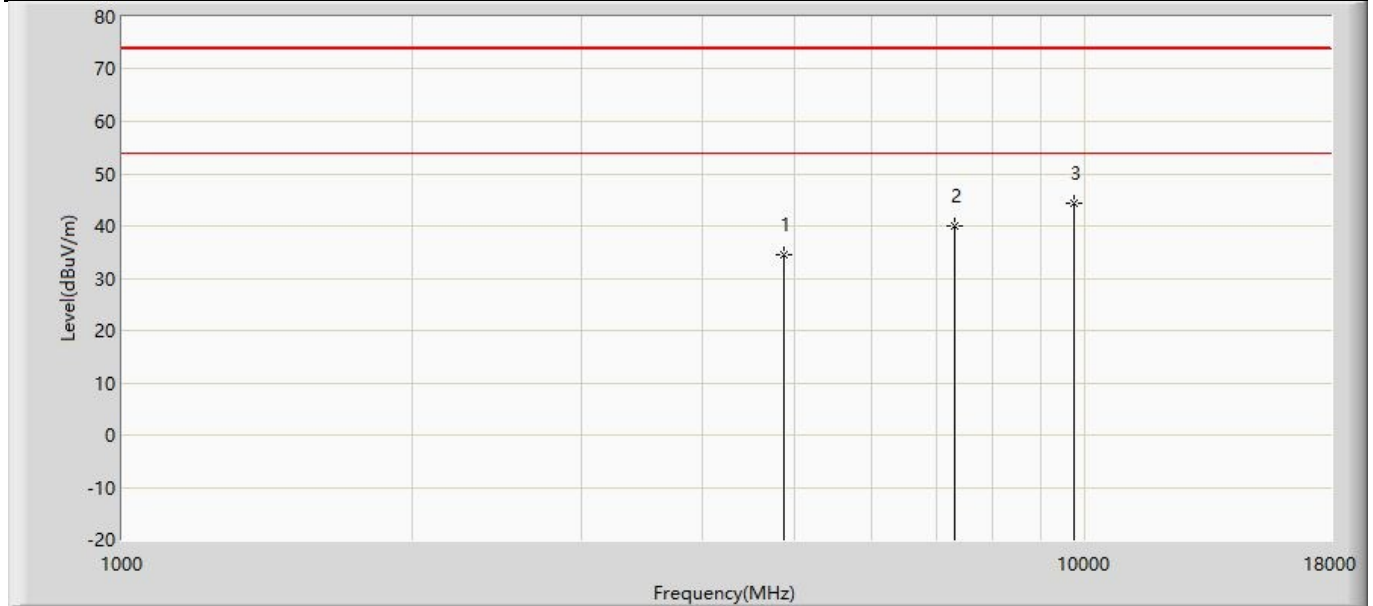

No	Mark	Frequency (MHz)	Measure Level (dBuV/m)	Reading Level (dBuV)	Over Limit (dB)	Limit (dBuV/m)	Factor (dB)	Type
1		4874.000	34.380	48.820	-39.620	74.000	-14.440	PK
2		7311.000	39.943	48.242	-34.057	74.000	-8.299	PK
3	*	9748.000	44.299	48.977	-29.701	74.000	-4.677	PK

Profile: 2250816R	Page No.: 22
Engineer: Yu Liu	
Site: AC5	Time: 2022/06/16 - 22:15
Limit: FCC_Part15.209_RE(3m)	Margin: 0
Probe: HORN_3117_00167055(1-18GHZ)	Polarity: Vertical
EUT: Touch All In One Computer	Power: AC 120V/60Hz
Note: Mode 1:Transmit at 2437MHz by 11b	

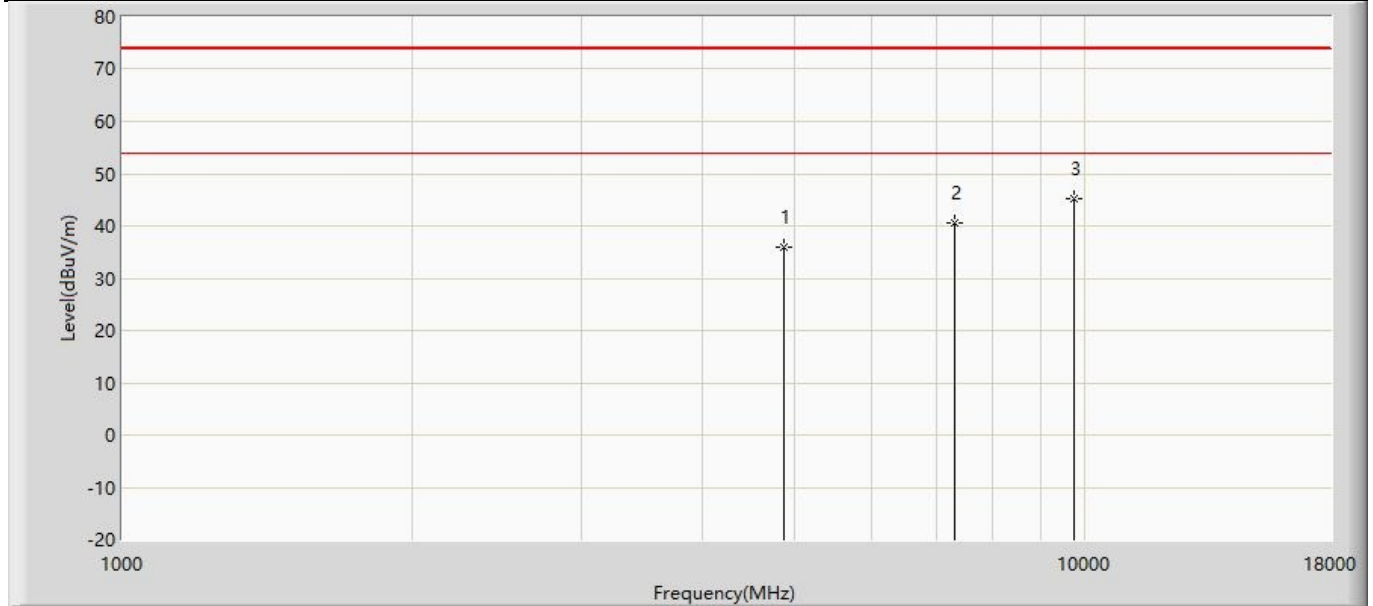

No	Mark	Frequency (MHz)	Measure Level (dBuV/m)	Reading Level (dBuV)	Over Limit (dB)	Limit (dBuV/m)	Factor (dB)	Type
1		4874.000	35.938	50.378	-38.062	74.000	-14.440	PK
2		7311.000	40.473	48.772	-33.527	74.000	-8.299	PK
3	*	9748.000	45.212	49.890	-28.788	74.000	-4.677	PK

Profile: 2250816R	Page No.: 23
Engineer: Yu Liu	
Site: AC5	Time: 2022/06/16 - 22:15
Limit: FCC_Part15.209_RE(3m)	Margin: 0
Probe: HORN_3117_00167055(1-18GHZ)	Polarity: Horizontal
EUT: Touch All In One Computer	Power: AC 120V/60Hz
Note: Mode 1:Transmit at 2462MHz by 11b	

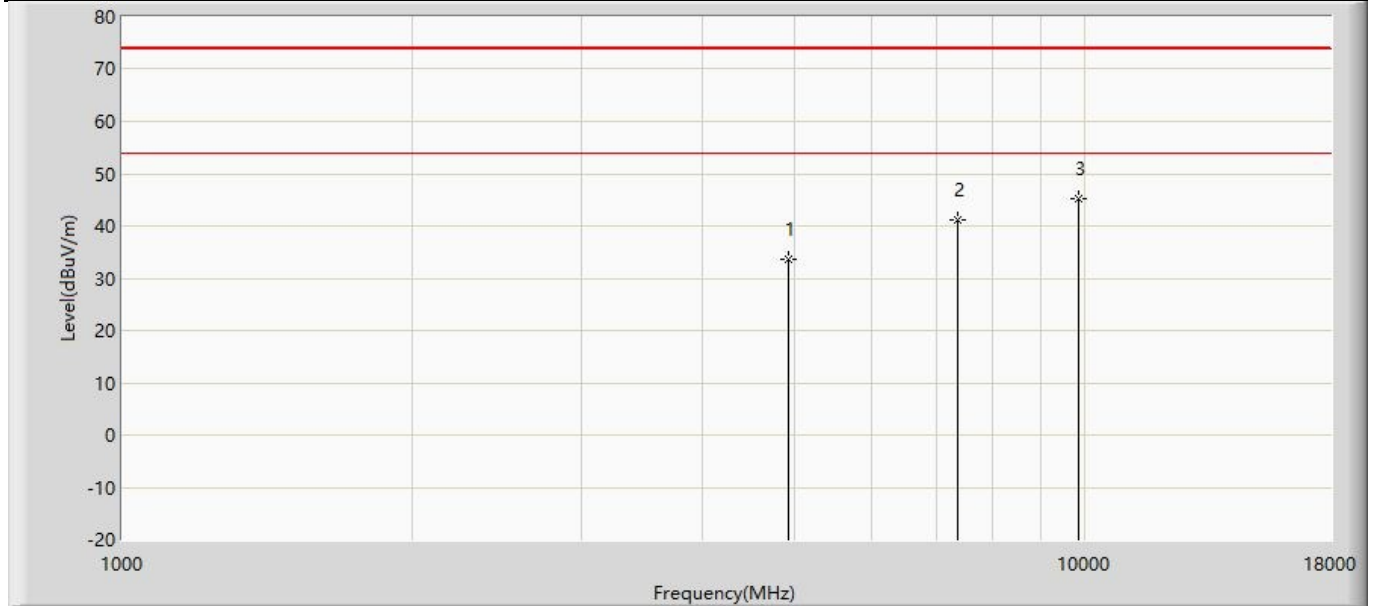

No	Mark	Frequency (MHz)	Measure Level (dBuV/m)	Reading Level (dBuV)	Over Limit (dB)	Limit (dBuV/m)	Factor (dB)	Type
1		4924.000	33.763	47.973	-40.237	74.000	-14.210	PK
2		7386.000	41.211	49.043	-32.789	74.000	-7.832	PK
3	*	9848.000	45.230	49.637	-28.770	74.000	-4.408	PK

Profile: 2250816R	Page No.: 24
Engineer: Yu Liu	
Site: AC5	Time: 2022/06/16 - 22:15
Limit: FCC_Part15.209_RE(3m)	Margin: 0
Probe: HORN_3117_00167055(1-18GHZ)	Polarity: Vertical
EUT: Touch All In One Computer	Power: AC 120V/60Hz
Note: Mode 1:Transmit at 2462MHz by 11b	

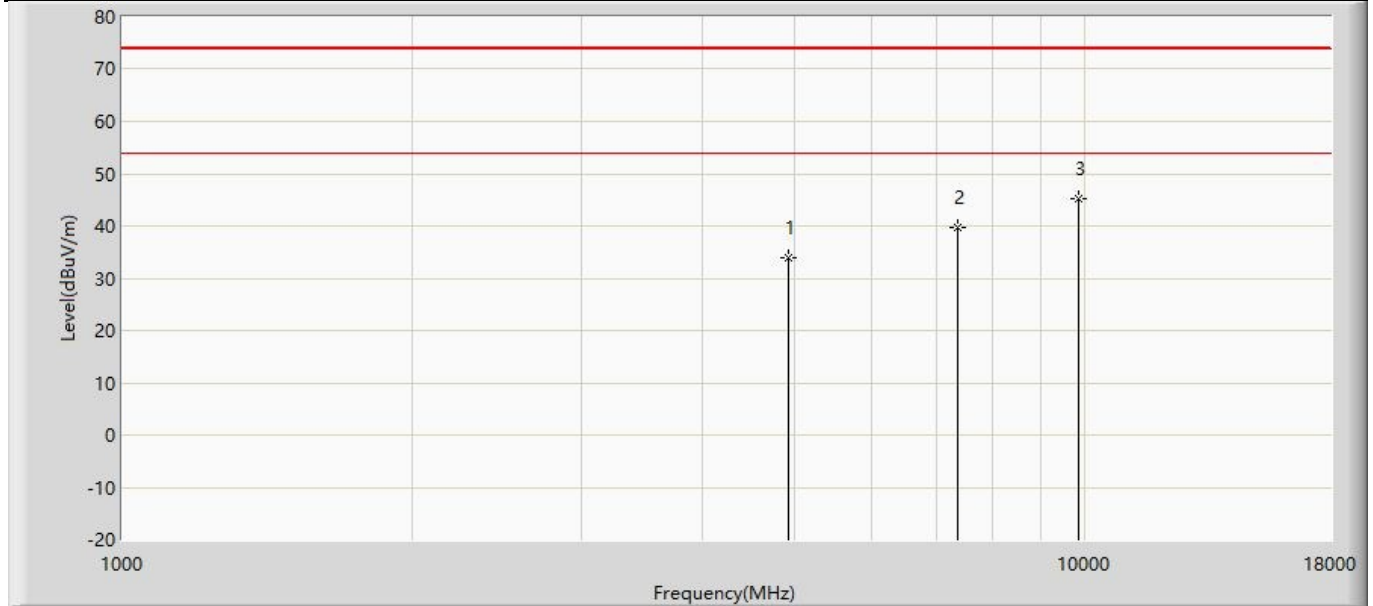

No	Mark	Frequency (MHz)	Measure Level (dBuV/m)	Reading Level (dBuV)	Over Limit (dB)	Limit (dBuV/m)	Factor (dB)	Type
1		4924.000	33.874	48.084	-40.126	74.000	-14.210	PK
2		7386.000	39.584	47.416	-34.416	74.000	-7.832	PK
3	*	9848.000	45.184	49.591	-28.816	74.000	-4.408	PK

Profile: 2250816R	Page No.: 25
Engineer: Yu Liu	
Site: AC5	Time: 2022/06/16 - 22:16
Limit: FCC_Part15.209_RE(3m)	Margin: 0
Probe: HORN_3117_00167055(1-18GHZ)	Polarity: Horizontal
EUT: Touch All In One Computer	Power: AC 120V/60Hz
Note: Mode 2:Transmit at 2412MHz by 11g	

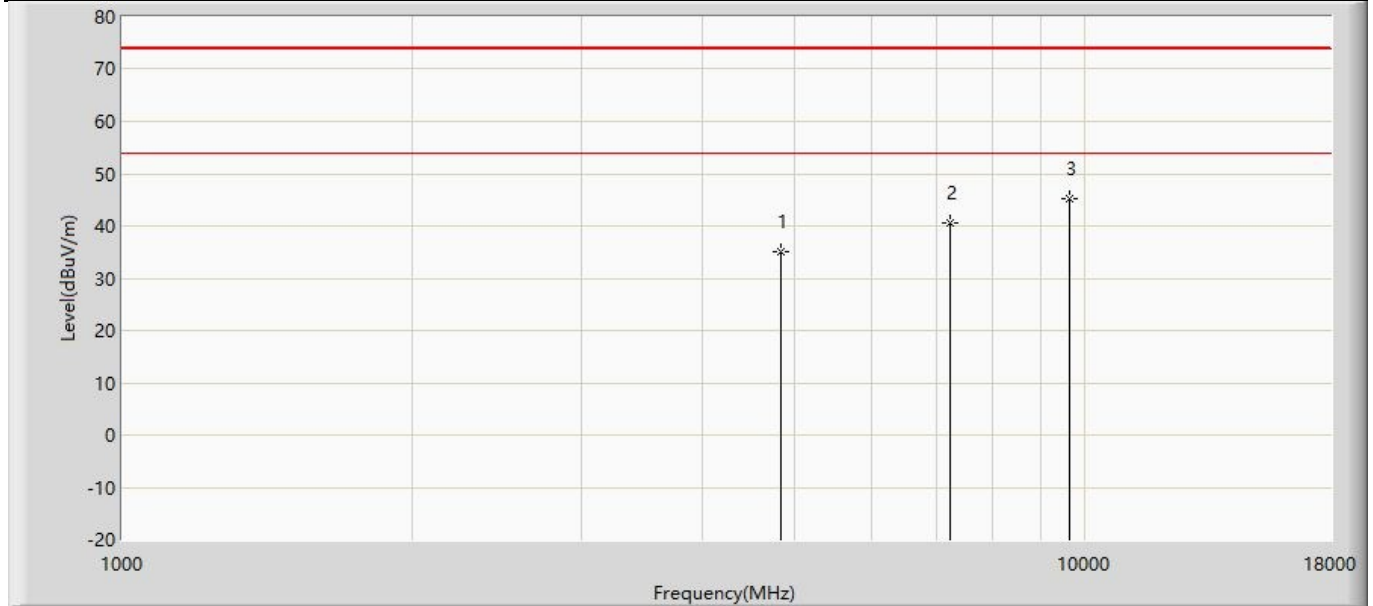

No	Mark	Frequency (MHz)	Measure Level (dBuV/m)	Reading Level (dBuV)	Over Limit (dB)	Limit (dBuV/m)	Factor (dB)	Type
1		4824.000	34.930	49.604	-39.070	74.000	-14.674	PK
2		7236.000	40.614	49.008	-33.386	74.000	-8.394	PK
3	*	9648.000	45.279	50.324	-28.721	74.000	-5.045	PK

Profile: 2250816R	Page No.: 26
Engineer: Yu Liu	
Site: AC5	Time: 2022/06/16 - 22:16
Limit: FCC_Part15.209_RE(3m)	Margin: 0
Probe: HORN_3117_00167055(1-18GHZ)	Polarity: Vertical
EUT: Touch All In One Computer	Power: AC 120V/60Hz
Note: Mode 2:Transmit at 2412MHz by 11g	

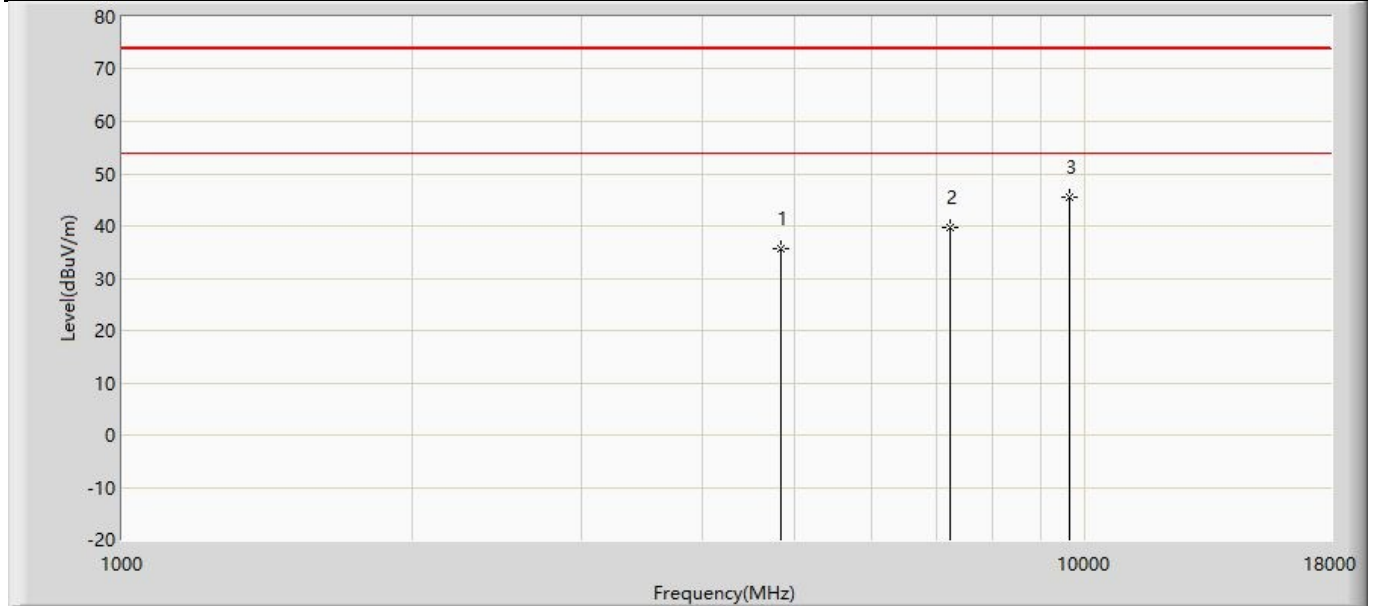

No	Mark	Frequency (MHz)	Measure Level (dBuV/m)	Reading Level (dBuV)	Over Limit (dB)	Limit (dBuV/m)	Factor (dB)	Type
1		4824.000	35.509	50.183	-38.491	74.000	-14.674	PK
2		7236.000	39.787	48.181	-34.213	74.000	-8.394	PK
3	*	9648.000	45.523	50.568	-28.477	74.000	-5.045	PK

Profile: 2250816R	Page No.: 27
Engineer: Yu Liu	
Site: AC5	Time: 2022/06/16 - 22:16
Limit: FCC_Part15.209_RE(3m)	Margin: 0
Probe: HORN_3117_00167055(1-18GHZ)	Polarity: Horizontal
EUT: Touch All In One Computer	Power: AC 120V/60Hz
Note: Mode 2:Transmit at 2437MHz by 11g	

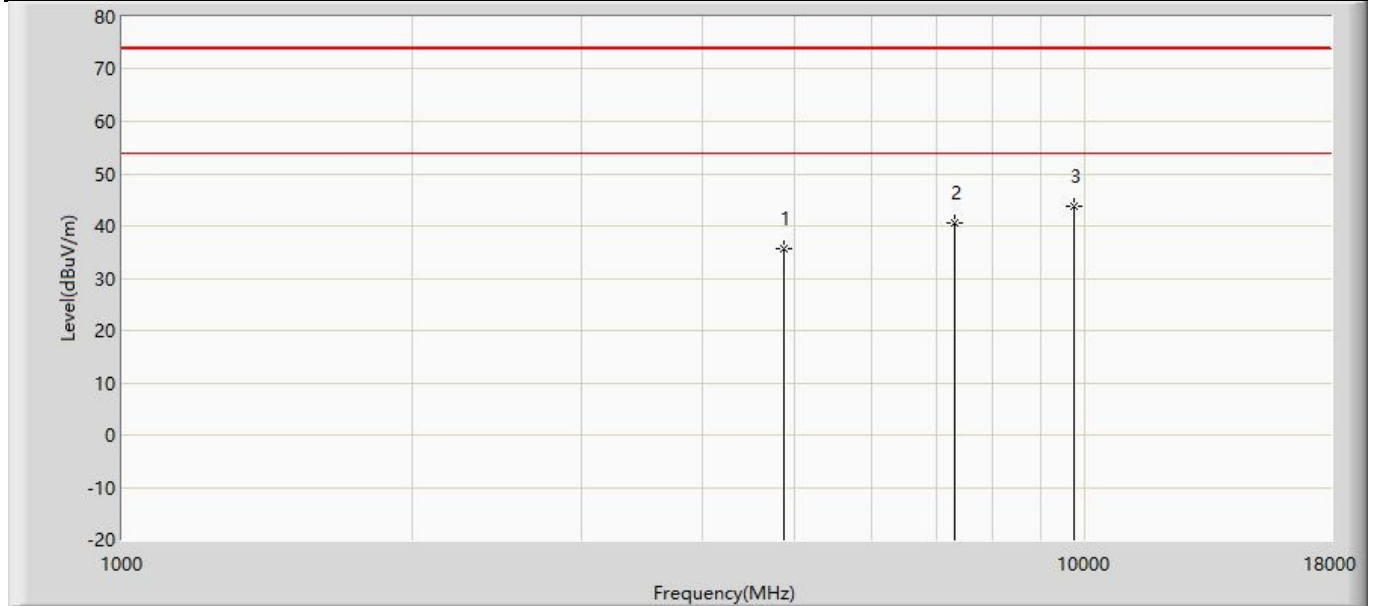

No	Mark	Frequency (MHz)	Measure Level (dBuV/m)	Reading Level (dBuV)	Over Limit (dB)	Limit (dBuV/m)	Factor (dB)	Type
1		4874.000	35.522	49.962	-38.478	74.000	-14.440	PK
2		7311.000	40.463	48.762	-33.537	74.000	-8.299	PK
3	*	9748.000	43.892	48.570	-30.108	74.000	-4.677	PK

Profile: 2250816R	Page No.: 28
Engineer: Yu Liu	
Site: AC5	Time: 2022/06/16 - 22:16
Limit: FCC_Part15.209_RE(3m)	Margin: 0
Probe: HORN_3117_00167055(1-18GHZ)	Polarity: Vertical
EUT: Touch All In One Computer	Power: AC 120V/60Hz
Note: Mode 2:Transmit at 2437MHz by 11g	

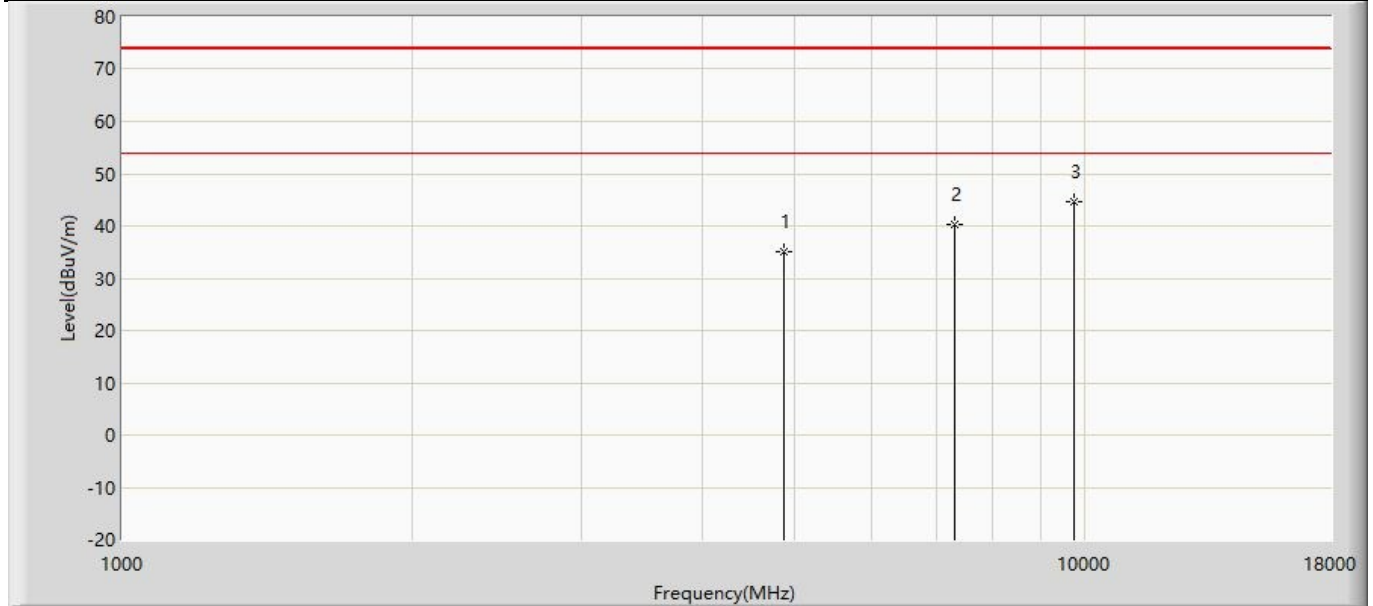

No	Mark	Frequency (MHz)	Measure Level (dBuV/m)	Reading Level (dBuV)	Over Limit (dB)	Limit (dBuV/m)	Factor (dB)	Type
1		4874.000	35.060	49.500	-38.940	74.000	-14.440	PK
2		7311.000	40.310	48.609	-33.690	74.000	-8.299	PK
3	*	9748.000	44.499	49.177	-29.501	74.000	-4.677	PK

Profile: 2250816R	Page No.: 29
Engineer: Yu Liu	
Site: AC5	Time: 2022/06/16 - 22:16
Limit: FCC_Part15.209_RE(3m)	Margin: 0
Probe: HORN_3117_00167055(1-18GHZ)	Polarity: Horizontal
EUT: Touch All In One Computer	Power: AC 120V/60Hz
Note: Mode 2:Transmit at 2462MHz by 11g	

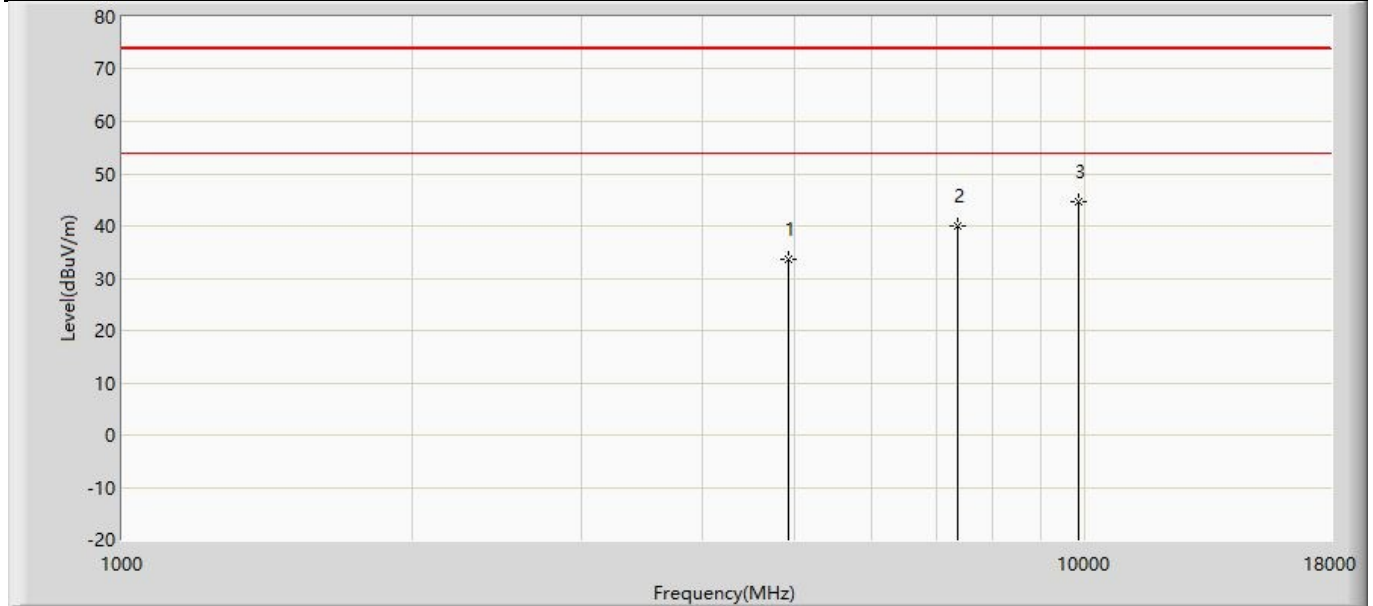

No	Mark	Frequency (MHz)	Measure Level (dBuV/m)	Reading Level (dBuV)	Over Limit (dB)	Limit (dBuV/m)	Factor (dB)	Type
1		4924.000	33.610	47.820	-40.390	74.000	-14.210	PK
2		7386.000	40.078	47.910	-33.922	74.000	-7.832	PK
3	*	9848.000	44.612	49.019	-29.388	74.000	-4.408	PK

Profile: 2250816R	Page No.: 30
Engineer: Yu Liu	
Site: AC5	Time: 2022/06/16 - 22:16
Limit: FCC_Part15.209_RE(3m)	Margin: 0
Probe: HORN_3117_00167055(1-18GHZ)	Polarity: Vertical
EUT: Touch All In One Computer	Power: AC 120V/60Hz
Note: Mode 2:Transmit at 2462MHz by 11g	

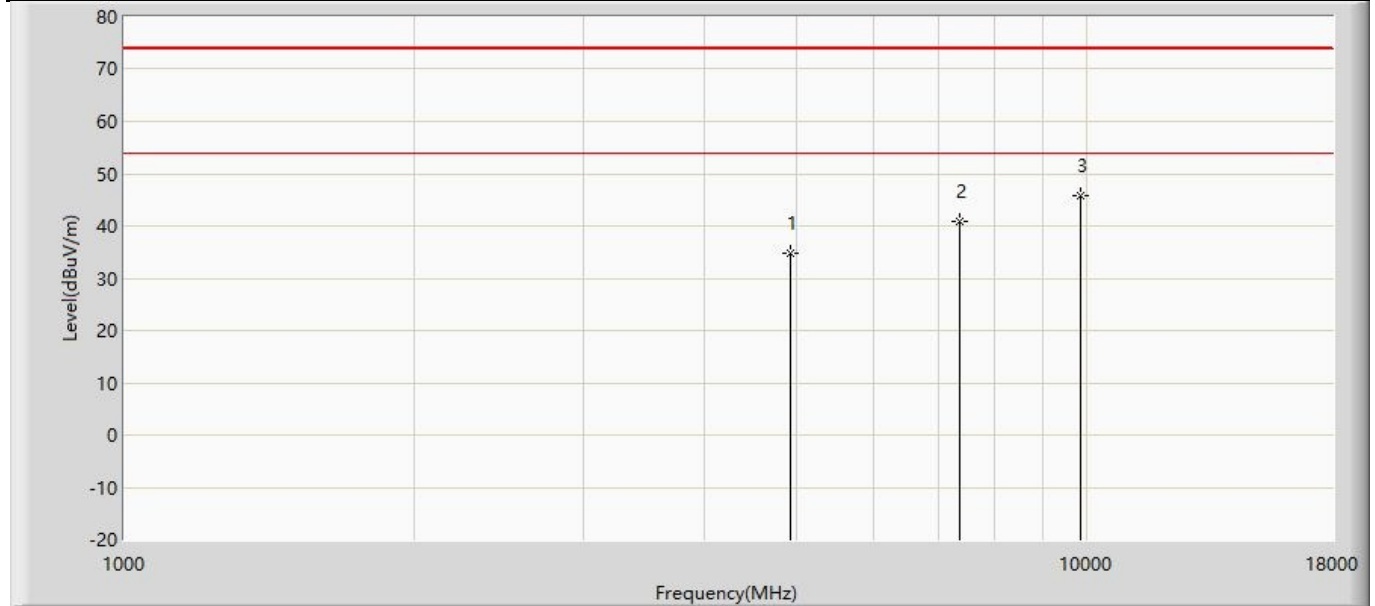

No	Mark	Frequency (MHz)	Measure Level (dBuV/m)	Reading Level (dBuV)	Over Limit (dB)	Limit (dBuV/m)	Factor (dB)	Type
1		4924.000	34.833	49.043	-39.167	74.000	-14.210	PK
2		7386.000	40.838	48.670	-33.162	74.000	-7.832	PK
3	*	9848.000	45.917	50.324	-28.083	74.000	-4.408	PK

Profile: 2250816R	Page No.: 31
Engineer: Yu Liu	
Site: AC5	Time: 2022/06/16 - 22:16
Limit: FCC_Part15.209_RE(3m)	Margin: 0
Probe: HORN_3117_00167055(1-18GHZ)	Polarity: Horizontal
EUT: Touch All In One Computer	Power: AC 120V/60Hz
Note: Mode 3:Transmit at 2412MHz by 11n20	

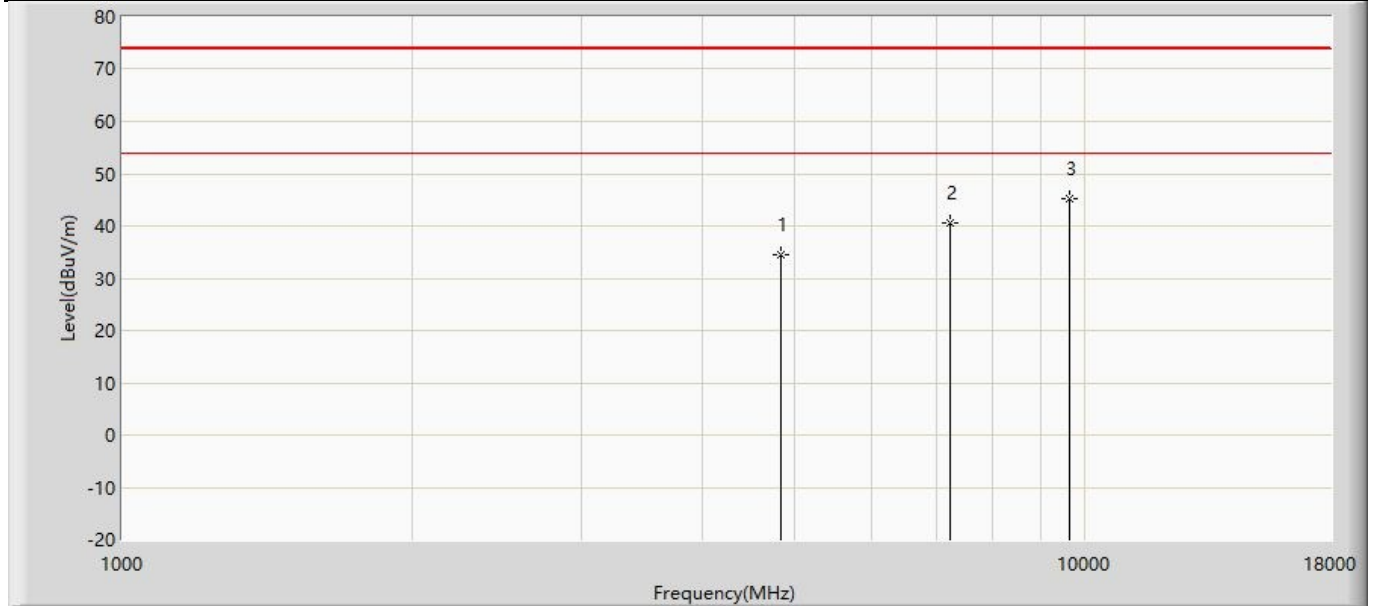

No	Mark	Frequency (MHz)	Measure Level (dBuV/m)	Reading Level (dBuV)	Over Limit (dB)	Limit (dBuV/m)	Factor (dB)	Type
1		4824.000	34.526	49.200	-39.474	74.000	-14.674	PK
2		7236.000	40.576	48.970	-33.424	74.000	-8.394	PK
3	*	9648.000	45.219	50.264	-28.781	74.000	-5.045	PK

Profile: 2250816R	Page No.: 32
Engineer: Yu Liu	
Site: AC5	Time: 2022/06/16 - 22:16
Limit: FCC_Part15.209_RE(3m)	Margin: 0
Probe: HORN_3117_00167055(1-18GHZ)	Polarity: Vertical
EUT: Touch All In One Computer	Power: AC 120V/60Hz
Note: Mode 3:Transmit at 2412MHz by 11n20	

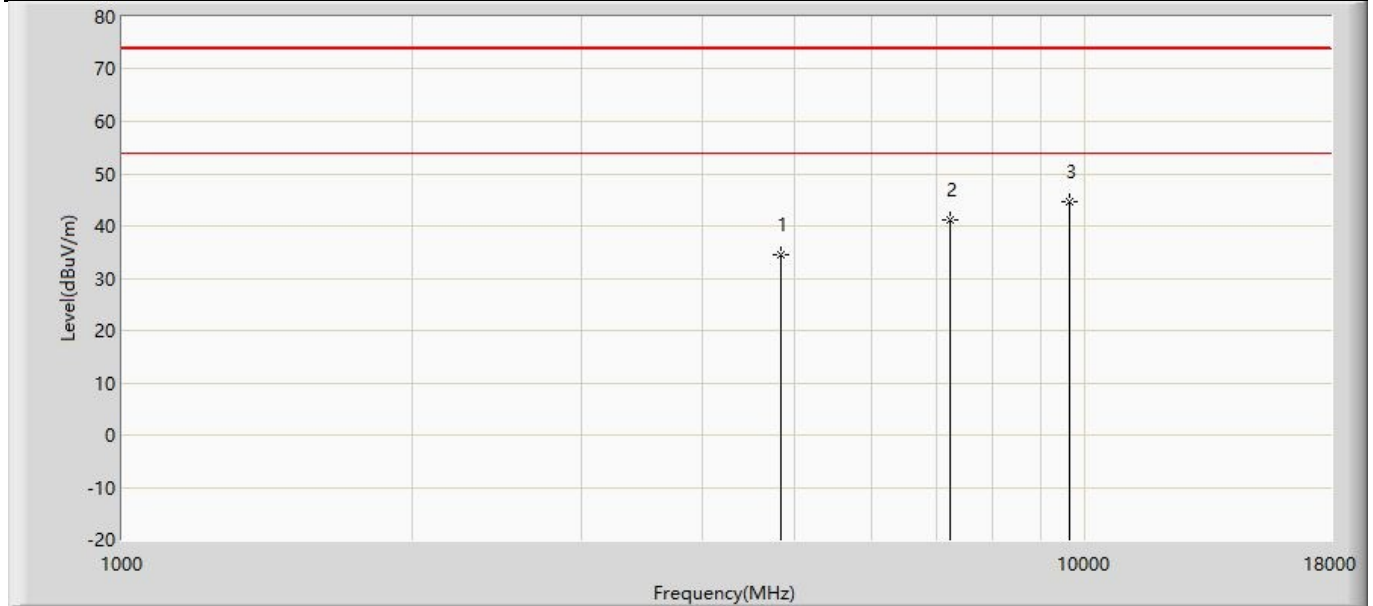

No	Mark	Frequency (MHz)	Measure Level (dBuV/m)	Reading Level (dBuV)	Over Limit (dB)	Limit (dBuV/m)	Factor (dB)	Type
1		4824.000	34.590	49.264	-39.410	74.000	-14.674	PK
2		7236.000	41.093	49.487	-32.907	74.000	-8.394	PK
3	*	9648.000	44.776	49.821	-29.224	74.000	-5.045	PK

Profile: 2250816R	Page No.: 33
Engineer: Yu Liu	
Site: AC5	Time: 2022/06/16 - 22:16
Limit: FCC_Part15.209_RE(3m)	Margin: 0
Probe: HORN_3117_00167055(1-18GHZ)	Polarity: Horizontal
EUT: Touch All In One Computer	Power: AC 120V/60Hz
Note: Mode 3:Transmit at 2437MHz by 11n20	

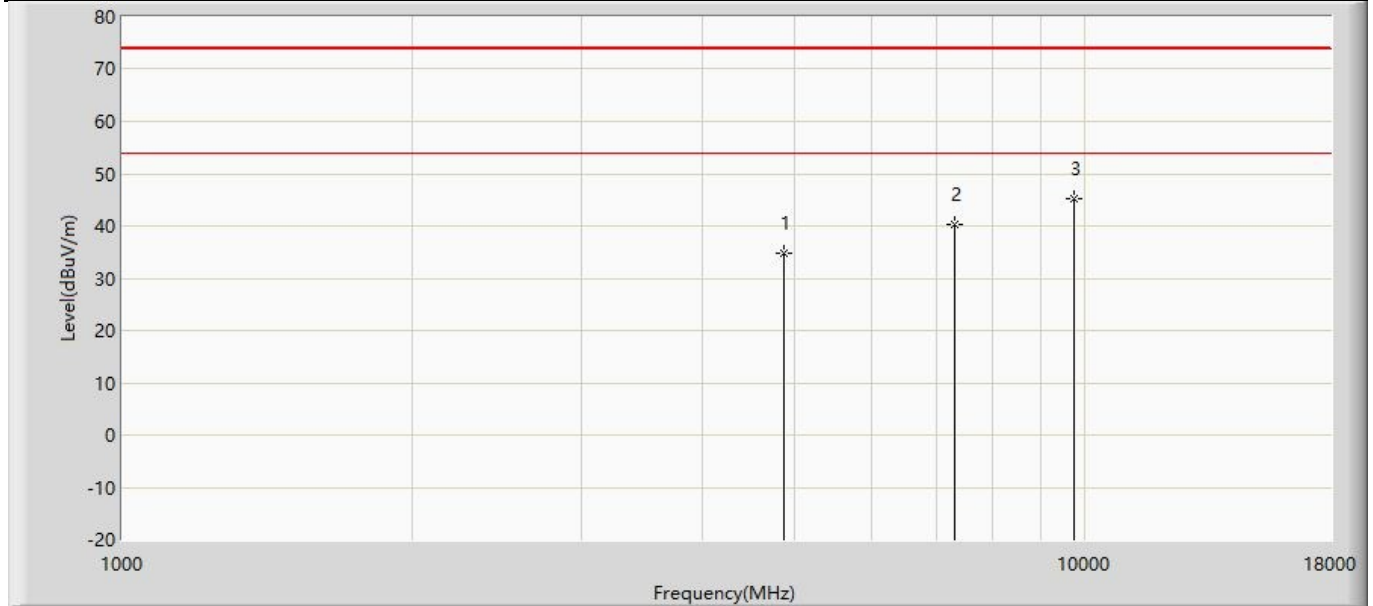

No	Mark	Frequency (MHz)	Measure Level (dBuV/m)	Reading Level (dBuV)	Over Limit (dB)	Limit (dBuV/m)	Factor (dB)	Type
1		4874.000	34.811	49.251	-39.189	74.000	-14.440	PK
2		7311.000	40.421	48.720	-33.579	74.000	-8.299	PK
3	*	9748.000	45.138	49.816	-28.862	74.000	-4.677	PK

Profile: 2250816R	Page No.: 34
Engineer: Yu Liu	
Site: AC5	Time: 2022/06/16 - 22:16
Limit: FCC_Part15.209_RE(3m)	Margin: 0
Probe: HORN_3117_00167055(1-18GHZ)	Polarity: Vertical
EUT: Touch All In One Computer	Power: AC 120V/60Hz
Note: Mode 3:Transmit at 2437MHz by 11n20	

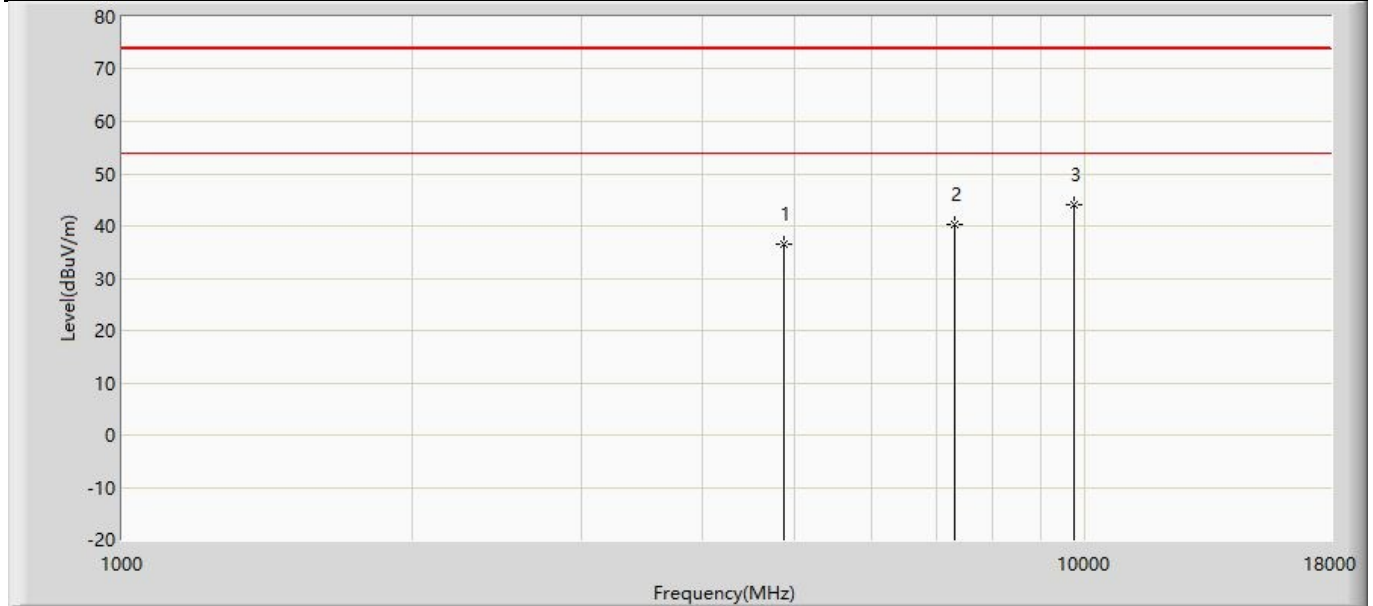

No	Mark	Frequency (MHz)	Measure Level (dBuV/m)	Reading Level (dBuV)	Over Limit (dB)	Limit (dBuV/m)	Factor (dB)	Type
1		4874.000	36.456	50.896	-37.544	74.000	-14.440	PK
2		7311.000	40.290	48.589	-33.710	74.000	-8.299	PK
3	*	9748.000	44.029	48.707	-29.971	74.000	-4.677	PK

Profile: 2250816R	Page No.: 35
Engineer: Yu Liu	
Site: AC5	Time: 2022/06/16 - 22:16
Limit: FCC_Part15.209_RE(3m)	Margin: 0
Probe: HORN_3117_00167055(1-18GHZ)	Polarity: Horizontal
EUT: Touch All In One Computer	Power: AC 120V/60Hz
Note: Mode 3:Transmit at 2462MHz by 11n20	

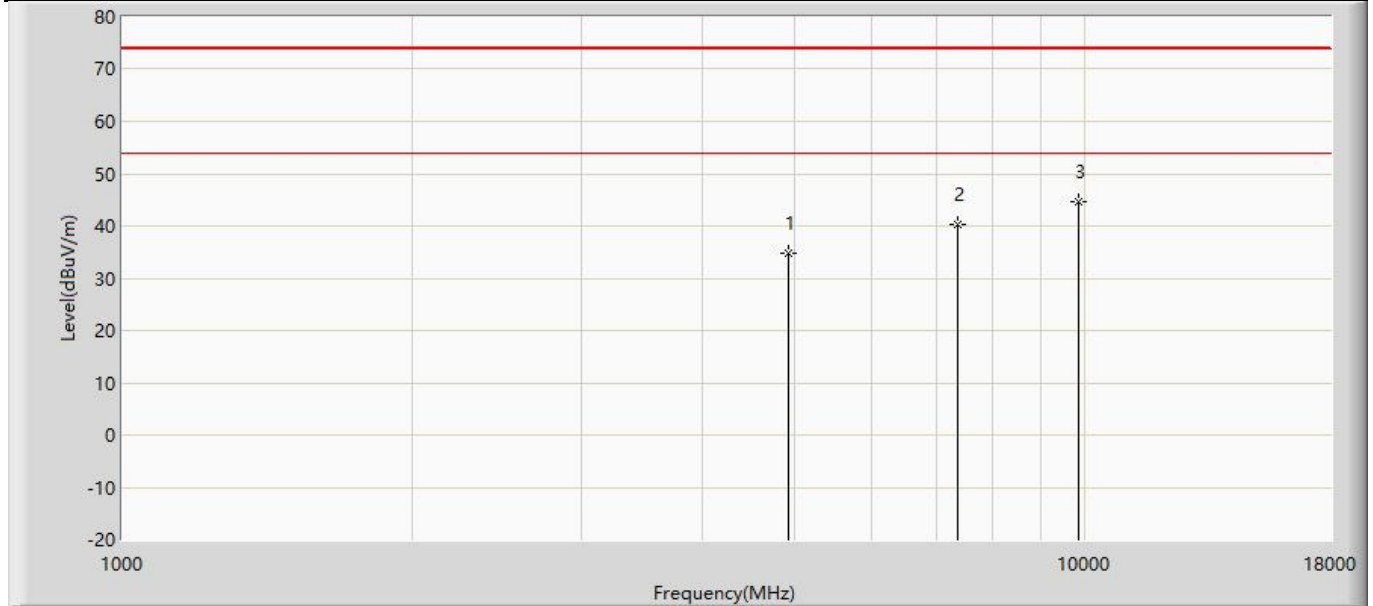

No	Mark	Frequency (MHz)	Measure Level (dBuV/m)	Reading Level (dBuV)	Over Limit (dB)	Limit (dBuV/m)	Factor (dB)	Type
1		4924.000	34.788	48.998	-39.212	74.000	-14.210	PK
2		7386.000	40.326	48.158	-33.674	74.000	-7.832	PK
3	*	9848.000	44.648	49.055	-29.352	74.000	-4.408	PK

Profile: 2250816R	Page No.: 36
Engineer: Yu Liu	
Site: AC5	Time: 2022/06/16 - 22:16
Limit: FCC_Part15.209_RE(3m)	Margin: 0
Probe: HORN_3117_00167055(1-18GHZ)	Polarity: Vertical
EUT: Touch All In One Computer	Power: AC 120V/60Hz
Note: Mode 3:Transmit at 2462MHz by 11n20	

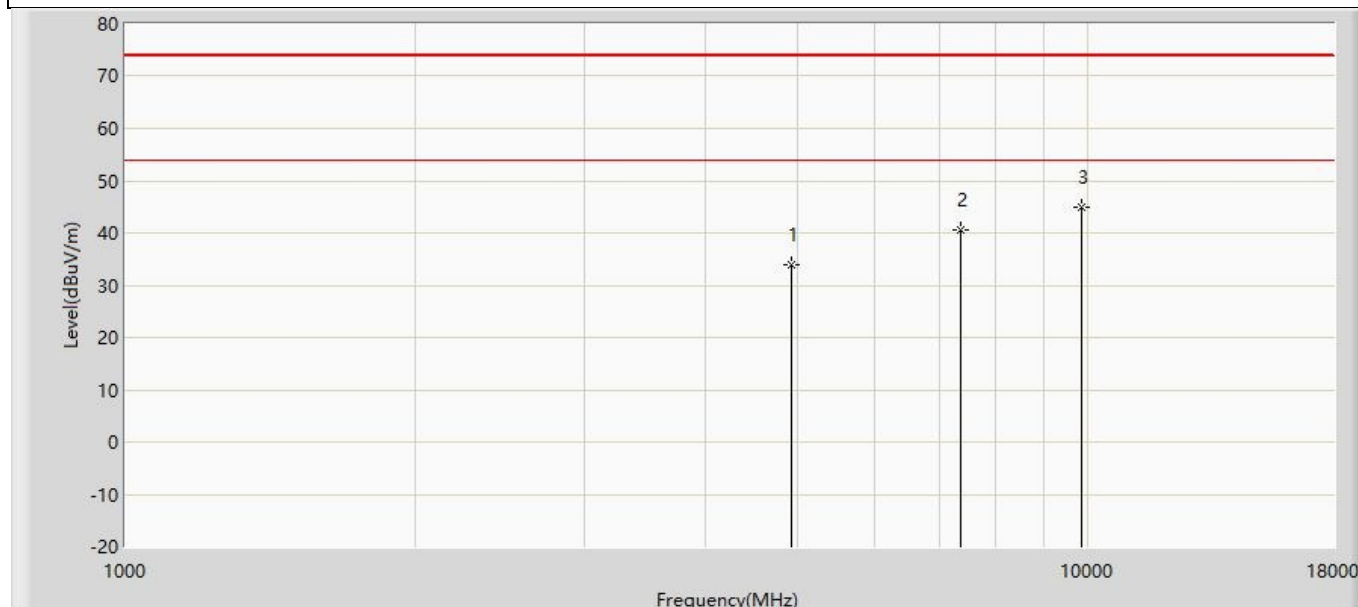

No	Mark	Frequency (MHz)	Measure Level (dBuV/m)	Reading Level (dBuV)	Over Limit (dB)	Limit (dBuV/m)	Factor (dB)	Type
1		4924.000	33.934	48.144	-40.066	74.000	-14.210	PK
2		7386.000	40.539	48.371	-33.461	74.000	-7.832	PK
3	*	9848.000	44.928	49.335	-29.072	74.000	-4.408	PK

Note:

1. We have evaluated both SISO and CDD mode, shown in the report is the worst data.
2. Measure Level = Reading Level + Factor.
3. The test frequency range, 9kHz~30MHz, 18GHz~25GHz, both of the worst case are at least 6dB below the limits, therefore no data appear in the report.
4. This limit applies for using average detector, if the test result on peak is lower than average limit, then average measurement needn't be performed.
5. As the radiated emission was performed, so conducted emission was not tested.

The worst case of Radiated Emission below 1GHz:

Profile: 2250816R	Page No.: 37
Engineer: YuLiu	
Site: AC2	Time: 2022/06/20 - 20:40
Limit: FCC_Part15.209_RE(3m)_ClassB	Margin: 0
Probe: AC2_3M(30-1000M)	Polarity: Horizontal
EUT: TOUCH ALL IN ONE COMPUTER	Power: 120V/60Hz
Note: Mode 1	

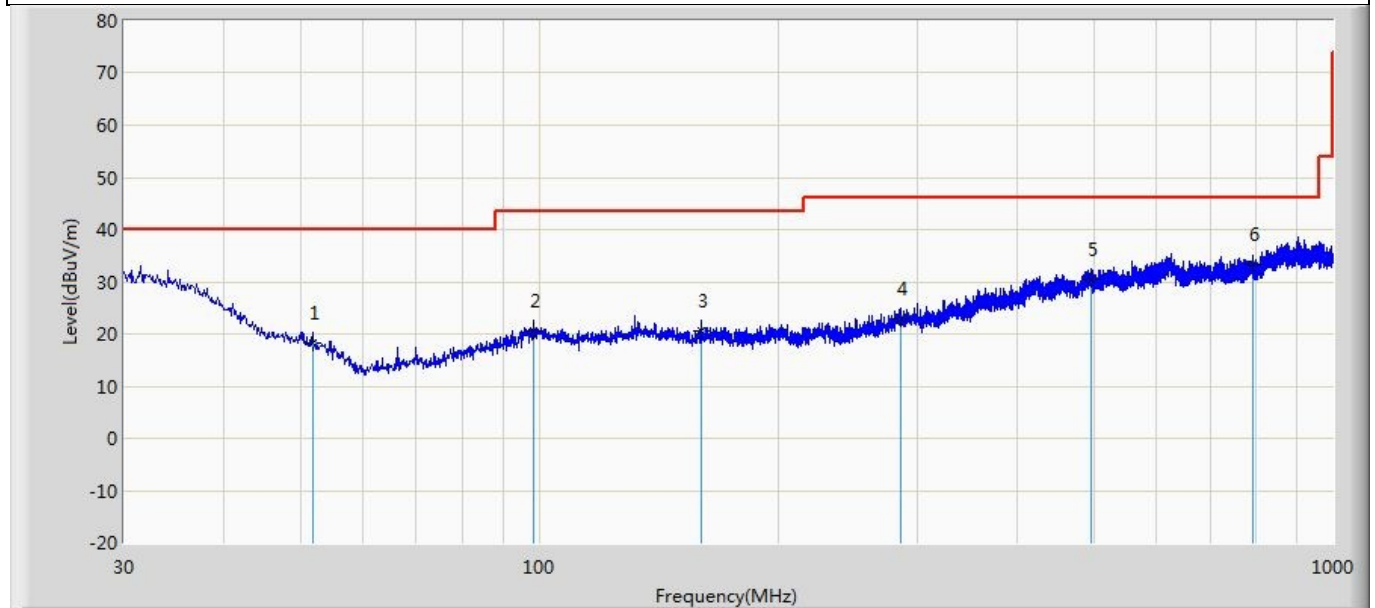

No	Mark	Frequency (MHz)	Measure Level (dBuV/m)	Reading Level (dBuV)	Over Limit (dB)	Limit (dBuV/m)	Factor (dB)	Type
1		51.825	18.221	3.234	-21.779	40.000	14.986	QP
2		98.506	20.566	4.062	-22.934	43.500	16.504	QP
3		159.738	20.503	3.428	-22.997	43.500	17.075	QP
4		285.837	23.019	2.534	-22.981	46.000	20.484	QP
5		496.570	30.570	2.744	-15.430	46.000	27.826	QP
6	*	792.784	33.209	2.895	-12.791	46.000	30.314	QP

Note:

1. All Readings below 1GHz are Quasi-Peak, above are performed with peak and/or average measurements as necessary.
2. " * ", means this data is the worst emission level.
3. Measurement Level = Reading Level + Factor(Probe+Cable-Amp)

Profile: 2250816R	Page No.: 38
Engineer: YuLiu	
Site: AC2	Time: 2022/06/20 - 20:40
Limit: FCC_Part15.209_RE(3m)_ClassB	Margin: 0
Probe: AC2_3M(30-1000M)	Polarity: Vertical
EUT: TOUCH ALL IN ONE COMPUTER	Power: 120V/60Hz
Note: Mode 1	

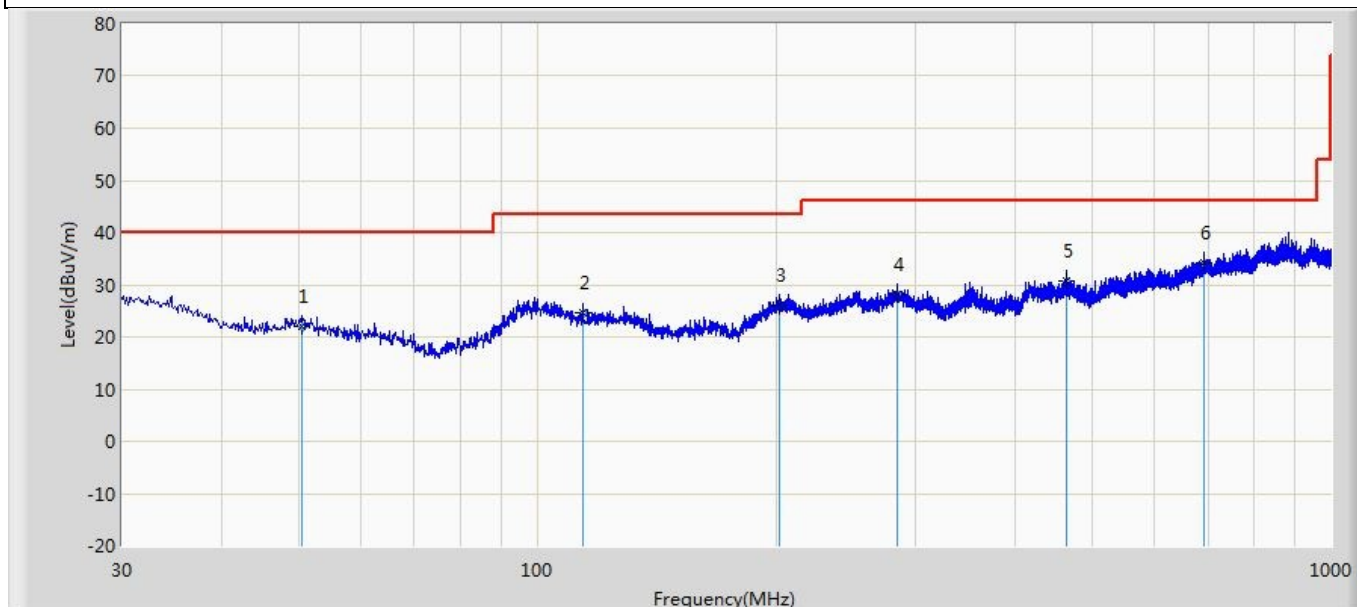

No	Mark	Frequency (MHz)	Measure Level (dBuV/m)	Reading Level (dBuV)	Over Limit (dB)	Limit (dBuV/m)	Factor (dB)	Type
1		50.612	21.929	2.577	-18.071	40.000	19.352	QP
2		114.147	24.548	4.223	-18.952	43.500	20.325	QP
3		201.569	25.974	2.486	-17.526	43.500	23.488	QP
4		283.897	28.213	3.068	-17.787	46.000	25.145	QP
5		463.832	30.712	3.989	-15.288	46.000	26.723	QP
6	*	692.631	34.132	3.759	-11.868	46.000	30.374	QP

Note:

1. All Readings below 1GHz are Quasi-Peak, above are performed with peak and/or average measurements as necessary.
2. " * ", means this data is the worst emission level.
3. Measurement Level = Reading Level + Factor(Probe+Cable-Amp)

The worst case of Simultaneous Radiated Emission:

Profile: 2250816R	Page No.: 9
Engineer: YuLiu	
Site: AC5	Time: 2022/07/04 - 09:30
Limit: FCC-15.209	Margin: 0
Probe: FCC_ANT-1-18G	Polarity: Horizontal
EUT: TOUCH ALL IN ONE COMPUTER	Power: AC 120V/60Hz
Note: Mode 1:Transmit at BLE 2402MHz+WIFI 2412MHZ	

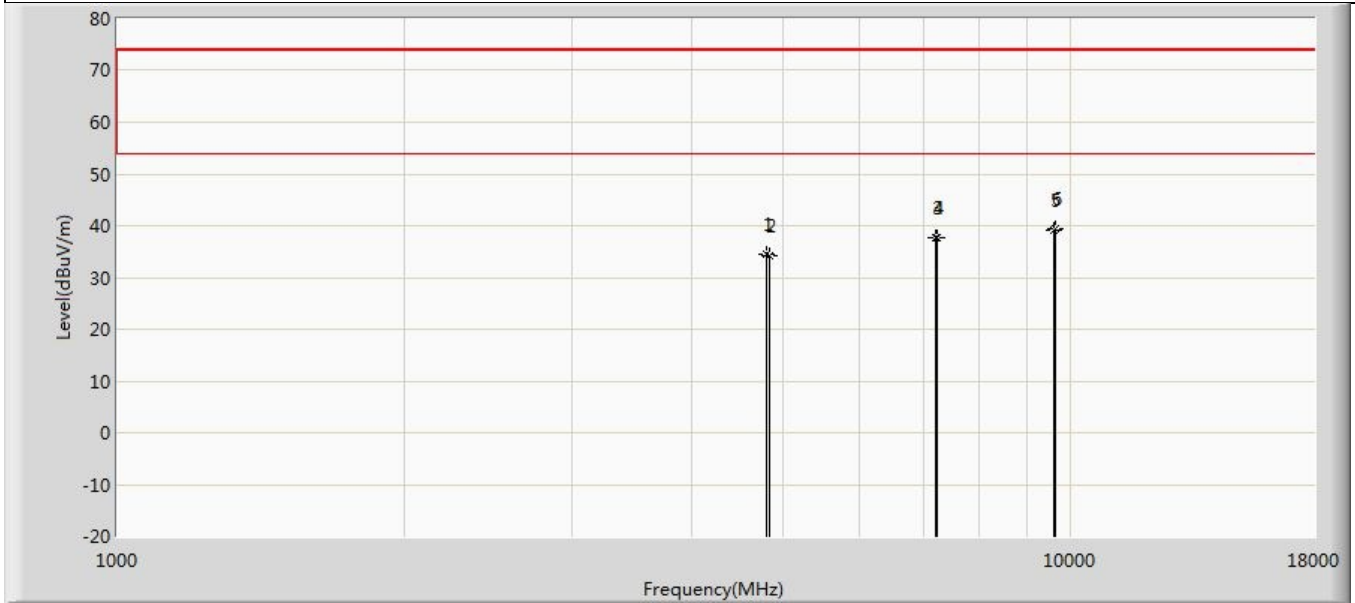

No	Mark	Frequency (MHz)	Measure Level (dBuV/m)	Reading Level (dBuV)	Over Limit (dB)	Limit (dBuV/m)	Factor (dB)	Type
1		4804.000	34.525	46.956	-39.475	74.000	-12.431	PK
2		4824.000	34.306	46.719	-39.694	74.000	-12.414	PK
3		7206.000	37.650	45.447	-36.350	74.000	-7.796	PK
4		7236.000	37.806	45.179	-36.194	74.000	-7.373	PK
5		9608.000	39.160	45.419	-34.840	74.000	-6.258	PK
6	*	9648.000	39.510	45.246	-34.490	74.000	-5.735	PK

Profile: 2250816R	Page No.: 10
Engineer: YuLiu	
Site: AC5	Time: 2022/07/04 - 09:31
Limit: FCC-15.209	Margin: 0
Probe: FCC_ANT-1-18G	Polarity: Vertical
EUT: TOUCH ALL IN ONE COMPUTER	Power: AC 120V/60Hz
Note: Mode 1:Transmit at BLE 2402MHz+WIFI 2412MHZ	

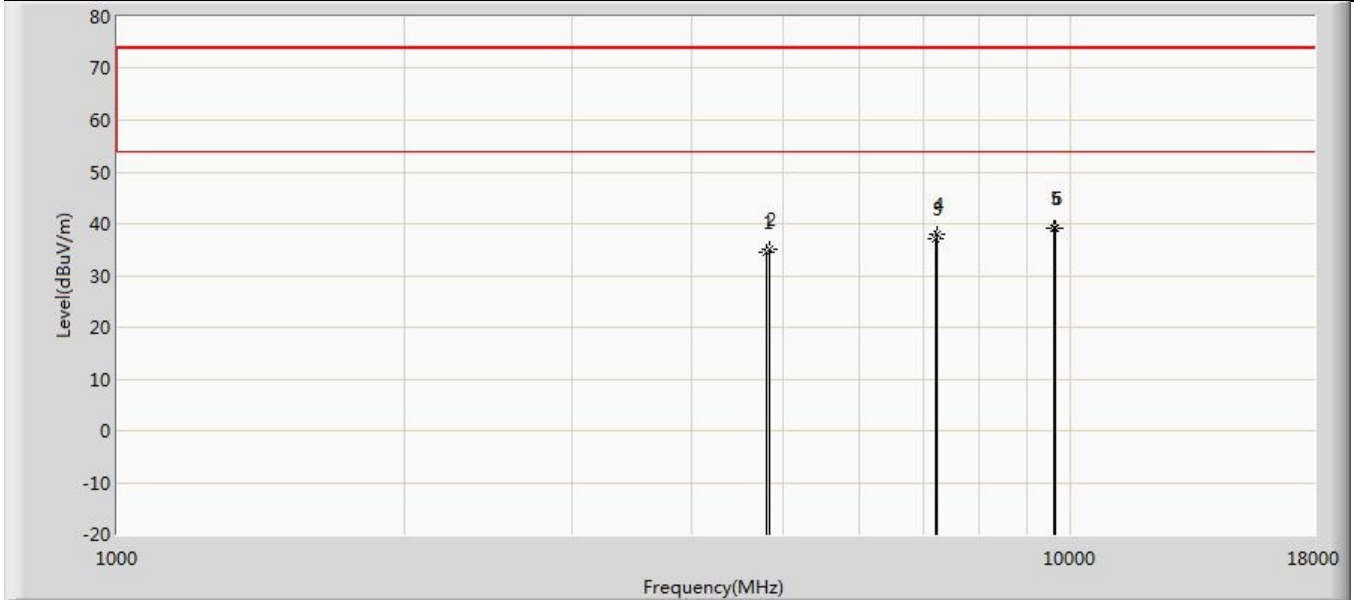

No	Mark	Frequency (MHz)	Measure Level (dBuV/m)	Reading Level (dBuV)	Over Limit (dB)	Limit (dBuV/m)	Factor (dB)	Type
1		4804.000	34.528	46.959	-39.472	74.000	-12.431	PK
2		4824.000	35.083	47.496	-38.917	74.000	-12.414	PK
3		7206.000	37.097	44.894	-36.903	74.000	-7.796	PK
4		7236.000	38.028	45.401	-35.972	74.000	-7.373	PK
5		9608.000	39.081	45.340	-34.919	74.000	-6.258	PK
6	*	9648.000	39.102	44.838	-34.898	74.000	-5.735	PK

4.3 Emissions in non-restricted frequency band	VERDICT: PASS
-------------------------------------------------------	----------------------

4.3.1 Limit

Standard	FCC Part 15 Subpart C Paragraph 15.247(d)	
RF Output power (Detection methods)	Limit(dB)	
RF Output power(Average detector)	30dBc(Note1)	
RF Output power(PK detector)	20dBc(Note2)	

Note 1: If maximum conducted (average) output power was used to demonstrate compliance as described in 9.2, then the peak power in any 100 kHz bandwidth outside of the authorized frequency band shall be attenuated by at least 30 dB relative to the maximum in-band peak PSD level in 100 kHz (i.e., 30 dBc).

Note 2: If the maximum peak conducted output power procedure was used, then the peak output power measured in any 100 kHz bandwidth outside of the authorized frequency band shall be attenuated by at least 20 dB relative to the maximum in-band peak PSD level in 100 kHz (i.e., 20 dBc).

4.3.2 Test Setup

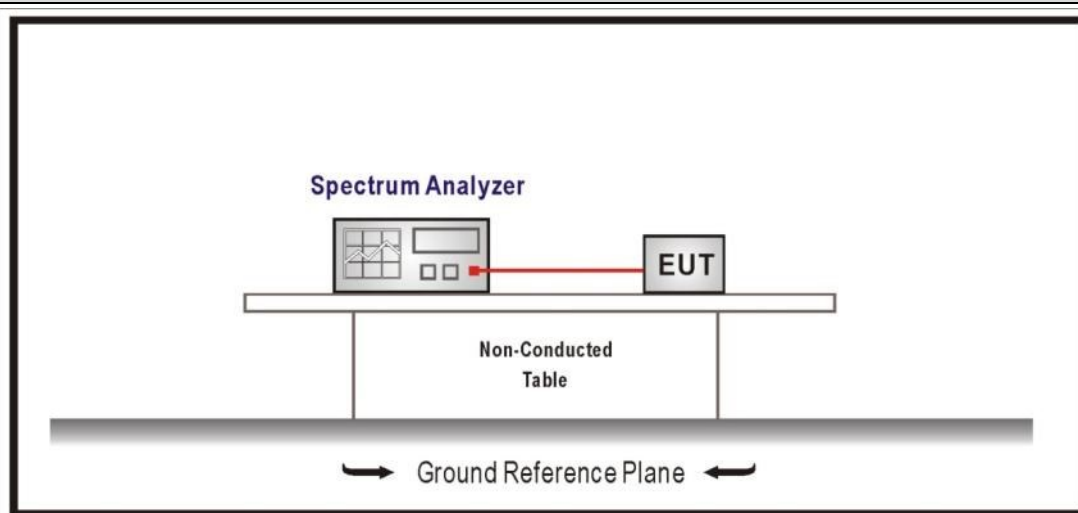

4.3.3 Test Procedure

References Rule	Chapter	Description
<input checked="" type="checkbox"/> ANSI C63.10	11.11	Emissions in non-restricted frequency bands
<input checked="" type="checkbox"/> ANSI C63.10	11.11.1	General
<input checked="" type="checkbox"/> ANSI C63.10	11.11.2	Reference level measurement
<input checked="" type="checkbox"/> ANSI C63.10	11.11.3	Emission level measurement

4.3.4 Test Data

Mode	Channel	Test Frequency (MHz)	Maximum In-Band PSD[a] (dBm/100kHz)	Frequency (MHz)	Out-Band PSD[b] (dBm/100kHz)	[a]-[b] (dB)	Limit (dB)	Result
1	1	2412	7.558	2400	-38.81	46.368	≥30	Pass
	11	2462	7.429	2500	-47.10	54.529	≥30	Pass
2	1	2412	4.640	2400	-33.20	37.840	≥30	Pass
	11	2462	4.046	2500	-52.19	56.236	≥30	Pass
3	1	2412	3.495	2400	-35.15	38.645	≥30	Pass
	11	2462	3.142	2500	-52.70	55.842	≥30	Pass

Note:1. We have evaluated SISO and MIMO mode, shown in the report is the worst data.

2. The worst case of emissions in non-restricted frequency bands as below:

Mode 2 CH01(2412MHz)

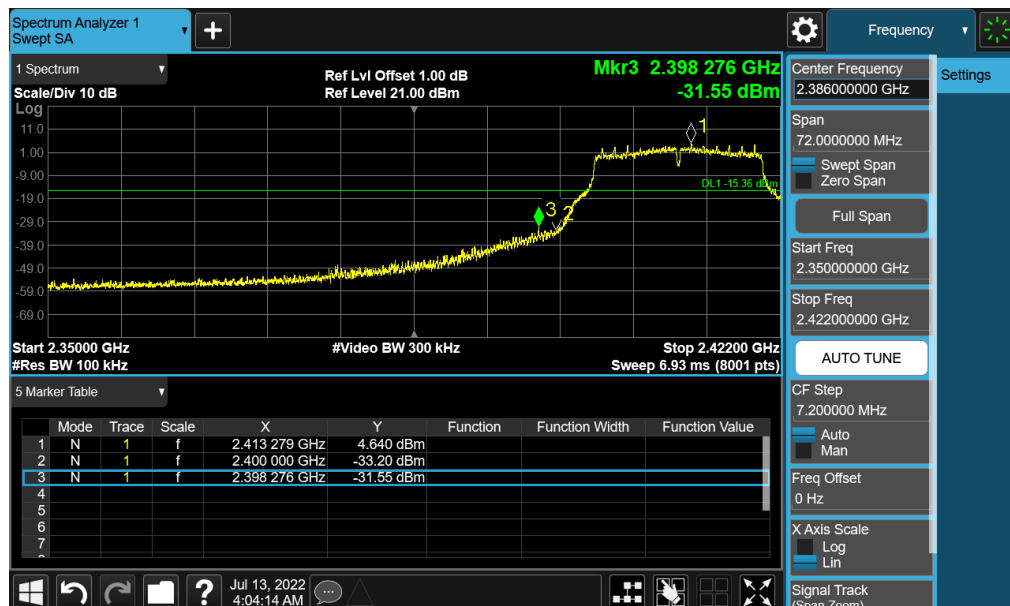

The data of entire corresponding spectrum:

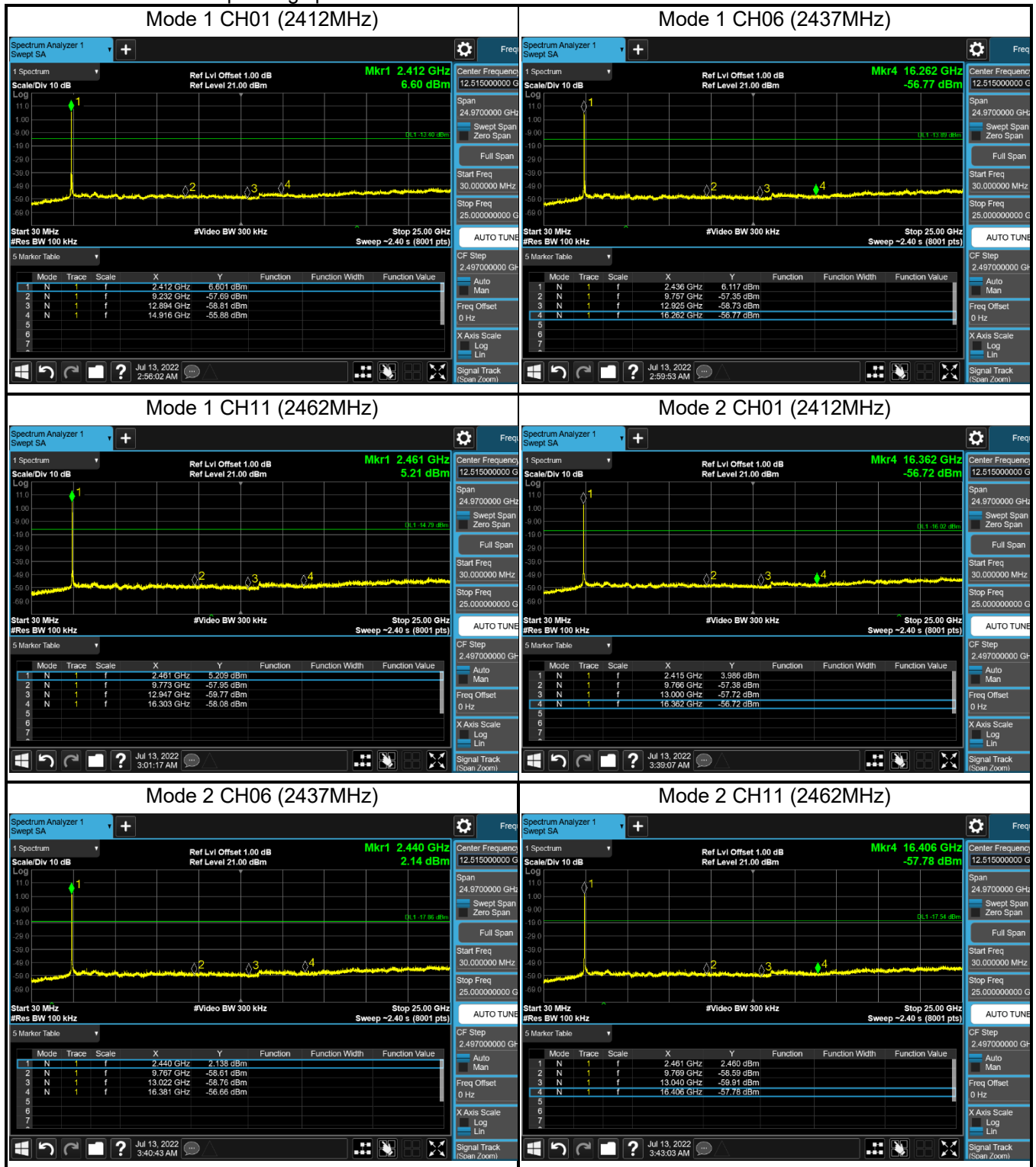

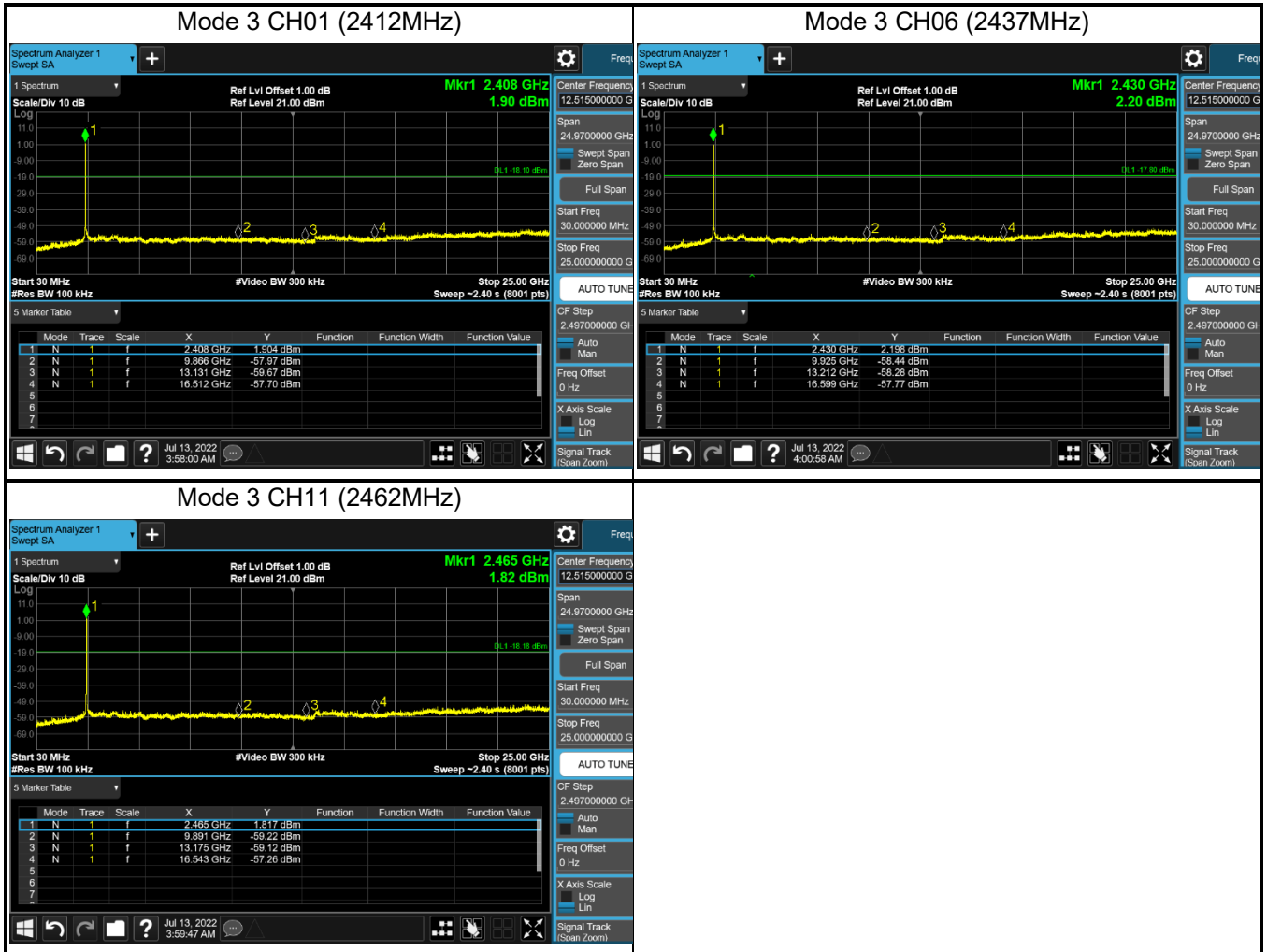

4.4 Duty cycle	VERDICT: PASS
-----------------------	----------------------

4.4.1 Limit
N/A

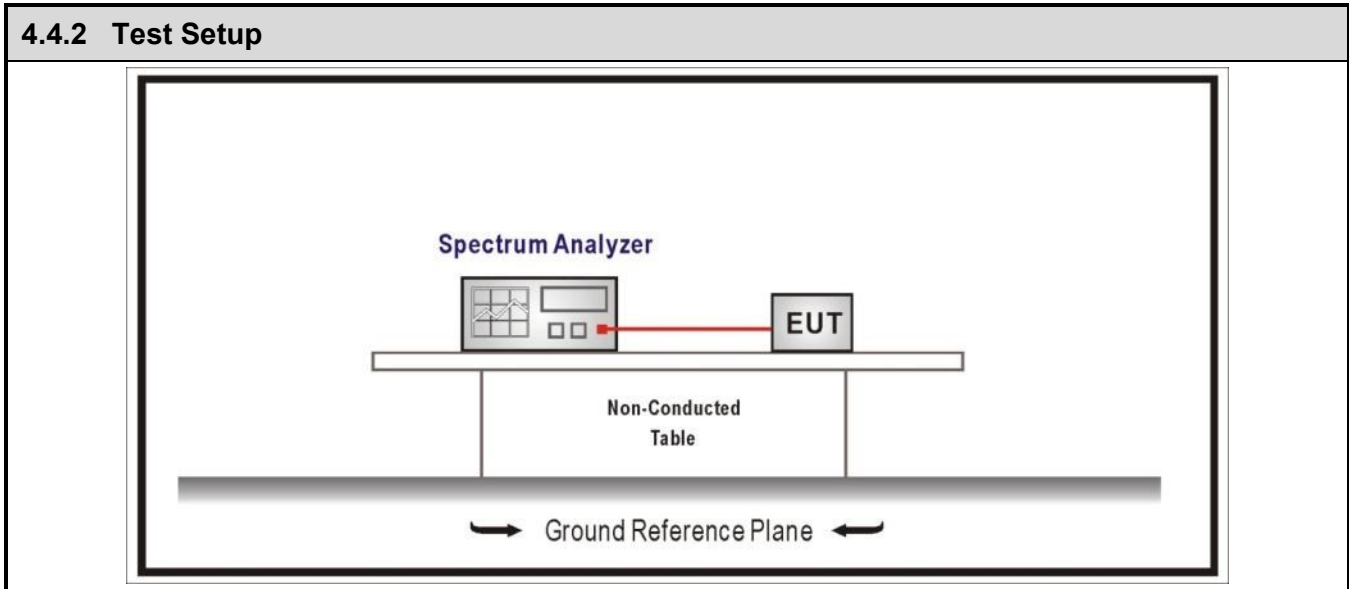

4.4.3 Test Procedure

References Rule	Chapter	Description
<input checked="" type="checkbox"/> ANSI C63.10	11.6	Duty cycle (D), transmission duration (T), and maximum power control level

4.4.4 Test Data

Test Mode	Tx On (ms)	VBW (MHz)	Tx On + Tx Off (ms)	Duty Cycle (%)
Mode 1	N/A	3	N/A	100
Mode 2	N/A	3	N/A	100
Mode 3	N/A	3	N/A	100

Note 1: T means the minimum transmission duration over which the transmitter is on and is transmitting at its maximum power control level for the tested mode of operation.

Note 2: According to KDB 558074, when test for Radiated Emission Band Edge and Radiated Emission, for average detector set: $VBW \geq 1/T$ will be used.

Note 3: When dutycycle $\geq 98\%$, for average detector set: $VBW \geq 3\text{MHz}$ will be used.

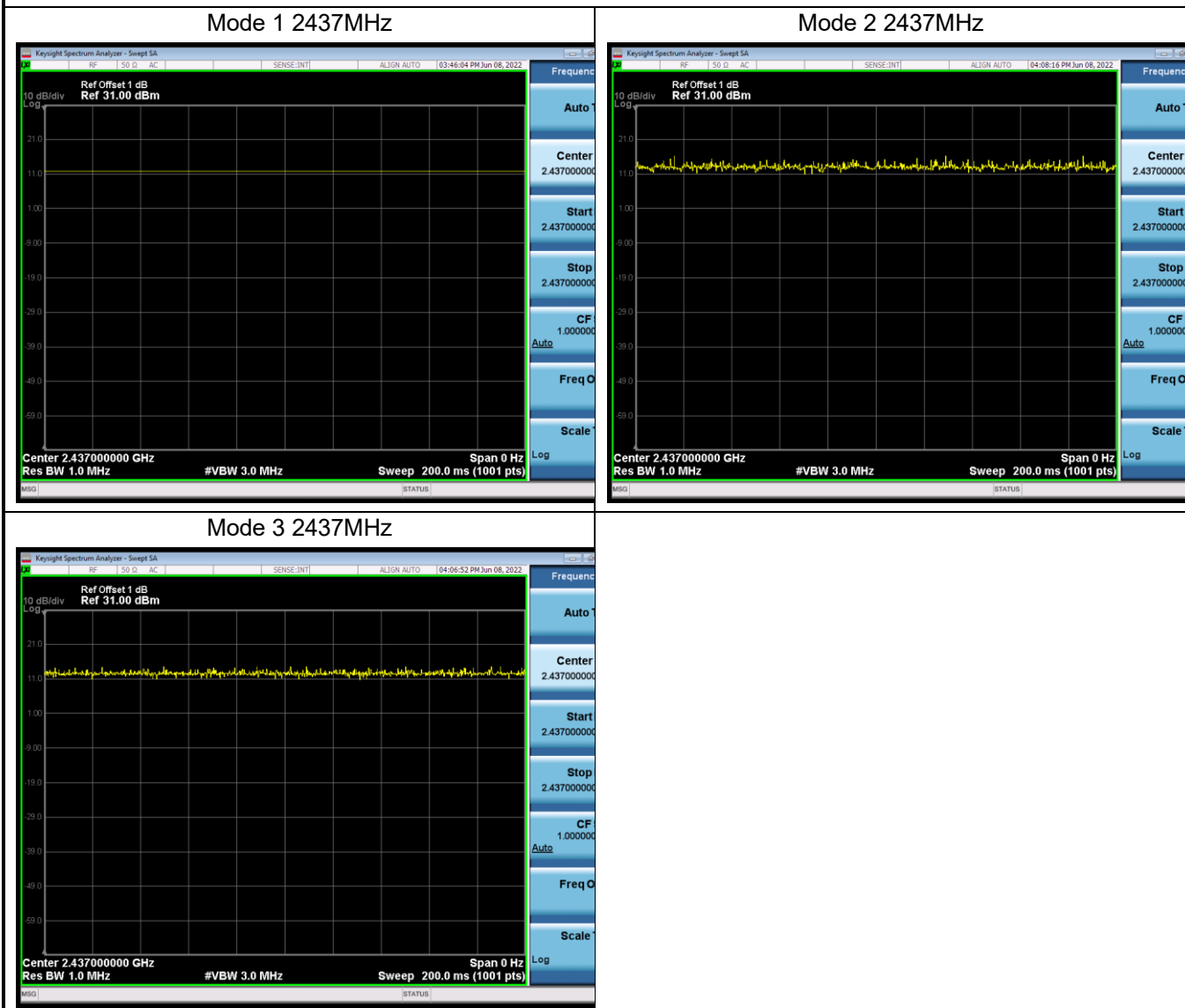

4.5 Radiated Emission Band Edge	VERDICT: PASS
----------------------------------------	----------------------

4.5.1 Limit				
Standard	FCC Part 15 Subpart C Paragraph 15.247(d) , 15.205, 15.209			
Frequency bands (MHz)	Detector	Limit (dB μ V/m)	RBW (MHz)	Distance (m)
2310-2390	PK	74	1	3
2483.5-2500	AV	54	1	3

Note: The field strength of emissions appearing within these frequency bands shall not exceed the limits.

4.5.2 Test Setup

Above 1GHz Test Setup:

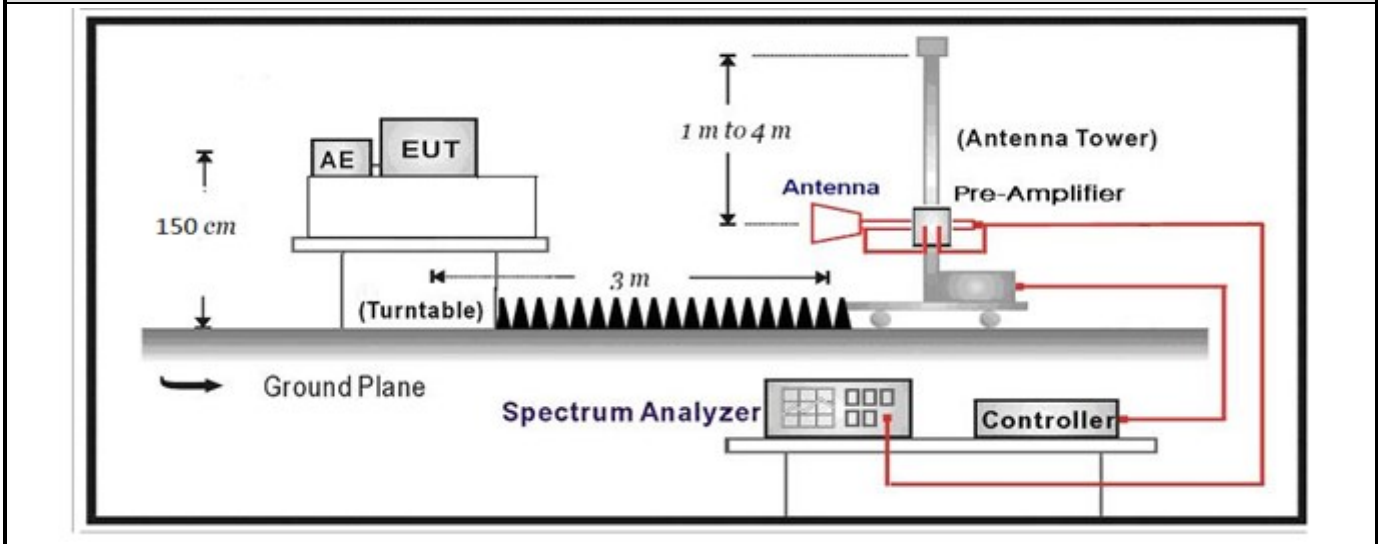

4.5.3 Test Procedure			
	References Rule	Chapter	Description
<input checked="" type="checkbox"/>	ANSI C63.10	6.10	Band-edge testing
	<input checked="" type="checkbox"/> ANSI C63.10	6.10.5	Restricted-band band-edge measurements
	<input type="checkbox"/> ANSI C63.10	6.10.6	Marker-delta method
<input checked="" type="checkbox"/>	ANSI C63.10	11.12	Emissions in restricted frequency bands
	<input checked="" type="checkbox"/> ANSI C63.10	11.12.1	Radiated emission measurements
	<input checked="" type="checkbox"/> ANSI C63.10	6.3	Radiated spurious emission test
<input type="checkbox"/>	ANSI C63.10	6.4	Radiated emissions from unlicensed wireless devices below 30 MHz
<input type="checkbox"/>	ANSI C63.10	6.5	Radiated emissions from unlicensed wireless devices in the frequency range of 30 MHz to 1000 MHz
<input checked="" type="checkbox"/>	ANSI C63.10	6.6	Radiated emissions from unlicensed wireless devices above 1 GHz

4.5.4 Test Data

SISO Antenna1:

Profile: 2250816R	Page No.: 1
Engineer: Yu Liu	
Site: AC5	Time: 2020/03/12 - 00:39
Limit: FCC_Part15.209_RE(3m)	Margin: 0
Probe: HORN_3117_00167055(1-18GHZ)	Polarity: Horizontal
EUT: Touch All In One Computer	Power: AC 120V/60Hz
Note: Mode 1:Transmit at 2412MHz by 11b	

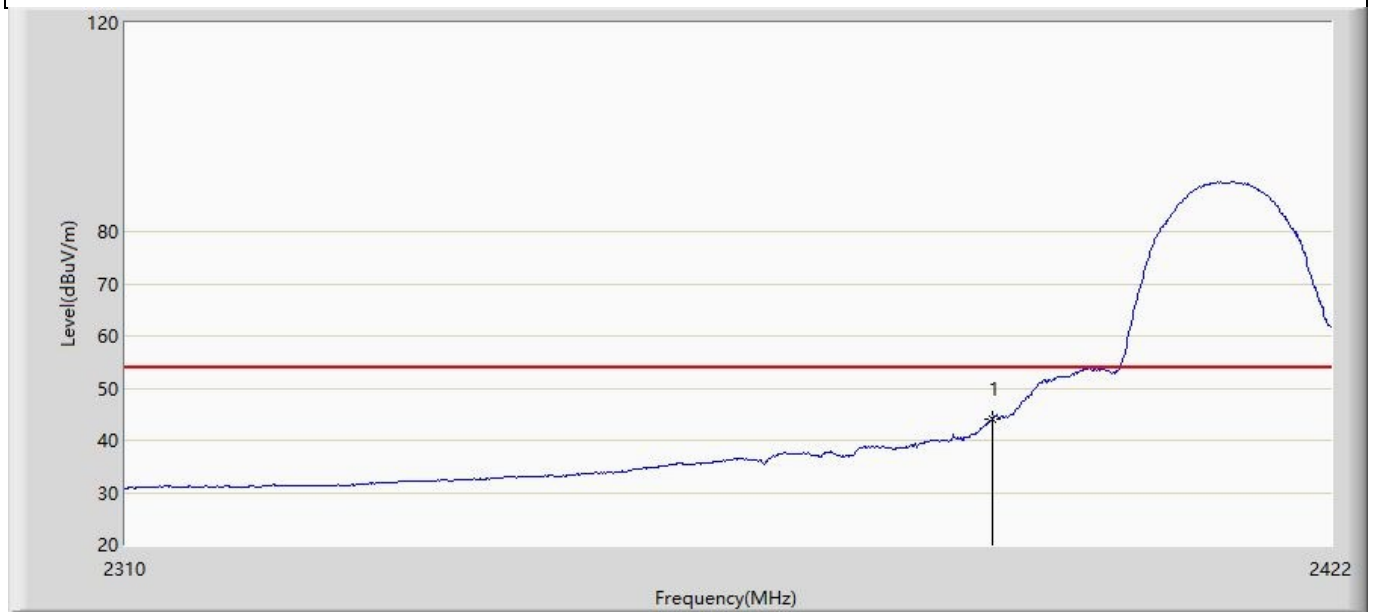

No	Mark	Frequency (MHz)	Measure Level (dBuV/m)	Reading Level (dBuV)	Over Limit (dB)	Limit (dBuV/m)	Factor (dB)	Type
1	*	2390.000	44.125	12.983	-9.875	54.000	31.141	AV

Profile: 2250816R	Page No.: 2
Engineer: Yu Liu	
Site: AC5	Time: 2022/06/23 - 07:40
Limit: FCC_Part15.209_RE(3m)	Margin: 0
Probe: HORN_3117_00167055(1-18GHZ)	Polarity: Horizontal
EUT: Touch All In One Computer	Power: AC 120V/60Hz
Note: Mode 1:Transmit at 2412MHz by 11b	

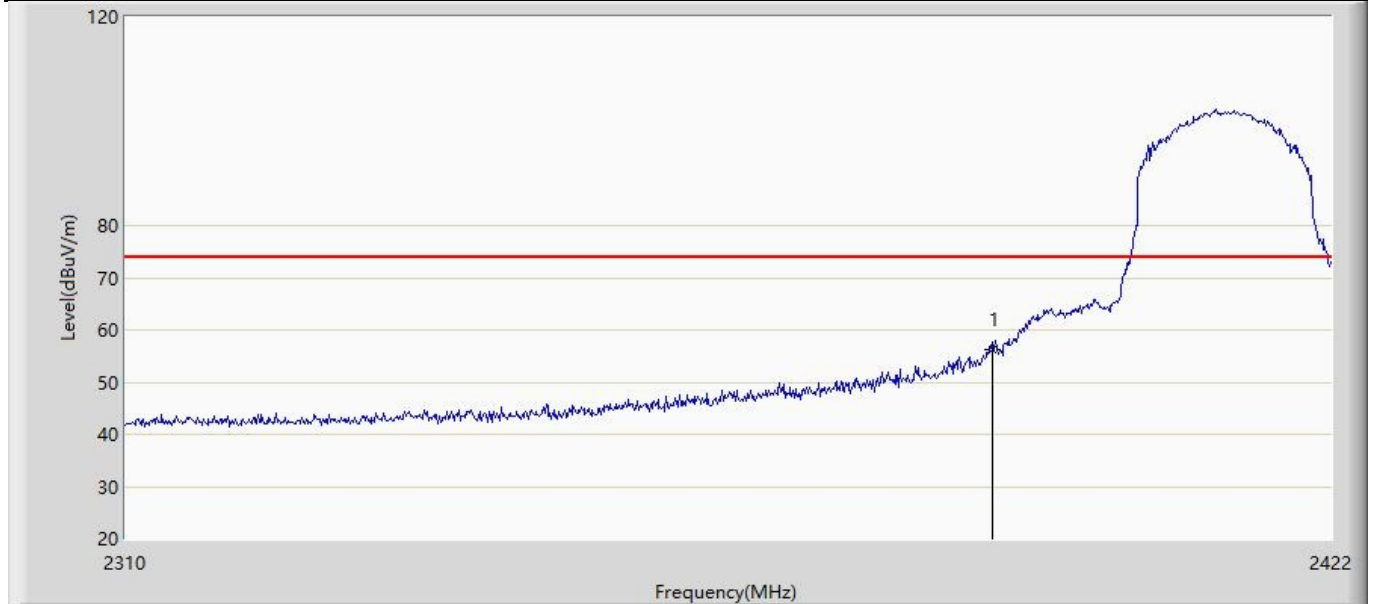

No	Mark	Frequency (MHz)	Measure Level (dBuV/m)	Reading Level (dBuV)	Over Limit (dB)	Limit (dBuV/m)	Factor (dB)	Type
1	*	2390.000	56.200	25.058	-17.800	74.000	31.141	PK

Profile: 2250816R	Page No.: 3
Engineer: Yu Liu	
Site: AC5	Time: 2022/06/23 - 07:41
Limit: FCC_Part15.209_RE(3m)	Margin: 0
Probe: HORN_3117_00167055(1-18GHZ)	Polarity: Vertical
EUT: Touch All In One Computer	Power: AC 120V/60Hz
Note: Mode 1:Transmit at 2412MHz by 11b	

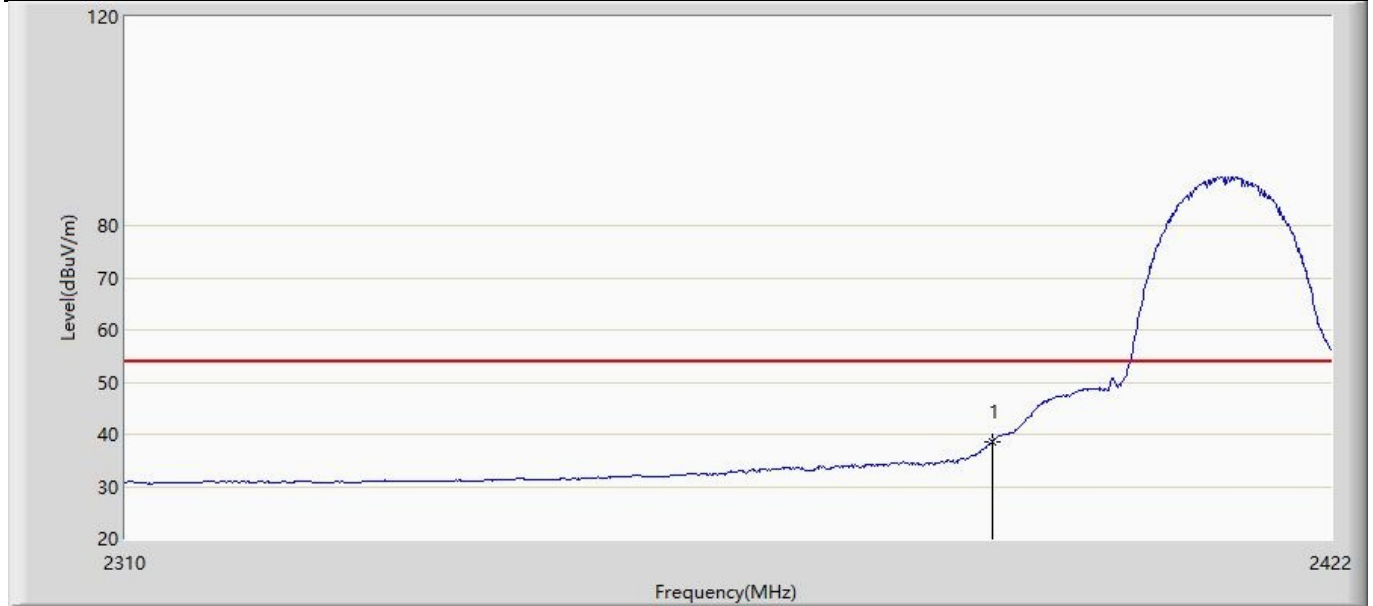

No	Mark	Frequency (MHz)	Measure Level (dBuV/m)	Reading Level (dBuV)	Over Limit (dB)	Limit (dBuV/m)	Factor (dB)	Type
1	*	2390.000	38.691	7.549	-15.309	54.000	31.141	AV

Profile: 2250816R	Page No.: 4
Engineer: Yu Liu	
Site: AC5	Time: 2022/06/23 - 07:42
Limit: FCC_Part15.209_RE(3m)	Margin: 0
Probe: HORN_3117_00167055(1-18GHZ)	Polarity: Vertical
EUT: Touch All In One Computer	Power: AC 120V/60Hz
Note: Mode 1:Transmit at 2402MHz by 11b	

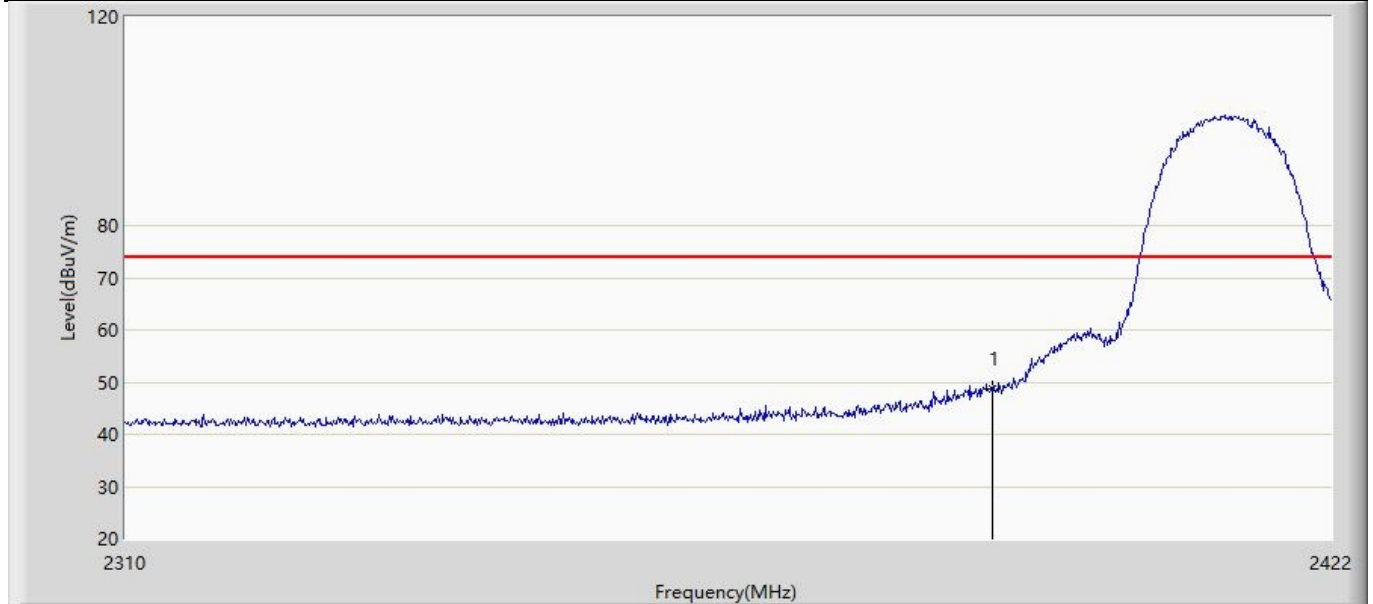

No	Mark	Frequency (MHz)	Measure Level (dBuV/m)	Reading Level (dBuV)	Over Limit (dB)	Limit (dBuV/m)	Factor (dB)	Type
1	*	2390.000	48.650	17.508	-25.350	74.000	31.141	PK

Profile: 2250816R	Page No.: 5
Engineer: Yu Liu	
Site: AC5	Time: 2022/06/23 - 07:44
Limit: FCC_Part15.209_RE(3m)	Margin: 0
Probe: HORN_3117_00167055(1-18GHZ)	Polarity: Horizontal
EUT: Touch All In One Computer	Power: AC 120V/60Hz
Note: Mode 1:Transmit at 2462MHz by 11b	

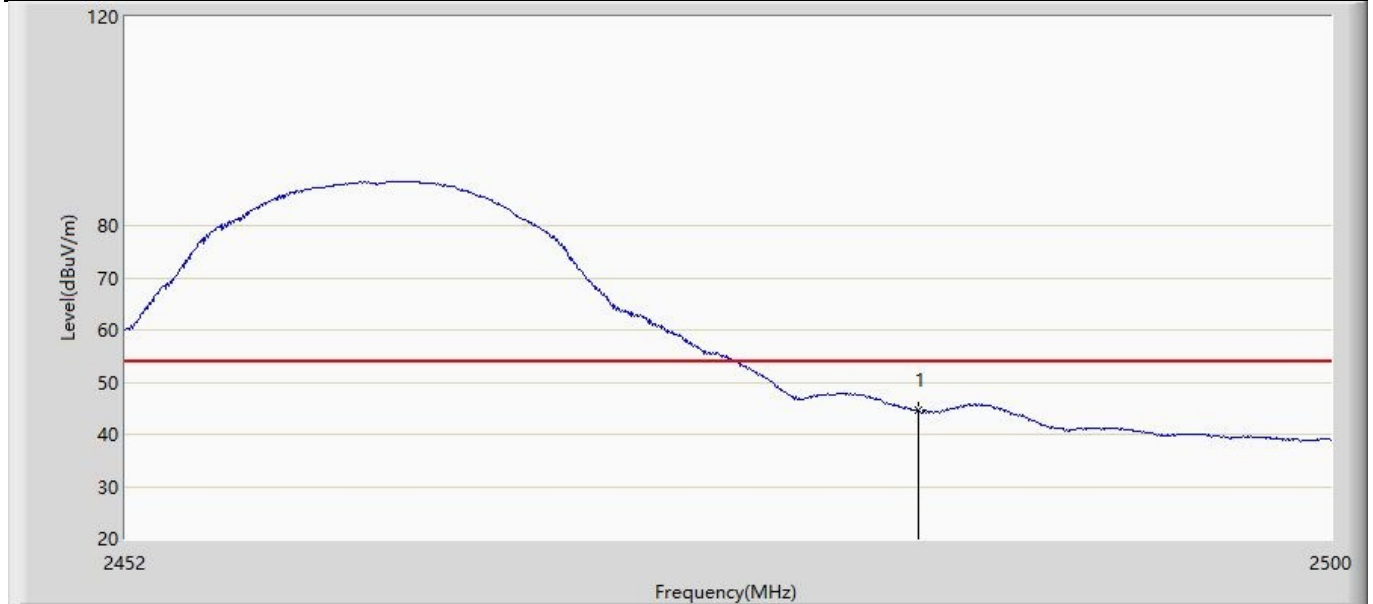

No	Mark	Frequency (MHz)	Measure Level (dBuV/m)	Reading Level (dBuV)	Over Limit (dB)	Limit (dBuV/m)	Factor (dB)	Type
1	*	2483.500	44.558	13.132	-9.442	54.000	31.426	AV

Profile: 2250816R	Page No.: 6
Engineer: Yu Liu	
Site: AC5	Time: 2022/06/23 - 07:49
Limit: FCC_Part15.209_RE(3m)	Margin: 0
Probe: HORN_3117_00167055(1-18GHZ)	Polarity: Horizontal
EUT: Touch All In One Computer	Power: AC 120V/60Hz
Note: Mode 1:Transmit at 2462MHz by 11b	

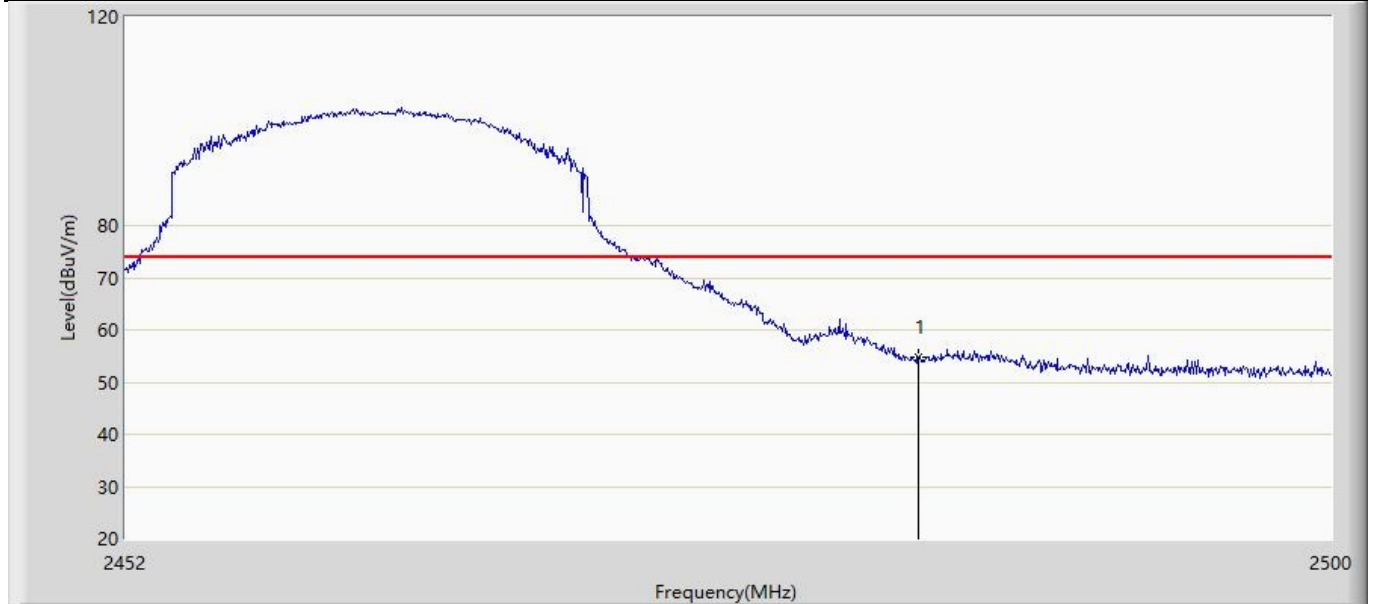

No	Mark	Frequency (MHz)	Measure Level (dBuV/m)	Reading Level (dBuV)	Over Limit (dB)	Limit (dBuV/m)	Factor (dB)	Type
1	*	2483.500	54.670	23.244	-19.330	74.000	31.426	PK

Profile: 2250816R	Page No.: 7
Engineer: Yu Liu	
Site: AC5	Time: 2022/06/23 - 07:52
Limit: FCC_Part15.209_RE(3m)	Margin: 0
Probe: HORN_3117_00167055(1-18GHZ)	Polarity: Vertical
EUT: Touch All In One Computer	Power: AC 120V/60Hz
Note: Mode 1:Transmit at 2462MHz by 11b	

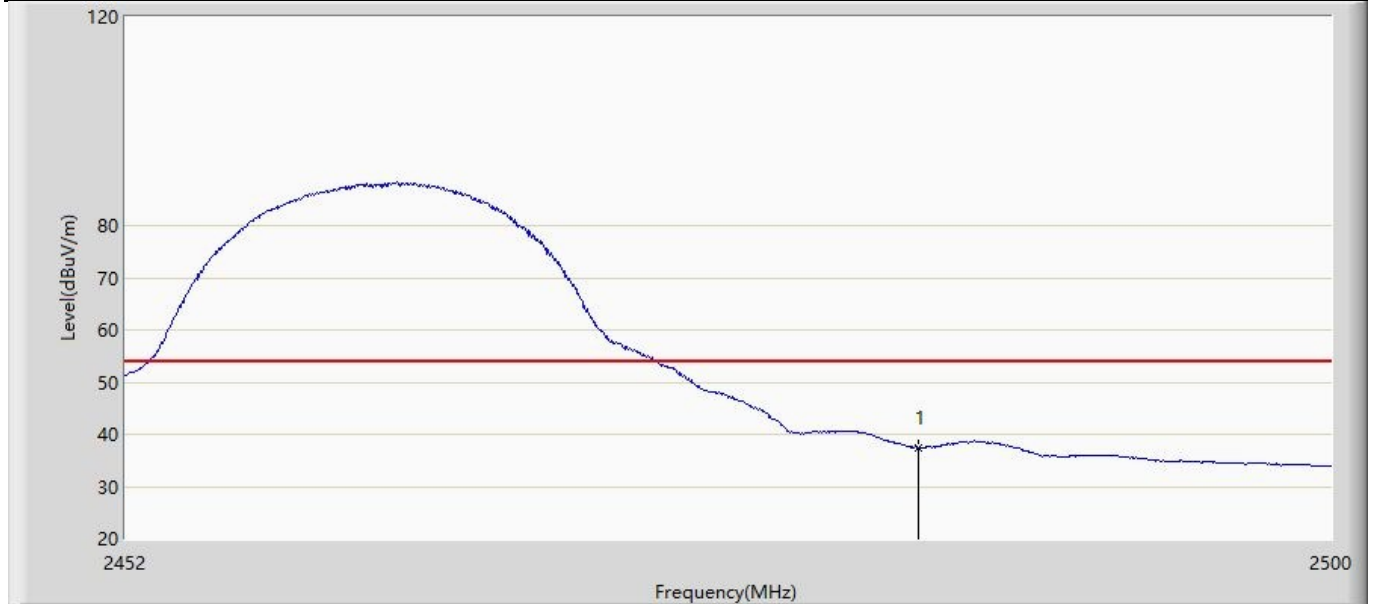

No	Mark	Frequency (MHz)	Measure Level (dBuV/m)	Reading Level (dBuV)	Over Limit (dB)	Limit (dBuV/m)	Factor (dB)	Type
1	*	2483.500	37.340	5.914	-16.660	54.000	31.426	AV

Profile: 2250816R	Page No.: 8
Engineer: Yu Liu	
Site: AC5	Time: 2022/06/23 - 07:53
Limit: FCC_Part15.209_RE(3m)	Margin: 0
Probe: HORN_3117_00167055(1-18GHZ)	Polarity: Vertical
EUT: Touch All In One Computer	Power: AC 120V/60Hz
Note: Mode 1:Transmit at 2462MHz by 11b	

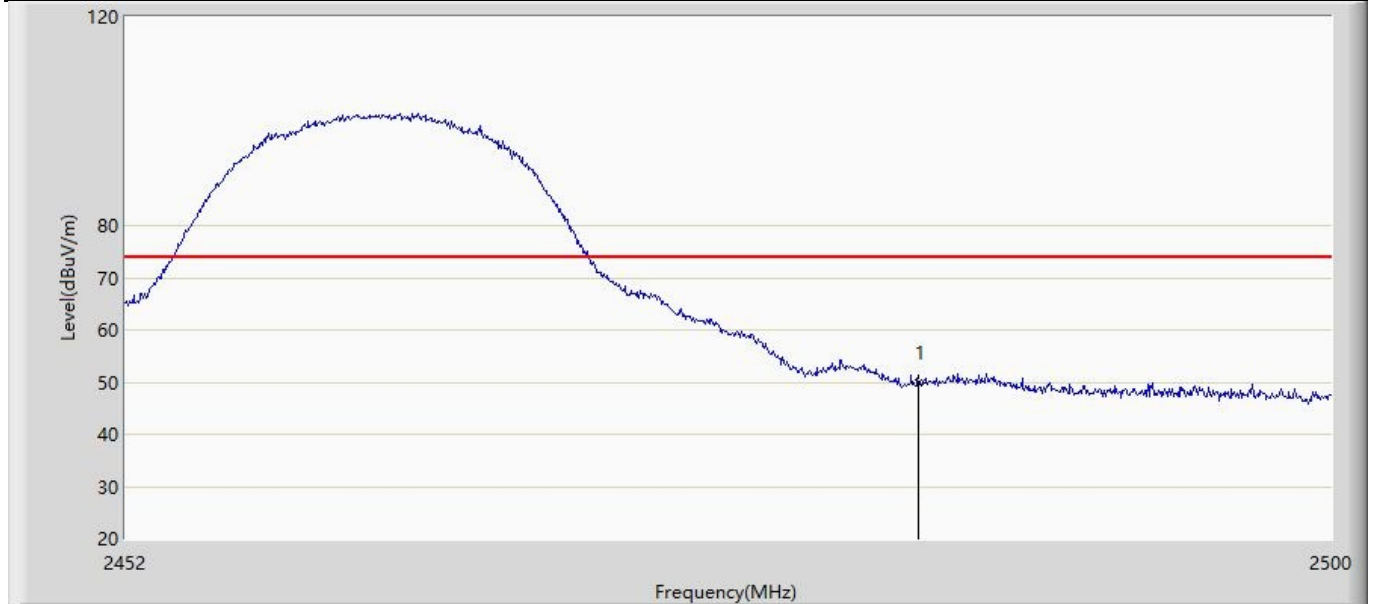

No	Mark	Frequency (MHz)	Measure Level (dBuV/m)	Reading Level (dBuV)	Over Limit (dB)	Limit (dBuV/m)	Factor (dB)	Type
1	*	2483.500	49.962	18.536	-24.038	74.000	31.426	PK

Profile: 2250816R	Page No.: 9
Engineer: Yu Liu	
Site: AC5	Time: 2022/06/23 - 07:55
Limit: FCC_Part15.209_RE(3m)	Margin: 0
Probe: HORN_3117_00167055(1-18GHZ)	Polarity: Horizontal
EUT: Touch All In One Computer	Power: AC 120V/60Hz
Note: Mode 2:Transmit at 2412MHz by 11g	

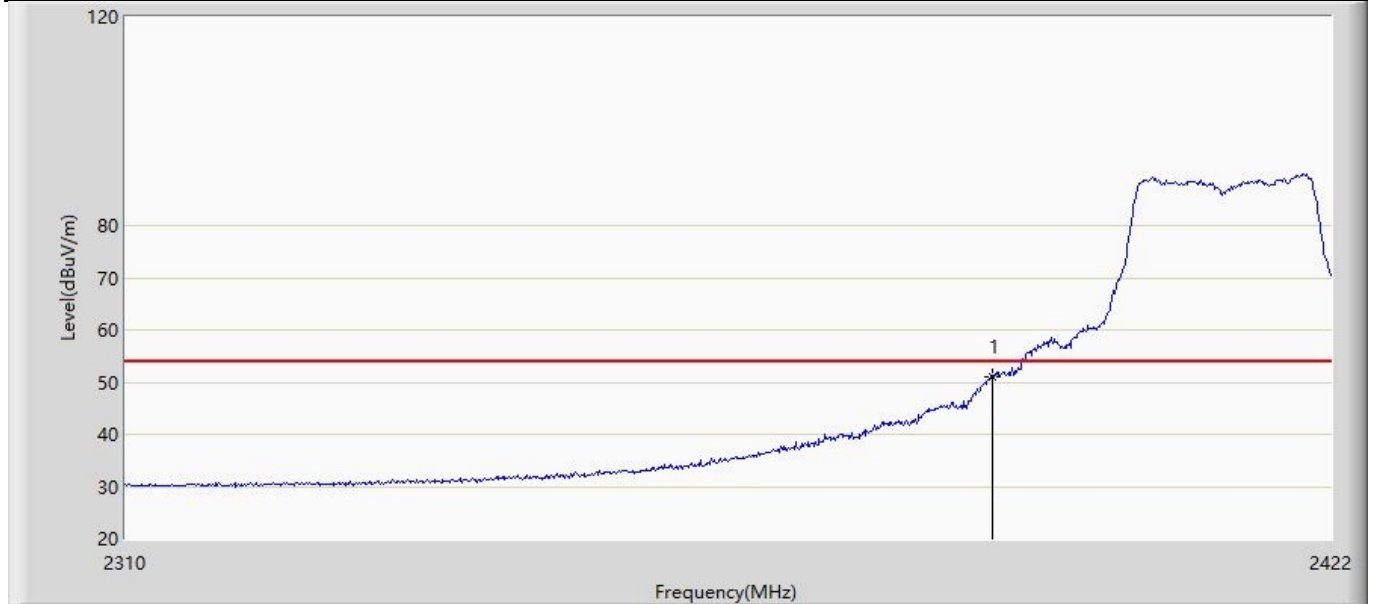

No	Mark	Frequency (MHz)	Measure Level (dBuV/m)	Reading Level (dBuV)	Over Limit (dB)	Limit (dBuV/m)	Factor (dB)	Type
1	*	2390.000	51.070	19.928	-2.930	54.000	31.141	AV

Profile: 2250816R	Page No.: 10
Engineer: Yu Liu	
Site: AC5	Time: 2022/06/23 - 07:57
Limit: FCC_Part15.209_RE(3m)	Margin: 0
Probe: HORN_3117_00167055(1-18GHZ)	Polarity: Horizontal
EUT: Touch All In One Computer	Power: AC 120V/60Hz
Note: Mode 2:Transmit at 2402MHz by 11g	

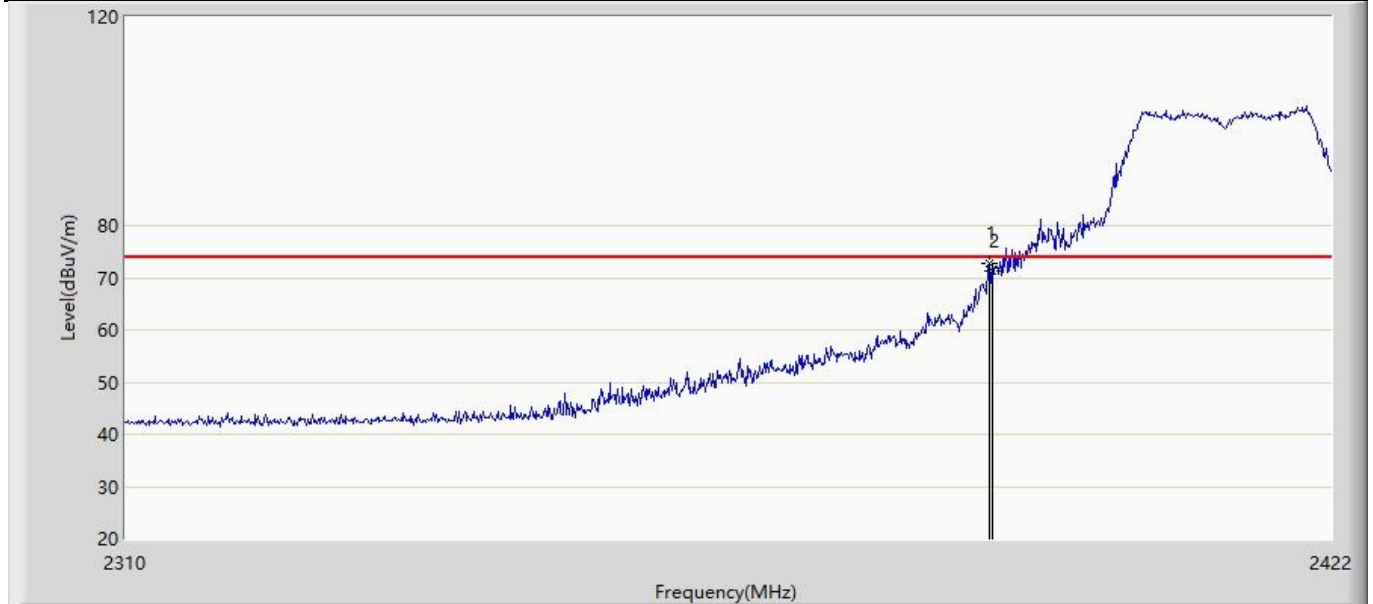

No	Mark	Frequency (MHz)	Measure Level (dBuV/m)	Reading Level (dBuV)	Over Limit (dB)	Limit (dBuV/m)	Factor (dB)	Type
1	*	2389.744	72.898	41.757	-1.102	74.000	31.140	PK
2		2390.000	71.213	40.071	-2.787	74.000	31.141	PK

Profile: 2250816R	Page No.: 11
Engineer: Yu Liu	
Site: AC5	Time: 2022/06/23 - 07:58
Limit: FCC_Part15.209_RE(3m)	Margin: 0
Probe: HORN_3117_00167055(1-18GHZ)	Polarity: Vertical
EUT: Touch All In One Computer	Power: AC 120V/60Hz
Note: Mode 2:Transmit at 2402MHz by 11g	

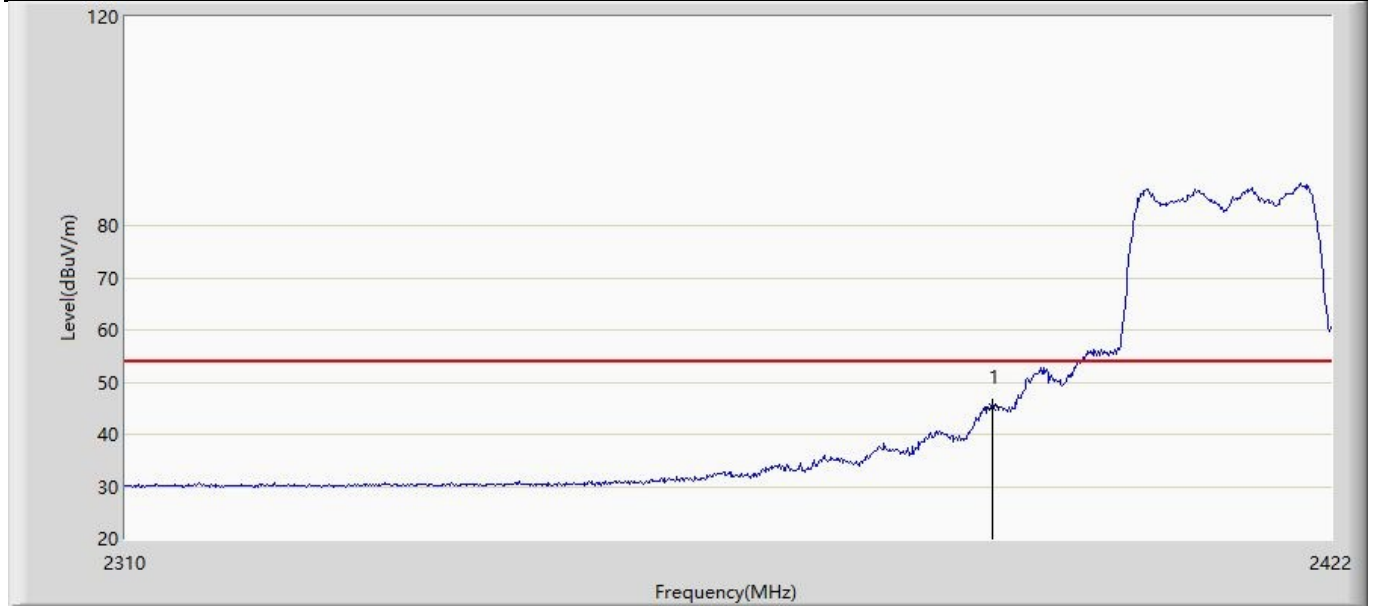

No	Mark	Frequency (MHz)	Measure Level (dBuV/m)	Reading Level (dBuV)	Over Limit (dB)	Limit (dBuV/m)	Factor (dB)	Type
1	*	2390.000	45.290	14.148	-8.710	54.000	31.141	AV

Profile: 2250816R	Page No.: 12
Engineer: Yu Liu	
Site: AC5	Time: 2022/06/23 - 08:00
Limit: FCC_Part15.209_RE(3m)	Margin: 0
Probe: HORN_3117_00167055(1-18GHZ)	Polarity: Vertical
EUT: Touch All In One Computer	Power: AC 120V/60Hz
Note: Mode 2:Transmit at 2402MHz by 11g	



No	Mark	Frequency (MHz)	Measure Level (dBuV/m)	Reading Level (dBuV)	Over Limit (dB)	Limit (dBuV/m)	Factor (dB)	Type
1	*	2390.000	62.501	31.359	-11.499	74.000	31.141	PK

Profile: 2250816R	Page No.: 13
Engineer: Yu Liu	
Site: AC5	Time: 2022/06/23 - 08:02
Limit: FCC_Part15.209_RE(3m)	Margin: 0
Probe: HORN_3117_00167055(1-18GHZ)	Polarity: Horizontal
EUT: Touch All In One Computer	Power: AC 120V/60Hz
Note: Mode 2:Transmit at 2462MHz by 11g	

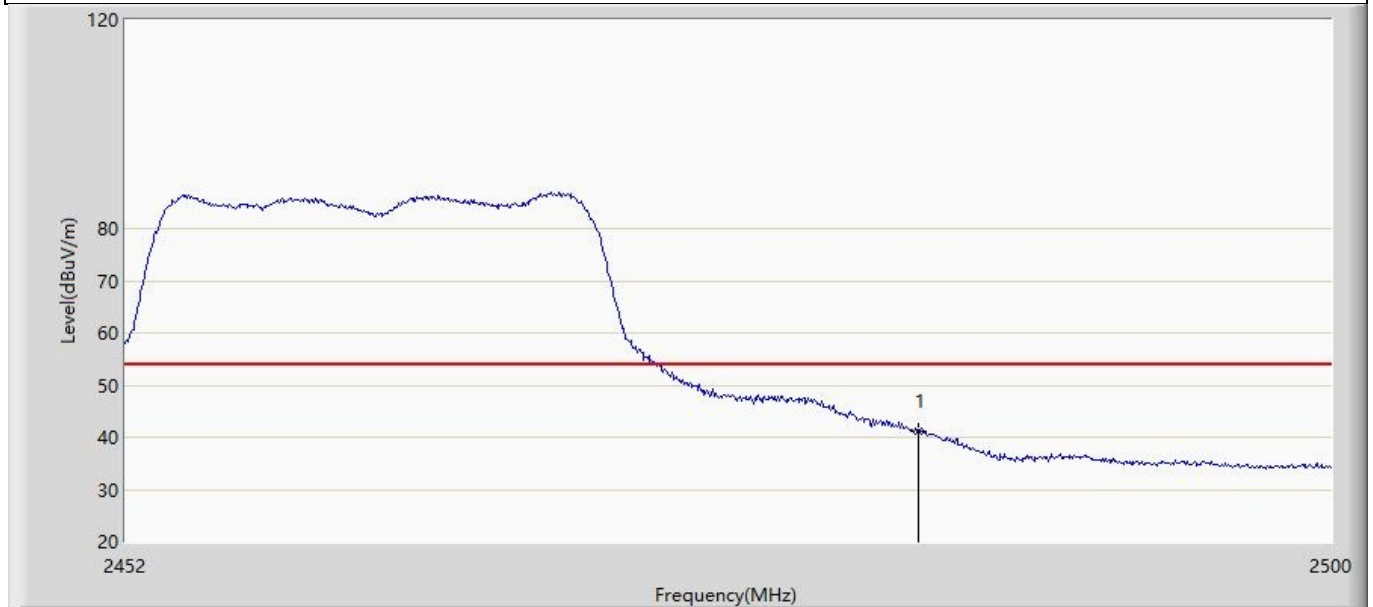

No	Mark	Frequency (MHz)	Measure Level (dBuV/m)	Reading Level (dBuV)	Over Limit (dB)	Limit (dBuV/m)	Factor (dB)	Type
1	*	2483.500	41.284	9.858	-12.716	54.000	31.426	AV

Profile: 2250816R	Page No.: 14
Engineer: Yu Liu	
Site: AC5	Time: 2022/06/23 - 08:03
Limit: FCC_Part15.209_RE(3m)	Margin: 0
Probe: HORN_3117_00167055(1-18GHZ)	Polarity: Horizontal
EUT: Touch All In One Computer	Power: AC 120V/60Hz
Note: Mode 2:Transmit at 2462MHz by 11g	

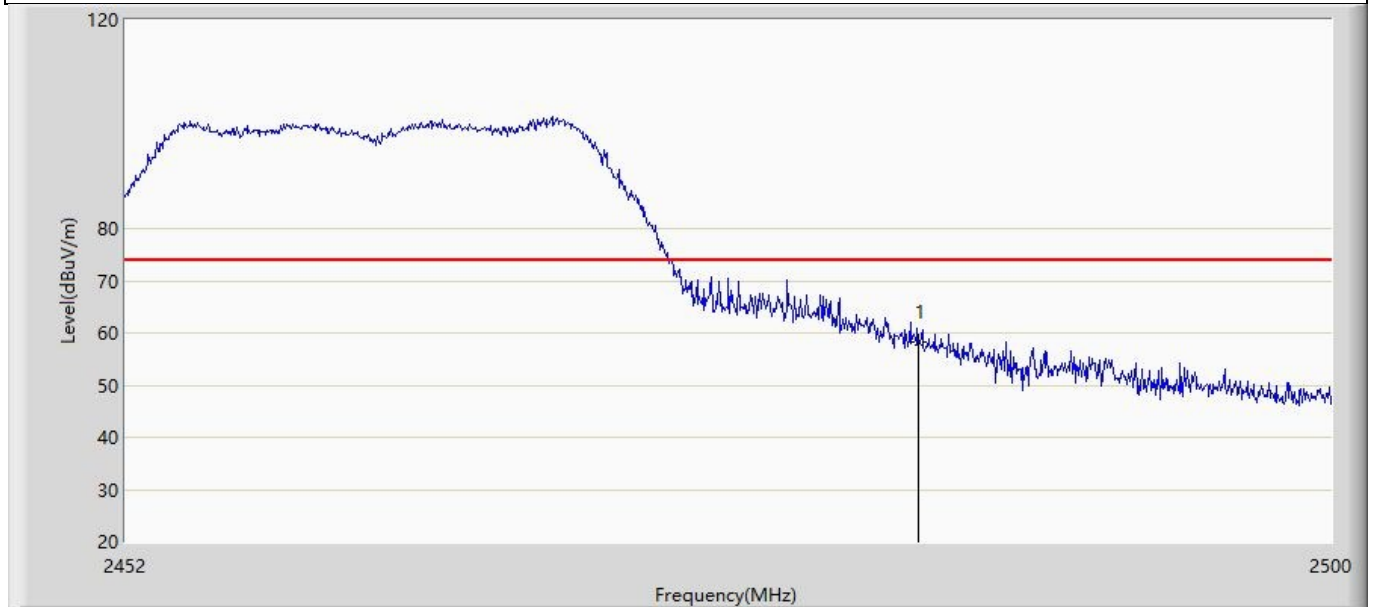

No	Mark	Frequency (MHz)	Measure Level (dBuV/m)	Reading Level (dBuV)	Over Limit (dB)	Limit (dBuV/m)	Factor (dB)	Type
1	*	2483.500	58.128	26.702	-15.872	74.000	31.426	PK

Profile: 2250816R	Page No.: 15
Engineer: Yu Liu	
Site: AC5	Time: 2022/06/23 - 08:05
Limit: FCC_Part15.209_RE(3m)	Margin: 0
Probe: HORN_3117_00167055(1-18GHZ)	Polarity: Vertical
EUT: Touch All In One Computer	Power: AC 120V/60Hz
Note: Mode 2:Transmit at 2462MHz by 11g	

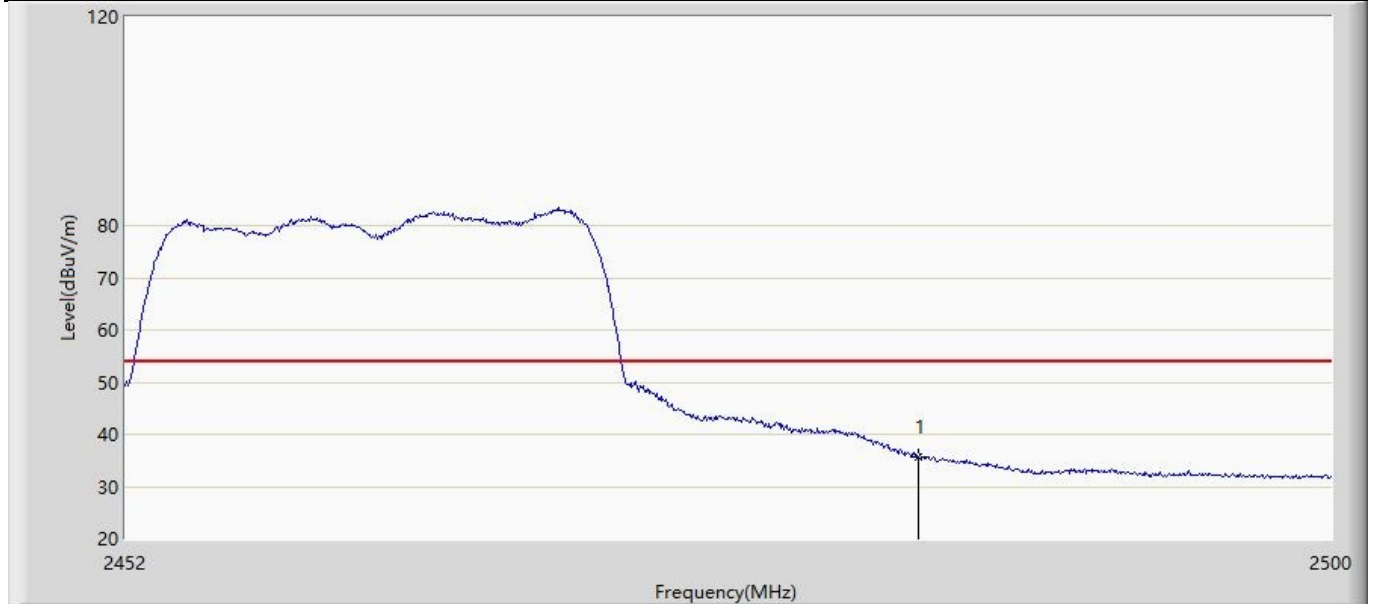

No	Mark	Frequency (MHz)	Measure Level (dBuV/m)	Reading Level (dBuV)	Over Limit (dB)	Limit (dBuV/m)	Factor (dB)	Type
1	*	2483.500	35.675	4.249	-18.325	54.000	31.426	AV

Profile: 2250816R	Page No.: 16
Engineer: Yu Liu	
Site: AC5	Time: 2022/06/23 - 08:06
Limit: FCC_Part15.209_RE(3m)	Margin: 0
Probe: HORN_3117_00167055(1-18GHZ)	Polarity: Vertical
EUT: Touch All In One Computer	Power: AC 120V/60Hz
Note: Mode 2:Transmit at 2462MHz by 11g	

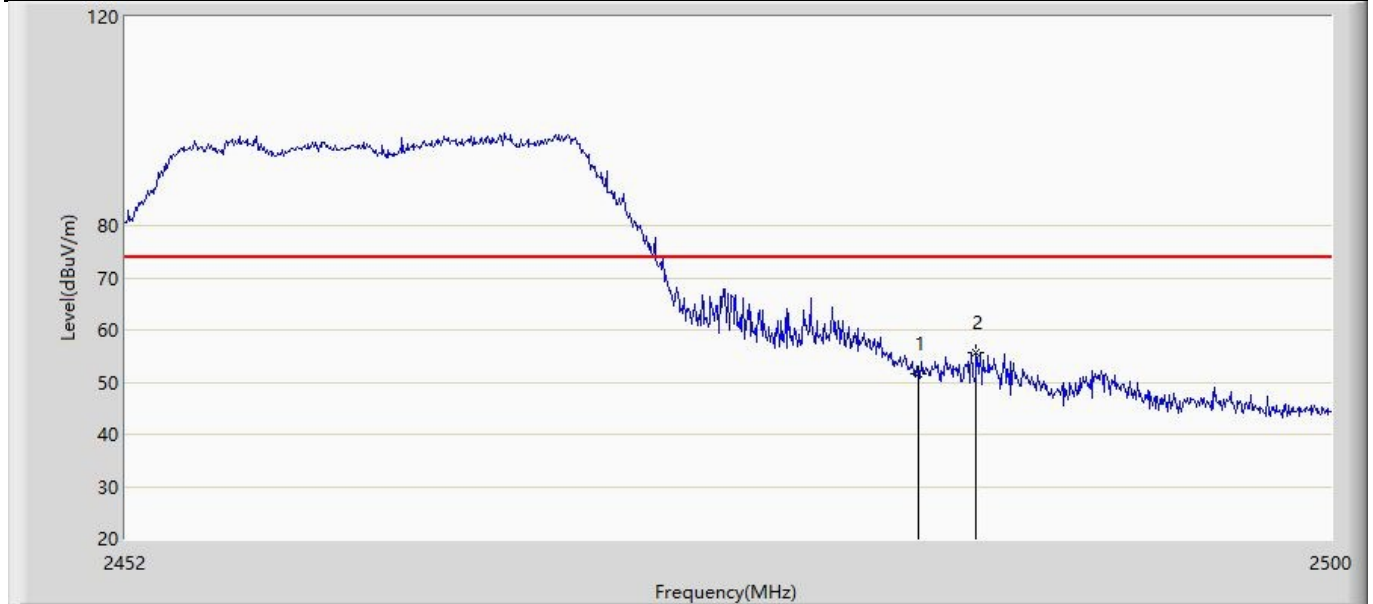

No	Mark	Frequency (MHz)	Measure Level (dBuV/m)	Reading Level (dBuV)	Over Limit (dB)	Limit (dBuV/m)	Factor (dB)	Type
1		2483.500	51.566	20.140	-22.434	74.000	31.426	PK
2	*	2485.792	55.581	24.148	-18.419	74.000	31.433	PK

Profile: 2250816R	Page No.: 17
Engineer: Yu Liu	
Site: AC5	Time: 2022/06/23 - 08:07
Limit: FCC_Part15.209_RE(3m)	Margin: 0
Probe: HORN_3117_00167055(1-18GHZ)	Polarity: Horizontal
EUT: Touch All In One Computer	Power: AC 120V/60Hz
Note: Mode 3:Transmit at 2412MHz by 11n20	

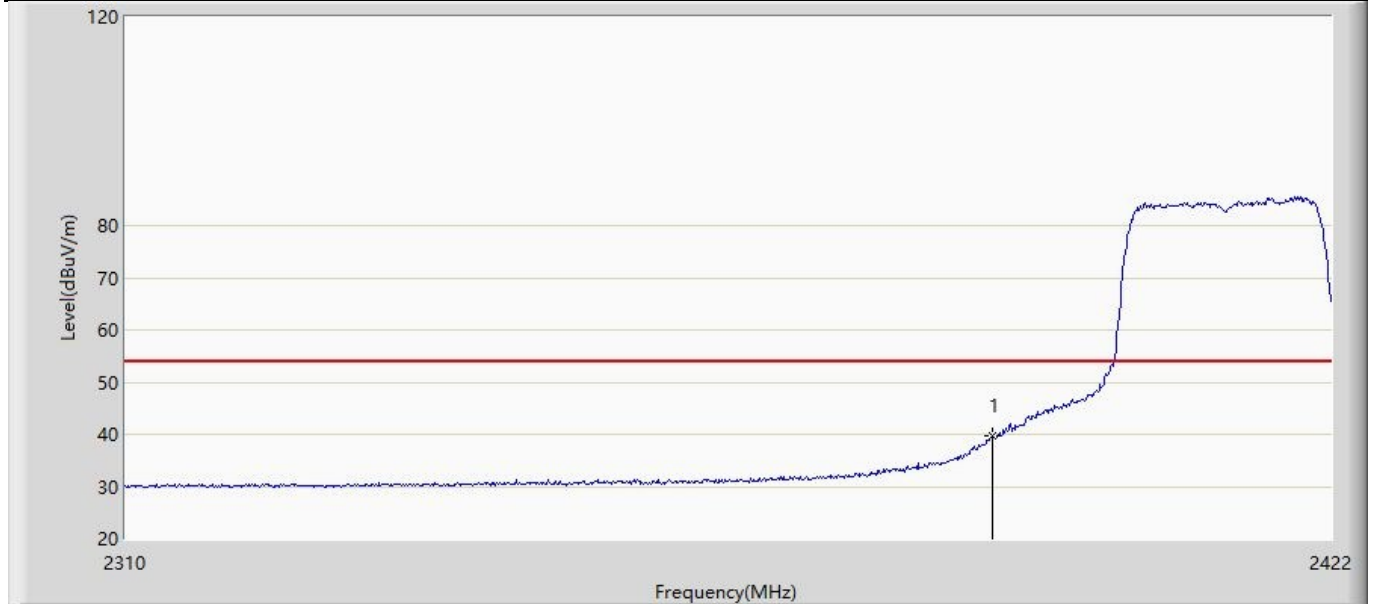

No	Mark	Frequency (MHz)	Measure Level (dBuV/m)	Reading Level (dBuV)	Over Limit (dB)	Limit (dBuV/m)	Factor (dB)	Type
1	*	2390.000	39.613	8.471	-14.387	54.000	31.141	AV

Profile: 2250816R	Page No.: 18
Engineer: Yu Liu	
Site: AC5	Time: 2022/06/23 - 08:09
Limit: FCC_Part15.209_RE(3m)	Margin: 0
Probe: HORN_3117_00167055(1-18GHZ)	Polarity: Horizontal
EUT: Touch All In One Computer	Power: AC 120V/60Hz
Note: Mode 3:Transmit at 2412MHz by 11n20	

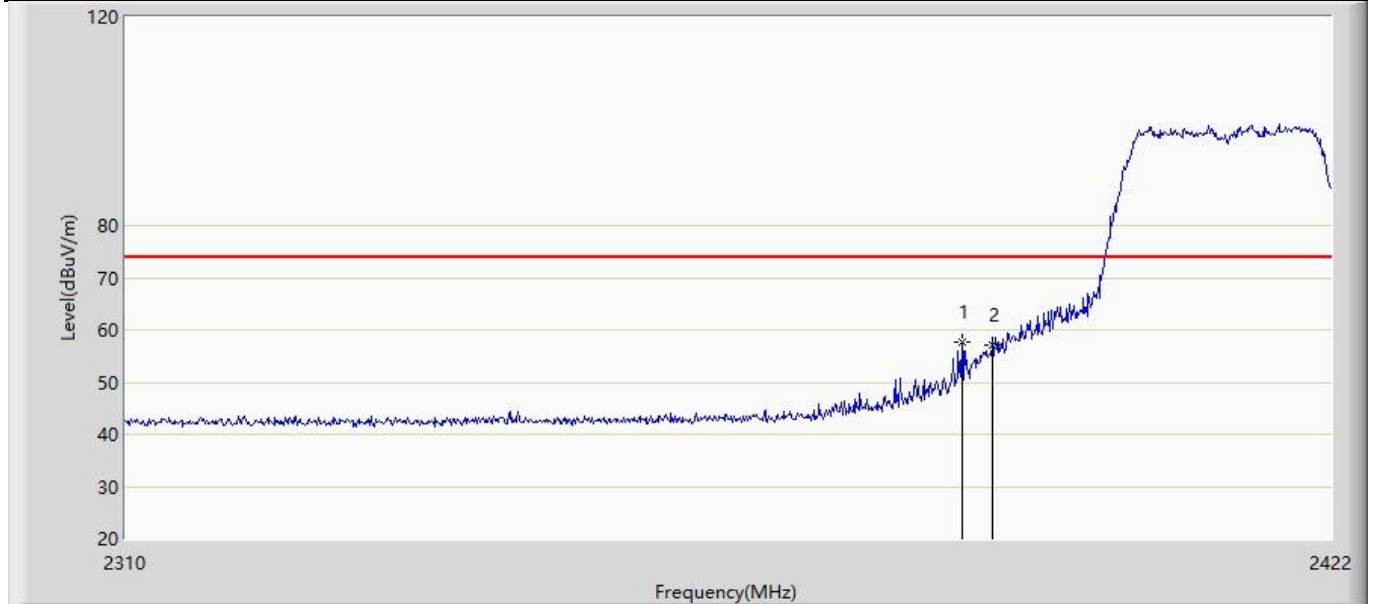

No	Mark	Frequency (MHz)	Measure Level (dBuV/m)	Reading Level (dBuV)	Over Limit (dB)	Limit (dBuV/m)	Factor (dB)	Type
1	*	2387.168	57.823	26.691	-16.177	74.000	31.132	PK
2		2390.000	57.164	26.022	-16.836	74.000	31.141	PK

Profile: 2250816R	Page No.: 19
Engineer: Yu Liu	
Site: AC5	Time: 2022/06/23 - 08:11
Limit: FCC_Part15.209_RE(3m)	Margin: 0
Probe: HORN_3117_00167055(1-18GHZ)	Polarity: Vertical
EUT: Touch All In One Computer	Power: AC 120V/60Hz
Note: Mode 3:Transmit at 2412MHz by 11n20	

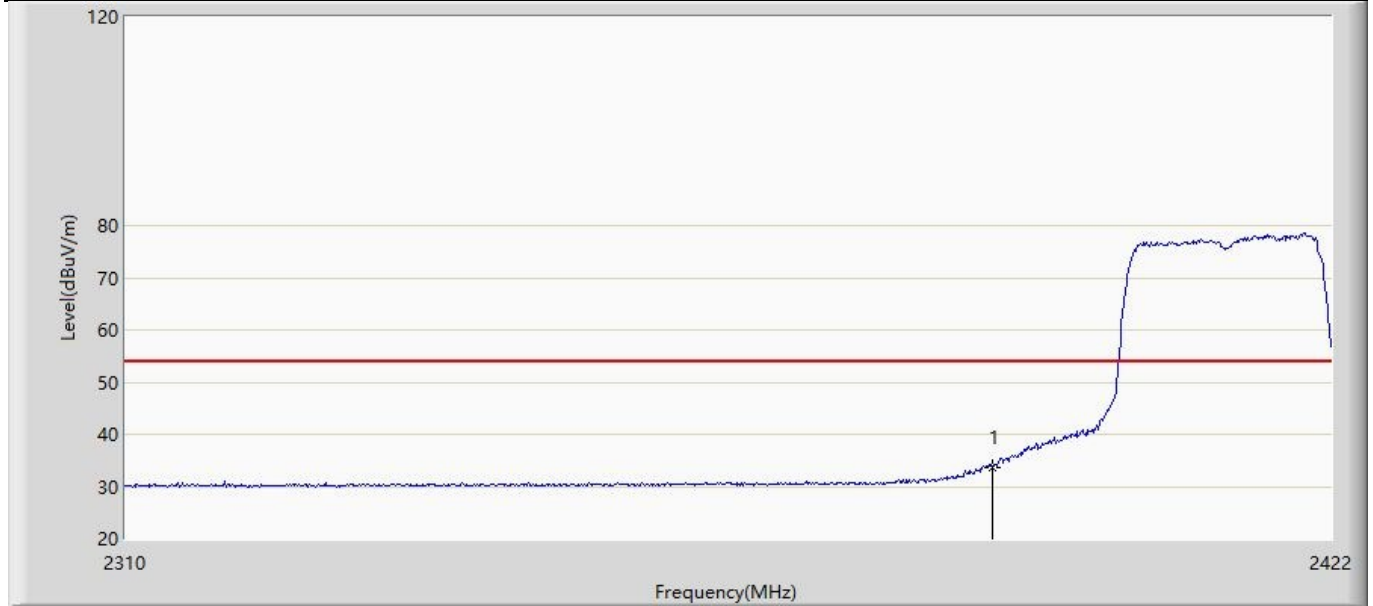

No	Mark	Frequency (MHz)	Measure Level (dBuV/m)	Reading Level (dBuV)	Over Limit (dB)	Limit (dBuV/m)	Factor (dB)	Type
1	*	2390.000	33.676	2.534	-20.324	54.000	31.141	AV

Profile: 2250816R	Page No.: 20
Engineer: Yu Liu	
Site: AC5	Time: 2022/06/23 - 08:12
Limit: FCC_Part15.209_RE(3m)	Margin: 0
Probe: HORN_3117_00167055(1-18GHZ)	Polarity: Vertical
EUT: Touch All In One Computer	Power: AC 120V/60Hz
Note: Mode 3:Transmit at 2412MHz by 11n20	

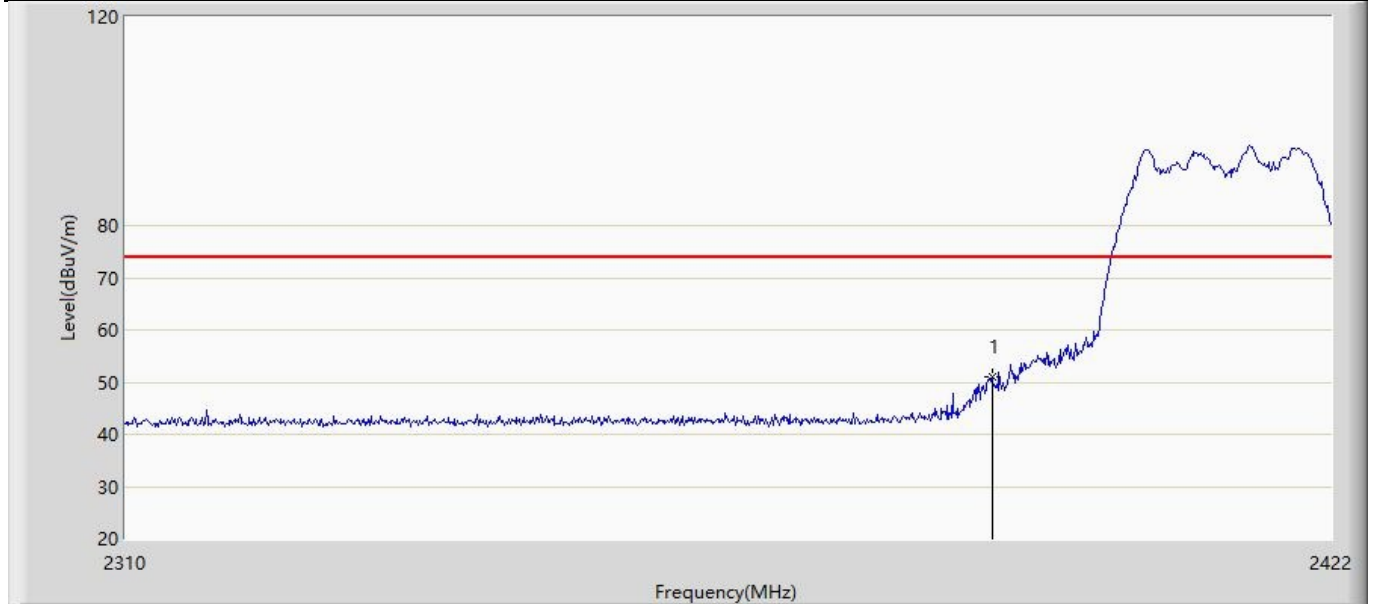

No	Mark	Frequency (MHz)	Measure Level (dBuV/m)	Reading Level (dBuV)	Over Limit (dB)	Limit (dBuV/m)	Factor (dB)	Type
1	*	2390.000	50.939	19.797	-23.061	74.000	31.141	PK

Profile: 2250816R	Page No.: 21
Engineer: Yu Liu	
Site: AC5	Time: 2022/06/23 - 08:13
Limit: FCC_Part15.209_RE(3m)	Margin: 0
Probe: HORN_3117_00167055(1-18GHZ)	Polarity: Horizontal
EUT: Touch All In One Computer	Power: AC 120V/60Hz
Note: Mode 3:Transmit at 2462MHz by 11n20	

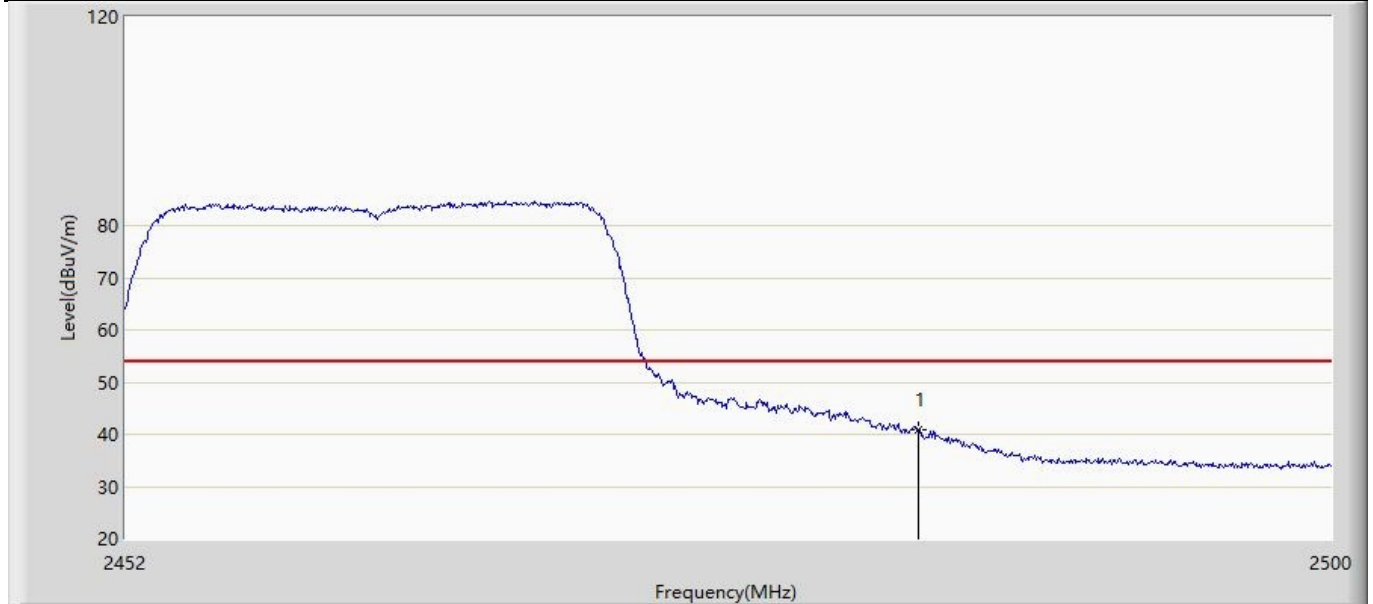

No	Mark	Frequency (MHz)	Measure Level (dBuV/m)	Reading Level (dBuV)	Over Limit (dB)	Limit (dBuV/m)	Factor (dB)	Type
1	*	2483.500	40.858	9.432	-13.142	54.000	31.426	AV

Profile: 2250816R	Page No.: 22
Engineer: Yu Liu	
Site: AC5	Time: 2022/06/23 - 08:15
Limit: FCC_Part15.209_RE(3m)	Margin: 0
Probe: HORN_3117_00167055(1-18GHZ)	Polarity: Horizontal
EUT: Touch All In One Computer	Power: AC 120V/60Hz
Note: Mode 3:Transmit at 2462MHz by 11n20	

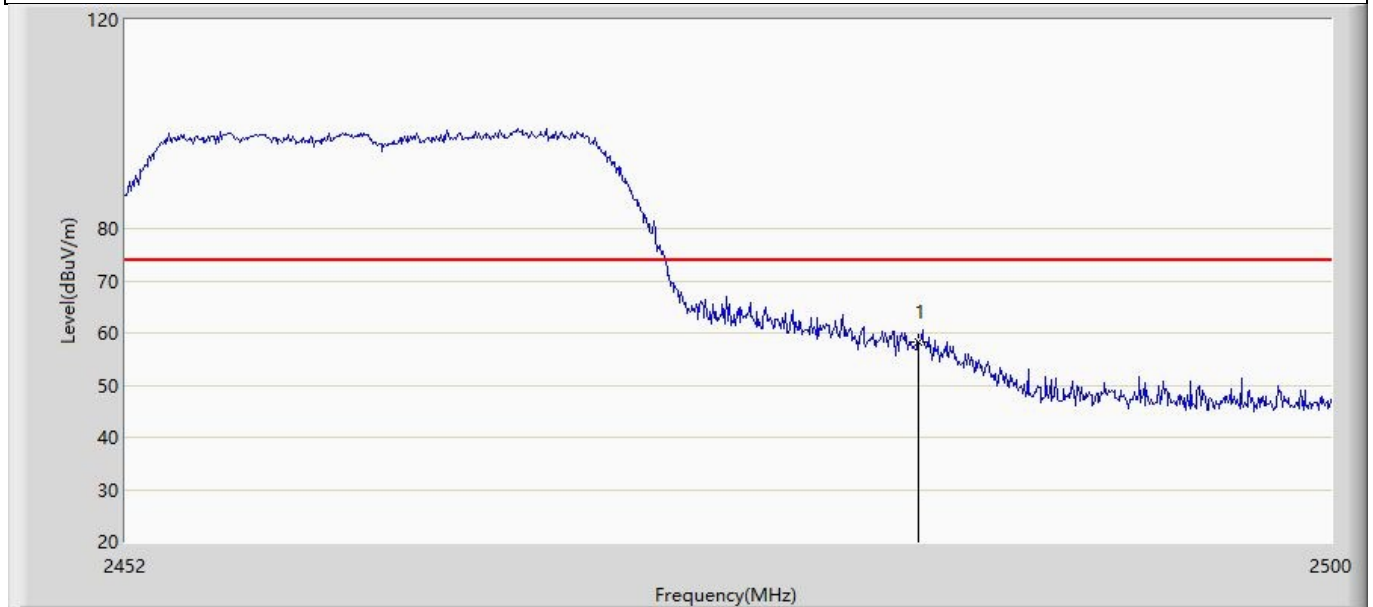

No	Mark	Frequency (MHz)	Measure Level (dBuV/m)	Reading Level (dBuV)	Over Limit (dB)	Limit (dBuV/m)	Factor (dB)	Type
1	*	2483.500	58.315	26.889	-15.685	74.000	31.426	PK

Profile: 2250816R	Page No.: 23
Engineer: Yu Liu	
Site: AC5	Time: 2022/06/23 - 08:18
Limit: FCC_Part15.209_RE(3m)	Margin: 0
Probe: HORN_3117_00167055(1-18GHZ)	Polarity: Vertical
EUT: Touch All In One Computer	Power: AC 120V/60Hz
Note: Mode 3:Transmit at 2462MHz by 11n20	

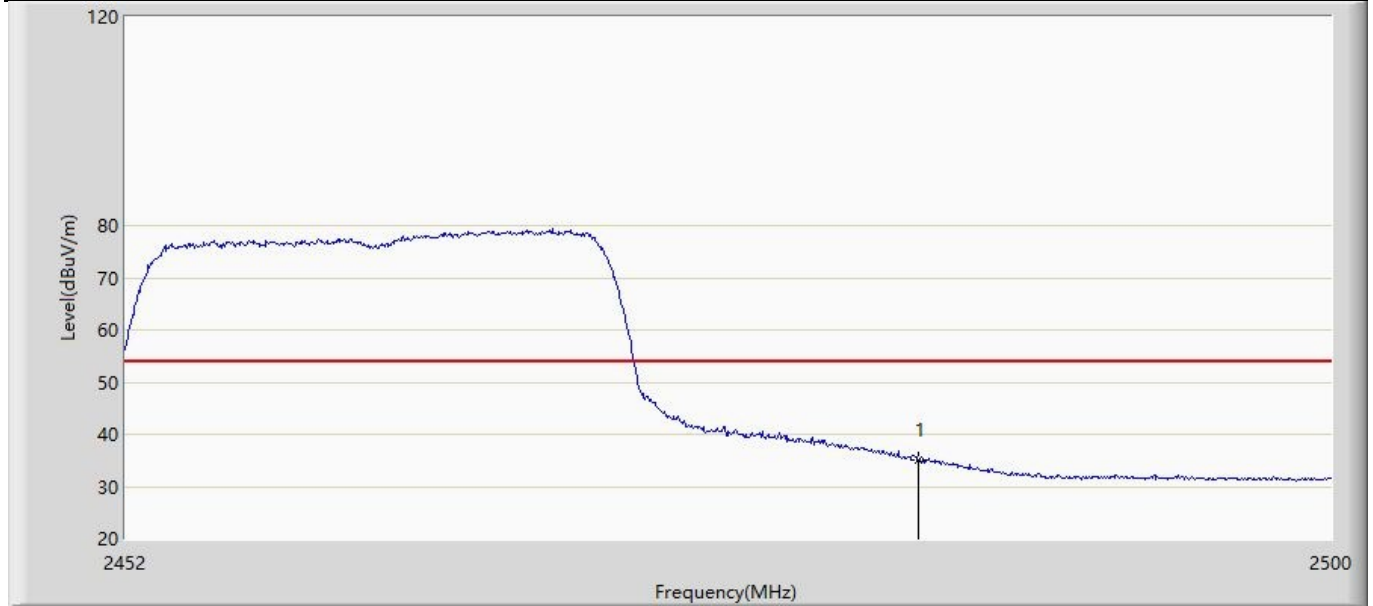

No	Mark	Frequency (MHz)	Measure Level (dBuV/m)	Reading Level (dBuV)	Over Limit (dB)	Limit (dBuV/m)	Factor (dB)	Type
1	*	2483.500	35.009	3.583	-18.991	54.000	31.426	AV

Profile: 2250816R	Page No.: 24
Engineer: Yu Liu	
Site: AC5	Time: 2022/06/23 - 08:19
Limit: FCC_Part15.209_RE(3m)	Margin: 0
Probe: HORN_3117_00167055(1-18GHZ)	Polarity: Vertical
EUT: Touch All In One Computer	Power: AC 120V/60Hz
Note: Mode 3:Transmit at 2462MHz by 11n20	

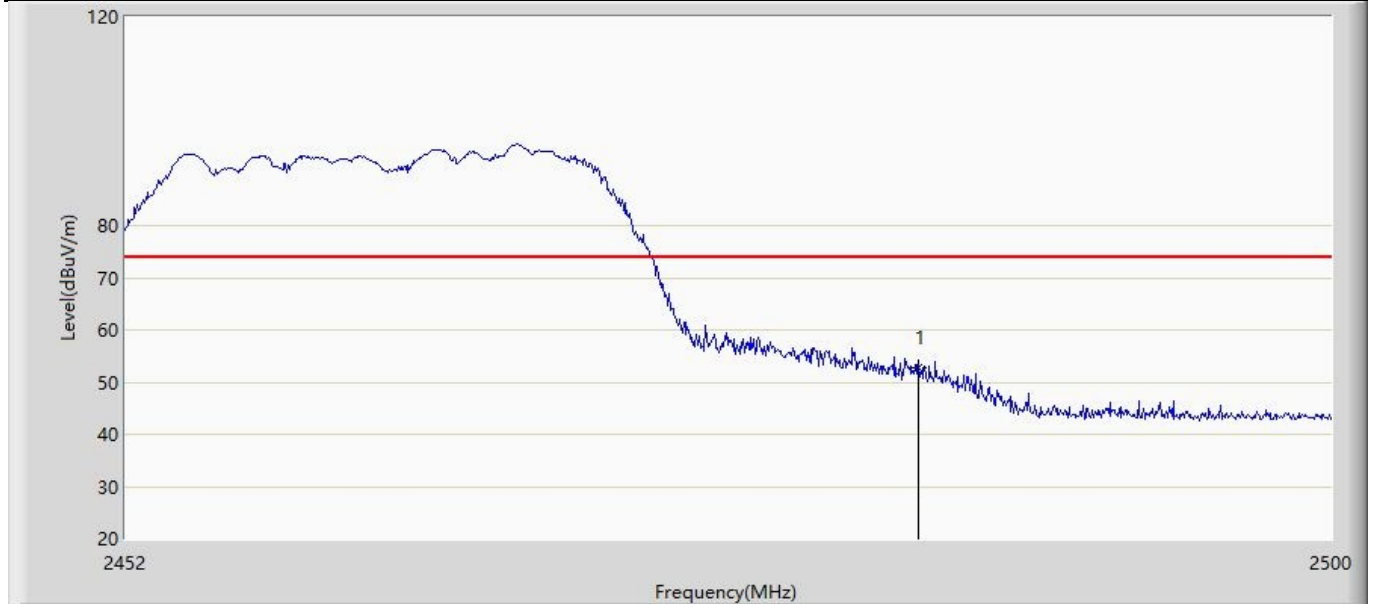

No	Mark	Frequency (MHz)	Measure Level (dBuV/m)	Reading Level (dBuV)	Over Limit (dB)	Limit (dBuV/m)	Factor (dB)	Type
1	*	2483.500	52.832	21.406	-21.168	74.000	31.426	PK

SISO Antenna2 :

Profile: 2250816R	Page No.: 1
Engineer: Yu Liu	
Site: AC5	Time: 2022/06/23 - 00:39
Limit: FCC_Part15.209_RE(3m)	Margin: 0
Probe: HORN_3117_00167055(1-18GHZ)	Polarity: Horizontal
EUT: Touch All In One Computer	Power: AC 120V/60Hz
Note: Mode 1:Transmit at 2412MHz by 11b	

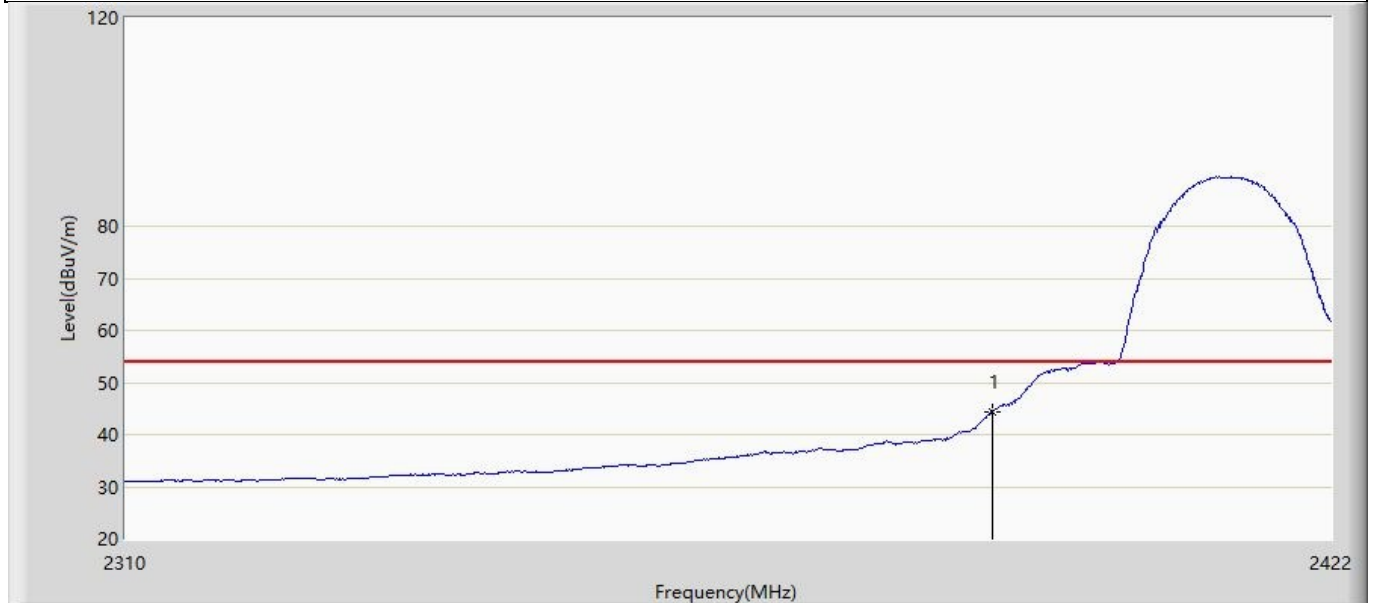

No	Mark	Frequency (MHz)	Measure Level (dBuV/m)	Reading Level (dBuV)	Over Limit (dB)	Limit (dBuV/m)	Factor (dB)	Type
1	*	2390.000	44.345	13.203	-9.655	54.000	31.141	AV

Profile: 2250816R	Page No.: 2
Engineer: Yu Liu	
Site: AC5	Time: 2022/06/23 - 07:40
Limit: FCC_Part15.209_RE(3m)	Margin: 0
Probe: HORN_3117_00167055(1-18GHZ)	Polarity: Horizontal
EUT: Touch All In One Computer	Power: AC 120V/60Hz
Note: Mode 1:Transmit at 2412MHz by 11b	

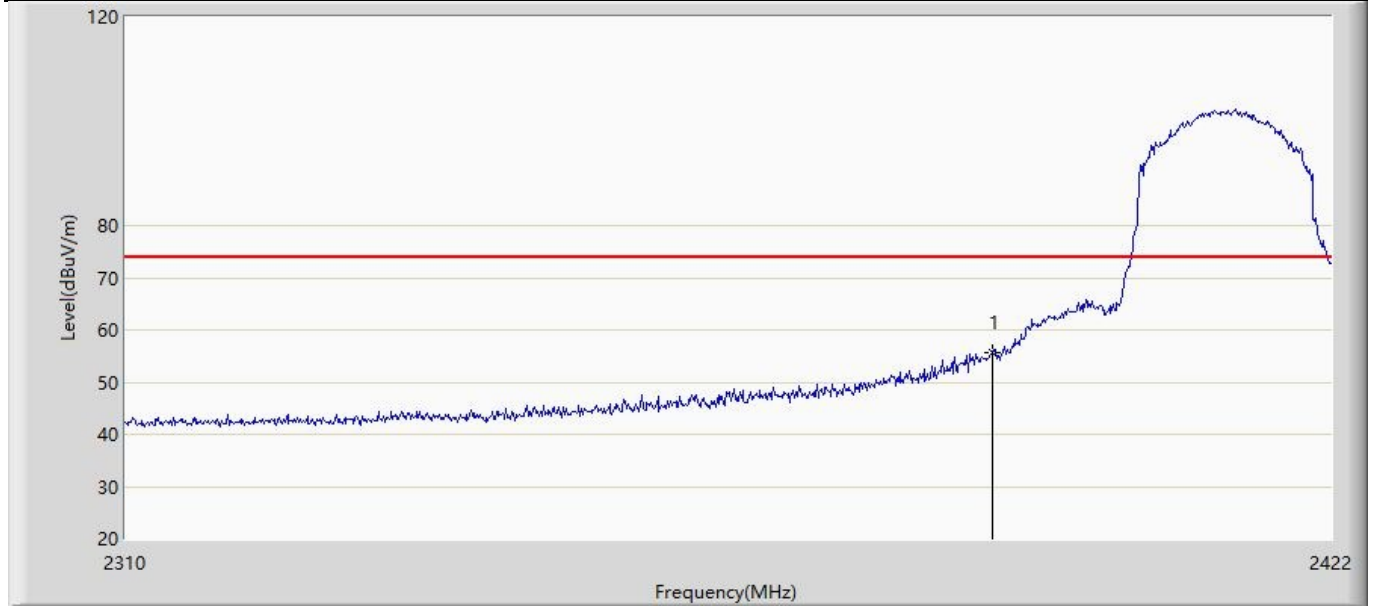

No	Mark	Frequency (MHz)	Measure Level (dBuV/m)	Reading Level (dBuV)	Over Limit (dB)	Limit (dBuV/m)	Factor (dB)	Type
1	*	2390.000	55.600	24.458	-18.400	74.000	31.141	PK

Profile: 2250816R	Page No.: 3
Engineer: Yu Liu	
Site: AC5	Time: 2022/06/23 - 07:41
Limit: FCC_Part15.209_RE(3m)	Margin: 0
Probe: HORN_3117_00167055(1-18GHZ)	Polarity: Vertical
EUT: Touch All In One Computer	Power: AC 120V/60Hz
Note: Mode 1:Transmit at 2412MHz by 11b	

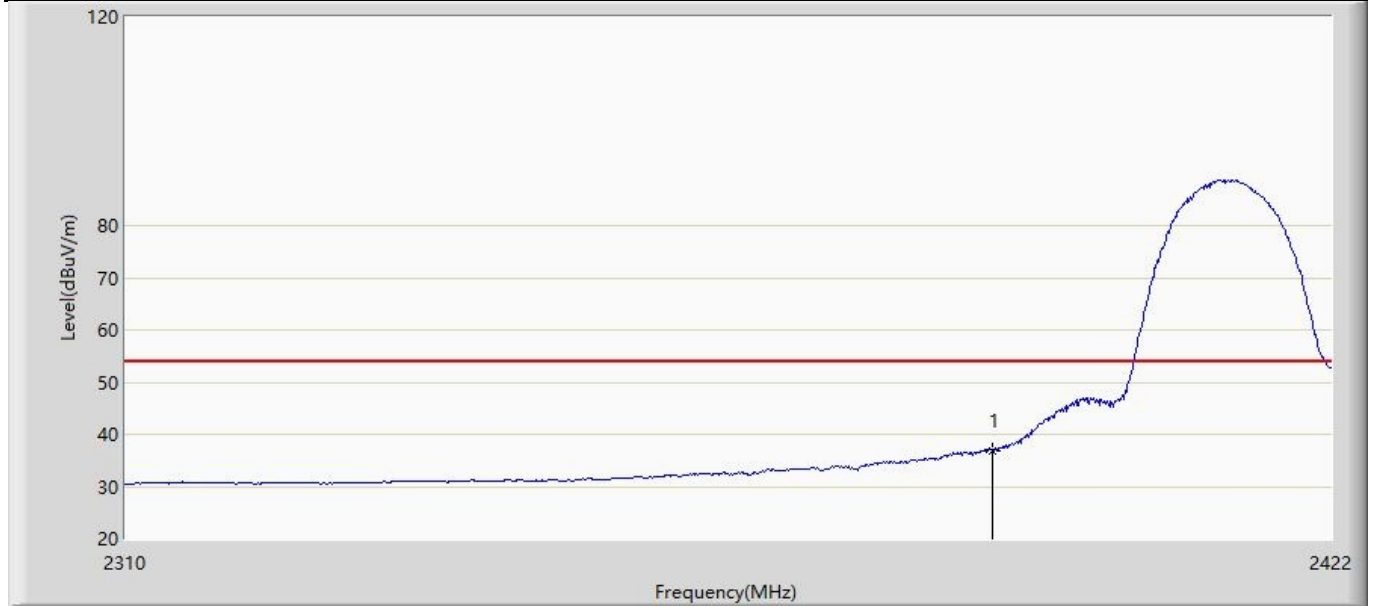

No	Mark	Frequency (MHz)	Measure Level (dBuV/m)	Reading Level (dBuV)	Over Limit (dB)	Limit (dBuV/m)	Factor (dB)	Type
1	*	2390.000	36.926	5.784	-17.074	54.000	31.141	AV

Profile: 2250816R	Page No.: 4
Engineer: Yu Liu	
Site: AC5	Time: 2022/06/23 - 07:42
Limit: FCC_Part15.209_RE(3m)	Margin: 0
Probe: HORN_3117_00167055(1-18GHZ)	Polarity: Vertical
EUT: Touch All In One Computer	Power: AC 120V/60Hz
Note: Mode 1:Transmit at 2402MHz by 11b	

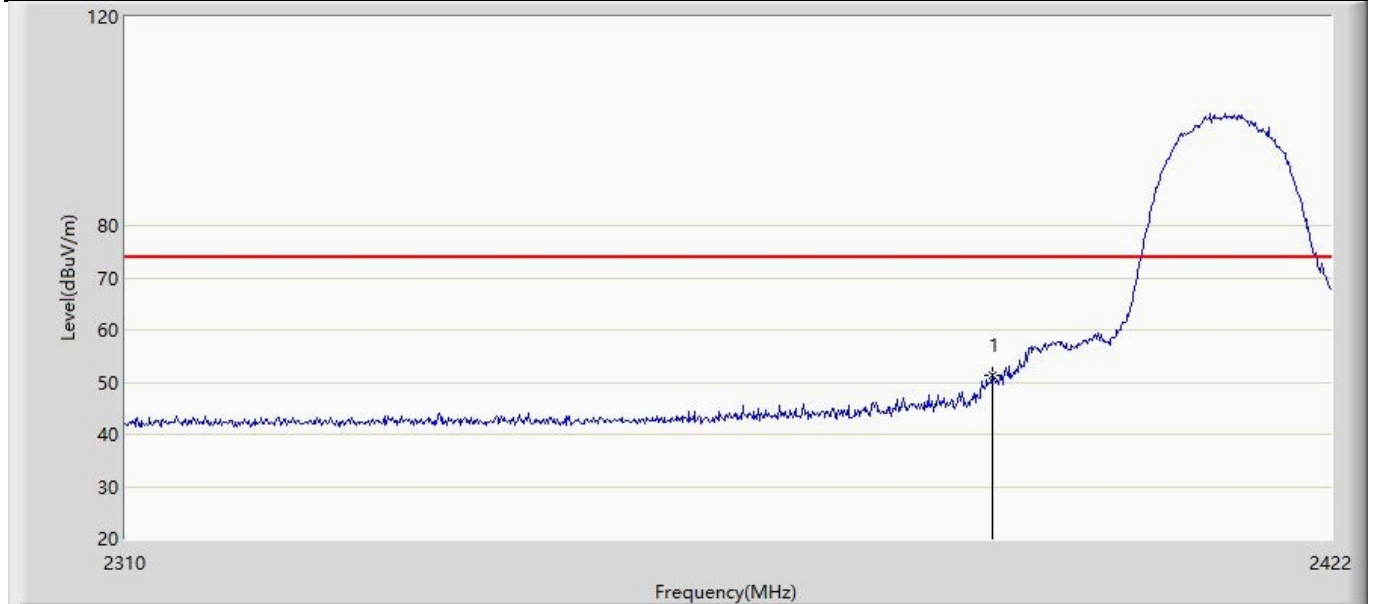

No	Mark	Frequency (MHz)	Measure Level (dBuV/m)	Reading Level (dBuV)	Over Limit (dB)	Limit (dBuV/m)	Factor (dB)	Type
1	*	2390.000	51.366	20.224	-22.634	74.000	31.141	PK

Profile: 2250816R	Page No.: 5
Engineer: Yu Liu	
Site: AC5	Time: 2022/06/23 - 07:44
Limit: FCC_Part15.209_RE(3m)	Margin: 0
Probe: HORN_3117_00167055(1-18GHZ)	Polarity: Horizontal
EUT: Touch All In One Computer	Power: AC 120V/60Hz
Note: Mode 1:Transmit at 2462MHz by 11b	

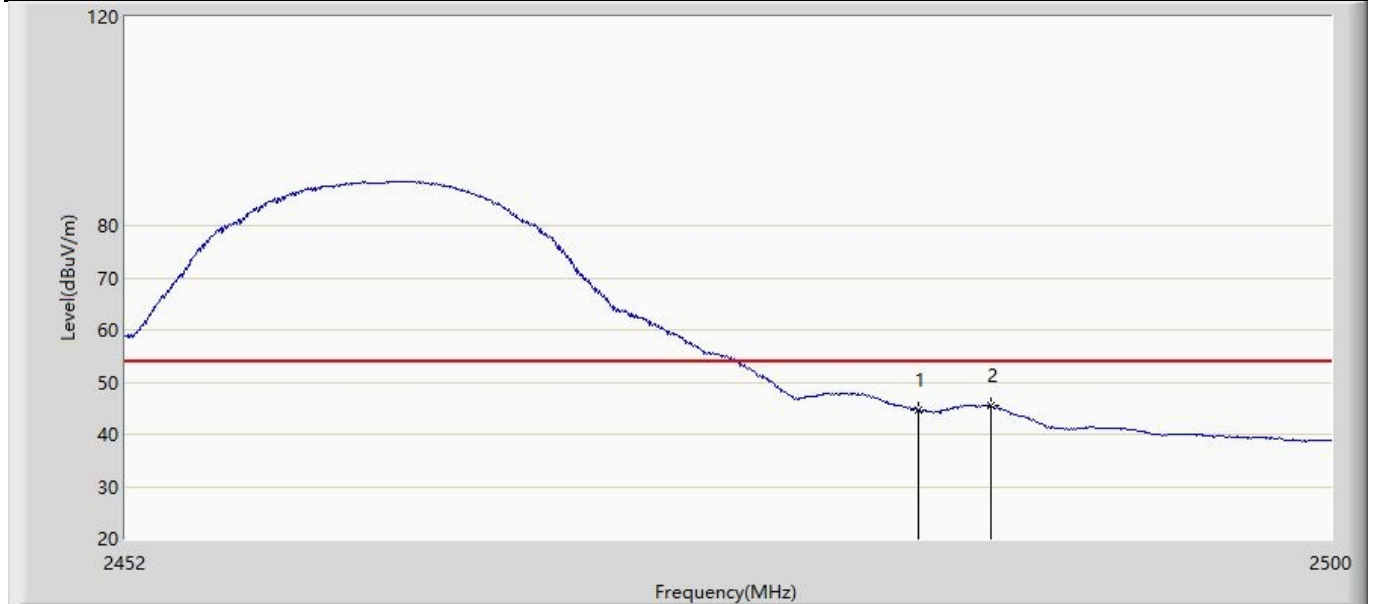

No	Mark	Frequency (MHz)	Measure Level (dBuV/m)	Reading Level (dBuV)	Over Limit (dB)	Limit (dBuV/m)	Factor (dB)	Type
1		2483.500	44.723	13.297	-9.277	54.000	31.426	AV
2	*	2486.368	45.461	14.027	-8.539	54.000	31.434	AV

Profile: 2250816R	Page No.: 6
Engineer: Yu Liu	
Site: AC5	Time: 2022/06/23 - 07:49
Limit: FCC_Part15.209_RE(3m)	Margin: 0
Probe: HORN_3117_00167055(1-18GHZ)	Polarity: Horizontal
EUT: Touch All In One Computer	Power: AC 120V/60Hz
Note: Mode 1:Transmit at 2462MHz by 11b	



No	Mark	Frequency (MHz)	Measure Level (dBuV/m)	Reading Level (dBuV)	Over Limit (dB)	Limit (dBuV/m)	Factor (dB)	Type
1	*	2483.500	55.326	23.900	-18.674	74.000	31.426	PK

Profile: 2250816R	Page No.: 7
Engineer: Yu Liu	
Site: AC5	Time: 2022/06/23 - 07:52
Limit: FCC_Part15.209_RE(3m)	Margin: 0
Probe: HORN_3117_00167055(1-18GHZ)	Polarity: Vertical
EUT: Touch All In One Computer	Power: AC 120V/60Hz
Note: Mode 1:Transmit at 2462MHz by 11b	

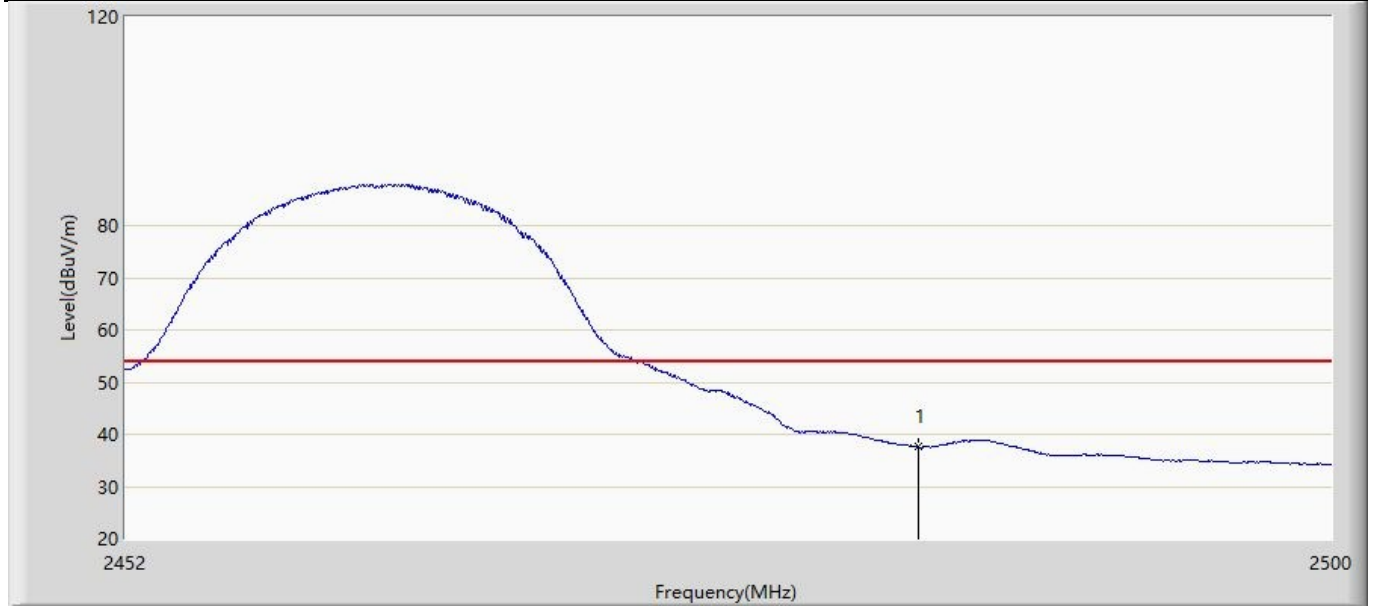

No	Mark	Frequency (MHz)	Measure Level (dBuV/m)	Reading Level (dBuV)	Over Limit (dB)	Limit (dBuV/m)	Factor (dB)	Type
1	*	2483.500	37.558	6.132	-16.442	54.000	31.426	AV

Profile: 2250816R	Page No.: 8
Engineer: Yu Liu	
Site: AC5	Time: 2022/06/23 - 07:53
Limit: FCC_Part15.209_RE(3m)	Margin: 0
Probe: HORN_3117_00167055(1-18GHZ)	Polarity: Vertical
EUT: Touch All In One Computer	Power: AC 120V/60Hz
Note: Mode 1:Transmit at 2462MHz by 11b	

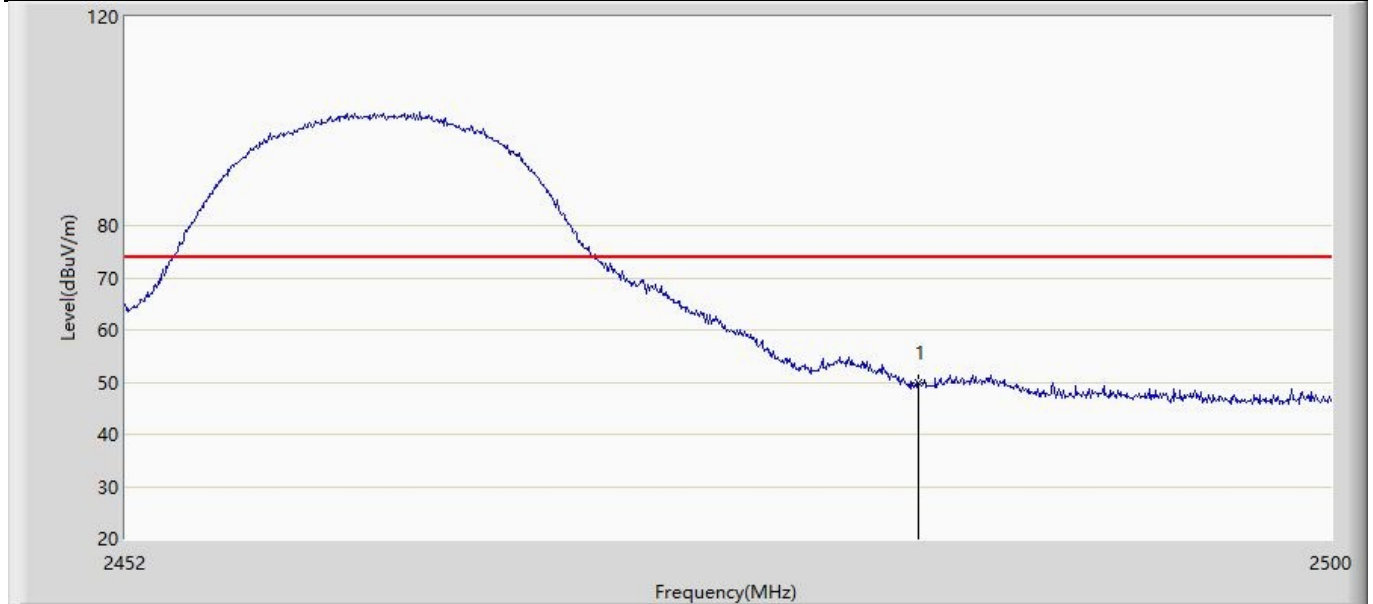

No	Mark	Frequency (MHz)	Measure Level (dBuV/m)	Reading Level (dBuV)	Over Limit (dB)	Limit (dBuV/m)	Factor (dB)	Type
1	*	2483.500	49.782	18.356	-24.218	74.000	31.426	PK

Profile: 2250816R	Page No.: 9
Engineer: Yu Liu	
Site: AC5	Time: 2022/06/23 - 07:55
Limit: FCC_Part15.209_RE(3m)	Margin: 0
Probe: HORN_3117_00167055(1-18GHZ)	Polarity: Horizontal
EUT: Touch All In One Computer	Power: AC 120V/60Hz
Note: Mode 2:Transmit at 2412MHz by 11g	

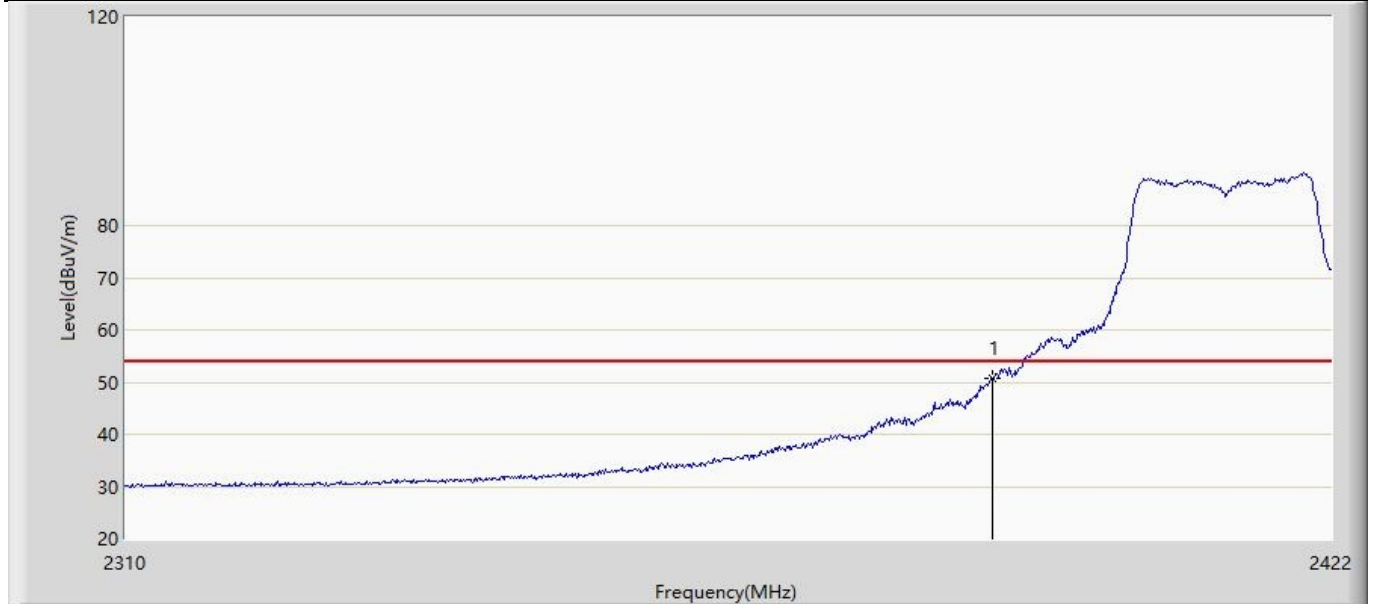

No	Mark	Frequency (MHz)	Measure Level (dBuV/m)	Reading Level (dBuV)	Over Limit (dB)	Limit (dBuV/m)	Factor (dB)	Type
1	*	2390.000	50.791	19.649	-3.209	54.000	31.141	AV

Profile: 2250816R	Page No.: 10
Engineer: Yu Liu	
Site: AC5	Time: 2022/06/23 - 07:57
Limit: FCC_Part15.209_RE(3m)	Margin: 0
Probe: HORN_3117_00167055(1-18GHZ)	Polarity: Horizontal
EUT: Touch All In One Computer	Power: AC 120V/60Hz
Note: Mode 2:Transmit at 2402MHz by 11g	

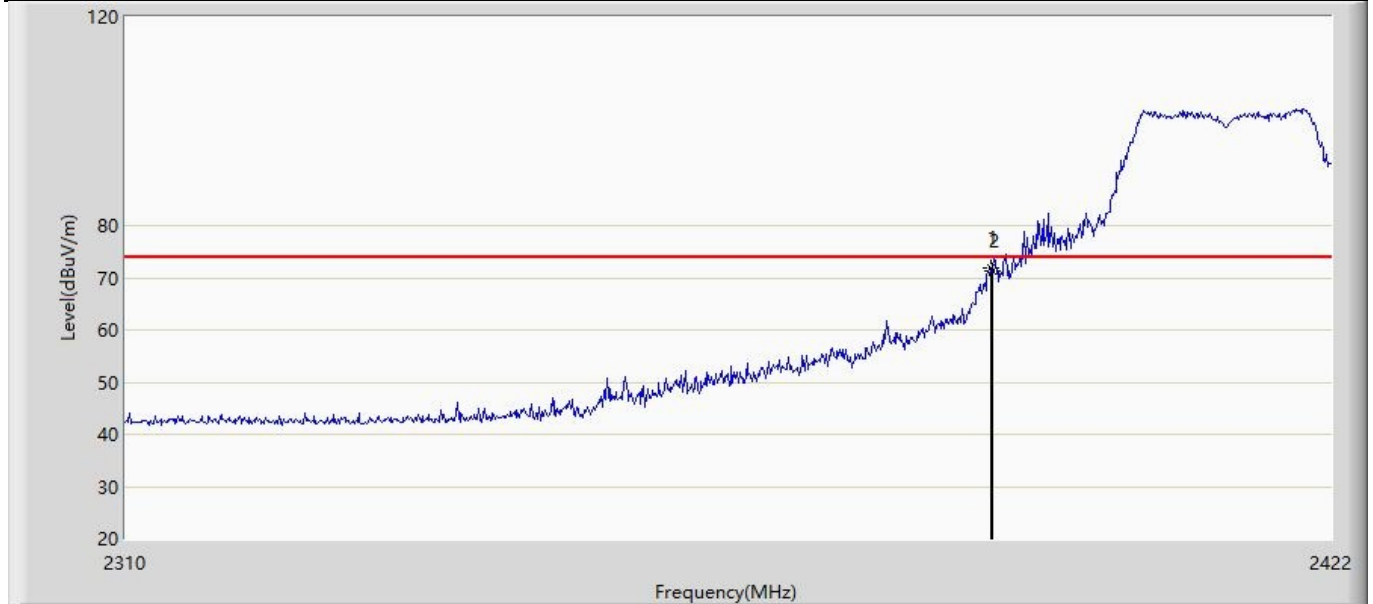

No	Mark	Frequency (MHz)	Measure Level (dBuV/m)	Reading Level (dBuV)	Over Limit (dB)	Limit (dBuV/m)	Factor (dB)	Type
1	*	2389.856	72.018	40.877	-1.982	74.000	31.141	PK
2		2390.000	71.370	40.228	-2.630	74.000	31.141	PK

Profile: 2250816R	Page No.: 11
Engineer: Yu Liu	
Site: AC5	Time: 2022/06/23 - 07:58
Limit: FCC_Part15.209_RE(3m)	Margin: 0
Probe: HORN_3117_00167055(1-18GHZ)	Polarity: Vertical
EUT: Touch All In One Computer	Power: AC 120V/60Hz
Note: Mode 2:Transmit at 2402MHz by 11g	

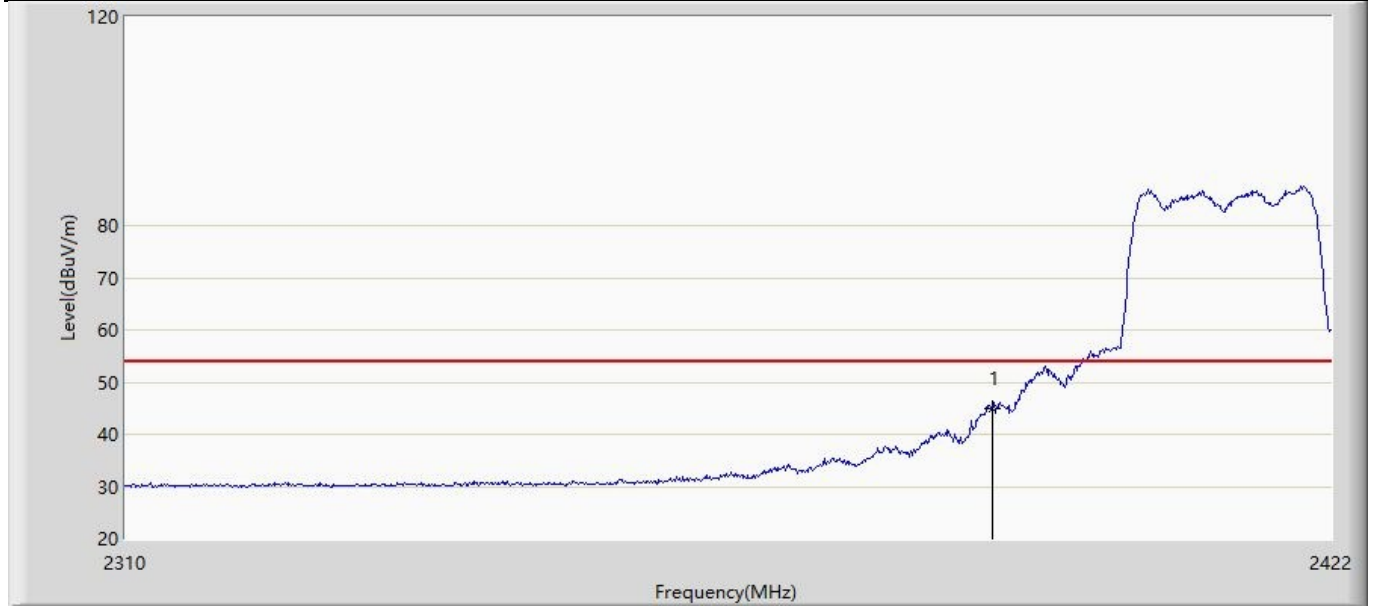

No	Mark	Frequency (MHz)	Measure Level (dBuV/m)	Reading Level (dBuV)	Over Limit (dB)	Limit (dBuV/m)	Factor (dB)	Type
1	*	2390.000	45.005	13.863	-8.995	54.000	31.141	AV

Profile: 2250816R	Page No.: 12
Engineer: Yu Liu	
Site: AC5	Time: 2022/06/23 - 08:00
Limit: FCC_Part15.209_RE(3m)	Margin: 0
Probe: HORN_3117_00167055(1-18GHZ)	Polarity: Vertical
EUT: Touch All In One Computer	Power: AC 120V/60Hz
Note: Mode 2:Transmit at 2402MHz by 11g	

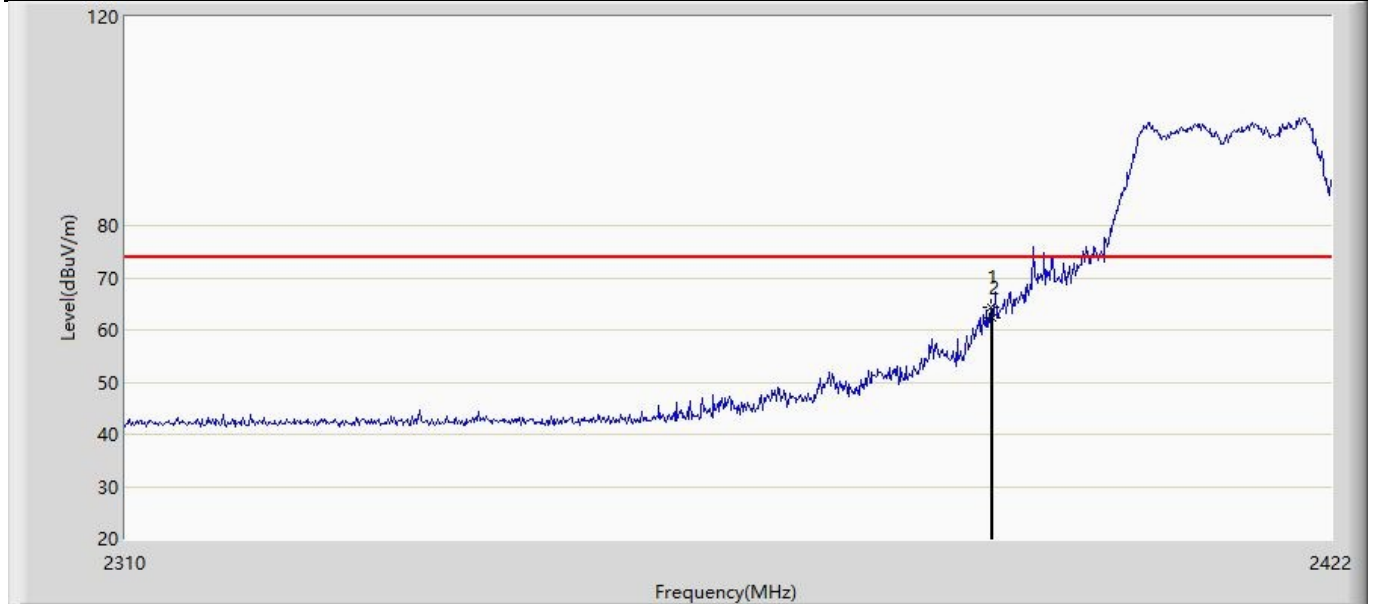

No	Mark	Frequency (MHz)	Measure Level (dBuV/m)	Reading Level (dBuV)	Over Limit (dB)	Limit (dBuV/m)	Factor (dB)	Type
1	*	2389.856	64.468	33.327	-9.532	74.000	31.141	PK
2		2390.000	62.274	31.132	-11.726	74.000	31.141	PK

Profile: 2250816R	Page No.: 13
Engineer: Yu Liu	
Site: AC5	Time: 2022/06/23 - 08:02
Limit: FCC_Part15.209_RE(3m)	Margin: 0
Probe: HORN_3117_00167055(1-18GHZ)	Polarity: Horizontal
EUT: Touch All In One Computer	Power: AC 120V/60Hz
Note: Mode 2:Transmit at 2462MHz by 11g	

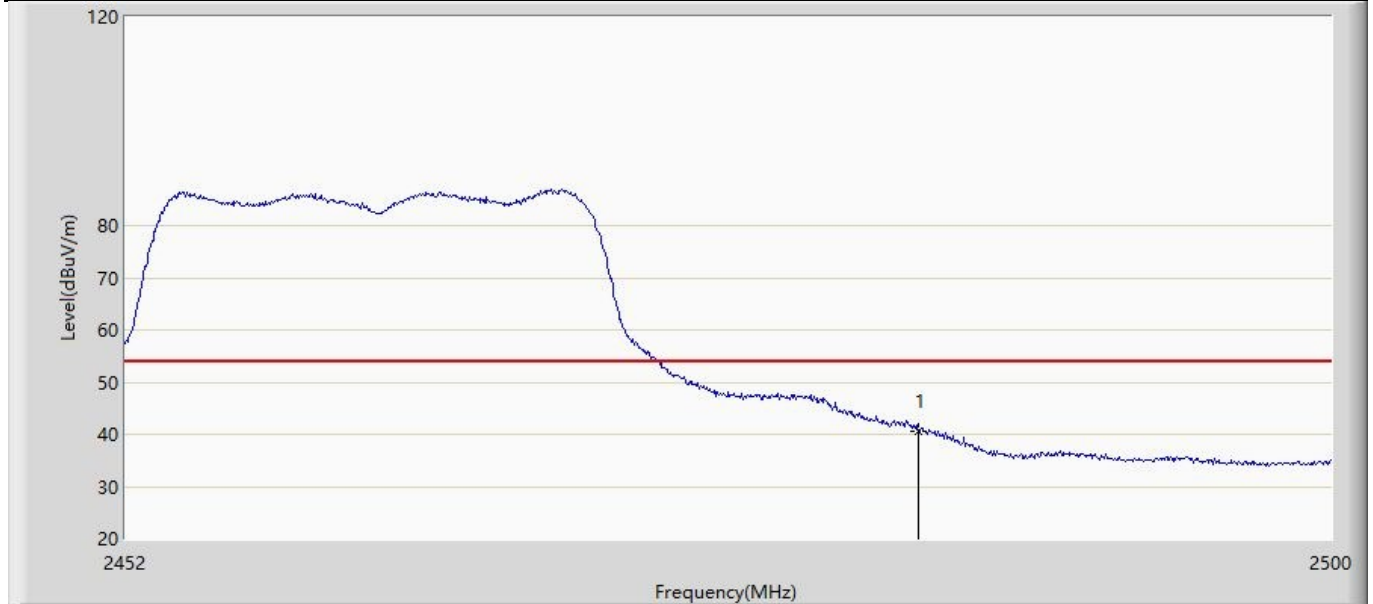

No	Mark	Frequency (MHz)	Measure Level (dBuV/m)	Reading Level (dBuV)	Over Limit (dB)	Limit (dBuV/m)	Factor (dB)	Type
1	*	2483.500	40.629	9.203	-13.371	54.000	31.426	AV

Profile: 2250816R	Page No.: 14
Engineer: Yu Liu	
Site: AC5	Time: 2022/06/23 - 08:03
Limit: FCC_Part15.209_RE(3m)	Margin: 0
Probe: HORN_3117_00167055(1-18GHZ)	Polarity: Horizontal
EUT: Touch All In One Computer	Power: AC 120V/60Hz
Note: Mode 2:Transmit at 2462MHz by 11g	

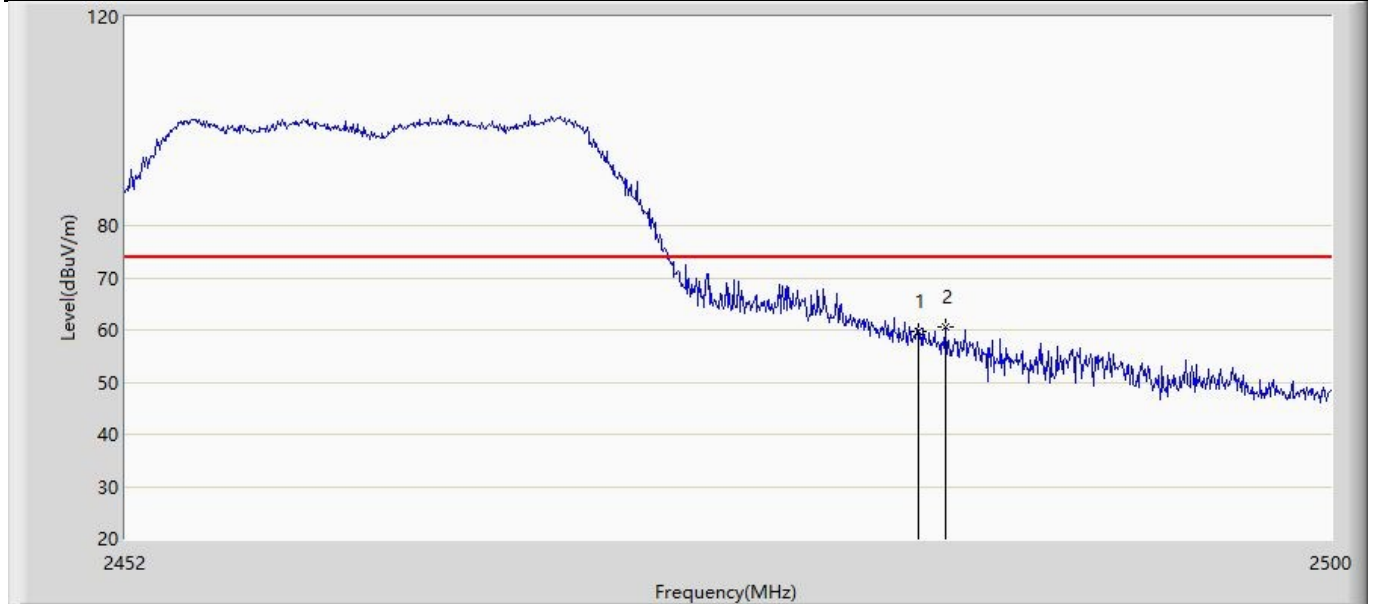

No	Mark	Frequency (MHz)	Measure Level (dBuV/m)	Reading Level (dBuV)	Over Limit (dB)	Limit (dBuV/m)	Factor (dB)	Type
1		2483.500	59.789	28.363	-14.211	74.000	31.426	PK
2	*	2484.544	60.571	29.142	-13.429	74.000	31.429	PK

Profile: 2250816R	Page No.: 15
Engineer: Yu Liu	
Site: AC5	Time: 2022/06/23 - 08:05
Limit: FCC_Part15.209_RE(3m)	Margin: 0
Probe: HORN_3117_00167055(1-18GHZ)	Polarity: Vertical
EUT: Touch All In One Computer	Power: AC 120V/60Hz
Note: Mode 2:Transmit at 2462MHz by 11g	

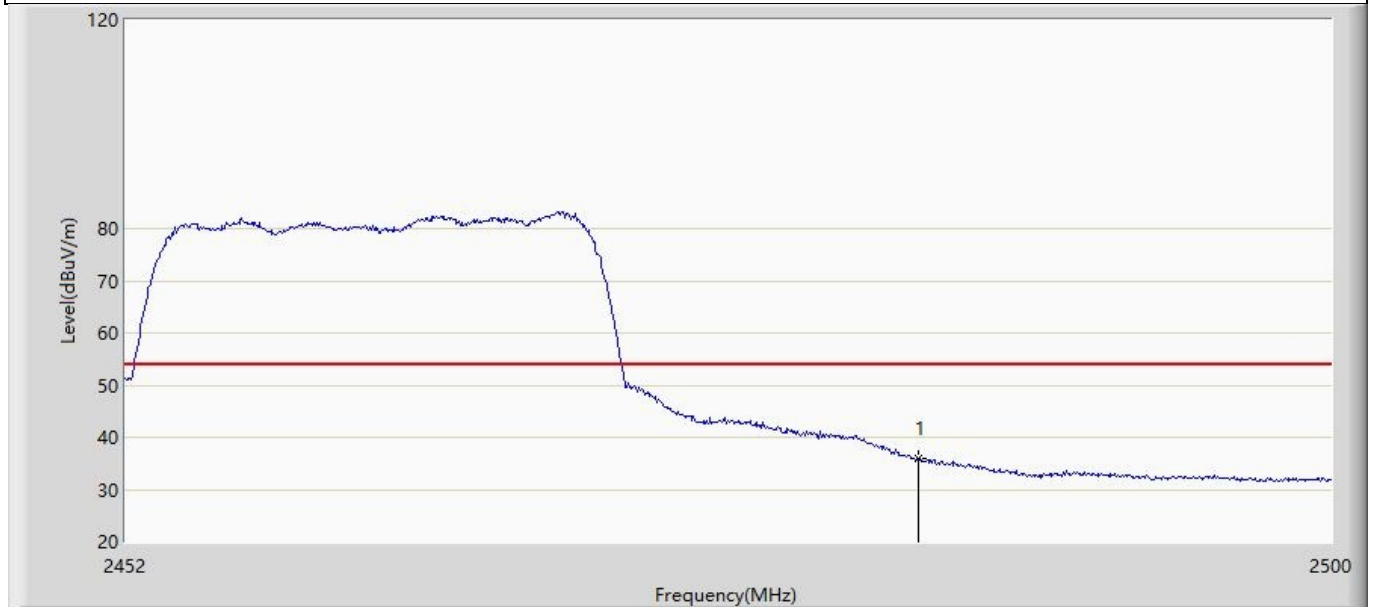

No	Mark	Frequency (MHz)	Measure Level (dBuV/m)	Reading Level (dBuV)	Over Limit (dB)	Limit (dBuV/m)	Factor (dB)	Type
1	*	2483.500	35.908	4.482	-18.092	54.000	31.426	AV

Profile: 2250816R	Page No.: 16
Engineer: Yu Liu	
Site: AC5	Time: 2022/06/23 - 08:06
Limit: FCC_Part15.209_RE(3m)	Margin: 0
Probe: HORN_3117_00167055(1-18GHZ)	Polarity: Vertical
EUT: Touch All In One Computer	Power: AC 120V/60Hz
Note: Mode 2:Transmit at 2462MHz by 11g	

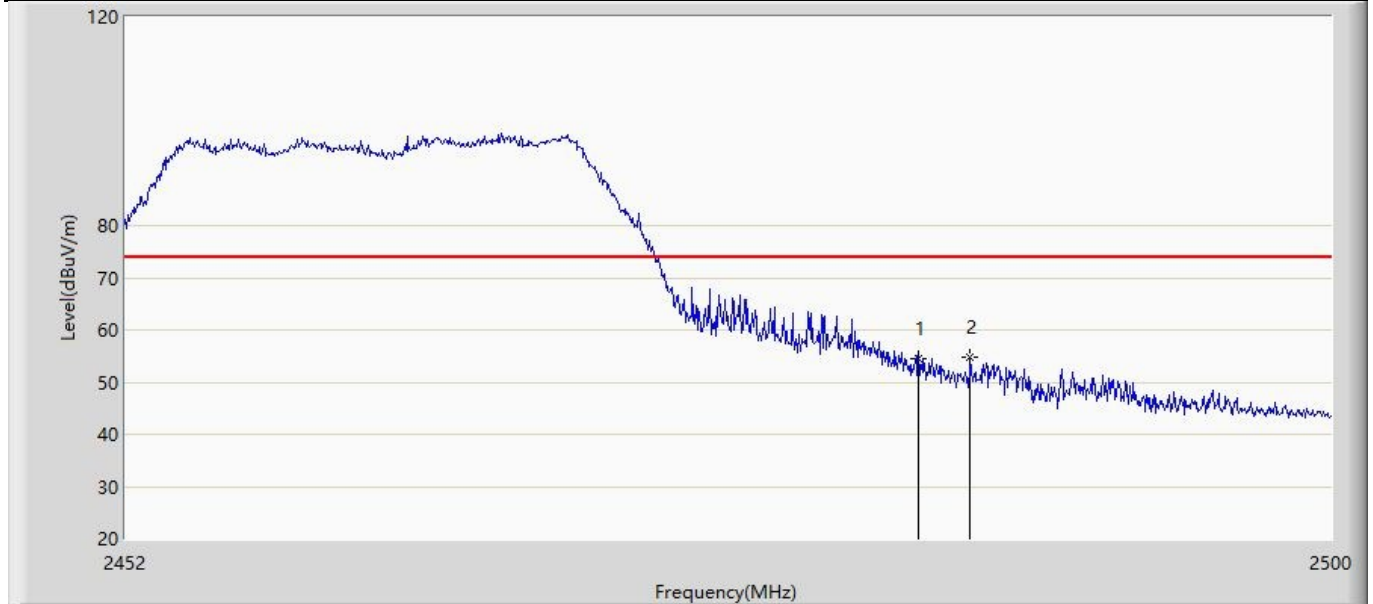

No	Mark	Frequency (MHz)	Measure Level (dBuV/m)	Reading Level (dBuV)	Over Limit (dB)	Limit (dBuV/m)	Factor (dB)	Type
1		2483.500	54.592	23.166	-19.408	74.000	31.426	PK
2	*	2485.552	54.694	23.262	-19.306	74.000	31.431	PK

Profile: 2250816R	Page No.: 17
Engineer: Yu Liu	
Site: AC5	Time: 2022/06/23 - 08:07
Limit: FCC_Part15.209_RE(3m)	Margin: 0
Probe: HORN_3117_00167055(1-18GHZ)	Polarity: Horizontal
EUT: Touch All In One Computer	Power: AC 120V/60Hz
Note: Mode 3:Transmit at 2412MHz by 11n20	

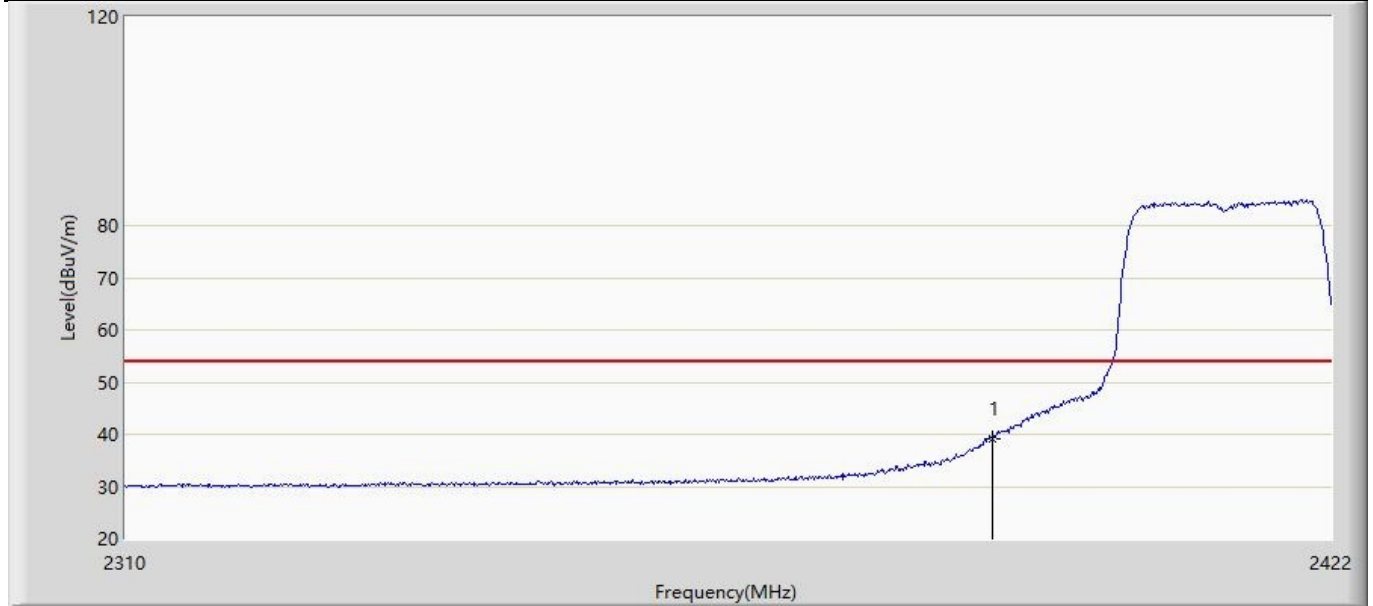

No	Mark	Frequency (MHz)	Measure Level (dBuV/m)	Reading Level (dBuV)	Over Limit (dB)	Limit (dBuV/m)	Factor (dB)	Type
1	*	2390.000	39.080	7.938	-14.920	54.000	31.141	AV

Profile: 2250816R	Page No.: 18
Engineer: Yu Liu	
Site: AC5	Time: 2022/06/23 - 08:09
Limit: FCC_Part15.209_RE(3m)	Margin: 0
Probe: HORN_3117_00167055(1-18GHZ)	Polarity: Horizontal
EUT: Touch All In One Computer	Power: AC 120V/60Hz
Note: Mode 3:Transmit at 2412MHz by 11n20	

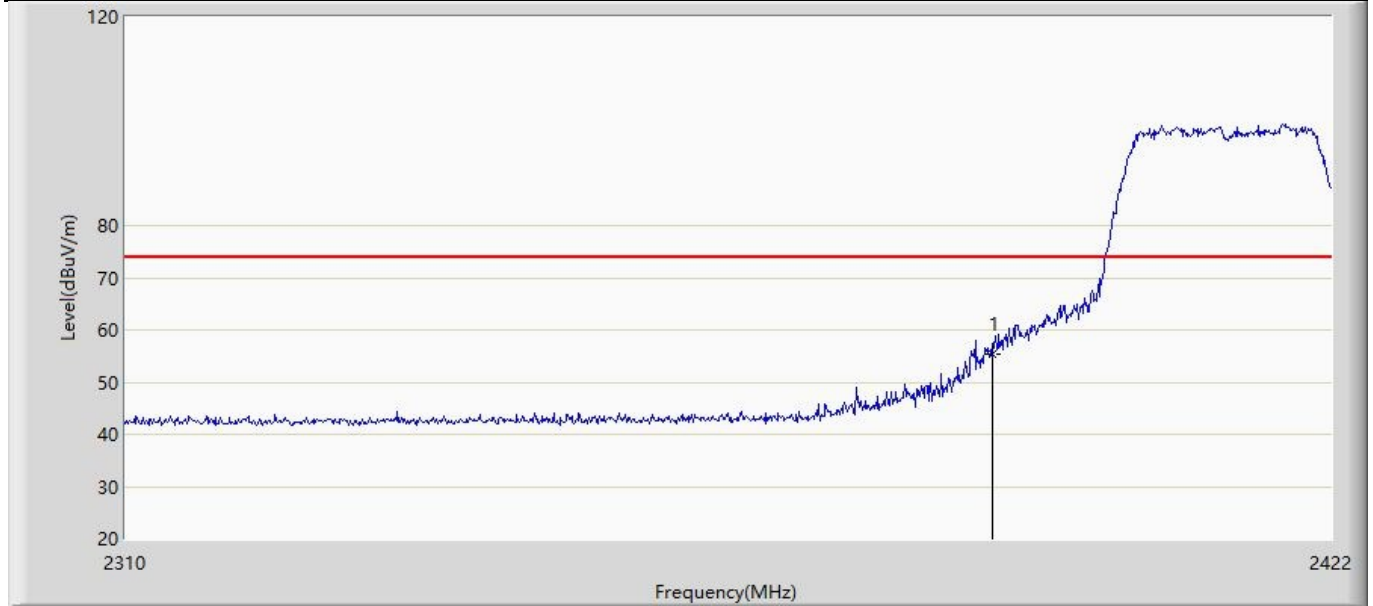

No	Mark	Frequency (MHz)	Measure Level (dBuV/m)	Reading Level (dBuV)	Over Limit (dB)	Limit (dBuV/m)	Factor (dB)	Type
1	*	2390.000	55.425	24.283	-18.575	74.000	31.141	PK

Profile: 2250816R	Page No.: 19
Engineer: Yu Liu	
Site: AC5	Time: 2022/06/23 - 08:11
Limit: FCC_Part15.209_RE(3m)	Margin: 0
Probe: HORN_3117_00167055(1-18GHZ)	Polarity: Vertical
EUT: Touch All In One Computer	Power: AC 120V/60Hz
Note: Mode 3:Transmit at 2412MHz by 11n20	

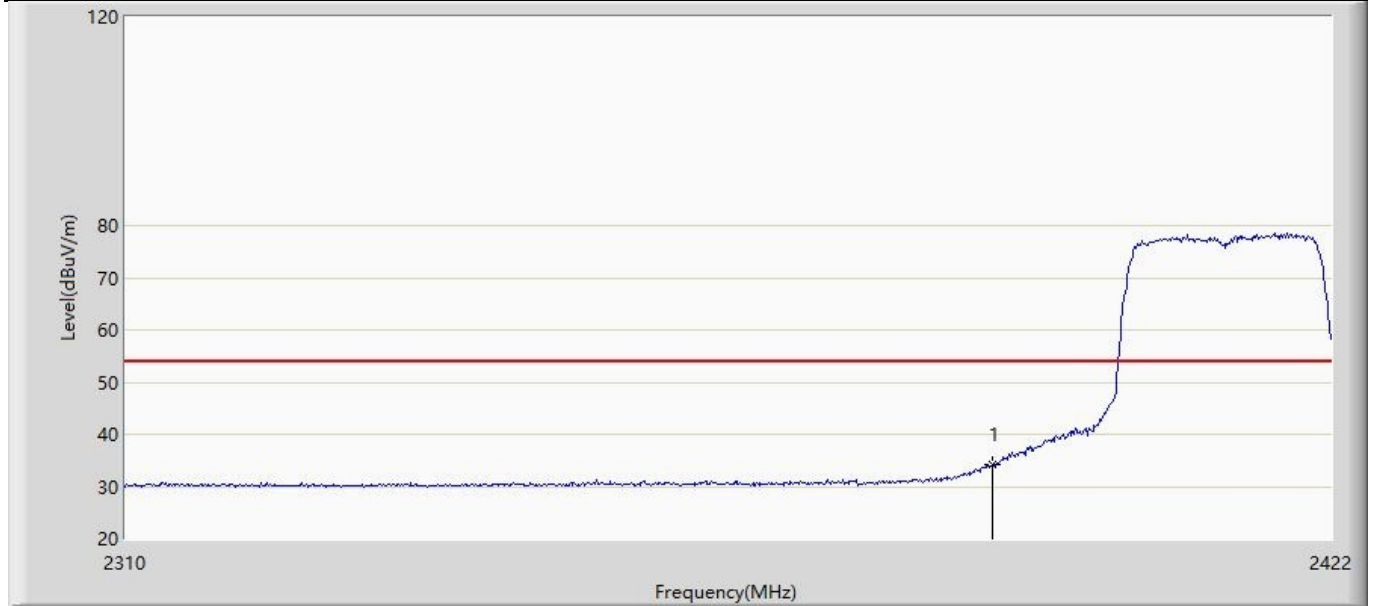

No	Mark	Frequency (MHz)	Measure Level (dBuV/m)	Reading Level (dBuV)	Over Limit (dB)	Limit (dBuV/m)	Factor (dB)	Type
1	*	2390.000	34.277	3.135	-19.723	54.000	31.141	AV

Profile: 2250816R	Page No.: 20
Engineer: Yu Liu	
Site: AC5	Time: 2022/06/23 - 08:12
Limit: FCC_Part15.209_RE(3m)	Margin: 0
Probe: HORN_3117_00167055(1-18GHZ)	Polarity: Vertical
EUT: Touch All In One Computer	Power: AC 120V/60Hz
Note: Mode 3:Transmit at 2412MHz by 11n20	

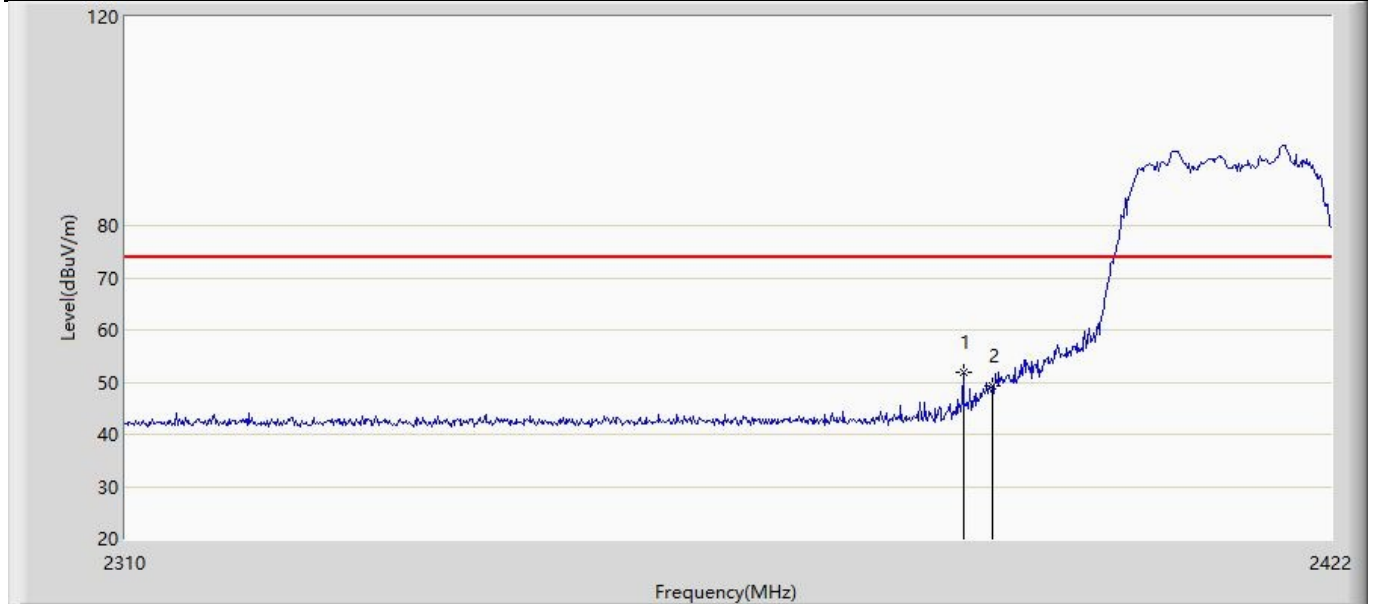

No	Mark	Frequency (MHz)	Measure Level (dBuV/m)	Reading Level (dBuV)	Over Limit (dB)	Limit (dBuV/m)	Factor (dB)	Type
1	*	2387.280	51.814	20.682	-22.186	74.000	31.132	PK
2		2390.000	49.146	18.004	-24.854	74.000	31.141	PK

Profile: 2250816R	Page No.: 21
Engineer: Yu Liu	
Site: AC5	Time: 2022/06/23 - 08:13
Limit: FCC_Part15.209_RE(3m)	Margin: 0
Probe: HORN_3117_00167055(1-18GHZ)	Polarity: Horizontal
EUT: Touch All In One Computer	Power: AC 120V/60Hz
Note: Mode 3:Transmit at 2462MHz by 11n20	

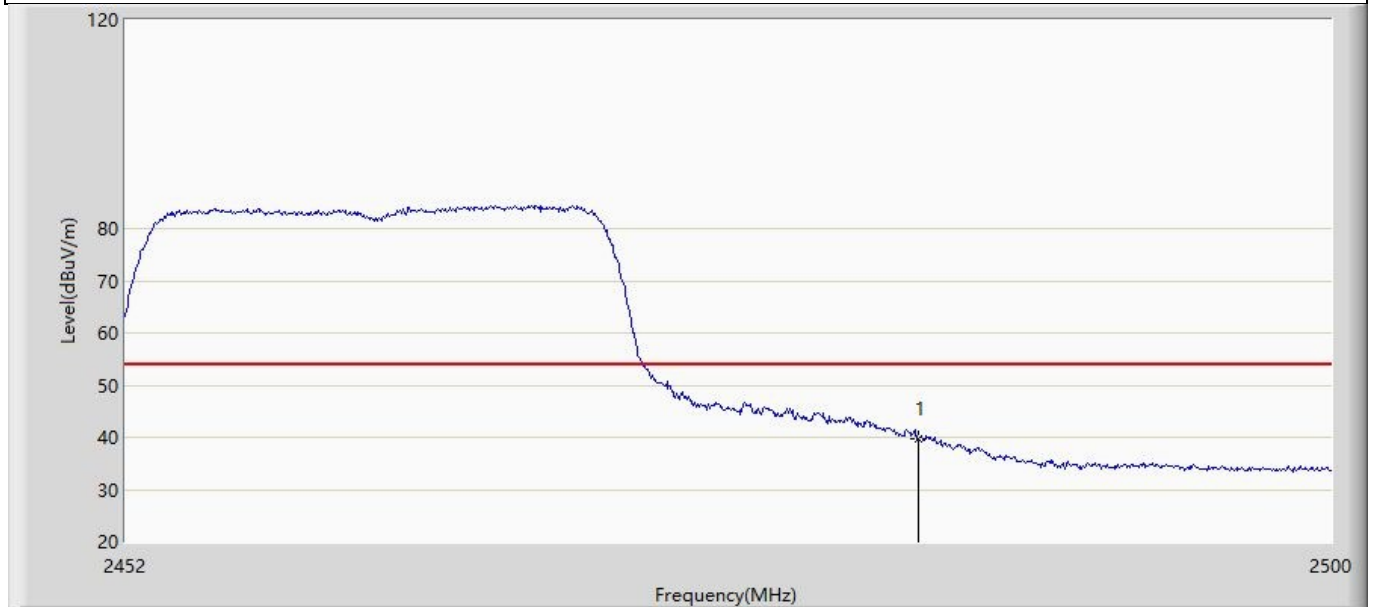

No	Mark	Frequency (MHz)	Measure Level (dBuV/m)	Reading Level (dBuV)	Over Limit (dB)	Limit (dBuV/m)	Factor (dB)	Type
1	*	2483.500	39.609	8.183	-14.391	54.000	31.426	AV