



FCC RADIO TEST REPORT

Applicant : Elo Touch Solutions, Inc.
Address : 670 N. McCarthy Blvd., Suite 100, Milpitas,
CA 95035, USA
Equipment : Touch All-in-One Computer
Model No. : ESY22I1D
Trade Name : Elo or 
FCC ID : RBWESY22I1D

I HEREBY CERTIFY THAT :

The sample was received on Dec. 19, 2022 and the testing was completed on Dec. 26, 2022 at CerpPASS Technology Corp. The test result refers exclusively to the test presented test model / sample. Without written approval of CerpPASS Technology Corp., the test report shall not be reproduced except in full.

Approved by:

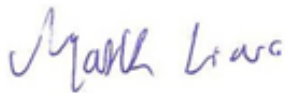

Mark Liao / Supervisor

Laboratory Accreditation:

CerpPASS Technology Corporation Test Laboratory





CONTENTS

- 1. Summary of Test Procedure and Test Results 5
 - 1.1. Applicable Standards5
- 2. Test Configuration of Equipment under Test 6
 - 2.1. Feature of Equipment under Test.....6
 - 2.2. Carrier Frequency of Channels 7
 - 2.3. Test Mode and Test Software9
 - 2.4. Description of Test System..... 11
 - 2.5. General Information of Test..... 12
 - 2.6. Measurement Uncertainty 13
- 3. Test Equipment and Ancillaries Used for Tests 14
- 4. Antenna Requirements 16
 - 4.1. Standard Applicable 16
 - 4.2. Antenna Construction and Directional Gain..... 16
- 5. Test of AC Power Line Conducted Emission 17
 - 5.1. Test Limit 17
 - 5.2. Test Procedures 17
 - 5.3. Typical Test Setup 18
 - 5.4. Test Result and Data..... 19
 - 5.5. Test Photographs 21
- 6. Test of Spurious Emission (Radiated)..... 22
 - 6.1. Test Limit 22
 - 6.2. Test Procedures 23
 - 6.3. Typical Test Setup 24
 - 6.4. Test Result and Data (9kHz ~ 30MHz)..... 25
 - 6.5. Test Result and Data (30MHz ~ 1GHz) 25
 - 6.6. Test Result and Data (1GHz ~ 40GHz)..... 27
 - 6.7. Restricted Bands of Operation 111
 - 6.8. Test Photographs (30MHz ~ 1GHz) 112
 - 6.9. Test Photographs (1GHz ~ 40GHz) 113
- 7. On Time, Duty Cycle and Measurement methods 115
 - 7.1. Test Limit 115
 - 7.2. Test Procedure 115
 - 7.3. Test Setup Layout 115
 - 7.4. Test Result and Data..... 116
 - 7.5. Measurement Methods 116
- 8. 6dB Bandwidth & 99% Occupied Bandwidth 118
 - 8.1. Test Limit 118
 - 8.2. Test Procedure 118
 - 8.3. Test Setup Layout 118
 - 8.4. Test Result and Data..... 119
- 9. 26dB Bandwidth & 99% Occupied Bandwidth 133
 - 9.1. Test Limit 133



- 9.2. Test Procedure 133
- 9.3. Test Setup Layout 133
- 9.4. Test Result and Data 134
- 10. Average Power..... 166
 - 10.1. Test Limit 166
 - 10.2. Test Procedure 167
 - 10.3. Test Setup Layout 167
 - 10.4. Test Result and Data..... 168
- 11. Power Spectral Density..... 176
 - 11.1. Test Limit 176
 - 11.2. Test Procedure 176
 - 11.3. Test Setup Layout 176
 - 11.4. Test Result and Data..... 177
- 12. Radio Frequency Exposure 197
 - 12.1. Applicable Standards 197
 - 12.2. EUT Specification..... 198
 - 12.3. Result 198



History of this test report

| Report No. | Issued Date | Description |
|------------------|---------------|-------------|
| 21030199-TRFCC04 | Dec. 26, 2022 | Original |
| | | |
| | | |
| | | |
| | | |
| | | |
| | | |
| | | |
| | | |
| | | |
| | | |
| | | |
| | | |
| | | |
| | | |
| | | |



1. Summary of Test Procedure and Test Results

1.1. Applicable Standards

ANSI C63.10:2013

FCC Rules and Regulations Part 15 Subpart E §15.407

KDB 789033

| FCC Rule | Description of Test | Result |
|------------------------|----------------------------------|--------|
| 15.203 | Antenna Requirement | PASS |
| 15.207(a) | AC Power Line Conducted Emission | PASS |
| 15.407(b) 15.209 | Radiated Spurious Emission | PASS |
| 15.407(a) | 26 dB & Occupied Bandwidth | PASS |
| 15.407 | 6 dB Bandwidth | PASS |
| 15.407 (a) & (a)(3) | Average Power | PASS |
| 15.407(a) | Power Spectral Density | PASS |
| 2.1091 | Radio Frequency Exposure | PASS |

*The lab has reduced the uncertainty risk factor from test equipment, environment and staff technicians which according to the standard on contract. Therefore, the test result will only be determined by standard requirement.



2. Test Configuration of Equipment under Test

2.1. Feature of Equipment under Test

| | |
|---------------------------|--|
| Operation Frequency Range | BT / BLE: 2400-2483.5MHz 802.11b/g/n: 2400-2483.5MHz 802.11a/n/ac: 5150-5250MHz, 5250-5350MHz, 5470-5725MHz, 5725-5850MHz |
| Center Frequency Range | BT / BLE: 2402MHz-2480MHz 802.11b/g/n: 2412MHz-2462MHz 802.11a/n/ac: 5180-5240MHz, 5260-5320MHz, 5500-5700MHz, 5745-5825MHz |
| Modulation Type | BT: GFSK, $\pi/4$ -DQPSK, 8DPSK BLE: GFSK WLAN: 802.11b: CCK, DQPSK, DBPSK 802.11g/n: BPSK, QPSK, 16QAM, 64QAM 802.11a: BPSK, QPSK, 16QAM, 64QAM 802.11ac: BPSK, QPSK, 16QAM, 64QAM, 256QAM |
| Modulation Technology | DSSS, OFDM, FHSS, DTS |
| Data Rate | BT: GFSK: 1Mbps, $\pi/4$ -DQPSK: 2Mbps, 8DPSK: 3Mbps BLE: GFSK: 1Mbps WLAN: 2.4GHz: 802.11b: 1, 2, 5.5, 11Mbps 802.11g: 6, 9, 12, 18, 24, 36, 48, 54Mbps 802.11n: MCS0 – MCS15, HT20 5GHz: 802.11a: 6, 9, 12, 18, 24, 36, 48, 54Mbps 802.11n: MCS0 – MCS15, HT20/40 802.11ac: MCS0 – MCS9, VHT20/40/80 |
| Antenna Type | Dipole Antenna |
| Antenna Gain | For BT / BLE: 2400-2480MHz: ANT A: 3.53dBi For WLAN: 2400-2500MHz: ANT A: 3.53dBi, ANT B: 3.26dBi 5150-5250MHz: ANT A: 2.49dBi, ANT B: 1.90dBi 5250-5350MHz: ANT A: 2.92dBi, ANT B: 1.90dBi 5471-5725MHz: ANT A: 3.50dBi, ANT B: 2.83dBi 5725-5850MHz: ANT A: 2.70dBi, ANT B: 2.32dBi |
| Adapter | Brand: BILLION Model: BA090-190474MBX |

Note:

1. EUT support TPC Function.
2. EUT support Client Mode.
3. EUT WLAN 2.4GHz 802.11b and 802.11g 1TX diversity
4. WLAN and BT can simultaneously transmission.
5. For more details, please refer to the User's manual of the EUT.



2.2. Carrier Frequency of Channels

Band: 5150MHz-5250MHz

802.11a, 802.11n HT20, 802.11ac VHT20

| Channel | Frequency(MHz) | Channel | Frequency(MHz) |
|------------|----------------|------------|----------------|
| *36 | 5180 | 44 | 5220 |
| *40 | 5200 | *48 | 5240 |

802.11n HT40, 802.11ac VHT40

| Channel | Frequency(MHz) | Channel | Frequency(MHz) |
|------------|----------------|------------|----------------|
| *38 | 5190 | *46 | 5230 |

802.11ac VHT80

| Channel | Frequency(MHz) |
|------------|----------------|
| *42 | 5210 |

Band: 5250MHz-5350MHz

802.11a, 802.11n HT20, 802.11ac VHT20

| Channel | Frequency(MHz) | Channel | Frequency(MHz) |
|------------|----------------|------------|----------------|
| *52 | 5260 | *60 | 5300 |
| 56 | 5280 | *64 | 5320 |

802.11n HT40, 802.11ac VHT40

| Channel | Frequency(MHz) | Channel | Frequency(MHz) |
|------------|----------------|------------|----------------|
| *54 | 5270 | *62 | 5310 |

802.11ac VHT80

| Channel | Frequency(MHz) |
|------------|----------------|
| *58 | 5290 |

Band: 5470MHz-5725MHz

802.11a, 802.11n HT20, 802.11ac VHT20

| Channel | Frequency(MHz) | Channel | Frequency(MHz) |
|-------------|----------------|-------------|----------------|
| *100 | 5500 | 124 | 5620 |
| 104 | 5520 | 128 | 5640 |
| 108 | 5540 | 132 | 5660 |
| 112 | 5560 | 136 | 5680 |
| 116 | 5580 | *140 | 5700 |
| *120 | 5600 | | |

802.11n HT40, 802.11ac VHT40

| Channel | Frequency(MHz) | Channel | Frequency(MHz) |
|-------------|----------------|-------------|----------------|
| *102 | 5510 | 126 | 5630 |
| 110 | 5550 | *134 | 5670 |
| *118 | 5590 | | |

802.11ac VHT80

| Channel | Frequency(MHz) | Channel | Frequency(MHz) |
|-------------|----------------|-------------|----------------|
| *106 | 5530 | *122 | 5610 |



Band 3: Straddle Channel

802.11a, 802.11n HT 20, 802.11ac VHT20

| Channel | Frequency(MHz) |
|-------------|----------------|
| *144 | 5720 |

802.11n HT40, 802.11ac VHT40

| Channel | Frequency(MHz) |
|-------------|----------------|
| *142 | 5710 |

802.11ac VHT80

| Channel | Frequency(MHz) |
|-------------|----------------|
| *138 | 5690 |

Band: 5725MHz-5850MHz

802.11a, 802.11n HT20, 802.11ac VHT20

| Channel | Frequency(MHz) | Channel | Frequency(MHz) |
|-------------|----------------|-------------|----------------|
| *149 | 5745 | 161 | 5805 |
| 153 | 5765 | *165 | 5825 |
| *157 | 5785 | | |

802.11n HT40, 802.11ac VHT40

| Channel | Frequency(MHz) | Channel | Frequency(MHz) |
|-------------|----------------|-------------|----------------|
| *151 | 5755 | *159 | 5795 |

802.11ac VHT80

| Channel | Frequency(MHz) |
|-------------|----------------|
| *155 | 5775 |

Note: Channels remarked * are selected to perform test.



2.3. Test Mode and Test Software

- a. During testing, the interface cables and equipment positions were varied according to ANSI C63.10.
- b. The complete test system included remote workstation and EUT for RF test. The remote workstation included Notebook.
- c. An executive program, " QRCT ver.4.0.00193.0" under Windows OS system was executed to transmit and receive data via WLAN.
- d. The following test modes were performed for the test:

| Conducted Emissions from the AC mains power ports | |
|--|--|
| Test Mode | Operating Description |
| 1 | 802.11a (6Mbps) , From Adapter |
| 2 | 802.11n HT20 (6.5Mbps) , From Adapter |
| 3 | 802.11n HT40 (13.5Mbps) , From Adapter |
| 4 | 802.11ac VHT20 (6.5Mbps) , From Adapter |
| 5 | 802.11ac VHT40 (13.5Mbps) , From Adapter |
| 6 | 802.11ac VHT80 (29.3Mbps) , From Adapter |
| caused "Test Mode 4" generated the worst case, it was reported as the final data. | |
| Radiation Emissions (Below 1GHz) | |
| Test Mode | Operating Description |
| 1 | 802.11a (6Mbps) , From Adapter |
| 2 | 802.11n HT20 (6.5Mbps) , From Adapter |
| 3 | 802.11n HT40 (13.5Mbps) , From Adapter |
| 4 | 802.11ac VHT20 (6.5Mbps) , From Adapter |
| 5 | 802.11ac VHT40 (13.5Mbps) , From Adapter |
| 6 | 802.11ac VHT80 (29.3Mbps) , From Adapter |
| caused "Test Mode 4" generated the worst case, it was reported as the final data. | |
| Radiation Emissions (Above 1GHz) | |
| Test Mode | Operating Description |
| 1 | 802.11a (6Mbps) , From Adapter |
| 2 | 802.11n HT20 (6.5Mbps) , From Adapter |
| 3 | 802.11n HT40 (13.5Mbps) , From Adapter |
| 4 | 802.11ac VHT20 (6.5Mbps) , From Adapter |
| 5 | 802.11ac VHT40 (13.5Mbps) , From Adapter |
| 6 | 802.11ac VHT80 (29.3Mbps) , From Adapter |
| caused "Test Mode 1,4~6" generated the worst case, they were reported as the final data. | |

Note: There are two kinds of test voltage: AC 120V / 60Hz and AC 240V / 60Hz.
 For AC Power Line Conducted Emission, AC 120V / 60Hz is worst case.
 For Radiated Spurious Emission, AC 120V / 60Hz is worst case.



The EUT incorporates a MIMO function

| Modulation Type | TX CONFIGURATION |
|-----------------|------------------|
| 802.11a | 2TX |
| 802.11n HT20 | 2TX |
| 802.11n HT40 | 2TX |
| 802.11ac VHT20 | 2TX |
| 802.11ac VHT40 | 2TX |
| 802.11ac VHT80 | 2TX |



2.4. Description of Test System

| RF Conducted | | | | |
|----------------------------------|--------|------------|-------------|------------------------|
| Equipment | Brand | Model | Length/Type | Power cord/Length/Type |
| Notebook | lenovo | S1GL2W | N/A | Adapter / 1.8m / NS |
| USB cable | BENEVO | E210567AWM | N/A | 0.6m / NS |
| Radiated Emissions | | | | |
| Equipment | Brand | Model | Length/Type | Power cord/Length/Type |
| Notebook | lenovo | S1GL2W | N/A | Adapter / 1.8m / NS |
| USB cable | BENEVO | E210567AWM | N/A | 0.6m / NS |
| AC Power Line Conducted Emission | | | | |
| Equipment | Brand | Model | Length/Type | Power cord/Length/Type |
| Notebook | lenovo | S1GL2W | N/A | Adapter / 1.8m / NS |
| USB cable | BENEVO | E210567AWM | N/A | 0.6m / NS |

**2.5. General Information of Test**

| | | |
|-------------------------------|---|--|
| Test Site | Cerpass Technology Corporation Test Laboratory Address: No.10, Ln. 2, Lianfu St., Luzhu Dist., Taoyuan City 33848, Taiwan (R.O.C.) Tel:+886-3-3226-888 Fax:+886-3-3226-881 | |
| | FCC | TW1439, TW1079 |
| | IC | 4934E-1, 4934E-2 |
| | VCCI | T-2205 for Telecommunication test C-4663 for Conducted emission test R-4218 for Radiated emission test G-10812, G-10813 for radiated disturbance above 1GHz |
| Frequency Range Investigated: | Conducted: from 150kHz to 30 MHz Radiation: from 30 MHz to 40,000MHz | |
| Test Distance: | The test distance of radiated emission from antenna to EUT is 3 M. | |

| Test Item | Test Site | Test period | Environmental Conditions | Tested By |
|----------------------------------|------------|-----------------------|--------------------------|------------|
| RF Conducted | RFCON01-NK | 2022/12/19~2022/12/26 | 20.5~23.9°C / 44~55% | Leon Huang |
| Radiated Emissions | 3M02-NK | 2022/12/18~2022/12/19 | 16~21°C / 44~53% | Leon Huang |
| AC Power Line Conducted Emission | CON01-NK | 2022/12/20 | 21°C / 66% | Leon Huang |



2.6. Measurement Uncertainty

ISO/IEC 17025 requires that an estimate of the measurement uncertainties associated with the emissions test results be included in the report. The measurement uncertainties given below are based on a 95% confidence level (based on a coverage factor (k=2))

| Measurement Item | Uncertainty |
|--|-------------|
| AC Power Line Conduction(150K~30MHz) | ±3.12dB |
| Radiated Spurious Emission(9KHz~30MHz) | ±3.4dB |
| Radiated Spurious Emission(30MHz~1GHz) | ±5.7dB |
| Radiated Spurious Emission(1GHz~40GHz) | ±6.8dB |
| 6dB Bandwidth | ±4.4% |
| 26dB Bandwidth | ±4.4% |
| Occupied Bandwidth | ±4.4% |
| Peak Output Power(Conducted Power Meter) | ±1.1dB |
| Power Spectral Density | ±1.8dB |
| Duty Cycle | ±1.2% |
| Frequency Stability | ±0.21KHz |



3. Test Equipment and Ancillaries Used for Tests

| Test Item | Radiated Emissions | | | | |
|---------------------|-----------------------------|---------------|-----------------|------------------|------------|
| Test Site | Semi Anechoic Room(3M02-NK) | | | | |
| Instrument | Manufacturer | Model No | Serial No | Calibration Date | Valid Date |
| Bilog Antenna | Schwarzbeck | VULB9168 | 369 | 2022/04/22 | 2023/04/21 |
| Active Loop Antenna | EMCO | 6507 | 40855 | 2022/05/25 | 2023/05/24 |
| Horn Antenna | EMCO | 3115 | 31601 | 2022/10/12 | 2023/10/11 |
| Horn Antenna | EMCO | 3116 | 31970 | 2022/03/18 | 2023/03/17 |
| EMI Receiver | ROHDE & SCHWARZ | ESCI | 101423 | 2022/07/05 | 2023/07/04 |
| Spectrum Analyzer | ROHDE & SCHWARZ | FSV 40-N | 102151 | 2022/08/19 | 2023/08/18 |
| Preamplifier | Agilent | 8449B | 3008A01954 | 2022/03/17 | 2023/03/16 |
| Preamplifier | EMC INSTRUMENTS | EMC184045 | 980065 | 2022/11/11 | 2023/11/10 |
| Preamplifier | EM Electronics corp. | EM330 | 60660 | 2022/04/08 | 2023/04/07 |
| Cable-6m(9k~300M) | NA | EMC5D-BM-BM-6 | 130605 | 2022/09/06 | 2023/09/05 |
| Cable-3in1(30M-1G) | HARBOUR INDUSTRIES | LL142 | CCE1315 | 2022/03/21 | 2023/03/20 |
| Cable-0.5m(1G-40G) | HUBER SUHNER | SUCOFLEX 104 | 805443/4 | 2022/01/11 | 2023/01/10 |
| Cable-3m(1G-40G) | HUBER SUHNER | SUCOFLEX 104 | 805796/4 | 2022/01/11 | 2023/01/10 |
| Cable-8m(1G-26.5G) | WOKEN | WCBA-WCA203SM | CCE1374 | 2022/04/25 | 2023/04/24 |
| Cable-0.5m(30M-40G) | HUBER SUHNER | SUCOFLEX 102 | 28420/2 | 2022/4/9 | 2023/4/8 |
| Cable-3m(30M-40G) | HUBER SUHNER | SUCOFLEX 102 | MY2608/2 | 2022/4/9 | 2023/4/8 |
| Cable-0.5m(1G-40G) | Rapidtek | 40GHZ 50CM | 38MS-38MS50314 | 2022/4/9 | 2023/4/8 |
| Cable-3m(1G-40G) | Rapidtek | 40GHZ 300CM | 38MS-38MS300314 | 2022/4/9 | 2023/4/8 |
| E3 | AUDIX | v8.2014-8-6 | RK-000529 | NA | NA |

| Test Item | RF Conducted | | | | |
|---------------------|--------------|----------|------------|------------------|------------|
| Test Site | RFCON01-NK | | | | |
| Instrument | Manufacturer | Model No | Serial No | Calibration Date | Valid Date |
| CAX Signal Analyzer | KEYSIGHT | N9000B | MY57100339 | 2022/11/29 | 2023/11/28 |
| Power Meter | Anritsu | ML2495A | 1224005 | 2022/04/12 | 2023/04/11 |
| Power Sensor | Anritsu | MA2411B | 1207295 | 2022/04/12 | 2023/04/11 |
| Attenuator | KEYSIGHT | 8491B | MY39250703 | 2022/04/12 | 2023/04/11 |



| | | | | | |
|--------------------------------------|----------------------------------|-----------------|------------------|-------------------------|-------------------|
| Test Item | AC Power Line Conducted Emission | | | | |
| Test Site | CON01-NK | | | | |
| Instrument | Manufacturer | Model No | Serial No | Calibration Date | Valid Date |
| EMI Receiver | ROHDE & SCHWARZ | ESCI | 101200 | 2022/08/22 | 2023/08/21 |
| Line Impedance Stabilization Network | Schwarzbeck | NSLK 8127 | 8127-740 | 2022/08/21 | 2023/08/20 |
| Pulse Limiter | ROHDE & SCHWARZ | ESH3-Z2 | 101934 | 2022/03/21 | 2023/03/20 |
| Cable-6m(9k~300M) | NA | EMC5D-BM-BM-6 | 130606 | 2022/03/21 | 2023/03/20 |
| E3 | AUDIX | v8.2014-8-6 | RK-000531 | NA | NA |



4. Antenna Requirements

4.1. Standard Applicable

For intentional device, according to FCC 47 CFR Section 15.203, an intentional radiator shall be designed to ensure that no antenna other than that furnished by the responsible party shall be used with the device.

And according to FCC 47 CFR Section 15.407 (a), if transmitting antennas of directional gain greater than 6dBi are used, the power shall be reduced by the amount in dB that the directional gain of the antenna exceeds 6dBi.

4.2. Antenna Construction and Directional Gain

| | |
|--------------|--|
| Antenna Type | Dipole Antenna |
| Antenna Gain | 5150-5250MHz: ANT A: 2.49dBi, ANT B: 1.90dBi 5250-5350MHz: ANT A: 2.92dBi, ANT B: 1.90dBi 5471-5725MHz: ANT A: 3.50dBi, ANT B: 2.83dBi 5725-5850MHz: ANT A: 2.70dBi, ANT B: 2.32dBi |

| |
|---|
| 5150MHz -5250MHz |
| For Power directional gain= $G_{ant}= 2.49\text{dBi}$ For PSD directional gain = $10 \log[(10^{G1/20} + 10^{G2/20} + \dots + 10^{GN/20})^2 / N_{ANT}]$ = 5.21 dBi |
| 5250MHz -5350MHz |
| For Power directional gain= $G_{ant}= 2.92\text{dBi}$ For PSD directional gain = $10 \log[(10^{G1/20} + 10^{G2/20} + \dots + 10^{GN/20})^2 / N_{ANT}]$ = 5.44 dBi |
| 5471MHz -5725MHz |
| For Power directional gain= $G_{ant}= 3.50\text{dBi}$ For PSD directional gain = $10 \log[(10^{G1/20} + 10^{G2/20} + \dots + 10^{GN/20})^2 / N_{ANT}]$ = 6.18 dBi |
| 5725MHz -5850MHz |
| For Power directional gain= $G_{ant}= 2.70 \text{ dBi}$ For PSD directional gain = $10 \log[(10^{G1/20} + 10^{G2/20} + \dots + 10^{GN/20})^2 / N_{ANT}]$ = 5.52 dBi |

*MIMO type: Cyclic Delay Diversity (CDD) mode.



5. Test of AC Power Line Conducted Emission

5.1. Test Limit

Conducted Emissions were measured from 150 kHz to 30 MHz with a bandwidth of 9 KHz, according to the methods defined in ANSI C63.10-2013. The EUT was placed on a nonmetallic stand in a shielded room 0.8 meters above the ground plane. The interface cables and equipment positioning were varied within limits of reasonable applications to determine the position produced maximum conducted emissions.

| Frequency (MHz) | Quasi Peak (dB μ V) | Average (dB μ V) |
|-----------------|-------------------------|----------------------|
| 0.15 – 0.5 | 66-56* | 56-46* |
| 0.5 – 5.0 | 56 | 46 |
| 5.0 – 30.0 | 60 | 50 |

*Decreases with the logarithm of the frequency.

5.2. Test Procedures

- The EUT was placed 0.4 meter from the conducting wall of the shielding room was kept at least 80 centimeters from any other grounded conducting surface.
- Connect EUT to the power mains through a line impedance stabilization network (LISN).
- All the support units are connecting to the other LISN.
- The LISN provides 50 ohm coupling impedance for the measuring instrument.
- The FCC states that a 50 ohm, 50 micro-Henry LISN should be used.
- Both sides of AC line were checked for maximum conducted interference.
- The frequency range from 150 kHz to 30 MHz was searched.
- Set the test-receiver system to Peak Detect Function and Specified Bandwidth with Maximum Hold Mode.



5.3. Typical Test Setup

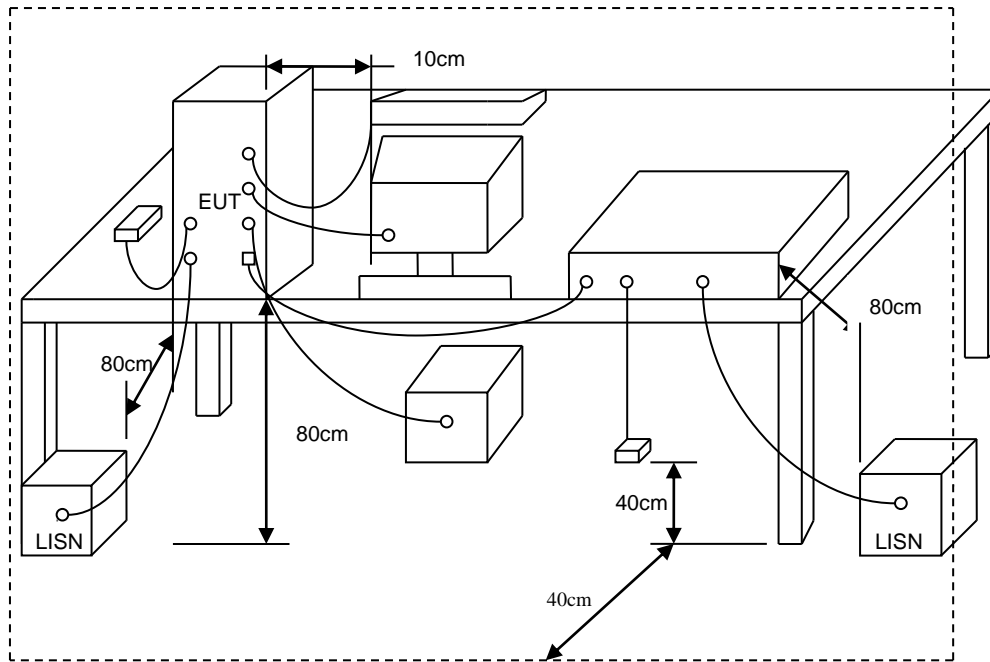



5.4. Test Result and Data

| | | | | | |
|-----------|---|----------------------------------|-----------|---|------|
| Power | : | From Adapter (AC 120V / 60Hz) | Pol/Phase | : | LINE |
| Test Mode | : | Mode 4, CH144 | | : | |

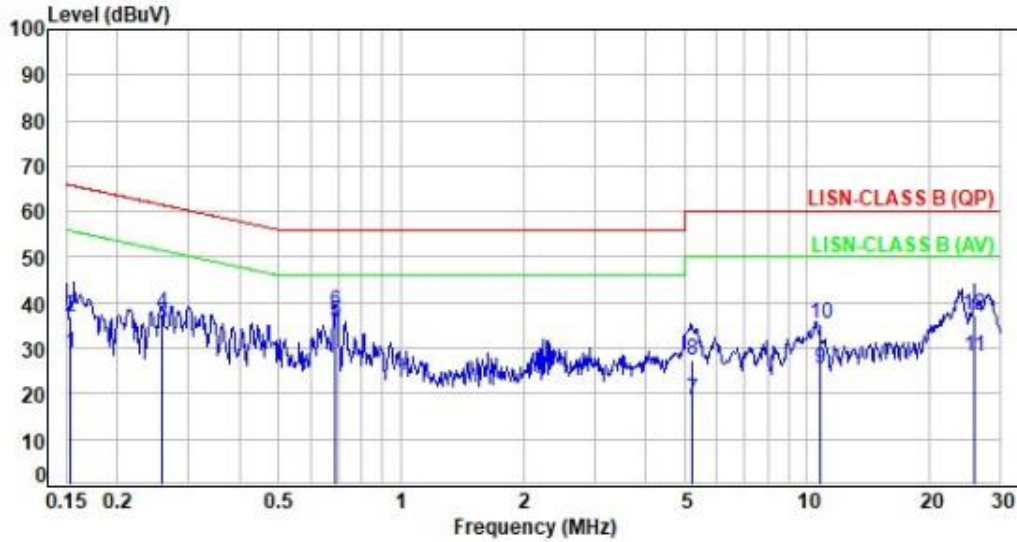

| No. | Frequency (MHz) | Factor (dB) | Reading (dBuV) | Level (dBuV) | Limit (dBuV) | Margin (dB) | Detector | P/F |
|-----|-----------------|-------------|----------------|--------------|--------------|-------------|----------|-----|
| 1 | 0.15 | 19.47 | 9.51 | 28.98 | 55.81 | -26.83 | Average | P |
| 2 | 0.15 | 19.47 | 17.42 | 36.89 | 65.81 | -28.92 | QP | P |
| 3 | 0.26 | 19.44 | 15.89 | 35.33 | 51.51 | -16.18 | Average | P |
| 4 | 0.26 | 19.44 | 18.37 | 37.81 | 61.51 | -23.70 | QP | P |
| 5 | 0.69 | 19.44 | 16.48 | 35.92 | 46.00 | -10.08 | Average | P |
| 6 | 0.69 | 19.44 | 18.43 | 37.87 | 56.00 | -18.13 | QP | P |
| 7 | 5.21 | 19.38 | -0.67 | 18.71 | 50.00 | -31.29 | Average | P |
| 8 | 5.21 | 19.38 | 8.00 | 27.38 | 60.00 | -32.62 | QP | P |
| 9 | 10.81 | 19.42 | 5.96 | 25.38 | 50.00 | -24.62 | Average | P |
| 10 | 10.81 | 19.42 | 15.83 | 35.25 | 60.00 | -24.75 | QP | P |
| 11 | 25.72 | 19.34 | 8.67 | 28.01 | 50.00 | -21.99 | Average | P |
| 12 | 25.72 | 19.34 | 17.95 | 37.29 | 60.00 | -22.71 | QP | P |

Note: Level=Reading+Factor
 Margin=Level-Limit
 Factor=(LISN or ISN or Current Probe)Factor + Cable Loss



| | | | |
|-----------|------------------------------------|-----------|-----------|
| Power | : From Adapter (AC 120V / 60Hz) | Pol/Phase | : NEUTRAL |
| Test Mode | : Mode 4, CH144 | | : |

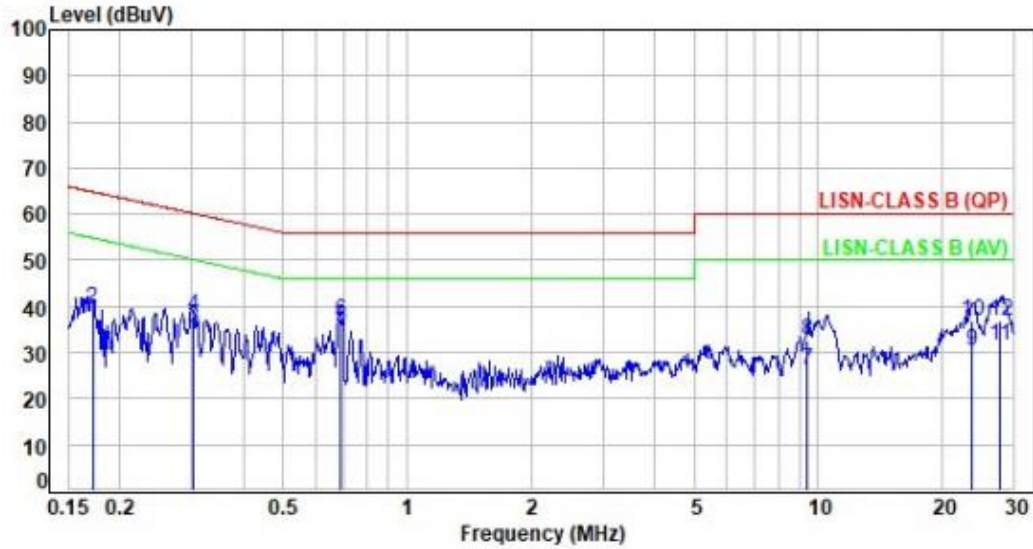

| No. | Frequency (MHz) | Factor (dB) | Reading (dBuV) | Level (dBuV) | Limit (dBuV) | Margin (dB) | Detector | P/F |
|-----|-----------------|-------------|----------------|--------------|--------------|-------------|----------|-----|
| 1 | 0.17 | 19.47 | 17.38 | 36.85 | 54.88 | -18.03 | Average | P |
| 2 | 0.17 | 19.47 | 20.01 | 39.48 | 64.88 | -25.40 | QP | P |
| 3 | 0.30 | 19.45 | 15.89 | 35.34 | 50.20 | -14.86 | Average | P |
| 4 | 0.30 | 19.45 | 18.43 | 37.88 | 60.20 | -22.32 | QP | P |
| 5 | 0.69 | 19.43 | 16.12 | 35.55 | 46.00 | -10.45 | Average | P |
| 6 | 0.69 | 19.43 | 17.63 | 37.06 | 56.00 | -18.94 | QP | P |
| 7 | 9.42 | 19.38 | 6.77 | 26.15 | 50.00 | -23.85 | Average | P |
| 8 | 9.42 | 19.38 | 13.22 | 32.60 | 60.00 | -27.40 | QP | P |
| 9 | 23.73 | 19.39 | 11.15 | 30.54 | 50.00 | -19.46 | Average | P |
| 10 | 23.73 | 19.39 | 17.51 | 36.90 | 60.00 | -23.10 | QP | P |
| 11 | 27.63 | 19.38 | 12.07 | 31.45 | 50.00 | -18.55 | Average | P |
| 12 | 27.63 | 19.38 | 17.51 | 36.89 | 60.00 | -23.11 | QP | P |

Note: Level=Reading+Factor
 Margin=Level-Limit
 Factor=(LISN or ISN or Current Probe)Factor + Cable Loss



6. Test of Spurious Emission (Radiated)

6.1. Test Limit

Undesirable emission limits. Except as shown in paragraph (b)(7) of this section, the maximum emissions outside of the frequency bands of operation shall be attenuated in accordance with the following limits:

- (1) For transmitters operating in the 5.15-5.25 GHz band: All emissions outside of the 5.15-5.35 GHz band shall not exceed an e.i.r.p. of -27 dBm/MHz.
- (2) For transmitters operating in the 5.25-5.35 GHz band: All emissions outside of the 5.15-5.35 GHz band shall not exceed an e.i.r.p. of -27 dBm/MHz.
- (3) For transmitters operating in the 5.47-5.725 GHz band: All emissions outside of the 5.47-5.725 GHz band shall not exceed an e.i.r.p. of -27 dBm/MHz.
- (4) For transmitters operating in the 5.725-5.85 GHz band:
All emissions shall be limited to a level of -27 dBm/MHz at 75 MHz or more above or below the band edge increasing linearly to 10 dBm/MHz at 25 MHz above or below the band edge, and from 25MHz above or below the band edge increasing linearly to a level of 15.6 dBm/MHz at 5 MHz above or below the band edge, and from 5 MHz above or below the band edge increasing linearly to a level of 27dBm/MHz at the band edge.
- (5) The emission measurements shall be performed using a minimum resolution bandwidth of 1 MHz. A lower resolution bandwidth may be employed near the band edge, when necessary, provided the measured energy is integrated to show the total power over 1 MHz.
- (6) Unwanted emissions below 1 GHz must comply with the general field strength limits set forth in §15.209. Further, any U-NII devices using an AC power line are required to comply also with the conducted limits set forth in §15.207.
- (7) The provisions of §15.205 apply to intentional radiators operating under this section.
- (8) When measuring the emission limits, the nominal carrier frequency shall be adjusted as close to the upper and lower frequency band edges as the design of the equipment permits.



6.2. Test Procedures

- a. The EUT was placed on a rotatable table top 0.8 meter above ground.
- b. The EUT was set 3 meters from the interference receiving antenna which was mounted on the top of a variable height antenna tower.
- c. The table was rotated 360 degrees to determine the position of the highest radiation.
- d. The antenna is a broadband antenna and its height is varied between one meter and four meters above ground to find the maximum value of the field strength both horizontal polarization and vertical polarization of the antenna are set to make the measurement.
- e. For each suspected emission the EUT was arranged to its worst case and then tune the antenna tower (from 1 M to 4 M) and turn table (from 0 degree to 360 degrees) to find the maximum reading.
- f. Set the test-receiver system to Peak or CISPR quasi-peak Detect Function and specified bandwidth with Maximum Hold Mode.
- g. If the emission level of the EUT in peak mode was 3 dB lower than the limit specified, then testing will be stopped and peak values of EUT will be reported, otherwise, the emissions which do not have 3 dB margin will be repeated one by one using the quasi-peak method and reported.
- h. For testing above 1GHz, the emission level of the EUT in peak mode was 20dB lower than average limit (that means the emission level in peak mode also complies with the limit in average mode), then testing will be stopped and peak values of EUT will be reported, otherwise, the emissions will be measured in average mode again and reported.
- i. "Cone of radiation" has been considered to be 3dB bandwidth of the measurement antenna.

Note:

- 1.The supporting fixture shall permit orientation of the EUT in each of three orthogonal axis positions such that emissions from the EUT are maximized.
(Y-AXIS is the worst.)
- 2.Due to the test software function limit the operation band setting(200dBuV/m). There's no corresponding limitation in the actual test item.



6.3. Typical Test Setup

Below 30MHz test setup

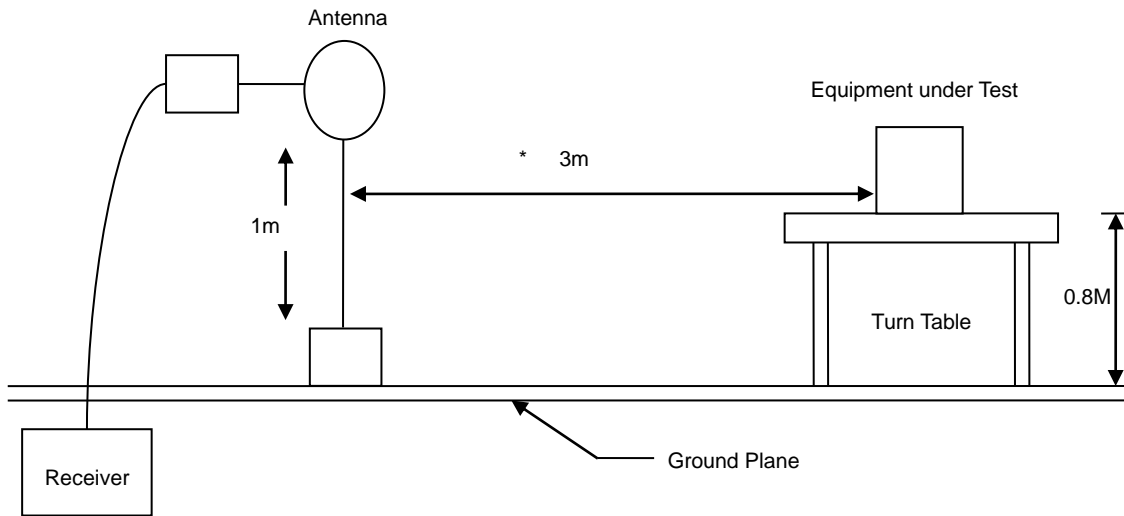

30MHz- 1GHz Test Setup

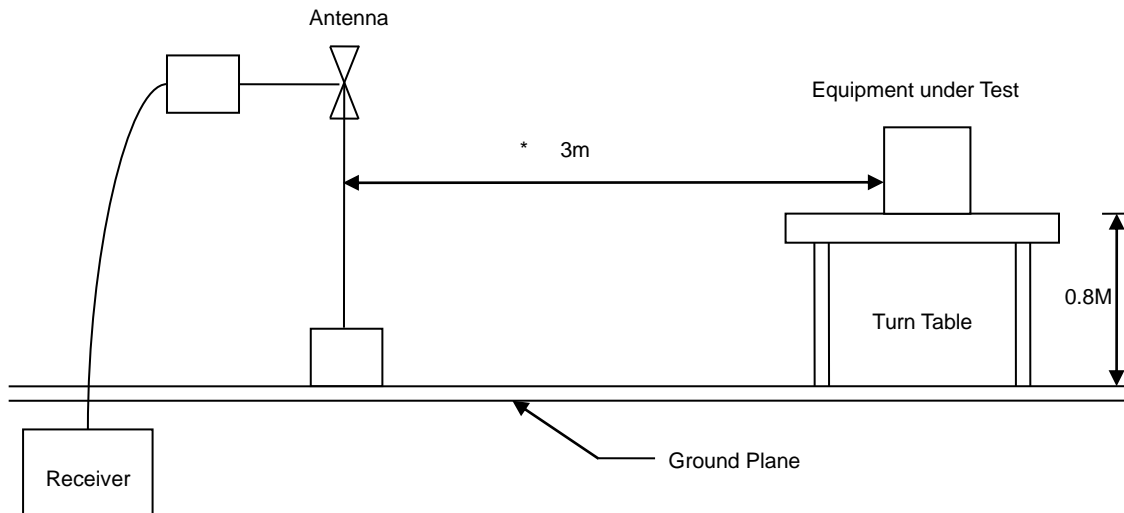

Above 1GHz Test Setup

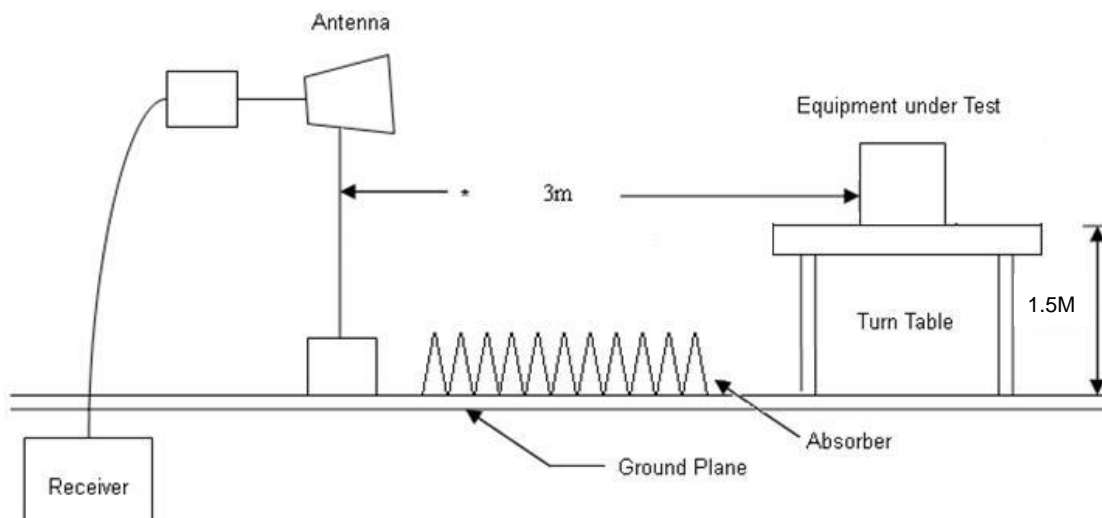



6.4. Test Result and Data (9kHz ~ 30MHz)

The 9kHz - 30MHz spurious emission is under limit 20dB more.

6.5. Test Result and Data (30MHz ~ 1GHz)

| | | | | | |
|-----------|---|----------------------------------|-----------|---|----------|
| Power | : | From Adapter (AC 120V / 60Hz) | Pol/Phase | : | VERTICAL |
| Test Mode | : | Mode 4, CH144 | | : | |

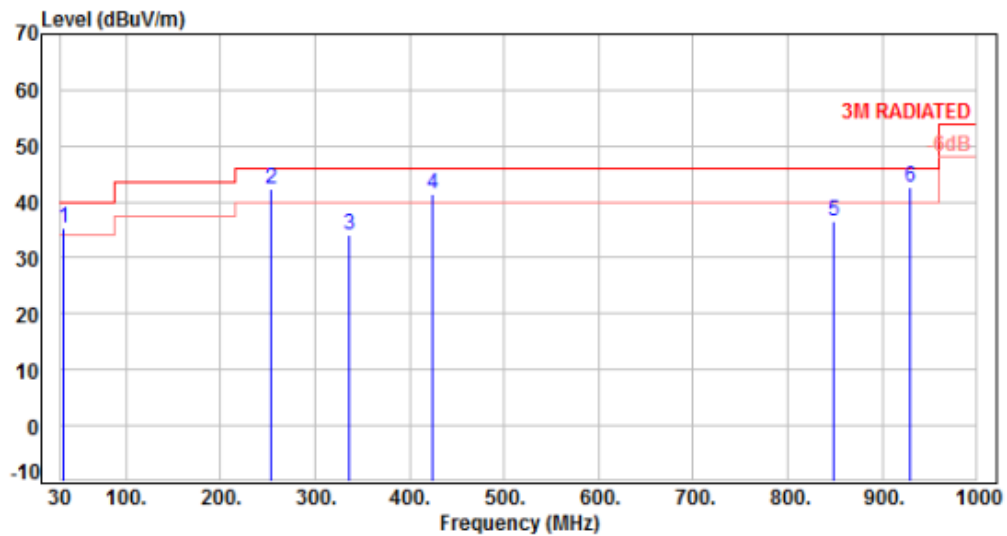

| No. | Frequency (MHz) | Factor (dB) | Reading (dBUV) | Level (dBUV/m) | Limit (dBUV/m) | Margin (dB) | Detector | Height (cm) | Azimuth (deg) | P/F |
|-----|-----------------|-------------|----------------|----------------|----------------|-------------|----------|-------------|---------------|-----|
| 1 | 33.88 | -9.64 | 45.00 | 35.36 | 40.00 | -4.64 | QP | 100 | 355 | P |
| 2 | 253.10 | -9.99 | 52.43 | 42.44 | 46.00 | -3.56 | Peak | 100 | 360 | P |
| 3 | 336.52 | -7.26 | 41.43 | 34.17 | 46.00 | -11.83 | Peak | 100 | 360 | P |
| 4 | 423.82 | -4.87 | 46.31 | 41.44 | 46.00 | -4.56 | Peak | 100 | 360 | P |
| 5 | 848.68 | 2.80 | 33.69 | 36.49 | 46.00 | -9.51 | Peak | 100 | 360 | P |
| 6 | 930.16 | 4.17 | 38.33 | 42.50 | 46.00 | -3.50 | Peak | 100 | 360 | P |

Note: Level=Reading+Factor
Margin=Level-Limit
Factor=Antenna Factor + cable loss - Amplifier Factor



| | | | | | |
|-----------|---|----------------------------------|-----------|---|------------|
| Power | : | From Adapter (AC 120V / 60Hz) | Pol/Phase | : | HORIZONTAL |
| Test Mode | : | Mode 4, CH144 | | : | |

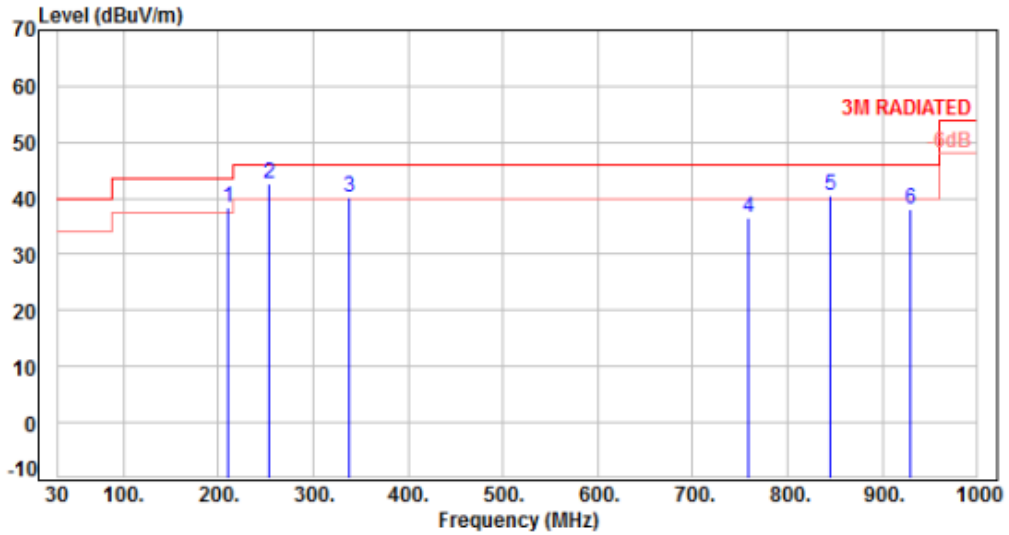

| No. | Frequency (MHz) | Factor (dB) | Reading (dBuV) | Level (dBuV/m) | Limit (dBuV/m) | Margin (dB) | Detector | Height (cm) | Azimuth (deg) | P/F |
|-----|-----------------|-------------|----------------|----------------|----------------|-------------|----------|-------------|---------------|-----|
| 1 | 210.42 | -11.59 | 49.91 | 38.32 | 43.50 | -5.18 | Peak | 100 | 360 | P |
| 2 | 253.10 | -9.99 | 52.47 | 42.48 | 46.00 | -3.52 | Peak | 100 | 360 | P |
| 3 | 338.46 | -7.21 | 47.52 | 40.31 | 46.00 | -5.69 | Peak | 100 | 360 | P |
| 4 | 759.44 | 1.87 | 34.70 | 36.57 | 46.00 | -9.43 | Peak | 100 | 360 | P |
| 5 | 844.80 | 2.71 | 37.80 | 40.51 | 46.00 | -5.49 | Peak | 100 | 360 | P |
| 6 | 930.16 | 4.17 | 33.93 | 38.10 | 46.00 | -7.90 | Peak | 100 | 360 | P |

Note: Level=Reading+Factor
 Margin=Level-Limit
 Factor=Antenna Factor + cable loss - Amplifier Factor



6.6. Test Result and Data (1GHz ~ 40GHz)

| | | | | | |
|-----------|---|----------------------------------|-----------|---|----------|
| Power | : | From Adapter (AC 120V / 60Hz) | Pol/Phase | : | VERTICAL |
| Test Mode | : | Mode 1, Band 1, CH36 | | : | |

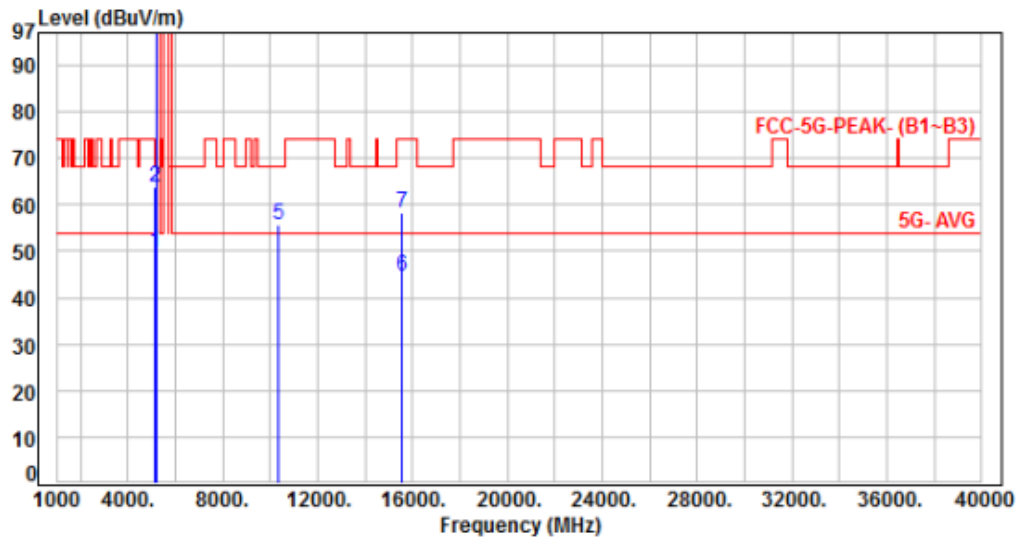

| No. | Frequency (MHz) | Factor (dB) | Reading (dBuV) | Level (dBuV/m) | Limit (dBuV/m) | Margin (dB) | Detector | Height (cm) | Azimuth (deg) | P/F |
|-----|-----------------|-------------|----------------|----------------|----------------|-------------|----------|-------------|---------------|-----|
| 1 | 5150.00 | 6.21 | 43.44 | 49.65 | 54.00 | -4.35 | Average | 100 | 108 | P |
| 2 | 5150.00 | 6.21 | 57.75 | 63.96 | 74.00 | -10.04 | Peak | 100 | 108 | P |
| 3 | 5180.00 | 6.29 | 89.33 | 95.62 | 200.00 | -104.38 | Average | 100 | 108 | P |
| 4 | 5180.00 | 6.29 | 100.17 | 106.46 | 200.00 | -93.54 | Peak | 100 | 108 | P |
| 5 | 10360.00 | 13.73 | 41.93 | 55.66 | 68.20 | -12.54 | Peak | 100 | 159 | P |
| 6 | 15540.00 | 16.41 | 28.38 | 44.79 | 54.00 | -9.21 | Average | 100 | 294 | P |
| 7 | 15540.00 | 16.41 | 42.03 | 58.44 | 74.00 | -15.56 | Peak | 100 | 294 | P |

Note: Level=Reading+Factor
Margin=Level-Limit
Factor=Antenna Factor + cable loss - Amplifier Factor



| | | | | | |
|-----------|---|----------------------------------|-----------|---|------------|
| Power | : | From Adapter (AC 120V / 60Hz) | Pol/Phase | : | HORIZONTAL |
| Test Mode | : | Mode 1, Band 1, CH36 | | : | |

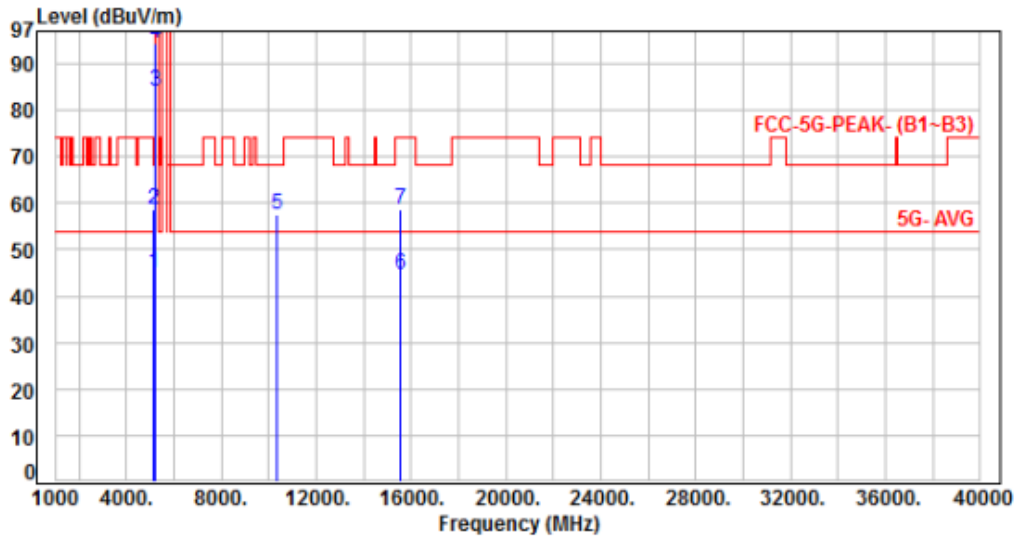

| No. | Frequency (MHz) | Factor (dB) | Reading (dBuV) | Level (dBuV/m) | Limit (dBuV/m) | Margin (dB) | Detector | Height (cm) | Azimuth (deg) | P/F |
|-----|-----------------|-------------|----------------|----------------|----------------|-------------|----------|-------------|---------------|-----|
| 1 | 5150.00 | 6.21 | 38.64 | 44.85 | 54.00 | -9.15 | Average | 100 | 223 | P |
| 2 | 5150.00 | 6.21 | 52.27 | 58.48 | 74.00 | -15.52 | Peak | 100 | 223 | P |
| 3 | 5180.00 | 6.29 | 77.92 | 84.21 | 200.00 | -115.79 | Average | 100 | 223 | P |
| 4 | 5180.00 | 6.29 | 88.23 | 94.52 | 200.00 | -105.48 | Peak | 100 | 223 | P |
| 5 | 10360.00 | 13.73 | 43.89 | 57.62 | 68.20 | -10.58 | Peak | 100 | 237 | P |
| 6 | 15540.00 | 16.41 | 28.11 | 44.52 | 54.00 | -9.48 | Average | 100 | 128 | P |
| 7 | 15540.00 | 16.41 | 42.23 | 58.64 | 74.00 | -15.36 | Peak | 100 | 128 | P |

Note: Level=Reading+Factor
 Margin=Level-Limit
 Factor=Antenna Factor + cable loss - Amplifier Factor



| | | | | | |
|-----------|---|----------------------------------|-----------|---|----------|
| Power | : | From Adapter (AC 120V / 60Hz) | Pol/Phase | : | VERTICAL |
| Test Mode | : | Mode 1, Band 1, CH40 | | : | |

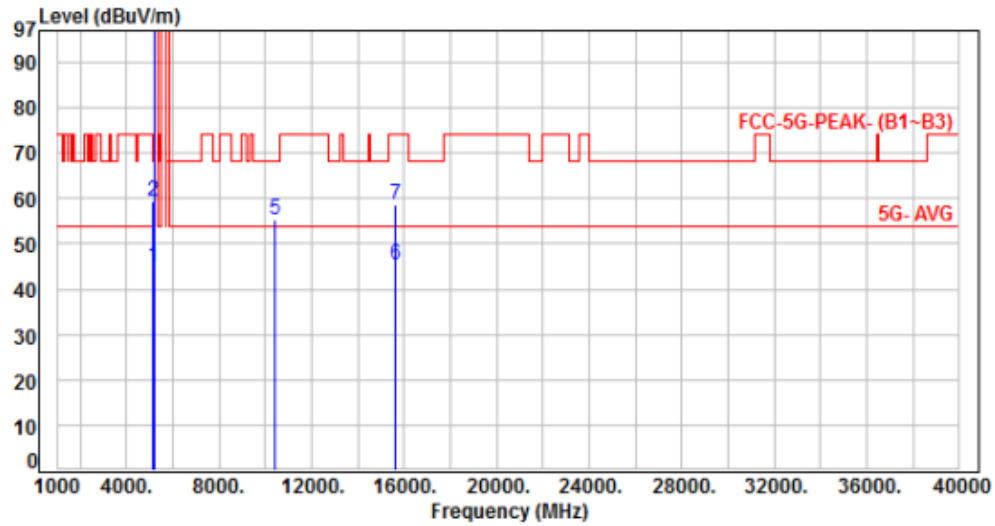

| No. | Frequency (MHz) | Factor (dB) | Reading (dBuV) | Level (dBuV/m) | Limit (dBuV/m) | Margin (dB) | Detector | Height (cm) | Azimuth (deg) | P/F |
|-----|-----------------|-------------|----------------|----------------|----------------|-------------|----------|-------------|---------------|-----|
| 1 | 5150.00 | 6.21 | 38.96 | 45.17 | 54.00 | -8.83 | Average | 100 | 110 | P |
| 2 | 5150.00 | 6.21 | 53.05 | 59.26 | 74.00 | -14.74 | Peak | 100 | 110 | P |
| 3 | 5200.00 | 6.34 | 89.19 | 95.53 | 200.00 | -104.47 | Average | 100 | 110 | P |
| 4 | 5200.00 | 6.34 | 99.99 | 106.33 | 200.00 | -93.67 | Peak | 100 | 110 | P |
| 5 | 10400.00 | 13.77 | 41.65 | 55.42 | 68.20 | -12.78 | Peak | 100 | 155 | P |
| 6 | 15600.00 | 16.33 | 29.08 | 45.41 | 54.00 | -8.59 | Average | 100 | 294 | P |
| 7 | 15600.00 | 16.33 | 42.23 | 58.56 | 74.00 | -15.44 | Peak | 100 | 294 | P |

Note: Level=Reading+Factor
Margin=Level-Limit
Factor=Antenna Factor + cable loss - Amplifier Factor



| | | | | | |
|-----------|---|----------------------------------|-----------|---|------------|
| Power | : | From Adapter (AC 120V / 60Hz) | Pol/Phase | : | HORIZONTAL |
| Test Mode | : | Mode 1, Band 1, CH40 | | : | |

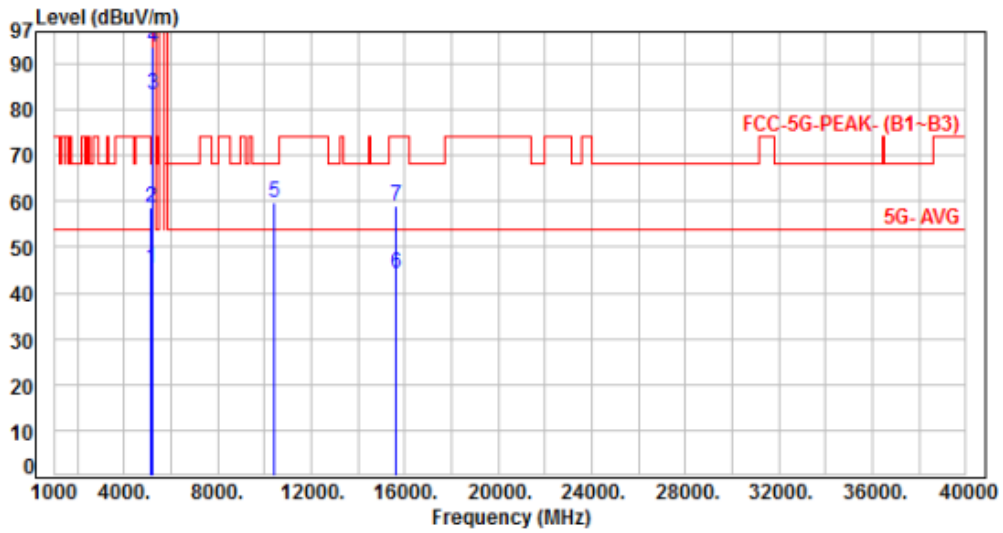

| No. | Frequency (MHz) | Factor (dB) | Reading (dBuV) | Level (dBuV/m) | Limit (dBuV/m) | Margin (dB) | Detector | Height (cm) | Azimuth (deg) | P/F |
|-----|-----------------|-------------|----------------|----------------|----------------|-------------|----------|-------------|---------------|-----|
| 1 | 5150.00 | 6.21 | 39.26 | 45.47 | 54.00 | -8.53 | Average | 100 | 221 | P |
| 2 | 5150.00 | 6.21 | 52.41 | 58.62 | 74.00 | -15.38 | Peak | 100 | 221 | P |
| 3 | 5200.00 | 6.34 | 76.97 | 83.31 | 200.00 | -116.69 | Average | 100 | 221 | P |
| 4 | 5200.00 | 6.34 | 87.23 | 93.57 | 200.00 | -106.43 | Peak | 100 | 221 | P |
| 5 | 10400.00 | 13.77 | 46.07 | 59.84 | 68.20 | -8.36 | Peak | 100 | 239 | P |
| 6 | 15600.00 | 16.33 | 28.05 | 44.38 | 54.00 | -9.62 | Average | 100 | 134 | P |
| 7 | 15600.00 | 16.33 | 42.66 | 58.99 | 74.00 | -15.01 | Peak | 100 | 134 | P |

Note: Level=Reading+Factor
 Margin=Level-Limit
 Factor=Antenna Factor + cable loss - Amplifier Factor



| | | | | | |
|-----------|---|----------------------------------|-----------|---|----------|
| Power | : | From Adapter (AC 120V / 60Hz) | Pol/Phase | : | VERTICAL |
| Test Mode | : | Mode 1, Band 1, CH48 | | : | |

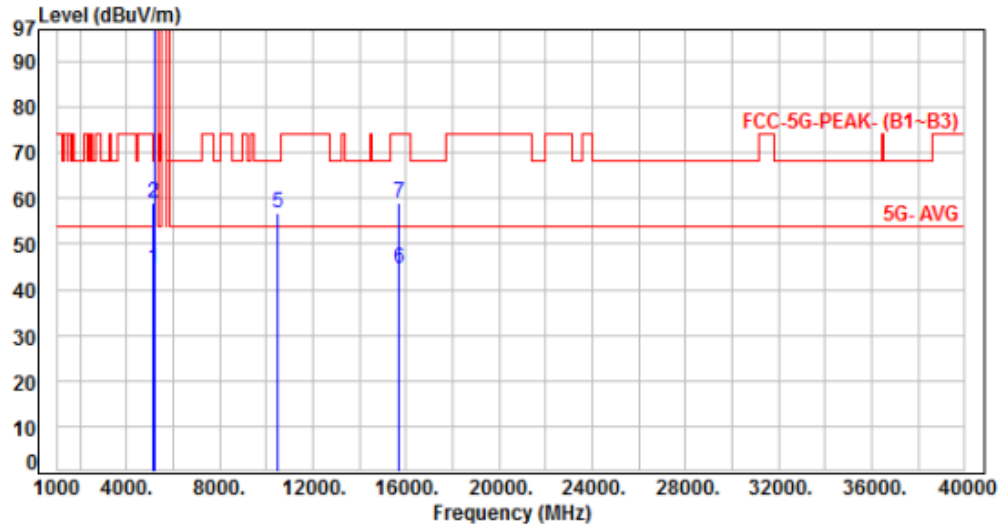

| No. | Frequency (MHz) | Factor (dB) | Reading (dBuV) | Level (dBuV/m) | Limit (dBuV/m) | Margin (dB) | Detector | Height (cm) | Azimuth (deg) | P/F |
|-----|-----------------|-------------|----------------|----------------|----------------|-------------|----------|-------------|---------------|-----|
| 1 | 5150.00 | 6.21 | 38.52 | 44.73 | 54.00 | -9.27 | Average | 100 | 107 | P |
| 2 | 5150.00 | 6.21 | 52.74 | 58.95 | 74.00 | -15.05 | Peak | 100 | 107 | P |
| 3 | 5240.00 | 6.46 | 89.10 | 95.56 | 200.00 | -104.44 | Average | 100 | 107 | P |
| 4 | 5240.00 | 6.46 | 100.55 | 107.01 | 200.00 | -92.99 | Peak | 100 | 107 | P |
| 5 | 10480.00 | 13.89 | 43.00 | 56.89 | 68.20 | -11.31 | Peak | 100 | 158 | P |
| 6 | 15720.00 | 15.62 | 28.87 | 44.49 | 54.00 | -9.51 | Average | 100 | 296 | P |
| 7 | 15720.00 | 15.62 | 43.29 | 58.91 | 74.00 | -15.09 | Peak | 100 | 296 | P |

Note: Level=Reading+Factor
 Margin=Level-Limit
 Factor=Antenna Factor + cable loss - Amplifier Factor



| | | | | | |
|-----------|---|----------------------------------|-----------|---|------------|
| Power | : | From Adapter (AC 120V / 60Hz) | Pol/Phase | : | HORIZONTAL |
| Test Mode | : | Mode 1, Band 1, CH48 | | : | |

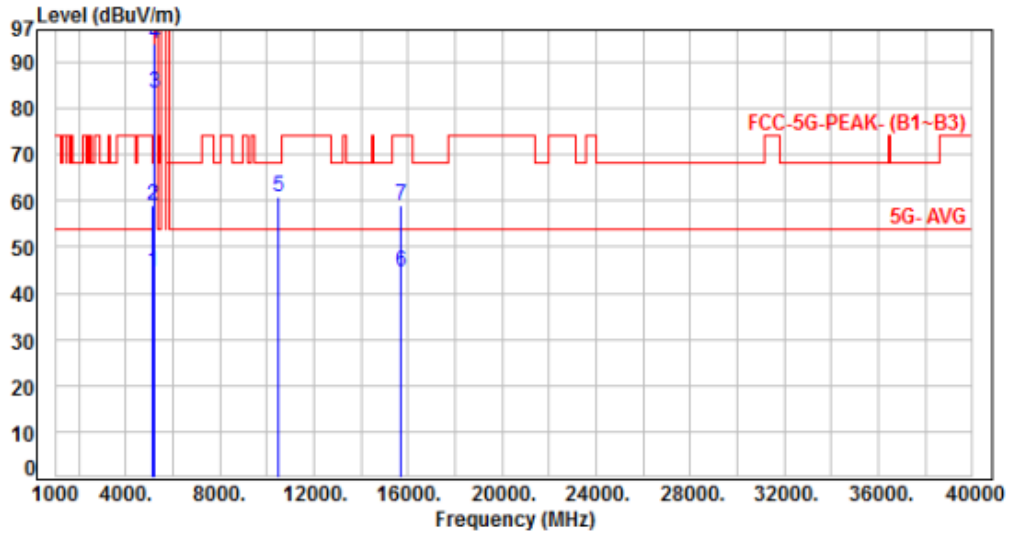

| No. | Frequency (MHz) | Factor (dB) | Reading (dBuV) | Level (dBuV/m) | Limit (dBuV/m) | Margin (dB) | Detector | Height (cm) | Azimuth (deg) | P/F |
|-----|-----------------|-------------|----------------|----------------|----------------|-------------|----------|-------------|---------------|-----|
| 1 | 5150.00 | 6.21 | 38.48 | 44.69 | 54.00 | -9.31 | Average | 100 | 219 | P |
| 2 | 5150.00 | 6.21 | 52.63 | 58.84 | 74.00 | -15.16 | Peak | 100 | 219 | P |
| 3 | 5240.00 | 6.46 | 77.03 | 83.49 | 200.00 | -116.51 | Average | 100 | 219 | P |
| 4 | 5240.00 | 6.46 | 87.57 | 94.03 | 200.00 | -105.97 | Peak | 100 | 219 | P |
| 5 | 10480.00 | 13.89 | 47.00 | 60.89 | 68.20 | -7.31 | Peak | 100 | 234 | P |
| 6 | 15720.00 | 15.62 | 29.11 | 44.73 | 54.00 | -9.27 | Average | 100 | 133 | P |
| 7 | 15720.00 | 15.62 | 43.49 | 59.11 | 74.00 | -14.89 | Peak | 100 | 133 | P |

Note: Level=Reading+Factor
 Margin=Level-Limit
 Factor=Antenna Factor + cable loss - Amplifier Factor



| | | | | | |
|-----------|---|----------------------------------|-----------|---|----------|
| Power | : | From Adapter (AC 120V / 60Hz) | Pol/Phase | : | VERTICAL |
| Test Mode | : | Mode 4, Band 1, CH36 | | : | |

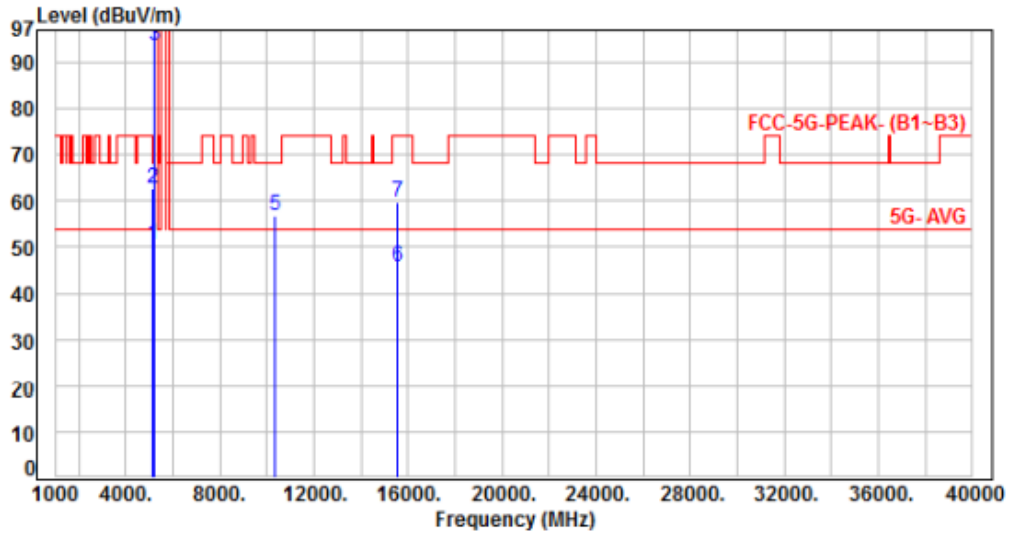

| No. | Frequency (MHz) | Factor (dB) | Reading (dBuV) | Level (dBuV/m) | Limit (dBuV/m) | Margin (dB) | Detector | Height (cm) | Azimuth (deg) | P/F |
|-----|-----------------|-------------|----------------|----------------|----------------|-------------|----------|-------------|---------------|-----|
| 1 | 5150.00 | 6.21 | 44.39 | 50.60 | 54.00 | -3.40 | Average | 100 | 103 | P |
| 2 | 5150.00 | 6.21 | 56.53 | 62.74 | 74.00 | -11.26 | Peak | 100 | 103 | P |
| 3 | 5180.00 | 6.29 | 87.33 | 93.62 | 200.00 | -106.38 | Average | 100 | 103 | P |
| 4 | 5180.00 | 6.29 | 97.56 | 103.85 | 200.00 | -96.15 | Peak | 100 | 103 | P |
| 5 | 10360.00 | 13.73 | 43.08 | 56.81 | 68.20 | -11.39 | Peak | 100 | 160 | P |
| 6 | 15540.00 | 16.41 | 29.26 | 45.67 | 54.00 | -8.33 | Average | 100 | 299 | P |
| 7 | 15540.00 | 16.41 | 43.43 | 59.84 | 74.00 | -14.16 | Peak | 100 | 299 | P |

Note: Level=Reading+Factor
 Margin=Level-Limit
 Factor=Antenna Factor + cable loss - Amplifier Factor



| | | | | | |
|-----------|---|----------------------------------|-----------|---|------------|
| Power | : | From Adapter (AC 120V / 60Hz) | Pol/Phase | : | HORIZONTAL |
| Test Mode | : | Mode 4, Band 1, CH36 | | : | |

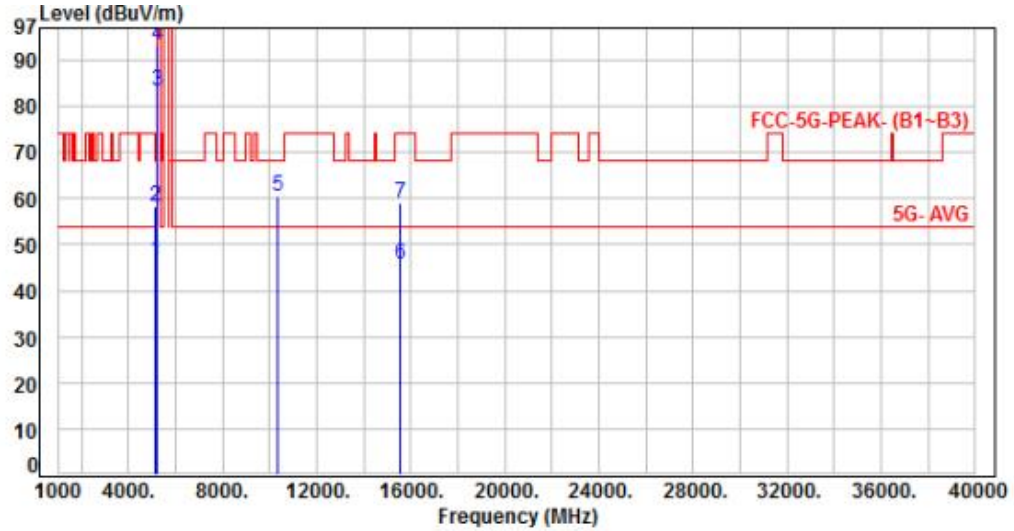

| No. | Frequency (MHz) | Factor (dB) | Reading (dBuV) | Level (dBuV/m) | Limit (dBuV/m) | Margin (dB) | Detector | Height (cm) | Azimuth (deg) | P/F |
|-----|-----------------|-------------|----------------|----------------|----------------|-------------|----------|-------------|---------------|-----|
| 1 | 5150.00 | 6.21 | 40.27 | 46.48 | 54.00 | -7.52 | Average | 100 | 216 | P |
| 2 | 5150.00 | 6.21 | 52.18 | 58.39 | 74.00 | -15.61 | Peak | 100 | 216 | P |
| 3 | 5180.00 | 6.29 | 76.92 | 83.21 | 200.00 | -116.79 | Average | 100 | 216 | P |
| 4 | 5180.00 | 6.29 | 87.16 | 93.45 | 200.00 | -106.55 | Peak | 100 | 216 | P |
| 5 | 10360.00 | 13.73 | 46.58 | 60.31 | 68.20 | -7.89 | Peak | 100 | 234 | P |
| 6 | 15540.00 | 16.41 | 29.36 | 45.77 | 54.00 | -8.23 | Average | 100 | 129 | P |
| 7 | 15540.00 | 16.41 | 42.78 | 59.19 | 74.00 | -14.81 | Peak | 100 | 129 | P |

Note: Level=Reading+Factor
 Margin=Level-Limit
 Factor=Antenna Factor + cable loss - Amplifier Factor



| | | | | | |
|-----------|---|----------------------------------|-----------|---|----------|
| Power | : | From Adapter (AC 120V / 60Hz) | Pol/Phase | : | VERTICAL |
| Test Mode | : | Mode 4, Band 1, CH40 | | : | |

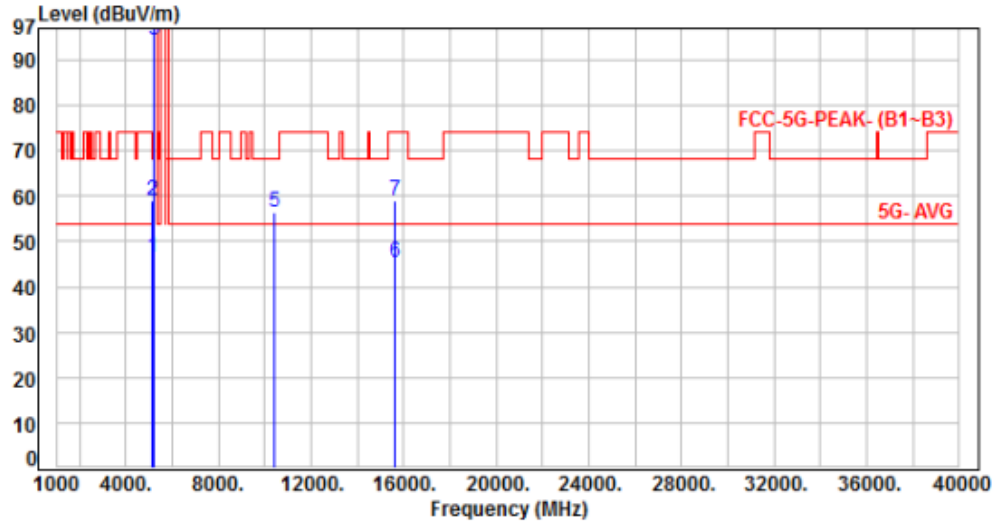

| No. | Frequency (MHz) | Factor (dB) | Reading (dBuV) | Level (dBuV/m) | Limit (dBuV/m) | Margin (dB) | Detector | Height (cm) | Azimuth (deg) | P/F |
|-----|-----------------|-------------|----------------|----------------|----------------|-------------|----------|-------------|---------------|-----|
| 1 | 5150.00 | 6.21 | 40.25 | 46.46 | 54.00 | -7.54 | Average | 100 | 106 | P |
| 2 | 5150.00 | 6.21 | 52.96 | 59.17 | 74.00 | -14.83 | Peak | 100 | 106 | P |
| 3 | 5200.00 | 6.34 | 87.96 | 94.30 | 200.00 | -105.70 | Average | 100 | 106 | P |
| 4 | 5200.00 | 6.34 | 98.06 | 104.40 | 200.00 | -95.60 | Peak | 100 | 106 | P |
| 5 | 10400.00 | 13.77 | 42.64 | 56.41 | 68.20 | -11.79 | Peak | 100 | 157 | P |
| 6 | 15600.00 | 16.33 | 28.94 | 45.27 | 54.00 | -8.73 | Average | 100 | 286 | P |
| 7 | 15600.00 | 16.33 | 42.58 | 58.91 | 74.00 | -15.09 | Peak | 100 | 286 | P |

Note: Level=Reading+Factor
Margin=Level-Limit
Factor=Antenna Factor + cable loss - Amplifier Factor



| | | | | | |
|-----------|---|----------------------------------|-----------|---|------------|
| Power | : | From Adapter (AC 120V / 60Hz) | Pol/Phase | : | HORIZONTAL |
| Test Mode | : | Mode 4, Band 1, CH40 | | : | |

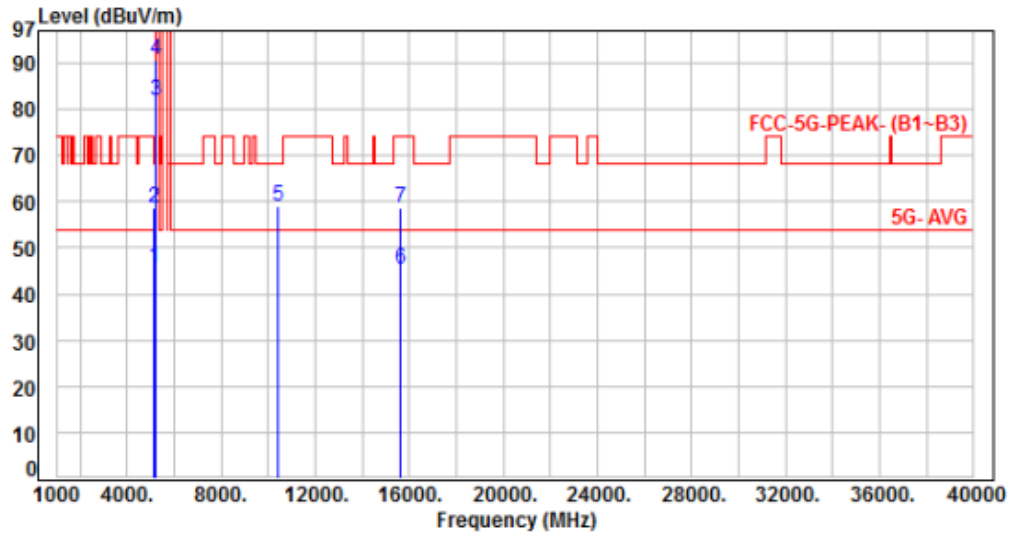

| No. | Frequency (MHz) | Factor (dB) | Reading (dBuV) | Level (dBuV/m) | Limit (dBuV/m) | Margin (dB) | Detector | Height (cm) | Azimuth (deg) | P/F |
|-----|-----------------|-------------|----------------|----------------|----------------|-------------|----------|-------------|---------------|-----|
| 1 | 5150.00 | 6.21 | 39.65 | 45.86 | 54.00 | -8.14 | Average | 100 | 220 | P |
| 2 | 5150.00 | 6.21 | 52.27 | 58.48 | 74.00 | -15.52 | Peak | 100 | 220 | P |
| 3 | 5200.00 | 6.34 | 75.37 | 81.71 | 200.00 | -118.29 | Average | 100 | 220 | P |
| 4 | 5200.00 | 6.34 | 84.30 | 90.64 | 200.00 | -109.36 | Peak | 100 | 220 | P |
| 5 | 10400.00 | 13.77 | 45.11 | 58.88 | 68.20 | -9.32 | Peak | 100 | 232 | P |
| 6 | 15600.00 | 16.33 | 29.01 | 45.34 | 54.00 | -8.66 | Average | 100 | 134 | P |
| 7 | 15600.00 | 16.33 | 42.21 | 58.54 | 74.00 | -15.46 | Peak | 100 | 134 | P |

Note: Level=Reading+Factor
 Margin=Level-Limit
 Factor=Antenna Factor + cable loss - Amplifier Factor



| | | | | | |
|-----------|---|----------------------------------|-----------|---|----------|
| Power | : | From Adapter (AC 120V / 60Hz) | Pol/Phase | : | VERTICAL |
| Test Mode | : | Mode 4, Band 1, CH48 | | : | |

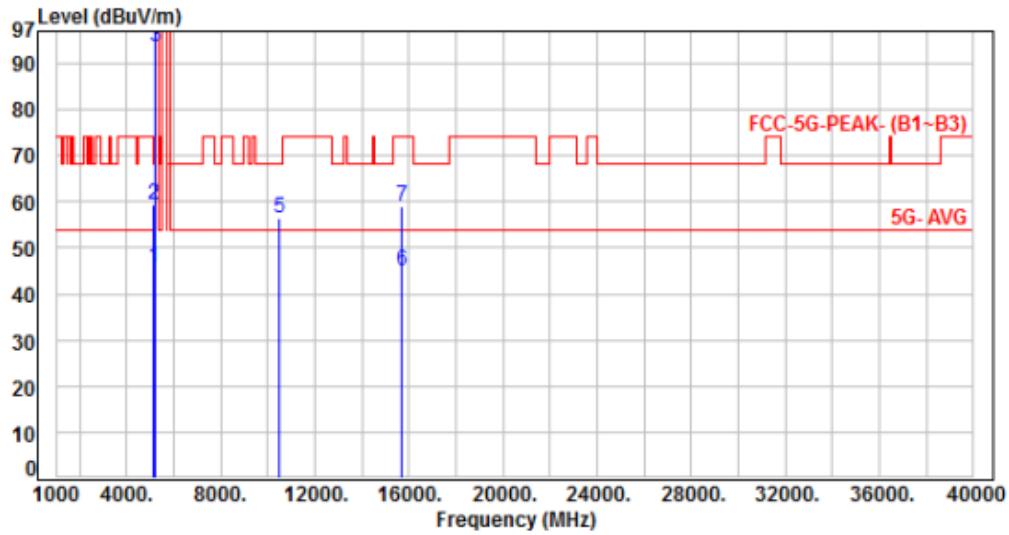

| No. | Frequency (MHz) | Factor (dB) | Reading (dBuV) | Level (dBuV/m) | Limit (dBuV/m) | Margin (dB) | Detector | Height (cm) | Azimuth (deg) | P/F |
|-----|-----------------|-------------|----------------|----------------|----------------|-------------|----------|-------------|---------------|-----|
| 1 | 5150.00 | 6.21 | 39.38 | 45.59 | 54.00 | -8.41 | Average | 100 | 111 | P |
| 2 | 5150.00 | 6.21 | 53.22 | 59.43 | 74.00 | -14.57 | Peak | 100 | 111 | P |
| 3 | 5240.00 | 6.46 | 87.11 | 93.57 | 200.00 | -106.43 | Average | 100 | 111 | P |
| 4 | 5240.00 | 6.46 | 96.97 | 103.43 | 200.00 | -96.57 | Peak | 100 | 111 | P |
| 5 | 10480.00 | 13.89 | 42.65 | 56.54 | 68.20 | -11.66 | Peak | 100 | 159 | P |
| 6 | 15720.00 | 15.62 | 29.38 | 45.00 | 54.00 | -9.00 | Average | 100 | 291 | P |
| 7 | 15720.00 | 15.62 | 43.26 | 58.88 | 74.00 | -15.12 | Peak | 100 | 291 | P |

Note: Level=Reading+Factor
 Margin=Level-Limit
 Factor=Antenna Factor + cable loss - Amplifier Factor



| | | | | | |
|-----------|---|----------------------------------|-----------|---|------------|
| Power | : | From Adapter (AC 120V / 60Hz) | Pol/Phase | : | HORIZONTAL |
| Test Mode | : | Mode 4, Band 1, CH48 | | : | |

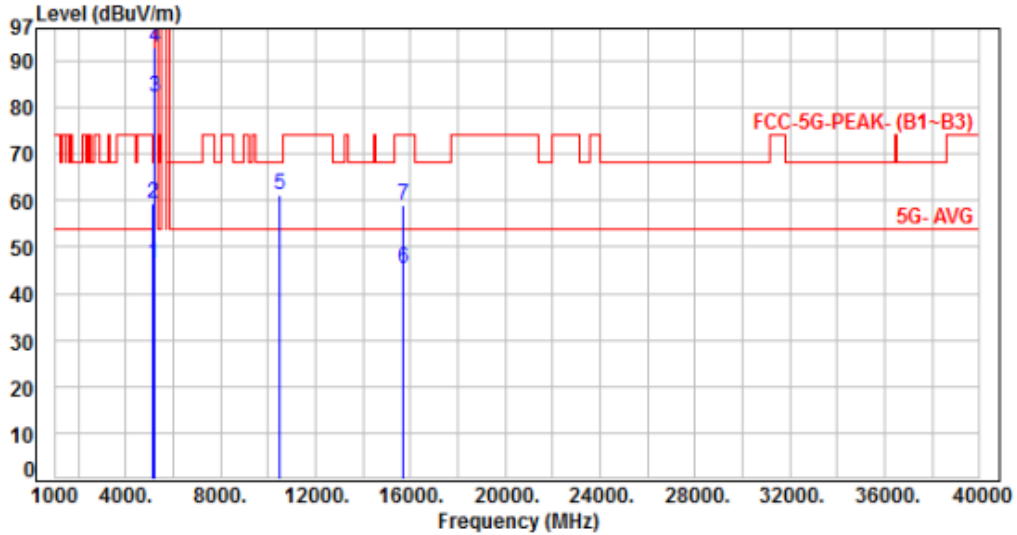

| No. | Frequency (MHz) | Factor (dB) | Reading (dBuV) | Level (dBuV/m) | Limit (dBuV/m) | Margin (dB) | Detector | Height (cm) | Azimuth (deg) | P/F |
|-----|-----------------|-------------|----------------|----------------|----------------|-------------|----------|-------------|---------------|-----|
| 1 | 5150.00 | 6.21 | 40.17 | 46.38 | 54.00 | -7.62 | Average | 100 | 215 | P |
| 2 | 5150.00 | 6.21 | 53.14 | 59.35 | 74.00 | -14.65 | Peak | 100 | 215 | P |
| 3 | 5240.00 | 6.46 | 75.90 | 82.36 | 200.00 | -117.64 | Average | 100 | 215 | P |
| 4 | 5240.00 | 6.46 | 86.65 | 93.11 | 200.00 | -106.89 | Peak | 100 | 215 | P |
| 5 | 10480.00 | 13.89 | 47.16 | 61.05 | 68.20 | -7.15 | Peak | 100 | 235 | P |
| 6 | 15720.00 | 15.62 | 29.86 | 45.48 | 54.00 | -8.52 | Average | 100 | 130 | P |
| 7 | 15720.00 | 15.62 | 43.37 | 58.99 | 74.00 | -15.01 | Peak | 100 | 130 | P |

Note: Level=Reading+Factor
 Margin=Level-Limit
 Factor=Antenna Factor + cable loss - Amplifier Factor



| | | | | | |
|-----------|---|----------------------------------|-----------|---|----------|
| Power | : | From Adapter (AC 120V / 60Hz) | Pol/Phase | : | VERTICAL |
| Test Mode | : | Mode 5, Band 1, CH38 | | : | |

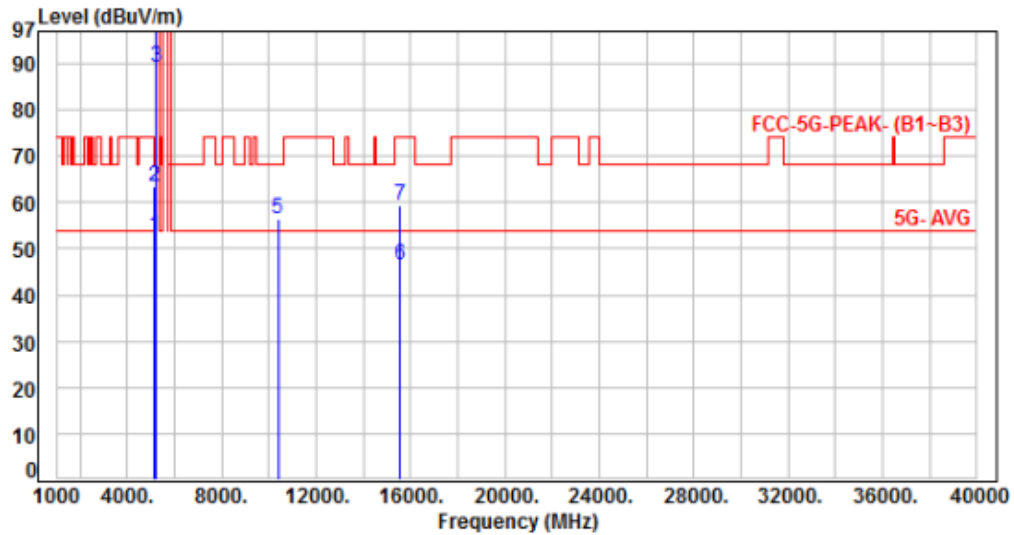

| No. | Frequency (MHz) | Factor (dB) | Reading (dBuV) | Level (dBuV/m) | Limit (dBuV/m) | Margin (dB) | Detector | Height (cm) | Azimuth (deg) | P/F |
|-----|-----------------|-------------|----------------|----------------|----------------|-------------|----------|-------------|---------------|-----|
| 1 | 5150.00 | 6.21 | 46.51 | 52.72 | 54.00 | -1.28 | Average | 100 | 107 | P |
| 2 | 5150.00 | 6.21 | 57.09 | 63.30 | 74.00 | -10.70 | Peak | 100 | 107 | P |
| 3 | 5190.00 | 6.32 | 82.80 | 89.12 | 200.00 | -110.88 | Average | 100 | 107 | P |
| 4 | 5190.00 | 6.32 | 92.19 | 98.51 | 200.00 | -101.49 | Peak | 100 | 107 | P |
| 5 | 10380.00 | 13.76 | 42.65 | 56.41 | 68.20 | -11.79 | Peak | 100 | 163 | P |
| 6 | 15570.00 | 16.37 | 30.22 | 46.59 | 54.00 | -7.41 | Average | 100 | 294 | P |
| 7 | 15570.00 | 16.37 | 42.96 | 59.33 | 74.00 | -14.67 | Peak | 100 | 294 | P |

Note: Level=Reading+Factor
Margin=Level-Limit
Factor=Antenna Factor + cable loss - Amplifier Factor



| | | | | | |
|-----------|---|----------------------------------|-----------|---|------------|
| Power | : | From Adapter (AC 120V / 60Hz) | Pol/Phase | : | HORIZONTAL |
| Test Mode | : | Mode 5, Band 1, CH38 | | : | |

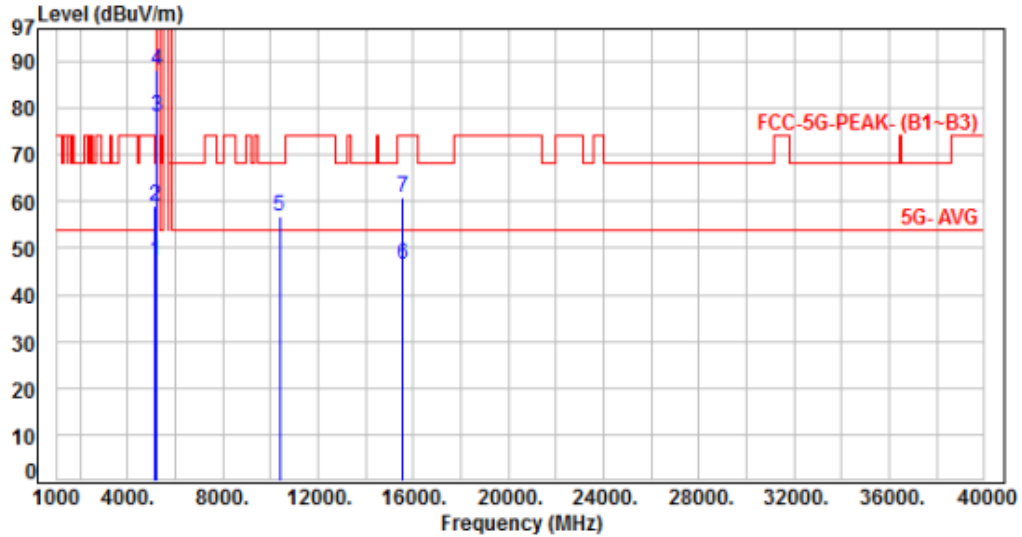

| No. | Frequency (MHz) | Factor (dB) | Reading (dBuV) | Level (dBuV/m) | Limit (dBuV/m) | Margin (dB) | Detector | Height (cm) | Azimuth (deg) | P/F |
|-----|-----------------|-------------|----------------|----------------|----------------|-------------|----------|-------------|---------------|-----|
| 1 | 5150.00 | 6.21 | 40.87 | 47.08 | 54.00 | -6.92 | Average | 100 | 221 | P |
| 2 | 5150.00 | 6.21 | 52.96 | 59.17 | 74.00 | -14.83 | Peak | 100 | 221 | P |
| 3 | 5190.00 | 6.32 | 71.82 | 78.14 | 200.00 | -121.86 | Average | 100 | 221 | P |
| 4 | 5190.00 | 6.32 | 81.80 | 88.12 | 200.00 | -111.88 | Peak | 100 | 221 | P |
| 5 | 10380.00 | 13.76 | 43.01 | 56.77 | 68.20 | -11.43 | Peak | 100 | 234 | P |
| 6 | 15570.00 | 16.37 | 30.27 | 46.64 | 54.00 | -7.36 | Average | 100 | 125 | P |
| 7 | 15570.00 | 16.37 | 44.41 | 60.78 | 74.00 | -13.22 | Peak | 100 | 125 | P |

Note: Level=Reading+Factor
 Margin=Level-Limit
 Factor=Antenna Factor + cable loss - Amplifier Factor



| | | | | | |
|-----------|---|----------------------------------|-----------|---|----------|
| Power | : | From Adapter (AC 120V / 60Hz) | Pol/Phase | : | VERTICAL |
| Test Mode | : | Mode 5, Band 1, CH46 | | : | |

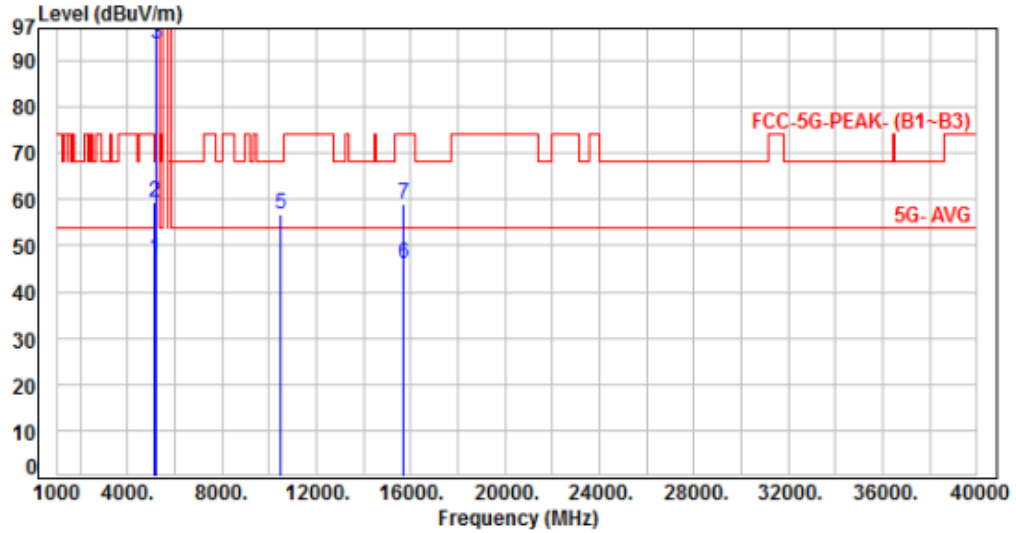

| No. | Frequency (MHz) | Factor (dB) | Reading (dBuV) | Level (dBuV/m) | Limit (dBuV/m) | Margin (dB) | Detector | Height (cm) | Azimuth (deg) | P/F |
|-----|-----------------|-------------|----------------|----------------|----------------|-------------|----------|-------------|---------------|-----|
| 1 | 5150.00 | 6.21 | 41.10 | 47.31 | 54.00 | -6.69 | Average | 100 | 108 | P |
| 2 | 5150.00 | 6.21 | 53.35 | 59.56 | 74.00 | -14.44 | Peak | 100 | 108 | P |
| 3 | 5230.00 | 6.44 | 87.35 | 93.79 | 200.00 | -106.21 | Average | 100 | 108 | P |
| 4 | 5230.00 | 6.44 | 98.05 | 104.49 | 200.00 | -95.51 | Peak | 100 | 108 | P |
| 5 | 10460.00 | 13.86 | 43.02 | 56.88 | 68.20 | -11.32 | Peak | 100 | 160 | P |
| 6 | 15690.00 | 15.67 | 30.43 | 46.10 | 54.00 | -7.90 | Average | 100 | 291 | P |
| 7 | 15690.00 | 15.67 | 43.18 | 58.85 | 74.00 | -15.15 | Peak | 100 | 291 | P |

Note: Level=Reading+Factor
 Margin=Level-Limit
 Factor=Antenna Factor + cable loss - Amplifier Factor



| | | | | | |
|-----------|---|----------------------------------|-----------|---|------------|
| Power | : | From Adapter (AC 120V / 60Hz) | Pol/Phase | : | HORIZONTAL |
| Test Mode | : | Mode 5, Band 1, CH46 | | : | |

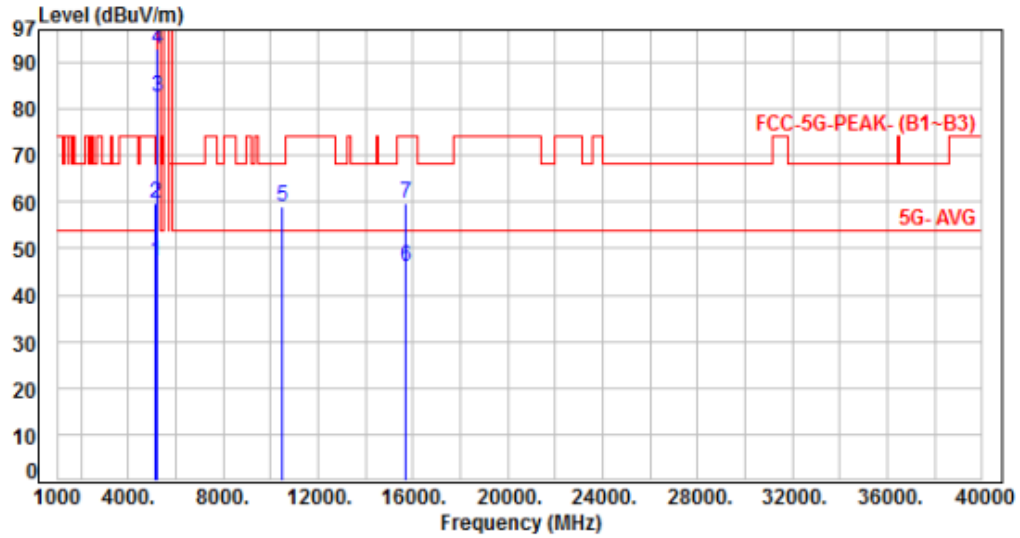

| No. | Frequency (MHz) | Factor (dB) | Reading (dBuV) | Level (dBuV/m) | Limit (dBuV/m) | Margin (dB) | Detector | Height (cm) | Azimuth (deg) | P/F |
|-----|-----------------|-------------|----------------|----------------|----------------|-------------|----------|-------------|---------------|-----|
| 1 | 5150.00 | 6.21 | 41.03 | 47.24 | 54.00 | -6.76 | Average | 100 | 219 | P |
| 2 | 5150.00 | 6.21 | 53.49 | 59.70 | 74.00 | -14.30 | Peak | 100 | 219 | P |
| 3 | 5230.00 | 6.44 | 76.01 | 82.45 | 200.00 | -117.55 | Average | 100 | 219 | P |
| 4 | 5230.00 | 6.44 | 86.42 | 92.86 | 200.00 | -107.14 | Peak | 100 | 219 | P |
| 5 | 10460.00 | 13.86 | 45.18 | 59.04 | 68.20 | -9.16 | Peak | 100 | 235 | P |
| 6 | 15690.00 | 15.67 | 30.59 | 46.26 | 54.00 | -7.74 | Average | 100 | 127 | P |
| 7 | 15690.00 | 15.67 | 44.15 | 59.82 | 74.00 | -14.18 | Peak | 100 | 127 | P |

Note: Level=Reading+Factor
 Margin=Level-Limit
 Factor=Antenna Factor + cable loss - Amplifier Factor



| | | | | | |
|-----------|---|----------------------------------|-----------|---|----------|
| Power | : | From Adapter (AC 120V / 60Hz) | Pol/Phase | : | VERTICAL |
| Test Mode | : | Mode 6, Band 1, CH42 | | : | |

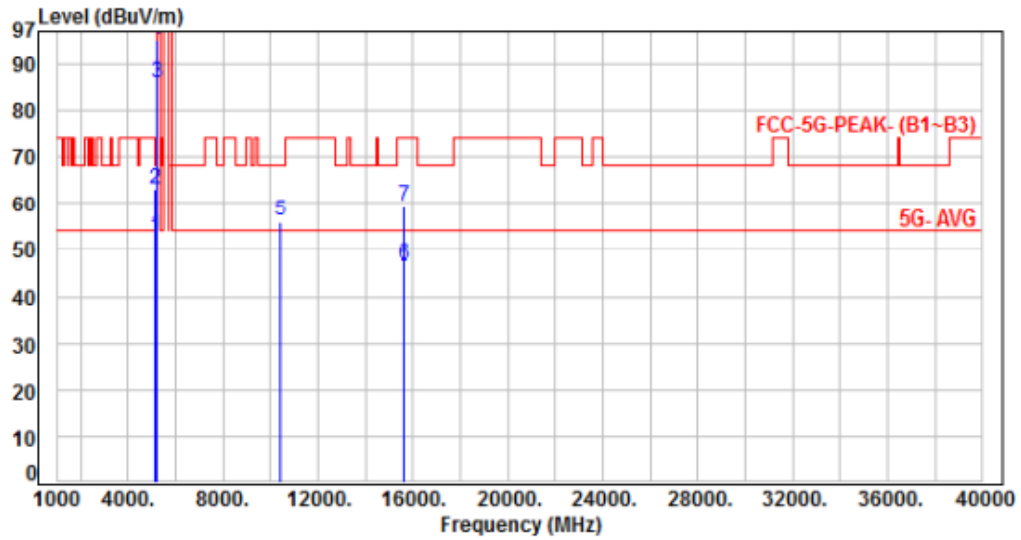

| No. | Frequency (MHz) | Factor (dB) | Reading (dBuV) | Level (dBuV/m) | Limit (dBuV/m) | Margin (dB) | Detector | Height (cm) | Azimuth (deg) | P/F |
|-----|-----------------|-------------|----------------|----------------|----------------|-------------|----------|-------------|---------------|-----|
| 1 | 5150.00 | 6.21 | 46.59 | 52.80 | 54.00 | -1.20 | Average | 100 | 109 | P |
| 2 | 5150.00 | 6.21 | 56.91 | 63.12 | 74.00 | -10.88 | Peak | 100 | 109 | P |
| 3 | 5210.00 | 6.38 | 79.51 | 85.89 | 200.00 | -114.11 | Average | 100 | 109 | P |
| 4 | 5210.00 | 6.38 | 88.72 | 95.10 | 200.00 | -104.90 | Peak | 100 | 109 | P |
| 5 | 10420.00 | 13.80 | 42.34 | 56.14 | 68.20 | -12.06 | Peak | 100 | 161 | P |
| 6 | 15630.00 | 16.10 | 30.49 | 46.59 | 54.00 | -7.41 | Average | 100 | 290 | P |
| 7 | 15630.00 | 16.10 | 43.15 | 59.25 | 74.00 | -14.75 | Peak | 100 | 290 | P |

Note: Level=Reading+Factor
 Margin=Level-Limit
 Factor=Antenna Factor + cable loss - Amplifier Factor



| | | | | | |
|-----------|---|----------------------------------|-----------|---|------------|
| Power | : | From Adapter (AC 120V / 60Hz) | Pol/Phase | : | HORIZONTAL |
| Test Mode | : | Mode 6, Band 1, CH42 | | : | |

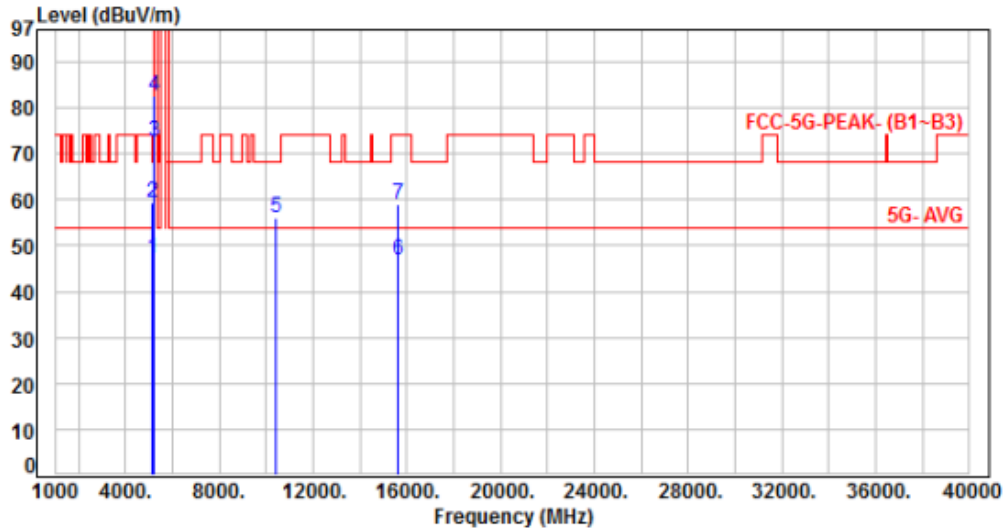

| No. | Frequency (MHz) | Factor (dB) | Reading (dBuV) | Level (dBuV/m) | Limit (dBuV/m) | Margin (dB) | Detector | Height (cm) | Azimuth (deg) | P/F |
|-----|-----------------|-------------|----------------|----------------|----------------|-------------|----------|-------------|---------------|-----|
| 1 | 5150.00 | 6.21 | 40.85 | 47.06 | 54.00 | -6.94 | Average | 100 | 225 | P |
| 2 | 5150.00 | 6.21 | 53.09 | 59.30 | 74.00 | -14.70 | Peak | 100 | 225 | P |
| 3 | 5210.00 | 6.38 | 66.41 | 72.79 | 200.00 | -127.21 | Average | 100 | 225 | P |
| 4 | 5210.00 | 6.38 | 76.18 | 82.56 | 200.00 | -117.44 | Peak | 100 | 225 | P |
| 5 | 10420.00 | 13.80 | 42.19 | 55.99 | 68.20 | -12.21 | Peak | 100 | 233 | P |
| 6 | 15630.00 | 16.10 | 30.83 | 46.93 | 54.00 | -7.07 | Average | 100 | 131 | P |
| 7 | 15630.00 | 16.10 | 43.05 | 59.15 | 74.00 | -14.85 | Peak | 100 | 131 | P |

Note: Level=Reading+Factor
Margin=Level-Limit
Factor=Antenna Factor + cable loss - Amplifier Factor



| | | | | | |
|-----------|---|----------------------------------|-----------|---|----------|
| Power | : | From Adapter (AC 120V / 60Hz) | Pol/Phase | : | VERTICAL |
| Test Mode | : | Mode 1, Band 2, CH52 | | : | |

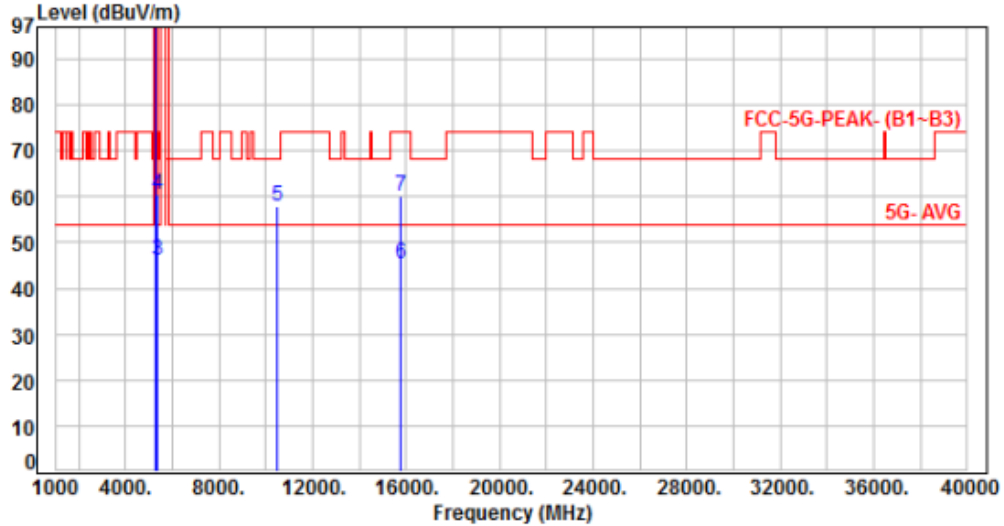

| No. | Frequency (MHz) | Factor (dB) | Reading (dBuV) | Level (dBuV/m) | Limit (dBuV/m) | Margin (dB) | Detector | Height (cm) | Azimuth (deg) | P/F |
|-----|-----------------|-------------|----------------|----------------|----------------|-------------|----------|-------------|---------------|-----|
| 1 | 5260.00 | 6.52 | 94.54 | 101.06 | 200.00 | -98.94 | Average | 327 | 10 | P |
| 2 | 5260.00 | 6.52 | 105.28 | 111.80 | 200.00 | -88.20 | Peak | 327 | 10 | P |
| 3 | 5350.00 | 6.57 | 39.59 | 46.16 | 54.00 | -7.84 | Average | 327 | 10 | P |
| 4 | 5350.00 | 6.57 | 53.94 | 60.51 | 74.00 | -13.49 | Peak | 327 | 10 | P |
| 5 | 10520.00 | 13.94 | 43.97 | 57.91 | 68.20 | -10.29 | Peak | 100 | 291 | P |
| 6 | 15780.00 | 15.71 | 29.58 | 45.29 | 54.00 | -8.71 | Average | 100 | 166 | P |
| 7 | 15780.00 | 15.71 | 44.36 | 60.07 | 74.00 | -13.93 | Peak | 100 | 166 | P |

Note: Level=Reading+Factor
 Margin=Level-Limit
 Factor=Antenna Factor + cable loss - Amplifier Factor



| | | | | | |
|-----------|---|----------------------------------|-----------|---|------------|
| Power | : | From Adapter (AC 120V / 60Hz) | Pol/Phase | : | HORIZONTAL |
| Test Mode | : | Mode 1, Band 2, CH52 | | : | |

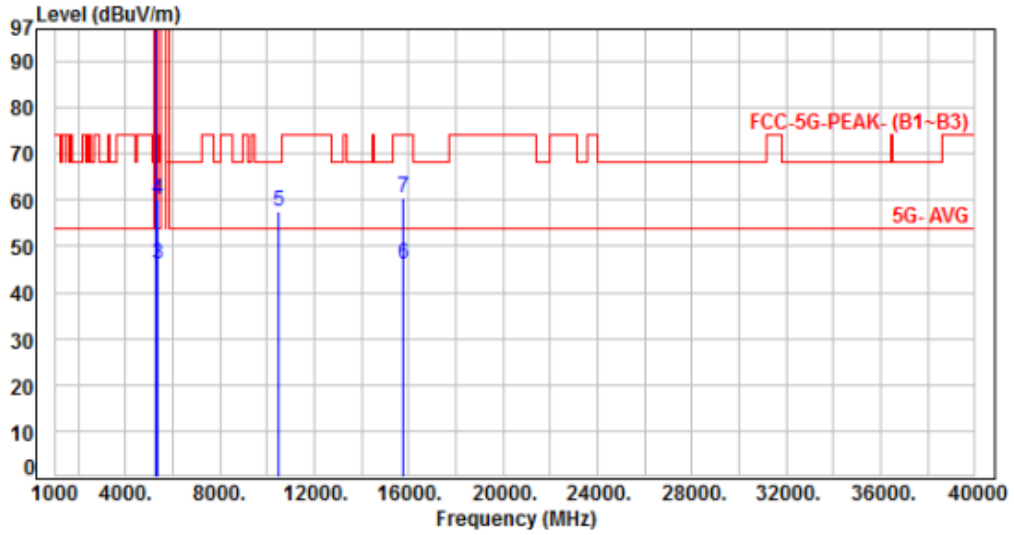

| No. | Frequency (MHz) | Factor (dB) | Reading (dBuV) | Level (dBuV/m) | Limit (dBuV/m) | Margin (dB) | Detector | Height (cm) | Azimuth (deg) | P/F |
|-----|-----------------|-------------|----------------|----------------|----------------|-------------|----------|-------------|---------------|-----|
| 1 | 5260.00 | 6.52 | 90.71 | 97.23 | 200.00 | -102.77 | Average | 233 | 314 | P |
| 2 | 5260.00 | 6.52 | 101.51 | 108.03 | 200.00 | -91.97 | Peak | 233 | 314 | P |
| 3 | 5350.00 | 6.57 | 39.64 | 46.21 | 54.00 | -7.79 | Average | 233 | 314 | P |
| 4 | 5350.00 | 6.57 | 53.69 | 60.26 | 74.00 | -13.74 | Peak | 233 | 314 | P |
| 5 | 10520.00 | 13.94 | 43.58 | 57.52 | 68.20 | -10.68 | Peak | 100 | 193 | P |
| 6 | 15780.00 | 15.71 | 30.28 | 45.99 | 54.00 | -8.01 | Average | 100 | 188 | P |
| 7 | 15780.00 | 15.71 | 44.86 | 60.57 | 74.00 | -13.43 | Peak | 100 | 188 | P |

Note: Level=Reading+Factor
 Margin=Level-Limit
 Factor=Antenna Factor + cable loss - Amplifier Factor



| | | | | | |
|-----------|---|----------------------------------|-----------|---|----------|
| Power | : | From Adapter (AC 120V / 60Hz) | Pol/Phase | : | VERTICAL |
| Test Mode | : | Mode 1, Band 2, CH60 | | : | |

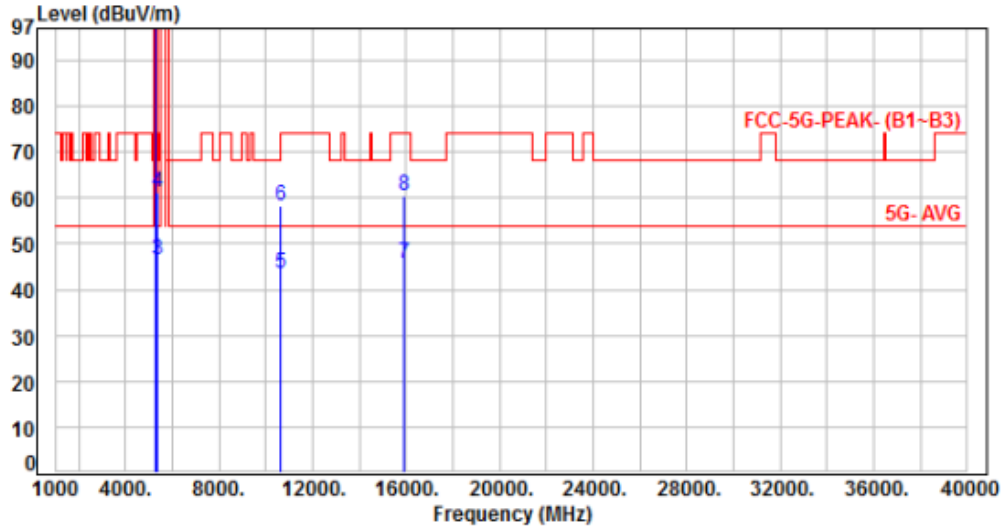

| No. | Frequency (MHz) | Factor (dB) | Reading (dBuV) | Level (dBuV/m) | Limit (dBuV/m) | Margin (dB) | Detector | Height (cm) | Azimuth (deg) | P/F |
|-----|-----------------|-------------|----------------|----------------|----------------|-------------|----------|-------------|---------------|-----|
| 1 | 5300.00 | 6.64 | 95.38 | 102.02 | 200.00 | -97.98 | Average | 333 | 5 | P |
| 2 | 5300.00 | 6.64 | 106.26 | 112.90 | 200.00 | -87.10 | Peak | 333 | 5 | P |
| 3 | 5350.00 | 6.57 | 39.77 | 46.34 | 54.00 | -7.66 | Average | 333 | 5 | P |
| 4 | 5350.00 | 6.57 | 54.65 | 61.22 | 74.00 | -12.78 | Peak | 333 | 5 | P |
| 5 | 10600.00 | 14.04 | 29.31 | 43.35 | 54.00 | -10.65 | Average | 100 | 294 | P |
| 6 | 10600.00 | 14.04 | 44.22 | 58.26 | 74.00 | -15.74 | Peak | 100 | 294 | P |
| 7 | 15900.00 | 15.80 | 30.04 | 45.84 | 54.00 | -8.16 | Average | 100 | 168 | P |
| 8 | 15900.00 | 15.80 | 44.73 | 60.53 | 74.00 | -13.47 | Peak | 100 | 168 | P |

Note: Level=Reading+Factor
 Margin=Level-Limit
 Factor=Antenna Factor + cable loss - Amplifier Factor



| | | | | | |
|-----------|---|----------------------------------|-----------|---|------------|
| Power | : | From Adapter (AC 120V / 60Hz) | Pol/Phase | : | HORIZONTAL |
| Test Mode | : | Mode 1, Band 2, CH60 | | : | |

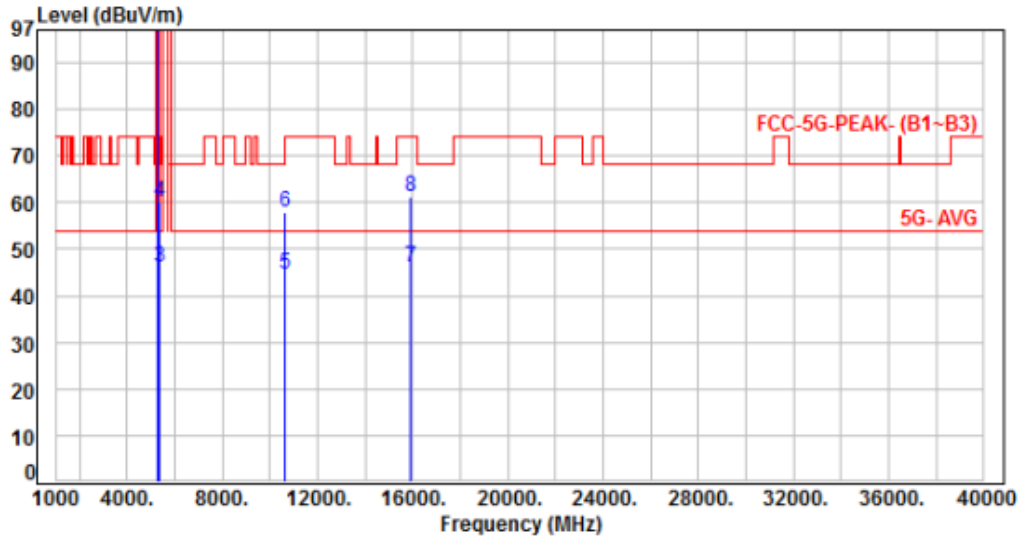

| No. | Frequency (MHz) | Factor (dB) | Reading (dBuV) | Level (dBuV/m) | Limit (dBuV/m) | Margin (dB) | Detector | Height (cm) | Azimuth (deg) | P/F |
|-----|-----------------|-------------|----------------|----------------|----------------|-------------|----------|-------------|---------------|-----|
| 1 | 5300.00 | 6.64 | 90.90 | 97.54 | 200.00 | -102.46 | Average | 254 | 311 | P |
| 2 | 5300.00 | 6.64 | 102.37 | 109.01 | 200.00 | -90.99 | Peak | 254 | 311 | P |
| 3 | 5350.00 | 6.57 | 39.64 | 46.21 | 54.00 | -7.79 | Average | 254 | 311 | P |
| 4 | 5350.00 | 6.57 | 53.59 | 60.16 | 74.00 | -13.84 | Peak | 254 | 311 | P |
| 5 | 10600.00 | 14.04 | 30.69 | 44.73 | 54.00 | -9.27 | Average | 100 | 198 | P |
| 6 | 10600.00 | 14.04 | 43.95 | 57.99 | 74.00 | -16.01 | Peak | 100 | 198 | P |
| 7 | 15900.00 | 15.80 | 30.12 | 45.92 | 54.00 | -8.08 | Average | 100 | 189 | P |
| 8 | 15900.00 | 15.80 | 45.49 | 61.29 | 74.00 | -12.71 | Peak | 100 | 189 | P |

Note: Level=Reading+Factor
 Margin=Level-Limit
 Factor=Antenna Factor + cable loss - Amplifier Factor



| | | | | | |
|-----------|---|----------------------------------|-----------|---|----------|
| Power | : | From Adapter (AC 120V / 60Hz) | Pol/Phase | : | VERTICAL |
| Test Mode | : | Mode 1, Band 2, CH64 | | : | |

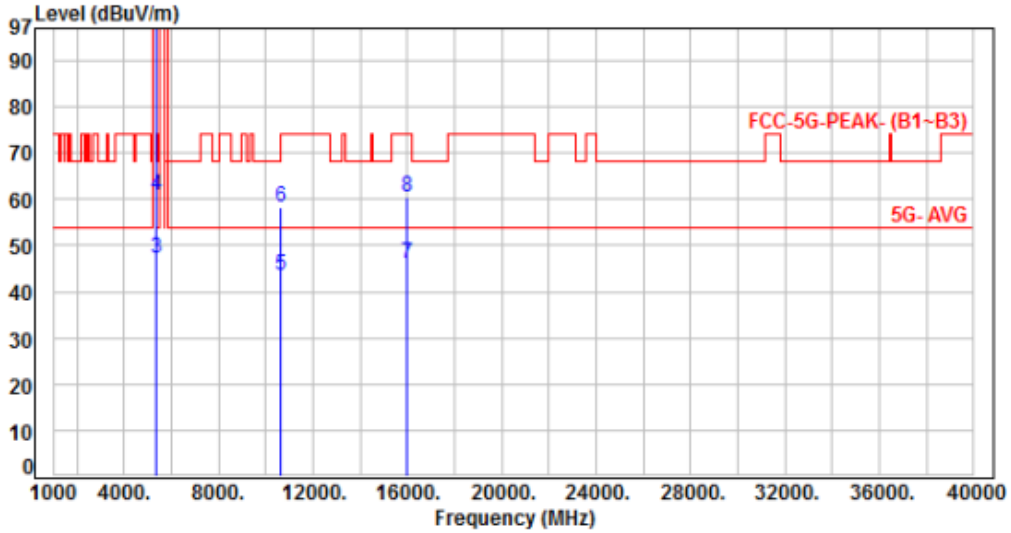

| No. | Frequency (MHz) | Factor (dB) | Reading (dBuV) | Level (dBuV/m) | Limit (dBuV/m) | Margin (dB) | Detector | Height (cm) | Azimuth (deg) | P/F |
|-----|-----------------|-------------|----------------|----------------|----------------|-------------|----------|-------------|---------------|-----|
| 1 | 5320.00 | 6.61 | 95.71 | 102.32 | 200.00 | -97.68 | Average | 314 | 3 | P |
| 2 | 5320.00 | 6.61 | 106.95 | 113.56 | 200.00 | -86.44 | Peak | 314 | 3 | P |
| 3 | 5350.00 | 6.57 | 40.61 | 47.18 | 54.00 | -6.82 | Average | 314 | 3 | P |
| 4 | 5350.00 | 6.57 | 54.19 | 60.76 | 74.00 | -13.24 | Peak | 314 | 3 | P |
| 5 | 10640.00 | 14.08 | 29.46 | 43.54 | 54.00 | -10.46 | Average | 100 | 299 | P |
| 6 | 10640.00 | 14.08 | 44.17 | 58.25 | 74.00 | -15.75 | Peak | 100 | 299 | P |
| 7 | 15960.00 | 15.66 | 30.28 | 45.94 | 54.00 | -8.06 | Average | 100 | 167 | P |
| 8 | 15960.00 | 15.66 | 44.65 | 60.31 | 74.00 | -13.69 | Peak | 100 | 167 | P |

Note: Level=Reading+Factor
 Margin=Level-Limit
 Factor=Antenna Factor + cable loss - Amplifier Factor



| | | | | | |
|-----------|---|----------------------------------|-----------|---|------------|
| Power | : | From Adapter (AC 120V / 60Hz) | Pol/Phase | : | HORIZONTAL |
| Test Mode | : | Mode 1, Band 2, CH64 | | : | |

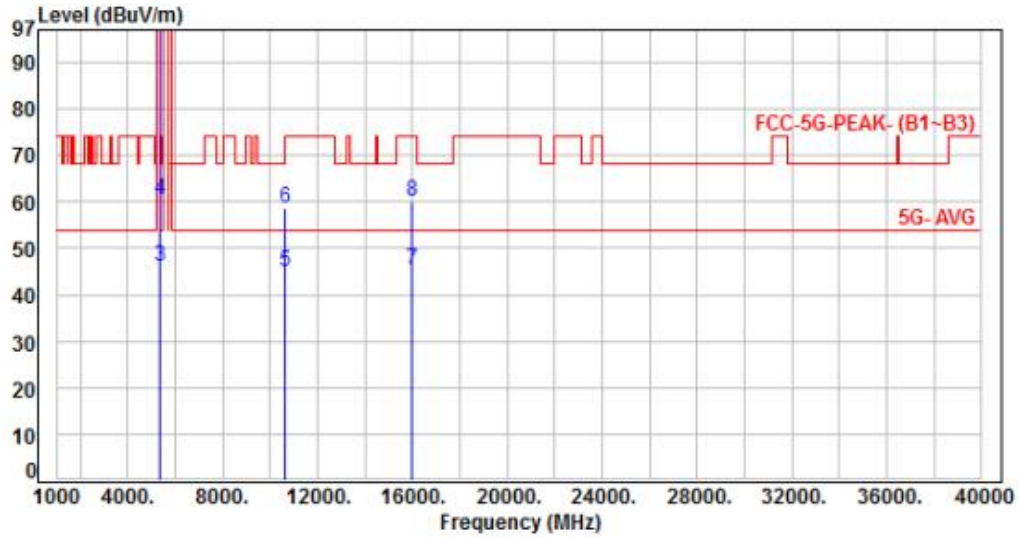

| No. | Frequency (MHz) | Factor (dB) | Reading (dBuV) | Level (dBuV/m) | Limit (dBuV/m) | Margin (dB) | Detector | Height (cm) | Azimuth (deg) | P/F |
|-----|-----------------|-------------|----------------|----------------|----------------|-------------|----------|-------------|---------------|-----|
| 1 | 5320.00 | 6.61 | 90.83 | 97.44 | 200.00 | -102.56 | Average | 249 | 308 | P |
| 2 | 5320.00 | 6.61 | 101.21 | 107.82 | 200.00 | -92.18 | Peak | 249 | 308 | P |
| 3 | 5350.00 | 6.57 | 39.58 | 46.15 | 54.00 | -7.85 | Average | 249 | 308 | P |
| 4 | 5350.00 | 6.57 | 53.91 | 60.48 | 74.00 | -13.52 | Peak | 249 | 308 | P |
| 5 | 10640.00 | 14.08 | 30.81 | 44.89 | 54.00 | -9.11 | Average | 100 | 202 | P |
| 6 | 10640.00 | 14.08 | 44.46 | 58.54 | 74.00 | -15.46 | Peak | 100 | 202 | P |
| 7 | 15960.00 | 15.66 | 29.75 | 45.41 | 54.00 | -8.59 | Average | 100 | 185 | P |
| 8 | 15960.00 | 15.66 | 44.37 | 60.03 | 74.00 | -13.97 | Peak | 100 | 185 | P |

Note: Level=Reading+Factor
 Margin=Level-Limit
 Factor=Antenna Factor + cable loss - Amplifier Factor



| | | | | | |
|-----------|---|----------------------------------|-----------|---|----------|
| Power | : | From Adapter (AC 120V / 60Hz) | Pol/Phase | : | VERTICAL |
| Test Mode | : | Mode 4, Band 2, CH52 | | : | |

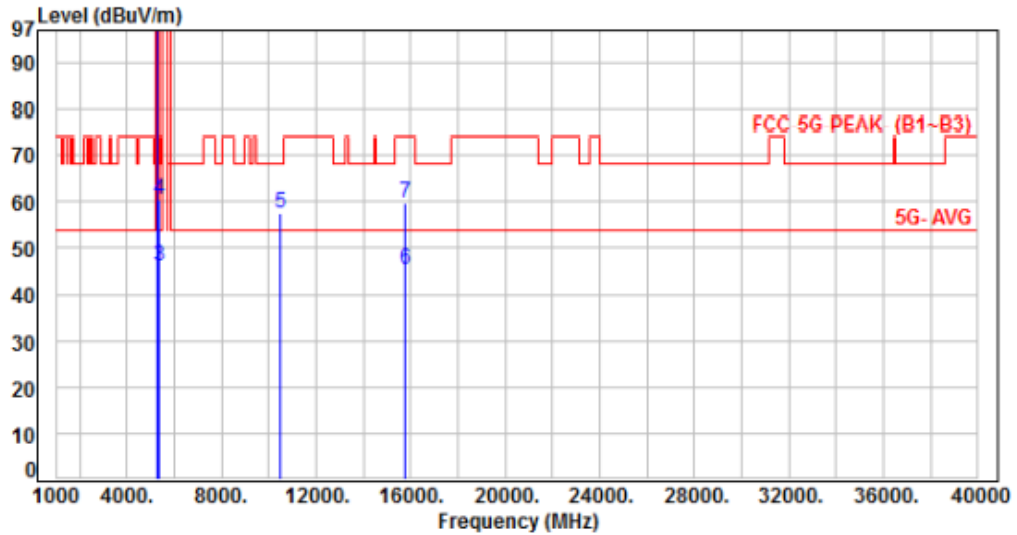

| No. | Frequency (MHz) | Factor (dB) | Reading (dBuV) | Level (dBuV/m) | Limit (dBuV/m) | Margin (dB) | Detector | Height (cm) | Azimuth (deg) | P/F |
|-----|-----------------|-------------|----------------|----------------|----------------|-------------|----------|-------------|---------------|-----|
| 1 | 5260.00 | 6.52 | 92.74 | 99.26 | 200.00 | -100.74 | Average | 249 | 311 | P |
| 2 | 5260.00 | 6.52 | 103.39 | 109.91 | 200.00 | -90.09 | Peak | 249 | 311 | P |
| 3 | 5350.00 | 6.57 | 39.71 | 46.28 | 54.00 | -7.72 | Average | 249 | 311 | P |
| 4 | 5350.00 | 6.57 | 54.08 | 60.65 | 74.00 | -13.35 | Peak | 249 | 311 | P |
| 5 | 10520.00 | 13.94 | 43.43 | 57.37 | 68.20 | -10.83 | Peak | 100 | 194 | P |
| 6 | 15780.00 | 15.71 | 29.68 | 45.39 | 54.00 | -8.61 | Average | 100 | 190 | P |
| 7 | 15780.00 | 15.71 | 44.05 | 59.76 | 74.00 | -14.24 | Peak | 100 | 190 | P |

Note: Level=Reading+Factor
 Margin=Level-Limit
 Factor=Antenna Factor + cable loss - Amplifier Factor



| | | | | | |
|-----------|---|----------------------------------|-----------|---|------------|
| Power | : | From Adapter (AC 120V / 60Hz) | Pol/Phase | : | HORIZONTAL |
| Test Mode | : | Mode 4, Band 2, CH52 | | : | |

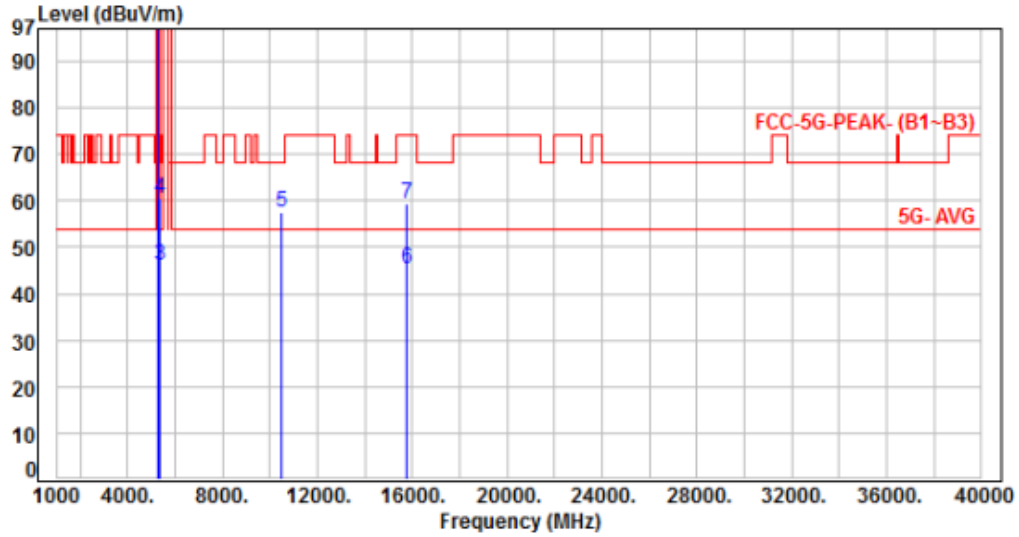

| No. | Frequency (MHz) | Factor (dB) | Reading (dBuV) | Level (dBuV/m) | Limit (dBuV/m) | Margin (dB) | Detector | Height (cm) | Azimuth (deg) | P/F |
|-----|-----------------|-------------|----------------|----------------|----------------|-------------|----------|-------------|---------------|-----|
| 1 | 5260.00 | 6.52 | 89.21 | 95.73 | 200.00 | -104.27 | Average | 303 | 26 | P |
| 2 | 5260.00 | 6.52 | 98.63 | 105.15 | 200.00 | -94.85 | Peak | 303 | 26 | P |
| 3 | 5350.00 | 6.57 | 39.45 | 46.02 | 54.00 | -7.98 | Average | 303 | 26 | P |
| 4 | 5350.00 | 6.57 | 53.96 | 60.53 | 74.00 | -13.47 | Peak | 303 | 26 | P |
| 5 | 10520.00 | 13.94 | 43.61 | 57.55 | 68.20 | -10.65 | Peak | 100 | 299 | P |
| 6 | 15780.00 | 15.71 | 29.47 | 45.18 | 54.00 | -8.82 | Average | 100 | 164 | P |
| 7 | 15780.00 | 15.71 | 43.73 | 59.44 | 74.00 | -14.56 | Peak | 100 | 164 | P |

Note: Level=Reading+Factor
 Margin=Level-Limit
 Factor=Antenna Factor + cable loss - Amplifier Factor



| | | | | | |
|-----------|---|----------------------------------|-----------|---|----------|
| Power | : | From Adapter (AC 120V / 60Hz) | Pol/Phase | : | VERTICAL |
| Test Mode | : | Mode 4, Band 2, CH60 | | : | |

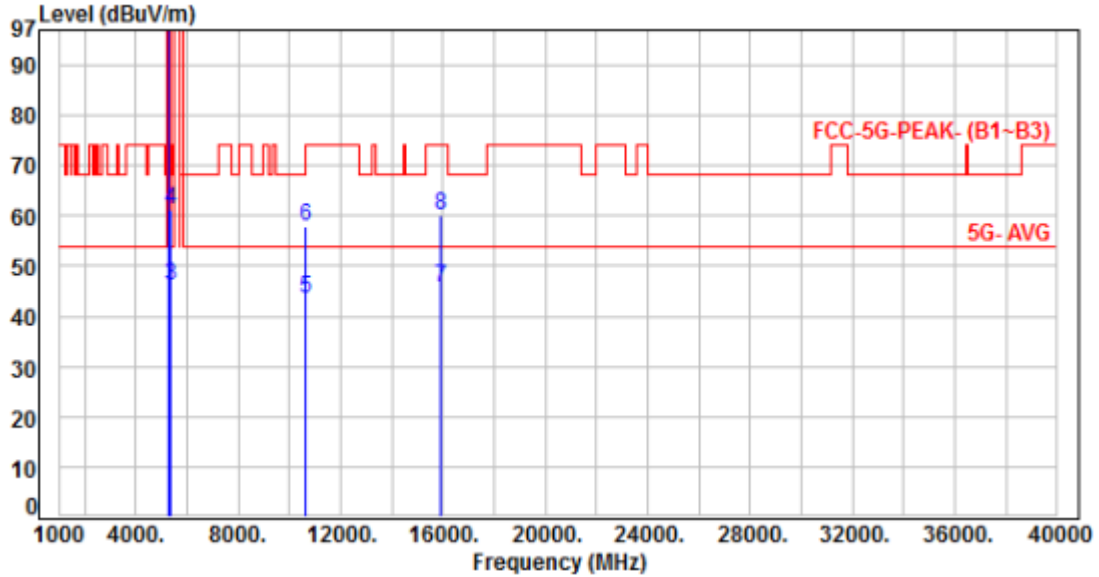

| No. | Frequency (MHz) | Factor (dB) | Reading (dBuV) | Level (dBuV/m) | Limit (dBuV/m) | Margin (dB) | Detector | Height (cm) | Azimuth (deg) | P/F |
|-----|-----------------|-------------|----------------|----------------|----------------|-------------|----------|-------------|---------------|-----|
| 1 | 5300.00 | 6.64 | 94.27 | 100.91 | 200.00 | -99.09 | Average | 333 | 5 | P |
| 2 | 5300.00 | 6.64 | 105.91 | 112.55 | 200.00 | -87.45 | Peak | 333 | 5 | P |
| 3 | 5350.00 | 6.57 | 39.61 | 46.18 | 54.00 | -7.82 | Average | 333 | 5 | P |
| 4 | 5350.00 | 6.57 | 54.60 | 61.17 | 74.00 | -12.83 | Peak | 333 | 5 | P |
| 5 | 10600.00 | 14.04 | 29.47 | 43.51 | 54.00 | -10.49 | Average | 100 | 288 | P |
| 6 | 10600.00 | 14.04 | 43.79 | 57.83 | 74.00 | -16.17 | Peak | 100 | 288 | P |
| 7 | 15900.00 | 15.80 | 30.08 | 45.88 | 54.00 | -8.12 | Average | 100 | 172 | P |
| 8 | 15900.00 | 15.80 | 44.23 | 60.03 | 74.00 | -13.97 | Peak | 100 | 172 | P |

Note: Level=Reading+Factor
 Margin=Level-Limit
 Factor=Antenna Factor + cable loss - Amplifier Factor



| | | | | | |
|-----------|---|----------------------------------|-----------|---|------------|
| Power | : | From Adapter (AC 120V / 60Hz) | Pol/Phase | : | HORIZONTAL |
| Test Mode | : | Mode 4, Band 2, CH60 | | : | |

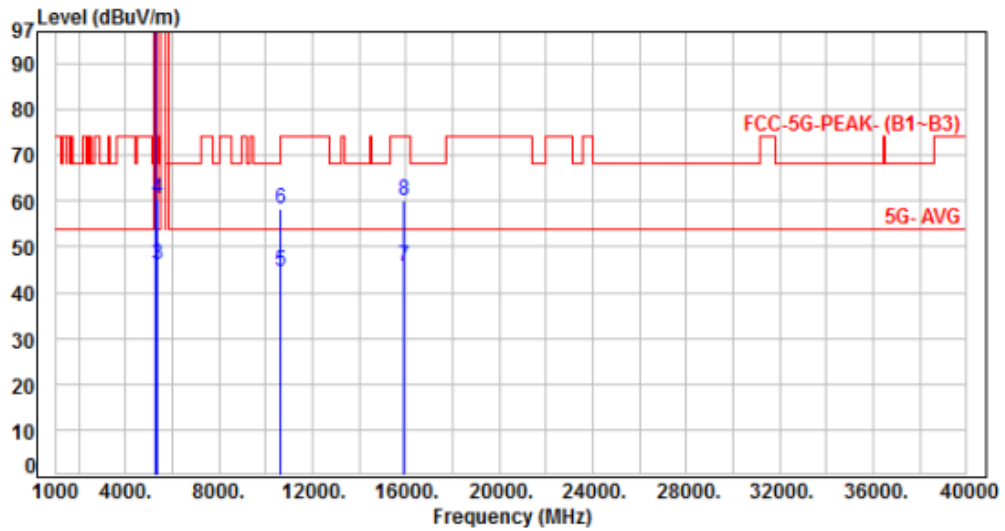

| No. | Frequency (MHz) | Factor (dB) | Reading (dBuV) | Level (dBuV/m) | Limit (dBuV/m) | Margin (dB) | Detector | Height (cm) | Azimuth (deg) | P/F |
|-----|-----------------|-------------|----------------|----------------|----------------|-------------|----------|-------------|---------------|-----|
| 1 | 5300.00 | 6.64 | 89.59 | 96.23 | 200.00 | -103.77 | Average | 252 | 312 | P |
| 2 | 5300.00 | 6.64 | 101.08 | 107.72 | 200.00 | -92.28 | Peak | 252 | 312 | P |
| 3 | 5350.00 | 6.57 | 39.48 | 46.05 | 54.00 | -7.95 | Average | 252 | 312 | P |
| 4 | 5350.00 | 6.57 | 54.00 | 60.57 | 74.00 | -13.43 | Peak | 252 | 312 | P |
| 5 | 10600.00 | 14.04 | 30.50 | 44.54 | 54.00 | -9.46 | Average | 100 | 198 | P |
| 6 | 10600.00 | 14.04 | 44.21 | 58.25 | 74.00 | -15.75 | Peak | 100 | 198 | P |
| 7 | 15900.00 | 15.80 | 30.06 | 45.86 | 54.00 | -8.14 | Average | 100 | 188 | P |
| 8 | 15900.00 | 15.80 | 44.25 | 60.05 | 74.00 | -13.95 | Peak | 100 | 188 | P |

Note: Level=Reading+Factor
 Margin=Level-Limit
 Factor=Antenna Factor + cable loss - Amplifier Factor



| | | | | | |
|-----------|---|----------------------------------|-----------|---|----------|
| Power | : | From Adapter (AC 120V / 60Hz) | Pol/Phase | : | VERTICAL |
| Test Mode | : | Mode 4, Band 2, CH64 | | : | |

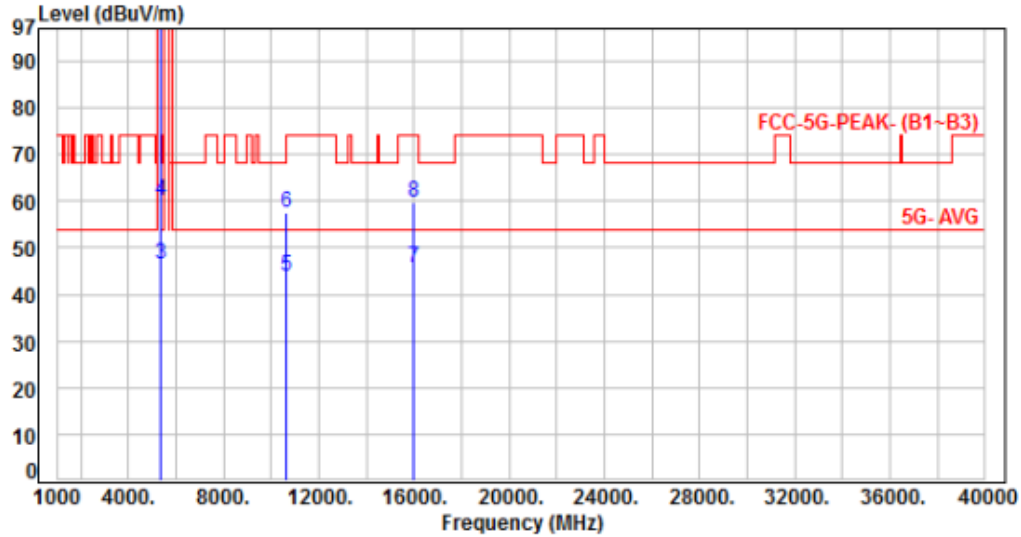

| No. | Frequency (MHz) | Factor (dB) | Reading (dBuV) | Level (dBuV/m) | Limit (dBuV/m) | Margin (dB) | Detector | Height (cm) | Azimuth (deg) | P/F |
|-----|-----------------|-------------|----------------|----------------|----------------|-------------|----------|-------------|---------------|-----|
| 1 | 5320.00 | 6.61 | 90.55 | 97.16 | 200.00 | -102.84 | Average | 312 | 359 | P |
| 2 | 5320.00 | 6.61 | 102.41 | 109.02 | 200.00 | -90.98 | Peak | 312 | 359 | P |
| 3 | 5350.00 | 6.57 | 39.93 | 46.50 | 54.00 | -7.50 | Average | 312 | 359 | P |
| 4 | 5350.00 | 6.57 | 53.65 | 60.22 | 74.00 | -13.78 | Peak | 312 | 359 | P |
| 5 | 10640.00 | 14.08 | 29.85 | 43.93 | 54.00 | -10.07 | Average | 100 | 296 | P |
| 6 | 10640.00 | 14.08 | 43.55 | 57.63 | 74.00 | -16.37 | Peak | 100 | 296 | P |
| 7 | 15960.00 | 15.66 | 29.94 | 45.60 | 54.00 | -8.40 | Average | 100 | 166 | P |
| 8 | 15960.00 | 15.66 | 44.15 | 59.81 | 74.00 | -14.19 | Peak | 100 | 166 | P |

Note: Level=Reading+Factor
 Margin=Level-Limit
 Factor=Antenna Factor + cable loss - Amplifier Factor



| | | | | | |
|-----------|---|----------------------------------|-----------|---|------------|
| Power | : | From Adapter (AC 120V / 60Hz) | Pol/Phase | : | HORIZONTAL |
| Test Mode | : | Mode 4, Band 2, CH64 | | : | |

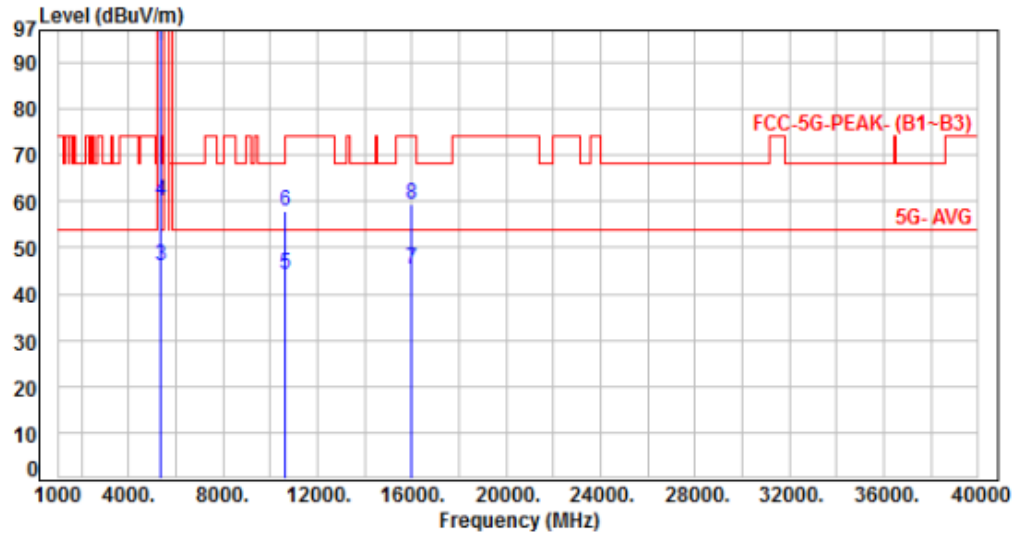

| No. | Frequency (MHz) | Factor (dB) | Reading (dBuV) | Level (dBuV/m) | Limit (dBuV/m) | Margin (dB) | Detector | Height (cm) | Azimuth (deg) | P/F |
|-----|-----------------|-------------|----------------|----------------|----------------|-------------|----------|-------------|---------------|-----|
| 1 | 5320.00 | 6.61 | 87.20 | 93.81 | 200.00 | -106.19 | Average | 253 | 313 | P |
| 2 | 5320.00 | 6.61 | 98.75 | 105.36 | 200.00 | -94.64 | Peak | 253 | 313 | P |
| 3 | 5350.00 | 6.57 | 39.64 | 46.21 | 54.00 | -7.79 | Average | 253 | 313 | P |
| 4 | 5350.00 | 6.57 | 53.70 | 60.27 | 74.00 | -13.73 | Peak | 253 | 313 | P |
| 5 | 10640.00 | 14.08 | 30.11 | 44.19 | 54.00 | -9.81 | Average | 100 | 196 | P |
| 6 | 10640.00 | 14.08 | 43.93 | 58.01 | 74.00 | -15.99 | Peak | 100 | 196 | P |
| 7 | 15960.00 | 15.66 | 29.69 | 45.35 | 54.00 | -8.65 | Average | 100 | 187 | P |
| 8 | 15960.00 | 15.66 | 43.78 | 59.44 | 74.00 | -14.56 | Peak | 100 | 187 | P |

Note: Level=Reading+Factor
Margin=Level-Limit
Factor=Antenna Factor + cable loss - Amplifier Factor



| | | | | | |
|-----------|---|----------------------------------|-----------|---|----------|
| Power | : | From Adapter (AC 120V / 60Hz) | Pol/Phase | : | VERTICAL |
| Test Mode | : | Mode 5, Band 2, CH54 | | : | |

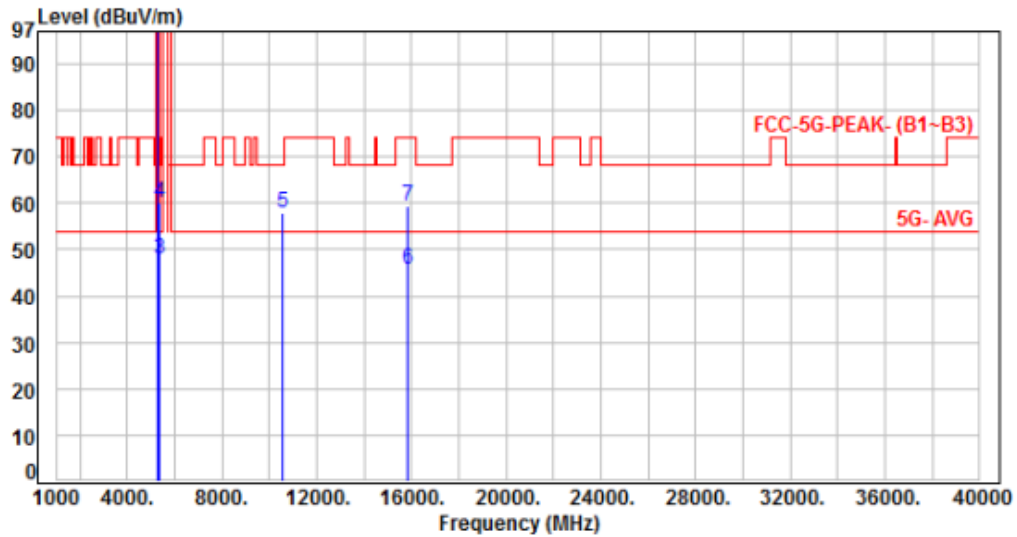

| No. | Frequency (MHz) | Factor (dB) | Reading (dBuV) | Level (dBuV/m) | Limit (dBuV/m) | Margin (dB) | Detector | Height (cm) | Azimuth (deg) | P/F |
|-----|-----------------|-------------|----------------|----------------|----------------|-------------|----------|-------------|---------------|-----|
| 1 | 5270.00 | 6.54 | 94.04 | 100.58 | 200.00 | -99.42 | Average | 400 | 4 | P |
| 2 | 5270.00 | 6.54 | 103.50 | 110.04 | 200.00 | -89.96 | Peak | 400 | 4 | P |
| 3 | 5350.00 | 6.57 | 41.33 | 47.90 | 54.00 | -6.10 | Average | 400 | 4 | P |
| 4 | 5350.00 | 6.57 | 53.43 | 60.00 | 74.00 | -14.00 | Peak | 400 | 4 | P |
| 5 | 10540.00 | 13.96 | 43.92 | 57.88 | 68.20 | -10.32 | Peak | 100 | 303 | P |
| 6 | 15810.00 | 15.74 | 29.82 | 45.56 | 54.00 | -8.44 | Average | 100 | 164 | P |
| 7 | 15810.00 | 15.74 | 43.53 | 59.27 | 74.00 | -14.73 | Peak | 100 | 164 | P |

Note: Level=Reading+Factor
 Margin=Level-Limit
 Factor=Antenna Factor + cable loss - Amplifier Factor



| | | | | | |
|-----------|---|----------------------------------|-----------|---|------------|
| Power | : | From Adapter (AC 120V / 60Hz) | Pol/Phase | : | HORIZONTAL |
| Test Mode | : | Mode 5, Band 2, CH54 | | : | |

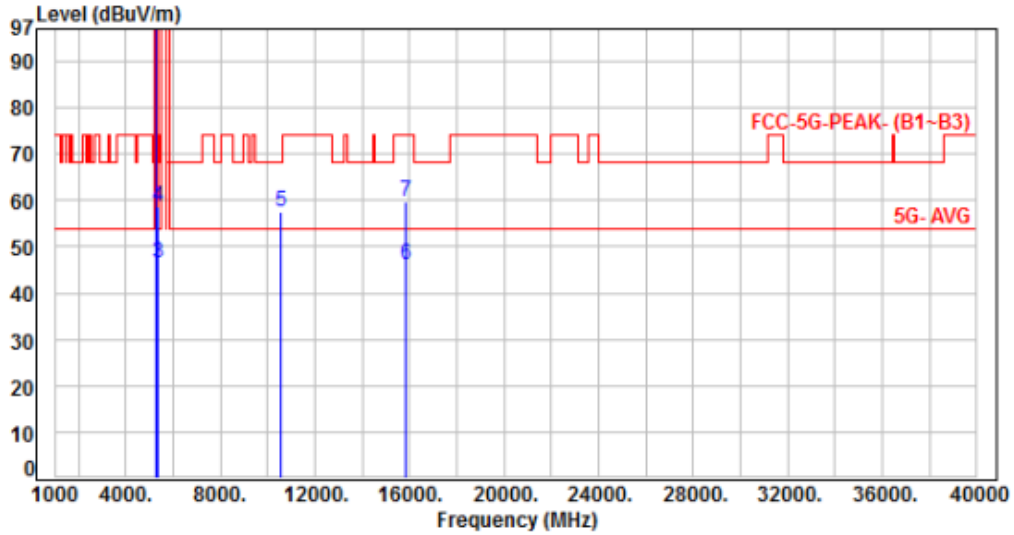

| No. | Frequency (MHz) | Factor (dB) | Reading (dBuV) | Level (dBuV/m) | Limit (dBuV/m) | Margin (dB) | Detector | Height (cm) | Azimuth (deg) | P/F |
|-----|-----------------|-------------|----------------|----------------|----------------|-------------|----------|-------------|---------------|-----|
| 1 | 5270.00 | 6.54 | 89.40 | 95.94 | 200.00 | -104.06 | Average | 249 | 307 | P |
| 2 | 5270.00 | 6.54 | 98.86 | 105.40 | 200.00 | -94.60 | Peak | 249 | 307 | P |
| 3 | 5350.00 | 6.57 | 39.76 | 46.33 | 54.00 | -7.67 | Average | 249 | 307 | P |
| 4 | 5350.00 | 6.57 | 51.89 | 58.46 | 74.00 | -15.54 | Peak | 249 | 307 | P |
| 5 | 10540.00 | 13.96 | 43.66 | 57.62 | 68.20 | -10.58 | Peak | 100 | 199 | P |
| 6 | 15810.00 | 15.74 | 30.19 | 45.93 | 54.00 | -8.07 | Average | 100 | 182 | P |
| 7 | 15810.00 | 15.74 | 43.93 | 59.67 | 74.00 | -14.33 | Peak | 100 | 182 | P |

Note: Level=Reading+Factor
 Margin=Level-Limit
 Factor=Antenna Factor + cable loss - Amplifier Factor



| | | | | | |
|-----------|---|----------------------------------|-----------|---|----------|
| Power | : | From Adapter (AC 120V / 60Hz) | Pol/Phase | : | VERTICAL |
| Test Mode | : | Mode 5, Band 2, CH62 | | : | |

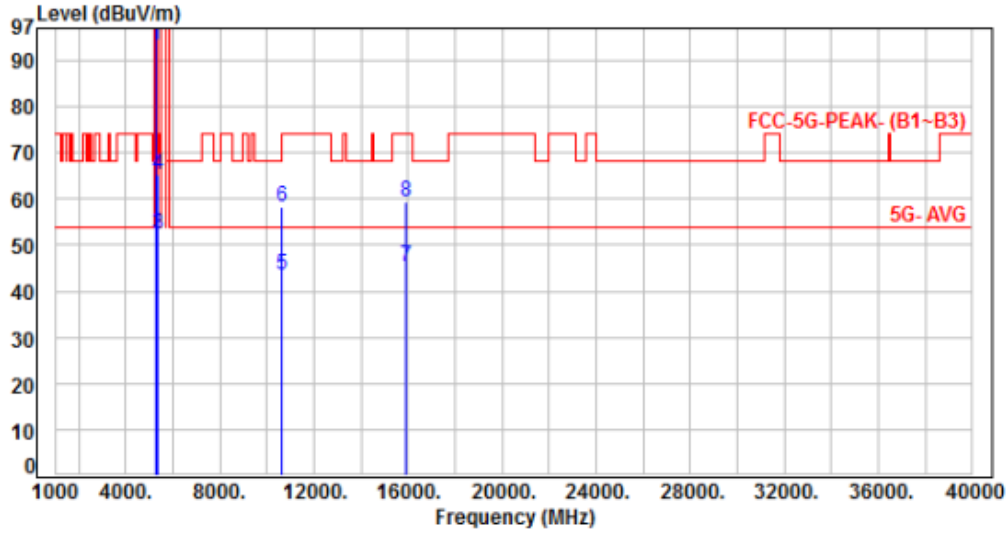

| No. | Frequency (MHz) | Factor (dB) | Reading (dBuV) | Level (dBuV/m) | Limit (dBuV/m) | Margin (dB) | Detector | Height (cm) | Azimuth (deg) | P/F |
|-----|-----------------|-------------|----------------|----------------|----------------|-------------|----------|-------------|---------------|-----|
| 1 | 5310.00 | 6.62 | 86.55 | 93.17 | 200.00 | -106.83 | Average | 335 | 5 | P |
| 2 | 5310.00 | 6.62 | 95.92 | 102.54 | 200.00 | -97.46 | Peak | 335 | 5 | P |
| 3 | 5350.00 | 6.57 | 45.64 | 52.21 | 54.00 | -1.79 | Average | 335 | 5 | P |
| 4 | 5350.00 | 6.57 | 58.62 | 65.19 | 74.00 | -8.81 | Peak | 335 | 5 | P |
| 5 | 10620.00 | 14.06 | 29.46 | 43.52 | 54.00 | -10.48 | Average | 100 | 298 | P |
| 6 | 10620.00 | 14.06 | 44.15 | 58.21 | 74.00 | -15.79 | Peak | 100 | 298 | P |
| 7 | 15930.00 | 15.73 | 29.67 | 45.40 | 54.00 | -8.60 | Average | 100 | 161 | P |
| 8 | 15930.00 | 15.73 | 43.82 | 59.55 | 74.00 | -14.45 | Peak | 100 | 161 | P |

Note: Level=Reading+Factor
 Margin=Level-Limit
 Factor=Antenna Factor + cable loss - Amplifier Factor



| | | | | | |
|-----------|---|----------------------------------|-----------|---|------------|
| Power | : | From Adapter (AC 120V / 60Hz) | Pol/Phase | : | HORIZONTAL |
| Test Mode | : | Mode 5, Band 2, CH62 | | : | |

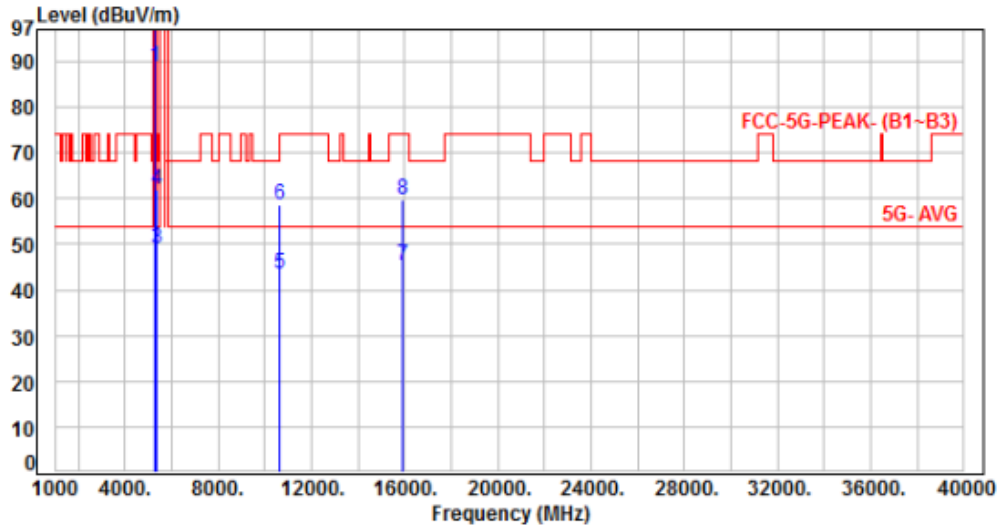

| No. | Frequency (MHz) | Factor (dB) | Reading (dBuV) | Level (dBuV/m) | Limit (dBuV/m) | Margin (dB) | Detector | Height (cm) | Azimuth (deg) | P/F |
|-----|-----------------|-------------|----------------|----------------|----------------|-------------|----------|-------------|---------------|-----|
| 1 | 5310.00 | 6.62 | 82.12 | 88.74 | 200.00 | -111.26 | Average | 241 | 310 | P |
| 2 | 5310.00 | 6.62 | 91.57 | 98.19 | 200.00 | -101.81 | Peak | 241 | 310 | P |
| 3 | 5350.00 | 6.57 | 42.43 | 49.00 | 54.00 | -5.00 | Average | 241 | 310 | P |
| 4 | 5350.00 | 6.57 | 55.27 | 61.84 | 74.00 | -12.16 | Peak | 241 | 310 | P |
| 5 | 10620.00 | 14.06 | 29.52 | 43.58 | 54.00 | -10.42 | Average | 100 | 203 | P |
| 6 | 10620.00 | 14.06 | 44.43 | 58.49 | 74.00 | -15.51 | Peak | 100 | 203 | P |
| 7 | 15930.00 | 15.73 | 29.79 | 45.52 | 54.00 | -8.48 | Average | 100 | 189 | P |
| 8 | 15930.00 | 15.73 | 43.94 | 59.67 | 74.00 | -14.33 | Peak | 100 | 189 | P |

Note: Level=Reading+Factor
 Margin=Level-Limit
 Factor=Antenna Factor + cable loss - Amplifier Factor



| | | | | | |
|-----------|---|----------------------------------|-----------|---|----------|
| Power | : | From Adapter (AC 120V / 60Hz) | Pol/Phase | : | VERTICAL |
| Test Mode | : | Mode 6, Band 2, CH58 | | : | |

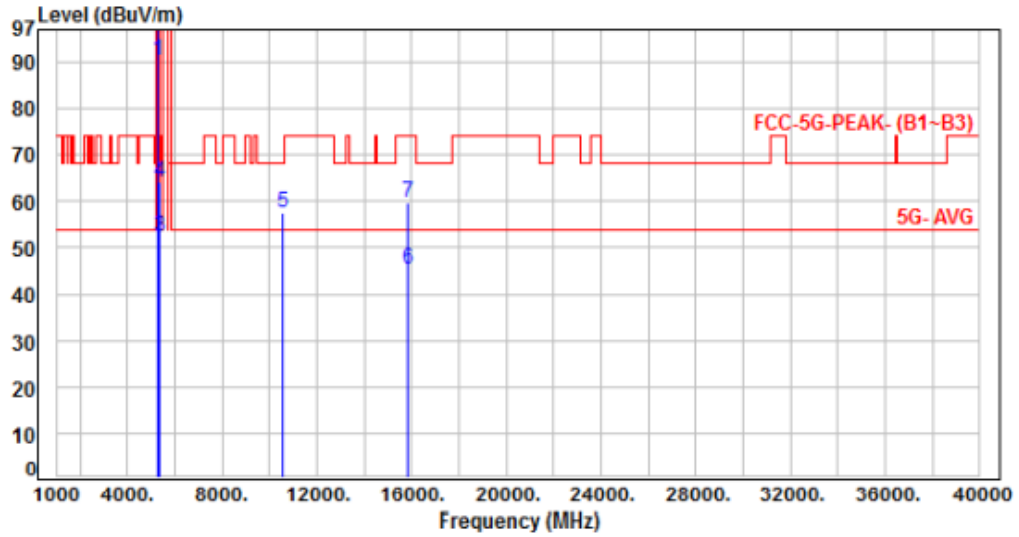

| No. | Frequency (MHz) | Factor (dB) | Reading (dBuV) | Level (dBuV/m) | Limit (dBuV/m) | Margin (dB) | Detector | Height (cm) | Azimuth (deg) | P/F |
|-----|-----------------|-------------|----------------|----------------|----------------|-------------|----------|-------------|---------------|-----|
| 1 | 5290.00 | 6.60 | 83.60 | 90.20 | 200.00 | -109.80 | Average | 345 | 5 | P |
| 2 | 5290.00 | 6.60 | 93.07 | 99.67 | 200.00 | -100.33 | Peak | 345 | 5 | P |
| 3 | 5350.00 | 6.57 | 45.75 | 52.32 | 54.00 | -1.68 | Average | 345 | 5 | P |
| 4 | 5350.00 | 6.57 | 57.49 | 64.06 | 74.00 | -9.94 | Peak | 345 | 5 | P |
| 5 | 10580.00 | 14.00 | 43.48 | 57.48 | 68.20 | -10.72 | Peak | 100 | 294 | P |
| 6 | 15870.00 | 15.79 | 29.74 | 45.53 | 54.00 | -8.47 | Average | 100 | 168 | P |
| 7 | 15870.00 | 15.79 | 44.06 | 59.85 | 74.00 | -14.15 | Peak | 100 | 168 | P |

Note: Level=Reading+Factor
 Margin=Level-Limit
 Factor=Antenna Factor + cable loss - Amplifier Factor



| | | | | | |
|-----------|---|----------------------------------|-----------|---|------------|
| Power | : | From Adapter (AC 120V / 60Hz) | Pol/Phase | : | HORIZONTAL |
| Test Mode | : | Mode 6, Band 2, CH58 | | : | |

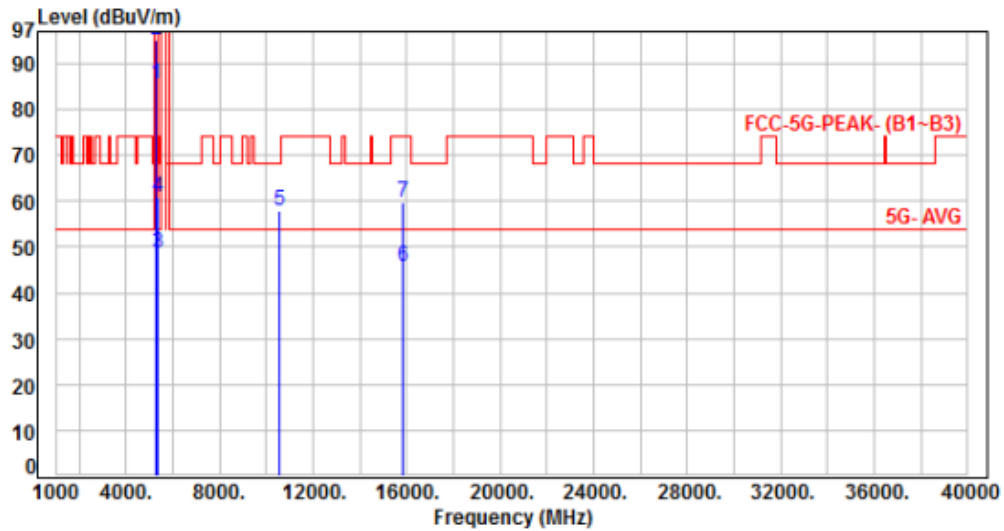

| No. | Frequency (MHz) | Factor (dB) | Reading (dBuV) | Level (dBuV/m) | Limit (dBuV/m) | Margin (dB) | Detector | Height (cm) | Azimuth (deg) | P/F |
|-----|-----------------|-------------|----------------|----------------|----------------|-------------|----------|-------------|---------------|-----|
| 1 | 5290.00 | 6.60 | 79.14 | 85.74 | 200.00 | -114.26 | Average | 255 | 316 | P |
| 2 | 5290.00 | 6.60 | 88.59 | 95.19 | 200.00 | -104.81 | Peak | 255 | 316 | P |
| 3 | 5350.00 | 6.57 | 42.28 | 48.85 | 54.00 | -5.15 | Average | 255 | 316 | P |
| 4 | 5350.00 | 6.57 | 54.11 | 60.68 | 74.00 | -13.32 | Peak | 255 | 316 | P |
| 5 | 10580.00 | 14.00 | 43.83 | 57.83 | 68.20 | -10.37 | Peak | 100 | 200 | P |
| 6 | 15870.00 | 15.79 | 29.90 | 45.69 | 54.00 | -8.31 | Average | 100 | 190 | P |
| 7 | 15870.00 | 15.79 | 43.84 | 59.63 | 74.00 | -14.37 | Peak | 100 | 190 | P |

Note: Level=Reading+Factor

Margin=Level-Limit

Factor=Antenna Factor + cable loss - Amplifier Factor



| | | | | | |
|-----------|---|----------------------------------|-----------|---|----------|
| Power | : | From Adapter (AC 120V / 60Hz) | Pol/Phase | : | VERTICAL |
| Test Mode | : | Mode 1, Band 3, CH100 | | : | |

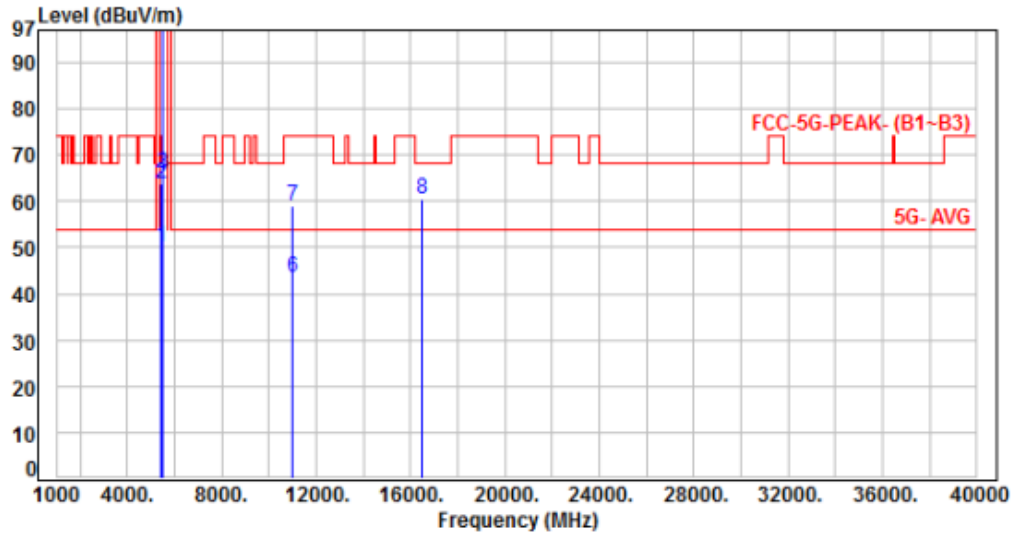

| No. | Frequency (MHz) | Factor (dB) | Reading (dBuV) | Level (dBuV/m) | Limit (dBuV/m) | Margin (dB) | Detector | Height (cm) | Azimuth (deg) | P/F |
|-----|-----------------|-------------|----------------|----------------|----------------|-------------|----------|-------------|---------------|-----|
| 1 | 5460.00 | 6.69 | 43.59 | 50.28 | 54.00 | -3.72 | Average | 336 | 3 | P |
| 2 | 5460.00 | 6.69 | 57.28 | 63.97 | 74.00 | -10.03 | Peak | 336 | 3 | P |
| 3 | 5470.00 | 6.72 | 59.35 | 66.07 | 68.20 | -2.13 | Peak | 336 | 3 | P |
| 4 | 5500.00 | 6.80 | 95.45 | 102.25 | 200.00 | -97.75 | Average | 336 | 3 | P |
| 5 | 5500.00 | 6.80 | 106.91 | 113.71 | 200.00 | -86.29 | Peak | 336 | 3 | P |
| 6 | 11000.00 | 14.68 | 28.94 | 43.62 | 54.00 | -10.38 | Average | 100 | 294 | P |
| 7 | 11000.00 | 14.68 | 44.16 | 58.84 | 74.00 | -15.16 | Peak | 100 | 294 | P |
| 8 | 16500.00 | 17.03 | 43.62 | 60.65 | 68.20 | -7.55 | Peak | 100 | 167 | P |

Note: Level=Reading+Factor
 Margin=Level-Limit
 Factor=Antenna Factor + cable loss - Amplifier Factor



| | | | | | |
|-----------|---|----------------------------------|-----------|---|------------|
| Power | : | From Adapter (AC 120V / 60Hz) | Pol/Phase | : | HORIZONTAL |
| Test Mode | : | Mode 1, Band 3, CH100 | | : | |

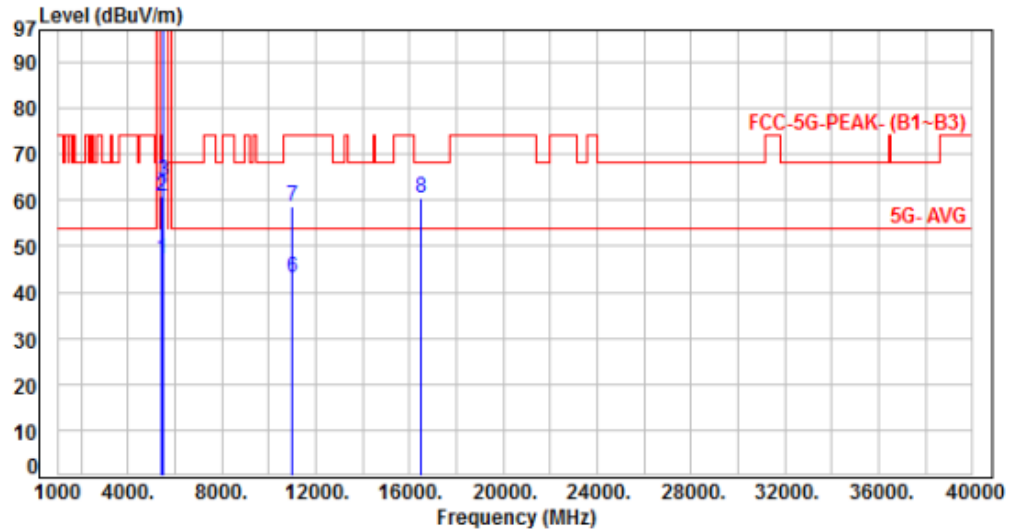

| No. | Frequency (MHz) | Factor (dB) | Reading (dBuV) | Level (dBuV/m) | Limit (dBuV/m) | Margin (dB) | Detector | Height (cm) | Azimuth (deg) | P/F |
|-----|-----------------|-------------|----------------|----------------|----------------|-------------|----------|-------------|---------------|-----|
| 1 | 5460.00 | 6.69 | 40.41 | 47.10 | 54.00 | -6.90 | Average | 242 | 309 | P |
| 2 | 5460.00 | 6.69 | 54.19 | 60.88 | 74.00 | -13.12 | Peak | 242 | 309 | P |
| 3 | 5470.00 | 6.72 | 57.56 | 64.28 | 68.20 | -3.92 | Peak | 242 | 309 | P |
| 4 | 5500.00 | 6.80 | 91.24 | 98.04 | 200.00 | -101.96 | Average | 242 | 309 | P |
| 5 | 5500.00 | 6.80 | 101.70 | 108.50 | 200.00 | -91.50 | Peak | 242 | 309 | P |
| 6 | 11000.00 | 14.68 | 28.44 | 43.12 | 54.00 | -10.88 | Average | 100 | 199 | P |
| 7 | 11000.00 | 14.68 | 43.84 | 58.52 | 74.00 | -15.48 | Peak | 100 | 199 | P |
| 8 | 16500.00 | 17.03 | 43.64 | 60.67 | 68.20 | -7.53 | Peak | 100 | 186 | P |

Note: Level=Reading+Factor
 Margin=Level-Limit
 Factor=Antenna Factor + cable loss - Amplifier Factor



| | | | | | |
|-----------|---|----------------------------------|-----------|---|----------|
| Power | : | From Adapter (AC 120V / 60Hz) | Pol/Phase | : | VERTICAL |
| Test Mode | : | Mode 1, Band 3, CH120 | | : | |

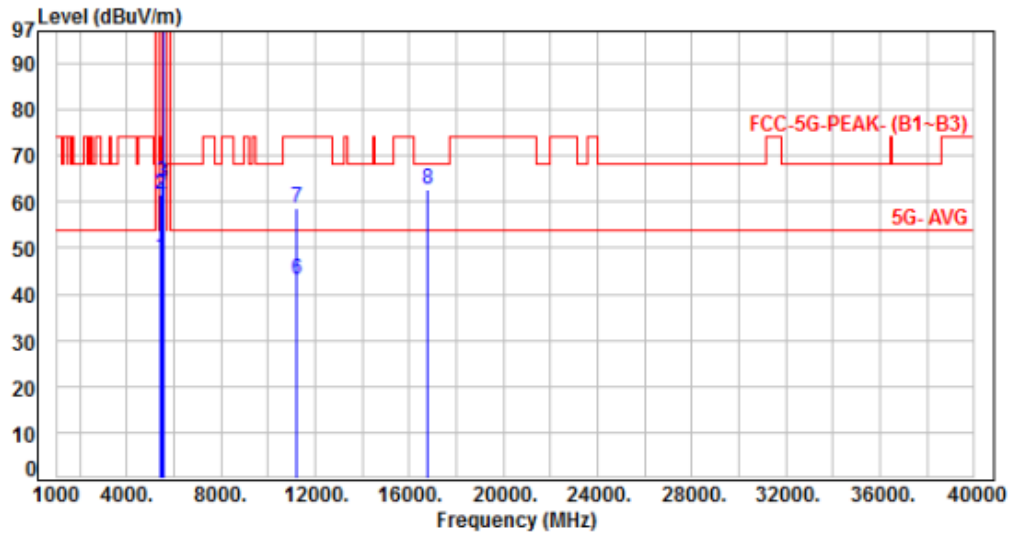

| No. | Frequency (MHz) | Factor (dB) | Reading (dBuV) | Level (dBuV/m) | Limit (dBuV/m) | Margin (dB) | Detector | Height (cm) | Azimuth (deg) | P/F |
|-----|-----------------|-------------|----------------|----------------|----------------|-------------|----------|-------------|---------------|-----|
| 1 | 5460.00 | 6.69 | 41.21 | 47.90 | 54.00 | -6.10 | Average | 333 | 357 | P |
| 2 | 5460.00 | 6.69 | 54.91 | 61.60 | 74.00 | -12.40 | Peak | 333 | 357 | P |
| 3 | 5470.00 | 6.72 | 57.53 | 64.25 | 68.20 | -3.95 | Peak | 333 | 357 | P |
| 4 | 5600.00 | 6.78 | 94.97 | 101.75 | 200.00 | -98.25 | Average | 333 | 357 | P |
| 5 | 5600.00 | 6.78 | 105.49 | 112.27 | 200.00 | -87.73 | Peak | 333 | 357 | P |
| 6 | 11200.00 | 14.71 | 28.60 | 43.31 | 54.00 | -10.69 | Average | 100 | 293 | P |
| 7 | 11200.00 | 14.71 | 43.97 | 58.68 | 74.00 | -15.32 | Peak | 100 | 293 | P |
| 8 | 16800.00 | 19.05 | 43.74 | 62.79 | 68.20 | -5.41 | Peak | 100 | 166 | P |

Note: Level=Reading+Factor
 Margin=Level-Limit
 Factor=Antenna Factor + cable loss - Amplifier Factor



| | | | | | |
|-----------|---|----------------------------------|-----------|---|------------|
| Power | : | From Adapter (AC 120V / 60Hz) | Pol/Phase | : | HORIZONTAL |
| Test Mode | : | Mode 1, Band 3, CH120 | | : | |

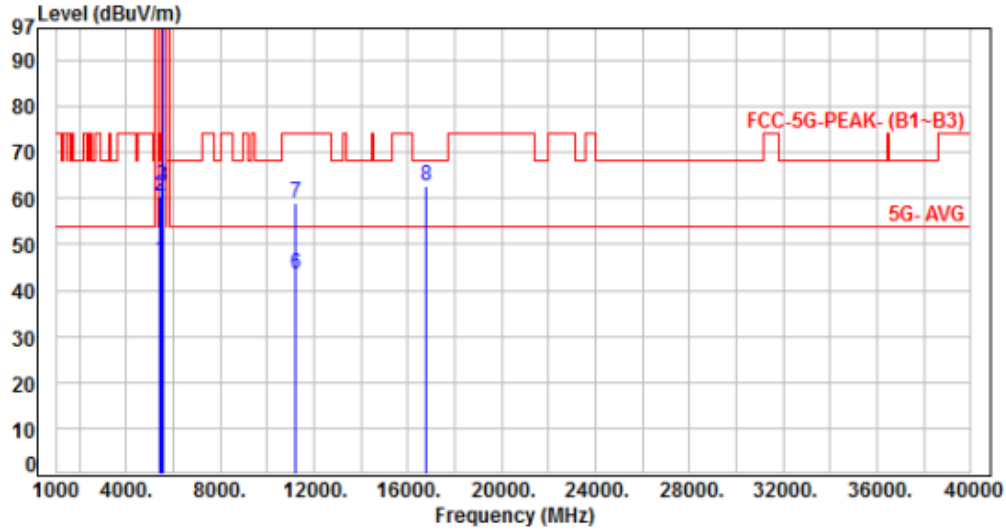

| No. | Frequency (MHz) | Factor (dB) | Reading (dBuV) | Level (dBuV/m) | Limit (dBuV/m) | Margin (dB) | Detector | Height (cm) | Azimuth (deg) | P/F |
|-----|-----------------|-------------|----------------|----------------|----------------|-------------|----------|-------------|---------------|-----|
| 1 | 5460.00 | 6.69 | 39.88 | 46.57 | 54.00 | -7.43 | Average | 246 | 311 | P |
| 2 | 5460.00 | 6.69 | 53.67 | 60.36 | 74.00 | -13.64 | Peak | 246 | 311 | P |
| 3 | 5470.00 | 6.72 | 56.07 | 62.79 | 68.20 | -5.41 | Peak | 246 | 311 | P |
| 4 | 5600.00 | 6.78 | 90.46 | 97.24 | 200.00 | -102.76 | Average | 246 | 311 | P |
| 5 | 5600.00 | 6.78 | 100.93 | 107.71 | 200.00 | -92.29 | Peak | 246 | 311 | P |
| 6 | 11200.00 | 14.71 | 28.71 | 43.42 | 54.00 | -10.58 | Average | 100 | 200 | P |
| 7 | 11200.00 | 14.71 | 44.20 | 58.91 | 74.00 | -15.09 | Peak | 100 | 200 | P |
| 8 | 16800.00 | 19.05 | 43.49 | 62.54 | 68.20 | -5.66 | Peak | 100 | 181 | P |

Note: Level=Reading+Factor
 Margin=Level-Limit
 Factor=Antenna Factor + cable loss - Amplifier Factor



| | | | | | |
|-----------|---|----------------------------------|-----------|---|----------|
| Power | : | From Adapter (AC 120V / 60Hz) | Pol/Phase | : | VERTICAL |
| Test Mode | : | Mode 1, Band 3, CH140 | | : | |

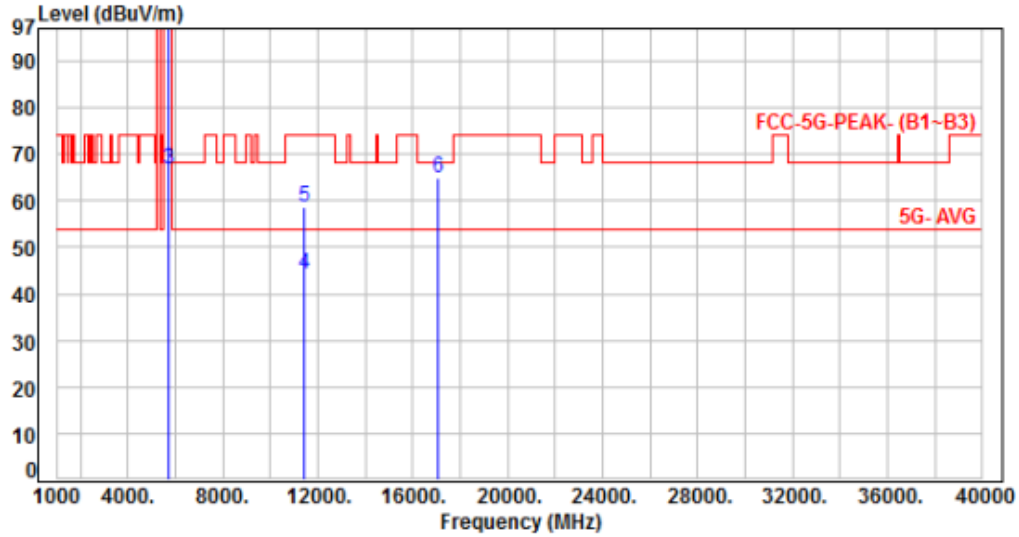

| No. | Frequency (MHz) | Factor (dB) | Reading (dBuV) | Level (dBuV/m) | Limit (dBuV/m) | Margin (dB) | Detector | Height (cm) | Azimuth (deg) | P/F |
|-----|-----------------|-------------|----------------|----------------|----------------|-------------|----------|-------------|---------------|-----|
| 1 | 5700.00 | 6.86 | 90.48 | 97.34 | 200.00 | -102.66 | Average | 326 | 4 | P |
| 2 | 5700.00 | 6.86 | 102.15 | 109.01 | 200.00 | -90.99 | Peak | 326 | 4 | P |
| 3 | 5725.00 | 6.83 | 59.79 | 66.62 | 68.20 | -1.58 | Peak | 326 | 4 | P |
| 4 | 11400.00 | 14.94 | 29.24 | 44.18 | 54.00 | -9.82 | Average | 100 | 296 | P |
| 5 | 11400.00 | 14.94 | 43.73 | 58.67 | 74.00 | -15.33 | Peak | 100 | 296 | P |
| 6 | 17100.00 | 20.81 | 44.07 | 64.88 | 68.20 | -3.32 | Peak | 100 | 163 | P |

Note: Level=Reading+Factor
 Margin=Level-Limit
 Factor=Antenna Factor + cable loss - Amplifier Factor



| | | | | | |
|-----------|---|----------------------------------|-----------|---|------------|
| Power | : | From Adapter (AC 120V / 60Hz) | Pol/Phase | : | HORIZONTAL |
| Test Mode | : | Mode 1, Band 3, CH140 | | : | |

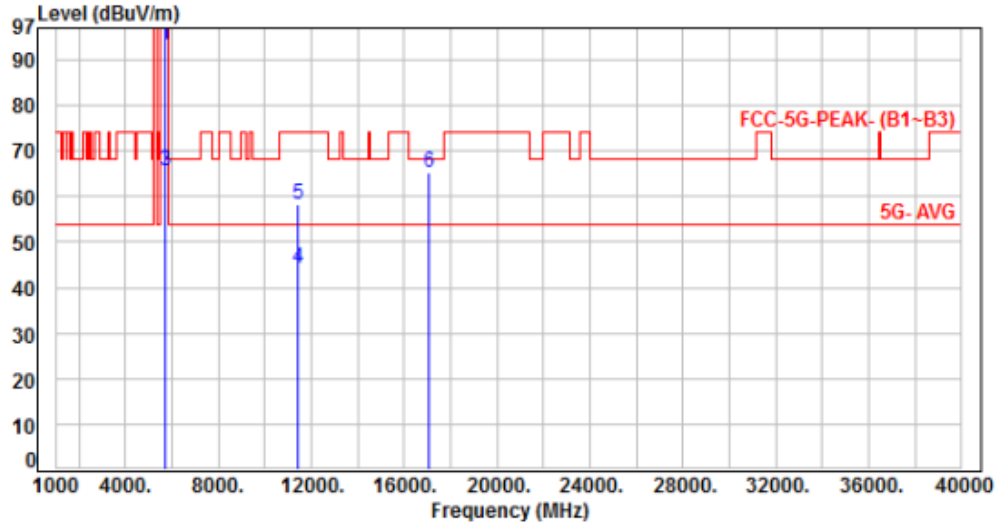

| No. | Frequency (MHz) | Factor (dB) | Reading (dBuV) | Level (dBuV/m) | Limit (dBuV/m) | Margin (dB) | Detector | Height (cm) | Azimuth (deg) | P/F |
|-----|-----------------|-------------|----------------|----------------|----------------|-------------|----------|-------------|---------------|-----|
| 1 | 5700.00 | 6.86 | 86.58 | 93.44 | 200.00 | -106.56 | Average | 236 | 305 | P |
| 2 | 5700.00 | 6.86 | 97.91 | 104.77 | 200.00 | -95.23 | Peak | 236 | 305 | P |
| 3 | 5725.00 | 6.83 | 58.90 | 65.73 | 68.20 | -2.47 | Peak | 236 | 305 | P |
| 4 | 11400.00 | 14.94 | 29.44 | 44.38 | 54.00 | -9.62 | Average | 100 | 197 | P |
| 5 | 11400.00 | 14.94 | 43.50 | 58.44 | 74.00 | -15.56 | Peak | 100 | 197 | P |
| 6 | 17100.00 | 20.81 | 44.39 | 65.20 | 68.20 | -3.00 | Peak | 100 | 188 | P |

Note: Level=Reading+Factor
 Margin=Level-Limit
 Factor=Antenna Factor + cable loss - Amplifier Factor



| | | | | | |
|-----------|---|----------------------------------|-----------|---|----------|
| Power | : | From Adapter (AC 120V / 60Hz) | Pol/Phase | : | VERTICAL |
| Test Mode | : | Mode 4, Band 3, CH100 | | : | |

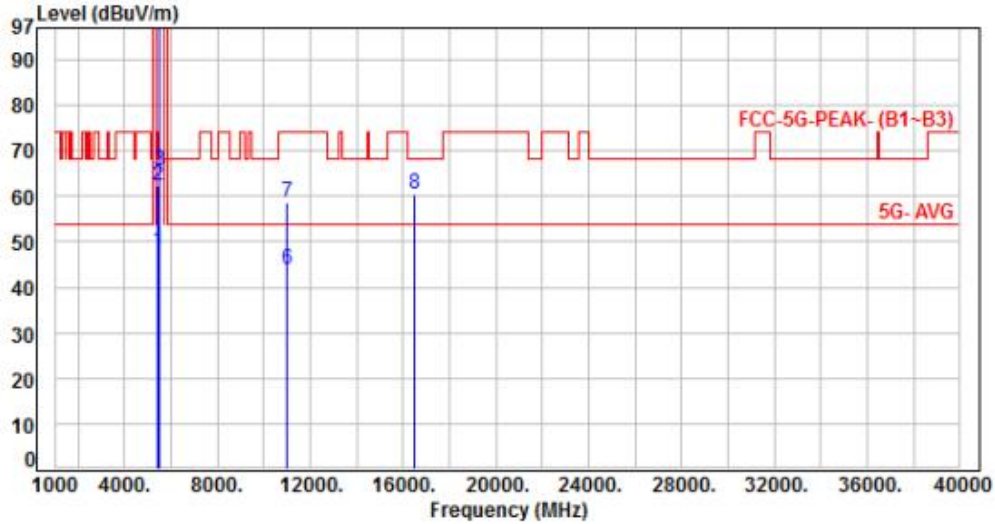

| No. | Frequency (MHz) | Factor (dB) | Reading (dBuV) | Level (dBuV/m) | Limit (dBuV/m) | Margin (dB) | Detector | Height (cm) | Azimuth (deg) | P/F |
|-----|-----------------|-------------|----------------|----------------|----------------|-------------|----------|-------------|---------------|-----|
| 1 | 5460.00 | 6.69 | 41.27 | 47.96 | 54.00 | -6.04 | Average | 335 | 0 | P |
| 2 | 5460.00 | 6.69 | 55.46 | 62.15 | 74.00 | -11.85 | Peak | 335 | 0 | P |
| 3 | 5470.00 | 6.72 | 58.76 | 65.48 | 68.20 | -2.72 | Peak | 335 | 0 | P |
| 4 | 5500.00 | 6.80 | 92.71 | 99.51 | 200.00 | -100.49 | Average | 335 | 0 | P |
| 5 | 5500.00 | 6.80 | 104.85 | 111.65 | 200.00 | -88.35 | Peak | 335 | 0 | P |
| 6 | 11000.00 | 14.68 | 29.08 | 43.76 | 54.00 | -10.24 | Average | 100 | 290 | P |
| 7 | 11000.00 | 14.68 | 43.81 | 58.49 | 74.00 | -15.51 | Peak | 100 | 290 | P |
| 8 | 16500.00 | 17.03 | 43.49 | 60.52 | 68.20 | -7.68 | Peak | 100 | 163 | P |

Note: Level=Reading+Factor
 Margin=Level-Limit
 Factor=Antenna Factor + cable loss - Amplifier Factor



| | | | | | |
|-----------|---|----------------------------------|-----------|---|------------|
| Power | : | From Adapter (AC 120V / 60Hz) | Pol/Phase | : | HORIZONTAL |
| Test Mode | : | Mode 4, Band 3, CH100 | | : | |

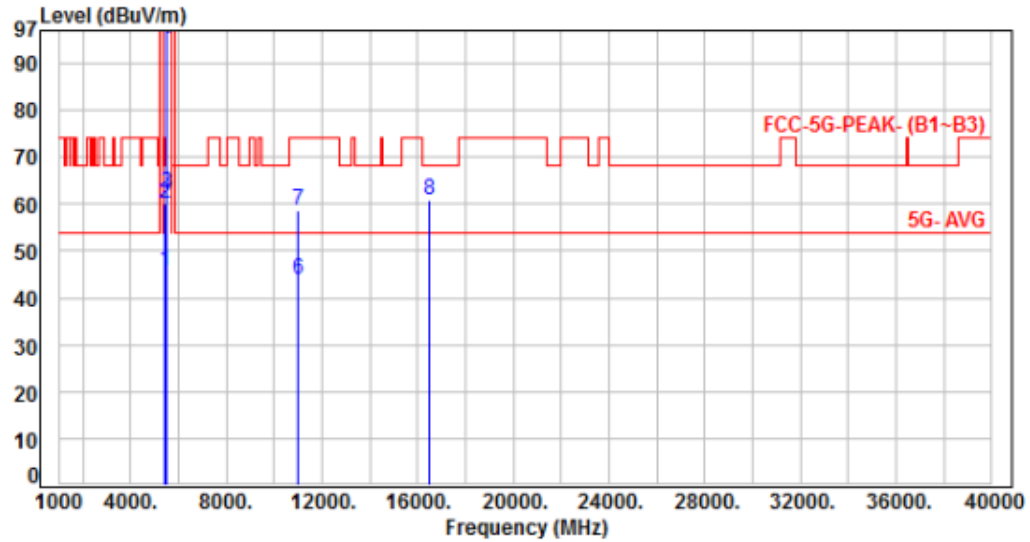

| No. | Frequency (MHz) | Factor (dB) | Reading (dBuV) | Level (dBuV/m) | Limit (dBuV/m) | Margin (dB) | Detector | Height (cm) | Azimuth (deg) | P/F |
|-----|-----------------|-------------|----------------|----------------|----------------|-------------|----------|-------------|---------------|-----|
| 1 | 5460.00 | 6.69 | 39.19 | 45.88 | 54.00 | -8.12 | Average | 239 | 311 | P |
| 2 | 5460.00 | 6.69 | 53.38 | 60.07 | 74.00 | -13.93 | Peak | 239 | 311 | P |
| 3 | 5470.00 | 6.72 | 55.53 | 62.25 | 68.20 | -5.95 | Peak | 239 | 311 | P |
| 4 | 5500.00 | 6.80 | 88.26 | 95.06 | 200.00 | -104.94 | Average | 239 | 311 | P |
| 5 | 5500.00 | 6.80 | 100.53 | 107.33 | 200.00 | -92.67 | Peak | 239 | 311 | P |
| 6 | 11000.00 | 14.68 | 29.19 | 43.87 | 54.00 | -10.13 | Average | 100 | 196 | P |
| 7 | 11000.00 | 14.68 | 43.85 | 58.53 | 74.00 | -15.47 | Peak | 100 | 196 | P |
| 8 | 16500.00 | 17.03 | 43.92 | 60.95 | 68.20 | -7.25 | Peak | 100 | 189 | P |

Note: Level=Reading+Factor
 Margin=Level-Limit
 Factor=Antenna Factor + cable loss - Amplifier Factor