



FCC RADIO TEST REPORT

Applicant : Elo Touch Solutions, Inc.
Address : 670 N. McCarthy Blvd., Suite 100, Milpitas,
CA 95035, USA
Equipment : Touch All-in-One Computer
Model No. : ESY22I1D
Trade Name : Elo or 
FCC ID : RBWESY22I1D

I HEREBY CERTIFY THAT :

The sample was received on Dec. 19, 2022 and the testing was completed on Dec. 20, 2022 at CerpPASS Technology Corp. The test result refers exclusively to the test presented test model / sample. Without written approval of CerpPASS Technology Corp., the test report shall not be reproduced except in full.

Approved by:

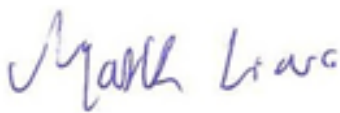

Mark Liao / Supervisor

Laboratory Accreditation:

CerpPASS Technology Corporation Test Laboratory





CONTENTS

- 1. **Summary of Test Procedure and Test Results5**
 - 1.1 Applicable Standards5
- 2. **Test Configuration of Equipment under Test6**
 - 2.1 Feature of Equipment under Test.....6
 - 2.2 Carrier Frequency of Channes.....7
 - 2.3 Test Mode & Test Software8
 - 2.4 Description of Test System.....9
 - 2.5 General Information of Test.....10
 - 2.6 Measurement Uncertainty11
- 3. **Test Equipment and Ancillaries Used for Tests12**
- 4. **Antenna Requirements.....14**
 - 4.1 Standard Applicable14
 - 4.2 Antenna Construction and Directional Gain.....14
- 5. **Frequency Hopping System Requirements15**
 - 5.1 Frequency Hopping Requirement15
 - 5.2 EUT Hopping System.....16
 - 5.3 Pseudorandom Frequency Hopping Sequence16
- 6. **Test of AC Power Line Conducted Emission17**
 - 6.1 Test Limit17
 - 6.2 Test Procedures17
 - 6.3 Typical Test Setup18
 - 6.4 Test Result and Data19
 - 6.5 Test Photographs21
- 7. **Test of Radiated Spurious Emission.....22**
 - 7.1 Test Limit22
 - 7.2 Test Procedures.....23
 - 7.3 Typical Test Setup24
 - 7.4 Test Result and Data (9kHz ~ 30MHz)25
 - 7.5 Test Result and Data (30MHz ~ 1GHz)25
 - 7.6 Test Result and Data (1GHz ~ 25GHz).....27
 - 7.7 Restricted Bands of Operation39
 - 7.8 Test Photographs (30MHz ~ 1GHz)40
 - 7.9 Test Photographs (1GHz ~ 25GHz)41
- 8. **Test of Conducted Spurious Emission43**
 - 8.1 Test Limit43
 - 8.2 Test Procedure43
 - 8.3 Test Setup Layout43
 - 8.4 Test Result and Data43
- 9. **20dB Bandwidth Measurement Data51**
 - 9.1 Test Limit51
 - 9.2 Test Procedures51
 - 9.3 Test Setup Layout51



9.4 Test Result and Data52

10. Carrier Frequency Separation55

10.1 Test Limit55

10.2 Test Procedures55

10.3 Test Setup Layout55

10.4 Test Result and Data56

11. Dwell Time on each channel59

11.1 Test Limit59

11.2 Test Procedures59

11.3 Test Setup Layout59

11.4 Test Result and Data60

12. Number of Hopping Channels63

12.1 Test Limit63

12.2 Test Procedures63

12.3 Test Setup Layout63

12.4 Test Result and Data63

13. Maximum Average Output Power65

13.1 Test Limit65

13.2 Test Procedures65

13.3 Test Setup Layout65

13.4 Test Result and Data66

14. Radio Frequency Exposure67

14.1 Applicable Standards67

14.2 EUT Specification.....68

14.3 Result68



History of this test report

Report No.	Issued Date	Description
21030199-TRFCC01	Dec. 23, 2022	Original



1. Summary of Test Procedure and Test Results

1.1 Applicable Standards

ANSI C63.10:2013

FCC Rules and Regulations Part 15 Subpart C §15.247

FCC Rule	Description of Test	Result
15.203	. Antenna Requirement	PASS
15.247(a)(1)	.Pseudorandom Frequency Hopping Sequence	PASS
15.207	. AC Power Line Conducted Emission	PASS
15.209 15.205	. Radiated Spurious Emission	PASS
15.247(d)	. Conducted Spurious Emission	PASS
15.247(a)(1)	. Channel Carrier Frequencies Separation	PASS
15.247(a)(1)	. 20dB Bandwidth	PASS
15.247(a)(1)	. Dwell Time	PASS
15.247(b)	. Number of Hopping Channels	PASS
15.247(b)	. Output Power	PASS
2.1091	. Radio Frequency Exposure	PASS

* The lab has reduced the uncertainty risk factor from test equipment, environment and staff technicians which according to the standard on contract. Therefore, the test result will only be determined by standard requirement.



2. Test Configuration of Equipment under Test

2.1 Feature of Equipment under Test

Operation Frequency Range	BT / BLE: 2400-2483.5MHz 802.11b/g/n: 2400-2483.5MHz 802.11a/n/ac: 5150-5250MHz, 5250-5350MHz, 5470-5725MHz, 5725-5850MHz
Center Frequency Range	BT / BLE: 2402MHz-2480MHz 802.11b/g/n: 2412MHz-2462MHz 802.11a/n/ac: 5180-5240MHz, 5260-5320MHz, 5500-5700MHz, 5745-5825MHz
Modulation Type	BT: GFSK, $\pi/4$ -DQPSK, 8DPSK BLE: GFSK WLAN: 802.11b: CCK, DQPSK, DBPSK 802.11g/n: BPSK, QPSK, 16QAM, 64QAM 802.11a: BPSK, QPSK, 16QAM, 64QAM 802.11ac: BPSK, QPSK, 16QAM, 64QAM, 256QAM
Modulation Technology	DSSS, OFDM, FHSS, DTS
Data Rate	BT: GFSK: 1Mbps, $\pi/4$ -DQPSK: 2Mbps, 8DPSK: 3Mbps BLE: GFSK: 1Mbps WLAN: 2.4GHz: 802.11b: 1, 2, 5.5, 11Mbps 802.11g: 6, 9, 12, 18, 24, 36, 48, 54Mbps 802.11n: MCS0 – MCS15, HT20 5GHz: 802.11a: 6, 9, 12, 18, 24, 36, 48, 54Mbps 802.11n: MCS0 – MCS15, HT20/40 802.11ac: MCS0 – MCS9, VHT20/40/80
Antenna Type	Dipole Antenna
Antenna Gain	For BT / BLE: 2400-2480MHz: ANT A: 3.53dBi For WLAN: 2400-2500MHz: ANT A: 3.53dBi, ANT B: 3.26dBi 5150-5250MHz: ANT A: 2.49dBi, ANT B: 1.90dBi 5250-5350MHz: ANT A: 2.92dBi, ANT B: 1.90dBi 5471-5725MHz: ANT A: 3.50dBi, ANT B: 2.83dBi 5725-5850MHz: ANT A: 2.70dBi, ANT B: 2.32dBi
Adapter	Brand: BILLION Model: BA090-190474MBX

Note:

1. EUT support TPC Function.
2. EUT support Client Mode.
3. EUT WLAN 2.4GHz 802.11b and 802.11g 1TX diversity
4. WLAN and BT can simultaneously transmission.
5. For more details, please refer to the User's manual of the EUT.



2.2 Carrier Frequency of Channes

Channel	Frequency (MHz)	Channel	Frequency (MHz)	Channel	Frequency (MHz)	Channel	Frequency (MHz)
*00	2402	20	2422	40	2442	60	2462
01	2403	21	2423	41	2443	61	2463
02	2404	22	2424	42	2444	62	2464
03	2405	23	2425	43	2445	63	2465
04	2406	24	2426	44	2446	64	2466
05	2407	25	2427	45	2447	65	2467
06	2408	26	2428	46	2448	66	2468
07	2409	27	2429	47	2449	67	2469
08	2410	28	2430	48	2450	68	2470
09	2411	29	2431	49	2451	69	2471
10	2412	30	2432	50	2452	70	2472
11	2413	31	2433	51	2453	71	2473
12	2414	32	2434	52	2454	72	2474
13	2415	33	2435	53	2455	73	2475
14	2416	34	2436	54	2456	74	2476
15	2417	35	2437	55	2457	75	2477
16	2418	36	2438	56	2458	76	2478
17	2419	37	2439	57	2459	77	2479
18	2420	38	2440	58	2460	*78	2480
19	2421	*39	2441	59	2461	---	---

Note: Channels remarked * are selected to perform test.



2.3 Test Mode & Test Software

- a. During testing, the interface cables and equipment positions were varied according to ANSI C63.10
- b. The complete test system included Notebook and EUT for RF test.
- c. An executive program, " QRCT ver. 4.0.00193.0" under Windows OS system was executed to transmit and receive data via Bluetooth.
- d. The following test modes were performed for the test:

Conducted Emissions from the AC mains power ports	
Test Mode	Operating Description
1	Transmitter Mode, From Adapter (120V/60 Hz)
2	Transmitter Mode, From Adapter (240V/60 Hz)
caused "Test Mode 1" generated the worst case, it was reported as the final data.	
Radiation Emissions (Below 1GHz)	
Test Mode	Operating Description
1	Transmitter Mode, From Adapter (120V/60 Hz)
2	Transmitter Mode, From Adapter (240V/60 Hz)
caused "Test Mode 1" generated the worst case, it was reported as the final data.	
Radiation Emissions (Above 1GHz)	
Test Mode	Operating Description
1	GFSK (1Mbps) , From Adapter (120V/60 Hz)
2	$\pi/4$ -DQPSK (2Mbps) , From Adapter (120V/60 Hz)
3	8DPSK (3Mbps) , From Adapter (120V/60 Hz)
caused "Test Mode 1, 3" generated the worst case, they were reported as the final data.	

Modulation Type	TX CONFIGURATION
GFSK	1TX
$\pi/4$ -DQPSK	1TX
8DPSK	1TX



2.4 Description of Test System

RF Conducted				
Equipment	Brand	Model	Length/Type	Power cord/Length/Type
Notebook	lenovo	S1GL2W	N/A	Adapter / 1.8m / NS
USB cable	BENEVO	E210567AWM	N/A	0.6m / NS
Radiated Emissions				
Equipment	Brand	Model	Length/Type	Power cord/Length/Type
Notebook	lenovo	S1GL2W	N/A	Adapter / 1.8m / NS
USB cable	BENEVO	E210567AWM	N/A	0.6m / NS
AC Power Line Conducted Emission				
Equipment	Brand	Model	Length/Type	Power cord/Length/Type
Notebook	lenovo	S1GL2W	N/A	Adapter / 1.8m / NS
USB cable	BENEVO	E210567AWM	N/A	0.6m / NS



2.5 General Information of Test

Test Site	CerpPASS Technology Corporation Test Laboratory Address: No.10, Ln. 2, Lianfu St., Luzhu Dist., Taoyuan City 33848, Taiwan (R.O.C.) Tel:+886-3-3226-888 Fax:+886-3-3226-881	
	FCC	TW1439, TW1079
	IC	4934E-1, 4934E-2
	VCCI	T-2205 for Telecommunication test C-4663 for Conducted emission test R-4218 for Radiated emission test G-10812, G-10813 for radiated disturbance above 1GHz
Frequency Range Investigated:	Conducted: from 150kHz to 30 MHz Radiation: from 30 MHz to 25,000MHz	
Test Distance:	The test distance of radiated emission from antenna to EUT is 3 M.	

Test Item	Test Site	Test period	Environmental Conditions	Tested By
RF Conducted	RFCON01-NK	2022/12/19	22.7°C / 48%	Leon Huang
Radiated Emissions	3M02-NK	2022/12/19	16°C / 44%	Leon Huang
AC Power Line Conducted Emission	CON01-NK	2022/12/20	21°C / 66%	Leon Huang



2.6 Measurement Uncertainty

ISO/IEC 17025 requires that an estimate of the measurement uncertainties associated with the emissions test results be included in the report. The measurement uncertainties given below are based on a 95% confidence level (based on a coverage factor (k=2))

Measurement Item	Uncertainty
AC Power Line Conduction(150K~30MHz)	±3.12dB
Radiated Spurious Emission(9KHz~30MHz)	±3.4dB
Radiated Spurious Emission(30MHz~1GHz)	±5.7dB
Radiated Spurious Emission(1GHz~25GHz)	±6.8dB
Conducted Spurious Emission	±1.8dB
6dB Bandwidth	±4.4%
20dB Bandwidth	±4.4%
Occupied Bandwidth	±4.4%
Peak Output Power(Conducted Power Meter)	±1.1dB
Dwell Time / Deactivation Time	±1.2%
Power Spectral Density	±1.8dB
Duty Cycle	±1.2%



3. Test Equipment and Ancillaries Used for Tests

Test Item	Radiated Emissions				
Test Site	Semi Anechoic Room(3M02-NK)				
Instrument	Manufacturer	Model No	Serial No	Calibration Date	Valid Date
Bilog Antenna	Schwarzbeck	VULB9168	369	2022/04/22	2023/04/21
Active Loop Antenna	EMCO	6507	40855	2022/05/25	2023/05/24
Horn Antenna	EMCO	3115	31601	2022/10/12	2023/10/11
Horn Antenna	EMCO	3116	31970	2022/03/18	2023/03/17
EMI Receiver	ROHDE & SCHWARZ	ESCI	101423	2022/07/05	2023/07/04
Spectrum Analyzer	ROHDE & SCHWARZ	FSV 40-N	102151	2022/08/19	2023/08/18
Preamplifier	Agilent	8449B	3008A01954	2022/03/17	2023/03/16
Preamplifier	EMC INSTRUMENTS	EMC184045	980065	2022/11/11	2023/11/10
Preamplifier	EM Electronics corp.	EM330	60660	2022/04/08	2023/04/07
Cable-6m(9k~300M)	NA	EMC5D-BM-BM-6	130605	2022/09/06	2023/09/05
Cable-3in1(30M-1G)	HARBOUR INDUSTRIES	LL142	CCE1315	2022/03/21	2023/03/20
Cable-0.5m(1G-40G)	HUBER SUHNER	SUCOFLEX 104	805443/4	2022/01/11	2023/01/10
Cable-3m(1G-40G)	HUBER SUHNER	SUCOFLEX 104	805796/4	2022/01/11	2023/01/10
Cable-8m(1G-26.5G)	WOKEN	WCBA-WCA203SM	CCE1374	2022/04/25	2023/04/24
Cable-0.5m(30M-40G)	HUBER SUHNER	SUCOFLEX 102	28420/2	2022/4/9	2023/4/8
Cable-3m(30M-40G)	HUBER SUHNER	SUCOFLEX 102	MY2608/2	2022/4/9	2023/4/8
Cable-0.5m(1G-40G)	Rapidtek	40GHZ 50CM	38MS-38MS50314	2022/4/9	2023/4/8
Cable-3m(1G-40G)	Rapidtek	40GHZ 300CM	38MS-38MS300314	2022/4/9	2023/4/8
E3	AUDIX	v8.2014-8-6	RK-000529	NA	NA

Test Item	RF Conducted				
Test Site	RFCON01-NK				
Instrument	Manufacturer	Model No	Serial No	Calibration Date	Valid Date
CAX Signal Analyzer	KEYSIGHT	N9000B	MY57100339	2022/01/10	2023/01/09
Power Meter	Anritsu	ML2495A	1224005	2022/04/12	2023/04/11
Power Sensor	Anritsu	MA2411B	1207295	2022/04/12	2023/04/11
Attenuator	KEYSIGHT	8491B	MY39250703	2022/04/12	2023/04/11



Test Item	AC Power Line Conducted Emission				
Test Site	CON01-NK				
Instrument	Manufacturer	Model No	Serial No	Calibration Date	Valid Date
EMI Receiver	ROHDE & SCHWARZ	ESCI	101200	2022/08/22	2023/08/21
Line Impedance Stabilization Network	Schwarzbeck	NSLK 8127	8127-740	2022/08/21	2023/08/20
Pulse Limiter	ROHDE & SCHWARZ	ESH3-Z2	101934	2022/03/21	2023/03/20
Cable-6m(9k~300M)	NA	EMC5D-BM-BM-6	130606	2022/03/21	2023/03/20
E3	AUDIX	v8.2014-8-6	RK-000531	NA	NA



4. Antenna Requirements

4.1 Standard Applicable

For intentional device, according to FCC 47 CFR Section 15.203, an intentional radiator shall be designed to ensure that no antenna other than that furnished by the responsible party shall be used with the device.

And according to FCC 47 CFR Section 15.247 (b), if transmitting antennas of directional gain greater than 6dBi are used, the power shall be reduced by the amount in dB that the directional gain of the antenna exceeds 6dBi.

4.2 Antenna Construction and Directional Gain

Antenna Type	Dipole Antenna
Antenna Gain	3.53 dBi



5. Frequency Hopping System Requirements

5.1 Frequency Hopping Requirement

According to FCC Part 15.247(a)(1), The system shall hop to channel frequencies that are selected at the system hopping rate from a pseudo randomly ordered list of hopping frequencies. Each frequency must be used equally on the average by each transmitter. The system receivers shall have input bandwidths that match the hopping channel bandwidths of their corresponding transmitters and shall shift frequencies in synchronization with the transmitted signals.

(g) Frequency hopping spread spectrum systems are not required to employ all available hopping channels during each transmission. However, the system, consisting of both the transmitter and the receiver, must be designed to comply with all of the regulations in this section should the transmitter be presented with a continuous data (or information) stream. In addition, a system employing short transmission bursts must comply with the definition of a frequency hopping system and must distribute its transmissions over the minimum number of hopping channels specified in this section.

(h) The incorporation of intelligence within a frequency hopping spread spectrum system that permits the system to recognize other users within the spectrum band so that it individually and independently chooses and adapts its hopsets to avoid hopping on occupied channels is permitted. The coordination of frequency hopping systems in any other manner for the express purpose of avoiding the simultaneous occupancy of individual hopping frequencies by multiple transmitters is not permitted.



5.2 EUT Hopping System

This transmitter device is frequency hopping device, and complies with FCC part 15.247 rule.

This device uses Bluetooth radio which operates in 2400-2483.5 MHz band. Bluetooth uses a radio technology called frequency-hopping spread spectrum, which chops up the data being sent and transmits chunks of it on up to 79 bands (1 MHz each; centred from 2402 to 2480MHz) in the range 2,400-2,483.5 MHz. The transmitter switches hop frequencies 1,600 times per second to assure a high degree of data security. All Bluetooth devices participating in a given piconet are synchronized to the frequency-hopping channel for the piconet. The frequency hopping sequence is determined by the master's device address and the phase of the hopping sequence (the frequency to hop at a specific time) is determined by the master's internal clock. Therefore, all slaves in a piconet must know the master's device address and must synchronize their clocks with the master's clock.

Adaptive Frequency Hopping (AFH) was introduced in the Bluetooth specification to provide an effective way for a Bluetooth radio to counteract normal interference. AFH identifies "bad" channels, where either other wireless devices are interfering with the Bluetooth signal or the Bluetooth signal is interfering with another device. The AFH-enabled Bluetooth device will then communicate with other devices within its piconet to share details of any identified bad channels. The devices will then switch to alternative available "good" channels, away from the areas of interference, thus having no impact on the bandwidth used.

5.3 Pseudorandom Frequency Hopping Sequence

Pseudorandom Frequency Hopping Sequence Table as below:

Channel number:

57	7	4	47	52	62	6	67	38	15
52	27	2	73	76	69	76	64	13	37
12	28	17	64	18	33	16	31	35	72
60	35	12	9	71	37	57	4	28	69

etc.

The system receiver have input bandwidths that match the hopping channel bandwidths of their corresponding transmitters and shift frequencies in synchronization with the transmitted signals.



6. Test of AC Power Line Conducted Emission

6.1 Test Limit

Conducted Emissions were measured from 150 kHz to 30 MHz with a bandwidth of 9 KHz, according to the methods defined in ANSI C63.10-2013. The EUT was placed on a nonmetallic stand in a shielded room 0.8 meters above the ground plane. The interface cables and equipment positioning were varied within limits of reasonable applications to determine the position produced maximum conducted emissions.

Frequency (MHz)	Quasi Peak (dB μ V)	Average (dB μ V)
0.15 – 0.5	66-56*	56-46*
0.5 – 5.0	56	46
5.0 – 30.0	60	50

*Decreases with the logarithm of the frequency.

6.2 Test Procedures

- a. The EUT was placed 0.4 meter from the conducting wall of the shielding room was kept at least 80 centimeters from any other grounded conducting surface.
- b. Connect EUT to the power mains through a line impedance stabilization network (LISN).
- c. All the support units are connecting to the other LISN.
- d. The LISN provides 50 ohm coupling impedance for the measuring instrument.
- e. The FCC states that a 50 ohm, 50 micro-Henry LISN should be used.
- f. Both sides of AC line were checked for maximum conducted interference.
- g. The frequency range from 150 kHz to 30 MHz was searched.
- h. Set the test-receiver system to Peak Detect Function and Specified Bandwidth with Maximum Hold Mode.



6.3 Typical Test Setup

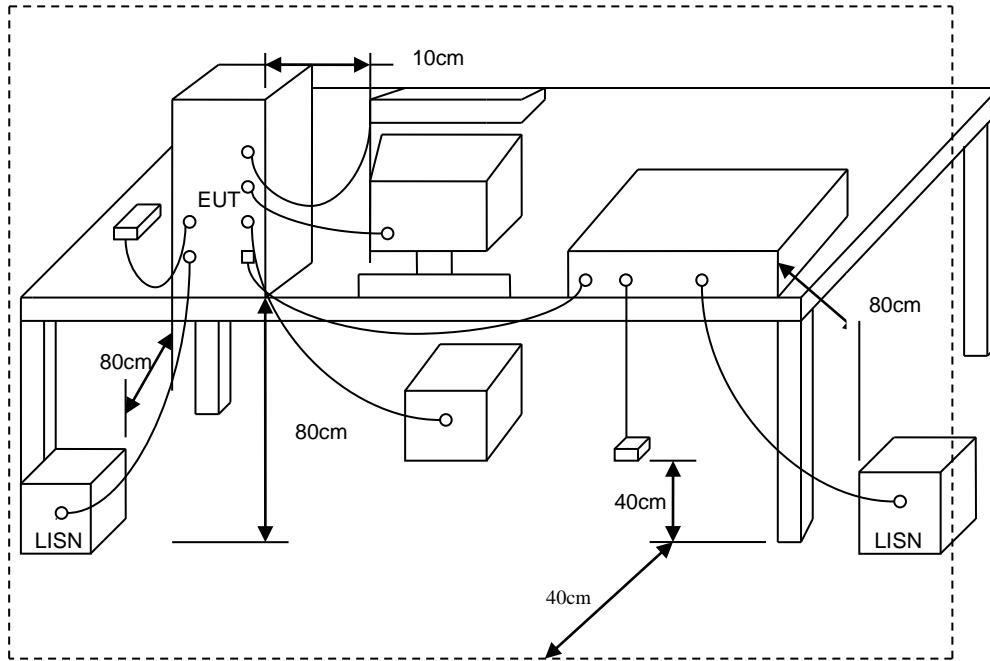



6.4 Test Result and Data

Power	: DC 19V From Adapter (AC 120V / 60Hz)	Pol/Phase	: LINE
Test Mode	: Mode 1		:

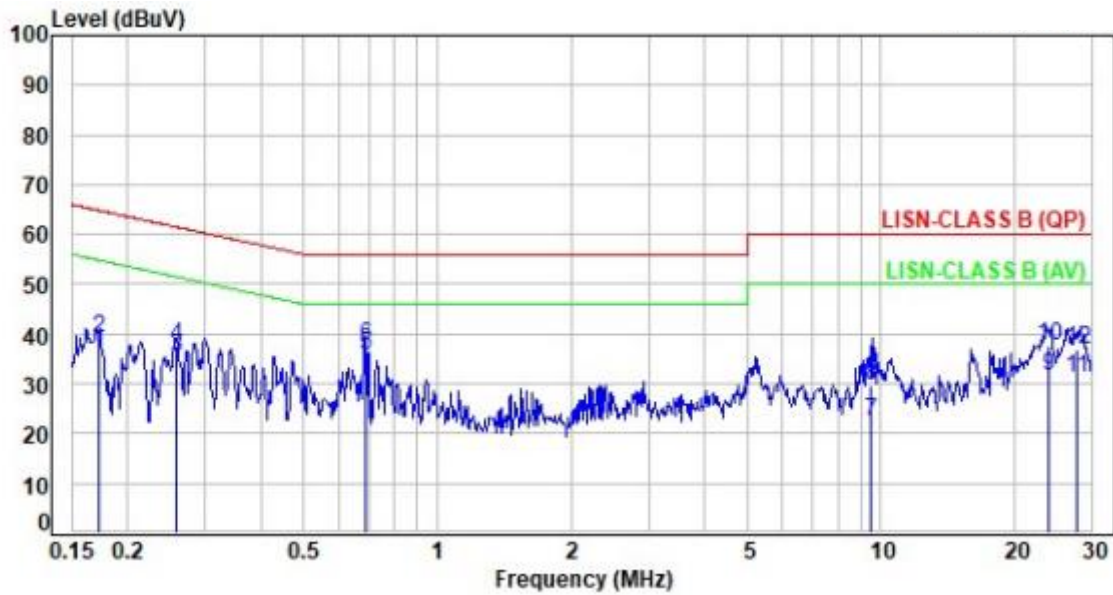

No.	Frequency (MHz)	Factor (dB)	Reading (dBuV)	Level (dBuV)	Limit (dBuV)	Margin (dB)	Detector	P/F
1	0.17	19.46	17.03	36.49	54.83	-18.34	Average	P
2	0.17	19.46	19.54	39.00	64.83	-25.83	QP	P
3	0.26	19.44	15.82	35.26	51.53	-16.27	Average	P
4	0.26	19.44	18.32	37.76	61.53	-23.77	QP	P
5	0.69	19.44	16.34	35.78	46.00	-10.22	Average	P
6	0.69	19.44	18.36	37.80	56.00	-18.20	QP	P
7	9.52	19.42	2.94	22.36	50.00	-27.64	Average	P
8	9.52	19.42	10.33	29.75	60.00	-30.25	QP	P
9	23.80	19.35	12.32	31.67	50.00	-18.33	Average	P
10	23.80	19.35	18.36	37.71	60.00	-22.29	QP	P
11	27.63	19.33	11.79	31.12	50.00	-18.88	Average	P
12	27.63	19.33	17.57	36.90	60.00	-23.10	QP	P

Note: Level=Reading+Factor
 Margin=Level-Limit
 Factor=(LISN or ISN or Current Probe)Factor + Cable Loss



Power	: DC 19V From Adapter (AC 120V / 60Hz)	Pol/Phase	: NEUTRAL
Test Mode	: Mode 1		:

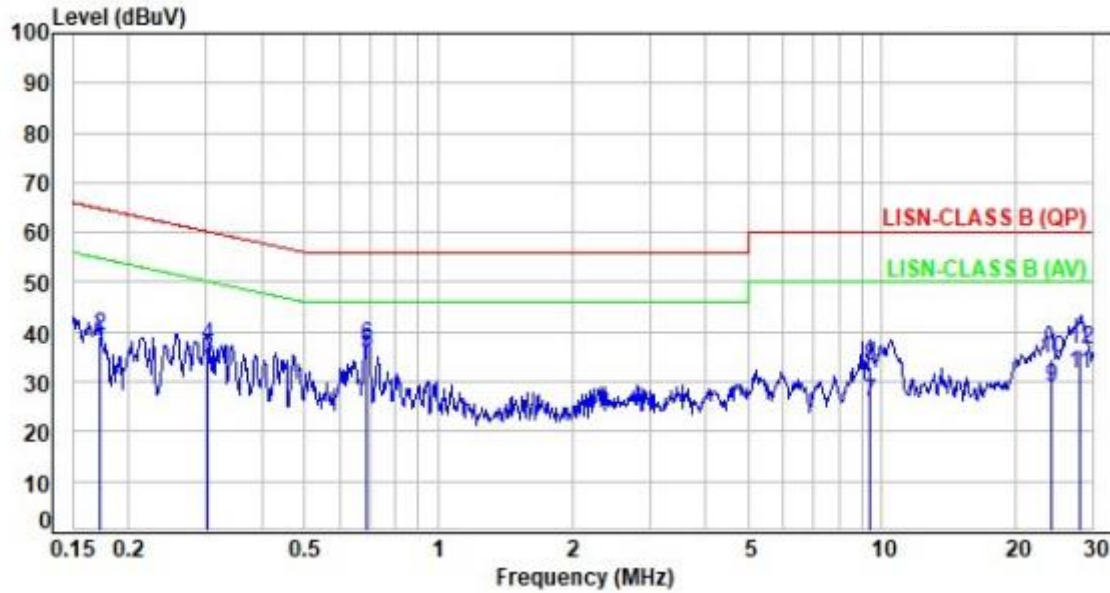

No.	Frequency (MHz)	Factor (dB)	Reading (dBuV)	Level (dBuV)	Limit (dBuV)	Margin (dB)	Detector	P/F
1	0.17	19.47	17.21	36.68	54.82	-18.14	Average	P
2	0.17	19.47	19.57	39.04	64.82	-25.78	QP	P
3	0.30	19.45	15.32	34.77	50.18	-15.41	Average	P
4	0.30	19.45	17.76	37.21	60.18	-22.97	QP	P
5	0.69	19.43	16.27	35.70	46.00	-10.30	Average	P
6	0.69	19.43	17.78	37.21	56.00	-18.79	QP	P
7	9.42	19.38	6.65	26.03	50.00	-23.97	Average	P
8	9.42	19.38	13.72	33.10	60.00	-26.90	QP	P
9	24.06	19.39	9.45	28.84	50.00	-21.16	Average	P
10	24.06	19.39	15.32	34.71	60.00	-25.29	QP	P
11	27.88	19.38	12.24	31.62	50.00	-18.38	Average	P
12	27.88	19.38	17.04	36.42	60.00	-23.58	QP	P

Note: Level=Reading+Factor
 Margin=Level-Limit
 Factor=(LISN or ISN or Current Probe)Factor + Cable Loss



7. Test of Radiated Spurious Emission

7.1 Test Limit

In any 100kHz bandwidth outside the frequency band in which the spread spectrum or digitally modulated intentional radiator is operating, the radio frequency power that is produced by the intentional radiator shall be at least 20dB below that in the 100kHz bandwidth within the band that contains the highest level of the desired power, based on either an RF conducted or a radiated measurement. If the transmitter measurement is based on the maximum conducted output power, the attenuation required under this paragraph shall be 30dB instead of 20dB. In addition, radiated emissions which fall in section 15.205(a) the restricted bands must also comply with the radiated emission limit specified in section 15.209(a).

Frequency (MHz)	Field Strength (microvolt/meter)	Measurement Distance (meters)
0.009 ~ 0.490	2400/F(kHz)	300
0.490 ~ 1.705	24000/F(kHz)	30
1.705 ~ 30.0	30	30
30 ~ 88	100	3
88 ~ 216	150	3
216 ~ 960	200	3
Above 960	500	3



7.2 Test Procedures

- a. The EUT was placed on a rotatable table top 0.8 meter above ground.
- b. The EUT was set 3 meters from the interference receiving antenna which was mounted on the top of a variable height antenna tower.
- c. The table was rotated 360 degrees to determine the position of the highest radiation.
- d. The antenna is a broadband antenna and its height is varied between one meter and four meters above ground to find the maximum value of the field strength both horizontal polarization and vertical polarization of the antenna are set to make the measurement.
- e. For each suspected emission the EUT was arranged to its worst case and then tune the antenna tower (from 1 M to 4 M) and turn table (from 0 degree to 360 degrees) to find the maximum reading.
- f. Set the test-receiver system to Peak or CISPR quasi-peak Detect Function and specified bandwidth with Maximum Hold Mode.
- g. If the emission level of the EUT in peak mode was 3 dB lower than the limit specified, then testing will be stopped and peak values of EUT will be reported, otherwise, the emissions which do not have 3 dB margin will be repeated one by one using the quasi-peak method and reported.
- h. For testing above 1GHz, the emission level of the EUT in peak mode was 20dB lower than average limit (that means the emission level in peak mode also complies with the limit in average mode), then testing will be stopped and peak values of EUT will be reported, otherwise, the emissions will be measured in average mode again and reported.
- i. "Cone of radiation" has been considered to be 3dB bandwidth of the measurement antenna.

Note:

- 1.The supporting fixture shall permit orientation of the EUT in each of three orthogonal axis positions such that emissions from the EUT are maximized.
(Y-AXIS is the worst.)
- 2.Due to the test software function limit the operation band setting(200dBuV/m).
There's no corresponding limitation in the actual test item.



7.3 Typical Test Setup

Below 30MHz test setup

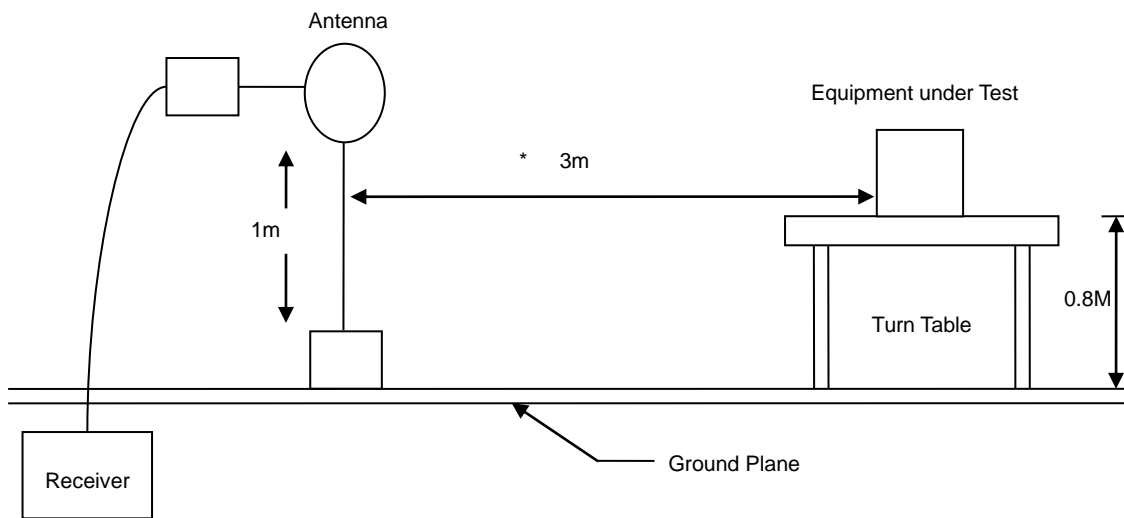

30MHz- 1GHz Test Setup

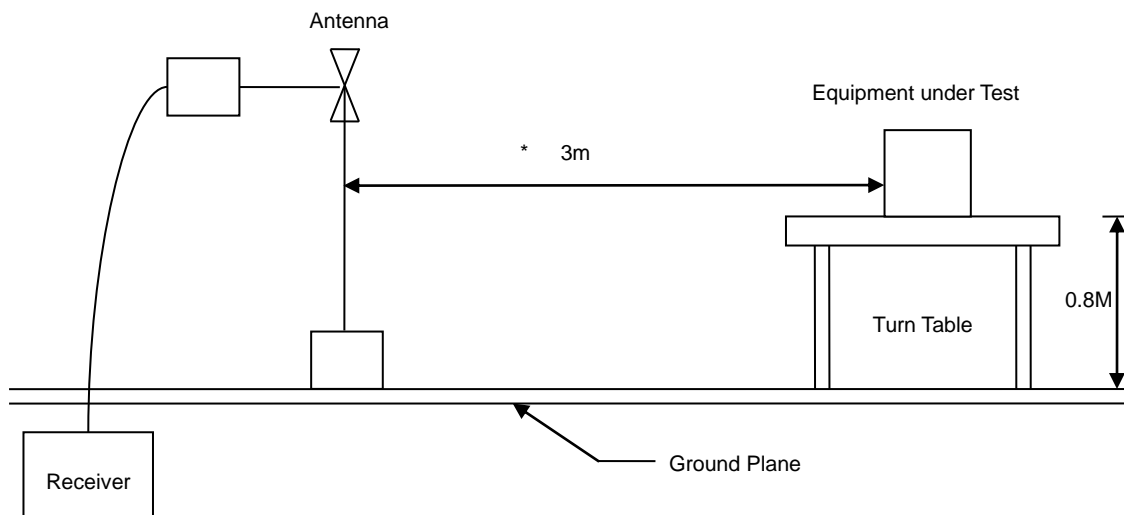

Above 1GHz Test Setup

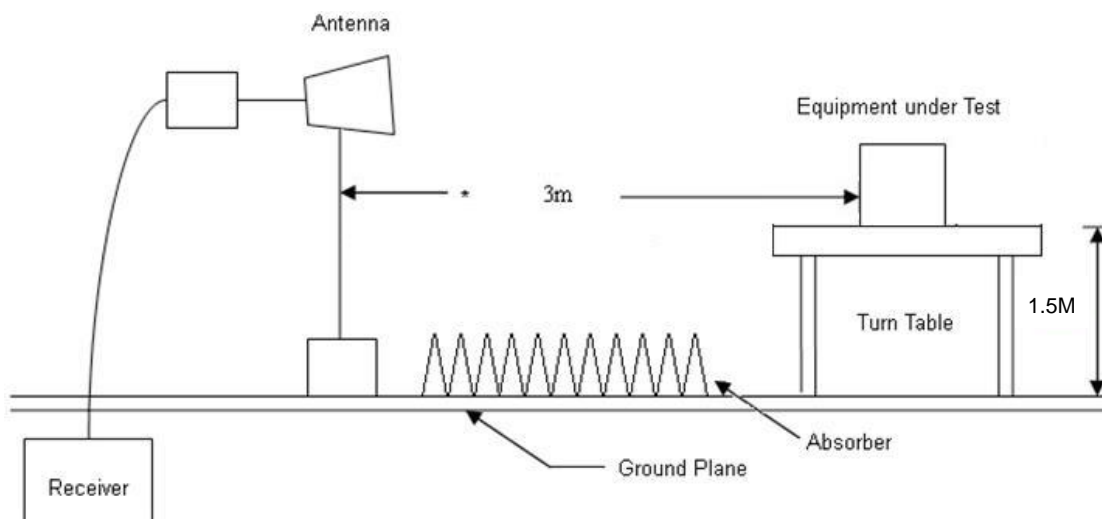



7.4 Test Result and Data (9kHz ~ 30MHz)

The 9kHz-30MHz spurious emission is under limit 20dB more.

7.5 Test Result and Data (30MHz ~ 1GHz)

Power	:	DC 19V From Adapter (AC 120V / 60Hz)	Pol/Phase	:	VERTICAL
Test Mode	:	Mode 1		:	

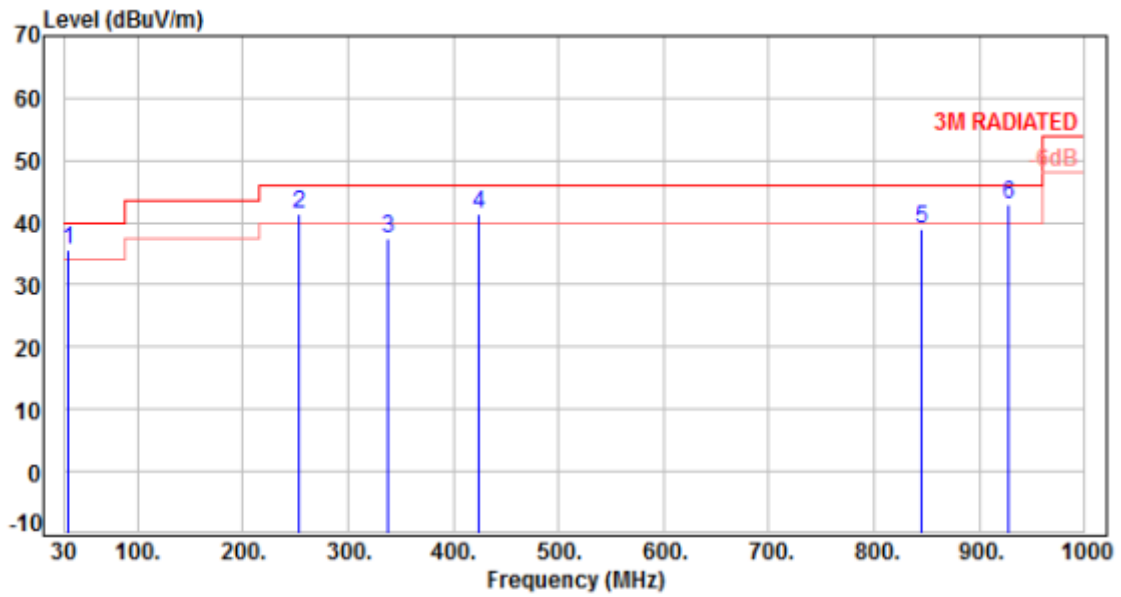

No.	Frequency (MHz)	Factor (dB)	Reading (dBuV)	Level (dBuV/m)	Limit (dBuV/m)	Margin (dB)	Detector	Height (cm)	Azimuth (deg)	P/F
1	33.88	-9.64	45.30	35.66	40.00	-4.34	QP	100	357	P
2	253.10	-9.99	51.41	41.42	46.00	-4.58	Peak	100	360	P
3	338.46	-7.21	44.59	37.38	46.00	-8.62	Peak	100	360	P
4	423.82	-4.87	46.25	41.38	46.00	-4.62	Peak	100	360	P
5	844.80	2.71	36.14	38.85	46.00	-7.15	Peak	100	360	P
6	928.22	4.12	38.77	42.89	46.00	-3.11	Peak	100	360	P

Note: Level=Reading+Factor
Margin=Level-Limit
Factor=Antenna Factor + cable loss - Amplifier Factor



Power	: DC 19V From Adapter (AC 120V / 60Hz)	Pol/Phase	: HORIZONTAL
Test Mode	: Mode 1		:

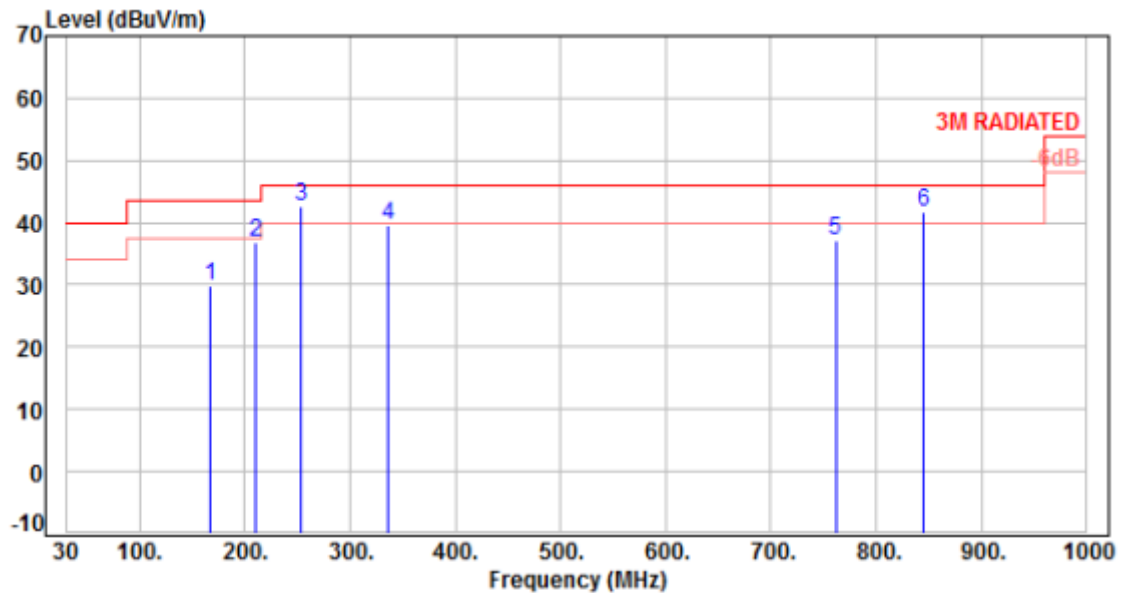

No.	Frequency (MHz)	Factor (dB)	Reading (dBuV)	Level (dBuV/m)	Limit (dBuV/m)	Margin (dB)	Detector	Height (cm)	Azimuth (deg)	P/F
1	167.74	-9.39	39.27	29.88	43.50	-13.62	Peak	100	0	P
2	210.42	-11.59	48.38	36.79	43.50	-6.71	Peak	100	0	P
3	253.10	-9.99	52.47	42.48	46.00	-3.52	Peak	100	0	P
4	336.52	-7.26	46.83	39.57	46.00	-6.43	Peak	100	0	P
5	761.38	1.83	35.22	37.05	46.00	-8.95	Peak	100	0	P
6	844.80	2.71	39.00	41.71	46.00	-4.29	Peak	100	0	P

Note: Level=Reading+Factor
 Margin=Level-Limit
 Factor=Antenna Factor + cable loss - Amplifier Factor



7.6 Test Result and Data (1GHz ~ 25GHz)

Power	:	DC 19V From Adapter (AC 120V / 60Hz)	Pol/Phase	:	VERTICAL
Test Mode	:	Mode 1, CH00		:	

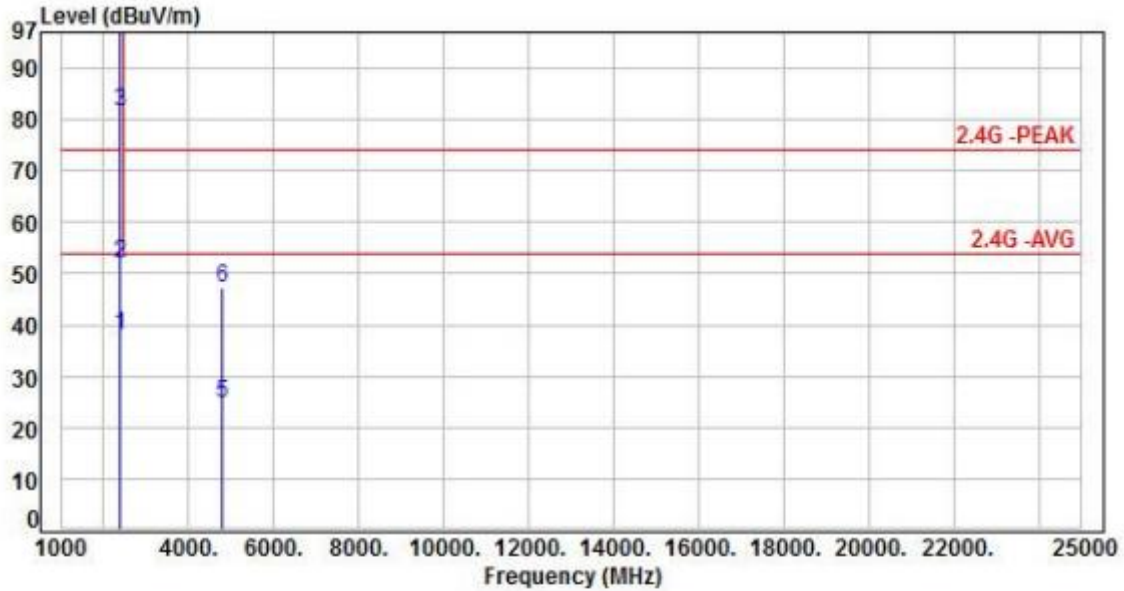

No.	Frequency (MHz)	Factor (dB)	Reading (dBuV)	Level (dBuV/m)	Limit (dBuV/m)	Margin (dB)	Detector	Height (cm)	Azimuth (deg)	P/F
1	2390.00	-3.22	41.39	38.17	54.00	-15.83	Average	100	292	P
2	2390.00	-3.22	55.31	52.09	74.00	-21.91	Peak	100	292	P
3	2402.00	-3.37	84.84	81.47	200.00	-118.53	Average	100	292	P
4	2402.00	-3.37	107.34	103.97	200.00	-96.03	Peak	100	292	P
5	4804.00	5.17	19.48	24.65	54.00	-29.35	Average	100	316	P
6	4804.00	5.17	41.98	47.15	74.00	-26.85	Peak	100	316	P

Note: Level=Reading+Factor
Margin=Level-Limit
Factor=Antenna Factor + cable loss - Amplifier Factor



Power	: DC 19V From Adapter (AC 120V / 60Hz)	Pol/Phase	: HORIZONTAL
Test Mode	: Mode 1, CH00		:

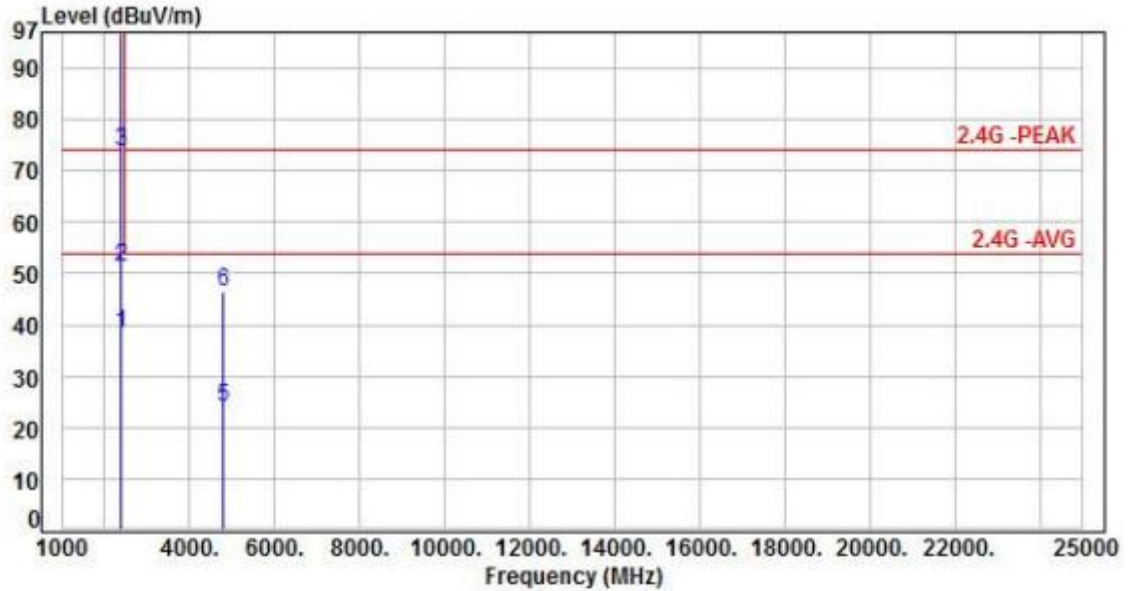

No.	Frequency (MHz)	Factor (dB)	Reading (dBuV)	Level (dBuV/m)	Limit (dBuV/m)	Margin (dB)	Detector	Height (cm)	Azimuth (deg)	P/F
1	2390.00	-3.22	41.40	38.18	54.00	-15.82	Average	100	129	P
2	2390.00	-3.22	54.52	51.30	74.00	-22.70	Peak	100	129	P
3	2402.00	-3.37	77.04	73.67	200.00	-126.33	Average	100	129	P
4	2402.00	-3.37	99.54	96.17	200.00	-103.83	Peak	100	129	P
5	4804.00	5.17	18.75	23.92	54.00	-30.08	Average	100	261	P
6	4804.00	5.17	41.25	46.42	74.00	-27.58	Peak	100	261	P

Note: Level=Reading+Factor
 Margin=Level-Limit
 Factor=Antenna Factor + cable loss - Amplifier Factor



Power	: DC 19V From Adapter (AC 120V / 60Hz)	Pol/Phase	: VERTICAL
Test Mode	: Mode 1, CH39		:

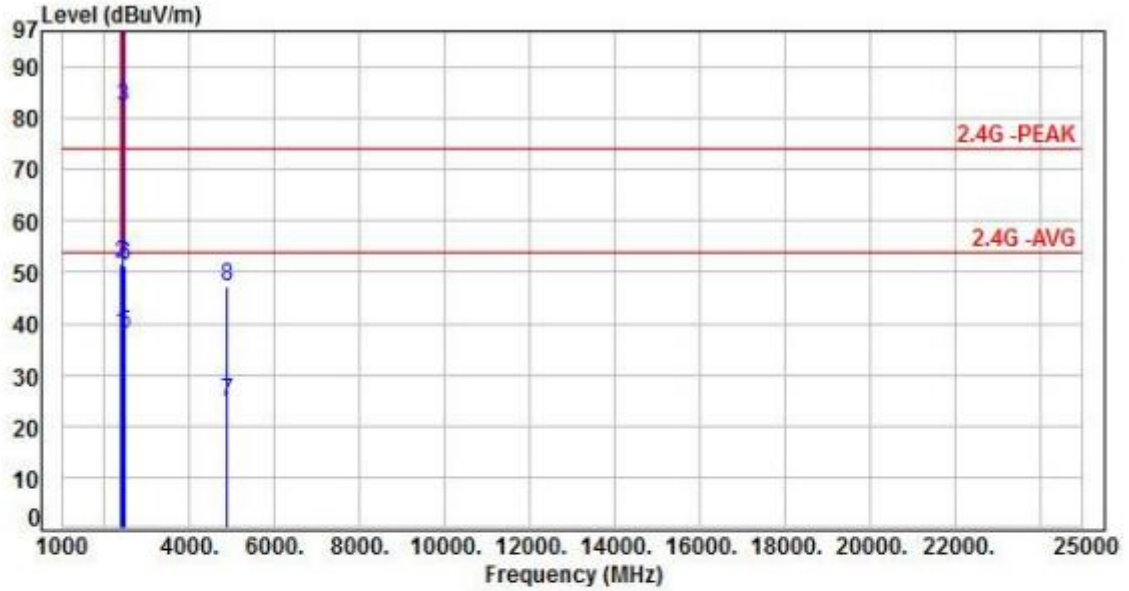

No.	Frequency (MHz)	Factor (dB)	Reading (dBuV)	Level (dBuV/m)	Limit (dBuV/m)	Margin (dB)	Detector	Height (cm)	Azimuth (deg)	P/F
1	2390.00	-3.22	41.16	37.94	54.00	-16.06	Average	100	298	P
2	2390.00	-3.22	54.74	51.52	74.00	-22.48	Peak	100	298	P
3	2441.00	-2.62	84.80	82.18	200.00	-117.82	Average	100	298	P
4	2441.00	-2.62	107.30	104.68	200.00	-95.32	Peak	100	298	P
5	2483.50	-2.35	40.19	37.84	54.00	-16.16	Average	100	298	P
6	2483.50	-2.35	53.66	51.31	74.00	-22.69	Peak	100	298	P
7	4882.00	5.51	19.28	24.79	54.00	-29.21	Average	100	315	P
8	4882.00	5.51	41.78	47.29	74.00	-26.71	Peak	100	315	P

Note: Level=Reading+Factor
Margin=Level-Limit
Factor=Antenna Factor + cable loss - Amplifier Factor



Power	: DC 19V From Adapter (AC 120V / 60Hz)	Pol/Phase	: HORIZONTAL
Test Mode	: Mode 1, CH39		:

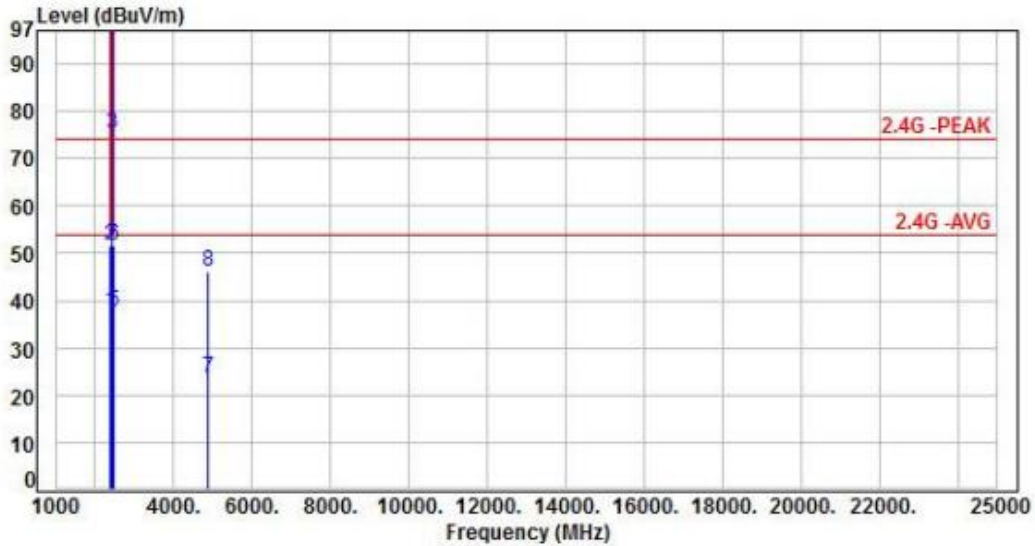

No.	Frequency (MHz)	Factor (dB)	Reading (dBUV)	Level (dBUV/m)	Limit (dBUV/m)	Margin (dB)	Detector	Height (cm)	Azimuth (deg)	P/F
1	2390.00	-3.22	40.87	37.65	54.00	-16.35	Average	100	130	P
2	2390.00	-3.22	54.69	51.47	74.00	-22.53	Peak	100	130	P
3	2441.00	-2.62	77.81	75.19	200.00	-124.81	Average	100	130	P
4	2441.00	-2.62	100.31	97.69	200.00	-102.31	Peak	100	130	P
5	2483.50	-2.35	40.13	37.78	54.00	-16.22	Average	100	130	P
6	2483.50	-2.35	53.93	51.58	74.00	-22.42	Peak	100	130	P
7	4882.00	5.51	18.02	23.53	54.00	-30.47	Average	100	266	P
8	4882.00	5.51	40.52	46.03	74.00	-27.97	Peak	100	266	P

Note: Level=Reading+Factor
 Margin=Level-Limit
 Factor=Antenna Factor + cable loss - Amplifier Factor



Power	: DC 19V From Adapter (AC 120V / 60Hz)	Pol/Phase	: VERTICAL
Test Mode	: Mode 1, CH78		:

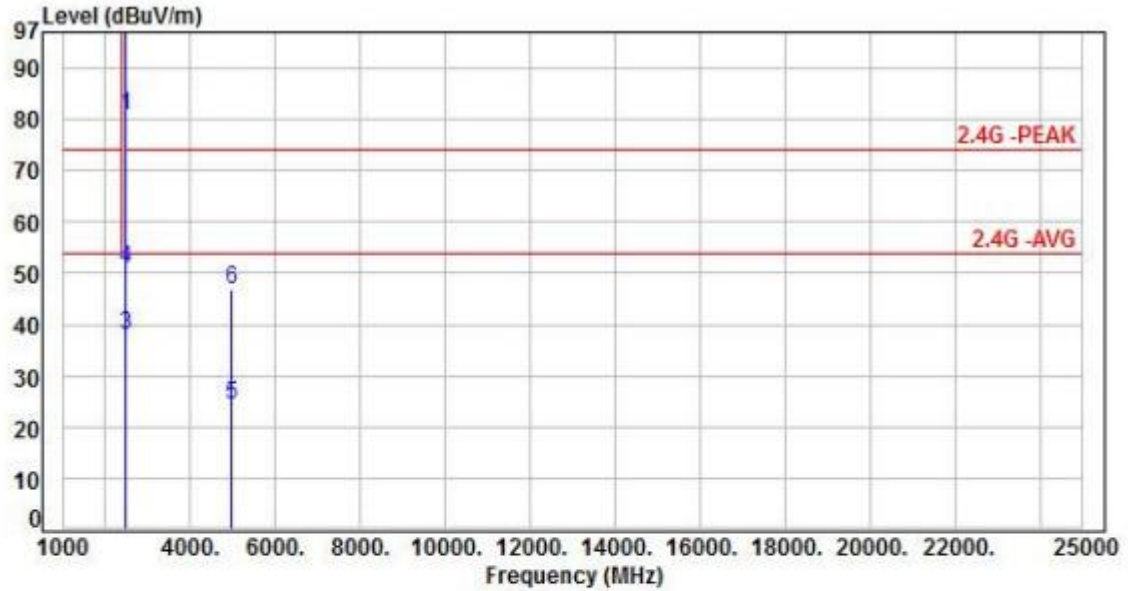

No.	Frequency (MHz)	Factor (dB)	Reading (dBuV)	Level (dBuV/m)	Limit (dBuV/m)	Margin (dB)	Detector	Height (cm)	Azimuth (deg)	P/F
1	2480.00	-2.36	83.23	80.87	200.00	-119.13	Average	100	291	P
2	2480.00	-2.36	105.73	103.37	200.00	-96.63	Peak	100	291	P
3	2483.50	-2.35	40.26	37.91	54.00	-16.09	Average	100	291	P
4	2483.50	-2.35	53.16	50.81	74.00	-23.19	Peak	100	291	P
5	4960.00	5.64	18.67	24.31	54.00	-29.69	Average	100	316	P
6	4960.00	5.64	41.17	46.81	74.00	-27.19	Peak	100	316	P

Note: Level=Reading+Factor
Margin=Level-Limit
Factor=Antenna Factor + cable loss - Amplifier Factor



Power	: DC 19V From Adapter (AC 120V / 60Hz)	Pol/Phase	: HORIZONTAL
Test Mode	: Mode 1, CH78		:

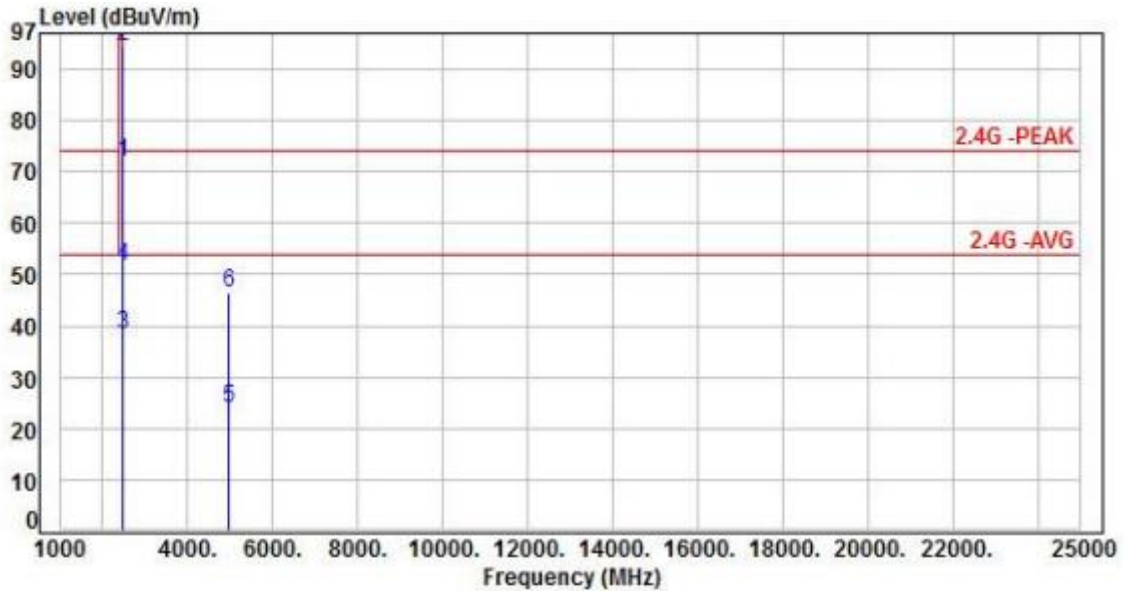

No.	Frequency (MHz)	Factor (dB)	Reading (dBuV)	Level (dBuV/m)	Limit (dBuV/m)	Margin (dB)	Detector	Height (cm)	Azimuth (deg)	P/F
1	2480.00	-2.36	74.29	71.93	200.00	-128.07	Average	100	129	P
2	2480.00	-2.36	96.79	94.43	200.00	-105.57	Peak	100	129	P
3	2483.50	-2.35	40.53	38.18	54.00	-15.82	Average	100	129	P
4	2483.50	-2.35	53.88	51.53	74.00	-22.47	Peak	100	129	P
5	4960.00	5.64	18.21	23.85	54.00	-30.15	Average	100	268	P
6	4960.00	5.64	40.71	46.35	74.00	-27.65	Peak	100	268	P

Note: Level=Reading+Factor

Margin=Level-Limit

Factor=Antenna Factor + cable loss - Amplifier Factor

S



Power	: DC 19V From Adapter (AC 120V / 60Hz)	Pol/Phase	: VERTICAL
Test Mode	: Mode 3, CH00		:

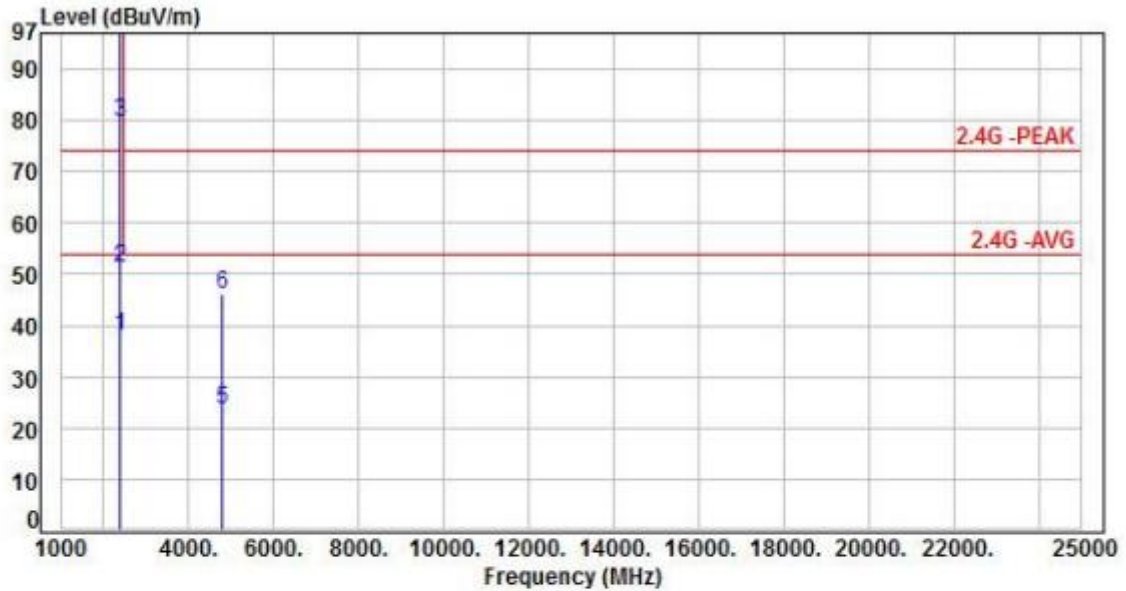

No.	Frequency (MHz)	Factor (dB)	Reading (dBuV)	Level (dBuV/m)	Limit (dBuV/m)	Margin (dB)	Detector	Height (cm)	Azimuth (deg)	P/F
1	2390.00	-3.22	41.30	38.08	54.00	-15.92	Average	100	295	P
2	2390.00	-3.22	54.42	51.20	74.00	-22.80	Peak	100	295	P
3	2402.00	-3.37	83.05	79.68	200.00	-120.32	Average	100	295	P
4	2402.00	-3.37	105.55	102.18	200.00	-97.82	Peak	100	295	P
5	4804.00	5.17	18.49	23.66	54.00	-30.34	Average	100	310	P
6	4804.00	5.17	40.99	46.16	74.00	-27.84	Peak	100	310	P

Note: Level=Reading+Factor
 Margin=Level-Limit
 Factor=Antenna Factor + cable loss - Amplifier Factor



Power	: DC 19V From Adapter (AC 120V / 60Hz)	Pol/Phase	: HORIZONTAL
Test Mode	: Mode 3, CH00		:

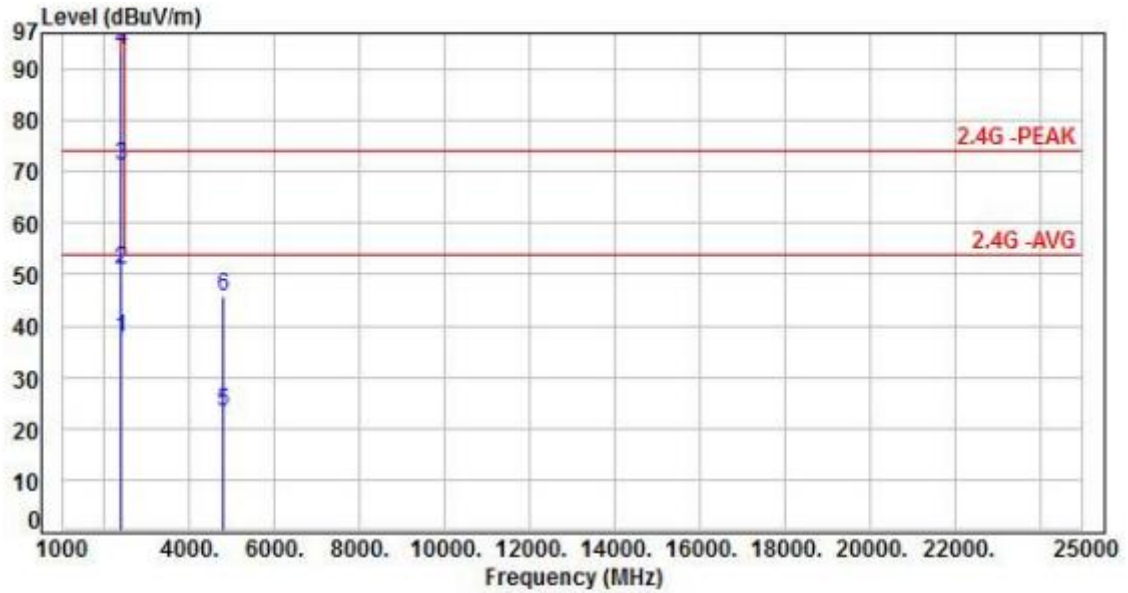

No.	Frequency (MHz)	Factor (dB)	Reading (dBuV)	Level (dBuV/m)	Limit (dBuV/m)	Margin (dB)	Detector	Height (cm)	Azimuth (deg)	P/F
1	2390.00	-3.22	40.76	37.54	54.00	-16.46	Average	100	129	P
2	2390.00	-3.22	54.19	50.97	74.00	-23.03	Peak	100	129	P
3	2402.00	-3.37	74.51	71.14	200.00	-128.86	Average	100	129	P
4	2402.00	-3.37	97.01	93.64	200.00	-106.36	Peak	100	129	P
5	4804.00	5.17	18.22	23.39	54.00	-30.61	Average	100	266	P
6	4804.00	5.17	40.72	45.89	74.00	-28.11	Peak	100	266	P

Note: Level=Reading+Factor
Margin=Level-Limit
Factor=Antenna Factor + cable loss - Amplifier Factor



Power	: DC 19V From Adapter (AC 120V / 60Hz)	Pol/Phase	: VERTICAL
Test Mode	: Mode 3, CH39		:

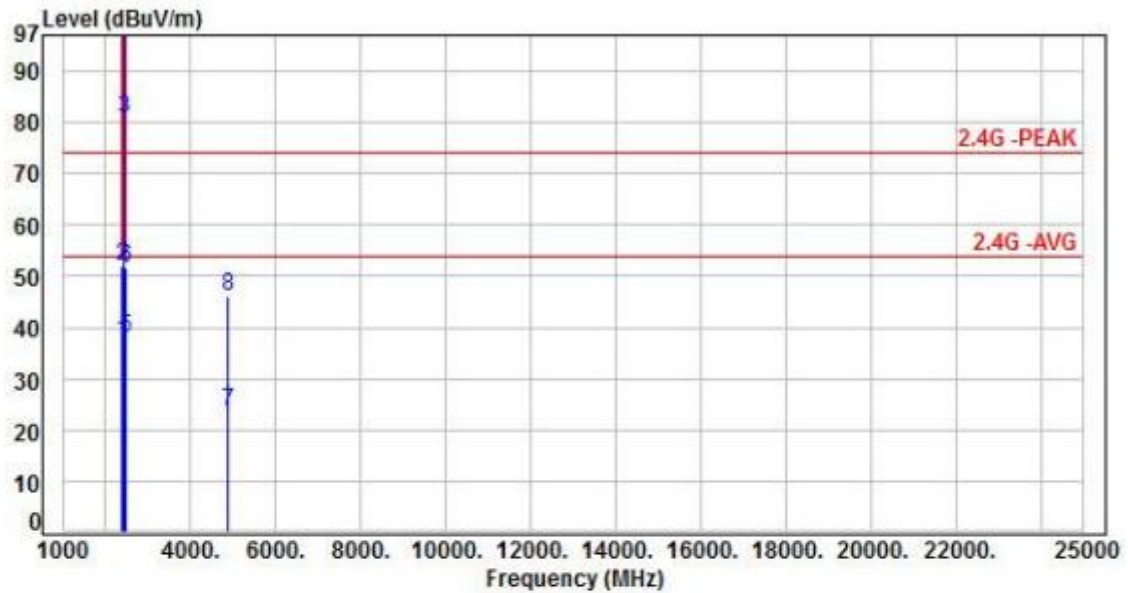

No.	Frequency (MHz)	Factor (dB)	Reading (dBuV)	Level (dBuV/m)	Limit (dBuV/m)	Margin (dB)	Detector	Height (cm)	Azimuth (deg)	P/F
1	2390.00	-3.22	40.32	37.10	54.00	-16.90	Average	100	295	P
2	2390.00	-3.22	55.26	52.04	74.00	-21.96	Peak	100	295	P
3	2441.00	-2.62	83.49	80.87	200.00	-119.13	Average	100	295	P
4	2441.00	-2.62	105.99	103.37	200.00	-96.63	Peak	100	295	P
5	2483.50	-2.35	40.30	37.95	54.00	-16.05	Average	100	295	P
6	2483.50	-2.35	54.13	51.78	74.00	-22.22	Peak	100	295	P
7	4882.00	5.51	18.04	23.55	54.00	-30.45	Average	100	316	P
8	4882.00	5.51	40.54	46.05	74.00	-27.95	Peak	100	316	P

Note: Level=Reading+Factor
 Margin=Level-Limit
 Factor=Antenna Factor + cable loss - Amplifier Factor



Power	: DC 19V From Adapter (AC 120V / 60Hz)	Pol/Phase	: HORIZONTAL
Test Mode	: Mode 3, CH39		:

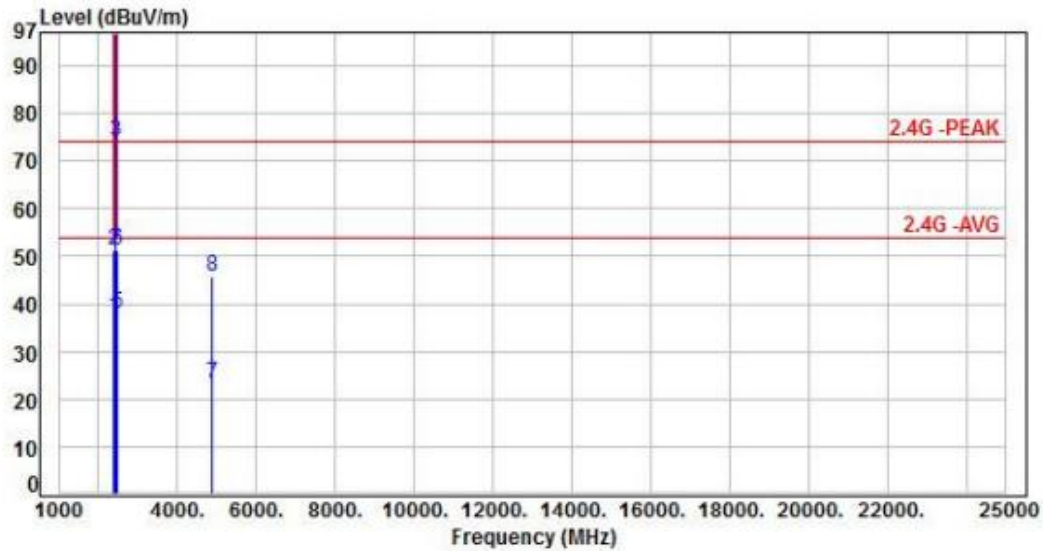

No.	Frequency (MHz)	Factor (dB)	Reading (dBuV)	Level (dBuV/m)	Limit (dBuV/m)	Margin (dB)	Detector	Height (cm)	Azimuth (deg)	P/F
1	2390.00	-3.22	40.64	37.42	54.00	-16.58	Average	100	131	P
2	2390.00	-3.22	54.66	51.44	74.00	-22.56	Peak	100	131	P
3	2441.00	-2.62	76.64	74.02	200.00	-125.98	Average	100	131	P
4	2441.00	-2.62	99.14	96.52	200.00	-103.48	Peak	100	131	P
5	2483.50	-2.35	40.16	37.81	54.00	-16.19	Average	100	131	P
6	2483.50	-2.35	53.66	51.31	74.00	-22.69	Peak	100	131	P
7	4882.00	5.51	17.87	23.38	54.00	-30.62	Average	100	269	P
8	4882.00	5.51	40.37	45.88	74.00	-28.12	Peak	100	269	P

Note: Level=Reading+Factor
 Margin=Level-Limit
 Factor=Antenna Factor + cable loss - Amplifier Factor



Power	: DC 19V From Adapter (AC 120V / 60Hz)	Pol/Phase	: VERTICAL
Test Mode	: Mode 3, CH78		:

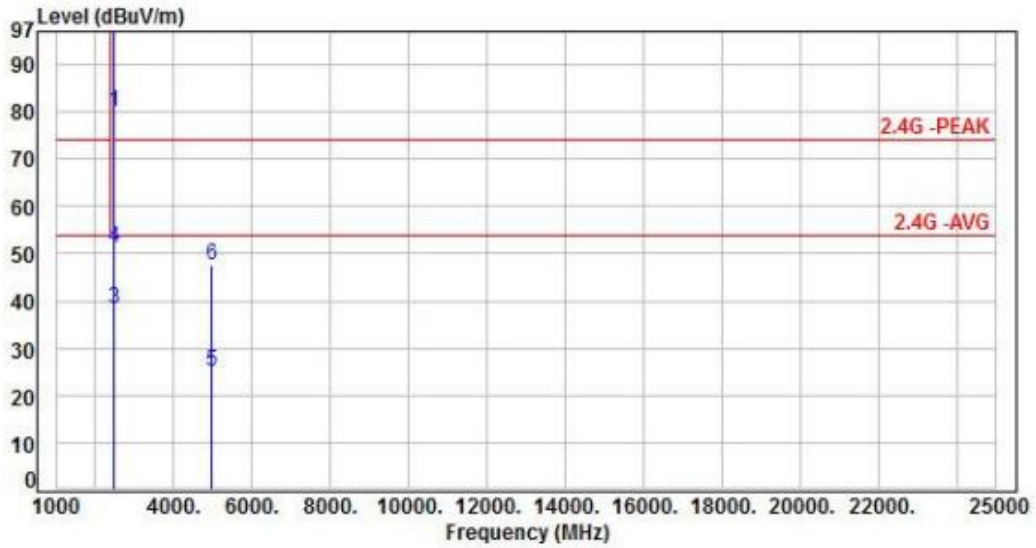

No.	Frequency (MHz)	Factor (dB)	Reading (dBuV)	Level (dBuV/m)	Limit (dBuV/m)	Margin (dB)	Detector	Height (cm)	Azimuth (deg)	P/F
1	2480.00	-2.36	82.39	80.03	200.00	-119.97	Average	100	298	P
2	2480.00	-2.36	104.89	102.53	200.00	-97.47	Peak	100	298	P
3	2483.50	-2.35	40.64	38.29	54.00	-15.71	Average	100	298	P
4	2483.50	-2.35	53.77	51.42	74.00	-22.58	Peak	100	298	P
5	4960.00	5.64	19.55	25.19	54.00	-28.81	Average	100	314	P
6	4960.00	5.64	42.05	47.69	74.00	-26.31	Peak	100	314	P

Note: Level=Reading+Factor
 Margin=Level-Limit
 Factor=Antenna Factor + cable loss - Amplifier Factor



Power	: DC 19V From Adapter (AC 120V / 60Hz)	Pol/Phase	: HORIZONTAL
Test Mode	: Mode 3, CH78		:

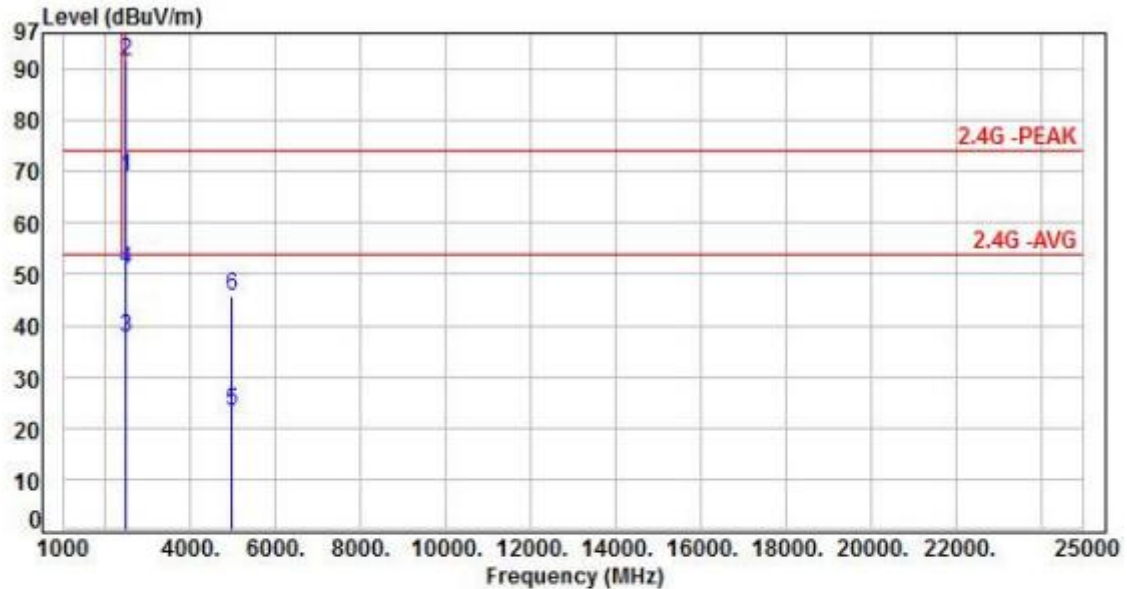

No.	Frequency (MHz)	Factor (dB)	Reading (dBuV)	Level (dBuV/m)	Limit (dBuV/m)	Margin (dB)	Detector	Height (cm)	Azimuth (deg)	P/F
1	2480.00	-2.36	71.18	68.82	200.00	-131.18	Average	100	129	P
2	2480.00	-2.36	93.68	91.32	200.00	-108.68	Peak	100	129	P
3	2483.50	-2.35	39.85	37.50	54.00	-16.50	Average	100	129	P
4	2483.50	-2.35	53.43	51.08	74.00	-22.92	Peak	100	129	P
5	4960.00	5.64	17.47	23.11	54.00	-30.89	Average	100	261	P
6	4960.00	5.64	39.97	45.61	74.00	-28.39	Peak	100	261	P

Note: Level=Reading+Factor
Margin=Level-Limit
Factor=Antenna Factor + cable loss - Amplifier Factor



7.7 Restricted Bands of Operation

Only spurious emissions are permitted in any of the frequency bands listed below:

MHz	MHz	MHz	GHz
0.09000 – 0.11000	16.42000 – 16.42300	399.9 – 410.0	4.500 – 5.250
0.49500 – 0.505**	16.69475 – 16.69525	608.0 – 614.0	5.350 – 5.460
2.17350 – 2.19050	16.80425 – 16.80475	960.0 – 1240.0	7.250 – 7.750
4.12500 – 4.12800	25.50000 – 25.67000	1300.0 – 1427.0	8.025 – 8.500
4.17725 – 4.17775	37.50000 – 38.25000	1435.0 – 1626.5	9.000 – 9.200
4.20725 – 4.20775	73.00000 – 74.60000	1645.5 – 1646.5	9.300 – 9.500
6.21500 – 6.21800	74.80000 – 75.20000	1660.0 – 1710.0	10.600 – 12.700
6.26775 – 6.26825	108.00000 – 121.94000	1718.8 – 1722.2	13.250 – 13.400
6.31175 – 6.31225	123.00000 – 138.00000	2200.0 – 2300.0	14.470 – 14.500
8.29100 – 8.29400	149.90000 – 150.05000	2310.0 – 2390.0	15.350 – 16.200
8.36200 – 8.36600	156.52475 – 156.52525	2483.5 – 2500.0	17.700 – 21.400
8.37625 – 8.38675	156.70000 – 156.90000	2655.0 – 2900.0	22.010 – 23.120
8.41425 – 8.41475	162.01250 – 167.17000	3260.0 – 3267.0	23.600 – 24.000
12.29000 – 12.29300	167.72000 – 173.20000	3332.0 – 3339.0	31.200 – 31.800
12.51975 – 12.52025	240.00000 – 285.00000	3345.8 – 3358.0	36.430 – 36.500
12.57675 – 12.57725	322.00000 – 335.40000	3600.0 – 4400.0	Above 38.6
13.36000 – 13.41000			

** : Until February 1, 1999, this restricted band shall be 0.490-0.510 MHz



8. Test of Conducted Spurious Emission

8.1 Test Limit

According to the methods defined in ANSI C63.10-2013 Section 7.8.8

Below -30dB of the highest emission level of operating band (in 100kHz Resolution Bandwidth).

8.2 Test Procedure

According to the methods defined in ANSI C63.10-2013

- a. The transmitter output was connected to the spectrum analyzer via a low loss cable.
- b. Set RBW of spectrum analyzer to 100 KHz and VBW of spectrum analyzer to 300 KHz with convenient frequency span including 100 KHz bandwidth from band edge.
- c. The band edges was measured and recorded.

8.3 Test Setup Layout

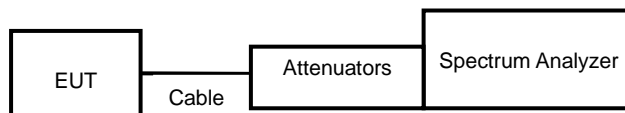

8.4 Test Result and Data

Note: Test plots refer to the following pages.



Modulation Type: GFSK (1Mbps)
Channel: 00

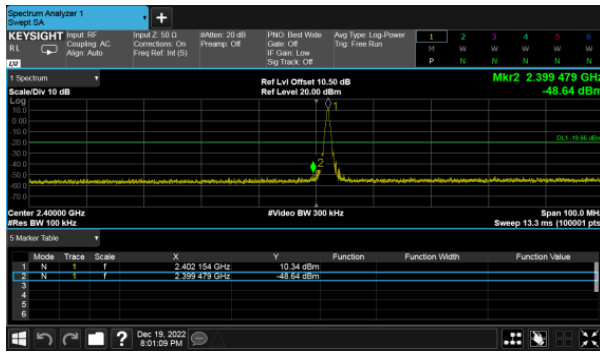

Modulation Type: GFSK (1Mbps)
Channel: 39

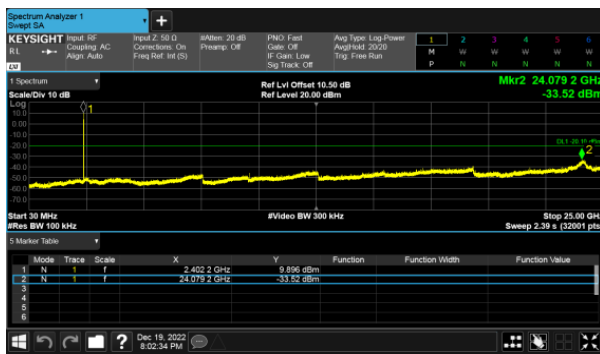
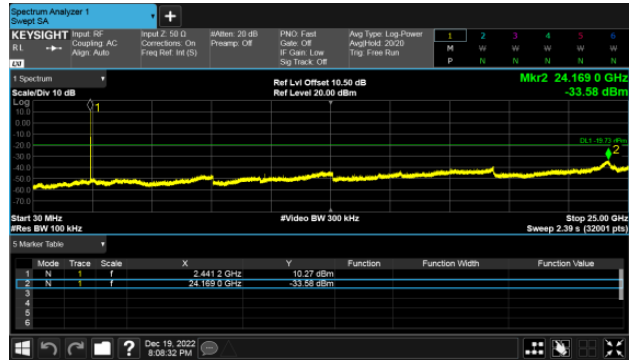



Modulation Type: GFSK (1Mbps)
Channel: 78

Modulation Type: $\pi/4$ -DQPSK (2Mbps)
Channel: 00

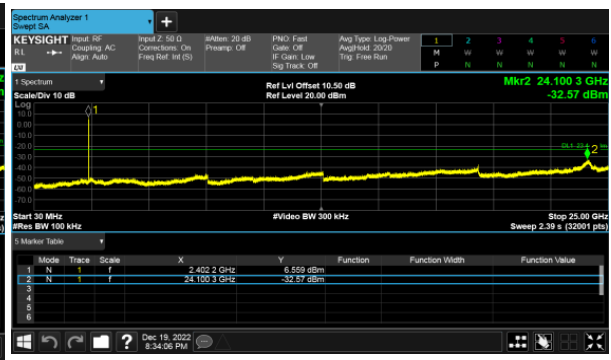
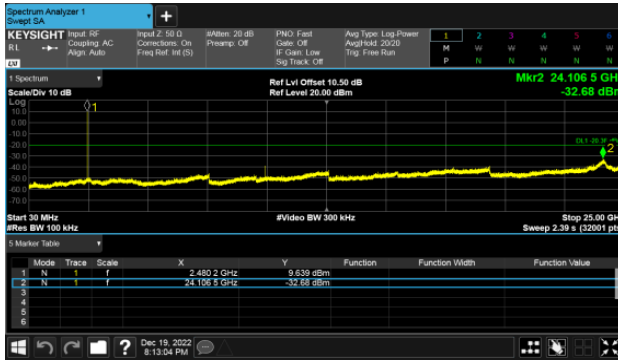
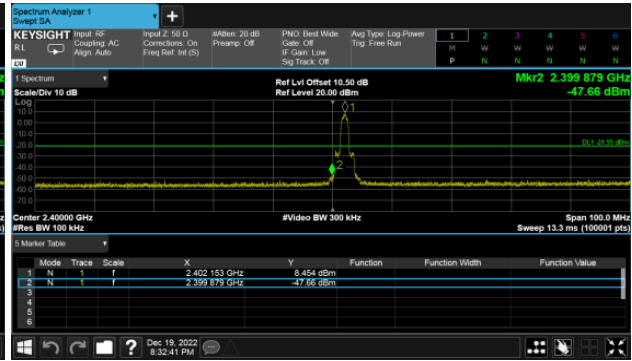
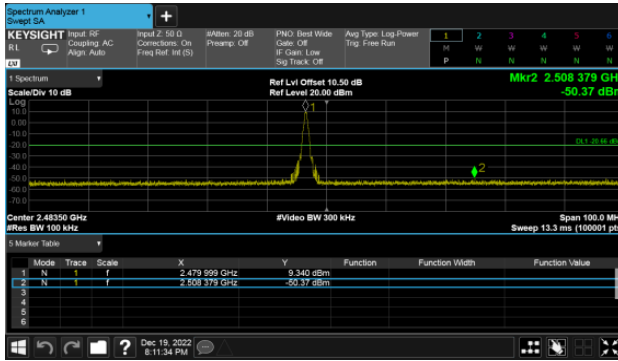



Modulation Type: $\pi/4$ -DQPSK (2Mbps)
Channel: 39

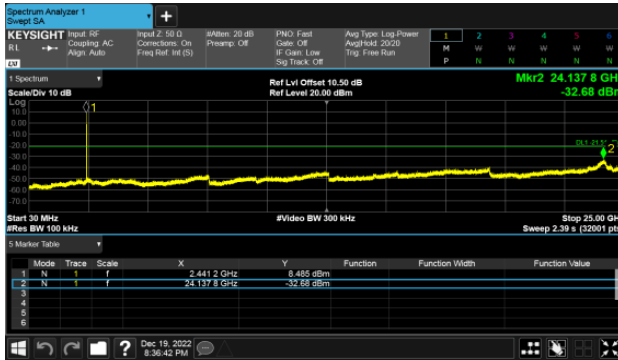

Modulation Type: $\pi/4$ -DQPSK (2Mbps)
Channel: 78

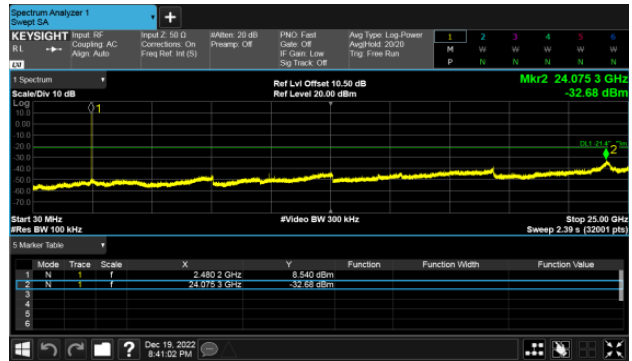
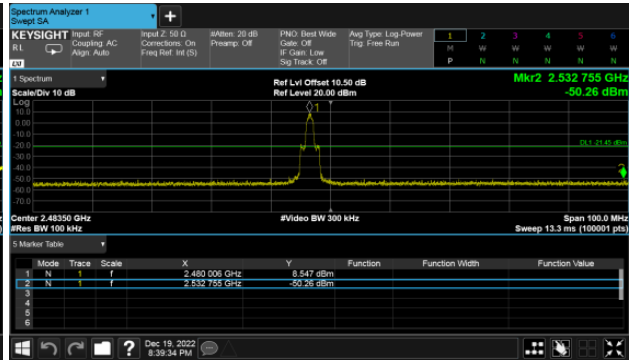



Modulation Type: 8DPSK (3Mbps)
Channel: 00

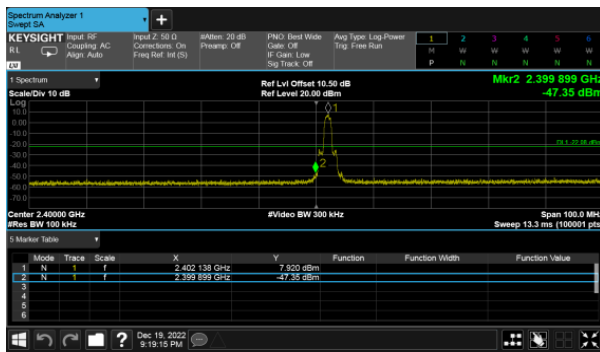

Modulation Type: 8DPSK (3Mbps)
Channel: 39

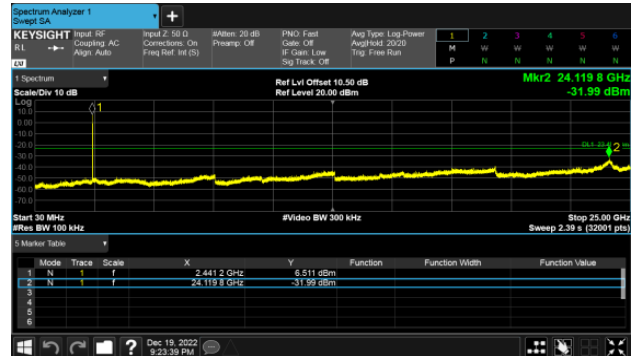



Modulation Type: 8DPSK (3Mbps)
Channel: 78

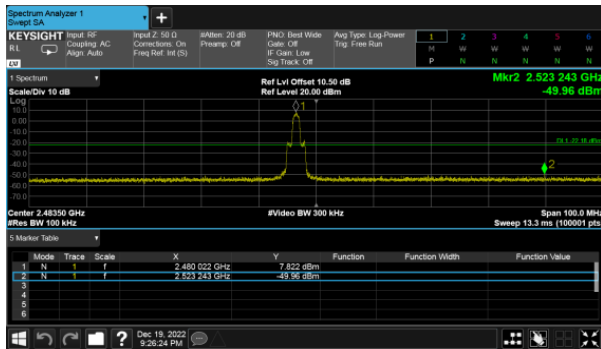



Hopping Mode: Modulation Type: GFSK

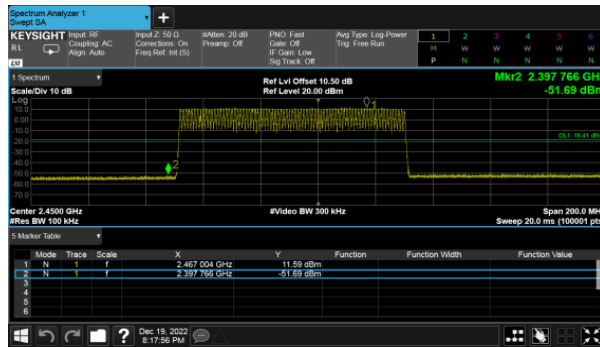

Modulation Type: $\pi/4$ -DQPSK

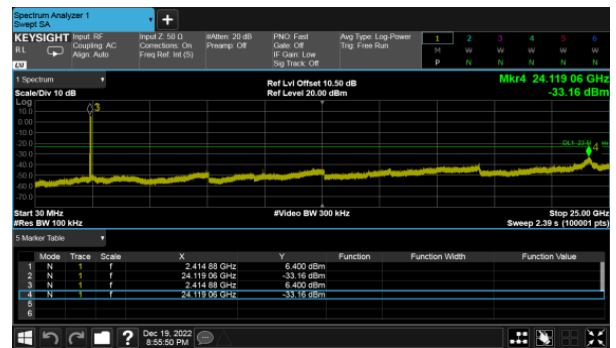
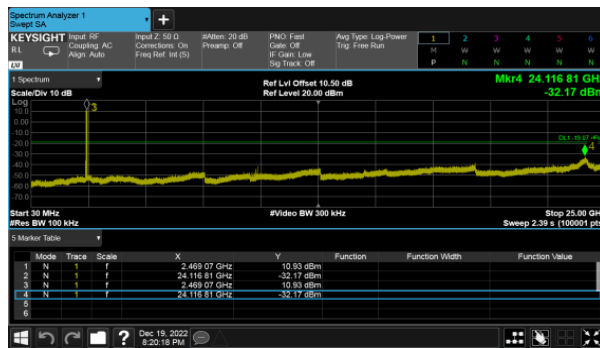
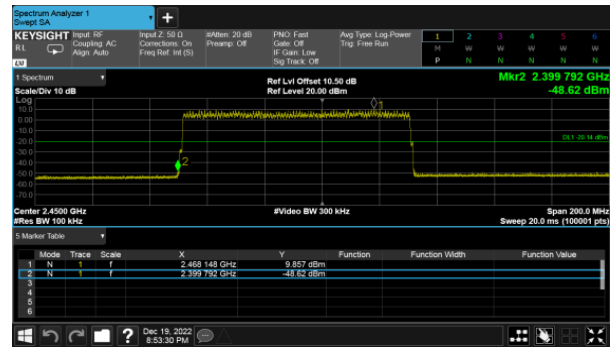



Modulation Type: 8DPSK

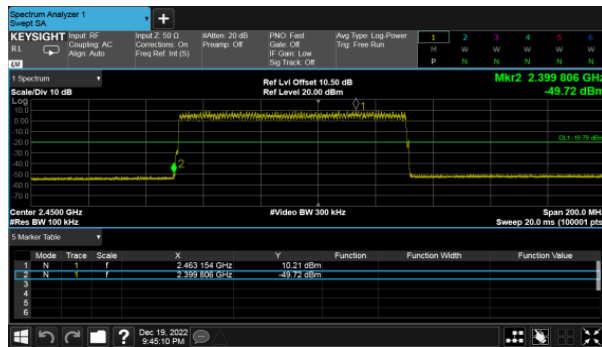



9. 20dB Bandwidth Measurement Data

9.1 Test Limit

For reference data.

9.2 Test Procedures

According to the methods defined in ANSI C63.10-2013 Section 6.9

- a. The transmitter output was connected to the spectrum analyzer.
- b. Set RBW of spectrum analyzer to 1% to 5% of the 20dB Bandwidth and VBW to approximately three times RBW.
- c. The 20 dB bandwidth is defined as the total spectrum the power of which is higher than peak power minus 20 dB.

9.3 Test Setup Layout

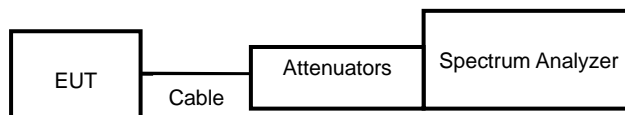



9.4 Test Result and Data

Modulation Type	Channel	Frequency (MHz)	20dB Bandwidth (MHz)	2/3 20dB Bandwidth (MHz)
GFSK	0	2402	0.939	0.626
	39	2441	0.939	0.626
	78	2480	0.934	0.623
$\pi/4$ -DQPSK	0	2402	1.283	0.855
	39	2441	1.281	0.854
	78	2480	1.288	0.859
8DPSK	0	2402	1.300	0.867
	39	2441	1.300	0.867
	78	2480	1.304	0.869



Modulation Type: GFSK (1Mbps)
Channel: 00

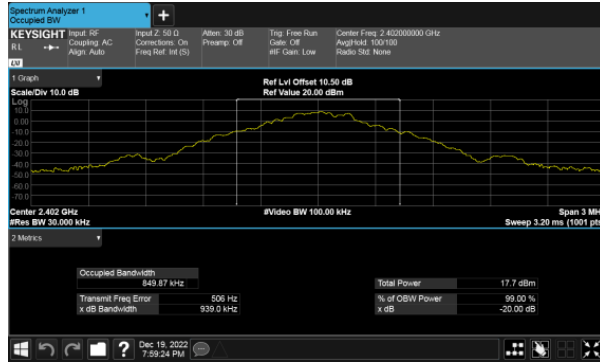

Modulation Type: $\pi/4$ -DQPSK (2Mbps)
Channel: 00



CH39



CH39



CH78



CH78





Modulation Type: 8DPSK (3Mbps)
Channel: 00

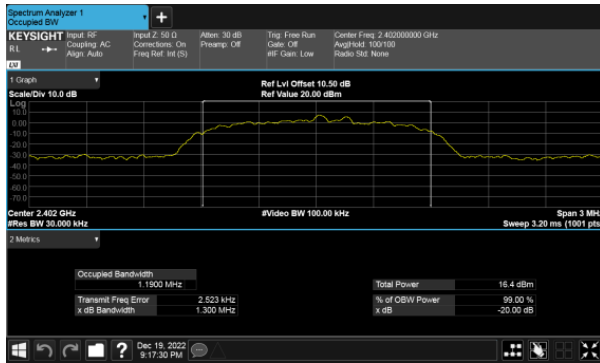

CH39

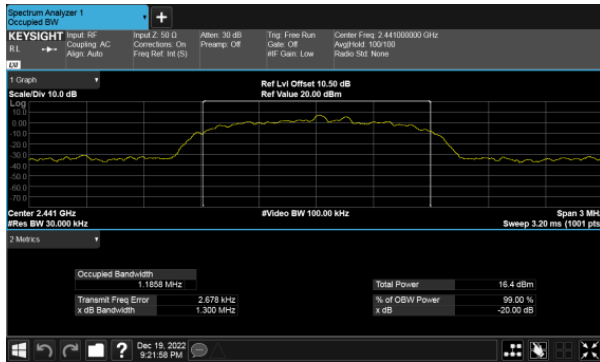

CH78





10. Carrier Frequency Separation

10.1 Test Limit

Frequency hopping systems shall have hopping channel carrier frequencies separated by a minimum of 25 kHz or the 20 dB bandwidth of the hopping channel, whichever is greater. Alternatively, frequency hopping systems operating in the 2400–2483.5 MHz band may have hopping channel carrier frequencies that are separated by 25 kHz or two-thirds of the 20 dB bandwidth of the hopping channel, whichever is greater, provided the systems operate with an output power no greater than 125 mW.

10.2 Test Procedures

According to the methods defined in ANSI C63.10-2013 Section 7.8.2

- a. The transmitter output was connected to the spectrum analyzer.
- b. Set RBW of spectrum analyzer to 300 KHz and VBW to 1000 KHz.
- c. By using the MaxHold function record the separation of two adjacent channels.
- d. Measure the frequency difference of these two adjacent channels.

10.3 Test Setup Layout

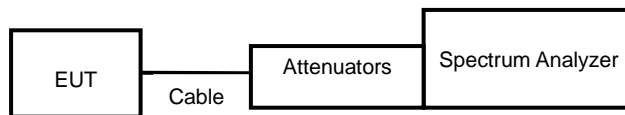



10.4 Test Result and Data

Modulation Type	Channel	Frequency (MHz)	Channel Separation (MHz)	Limit (MHz)
GFSK	0	2402	1.002	0.626
	39	2441	1.002	0.626
	78	2480	1.002	0.623
$\pi/4$ -DQPSK	0	2402	1.002	0.855
	39	2441	1.002	0.854
	78	2480	1.002	0.859
8DPSK	0	2402	1.002	0.867
	39	2441	1.002	0.867
	78	2480	1.002	0.869



Modulation Type: GFSK (1Mbps)
Channel: 00

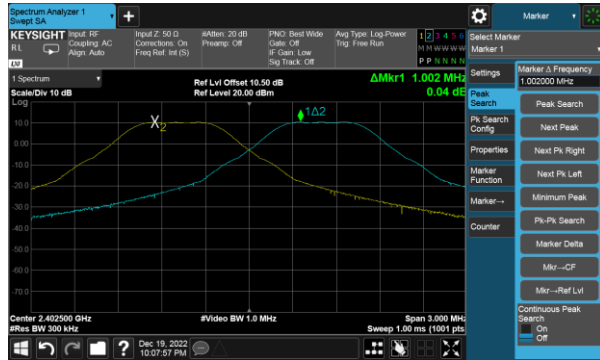

Modulation Type: $\pi/4$ -DQPSK (2Mbps)
Channel: 00

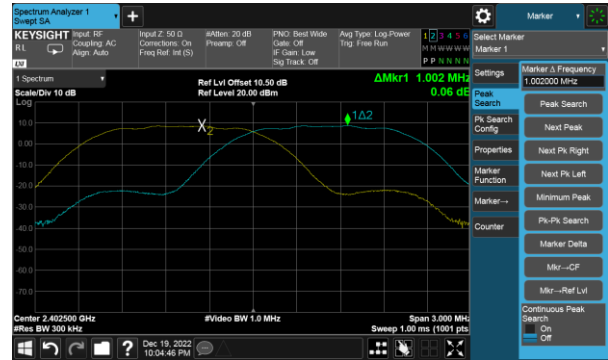

CH39

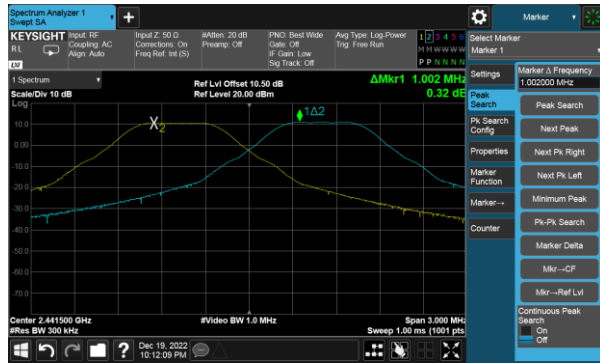

CH39

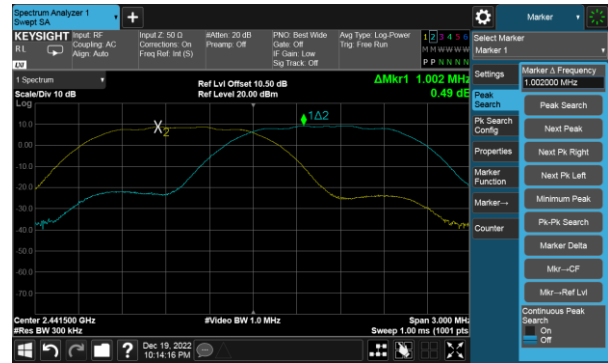

CH78

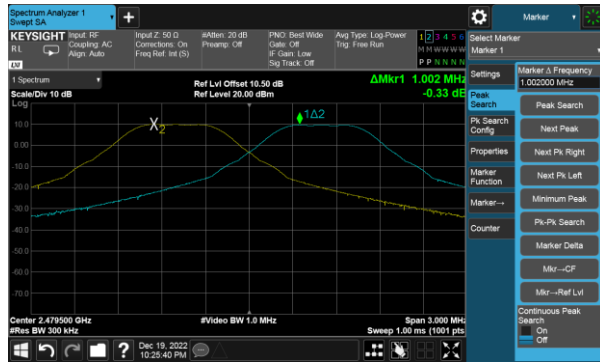

CH78

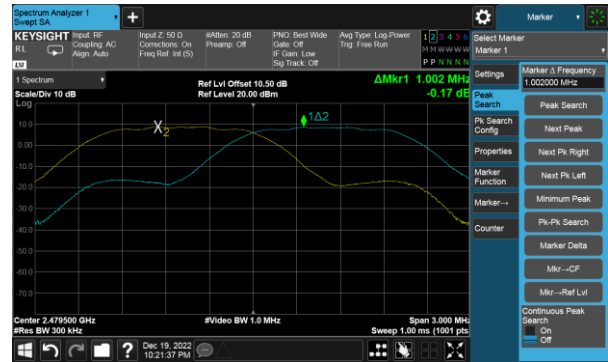



Modulation Type: 8DPSK (3Mbps)
Channel: 00

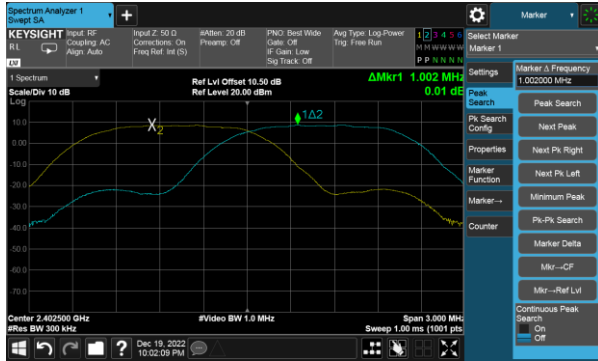

CH39

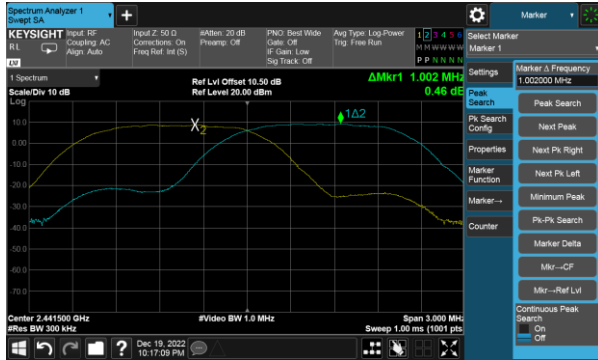

CH78

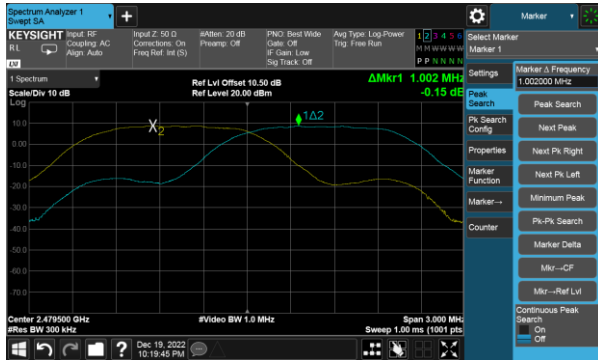



11. Dwell Time on each channel

11.1 Test Limit

The average time of occupancy on any channel shall not be greater than 0.4 seconds within a period of 0.4 seconds multiplied by the number of hopping channels employed.

11.2 Test Procedures

According to the methods defined in ANSI C63.10-2013 Section 7.8.4

1. The transmitter output was connected to the spectrum analyzer.
2. Adjust the center frequency to measure frequency, then set zero span mode.
3. Set RBW of spectrum analyzer to 300KHz and VBW to 1MHz.
4. Measure the time duration of one transmission on the measured frequency.

11.3 Test Setup Layout

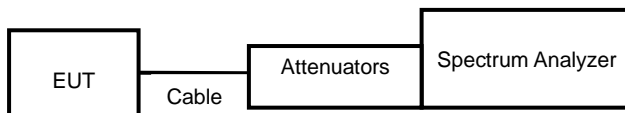



11.4 Test Result and Data

Channel	Frequency (MHz)	Length of transmission time (ms)	Number of transmission in a 31.6 (79 Hopping*0.4)	Dwell Time (ms)	Limit (ms)
GFSK-DH1	2402	0.408	320.00	130.56	400
GFSK-DH3	2402	1.664	160.00	266.24	400
GFSK-DH5	2402	2.922	106.67	311.68	400
$\pi/4$ -DQPSK-DH1	2402	0.414	320.00	132.48	400
$\pi/4$ -DQPSK-DH3	2402	1.666	160.00	266.56	400
$\pi/4$ -DQPSK-DH5	2402	2.919	106.67	311.36	400
8DPSK-DH1	2402	0.414	320.00	132.48	400
8DPSK-DH3	2402	1.666	160.00	266.56	400
8DPSK-DH5	2402	2.919	106.67	311.36	400

Channel	Frequency (MHz)	Length of transmission time (ms)	Number of transmission in a 8 (20 Hopping*0.4)	Dwell Time (ms)	Limit (ms)
AFH-DH1	2402-2421	0.406	160.00	64.96	400
AFH-DH3	2402-2421	1.664	80.00	133.12	400
AFH-DH5	2402-2421	2.913	53.33	155.35	400



Modulation Type: GFSK-DH1
Channel: 00

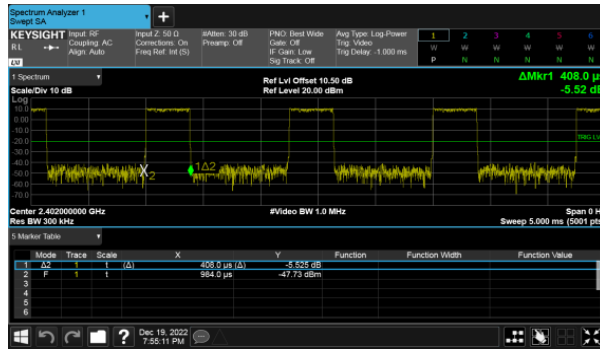

Modulation Type: $\pi/4$ -DQPSK-DH1
Channel: 00



Modulation Type: GFSK-DH3

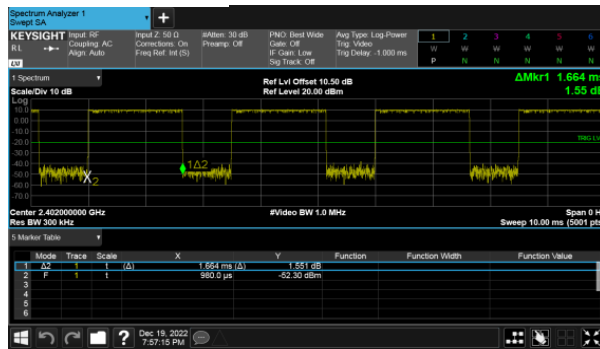

Modulation Type: $\pi/4$ -DQPSK-DH3

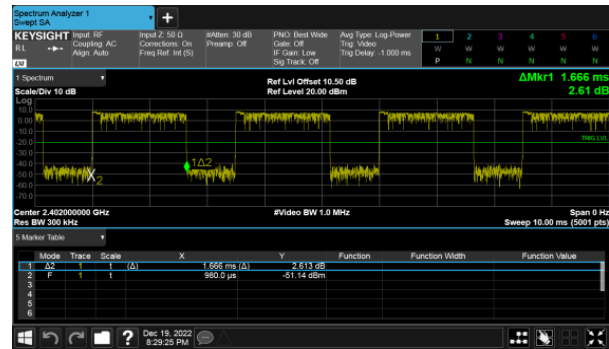

Modulation Type: GFSK-DH5
Channel: 00

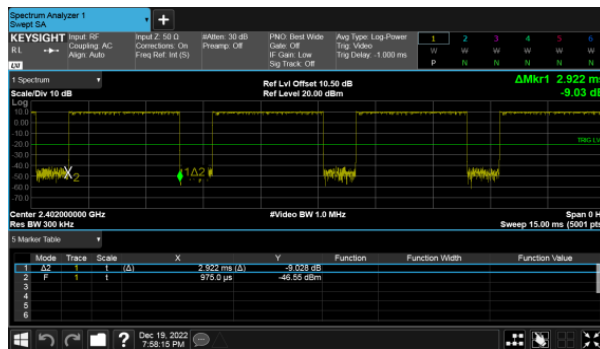

Modulation Type: $\pi/4$ -DQPSK-DH5
Channel: 00

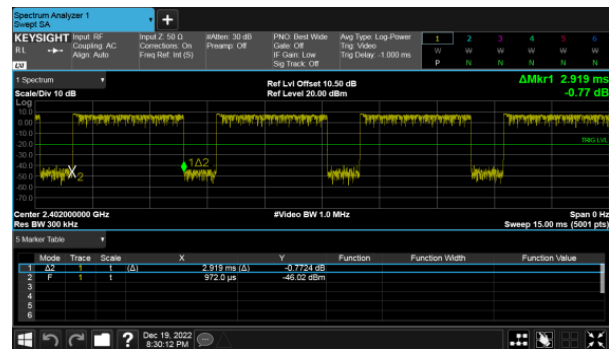



Modulation Type: 8DPSK-DH1
Channel: 00



Modulation Type: AFH (DH1)

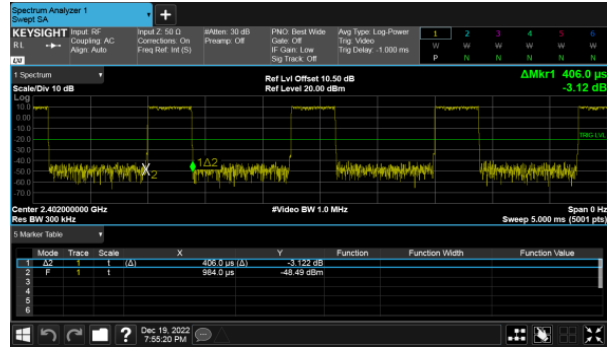

Modulation Type: 8DPSK-DH3

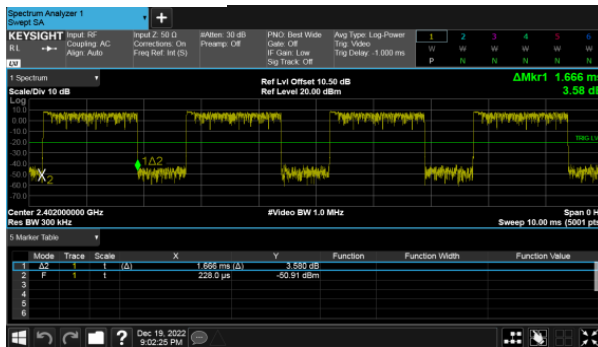

Modulation Type: AFH (DH3)

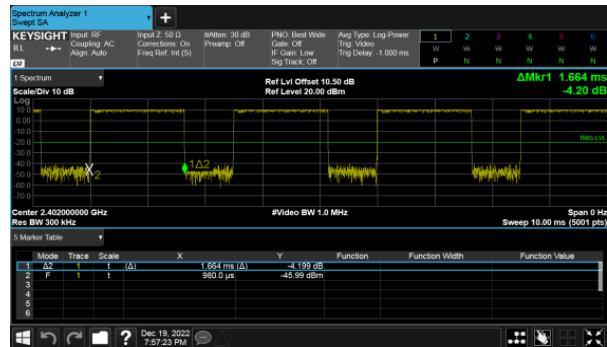

Modulation Type: 8DPSK-DH5
Channel: 00

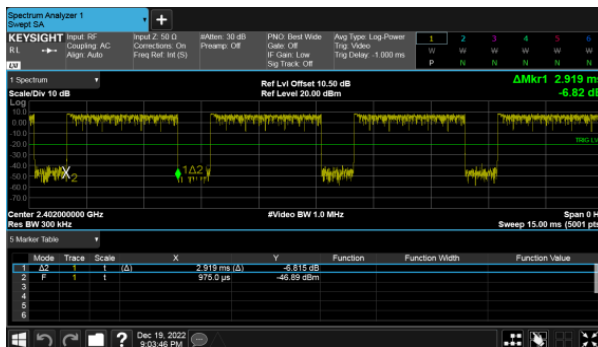

Modulation Type: AFH (DH5)

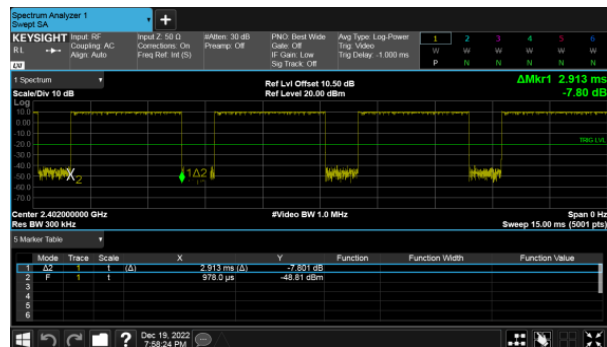



12. Number of Hopping Channels

12.1 Test Limit

Frequency hopping systems in the 2400 ~ 2483.5 MHz band shall use at least 15 channels.

12.2 Test Procedures

According to the methods defined in ANSI C63.10-2013 Section 7.8.3

- a. The transmitter output was connected to the spectrum analyzer.
- b. 2. Set RBW of spectrum analyzer to 100 KHz and VBW to 300 KHz.
- c. 3. Set the MaxHold function, and then keep the EUT in hopping mode. Record all the signals from each channel until each one has been record.

12.3 Test Setup Layout

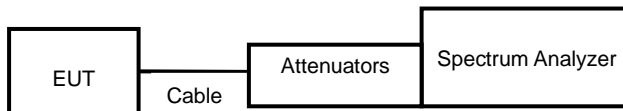

12.4 Test Result and Data

Modulation Type	Hopping Channels
GFSK	79
$\pi/4$ -DQPSK	79
8DPSK	79



Modulation Type: GFSK (1Mbps)

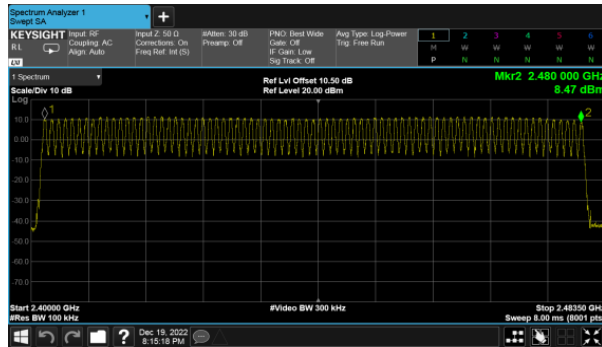

Modulation Type: $\pi/4$ -DQPSK (2Mbps)

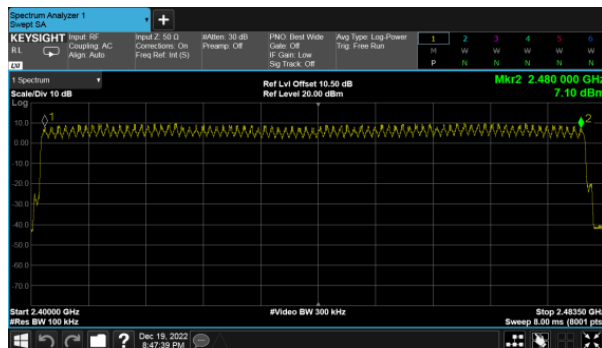

Modulation Type: 8DPSK (3Mbps)

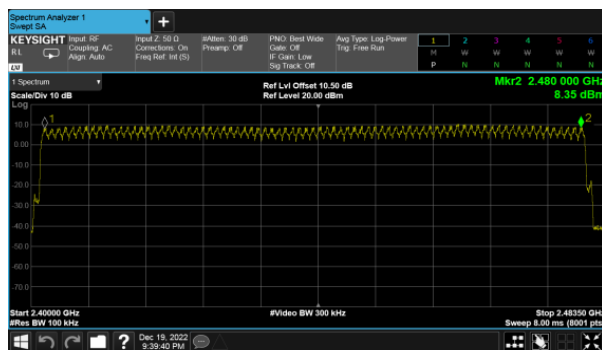



13. Maximum Average Output Power

13.1 Test Limit

The Maximum Average Output Power Measurement is 30dBm.

13.2 Test Procedures

According to the methods defined in ANSI C63.10-2013 Section 7.8.5

The antenna port(RF output)of the EUT was connected to the input(RF input)of a power meter.

Power was read directly from the meter and cable loss connection was added to the reading to obtain power at the EUT antenna terminal. The EUT Output Power was set to maximum to produce the worse case test result.

13.3 Test Setup Layout

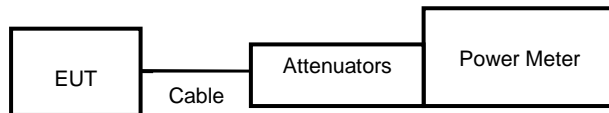



13.4 Test Result and Data

Modulation Type	Setting	Channel	Frequency (MHz)	AV Output Power (dBm)	AV Output Power (mW)
GFSK	39	0	2402	10.72	11.803
	39	39	2441	11.02	12.647
	39	78	2480	9.93	9.840
π/4-DQPSK	39	0	2402	8.33	6.808
	39	39	2441	8.39	6.902
	39	78	2480	8.24	6.668
8DPSK	39	0	2402	8.34	6.823
	39	39	2441	8.40	6.918
	39	78	2480	8.25	6.683

AFH Mode

Modulation Type	Setting	Channel	Frequency (MHz)	AV Output Power (dBm)	AV Output Power (mW)
GFSK	39	0-19	2402-2421	10.87	12.218
π/4-DQPSK	39	0-19	2402-2421	8.36	6.855
8DPSK	39	0-19	2402-2421	8.37	6.871