



# FCC RADIO TEST REPORT

Applicant : Elo Touch Solutions, Inc.  
Address : 670 N. McCarthy Blvd., Suite 100, Milpitas, CA95035  
Equipment : Touch All in one Computer  
Model No. : ESY22i1B  
Trade Name : Elo or   
FCC ID : RBWESY22I1B

**I HEREBY CERTIFY THAT :**

The sample was received on Nov. 15, 2019 and the testing was completed on Dec. 27, 2019 at CerpPASS Technology Corp. The test result refers exclusively to the test presented test model / sample. Without written approval of CerpPASS Technology Corp., the test report shall not be reproduced except in full.

Approved by:

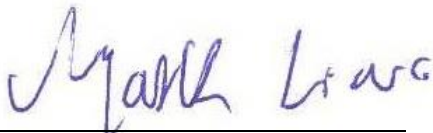

Mark Liao / Supervisor

Laboratory Accreditation:

CerpPASS Technology Corporation Test Laboratory





CONTENTS

- 1. Summary of Test Procedure and Test Results ..... 5
  - 1.1. Applicable Standards .....5
- 2. Test Configuration of Equipment under Test ..... 6
  - 2.1. Feature of Equipment and Model Description.....6
  - 2.2. Difference Description .....6
  - 2.3. Carrier Frequency of Channels ..... 7
  - 2.4. Test Mode and Test Software .....8
  - 2.5. Description of Test System.....8
  - 2.6. General Information of Test.....9
  - 2.7. Measurement Uncertainty .....9
- 3. Test Equipment and Ancillaries Used for Tests ..... 10
- 4. Antenna Requirements ..... 12
  - 4.1. Standard Applicable ..... 12
  - 4.2. Antenna Construction and Directional Gain.....12
- 5. Test of AC Power Line Conducted Emission ..... 13
  - 5.1. Test Limit ..... 13
  - 5.2. Test Procedures ..... 13
  - 5.3. Typical Test Setup ..... 14
  - 5.4. Test Result and Data ..... 15
  - 5.5. Test Photographs ..... 17
- 6. Test of Spurious Emission (Radiated) ..... 18
  - 6.1. Test Limit ..... 18
  - 6.2. Test Procedures ..... 18
  - 6.3. Typical Test Setup ..... 19
  - 6.4. Test Result and Data (9kHz ~ 30MHz).....20
  - 6.5. Test Result and Data (30MHz ~ 1GHz).....20
  - 6.6. Test Result and Data (1GHz ~ 40GHz).....22
  - 6.7. Restricted Bands of Operation .....60
  - 6.8. Test Photographs (30MHz ~ 1GHz) .....61
  - 6.9. Test Photographs (1GHz ~ 40GHz) .....62
- 7. On Time, Duty Cycle and Measurement methods ..... 63
  - 7.1. Test Limit .....63
  - 7.2. Test Procedure .....63
  - 7.3. Test Setup Layout .....63
  - 7.4. Test Result and Data .....63
  - 7.5. Measurement Methods .....63
- 8. 26dB Bandwidth & 99% Occupied Bandwidth ..... 65
  - 8.1. Test Limit .....65
  - 8.2. Test Procedure .....65
  - 8.3. Test Setup Layout .....65



- 8.4. Test Result and Data (26dB Bandwidth) .....66
- 8.5. Test Result and Data (99% Occupied Bandwidth) .....67
- 9. Average Power..... 76
  - 9.1. Test Limit ..... 76
  - 9.2. Test Procedure ..... 77
  - 9.3. Test Setup Layout ..... 77
  - 9.4. Test Result and Data ..... 78
- 10. Maximum Power Spectral Density ..... 79
  - 10.1. Test Limit ..... 79
  - 10.2. Test Procedure ..... 79
  - 10.3. Test Setup Layout ..... 79
  - 10.4. Test Result and Data ..... 80
- 11. Frequency Stability ..... 85
  - 11.1. Test Procedure ..... 85
  - 11.2. Test Setup Layout ..... 85
  - 11.3. Test Result and Data ..... 86
- 12. Radio Frequency Exposure ..... 87
  - 12.1. Applicable Standards ..... 87
  - 12.2. EUT Specification ..... 87
  - 12.3. Test Results ..... 87
  - 12.4. Calculation ..... 88
  - 12.5. Maximum Permissible Exposure ..... 89



History of this test report

Report No.	Issue Date	Description
TEDL1707267-C	Sep. 21, 2017	Original.
TEFE1909259-243	Jan. 06, 2020	ADD DFS BAND.



# 1. Summary of Test Procedure and Test Results

## 1.1. Applicable Standards

**ANSI C63.10:2013**

**FCC Rules and Regulations Part 15 Subpart E §15.407**

**KDB789033**

FCC Rule	Description of Test	Result
15.203	Antenna Requirement	PASS
15.207(a)	AC Power Line Conducted Emission	PASS
15.407(b) 15.209	Radiated Spurious Emission	PASS
15.407(a)	26 dB & Occupied Bandwidth	PASS
15.407 (a) & (a)(3)	Average Power	PASS
15.407(a)	Power Spectral Density	PASS
15.407(g)	Frequency Stability	PASS

\*The lab has lowered the uncertainty risk of test equipment, environment, and staff technicians according to ISO-IEC17025. Therefore we define test result as compliant when it complies with the standard without further evaluation of test result uncertainty.



## 2. Test Configuration of Equipment under Test

### 2.1. Feature of Equipment and Model Description

Frequency Range	802.11a/n/ac: 5260-5320MHz, 5500-5700MHz
Modulation Type	802.11a/n: BPSK, QPSK, 16QAM, 64QAM 802.11ac: BPSK, QPSK, 16QAM, 64QAM, 256QAM
Modulation Technology	OFDM
Data Rate	802.11a: 6, 9, 12, 18, 24, 36, 48, 54Mbps 802.11n: MCS0 – MCS7, HT20/40 802.11ac: MCS0 – MCS9, VHT20/40/80
Antenna Type	PCB Antenna
Adapter	Brand: DELTA Model: ADP-65JH HB INPUT: 100-240V~1.5A 50-60Hz OUTPUT: 19V / 3.42A

Note:

1. For a more detailed features description, please refer to the manufacturer’s specifications or the User's Manual.
2. The band from 5600-5650MHz will be disabled by the software during the manufacturing and cannot be changed by the end user.
3. This device supports DFS client mode.

### 2.2. Difference Description

N/A



### 2.3. Carrier Frequency of Channels

Band: 5250MHz -5350MHz

802.11a, 802.11n HT 20, 802.11ac VHT20

Channel	Frequency(MHz)	Channel	Frequency(MHz)
<b>*52</b>	<b>5260</b>	<b>*60</b>	<b>5300</b>
56	5280	<b>*64</b>	<b>5320</b>

802.11n HT 40, 802.11ac VHT40

Channel	Frequency(MHz)	Channel	Frequency(MHz)
<b>*54</b>	<b>5270</b>	<b>*62</b>	<b>5310</b>

802.11ac VHT80

Channel	Frequency(MHz)
<b>*58</b>	<b>5290</b>

Band: 5470MHz -5725MHz

802.11a, 802.11n HT 20, 802.11ac VHT20

Channel	Frequency(MHz)	Channel	Frequency(MHz)
<b>*100</b>	<b>5500</b>	<b>*116</b>	<b>5580</b>
104	5520	132	5660
108	5540	136	5680
112	5560	<b>*140</b>	<b>5700</b>

802.11n HT 40, 802.11ac VHT40

Channel	Frequency(MHz)	Channel	Frequency(MHz)
<b>*102</b>	<b>5510</b>	<b>*134</b>	<b>5670</b>
<b>*110</b>	<b>5550</b>		

802.11ac VHT80

Channel	Frequency(MHz)	Channel	Frequency(MHz)
<b>*106</b>	<b>5530</b>	-	-



### 2.4. Test Mode and Test Software

- a. During testing, the interface cables and equipment positions were varied according to ANSI C63.10.
- b. The complete test system included remote workstation and EUT for RF test. The remote workstation included Notebook.
- c. An executive program, " qdart ver. qdart.win.4.8\_installer\_00031.310-23-19\_12\_36\_59" under Windows OS system was executed to transmit and receive data via WLAN.
- d. The following test modes were performed for the test:

Conducted Emissions from the AC mains power ports	
Test Mode	Operating Description
1	802.11a (6Mbps)
2	802.11ac VHT20 (6.5Mbps)
3	802.11ac VHT40 (13.5Mbps)
4	802.11ac VHT80 (29.3Mbps)
caused "Test Mode 2" generated the worst case, it was reported as the final data.	
Radiation Emissions (30MHz ~ 1GHz)	
Test Mode	Operating Description
1	802.11a (6Mbps)
2	802.11ac VHT20 (6.5Mbps)
3	802.11ac VHT40 (13.5Mbps)
4	802.11ac VHT80 (29.3Mbps)
caused "Test Mode 2" generated the worst case, it was reported as the final data.	
Radiation Emissions (1GHz ~ 40GHz)	
Test Mode	Operating Description
1	802.11a (6Mbps)
2	802.11ac VHT20 (6.5Mbps)
3	802.11ac VHT40 (13.5Mbps)
4	802.11ac VHT80 (29.3Mbps)
caused "Test Mode 1~4" generated the worst case, it was reported as the final data.	

### 2.5. Description of Test System

N/A



**2.6. General Information of Test**

Test Site	<b>CerpPASS Technology Corporation Test Laboratory</b> Address: No.10, Ln. 2, Lianfu St., Luzhu Dist., Taoyuan City 33848, Taiwan (R.O.C.) Tel:+886-3-3226-888 Fax:+886-3-3226-881	
	FCC	TW1439, TW1079
	IC	4934E-1, 4934E-2
	VCCI	T-2205 for Telecommunication test C-4663 for Conducted emission test R-4218 for Radiated emission test G-10812, G-10813 for radiated disturbance above 1GHz
Frequency Range Investigated:	Conducted: from 150kHz to 30 MHz Radiation: from 30 MHz to 40,000MHz	
Test Distance:	The test distance of radiated emission from antenna to EUT is 3 M.	

Test Item	Test Site	Finish Date	Environmental Conditions	Tested By
RF Conducted	RFCON01-NK	2019/11/30	22°C / 63%	Nick Guan
Radiated Emissions	3M02-NK	2019/12/23	24°C / 52%	Vic Yeh
AC Power Line Conducted Emission	CON02-NK	2019/12/27	24°C / 58%	Dian Chen

**2.7. Measurement Uncertainty**

Measurement Item	Uncertainty
Radiated Spurious Emission(9KHz~30MHz)	±3.405dB
Radiated Spurious Emission(30MHz~1GHz)	±5.326dB
Radiated Spurious Emission(1GHz~40GHz)	±5.011dB
6dB Bandwidth	±4.407%
26dB Bandwidth	±4.459%
Occupied Bandwidth	±4.403%
Peak Output Power(Conducted Power Meter)	±1.31dB
Power Spectral Density	±2.106dB
Duty Cycle	±0.17%
Frequency Stability	±156.543Hz



### 3. Test Equipment and Ancillaries Used for Tests

Test Item	Radiated Emissions				
Test Site	Semi Anechoic Room(3M02-NK)				
Instrument	Manufacturer	Model No	Serial No	Calibration Date	Valid Date
Bilog Antenna	Schwarzbeck	VULB9168	275	2019/09/24	2020/09/23
Bilog Antenna	Schwarzbeck	VULB9168	369	2019/03/29	2020/03/28
Active Loop Antenna	EMCO	6507	40855	2019/05/24	2020/05/23
Horn Antenna	EMCO	3115	31589	2019/04/01	2020/03/31
Horn Antenna	EMCO	3116	31974	2019/09/17	2020/09/16
EMI Receiver	ROHDE & SCHWARZ	ESCI	101423	2019/05/14	2020/05/13
Spectrum Analyzer	ROHDE & SCHWARZ	FSP 40	100047	2019/03/28	2020/03/27
Spectrum Analyzer	ROHDE & SCHWARZ	FSV 40-N	102151	2019/08/02	2020/08/01
Preamplifier	EM Electronics corp.	EM330	60660	2019/03/11	2020/03/10
Preamplifier	EMC INSTRUMENTS	EMC051845SE	980333	2019/09/20	2020/09/19
Preamplifier	Agilent	8449B	3008A01954	2019/03/11	2020/03/10
Preamplifier	EMC INSTRUMENTS	EMC184045	980065	2019/11/07	2020/11/06
Bluetooth Tester	ROHDE & SCHWARZ	CBT	101133	2019/04/07	2020/04/06
Cable-3in1(30M-1G)	HARBOUR INDUSTRIES	LL142	CCE1315	2019/04/09	2020/04/08
Cable-3in1(30M-1G)	HARBOUR INDUSTRIES	LL142	CCE1316	2019/09/20	2020/09/19
Cable-0.5m(1G-40G)	HUBER SUHNER	SUCOFLEX 100	805443/4	2019/05/20	2020/05/19
Cable-3m(1G-40G)	HUBER SUHNER	SUCOFLEX 100	805796/4	2019/05/20	2020/05/19
Cable-8m(1G-40G)	HUBER SUHNER	SUCOFLEX 100	805795/4	2019/05/20	2020/05/19
E3	AUDIX	v8.2014-8-6	RK-000529	NA	NA

Test Item	RF Conducted				
Test Site	RFCON01-NK				
Instrument	Manufacturer	Model No	Serial No	Calibration Date	Valid Date
Spectrum Analyzer	ROHDE & SCHWARZ	FSP 40	100047	2019/03/28	2020/03/27
Spectrum Analyzer	ROHDE & SCHWARZ	FSV 40-N	102151	2019/08/02	2020/08/01
Bluetooth Tester	ROHDE & SCHWARZ	CBT	101133	2019/04/07	2020/04/06
Attenuator	KEYSIGHT	8491B	MY39250703	2019/09/12	2020/09/11
TEMP & HUMI CHAMBER	T-MACHINE	TMJ-9712	T-12-040111	2019/08/28	2020/08/27
Power Meter	Anritsu	ML2495A	1224005	2019/04/11	2020/04/10
Power Sensor	Anritsu	MA2411B	1207295	2019/04/09	2020/04/08



<b>Test Item</b>	AC Power Line Conducted Emission				
<b>Test Site</b>	CON02-NK				
<b>Instrument</b>	<b>Manufacturer</b>	<b>Model No</b>	<b>Serial No</b>	<b>Calibration Date</b>	<b>Valid Date</b>
EMI Receiver	ROHDE & SCHWARZ	ESCI	100821	2019/09/16	2020/09/15
Line Impedance Stabilization Network	Schwarzbeck	NSLK 8127	8127-516	2019/09/19	2020/09/18
TWO-LINE V-NETWORK	ROHDE & SCHWARZ	ENV216	102185	2019/07/05	2020/07/04
Cable-6m(9k~300M)	NA	EMC5D-BM-BM-6	130606	2019/03/14	2020/03/13
E3	AUDIX	v8.2014-8-6	RK-000536	NA	NA



### 4. Antenna Requirements

#### 4.1. Standard Applicable

For intentional device, according to FCC 47 CFR Section 15.203, an intentional radiator shall be designed to ensure that no antenna other than that furnished by the responsible party shall be used with the device.

And according to FCC 47 CFR Section 15.407 (a), if transmitting antennas of directional gain greater than 6dBi are used, the power shall be reduced by the amount in dB that the directional gain of the antenna exceeds 6dBi.

#### 4.2. Antenna Construction and Directional Gain

Antenna Type	PCB Antenna
Antenna Gain	5260MHz-5320MHz: ANT A: 2.57 dBi 5500MHz-5700MHz: ANT A: 2.57 dBi

5260MHz - 5320MHz
For Power directional gain= $G_{ant}= 2.57 \text{ dBi}$ For PSD directional gain = $10 \log[(10^{G1/20} + 10^{G2/20})^2 / NANT]$ = 2.57 (dBi)
5500MHz - 5700MHz
For Power directional gain= $G_{ant}= 2.57 \text{ dBi}$ For PSD directional gain = $10 \log[(10^{G1/20} + 10^{G2/20})^2 / NANT]$ = 2.57 (dBi)



## 5. Test of AC Power Line Conducted Emission

### 5.1. Test Limit

Conducted Emissions were measured from 150 kHz to 30 MHz with a bandwidth of 9 KHz, according to the methods defined in ANSI C63.4-2014. The EUT was placed on a nonmetallic stand in a shielded room 0.8 meters above the ground plane. The interface cables and equipment positioning were varied within limits of reasonable applications to determine the position produced maximum conducted emissions.

Frequency (MHz)	Quasi Peak (dB $\mu$ V)	Average (dB $\mu$ V)
0.15 – 0.5	66-56*	56-46*
0.5 – 5.0	56	46
5.0 – 30.0	60	50

\*Decreases with the logarithm of the frequency.

### 5.2. Test Procedures

- a. The EUT was placed 0.4 meter from the conducting wall of the shielding room was kept at least 80 centimeters from any other grounded conducting surface.
- b. Connect EUT to the power mains through a line impedance stabilization network (LISN).
- c. All the support units are connecting to the other LISN.
- d. The LISN provides 50 ohm coupling impedance for the measuring instrument.
- e. The FCC states that a 50 ohm, 50 micro-Henry LISN should be used.
- f. Both sides of AC line were checked for maximum conducted interference.
- g. The frequency range from 150 kHz to 30 MHz was searched.
- h. Set the test-receiver system to Peak Detect Function and Specified Bandwidth with Maximum Hold Mode.



### 5.3. Typical Test Setup

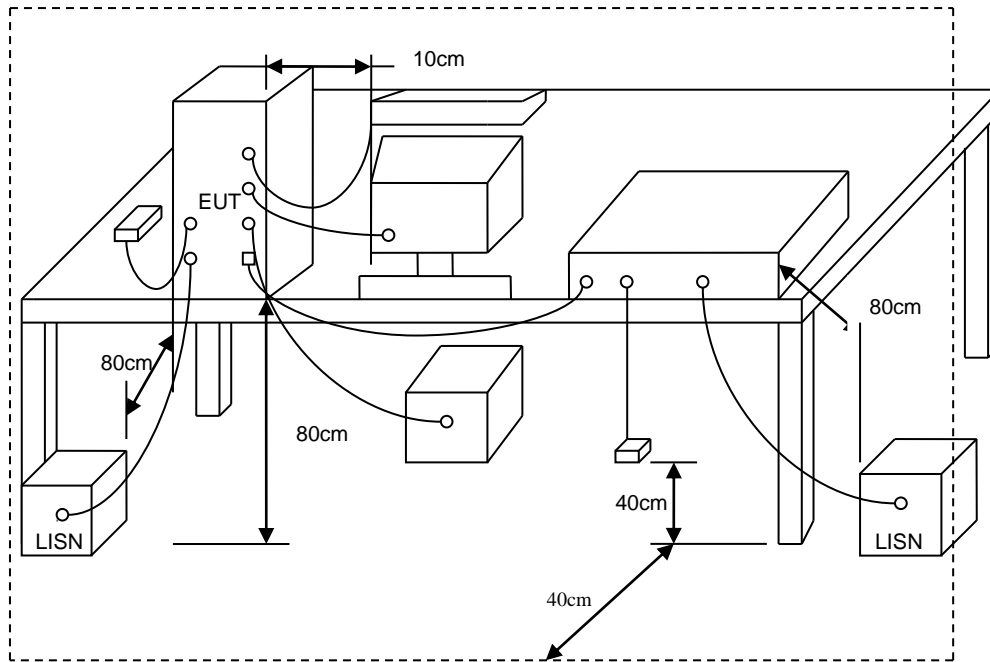



5.4. Test Result and Data

Power	: AC 120V / 60Hz	Pol/Phase	: LINE
Test Mode	: Mode 2, Band 2, CH52		

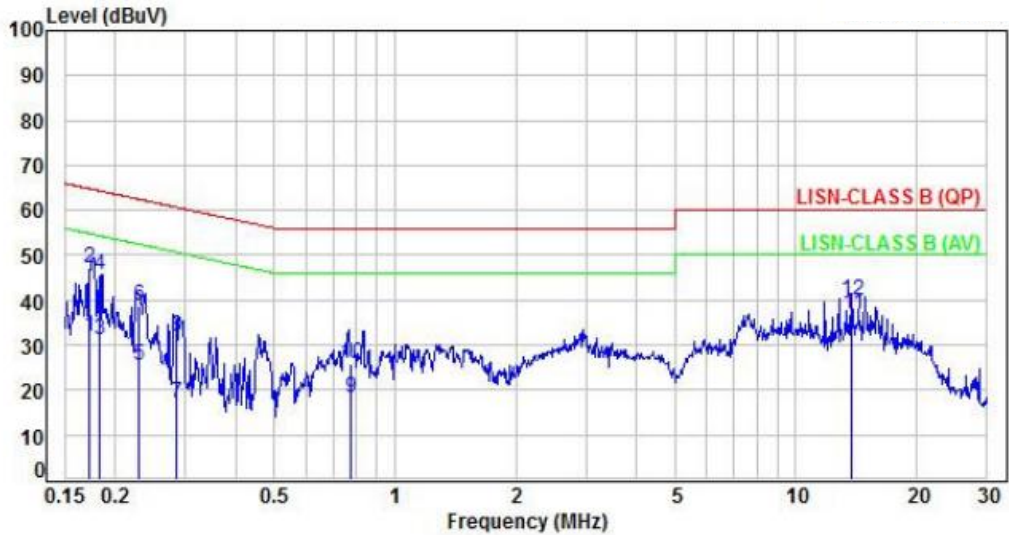

No.	Frequency (MHz)	Factor (dB)	Reading (dBuV)	Level (dBuV)	Limit (dBuV)	Margin (dB)	Detector	P/F
1	0.17	9.64	22.21	31.85	54.87	-23.02	Average	P
2	0.17	9.64	37.43	47.07	64.87	-17.80	QP	P
3	0.18	9.64	21.54	31.18	54.38	-23.20	Average	P
4	0.18	9.64	35.81	45.45	64.38	-18.93	QP	P
5	0.23	9.64	15.70	25.34	52.49	-27.15	Average	P
6	0.23	9.64	29.15	38.79	62.49	-23.70	QP	P
7	0.28	9.63	7.37	17.00	50.67	-33.67	Average	P
8	0.28	9.63	22.35	31.98	60.67	-28.69	QP	P
9	0.77	9.66	8.41	18.07	46.00	-27.93	Average	P
10	0.77	9.66	16.19	25.85	56.00	-30.15	QP	P
11	13.84	9.91	26.98	36.89	50.00	-13.11	Average	P
12	13.84	9.91	29.91	39.82	60.00	-20.18	QP	P

Note: Level=Reading+Factor  
Margin=Level-Limit  
Factor=(LISN or ISN or Current Probe)Factor + Cable Loss



Power	: AC 120V / 60Hz	Pol/Phase	: NEUTRAL
Test Mode	: Mode 2, Band 2, CH52		

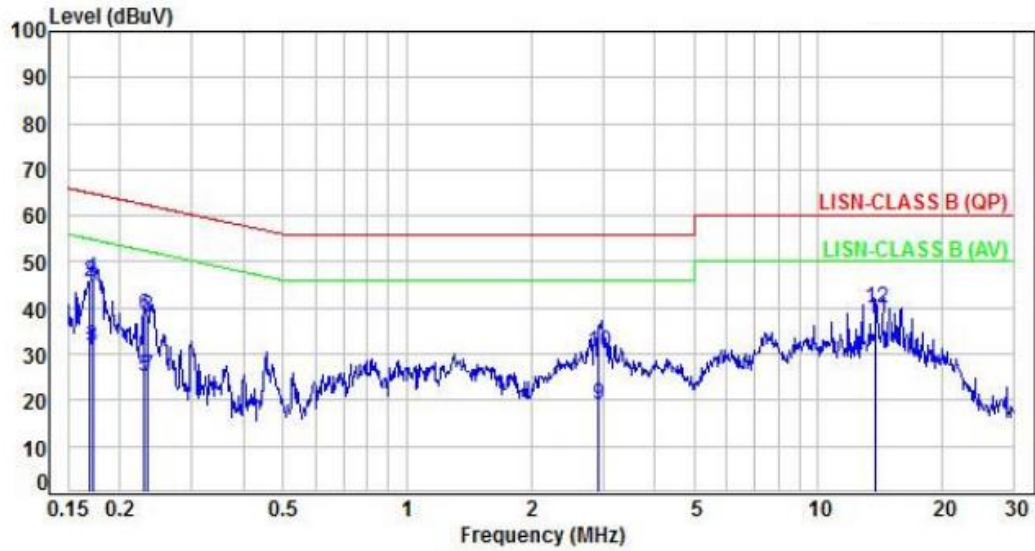

No.	Frequency (MHz)	Factor (dB)	Reading (dBUV)	Level (dBUV)	Limit (dBUV)	Margin (dB)	Detector	P/F
1	0.17	9.64	21.13	30.77	54.97	-24.20	Average	P
2	0.17	9.64	36.02	45.66	64.97	-19.31	QP	P
3	0.17	9.64	21.84	31.48	54.88	-23.40	Average	P
4	0.17	9.64	36.73	46.37	64.88	-18.51	QP	P
5	0.23	9.63	15.65	25.28	52.48	-27.20	Average	P
6	0.23	9.63	28.70	38.33	62.48	-24.15	QP	P
7	0.23	9.63	15.60	25.23	52.33	-27.10	Average	P
8	0.23	9.63	28.33	37.96	62.33	-24.37	QP	P
9	2.92	9.75	9.37	19.12	46.00	-26.88	Average	P
10	2.92	9.75	20.82	30.57	56.00	-25.43	QP	P
11	13.85	9.95	27.74	37.69	50.00	-12.31	Average	P
12	13.85	9.95	29.81	39.76	60.00	-20.24	QP	P

Note: Level=Reading+Factor  
 Margin=Level-Limit  
 Factor=(LISN or ISN or Current Probe)Factor + Cable Loss





## 6. Test of Spurious Emission (Radiated)

### 6.1. Test Limit

Undesirable emission limits. Except as shown in paragraph (b)(7) of this section, the maximum emissions outside of the frequency bands of operation shall be attenuated in accordance with the following limits:

- (1) For transmitters operating in the 5.15-5.25 GHz band: All emissions outside of the 5.15-5.35 GHz band shall not exceed an e.i.r.p. of  $-27$  dBm/MHz.
- (2) For transmitters operating in the 5.25-5.35 GHz band: All emissions outside of the 5.15-5.35 GHz band shall not exceed an e.i.r.p. of  $-27$  dBm/MHz.
- (3) For transmitters operating in the 5.47-5.725 GHz band: All emissions outside of the 5.47-5.725 GHz band shall not exceed an e.i.r.p. of  $-27$  dBm/MHz.
- (4) For transmitters operating in the 5.725-5.85 GHz band:  
All emissions shall be limited to a level of  $-27$  dBm/MHz at 75 MHz or more above or below the band edge increasing linearly to 10 dBm/MHz at 25 MHz above or below the band edge, and from 25MHz above or below the band edge increasing linearly to a level of 15.6 dBm/MHz at 5 MHz above or below the band edge, and from 5 MHz above or below the band edge increasing linearly to a level of 27dBm/MHz at the band edge.
- (5) The emission measurements shall be performed using a minimum resolution bandwidth of 1 MHz. A lower resolution bandwidth may be employed near the band edge, when necessary, provided the measured energy is integrated to show the total power over 1 MHz.
- (6) Unwanted emissions below 1 GHz must comply with the general field strength limits set forth in §15.209. Further, any U-NII devices using an AC power line are required to comply also with the conducted limits set forth in §15.207.
- (7) The provisions of §15.205 apply to intentional radiators operating under this section.
- (8) When measuring the emission limits, the nominal carrier frequency shall be adjusted as close to the upper and lower frequency band edges as the design of the equipment permits.

### 6.2. Test Procedures

- a. The EUT was placed on a rotatable table top 0.8 meter above ground.
- b. The EUT was set 3 meters from the interference receiving antenna which was mounted on the top of a variable height antenna tower.
- c. The table was rotated 360 degrees to determine the position of the highest radiation.
- d. The antenna is a broadband antenna and its height is varied between one meter and four meters above ground to find the maximum value of the field strength both horizontal polarization and vertical polarization of the antenna are set to make the measurement.
- e. For each suspected emission the EUT was arranged to its worst case and then tune the antenna tower (from 1 M to 4 M) and turn table (from 0 degree to 360 degrees) to find the maximum reading.
- f. Set the test-receiver system to Peak or CISPR quasi-peak Detect Function and specified bandwidth with Maximum Hold Mode.
- g. If the emission level of the EUT in peak mode was 3 dB lower than the limit specified, then testing will be stopped and peak values of EUT will be reported, otherwise, the emissions which do not have 3 dB margin will be repeated one by one using the quasi-peak method and reported.
- h. For testing above 1GHz, the emission level of the EUT in peak mode was 20dB lower than average limit (that means the emission level in peak mode also complies with the limit in average mode), then testing will be stopped and peak values of EUT will be reported, otherwise, the emissions will be measured in average mode again and reported.
- i. "Cone of radiation" has been considered to be 3dB bandwidth of the measurement antenna.



### 6.3. Typical Test Setup

Below 30MHz test setup

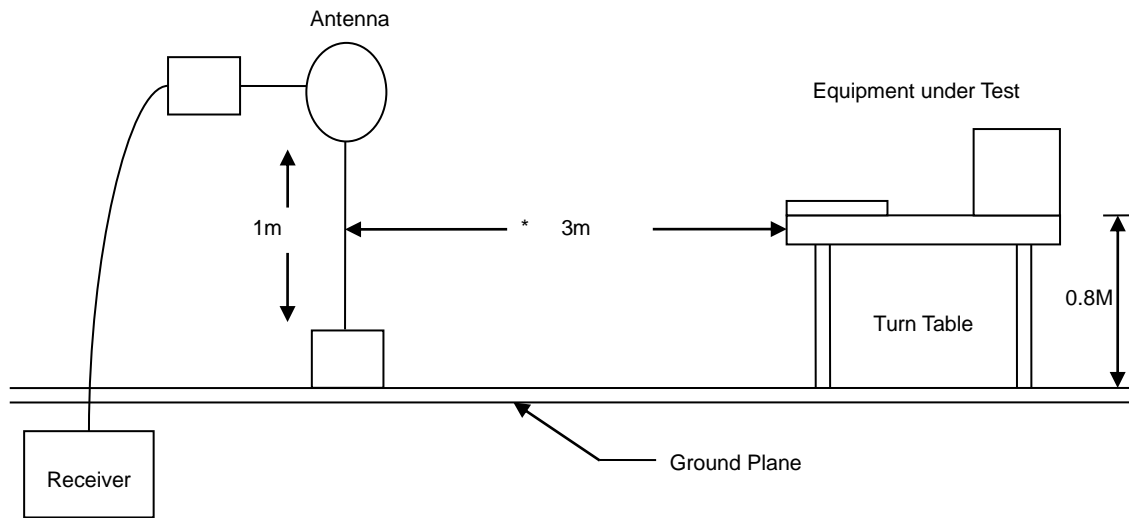

30MHz- 1GHz Test Setup

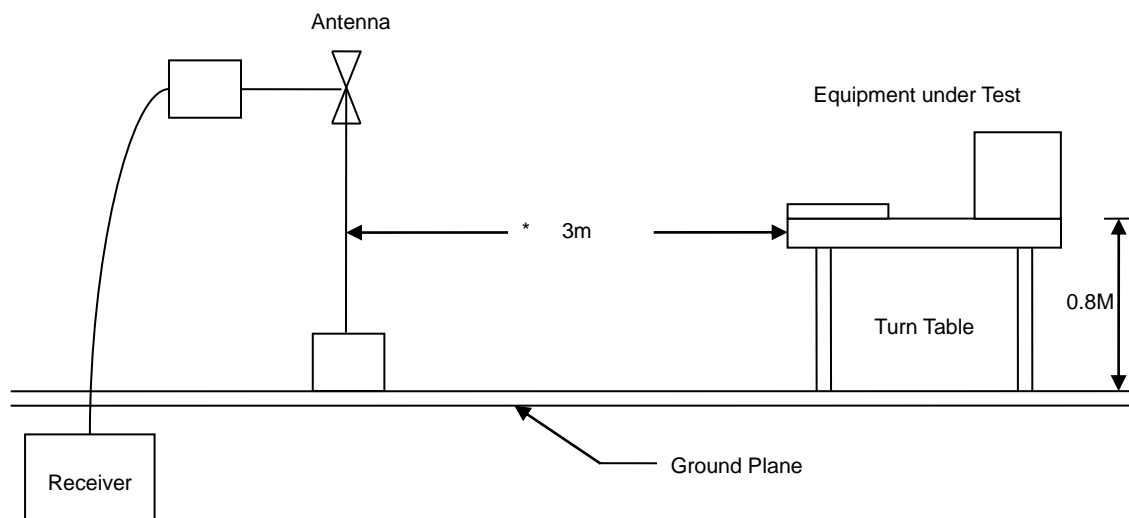

Above 1GHz Test Setup

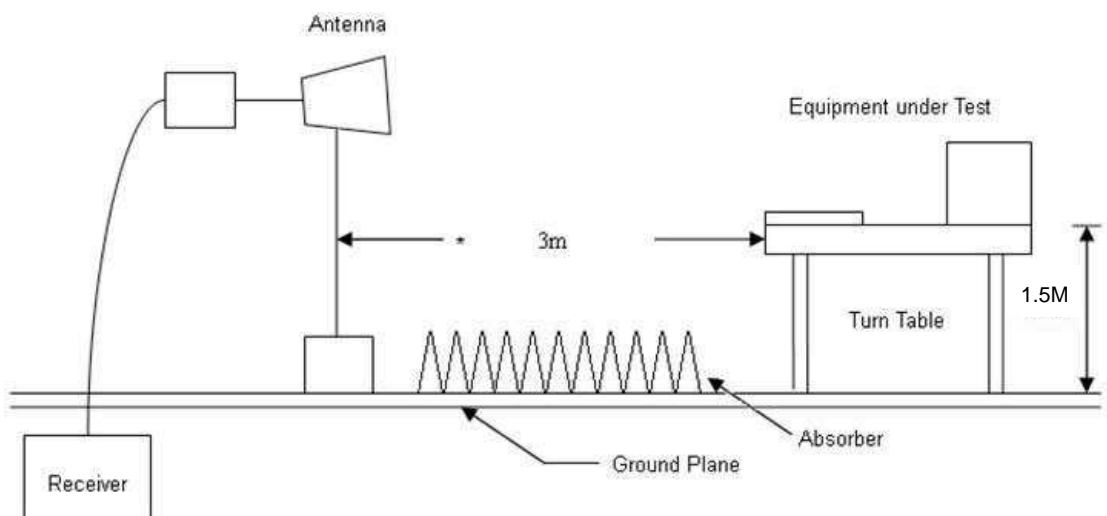



### 6.4. Test Result and Data (9kHz ~ 30MHz)

The 9kHz - 30MHz spurious emission is under limit 20dB more.

### 6.5. Test Result and Data (30MHz ~ 1GHz)

Power	: AC 120V / 60Hz	Pol/Phase	: VERTICAL
Test Mode	: Mode 2, Band 2, CH52		:

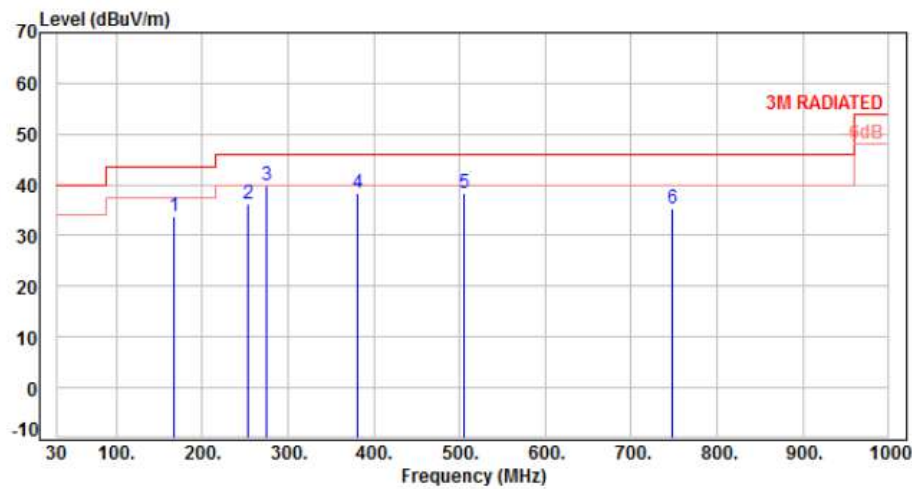

No.	Frequency (MHz)	Factor (dB)	Reading (dBuV)	Level (dBuV/m)	Limit (dBuV/m)	Margin (dB)	Detector	Height (cm)	Azimuth (deg)	P/F
1	167.74	-9.64	43.58	33.94	43.50	-9.56	Peak	100	0	P
2	253.10	-10.22	46.51	36.29	46.00	-9.71	Peak	100	0	P
3	274.44	-9.21	49.10	39.89	46.00	-6.11	Peak	100	0	P
4	381.14	-6.17	44.40	38.23	46.00	-7.77	Peak	100	0	P
5	505.30	-3.45	41.81	38.36	46.00	-7.64	Peak	100	0	P
6	747.80	1.13	34.09	35.22	46.00	-10.78	Peak	100	0	P

Note: Level=Reading+Factor  
Margin=Level-Limit  
Factor=Antenna Factor + cable loss - Amplifier Factor



Power	: AC 120V / 60Hz	Pol/Phase	: HORIZONTAL
Test Mode	: Mode 2, Band 2, CH52		:

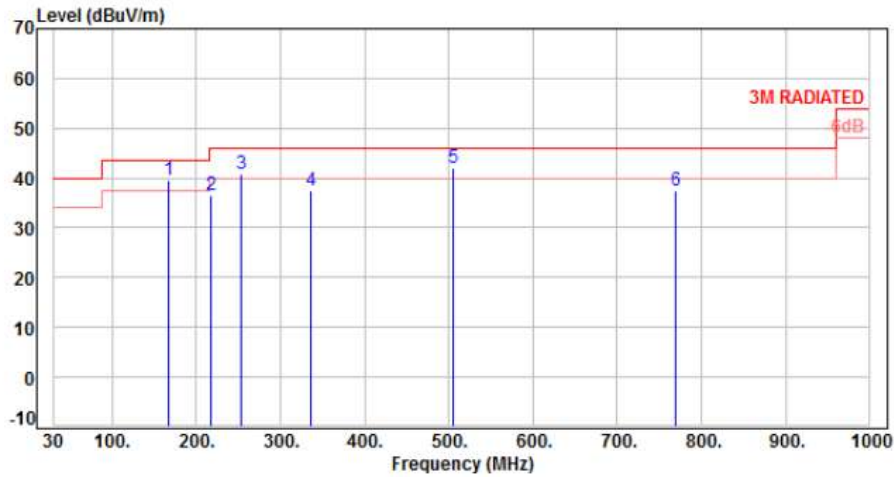

No.	Frequency (MHz)	Factor (dB)	Reading (dBuV)	Level (dBuV/m)	Limit (dBuV/m)	Margin (dB)	Detector	Height (cm)	Azimuth (deg)	P/F
1	167.74	-9.64	49.10	39.46	43.50	-4.04	QP	150	355	P
2	218.18	-11.94	48.59	36.65	46.00	-9.35	Peak	100	0	P
3	253.10	-10.22	51.00	40.78	46.00	-5.22	QP	100	188	P
4	336.52	-7.35	44.88	37.53	46.00	-8.47	Peak	100	0	P
5	505.30	-3.45	45.36	41.91	46.00	-4.09	Peak	100	0	P
6	769.14	1.47	36.01	37.48	46.00	-8.52	Peak	100	0	P

Note: Level=Reading+Factor  
Margin=Level-Limit  
Factor=Antenna Factor + cable loss - Amplifier Factor



### 6.6. Test Result and Data (1GHz ~ 40GHz)

Power	: AC 120V / 60Hz	Pol/Phase	: VERTICAL
Test Mode	: Mode 1, Band 2, CH52		:

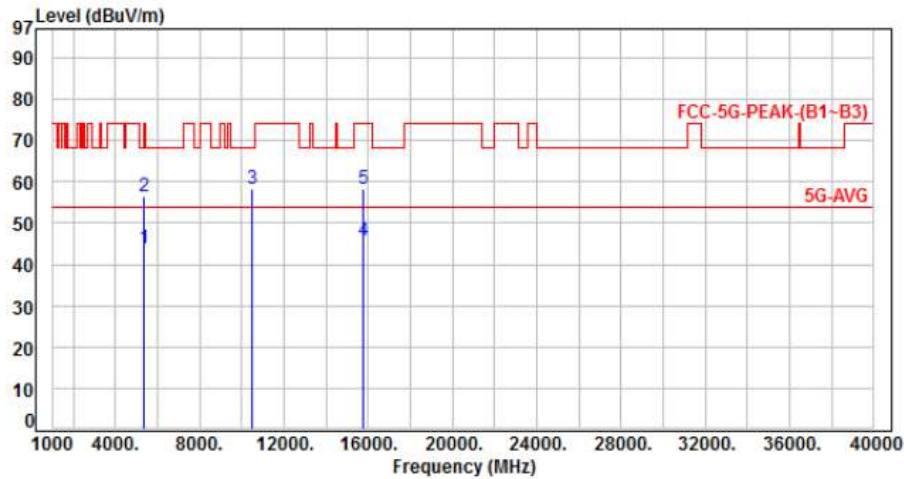

No.	Frequency (MHz)	Factor (dB)	Reading (dBuV)	Level (dBuV/m)	Limit (dBuV/m)	Margin (dB)	Detector	Height (cm)	Azimuth (deg)	P/F
1	5350.00	5.07	38.94	44.01	54.00	-9.99	Average	100	124	P
2	5350.00	5.07	51.46	56.53	74.00	-17.47	Peak	100	124	P
3	10520.00	11.74	46.51	58.25	68.20	-9.95	Peak	100	167	P
4	15780.00	13.57	32.18	45.75	54.00	-8.25	Average	100	115	P
5	15780.00	13.57	44.81	58.38	74.00	-15.62	Peak	100	115	P

Note: Level=Reading+Factor  
Margin=Level-Limit  
Factor=Antenna Factor + cable loss - Amplifier Factor



Power	: AC 120V / 60Hz	Pol/Phase	: HORIZONTAL
Test Mode	: Mode 1, Band 2, CH52		:

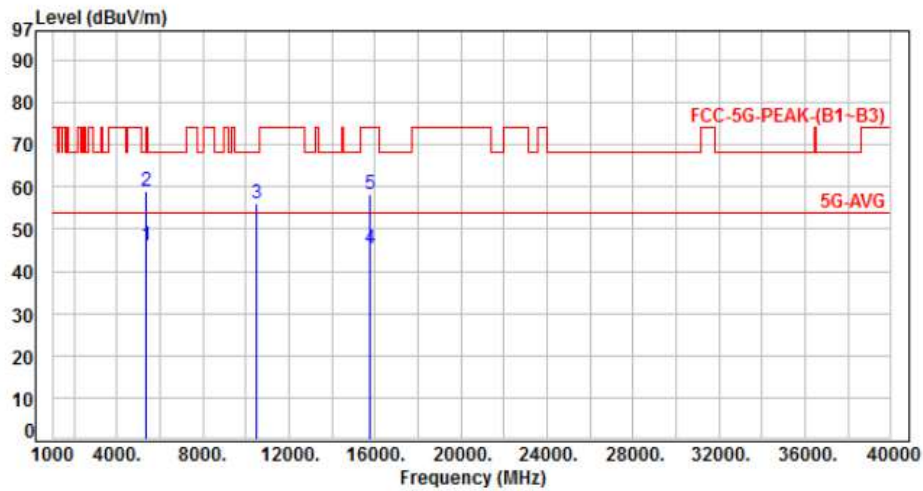

No.	Frequency (MHz)	Factor (dB)	Reading (dBuV)	Level (dBuV/m)	Limit (dBuV/m)	Margin (dB)	Detector	Height (cm)	Azimuth (deg)	P/F
1	5350.00	5.07	41.13	46.20	54.00	-7.80	Average	100	288	P
2	5350.00	5.07	53.85	58.92	74.00	-15.08	Peak	100	288	P
3	10520.00	11.74	44.32	56.06	68.20	-12.14	Peak	100	190	P
4	15780.00	13.57	31.90	45.47	54.00	-8.53	Average	100	221	P
5	15780.00	13.57	44.61	58.18	74.00	-15.82	Peak	100	221	P

Note: Level=Reading+Factor  
Margin=Level-Limit  
Factor=Antenna Factor + cable loss - Amplifier Factor



Power	: AC 120V / 60Hz	Pol/Phase	: VERTICAL
Test Mode	: Mode 1, Band 2, CH60		:

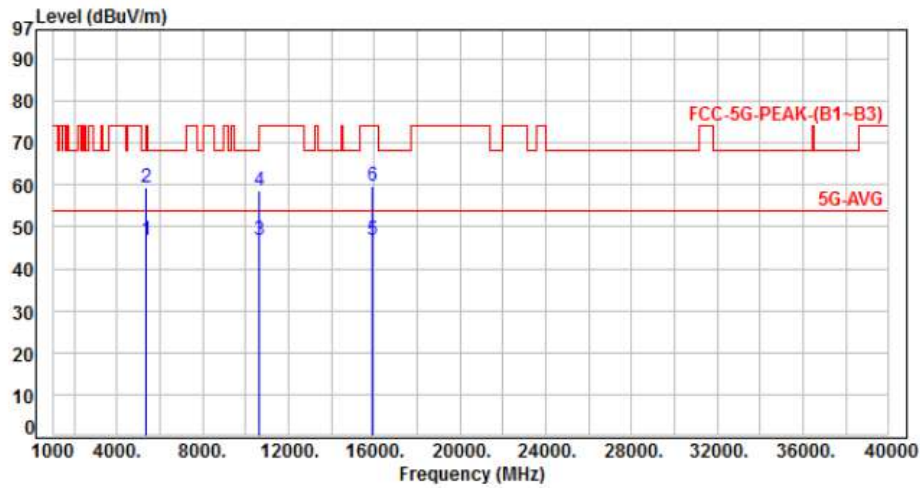

No.	Frequency (MHz)	Factor (dB)	Reading (dBuV)	Level (dBuV/m)	Limit (dBuV/m)	Margin (dB)	Detector	Height (cm)	Azimuth (deg)	P/F
1	5350.00	5.07	41.89	46.96	54.00	-7.04	Average	100	166	P
2	5350.00	5.07	54.37	59.44	74.00	-14.56	Peak	100	166	P
3	10600.00	11.91	34.99	46.90	54.00	-7.10	Average	100	145	P
4	10600.00	11.91	46.63	58.54	74.00	-15.46	Peak	100	145	P
5	15900.00	13.59	33.25	46.84	54.00	-7.16	Average	100	189	P
6	15900.00	13.59	45.98	59.57	74.00	-14.43	Peak	100	189	P

Note: Level=Reading+Factor  
 Margin=Level-Limit  
 Factor=Antenna Factor + cable loss - Amplifier Factor



Power	: AC 120V / 60Hz	Pol/Phase	: HORIZONTAL
Test Mode	: Mode 1, Band 2, CH60		:

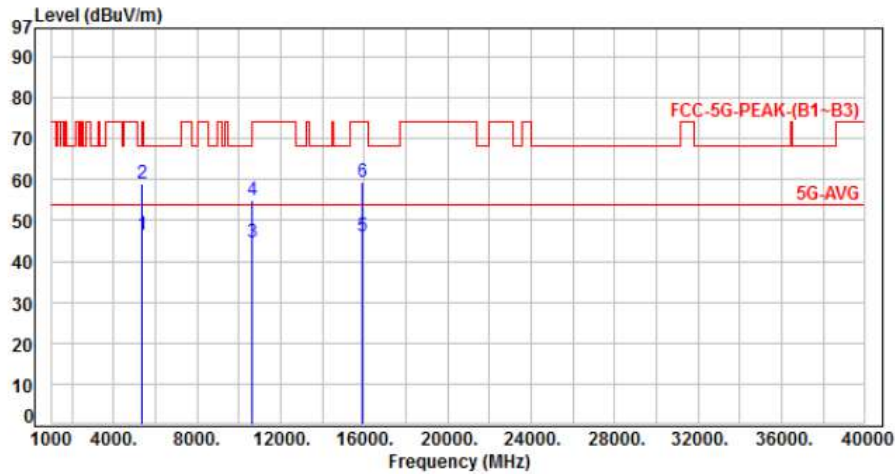

No.	Frequency (MHz)	Factor (dB)	Reading (dBuV)	Level (dBuV/m)	Limit (dBuV/m)	Margin (dB)	Detector	Height (cm)	Azimuth (deg)	P/F
1	5350.00	5.07	41.24	46.31	54.00	-7.69	Average	100	245	P
2	5350.00	5.07	53.94	59.01	74.00	-14.99	Peak	100	245	P
3	10600.00	11.91	32.73	44.64	54.00	-9.36	Average	100	221	P
4	10600.00	11.91	43.11	55.02	74.00	-18.98	Peak	100	221	P
5	15900.00	13.59	32.42	46.01	54.00	-7.99	Average	100	285	P
6	15900.00	13.59	45.91	59.50	74.00	-14.50	Peak	100	285	P

Note: Level=Reading+Factor  
Margin=Level-Limit  
Factor=Antenna Factor + cable loss - Amplifier Factor





Power	: AC 120V / 60Hz	Pol/Phase	: VERTICAL
Test Mode	: Mode 1, Band 2, CH64		:

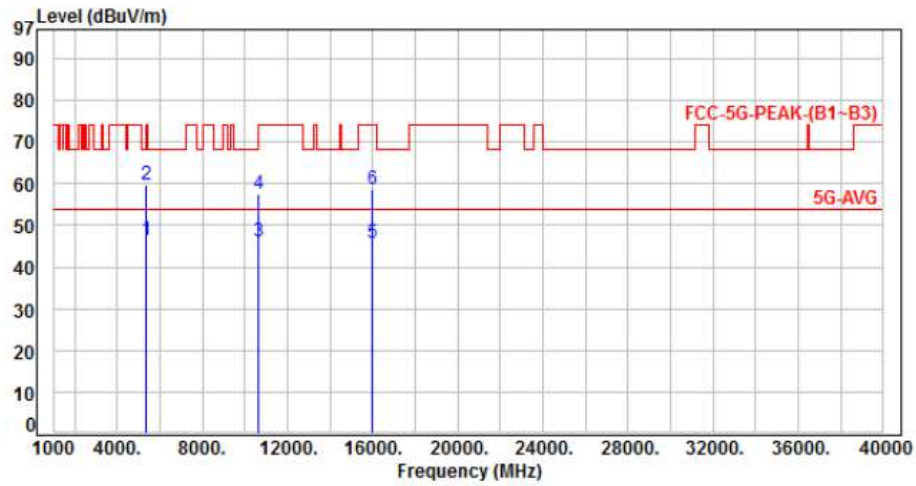

No.	Frequency (MHz)	Factor (dB)	Reading (dBuV)	Level (dBuV/m)	Limit (dBuV/m)	Margin (dB)	Detector	Height (cm)	Azimuth (deg)	P/F
1	5350.00	5.07	41.56	46.63	54.00	-7.37	Average	100	172	P
2	5350.00	5.07	54.68	59.75	74.00	-14.25	Peak	100	172	P
3	10640.00	11.98	34.27	46.25	54.00	-7.75	Average	100	170	P
4	10640.00	11.98	45.42	57.40	74.00	-16.60	Peak	100	170	P
5	15960.00	13.44	32.13	45.57	54.00	-8.43	Average	100	188	P
6	15960.00	13.44	45.05	58.49	74.00	-15.51	Peak	100	188	P

Note: Level=Reading+Factor  
 Margin=Level-Limit  
 Factor=Antenna Factor + cable loss - Amplifier Factor



Power	: AC 120V / 60Hz	Pol/Phase	: HORIZONTAL
Test Mode	: Mode 1, Band 2, CH64		:

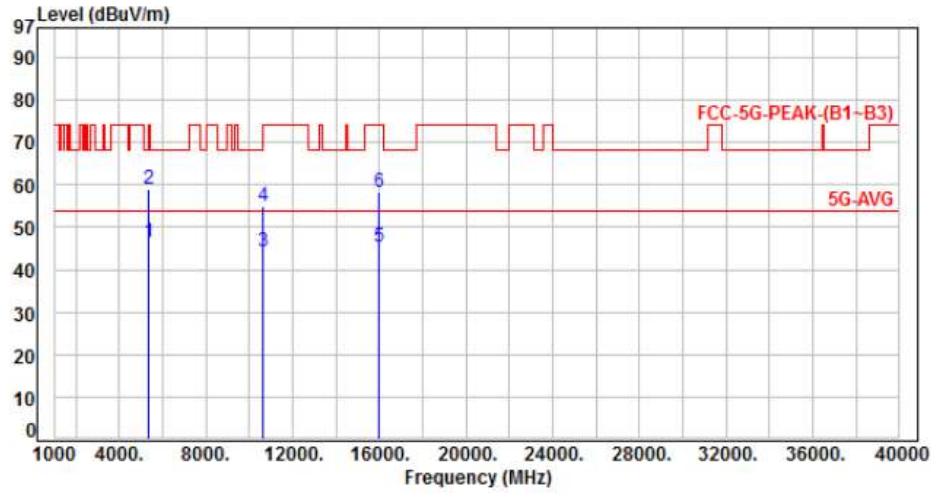

No.	Frequency (MHz)	Factor (dB)	Reading (dBuV)	Level (dBuV/m)	Limit (dBuV/m)	Margin (dB)	Detector	Height (cm)	Azimuth (deg)	P/F
1	5350.00	5.07	41.22	46.29	54.00	-7.71	Average	100	284	P
2	5350.00	5.07	53.91	58.98	74.00	-15.02	Peak	100	284	P
3	10640.00	11.98	32.38	44.36	54.00	-9.64	Average	100	231	P
4	10640.00	11.98	42.97	54.95	74.00	-19.05	Peak	100	231	P
5	15960.00	13.44	31.97	45.41	54.00	-8.59	Average	100	248	P
6	15960.00	13.44	44.65	58.09	74.00	-15.91	Peak	100	248	P

Note: Level=Reading+Factor  
 Margin=Level-Limit  
 Factor=Antenna Factor + cable loss - Amplifier Factor



Power	: AC 120V / 60Hz	Pol/Phase	: VERTICAL
Test Mode	: Mode 1, Band 3, CH100		:

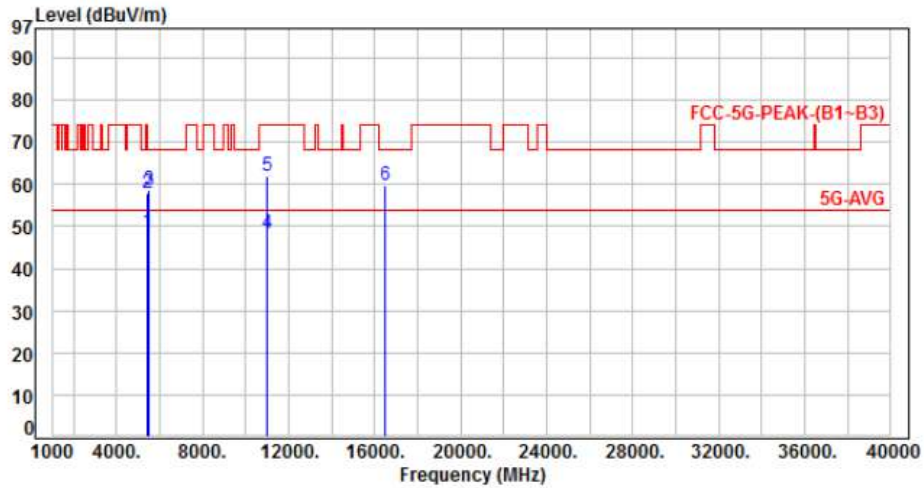

No.	Frequency (MHz)	Factor (dB)	Reading (dBuV)	Level (dBuV/m)	Limit (dBuV/m)	Margin (dB)	Detector	Height (cm)	Azimuth (deg)	P/F
1	5460.00	5.33	43.36	48.69	54.00	-5.31	Average	100	160	P
2	5460.00	5.33	52.72	58.05	74.00	-15.95	Peak	100	160	P
3	5470.00	5.31	53.41	58.72	68.20	-9.48	Peak	100	160	P
4	11000.00	12.51	35.78	48.29	54.00	-5.71	Average	100	175	P
5	11000.00	12.51	49.52	62.03	74.00	-11.97	Peak	100	175	P
6	16500.00	15.08	44.81	59.89	68.20	-8.31	Peak	100	140	P

Note: Level=Reading+Factor  
Margin=Level-Limit  
Factor=Antenna Factor + cable loss - Amplifier Factor



Power	: AC 120V / 60Hz	Pol/Phase	: HORIZONTAL
Test Mode	: Mode 1, Band 3, CH100		:

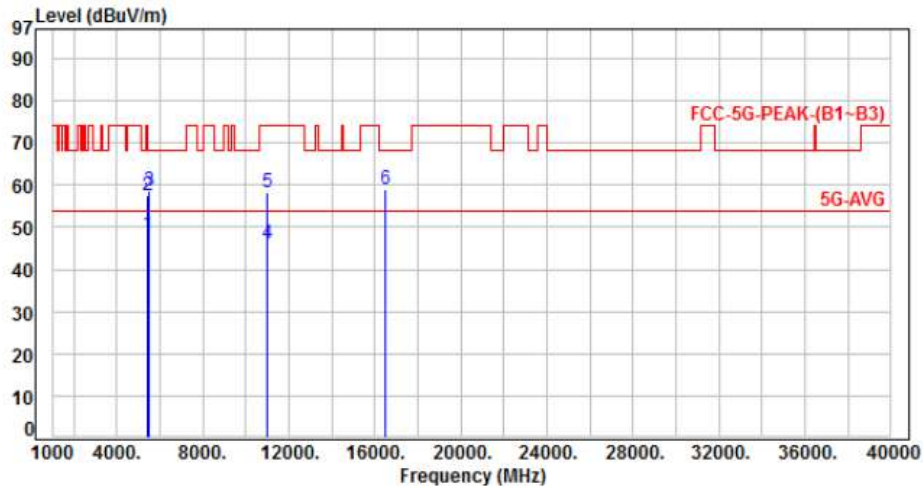

No.	Frequency (MHz)	Factor (dB)	Reading (dBUV)	Level (dBUV/m)	Limit (dBUV/m)	Margin (dB)	Detector	Height (cm)	Azimuth (deg)	P/F
1	5460.00	5.33	42.88	48.21	54.00	-5.79	Average	100	226	P
2	5460.00	5.33	52.37	57.70	74.00	-16.30	Peak	100	226	P
3	5470.00	5.31	53.25	58.56	68.20	-9.64	Peak	100	226	P
4	11000.00	12.51	33.71	46.22	54.00	-7.78	Average	100	215	P
5	11000.00	12.51	45.63	58.14	74.00	-15.86	Peak	100	215	P
6	16500.00	15.08	44.11	59.19	68.20	-9.01	Peak	100	254	P

Note: Level=Reading+Factor  
 Margin=Level-Limit  
 Factor=Antenna Factor + cable loss - Amplifier Factor



Power	: AC 120V / 60Hz	Pol/Phase	: VERTICAL
Test Mode	: Mode 1, Band 3, CH116		:

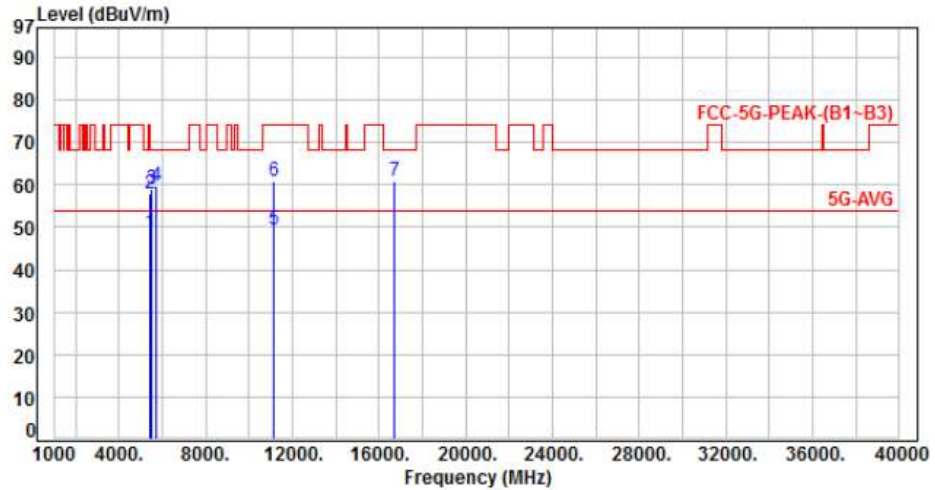

No.	Frequency (MHz)	Factor (dB)	Reading (dBuV)	Level (dBuV/m)	Limit (dBuV/m)	Margin (dB)	Detector	Height (cm)	Azimuth (deg)	P/F
1	5460.00	5.33	43.20	48.53	54.00	-5.47	Average	100	143	P
2	5460.00	5.33	52.52	57.85	74.00	-16.15	Peak	100	143	P
3	5470.00	5.31	53.80	59.11	68.20	-9.09	Peak	100	143	P
4	5725.00	5.19	54.52	59.71	68.20	-8.49	Peak	100	143	P
5	11160.00	12.70	36.57	49.27	54.00	-4.73	Average	100	165	P
6	11160.00	12.70	48.32	61.02	74.00	-12.98	Peak	100	165	P
7	16740.00	16.45	44.38	60.83	68.20	-7.37	Peak	100	146	P

Note: Level=Reading+Factor  
 Margin=Level-Limit  
 Factor=Antenna Factor + cable loss - Amplifier Factor



Power	: AC 120V / 60Hz	Pol/Phase	: HORIZONTAL
Test Mode	: Mode 1, Band 3, CH116		:

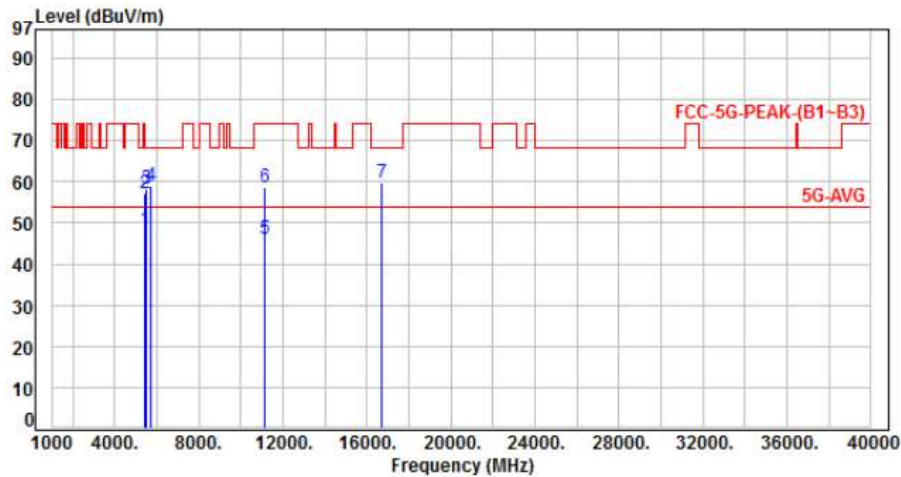

No.	Frequency (MHz)	Factor (dB)	Reading (dBuV)	Level (dBuV/m)	Limit (dBuV/m)	Margin (dB)	Detector	Height (cm)	Azimuth (deg)	P/F
1	5460.00	5.33	42.84	48.17	54.00	-5.83	Average	100	223	P
2	5460.00	5.33	51.75	57.08	74.00	-16.92	Peak	100	223	P
3	5470.00	5.31	52.91	58.22	68.20	-9.98	Peak	100	223	P
4	5725.00	5.19	53.78	58.97	68.20	-9.23	Peak	100	223	P
5	11160.00	12.70	33.24	45.94	54.00	-8.06	Average	100	268	P
6	11160.00	12.70	45.80	58.50	74.00	-15.50	Peak	100	268	P
7	16740.00	16.45	43.29	59.74	68.20	-8.46	Peak	100	156	P

Note: Level=Reading+Factor  
Margin=Level-Limit  
Factor=Antenna Factor + cable loss - Amplifier Factor



Power	: AC 120V / 60Hz	Pol/Phase	: VERTICAL
Test Mode	: Mode 1, Band 3, CH140		:

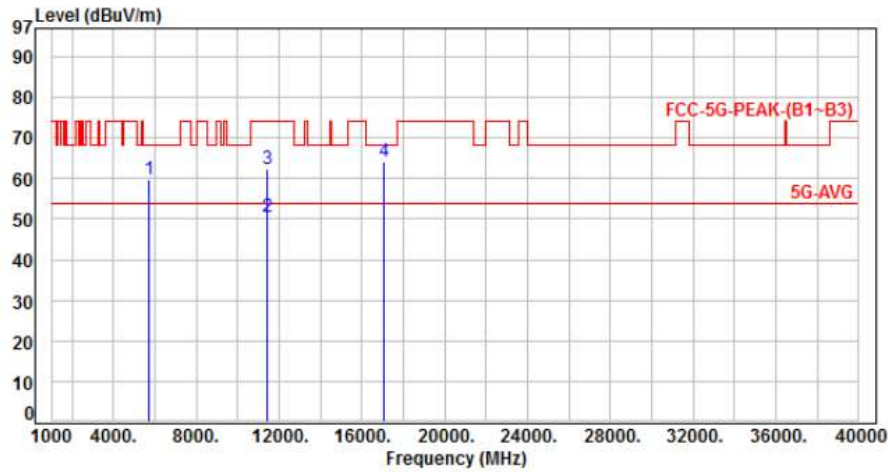

No.	Frequency (MHz)	Factor (dB)	Reading (dBuV)	Level (dBuV/m)	Limit (dBuV/m)	Margin (dB)	Detector	Height (cm)	Azimuth (deg)	P/F
1	5725.00	5.19	54.69	59.88	68.20	-8.32	Peak	100	183	P
2	11400.00	13.02	37.42	50.44	54.00	-3.56	Average	100	155	P
3	11400.00	13.02	49.26	62.28	74.00	-11.72	Peak	100	155	P
4	17100.00	18.43	45.86	64.29	68.20	-3.91	Peak	100	181	P

Note: Level=Reading+Factor  
Margin=Level-Limit  
Factor=Antenna Factor + cable loss - Amplifier Factor



Power	: AC 120V / 60Hz	Pol/Phase	: HORIZONTAL
Test Mode	: Mode 1, Band 3, CH140		:

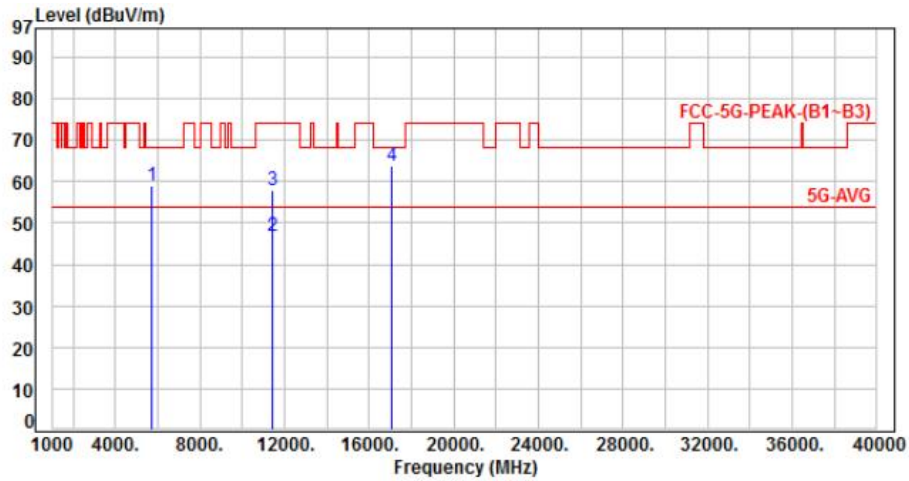

No.	Frequency (MHz)	Factor (dB)	Reading (dBuV)	Level (dBuV/m)	Limit (dBuV/m)	Margin (dB)	Detector	Height (cm)	Azimuth (deg)	P/F
1	5725.00	5.19	53.97	59.16	68.20	-9.04	Peak	100	255	P
2	11400.00	13.02	33.69	46.71	54.00	-7.29	Average	100	152	P
3	11400.00	13.02	45.06	58.08	74.00	-15.92	Peak	100	152	P
4	17100.00	18.43	45.49	63.92	68.20	-4.28	Peak	100	267	P

Note: Level=Reading+Factor  
Margin=Level-Limit  
Factor=Antenna Factor + cable loss - Amplifier Factor





Power	: AC 120V / 60Hz	Pol/Phase	: VERTICAL
Test Mode	: Mode 2, Band 2, CH52		:

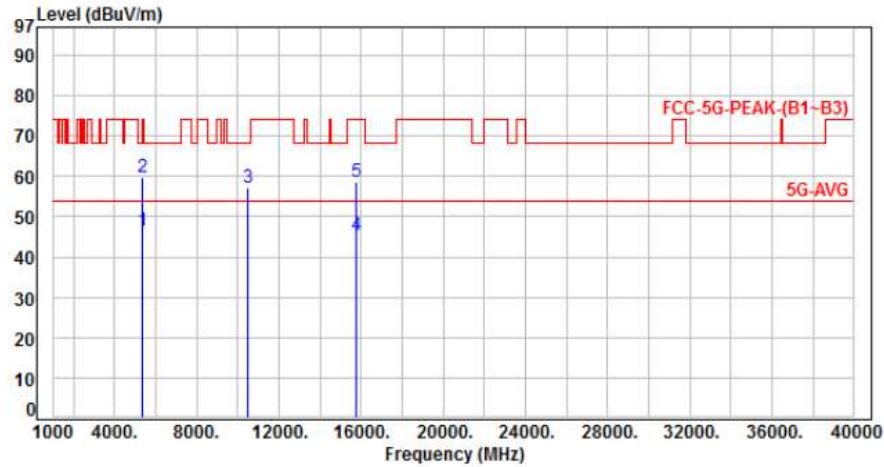

No.	Frequency (MHz)	Factor (dB)	Reading (dBuV)	Level (dBuV/m)	Limit (dBuV/m)	Margin (dB)	Detector	Height (cm)	Azimuth (deg)	P/F
1	5350.00	5.07	41.33	46.40	54.00	-7.60	Average	100	167	P
2	5350.00	5.07	54.71	59.78	74.00	-14.22	Peak	100	167	P
3	10520.00	11.74	45.29	57.03	68.20	-11.17	Peak	100	203	P
4	15780.00	13.57	31.91	45.48	54.00	-8.52	Average	100	173	P
5	15780.00	13.57	45.01	58.58	74.00	-15.42	Peak	100	173	P

Note: Level=Reading+Factor  
 Margin=Level-Limit  
 Factor=Antenna Factor + cable loss - Amplifier Factor



Power	: AC 120V / 60Hz	Pol/Phase	: HORIZONTAL
Test Mode	: Mode 2, Band 2, CH52		:

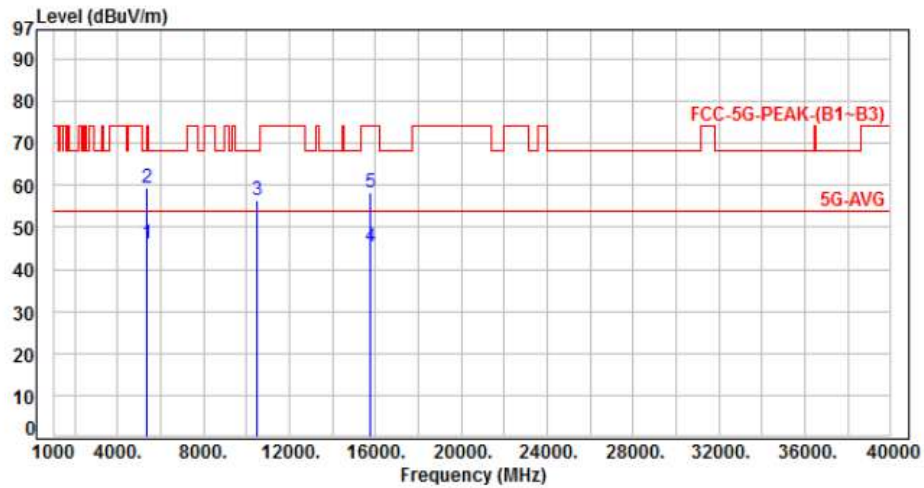

No.	Frequency (MHz)	Factor (dB)	Reading (dBuV)	Level (dBuV/m)	Limit (dBuV/m)	Margin (dB)	Detector	Height (cm)	Azimuth (deg)	P/F
1	5350.00	5.07	41.03	46.10	54.00	-7.90	Average	100	251	P
2	5350.00	5.07	54.28	59.35	74.00	-14.65	Peak	100	251	P
3	10520.00	11.74	44.62	56.36	68.20	-11.84	Peak	100	203	P
4	15780.00	13.57	31.87	45.44	54.00	-8.56	Average	100	213	P
5	15780.00	13.57	44.77	58.34	74.00	-15.66	Peak	100	213	P

Note: Level=Reading+Factor  
 Margin=Level-Limit  
 Factor=Antenna Factor + cable loss - Amplifier Factor



Power	: AC 120V / 60Hz	Pol/Phase	: VERTICAL
Test Mode	: Mode 2, Band 2, CH60		:

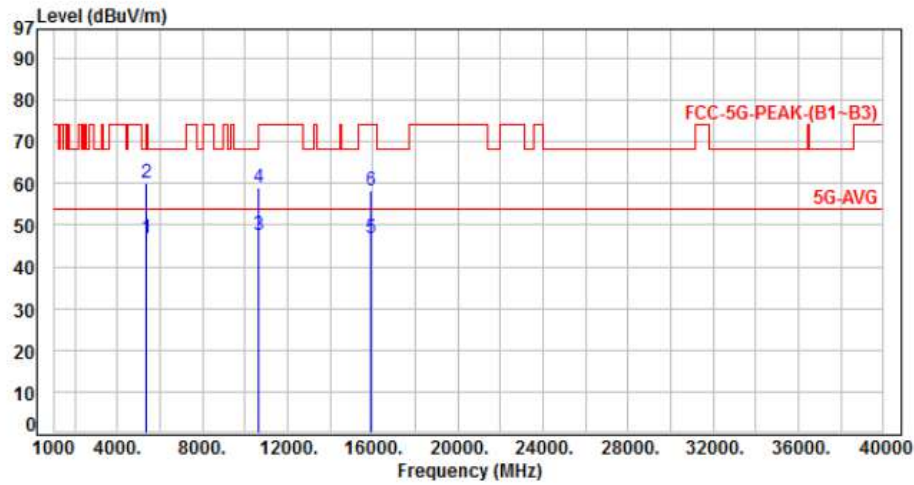

No.	Frequency (MHz)	Factor (dB)	Reading (dBuV)	Level (dBuV/m)	Limit (dBuV/m)	Margin (dB)	Detector	Height (cm)	Azimuth (deg)	P/F
1	5350.00	5.07	41.92	46.99	54.00	-7.01	Average	100	113	P
2	5350.00	5.07	54.89	59.96	74.00	-14.04	Peak	100	113	P
3	10600.00	11.91	35.57	47.48	54.00	-6.52	Average	100	169	P
4	10600.00	11.91	46.99	58.90	74.00	-15.10	Peak	100	169	P
5	15900.00	13.59	33.19	46.78	54.00	-7.22	Average	100	140	P
6	15900.00	13.59	44.59	58.18	74.00	-15.82	Peak	100	140	P

Note: Level=Reading+Factor  
 Margin=Level-Limit  
 Factor=Antenna Factor + cable loss - Amplifier Factor



Power	: AC 120V / 60Hz	Pol/Phase	: HORIZONTAL
Test Mode	: Mode 2, Band 2, CH60		:

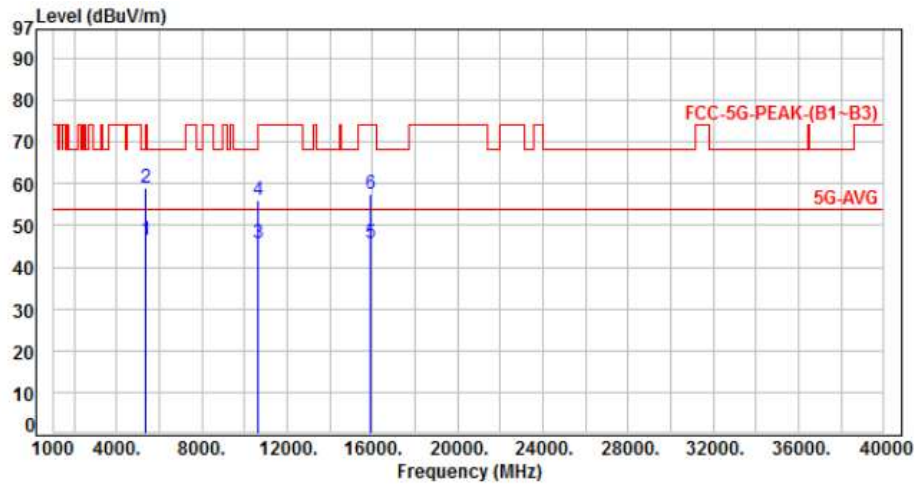

No.	Frequency (MHz)	Factor (dB)	Reading (dBuV)	Level (dBuV/m)	Limit (dBuV/m)	Margin (dB)	Detector	Height (cm)	Azimuth (deg)	P/F
1	5350.00	5.07	41.50	46.57	54.00	-7.43	Average	100	285	P
2	5350.00	5.07	54.08	59.15	74.00	-14.85	Peak	100	285	P
3	10600.00	11.91	33.68	45.59	54.00	-8.41	Average	100	190	P
4	10600.00	11.91	44.19	56.10	74.00	-17.90	Peak	100	190	P
5	15900.00	13.59	32.25	45.84	54.00	-8.16	Average	100	311	P
6	15900.00	13.59	44.06	57.65	74.00	-16.35	Peak	100	311	P

Note: Level=Reading+Factor  
 Margin=Level-Limit  
 Factor=Antenna Factor + cable loss - Amplifier Factor



Power	: AC 120V / 60Hz	Pol/Phase	: VERTICAL
Test Mode	: Mode 2, Band 2, CH64		:

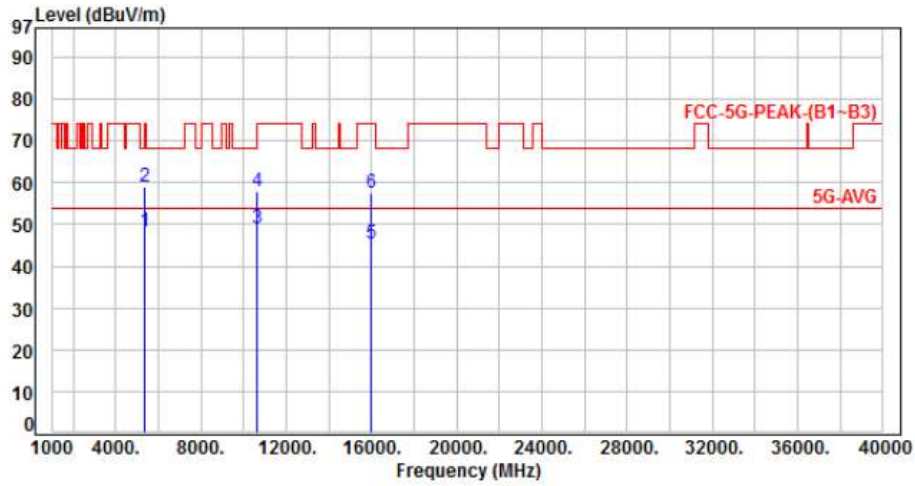

No.	Frequency (MHz)	Factor (dB)	Reading (dBuV)	Level (dBuV/m)	Limit (dBuV/m)	Margin (dB)	Detector	Height (cm)	Azimuth (deg)	P/F
1	5350.00	5.07	43.16	48.23	54.00	-5.77	Average	100	126	P
2	5350.00	5.07	53.88	58.95	74.00	-15.05	Peak	100	126	P
3	10640.00	11.98	37.21	49.19	54.00	-4.81	Average	100	160	P
4	10640.00	11.98	46.01	57.99	74.00	-16.01	Peak	100	160	P
5	15960.00	13.44	31.79	45.23	54.00	-8.77	Average	100	136	P
6	15960.00	13.44	44.11	57.55	74.00	-16.45	Peak	100	136	P

Note: Level=Reading+Factor  
Margin=Level-Limit  
Factor=Antenna Factor + cable loss - Amplifier Factor



Power	: AC 120V / 60Hz	Pol/Phase	: HORIZONTAL
Test Mode	: Mode 2, Band 2, CH64		:

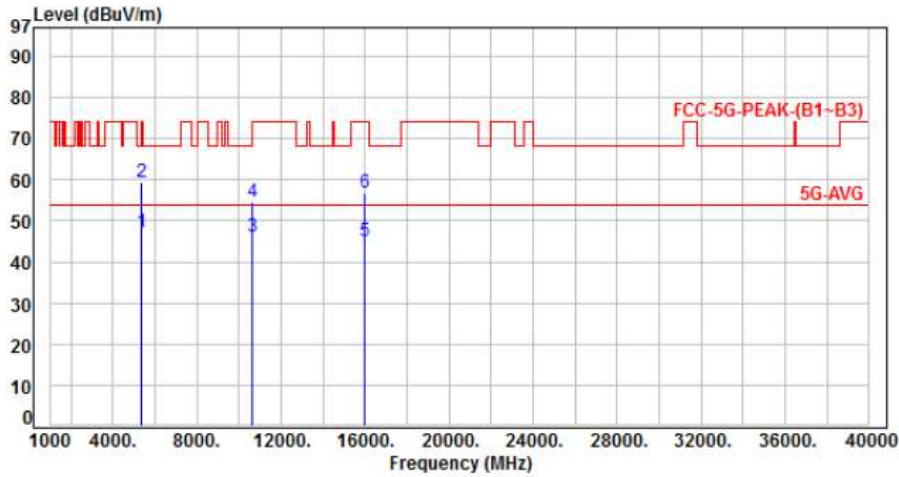

No.	Frequency (MHz)	Factor (dB)	Reading (dBuV)	Level (dBuV/m)	Limit (dBuV/m)	Margin (dB)	Detector	Height (cm)	Azimuth (deg)	P/F
1	5350.00	5.07	42.16	47.23	54.00	-6.77	Average	100	221	P
2	5350.00	5.07	54.18	59.25	74.00	-14.75	Peak	100	221	P
3	10640.00	11.98	34.06	46.04	54.00	-7.96	Average	100	146	P
4	10640.00	11.98	42.76	54.74	74.00	-19.26	Peak	100	146	P
5	15960.00	13.44	31.39	44.83	54.00	-9.17	Average	100	283	P
6	15960.00	13.44	43.49	56.93	74.00	-17.07	Peak	100	283	P

Note: Level=Reading+Factor  
 Margin=Level-Limit  
 Factor=Antenna Factor + cable loss - Amplifier Factor



Power	: AC 120V / 60Hz	Pol/Phase	: VERTICAL
Test Mode	: Mode 2, Band 3, CH100		

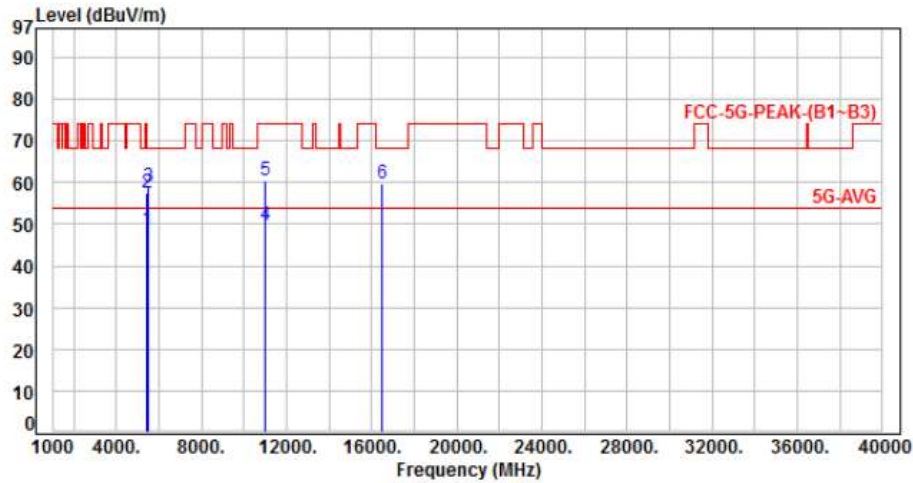

No.	Frequency (MHz)	Factor (dB)	Reading (dBuV)	Level (dBuV/m)	Limit (dBuV/m)	Margin (dB)	Detector	Height (cm)	Azimuth (deg)	P/F
1	5460.00	5.33	43.40	48.73	54.00	-5.27	Average	100	179	P
2	5460.00	5.33	52.17	57.50	74.00	-16.50	Peak	100	179	P
3	5470.00	5.31	53.55	58.86	68.20	-9.34	Peak	100	179	P
4	11000.00	12.51	37.46	49.97	54.00	-4.03	Average	100	163	P
5	11000.00	12.51	48.15	60.66	74.00	-13.34	Peak	100	163	P
6	16500.00	15.08	44.72	59.80	68.20	-8.40	Peak	100	149	P

Note: Level=Reading+Factor  
Margin=Level-Limit  
Factor=Antenna Factor + cable loss - Amplifier Factor



Power	: AC 120V / 60Hz	Pol/Phase	: HORIZONTAL
Test Mode	: Mode 2, Band 3, CH100		:

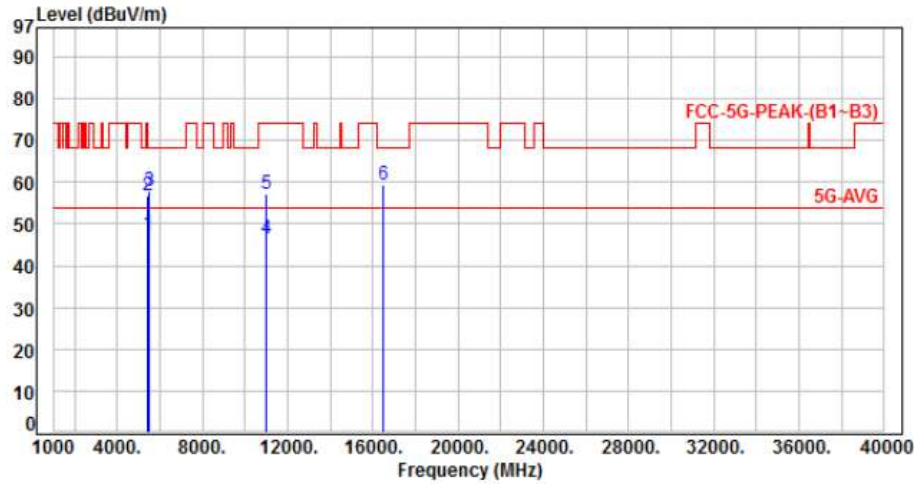

No.	Frequency (MHz)	Factor (dB)	Reading (dBuV)	Level (dBuV/m)	Limit (dBuV/m)	Margin (dB)	Detector	Height (cm)	Azimuth (deg)	P/F
1	5460.00	5.33	42.36	47.69	54.00	-6.31	Average	100	237	P
2	5460.00	5.33	51.48	56.81	74.00	-17.19	Peak	100	237	P
3	5470.00	5.31	52.68	57.99	68.20	-10.21	Peak	100	237	P
4	11000.00	12.51	33.86	46.37	54.00	-7.63	Average	100	255	P
5	11000.00	12.51	44.66	57.17	74.00	-16.83	Peak	100	255	P
6	16500.00	15.08	44.23	59.31	68.20	-8.89	Peak	100	276	P

Note: Level=Reading+Factor  
Margin=Level-Limit  
Factor=Antenna Factor + cable loss - Amplifier Factor





Power	: AC 120V / 60Hz	Pol/Phase	: VERTICAL
Test Mode	: Mode 2, Band 3, CH116		:

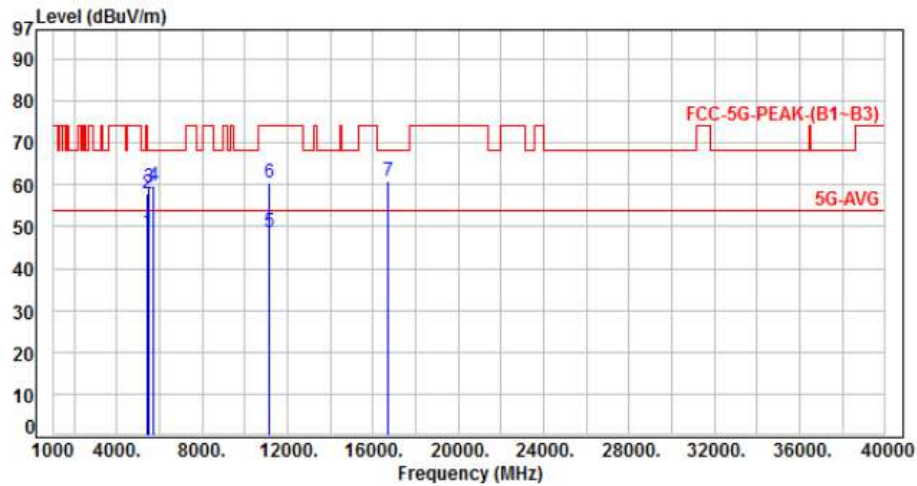

No.	Frequency (MHz)	Factor (dB)	Reading (dBuV)	Level (dBuV/m)	Limit (dBuV/m)	Margin (dB)	Detector	Height (cm)	Azimuth (deg)	P/F
1	5460.00	5.33	43.25	48.58	54.00	-5.42	Average	100	179	P
2	5460.00	5.33	52.47	57.80	74.00	-16.20	Peak	100	179	P
3	5470.00	5.31	54.08	59.39	68.20	-8.81	Peak	100	179	P
4	5725.00	5.19	54.72	59.91	68.20	-8.29	Peak	100	179	P
5	11160.00	12.70	36.16	48.86	54.00	-5.14	Average	100	158	P
6	11160.00	12.70	47.82	60.52	74.00	-13.48	Peak	100	158	P
7	16740.00	16.45	44.59	61.04	68.20	-7.16	Peak	100	164	P

Note: Level=Reading+Factor  
Margin=Level-Limit  
Factor=Antenna Factor + cable loss - Amplifier Factor



Power	: AC 120V / 60Hz	Pol/Phase	: HORIZONTAL
Test Mode	: Mode 2, Band 3, CH116		:

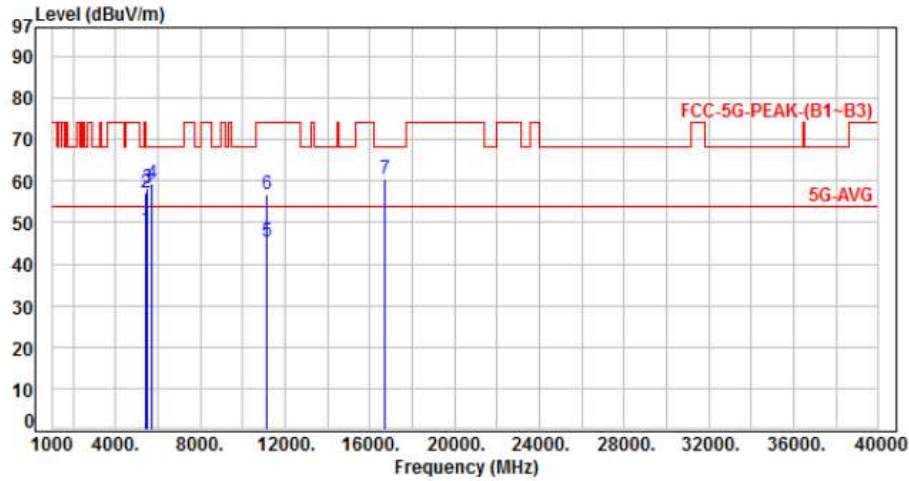

No.	Frequency (MHz)	Factor (dB)	Reading (dBuV)	Level (dBuV/m)	Limit (dBuV/m)	Margin (dB)	Detector	Height (cm)	Azimuth (deg)	P/F
1	5460.00	5.33	42.85	48.18	54.00	-5.82	Average	100	220	P
2	5460.00	5.33	51.72	57.05	74.00	-16.95	Peak	100	220	P
3	5470.00	5.31	53.10	58.41	68.20	-9.79	Peak	100	220	P
4	5725.00	5.19	54.33	59.52	68.20	-8.68	Peak	100	220	P
5	11160.00	12.70	32.82	45.52	54.00	-8.48	Average	100	149	P
6	11160.00	12.70	44.24	56.94	74.00	-17.06	Peak	100	149	P
7	16740.00	16.45	43.87	60.32	68.20	-7.88	Peak	100	200	P

Note: Level=Reading+Factor  
Margin=Level-Limit  
Factor=Antenna Factor + cable loss - Amplifier Factor



Power	: AC 120V / 60Hz	Pol/Phase	: VERTICAL
Test Mode	: Mode 2, Band 3, CH140		:

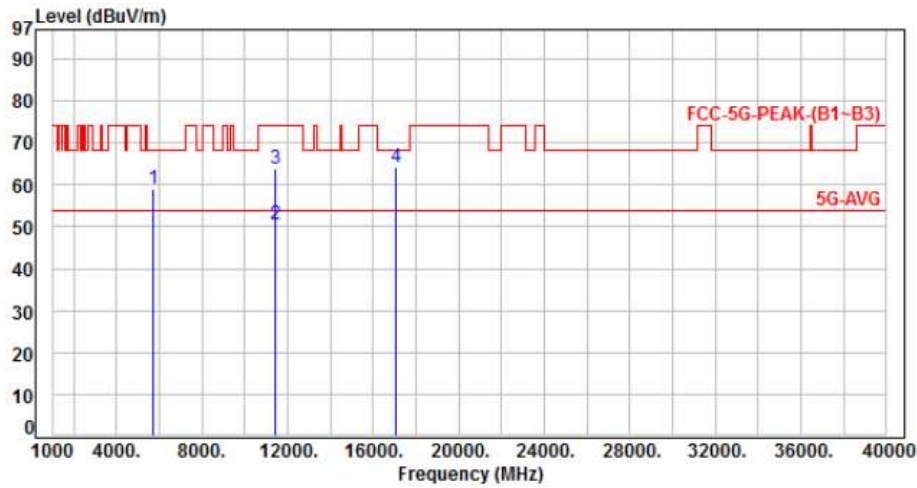

No.	Frequency (MHz)	Factor (dB)	Reading (dBuV)	Level (dBuV/m)	Limit (dBuV/m)	Margin (dB)	Detector	Height (cm)	Azimuth (deg)	P/F
1	5725.00	5.19	53.73	58.92	68.20	-9.28	Peak	100	185	P
2	11400.00	13.02	37.65	50.67	54.00	-3.33	Average	100	150	P
3	11400.00	13.02	50.73	63.75	74.00	-10.25	Peak	100	150	P
4	17100.00	18.43	45.74	64.17	68.20	-4.03	Peak	100	138	P

Note: Level=Reading+Factor  
Margin=Level-Limit  
Factor=Antenna Factor + cable loss - Amplifier Factor



Power	: AC 120V / 60Hz	Pol/Phase	: HORIZONTAL
Test Mode	: Mode 2, Band 3, CH140		:

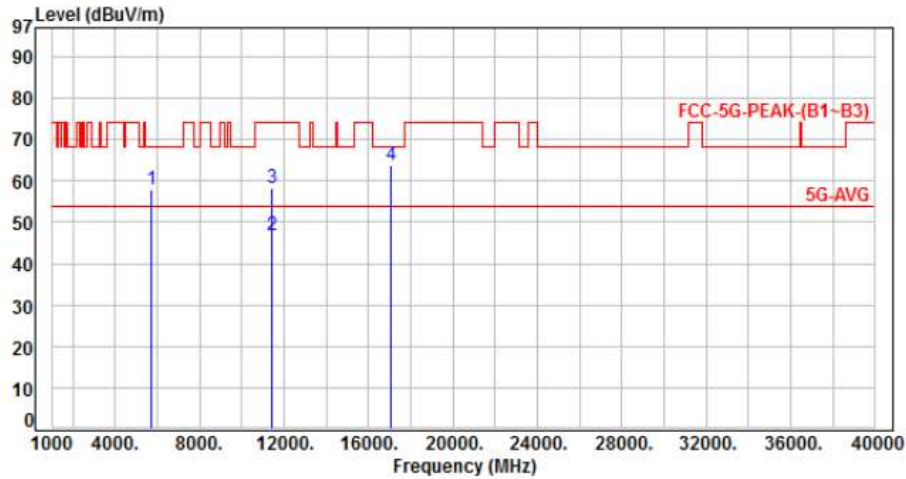

No.	Frequency (MHz)	Factor (dB)	Reading (dBuV)	Level (dBuV/m)	Limit (dBuV/m)	Margin (dB)	Detector	Height (cm)	Azimuth (deg)	P/F
1	5725.00	5.19	52.64	57.83	68.20	-10.37	Peak	100	251	P
2	11400.00	13.02	33.83	46.85	54.00	-7.15	Average	100	165	P
3	11400.00	13.02	45.42	58.44	74.00	-15.56	Peak	100	165	P
4	17100.00	18.43	45.38	63.81	68.20	-4.39	Peak	100	226	P

Note: Level=Reading+Factor  
Margin=Level-Limit  
Factor=Antenna Factor + cable loss - Amplifier Factor



Power	: AC 120V / 60Hz	Pol/Phase	: VERTICAL
Test Mode	: Mode 3, Band 2, CH54		:

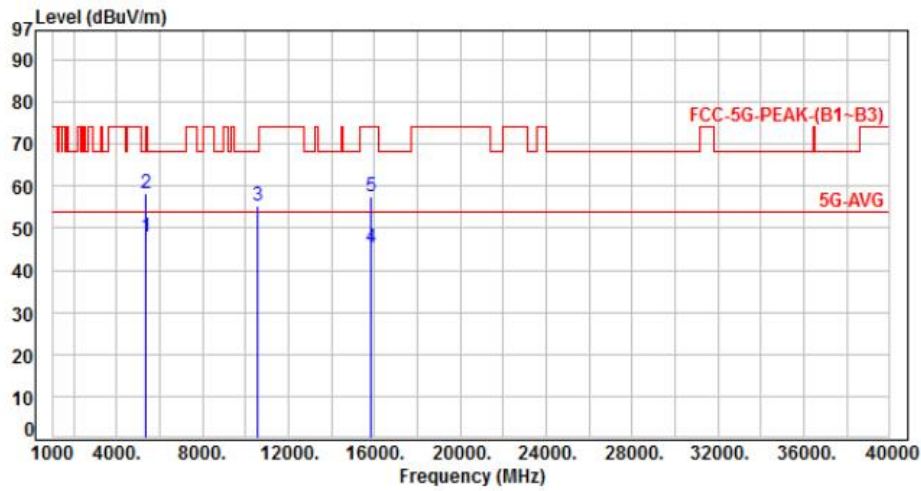

No.	Frequency (MHz)	Factor (dB)	Reading (dBuV)	Level (dBuV/m)	Limit (dBuV/m)	Margin (dB)	Detector	Height (cm)	Azimuth (deg)	P/F
1	5350.00	5.07	42.91	47.98	54.00	-6.02	Average	100	135	P
2	5350.00	5.07	53.05	58.12	74.00	-15.88	Peak	100	135	P
3	10540.00	11.78	43.62	55.40	68.20	-12.80	Peak	100	144	P
4	15810.00	13.56	31.65	45.21	54.00	-8.79	Average	100	111	P
5	15810.00	13.56	44.11	57.67	74.00	-16.33	Peak	100	111	P

Note: Level=Reading+Factor  
 Margin=Level-Limit  
 Factor=Antenna Factor + cable loss - Amplifier Factor



Power	: AC 120V / 60Hz	Pol/Phase	: HORIZONTAL
Test Mode	: Mode 3, Band 2, CH54		:

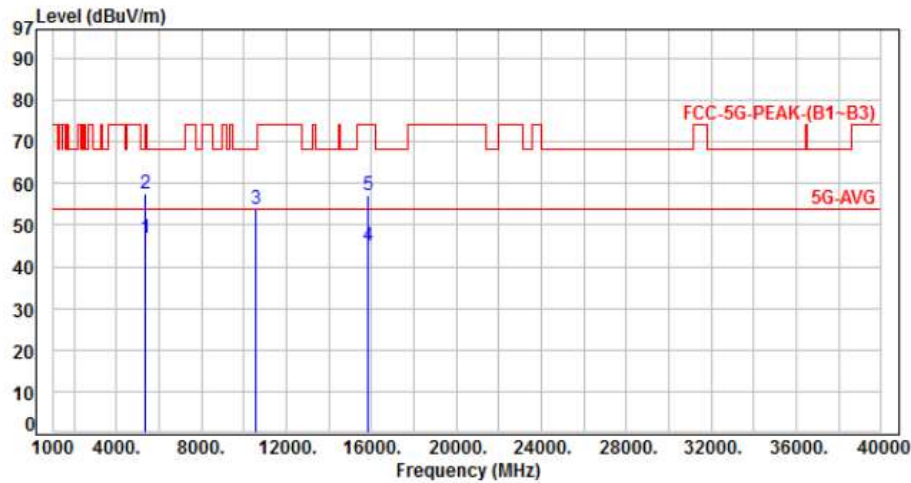

No.	Frequency (MHz)	Factor (dB)	Reading (dBUV)	Level (dBUV/m)	Limit (dBUV/m)	Margin (dB)	Detector	Height (cm)	Azimuth (deg)	P/F
1	5350.00	5.07	41.81	46.88	54.00	-7.12	Average	100	238	P
2	5350.00	5.07	52.31	57.38	74.00	-16.62	Peak	100	238	P
3	10540.00	11.78	41.90	53.68	68.20	-14.52	Peak	100	134	P
4	15810.00	13.56	31.55	45.11	54.00	-8.89	Average	100	240	P
5	15810.00	13.56	43.56	57.12	74.00	-16.88	Peak	100	240	P

Note: Level=Reading+Factor  
 Margin=Level-Limit  
 Factor=Antenna Factor + cable loss - Amplifier Factor



Power	: AC 120V / 60Hz	Pol/Phase	: VERTICAL
Test Mode	: Mode 3, Band 2, CH62		

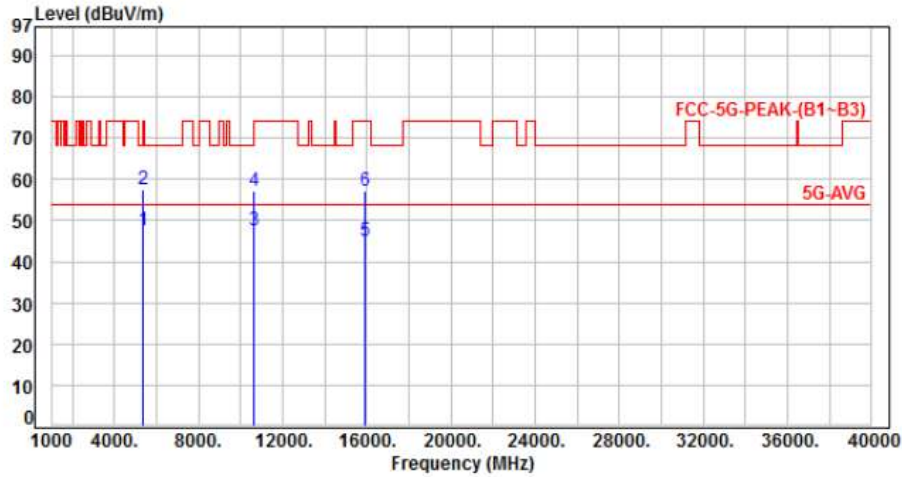

No.	Frequency (MHz)	Factor (dB)	Reading (dBuV)	Level (dBuV/m)	Limit (dBuV/m)	Margin (dB)	Detector	Height (cm)	Azimuth (deg)	P/F
1	5350.00	5.07	42.56	47.63	54.00	-6.37	Average	100	157	P
2	5350.00	5.07	52.59	57.66	74.00	-16.34	Peak	100	157	P
3	10620.00	11.95	35.80	47.75	54.00	-6.25	Average	130	150	P
4	10620.00	11.95	45.31	57.26	74.00	-16.74	Peak	130	150	P
5	15930.00	13.52	31.50	45.02	54.00	-8.98	Average	100	119	P
6	15930.00	13.52	43.52	57.04	74.00	-16.96	Peak	100	119	P

Note: Level=Reading+Factor  
 Margin=Level-Limit  
 Factor=Antenna Factor + cable loss - Amplifier Factor



Power	: AC 120V / 60Hz	Pol/Phase	: HORIZONTAL
Test Mode	: Mode 3, Band 2, CH62		:

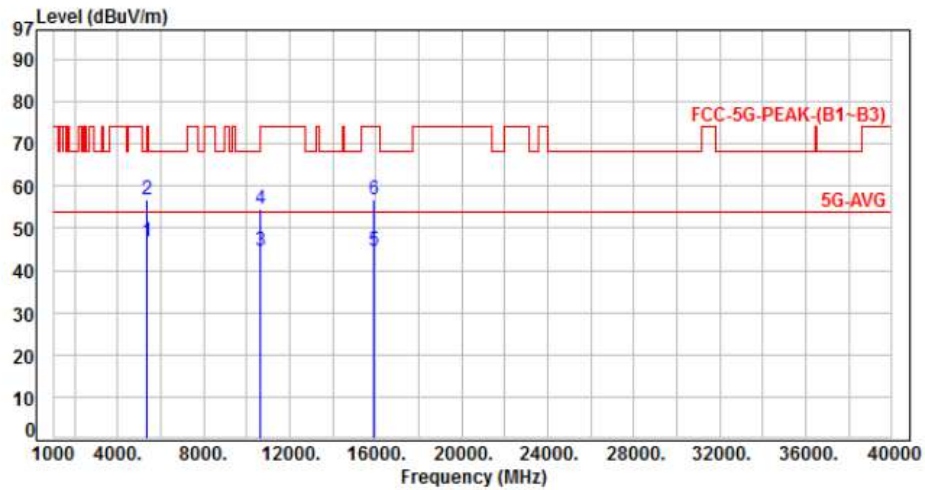

No.	Frequency (MHz)	Factor (dB)	Reading (dBuV)	Level (dBuV/m)	Limit (dBuV/m)	Margin (dB)	Detector	Height (cm)	Azimuth (deg)	P/F
1	5350.00	5.07	41.93	47.00	54.00	-7.00	Average	100	210	P
2	5350.00	5.07	51.90	56.97	74.00	-17.03	Peak	100	210	P
3	10620.00	11.95	32.57	44.52	54.00	-9.48	Average	100	155	P
4	10620.00	11.95	42.75	54.70	74.00	-19.30	Peak	100	155	P
5	15930.00	13.52	31.13	44.65	54.00	-9.35	Average	100	257	P
6	15930.00	13.52	43.38	56.90	74.00	-17.10	Peak	100	257	P

Note: Level=Reading+Factor  
 Margin=Level-Limit  
 Factor=Antenna Factor + cable loss - Amplifier Factor





Power	: AC 120V / 60Hz	Pol/Phase	: VERTICAL
Test Mode	: Mode 3, Band 3, CH102		:

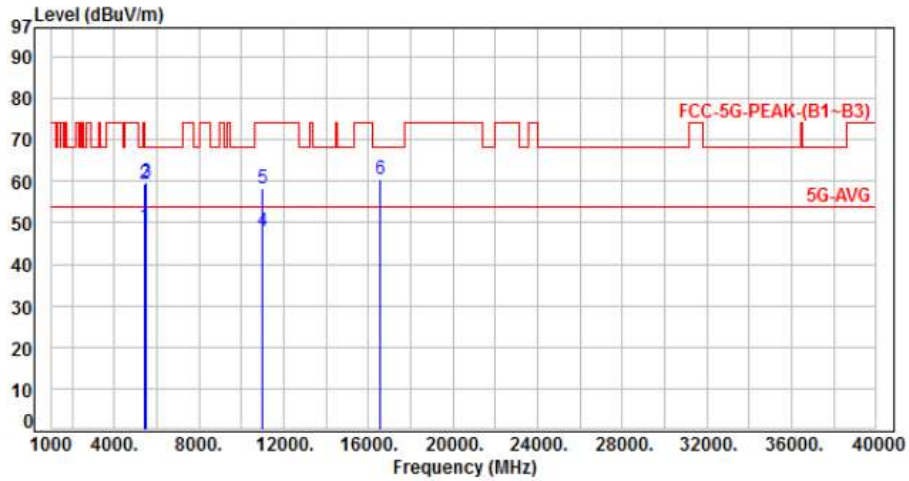

No.	Frequency (MHz)	Factor (dB)	Reading (dBUV)	Level (dBUV/m)	Limit (dBUV/m)	Margin (dB)	Detector	Height (cm)	Azimuth (deg)	P/F
1	5460.00	5.33	43.57	48.90	54.00	-5.10	Average	100	173	P
2	5460.00	5.33	53.87	59.20	74.00	-14.80	Peak	100	173	P
3	5470.00	5.31	54.56	59.87	68.20	-8.33	Peak	100	173	P
4	11020.00	12.54	35.42	47.96	54.00	-6.04	Average	100	152	P
5	11020.00	12.54	45.87	58.41	74.00	-15.59	Peak	100	152	P
6	16530.00	15.26	45.25	60.51	68.20	-7.69	Peak	100	175	P

Note: Level=Reading+Factor  
 Margin=Level-Limit  
 Factor=Antenna Factor + cable loss - Amplifier Factor



Power	: AC 120V / 60Hz	Pol/Phase	: HORIZONTAL
Test Mode	: Mode 3, Band 3, CH102		:

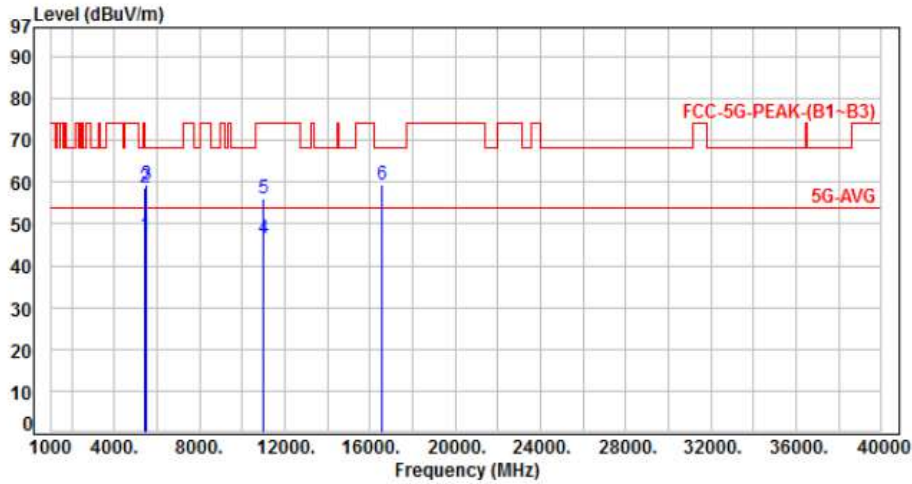

No.	Frequency (MHz)	Factor (dB)	Reading (dBuV)	Level (dBuV/m)	Limit (dBuV/m)	Margin (dB)	Detector	Height (cm)	Azimuth (deg)	P/F
1	5460.00	5.33	42.04	47.37	54.00	-6.63	Average	100	229	P
2	5460.00	5.33	53.19	58.52	74.00	-15.48	Peak	100	229	P
3	5470.00	5.31	54.09	59.40	68.20	-8.80	Peak	100	229	P
4	11020.00	12.54	33.81	46.35	54.00	-7.65	Average	100	217	P
5	11020.00	12.54	43.67	56.21	74.00	-17.79	Peak	100	217	P
6	16530.00	15.26	44.26	59.52	68.20	-8.68	Peak	100	260	P

Note: Level=Reading+Factor  
Margin=Level-Limit  
Factor=Antenna Factor + cable loss - Amplifier Factor



Power	: AC 120V / 60Hz	Pol/Phase	: VERTICAL
Test Mode	: Mode 3, Band 3, CH110		:

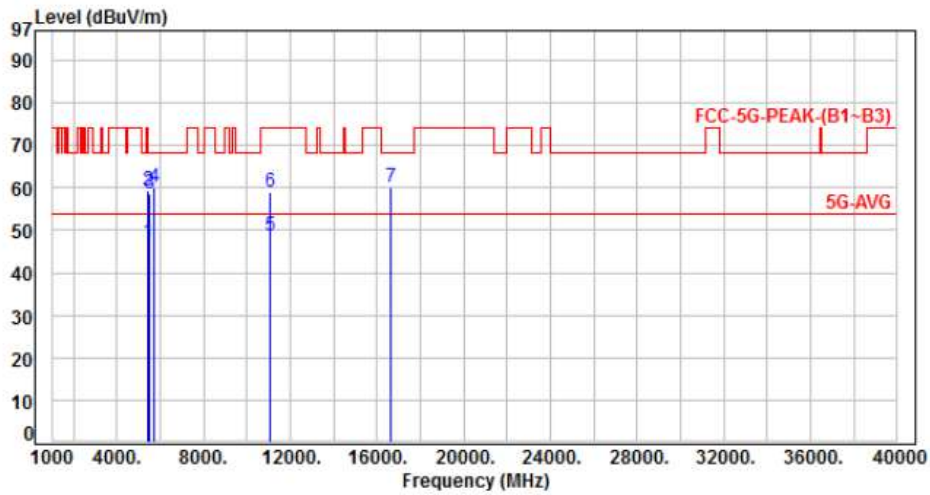

No.	Frequency (MHz)	Factor (dB)	Reading (dBuV)	Level (dBuV/m)	Limit (dBuV/m)	Margin (dB)	Detector	Height (cm)	Azimuth (deg)	P/F
1	5460.00	5.33	42.05	47.38	54.00	-6.62	Average	100	173	P
2	5460.00	5.33	54.14	59.47	74.00	-14.53	Peak	100	173	P
3	5470.00	5.31	53.16	58.47	68.20	-9.73	Peak	100	173	P
4	5725.00	5.19	54.84	60.03	68.20	-8.17	Peak	100	173	P
5	11100.00	12.66	35.84	48.50	54.00	-5.50	Average	100	160	P
6	11100.00	12.66	46.24	58.90	74.00	-15.10	Peak	100	160	P
7	16650.00	15.89	44.25	60.14	68.20	-8.06	Peak	100	121	P

Note: Level=Reading+Factor  
 Margin=Level-Limit  
 Factor=Antenna Factor + cable loss - Amplifier Factor



Power	: AC 120V / 60Hz	Pol/Phase	: HORIZONTAL
Test Mode	: Mode 3, Band 3, CH110		:

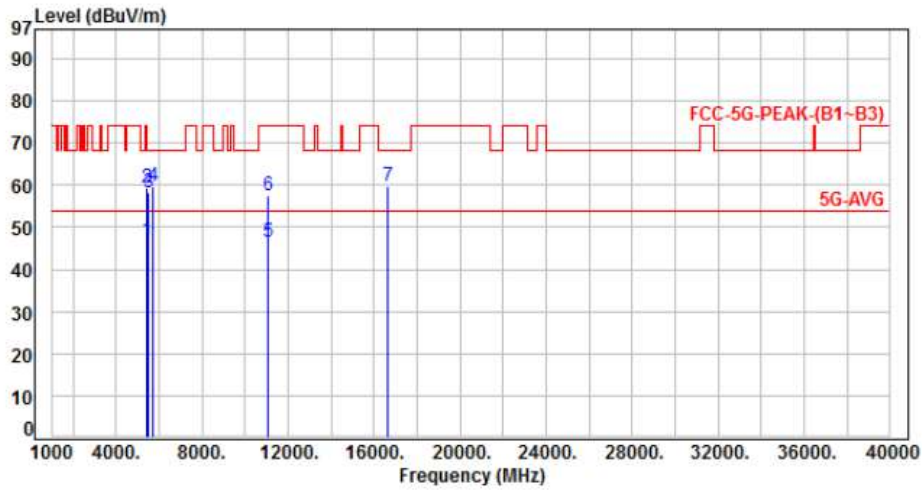

No.	Frequency (MHz)	Factor (dB)	Reading (dBUV)	Level (dBUV/m)	Limit (dBUV/m)	Margin (dB)	Detector	Height (cm)	Azimuth (deg)	P/F
1	5460.00	5.33	41.55	46.88	54.00	-7.12	Average	100	250	P
2	5460.00	5.33	53.91	59.24	74.00	-14.76	Peak	100	250	P
3	5470.00	5.31	52.83	58.14	68.20	-10.06	Peak	100	250	P
4	5725.00	5.19	54.60	59.79	68.20	-8.41	Peak	100	250	P
5	11100.00	12.66	33.80	46.46	54.00	-7.54	Average	100	276	P
6	11100.00	12.66	44.82	57.48	74.00	-16.52	Peak	100	276	P
7	16650.00	15.89	43.85	59.74	68.20	-8.46	Peak	100	241	P

Note: Level=Reading+Factor  
Margin=Level-Limit  
Factor=Antenna Factor + cable loss - Amplifier Factor



Power	: AC 120V / 60Hz	Pol/Phase	: VERTICAL
Test Mode	: Mode 3, Band 3, CH134		:

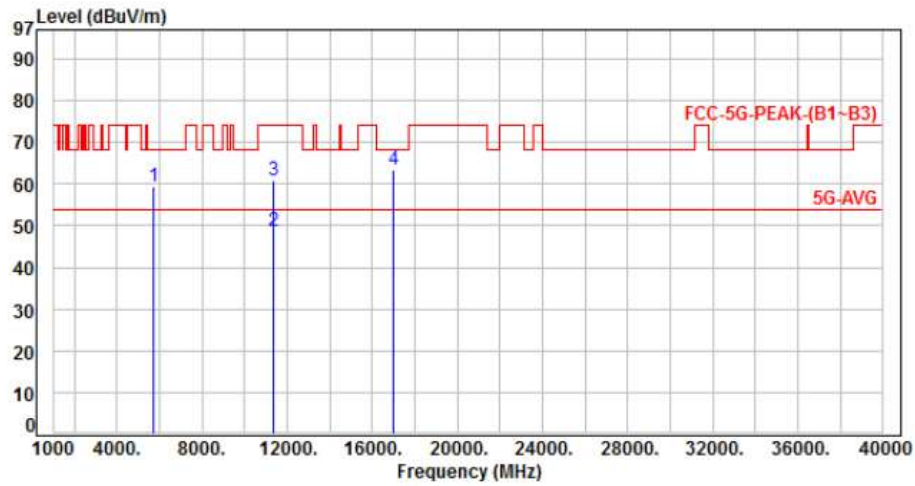

No.	Frequency (MHz)	Factor (dB)	Reading (dBuV)	Level (dBuV/m)	Limit (dBuV/m)	Margin (dB)	Detector	Height (cm)	Azimuth (deg)	P/F
1	5725.00	5.19	54.18	59.37	68.20	-8.83	Peak	100	132	P
2	11340.00	12.86	35.89	48.75	54.00	-5.25	Average	100	157	P
3	11340.00	12.86	47.83	60.69	74.00	-13.31	Peak	100	157	P
4	17010.00	18.13	45.44	63.57	68.20	-4.63	Peak	100	133	P

Note: Level=Reading+Factor  
 Margin=Level-Limit  
 Factor=Antenna Factor + cable loss - Amplifier Factor



Power	: AC 120V / 60Hz	Pol/Phase	: HORIZONTAL
Test Mode	: Mode 3, Band 3, CH134		:

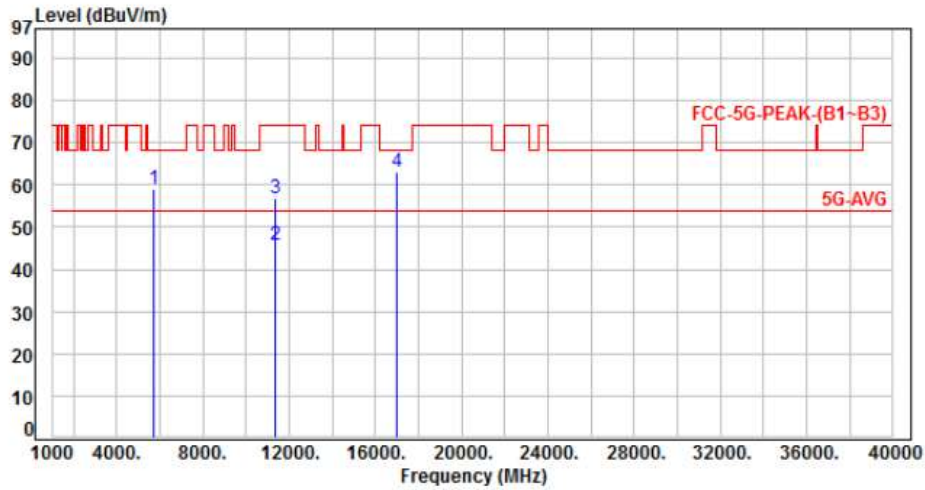

No.	Frequency (MHz)	Factor (dB)	Reading (dBuV)	Level (dBuV/m)	Limit (dBuV/m)	Margin (dB)	Detector	Height (cm)	Azimuth (deg)	P/F
1	5725.00	5.19	53.72	58.91	68.20	-9.29	Peak	100	243	P
2	11340.00	12.86	33.03	45.89	54.00	-8.11	Average	100	150	P
3	11340.00	12.86	44.12	56.98	74.00	-17.02	Peak	100	150	P
4	17010.00	18.13	44.83	62.96	68.20	-5.24	Peak	100	269	P

Note: Level=Reading+Factor  
Margin=Level-Limit  
Factor=Antenna Factor + cable loss - Amplifier Factor



Power	: AC 120V / 60Hz	Pol/Phase	: VERTICAL
Test Mode	: Mode 4, Band 2, CH58		:

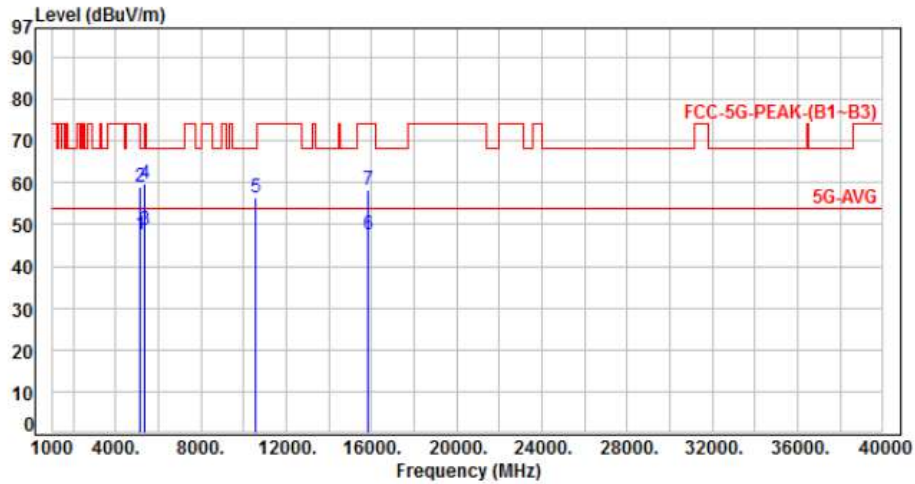

No.	Frequency (MHz)	Factor (dB)	Reading (dBUV)	Level (dBUV/m)	Limit (dBUV/m)	Margin (dB)	Detector	Height (cm)	Azimuth (deg)	P/F
1	5150.00	4.73	42.77	47.50	54.00	-6.50	Average	100	158	P
2	5150.00	4.73	54.46	59.19	74.00	-14.81	Peak	100	158	P
3	5350.00	5.07	43.52	48.59	54.00	-5.41	Average	100	158	P
4	5350.00	5.07	54.86	59.93	74.00	-14.07	Peak	100	158	P
5	10580.00	11.86	44.57	56.43	68.20	-11.77	Peak	100	162	P
6	15870.00	13.58	33.82	47.40	54.00	-6.60	Average	100	180	P
7	15870.00	13.58	44.78	58.36	74.00	-15.64	Peak	100	180	P

Note: Level=Reading+Factor  
 Margin=Level-Limit  
 Factor=Antenna Factor + cable loss - Amplifier Factor



Power	: AC 120V / 60Hz	Pol/Phase	: HORIZONTAL
Test Mode	: Mode 4, Band 2, CH58		:

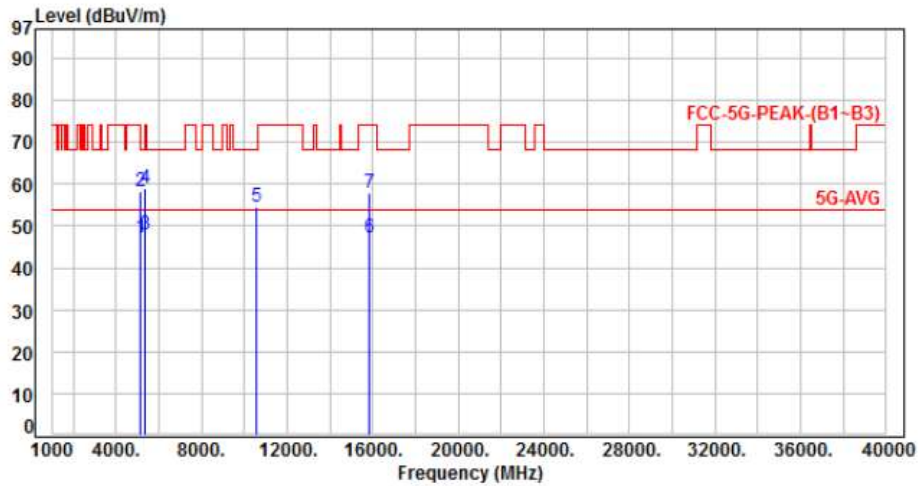

No.	Frequency (MHz)	Factor (dB)	Reading (dBuV)	Level (dBuV/m)	Limit (dBuV/m)	Margin (dB)	Detector	Height (cm)	Azimuth (deg)	P/F
1	5150.00	4.73	42.34	47.07	54.00	-6.93	Average	100	256	P
2	5150.00	4.73	53.66	58.39	74.00	-15.61	Peak	100	256	P
3	5350.00	5.07	42.93	48.00	54.00	-6.00	Average	100	256	P
4	5350.00	5.07	53.85	58.92	74.00	-15.08	Peak	100	256	P
5	10580.00	11.86	42.59	54.45	68.20	-13.75	Peak	100	167	P
6	15870.00	13.58	33.46	47.04	54.00	-6.96	Average	100	211	P
7	15870.00	13.58	44.45	58.03	74.00	-15.97	Peak	100	211	P

Note: Level=Reading+Factor  
 Margin=Level-Limit  
 Factor=Antenna Factor + cable loss - Amplifier Factor





Power	: AC 120V / 60Hz	Pol/Phase	: VERTICAL
Test Mode	: Mode 4, Band 3, CH106		:

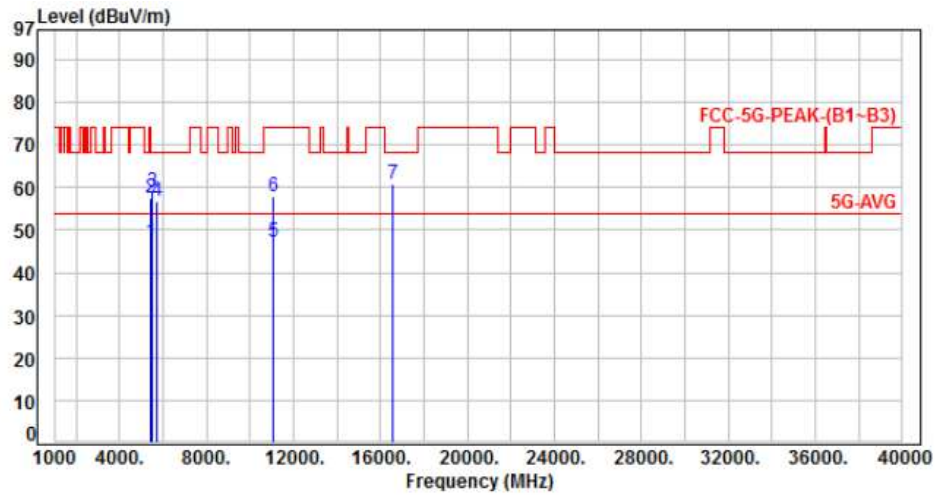

No.	Frequency (MHz)	Factor (dB)	Reading (dBuV)	Level (dBuV/m)	Limit (dBuV/m)	Margin (dB)	Detector	Height (cm)	Azimuth (deg)	P/F
1	5460.00	5.33	42.02	47.35	54.00	-6.65	Average	100	120	P
2	5460.00	5.33	52.30	57.63	74.00	-16.37	Peak	100	120	P
3	5470.00	5.31	53.71	59.02	68.20	-9.18	Peak	100	120	P
4	5725.00	5.19	51.64	56.83	68.20	-11.37	Peak	100	120	P
5	11060.00	12.60	34.50	47.10	54.00	-6.90	Average	100	166	P
6	11060.00	12.60	45.44	58.04	74.00	-15.96	Peak	100	166	P
7	16590.00	15.62	45.21	60.83	68.20	-7.37	Peak	100	178	P

Note: Level=Reading+Factor  
Margin=Level-Limit  
Factor=Antenna Factor + cable loss - Amplifier Factor



Power	: AC 120V / 60Hz	Pol/Phase	: HORIZONTAL
Test Mode	: Mode 4, Band 3, CH106		:

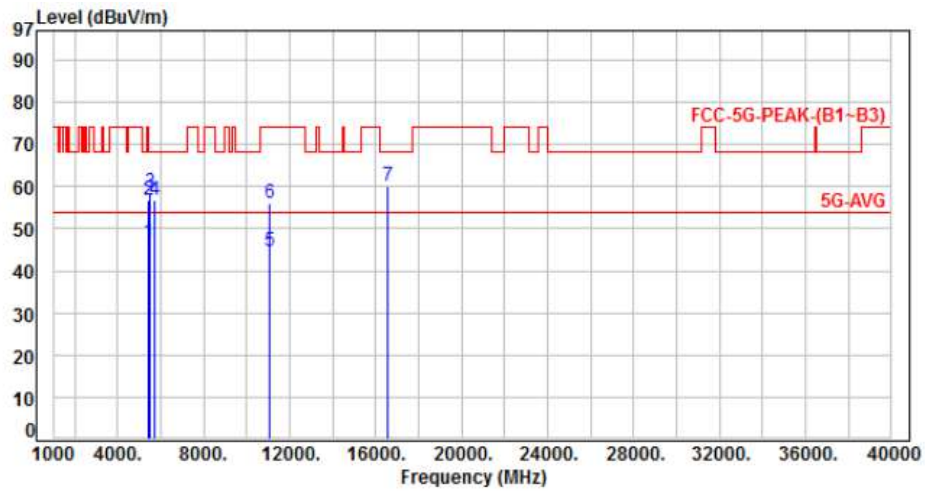

No.	Frequency (MHz)	Factor (dB)	Reading (dBuV)	Level (dBuV/m)	Limit (dBuV/m)	Margin (dB)	Detector	Height (cm)	Azimuth (deg)	P/F
1	5460.00	5.33	41.55	46.88	54.00	-7.12	Average	100	247	P
2	5460.00	5.33	51.65	56.98	74.00	-17.02	Peak	100	247	P
3	5470.00	5.31	53.43	58.74	68.20	-9.46	Peak	100	247	P
4	5725.00	5.19	51.50	56.69	68.20	-11.51	Peak	100	247	P
5	11060.00	12.60	32.18	44.78	54.00	-9.22	Average	100	170	P
6	11060.00	12.60	43.51	56.11	74.00	-17.89	Peak	100	170	P
7	16590.00	15.62	44.36	59.98	68.20	-8.22	Peak	100	220	P

Note: Level=Reading+Factor  
 Margin=Level-Limit  
 Factor=Antenna Factor + cable loss - Amplifier Factor



6.7. Restricted Bands of Operation

Only spurious emissions are permitted in any of the frequency bands listed below:

MHz	MHz	MHz	GHz
0.09000 – 0.11000	16.42000 – 16.42300	399.9 – 410.0	4.500 – 5.150
0.49500 – 0.505**	16.69475 – 16.69525	608.0 – 614.0	5.350 – 5.460
2.17350 – 2.19050	16.80425 – 16.80475	960.0 – 1240.0	7.250 – 7.750
4.12500 – 4.12800	25.50000 – 25.67000	1300.0 – 1427.0	8.025 – 8.500
4.17725 – 4.17775	37.50000 – 38.25000	1435.0 – 1626.5	9.000 – 9.200
4.20725 – 4.20775	73.00000 – 74.60000	1645.5 – 1646.5	9.300 – 9.500
6.21500 – 6.21800	74.80000 – 75.20000	1660.0 – 1710.0	10.600 – 12.700
6.26775 – 6.26825	108.00000 – 121.94000	1718.8 – 1722.2	13.250 – 13.400
6.31175 – 6.31225	123.00000 – 138.00000	2200.0 – 2300.0	14.470 – 14.500
8.29100 – 8.29400	149.90000 – 150.05000	2310.0 – 2390.0	15.350 – 16.200
8.36200 – 8.36600	156.52475 – 156.52525	2483.5 – 2500.0	17.700 – 21.400
8.37625 – 8.38675	156.70000 – 156.90000	2655.0 – 2900.0	22.010 – 23.120
8.41425 – 8.41475	162.01250 – 167.17000	3260.0 – 3267.0	23.600 – 24.000
12.29000 – 12.29300	167.72000 – 173.20000	3332.0 – 3339.0	31.200 – 31.800
12.51975 – 12.52025	240.00000 – 285.00000	3345.8 – 3358.0	36.430 – 36.500
12.57675 – 12.57725	322.00000 – 335.40000	3600.0 – 4400.0	Above 38.6
13.36000 – 13.41000			

\*\* : Until February 1, 1999, this restricted band shall be 0.490-0.510 MHz



### 7. On Time, Duty Cycle and Measurement methods

#### 7.1. Test Limit

None; for reporting purposes only.

#### 7.2. Test Procedure

KDB 789033 Zero-Span Spectrum Analyzer Method.

#### 7.3. Test Setup Layout

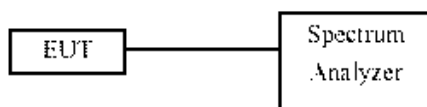

#### 7.4. Test Result and Data

Modulation Type	On Time (ms)	Period Time (ms)	Duty Cycle (%)
802.11a,6M	1.06	1.24	85.48%
802.11ac VHT20	1.00	1.17	85.47%
802.11ac VHT40	0.51	0.70	72.49%
802.11ac VHT80	0.25	0.45	56.44%

#### 7.5. Measurement Methods

26 dB and 6dB Emission BW	KDB 789033 D02 v01, Section C
99% Occupied BW	KDB 789033 D02 v01, Section D
Conducted Output Power	KDB 789033 D02 v01, Section E.2.d and E.3.b (Method PM-G)
Power Spectral Density	KDB 789033 D02 v01, Section F
Unwanted emissions in restricted bands	KDB 789033 D02 v01, Sections G and H
Unwanted emissions in non-restricted bands	KDB 789033 D02 v01, Sections G and H



Modulation Type: 802.11a (6Mbps)

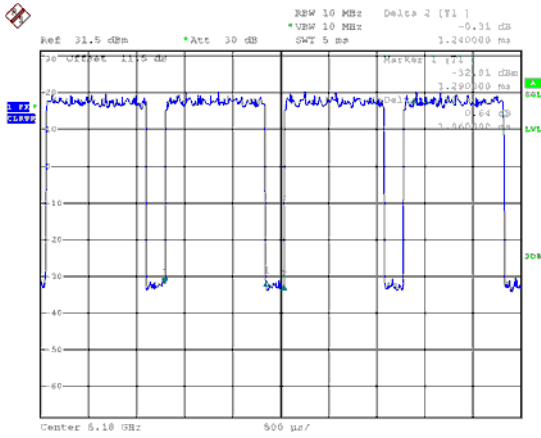

Modulation Type: 802.11ac VHT20 (6.5Mbps)

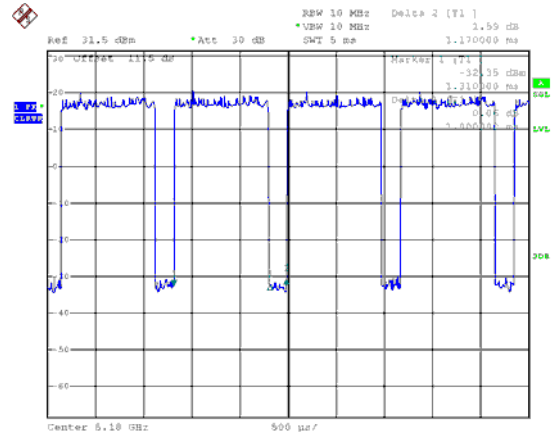

Modulation Type: 802.11ac VHT40 (13.5Mbps)

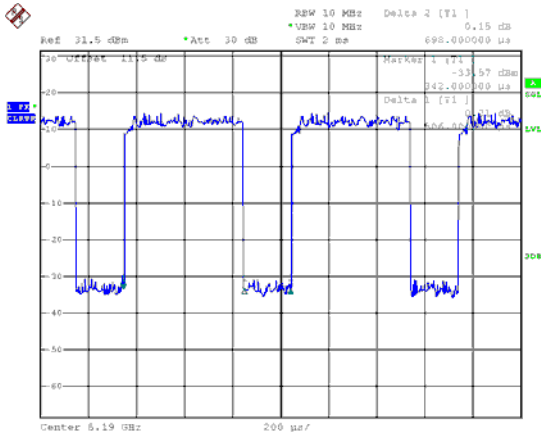

Modulation Type: 802.11ac VHT80 (29.3Mbps)

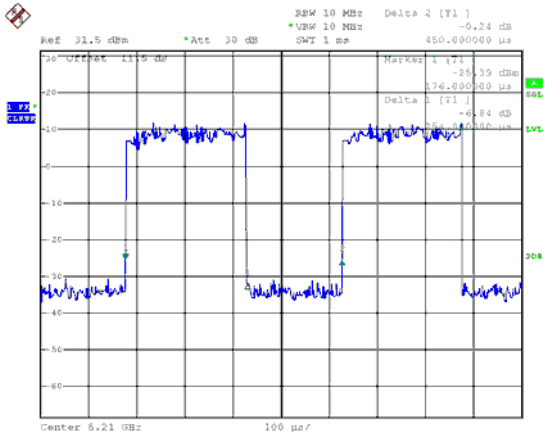



## 8. 26dB Bandwidth & 99% Occupied Bandwidth

### 8.1. Test Limit

None; for reporting purposes only.

### 8.2. Test Procedure

Reference to 789033 D02 General UNII Test Procedures New Rules v01: The transmitter output is connected to a spectrum analyzer with the RBW = approximately 1% of the emission bandwidth, the VBW  $\geq 3 \times$  RBW, peak detector and max hold.

### 8.3. Test Setup Layout

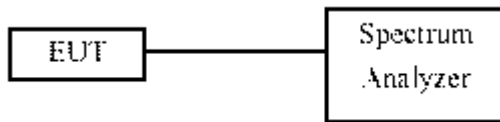



### 8.4. Test Result and Data (26dB Bandwidth)

In the 5.3G Band

Mode	Channel	Frequency (MHz)	26dB Bandwidth(MHz)
			ANT A
11a	52	5260	22.15
11a	60	5300	22.25
11a	64	5320	22.50
11ac VHT20	52	5260	22.45
11ac VHT20	60	5300	22.45
11ac VHT20	64	5320	22.45
11ac VHT40	54	5270	44.60
11ac VHT40	62	5310	44.70
11ac VHT80	58	5290	<b>84.80</b>

In the 5.5G Band

Mode	Channel	Frequency (MHz)	26dB Bandwidth(MHz)
			ANT A
11a	100	5500	22.25
11a	116	5580	22.30
11a	140	5700	21.90
11ac VHT20	100	5500	22.25
11ac VHT20	116	5580	22.40
11ac VHT20	140	5700	22.35
11ac VHT40	102	5510	44.70
11ac VHT40	110	5550	44.70
11ac VHT40	134	5670	44.70
11ac VHT80	106	5530	<b>85.12</b>



### 8.5. Test Result and Data (99% Occupied Bandwidth)

In the 5.3G Band

Modulation Type	Channel	Frequency (MHz)	99% Bandwidth(MHz)
			ANT A
11a	52	5260	17.00
11a	60	5300	16.95
11a	64	5320	17.05
11ac VHT20	52	5260	18.10
11ac VHT20	60	5300	18.05
11ac VHT20	64	5320	18.05
11ac VHT40	54	5270	36.60
11ac VHT40	62	5310	36.60
11ac VHT80	58	5290	<b>75.04</b>

In the 5.5G Band

Modulation Type	Channel	Frequency (MHz)	99% Bandwidth(MHz)
			ANT A
11a	100	5500	17.00
11a	116	5580	16.90
11a	140	5700	16.95
11ac VHT20	100	5500	18.10
11ac VHT20	116	5580	18.05
11ac VHT20	140	5700	18.10
11ac VHT40	102	5510	36.50
11ac VHT40	110	5550	36.40
11ac VHT40	134	5670	36.50
11ac VHT80	106	5530	<b>74.88</b>





26dB Bandwidth  
Band 2, ANT A  
Modulation Type: 802.11a (6Mbps)  
CH52

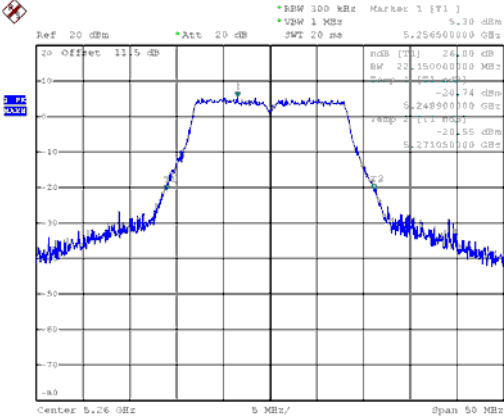

Modulation Type: 802.11ac VHT20 (6.5Mbps)  
CH52

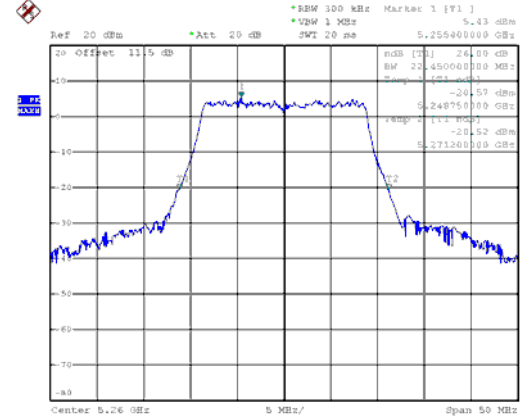

CH60

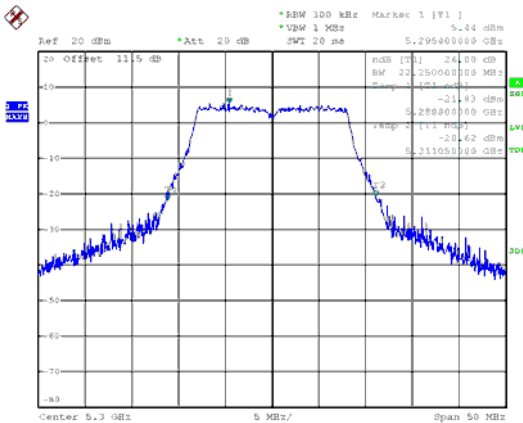

CH60

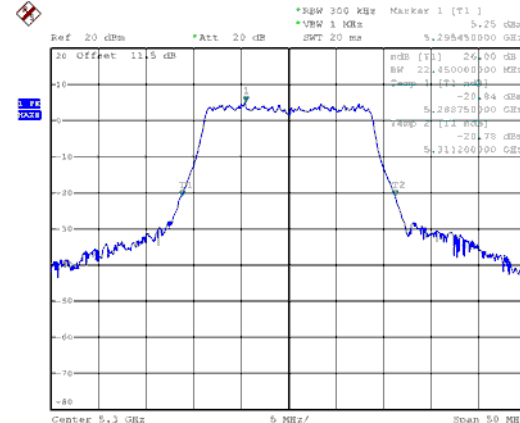

CH64

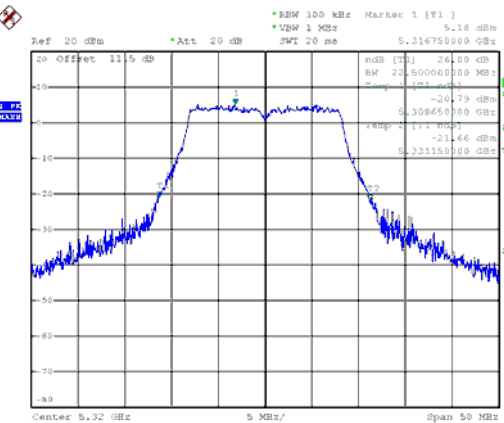

CH64

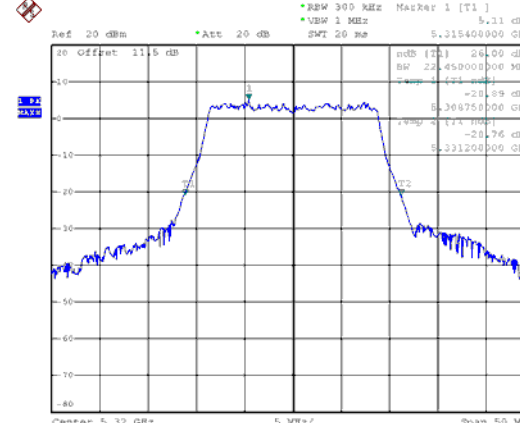



Band 2, ANT A  
Modulation Type: 802.11ac VHT40 (13.5Mbps)  
CH54

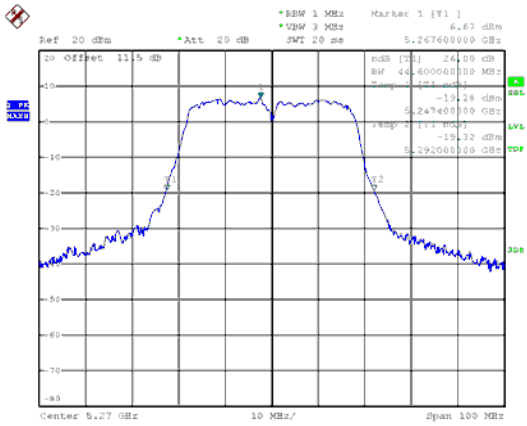

Modulation Type: 802.11ac VHT80 (29.3Mbps)  
CH58

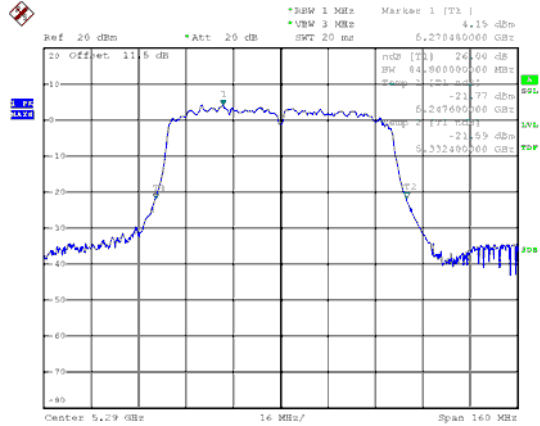

CH62

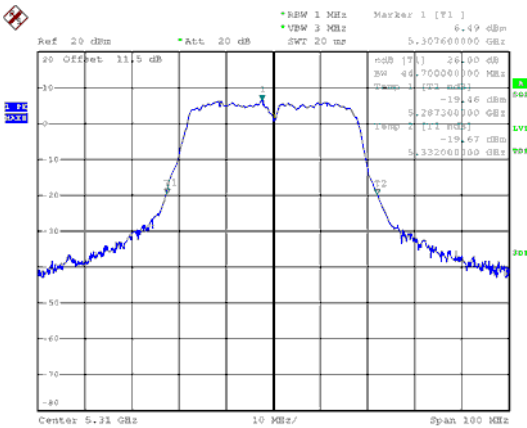



Band 3, ANT A  
Modulation Type: 802.11a (6Mbps)  
CH100

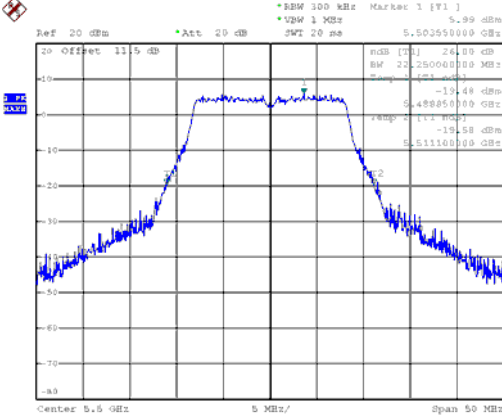

Modulation Type: 802.11ac VHT20 (6.5Mbps)  
CH100

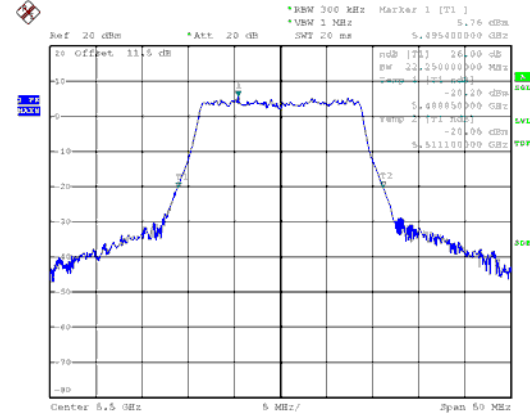

CH116

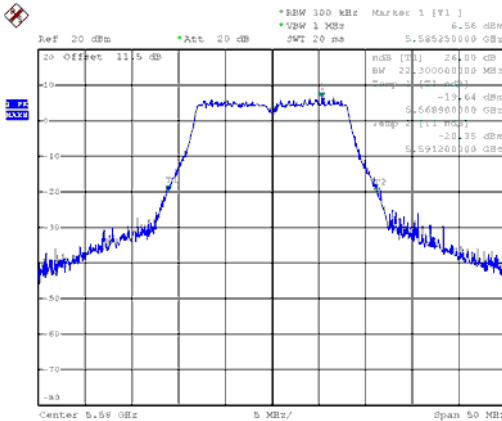

CH116

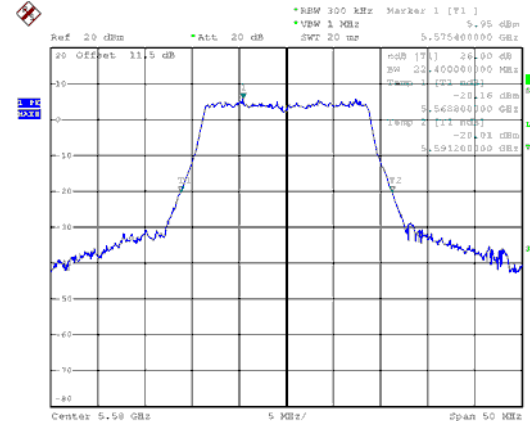

CH140

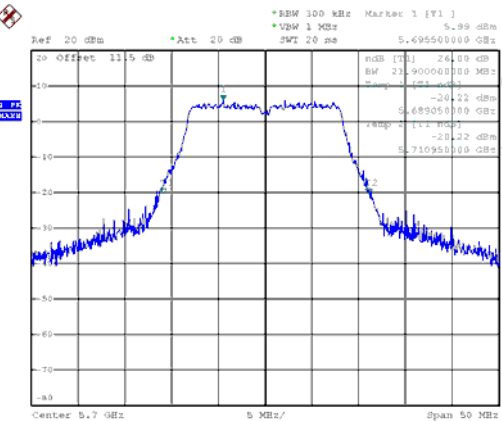

CH140

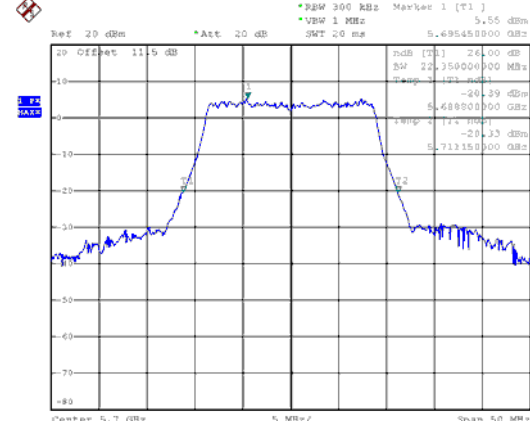



Band 3, ANT A  
Modulation Type: 802.11ac VHT40 (13.5Mbps)  
CH102

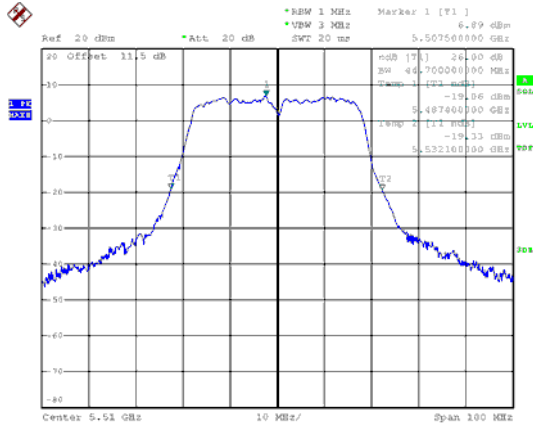

Modulation Type: 802.11ac VHT80 (29.3Mbps)  
CH106

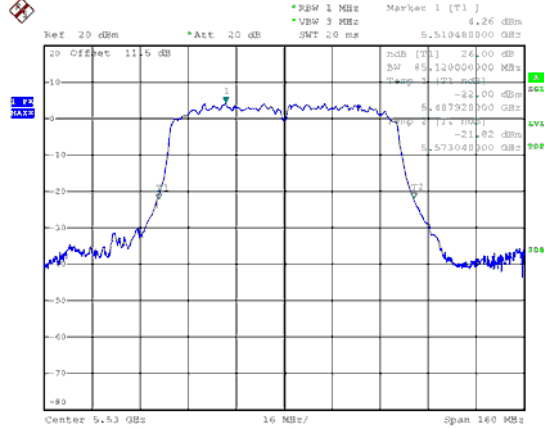

CH110

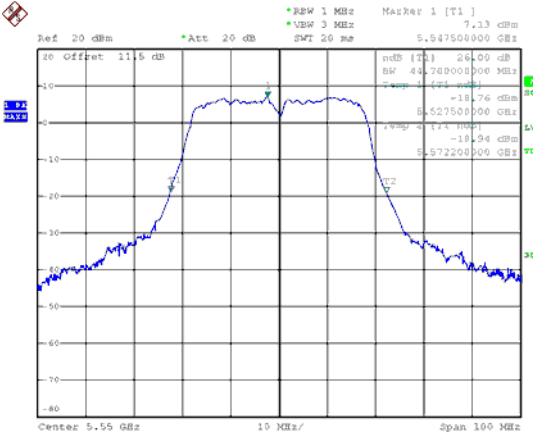

CH134

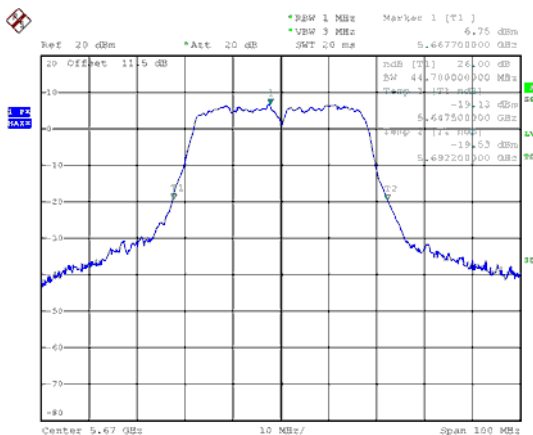



99% Occupied Bandwidth  
Band 2, ANT A  
Modulation Type: 802.11a (6Mbps)  
CH52

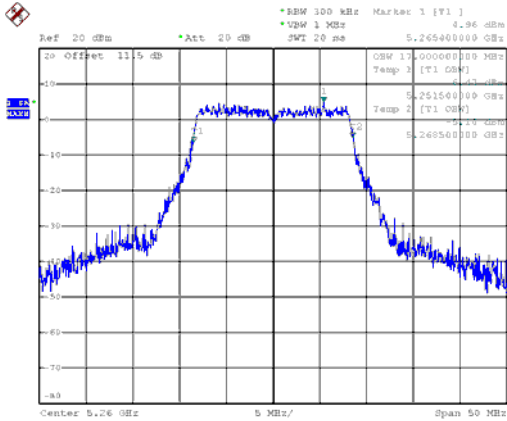

Modulation Type: 802.11ac VHT20 (6.5Mbps)  
CH52

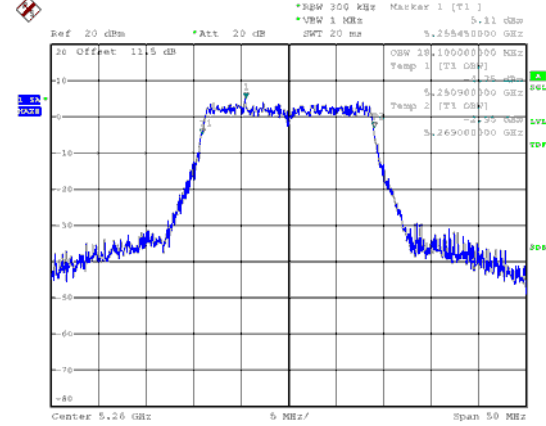

CH60

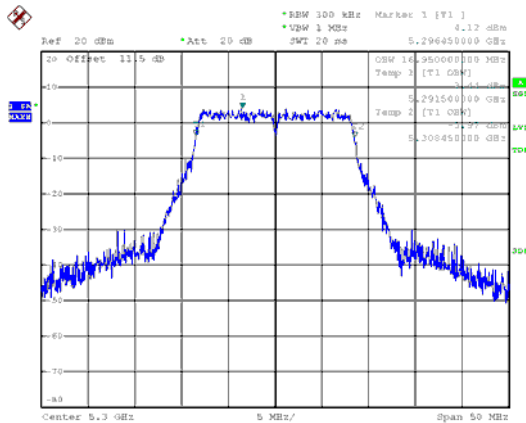

CH60

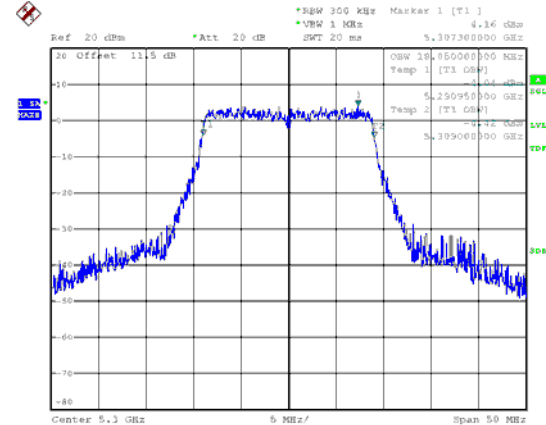

CH64

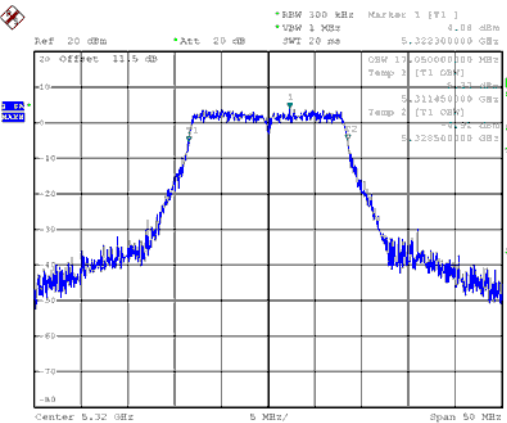

CH64

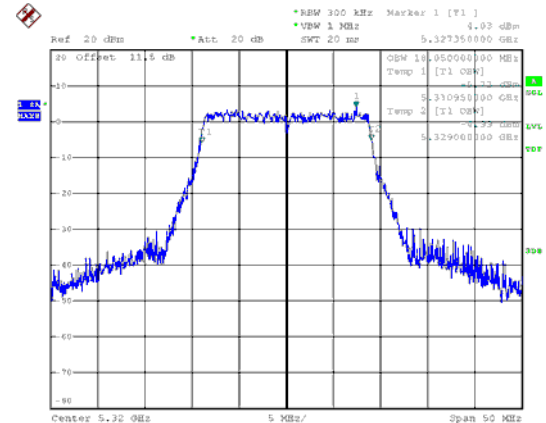



Band 2, ANT A  
Modulation Type: 802.11ac VHT40 (13.5Mbps)  
CH54

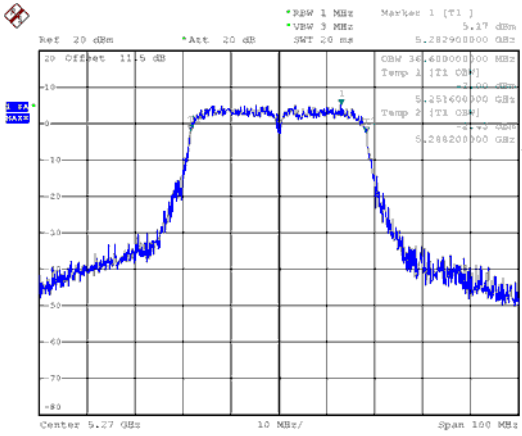

Modulation Type: 802.11ac VHT80 (29.3Mbps)  
CH58

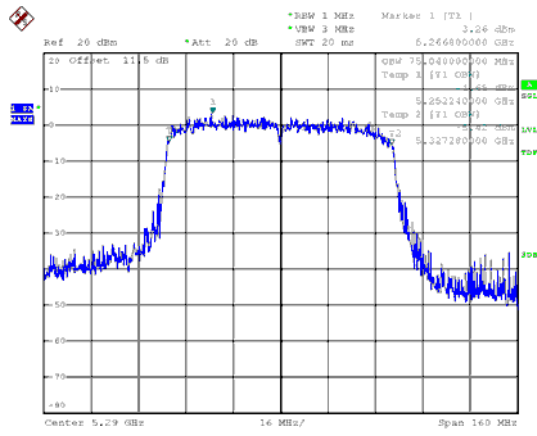

CH62

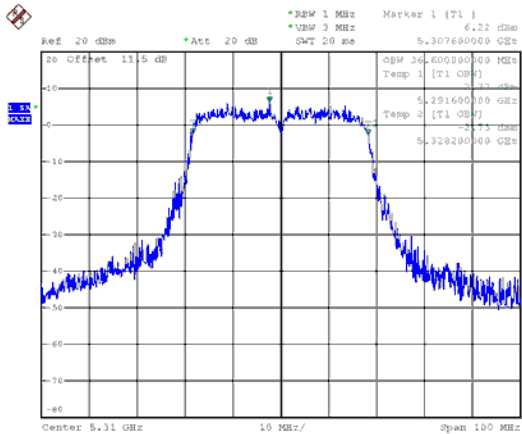



Band 3, ANT A  
Modulation Type: 802.11a (6Mbps)  
CH100

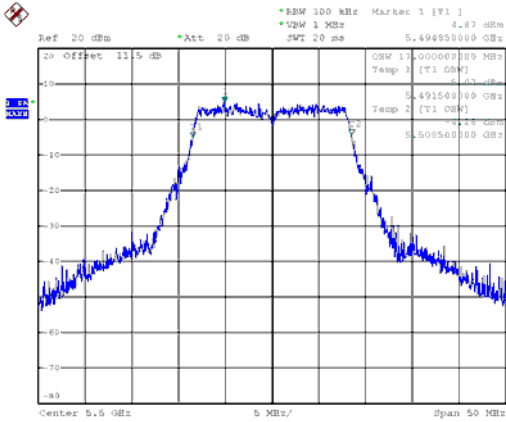

Modulation Type: 802.11ac VHT20 (6.5Mbps)  
CH100

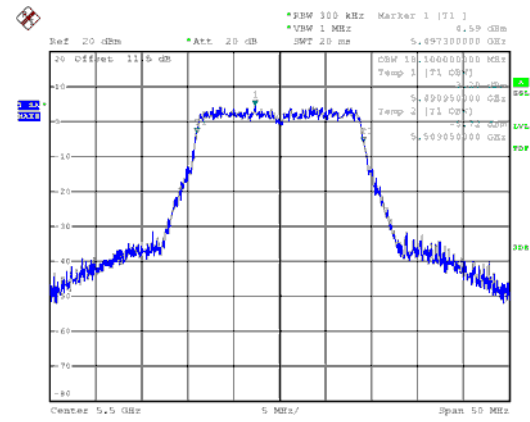

CH116

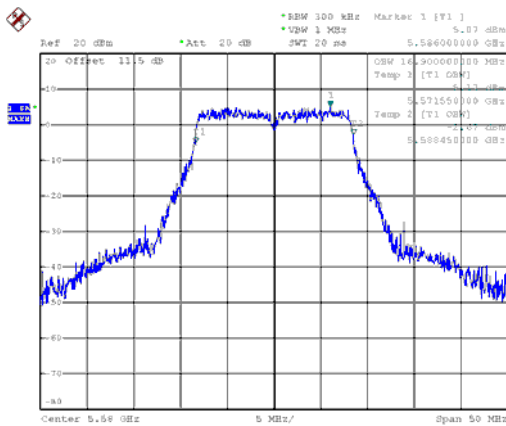

CH116

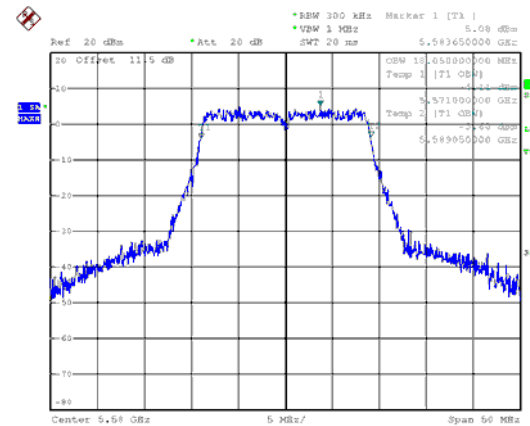

CH140

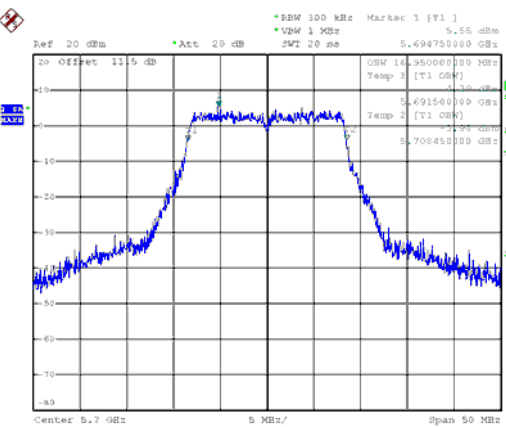

CH140

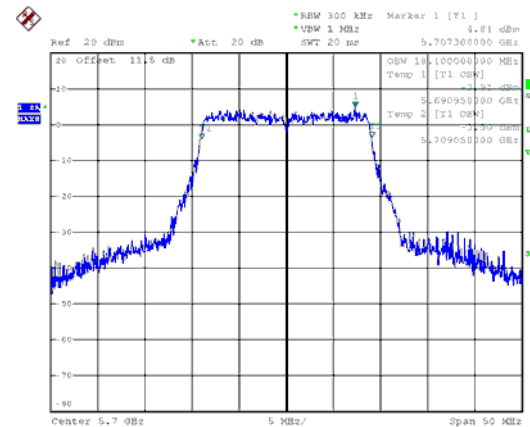



Band 3, ANT A  
Modulation Type: 802.11ac VHT40 (13.5Mbps)  
CH102

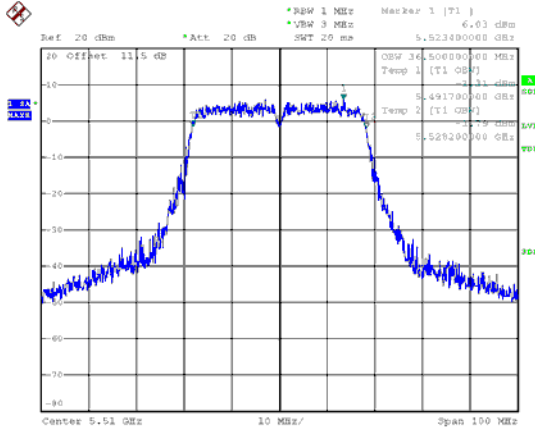

Modulation Type: 802.11ac VHT80 (29.3Mbps)  
CH106

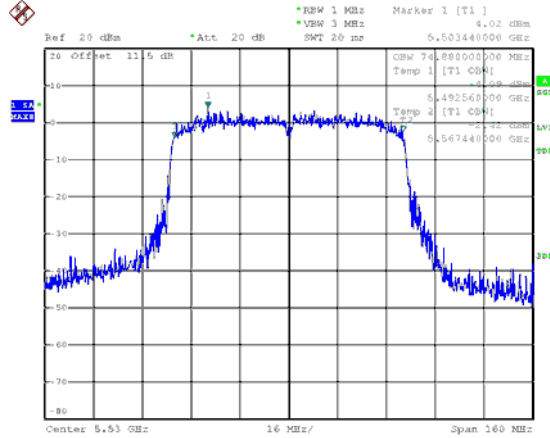

CH110

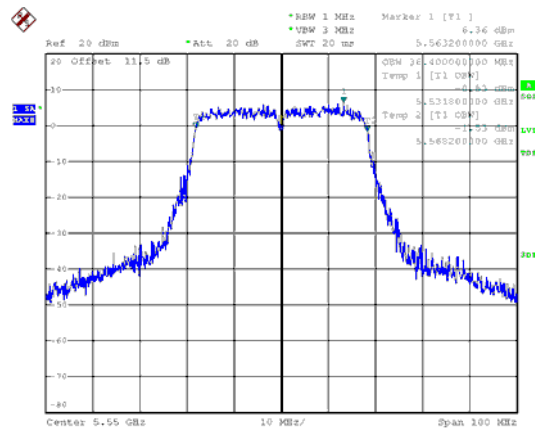

CH134

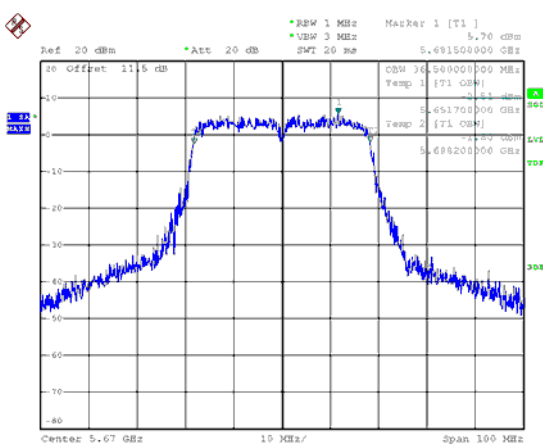





## 9. Average Power

### 9.1. Test Limit

**Output Power:**

Frequency Band	Limit
<input type="checkbox"/> 5.15~5.25GHz	
Operating Mode	
<input type="checkbox"/> Outdoor access point	The maximum conducted output power over the frequency band of operation shall not exceed 1 W (30dBm) provided the maximum antenna gain does not exceed 6 dBi. If transmitting antennas of directional gain greater than 6 dBi are used, both the maximum conducted output power and the maximum power spectral density shall be reduced by the amount in dB that the directional gain of the antenna exceeds 6 dBi. The maximum e.i.r.p. at any elevation angle above 30degrees as measured from the horizon must not exceed 125 mW (21 dBm).
<input type="checkbox"/> Indoor access point	The maximum conducted output power over the frequency band of operation shall not exceed 1 W (30dBm) provided the maximum antenna gain does not exceed 6 dBi. If transmitting antennas of directional gain greater than 6 dBi are used, both the maximum conducted output power and the maximum power spectral density shall be reduced by the amount in dB that the directional gain of the antenna exceeds 6 dBi.
<input type="checkbox"/> Fixed point-to-point access points	The maximum conducted output power over the frequency band of operation shall not exceed 1 W (30dBm). Fixed point-to-point U-NII devices may employ antennas with directional gain up to 23 dBi without any corresponding reduction in the maximum conducted output power or maximum power spectral density. For fixed point-to-point transmitters that employ a directional antenna gain greater than 23 dBi, a 1 dB reduction in maximum conducted output power and maximum power spectral density is required for each 1 dB of antenna gain in excess of 23 dBi.
<input type="checkbox"/> client devices	The maximum conducted output power over the frequency band of operation shall not exceed 250 mW (24dBm) provided the maximum antenna gain does not exceed 6 dBi. If transmitting antennas of directional gain greater than 6 dBi are used, both the maximum conducted output power and the maximum power spectral density shall be reduced by the amount in dB that the directional gain of the antenna exceeds 6 dBi.



Frequency Band		Limit
<input checked="" type="checkbox"/>	5.25-5.35 GHz	The maximum conducted output power over the frequency bands of operation shall not exceed the lesser of 250 mW (24dBm) or 11 dBm 10 log B, where B is the 26 dB emission bandwidth in megahertz. If transmitting antennas of directional gain greater than 6 dBi are used, both the maximum conducted output power and the maximum power spectral density shall be reduced by the amount in dB that the directional gain of the antenna exceeds 6 dBi.
<input checked="" type="checkbox"/>	5.470-5.725 GHz	
<input type="checkbox"/>	5.725~5.85 GHz	The maximum conducted output power over the frequency band of operation shall not exceed 1 W (30dBm). If transmitting antennas of directional gain greater than 6 dBi are used, both the maximum conducted output power and the maximum power spectral density shall be reduced by the amount in dB that the directional gain of the antenna exceeds 6 dBi. However, fixed point-to-point U-NII devices operating in this band may employ transmitting antennas with directional gain greater than 6 dBi without any corresponding reduction in transmitter conducted power.

### 9.2. Test Procedure

The transmitter output is connected to a power meter.

The cable assembly insertion loss of 11 dB (including 10 dB pad and 1 dB cable) was entered as an offset in the power meter to allow for direct reading of power.

### 9.3. Test Setup Layout

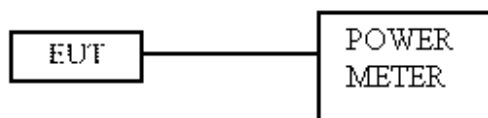

**9.4. Test Result and Data**

Modulation Type	Data Rate	Setting	Channel	Frequency (MHz)	Measured value of each antenna port (dBm)	Total power (dBm)	Total power (mW)	FCC Limit (dBm)
					ANT A			
11a	6 Mbps	15	52	5260	14.37	14.37	27.353	24.00
11a	6 Mbps	15	60	5300	14.22	14.22	26.424	24.00
11a	6 Mbps	15	64	5320	14.19	14.19	26.242	24.00
11n HT20	MCS 0	15	52	5260	14.34	14.34	27.164	24.00
11n HT20	MCS 0	15	60	5300	14.17	14.17	26.122	24.00
11n HT20	MCS 0	15	64	5320	14.16	14.16	26.062	24.00
11n HT40	MCS 0	15	54	5270	12.78	12.78	18.967	24.00
11n HT40	MCS 0	15	62	5310	13.14	13.14	20.606	24.00
11ac VHT20	MCS0-NSS1	15	52	5260	14.39	<b>14.39</b>	27.479	24.00
11ac VHT20	MCS0-NSS1	15	60	5300	14.25	14.25	26.607	24.00
11ac VHT20	MCS0-NSS1	15	64	5320	14.20	14.20	26.303	24.00
11ac VHT40	MCS0-NSS1	15	54	5270	12.85	12.85	19.275	24.00
11ac VHT40	MCS0-NSS1	15	62	5310	12.76	12.76	18.880	24.00
11ac VHT80	MCS0-NSS1	15	58	5290	13.23	13.23	21.038	24.00

Modulation Type	Data Rate	Setting	Channel	Frequency (MHz)	Measured value of each antenna port (dBm)	Total power (dBm)	Total power (mW)	FCC Limit (dBm)
					ANT A			
11a	6 Mbps	15	100	5500	13.68	13.68	23.335	24.00
11a	6 Mbps	15	116	5580	13.87	13.87	24.378	24.00
11a	6 Mbps	15	140	5700	13.98	13.98	25.003	24.00
11n HT20	MCS 0	15	100	5500	13.65	13.65	23.174	24.00
11n HT20	MCS 0	15	116	5580	13.85	13.85	24.266	24.00
11n HT20	MCS 0	15	140	5700	13.95	13.95	24.831	24.00
11n HT40	MCS 0	15	102	5510	12.15	12.15	16.406	24.00
11n HT40	MCS 0	15	110	5550	12.24	12.24	16.749	24.00
11n HT40	MCS 0	15	134	5670	12.52	12.52	17.865	24.00
11ac VHT20	MCS0-NSS1	15	100	5500	13.73	13.73	23.605	24.00
11ac VHT20	MCS0-NSS1	15	116	5580	13.90	13.90	24.547	24.00
11ac VHT20	MCS0-NSS1	15	140	5700	14.02	<b>14.02</b>	25.235	24.00
11ac VHT40	MCS0-NSS1	15	102	5510	12.24	12.24	16.749	24.00
11ac VHT40	MCS0-NSS1	15	110	5550	12.32	12.32	17.061	24.00
11ac VHT40	MCS0-NSS1	15	134	5670	12.58	12.58	18.113	24.00
11ac VHT80	MCS0-NSS1	15	106	5530	12.79	12.79	19.011	24.00



### 10. Maximum Power Spectral Density

#### 10.1. Test Limit

PSD:

Frequency Band	Limit
<input type="checkbox"/> 5.15~5.25GHz	
Operating Mode	
<input type="checkbox"/> Outdoor access point	17 dBm/MHz
<input type="checkbox"/> Indoor access point	17 dBm/MHz
<input type="checkbox"/> Fixed point-to-point access points	17 dBm/MHz
<input type="checkbox"/> client devices	11 dBm/MHz
<input checked="" type="checkbox"/> 5.250~5.350 GHz	11 dBm/MHz
<input checked="" type="checkbox"/> 5.470~5.725 GHz	11 dBm/MHz
<input type="checkbox"/> 5.725~5.85 GHz	30 dBm/500kHz

#### 10.2. Test Procedure

Reference to KDB789033 D02 General UNII Test Procedures New Rules v02r01

#### 10.3. Test Setup Layout

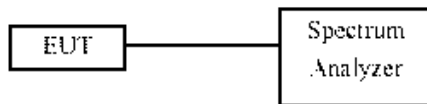

**10.4. Test Result and Data**

## In the 5.3G Band

Modulation Type	Channel	Frequency (MHz)	Meas PSD (dBm/MHz)	Sum chain (dBm)	Duty Cycle CF(dB)	Total Corr'd PSD (dBm/MHz)	PSD Limit (dBm/MHz)
			ANT A				
11a	52	5260	1.80	1.80	0.68	2.48	11.00
11a	60	5300	1.47	1.47	0.68	2.15	11.00
11a	64	5320	1.40	1.40	0.68	2.08	11.00
11ac VHT20	52	5260	1.58	1.58	0.68	2.26	11.00
11ac VHT20	60	5300	1.14	1.14	0.68	1.82	11.00
11ac VHT20	64	5320	1.09	1.09	0.68	1.77	11.00
11ac VHT40	54	5270	-3.24	-3.24	1.40	-1.84	11.00
11ac VHT40	62	5310	-3.55	-3.55	1.40	-2.15	11.00
11ac VHT80	58	5290	-6.81	-6.81	2.48	-4.33	11.00

## In the 5.5G Band

Modulation Type	Channel (MHz)	Frequency (MHz)	Meas PSD (dBm/MHz)	Sum chain (dBm)	Duty Cycle CF(dB)	Total Corr'd PSD (dBm/MHz)	PSD Limit (dBm/MHz)
			ANT A				
11a	100	5500	1.91	1.91	0.68	2.59	11.00
11a	116	5580	2.23	2.23	0.68	2.91	11.00
11a	140	5700	1.93	1.93	0.68	2.61	11.00
11ac VHT20	100	5500	1.54	1.54	0.68	2.22	11.00
11ac VHT20	116	5580	1.97	1.97	0.68	2.65	11.00
11ac VHT20	140	5700	1.65	1.65	0.68	2.33	11.00
11ac VHT40	102	5510	-3.34	-3.34	1.40	-1.94	11.00
11ac VHT40	110	5550	-3.07	-3.07	1.40	-1.67	11.00
11ac VHT40	134	5670	-3.37	-3.37	1.40	-1.97	11.00
11ac VHT80	106	5530	-6.83	-6.83	2.48	-4.35	11.00



Band 2, ANT A  
Modulation Type: 802.11a (6Mbps)  
CH52

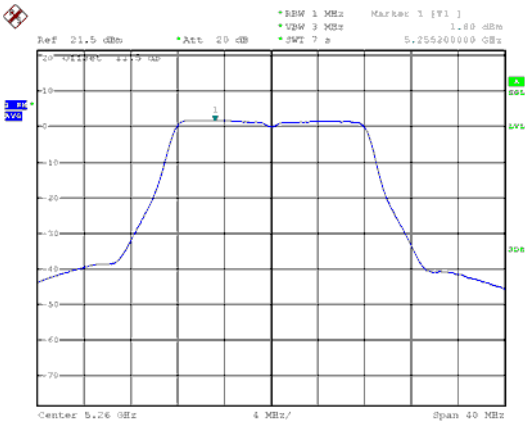

Modulation Type: 802.11ac VHT20 (6.5Mbps)  
CH52

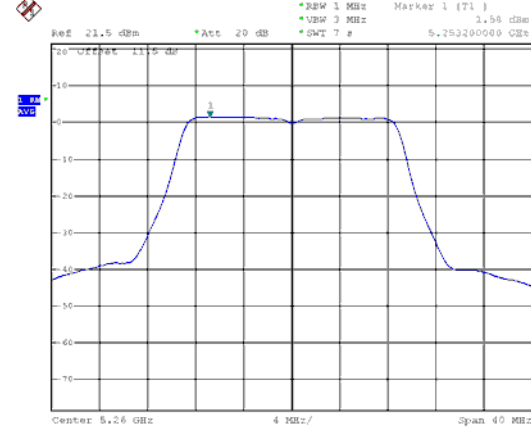

CH60

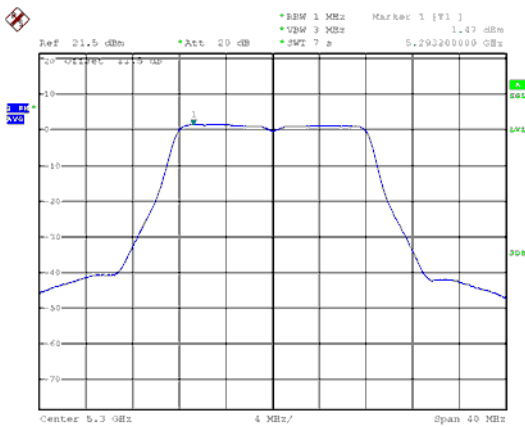

CH60

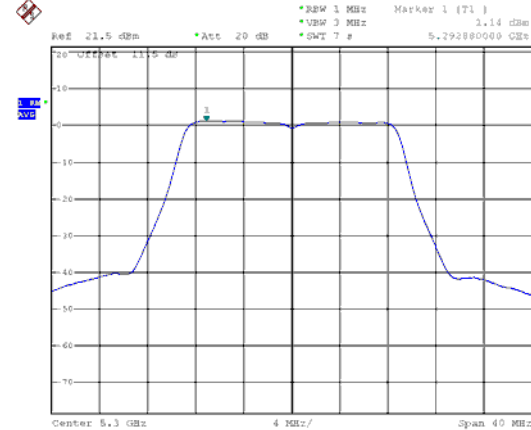

CH64

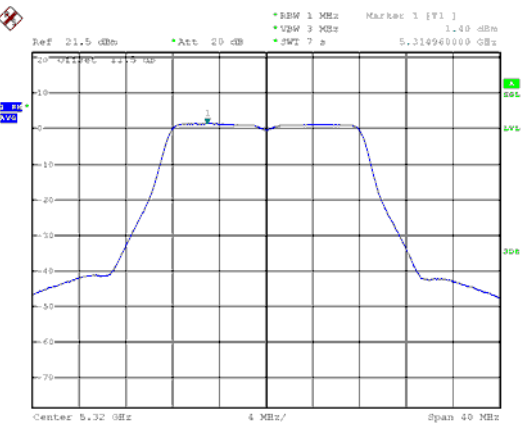

CH64

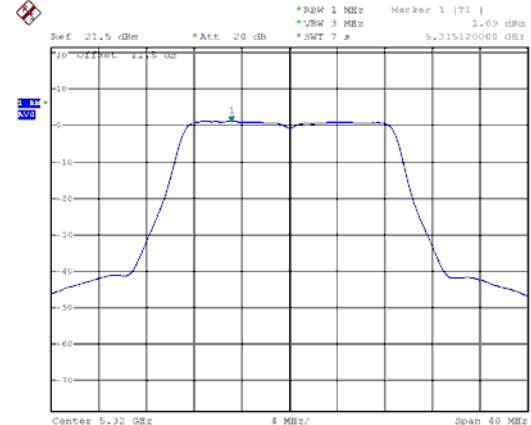



Band 2, ANT A  
Modulation Type: 802.11ac VHT40 (13.5Mbps)  
CH54

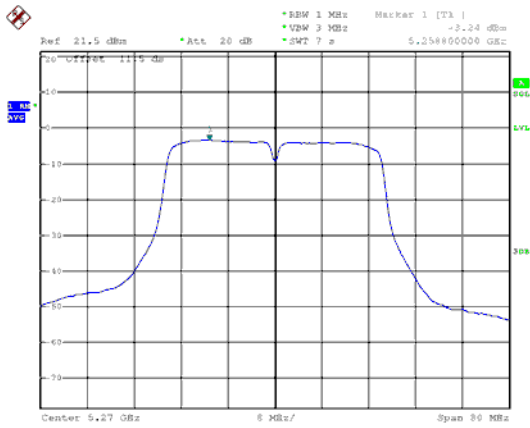

Modulation Type: 802.11ac VHT80 (29.3Mbps)  
CH58

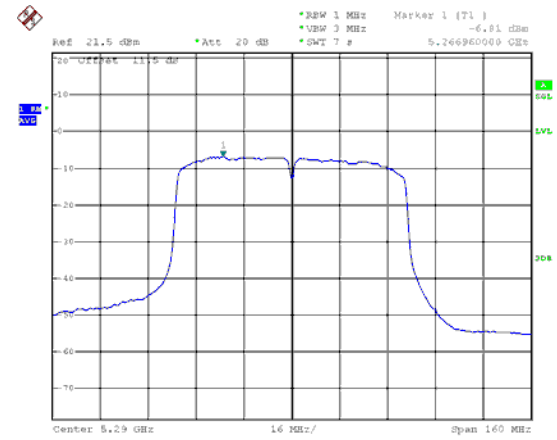

CH62

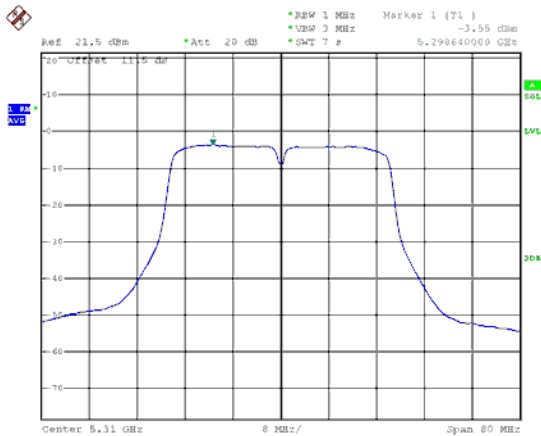



Band 3, ANT A  
Modulation Type: 802.11a (6Mbps)  
CH100

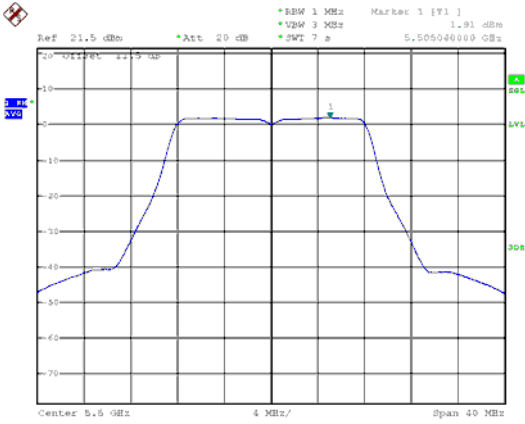

Modulation Type: 802.11ac VHT20 (6.5Mbps)  
CH100

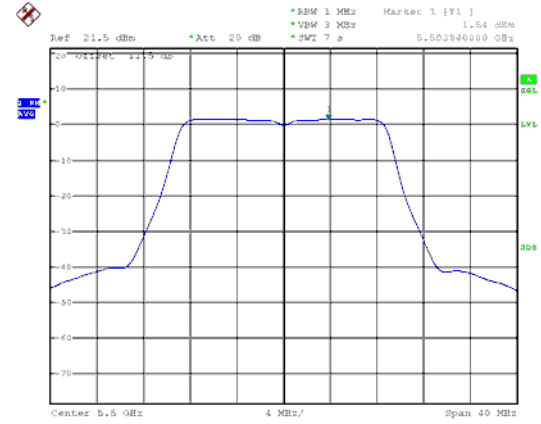

CH116

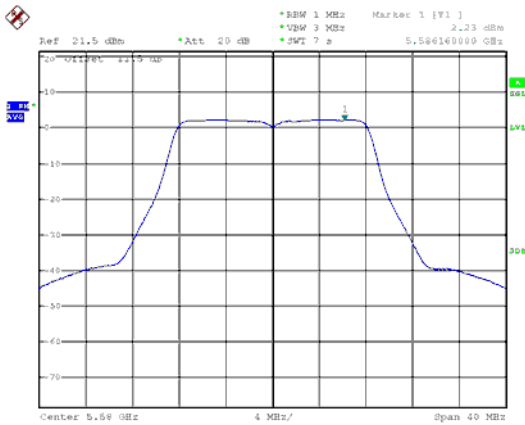

CH116

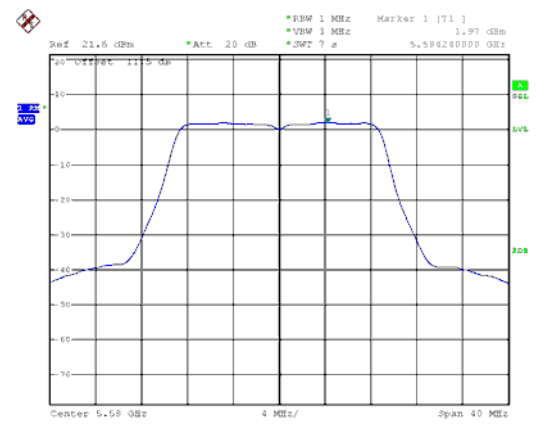

CH140

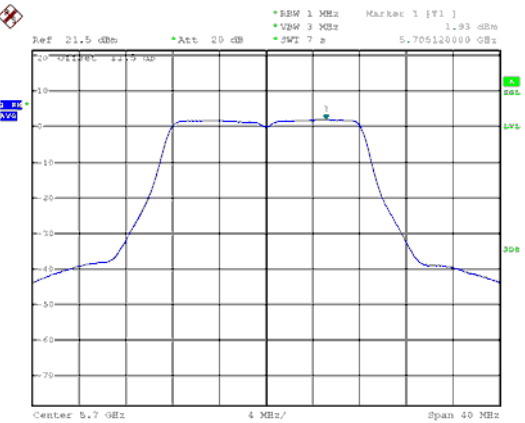

CH140

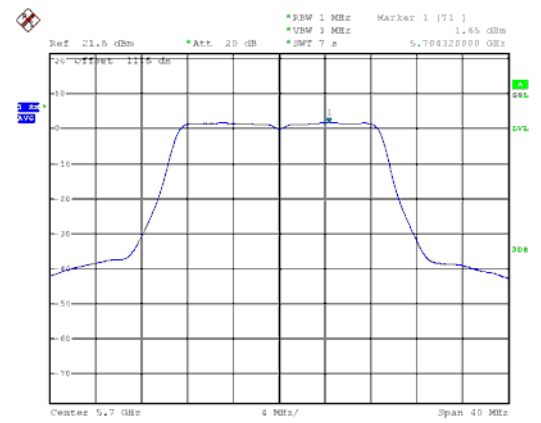





Band 3, ANT A  
Modulation Type: 802.11ac VHT40 (13.5Mbps)  
CH102

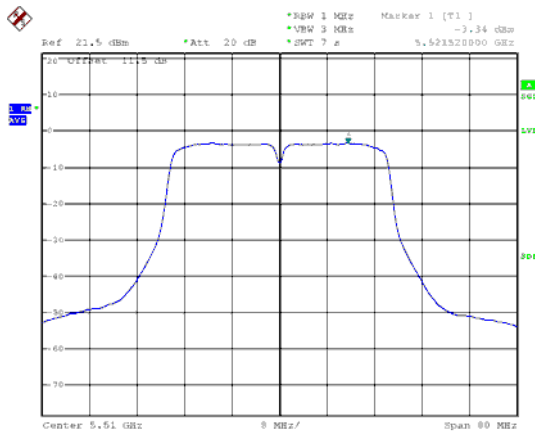

Modulation Type: 802.11ac VHT80 (29.3Mbps)  
CH106

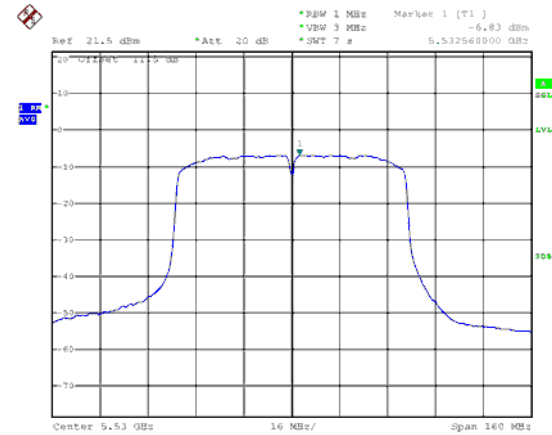

CH110

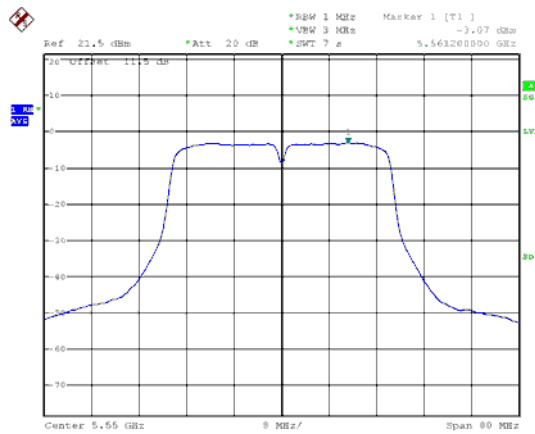

CH134

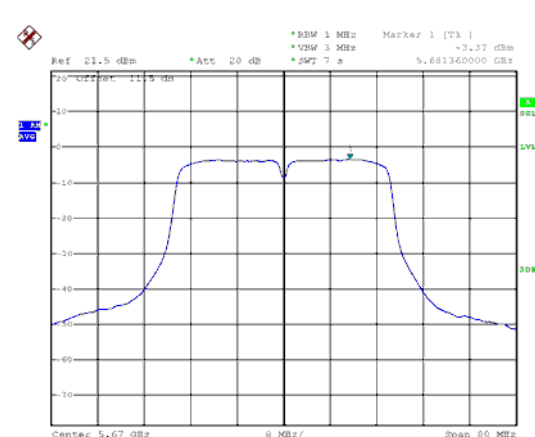



## 11. Frequency Stability

### 11.1. Test Procedure

1. The EUT was placed inside the Temperature and Humidity chamber.
2. The transmitter output was connected to spectrum analyzer.
3. Turn the EUT on and couple its output to a spectrum analyzer.
4. Turn the EUT off and set the chamber to the highest temperature specified.
5. Allow sufficient time (approximately 30 min) for the temperature of the chamber to stabilize, turn the EUT on and measure the operating frequency after 2, 5, and 10 minutes.
6. Repeat step 2 and 3 with the temperature chamber set to the lowest temperature.
7. The test chamber was allowed to stabilize at +20 degree C for a minimum of 30 minutes. The supply voltage was then adjusted on the EUT from 85% to 115% and the frequency record.

### 11.2. Test Setup Layout

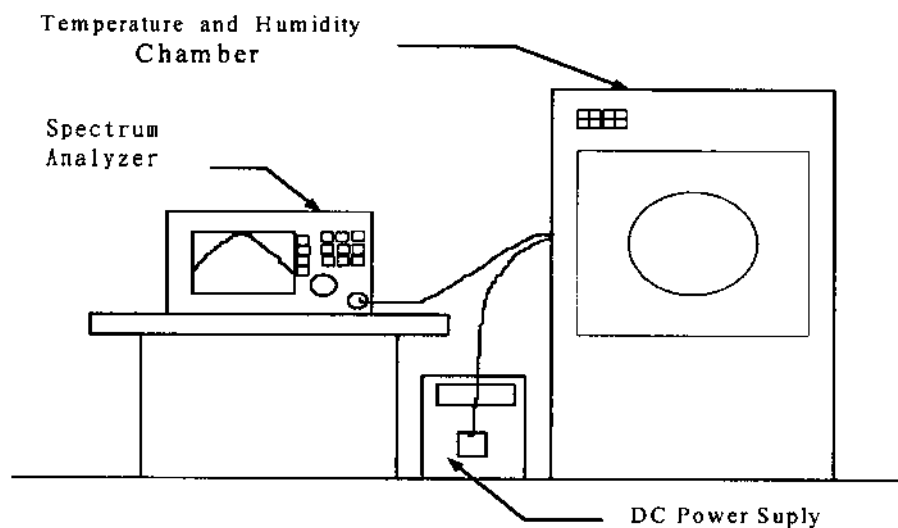



**11.3. Test Result and Data**

Operating frequency:5320 MHz							
Temp (°C)	Power supply (V)	2 minute		5 minute		10 minute	
		(MHz)	(%)	(MHz)	(%)	(MHz)	(%)
40	102	5320.0198	0.000372	5320.0198	0.000372	5320.0198	0.000372
	120	5320.0200	0.000376	5320.0200	0.000376	5320.0200	0.000376
	138	5320.0230	0.000432	5320.0230	0.000432	5320.0230	0.000432
30	102	5320.0228	0.000429	5320.0228	0.000429	5320.0228	0.000429
	120	5320.0230	0.000432	5320.0230	0.000432	5320.0230	0.000432
	138	5320.0260	0.000489	5320.0260	0.000489	5320.0260	0.000489
20	102	5320.0286	0.000538	5320.0286	0.000538	5320.0286	0.000538
	120	5320.0288	0.000541	5320.0288	0.000541	5320.0288	0.000541
	138	5320.0318	0.000598	5320.0318	0.000598	5320.0318	0.000598
10	102	5320.0478	0.000898	5320.0478	0.000898	5320.0478	0.000898
	120	5320.0480	0.000902	5320.0480	0.000902	5320.0480	0.000902
	138	5320.0510	0.000959	5320.0510	0.000959	5320.0510	0.000959
0	102	5320.0616	0.001158	5320.0616	0.001158	5320.0616	0.001158
	120	5320.0618	0.001162	5320.0618	0.001162	5320.0618	0.001162
	138	5320.0648	0.001218	5320.0648	0.001218	5320.0648	0.001218

Limit:

Manufacturers of U-NII devices are responsible for ensuring frequency stability such that an emission is maintained within the band of operation under all conditions of normal operation as specified in the users manual.