





FCC RF Test Report

APPLICANT : Elo Touch Solutions, Inc.
EQUIPMENT : Touch All-in-One Computer
BRAND NAME : 
Elo or 
MODEL NAME : ESY15i1
FCC ID : RBWESY1511
STANDARD : FCC Part 15 Subpart C §15.247
CLASSIFICATION : (DTS) Digital Transmission System

This is a partial report which is included the RF power, radiated band edges, radiated spurious emission, and AC conducted emission test items. The product was received on Dec. 02, 2014 and testing was completed on Dec. 28, 2014. We, SPORTON INTERNATIONAL INC., would like to declare that the tested sample has been evaluated in accordance with the test procedures and has been in compliance with the applicable technical standards.

The test results in this report apply exclusively to the tested model / sample. Without written approval of SPORTON INTERNATIONAL INC., the test report shall not be reproduced except in full.



Reviewed by: Joseph Lin / Supervisor

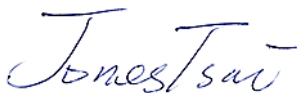

Approved by: Jones Tsai / Manager



SPORTON INTERNATIONAL INC.

No. 52, Hwa Ya 1st Rd., Hwa Ya Technology Park, Kwei-Shan Hsiang, Tao Yuan Hsien, Taiwan, R.O.C.

SPORTON INTERNATIONAL INC.

TEL : 886-3-327-3456

FAX : 886-3-328-4978

FCC ID : RBWESY1511

Page Number : 1 of 22

Report Issued Date : Jan. 15, 2015

Report Version : Rev. 01

Report Template No.: BU5-FR15CBT4.0 Version 1.0



TABLE OF CONTENTS

REVISION HISTORY..... 3

SUMMARY OF TEST RESULT 4

1 GENERAL DESCRIPTION..... 5

 1.1 Applicant 5

 1.2 Product Feature of Equipment Under Test..... 5

 1.3 Product Specification subjective to this standard 5

 1.4 Modification of EUT 5

 1.5 Testing Location 6

 1.6 Applicable Standards..... 6

2 TEST CONFIGURATION OF EQUIPMENT UNDER TEST..... 7

 2.1 Descriptions of Test Mode 7

 2.2 Test Mode 7

 2.3 Connection Diagram of Test System 8

 2.4 Support Unit used in test configuration and system 9

 2.5 EUT Operation Test Setup 9

3 TEST RESULT 10

 3.1 Radiated Band Edges and Spurious Emission Measurement 10

 3.2 AC Conducted Emission Measurement..... 14

 3.3 Antenna Requirements 20

4 LIST OF MEASURING EQUIPMENT..... 21

5 UNCERTAINTY OF EVALUATION..... 22

APPENDIX A. TEST RESULT OF RADIATED TEST RESULTS

APPENDIX B. SETUP PHOTOGRAPHS



SUMMARY OF TEST RESULT

Report Section	FCC Rule	IC Rule	Description	Limit	Result	Remark
3.1	15.247(d)	RSS-210 A8.5	Radiated Band Edges and Spurious Emission	15.209(a) & 15.247(d)	Pass	Under limit 1.86 dB at 664.000 MHz
3.2	15.207	RSS-Gen 7.2.4	AC Conducted Emission	15.207(a)	Pass	Under limit 3.10 dB at 27.118 MHz
3.3	15.203 & 15.247(b)	RSS-210 A8.4	Antenna Requirement	N/A	Pass	-



1 General Description

1.1 Applicant

Elo Touch Solutions, Inc.
1033McCarthy Blvd, Milpitas, CA95035, USA

1.2 Product Feature of Equipment Under Test

Product Feature	
Equipment	Touch All-in-One Computer
Brand Name	Elo or 
Model Name	ESY15i1
FCC ID	RBWESY15I1
EUT supports Radios application	WLAN 11b/g/n HT20 Bluetooth v4.0 LE
HW Version	A00
SW Version	0.11
EUT Stage	Production Unit

Remark: The above EUT's information was declared by manufacturer. Please refer to the specifications or user's manual for more detailed description.

1.3 Product Specification subjective to this standard

Product Specification subjective to this standard	
Tx/Rx Frequency Range	2402 MHz ~ 2480 MHz
Number of Channels	40
Carrier Frequency of Each Channel	40 Channel(37 hopping + 3 advertising channel)
Maximum Output Power to Antenna	2.99 dBm (0.0020 W)
Antenna Type	PIFA Antenna type with gain -2.89 dBi
Type of Modulation	Bluetooth LE : GFSK

1.4 Modification of EUT

No modifications are made to the EUT during all test items.



1.5 Testing Location

Sporton Lab is accredited to ISO 17025 by Taiwan Accreditation Foundation (TAF code : 1190) and the FCC designation No. TW1022 under the FCC 2.948(e) by Mutual Recognition Agreement (MRA) in FCC Test.

Test Site	SPORTON INTERNATIONAL INC.		
Test Site Location	No. 52, Hwa Ya 1 st Rd., Hwa Ya Technology Park, Kwei-Shan Hsiang, Tao Yuan Hsien, Taiwan, R.O.C. TEL: +886-3-327-3456 FAX: +886-3-328-4978		
Test Site No.	Sporton Site No.		
	TH02-HY	CO05-HY	03CH07-HY

Note: The test site complies with ANSI C63.4 2009 requirement.

1.6 Applicable Standards

According to the specifications of the manufacturer, the EUT must comply with the requirements of the following standards:

- ♦ FCC Part 15 Subpart C §15.247
- ♦ FCC KDB Publication No. 558074 D01 DTS Meas. Guidance v03r02
- ♦ ANSI C63.10-2013

Remark:

1. All test items were verified and recorded according to the standards and without any deviation during the test.
2. This EUT has also been tested and complied with the requirements of FCC Part 15, Subpart B, recorded in a separate test report.
3. The EUT was placed 1.5m height for frequency above 1GHz in accordance with ANSI C63.10 2013 through FCC inquiry (KDB 961829).



2 Test Configuration of Equipment Under Test

2.1 Descriptions of Test Mode

The RF output power was recorded in the following table:

Channel	Frequency	Bluetooth 4.0 – LE RF Output Power	
		Data Rate / Modulation	
		GFSK	
		1Mbps	
Ch00	2402MHz	2.73 dBm	
Ch19	2440MHz	2.99 dBm	
Ch39	2480MHz	2.67 dBm	

- a. The EUT has been associated with peripherals and configuration operated in a manner tended to maximize its emission characteristics in a typical application. Frequency range investigated: conduction (150 kHz to 30 MHz), radiation (9 kHz to the 10th harmonic of the highest fundamental frequency or to 40 GHz, whichever is lower). Pre-scanned tests, X, Y, Z in three orthogonal panels to determine the final configuration (Z plane as worst plane) from all possible combinations.
- b. AC power line Conducted Emission was tested under maximum output power.

2.2 Test Mode

The following summary table is showing all test modes to demonstrate in compliance with the standard.

Summary table of Test Cases	
Test Item	Data Rate / Modulation
	Bluetooth 4.0 – LE / GFSK
Radiated TCs	Mode 1: Bluetooth Tx CH39_2480 MHz_1Mbps
AC Conducted Emission	Mode 1: WLAN Link + Bluetooth Link + MSR On (Micro USB at bottom side) + RJ-45 (Load) + MPEG4 + RFID On (Micro USB at right side) + TC + Adapter 2
Remark: 1. TC stands for Test Configuration, and consists of Earphone, Micro HDMI, SD Card, and USB flash drive. 2. For radiated TCs, all tests were performed with adapter 1.	

2.3 Connection Diagram of Test System

<Bluetooth 4.0 – LE Tx Mode>

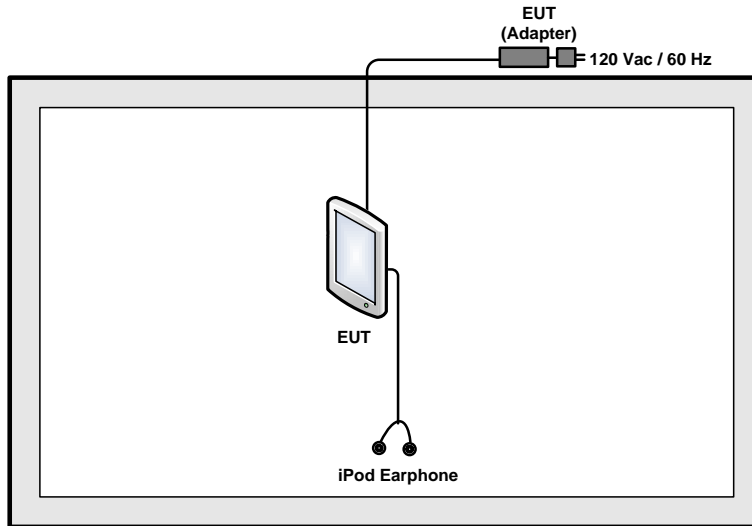

<AC Conducted Emission Mode>

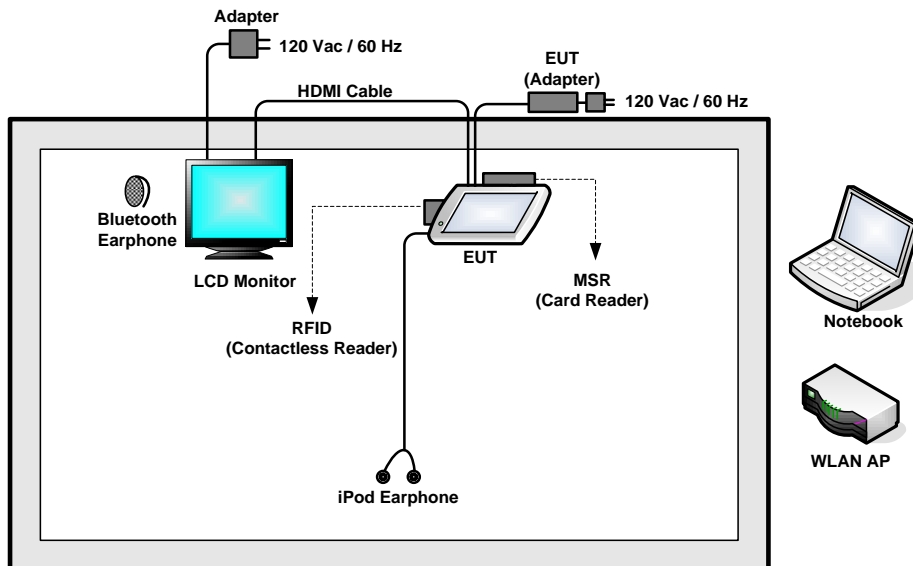



2.4 Support Unit used in test configuration and system

Item	Equipment	Trade Name	Model Name	FCC ID	Data Cable	Power Cord
1.	Bluetooth Earphone	Sony Ericsson	MW600	PY7DDA-2029	N/A	N/A
2.	WLAN AP	D-Link	DIR-628	KA2DIR628A2	N/A	Unshielded, 1.8 m
3.	Notebook	DELL	Latitude E6320	FCC DoC/ Contains FCC ID: QDS-BRCM1054	N/A	AC I/P: Unshielded, 1.2 m DC O/P: Shielded, 1.8 m
4.	LCD Monitor	DELL	U2410	FCC DoC	Shielded, 1.6 m	Unshielded, 1.8 m
5.	USB flash drive	Transcend	N/A	FCC DoC	N/A	N/A
6.	SD Card	SanDisk	MicroSD HC	FCC DoC	N/A	N/A
7.	iPod Earphone	Apple	N/A	Verification	Unshielded, 1.0 m	N/A
8.	RFID (Contactless Reader)	Uniform	UIC680 Series	TFJ680TG	N/A	N/A
9.	MSR (Card Reader)	Magtek	21030085	FCC DoC	N/A	N/A

2.5 EUT Operation Test Setup

For Bluetooth function, programmed RF utility, "QRCT" installed in the notebook make the EUT provide functions like channel selection and power level for continuous transmitting and receiving signals.



3 Test Result

3.1 Radiated Band Edges and Spurious Emission Measurement

3.1.1 Limit of Radiated Band Edges and Spurious Emission

In any 100 kHz bandwidth outside the intentional radiator frequency band, all harmonics/spurious must be at least 20 dB below the highest emission level within the authorized band. If the output power of this device was measured by spectrum analyzer, the attenuation under this paragraph shall be 30 dB instead of 20 dB. In addition, radiated emissions which fall in the restricted bands must also comply with the FCC section 15.209 limits as below.

Frequency (MHz)	Field Strength (microvolts/meter)	Measurement Distance (meters)
0.009 – 0.490	2400/F(kHz)	300
0.490 – 1.705	24000/F(kHz)	30
1.705 – 30.0	30	30
30 – 88	100	3
88 – 216	150	3
216 - 960	200	3
Above 960	500	3

3.1.2 Measuring Instruments

The section 4.0 of List of Measuring Equipment of this test report is used for test.



3.1.3 Test Procedures

1. The testing follows FCC KDB Publication No. 558074 D01 DTS Meas. Guidance v03r02.
2. The EUT was arranged to its worst case and then tune the antenna tower (from 1 m to 4 m) and turntable (from 0 degree to 360 degrees) to find the maximum reading. A pre-amp and a high pass filter are used for the test in order to get better signal level.
3. The EUT was placed on a turntable with 0.8 meter for frequency < 1GHz and 1.5 meter for frequency > 1GHz above ground.
4. The EUT was set 3 meters from the interference receiving antenna, which was mounted on the top of a variable height antenna tower.
5. Corrected Reading: Antenna Factor + Cable Loss + Read Level - Preamp Factor = Level
6. For measurement below 1GHz, If the emission level of the EUT measured by the peak detector is 3 dB lower than the applicable limit, the peak emission level will be reported. Otherwise, the emission measurement will be repeated using the quasi-peak detector and reported.
7. Use the following spectrum analyzer settings:
 - (1) Span shall wide enough to fully capture the emission being measured;
 - (2) Set RBW=100 kHz for f < 1 GHz; VBW ≥ RBW; Sweep = auto; Detector function = peak; Trace = max hold;
 - (3) Set RBW = 1 MHz, VBW= 3MHz for f ≥ 1 GHz for peak measurement.

For average measurement:

 - VBW = 10 Hz, when duty cycle is no less than 98 percent.
 - VBW ≥ 1/T, when duty cycle is less than 98 percent where T is the minimum transmission duration over which the transmitter is on and is transmitting at its maximum power control level for the tested mode of operation.

Band	Duty Cycle(%)	T(μs)	1/T(kHz)	VBW Setting
Bluetooth 4.0 - LE	62.42	392.00	2.55	3kHz

3.1.4 Test Setup

For radiated emissions below 30MHz

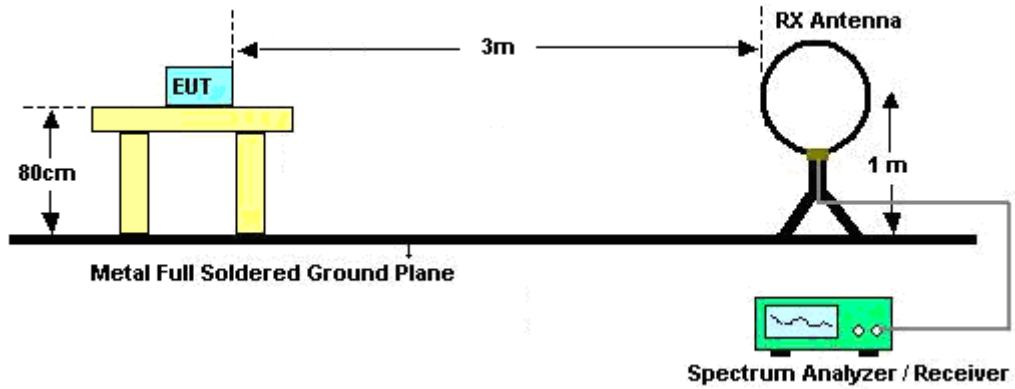

For radiated emissions from 30MHz to 1GHz

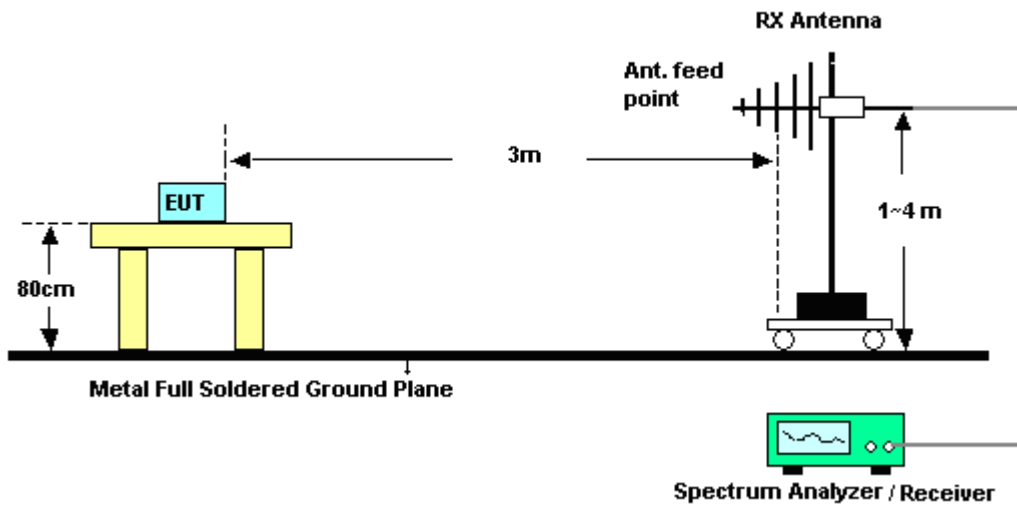

For radiated emissions above 1GHz

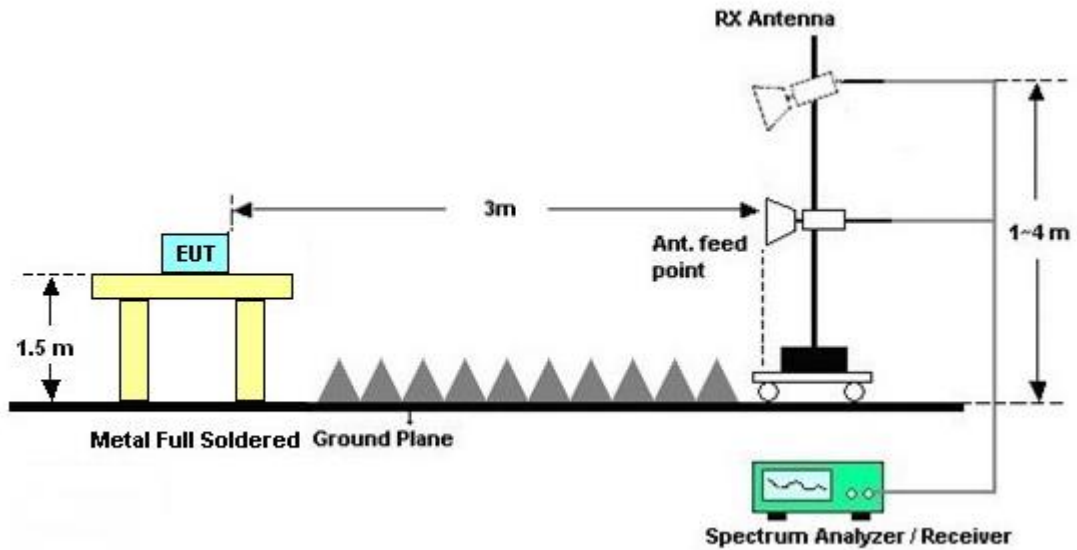

3.1.5 Test Results of Radiated Spurious Emissions (9 kHz ~ 30 MHz)

The low frequency, which started from 9 kHz to 30MHz, was pre-scanned and the result which was 20dB lower than the limit line per 15.31(o) was not reported.

3.1.6 Test Result of Radiated Spurious at Band Edges

Please refer to Appendix A.

3.1.7 Test Result of Radiated Spurious Emission (30MHz ~ 10th Harmonic)

Please refer to Appendix A.



3.2 AC Conducted Emission Measurement

3.2.1 Limit of AC Conducted Emission

For equipment that is designed to be connected to the public utility (AC) power line, the radio frequency voltage that is conducted back onto the AC power line on any frequency or frequencies within the band 150 kHz to 30 MHz shall not exceed the limits in the following table.

Frequency of emission (MHz)	Conducted limit (dB μ V)	
	Quasi-peak	Average
0.15-0.5	66 to 56*	56 to 46*
0.5-5	56	46
5-30	60	50

*Decreases with the logarithm of the frequency.

3.2.2 Measuring Instruments

The section 4.0 of List of Measuring Equipment of this test report is used for test.

3.2.3 Test Procedures

1. The EUT was placed 0.4 meter from the conducting wall of the shielding room was kept at least 80 centimeters from any other grounded conducting surface.
2. Connect EUT to the power mains through a line impedance stabilization network (LISN).
3. All the support units are connecting to the other LISN.
4. The LISN provides 50 ohm coupling impedance for the measuring instrument.
5. The FCC states that a 50 ohm, 50 microhenry LISN should be used.
6. Both sides of AC line were checked for maximum conducted interference.
7. The frequency range from 150 kHz to 30 MHz was searched.
8. Set the test-receiver system to Peak Detect Function and specified bandwidth (IF Bandwidth = 9kHz) with Maximum Hold Mode. Then measurement is also conducted by Average Detector and Quasi-Peak Detector Function respectively.

3.2.4 Test Setup

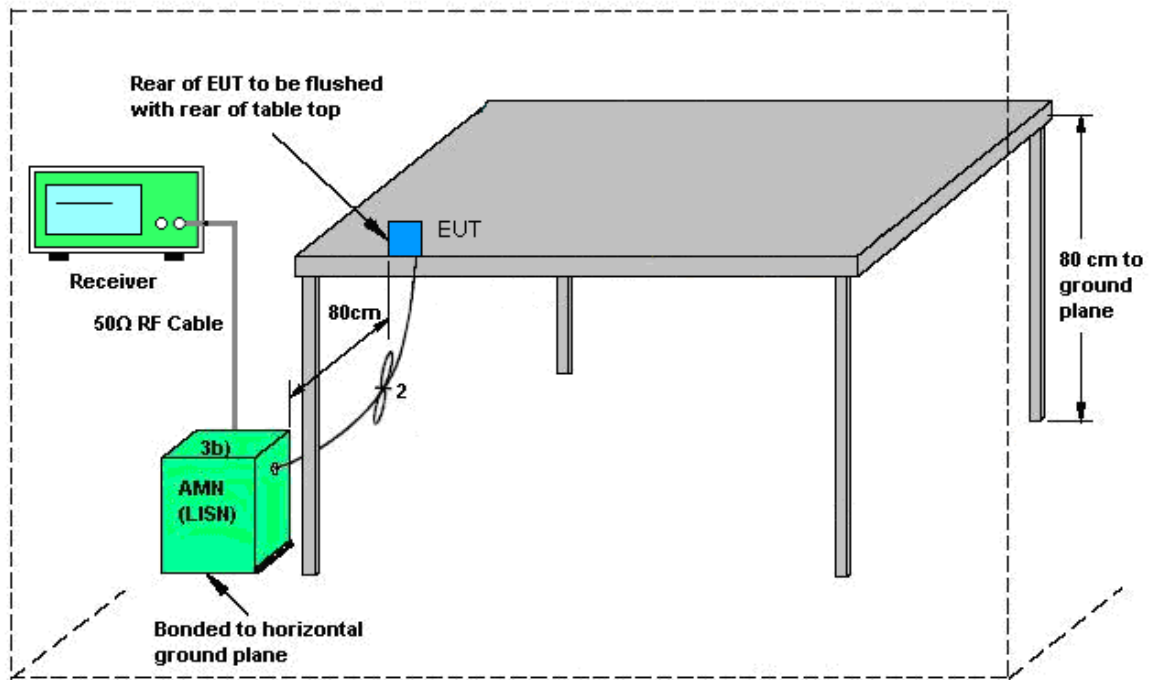

AMN = Artificial mains network (LISN)
AE = Associated equipment
EUT = Equipment under test
ISN = Impedance stabilization network



3.2.5 Test Result of AC Conducted Emission

<Original Test Result>

Test Mode :	Mode 1	Temperature :	21~23°C
Test Engineer :	Eric Jeng	Relative Humidity :	46~48%
Test Voltage :	120Vac / 60Hz	Phase :	Line
Function Type :	WLAN Link + Bluetooth Link + MSR On (Micro USB at bottom side) + RJ-45 (Load) + MPEG4 + RFID On (Micro USB at right side) + TC + Adapter 2		

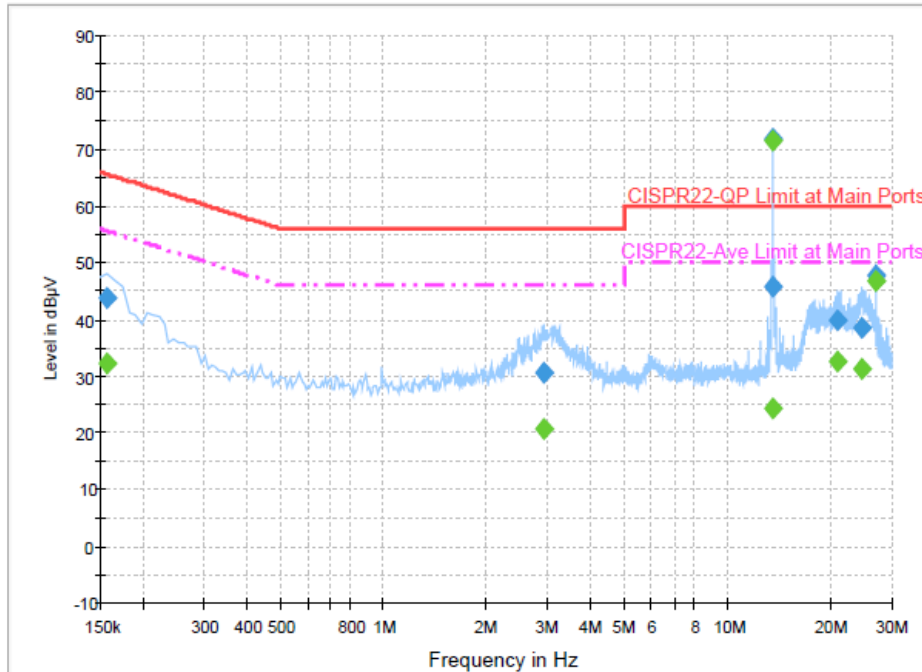

Final Result : Quasi-Peak

Frequency (MHz)	Quasi-Peak (dBµV)	Filter	Line	Corr. (dB)	Margin (dB)	Limit (dBµV)
0.158000	43.6	Off	L1	19.5	22.0	65.6
2.934000	30.4	Off	L1	19.6	25.6	56.0
13.558000	71.8	Off	L1	19.9	-11.8	60.0
13.614000	45.7	Off	L1	19.9	14.3	60.0
20.814000	39.8	Off	L1	19.9	20.2	60.0
24.462000	38.5	Off	L1	19.9	21.5	60.0
27.118000	47.9	Off	L1	20.0	12.1	60.0

Final Result : Average

Frequency (MHz)	Average (dBµV)	Filter	Line	Corr. (dB)	Margin (dB)	Limit (dBµV)
0.158000	32.2	Off	L1	19.5	23.4	55.6
2.934000	20.8	Off	L1	19.6	25.2	46.0
13.558000	71.6	Off	L1	19.9	-21.6	50.0
13.614000	24.2	Off	L1	19.9	25.8	50.0
20.814000	32.6	Off	L1	19.9	17.4	50.0
24.462000	31.3	Off	L1	19.9	18.7	50.0
27.118000	46.9	Off	L1	20.0	3.1	50.0



<Original Test Result>

Test Mode :	Mode 1	Temperature :	21~23°C
Test Engineer :	Eric Jeng	Relative Humidity :	46~48%
Test Voltage :	120Vac / 60Hz	Phase :	Neutral
Function Type :	WLAN Link + Bluetooth Link + MSR On (Micro USB at bottom side) + RJ-45 (Load) + MPEG4 + RFID On (Micro USB at right side) + TC + Adapter 2		

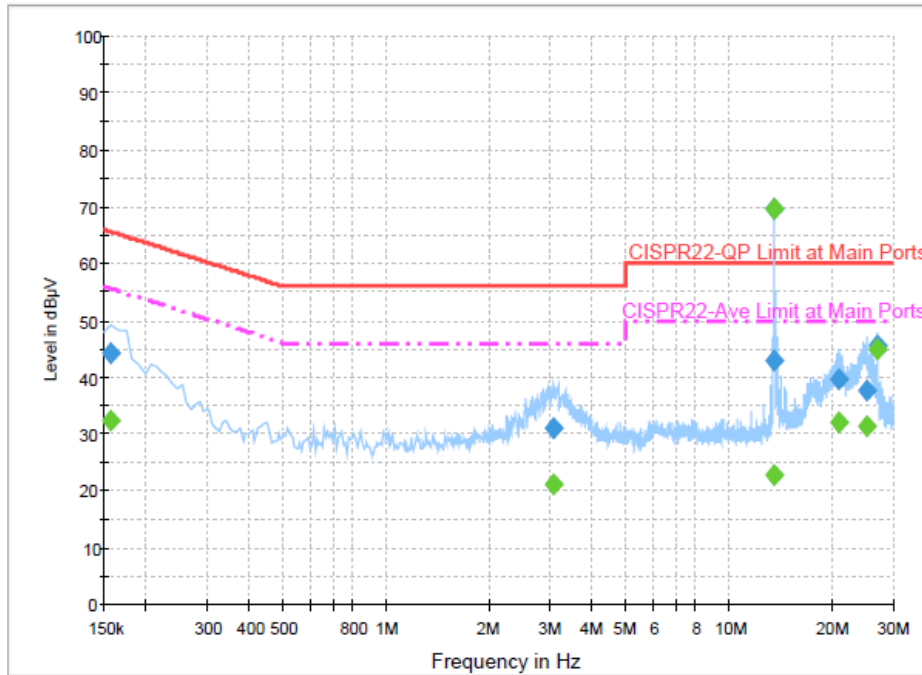

Final Result : Quasi-Peak

Frequency (MHz)	Quasi-Peak (dBµV)	Filter	Line	Corr. (dB)	Margin (dB)	Limit (dBµV)
0.158000	44.3	Off	N	19.5	21.3	65.6
3.086000	31.1	Off	N	19.6	24.9	56.0
13.518000	42.7	Off	N	19.9	17.3	60.0
13.558000	69.6	Off	N	19.9	-9.6	60.0
20.950000	39.5	Off	N	20.0	20.5	60.0
25.230000	37.6	Off	N	20.0	22.4	60.0
27.118000	45.6	Off	N	20.1	14.4	60.0

Final Result : Average

Frequency (MHz)	Average (dBµV)	Filter	Line	Corr. (dB)	Margin (dB)	Limit (dBµV)
0.158000	32.3	Off	N	19.5	23.3	55.6
3.086000	21.2	Off	N	19.6	24.8	46.0
13.518000	22.8	Off	N	19.9	27.2	50.0
13.558000	69.5	Off	N	19.9	-19.5	50.0
20.950000	32.0	Off	N	20.0	18.0	50.0
25.230000	31.3	Off	N	20.0	18.7	50.0
27.118000	44.8	Off	N	20.1	5.2	50.0



<Terminal Test Result>

Test Mode :	Mode 1	Temperature :	21~23°C
Test Engineer :	Eric Jeng	Relative Humidity :	46~48%
Test Voltage :	120Vac / 60Hz	Phase :	Line
Function Type :	WLAN Link + Bluetooth Link + MSR On (Micro USB at bottom side) + RJ-45 (Load) + MPEG4 + RFID On (Micro USB at right side) + TC + Adapter 2		

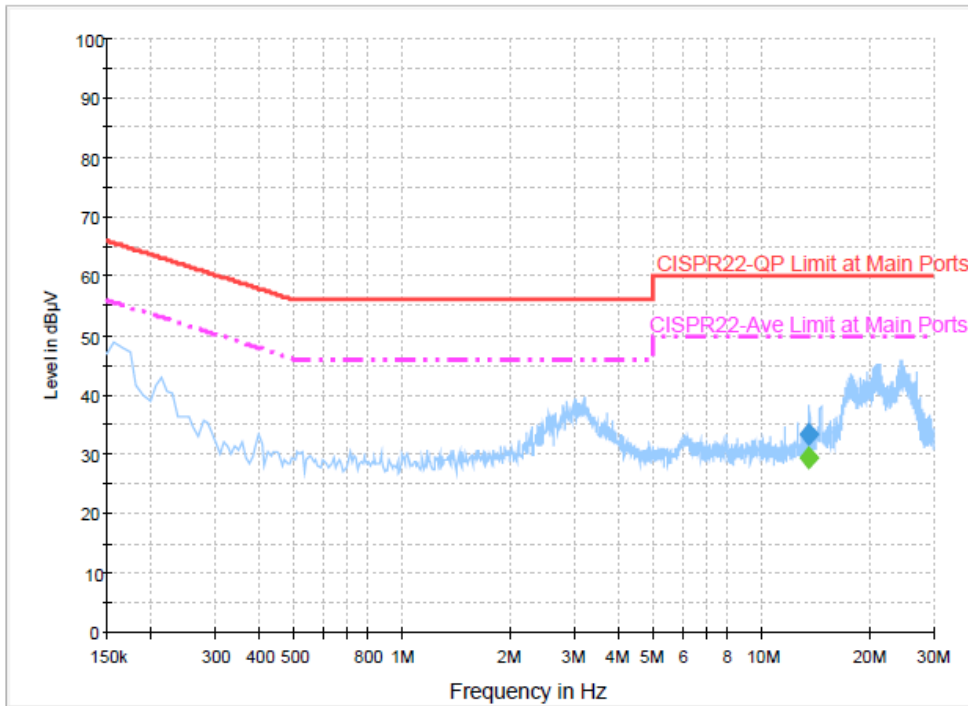

Final Result : Quasi-Peak

Frequency (MHz)	Quasi-Peak (dBµV)	Filter	Line	Corr. (dB)	Margin (dB)	Limit (dBµV)
13.558000	33.3	Off	L1	19.9	26.7	60.0

Final Result : Average

Frequency (MHz)	Average (dBµV)	Filter	Line	Corr. (dB)	Margin (dB)	Limit (dBµV)
13.558000	29.5	Off	L1	19.9	20.5	50.0



<Terminal Test Result>

Test Mode :	Mode 1	Temperature :	21~23°C
Test Engineer :	Eric Jeng	Relative Humidity :	46~48%
Test Voltage :	120Vac / 60Hz	Phase :	Neutral
Function Type :	WLAN Link + Bluetooth Link + MSR On (Micro USB at bottom side) + RJ-45 (Load) + MPEG4 + RFID On (Micro USB at right side) + TC + Adapter 2		

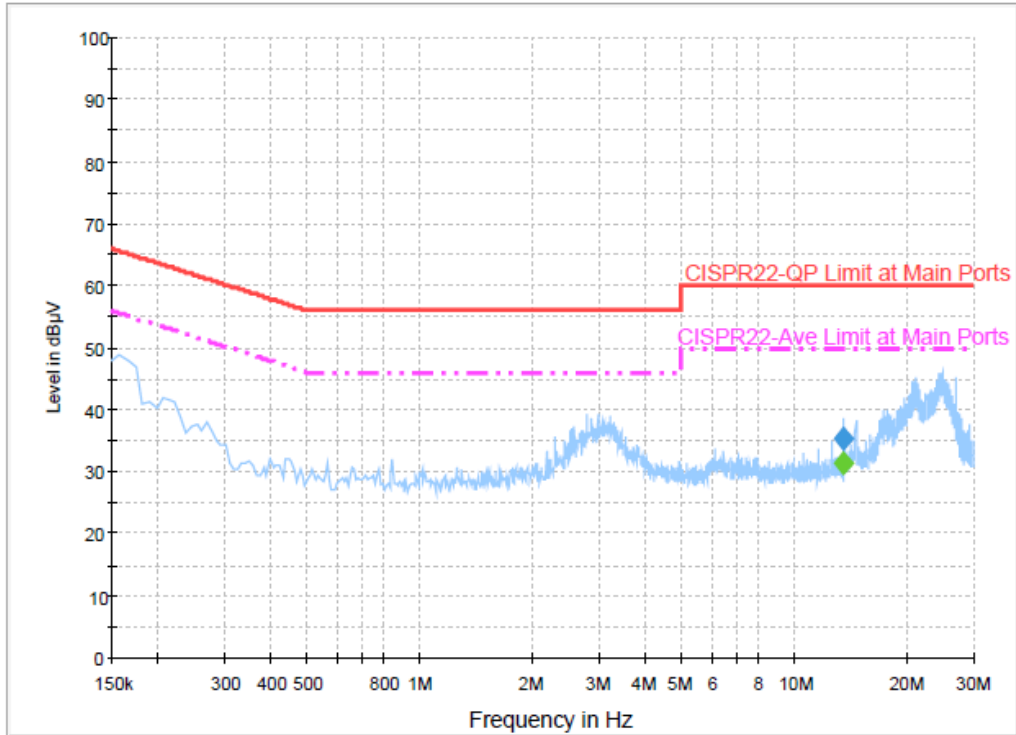

Final Result : Quasi-Peak

Frequency (MHz)	Quasi-Peak (dBµV)	Filter	Line	Corr. (dB)	Margin (dB)	Limit (dBµV)
13.558000	35.4	Off	N	19.9	24.6	60.0

Final Result : Average

Frequency (MHz)	Average (dBµV)	Filter	Line	Corr. (dB)	Margin (dB)	Limit (dBµV)
13.558000	31.2	Off	N	19.9	18.8	50.0



3.3 Antenna Requirements

3.3.1 Standard Applicable

If directional gain of transmitting antennas is greater than 6dBi, the power shall be reduced by the same level in dB comparing to gain minus 6dBi. The use of a permanently attached antenna or of an antenna that uses a unique coupling to the intentional radiator shall be considered sufficient to comply with the FCC rule.

3.3.2 Antenna Anti-Replacement Construction

An embedded-in antenna design is used.

3.3.3 Antenna Gain

The antenna peak gain of EUT is less than 6 dBi. Therefore, it is not necessary to reduce maximum peak output power limit.



4 List of Measuring Equipment

Instrument	Manufacturer	Model No.	Serial No.	Characteristics	Calibration Date	Test Date	Due Date	Remark
Power Meter	Agilent	E4416A	GB412923 44	300MHz~40GHz	Jan. 28, 2014	Dec. 15, 2014	Jan. 27, 2015	Conducted (TH02-HY)
Power Sensor	Agilent	E9327A	US404415 48	300MHz~40GHz	Jan. 28, 2014	Dec. 15, 2014	Jan. 27, 2015	Conducted (TH02-HY)
EMI Test Receiver	Rohde & Schwarz	ESCI 7	100724	9 kHz~7 GHz	Aug. 30, 2014	Dec. 23, 2014 ~ Dec. 28, 2014	Aug. 29, 2015	Radiation (03CH07-HY)
Spectrum Analyzer	Rohde & Schwarz	FSV30	101749	10Hz ~ 30GHz	Feb. 10, 2014	Dec. 23, 2014 ~ Dec. 28, 2014	Feb. 09, 2015	Radiation (03CH07-HY)
Loop Antenna	R&S	HFH2-Z2	100315	9 kHz~30 MHz	Jul. 28, 2014	Dec. 23, 2014 ~ Dec. 28, 2014	Jul. 27, 2015	Radiation (03CH07-HY)
Bilog Antenna	Schaffner	CBL6111C	2726	30MHz ~ 1GHz	Sep. 27, 2014	Dec. 23, 2014 ~ Dec. 28, 2014	Sep. 26, 2015	Radiation (03CH07-HY)
Double Ridge Horn Antenna	ESCO	3117	75962	1GHz~18GHz	Aug. 19, 2014	Dec. 23, 2014 ~ Dec. 28, 2014	Aug. 18, 2015	Radiation (03CH07-HY)
SHF-EHF Horn Antenna	SCHWARZBECK	BBHA 9170	BBHA9170 251	18GHz~40GHz	Oct. 02, 2014	Dec. 23, 2014 ~ Dec. 28, 2014	Oct. 01, 2015	Radiation (03CH07-HY)
Preamplifier	COM-POWER	PA-103A	161241	10 MHz ~ 1000MHz	Mar. 17, 2014	Dec. 23, 2014 ~ Dec. 28, 2014	Mar. 16, 2015	Radiation (03CH07-HY)
Preamplifier	Agilent	8449B	3008A023 62	1 GHz~26.5 GHz	Oct. 21, 2014	Dec. 23, 2014 ~ Dec. 28, 2014	Oct. 20, 2015	Radiation (03CH07-HY)
Preamplifier	MITEQ	AMF-7D-0010 1800-30-10P	1590074	DC~18 GHz	Jul. 07, 2014	Dec. 23, 2014 ~ Dec. 28, 2014	Jul. 06, 2015	Radiation (03CH07-HY)
Preamplifier	MITEQ	AMF-7D-0010 1800-30-10P	1590075	DC~18 GHz	Apr. 21, 2014	Dec. 23, 2014 ~ Dec. 28, 2014	Apr. 20, 2015	Radiation (03CH07-HY)
Turn Table	ChainTek	ChainTek 3000	N/A	0 ~ 360 degree	N/A	Dec. 23, 2014 ~ Dec. 28, 2014	N/A	Radiation (03CH07-HY)
Antenna Mast	ChainTek	ChainTek 3000	N/A	N/A	N/A	Dec. 23, 2014 ~ Dec. 28, 2014	N/A	Radiation (03CH07-HY)
EMI Test Receiver	Rohde & Schwarz	ESCS 30	100356	9kHz ~ 2.75GHz	Dec. 01, 2014	Dec. 22, 2014	Nov. 30, 2015	Conduction (CO05-HY)
LISN (for auxiliary equipment)	Rohde & Schwarz	ENV216	100081	9kHz ~ 30MHz	Dec. 08, 2014	Dec. 22, 2014	Dec. 07, 2015	Conduction (CO05-HY)
LISN	Rohde & Schwarz	ENV216	100080	9kHz ~ 30MHz	Dec. 02, 2014	Dec. 22, 2014	Dec. 01, 2015	Conduction (CO05-HY)
AC Power Source	ChainTek	APC-1000W	N/A	N/A	N/A	Dec. 22, 2014	N/A	Conduction (CO05-HY)



5 Uncertainty of Evaluation

Uncertainty of Conducted Emission Measurement (150 kHz ~ 30 MHz)

Measuring Uncertainty for a Level of Confidence of 95% ($U = 2Uc(y)$)	2.26
---	------

Uncertainty of Radiated Emission Measurement (30 MHz ~ 1000 MHz)

Measuring Uncertainty for a Level of Confidence of 95% ($U = 2Uc(y)$)	4.50
---	------