



# FCC RADIO TEST REPORT

Applicant : Elo Touch Solutions, Inc.  
Address : 670 N. McCarthy Blvd., Suite 100, Milpitas,  
CA 95035, USA  
Equipment : Touch All-in-One Computer  
Model No. : ESY10I1D  
Trade Name : Elo or   
FCC ID : RBWESY10I1D

**I HEREBY CERTIFY THAT :**

The sample was received on Dec. 19, 2022 and the testing was completed on Jan. 05, 2023 at CerpPASS Technology Corp. The test result refers exclusively to the test presented test model / sample. Without written approval of CerpPASS Technology Corp., the test report shall not be reproduced except in full.

Approved by:



Mark Liao / Supervisor

Laboratory Accreditation:

CerpPASS Technology Corporation Test Laboratory





CONTENTS

- 1. Summary of Test Procedure and Test Results ..... 5
  - 1.1. Applicable Standards .....5
- 2. Test Configuration of Equipment under Test ..... 6
  - 2.1. Feature of Equipment under Test.....6
  - 2.2. Carrier Frequency of Channels ..... 7
  - 2.3. Test Mode and Test Software .....9
  - 2.4. Description of Test System..... 11
  - 2.5. General Information of Test..... 12
  - 2.6. Measurement Uncertainty ..... 13
- 3. Test Equipment and Ancillaries Used for Tests ..... 14
- 4. Antenna Requirements ..... 16
  - 4.1. Standard Applicable ..... 16
  - 4.2. Antenna Construction and Directional Gain..... 16
- 5. Test of AC Power Line Conducted Emission ..... 17
  - 5.1. Test Limit ..... 17
  - 5.2. Test Procedures ..... 17
  - 5.3. Typical Test Setup ..... 18
  - 5.4. Test Result and Data..... 19
  - 5.5. Test Photographs ..... 21
- 6. Test of Spurious Emission (Radiated)..... 22
  - 6.1. Test Limit ..... 22
  - 6.2. Test Procedures ..... 23
  - 6.3. Typical Test Setup ..... 24
  - 6.4. Test Result and Data (9kHz ~ 30MHz)..... 25
  - 6.5. Test Result and Data (30MHz ~ 1GHz) ..... 25
  - 6.6. Test Result and Data (1GHz ~ 40GHz)..... 27
  - 6.7. Restricted Bands of Operation ..... 111
  - 6.8. Test Photographs (30MHz ~ 1GHz) ..... 112
  - 6.9. Test Photographs (1GHz ~ 40GHz) ..... 113
- 7. On Time, Duty Cycle and Measurement methods ..... 115
  - 7.1. Test Limit ..... 115
  - 7.2. Test Procedure ..... 115
  - 7.3. Test Setup Layout ..... 115
  - 7.4. Test Result and Data..... 116
  - 7.5. Measurement Methods ..... 116
- 8. 6dB Bandwidth & 99% Occupied Bandwidth ..... 118
  - 8.1. Test Limit ..... 118
  - 8.2. Test Procedure ..... 118
  - 8.3. Test Setup Layout ..... 118
  - 8.4. Test Result and Data..... 119
- 9. 26dB Bandwidth & 99% Occupied Bandwidth ..... 133
  - 9.1. Test Limit ..... 133



- 9.2. Test Procedure ..... 133
- 9.3. Test Setup Layout ..... 133
- 9.4. Test Result and Data ..... 134
- 10. Average Power..... 166
  - 10.1. Test Limit ..... 166
  - 10.2. Test Procedure ..... 167
  - 10.3. Test Setup Layout ..... 167
  - 10.4. Test Result and Data..... 168
- 11. Power Spectral Density ..... 176
  - 11.1. Test Limit ..... 176
  - 11.2. Test Procedure ..... 176
  - 11.3. Test Setup Layout ..... 176
  - 11.4. Test Result and Data..... 177
- 12. Radio Frequency Exposure ..... 197
  - 12.1. Applicable Standards ..... 197
  - 12.2. EUT Specification..... 198
  - 12.3. Result ..... 198



### History of this test report

Report No.	Issued Date	Description
21030198-TRFCC04	Jan. 05, 2023	Original

Report Type	Description
<input type="checkbox"/> Original report	NA
<input checked="" type="checkbox"/> Derivative Report	<p>Both ESY10I1D (Cerpass project Number: 21030198) and ESY22I1D (Cerpass project Number: 21030199) use the same RF component design.</p> <p>Compared with ESY22I1D, ESY10I1D has smaller size, fewer electronic components and a little different antenna gain.</p> <p>After verification pretest data of ESY10I1D, ESY22I1D by the laboratory, ESY22I1D is the worst case in terms of EMC and RF data.</p> <p>Therefore, we measure Power, PSD, RSE and AC conduction, other emission data perform from ESY22I1D.</p>



# 1. Summary of Test Procedure and Test Results

## 1.1. Applicable Standards

**ANSI C63.10:2013**

**FCC Rules and Regulations Part 15 Subpart E §15.407**

**KDB 789033**

FCC Rule	Description of Test	Result
15.203	Antenna Requirement	PASS
15.207(a)	AC Power Line Conducted Emission	PASS
15.407(b) 15.209	Radiated Spurious Emission	PASS
15.407(a)	26 dB & Occupied Bandwidth	PASS
15.407	6 dB Bandwidth	PASS
15.407 (a) & (a)(3)	Average Power	PASS
15.407(a)	Power Spectral Density	PASS
2.1091	Radio Frequency Exposure	PASS

\*The lab has reduced the uncertainty risk factor from test equipment, environment and staff technicians which according to the standard on contract. Therefore, the test result will only be determined by standard requirement.



## 2. Test Configuration of Equipment under Test

### 2.1. Feature of Equipment under Test

Operation Frequency Range	BT / BLE: 2400-2483.5MHz 802.11b/g/n: 2400-2483.5MHz 802.11a/n/ac: 5150-5250MHz, 5250-5350MHz, 5470-5725MHz, 5725-5850MHz
Center Frequency Range	BT / BLE: 2402MHz-2480MHz 802.11b/g/n: 2412MHz-2462MHz 802.11a/n/ac: 5180-5240MHz, 5260-5320MHz, 5500-5700MHz, 5745-5825MHz
Modulation Type	BT: GFSK, $\pi/4$ -DQPSK, 8DPSK BLE: GFSK WLAN: 802.11b: CCK, DQPSK, DBPSK 802.11g/n: BPSK, QPSK, 16QAM, 64QAM 802.11a: BPSK, QPSK, 16QAM, 64QAM 802.11ac: BPSK, QPSK, 16QAM, 64QAM, 256QAM
Modulation Technology	DSSS, OFDM, FHSS, DTS
Data Rate	BT: GFSK: 1Mbps, $\pi/4$ -DQPSK: 2Mbps, 8DPSK: 3Mbps BLE: GFSK: 1Mbps WLAN: 2.4GHz: 802.11b: 1, 2, 5.5, 11Mbps 802.11g: 6, 9, 12, 18, 24, 36, 48, 54Mbps 802.11n: MCS0 – MCS15, HT20 5GHz: 802.11a: 6, 9, 12, 18, 24, 36, 48, 54Mbps 802.11n: MCS0 – MCS15, HT20/40 802.11ac: MCS0 – MCS9, VHT20/40/80
Antenna Type	Dipole Antenna
Antenna Gain	For BT / BLE: 2400-2480MHz: ANT A: 3.53dBi For WLAN: 2400-2500MHz: ANT A: 3.53dBi, ANT B: 2.11dBi 5150-5250MHz: ANT A: 4.23dBi, ANT B: 2.96dBi 5250-5350MHz: ANT A: 3.94dBi, ANT B: 3.32dBi 5470-5725MHz: ANT A: 3.71dBi, ANT B: 3.67dBi 5725-5850MHz: ANT A: 3.35dBi, ANT B: 3.24dBi
Adapter	Brand: DELTA Model: ADP-65JH HB

Note:

1. EUT support TPC Function.
2. EUT support Client Mode.
3. EUT WLAN 2.4GHz 802.11b and 802.11g 1TX diversity
4. WLAN and BT can simultaneously transmission.
5. For more details, please refer to the User's manual of the EUT.



## 2.2. Carrier Frequency of Channels

Band: 5150MHz-5250MHz

802.11a, 802.11n HT20, 802.11ac VHT20

Channel	Frequency(MHz)	Channel	Frequency(MHz)
<b>*36</b>	<b>5180</b>	44	5220
<b>*40</b>	<b>5200</b>	<b>*48</b>	<b>5240</b>

802.11n HT40, 802.11ac VHT40

Channel	Frequency(MHz)	Channel	Frequency(MHz)
<b>*38</b>	<b>5190</b>	<b>*46</b>	<b>5230</b>

802.11ac VHT80

Channel	Frequency(MHz)
<b>*42</b>	<b>5210</b>

Band: 5250MHz-5350MHz

802.11a, 802.11n HT20, 802.11ac VHT20

Channel	Frequency(MHz)	Channel	Frequency(MHz)
<b>*52</b>	<b>5260</b>	<b>*60</b>	<b>5300</b>
56	5280	<b>*64</b>	<b>5320</b>

802.11n HT40, 802.11ac VHT40

Channel	Frequency(MHz)	Channel	Frequency(MHz)
<b>*54</b>	<b>5270</b>	<b>*62</b>	<b>5310</b>

802.11ac VHT80

Channel	Frequency(MHz)
<b>*58</b>	<b>5290</b>

Band: 5470MHz-5725MHz

802.11a, 802.11n HT20, 802.11ac VHT20

Channel	Frequency(MHz)	Channel	Frequency(MHz)
<b>*100</b>	<b>5500</b>	124	5620
104	5520	128	5640
108	5540	132	5660
112	5560	136	5680
116	5580	<b>*140</b>	<b>5700</b>
<b>*120</b>	<b>5600</b>		

802.11n HT40, 802.11ac VHT40

Channel	Frequency(MHz)	Channel	Frequency(MHz)
<b>*102</b>	<b>5510</b>	126	5630
110	5550	<b>*134</b>	<b>5670</b>
<b>*118</b>	<b>5590</b>		

802.11ac VHT80

Channel	Frequency(MHz)	Channel	Frequency(MHz)
<b>*106</b>	<b>5530</b>	<b>*122</b>	<b>5610</b>



Band 3: Straddle Channel

802.11a, 802.11n HT 20, 802.11ac VHT20

Channel	Frequency(MHz)
<b>*144</b>	<b>5720</b>

802.11n HT40, 802.11ac VHT40

Channel	Frequency(MHz)
<b>*142</b>	<b>5710</b>

802.11ac VHT80

Channel	Frequency(MHz)
<b>*138</b>	<b>5690</b>

Band: 5725MHz-5850MHz

802.11a, 802.11n HT20, 802.11ac VHT20

Channel	Frequency(MHz)	Channel	Frequency(MHz)
<b>*149</b>	<b>5745</b>	161	5805
153	5765	<b>*165</b>	<b>5825</b>
<b>*157</b>	<b>5785</b>		

802.11n HT40, 802.11ac VHT40

Channel	Frequency(MHz)	Channel	Frequency(MHz)
<b>*151</b>	<b>5755</b>	<b>*159</b>	<b>5795</b>

802.11ac VHT80

Channel	Frequency(MHz)
<b>*155</b>	<b>5775</b>

Note: Channels remarked \* are selected to perform test.





### 2.3. Test Mode and Test Software

- a. During testing, the interface cables and equipment positions were varied according to ANSI C63.10.
- b. The complete test system included remote workstation and EUT for RF test. The remote workstation included Notebook.
- c. An executive program, " QRCT ver.4.0.00193.0" under Windows OS system was executed to transmit and receive data via WLAN.
- d. The following test modes were performed for the test:

Conducted Emissions from the AC mains power ports	
Test Mode	Operating Description
1	802.11a (6Mbps) , From Adapter
2	802.11n HT20 (6.5Mbps) , From Adapter
3	802.11n HT40 (13.5Mbps) , From Adapter
4	802.11ac VHT20 (6.5Mbps) , From Adapter
5	802.11ac VHT40 (13.5Mbps) , From Adapter
6	802.11ac VHT80 (29.3Mbps) , From Adapter
caused "Test Mode 4" generated the worst case, it was reported as the final data.	
Radiation Emissions (Below 1GHz)	
Test Mode	Operating Description
1	802.11a (6Mbps) , From Adapter
2	802.11n HT20 (6.5Mbps) , From Adapter
3	802.11n HT40 (13.5Mbps) , From Adapter
4	802.11ac VHT20 (6.5Mbps) , From Adapter
5	802.11ac VHT40 (13.5Mbps) , From Adapter
6	802.11ac VHT80 (29.3Mbps) , From Adapter
caused "Test Mode 4" generated the worst case, it was reported as the final data.	
Radiation Emissions (Above 1GHz)	
Test Mode	Operating Description
1	802.11a (6Mbps) , From Adapter
2	802.11n HT20 (6.5Mbps) , From Adapter
3	802.11n HT40 (13.5Mbps) , From Adapter
4	802.11ac VHT20 (6.5Mbps) , From Adapter
5	802.11ac VHT40 (13.5Mbps) , From Adapter
6	802.11ac VHT80 (29.3Mbps) , From Adapter
caused "Test Mode 1,4~6" generated the worst case, they were reported as the final data.	

Note: There are two kinds of test voltage: AC 120V / 60Hz and AC 240V / 60Hz.  
 For AC Power Line Conducted Emission, AC 120V / 60Hz is worst case.  
 For Radiated Spurious Emission, AC 120V / 60Hz is worst case.



The EUT incorporates a MIMO function

Modulation Type	TX CONFIGURATION
802.11a	2TX
802.11n HT20	2TX
802.11n HT40	2TX
802.11ac VHT20	2TX
802.11ac VHT40	2TX
802.11ac VHT80	2TX



### 2.4. Description of Test System

RF Conducted				
Equipment	Brand	Model	Length/Type	Power cord/Length/Type
Notebook	lenovo	S1GL2W	N/A	Adapter / 1.8m / NS
USB cable	BENEVO	E210567AWM	N/A	0.6m / NS
Radiated Emissions				
Equipment	Brand	Model	Length/Type	Power cord/Length/Type
Notebook	lenovo	S1GL2W	N/A	Adapter / 1.8m / NS
USB cable	BENEVO	E210567AWM	N/A	0.6m / NS
AC Power Line Conducted Emission				
Equipment	Brand	Model	Length/Type	Power cord/Length/Type
Notebook	lenovo	S1GL2W	N/A	Adapter / 1.8m / NS
USB cable	BENEVO	E210567AWM	N/A	0.6m / NS

**2.5. General Information of Test**

Test Site	<b>Cerpass Technology Corporation Test Laboratory</b> Address: No.10, Ln. 2, Lianfu St., Luzhu Dist., Taoyuan City 33848, Taiwan (R.O.C.) Tel:+886-3-3226-888 Fax:+886-3-3226-881	
	FCC	TW1439, TW1079
	IC	4934E-1, 4934E-2
	VCCI	T-2205 for Telecommunication test C-4663 for Conducted emission test R-4218 for Radiated emission test G-10812, G-10813 for radiated disturbance above 1GHz
Frequency Range Investigated:	Conducted: from 150kHz to 30 MHz Radiation: from 30 MHz to 40,000MHz	
Test Distance:	The test distance of radiated emission from antenna to EUT is 3 M.	

Test Item	Test Site	Test period	Environmental Conditions	Tested By
RF Conducted	RFCON01-NK	2022/12/27~2023/1/5	21.5~23.1°C / 48~51%	Leon Huang
Radiated Emissions	3M02-NK	2022/12/19	16°C / 44%	Leon Huang
AC Power Line Conducted Emission	CON01-NK	2022/12/20	21°C / 66%	Leon Huang



## 2.6. Measurement Uncertainty

ISO/IEC 17025 requires that an estimate of the measurement uncertainties associated with the emissions test results be included in the report. The measurement uncertainties given below are based on a 95% confidence level (based on a coverage factor (k=2))

Measurement Item	Uncertainty
AC Power Line Conduction(150K~30MHz)	±3.12dB
Radiated Spurious Emission(9KHz~30MHz)	±3.4dB
Radiated Spurious Emission(30MHz~1GHz)	±5.7dB
Radiated Spurious Emission(1GHz~40GHz)	±6.8dB
6dB Bandwidth	±4.4%
26dB Bandwidth	±4.4%
Occupied Bandwidth	±4.4%
Peak Output Power(Conducted Power Meter)	±1.1dB
Power Spectral Density	±1.8dB
Duty Cycle	±1.2%
Frequency Stability	±0.21KHz



### 3. Test Equipment and Ancillaries Used for Tests

Test Item	Radiated Emissions				
Test Site	Semi Anechoic Room(3M02-NK)				
Instrument	Manufacturer	Model No	Serial No	Calibration Date	Valid Date
Bilog Antenna	Schwarzbeck	VULB9168	369	2022/04/22	2023/04/21
Active Loop Antenna	EMCO	6507	40855	2022/05/25	2023/05/24
Horn Antenna	EMCO	3115	31601	2022/10/12	2023/10/11
Horn Antenna	EMCO	3116	31970	2022/03/18	2023/03/17
EMI Receiver	ROHDE & SCHWARZ	ESCI	101423	2022/07/05	2023/07/04
Spectrum Analyzer	ROHDE & SCHWARZ	FSV 40-N	102151	2022/08/19	2023/08/18
Preamplifier	Agilent	8449B	3008A01954	2022/03/17	2023/03/16
Preamplifier	EMC INSTRUMENTS	EMC184045	980065	2022/11/11	2023/11/10
Preamplifier	EM Electronics corp.	EM330	60660	2022/04/08	2023/04/07
Cable-6m(9k~300M)	NA	EMC5D-BM-BM-6	130605	2022/09/06	2023/09/05
Cable-3in1(30M-1G)	HARBOUR INDUSTRIES	LL142	CCE1315	2022/03/21	2023/03/20
Cable-0.5m(1G-40G)	HUBER SUHNER	SUCOFLEX 104	805443/4	2022/01/11	2023/01/10
Cable-3m(1G-40G)	HUBER SUHNER	SUCOFLEX 104	805796/4	2022/01/11	2023/01/10
Cable-8m(1G-26.5G)	WOKEN	WCBA-WCA203SM	CCE1374	2022/04/25	2023/04/24
Cable-0.5m(30M-40G)	HUBER SUHNER	SUCOFLEX 102	28420/2	2022/4/9	2023/4/8
Cable-3m(30M-40G)	HUBER SUHNER	SUCOFLEX 102	MY2608/2	2022/4/9	2023/4/8
Cable-0.5m(1G-40G)	Rapidtek	40GHZ 50CM	38MS-38MS50314	2022/4/9	2023/4/8
Cable-3m(1G-40G)	Rapidtek	40GHZ 300CM	38MS-38MS300314	2022/4/9	2023/4/8
E3	AUDIX	v8.2014-8-6	RK-000529	NA	NA

Test Item	RF Conducted				
Test Site	RFCON01-NK				
Instrument	Manufacturer	Model No	Serial No	Calibration Date	Valid Date
CAX Signal Analyzer	KEYSIGHT	N9000B	MY57100339	2022/11/29	2023/11/28
Power Meter	Anritsu	ML2495A	1224005	2022/04/12	2023/04/11
Power Sensor	Anritsu	MA2411B	1207295	2022/04/12	2023/04/11
Attenuator	KEYSIGHT	8491B	MY39250703	2022/04/12	2023/04/11



<b>Test Item</b>	AC Power Line Conducted Emission				
<b>Test Site</b>	CON01-NK				
<b>Instrument</b>	<b>Manufacturer</b>	<b>Model No</b>	<b>Serial No</b>	<b>Calibration Date</b>	<b>Valid Date</b>
EMI Receiver	ROHDE & SCHWARZ	ESCI	101200	2022/08/22	2023/08/21
Line Impedance Stabilization Network	Schwarzbeck	NSLK 8127	8127-740	2022/08/21	2023/08/20
Pulse Limiter	ROHDE & SCHWARZ	ESH3-Z2	101934	2022/03/21	2023/03/20
Cable-6m(9k~300M)	NA	EMC5D-BM-BM-6	130606	2022/03/21	2023/03/20
E3	AUDIX	v8.2014-8-6	RK-000531	NA	NA



## 4. Antenna Requirements

### 4.1. Standard Applicable

For intentional device, according to FCC 47 CFR Section 15.203, an intentional radiator shall be designed to ensure that no antenna other than that furnished by the responsible party shall be used with the device.

And according to FCC 47 CFR Section 15.407 (a), if transmitting antennas of directional gain greater than 6dBi are used, the power shall be reduced by the amount in dB that the directional gain of the antenna exceeds 6dBi.

### 4.2. Antenna Construction and Directional Gain

Antenna Type	Dipole Antenna
Antenna Gain	5150-5250MHz: ANT A: 4.23dBi, ANT B: 2.96dBi 5250-5350MHz: ANT A: 3.94dBi, ANT B: 3.32dBi 5470-5725MHz: ANT A: 3.71dBi, ANT B: 3.67dBi 5725-5850MHz: ANT A: 3.35dBi, ANT B: 3.24dBi

5150MHz -5250MHz
For Power directional gain= $G_{ant}= 4.23\text{dBi}$ For PSD directional gain = $10 \log[(10^{G1/20} + 10^{G2/20} + \dots + 10^{GN/20})^2 / N_{ANT}]$ = 6.63 dBi
5250MHz -5350MHz
For Power directional gain= $G_{ant}= 3.94\text{dBi}$ For PSD directional gain = $10 \log[(10^{G1/20} + 10^{G2/20} + \dots + 10^{GN/20})^2 / N_{ANT}]$ = 6.65 dBi
5470MHz -5725MHz
For Power directional gain= $G_{ant}= 3.71\text{dBi}$ For PSD directional gain = $10 \log[(10^{G1/20} + 10^{G2/20} + \dots + 10^{GN/20})^2 / N_{ANT}]$ = 6.70 dBi
5725MHz -5850MHz
For Power directional gain= $G_{ant}= 3.35 \text{ dBi}$ For PSD directional gain = $10 \log[(10^{G1/20} + 10^{G2/20} + \dots + 10^{GN/20})^2 / N_{ANT}]$ = 6.31 dBi

\*MIMO type: Cyclic Delay Diversity (CDD) mode.





## 5. Test of AC Power Line Conducted Emission

### 5.1. Test Limit

Conducted Emissions were measured from 150 kHz to 30 MHz with a bandwidth of 9 KHz, according to the methods defined in ANSI C63.10-2013. The EUT was placed on a nonmetallic stand in a shielded room 0.8 meters above the ground plane. The interface cables and equipment positioning were varied within limits of reasonable applications to determine the position produced maximum conducted emissions.

Frequency (MHz)	Quasi Peak (dB $\mu$ V)	Average (dB $\mu$ V)
0.15 – 0.5	66-56*	56-46*
0.5 – 5.0	56	46
5.0 – 30.0	60	50

\*Decreases with the logarithm of the frequency.

### 5.2. Test Procedures

- The EUT was placed 0.4 meter from the conducting wall of the shielding room was kept at least 80 centimeters from any other grounded conducting surface.
- Connect EUT to the power mains through a line impedance stabilization network (LISN).
- All the support units are connecting to the other LISN.
- The LISN provides 50 ohm coupling impedance for the measuring instrument.
- The FCC states that a 50 ohm, 50 micro-Henry LISN should be used.
- Both sides of AC line were checked for maximum conducted interference.
- The frequency range from 150 kHz to 30 MHz was searched.
- Set the test-receiver system to Peak Detect Function and Specified Bandwidth with Maximum Hold Mode.



### 5.3. Typical Test Setup

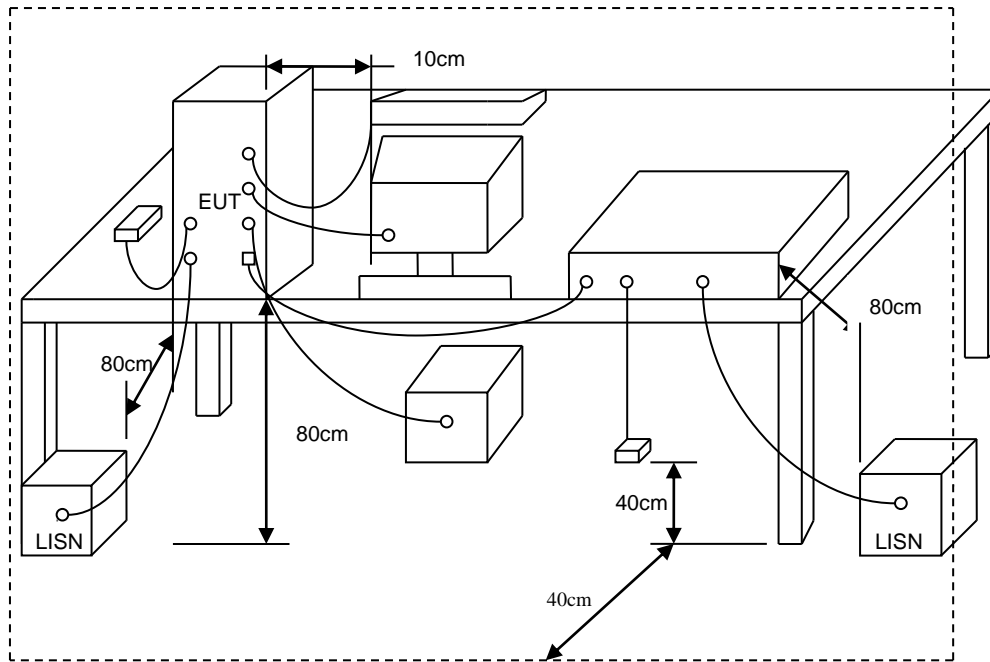



5.4. Test Result and Data

Power	: DC From Adapter (AC 120V / 60Hz)	Pol/Phase	: LINE
Test Mode	: Mode 4		:

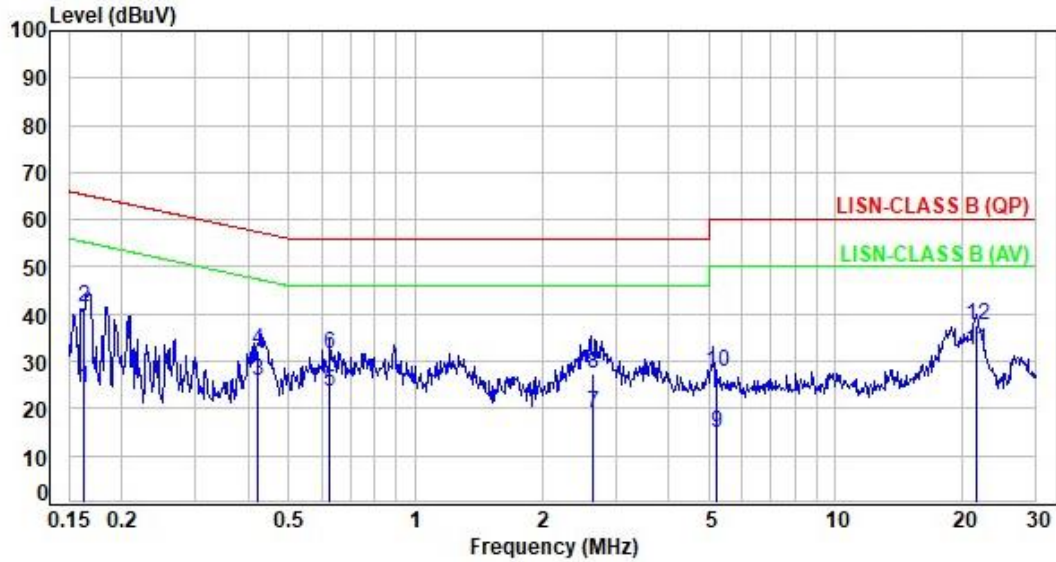

No.	Frequency (MHz)	Factor (dB)	Reading (dBuV)	Level (dBuV)	Limit (dBuV)	Margin (dB)	Detector	P/F
1	0.16	19.46	4.96	24.42	55.35	-30.93	Average	P
2	0.16	19.46	21.91	41.37	65.35	-23.98	QP	P
3	0.42	19.44	6.57	26.01	47.42	-21.41	Average	P
4	0.42	19.44	13.01	32.45	57.42	-24.97	QP	P
5	0.63	19.43	4.09	23.52	46.00	-22.48	Average	P
6	0.63	19.43	12.21	31.64	56.00	-24.36	QP	P
7	2.66	19.39	-0.44	18.95	46.00	-27.05	Average	P
8	2.66	19.39	7.95	27.34	56.00	-28.66	QP	P
9	5.22	19.38	-4.63	14.75	50.00	-35.25	Average	P
10	5.22	19.38	8.55	27.93	60.00	-32.07	QP	P
11	21.65	19.37	13.06	32.43	50.00	-17.57	Average	P
12	21.65	19.37	18.28	37.65	60.00	-22.35	QP	P

Note: Level=Reading+Factor  
Margin=Level-Limit  
Factor=(LISN or ISN or Current Probe)Factor + Cable Loss



Power	: DC From Adapter (AC 120V / 60Hz)	Pol/Phase	: NEUTRAL
Test Mode	: Mode 4		:

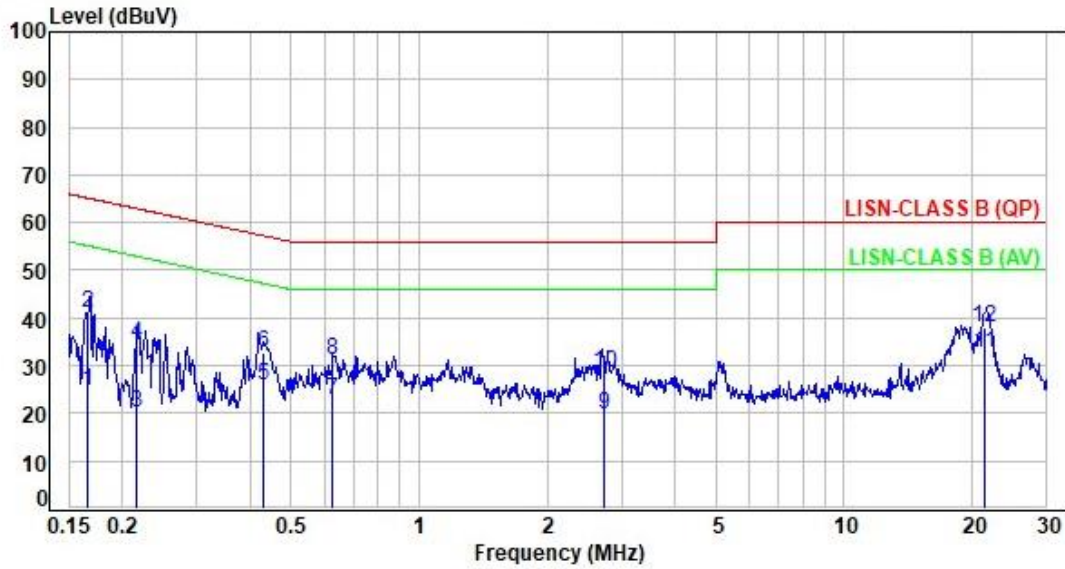

No.	Frequency (MHz)	Factor (dB)	Reading (dBuV)	Level (dBuV)	Limit (dBuV)	Margin (dB)	Detector	P/F
1	0.17	19.47	5.08	24.55	55.20	-30.65	Average	P
2	0.17	19.47	21.46	40.93	65.20	-24.27	QP	P
3	0.22	19.46	0.71	20.17	52.94	-32.77	Average	P
4	0.22	19.46	15.17	34.63	62.94	-28.31	QP	P
5	0.43	19.44	6.58	26.02	47.27	-21.25	Average	P
6	0.43	19.44	13.15	32.59	57.27	-24.68	QP	P
7	0.63	19.43	3.37	22.80	46.00	-23.20	Average	P
8	0.63	19.43	11.60	31.03	56.00	-24.97	QP	P
9	2.72	19.37	0.30	19.67	46.00	-26.33	Average	P
10	2.72	19.37	8.96	28.33	56.00	-27.67	QP	P
11	21.34	19.40	13.24	32.64	50.00	-17.36	Average	P
12	21.34	19.40	18.64	38.04	60.00	-21.96	QP	P

Note: Level=Reading+Factor  
 Margin=Level-Limit  
 Factor=(LISN or ISN or Current Probe)Factor + Cable Loss



## 6. Test of Spurious Emission (Radiated)

### 6.1. Test Limit

Undesirable emission limits. Except as shown in paragraph (b)(7) of this section, the maximum emissions outside of the frequency bands of operation shall be attenuated in accordance with the following limits:

- (1) For transmitters operating in the 5.15-5.25 GHz band: All emissions outside of the 5.15-5.35 GHz band shall not exceed an e.i.r.p. of  $-27$  dBm/MHz.
- (2) For transmitters operating in the 5.25-5.35 GHz band: All emissions outside of the 5.15-5.35 GHz band shall not exceed an e.i.r.p. of  $-27$  dBm/MHz.
- (3) For transmitters operating in the 5.47-5.725 GHz band: All emissions outside of the 5.47-5.725 GHz band shall not exceed an e.i.r.p. of  $-27$  dBm/MHz.
- (4) For transmitters operating in the 5.725-5.85 GHz band:  
All emissions shall be limited to a level of  $-27$  dBm/MHz at 75 MHz or more above or below the band edge increasing linearly to 10 dBm/MHz at 25 MHz above or below the band edge, and from 25MHz above or below the band edge increasing linearly to a level of 15.6 dBm/MHz at 5 MHz above or below the band edge, and from 5 MHz above or below the band edge increasing linearly to a level of 27dBm/MHz at the band edge.
- (5) The emission measurements shall be performed using a minimum resolution bandwidth of 1 MHz. A lower resolution bandwidth may be employed near the band edge, when necessary, provided the measured energy is integrated to show the total power over 1 MHz.
- (6) Unwanted emissions below 1 GHz must comply with the general field strength limits set forth in §15.209. Further, any U-NII devices using an AC power line are required to comply also with the conducted limits set forth in §15.207.
- (7) The provisions of §15.205 apply to intentional radiators operating under this section.
- (8) When measuring the emission limits, the nominal carrier frequency shall be adjusted as close to the upper and lower frequency band edges as the design of the equipment permits.



## 6.2. Test Procedures

- a. The EUT was placed on a rotatable table top 0.8 meter above ground.
- b. The EUT was set 3 meters from the interference receiving antenna which was mounted on the top of a variable height antenna tower.
- c. The table was rotated 360 degrees to determine the position of the highest radiation.
- d. The antenna is a broadband antenna and its height is varied between one meter and four meters above ground to find the maximum value of the field strength both horizontal polarization and vertical polarization of the antenna are set to make the measurement.
- e. For each suspected emission the EUT was arranged to its worst case and then tune the antenna tower (from 1 M to 4 M) and turn table (from 0 degree to 360 degrees) to find the maximum reading.
- f. Set the test-receiver system to Peak or CISPR quasi-peak Detect Function and specified bandwidth with Maximum Hold Mode.
- g. If the emission level of the EUT in peak mode was 3 dB lower than the limit specified, then testing will be stopped and peak values of EUT will be reported, otherwise, the emissions which do not have 3 dB margin will be repeated one by one using the quasi-peak method and reported.
- h. For testing above 1GHz, the emission level of the EUT in peak mode was 20dB lower than average limit (that means the emission level in peak mode also complies with the limit in average mode), then testing will be stopped and peak values of EUT will be reported, otherwise, the emissions will be measured in average mode again and reported.
- i. "Cone of radiation" has been considered to be 3dB bandwidth of the measurement antenna.

Note:

- 1.The supporting fixture shall permit orientation of the EUT in each of three orthogonal axis positions such that emissions from the EUT are maximized.  
(Y-AXIS is the worst.)
- 2.Due to the test software function limit the operation band setting(200dBuV/m). There's no corresponding limitation in the actual test item.



### 6.3. Typical Test Setup

Below 30MHz test setup

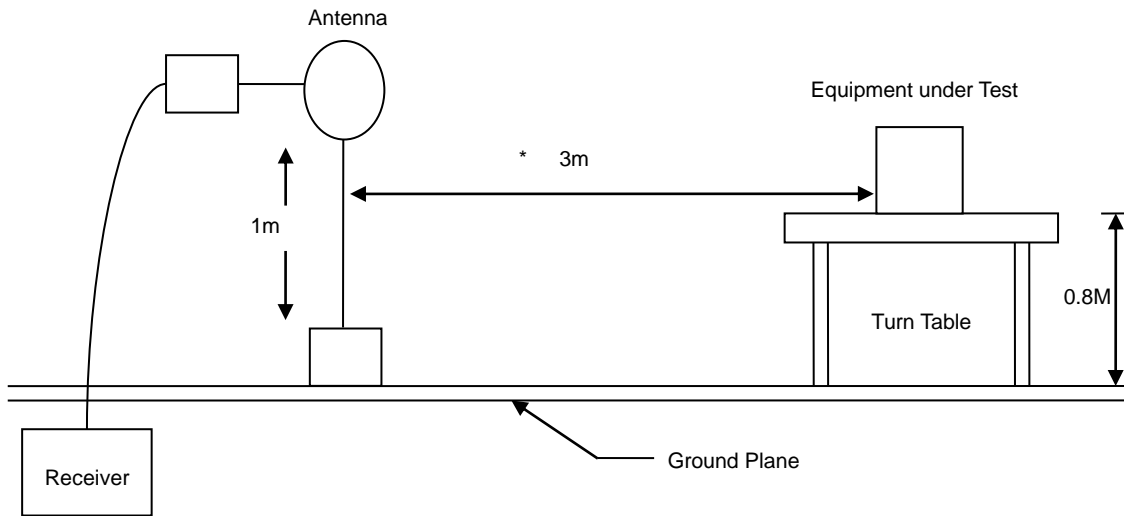

30MHz- 1GHz Test Setup

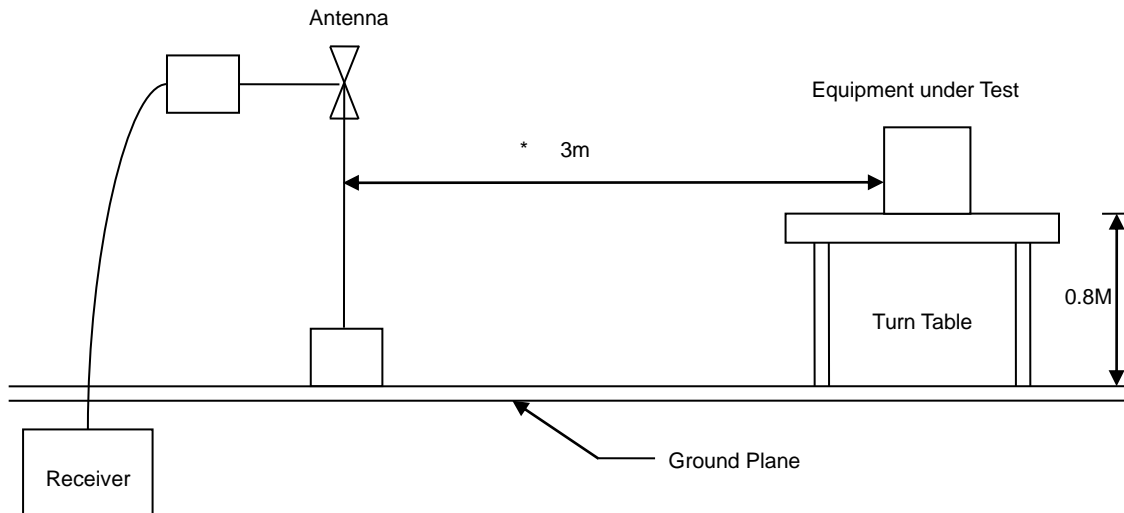

Above 1GHz Test Setup

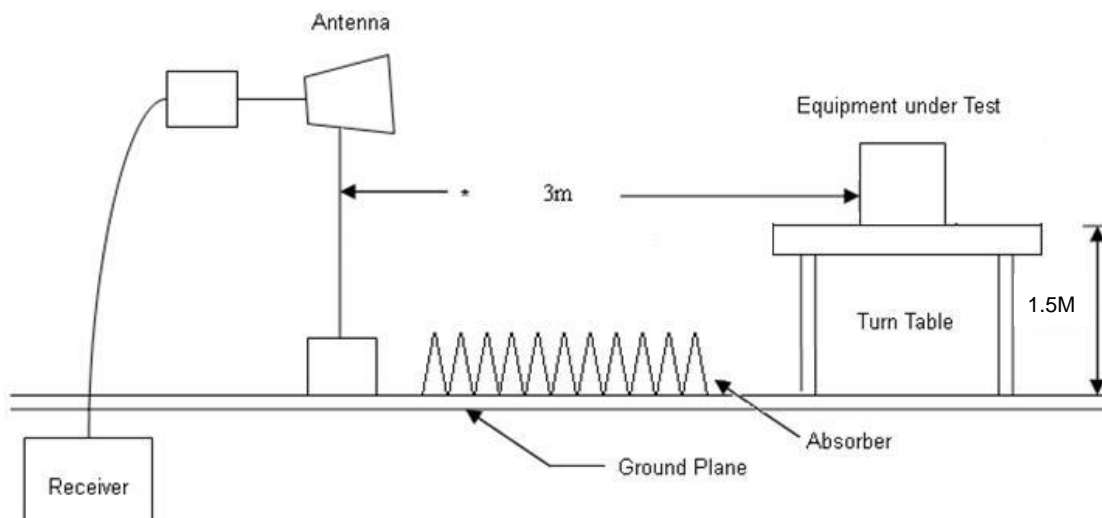



### 6.4. Test Result and Data (9kHz ~ 30MHz)

The 9kHz - 30MHz spurious emission is under limit 20dB more.

### 6.5. Test Result and Data (30MHz ~ 1GHz)

Power	:	DC From Adapter (AC 120V / 60Hz)	Pol/Phase	:	VERTICAL
Test Mode	:	Mode 4		:	

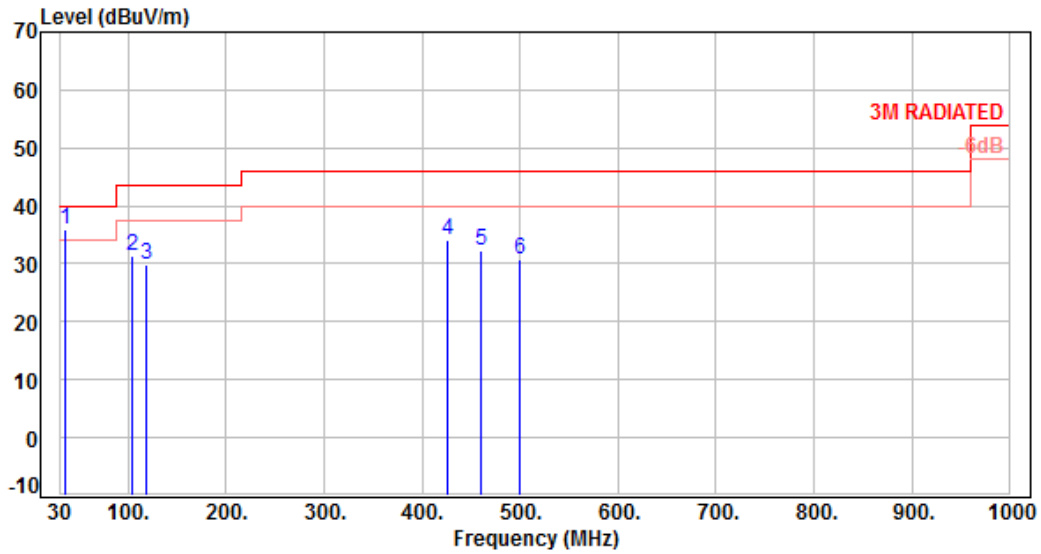

No.	Frequency (MHz)	Factor (dB)	Reading (dBuV)	Level (dBuV/m)	Limit (dBuV/m)	Margin (dB)	Detector	Height (cm)	Azimuth (deg)	P/F
1	35.82	-9.23	45.31	36.08	40.00	-3.92	QP	100	48	P
2	104.69	-12.83	44.12	31.29	43.50	-12.21	Peak	100	360	P
3	119.24	-11.25	41.09	29.84	43.50	-13.66	Peak	100	360	P
4	425.76	-4.84	38.90	34.06	46.00	-11.94	Peak	100	360	P
5	460.68	-4.13	36.45	32.32	46.00	-13.68	Peak	100	360	P
6	499.48	-3.46	34.28	30.82	46.00	-15.18	Peak	100	360	P

Note: Level=Reading+Factor  
Margin=Level-Limit  
Factor=Antenna Factor + cable loss - Amplifier Factor





Power	: DC From Adapter (AC 120V / 60Hz)	Pol/Phase	: HORIZONTAL
Test Mode	: Mode 4		:

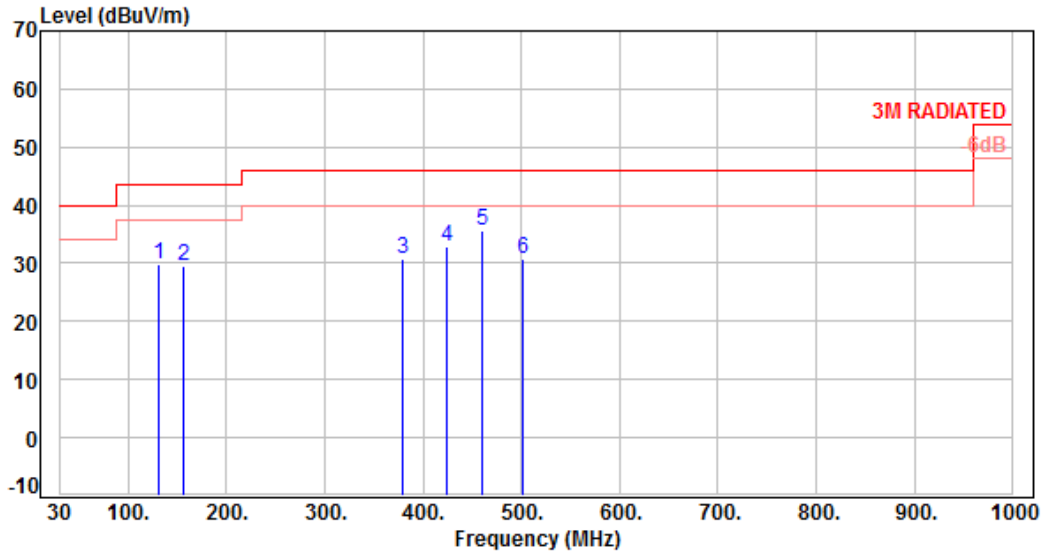

No.	Frequency (MHz)	Factor (dB)	Reading (dBuV)	Level (dBuV/m)	Limit (dBuV/m)	Margin (dB)	Detector	Height (cm)	Azimuth (deg)	P/F
1	130.88	-10.22	40.00	29.78	43.50	-13.72	Peak	100	0	P
2	156.10	-9.28	38.94	29.66	43.50	-13.84	Peak	100	0	P
3	379.20	-6.11	36.79	30.68	46.00	-15.32	Peak	100	0	P
4	423.82	-4.87	37.89	33.02	46.00	-12.98	Peak	100	0	P
5	460.68	-4.13	39.73	35.60	46.00	-10.40	Peak	100	0	P
6	501.42	-3.43	34.27	30.84	46.00	-15.16	Peak	100	0	P

Note: Level=Reading+Factor  
 Margin=Level-Limit  
 Factor=Antenna Factor + cable loss - Amplifier Factor



6.6. Test Result and Data (1GHz ~ 40GHz)

Power	:	From Adapter (AC 120V / 60Hz)	Pol/Phase	:	VERTICAL
Test Mode	:	Mode 1, Band 1, CH36		:	

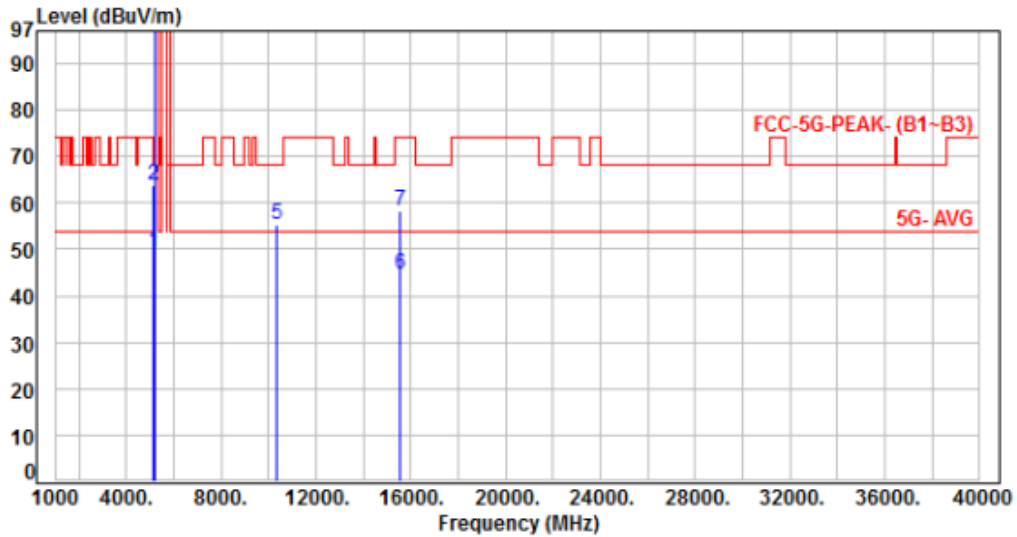

No.	Frequency (MHz)	Factor (dB)	Reading (dBuV)	Level (dBuV/m)	Limit (dBuV/m)	Margin (dB)	Detector	Height (cm)	Azimuth (deg)	P/F
1	5150.00	6.21	43.15	49.36	54.00	-4.64	Average	100	156	P
2	5150.00	6.21	57.49	63.70	74.00	-10.30	Peak	100	156	P
3	5180.00	6.29	91.07	97.36	200.00	-102.64	Average	100	156	P
4	5180.00	6.29	101.89	108.18	200.00	-91.82	Peak	100	156	P
5	10360.00	13.73	41.70	55.43	68.20	-12.77	Peak	100	54	P
6	15540.00	16.41	28.16	44.57	54.00	-9.43	Average	100	102	P
7	15540.00	16.41	41.85	58.26	74.00	-15.74	Peak	100	102	P

Note: Level=Reading+Factor  
 Margin=Level-Limit  
 Factor=Antenna Factor + cable loss - Amplifier Factor



Power	:	From Adapter (AC 120V / 60Hz)	Pol/Phase	:	HORIZONTAL
Test Mode	:	Mode 1, Band 1, CH36		:	

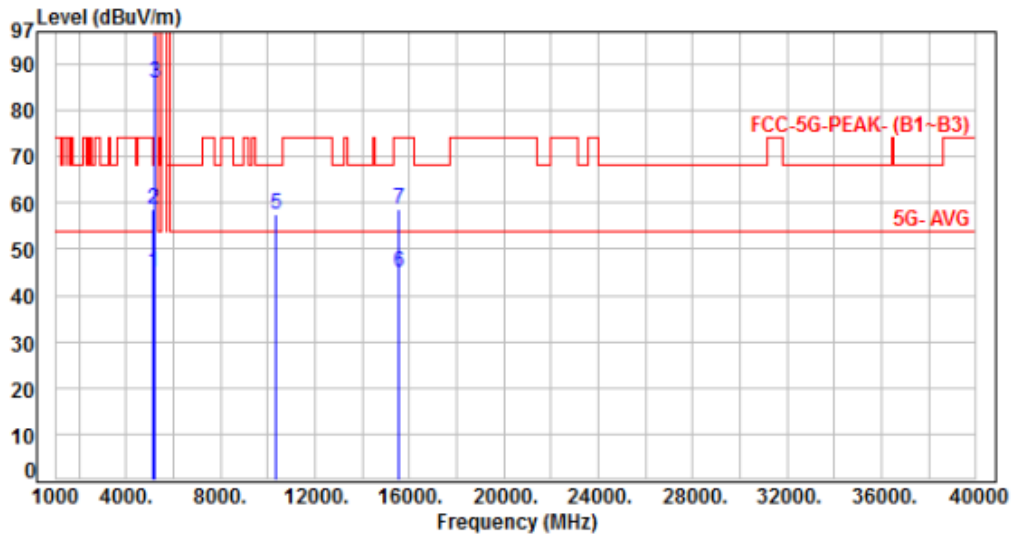

No.	Frequency (MHz)	Factor (dB)	Reading (dBuV)	Level (dBuV/m)	Limit (dBuV/m)	Margin (dB)	Detector	Height (cm)	Azimuth (deg)	P/F
1	5150.00	6.21	38.79	45.00	54.00	-9.00	Average	100	72	P
2	5150.00	6.21	52.46	58.67	74.00	-15.33	Peak	100	72	P
3	5180.00	6.29	79.65	85.94	200.00	-114.06	Average	100	72	P
4	5180.00	6.29	90.11	96.40	200.00	-103.60	Peak	100	72	P
5	10360.00	13.73	43.67	57.40	68.20	-10.80	Peak	100	203	P
6	15540.00	16.41	28.41	44.82	54.00	-9.18	Average	100	139	P
7	15540.00	16.41	42.33	58.74	74.00	-15.26	Peak	100	139	P

Note: Level=Reading+Factor  
 Margin=Level-Limit  
 Factor=Antenna Factor + cable loss - Amplifier Factor



Power	:	From Adapter (AC 120V / 60Hz)	Pol/Phase	:	VERTICAL
Test Mode	:	Mode 1, Band 1, CH40		:	

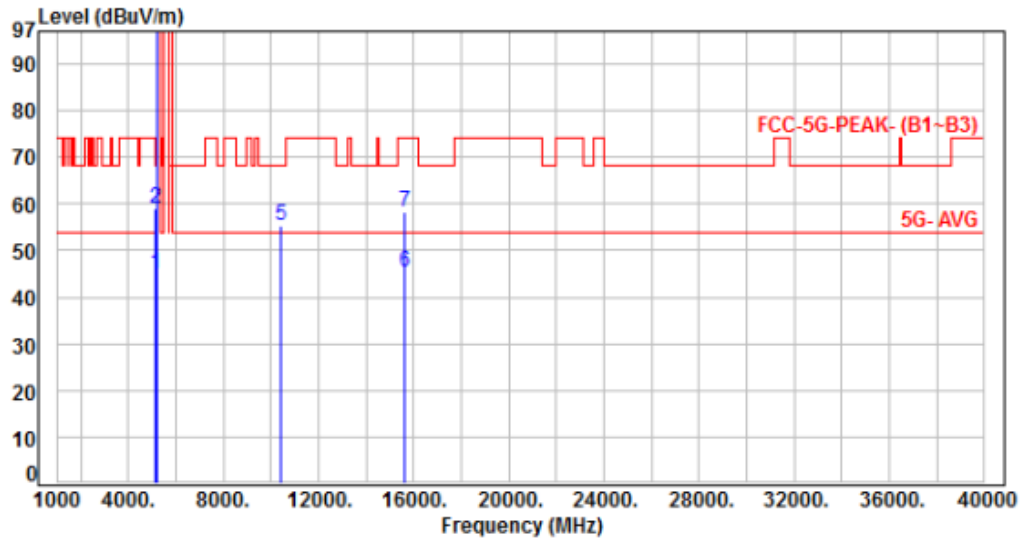

No.	Frequency (MHz)	Factor (dB)	Reading (dBuV)	Level (dBuV/m)	Limit (dBuV/m)	Margin (dB)	Detector	Height (cm)	Azimuth (deg)	P/F
1	5150.00	6.21	38.71	44.92	54.00	-9.08	Average	100	157	P
2	5150.00	6.21	52.68	58.89	74.00	-15.11	Peak	100	157	P
3	5200.00	6.34	90.95	97.29	200.00	-102.71	Average	100	157	P
4	5200.00	6.34	101.76	108.10	200.00	-91.90	Peak	100	157	P
5	10400.00	13.77	41.54	55.31	68.20	-12.89	Peak	100	54	P
6	15600.00	16.33	28.94	45.27	54.00	-8.73	Average	100	97	P
7	15600.00	16.33	42.13	58.46	74.00	-15.54	Peak	100	97	P

Note: Level=Reading+Factor  
 Margin=Level-Limit  
 Factor=Antenna Factor + cable loss - Amplifier Factor



Power	:	From Adapter (AC 120V / 60Hz)	Pol/Phase	:	HORIZONTAL
Test Mode	:	Mode 1, Band 1, CH40		:	

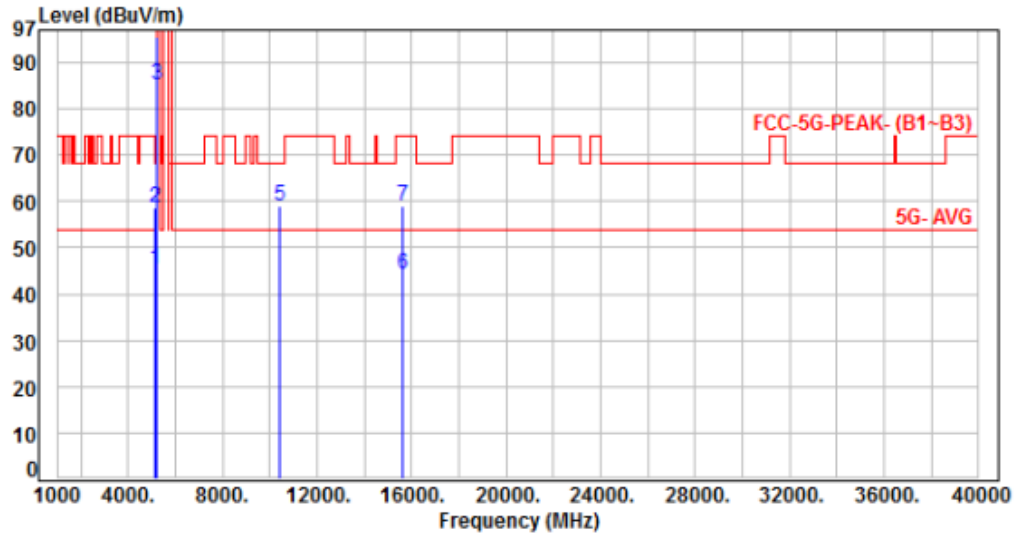

No.	Frequency (MHz)	Factor (dB)	Reading (dBuV)	Level (dBuV/m)	Limit (dBuV/m)	Margin (dB)	Detector	Height (cm)	Azimuth (deg)	P/F
1	5150.00	6.21	39.03	45.24	54.00	-8.76	Average	100	73	P
2	5150.00	6.21	52.27	58.48	74.00	-15.52	Peak	100	73	P
3	5200.00	6.34	78.82	85.16	200.00	-114.84	Average	100	73	P
4	5200.00	6.34	89.19	95.53	200.00	-104.47	Peak	100	73	P
5	10400.00	13.77	45.36	59.13	68.20	-9.07	Peak	100	204	P
6	15600.00	16.33	27.92	44.25	54.00	-9.75	Average	100	139	P
7	15600.00	16.33	42.54	58.87	74.00	-15.13	Peak	100	139	P

Note: Level=Reading+Factor  
 Margin=Level-Limit  
 Factor=Antenna Factor + cable loss - Amplifier Factor



Power	:	From Adapter (AC 120V / 60Hz)	Pol/Phase	:	VERTICAL
Test Mode	:	Mode 1, Band 1, CH48		:	

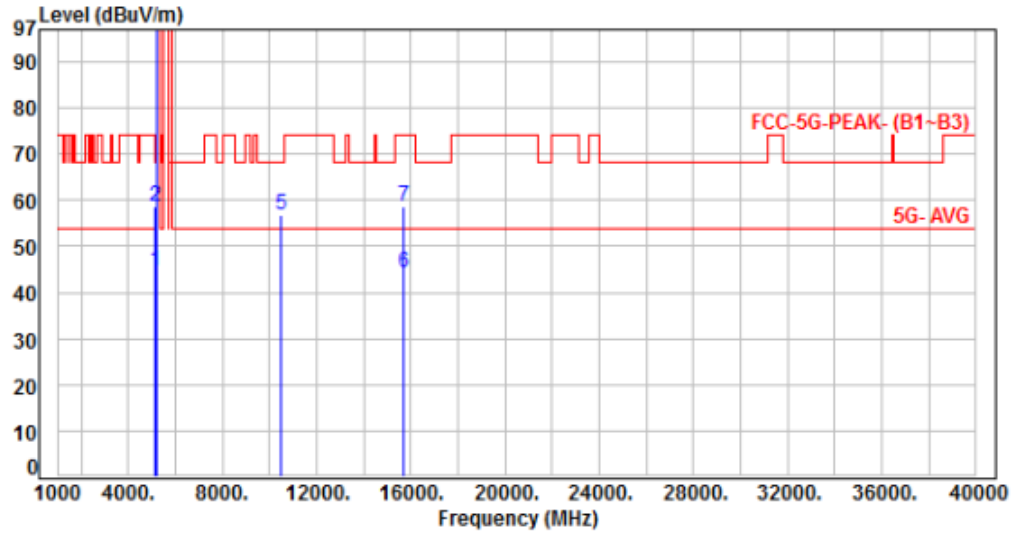

No.	Frequency (MHz)	Factor (dB)	Reading (dBuV)	Level (dBuV/m)	Limit (dBuV/m)	Margin (dB)	Detector	Height (cm)	Azimuth (deg)	P/F
1	5150.00	6.21	38.34	44.55	54.00	-9.45	Average	100	154	P
2	5150.00	6.21	52.52	58.73	74.00	-15.27	Peak	100	154	P
3	5240.00	6.46	90.94	97.40	200.00	-102.60	Average	100	154	P
4	5240.00	6.46	102.36	108.82	200.00	-91.18	Peak	100	154	P
5	10480.00	13.89	42.86	56.75	68.20	-11.45	Peak	100	55	P
6	15720.00	15.62	28.74	44.36	54.00	-9.64	Average	100	102	P
7	15720.00	15.62	43.18	58.80	74.00	-15.20	Peak	100	102	P

Note: Level=Reading+Factor  
 Margin=Level-Limit  
 Factor=Antenna Factor + cable loss - Amplifier Factor



Power	:	From Adapter (AC 120V / 60Hz)	Pol/Phase	:	HORIZONTAL
Test Mode	:	Mode 1, Band 1, CH48		:	

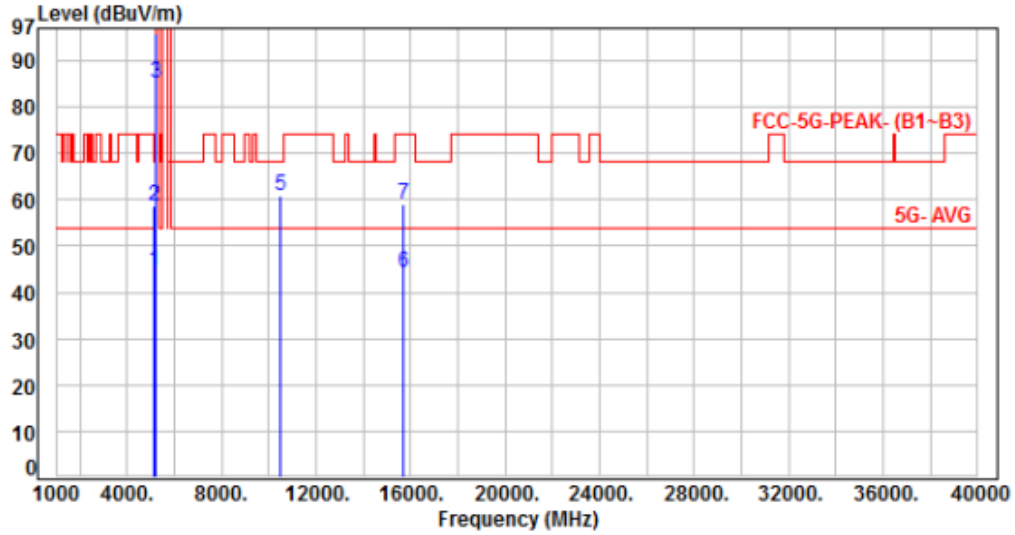

No.	Frequency (MHz)	Factor (dB)	Reading (dBuV)	Level (dBuV/m)	Limit (dBuV/m)	Margin (dB)	Detector	Height (cm)	Azimuth (deg)	P/F
1	5150.00	6.21	38.33	44.54	54.00	-9.46	Average	100	68	P
2	5150.00	6.21	52.47	58.68	74.00	-15.32	Peak	100	68	P
3	5240.00	6.46	78.89	85.35	200.00	-114.65	Average	100	68	P
4	5240.00	6.46	89.48	95.94	200.00	-104.06	Peak	100	68	P
5	10480.00	13.89	46.83	60.72	68.20	-7.48	Peak	100	206	P
6	15720.00	15.62	28.75	44.37	54.00	-9.63	Average	100	135	P
7	15720.00	15.62	43.29	58.91	74.00	-15.09	Peak	100	135	P

Note: Level=Reading+Factor  
 Margin=Level-Limit  
 Factor=Antenna Factor + cable loss - Amplifier Factor



Power	:	From Adapter (AC 120V / 60Hz)	Pol/Phase	:	VERTICAL
Test Mode	:	Mode 4, Band 1, CH36		:	

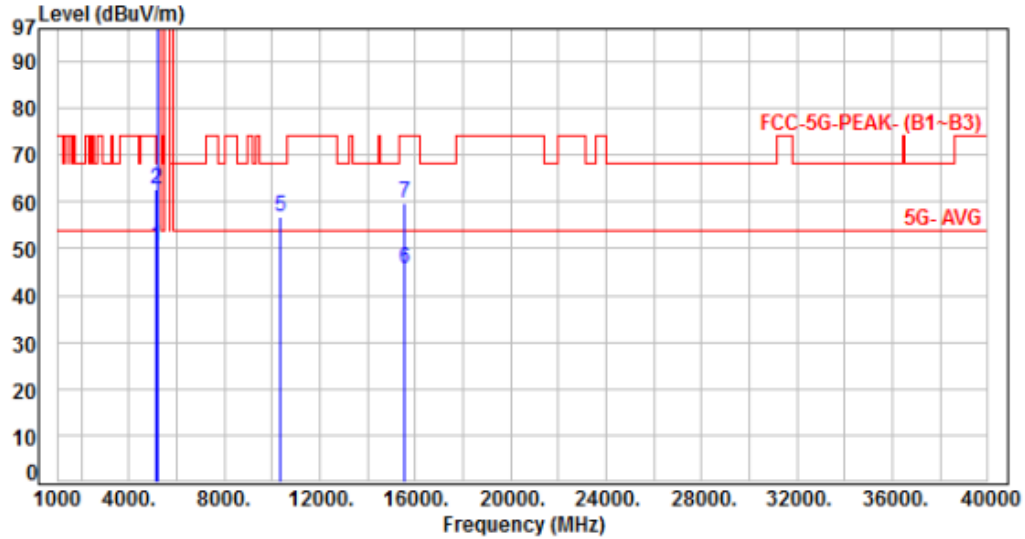

No.	Frequency (MHz)	Factor (dB)	Reading (dBuV)	Level (dBuV/m)	Limit (dBuV/m)	Margin (dB)	Detector	Height (cm)	Azimuth (deg)	P/F
1	5150.00	6.21	44.20	50.41	54.00	-3.59	Average	100	154	P
2	5150.00	6.21	56.37	62.58	74.00	-11.42	Peak	100	154	P
3	5180.00	6.29	89.14	95.43	200.00	-104.57	Average	100	154	P
4	5180.00	6.29	99.48	105.77	200.00	-94.23	Peak	100	154	P
5	10360.00	13.73	43.00	56.73	68.20	-11.47	Peak	100	59	P
6	15540.00	16.41	29.15	45.56	54.00	-8.44	Average	100	100	P
7	15540.00	16.41	43.26	59.67	74.00	-14.33	Peak	100	100	P

Note: Level=Reading+Factor  
 Margin=Level-Limit  
 Factor=Antenna Factor + cable loss - Amplifier Factor





Power	:	From Adapter (AC 120V / 60Hz)	Pol/Phase	:	HORIZONTAL
Test Mode	:	Mode 4, Band 1, CH36		:	

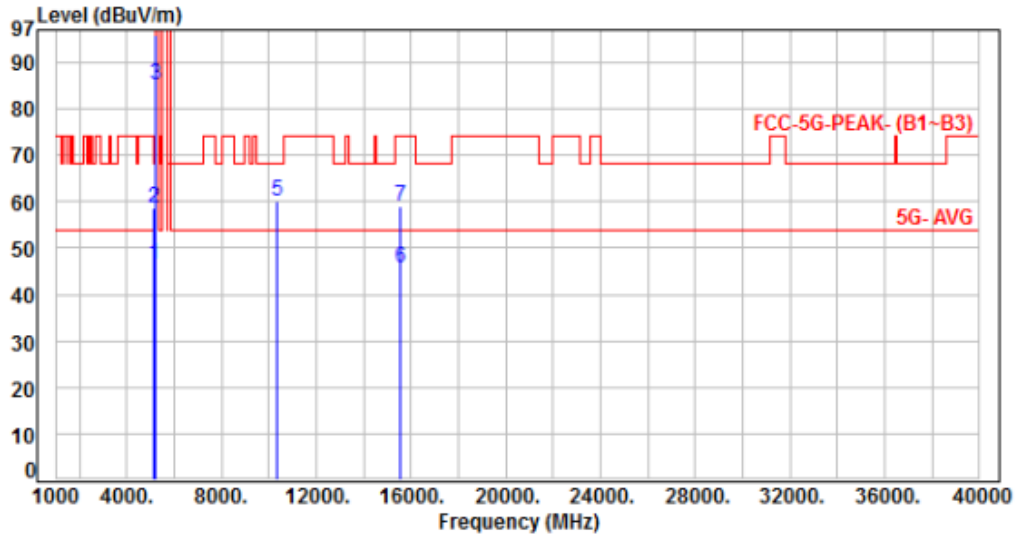

No.	Frequency (MHz)	Factor (dB)	Reading (dBuV)	Level (dBuV/m)	Limit (dBuV/m)	Margin (dB)	Detector	Height (cm)	Azimuth (deg)	P/F
1	5150.00	6.21	40.25	46.46	54.00	-7.54	Average	100	71	P
2	5150.00	6.21	52.35	58.56	74.00	-15.44	Peak	100	71	P
3	5180.00	6.29	78.75	85.04	200.00	-114.96	Average	100	71	P
4	5180.00	6.29	89.49	95.78	200.00	-104.22	Peak	100	71	P
5	10360.00	13.73	46.42	60.15	68.20	-8.05	Peak	100	198	P
6	15540.00	16.41	29.15	45.56	54.00	-8.44	Average	100	142	P
7	15540.00	16.41	42.57	58.98	74.00	-15.02	Peak	100	142	P

Note: Level=Reading+Factor  
 Margin=Level-Limit  
 Factor=Antenna Factor + cable loss - Amplifier Factor



Power	:	From Adapter (AC 120V / 60Hz)	Pol/Phase	:	VERTICAL
Test Mode	:	Mode 4, Band 1, CH40		:	

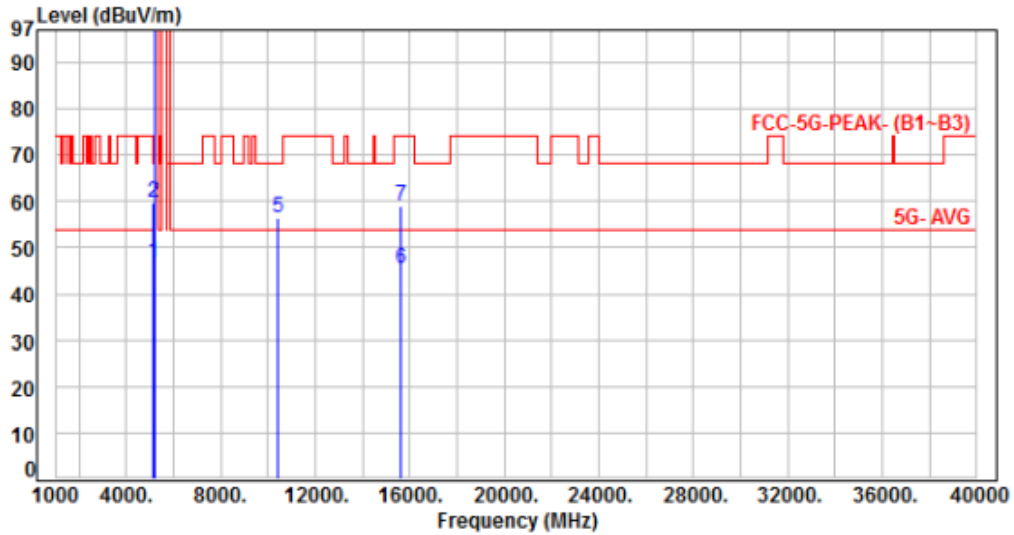

No.	Frequency (MHz)	Factor (dB)	Reading (dBuV)	Level (dBuV/m)	Limit (dBuV/m)	Margin (dB)	Detector	Height (cm)	Azimuth (deg)	P/F
1	5150.00	6.21	40.51	46.72	54.00	-7.28	Average	100	156	P
2	5150.00	6.21	53.42	59.63	74.00	-14.37	Peak	100	156	P
3	5200.00	6.34	90.17	96.51	200.00	-103.49	Average	100	156	P
4	5200.00	6.34	100.42	106.76	200.00	-93.24	Peak	100	156	P
5	10400.00	13.77	42.82	56.59	68.20	-11.61	Peak	100	57	P
6	15600.00	16.33	29.18	45.51	54.00	-8.49	Average	100	103	P
7	15600.00	16.33	42.73	59.06	74.00	-14.94	Peak	100	103	P

Note: Level=Reading+Factor  
 Margin=Level-Limit  
 Factor=Antenna Factor + cable loss - Amplifier Factor



Power	:	From Adapter (AC 120V / 60Hz)	Pol/Phase	:	HORIZONTAL
Test Mode	:	Mode 4, Band 1, CH40		:	

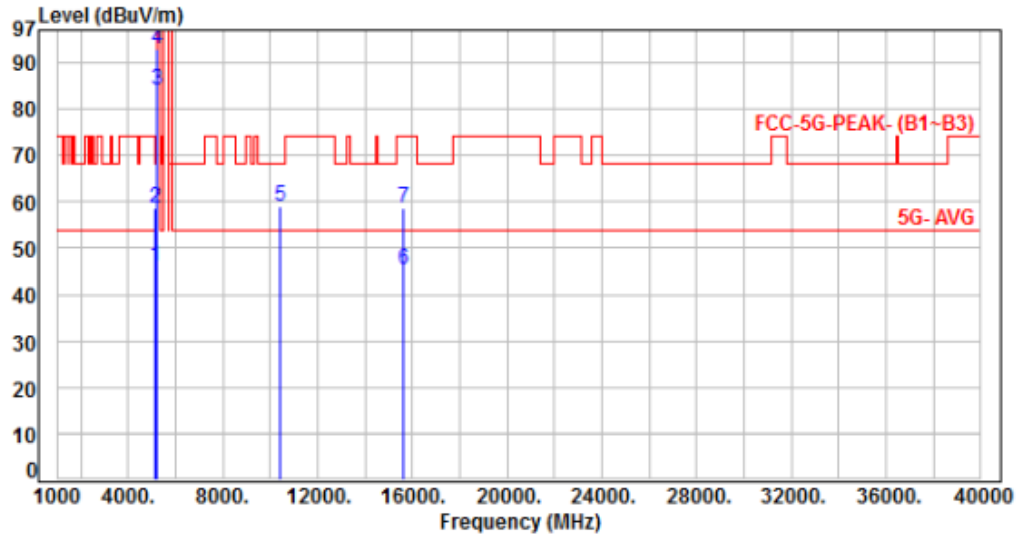

No.	Frequency (MHz)	Factor (dB)	Reading (dBuV)	Level (dBuV/m)	Limit (dBuV/m)	Margin (dB)	Detector	Height (cm)	Azimuth (deg)	P/F
1	5150.00	6.21	39.94	46.15	54.00	-7.85	Average	100	74	P
2	5150.00	6.21	52.56	58.77	74.00	-15.23	Peak	100	74	P
3	5200.00	6.34	77.59	83.93	200.00	-116.07	Average	100	74	P
4	5200.00	6.34	86.50	92.84	200.00	-107.16	Peak	100	74	P
5	10400.00	13.77	45.06	58.83	68.20	-9.37	Peak	100	202	P
6	15600.00	16.33	29.16	45.49	54.00	-8.51	Average	100	140	P
7	15600.00	16.33	42.35	58.68	74.00	-15.32	Peak	100	140	P

Note: Level=Reading+Factor  
 Margin=Level-Limit  
 Factor=Antenna Factor + cable loss - Amplifier Factor



Power	: From Adapter (AC 120V / 60Hz)	Pol/Phase	: VERTICAL
Test Mode	: Mode 4, Band 1, CH48		:

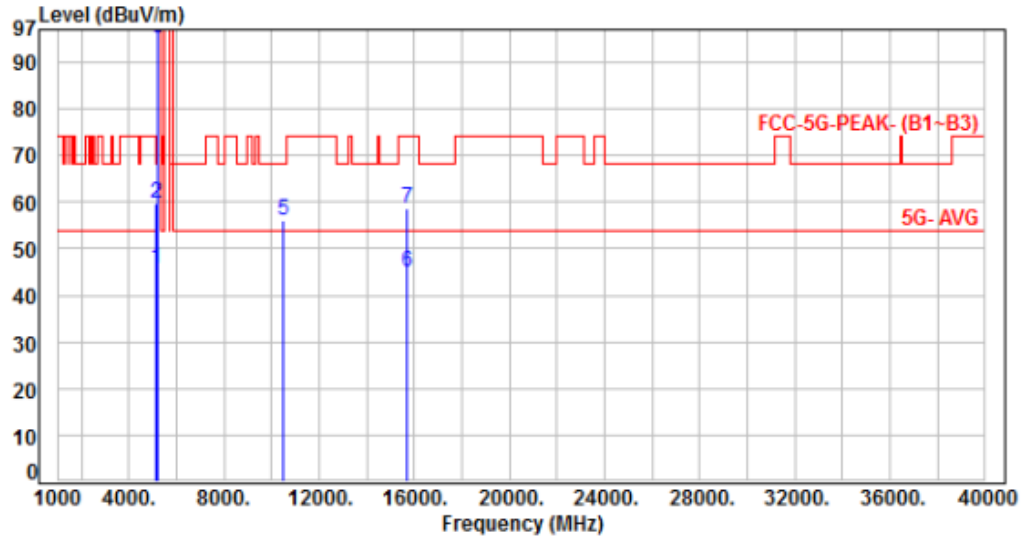

No.	Frequency (MHz)	Factor (dB)	Reading (dBuV)	Level (dBuV/m)	Limit (dBuV/m)	Margin (dB)	Detector	Height (cm)	Azimuth (deg)	P/F
1	5150.00	6.21	39.71	45.92	54.00	-8.08	Average	100	159	P
2	5150.00	6.21	53.62	59.83	74.00	-14.17	Peak	100	159	P
3	5240.00	6.46	88.71	95.17	200.00	-104.83	Average	100	159	P
4	5240.00	6.46	98.58	105.04	200.00	-94.96	Peak	100	159	P
5	10480.00	13.89	42.11	56.00	68.20	-12.20	Peak	100	57	P
6	15720.00	15.62	29.22	44.84	54.00	-9.16	Average	100	101	P
7	15720.00	15.62	43.08	58.70	74.00	-15.30	Peak	100	101	P

Note: Level=Reading+Factor  
 Margin=Level-Limit  
 Factor=Antenna Factor + cable loss - Amplifier Factor



Power	:	From Adapter (AC 120V / 60Hz)	Pol/Phase	:	HORIZONTAL
Test Mode	:	Mode 4, Band 1, CH48		:	

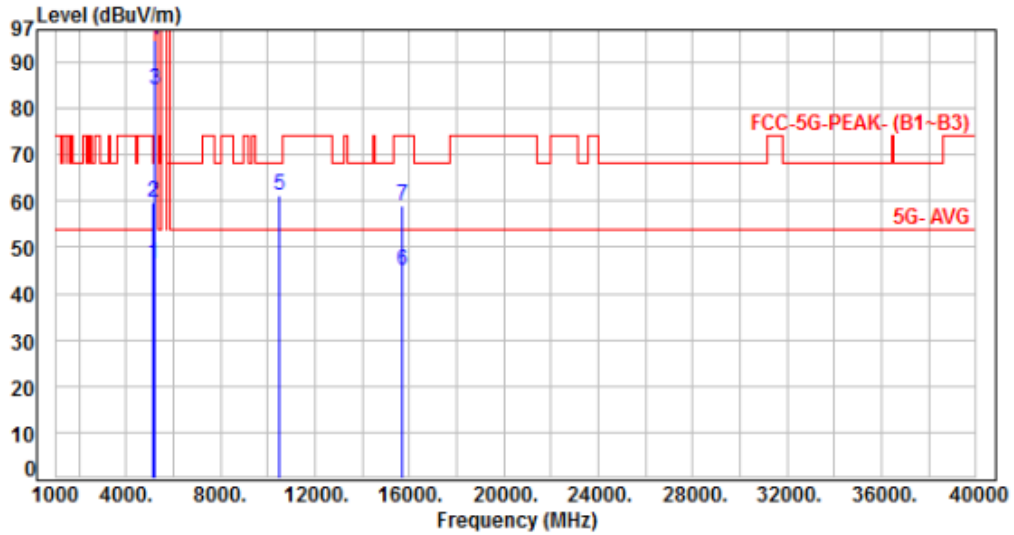

No.	Frequency (MHz)	Factor (dB)	Reading (dBuV)	Level (dBuV/m)	Limit (dBuV/m)	Margin (dB)	Detector	Height (cm)	Azimuth (deg)	P/F
1	5150.00	6.21	40.28	46.49	54.00	-7.51	Average	100	69	P
2	5150.00	6.21	53.41	59.62	74.00	-14.38	Peak	100	69	P
3	5240.00	6.46	77.67	84.13	200.00	-115.87	Average	100	69	P
4	5240.00	6.46	88.42	94.88	200.00	-105.12	Peak	100	69	P
5	10480.00	13.89	47.29	61.18	68.20	-7.02	Peak	100	206	P
6	15720.00	15.62	29.48	45.10	54.00	-8.90	Average	100	143	P
7	15720.00	15.62	43.44	59.06	74.00	-14.94	Peak	100	143	P

Note: Level=Reading+Factor  
Margin=Level-Limit  
Factor=Antenna Factor + cable loss - Amplifier Factor



Power	:	From Adapter (AC 120V / 60Hz)	Pol/Phase	:	VERTICAL
Test Mode	:	Mode 5, Band 1, CH38		:	

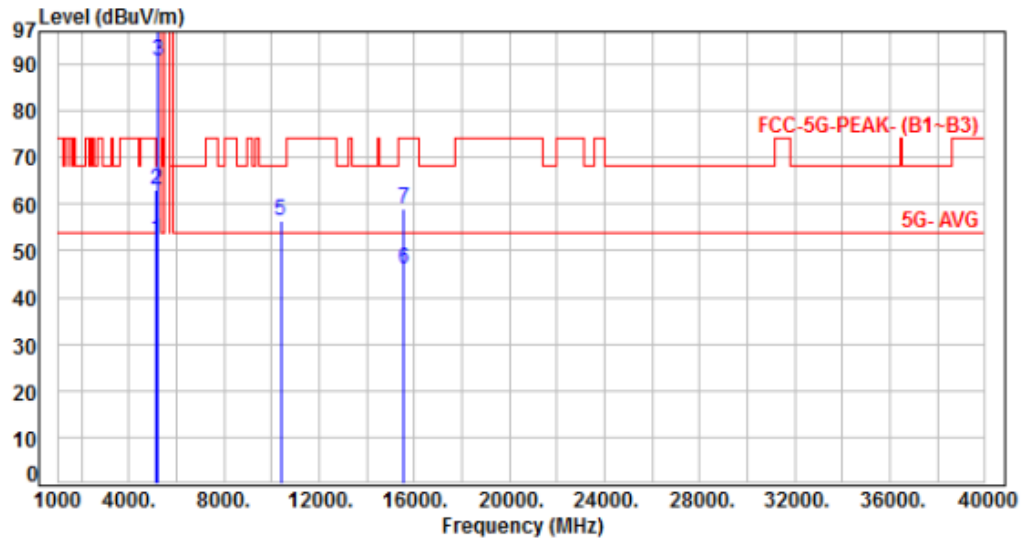

No.	Frequency (MHz)	Factor (dB)	Reading (dBuV)	Level (dBuV/m)	Limit (dBuV/m)	Margin (dB)	Detector	Height (cm)	Azimuth (deg)	P/F
1	5150.00	6.21	46.17	52.38	54.00	-1.62	Average	100	156	P
2	5150.00	6.21	56.81	63.02	74.00	-10.98	Peak	100	156	P
3	5190.00	6.32	84.43	90.75	200.00	-109.25	Average	100	156	P
4	5190.00	6.32	94.08	100.40	200.00	-99.60	Peak	100	156	P
5	10380.00	13.76	42.71	56.47	68.20	-11.73	Peak	100	50	P
6	15570.00	16.37	29.76	46.13	54.00	-7.87	Average	100	98	P
7	15570.00	16.37	42.61	58.98	74.00	-15.02	Peak	100	98	P

Note: Level=Reading+Factor  
 Margin=Level-Limit  
 Factor=Antenna Factor + cable loss - Amplifier Factor



Power	:	From Adapter (AC 120V / 60Hz)	Pol/Phase	:	HORIZONTAL
Test Mode	:	Mode 5, Band 1, CH38		:	

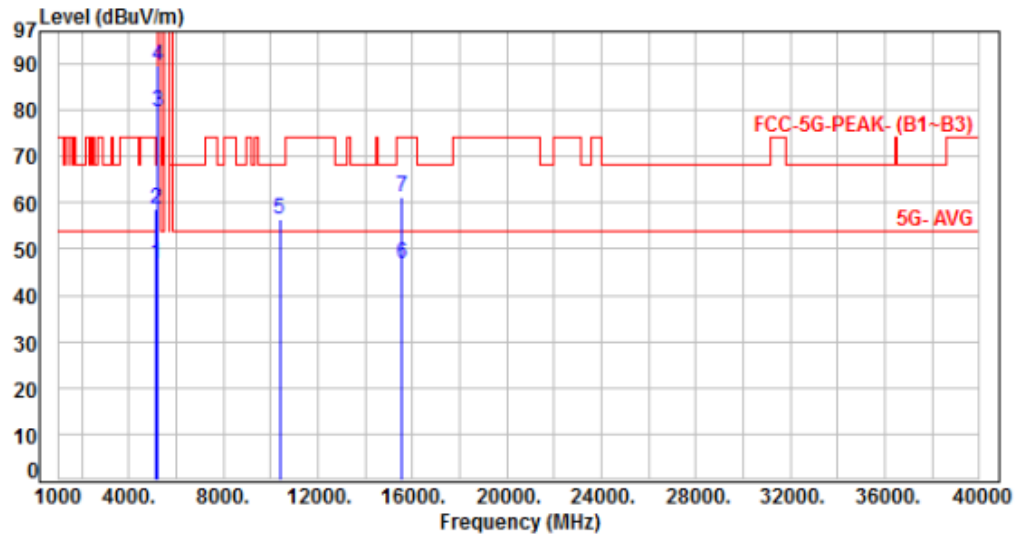

No.	Frequency (MHz)	Factor (dB)	Reading (dBuV)	Level (dBuV/m)	Limit (dBuV/m)	Margin (dB)	Detector	Height (cm)	Azimuth (deg)	P/F
1	5150.00	6.21	40.72	46.93	54.00	-7.07	Average	100	70	P
2	5150.00	6.21	52.58	58.79	74.00	-15.21	Peak	100	70	P
3	5190.00	6.32	73.39	79.71	200.00	-120.29	Average	100	70	P
4	5190.00	6.32	83.45	89.77	200.00	-110.23	Peak	100	70	P
5	10380.00	13.76	42.80	56.56	68.20	-11.64	Peak	100	205	P
6	15570.00	16.37	30.46	46.83	54.00	-7.17	Average	100	143	P
7	15570.00	16.37	44.72	61.09	74.00	-12.91	Peak	100	143	P

Note: Level=Reading+Factor  
 Margin=Level-Limit  
 Factor=Antenna Factor + cable loss - Amplifier Factor



Power	:	From Adapter (AC 120V / 60Hz)	Pol/Phase	:	VERTICAL
Test Mode	:	Mode 5, Band 1, CH46		:	

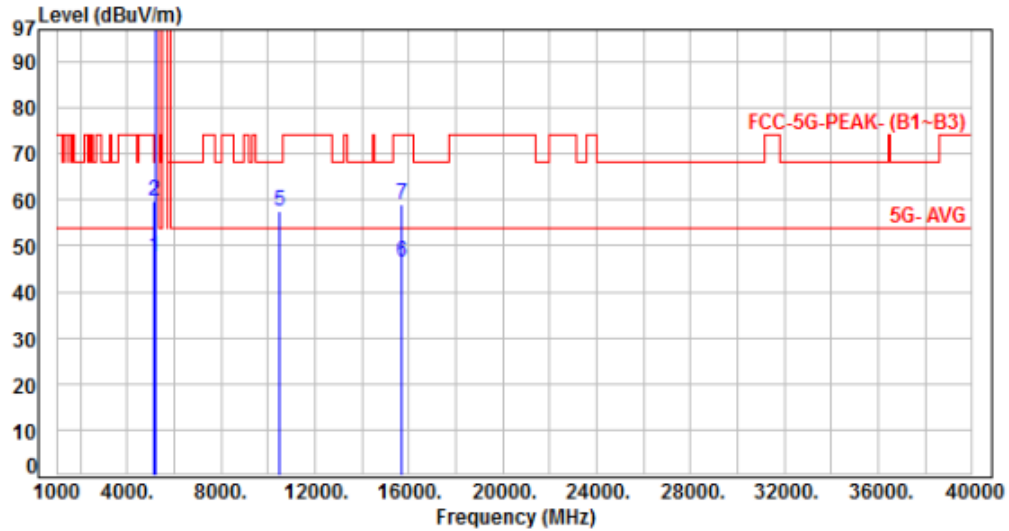

No.	Frequency (MHz)	Factor (dB)	Reading (dBuV)	Level (dBuV/m)	Limit (dBuV/m)	Margin (dB)	Detector	Height (cm)	Azimuth (deg)	P/F
1	5150.00	6.21	41.34	47.55	54.00	-6.45	Average	100	160	P
2	5150.00	6.21	53.64	59.85	74.00	-14.15	Peak	100	160	P
3	5230.00	6.44	89.54	95.98	200.00	-104.02	Average	100	160	P
4	5230.00	6.44	100.36	106.80	200.00	-93.20	Peak	100	160	P
5	10460.00	13.86	43.58	57.44	68.20	-10.76	Peak	100	55	P
6	15690.00	15.67	30.74	46.41	54.00	-7.59	Average	100	104	P
7	15690.00	15.67	43.51	59.18	74.00	-14.82	Peak	100	104	P

Note: Level=Reading+Factor

Margin=Level-Limit

Factor=Antenna Factor + cable loss - Amplifier Factor





Power	:	From Adapter (AC 120V / 60Hz)	Pol/Phase	:	HORIZONTAL
Test Mode	:	Mode 5, Band 1, CH46		:	

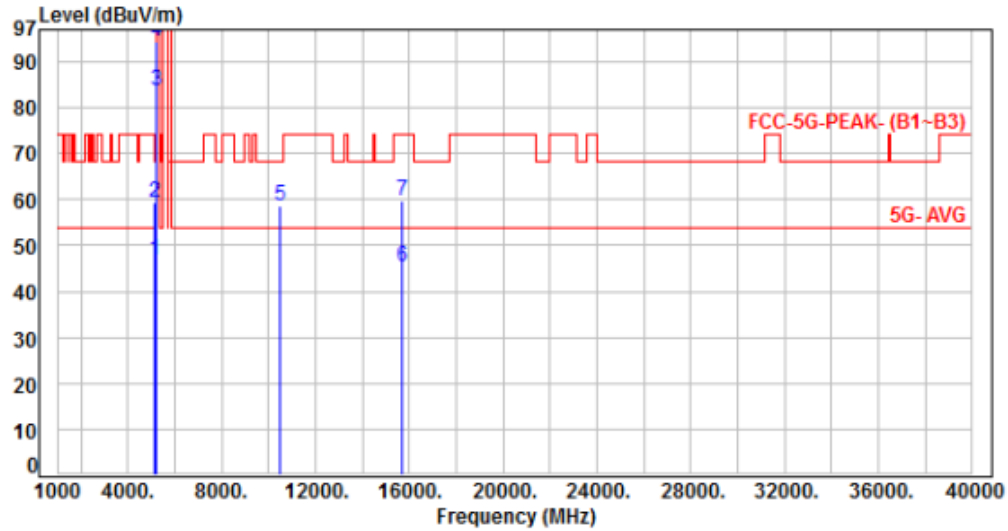

No.	Frequency (MHz)	Factor (dB)	Reading (dBuV)	Level (dBuV/m)	Limit (dBuV/m)	Margin (dB)	Detector	Height (cm)	Azimuth (deg)	P/F
1	5150.00	6.21	40.72	46.93	54.00	-7.07	Average	100	70	P
2	5150.00	6.21	53.06	59.27	74.00	-14.73	Peak	100	70	P
3	5230.00	6.44	77.28	83.72	200.00	-116.28	Average	100	70	P
4	5230.00	6.44	87.93	94.37	200.00	-105.63	Peak	100	70	P
5	10460.00	13.86	44.86	58.72	68.20	-9.48	Peak	100	199	P
6	15690.00	15.67	29.70	45.37	54.00	-8.63	Average	100	139	P
7	15690.00	15.67	43.93	59.60	74.00	-14.40	Peak	100	139	P

Note: Level=Reading+Factor  
 Margin=Level-Limit  
 Factor=Antenna Factor + cable loss - Amplifier Factor



Power	:	From Adapter (AC 120V / 60Hz)	Pol/Phase	:	VERTICAL
Test Mode	:	Mode 6, Band 1, CH42		:	

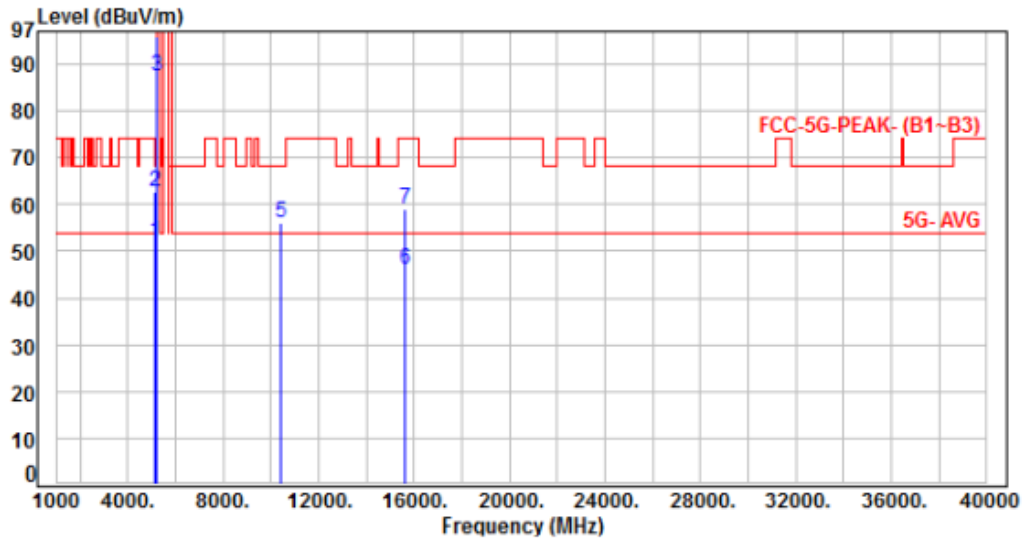

No.	Frequency (MHz)	Factor (dB)	Reading (dBuV)	Level (dBuV/m)	Limit (dBuV/m)	Margin (dB)	Detector	Height (cm)	Azimuth (deg)	P/F
1	5150.00	6.21	45.93	52.14	54.00	-1.86	Average	100	153	P
2	5150.00	6.21	56.59	62.80	74.00	-11.20	Peak	100	153	P
3	5210.00	6.38	81.00	87.38	200.00	-112.62	Average	100	153	P
4	5210.00	6.38	89.59	95.97	200.00	-104.03	Peak	100	153	P
5	10420.00	13.80	42.12	55.92	68.20	-12.28	Peak	100	55	P
6	15630.00	16.10	30.16	46.26	54.00	-7.74	Average	100	100	P
7	15630.00	16.10	42.80	58.90	74.00	-15.10	Peak	100	100	P

Note: Level=Reading+Factor  
 Margin=Level-Limit  
 Factor=Antenna Factor + cable loss - Amplifier Factor



Power	:	From Adapter (AC 120V / 60Hz)	Pol/Phase	:	HORIZONTAL
Test Mode	:	Mode 6, Band 1, CH42		:	

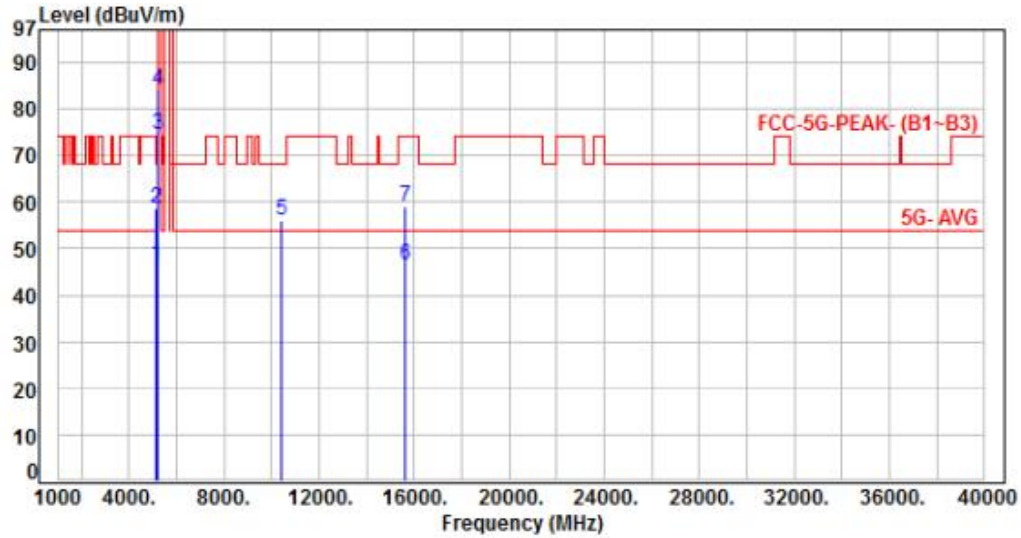

No.	Frequency (MHz)	Factor (dB)	Reading (dBuV)	Level (dBuV/m)	Limit (dBuV/m)	Margin (dB)	Detector	Height (cm)	Azimuth (deg)	P/F
1	5150.00	6.21	40.17	46.38	54.00	-7.62	Average	100	69	P
2	5150.00	6.21	52.59	58.80	74.00	-15.20	Peak	100	69	P
3	5210.00	6.38	68.27	74.65	200.00	-125.35	Average	100	69	P
4	5210.00	6.38	77.83	84.21	200.00	-115.79	Peak	100	69	P
5	10420.00	13.80	42.37	56.17	68.20	-12.03	Peak	100	197	P
6	15630.00	16.10	30.45	46.55	54.00	-7.45	Average	100	145	P
7	15630.00	16.10	42.91	59.01	74.00	-14.99	Peak	100	145	P

Note: Level=Reading+Factor  
 Margin=Level-Limit  
 Factor=Antenna Factor + cable loss - Amplifier Factor



Power	:	From Adapter (AC 120V / 60Hz)	Pol/Phase	:	VERTICAL
Test Mode	:	Mode 1, Band 2, CH52		:	

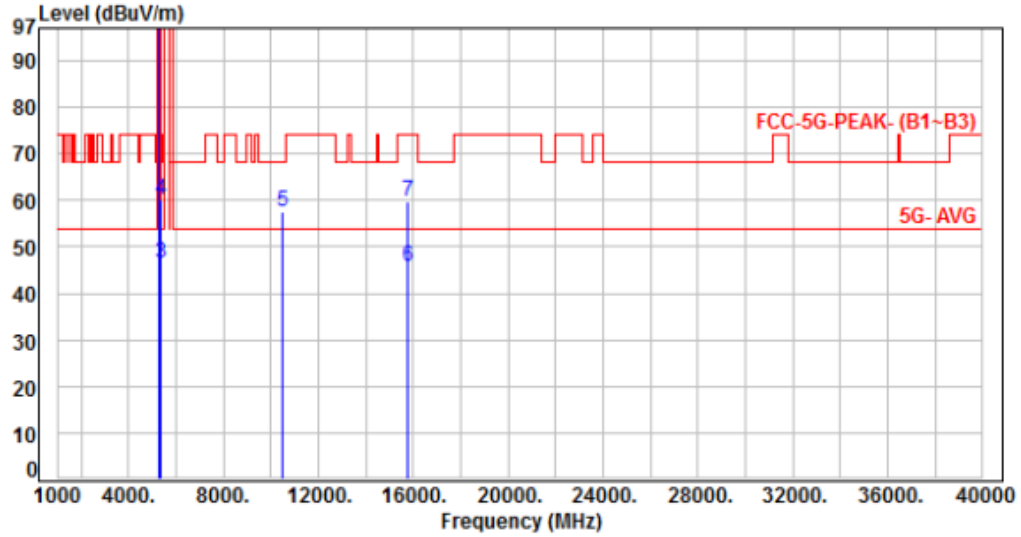

No.	Frequency (MHz)	Factor (dB)	Reading (dBuV)	Level (dBuV/m)	Limit (dBuV/m)	Margin (dB)	Detector	Height (cm)	Azimuth (deg)	P/F
1	5260.00	6.52	95.24	101.76	200.00	-98.24	Average	327	10	P
2	5260.00	6.52	105.93	112.45	200.00	-87.55	Peak	327	10	P
3	5350.00	6.57	39.81	46.38	54.00	-7.62	Average	327	10	P
4	5350.00	6.57	53.71	60.28	74.00	-13.72	Peak	327	10	P
5	10520.00	13.94	43.62	57.56	68.20	-10.64	Peak	100	291	P
6	15780.00	15.71	29.86	45.57	54.00	-8.43	Average	100	166	P
7	15780.00	15.71	44.07	59.78	74.00	-14.22	Peak	100	166	P

Note: Level=Reading+Factor  
 Margin=Level-Limit  
 Factor=Antenna Factor + cable loss - Amplifier Factor



Power	:	From Adapter (AC 120V / 60Hz)	Pol/Phase	:	HORIZONTAL
Test Mode	:	Mode 1, Band 2, CH52		:	

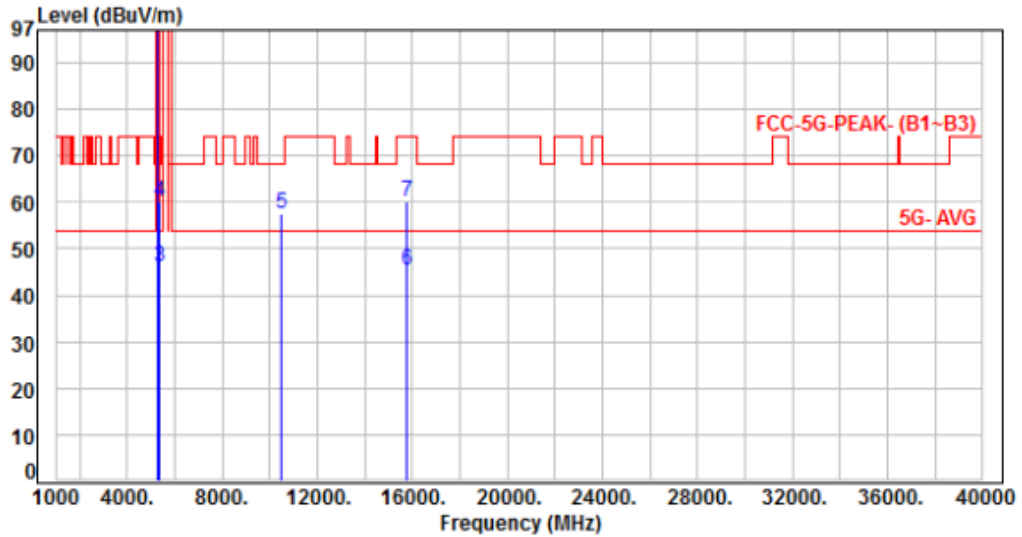

No.	Frequency (MHz)	Factor (dB)	Reading (dBuV)	Level (dBuV/m)	Limit (dBuV/m)	Margin (dB)	Detector	Height (cm)	Azimuth (deg)	P/F
1	5260.00	6.52	91.59	98.11	200.00	-101.89	Average	233	314	P
2	5260.00	6.52	102.18	108.70	200.00	-91.30	Peak	233	314	P
3	5350.00	6.57	39.54	46.11	54.00	-7.89	Average	233	314	P
4	5350.00	6.57	53.43	60.00	74.00	-14.00	Peak	233	314	P
5	10520.00	13.94	43.71	57.65	68.20	-10.55	Peak	100	193	P
6	15780.00	15.71	29.81	45.52	54.00	-8.48	Average	100	188	P
7	15780.00	15.71	44.27	59.98	74.00	-14.02	Peak	100	188	P

Note: Level=Reading+Factor  
 Margin=Level-Limit  
 Factor=Antenna Factor + cable loss - Amplifier Factor



Power	:	From Adapter (AC 120V / 60Hz)	Pol/Phase	:	VERTICAL
Test Mode	:	Mode 1, Band 2, CH60		:	

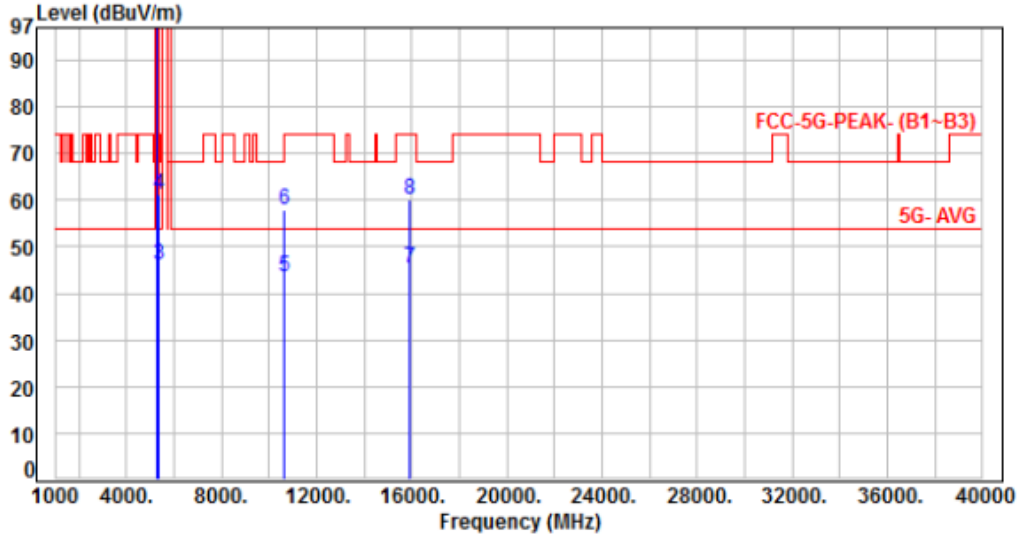

No.	Frequency (MHz)	Factor (dB)	Reading (dBuV)	Level (dBuV/m)	Limit (dBuV/m)	Margin (dB)	Detector	Height (cm)	Azimuth (deg)	P/F
1	5300.00	6.64	96.21	102.85	200.00	-97.15	Average	333	5	P
2	5300.00	6.64	106.92	113.56	200.00	-86.44	Peak	333	5	P
3	5350.00	6.57	39.49	46.06	54.00	-7.94	Average	333	5	P
4	5350.00	6.57	54.53	61.10	74.00	-12.90	Peak	333	5	P
5	10600.00	14.04	29.59	43.63	54.00	-10.37	Average	100	294	P
6	10600.00	14.04	43.92	57.96	74.00	-16.04	Peak	100	294	P
7	15900.00	15.80	29.74	45.54	54.00	-8.46	Average	100	168	P
8	15900.00	15.80	44.21	60.01	74.00	-13.99	Peak	100	168	P

Note: Level=Reading+Factor  
 Margin=Level-Limit  
 Factor=Antenna Factor + cable loss - Amplifier Factor



Power	:	From Adapter (AC 120V / 60Hz)	Pol/Phase	:	HORIZONTAL
Test Mode	:	Mode 1, Band 2, CH60		:	

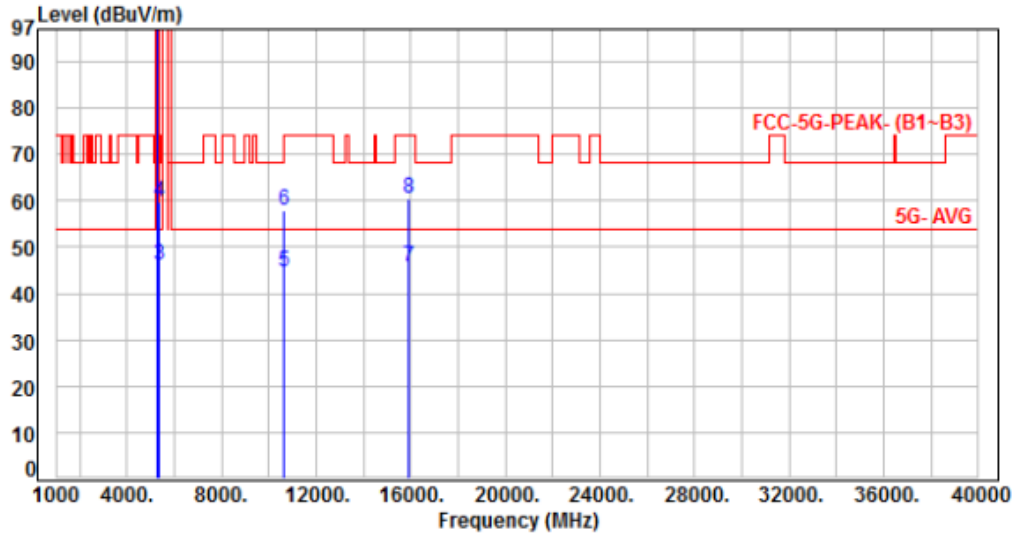

No.	Frequency (MHz)	Factor (dB)	Reading (dBuV)	Level (dBuV/m)	Limit (dBuV/m)	Margin (dB)	Detector	Height (cm)	Azimuth (deg)	P/F
1	5300.00	6.64	91.50	98.14	200.00	-101.86	Average	254	311	P
2	5300.00	6.64	103.04	109.68	200.00	-90.32	Peak	254	311	P
3	5350.00	6.57	39.41	45.98	54.00	-8.02	Average	254	311	P
4	5350.00	6.57	53.29	59.86	74.00	-14.14	Peak	254	311	P
5	10600.00	14.04	30.48	44.52	54.00	-9.48	Average	100	198	P
6	10600.00	14.04	43.74	57.78	74.00	-16.22	Peak	100	198	P
7	15900.00	15.80	29.80	45.60	54.00	-8.40	Average	100	189	P
8	15900.00	15.80	44.86	60.66	74.00	-13.34	Peak	100	189	P

Note: Level=Reading+Factor  
 Margin=Level-Limit  
 Factor=Antenna Factor + cable loss - Amplifier Factor



Power	:	From Adapter (AC 120V / 60Hz)	Pol/Phase	:	VERTICAL
Test Mode	:	Mode 1, Band 2, CH64		:	

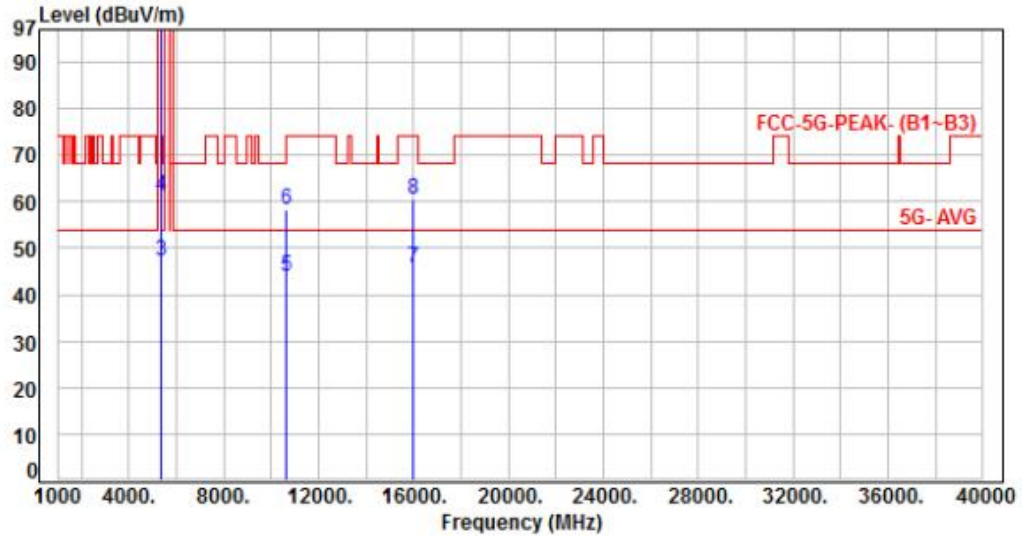

No.	Frequency (MHz)	Factor (dB)	Reading (dBuV)	Level (dBuV/m)	Limit (dBuV/m)	Margin (dB)	Detector	Height (cm)	Azimuth (deg)	P/F
1	5320.00	6.61	96.17	102.78	200.00	-97.22	Average	314	3	P
2	5320.00	6.61	107.29	113.90	200.00	-86.10	Peak	314	3	P
3	5350.00	6.57	40.75	47.32	54.00	-6.68	Average	314	3	P
4	5350.00	6.57	54.63	61.20	74.00	-12.80	Peak	314	3	P
5	10640.00	14.08	29.79	43.87	54.00	-10.13	Average	100	299	P
6	10640.00	14.08	44.35	58.43	74.00	-15.57	Peak	100	299	P
7	15960.00	15.66	30.06	45.72	54.00	-8.28	Average	100	167	P
8	15960.00	15.66	44.82	60.48	74.00	-13.52	Peak	100	167	P

Note: Level=Reading+Factor  
 Margin=Level-Limit  
 Factor=Antenna Factor + cable loss - Amplifier Factor





Power	:	From Adapter (AC 120V / 60Hz)	Pol/Phase	:	HORIZONTAL
Test Mode	:	Mode 1, Band 2, CH64		:	

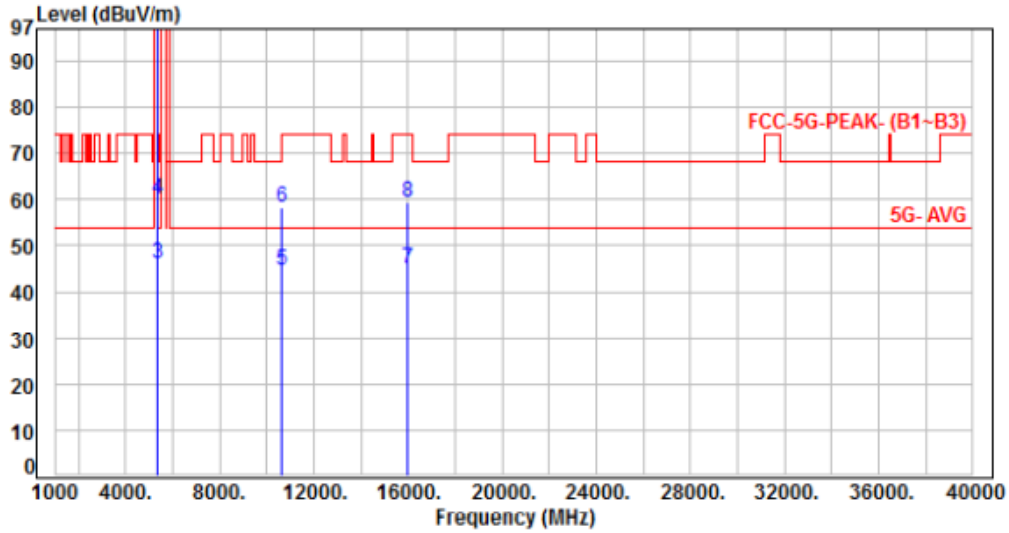

No.	Frequency (MHz)	Factor (dB)	Reading (dBUV)	Level (dBUV/m)	Limit (dBUV/m)	Margin (dB)	Detector	Height (cm)	Azimuth (deg)	P/F
1	5320.00	6.61	91.52	98.13	200.00	-101.87	Average	249	308	P
2	5320.00	6.61	101.83	108.44	200.00	-91.56	Peak	249	308	P
3	5350.00	6.57	39.43	46.00	54.00	-8.00	Average	249	308	P
4	5350.00	6.57	53.61	60.18	74.00	-13.82	Peak	249	308	P
5	10640.00	14.08	30.58	44.66	54.00	-9.34	Average	100	202	P
6	10640.00	14.08	44.19	58.27	74.00	-15.73	Peak	100	202	P
7	15960.00	15.66	29.49	45.15	54.00	-8.85	Average	100	185	P
8	15960.00	15.66	43.76	59.42	74.00	-14.58	Peak	100	185	P

Note: Level=Reading+Factor  
 Margin=Level-Limit  
 Factor=Antenna Factor + cable loss - Amplifier Factor



Power	:	From Adapter (AC 120V / 60Hz)	Pol/Phase	:	VERTICAL
Test Mode	:	Mode 4, Band 2, CH52		:	

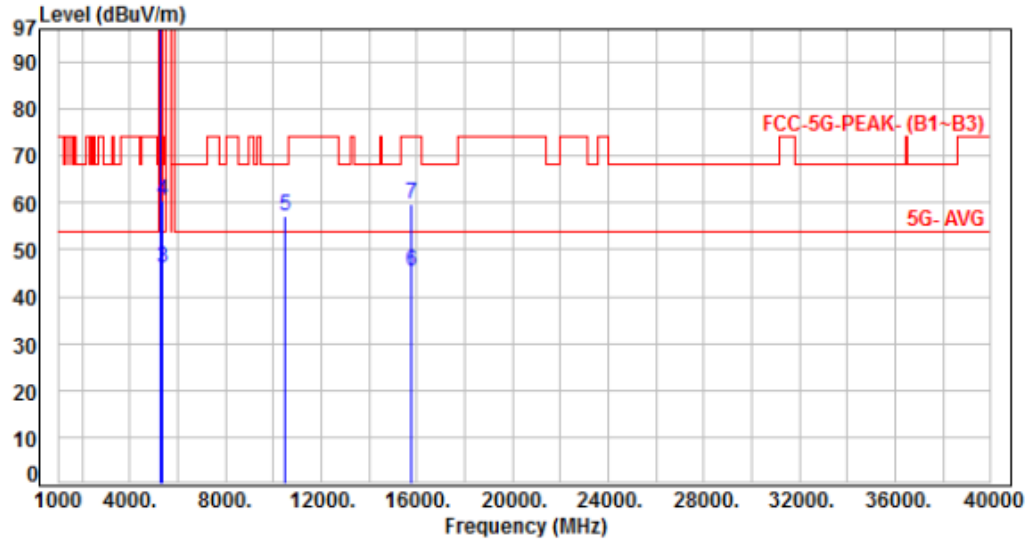

No.	Frequency (MHz)	Factor (dB)	Reading (dBuV)	Level (dBuV/m)	Limit (dBuV/m)	Margin (dB)	Detector	Height (cm)	Azimuth (deg)	P/F
1	5260.00	6.52	93.84	100.36	200.00	-99.64	Average	303	26	P
2	5260.00	6.52	105.20	111.72	200.00	-88.28	Peak	303	26	P
3	5350.00	6.57	39.60	46.17	54.00	-7.83	Average	303	26	P
4	5350.00	6.57	53.75	60.32	74.00	-13.68	Peak	303	26	P
5	10520.00	13.94	43.35	57.29	68.20	-10.91	Peak	100	299	P
6	15780.00	15.71	29.50	45.21	54.00	-8.79	Average	100	164	P
7	15780.00	15.71	43.92	59.63	74.00	-14.37	Peak	100	164	P

Note: Level=Reading+Factor  
 Margin=Level-Limit  
 Factor=Antenna Factor + cable loss - Amplifier Factor



Power	:	From Adapter (AC 120V / 60Hz)	Pol/Phase	:	HORIZONTAL
Test Mode	:	Mode 4, Band 2, CH52		:	

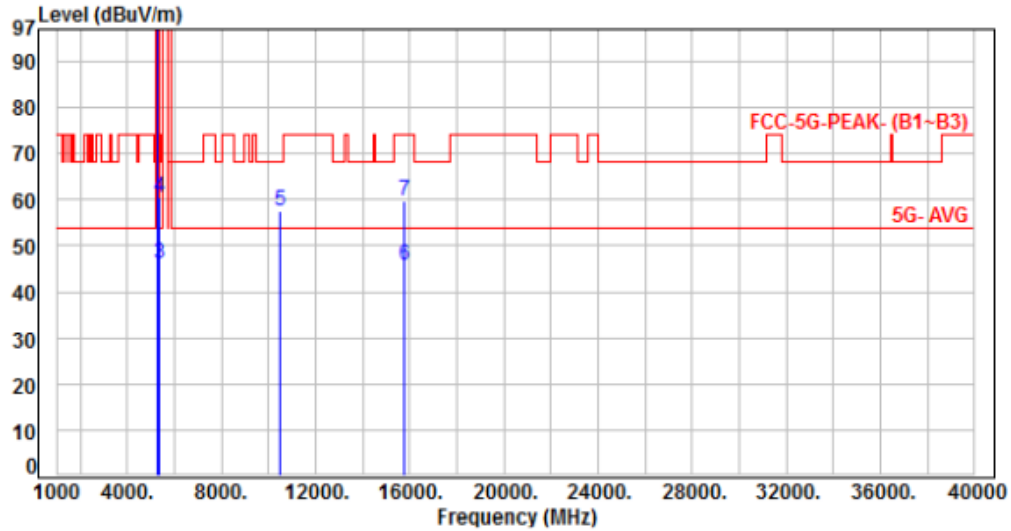

No.	Frequency (MHz)	Factor (dB)	Reading (dBUV)	Level (dBUV/m)	Limit (dBUV/m)	Margin (dB)	Detector	Height (cm)	Azimuth (deg)	P/F
1	5260.00	6.52	89.42	95.94	200.00	-104.06	Average	249	311	P
2	5260.00	6.52	99.97	106.49	200.00	-93.51	Peak	249	311	P
3	5350.00	6.57	39.48	46.05	54.00	-7.95	Average	249	311	P
4	5350.00	6.57	53.83	60.40	74.00	-13.60	Peak	249	311	P
5	10520.00	13.94	43.77	57.71	68.20	-10.49	Peak	100	194	P
6	15780.00	15.71	29.87	45.58	54.00	-8.42	Average	100	190	P
7	15780.00	15.71	44.19	59.90	74.00	-14.10	Peak	100	190	P

Note: Level=Reading+Factor  
 Margin=Level-Limit  
 Factor=Antenna Factor + cable loss - Amplifier Factor



Power	:	From Adapter (AC 120V / 60Hz)	Pol/Phase	:	VERTICAL
Test Mode	:	Mode 4, Band 2, CH60		:	

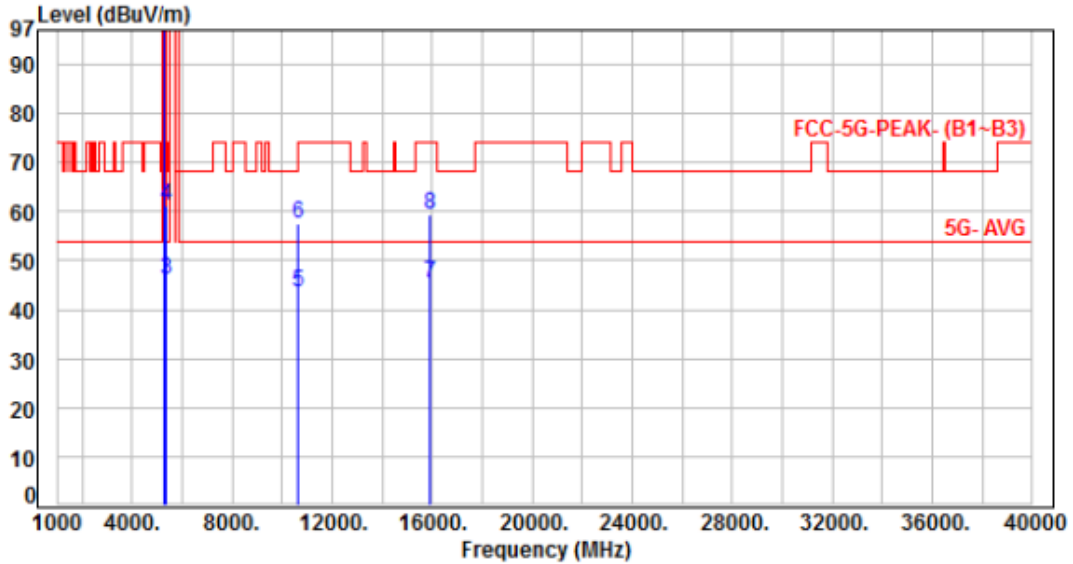

No.	Frequency (MHz)	Factor (dB)	Reading (dBuV)	Level (dBuV/m)	Limit (dBuV/m)	Margin (dB)	Detector	Height (cm)	Azimuth (deg)	P/F
1	5300.00	6.64	94.78	101.42	200.00	-98.58	Average	333	5	P
2	5300.00	6.64	106.60	113.24	200.00	-86.76	Peak	333	5	P
3	5350.00	6.57	39.43	46.00	54.00	-8.00	Average	333	5	P
4	5350.00	6.57	54.47	61.04	74.00	-12.96	Peak	333	5	P
5	10600.00	14.04	29.36	43.40	54.00	-10.60	Average	100	288	P
6	10600.00	14.04	43.60	57.64	74.00	-16.36	Peak	100	288	P
7	15900.00	15.80	29.66	45.46	54.00	-8.54	Average	100	172	P
8	15900.00	15.80	43.59	59.39	74.00	-14.61	Peak	100	172	P

Note: Level=Reading+Factor

Margin=Level-Limit

Factor=Antenna Factor + cable loss - Amplifier Factor



Power	:	From Adapter (AC 120V / 60Hz)	Pol/Phase	:	HORIZONTAL
Test Mode	:	Mode 4, Band 2, CH60		:	

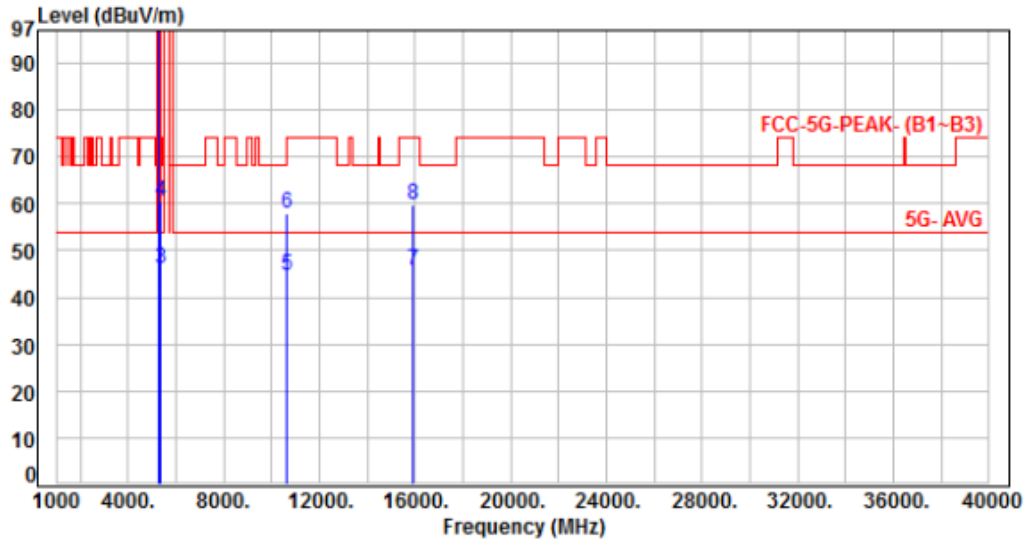

No.	Frequency (MHz)	Factor (dB)	Reading (dBuV)	Level (dBuV/m)	Limit (dBuV/m)	Margin (dB)	Detector	Height (cm)	Azimuth (deg)	P/F
1	5300.00	6.64	90.43	97.07	200.00	-102.93	Average	252	312	P
2	5300.00	6.64	101.82	108.46	200.00	-91.54	Peak	252	312	P
3	5350.00	6.57	39.37	45.94	54.00	-8.06	Average	252	312	P
4	5350.00	6.57	53.88	60.45	74.00	-13.55	Peak	252	312	P
5	10600.00	14.04	30.48	44.52	54.00	-9.48	Average	100	198	P
6	10600.00	14.04	43.80	57.84	74.00	-16.16	Peak	100	198	P
7	15900.00	15.80	29.96	45.76	54.00	-8.24	Average	100	188	P
8	15900.00	15.80	44.10	59.90	74.00	-14.10	Peak	100	188	P

Note: Level=Reading+Factor  
 Margin=Level-Limit  
 Factor=Antenna Factor + cable loss - Amplifier Factor



Power	:	From Adapter (AC 120V / 60Hz)	Pol/Phase	:	VERTICAL
Test Mode	:	Mode 4, Band 2, CH64		:	

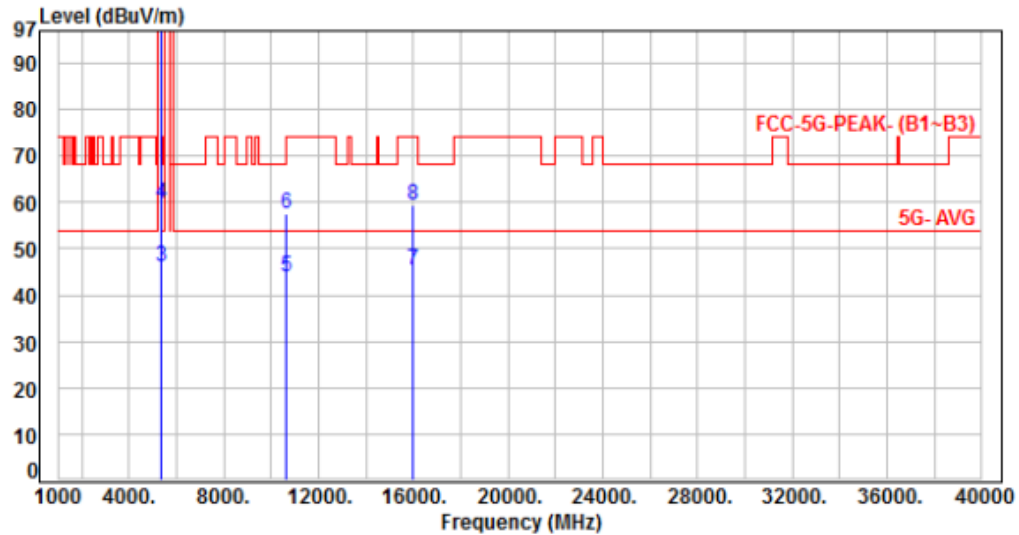

No.	Frequency (MHz)	Factor (dB)	Reading (dBuV)	Level (dBuV/m)	Limit (dBuV/m)	Margin (dB)	Detector	Height (cm)	Azimuth (deg)	P/F
1	5320.00	6.61	91.15	97.76	200.00	-102.24	Average	312	359	P
2	5320.00	6.61	102.99	109.60	200.00	-90.40	Peak	312	359	P
3	5350.00	6.57	39.58	46.15	54.00	-7.85	Average	312	359	P
4	5350.00	6.57	53.28	59.85	74.00	-14.15	Peak	312	359	P
5	10640.00	14.08	29.77	43.85	54.00	-10.15	Average	100	296	P
6	10640.00	14.08	43.61	57.69	74.00	-16.31	Peak	100	296	P
7	15960.00	15.66	29.81	45.47	54.00	-8.53	Average	100	166	P
8	15960.00	15.66	43.76	59.42	74.00	-14.58	Peak	100	166	P

Note: Level=Reading+Factor  
 Margin=Level-Limit  
 Factor=Antenna Factor + cable loss - Amplifier Factor



Power	:	From Adapter (AC 120V / 60Hz)	Pol/Phase	:	HORIZONTAL
Test Mode	:	Mode 4, Band 2, CH64		:	

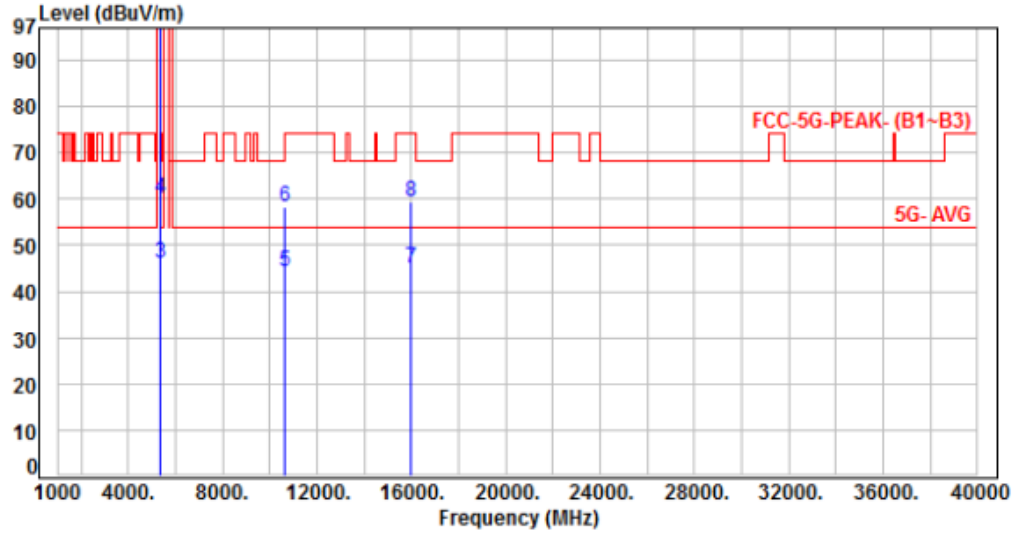

No.	Frequency (MHz)	Factor (dB)	Reading (dBuV)	Level (dBuV/m)	Limit (dBuV/m)	Margin (dB)	Detector	Height (cm)	Azimuth (deg)	P/F
1	5320.00	6.61	88.52	95.13	200.00	-104.87	Average	253	313	P
2	5320.00	6.61	100.06	106.67	200.00	-93.33	Peak	253	313	P
3	5350.00	6.57	39.42	45.99	54.00	-8.01	Average	253	313	P
4	5350.00	6.57	53.61	60.18	74.00	-13.82	Peak	253	313	P
5	10640.00	14.08	30.35	44.43	54.00	-9.57	Average	100	196	P
6	10640.00	14.08	44.22	58.30	74.00	-15.70	Peak	100	196	P
7	15960.00	15.66	29.40	45.06	54.00	-8.94	Average	100	187	P
8	15960.00	15.66	43.89	59.55	74.00	-14.45	Peak	100	187	P

Note: Level=Reading+Factor  
 Margin=Level-Limit  
 Factor=Antenna Factor + cable loss - Amplifier Factor



Power	:	From Adapter (AC 120V / 60Hz)	Pol/Phase	:	VERTICAL
Test Mode	:	Mode 5, Band 2, CH54		:	

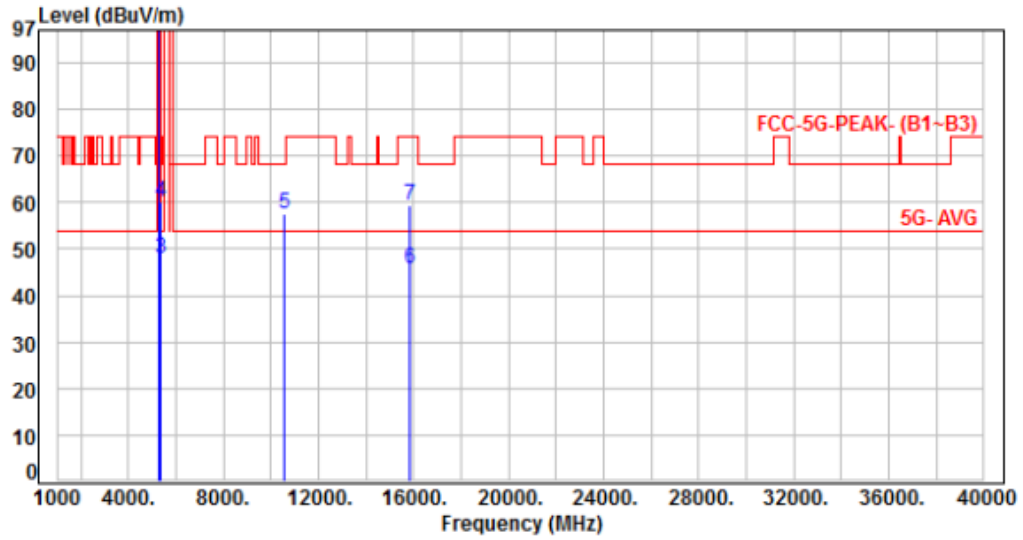

No.	Frequency (MHz)	Factor (dB)	Reading (dBuV)	Level (dBuV/m)	Limit (dBuV/m)	Margin (dB)	Detector	Height (cm)	Azimuth (deg)	P/F
1	5270.00	6.54	94.77	101.31	200.00	-98.69	Average	400	4	P
2	5270.00	6.54	104.28	110.82	200.00	-89.18	Peak	400	4	P
3	5350.00	6.57	41.47	48.04	54.00	-5.96	Average	400	4	P
4	5350.00	6.57	53.62	60.19	74.00	-13.81	Peak	400	4	P
5	10540.00	13.96	43.56	57.52	68.20	-10.68	Peak	100	303	P
6	15810.00	15.74	30.09	45.83	54.00	-8.17	Average	100	164	P
7	15810.00	15.74	43.63	59.37	74.00	-14.63	Peak	100	164	P

Note: Level=Reading+Factor  
 Margin=Level-Limit  
 Factor=Antenna Factor + cable loss - Amplifier Factor





Power	:	From Adapter (AC 120V / 60Hz)	Pol/Phase	:	HORIZONTAL
Test Mode	:	Mode 5, Band 2, CH54		:	

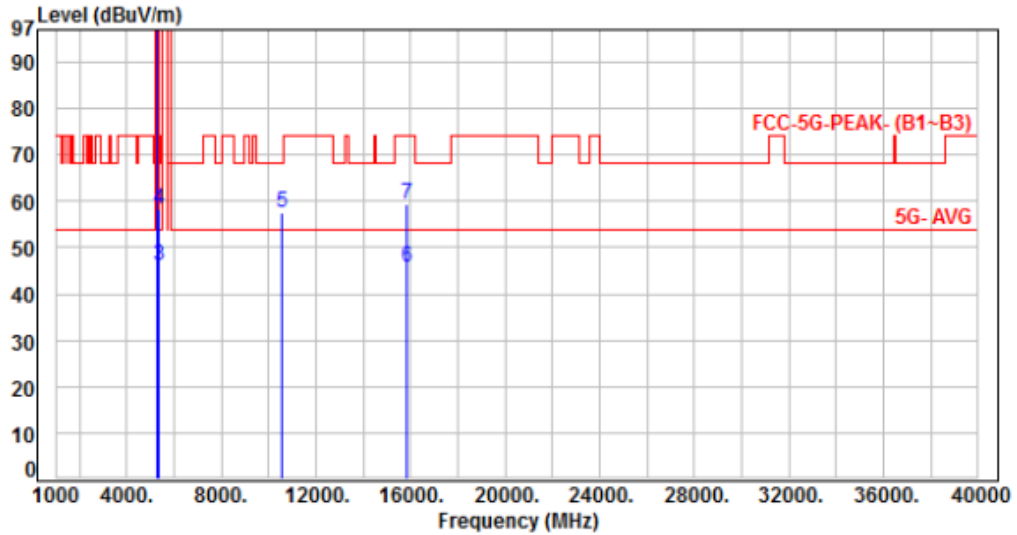

No.	Frequency (MHz)	Factor (dB)	Reading (dBuV)	Level (dBuV/m)	Limit (dBuV/m)	Margin (dB)	Detector	Height (cm)	Azimuth (deg)	P/F
1	5270.00	6.54	90.29	96.83	200.00	-103.17	Average	249	307	P
2	5270.00	6.54	99.58	106.12	200.00	-93.88	Peak	249	307	P
3	5350.00	6.57	39.55	46.12	54.00	-7.88	Average	249	307	P
4	5350.00	6.57	51.62	58.19	74.00	-15.81	Peak	249	307	P
5	10540.00	13.96	43.41	57.37	68.20	-10.83	Peak	100	199	P
6	15810.00	15.74	29.85	45.59	54.00	-8.41	Average	100	182	P
7	15810.00	15.74	43.68	59.42	74.00	-14.58	Peak	100	182	P

Note: Level=Reading+Factor  
 Margin=Level-Limit  
 Factor=Antenna Factor + cable loss - Amplifier Factor



Power	:	From Adapter (AC 120V / 60Hz)	Pol/Phase	:	VERTICAL
Test Mode	:	Mode 5, Band 2, CH62		:	

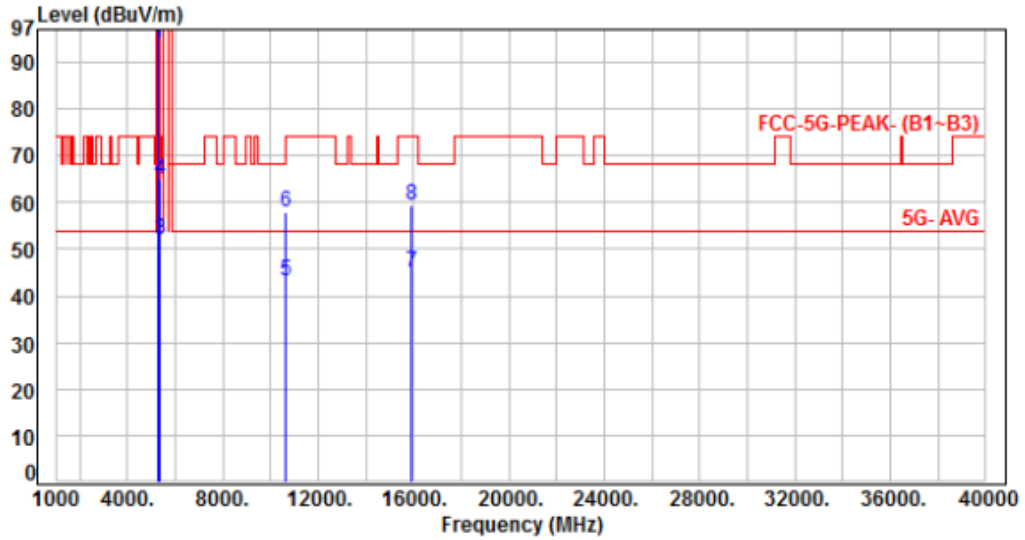

No.	Frequency (MHz)	Factor (dB)	Reading (dBuV)	Level (dBuV/m)	Limit (dBuV/m)	Margin (dB)	Detector	Height (cm)	Azimuth (deg)	P/F
1	5310.00	6.62	87.31	93.93	200.00	-106.07	Average	335	5	P
2	5310.00	6.62	96.84	103.46	200.00	-96.54	Peak	335	5	P
3	5350.00	6.57	45.37	51.94	54.00	-2.06	Average	335	5	P
4	5350.00	6.57	58.46	65.03	74.00	-8.97	Peak	335	5	P
5	10620.00	14.06	29.17	43.23	54.00	-10.77	Average	100	298	P
6	10620.00	14.06	43.75	57.81	74.00	-16.19	Peak	100	298	P
7	15930.00	15.73	29.44	45.17	54.00	-8.83	Average	100	161	P
8	15930.00	15.73	43.72	59.45	74.00	-14.55	Peak	100	161	P

Note: Level=Reading+Factor  
 Margin=Level-Limit  
 Factor=Antenna Factor + cable loss - Amplifier Factor



Power	:	From Adapter (AC 120V / 60Hz)	Pol/Phase	:	HORIZONTAL
Test Mode	:	Mode 5, Band 2, CH62		:	

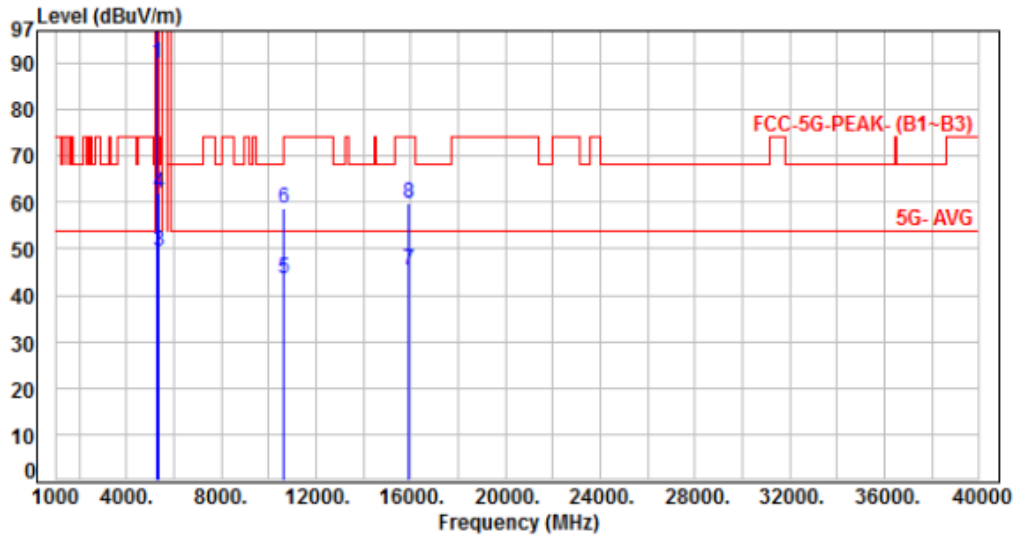

No.	Frequency (MHz)	Factor (dB)	Reading (dBuV)	Level (dBuV/m)	Limit (dBuV/m)	Margin (dB)	Detector	Height (cm)	Azimuth (deg)	P/F
1	5310.00	6.62	83.23	89.85	200.00	-110.15	Average	241	310	P
2	5310.00	6.62	92.74	99.36	200.00	-100.64	Peak	241	310	P
3	5350.00	6.57	42.73	49.30	54.00	-4.70	Average	241	310	P
4	5350.00	6.57	55.52	62.09	74.00	-11.91	Peak	241	310	P
5	10620.00	14.06	29.60	43.66	54.00	-10.34	Average	100	203	P
6	10620.00	14.06	44.75	58.81	74.00	-15.19	Peak	100	203	P
7	15930.00	15.73	29.77	45.50	54.00	-8.50	Average	100	189	P
8	15930.00	15.73	44.03	59.76	74.00	-14.24	Peak	100	189	P

Note: Level=Reading+Factor  
 Margin=Level-Limit  
 Factor=Antenna Factor + cable loss - Amplifier Factor



Power	:	From Adapter (AC 120V / 60Hz)	Pol/Phase	:	VERTICAL
Test Mode	:	Mode 6, Band 2, CH58		:	

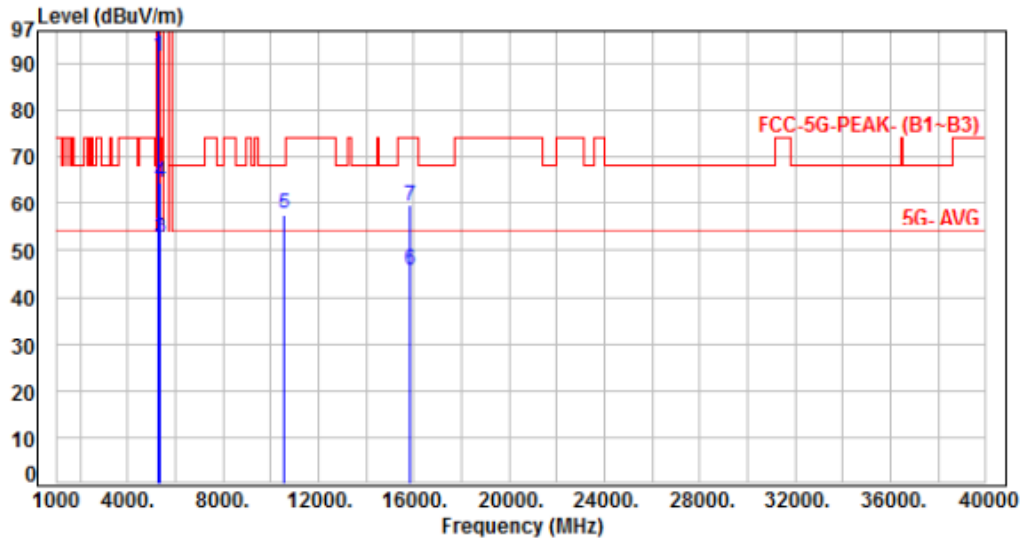

No.	Frequency (MHz)	Factor (dB)	Reading (dBuV)	Level (dBuV/m)	Limit (dBuV/m)	Margin (dB)	Detector	Height (cm)	Azimuth (deg)	P/F
1	5290.00	6.60	84.94	91.54	200.00	-108.46	Average	345	5	P
2	5290.00	6.60	94.29	100.89	200.00	-99.11	Peak	345	5	P
3	5350.00	6.57	45.83	52.40	54.00	-1.60	Average	345	5	P
4	5350.00	6.57	57.81	64.38	74.00	-9.62	Peak	345	5	P
5	10580.00	14.00	43.61	57.61	68.20	-10.59	Peak	100	294	P
6	15870.00	15.79	29.90	45.69	54.00	-8.31	Average	100	168	P
7	15870.00	15.79	43.69	59.48	74.00	-14.52	Peak	100	168	P

Note: Level=Reading+Factor  
Margin=Level-Limit  
Factor=Antenna Factor + cable loss - Amplifier Factor



Power	:	From Adapter (AC 120V / 60Hz)	Pol/Phase	:	HORIZONTAL
Test Mode	:	Mode 6, Band 2, CH58		:	

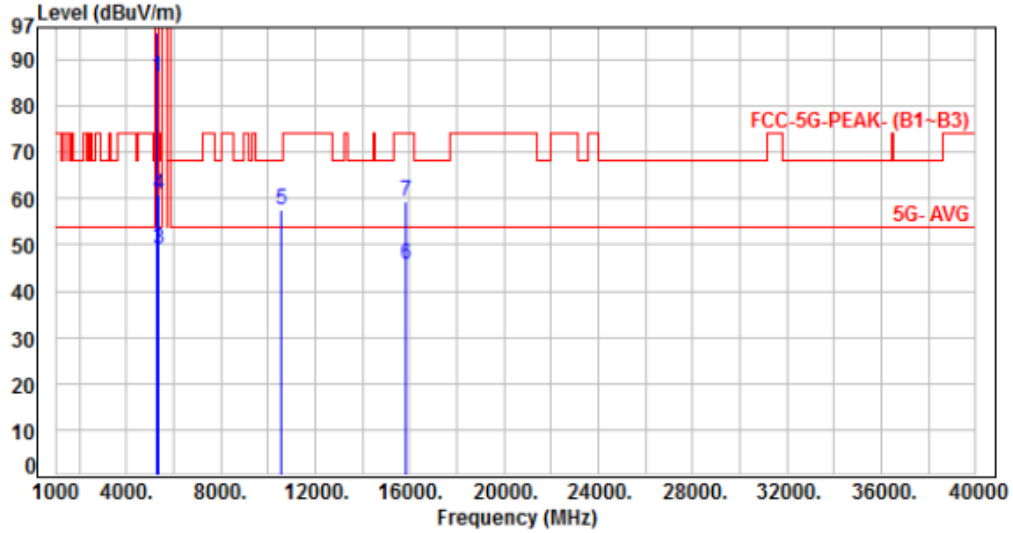

No.	Frequency (MHz)	Factor (dB)	Reading (dBuV)	Level (dBuV/m)	Limit (dBuV/m)	Margin (dB)	Detector	Height (cm)	Azimuth (deg)	P/F
1	5290.00	6.60	79.82	86.42	200.00	-113.58	Average	255	316	P
2	5290.00	6.60	89.31	95.91	200.00	-104.09	Peak	255	316	P
3	5350.00	6.57	42.51	49.08	54.00	-4.92	Average	255	316	P
4	5350.00	6.57	54.38	60.95	74.00	-13.05	Peak	255	316	P
5	10580.00	14.00	43.63	57.63	68.20	-10.57	Peak	100	200	P
6	15870.00	15.79	29.76	45.55	54.00	-8.45	Average	100	190	P
7	15870.00	15.79	43.60	59.39	74.00	-14.61	Peak	100	190	P

Note: Level=Reading+Factor  
 Margin=Level-Limit  
 Factor=Antenna Factor + cable loss - Amplifier Factor



Power	:	From Adapter (AC 120V / 60Hz)	Pol/Phase	:	VERTICAL
Test Mode	:	Mode 1, Band 3, CH100		:	

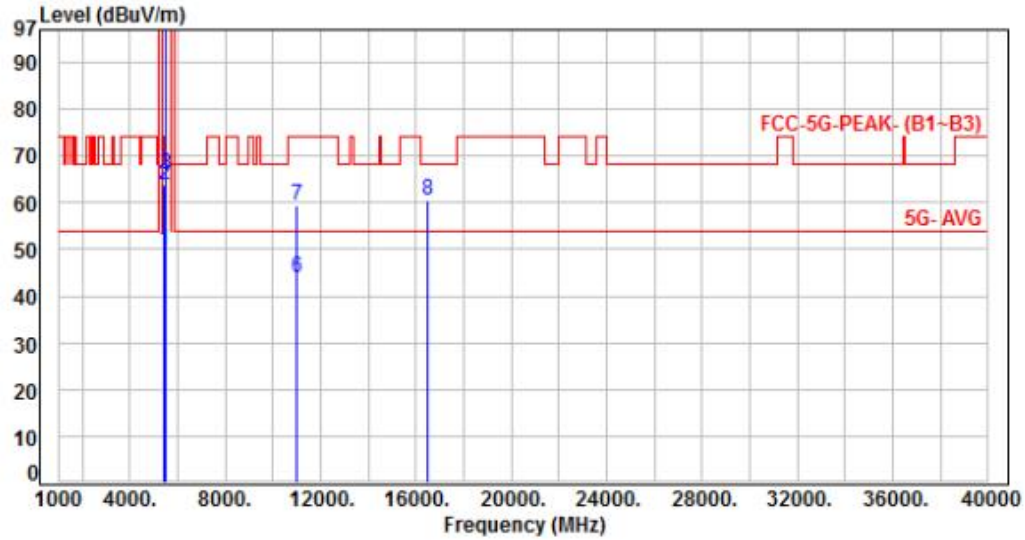

No.	Frequency (MHz)	Factor (dB)	Reading (dBuV)	Level (dBuV/m)	Limit (dBuV/m)	Margin (dB)	Detector	Height (cm)	Azimuth (deg)	P/F
1	5460.00	6.69	43.19	49.88	54.00	-4.12	Average	336	3	P
2	5460.00	6.69	57.11	63.80	74.00	-10.20	Peak	336	3	P
3	5470.00	6.72	59.19	65.91	68.20	-2.29	Peak	336	3	P
4	5500.00	6.80	95.07	101.87	200.00	-98.13	Average	336	3	P
5	5500.00	6.80	106.27	113.07	200.00	-86.93	Peak	336	3	P
6	11000.00	14.68	29.26	43.94	54.00	-10.06	Average	100	294	P
7	11000.00	14.68	44.57	59.25	74.00	-14.75	Peak	100	294	P
8	16500.00	17.03	43.43	60.46	68.20	-7.74	Peak	100	167	P

Note: Level=Reading+Factor  
 Margin=Level-Limit  
 Factor=Antenna Factor + cable loss - Amplifier Factor



Power	:	From Adapter (AC 120V / 60Hz)	Pol/Phase	:	HORIZONTAL
Test Mode	:	Mode 1, Band 3, CH100		:	

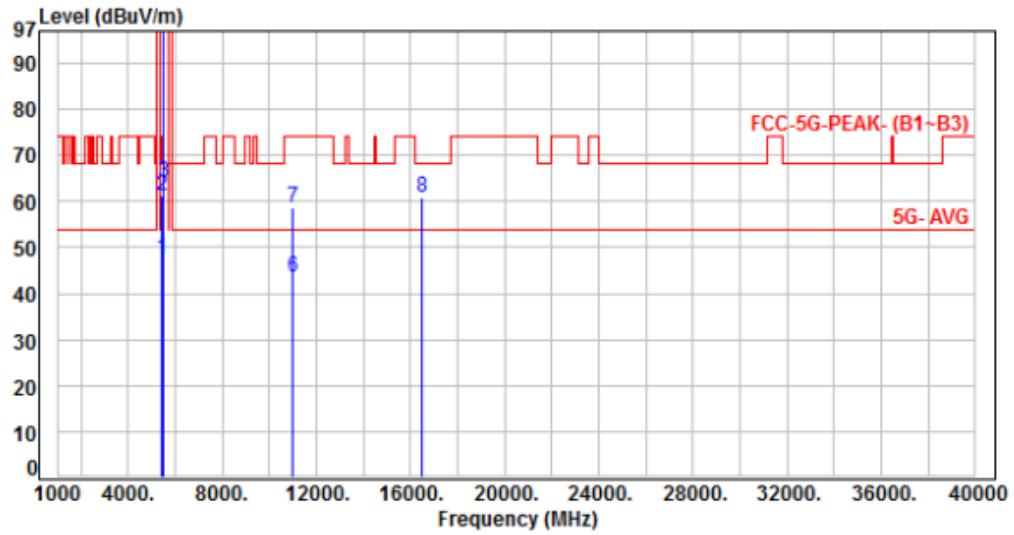

No.	Frequency (MHz)	Factor (dB)	Reading (dBUV)	Level (dBUV/m)	Limit (dBUV/m)	Margin (dB)	Detector	Height (cm)	Azimuth (deg)	P/F
1	5460.00	6.69	40.79	47.48	54.00	-6.52	Average	242	309	P
2	5460.00	6.69	54.38	61.07	74.00	-12.93	Peak	242	309	P
3	5470.00	6.72	57.43	64.15	68.20	-4.05	Peak	242	309	P
4	5500.00	6.80	91.36	98.16	200.00	-101.84	Average	242	309	P
5	5500.00	6.80	101.92	108.72	200.00	-91.28	Peak	242	309	P
6	11000.00	14.68	28.91	43.59	54.00	-10.41	Average	100	199	P
7	11000.00	14.68	43.99	58.67	74.00	-15.33	Peak	100	199	P
8	16500.00	17.03	43.96	60.99	68.20	-7.21	Peak	100	186	P

Note: Level=Reading+Factor  
Margin=Level-Limit  
Factor=Antenna Factor + cable loss - Amplifier Factor



Power	:	From Adapter (AC 120V / 60Hz)	Pol/Phase	:	VERTICAL
Test Mode	:	Mode 1, Band 3, CH120		:	

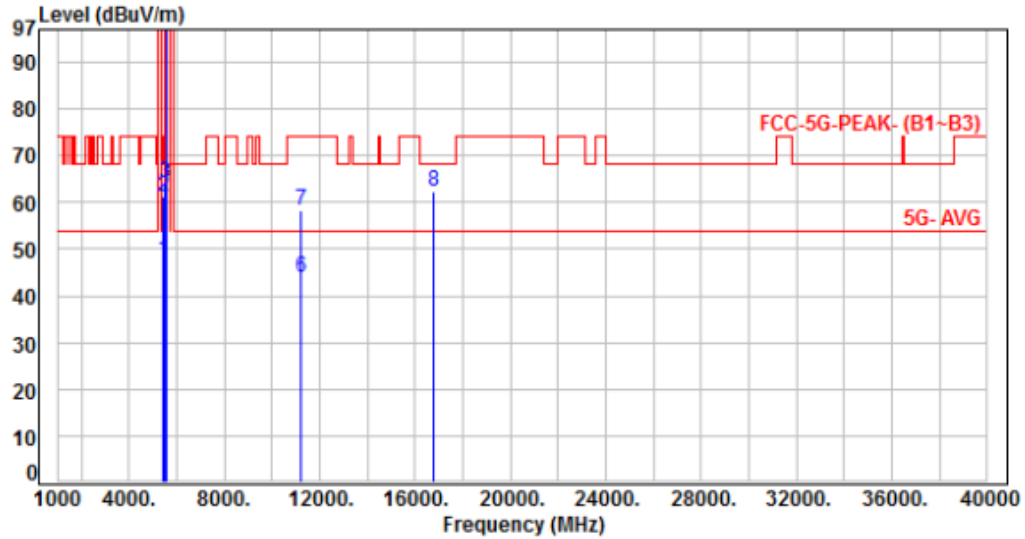

No.	Frequency (MHz)	Factor (dB)	Reading (dBuV)	Level (dBuV/m)	Limit (dBuV/m)	Margin (dB)	Detector	Height (cm)	Azimuth (deg)	P/F
1	5460.00	6.69	41.05	47.74	54.00	-6.26	Average	333	357	P
2	5460.00	6.69	54.60	61.29	74.00	-12.71	Peak	333	357	P
3	5470.00	6.72	57.43	64.15	68.20	-4.05	Peak	333	357	P
4	5600.00	6.78	94.57	101.35	200.00	-98.65	Average	333	357	P
5	5600.00	6.78	105.29	112.07	200.00	-87.93	Peak	333	357	P
6	11200.00	14.71	29.05	43.76	54.00	-10.24	Average	100	293	P
7	11200.00	14.71	43.57	58.28	74.00	-15.72	Peak	100	293	P
8	16800.00	19.05	43.45	62.50	68.20	-5.70	Peak	100	166	P

Note: Level=Reading+Factor  
 Margin=Level-Limit  
 Factor=Antenna Factor + cable loss - Amplifier Factor





Power	:	From Adapter (AC 120V / 60Hz)	Pol/Phase	:	HORIZONTAL
Test Mode	:	Mode 1, Band 3, CH120		:	

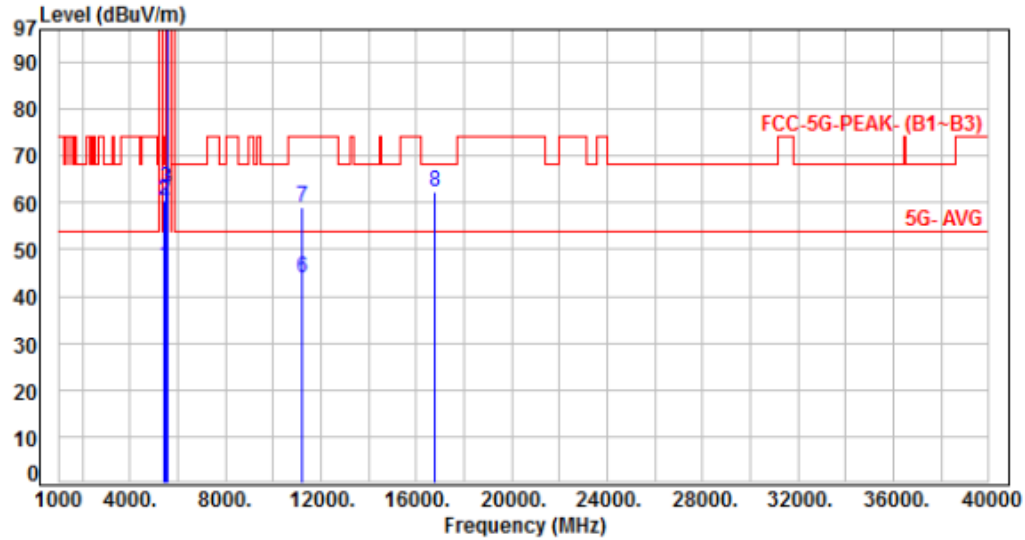

No.	Frequency (MHz)	Factor (dB)	Reading (dBuV)	Level (dBuV/m)	Limit (dBuV/m)	Margin (dB)	Detector	Height (cm)	Azimuth (deg)	P/F
1	5460.00	6.69	39.71	46.40	54.00	-7.60	Average	246	311	P
2	5460.00	6.69	53.82	60.51	74.00	-13.49	Peak	246	311	P
3	5470.00	6.72	56.33	63.05	68.20	-5.15	Peak	246	311	P
4	5600.00	6.78	90.17	96.95	200.00	-103.05	Average	246	311	P
5	5600.00	6.78	100.63	107.41	200.00	-92.59	Peak	246	311	P
6	11200.00	14.71	29.11	43.82	54.00	-10.18	Average	100	200	P
7	11200.00	14.71	44.15	58.86	74.00	-15.14	Peak	100	200	P
8	16800.00	19.05	43.28	62.33	68.20	-5.87	Peak	100	181	P

Note: Level=Reading+Factor  
 Margin=Level-Limit  
 Factor=Antenna Factor + cable loss - Amplifier Factor



Power	:	From Adapter (AC 120V / 60Hz)	Pol/Phase	:	VERTICAL
Test Mode	:	Mode 1, Band 3, CH140		:	

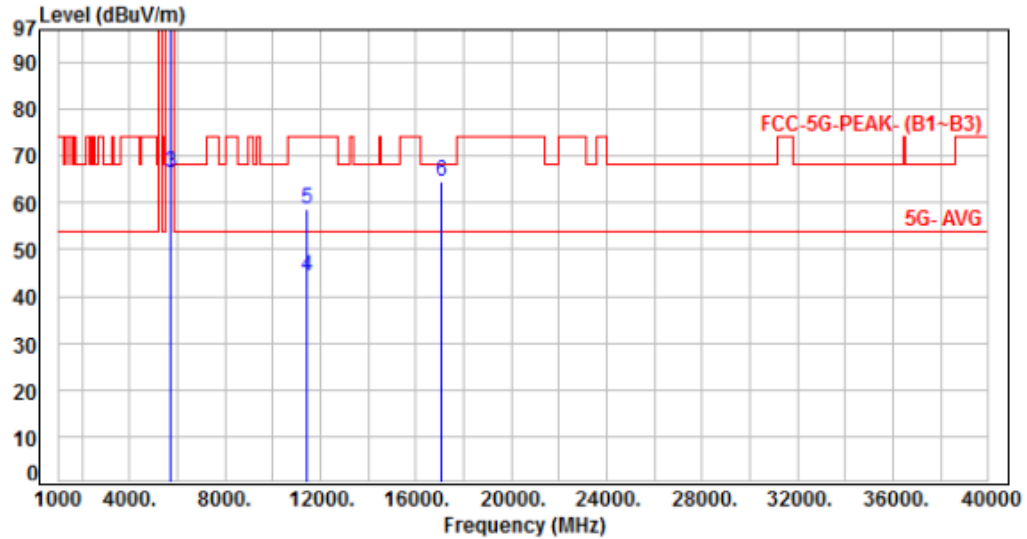

No.	Frequency (MHz)	Factor (dB)	Reading (dBuV)	Level (dBuV/m)	Limit (dBuV/m)	Margin (dB)	Detector	Height (cm)	Azimuth (deg)	P/F
1	5700.00	6.86	90.55	97.41	200.00	-102.59	Average	326	4	P
2	5700.00	6.86	102.34	109.20	200.00	-90.80	Peak	326	4	P
3	5725.00	6.83	59.65	66.48	68.20	-1.72	Peak	326	4	P
4	11400.00	14.94	29.38	44.32	54.00	-9.68	Average	100	296	P
5	11400.00	14.94	43.59	58.53	74.00	-15.47	Peak	100	296	P
6	17100.00	20.81	43.82	64.63	68.20	-3.57	Peak	100	163	P

Note: Level=Reading+Factor  
 Margin=Level-Limit  
 Factor=Antenna Factor + cable loss - Amplifier Factor



Power	:	From Adapter (AC 120V / 60Hz)	Pol/Phase	:	HORIZONTAL
Test Mode	:	Mode 1, Band 3, CH140		:	

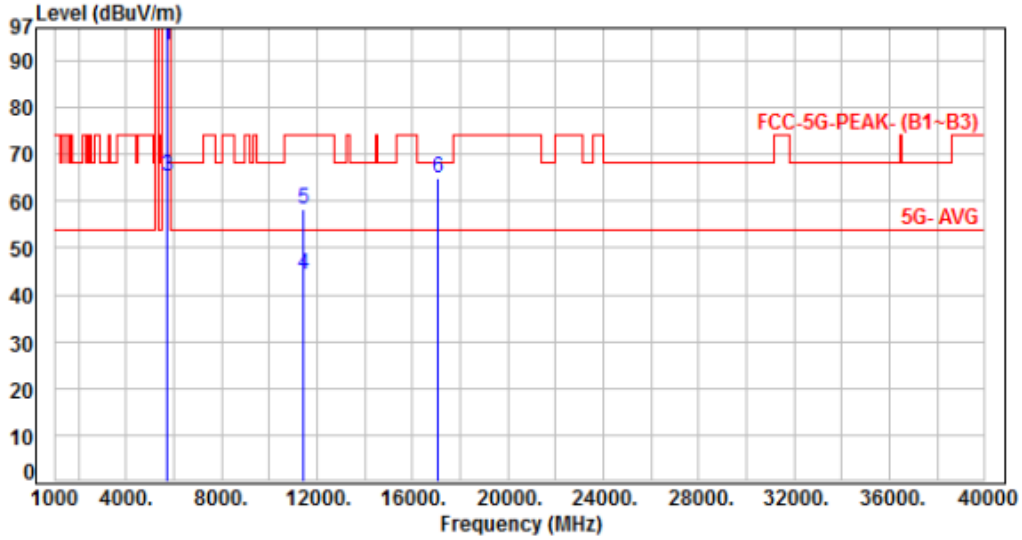

No.	Frequency (MHz)	Factor (dB)	Reading (dBuV)	Level (dBuV/m)	Limit (dBuV/m)	Margin (dB)	Detector	Height (cm)	Azimuth (deg)	P/F
1	5700.00	6.86	86.30	93.16	200.00	-106.84	Average	236	305	P
2	5700.00	6.86	97.57	104.43	200.00	-95.57	Peak	236	305	P
3	5725.00	6.83	58.55	65.38	68.20	-2.82	Peak	236	305	P
4	11400.00	14.94	29.17	44.11	54.00	-9.89	Average	100	197	P
5	11400.00	14.94	43.16	58.10	74.00	-15.90	Peak	100	197	P
6	17100.00	20.81	43.94	64.75	68.20	-3.45	Peak	100	188	P

Note: Level=Reading+Factor  
 Margin=Level-Limit  
 Factor=Antenna Factor + cable loss - Amplifier Factor



Power	:	From Adapter (AC 120V / 60Hz)	Pol/Phase	:	VERTICAL
Test Mode	:	Mode 4, Band 3, CH100		:	

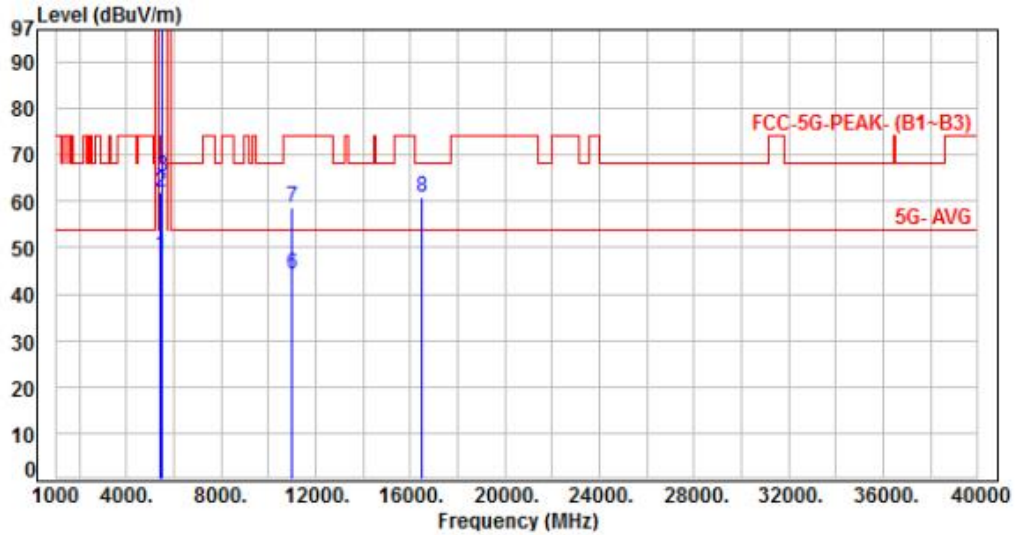

No.	Frequency (MHz)	Factor (dB)	Reading (dBUV)	Level (dBUV/m)	Limit (dBUV/m)	Margin (dB)	Detector	Height (cm)	Azimuth (deg)	P/F
1	5460.00	6.69	41.48	48.17	54.00	-5.83	Average	335	0	P
2	5460.00	6.69	55.16	61.85	74.00	-12.15	Peak	335	0	P
3	5470.00	6.72	58.42	65.14	68.20	-3.06	Peak	335	0	P
4	5500.00	6.80	92.41	99.21	200.00	-100.79	Average	335	0	P
5	5500.00	6.80	104.50	111.30	200.00	-88.70	Peak	335	0	P
6	11000.00	14.68	29.47	44.15	54.00	-9.85	Average	100	290	P
7	11000.00	14.68	44.08	58.76	74.00	-15.24	Peak	100	290	P
8	16500.00	17.03	43.70	60.73	68.20	-7.47	Peak	100	163	P

Note: Level=Reading+Factor  
 Margin=Level-Limit  
 Factor=Antenna Factor + cable loss - Amplifier Factor



Power	:	From Adapter (AC 120V / 60Hz)	Pol/Phase	:	HORIZONTAL
Test Mode	:	Mode 4, Band 3, CH100		:	

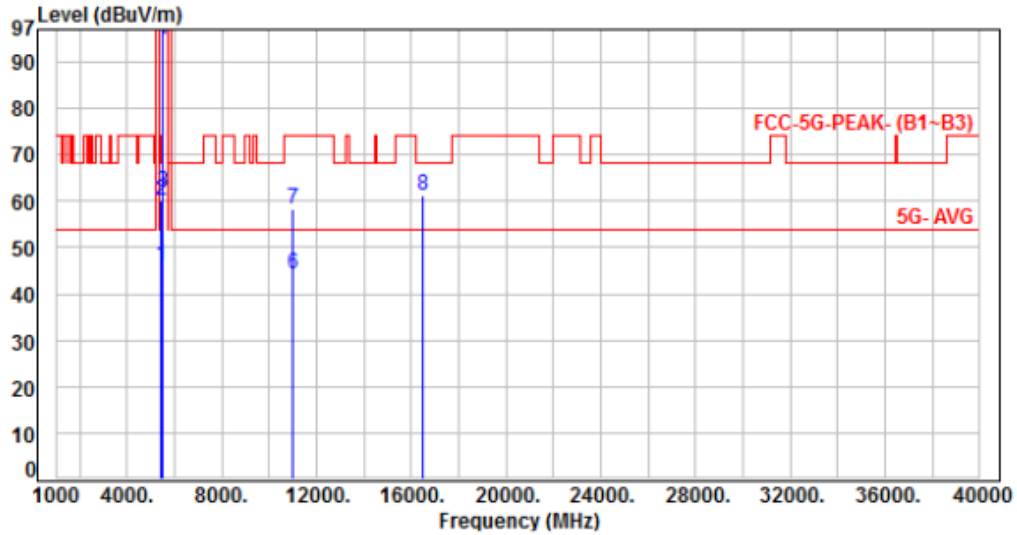

No.	Frequency (MHz)	Factor (dB)	Reading (dBuV)	Level (dBuV/m)	Limit (dBuV/m)	Margin (dB)	Detector	Height (cm)	Azimuth (deg)	P/F
1	5460.00	6.69	39.28	45.97	54.00	-8.03	Average	239	311	P
2	5460.00	6.69	53.41	60.10	74.00	-13.90	Peak	239	311	P
3	5470.00	6.72	55.33	62.05	68.20	-6.15	Peak	239	311	P
4	5500.00	6.80	88.02	94.82	200.00	-105.18	Average	239	311	P
5	5500.00	6.80	100.24	107.04	200.00	-92.96	Peak	239	311	P
6	11000.00	14.68	29.47	44.15	54.00	-9.85	Average	100	196	P
7	11000.00	14.68	43.61	58.29	74.00	-15.71	Peak	100	196	P
8	16500.00	17.03	44.18	61.21	68.20	-6.99	Peak	100	189	P

Note: Level=Reading+Factor  
 Margin=Level-Limit  
 Factor=Antenna Factor + cable loss - Amplifier Factor



Power	:	From Adapter (AC 120V / 60Hz)	Pol/Phase	:	VERTICAL
Test Mode	:	Mode 4, Band 3, CH120		:	

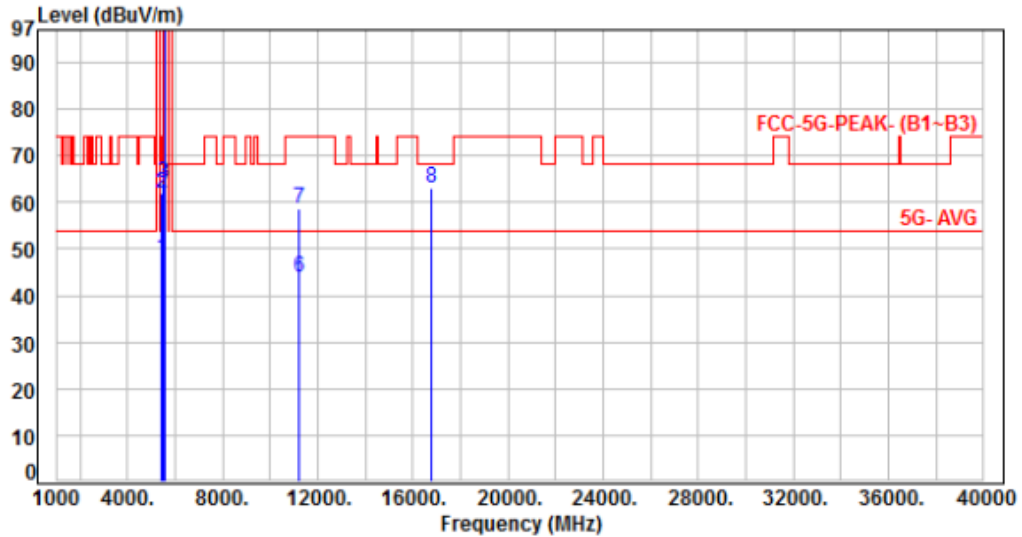

No.	Frequency (MHz)	Factor (dB)	Reading (dBuV)	Level (dBuV/m)	Limit (dBuV/m)	Margin (dB)	Detector	Height (cm)	Azimuth (deg)	P/F
1	5460.00	6.69	41.28	47.97	54.00	-6.03	Average	340	355	P
2	5460.00	6.69	55.11	61.80	74.00	-12.20	Peak	340	355	P
3	5470.00	6.72	57.35	64.07	68.20	-4.13	Peak	340	355	P
4	5600.00	6.78	93.55	100.33	200.00	-99.67	Average	340	355	P
5	5600.00	6.78	104.08	110.86	200.00	-89.14	Peak	340	355	P
6	11200.00	14.71	29.23	43.94	54.00	-10.06	Average	100	294	P
7	11200.00	14.71	44.09	58.80	74.00	-15.20	Peak	100	294	P
8	16800.00	19.05	44.14	63.19	68.20	-5.01	Peak	100	165	P

Note: Level=Reading+Factor  
 Margin=Level-Limit  
 Factor=Antenna Factor + cable loss - Amplifier Factor



Power	:	From Adapter (AC 120V / 60Hz)	Pol/Phase	:	HORIZONTAL
Test Mode	:	Mode 4, Band 3, CH120		:	

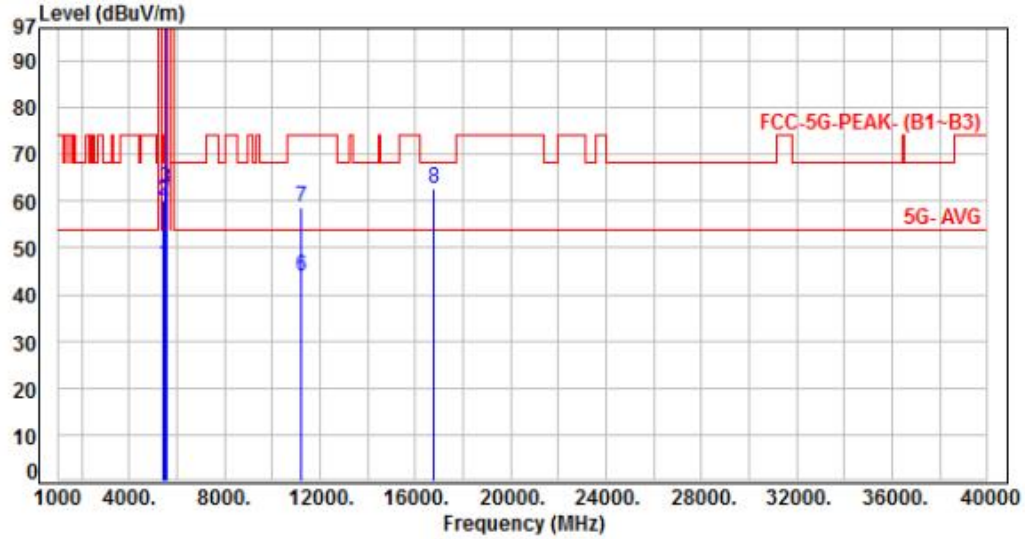

No.	Frequency (MHz)	Factor (dB)	Reading (dBuV)	Level (dBuV/m)	Limit (dBuV/m)	Margin (dB)	Detector	Height (cm)	Azimuth (deg)	P/F
1	5460.00	6.69	39.61	46.30	54.00	-7.70	Average	241	309	P
2	5460.00	6.69	53.42	60.11	74.00	-13.89	Peak	241	309	P
3	5470.00	6.72	55.80	62.52	68.20	-5.68	Peak	241	309	P
4	5600.00	6.78	88.94	95.72	200.00	-104.28	Average	241	309	P
5	5600.00	6.78	99.57	106.35	200.00	-93.65	Peak	241	309	P
6	11200.00	14.71	29.18	43.89	54.00	-10.11	Average	100	198	P
7	11200.00	14.71	43.75	58.46	74.00	-15.54	Peak	100	198	P
8	16800.00	19.05	43.81	62.86	68.20	-5.34	Peak	100	191	P

Note: Level=Reading+Factor  
 Margin=Level-Limit  
 Factor=Antenna Factor + cable loss - Amplifier Factor



Power	:	From Adapter (AC 120V / 60Hz)	Pol/Phase	:	VERTICAL
Test Mode	:	Mode 4, Band 3, CH140		:	

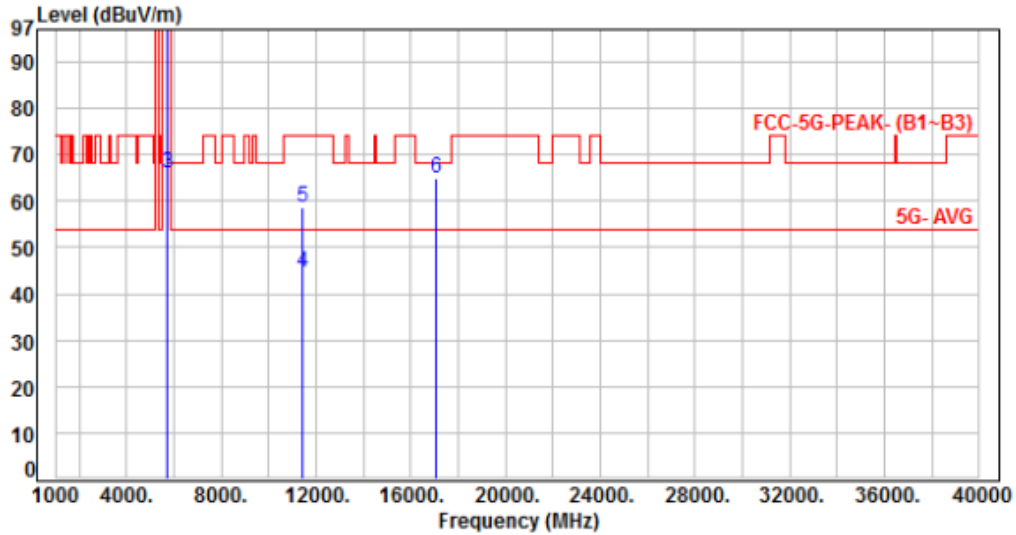

No.	Frequency (MHz)	Factor (dB)	Reading (dBuV)	Level (dBuV/m)	Limit (dBuV/m)	Margin (dB)	Detector	Height (cm)	Azimuth (deg)	P/F
1	5700.00	6.86	89.80	96.66	200.00	-103.34	Average	306	9	P
2	5700.00	6.86	101.25	108.11	200.00	-91.89	Peak	306	9	P
3	5725.00	6.83	59.27	66.10	68.20	-2.10	Peak	306	9	P
4	11400.00	14.94	29.81	44.75	54.00	-9.25	Average	100	292	P
5	11400.00	14.94	43.75	58.69	74.00	-15.31	Peak	100	292	P
6	17100.00	20.81	44.12	64.93	68.20	-3.27	Peak	100	161	P

Note: Level=Reading+Factor

Margin=Level-Limit

Factor=Antenna Factor + cable loss - Amplifier Factor





Power	:	From Adapter (AC 120V / 60Hz)	Pol/Phase	:	HORIZONTAL
Test Mode	:	Mode 4, Band 3, CH140		:	

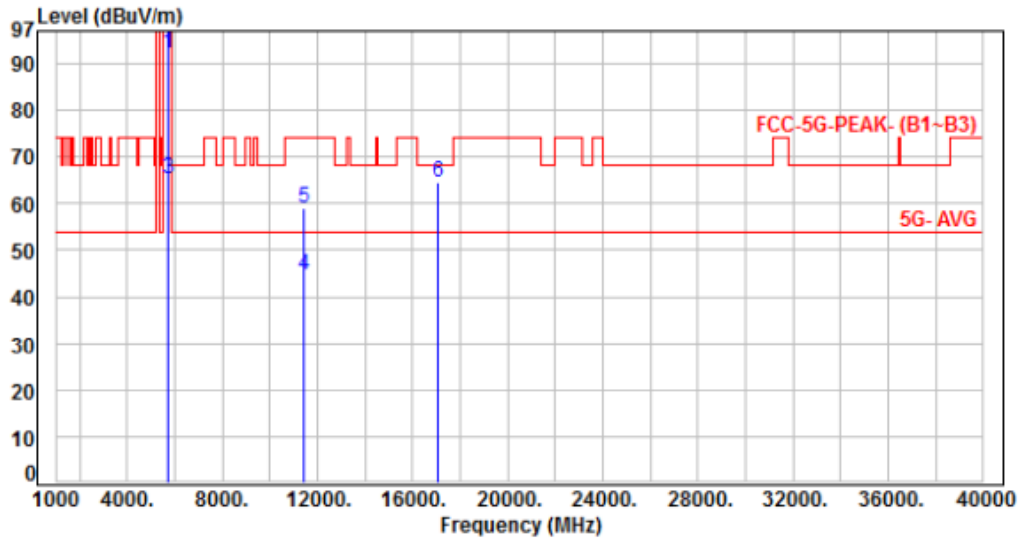

No.	Frequency (MHz)	Factor (dB)	Reading (dBuV)	Level (dBuV/m)	Limit (dBuV/m)	Margin (dB)	Detector	Height (cm)	Azimuth (deg)	P/F
1	5700.00	6.86	85.52	92.38	200.00	-107.62	Average	239	311	P
2	5700.00	6.86	97.03	103.89	200.00	-96.11	Peak	239	311	P
3	5725.00	6.83	58.48	65.31	68.20	-2.89	Peak	239	311	P
4	11400.00	14.94	29.74	44.68	54.00	-9.32	Average	100	194	P
5	11400.00	14.94	43.96	58.90	74.00	-15.10	Peak	100	194	P
6	17100.00	20.81	43.85	64.66	68.20	-3.54	Peak	100	179	P

Note: Level=Reading+Factor  
 Margin=Level-Limit  
 Factor=Antenna Factor + cable loss - Amplifier Factor



Power	:	From Adapter (AC 120V / 60Hz)	Pol/Phase	:	VERTICAL
Test Mode	:	Mode 5, Band 3, CH102		:	

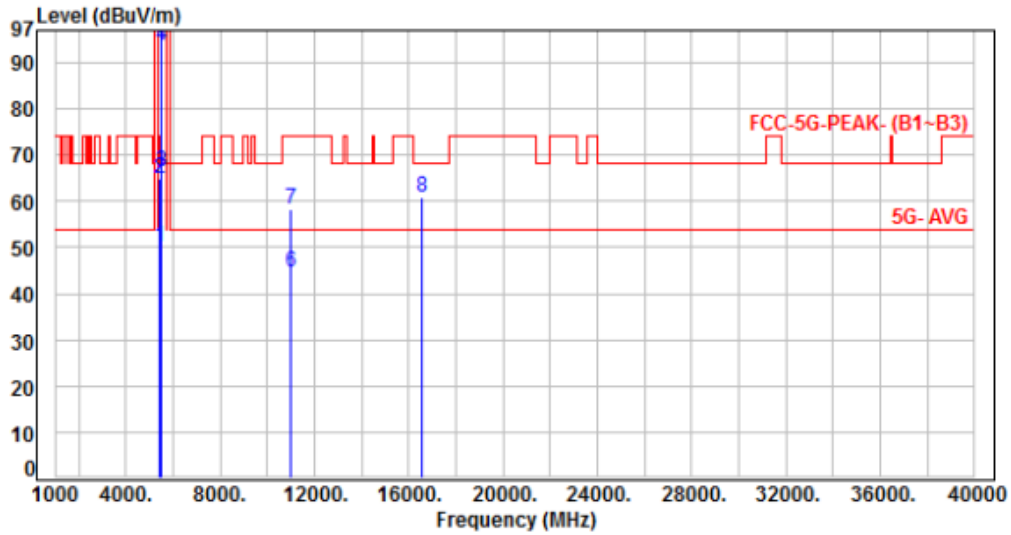

No.	Frequency (MHz)	Factor (dB)	Reading (dBuV)	Level (dBuV/m)	Limit (dBuV/m)	Margin (dB)	Detector	Height (cm)	Azimuth (deg)	P/F
1	5460.00	6.69	43.59	50.28	54.00	-3.72	Average	381	355	P
2	5460.00	6.69	58.11	64.80	74.00	-9.20	Peak	381	355	P
3	5470.00	6.72	59.64	66.36	68.20	-1.84	Peak	381	355	P
4	5510.00	6.79	86.75	93.54	200.00	-106.46	Average	381	355	P
5	5510.00	6.79	96.11	102.90	200.00	-97.10	Peak	381	355	P
6	11020.00	14.67	30.08	44.75	54.00	-9.25	Average	100	293	P
7	11020.00	14.67	43.72	58.39	74.00	-15.61	Peak	100	293	P
8	16530.00	17.31	43.57	60.88	68.20	-7.32	Peak	100	164	P

Note: Level=Reading+Factor  
 Margin=Level-Limit  
 Factor=Antenna Factor + cable loss - Amplifier Factor



Power	:	From Adapter (AC 120V / 60Hz)	Pol/Phase	:	HORIZONTAL
Test Mode	:	Mode 5, Band 3, CH102		:	

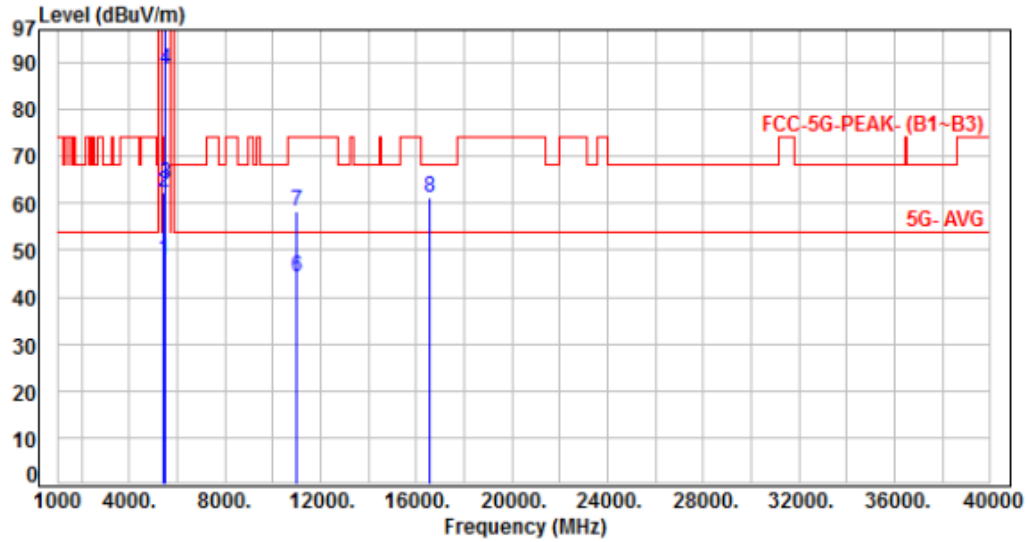

No.	Frequency (MHz)	Factor (dB)	Reading (dBuV)	Level (dBuV/m)	Limit (dBuV/m)	Margin (dB)	Detector	Height (cm)	Azimuth (deg)	P/F
1	5460.00	6.69	41.08	47.77	54.00	-6.23	Average	244	312	P
2	5460.00	6.69	55.74	62.43	74.00	-11.57	Peak	244	312	P
3	5470.00	6.72	57.48	64.20	68.20	-4.00	Peak	244	312	P
4	5510.00	6.79	81.72	88.51	200.00	-111.49	Average	244	312	P
5	5510.00	6.79	90.89	97.68	200.00	-102.32	Peak	244	312	P
6	11020.00	14.67	29.74	44.41	54.00	-9.59	Average	100	197	P
7	11020.00	14.67	43.67	58.34	74.00	-15.66	Peak	100	197	P
8	16530.00	17.31	43.82	61.13	68.20	-7.07	Peak	100	185	P

Note: Level=Reading+Factor  
 Margin=Level-Limit  
 Factor=Antenna Factor + cable loss - Amplifier Factor



Power	:	From Adapter (AC 120V / 60Hz)	Pol/Phase	:	VERTICAL
Test Mode	:	Mode 5, Band 3, CH118		:	

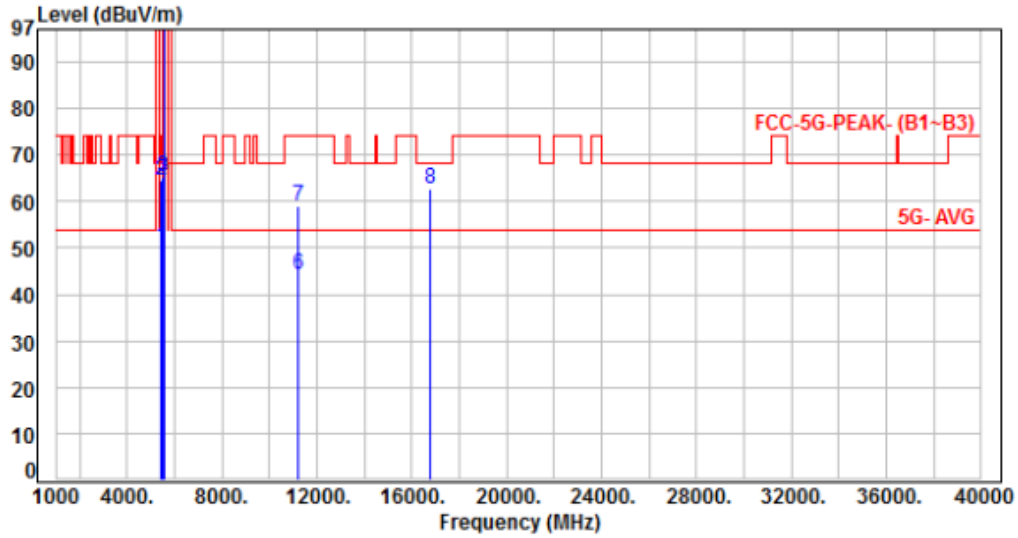

No.	Frequency (MHz)	Factor (dB)	Reading (dBuV)	Level (dBuV/m)	Limit (dBuV/m)	Margin (dB)	Detector	Height (cm)	Azimuth (deg)	P/F
1	5460.00	6.69	43.58	50.27	54.00	-3.73	Average	394	351	P
2	5460.00	6.69	57.74	64.43	74.00	-9.57	Peak	394	351	P
3	5470.00	6.72	58.65	65.37	68.20	-2.83	Peak	394	351	P
4	5590.00	6.77	91.58	98.35	200.00	-101.65	Average	394	351	P
5	5590.00	6.77	100.52	107.29	200.00	-92.71	Peak	394	351	P
6	11180.00	14.70	29.60	44.30	54.00	-9.70	Average	100	295	P
7	11180.00	14.70	44.14	58.84	74.00	-15.16	Peak	100	295	P
8	16770.00	18.88	43.78	62.66	68.20	-5.54	Peak	100	163	P

Note: Level=Reading+Factor  
 Margin=Level-Limit  
 Factor=Antenna Factor + cable loss - Amplifier Factor



Power	:	From Adapter (AC 120V / 60Hz)	Pol/Phase	:	HORIZONTAL
Test Mode	:	Mode 5, Band 3, CH118		:	

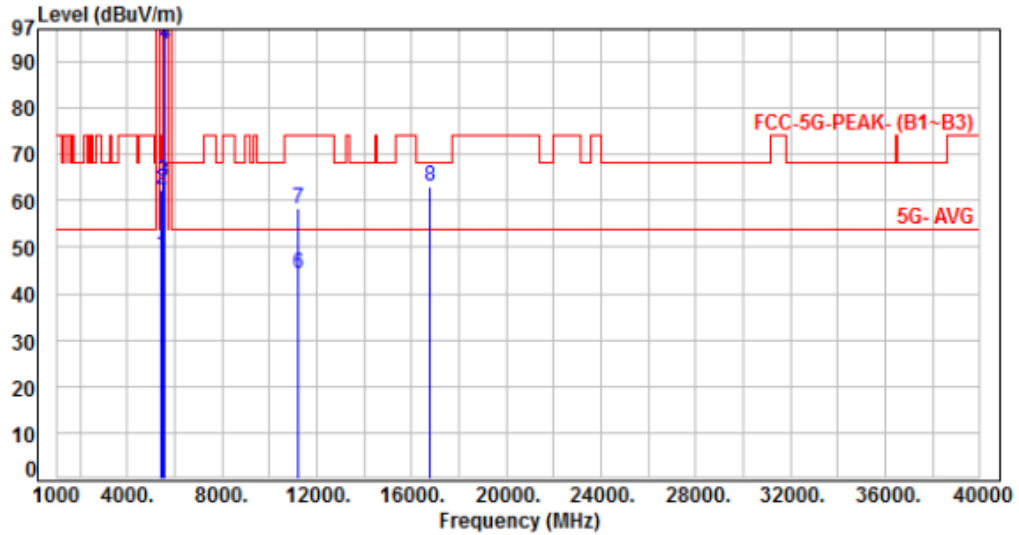

No.	Frequency (MHz)	Factor (dB)	Reading (dBuV)	Level (dBuV/m)	Limit (dBuV/m)	Margin (dB)	Detector	Height (cm)	Azimuth (deg)	P/F
1	5460.00	6.69	41.64	48.33	54.00	-5.67	Average	239	316	P
2	5460.00	6.69	55.59	62.28	74.00	-11.72	Peak	239	316	P
3	5470.00	6.72	57.48	64.20	68.20	-4.00	Peak	239	316	P
4	5590.00	6.77	87.08	93.85	200.00	-106.15	Average	239	316	P
5	5590.00	6.77	96.71	103.48	200.00	-96.52	Peak	239	316	P
6	11180.00	14.70	29.45	44.15	54.00	-9.85	Average	100	194	P
7	11180.00	14.70	43.73	58.43	74.00	-15.57	Peak	100	194	P
8	16770.00	18.88	44.08	62.96	68.20	-5.24	Peak	100	188	P

Note: Level=Reading+Factor  
 Margin=Level-Limit  
 Factor=Antenna Factor + cable loss - Amplifier Factor



Power	: From Adapter (AC 120V / 60Hz)	Pol/Phase	: VERTICAL
Test Mode	: Mode 5, Band 3, CH134		:

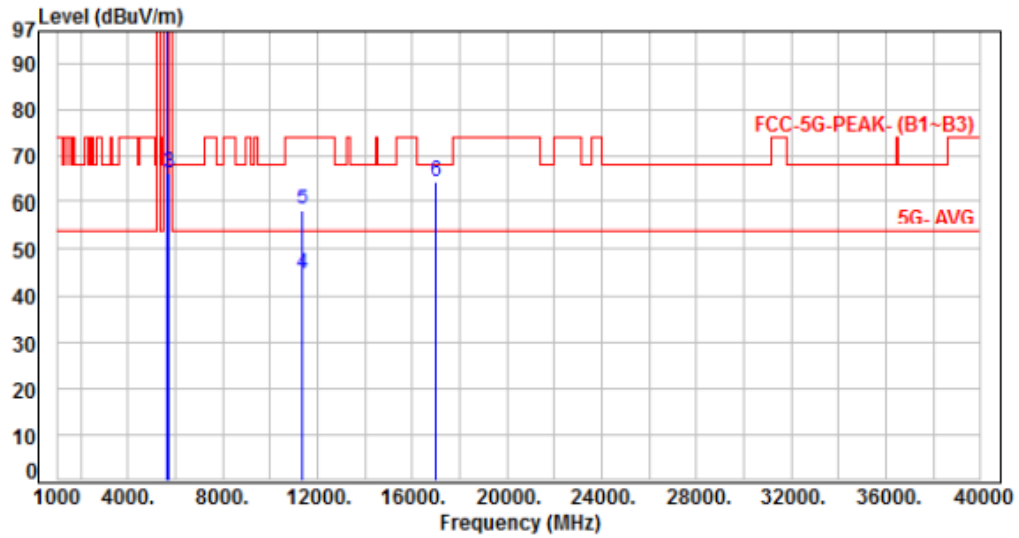

No.	Frequency (MHz)	Factor (dB)	Reading (dBuV)	Level (dBuV/m)	Limit (dBuV/m)	Margin (dB)	Detector	Height (cm)	Azimuth (deg)	P/F
1	5670.00	6.71	89.29	96.00	200.00	-104.00	Average	329	8	P
2	5670.00	6.71	98.82	105.53	200.00	-94.47	Peak	329	8	P
3	5725.00	6.83	59.66	66.49	68.20	-1.71	Peak	329	8	P
4	11340.00	14.84	29.71	44.55	54.00	-9.45	Average	100	295	P
5	11340.00	14.84	43.50	58.34	74.00	-15.66	Peak	100	295	P
6	17010.00	20.59	43.91	64.50	68.20	-3.70	Peak	100	170	P

Note: Level=Reading+Factor  
 Margin=Level-Limit  
 Factor=Antenna Factor + cable loss - Amplifier Factor



Power	:	From Adapter (AC 120V / 60Hz)	Pol/Phase	:	HORIZONTAL
Test Mode	:	Mode 5, Band 3, CH134		:	

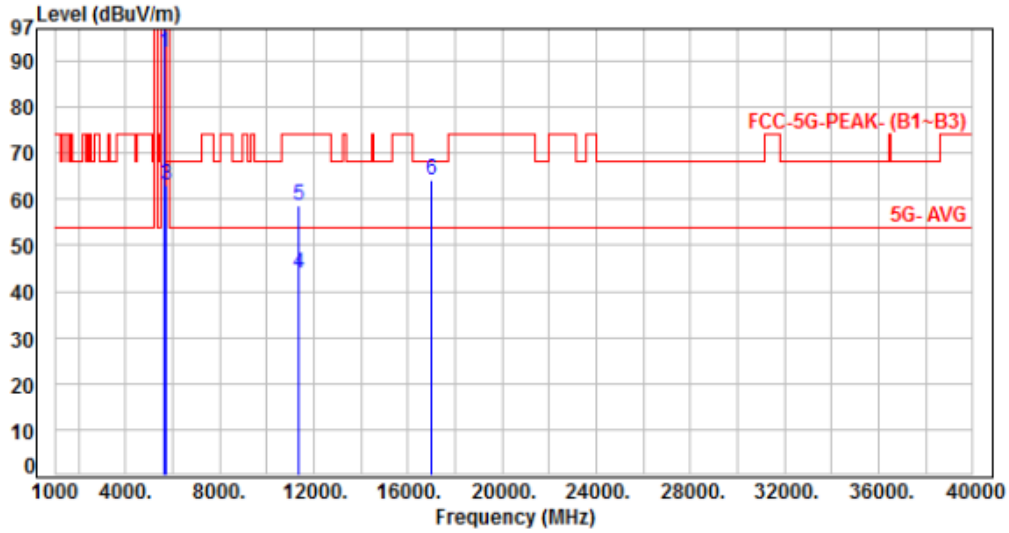

No.	Frequency (MHz)	Factor (dB)	Reading (dBuV)	Level (dBuV/m)	Limit (dBuV/m)	Margin (dB)	Detector	Height (cm)	Azimuth (deg)	P/F
1	5670.00	6.71	85.21	91.92	200.00	-108.08	Average	238	315	P
2	5670.00	6.71	94.99	101.70	200.00	-98.30	Peak	238	315	P
3	5725.00	6.83	56.07	62.90	68.20	-5.30	Peak	238	315	P
4	11340.00	14.84	29.17	44.01	54.00	-9.99	Average	100	196	P
5	11340.00	14.84	43.72	58.56	74.00	-15.44	Peak	100	196	P
6	17010.00	20.59	43.57	64.16	68.20	-4.04	Peak	100	185	P

Note: Level=Reading+Factor  
 Margin=Level-Limit  
 Factor=Antenna Factor + cable loss - Amplifier Factor



Power	:	From Adapter (AC 120V / 60Hz)	Pol/Phase	:	VERTICAL
Test Mode	:	Mode 6, Band 3, CH106		:	

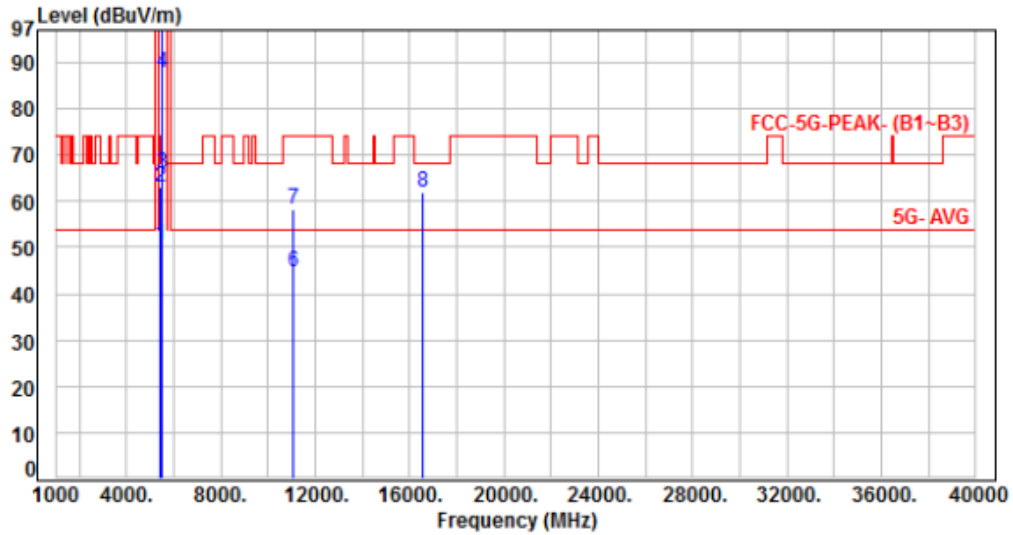

No.	Frequency (MHz)	Factor (dB)	Reading (dBuV)	Level (dBuV/m)	Limit (dBuV/m)	Margin (dB)	Detector	Height (cm)	Azimuth (deg)	P/F
1	5460.00	6.69	44.02	50.71	54.00	-3.29	Average	272	21	P
2	5460.00	6.69	56.47	63.16	74.00	-10.84	Peak	272	21	P
3	5470.00	6.72	59.16	65.88	68.20	-2.32	Peak	272	21	P
4	5530.00	6.76	80.93	87.69	200.00	-112.31	Average	272	21	P
5	5530.00	6.76	90.57	97.33	200.00	-102.67	Peak	272	21	P
6	11060.00	14.66	29.94	44.60	54.00	-9.40	Average	100	291	P
7	11060.00	14.66	43.69	58.35	74.00	-15.65	Peak	100	291	P
8	16590.00	17.84	44.19	62.03	68.20	-6.17	Peak	100	166	P

Note: Level=Reading+Factor  
 Margin=Level-Limit  
 Factor=Antenna Factor + cable loss - Amplifier Factor