



Test report No:
2360694R-RF-US-P06V01

FCC&IC TEST REPORT

Product Name	POS
Trademark	Elo
Model and /or type reference	ESY07P1
FCC ID	RBWESY07P1
IC	10757B-ESY07P1
Applicant's name / address	Elo Touch Solutions, Inc 670 N. McCarthy Blvd., Suite 100, Milpitas, CA 95035, USA.
Test method requested, standard	47 CFR FCC Part 15 (Section 15.225) ANSI C63.10: 2013 RSS-210 Issue 10 RSS-Gen Issue 5
Verdict Summary	IN COMPLIANCE
Documented by (name / position & signature)	Jun Xu/ Project Manager 
Approved by (name / position & signature)	Jack Zhang/ Manager 
Date of issue	2023-11-15
Report Version	V1.0
Report template No	Template_FCC 15.225-RF-V1.0

INDEX

	page
Competences and Guarantees.....	4
General conditions.....	4
Environmental conditions.....	4
Possible test case verdicts	5
Abbreviations	5
Document History	6
Remarks and Comments	6
Used Equipment	7
Uncertainty.....	8
1 General Information.....	9
1.1 General Description of the Item(s)	9
1.2. Antenna information	11
1.3. Channel List	12
2 Description of Test Setup	13
2.1 Operating mode(s) used for tests.....	13
2.2 Support / Auxiliary equipment / unit / Test software for the EUT	13
2.3 Test Configuration / Block diagram used for tests	14
2.4 Testing process	15
3 Verdict summary section	16
3.1 Standards	16
3.2 Overview of results.....	17
3.3 Test Matrix.....	18
3.4 Test Facility	19
4 Test Results.....	20
4.1 AC Power Line Conducted Emission	20
4.1.1 Limit.....	20
4.1.2 Test Setup.....	20
4.1.3 Test Procedure	20
4.2 E-field Emission.....	21
4.2.1 Limit.....	21
4.2.2 Test Setup.....	21
4.2.3 Test Procedure	21
4.3 Field Strength of Spurious.....	22
4.3.1 Limit.....	22

4.3.2	Test Setup.....	23
4.3.3	Test Procedure	24
4.4	Emission bandwidth	25
4.4.1	Limit.....	25
4.4.2	Test Setup.....	25
4.4.3	Test Procedure	25
4.5	Frequency Stability.....	26
4.5.1	Limit:.....	26
4.5.2	Test Setup.....	26
4.5.3	Test Procedure	26
4.6	Antenna Requirement	27
4.6.1	Limit:.....	27
4.6.2	Antenna Connector Construction:.....	27
5	Test setup photo and EUT Photo	28
	Appendix A: AC Power Line Conducted Emission	29
	Appendix B: E-field Emission	31
	Appendix C: Field Strength of Spurious	34
	Appendix D: Emission Bandwidth.....	42
	Appendix E: Frequency Stability.....	43

COMPETENCES AND GUARANTEES

DEKRA is a testing laboratory competent to carry out the tests described in this report.

In order to assure the traceability to other national and international laboratories, DEKRA has a calibration and maintenance program for its measurement equipment.

DEKRA guarantees the reliability of the data presented in this report, which is the result of the measurements and the tests performed to the item under test on the date and under the conditions stated in the report and it is based on the knowledge and technical facilities available at DEKRA at the time of performance of the test.

DEKRA is liable to the client for the maintenance of the confidentiality of all information related to the item under test and the results of the test.

The results presented in this Test Report apply only to the particular item under test established in this document.

IMPORTANT: No parts of this report may be reproduced or quoted out of context, in any form or by any means, except in full, without the previous written permission of DEKRA.

GENERAL CONDITIONS

Test Location	No. 99, Hongye Road, Suzhou Industrial Park Suzhou, 215006, P.R. China
Date(receive sample)	Aug. 14, 2023
Date (start test)	Aug. 19, 2023
Date (finish test)	Oct. 16, 2023

1. This report is only referred to the item that has undergone the test.
2. This report does not constitute or imply on its own an approval of the product by the Certification Bodies or Competent Authorities.
3. This document is only valid if complete; no partial reproduction can be made without previous written permission of DEKRA.
4. This test report cannot be used partially or in full for publicity and/or promotional purposes without previous written permission of DEKRA.

ENVIRONMENTAL CONDITIONS

The climatic conditions during the tests are within the limits specified by the manufacturer for the operation of the EUT and the test equipment. The climatic conditions during the tests were within the following limits:

Ambient temperature	15 °C – 35 °C
Relative Humidity air	30% - 60%

If explicitly required in the basic standard or applied product / product family standard the climatic values are recorded and documented separately in this test report.

POSSIBLE TEST CASE VERDICTS

Test case does not apply to test object	N/A
Test object does meet requirement	P (Pass) / PASS
Test object does not meet requirement	F (Fail) / FAIL
Not measured	N/M

ABBREVIATIONS

For the purposes of the present document, the following abbreviations apply:

EUT	: Equipment Under Test
QP	: Quasi-Peak
CAV	: CISPR Average
AV	: Average
CDN	: Coupling Decoupling Network
SAC	: Semi-Anechoic Chamber
OATS	: Open Area Test Site
BW	: Bandwidth
AM	: Amplitude Modulation
PM	: Pulse Modulation
HCP	: Horizontal Coupling Plane
VCP	: Vertical Coupling Plane
U_N	: Nominal voltage
T_x	: Transmitter
R_x	: Receiver
N/A	: Not Applicable
N/M	: Not Measured

DOCUMENT HISTORY

Report No.	Version	Description	Issued Date
2360694R-RF-US-P06V01	V1.0	Initial issue of report.	2023-11-15

REMARKS AND COMMENTS

1. The equipment under test (EUT) does meet the essential requirements of the stated standard(s)/test(s).
2. These test results on a sample of the device are for the purpose of demonstrating Compliance with 47 CFR FCC Part 15 (Section 15.225) and RSS-210 Issue 10, RSS-Gen Issue 5.
3. The measurement result is considered in conformance with the requirement if it is within the prescribed limit, It is not necessary to account the uncertainty associated with the measurement result.
4. The test results presented in this report relate only to the object tested.
5. The test report shall not be reproduced without the written approval of DEKRA Testing and Certification (Suzhou) Co., Ltd.
6. This report will not be used for social proof function in China market.
7. DEKRA declines any responsibility with the following test data provided by customer that may affect the validity of result:
 - Chapter 1.1 General Description of the Item(s);
 - Chapter 1.2 Antenna Informaion;
 - Chapter 1.3 Channel List.

USED EQUIPMENT

AC Power Line Conducted Emission / TR1

Instrument	Manufacturer	Model No.	Serial No.	Cal. Date	Next Cal. Date	Firmware Version	Software version
EMI Test Receiver	R&S	ESCI	100726	2023.08.26	2024.08.25	4.42 SP1	N/A
Two-Line V-Network	R&S	ENV 216	101044	2023.01.07	2024.01.06	N/A	N/A
Two-Line V-Network	R&S	ENV 216	101189	2023.05.14	2024.05.13	N/A	N/A
50ohm Coaxial Switch	Anritsu	MP59B	6200464462	2023.05.14	2024.05.13	N/A	N/A
Coaxial Cable	Huber+Suhner	RG 223	TR1-C1	2023.05.14	2024.05.13	N/A	N/A
Impedance Stabilization Network	Teseq GmbH	ISN T800	57318	2023.03.07	2024.03.06	N/A	N/A
Temperature/Humidity Meter	RTS	RTS-8S	EMC01	2023.05.19	2024.05.18	N/A	N/A
Dekra test software	Dekra	N/A	N/A	N/A	N/A	N/A	N/A

Field Strength of Fundamental, E-field Emission/ Field Strength of Spurious/ Frequency Stability/ Emission Bandwidth (9KHz-1GHz) / AC2

Instrument	Manufacturer	Model No.	Serial No.	Cal. Date	Next Cal. Date	Firmware Version	Software version
EMI Test Receiver	R&S	ESCI	100176	2023.05.20	2024.05.19	4.42 SP3	N/A
Loop Antenna	R&S	HFH2-Z2E	101149	2023.04.25	2024.04.24	N/A	N/A
Bilog Antenna	Teseq GmbH	CBL6112D	27611	2023.02.20	2024.02.19	N/A	N/A
Temperature/Humidity Meter	RTS	RTS-8S	AC2-TH	2023.05.19	2024.05.18	N/A	N/A
Coaxial Cable	Huber+Suhner	SUCOFLEX 106	AC2-C	2023.05.21	2024.05.20	N/A	N/A
Dekra test software	Dekra	N/A	N/A	N/A	N/A	N/A	3

UNCERTAINTY

Uncertainties have been calculated according to the DEKRA internal document. The reported expanded uncertainties are based on a standard uncertainty multiplied by a coverage factor of $k=2$, providing a level of confidence of approximately 95%.

Test item	Uncertainty
AC Power Line Conducted Emission	± 2.02 dB
Radiated Emission(9KHz~30MHz)	Horizontal: 9KHz~30MHz: 2.10 dB Vertical: 30MHz~200MHz: 2.30 dB
Radiated Emission(30MHz~1GHz)	± 3.80 dB
Occupied Bandwidth	± 1 kHz

1 GENERAL INFORMATION

1.1 General Description of the Item(s)

Product Name.....:	POS
Model No.:	ESY07P1
Trademark.:	Elo
FCC ID	RBWESY07P1
IC	10757B-ESY07P1
Hardware Version	V1.05
Software Version	T14
Manufacturer.....:	Elo Touch Solutions, Inc
Manufacturer Address	670 N. McCarthy Blvd., Suite 100, Milpitas, CA 95035, USA.
Factory	ShuoGe Intelligent Technology Co.,Ltd.
Factory address	Room 308-310, Building 1, No.2 8th Road, Baiyang Street, Qiantang New Area, Hangzhou City, Zhejiang Province, P.R. China(310018)

Wireless Specification.....:	NFC
Operating frequency range(s).....:	13.56 MHz
Type of modulation	ASK
Number of channel	1

Rated power supply	Voltage and Frequency	
	<input type="checkbox"/>	AC: 220 - 240 V, 50/60 Hz
	<input type="checkbox"/>	AC: 100 - 240 V, 50/60 Hz
	<input type="checkbox"/>	DC: 24 Vdc
	<input type="checkbox"/>	Poe:
	<input checked="" type="checkbox"/>	Adapter:
Brand of adapter	BJD	
Adapter model	AT-803A-090200A	
	Input: 100-240V ~0.5A, 50/60Hz Output: 5V/3.0A, 9V/2.0A PPS: 3.3-5.9V/3A, 3.3V-11V/1.65A Max WATT: 18W Max	
Brand of adapter	BILLION	
Adapter model	BQ018-090200CXX	
	Input: 100-240V ~0.5A, 50/60Hz Output: 5V/3.0A, 9V/2.0A PPS: 3.3-5.9V/3A, 3.3V-11V/2.0A Max WATT: 18W Max	
Mounting position.....:	<input checked="" type="checkbox"/>	Tabletop equipment
	<input type="checkbox"/>	Wall/Ceiling mounted equipment
	<input type="checkbox"/>	Floor standing equipment

	<input type="checkbox"/>	Hand-held/Portable equipment
	<input type="checkbox"/>	Other:
<p>Note: The customer used two adapter models, AT-803A-090200A and BQ018-090200CXX. We verified the two adapters and there was no difference in the test results. Finally, we used the AT-803A-090200A adapter for all tests.</p>		

1.2. Antenna information

Antenna model.....:	N/A		
Antenna Delivery	<input checked="" type="checkbox"/>	1TX + 1RX	
	<input type="checkbox"/>	2TX + 2RX	
	<input type="checkbox"/>	Others:.....	
Antenna technology	<input checked="" type="checkbox"/>	SISO	
	<input type="checkbox"/>	MIMO	<input type="checkbox"/> CDD
			<input type="checkbox"/> Beam-forming
Antenna Type	<input type="checkbox"/>	External	<input type="checkbox"/> Dipole
			<input type="checkbox"/> Sectorized
	<input checked="" type="checkbox"/>	Internal	<input type="checkbox"/> Ceramic Chip
			<input type="checkbox"/> PIFA
			<input checked="" type="checkbox"/> LOOP
			<input type="checkbox"/> Others:
Antenna Gain.....:	N/A		

1.3. Channel List

Frequency of Each Channel:							
Channel	Frequency	Channel	Frequency	Channel	Frequency	Channel	Frequency
01	13.56 MHz	--	--	--	--	--	--

Note: The general description of the Item(s), antenna information and channel list in clause 1 are provided and confirmed by the client.

2 DESCRIPTION OF TEST SETUP

2.1 Operating mode(s) used for tests

During the tests the following operating mode(s) has(have) been used.

Test Mode	Mode 1: Transmit by NFC
-----------	-------------------------

2.2 Support / Auxiliary equipment / unit / Test software for the EUT

Auxiliary equipment	Type / Version	Manufacturer	Supplied by
NFC Card	N/A	Tesla	N/A
software	Type / Version	Manufacturer	Supplied by
N/A	N/A	N/A	N/A

2.3 Test Configuration / Block diagram used for tests

Test setup Diagram- AC Line Conducted Emission Test

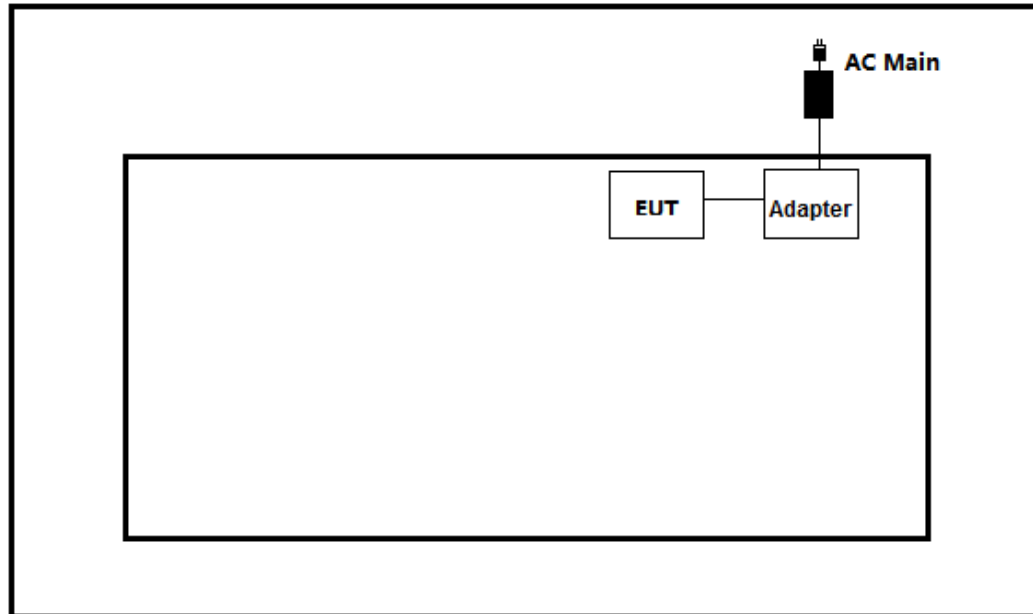

Test setup Diagram- Radiated Emission

Chamber

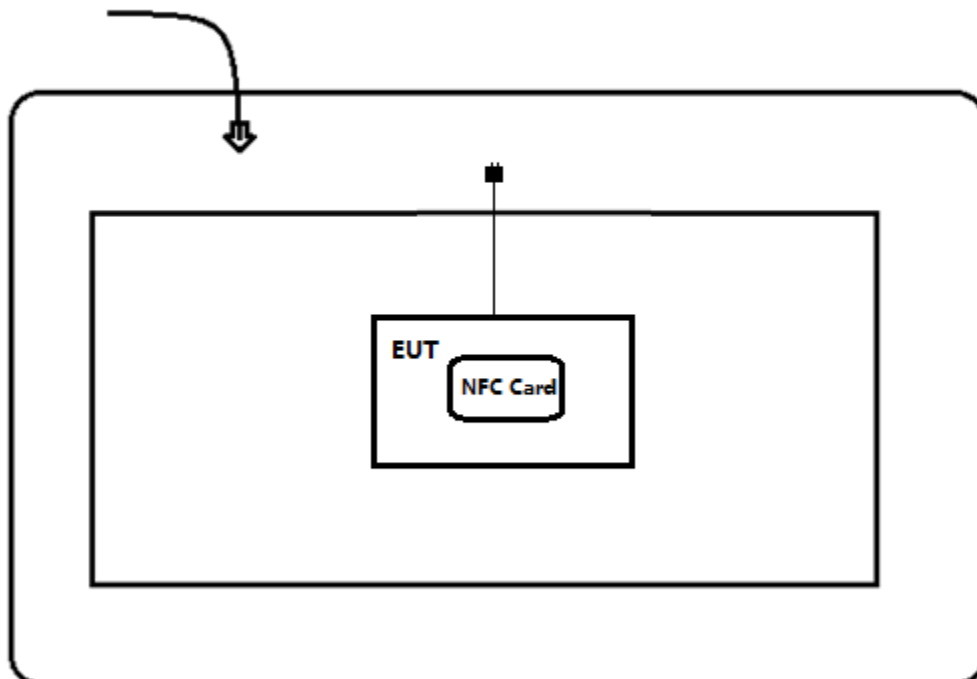

2.4 Testing process

1	Setup the EUT as shown in Section 2.3.
2	Execute the power on the EUT.
3	Verify that the EUT works properly.

3 VERDICT SUMMARY SECTION

This chapter presents an overview of standards and results. Refer to the next chapters for details of measured test results and applied test levels.

3.1 Standards

Standard	Year	Description
FCC CFR Title 47 Part 15 Subpart C Section 15.225	2023	Operation within the band 13.110-14.010 MHz
RSS-210 Issue 10	2019	Band 13.110-14.010 MHz
ANSI C63.10	2013	American National Standard of Procedures for Compliance Testing of Unlicensed Wireless Devices
RSS-Gen Issue 5 Amendment 2	2021	General Requirements for Compliance of Radio Apparatus

3.2 Overview of results

For FCC

Requirement – Test case	Basic standard(s)	Verdict	Remark
AC Power Line Conducted Emission	FCC CFR Title 47 Part 15 Subpart C Section 15.207	PASS	Test data please refer to Appendix A
Field Strength of Fundamental, E-field Emission	FCC CFR Title 47 Part 15 Subpart C Section 15.225(a)(b)(c)	PASS	Test data please refer to Appendix B
Field Strength of Spurious	FCC CFR Title 47 Part 15 Subpart C Section 15.209 & 15.225(d)	PASS	Test data please refer to Appendix C
Emission Bandwidth	FCC CFR Title 47 Part 15 Subpart C Section 15.215(c)	PASS	Test data please refer to Appendix D
Frequency Stability	FCC CFR Title 47 Part 15 Subpart C Section 15.225(e)	PASS	Test data please refer to Appendix E
Antenna Requirement	FCC CFR Title 47 Part 15 Subpart C Section 15.203	PASS	---

For ISED

Requirement – Test case	Basic standard(s)	Verdict	Remark
AC Power Line Conducted Emission	RSS-Gen Issue 5 Section 8.8	PASS	Test data please refer to Appendix A
Field Strength of Fundamental, E-field Emission	RSS-210 Issue 10 Section B.6	PASS	Test data please refer to Appendix B
Field Strength of Spurious	RSS-210 Issue 10, Section B.6 RSS-Gen Issue 5, Section 8.9	PASS	Test data please refer to Appendix C
Emission Bandwidth	RSS-Gen Section 6.7	PASS	Test data please refer to Appendix D
Frequency Stability	RSS-210 Issue 10 Section B.6	PASS	Test data please refer to Appendix E
Antenna Requirement	RSS-Gen Section 8.3	PASS	---

3.3 Test Matrix

Test item	Model: ESY07P1
	1(#1)
AC Power Line Conducted Emission	<input checked="" type="checkbox"/>
E-field Emission	<input checked="" type="checkbox"/>
Field Strength of Spurious	<input checked="" type="checkbox"/>
Frequency Stability	<input checked="" type="checkbox"/>
Emission Bandwidth	<input checked="" type="checkbox"/>
Field Strength of Fundamental	<input checked="" type="checkbox"/>

3.4 Test Facility

USA	:	FCC Designation Number: CN1199
Canada	:	CAB identifier Number: CN0040

4 TEST RESULTS

4.1 AC Power Line Conducted Emission	VERDICT: PASS
---	----------------------

4.1.1 Limit

Standard	FCC Part 15 Subpart C Paragraph 15.207; RSS-Gen Issue 5 Section 8.8	
Frequency range [MHz]	Limit: QP [dB(μV) ¹⁾	Limit: AV [dB(μV) ¹⁾
0,15 - 0,50	66 - 56 ²⁾	56 - 46 ²⁾
0,50 - 5,0	56	46
5,0 - 30	60	50

¹⁾ At the transition frequency, the lower limit applies.

²⁾ The limit decreases linearly with the logarithm of the frequency.

NOTE 1: The exclusion band for transmitters shall be considered for transmitters operating at frequencies below 30 MHz.

NOTE 2: Where the AC output port is directly connected (or via a circuit breaker) to the AC power input port of the EUT the AC power output port need not to be tested.

4.1.2 Test Setup

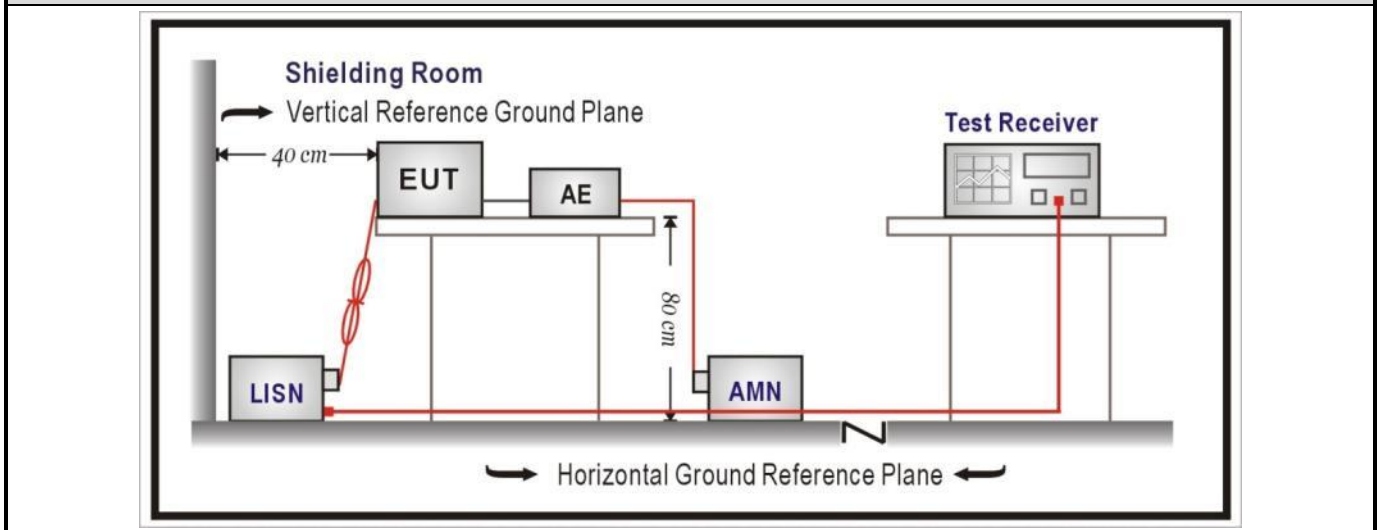

4.1.3 Test Procedure

	References Rule	Chapter	Item
<input checked="" type="checkbox"/>	ANSI C63.10	6.2	Standard test method for ac power-line conducted emissions from unlicensed wireless devices

4.2 E-field Emission	VERDICT: PASS
-----------------------------	----------------------

4.2.1 Limit

Standard	FCC Part 15 Subpart C Paragraph 15.225; RSS-210 Issue 10 Section B.6
-----------------	--

(a) The field strength of any emissions within the band 13.553-13.567 MHz shall not exceed 15,848 microvolts/meter at 30 meters.

(b) Within the bands 13.410-13.553 MHz and 13.567-13.710 MHz, the field strength of any emissions shall not exceed 334 microvolts/meter at 30 meters.

(c) Within the bands 13.110-13.410 MHz and 13.710-14.010 MHz the field strength of any emissions shall not exceed 106 microvolts/meter at 30 meters.

(d) The field strength of any emissions appearing outside of the 13.110-14.010 MHz band shall not exceed the general radiated emission limits in §15.209.

4.2.2 Test Setup

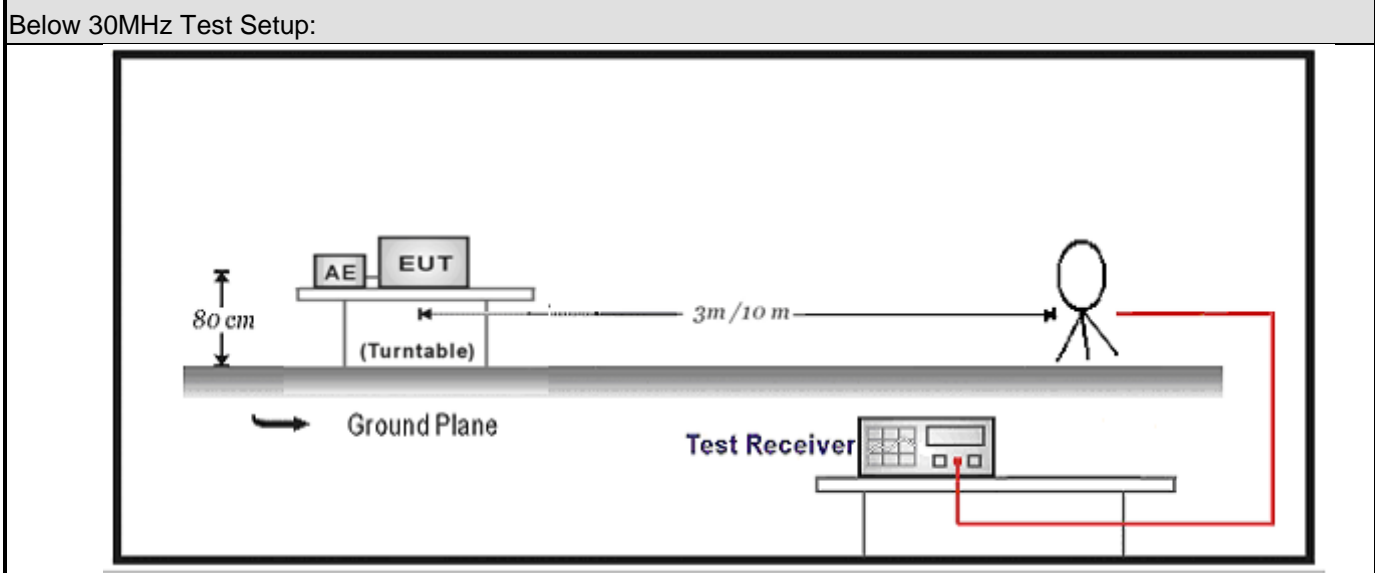

4.2.3 Test Procedure

	References Rule	Chapter	Description
<input checked="" type="checkbox"/>	ANSI C63.10	6.4	Radiated emissions from unlicensed wireless devices below 30 MHz
<input type="checkbox"/>	ANSI C63.10	6.5	Radiated emissions from unlicensed wireless devices in the frequency range of 30 MHz to 1000 MHz
<input type="checkbox"/>	ANSI C63.10	6.6	Radiated emissions from unlicensed wireless devices above 1 GHz

4.3 Field Strength of Spurious	VERDICT: PASS
---------------------------------------	----------------------

4.3.1 Limit

Standard	FCC Part 15 Subpart C Paragraph 15. 209; RSS-210 Issue 10, Section B.6 RSS-Gen Issue 5, Section 8.9
-----------------	--

Restricted Band Emissions Limit			
Frequency (MHz)	Field strength (μ V/m)	Field strength (dB μ V/m)	Measurement distance (m)
0.009 - 0.49	2400/F(kHz)	48.5 – 13.8	300 _(Note 1)
0.49 - 1.705	24000/F(kHz)	33.8 - 23	30 _(Note 1)
1.705 - 30	30	29.5	30 _(Note 1)
30 - 88	100	40	3 _(Note 2)
88 - 216	150	43.5	3 _(Note 2)
216 - 960	200	46	3 _(Note 2)
Above 960	500	54	3 _(Note 2)

Note 1: At frequencies below 30 MHz, measurements may be performed at a distance closer than that specified in the regulations; however, an attempt should be made to avoid making measurements in the near field. Pending the development of an appropriate measurement procedure for measurements performed below 30 MHz, when performing measurements at a closer distance than specified, the results shall be extrapolated to the specified distance by either making measurements at a minimum of two distances on at least one radial to determine the proper extrapolation factor or by using the square of an inverse linear distance extrapolation factor (40 dB/decade).

Note 2: At frequencies at or above 30 MHz, measurements may be performed at a distance other than what is specified provided: measurements are not made in the near field except where it can be shown that near field measurements are appropriate due to the characteristics of the device; and it can be demonstrated that the signal levels needed to be measured at the distance employed can be detected by the measurement equipment. Measurements shall not be performed at a distance greater than 30 meters unless it can be further demonstrated that measurements at a distance of 30 meters or less are impractical. When performing measurements at a distance other than that specified, the results shall be extrapolated to the specified distance using an extrapolation factor of 20 dB/decade (inverse linear-distance for field strength measurements; inverse-linear-distance-squared for power density measurements).

4.3.2 Test Setup

Below 30MHz Test Setup:

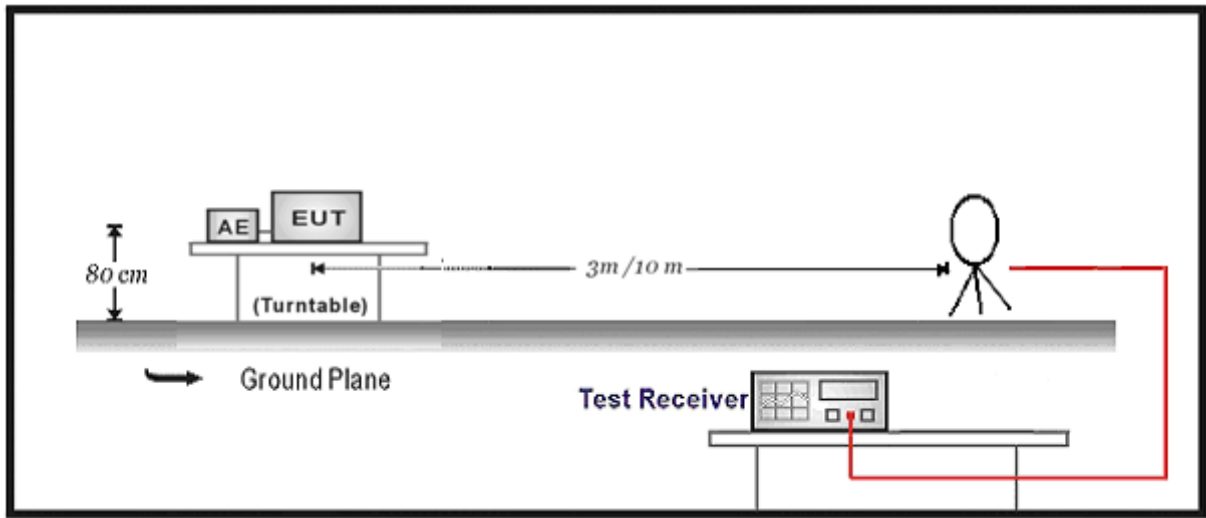

30MHz-1GHz Test Setup:

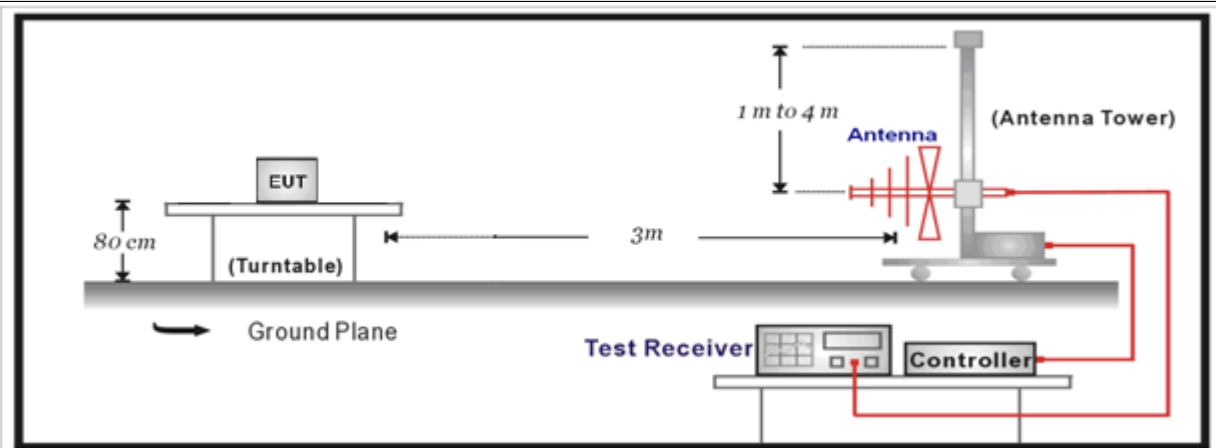

4.3.3 Test Procedure

	References Rule	Chapter	Description
<input checked="" type="checkbox"/>	ANSI C63.10	6.4	Radiated emissions from unlicensed wireless devices below 30 MHz
<input checked="" type="checkbox"/>	ANSI C63.10	6.5	Radiated emissions from unlicensed wireless devices in the frequency range of 30 MHz to 1000 MHz
<input type="checkbox"/>	ANSI C63.10	6.6	Radiated emissions from unlicensed wireless devices above 1 GHz

4.4 Emission bandwidth	VERDICT: PASS
-------------------------------	----------------------

4.4.1 Limit	
Standard	FCC Part 15 Subpart C Paragraph 15.215; RSS-Gen Section 6.7
Within the band.	

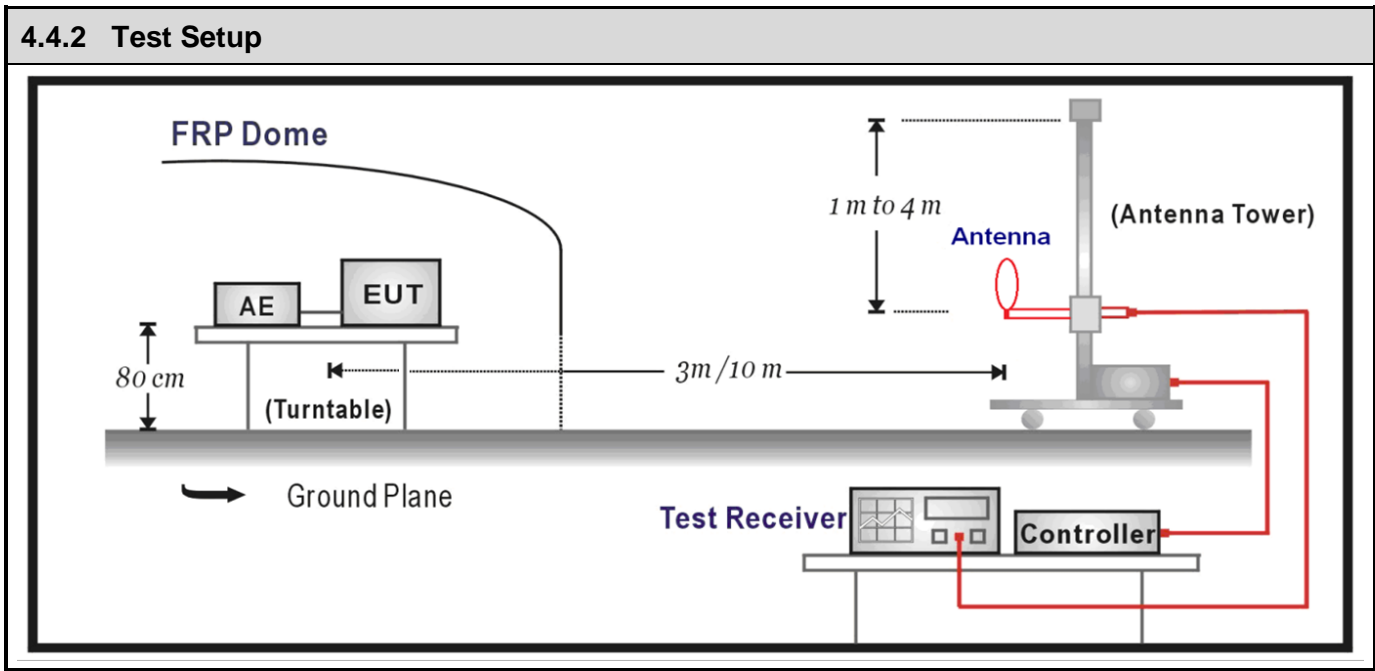

4.4.3 Test Procedure

	Reference Rule	Chapter	Description
<input checked="" type="checkbox"/>	ANSI C63.10	6.9.2	Occupied bandwidth—relative measurement procedure

4.5 Frequency Stability	VERDICT: PASS
--------------------------------	----------------------

4.5.1 Limit:	
Standard	FCC Part 15 Subpart C Paragraph 15.225(e); RSS-210 Issue 10 Section B.6
<input checked="" type="checkbox"/>	The frequency tolerance of the carrier signal shall be maintained within $\pm 0.01\%$ of the operating frequency over a temperature variation of -20 degrees to $+ 50$ degrees C at normal supply voltage, and for a variation in the primary supply voltage from 85% to 115% of the rated supply voltage at a temperature of 20 degrees C. For battery operated equipment, the equipment tests shall be performed using a new battery.

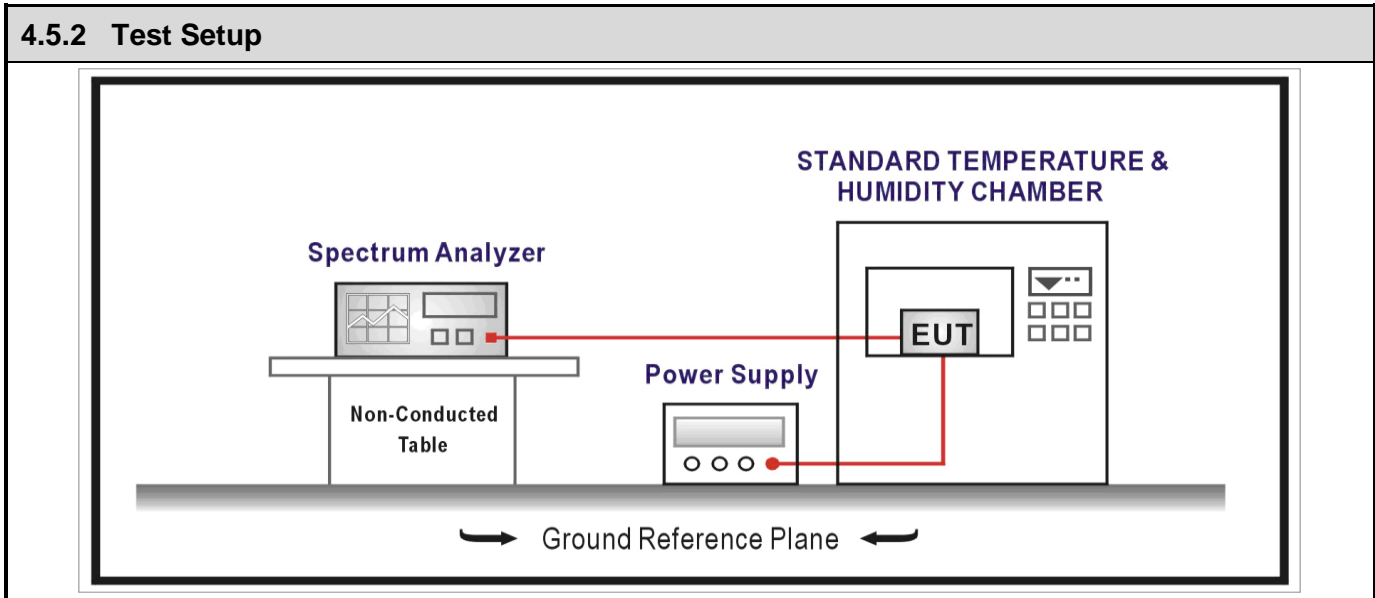

4.5.3 Test Procedure			
	References Rule	Chapter	Description
<input checked="" type="checkbox"/>	ANSI C63.10	6.8	Frequency stability tests
<input checked="" type="checkbox"/>	ANSI C63.10	6.8.1	Frequency stability with respect to ambient temperature
<input checked="" type="checkbox"/>	ANSI C63.10	6.8.2	Frequency stability when varying supply voltage

4.6 Antenna Requirement	VERDICT: PASS
--------------------------------	----------------------

4.6.1 Limit:

Standard	FCC Part 15 Subpart E Paragraph 15.203
<p>An intentional radiator shall be designed to ensure that no antenna other than that furnished by the responsible party shall be used with the device. The use of a permanently attached antenna or of an antenna that uses a unique coupling to the intentional radiator shall be considered sufficient to comply with the provisions of this section. The manufacturer may design the unit so that a broken antenna can be replaced by the user, but the use of a standard antenna jack or electrical connector is prohibited. This requirement does not apply to carrier current devices or to devices operated under the provisions of §15.211, §15.213, §15.217, §15.219, or §15.221. Further, this requirement does not apply to intentional radiators that must be professionally installed, such as perimeter protection systems and some field disturbance sensors, or to other intentional radiators which, in accordance with §15.31(d), must be measured at the installation site. However, the installer shall be responsible for ensuring that the proper antenna is employed so that the limits in this part are not exceeded.</p>	

4.6.2 Antenna Connector Construction:

<input checked="" type="checkbox"/>	The use of a permanently attached antenna
<input type="checkbox"/>	The antenna use of a unique coupling to the intentional radiator
<input type="checkbox"/>	The use of a nonstandard antenna jack or electrical connector
Please refer to the attached document "Internal Photograph" to show the antenna connector.	

5 TEST SETUP PHOTO AND EUT PHOTO	VERDICT: PASS
---	----------------------

Remark: The test setup photo and EUT Photo please see appendix.

Appendix A: AC Power Line Conducted Emission

Profile: 2360694R	Page No.: 217
Engineer: Pengchengyang	
Site: TR1	Time: 2023/10/13 - 09:49
Limit: FCC_Part 15.207	Margin: 0
Probe: ENV216_101189(0.009-30MHz)	Polarity: Line
EUT: POS	Power: 120 Vac / 60 Hz
Note: Mode 1 : Transmit at 13.56MHz by NFC	

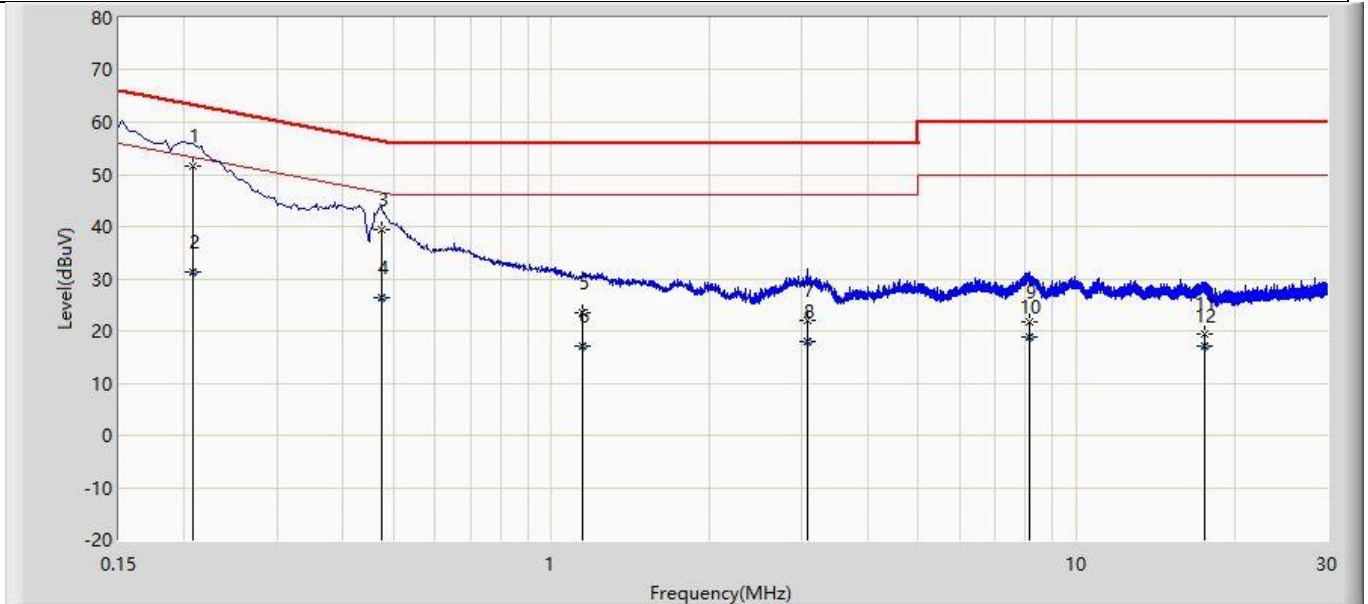

No	Mark	Frequency (MHz)	Measure Level (dBuV)	Reading Level (dBuV)	Over Limit (dB)	Limit (dBuV)	Factor (dB)	Type
1	*	0.208	51.725	22.139	-11.540	63.265	29.586	QP
2		0.208	31.175	1.588	-22.090	53.265	29.586	AV
3		0.474	39.557	9.956	-16.887	56.444	29.601	QP
4		0.474	26.432	-3.169	-20.012	46.444	29.601	AV
5		1.149	23.336	-6.299	-32.664	56.000	29.635	QP
6		1.149	16.980	-12.655	-29.020	46.000	29.635	AV
7		3.068	21.998	-7.693	-34.002	56.000	29.690	QP
8		3.068	17.915	-11.776	-28.085	46.000	29.690	AV
9		8.124	21.825	-7.971	-38.175	60.000	29.796	QP
10		8.124	18.823	-10.973	-31.177	50.000	29.796	AV
11		17.511	19.535	-10.499	-40.465	60.000	30.035	QP
12		17.511	17.111	-12.923	-32.889	50.000	30.035	AV

Note 1: " * ", means this data is the worst emission level.

Note 2: Measurement Level = Reading Level + Factor(Probe+Cable-Amp).

Profile: 2360694R	Page No.: 218
Engineer: Pengchengyang	
Site: TR1	Time: 2023/10/13 - 09:50
Limit: FCC_Part 15.207	Margin: 0
Probe: ENV216_101189(0.009-30MHz)	Polarity: Neutral
EUT: POS	Power: 120 Vac / 60 Hz
Note: Mode 1 : Transmit at 13.56MHz by NFC	

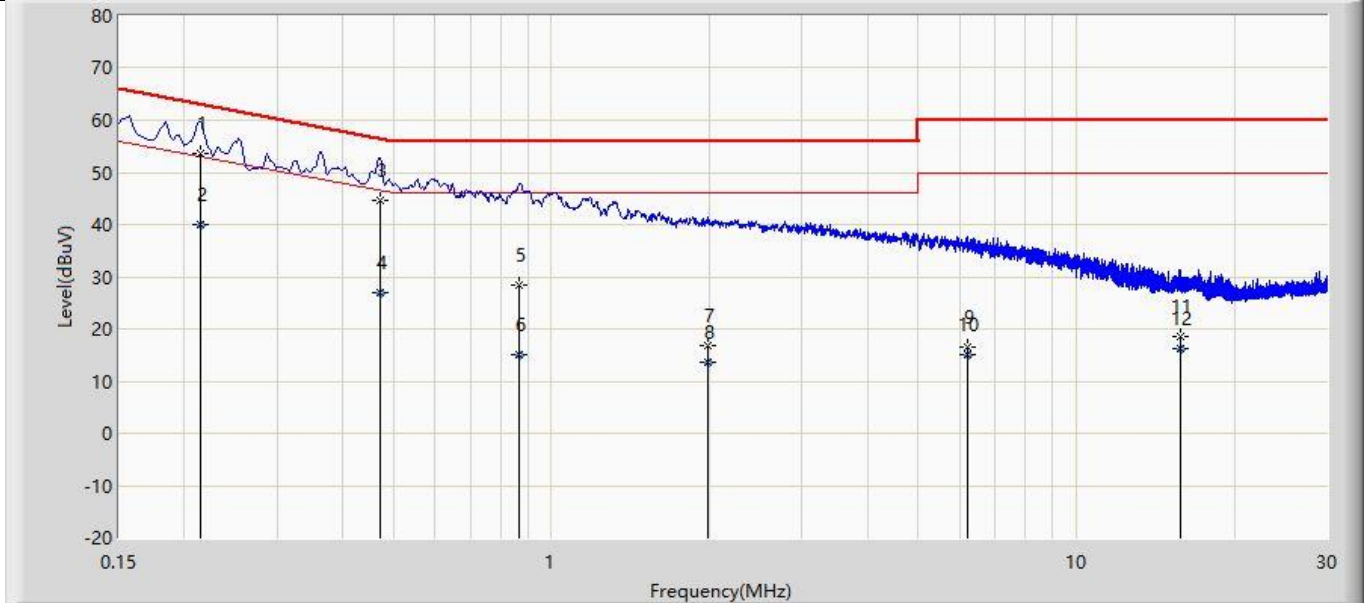

No	Mark	Frequency (MHz)	Measure Level (dBuV)	Reading Level (dBuV)	Over Limit (dB)	Limit (dBuV)	Factor (dB)	Type
1	*	0.215	53.560	23.963	-9.440	63.000	29.597	QP
2		0.215	39.915	10.318	-13.085	53.000	29.597	AV
3		0.472	44.618	15.007	-11.866	56.483	29.610	QP
4		0.472	26.943	-2.667	-19.540	46.483	29.610	AV
5		0.870	28.528	-1.101	-27.472	56.000	29.629	QP
6		0.870	15.118	-14.511	-30.882	46.000	29.629	AV
7		1.982	16.784	-12.876	-39.216	56.000	29.660	QP
8		1.982	13.763	-15.896	-32.237	46.000	29.660	AV
9		6.187	16.606	-13.160	-43.394	60.000	29.766	QP
10		6.187	15.178	-14.588	-34.822	50.000	29.766	AV
11		15.823	18.694	-11.240	-41.306	60.000	29.934	QP
12		15.823	16.169	-13.764	-33.831	50.000	29.934	AV

Note 1: " * ", means this data is the worst emission level.

Note 2: Measurement Level = Reading Level + Factor(Probe+Cable-Amp).

Appendix B: E-field Emission

Profile: 2360694R	Page No.: 7
Engineer: Pengchengyang	
Site: AC2	Time: 2023/010/13 - 20:36
Limit: 13.56 mask	Margin: 0
Probe: RF(0.009-30MHz)	Polarity: X
EUT: POS	Power: 120 Vac / 60 Hz
Note: Mode 1 : Transmit at 13.56MHz by NFC	

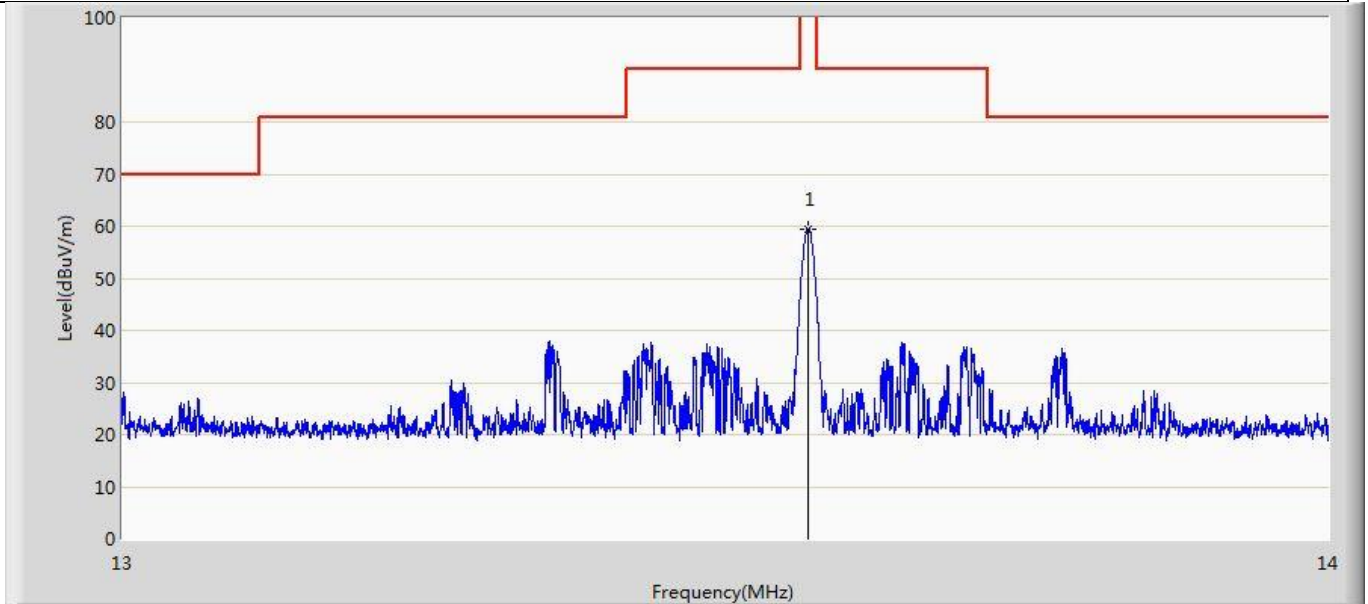

No	Mark	Frequency (MHz)	Measure Level (dBuV/m)	Reading Level (dBuV)	Over Limit (dB)	Limit (dBuV/m)	Factor (dB)	Type
1	*	13.560	59.541	38.489	-64.459	122.000	21.052	QP

Note : Measurement Level = Reading Level + Factor(Probe+Cable-Amp).

Profile: 2360694R	Page No.: 8
Engineer: Pengchengyang	
Site: AC2	Time: 2023/010/13 - 20:39
Limit: 13.56 mask	Margin: 0
Probe: RF(0.009-30MHz)	Polarity: Y
EUT: POS	Power: 120 Vac / 60 Hz
Note: Mode 1 : Transmit at 13.56MHz by NFC	

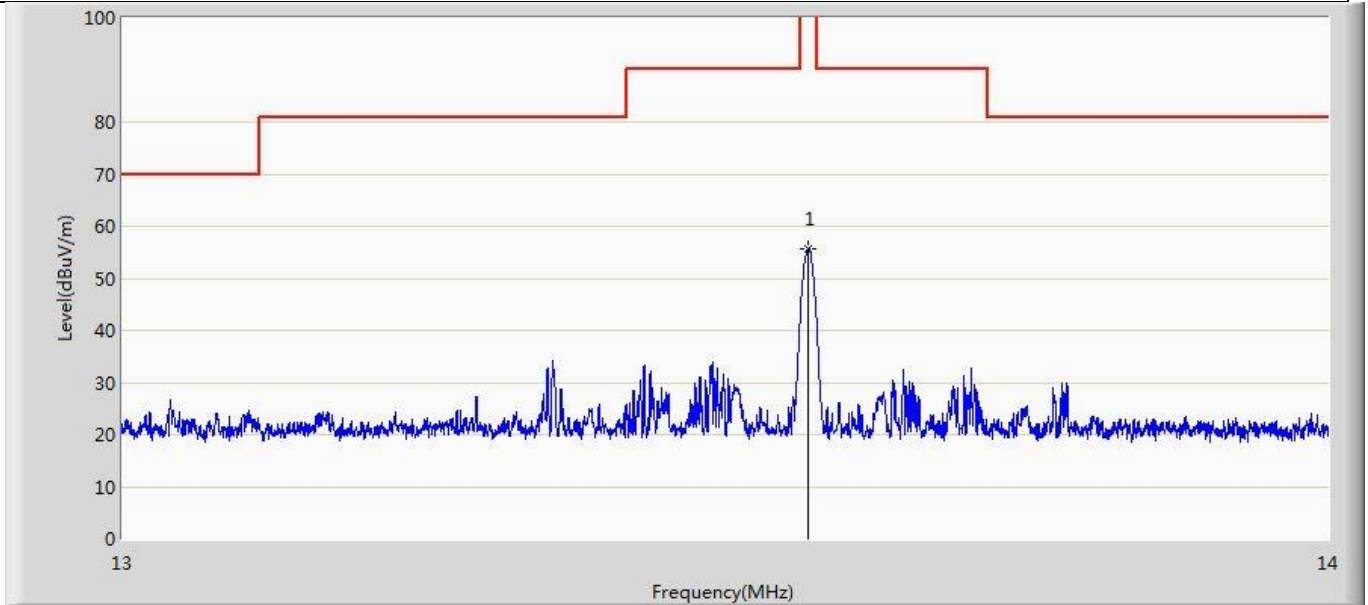

No	Mark	Frequency (MHz)	Measure Level (dBuV/m)	Reading Level (dBuV)	Over Limit (dB)	Limit (dBuV/m)	Factor (dB)	Type
1	*	13.560	55.676	35.124	-68.324	122.000	20.552	QP

Note : Measurement Level = Reading Level + Factor(Probe+Cable-Amp).

Profile: 2360694R	Page No.: 9
Engineer: Pengchengyang	
Site: AC2	Time: 2023/010/13 - 20:41
Limit: 13.56 mask	Margin: 0
Probe: RF(0.009-30MHz)	Polarity: Z
EUT: POS	Power: 120 Vac / 60 Hz
Note: Mode 1 : Transmit at 13.56MHz by NFC	

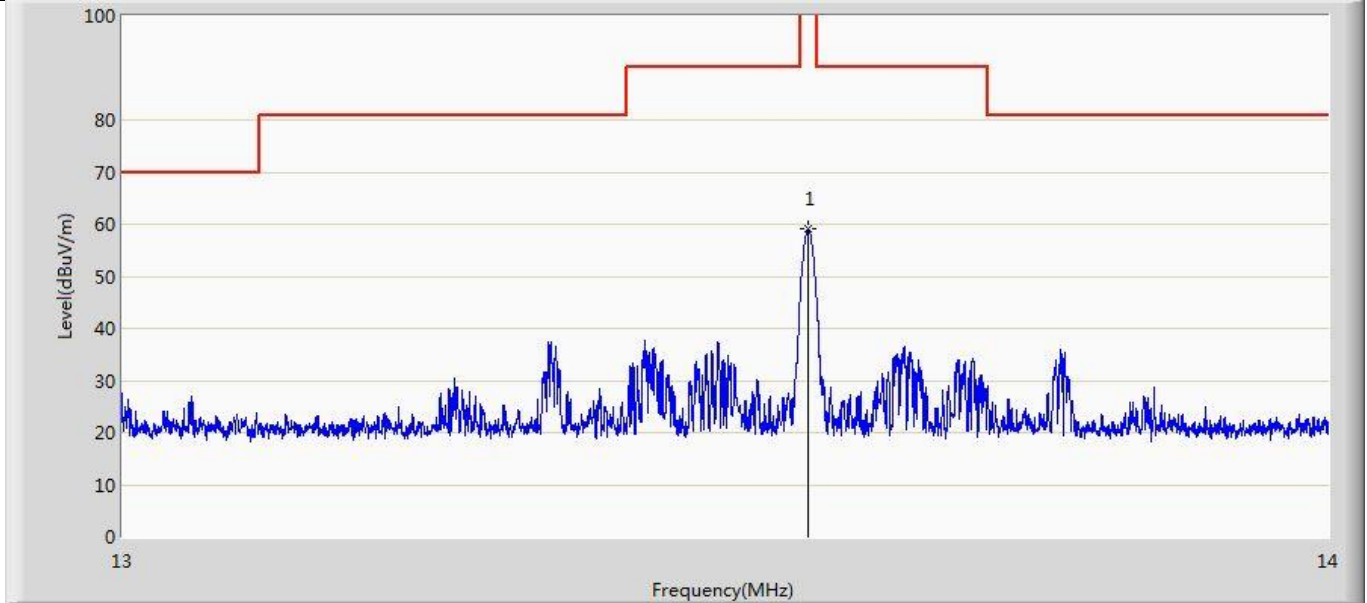

No	Mark	Frequency (MHz)	Measure Level (dBuV/m)	Reading Level (dBuV)	Over Limit (dB)	Limit (dBuV/m)	Factor (dB)	Type
1	*	13.560	59.083	38.531	-64.917	122.000	20.552	QP

Note : Measurement Level = Reading Level + Factor(Probe+Cable-Amp).

Appendix C: Field Strength of Spurious

Profile: 2360694R	Page No.: 1
Engineer: Pengchengyang	
Site: AC2	Time: 2023/09/22 - 08:17
Limit: 15.209	Margin: 0
Probe: RF(0.009-30MHz)	Polarity: X
EUT: POS	Power: 120 Vac / 60 Hz
Note: Mode 1 : Transmit at 13.56MHz by NFC	

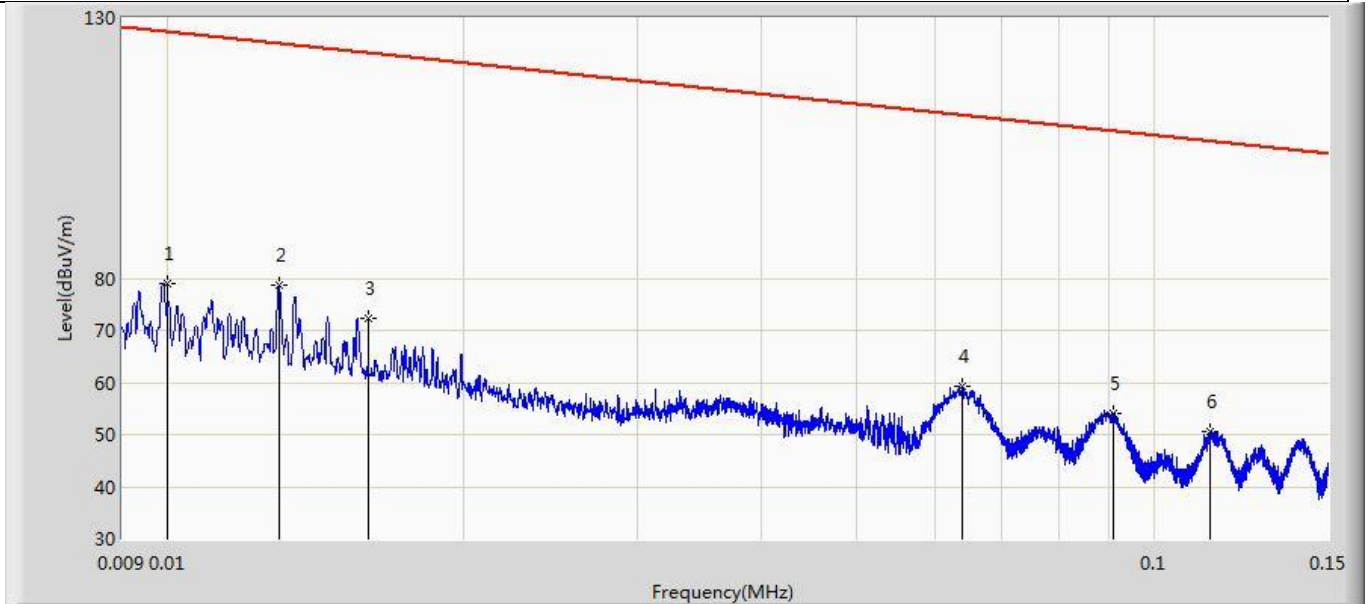

No	Mark	Frequency (MHz)	Measure Level (dBuV/m)	Reading Level (dBuV)	Over Limit (dB)	Limit (dBuV/m)	Factor (dB)	Type
1		0.010	78.995	57.933	-48.490	127.485	21.062	PK
2	*	0.013	78.658	57.502	-46.550	125.208	21.155	PK
3		0.016	72.393	51.144	-51.013	123.405	21.248	PK
4		0.064	59.179	37.244	-52.192	111.371	21.935	PK
5		0.091	54.106	32.202	-54.209	108.315	21.904	PK
6		0.114	50.710	28.833	-55.649	106.359	21.877	PK

Note : We tested the empty field, and the test results are consistent with the above test results. So, it proves that the above test results are background noise.

Profile: 2360694R	Page No.: 2
Engineer: Pengchengyang	
Site: AC2	Time: 2023/09/22 - 08:19
Limit: 15.209	Margin: 0
Probe: RF(0.009-30MHz)	Polarity: X
EUT: POS	Power: 120 Vac / 60 Hz
Note: Mode 1 : Transmit at 13.56MHz by NFC	

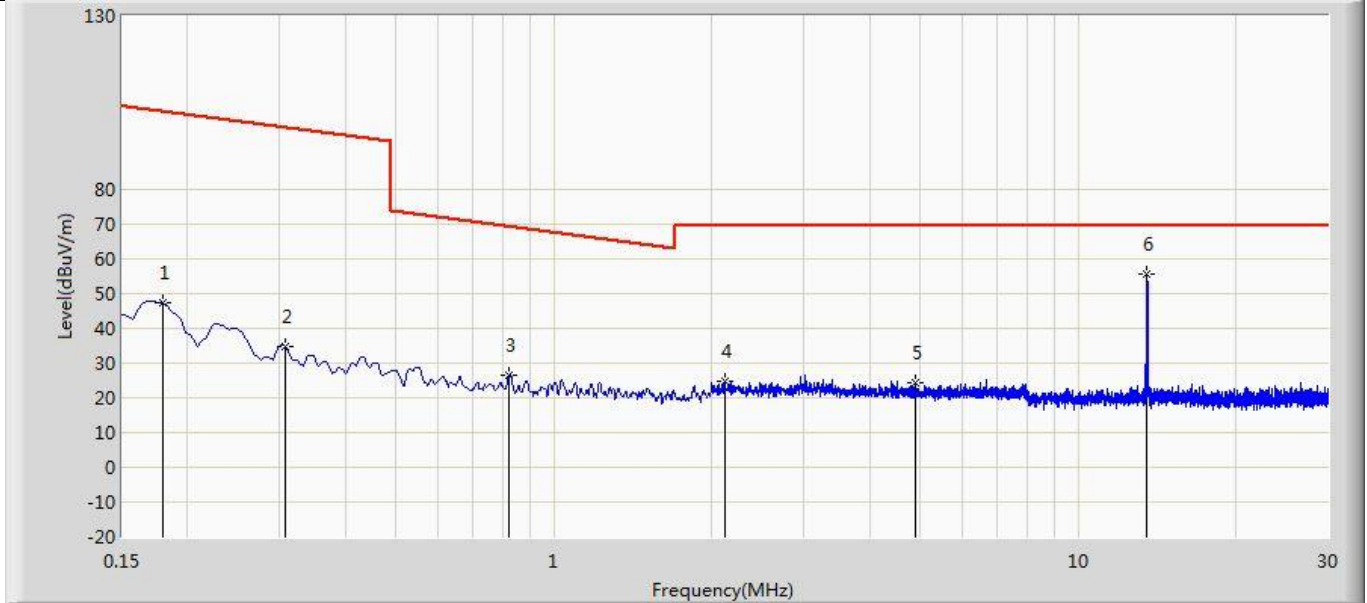

No	Mark	Frequency (MHz)	Measure Level (dBuV/m)	Reading Level (dBuV)	Over Limit (dB)	Limit (dBuV/m)	Factor (dB)	Type
1		0.180	47.323	25.517	-55.071	102.394	21.806	PK
2		0.307	34.881	13.198	-62.878	97.759	21.683	PK
3		0.822	26.393	5.898	-42.826	69.219	20.495	PK
4		2.116	24.796	3.867	-44.604	69.400	20.929	PK
5		4.907	24.409	3.816	-44.991	69.400	20.593	PK
6	*	13.564	55.717	34.665	-13.683	69.400	21.052	PK

Mark 6 is the fundamental emission.

Profile: 2360694R	Page No.: 3
Engineer: Pengchengyang	
Site: AC2	Time: 2023/09/22 - 08:22
Limit: 15.209	Margin: 0
Probe: RF(0.009-30MHz)	Polarity: Y
EUT: POS	Power: 120 Vac / 60 Hz
Note: Mode 1 : Transmit at 13.56MHz by NFC	

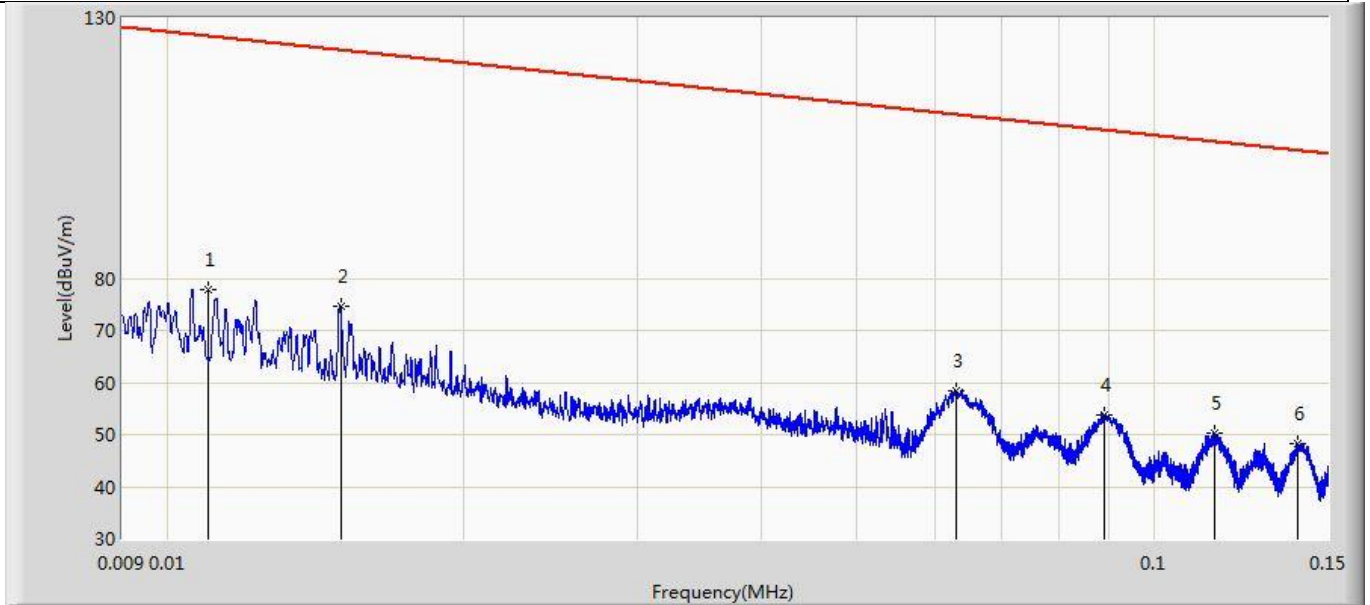

No	Mark	Frequency (MHz)	Measure Level (dBuV/m)	Reading Level (dBuV)	Over Limit (dB)	Limit (dBuV/m)	Factor (dB)	Type
1	*	0.011	77.946	57.353	-48.711	126.658	20.594	PK
2		0.015	74.571	53.853	-49.395	123.965	20.718	PK
3		0.063	58.428	36.992	-53.079	111.507	21.436	PK
4		0.089	53.859	32.453	-54.649	108.508	21.406	PK
5		0.115	50.282	28.906	-56.001	106.283	21.376	PK
6		0.140	48.281	26.929	-56.295	104.575	21.352	PK

Note : We tested the empty field, and the test results are consistent with the above test results. So, it proves that the above test results are background noise.

Profile: 2360694R	Page No.: 4
Engineer: Pengchengyang	
Site: AC2	Time: 2023/09/22 - 08:25
Limit: 15.209	Margin: 0
Probe: RF(0.009-30MHz)	Polarity: Y
EUT: POS	Power: 120 Vac / 60 Hz
Note: Mode 1 : Transmit at 13.56MHz by NFC	

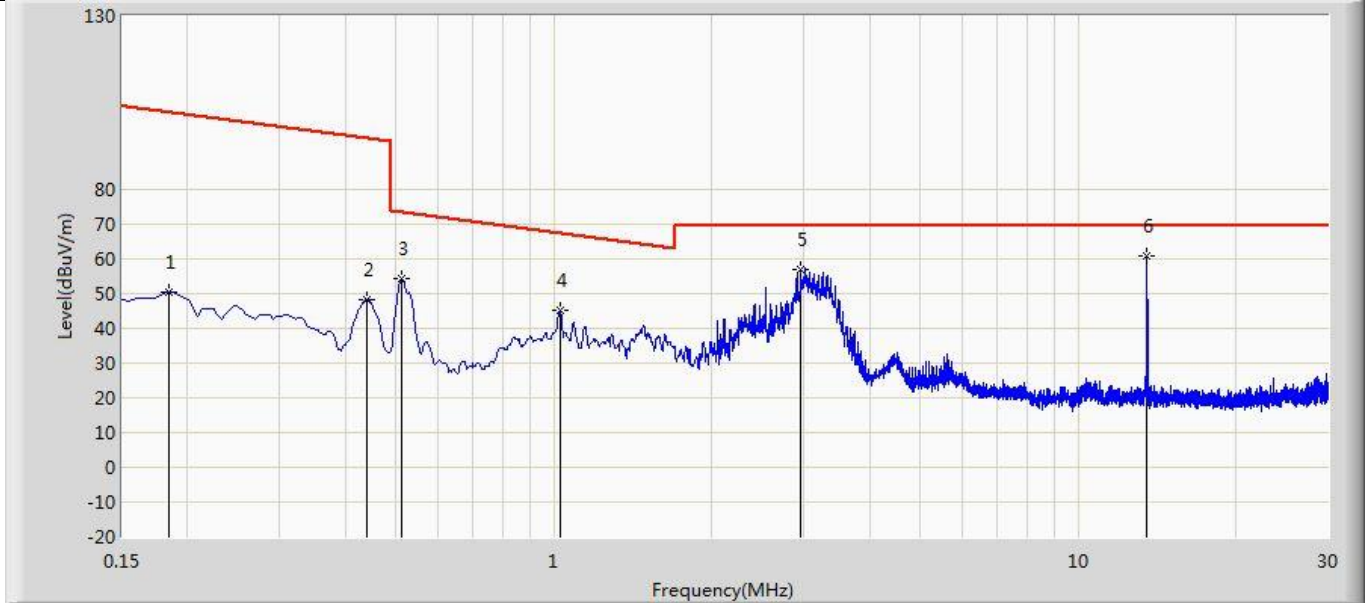

No	Mark	Frequency (MHz)	Measure Level (dBuV/m)	Reading Level (dBuV)	Over Limit (dB)	Limit (dBuV/m)	Factor (dB)	Type
1		0.184	50.408	29.107	-51.795	102.203	21.301	PK
2		0.441	48.347	27.297	-46.268	94.615	21.050	PK
3		0.512	54.226	33.290	-19.094	73.320	20.936	PK
4		1.027	45.084	25.620	-22.207	67.291	19.464	PK
5		2.960	56.784	36.450	-12.616	69.400	20.334	PK
6	*	13.560	60.951	40.399	-8.449	69.400	20.552	PK

Mark 6 is the fundamental emission.

Profile: 2360694R	Page No.: 5
Engineer: Pengchengyang	
Site: AC2	Time: 2023/09/22 - 08:28
Limit: 15.209	Margin: 0
Probe: RF(0.009-30MHz)	Polarity: Z
EUT: POS	Power: 120 Vac / 60 Hz
Note: Mode 1 : Transmit at 13.56MHz by NFC	

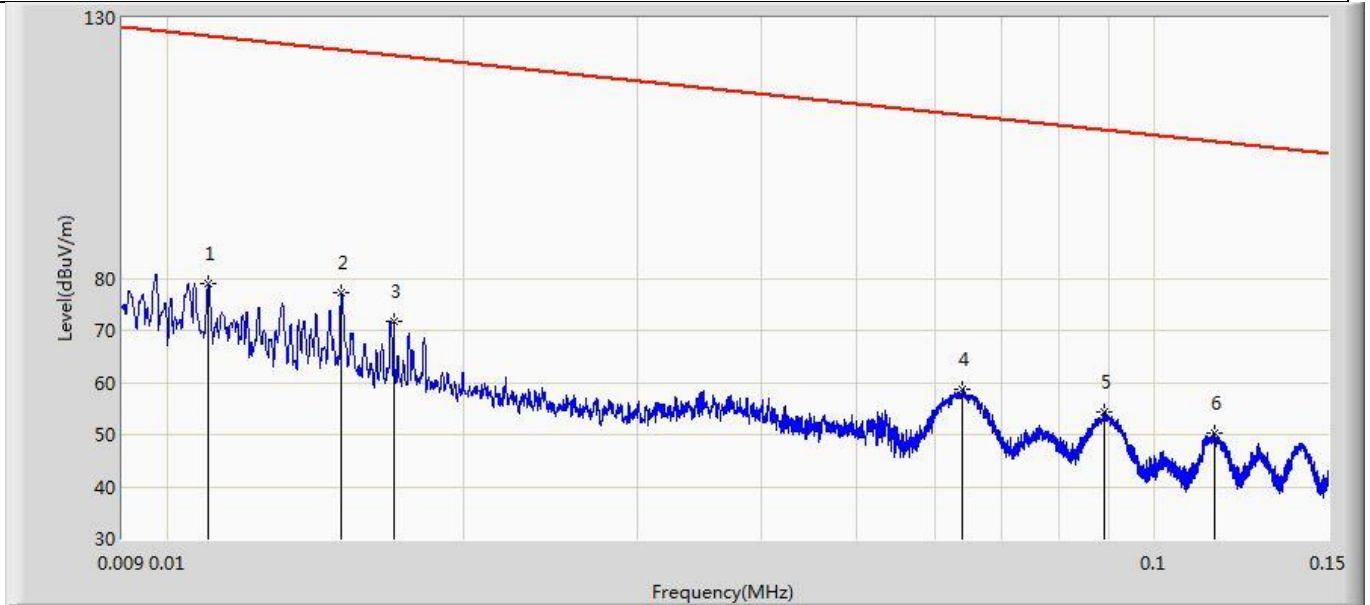

No	Mark	Frequency (MHz)	Measure Level (dBuV/m)	Reading Level (dBuV)	Over Limit (dB)	Limit (dBuV/m)	Factor (dB)	Type
1		0.011	78.999	58.406	-47.658	126.658	20.594	PK
2	*	0.015	77.186	56.468	-46.780	123.965	20.718	PK
3		0.017	71.621	50.841	-51.258	122.879	20.780	PK
4		0.064	58.583	37.148	-52.788	111.371	21.435	PK
5		0.089	54.237	32.831	-54.271	108.508	21.406	PK
6		0.115	50.156	28.780	-56.127	106.283	21.376	PK

Note : We tested the empty field, and the test results are consistent with the above test results. So, it proves that the above test results are background noise.

Profile: 2360694R	Page No.: 6
Engineer: Pengchengyang	
Site: AC2	Time: 2023/09/22 - 08:32
Limit: 15.209	Margin: 0
Probe: RF(0.009-30MHz)	Polarity: Z
EUT: POS	Power: 120 Vac / 60 Hz
Note: Mode 1 : Transmit at 13.56MHz by NFC	

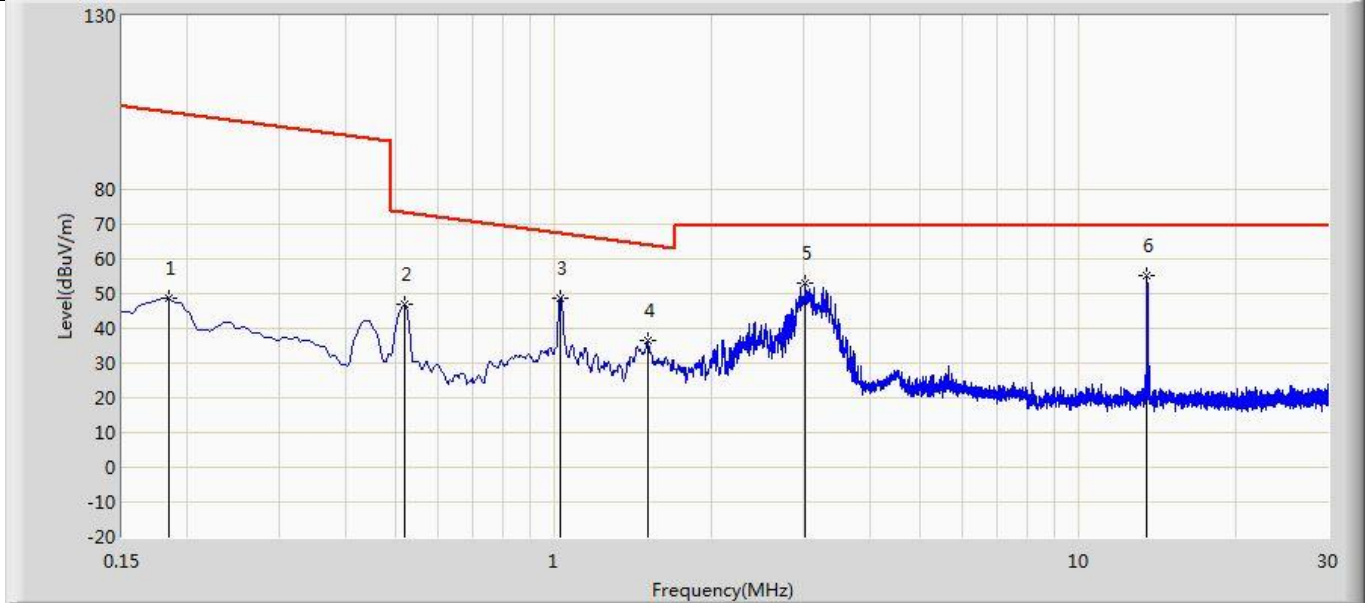

No	Mark	Frequency (MHz)	Measure Level (dBuV/m)	Reading Level (dBuV)	Over Limit (dB)	Limit (dBuV/m)	Factor (dB)	Type
1		0.184	48.901	27.601	-53.302	102.203	21.301	PK
2		0.519	46.857	25.939	-26.345	73.202	20.919	PK
3		1.031	48.723	29.256	-18.533	67.257	19.467	PK
4		1.512	36.625	16.672	-27.315	63.941	19.953	PK
5		3.016	53.074	32.735	-16.326	69.400	20.339	PK
6	*	13.560	55.261	34.709	-14.139	69.400	20.552	PK

Mark 6 is the fundamental emission.

Profile: 2360694R	Page No.: 1
Engineer: Pengchengyang	
Site: AC2	Time: 2023/05/19 - 16:13
Limit: FCC_Part 15.209_RE (3m)	Margin: 0
Probe: CBL6112B_2933(30-1000MHz)	Polarity: Horizontal
EUT : POS	Power: 120 Vac / 60 Hz
Note: Mode 1 : Transmit at 13.56MHz by NFC	

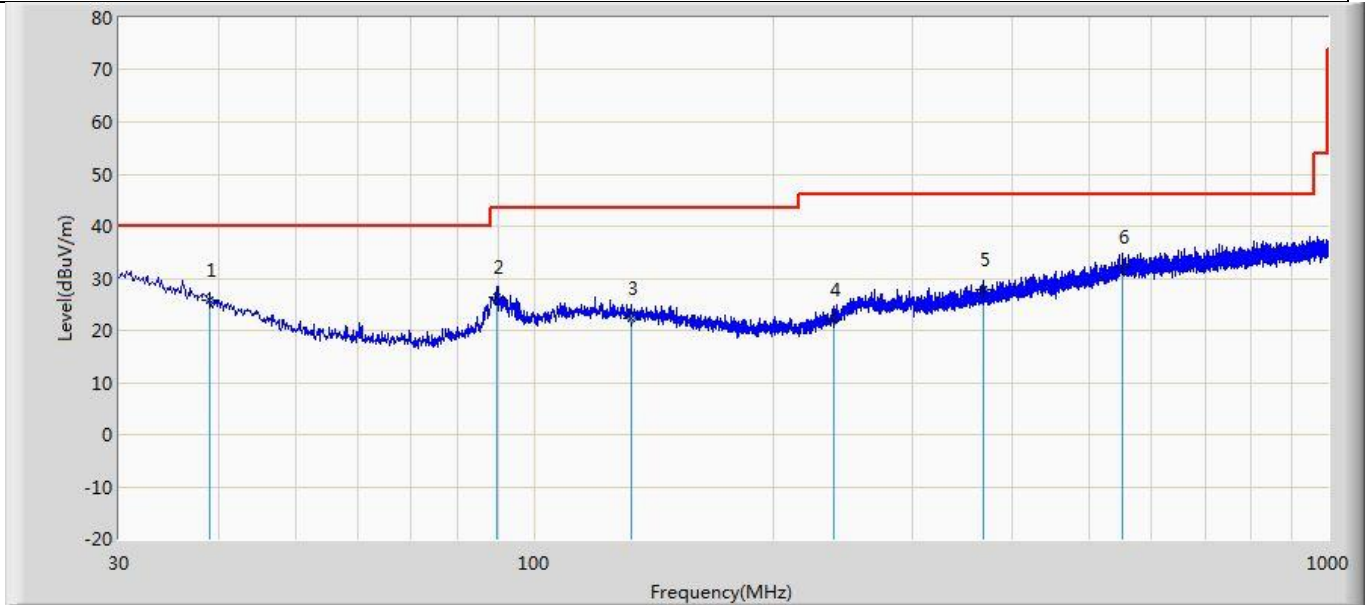

No	Mark	Frequency (MHz)	Measure Level (dBuV/m)	Reading Level (dBuV)	Over Limit (dB)	Limit (dBuV/m)	Factor (dB)	Type
1		38.972	25.810	5.284	-14.190	40.000	20.525	QP
2		89.776	26.340	10.446	-17.160	43.500	15.894	QP
3		132.577	22.189	3.547	-21.311	43.500	18.643	QP
4		238.671	22.167	3.586	-23.833	46.000	18.581	QP
5		367.439	27.875	5.194	-18.125	46.000	22.681	QP
6	*	549.920	32.188	4.702	-13.812	46.000	27.486	QP

Profile: 2360694R	Page No.: 2
Engineer: Pengchengyang	
Site: AC2	Time: 2023/07/26 - 18:22
Limit: FCC_Part 15.209_RE (3m)	Margin: 0
Probe: CBL6112B_2933(30-1000MHz)	Polarity: Vertical
EUT : POS	Power: 120 Vac / 60 Hz
Note: Mode 1 : Transmit at 13.56MHz by NFC	

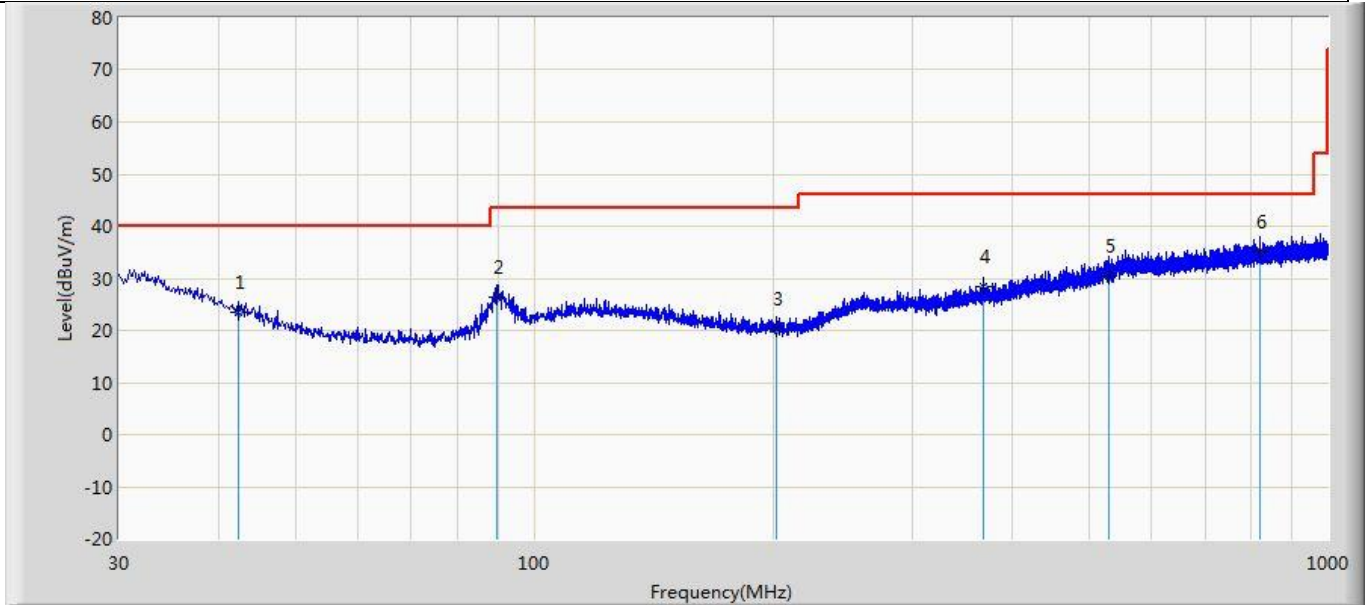

No	Mark	Frequency (MHz)	Measure Level (dBuV/m)	Reading Level (dBuV)	Over Limit (dB)	Limit (dBuV/m)	Factor (dB)	Type
1		42.368	23.350	4.664	-16.650	40.000	18.686	QP
2		89.897	26.267	10.349	-17.233	43.500	15.918	QP
3		202.175	20.266	3.766	-23.234	43.500	16.500	QP
4		367.439	28.541	5.860	-17.459	46.000	22.681	QP
5		530.520	30.522	4.149	-15.478	46.000	26.373	QP
6	*	821.156	35.148	5.458	-10.852	46.000	29.690	QP

Note 1: " * ", means this data is the worst emission level.

Note 2: Measurement Level = Reading Level + Factor(Probe+Cable-Amp).

Appendix D: Emission Bandwidth

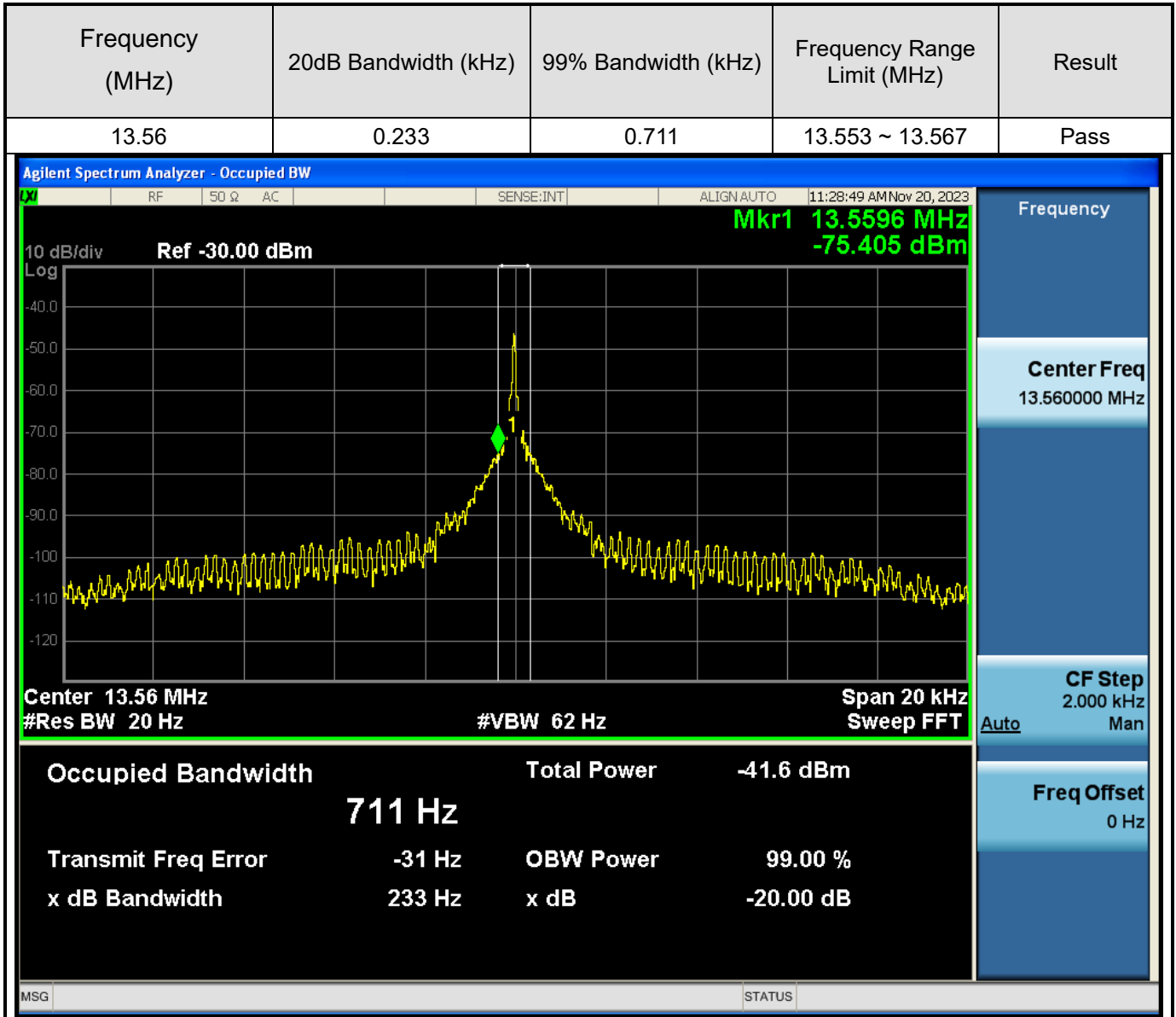

Appendix E: Frequency Stability

Frequency Stability under Temperature at 0min			
Temperature Interval (°C)	Test Frequency (MHz)	Deviation (ppm)	Limit (ppm)
0	13.56	64.36	±100
10	13.56	64.32	±100
20	13.56	64.35	±100
30	13.56	64.36	±100
35	13.56	64.33	±100
Frequency Stability under Temperature at 2min			
Temperature Interval (°C)	Test Frequency (MHz)	Deviation (ppm)	Limit (ppm)
0	13.56	64.38	±100
10	13.56	64.36	±100
20	13.56	64.35	±100
30	13.56	64.31	±100
35	13.56	64.35	±100
Frequency Stability under Temperature at 5min			
Temperature Interval (°C)	Test Frequency (MHz)	Deviation (ppm)	Limit (ppm)
0	13.56	64.33	±100
10	13.56	64.32	±100
20	13.56	64.38	±100
30	13.56	64.37	±100
35	13.56	64.35	±100
Frequency Stability under Temperature at 10min			
Temperature Interval (°C)	Test Frequency (MHz)	Deviation (ppm)	Limit (ppm)
0	13.56	64.39	±100
10	13.56	64.32	±100
20	13.56	64.38	±100
30	13.56	64.36	±100
35	13.56	64.35	±100

Frequency Stability under Voltage			
DC Voltage (V)	Test Frequency (MHz)	Deviation (ppm)	Limit (ppm)
40.8	13.56	64.66	±100
48.0	13.56	64.71	±100
55.2	13.56	64.91	±100

_____ The End _____