

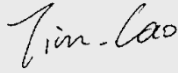
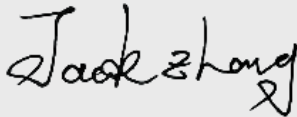

Test report No:
2250810R-RF-US-P06V02

FCC & ISED TEST REPORT

Product Name	Computer BOX
Trademark	Elo
Model and /or type reference	ESY00I4
FCC ID	RBWESY00I4SV
IC	10757B-ESY00I4SV
Applicant's name / address	Elo Touch Solutions, Inc 670 N. McCarthy Blvd., Suite 100, Milpitas, CA 95035, USA.
Test method requested, standard	FCC CFR Title 47 Part 15 Subpart C Section 15.247 ANSI C63.10: 2013 KD558074 D01 15.247 Meas Guidance v05r02 RSS-Gen Issue 5 RSS-247 Issue 2
Verdict Summary	IN COMPLIANCE
Tested by (name / position & signature)	Tim Cao/Project Engineer 
Approved by (name / position & signature)	Jack Zhang/Manager 
Date of issue	2022-10-12
Report Version	V1.1
Report template No	Template_FCC 15.247-RF-V1.0

INDEX

	page
General conditions	4
Environmental conditions	4
Possible test case verdicts	5
Abbreviations	5
Document History	6
Remarks and Comments.....	6
Used Equipment	7
Uncertainty	9
1 General Information.....	10
1.1 General Description of the Item(s)	10
1.2 Antenna Information	11
1.3 Channel List	12
2 Description of Test Setup	13
2.1 Operating mode(s) used for tests.....	13
2.2 Auxiliary equipment / Test software for the EUT.....	13
2.3 Test Configuration / Block diagram used for tests	14
2.4 Testing process.....	15
3 Verdict summary section	16
3.1 Standards.....	16
3.2 Deviation(s) from the Standard(s) / Test Specification(s).....	16
3.3 Overview of results.....	17
3.4 Test Facility.....	18
4 Test Results.....	19
4.1 AC Power Line Conducted Emission	19
4.1.1 Limit	19
4.1.2 Test Setup.....	19
4.1.3 Test Procedure.....	19
4.1.4 Test Data	20
4.2 Emissions in restricted frequency bands	22
4.2.1 Limit	22
4.2.2 Test Setup.....	24
4.2.3 Test Procedure.....	25
4.2.4 Test Data	26
4.3 Emissions in non-restricted frequency band.....	42

4.3.1	Limit	42
4.3.2	Test Setup.....	42
4.3.3	Test Procedure.....	42
4.3.4	Test Data	43
4.4	Duty cycle	47
4.4.1	Limit	47
4.4.2	Test Setup.....	47
4.4.3	Test Procedure.....	47
4.4.4	Test Data	48
4.5	Band Edge	49
4.5.1	Limit	49
4.5.2	Test Setup.....	49
4.5.3	Test Procedure.....	49
4.5.4	Test Data	50
4.6	DTS Bandwidth	66
4.6.1	Limit	66
4.6.2	Test Setup.....	66
4.6.3	Test Procedure.....	66
4.6.4	Test Data	67
4.7	Fundamental emission output power	68
4.7.1	Limit	68
4.7.2	Test Setup.....	68
4.7.3	Test Procedure.....	69
4.7.4	Test Data	70
4.8	Power Density	71
4.8.1	Limit:.....	71
4.8.2	Test Setup.....	71
4.8.3	Test Procedure.....	71
4.8.4	Test Data	72
4.9	Antenna Requirement.....	73
4.9.1	Limit:.....	73
4.9.2	Antenna Connector Construction:	73
5	Test setup photo and EUT Photo.....	74

COMPETENCES AND GUARANTEES

DEKRA is a testing laboratory competent to carry out the tests described in this report.

In order to assure the traceability to other national and international laboratories, DEKRA has a calibration and maintenance program for its measurement equipment.

DEKRA guarantees the reliability of the data presented in this report, which is the result of the measurements and the tests performed to the item under test on the date and under the conditions stated in the report and it is based on the knowledge and technical facilities available at DEKRA at the time of performance of the test.

DEKRA is liable to the client for the maintenance of the confidentiality of all information related to the item under test and the results of the test.

The results presented in this Test Report apply only to the particular item under test established in this document.

IMPORTANT: No parts of this report may be reproduced or quoted out of context, in any form or by any means, except in full, without the previous written permission of DEKRA.

GENERAL CONDITIONS

Test Location	No. 99, Hongye Road, Suzhou Industrial Park Suzhou, 215006, P.R. China
Date(receive sample)	May. 30, 2022
Date (start test)	May. 31, 2022
Date (finish test)	Jul. 15, 2022

1. This report is only referred to the item that has undergone the test.
2. This report does not constitute or imply on its own an approval of the product by the Certification Bodies or Competent Authorities.
3. This document is only valid if complete; no partial reproduction can be made without previous written permission of DEKRA.
4. This test report cannot be used partially or in full for publicity and/or promotional purposes without previous written permission of DEKRA.

ENVIRONMENTAL CONDITIONS

The climatic conditions during the tests are within the limits specified by the manufacturer for the operation of the EUT and the test equipment. The climatic conditions during the tests were within the following limits:

Ambient temperature	15 °C – 35 °C
Relative Humidity air	30% - 60%

If explicitly required in the basic standard or applied product / product family standard the climatic values are recorded and documented separately in this test report.

POSSIBLE TEST CASE VERDICTS

Test case does not apply to test object	N/A
Test object does meet requirement	P (Pass) / PASS
Test object does not meet requirement	F (Fail) / FAIL
Not measured	N/M

ABBREVIATIONS

For the purposes of the present document, the following abbreviations apply:

EUT	: Equipment Under Test
QP	: Quasi-Peak
CAV	: CISPR Average
AV	: Average
CDN	: Coupling Decoupling Network
SAC	: Semi-Anechoic Chamber
OATS	: Open Area Test Site
BW	: Bandwidth
AM	: Amplitude Modulation
PM	: Pulse Modulation
HCP	: Horizontal Coupling Plane
VCP	: Vertical Coupling Plane
U_N	: Nominal voltage
T_x	: Transmitter
R_x	: Receiver
N/A	: Not Applicable
N/M	: Not Measured

DOCUMENT HISTORY

Report No.	Version	Description	Issued Date
2250810R-RF-US-P06V02	V1.0	Initial issue of report.	2022-09-16
2250810R-RF-US-P06V02	V1.1	Modify the product name.	2022-10-12

REMARKS AND COMMENTS

1. The equipment under test (EUT) does meet the essential requirements of the stated standard(s)/test(s).
2. These test results on a sample of the device are for the purpose of demonstrating Compliance with Part 15 Subpart C Paragraph 15.247, RSS-Gen Issue 5, RSS-247 Issue 2.
3. The measurement result is considered in conformance with the requirement if it is within the prescribed limit, It is not necessary to account the uncertainty associated with the measurement result.
4. The test results presented in this report relate only to the object tested.
5. The test report shall not be reproduced without the written approval of DEKRA Testing and Certification (Suzhou) Co., Ltd.
6. This report will not be used for social proof function in China market.
7. DEKRA declines any responsibility with the following test data provided by customer that may affect the validity of result:
 - Chapter 1.1 General Description of the Item(s);
 - Chapter 1.2 Antenna Information;
 - Chapter 1.3 Channel List.
8. Client claims the EUT has the same BT/WIFI module of DEKRA report No. 2250816R-RF-US-P06V02, so only conducted emission, band edge and radiated test items is re-evaluated.

USED EQUIPMENT

AC Power Line Conducted Emission / TR1

Instrument	Manufacturer	Model No.	Serial No.	Cal. Date	Next Cal. Date
EMI Test Receiver	R&S	ESCI	100726	2021.10.30	2022.10.29
Two-Line V-Network	R&S	ENV216	101044	2022.03.12	2023.03.11
50ohm Termination	SHX	TF2	7081403	2021.09.04	2022.09.03
50ohm Coaxial Switch	Anritsu	MP59B	6200464462	N/A	N/A
Temperature/Humidity Meter	RTS	RTS-8S	TR1-TH	2022.07.07	2023.07.06
Dekra test software	Dekra	-	-	-	-

Emissions in non-restricted frequency bands/ Occupied Bandwidth/ Fundamental emission output power/ Power Spectral Density/Band Edge/ TR8

Instrument	Manufacturer	Model No.	Serial No.	Cal. Date	Next Cal. Date
Spectrum Analyzer	Agilent	N9010A	MY48030494	2021.12.15	2022.12.14
EXA Spectrum Analyzer	Keysight	N9010A	MY55370495	2021.08.12	2022.08.11
MXA Signal Analyzer	Keysight	N9020A	MY56060147	2022.07.14	2023.07.13
4TX MIMO Power Sensor	Keysight	X8750A	MY59400102	2022.03.16	2023.03.15
Coaxial Cable	Woken	N/A	N/A	2022.01.18	2023.01.17
Temperature/Humidity Meter	RTS	RTS-8S	RF08	2022.07.07	2023.07.06

Radiated Emission(30MHz-1GHz) / AC3

Instrument	Manufacturer	Model No.	Serial No.	Cal. Date	Next Cal. Date
EMI Test Receiver	R&S	ESCI	100176	2020.08.15	2021.08.14
Loop Antenna	R&S	HFH2-Z2	833799/003	2022.04.15	2023.04.14
Bilog Antenna	Teseq GmbH	CBL6112D	27613	2021.08.23	2022.08.22
Coaxial Cable	Huber+Suhner	RG 214	AC3-C	2022.03.30	2023.03.29
Temperature/Humidity Meter	RTS	RTS-8S	AC3-TH	2022.07.07	2023.07.06
Dekra test software	Dekra	-	-	-	-

Radiated Emission(1GHz-40GHz) / AC5

Instrument	Manufacturer	Model No.	Serial No.	Cal. Date	Next Cal. Date
EXA Spectrum Analyzer	Keysight	N9010A	MY55370495	2021.08.12	2022.08.11
Amplifier	SKET	LNPA_0118G-45	SK2021041201	2022.04.15	2023.04.14
Preamplifier	EMCI	EMC184045SE	980263	2022.05.21	2023.05.20
DRG Horn Antenna	ETS-Lindgren	3117	00167055	2021.08.23	2022.08.22
Broad-Band Horn Antenna	Schwarzbeck	BBHA9170	294	2022.05.19	2023.05.18
Coaxial Cable	Huber+Suhner	SUCOFLEX 106	AC5-C2	2022.05.22	2023.05.21
Coaxial Cable	ROSENBERGER	LA1-C011-2000/3000	AC5-40G	2022.03.21	2023.03.20
High-Pass Filter	Wainwright	WHKX3.0/18G-12SS	AC5&AC6	2022.06.07	2023.06.06
Temperature/Humidity Meter	RTS	RTS-8S	AC5-TH	2022.07.07	2023.07.06
Dekra test software	Dekra	-	-	-	-

UNCERTAINTY

Uncertainties have been calculated according to the DEKRA internal document. The reported expanded uncertainties are based on a standard uncertainty multiplied by a coverage factor of $k=2$, providing a level of confidence of approximately 95%. The Uncertainties is comply with standard required as below.

Test item	Uncertainty
AC Power Line Conducted Emission	9kHz~150kHz: 2.80dB 150kHz~30MHz: 2.40dB
Peak Power Output	± 1.27 dB
Radiated Emission(30MHz~1GHz)	Horizontal: 30MHz~200MHz: 3.50 dB 300MHz~1GHz: 3.60 dB Vertical: 30MHz~200MHz: 3.60 dB 300MHz~1GHz: 3.50 dB
Radiated Emission(1GHz~26.5GHz)	Horizontal: 1GHz~18GHz: 5.00 dB Vertical: 1GHz~18GHz: 4.80 dB
RF antenna conducted test	± 1.27 dB
Radiated Emission Band Edge	± 3.9 dB
DTS Bandwidth	± 150 Hz
Occupied Bandwidth	± 1 kHz
Power Density	± 1.27 dB

1 GENERAL INFORMATION

1.1 General Description of the Item(s)

Product Name..... :	Computer BOX
Model No. :	ESY0014
Hardware Version. :	R04
Software Version..... :	Android 10
HVIN..... :	ESY0014SV
FCC ID :	RBWESY0014SV
IC..... :	10757B-ESY0014SV
Manufacturer..... :	Elo Touch Solutions, Inc
Manufacturer Address..... :	670 N. McCarthy Blvd., Suite 100, Milpitas, CA 95035, USA.

Wireless specification..... :	Bluetooth 5.0					
Operating frequency range(s)..... :	2400~2483.5MHz					
Type of Modulation..... :	GFSK					
PHYs :	<input checked="" type="checkbox"/>	LE 1M	<input checked="" type="checkbox"/>	LE 2M	<input type="checkbox"/>	LE Coded S=2/8
Data Rate :	<input checked="" type="checkbox"/>	1Mbit/s	<input checked="" type="checkbox"/>	2Mbit/s	<input type="checkbox"/>	500/125 Kbit/s
Number of channel..... :	40					

Rated power supply	Voltage and Frequency				
	<input type="checkbox"/>	AC: 220 – 240 V, 50/60 Hz			
	<input type="checkbox"/>	AC: 110 – 130 Vac, 50/60 Hz			
	<input checked="" type="checkbox"/>	19 Vdc and POE 44-57V for ESY0014			
	<input type="checkbox"/>	Battery:			

1.2 Antenna Information

Antenna model / type number.....:	N/A		
Antenna serial number	N/A		
Antenna Delivery	<input checked="" type="checkbox"/>	1TX + 1RX	
	<input type="checkbox"/>	2TX + 2RX	
	<input type="checkbox"/>	Others:.....	
Antenna technology.....:	<input checked="" type="checkbox"/>	SISO	
	<input type="checkbox"/>	MIMO	<input type="checkbox"/> CDD
			<input type="checkbox"/> Beam-forming
Antenna Type.....:	<input type="checkbox"/>	External	<input type="checkbox"/> Dipole
			<input type="checkbox"/> Sectorized
	<input checked="" type="checkbox"/>	Internal	<input checked="" type="checkbox"/> PIFA
			<input type="checkbox"/> PCB
			<input type="checkbox"/> Dipole
			<input type="checkbox"/> Others.....
Antenna Gain	2 dBi for ESY0014		

1.3 Channel List

Bluetooth Working Frequency of Each Channel:							
Channel	Frequency	Channel	Frequency	Channel	Frequency	Channel	Frequency
00	2402 MHz	01	2404 MHz	02	2406 MHz	03	2408 MHz
04	2410 MHz	05	2412 MHz	06	2414 MHz	07	2416 MHz
08	2418 MHz	09	2420 MHz	10	2422 MHz	11	2424 MHz
12	2426 MHz	13	2428 MHz	14	2430 MHz	15	2432 MHz
16	2434 MHz	17	2436 MHz	18	2438 MHz	19	2440 MHz
20	2442 MHz	21	2444 MHz	22	2446 MHz	23	2448 MHz
24	2450 MHz	25	2452 MHz	26	2454 MHz	27	2456 MHz
28	2458 MHz	29	2460 MHz	30	2462 MHz	31	2464 MHz
32	2466 MHz	33	2468 MHz	34	2470 MHz	35	2472 MHz
36	2474 MHz	37	2476 MHz	38	2478 MHz	39	2480 MHz

Note: The general description of the Item(s), antenna information and channel list in clause 1 are provided and confirmed by the client.

2 DESCRIPTION OF TEST SETUP

2.1 Operating mode(s) used for tests

During the tests the following operating mode(s) has(have) been used.

Test Mode For Bluetooth	Mode1: Transmit by LE_1Mbps
	Mode2: Transmit by LE_2Mbps

2.2 Auxiliary equipment / Test software for the EUT

Auxiliary equipment	Type / Version	Manufacturer	Supplied by
Notebook	2526	Think Pad	N/A
Software	Type / Version	Manufacturer	Supplied by
Ampak RFTestTool	N/A	N/A	N/A

2.3 Test Configuration / Block diagram used for tests

Test setup Diagram- AC Line Conducted Emission Test

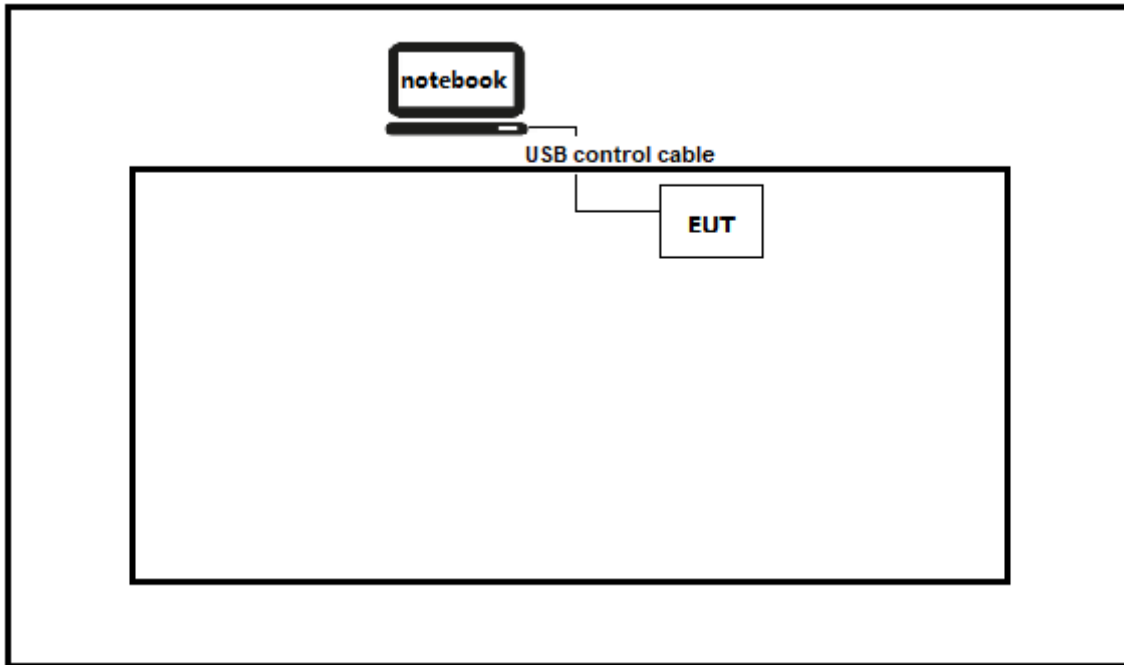

Test setup Diagram- Radiated Emission

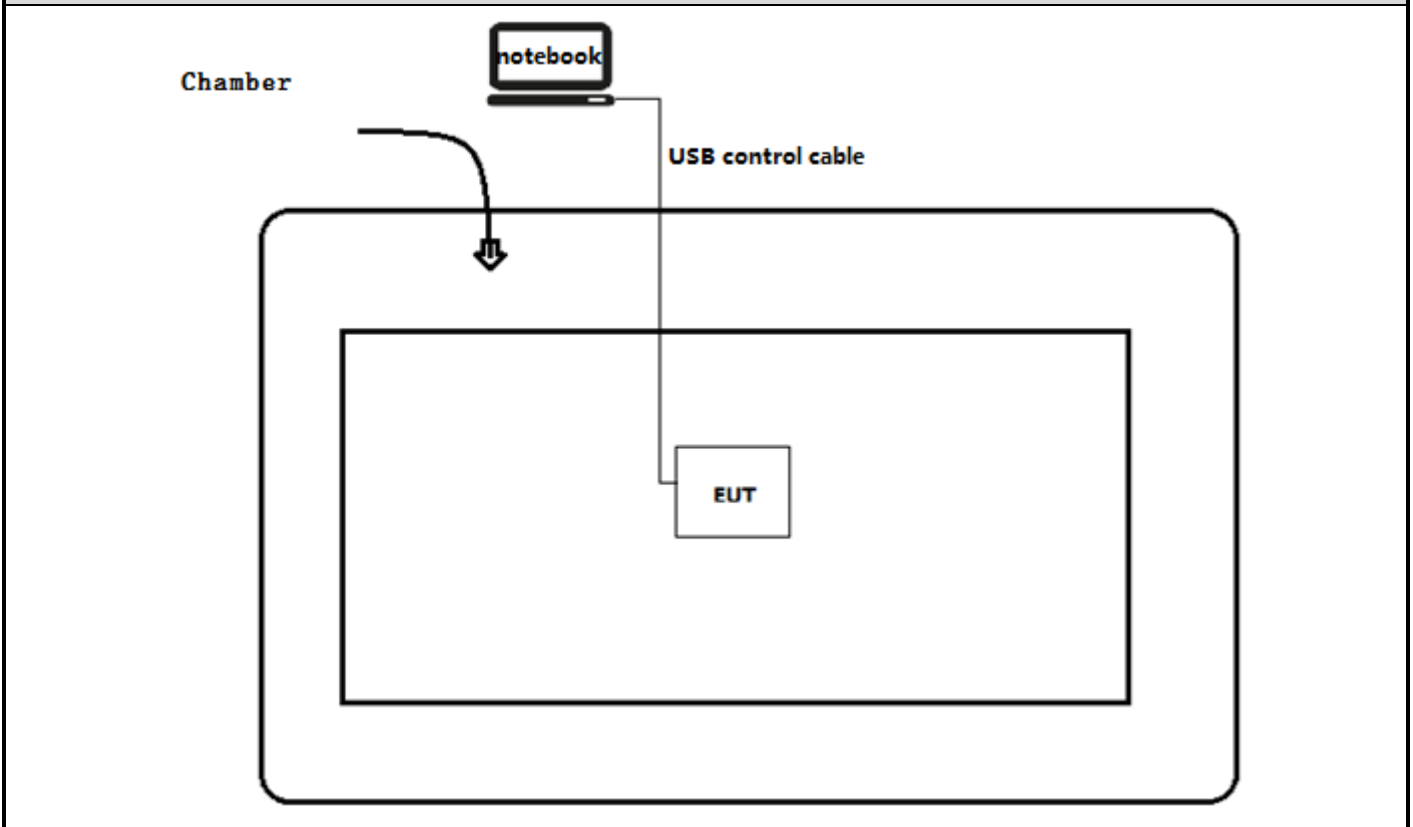

2.4 Testing process

1	Setup the EUT as shown in Section 2.3
2	Execute the test program.
3	Configure the test mode and test channel.
4	Verify that the EUT works properly.

3 VERDICT SUMMARY SECTION

This chapter presents an overview of standards and results. Refer to the next chapters for details of measured test results and applied test levels.

3.1 Standards

Standard	Year	Description
FCC CFR Title 47 Part 15 Subpart C Section 15.247	2021	Operation within the bands 902–928 MHz, 2400–2483.5 MHz, and 5725–5850 MHz.
ANSI C63.10	2013	American National Standard of Procedures for Compliance Testing of Unlicensed Wireless Devices
KDB558074 D01 v05r02	2019	Guidance for performing compliance measurements on Digital Transmission System (DTS) operating under section 15.247
RSS-Gen Issue 5 Amendment 2	2021	General Requirements for Compliance of Radio Apparatus
RSS-247 Issue 2	2017	Digital Transmission Systems (DTSs), Frequency Hopping Systems (FHSs) and Licence-Exempt Local Area Network (LE-LAN) Devices

3.2 Deviation(s) from the Standard(s) / Test Specification(s)

The following deviation(s) was / were made from the published requirements of the listed standards: N/A.

(Please define the deviations from the standard(s) if applicable)

3.3 Overview of results

For FCC

Requirement – Test case	Basic standard(s)	Verdict	Remark
AC Power Line Conducted Emission	FCC 15.207	PASS	---
Emissions in restricted frequency bands	FCC 15.247(b)(3)	PASS	---
Duty cycle	ANSI C63.10:2013	PASS	---
Emissions in non-restricted frequency bands	FCC 15.247(d), FCC 15.209	PASS	---
Band Edge	FCC 15.247(d)	PASS	---
Fundamental emission output power	FCC 15.247(d), FCC 15.209	PASS	---
DTS Bandwidth	FCC 15.247(a)(2)	PASS	---
Power Spectral Density	FCC 15.247(e)	PASS	---
Antenna Requirement	FCC 15.203	PASS	---

For ISED

Requirement – Test case	Basic standard(s)	Verdict	Remark
AC Power Line Conducted Emission	RSS-Gen Issue 5 Section 8.8	PASS	---
Emissions in restricted frequency bands	RSS-Gen Issue 5 Section 8.9	PASS	---
Duty cycle	ANSI C63.10:2013	PASS	---
Emissions in non-restricted frequency bands	RSS-247 Issue 2 Section 5.5	PASS	---
Band Edge	RSS-Gen Issue 5 Section 8.10	PASS	---
Fundamental emission output power	RSS-247 Issue 2 Section 5.4(d)	PASS	---
DTS Bandwidth	RSS-Gen Issue 5 Section 6.7	PASS	---
Power Spectral Density	RSS-247 Issue 2 Section 5.2(b)	PASS	---
Antenna Requirement	RSS-Gen Issue 5 Section 6.8	PASS	---

3.4 Test Facility

USA	:	FCC Designation Number: CN1199
CA	:	ISED CAB identifier: CN0040

4 TEST RESULTS

4.1 AC Power Line Conducted Emission

VERDICT: PASS

4.1.1 Limit

Standard FCC Part 15 Subpart C Paragraph 15.207

Frequency range [MHz]	Limit: QP [dB(μV) ¹⁾	Limit: AV [dB(μV) ¹⁾
0,15 - 0,50	66 - 56 ²⁾	56 - 46 ²⁾
0,50 - 5,0	56	46
5,0 - 30	60	50

¹⁾ At the transition frequency, the lower limit applies.

²⁾ The limit decreases linearly with the logarithm of the frequency.

NOTE 1: The exclusion band for transmitters shall be considered for transmitters operating at frequencies below 30 MHz.

NOTE 2: Where the AC output port is directly connected (or via a circuit breaker) to the AC power input port of the EUT the AC power output port need not to be tested.

4.1.2 Test Setup

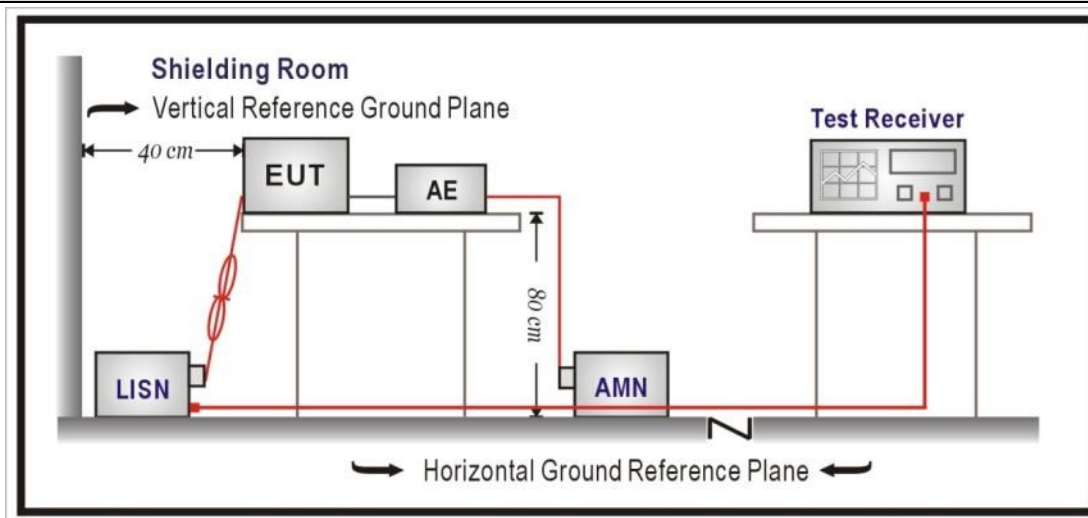

4.1.3 Test Procedure

	References Rule	Chapter	Item
<input checked="" type="checkbox"/>	ANSI C63.10-2013	6.2	Standard test method for ac power-line conducted emissions from unlicensed wireless devices

4.1.4 Test Data

Profile: 2250810R	Page No.: 14
Engineer: Yu Liu	
Site: TR1	Time: 2022/06/28 - 19:32
Limit: FCC_Part15.207_CE_AC Power	Margin: 0
Probe: ENV216_101190(0.009-30MHz)	Polarity: Line
EUT: Computer BOX	Power: AC 120V/60Hz
Note: Mode 1	

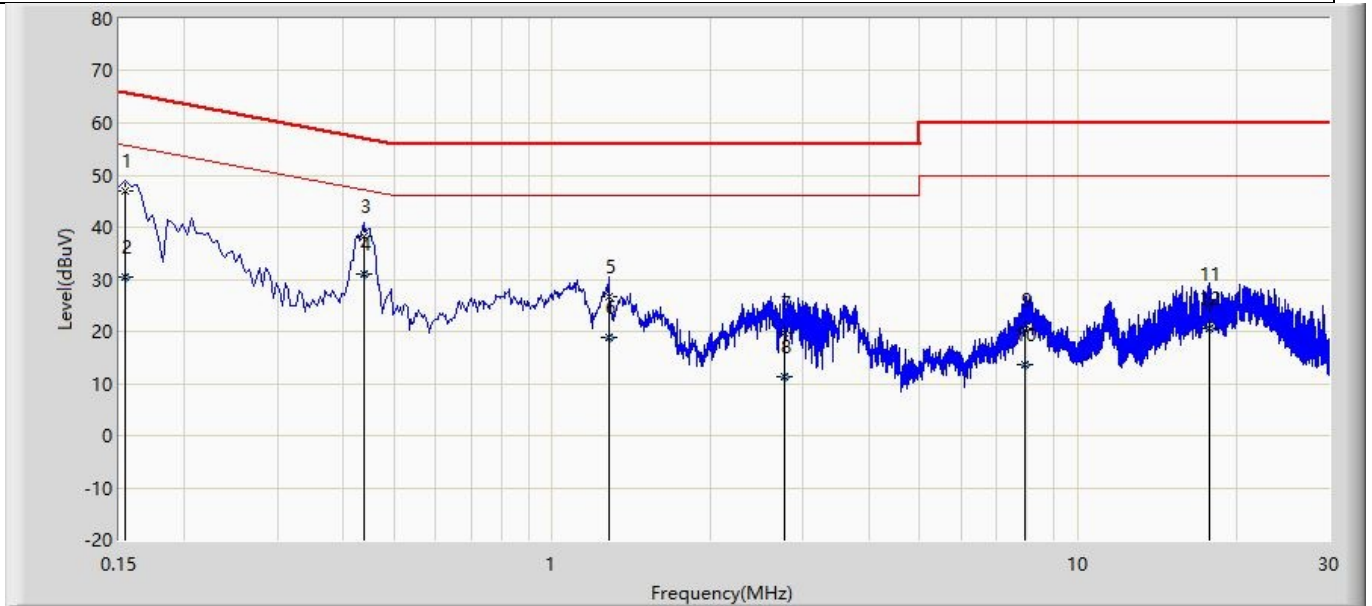

No	Mark	Frequency (MHz)	Measure Level (dBuV)	Reading Level (dBuV)	Over Limit (dB)	Limit (dBuV)	Probe (dB)	Cable (dB)	Amp (dB)	Type
1		0.154	46.921	37.342	-18.861	65.781	9.550	0.028	0.000	QP
2		0.154	30.481	20.903	-25.300	55.781	9.550	0.028	0.000	AV
3		0.438	38.184	28.567	-18.916	57.100	9.576	0.041	0.000	QP
4	*	0.438	31.062	21.445	-16.038	47.100	9.576	0.041	0.000	AV
5		1.282	26.755	17.101	-29.245	56.000	9.590	0.064	0.000	QP
6		1.282	18.853	9.199	-27.147	46.000	9.590	0.064	0.000	AV
7		2.770	19.811	10.091	-36.189	56.000	9.610	0.109	0.000	QP
8		2.770	11.328	1.609	-34.672	46.000	9.610	0.109	0.000	AV
9		7.950	20.252	10.309	-39.748	60.000	9.762	0.181	0.000	QP
10		7.950	13.661	3.717	-36.339	50.000	9.762	0.181	0.000	AV
11		17.818	25.276	15.086	-34.724	60.000	9.920	0.271	0.000	QP
12		17.818	20.561	10.370	-29.439	50.000	9.920	0.271	0.000	AV

Profile: 2250810R	Page No.: 19
Engineer: Yu Liu	
Site: TR1	Time: 2022/06/28 - 19:40
Limit: FCC_Part15.207_CE_AC Power	Margin: 0
Probe: ENV216_101190(0.009-30MHz)	Polarity: Neutral
EUT: Computer BOX	Power: AC 120V/60Hz
Note: Mode 1	

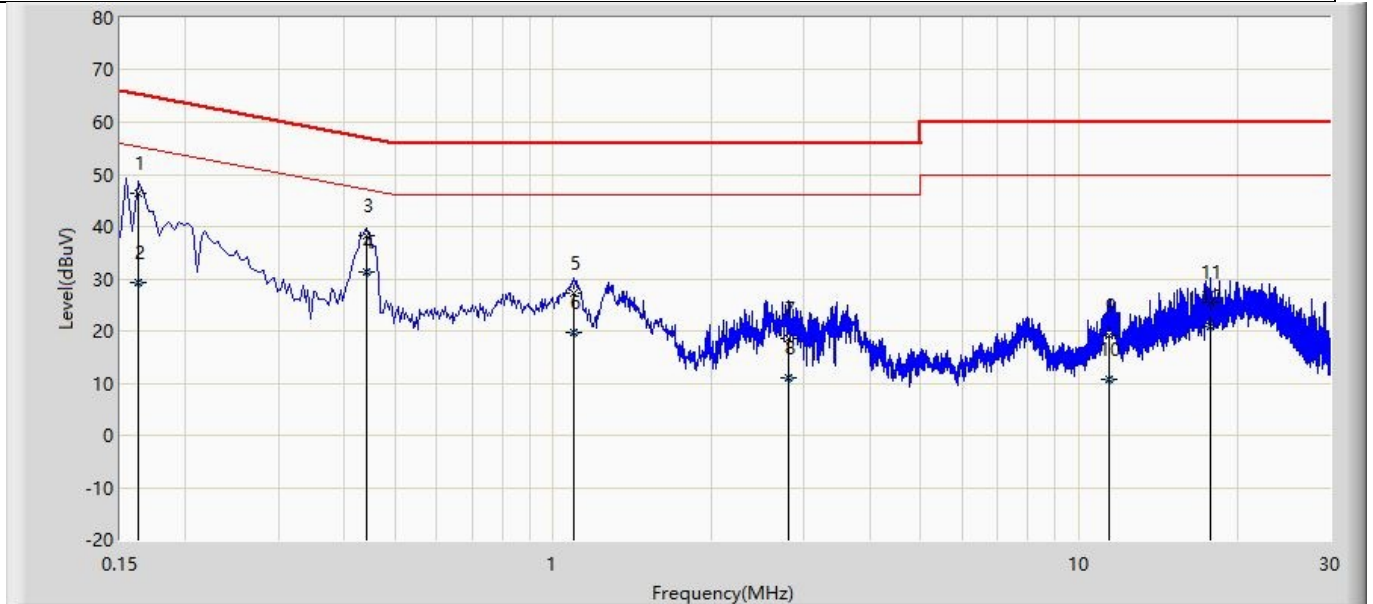

No	Mark	Frequency (MHz)	Measure Level (dBuV)	Reading Level (dBuV)	Over Limit (dB)	Limit (dBuV)	Probe (dB)	Cable (dB)	Amp (dB)	Type
1		0.162	46.267	36.696	-19.094	65.361	9.543	0.029	0.000	QP
2		0.162	29.298	19.727	-26.063	55.361	9.543	0.029	0.000	AV
3		0.442	38.280	28.665	-18.744	57.024	9.574	0.040	0.000	QP
4	*	0.442	31.255	21.641	-15.769	47.024	9.574	0.040	0.000	AV
5		1.094	27.184	17.535	-28.816	56.000	9.590	0.059	0.000	QP
6		1.094	19.848	10.198	-26.152	46.000	9.590	0.059	0.000	AV
7		2.806	18.644	8.930	-37.356	56.000	9.609	0.105	0.000	QP
8		2.806	10.885	1.172	-35.115	46.000	9.609	0.105	0.000	AV
9		11.414	19.095	9.045	-40.905	60.000	9.835	0.215	0.000	QP
10		11.414	10.789	0.739	-39.211	50.000	9.835	0.215	0.000	AV
11		17.818	25.525	15.310	-34.475	60.000	9.945	0.271	0.000	QP
12		17.818	20.860	10.644	-29.140	50.000	9.945	0.271	0.000	AV

4.2 Emissions in restricted frequency bands	VERDICT: PASS
--	----------------------

4.2.1 Limit			
Standard		FCC Part 15 Subpart C Paragraph 15.209	
Restricted Bands of operationfor FCC			
Frequency (MHz)	Frequency (MHz)	Frequency (MHz)	Frequency (GHz)
0.090 – 0.110	16.42 – 16.423	399.9 – 410	4.5 – 5.15
0.495 – 0.505	16.69475 – 16.69525	608 – 614	5.35 – 5.46
2.1735 – 2.1905	16.80425 – 16.80475	960 – 1240	7.25 – 7.75
4.125 – 4.128	25.5 – 25.67	1300 – 1427	8.025 – 8.5
4.17725 – 4.17775	37.5 – 38.25	1435 – 1626.5	9.0 – 9.2
4.20725 – 4.20775	73 – 74.6	1645.5 – 1646.5	9.3 – 9.5
6.215 – 6.218	74.8 – 75.2	1660 – 1710	10.6 – 12.7
6.26775 – 6.26825	108 – 121.94	1718.8 – 1722.2	13.25 – 13.4
6.31175 – 6.31225	123 – 138	2200 – 2300	14.47 – 14.5
8.291 – 8.294	149.9 – 150.05	2310 – 2390	15.35 – 16.2
8.362 – 8.366	156.52475 – 156.52525	2483.5 – 2500	17.7 – 21.4
8.37625 – 8.38675	156.7 – 156.9	2690 – 2900	22.01 – 23.12
8.81425 – 8.81475	162.0125 – 167.17	3260 – 3267	23.6 – 24.0
12.29 – 12.293	167.72 – 173.2	3332 – 3339	31.2 – 31.8
12.51975 – 12.52025	240 – 285	3345.8 – 3358	36.43 – 36.5
12.57675 – 12.57725	322 – 335.4	3600 – 4400	
13.36 – 13.41			
Restricted Bands of operationfor IC			
0.090 - 0.110	13.36 - 13.41	960 - 1427	9.0 - 9.2
0.495 - 0.505	16.42 - 16.423	1435 - 1626.5	9.3 - 9.5
2.1735 - 2.1905	16.69475 - 16.69525	1645.5 - 1646.5	10.6 - 12.7
3.020 - 3.026	16.80425 - 16.80475	1660 - 1710	13.25 - 13.4
4.125 - 4.128	25.5 - 25.67	1718.8 - 1722.2	14.47 - 14.5
4.17725 - 4.17775	37.5 - 38.25	2200 - 2300	15.35 - 16.2
4.20725 - 4.20775	73 - 74.6	2310 - 2390	17.7 - 21.4
5.677 - 5.683	74.8 - 75.2	2483.5 - 2500	22.01 - 23.12
6.215 - 6.218	108 - 138	2655 - 2900	23.6 - 24.0
6.26775 - 6.26825	149.9 - 150.05	3260 - 3267	31.2 - 31.8
6.31175 - 6.31225	156.52475 - 156.52525	3332 - 3339	36.43 - 36.5
8.291 - 8.294	156.7 - 156.9	3345.8 - 3358	Above 38.6
8.362 - 8.366	162.0125 - 167.17	3500 - 4400	
8.37625 - 8.38675	167.72 - 173.2	4500 - 5150	
8.41425 - 8.41475	240 - 285	5350 - 5460	
12.29 - 12.293	322 - 335.4	7250 - 7750	
12.51975 - 12.52025	399.9 - 410	8025 - 8500	
12.57675 - 12.57725	608 - 614	--	

Restricted Band Emissions Limit			
Frequency (MHz)	Field strength (μ V/m)	Field strength (dB μ V/m)	Measurement distance (m)
0.009 - 0.49	2400/F(kHz)	48.5 – 13.8	300 _(Note 1)
0.49 - 1.705	24000/F(kHz)	33.8 - 23	30 _(Note 1)
1.705 - 30	30	29.5	30 _(Note 1)
30 -88	100	40	3 _(Note 2)
88-216	150	43.5	3 _(Note 2)
216 - 960	200	46	3 _(Note 2)
Above 960	500	54	3 _(Note 2)

Note 1: At frequencies below 30 MHz, measurements may be performed at a distance closer than that specified in the regulations; however, an attempt should be made to avoid making measurements in the near field. Pending the development of an appropriate measurement procedure for measurements performed below 30 MHz, when performing measurements at a closer distance than specified, the results shall be extrapolated to the specified distance by either making measurements at a minimum of two distances on at least one radial to determine the proper extrapolation factor or by using the square of an inverse linear distance extrapolation factor (40 dB/decade).

Note 2: At frequencies at or above 30 MHz, measurements may be performed at a distance other than what is specified provided: measurements are not made in the near field except where it can be shown that near field measurements are appropriate due to the characteristics of the device; and it can be demonstrated that the signal levels needed to be measured at the distance employed can be detected by the measurement equipment.

Measurements shall not be performed at a distance greater than 30 meters unless it can be further demonstrated that measurements at a distance of 30 meters or less are impractical. When performing measurements at a distance other than that specified, the results shall be extrapolated to the specified distance using an extrapolation factor of 20 dB/decade (inverse linear-distance for field strength measurements; inverse-linear-distance-squared for power density measurements).

4.2.2 Test Setup

Below 30MHz Test Setup:

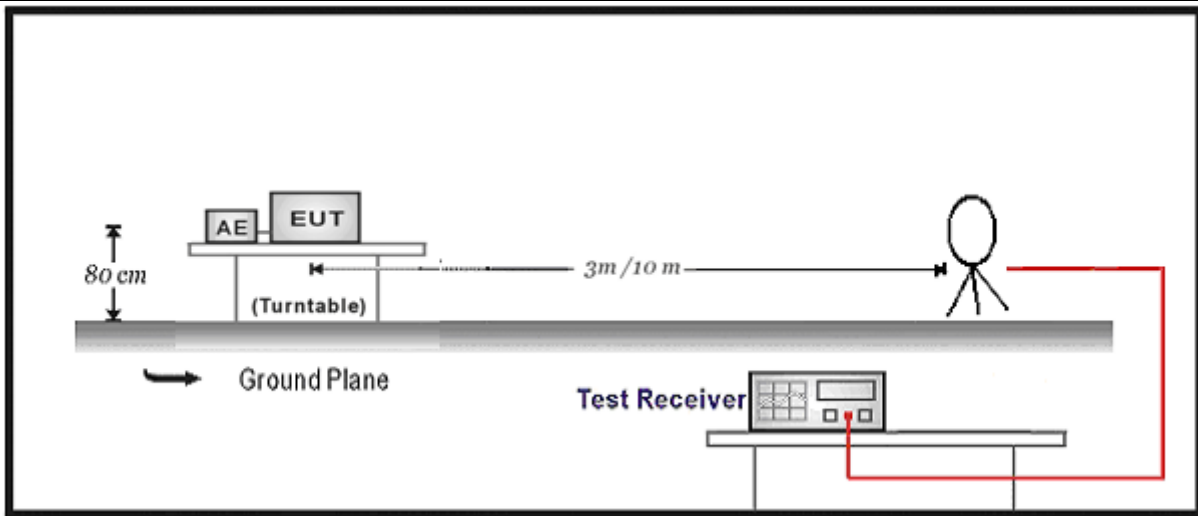

30MHz-1GHz Test Setup:

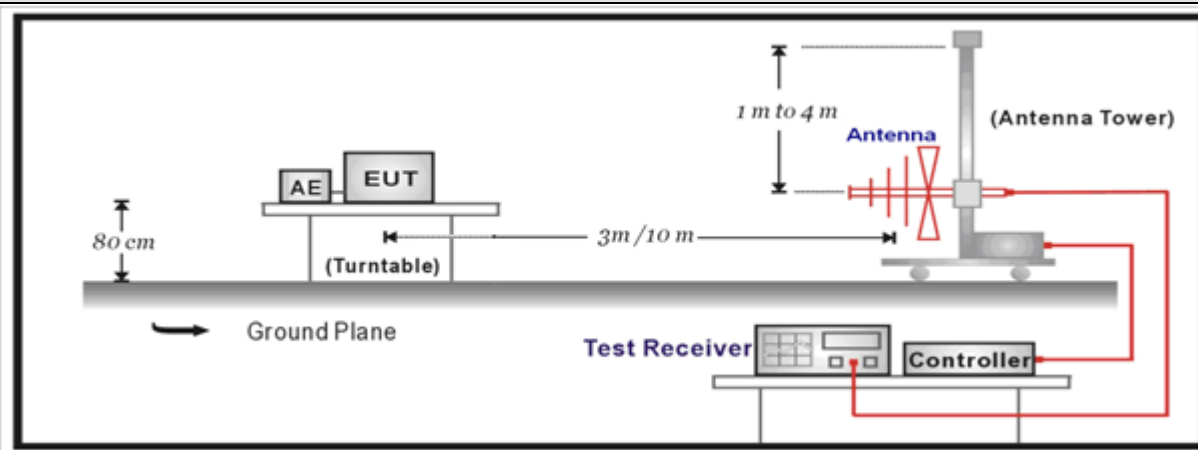

Above 1GHz Test Setup:

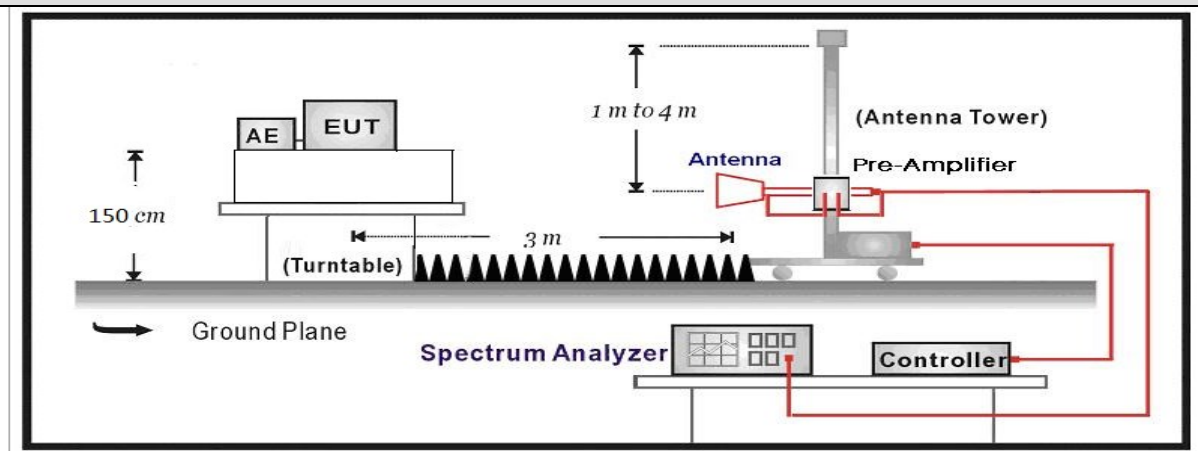

4.2.3 Test Procedure			
	References Rule	Chapter	Description
<input checked="" type="checkbox"/>	ANSI C63.10	11.12	Emissions in restricted frequency bands
	<input checked="" type="checkbox"/> ANSI C63.10	11.12.1	Radiated emission measurements
	<input checked="" type="checkbox"/> ANSI C63.10	11.12.2.7	Radiated spurious emission test
	<input checked="" type="checkbox"/> ANSI C63.10	6.4	Radiated emissions from unlicensed wireless devices below 30 MHz
	<input checked="" type="checkbox"/> ANSI C63.10	6.5	Radiated emissions from unlicensed wireless devices in the frequency range of 30 MHz to 1000 MHz
	<input checked="" type="checkbox"/> ANSI C63.10	6.6	Radiated emissions from unlicensed wireless devices above 1 GHz

4.2.4 Test Data

Profile: 2250810R	Page No.: 13
Engineer: Yu Liu	
Site: AC5	Time: 2022/06/25 - 22:31
Limit: FCC_Part15.209_RE(3m)	Margin: 0
Probe: HORN_3117_00167055(1-18GHZ)	Polarity: Horizontal
EUT: Computer BOX	Power: AC 120V/60Hz
Note: Mode 1:Transmit at 2402MHz by BLE_1M	

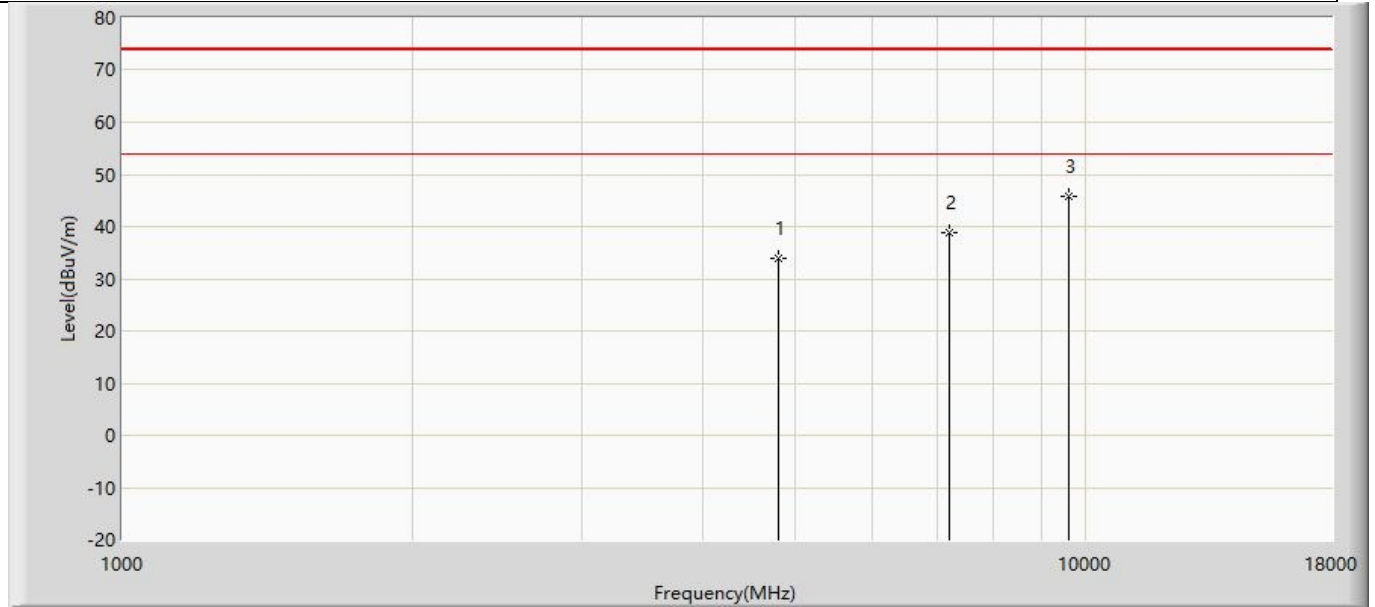

No	Mark	Frequency (MHz)	Measure Level (dBuV/m)	Reading Level (dBuV)	Over Limit (dB)	Limit (dBuV/m)	Factor (dB)	Type
1		4804.000	33.773	48.431	-40.227	74.000	-14.657	PK
2		7206.000	38.779	47.510	-35.221	74.000	-8.731	PK
3	*	9608.000	45.814	50.636	-28.186	74.000	-4.822	PK

Profile: 2250810R	Page No.: 14
Engineer: Yu Liu	
Site: AC5	Time: 2022/06/25 - 22:31
Limit: FCC_Part15.209_RE(3m)	Margin: 0
Probe: HORN_3117_00167055(1-18GHZ)	Polarity: Vertical
EUT: Computer BOX	Power: AC 120V/60Hz
Note: Mode 1:Transmit at 2402MHz by BLE_1M	

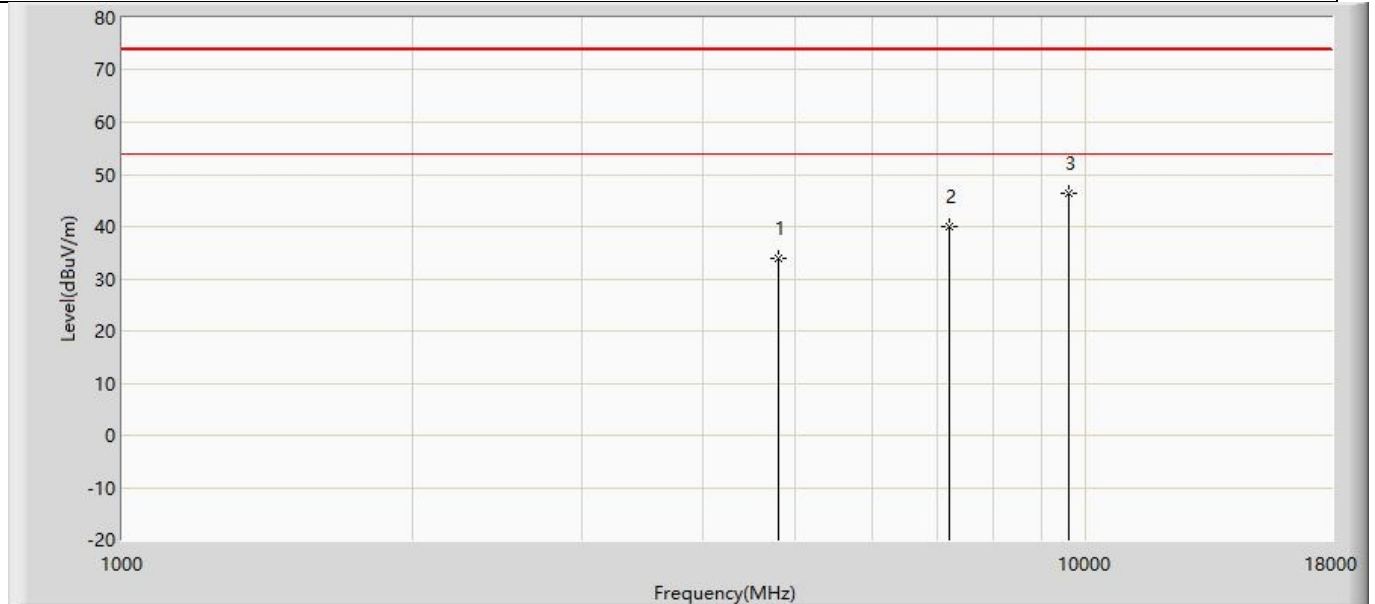

No	Mark	Frequency (MHz)	Measure Level (dBuV/m)	Reading Level (dBuV)	Over Limit (dB)	Limit (dBuV/m)	Factor (dB)	Type
1		4804.000	33.904	48.562	-40.096	74.000	-14.657	PK
2		7206.000	39.938	48.669	-34.062	74.000	-8.731	PK
3	*	9608.000	46.304	51.126	-27.696	74.000	-4.822	PK

Profile: 2250810R	Page No.: 15
Engineer: Yu Liu	
Site:	Time: 2022/06/25 - 22:31
Limit: FCC_Part15.209_RE(3m)	Margin: 0
Probe: HORN_3117_00167055(1-18GHZ)	Polarity: Horizontal
EUT: Computer BOX	Power: AC 120V/60Hz
Note: Mode 1:Transmit at 2440MHz by BLE_1M	

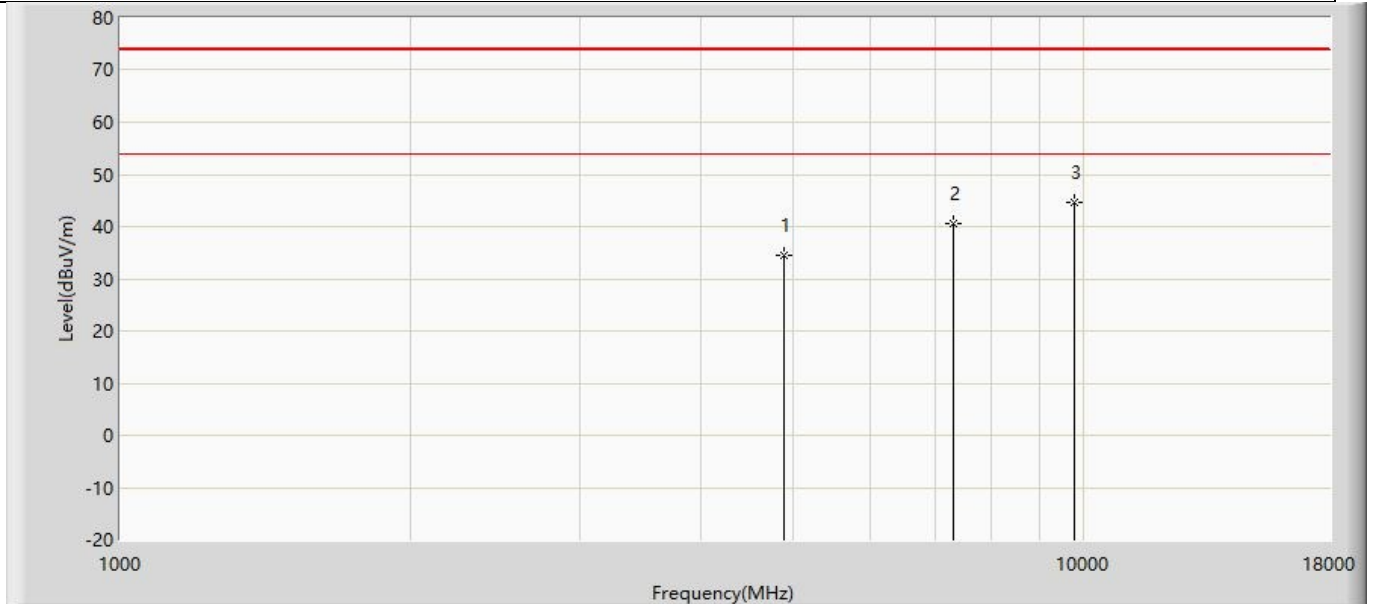

No	Mark	Frequency (MHz)	Measure Level (dBuV/m)	Reading Level (dBuV)	Over Limit (dB)	Limit (dBuV/m)	Factor (dB)	Type
1		4880.000	34.606	48.994	-39.394	74.000	-14.388	PK
2		7320.000	40.494	48.814	-33.506	74.000	-8.320	PK
3	*	9760.000	44.747	49.421	-29.253	74.000	-4.673	PK

Profile: 2250810R	Page No.: 16
Engineer: Yu Liu	
Site:	Time: 2022/06/25 - 22:31
Limit: FCC_Part15.209_RE(3m)	Margin: 0
Probe: HORN_3117_00167055(1-18GHZ)	Polarity: Vertical
EUT: Computer BOX	Power: AC 120V/60Hz
Note: Mode 1:Transmit at 2440MHz by BLE_1M	

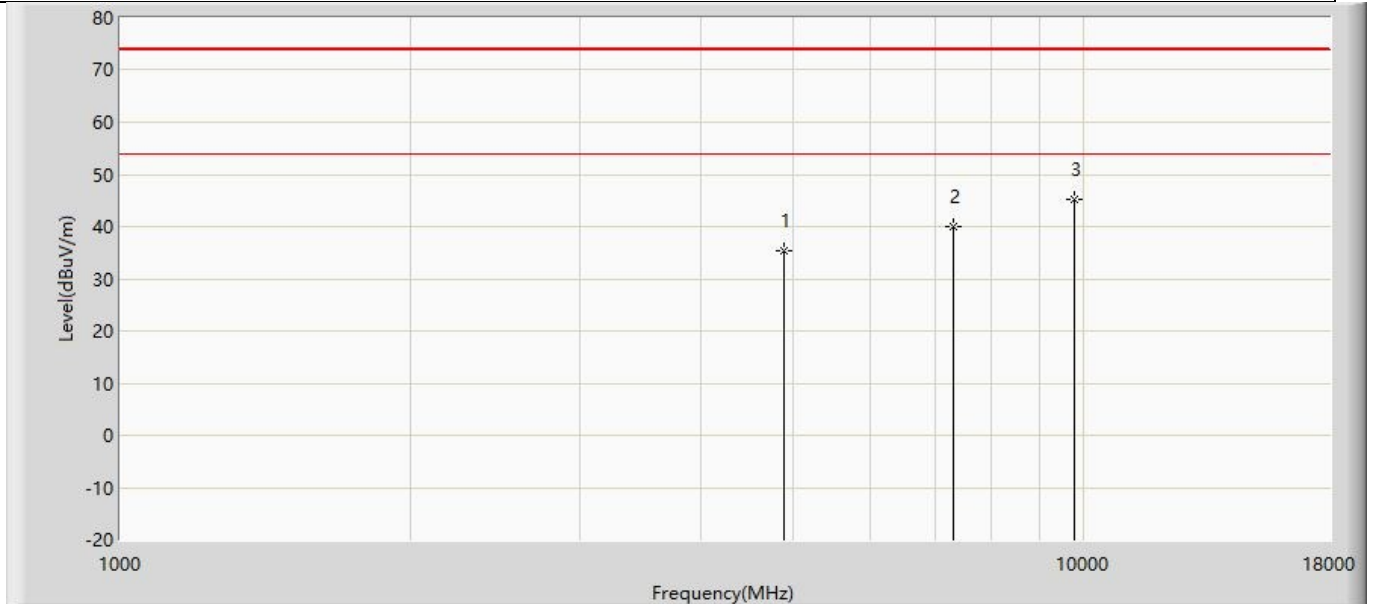

No	Mark	Frequency (MHz)	Measure Level (dBuV/m)	Reading Level (dBuV)	Over Limit (dB)	Limit (dBuV/m)	Factor (dB)	Type
1		4880.000	35.365	49.753	-38.635	74.000	-14.388	PK
2		7320.000	40.132	48.452	-33.868	74.000	-8.320	PK
3	*	9760.000	45.269	49.943	-28.731	74.000	-4.673	PK

Profile: 2250810R	Page No.: 17
Engineer: Yu Liu	
Site:	Time: 2022/06/25 - 22:32
Limit: FCC_Part15.209_RE(3m)	Margin: 0
Probe: HORN_3117_00167055(1-18GHZ)	Polarity: Horizontal
EUT: Computer BOX	Power: AC 120V/60Hz
Note: Mode 1:Transmit at 2480MHz by BLE_1M	

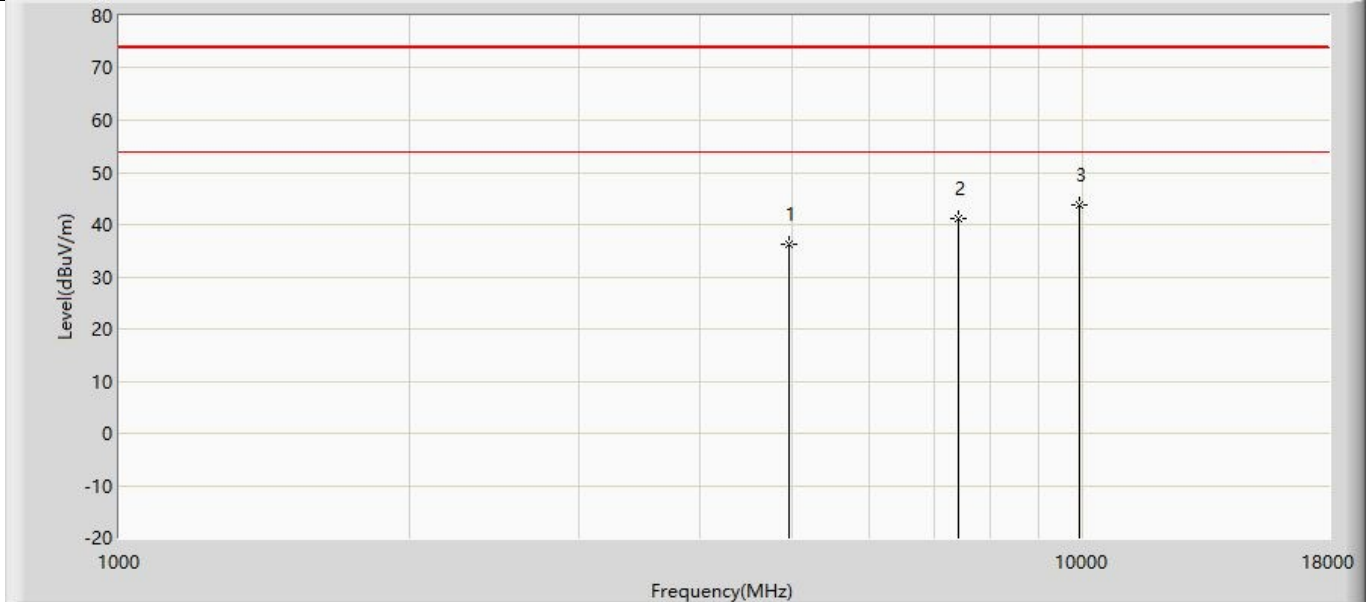

No	Mark	Frequency (MHz)	Measure Level (dBuV/m)	Reading Level (dBuV)	Over Limit (dB)	Limit (dBuV/m)	Factor (dB)	Type
1		4960.000	36.295	50.415	-37.705	74.000	-14.120	PK
2		7440.000	41.071	48.906	-32.929	74.000	-7.834	PK
3	*	9920.000	43.907	47.978	-30.093	74.000	-4.071	PK

Profile: 2250810R	Page No.: 18
Engineer: Yu Liu	
Site:	Time: 2022/06/25 - 22:32
Limit: FCC_Part15.209_RE(3m)	Margin: 0
Probe: HORN_3117_00167055(1-18GHZ)	Polarity: Vertical
EUT: Computer BOX	Power: AC 120V/60Hz
Note: Mode 1:Transmit at 2480MHz by BLE_1M	

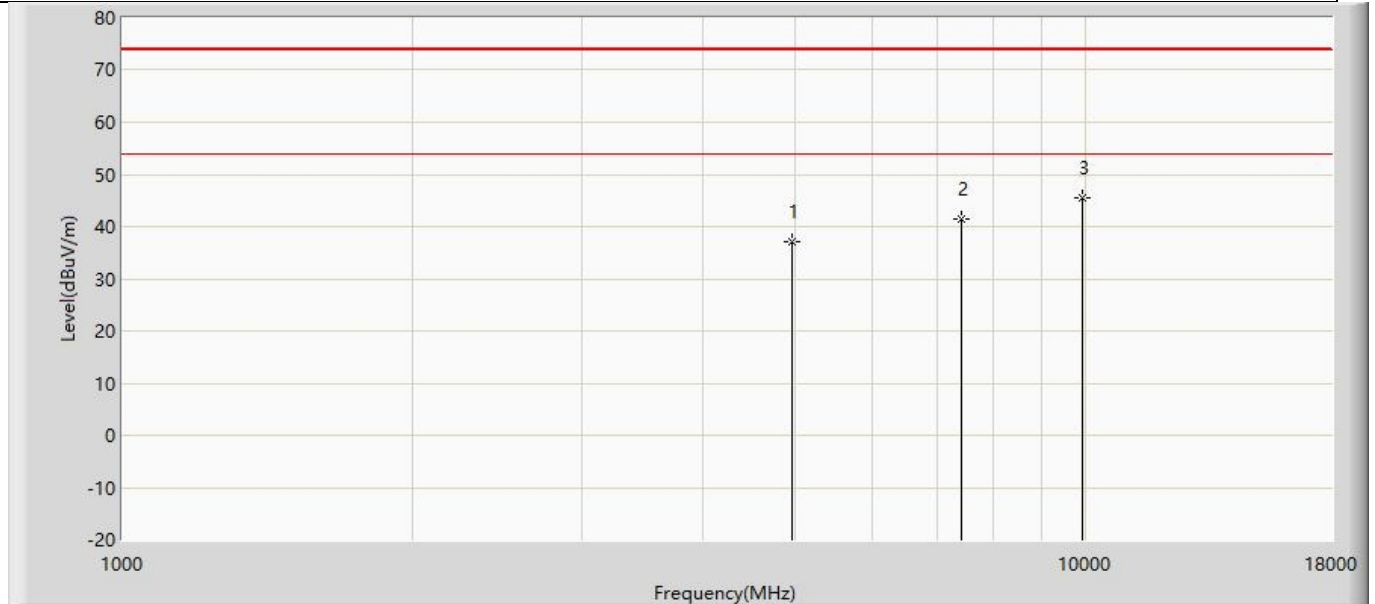

No	Mark	Frequency (MHz)	Measure Level (dBuV/m)	Reading Level (dBuV)	Over Limit (dB)	Limit (dBuV/m)	Factor (dB)	Type
1		4960.000	37.178	51.298	-36.822	74.000	-14.120	PK
2		7440.000	41.306	49.141	-32.694	74.000	-7.834	PK
3	*	9920.000	45.421	49.492	-28.579	74.000	-4.071	PK

Profile: 2250810R	Page No.: 19
Engineer: Yu Liu	
Site:	Time: 2022/06/25 - 22:32
Limit: FCC_Part15.209_RE(3m)	Margin: 0
Probe: HORN_3117_00167055(1-18GHZ)	Polarity: Horizontal
EUT: Computer BOX	Power: AC 120V/60Hz
Note: Mode 2:Transmit at 2402MHz by BLE_2M	

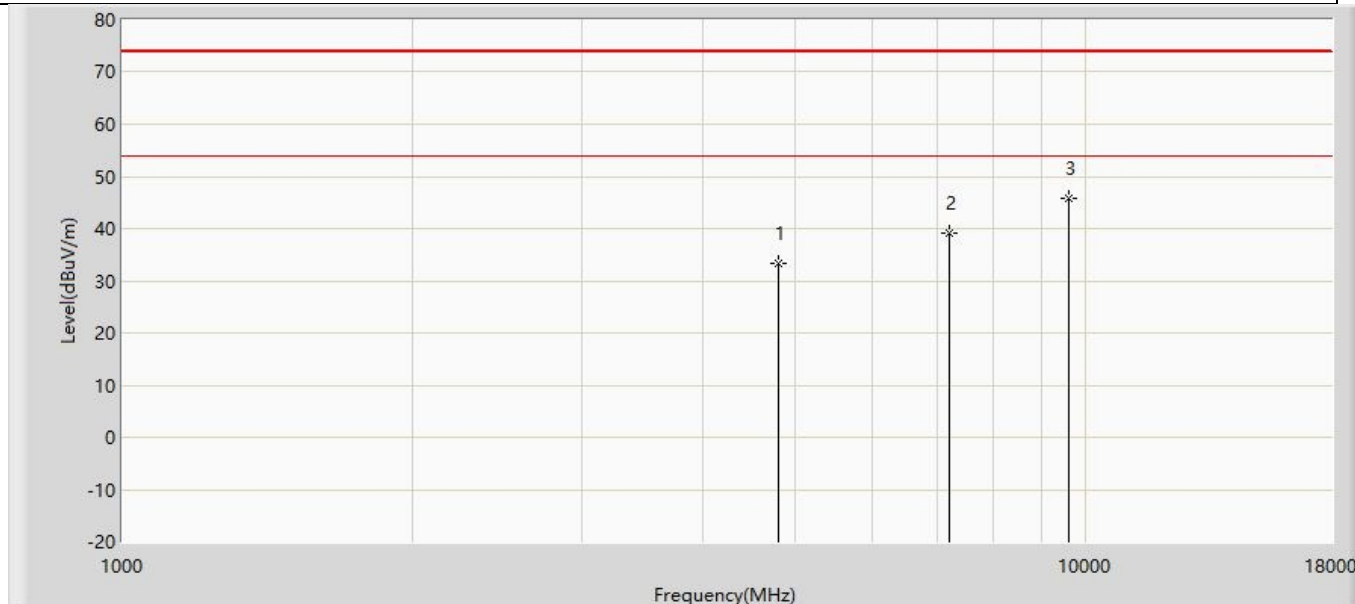

No	Mark	Frequency (MHz)	Measure Level (dBuV/m)	Reading Level (dBuV)	Over Limit (dB)	Limit (dBuV/m)	Factor (dB)	Type
1		4804.000	33.409	48.067	-40.591	74.000	-14.657	PK
2		7206.000	39.225	47.956	-34.775	74.000	-8.731	PK
3	*	9608.000	45.837	50.659	-28.163	74.000	-4.822	PK

Profile: 2250810R	Page No.: 20
Engineer: Yu Liu	
Site:	Time: 2022/06/25 - 22:32
Limit: FCC_Part15.209_RE(3m)	Margin: 0
Probe: HORN_3117_00167055(1-18GHZ)	Polarity: Vertical
EUT: Computer BOX	Power: AC 120V/60Hz
Note: Mode 2:Transmit at 2402MHz by BLE_2M	

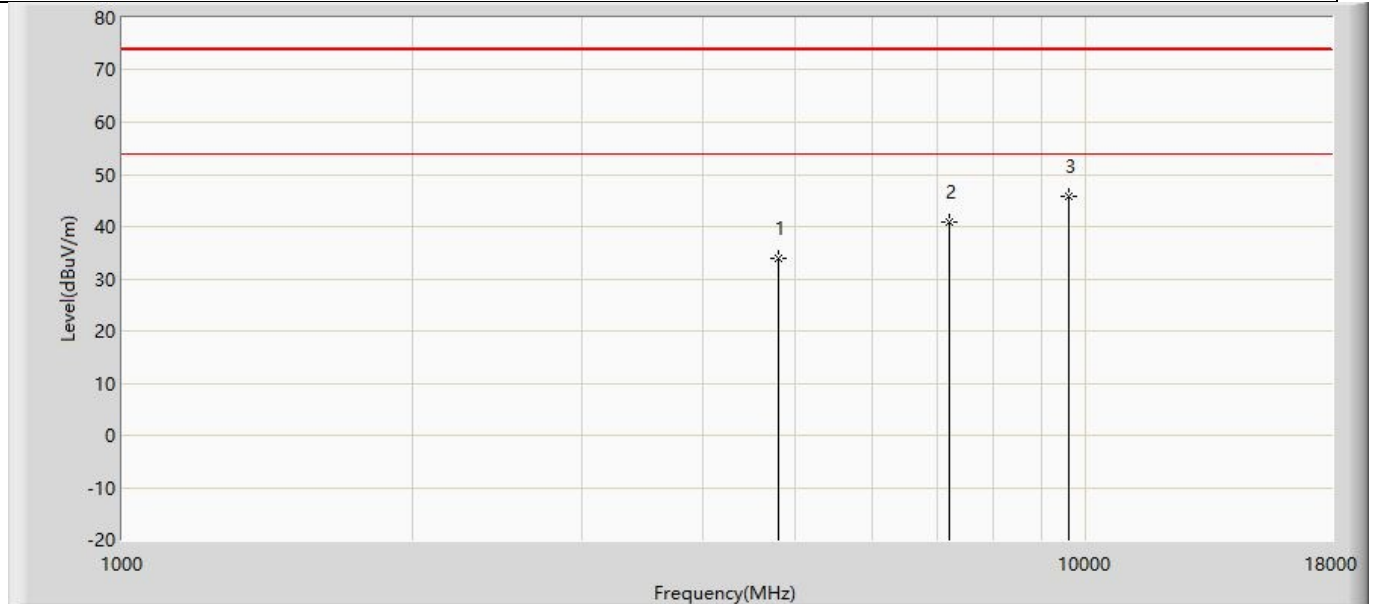

No	Mark	Frequency (MHz)	Measure Level (dBuV/m)	Reading Level (dBuV)	Over Limit (dB)	Limit (dBuV/m)	Factor (dB)	Type
1		4804.000	34.051	48.709	-39.949	74.000	-14.657	PK
2		7206.000	40.871	49.602	-33.129	74.000	-8.731	PK
3	*	9608.000	45.903	50.725	-28.097	74.000	-4.822	PK

Profile: 2250810R	Page No.: 21
Engineer: Yu Liu	
Site:	Time: 2022/06/25 - 22:32
Limit: FCC_Part15.209_RE(3m)	Margin: 0
Probe: HORN_3117_00167055(1-18GHZ)	Polarity: Horizontal
EUT: Computer BOX	Power: AC 120V/60Hz
Note: Mode 2:Transmit at 2440MHz by BLE_2M	

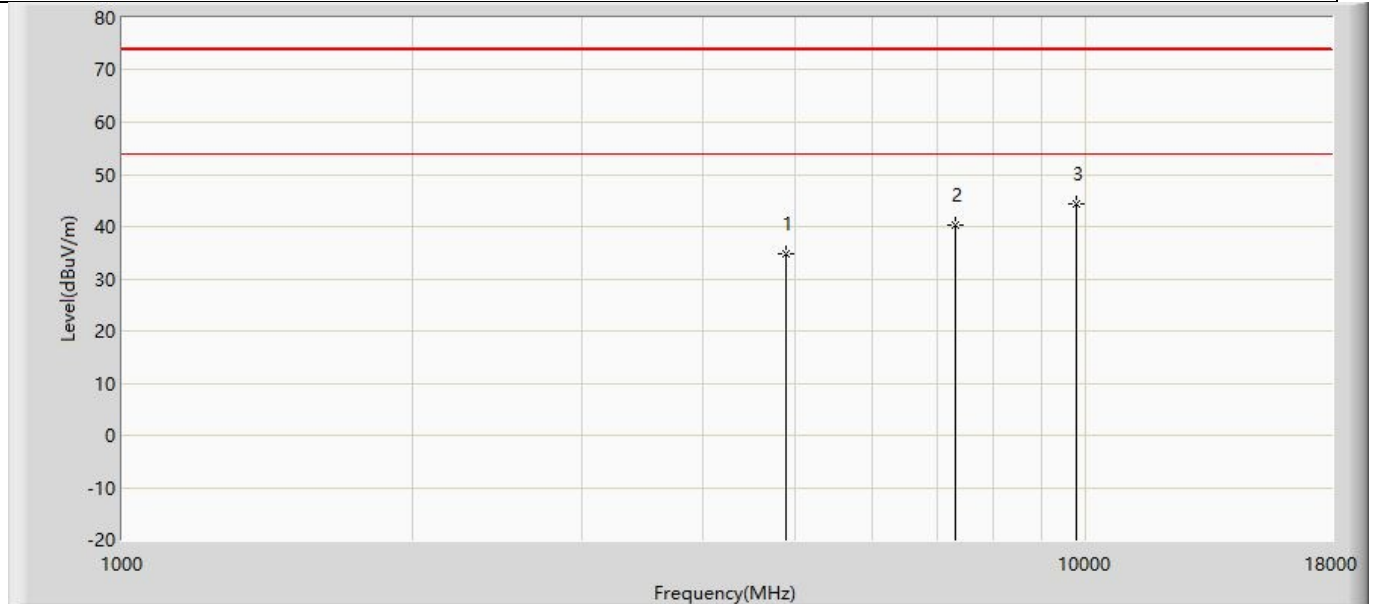

No	Mark	Frequency (MHz)	Measure Level (dBuV/m)	Reading Level (dBuV)	Over Limit (dB)	Limit (dBuV/m)	Factor (dB)	Type
1		4880.000	34.692	49.080	-39.308	74.000	-14.388	PK
2		7320.000	40.165	48.485	-33.835	74.000	-8.320	PK
3	*	9760.000	44.319	48.993	-29.681	74.000	-4.673	PK

Profile: 2250810R	Page No.: 22
Engineer: Yu Liu	
Site:	Time: 2022/06/25 - 22:32
Limit: FCC_Part15.209_RE(3m)	Margin: 0
Probe: HORN_3117_00167055(1-18GHZ)	Polarity: Vertical
EUT: Computer BOX	Power: AC 120V/60Hz
Note: Mode 2:Transmit at 2440MHz by BLE_2M	

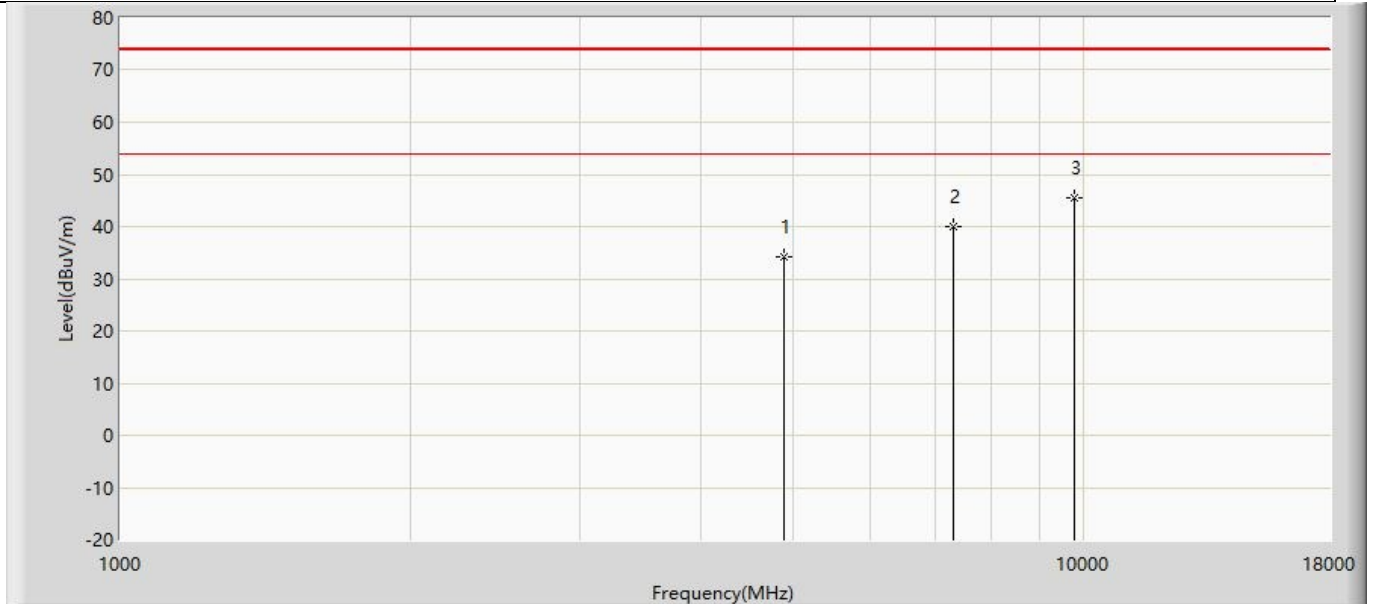

No	Mark	Frequency (MHz)	Measure Level (dBuV/m)	Reading Level (dBuV)	Over Limit (dB)	Limit (dBuV/m)	Factor (dB)	Type
1		4880.000	34.320	48.708	-39.680	74.000	-14.388	PK
2		7320.000	40.073	48.393	-33.927	74.000	-8.320	PK
3	*	9760.000	45.373	50.047	-28.627	74.000	-4.673	PK

Profile: 2250810R	Page No.: 23
Engineer: Yu Liu	
Site:	Time: 2022/06/25 - 22:32
Limit: FCC_Part15.209_RE(3m)	Margin: 0
Probe: HORN_3117_00167055(1-18GHZ)	Polarity: Horizontal
EUT: Computer BOX	Power: AC 120V/60Hz
Note: Mode 2:Transmit at 2480MHz by BLE_2M	

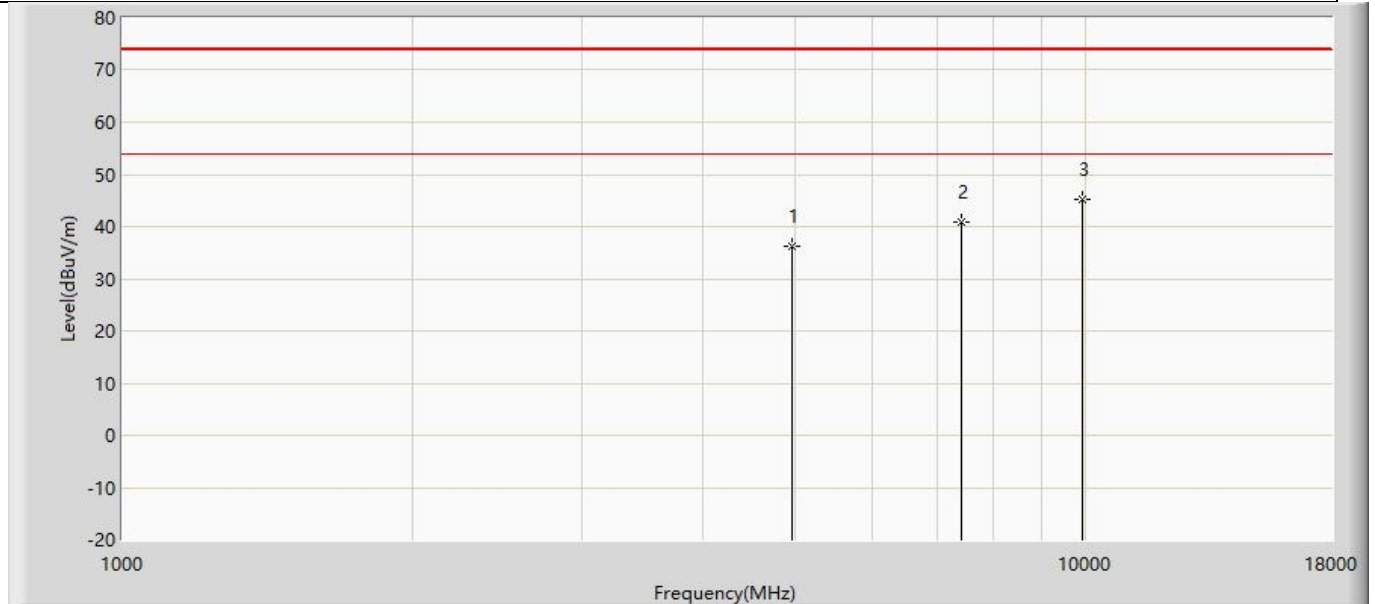

No	Mark	Frequency (MHz)	Measure Level (dBuV/m)	Reading Level (dBuV)	Over Limit (dB)	Limit (dBuV/m)	Factor (dB)	Type
1		4960.000	36.152	50.272	-37.848	74.000	-14.120	PK
2		7440.000	41.006	48.841	-32.994	74.000	-7.834	PK
3	*	9920.000	45.216	49.287	-28.784	74.000	-4.071	PK

Profile: 2250810R	Page No.: 24
Engineer: Yu Liu	
Site:	Time: 2022/06/25 - 22:32
Limit: FCC_Part15.209_RE(3m)	Margin: 0
Probe: HORN_3117_00167055(1-18GHZ)	Polarity: Vertical
EUT: Computer BOX	Power: AC 120V/60Hz
Note: Mode 2:Transmit at 2480MHz by BLE_2M	

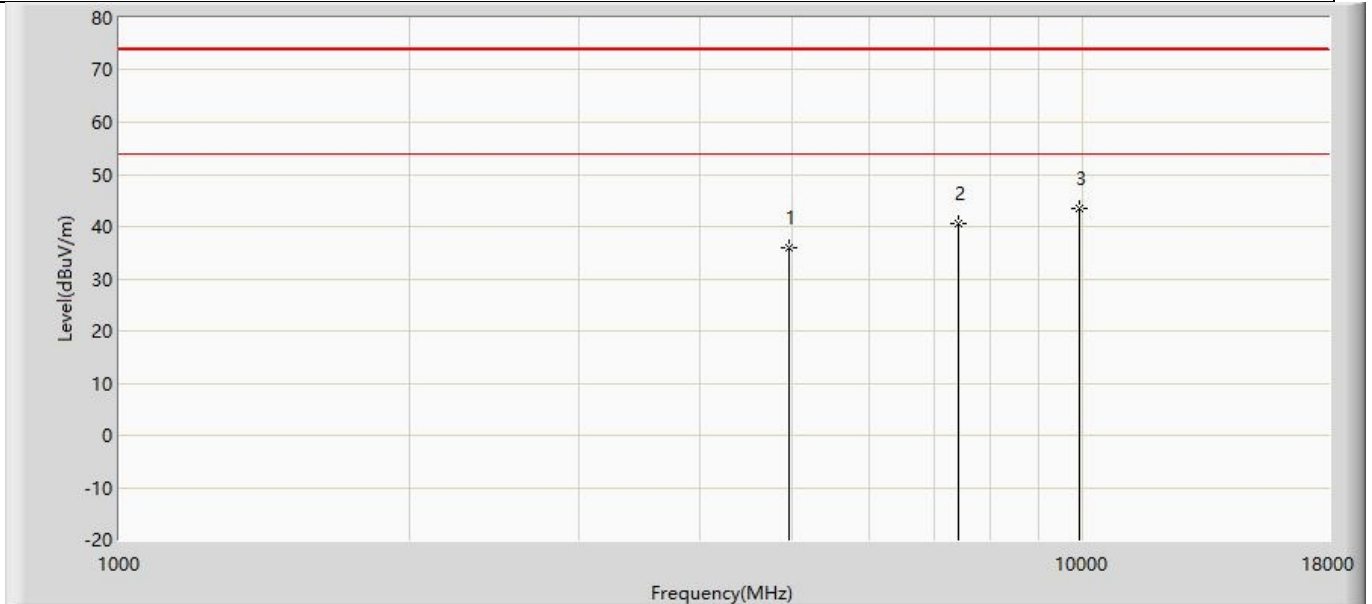

No	Mark	Frequency (MHz)	Measure Level (dBuV/m)	Reading Level (dBuV)	Over Limit (dB)	Limit (dBuV/m)	Factor (dB)	Type
1		4960.000	35.864	49.984	-38.136	74.000	-14.120	PK
2		7440.000	40.639	48.474	-33.361	74.000	-7.834	PK
3	*	9920.000	43.622	47.693	-30.378	74.000	-4.071	PK

Note:

1. Measured Level = Reading Level + Factor.
2. The test frequency range, 9kHz~30MHz, 18GHz~26GHz, both of the worst case are at least 20dB below the limits, therefore no data appear in the report.
3. This limit applies for using average detector, if the test result on peak is lower than average limit, then average measurement needn't be performed.
4. As the radiated emission was performed, so conducted emission was not tested.

The worst case of Radiated Emission below 1GHz:

Profile: 2250810R	Page No.: 9
Engineer: Yu Liu	
Site: AC3	Time: 2022/06/27 - 22:22
Limit: FCC_Part15.209_RE(3m)	Margin: 0
Probe: AC3_3m (30-1000MHz)	Polarity: Horizontal
EUT: Computer BOX	Power: AC 120V/60Hz
Note: Mode 1	

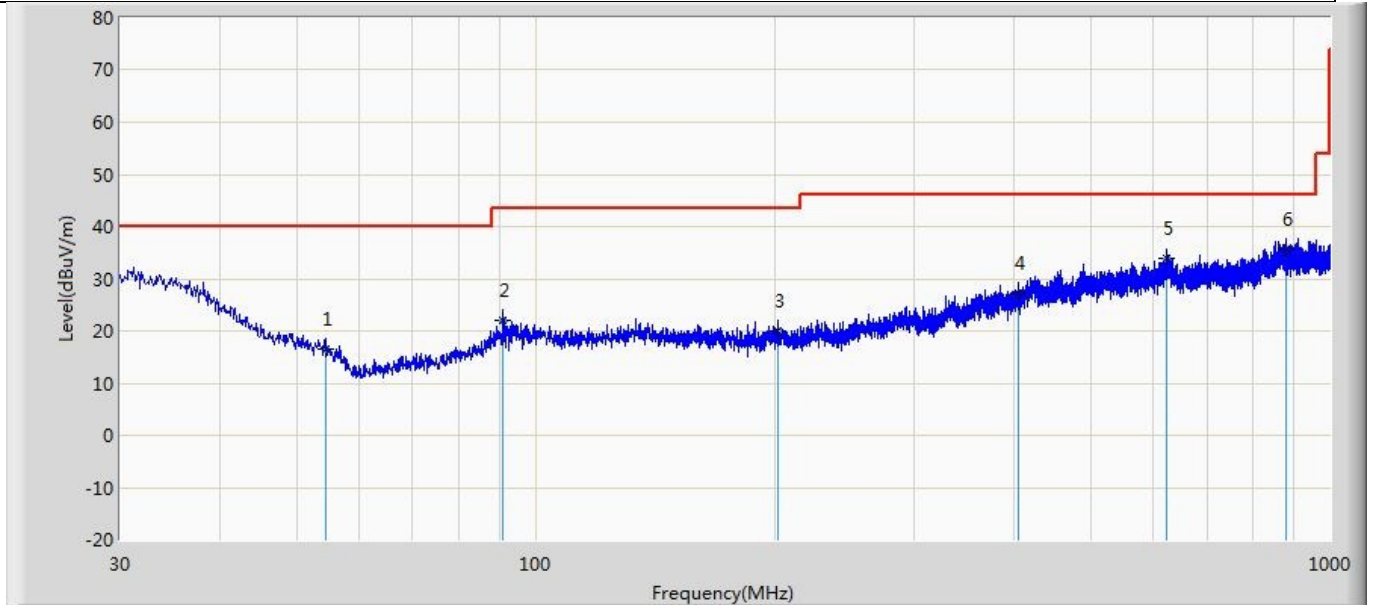

No	Mark	Frequency (MHz)	Measure Level (dBuV/m)	Reading Level (dBuV)	Over Limit (dB)	Limit (dBuV/m)	Factor (dB)	Type
1		54.371	16.442	2.635	-23.558	40.000	13.807	QP
2		90.989	22.144	8.374	-21.356	43.500	13.770	QP
3		202.175	19.910	2.213	-23.590	43.500	17.696	QP
4		404.663	27.252	1.952	-18.748	46.000	25.301	QP
5		624.125	33.780	3.099	-12.220	46.000	30.681	QP
6	*	880.084	35.555	3.025	-10.445	46.000	32.529	QP

Note:

1. All Readings below 1GHz are Quasi-Peak, above are performed with peak and/or average measurements as necessary.
2. " * ", means this data is the worst emission level.
3. Measurement Level = Reading Level + Factor(Probe+Cable-Amp)

Profile: 2250810R	Page No.: 14
Engineer: Yu Liu	
Site: AC3	Time: 2022/06/27 - 22:26
Limit: FCC_Part15.209_RE(3m)	Margin: 0
Probe: AC3_3m (30-1000MHz)	Polarity: Vertical
EUT: Computer BOX	Power: AC 120V/60Hz
Note: Mode 1	

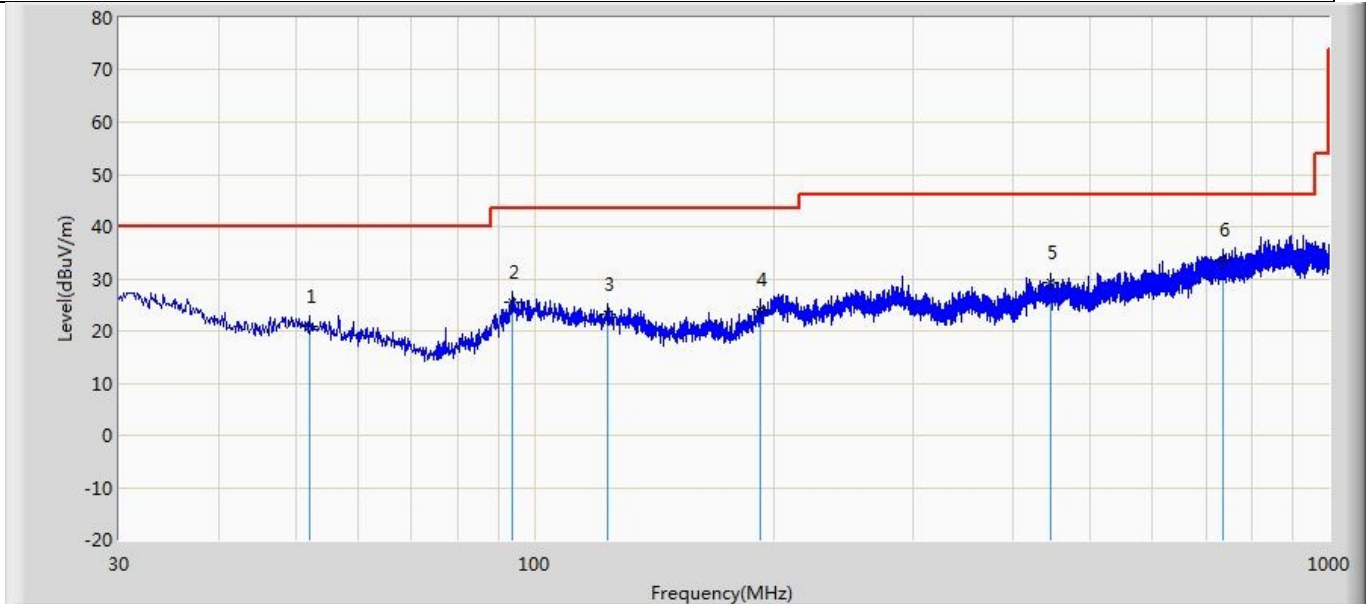

No	Mark	Frequency (MHz)	Measure Level (dBuV/m)	Reading Level (dBuV)	Over Limit (dB)	Limit (dBuV/m)	Factor (dB)	Type
1		52.068	20.958	2.249	-19.042	40.000	18.709	QP
2		93.899	25.627	6.369	-17.873	43.500	19.258	QP
3		123.363	23.282	2.788	-20.218	43.500	20.494	QP
4		192.475	24.194	2.592	-19.306	43.500	21.602	QP
5		446.615	29.156	3.151	-16.844	46.000	26.005	QP
6	*	735.917	33.682	2.963	-12.318	46.000	30.719	QP

Note:

1. All Readings below 1GHz are Quasi-Peak, above are performed with peak and/or average measurements as necessary.
2. " * ", means this data is the worst emission level.
3. Measurement Level = Reading Level + Factor(Probe+Cable-Amp)

The worst case of Simultaneous Radiated Emission:

Profile: 2250810R	Page No.: 244
Engineer: Yu Liu	
Site: AC5	Time: 2021/05/10 - 11:54
Limit: FCC_Part15.209_RE(3m)	Margin: 0
Probe: Horn_3117_00167055(1-18GHz)	Polarity: Vertical
EUT: Computer BOX	Power: AC 120V/60Hz
Note: Simultaneous transmission with BT + 5G WIFI	

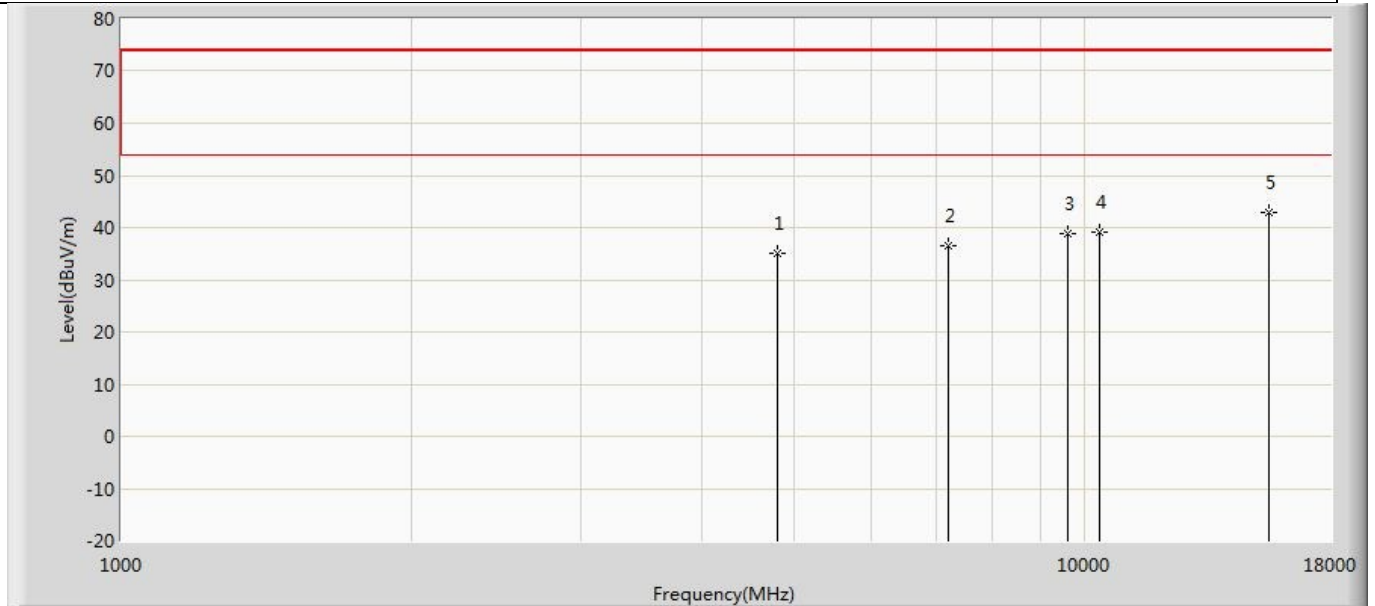

No	Mark	Frequency (MHz)	Measure Level (dBuV/m)	Reading Level (dBuV)	Over Limit (dB)	Limit (dBuV/m)	Factor (dB)	Type
1		4804.000	34.945	47.376	-39.055	74.000	-12.431	PK
2		7206.000	36.475	44.272	-37.525	74.000	-7.796	PK
3		9608.000	38.894	45.153	-35.106	74.000	-6.258	PK
4		10360.000	39.214	43.774	-34.786	74.000	-4.560	PK
5	*	15540.000	43.039	43.692	-30.961	74.000	-0.654	PK

Profile: 2250810R	Page No.: 245
Engineer: Yu Liu	
Site: AC5	Time: 2021/05/10 - 11:54
Limit: FCC_Part15.209_RE(3m)	Margin: 0
Probe: Horn_3117_00167055(1-18GHz)	Polarity: Horizontal
EUT: Computer BOX	Power: AC 120V/60Hz
Note: Simultaneous transmission with BT + 5G WIFI	

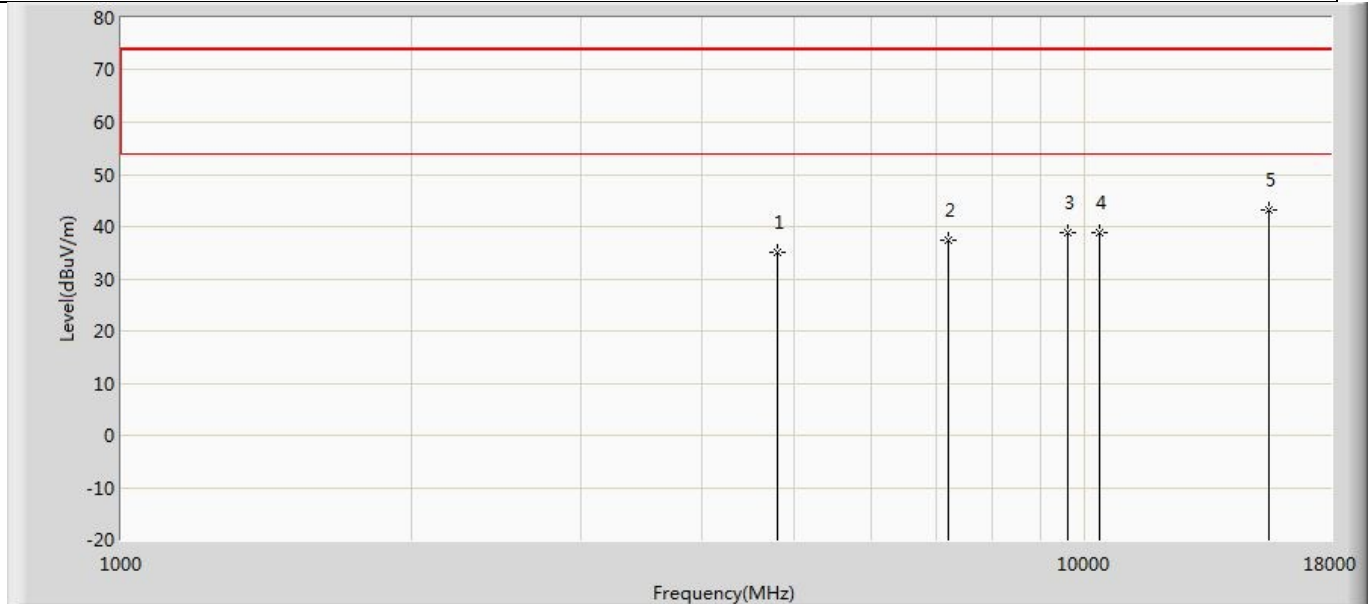

No	Mark	Frequency (MHz)	Measure Level (dBuV/m)	Reading Level (dBuV)	Over Limit (dB)	Limit (dBuV/m)	Factor (dB)	Type
1		4804.000	35.147	47.578	-38.853	74.000	-12.431	PK
2		7206.000	37.357	45.154	-36.643	74.000	-7.796	PK
3		9608.000	38.920	45.179	-35.080	74.000	-6.258	PK
4		10360.000	38.855	43.415	-35.145	74.000	-4.560	PK
5	*	15540.000	43.252	43.905	-30.748	74.000	-0.654	PK

4.3 Emissions in non-restricted frequency band	VERDICT: PASS
---	----------------------

4.3.1 Limit	
Standard	FCC Part 15 Subpart C Paragraph 15.247(d)
RF Output power (Detection methods)	Limit(dB)
RF Output power(Average detector)	30dBc(Note1)
RF Output power(PK detector)	20dBc(Note2)
<p>Note 1: If maximum conducted (average) output power was used to demonstrate compliance as described in 9.2, then the peak power in any 100 kHz bandwidth outside of the authorized frequency band shall be attenuated by at least 30 dB relative to the maximum in-band peak PSD level in 100 kHz (i.e., 30 dBc).</p> <p>Note 2: If the maximum peak conducted output power procedure was used, then the peak output power measured in any 100 kHz bandwidth outside of the authorized frequency band shall be attenuated by at least 20 dB relative to the maximum in-band peak PSD level in 100 kHz (i.e., 20 dBc).</p>	

4.3.2 Test Setup

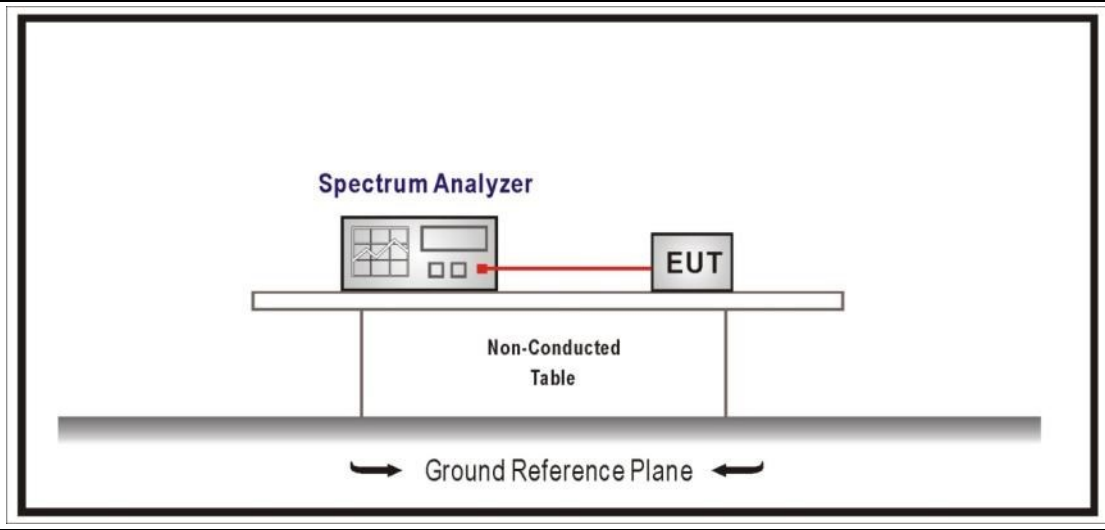

4.3.3 Test Procedure

References Rule	Chapter	Description
<input checked="" type="checkbox"/> ANSI C63.10	11.11	Emissions in non-restricted frequency bands
<input checked="" type="checkbox"/> ANSI C63.10	11.11.1	General
<input checked="" type="checkbox"/> ANSI C63.10	11.11.2	Reference level measurement
<input checked="" type="checkbox"/> ANSI C63.10	11.11.3	Emission level measurement

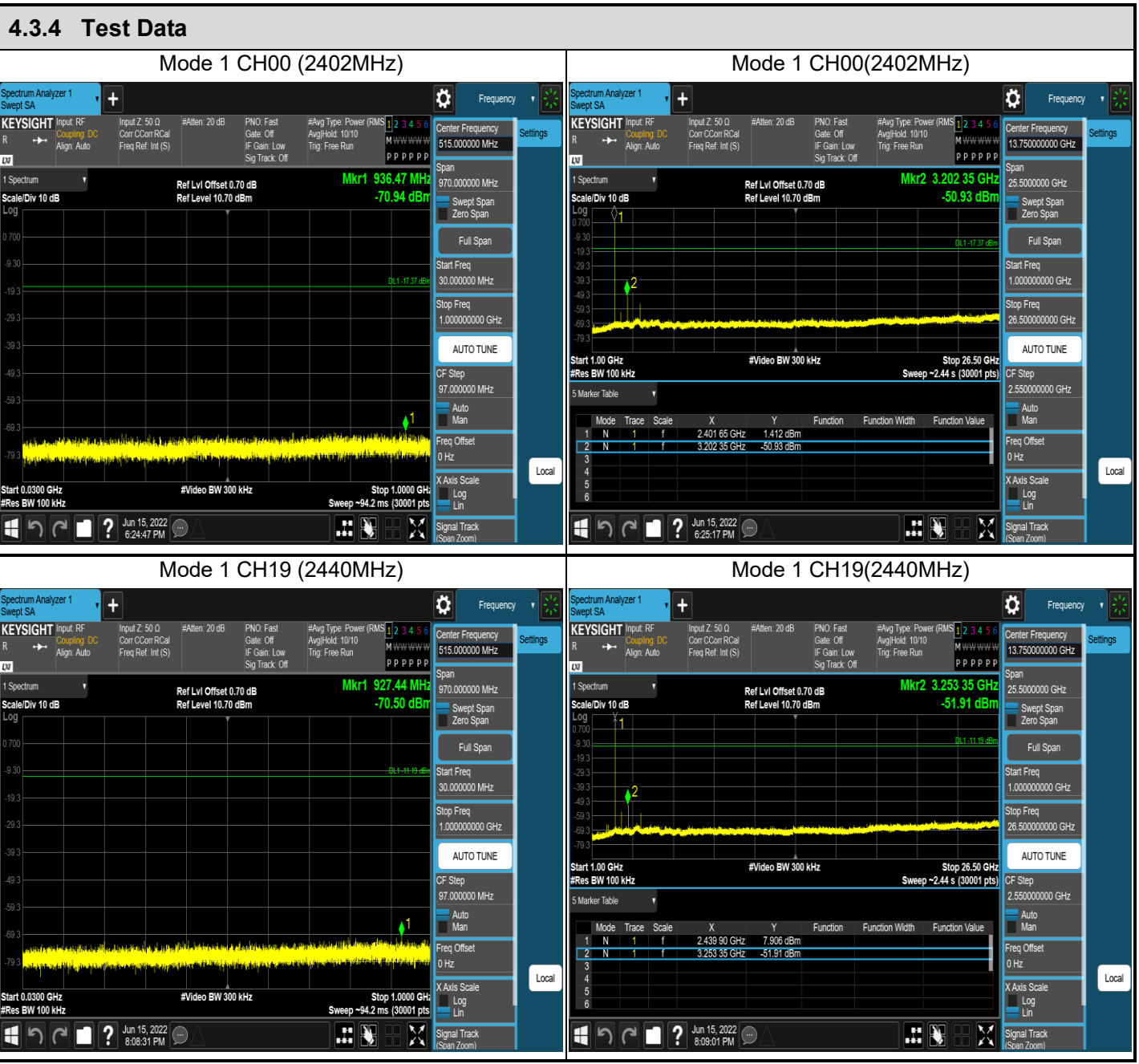







4.4 Duty cycle

VERDICT: PASS

4.4.1 Limit

N/A

4.4.2 Test Setup

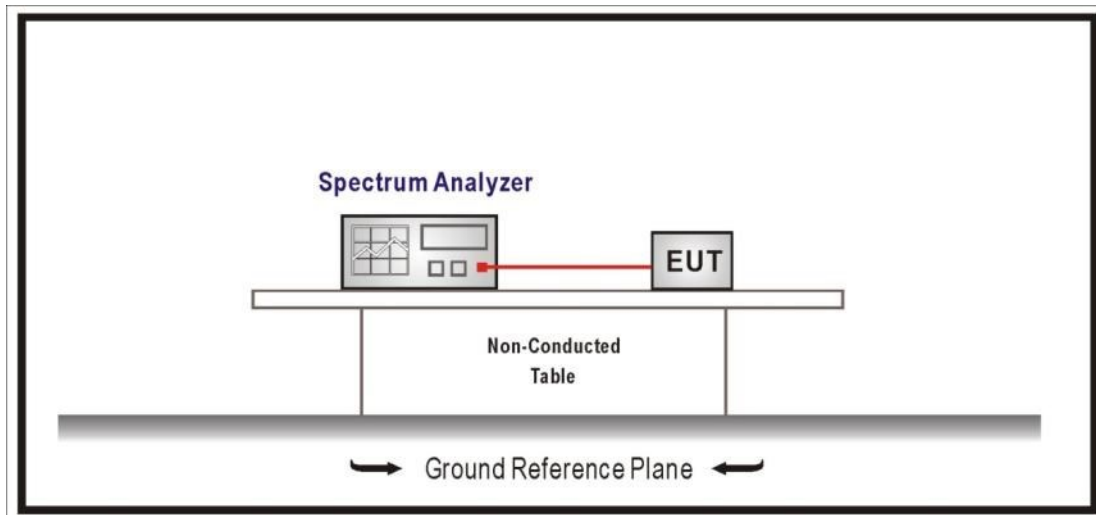

4.4.3 Test Procedure

References Rule	Chapter	Description
<input checked="" type="checkbox"/> ANSI C63.10	11.6	Duty cycle (D), transmission duration (T), and maximum power control level

4.4.4 Test Data

Test Mode	Tx On (us)	Tx Off (us)	VBW (kHz)	Tx On + Tx Off (us)	Duty Cycle (%)
Mode 1	380	250	2.7	630	60.32
Mode 2	200	430	4.7	630	31.75

Note 1: T means the minimum transmission duration over which the transmitter is on and is transmitting at its maximum power control level for the tested mode of operation.

Note 2: According to KDB 558074, when test for Radiated Emission Band Edge and Radiated Emission, for average detector set: $VBW \geq 1/T$ will be used.

Mode 1 CH19 2440MHz

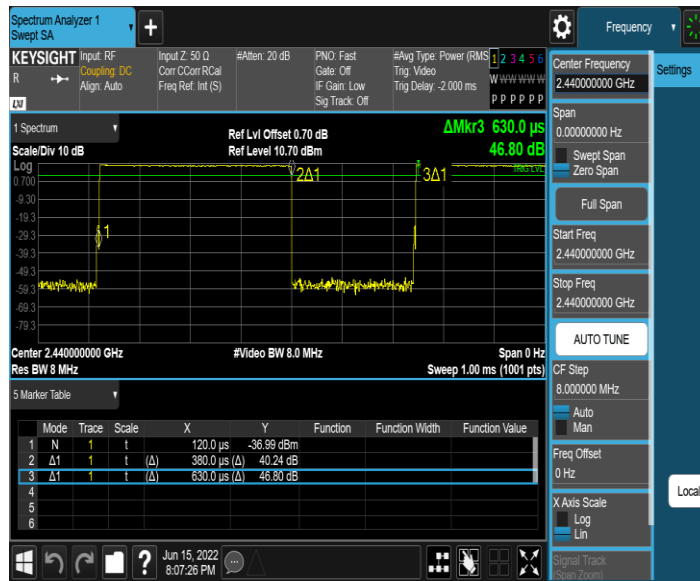

Mode 2 CH19 2440MHz

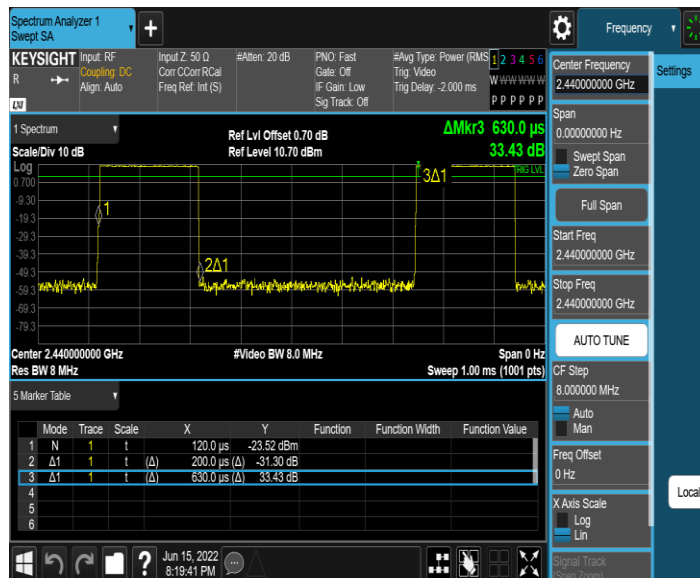

4.5 Band Edge	VERDICT: PASS
----------------------	----------------------

4.5.1 Limit

Standard		FCC Part 15 Subpart C Paragraph 15.247(d) , 15.209		
Frequency bands (MHz)	Detector	Limit (dB μ V/m)	RBW (MHz)	Distance (m)
2310-2390	PK	74	1	3
2483.5-2500	AV	54	1	3

Note: The field strength of emissions appearing within these frequency bands shall not exceed the limits.

4.5.2 Test Setup

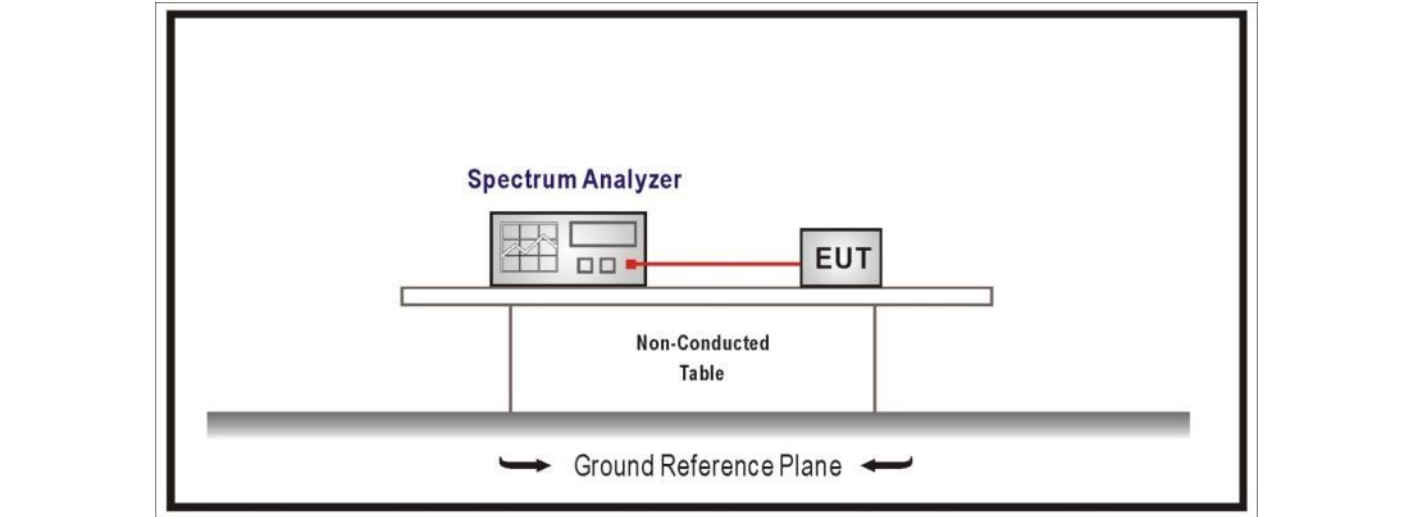

4.5.3 Test Procedure

	References Rule	Chapter	Description
<input checked="" type="checkbox"/>	ANSI C63.10	6.10	Band-edge testing
	<input checked="" type="checkbox"/> ANSI C63.10	6.10.5	Restricted-band band-edge measurements
	<input type="checkbox"/> ANSI C63.10	6.10.6	Marker-delta method
<input checked="" type="checkbox"/>	ANSI C63.10	11.12	Emissions in restricted frequency bands
	<input checked="" type="checkbox"/> ANSI C63.10	11.12.2	Antenna-port conducted measurements
	<input type="checkbox"/> ANSI C63.10	11.12.2.3	Quasi-peak measurement procedure
	<input checked="" type="checkbox"/> ANSI C63.10	11.12.2.4	Peak power measurement procedure
	<input checked="" type="checkbox"/> ANSI C63.10	11.12.2.5	Average power measurement procedures

4.5.4 Test Data

Profile: 2250810R	Page No.: 1
Engineer: Yu Liu	
Site: AC5	Time: 2022/06/12 - 00:39
Limit: FCC_Part15.209_RE(3m)	Margin: 0
Probe: FCC_ANT-1-18G	Polarity: Horizontal
EUT: Computer BOX	Power: AC 120V/60Hz
Note: Mode 1:Transmit at 2402MHz by BLE_1M	

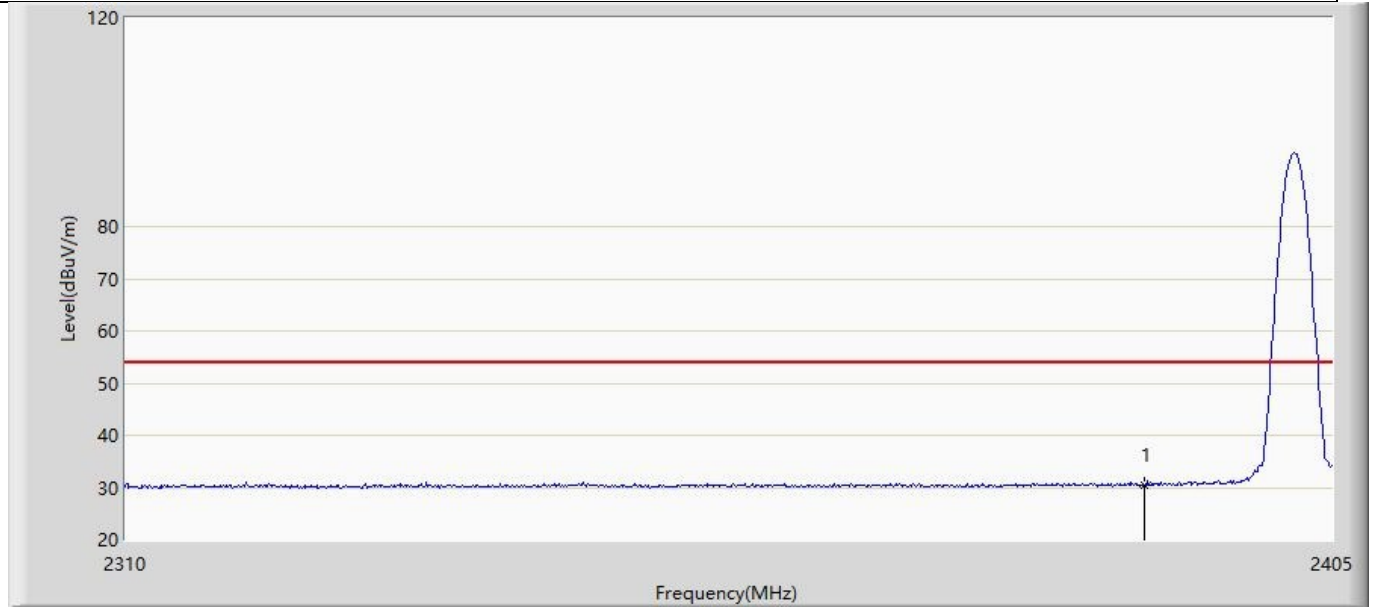

No	Mark	Frequency (MHz)	Measure Level (dBuV/m)	Reading Level (dBuV)	Over Limit (dB)	Limit (dBuV/m)	Factor (dB)	Type
1	*	2390.000	30.548	-0.594	-23.452	54.000	31.141	AV

Profile: 2250810R	Page No.: 2
Engineer: Yu Liu	
Site: AC5	Time: 2022/06/12 - 19:38
Limit: FCC_Part15.209_RE(3m)	Margin: 0
Probe: FCC_ANT-1-18G	Polarity: Horizontal
EUT: Computer BOX	Power: AC 120V/60Hz
Note: Mode 1:Transmit at 2402MHz by BLE_1M	

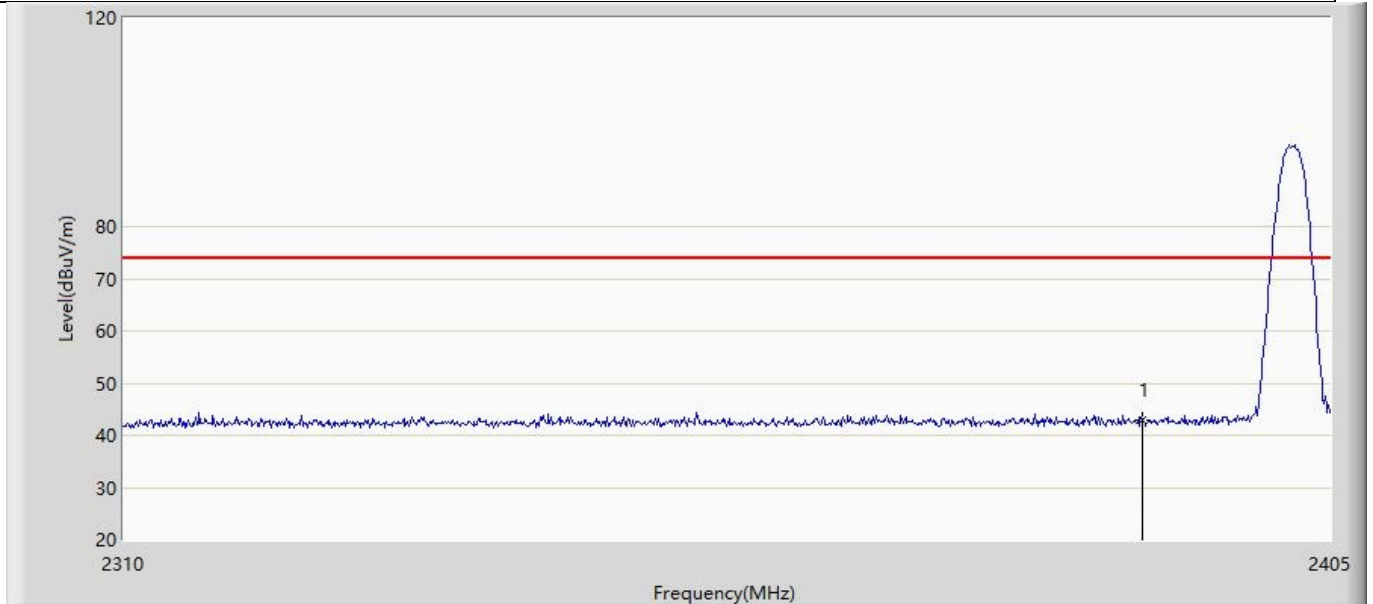

No	Mark	Frequency (MHz)	Measure Level (dBuV/m)	Reading Level (dBuV)	Over Limit (dB)	Limit (dBuV/m)	Factor (dB)	Type
1	*	2390.000	43.008	11.866	-30.992	74.000	31.141	PK

Profile: 2250810R	Page No.: 3
Engineer: Yu Liu	
Site: AC5	Time: 2022/06/12 - 19:39
Limit: FCC_Part15.209_RE(3m)	Margin: 0
Probe: FCC_ANT-1-18G	Polarity: Vertical
EUT: Computer BOX	Power: AC 120V/60Hz
Note: Mode 1:Transmit at 2402MHz by BLE_1M	

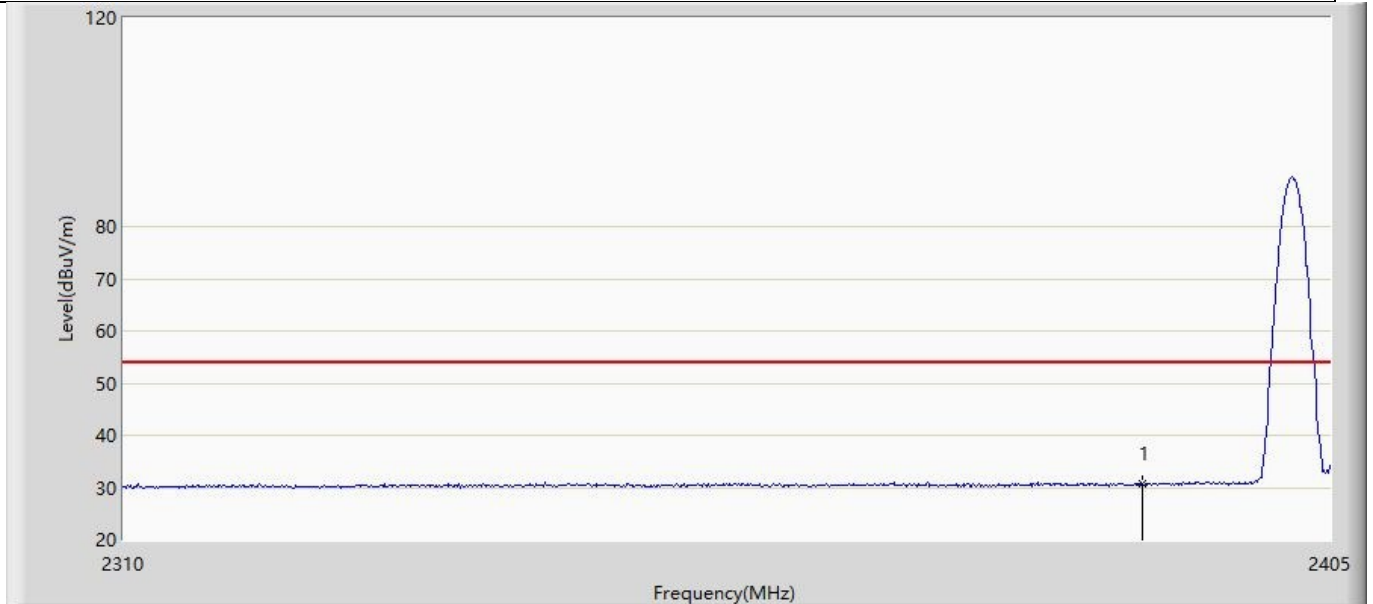

No	Mark	Frequency (MHz)	Measure Level (dBuV/m)	Reading Level (dBuV)	Over Limit (dB)	Limit (dBuV/m)	Factor (dB)	Type
1	*	2390.000	30.776	-0.366	-23.224	54.000	31.141	AV

Profile: 2250810R	Page No.: 4
Engineer: Yu Liu	
Site: AC5	Time: 2022/06/12 - 19:43
Limit: FCC_Part15.209_RE(3m)	Margin: 0
Probe: FCC_ANT-1-18G	Polarity: Vertical
EUT: Computer BOX	Power: AC 120V/60Hz
Note: Mode 1:Transmit at 2402MHz by BLE_1M	

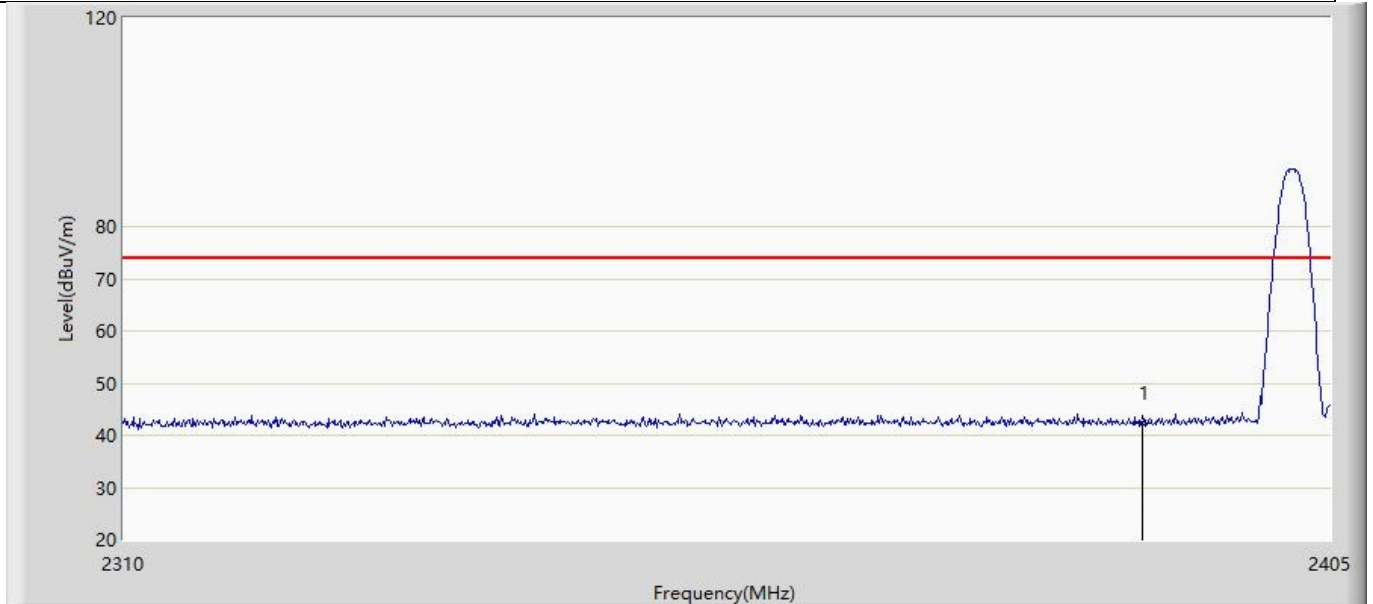

No	Mark	Frequency (MHz)	Measure Level (dBuV/m)	Reading Level (dBuV)	Over Limit (dB)	Limit (dBuV/m)	Factor (dB)	Type
1	*	2390.000	42.247	11.105	-31.753	74.000	31.141	PK

Profile: 2250810R	Page No.: 5
Engineer: Yu Liu	
Site: AC5	Time: 2022/06/12 - 19:45
Limit: FCC_Part15.209_RE(3m)	Margin: 0
Probe: FCC_ANT-1-18G	Polarity: Horizontal
EUT: Computer BOX	Power: AC 120V/60Hz
Note: Mode 1:Transmit at 2480MHz by BLE_1M	

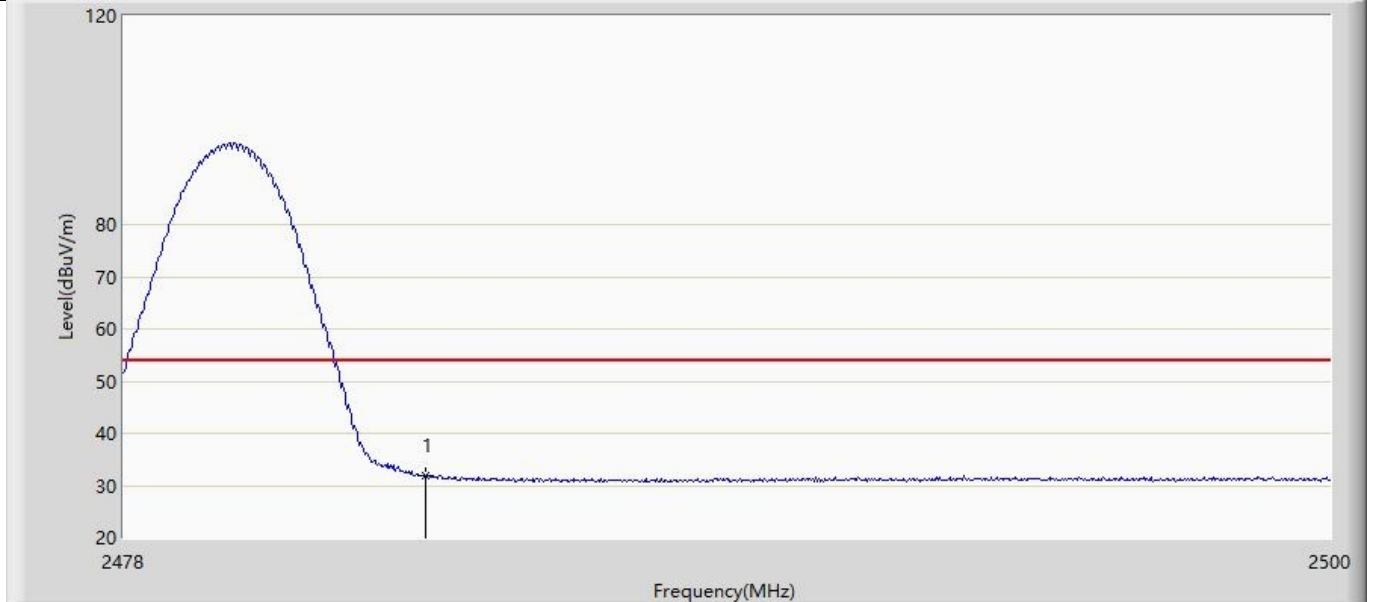

No	Mark	Frequency (MHz)	Measure Level (dBuV/m)	Reading Level (dBuV)	Over Limit (dB)	Limit (dBuV/m)	Factor (dB)	Type
1	*	2483.500	31.918	0.492	-22.082	54.000	31.426	AV

Profile: 2250810R	Page No.: 6
Engineer: Yu Liu	
Site: AC5	Time: 2022/06/12 - 19:48
Limit: FCC_Part15.209_RE(3m)	Margin: 0
Probe: FCC_ANT-1-18G	Polarity: Horizontal
EUT: Computer BOX	Power: AC 120V/60Hz
Note: Mode 1:Transmit at 2480MHz by BLE_1M	

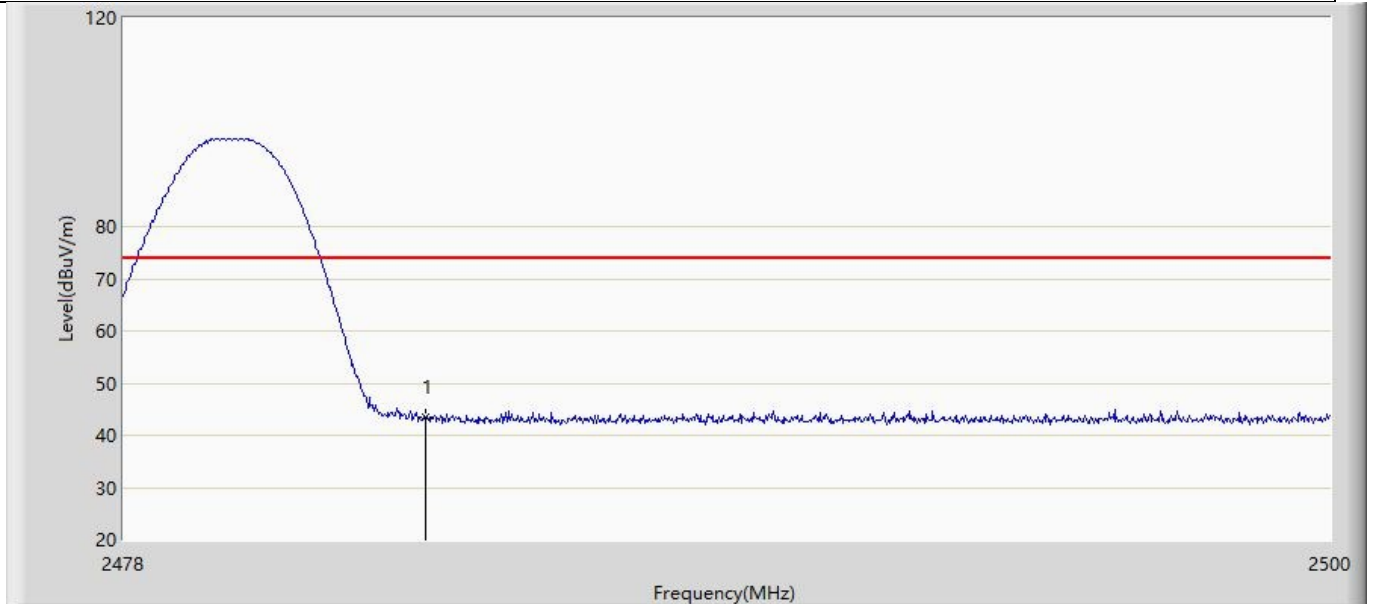

No	Mark	Frequency (MHz)	Measure Level (dBuV/m)	Reading Level (dBuV)	Over Limit (dB)	Limit (dBuV/m)	Factor (dB)	Type
1	*	2483.500	43.388	11.962	-30.612	74.000	31.426	PK

Profile: 2250810R	Page No.: 7
Engineer: Yu Liu	
Site: AC5	Time: 2022/06/12 - 19:49
Limit: FCC_Part15.209_RE(3m)	Margin: 0
Probe: FCC_ANT-1-18G	Polarity: Vertical
EUT: Computer BOX	Power: AC 120V/60Hz
Note: Mode 1:Transmit at 2480MHz by BLE_1M	

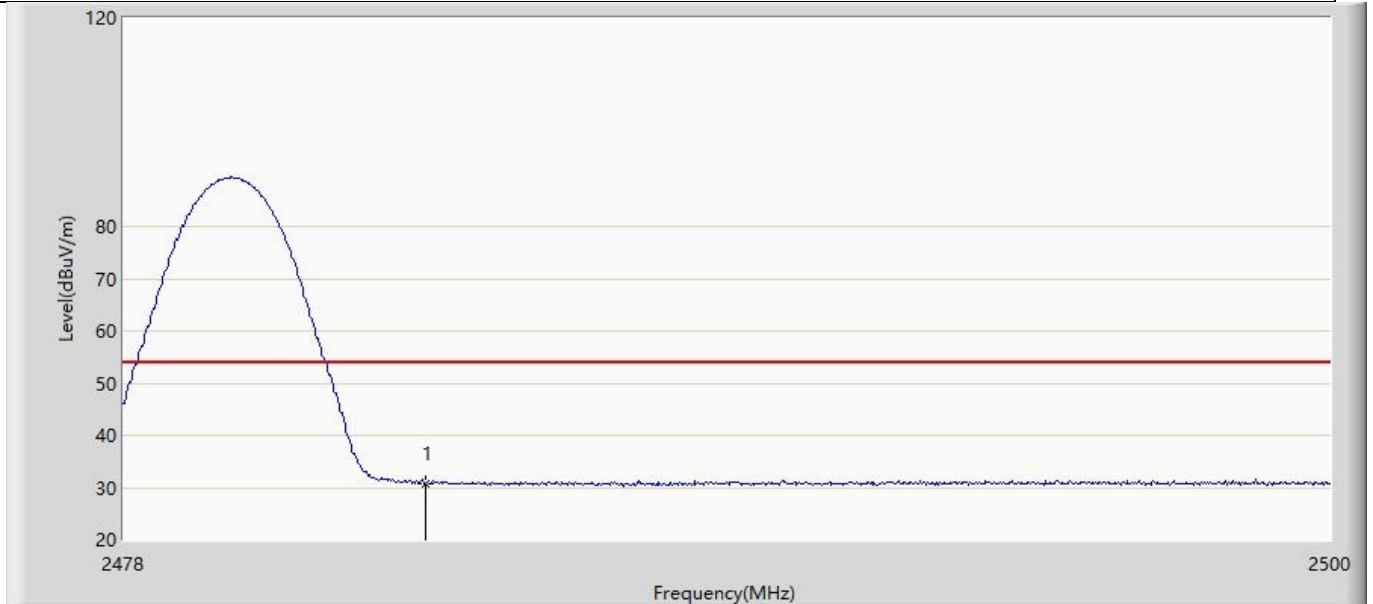

No	Mark	Frequency (MHz)	Measure Level (dBuV/m)	Reading Level (dBuV)	Over Limit (dB)	Limit (dBuV/m)	Factor (dB)	Type
1	*	2483.500	30.866	-0.560	-23.134	54.000	31.426	AV

Profile: 2250810R	Page No.: 8
Engineer: Yu Liu	
Site: AC5	Time: 2022/06/12 - 19:52
Limit: FCC_Part15.209_RE(3m)	Margin: 0
Probe: FCC_ANT-1-18G	Polarity: Vertical
EUT: Computer BOX	Power: AC 120V/60Hz
Note: Mode 1:Transmit at 2480MHz by BLE_1M	

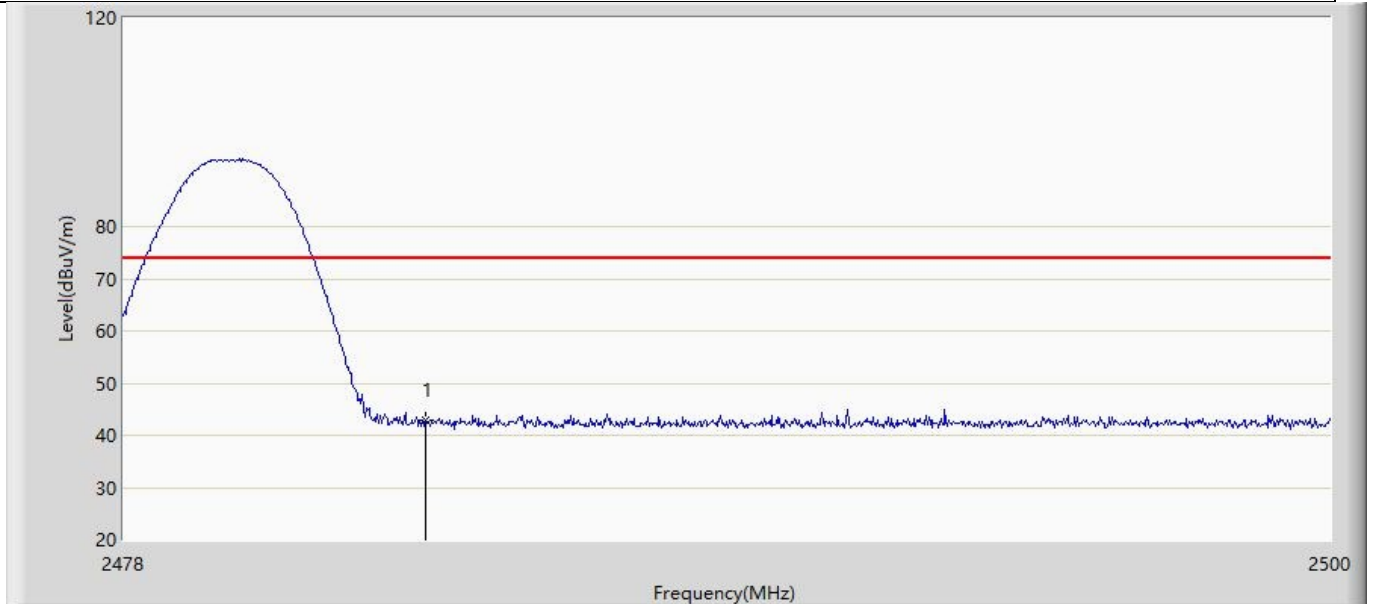

No	Mark	Frequency (MHz)	Measure Level (dBuV/m)	Reading Level (dBuV)	Over Limit (dB)	Limit (dBuV/m)	Factor (dB)	Type
1	*	2483.500	42.930	11.504	-31.070	74.000	31.426	PK

Profile: 2250810R	Page No.: 9
Engineer: Yu Liu	
Site: AC5	Time: 2022/06/12 - 19:54
Limit: FCC_Part15.209_RE(3m)	Margin: 0
Probe: FCC_ANT-1-18G	Polarity: Horizontal
EUT: Computer BOX	Power: AC 120V/60Hz
Note: Mode 2:Transmit at 2402MHz by BLE_2M	

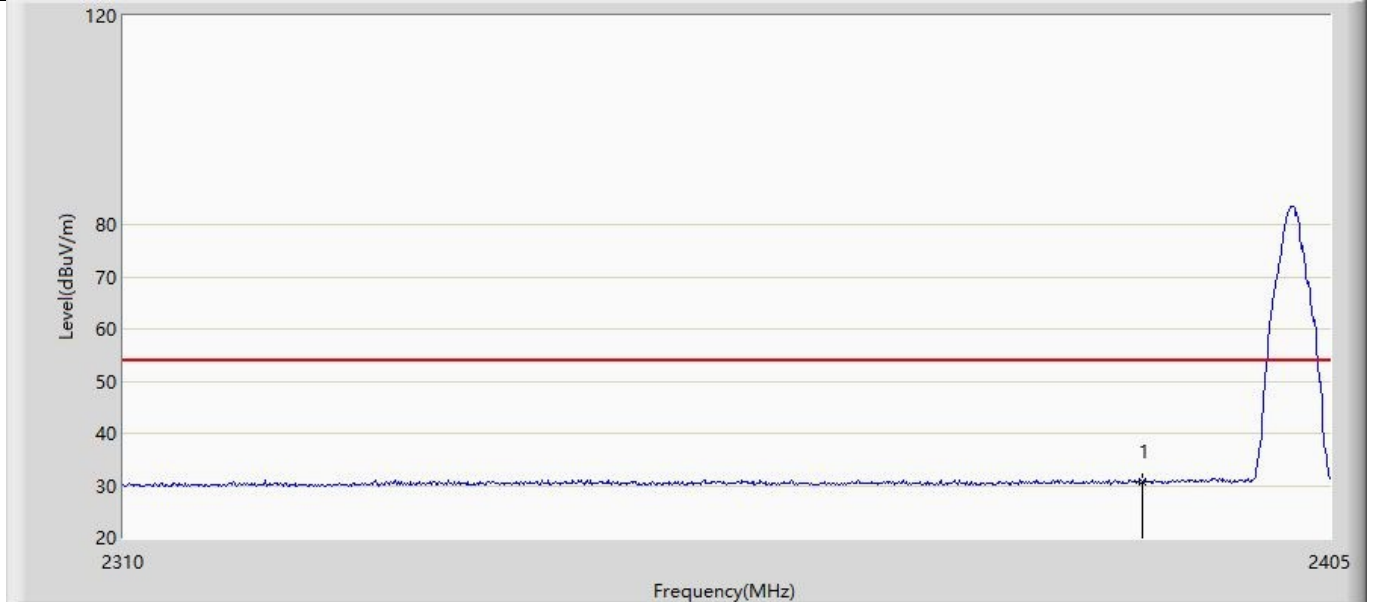

No	Mark	Frequency (MHz)	Measure Level (dBuV/m)	Reading Level (dBuV)	Over Limit (dB)	Limit (dBuV/m)	Factor (dB)	Type
1	*	2390.000	30.764	-0.378	-23.236	54.000	31.141	AV

Profile: 2250810R	Page No.: 10
Engineer: Yu Liu	
Site: AC5	Time: 2022/06/12 - 19:57
Limit: FCC_Part15.209_RE(3m)	Margin: 0
Probe: FCC_ANT-1-18G	Polarity: Horizontal
EUT: Computer BOX	Power: AC 120V/60Hz
Note: Mode 2:Transmit at 2402MHz by BLE_2M	

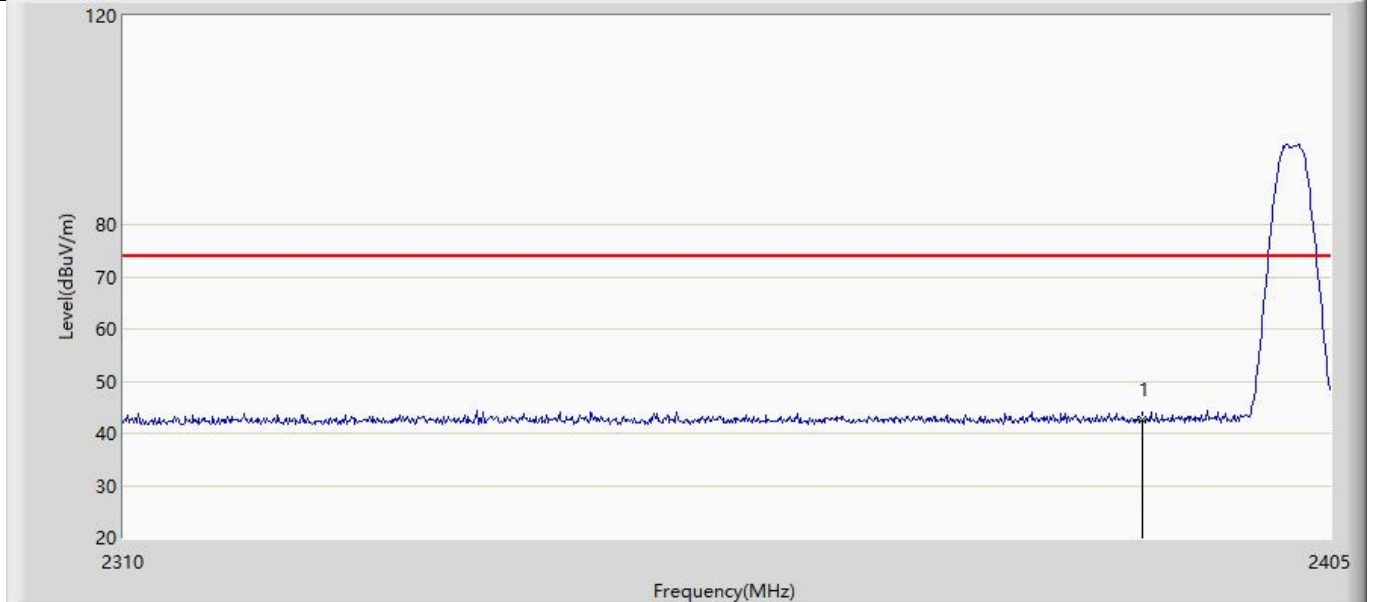

No	Mark	Frequency (MHz)	Measure Level (dBuV/m)	Reading Level (dBuV)	Over Limit (dB)	Limit (dBuV/m)	Factor (dB)	Type
1	*	2390.000	42.650	11.508	-31.350	74.000	31.141	PK

Profile: 2250810R	Page No.: 11
Engineer: Yu Liu	
Site: AC5	Time: 2022/06/12 - 22:11
Limit: FCC_Part15.209_RE(3m)	Margin: 0
Probe: FCC_ANT-1-18G	Polarity: Vertical
EUT: Computer BOX	Power: AC 120V/60Hz
Note: Mode 2:Transmit at 2402MHz by BLE_2M	

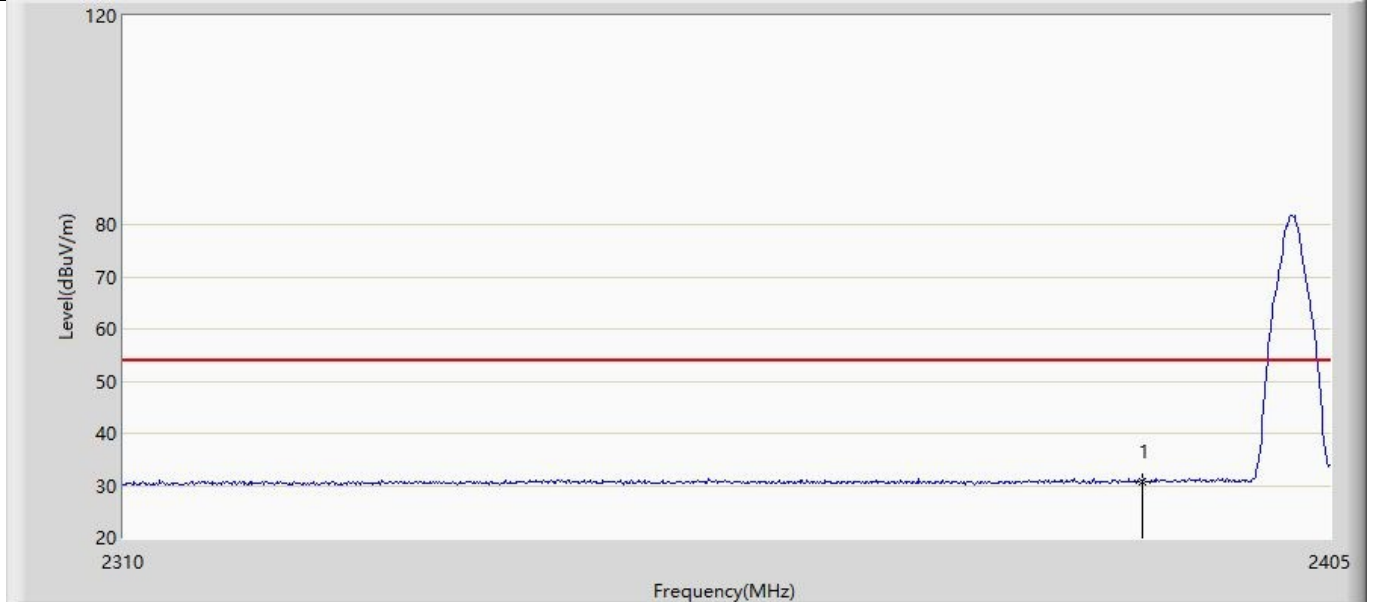

No	Mark	Frequency (MHz)	Measure Level (dBuV/m)	Reading Level (dBuV)	Over Limit (dB)	Limit (dBuV/m)	Factor (dB)	Type
1	*	2390.000	30.855	-0.287	-23.145	54.000	31.141	AV

Profile: 2250810R	Page No.: 12
Engineer: Yu Liu	
Site: AC5	Time: 2022/06/12 - 22:12
Limit: FCC_Part15.209_RE(3m)	Margin: 0
Probe: FCC_ANT-1-18G	Polarity: Vertical
EUT: Computer BOX	Power: AC 120V/60Hz
Note: Mode 2:Transmit at 2402MHz by BLE_2M	

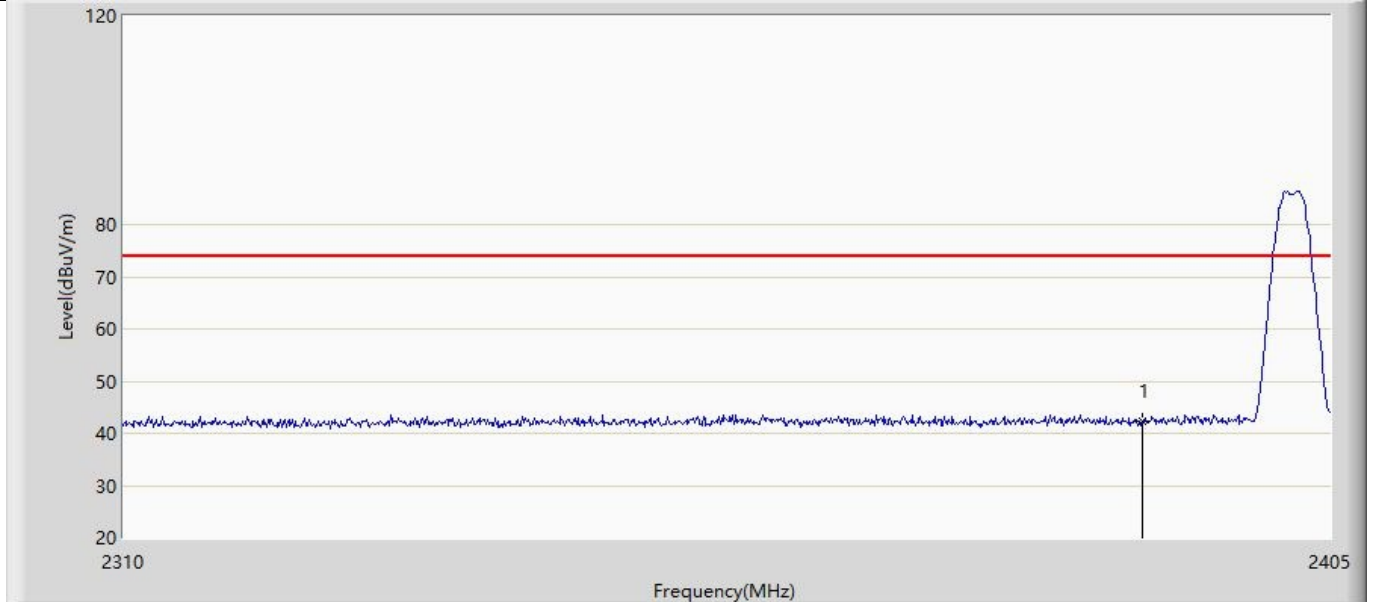

No	Mark	Frequency (MHz)	Measure Level (dBuV/m)	Reading Level (dBuV)	Over Limit (dB)	Limit (dBuV/m)	Factor (dB)	Type
1	*	2390.000	42.204	11.062	-31.796	74.000	31.141	PK

Profile: 2250810R	Page No.: 13
Engineer: Yu Liu	
Site: AC5	Time: 2022/06/12 - 22:14
Limit: FCC_Part15.209_RE(3m)	Margin: 0
Probe: FCC_ANT-1-18G	Polarity: Horizontal
EUT: Computer BOX	Power: AC 120V/60Hz
Note: Mode 2:Transmit at 2480MHz by BLE_2M	

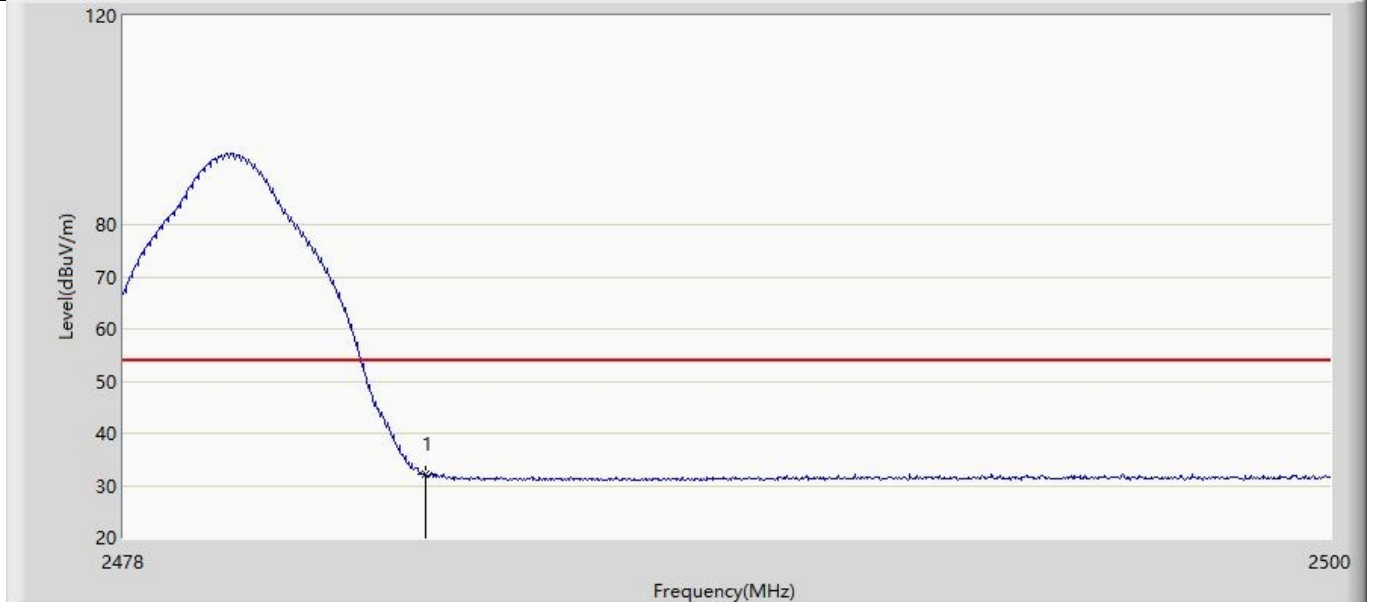

No	Mark	Frequency (MHz)	Measure Level (dBuV/m)	Reading Level (dBuV)	Over Limit (dB)	Limit (dBuV/m)	Factor (dB)	Type
1	*	2483.500	32.077	0.651	-21.923	54.000	31.426	AV

Profile: 2250810R	Page No.: 14
Engineer: Yu Liu	
Site: AC5	Time: 2022/06/12 - 22:16
Limit: FCC_Part15.209_RE(3m)	Margin: 0
Probe: FCC_ANT-1-18G	Polarity: Horizontal
EUT: Computer BOX	Power: AC 120V/60Hz
Note: Mode 2:Transmit at 2480MHz by BLE_2M	

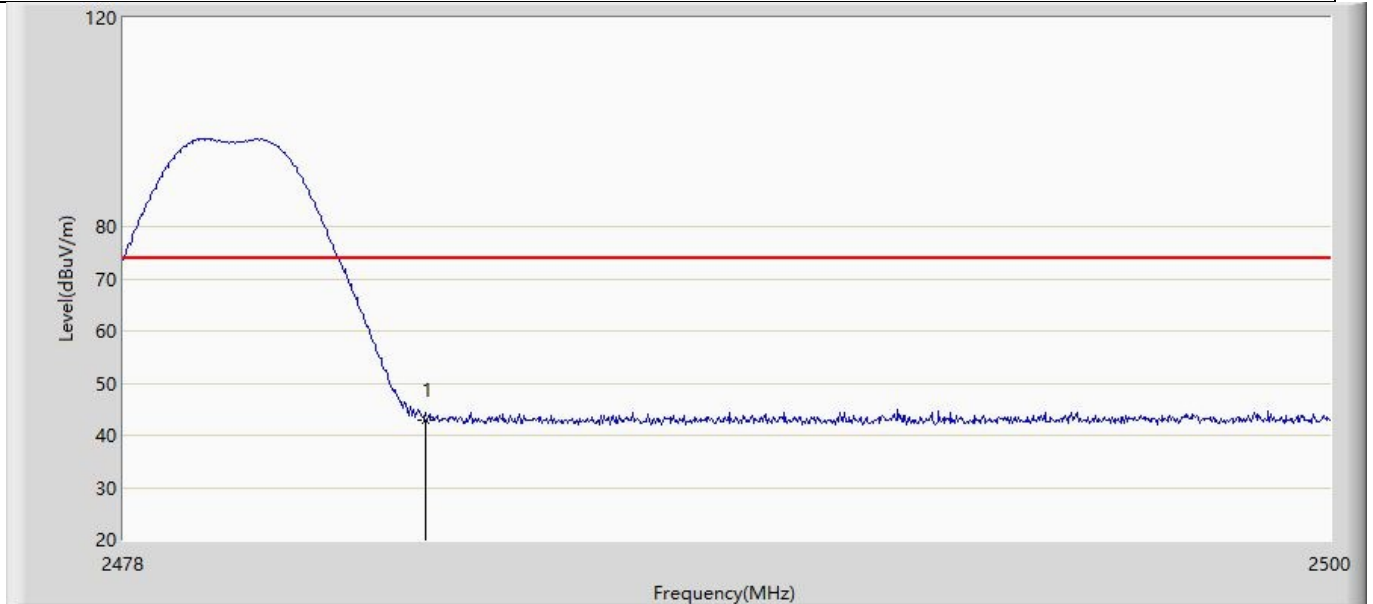

No	Mark	Frequency (MHz)	Measure Level (dBuV/m)	Reading Level (dBuV)	Over Limit (dB)	Limit (dBuV/m)	Factor (dB)	Type
1	*	2483.500	42.943	11.517	-31.057	74.000	31.426	PK

Profile: 2250810R	Page No.: 15
Engineer: Yu Liu	
Site: AC5	Time: 2022/06/12 - 22:17
Limit: FCC_Part15.209_RE(3m)	Margin: 0
Probe: FCC_ANT-1-18G	Polarity: Vertical
EUT: Computer BOX	Power: AC 120V/60Hz
Note: Mode 2:Transmit at 2480MHz by BLE_2M	

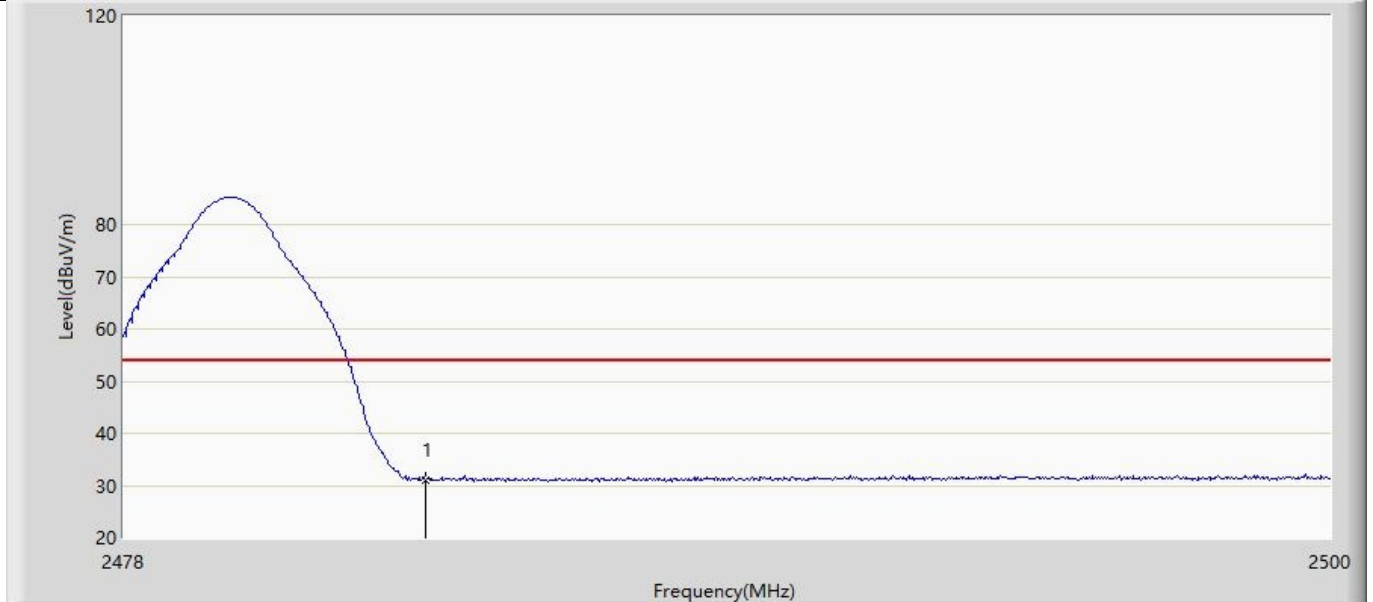

No	Mark	Frequency (MHz)	Measure Level (dBuV/m)	Reading Level (dBuV)	Over Limit (dB)	Limit (dBuV/m)	Factor (dB)	Type
1	*	2483.500	31.121	-0.305	-22.879	54.000	31.426	AV

Profile: 2250810R	Page No.: 16
Engineer: Yu Liu	
Site: AC5	Time: 2022/06/12 - 22:18
Limit: FCC_Part15.209_RE(3m)	Margin: 0
Probe: FCC_ANT-1-18G	Polarity: Vertical
EUT: Computer BOX	Power: AC 120V/60Hz
Note: Mode 2:Transmit at 2480MHz by BLE_2M	

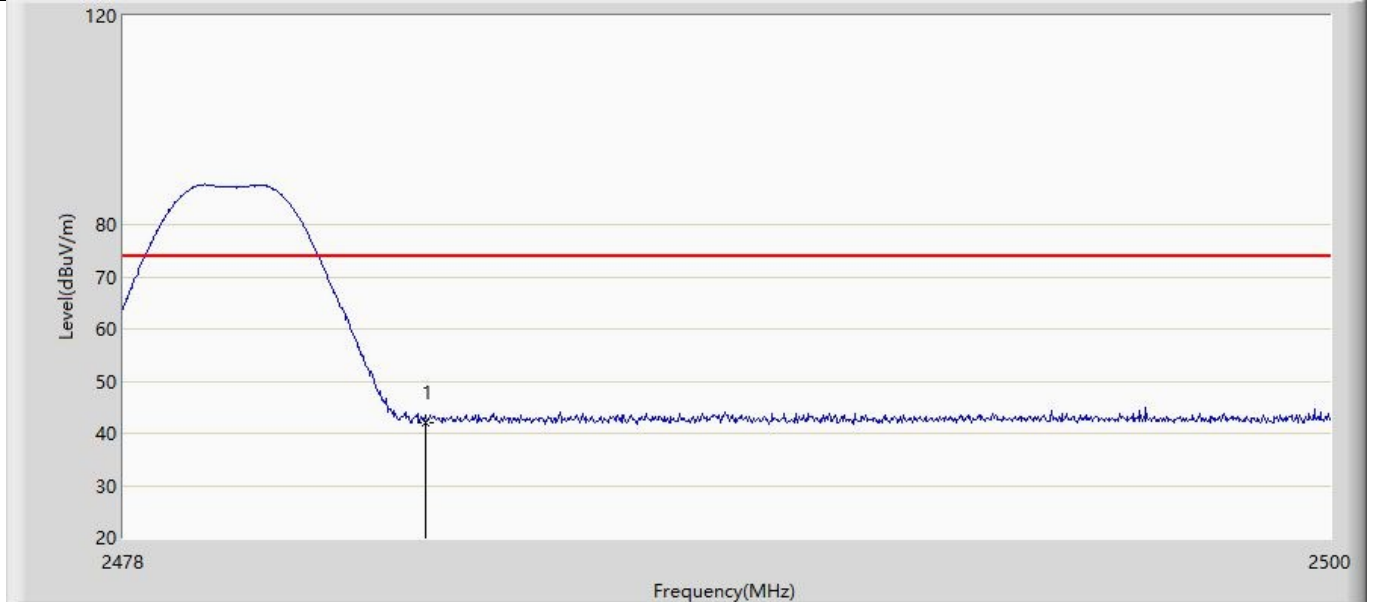

No	Mark	Frequency (MHz)	Measure Level (dBuV/m)	Reading Level (dBuV)	Over Limit (dB)	Limit (dBuV/m)	Factor (dB)	Type
1	*	2483.500	42.009	10.583	-31.991	74.000	31.426	PK

Note:

1. Measured Level = Reading Level + Factor.
2. This limit applies for using average detector, if the test result on peak is lower than average limit, then average measurement needn't be performed.
3. As the radiated emission was performed, so conducted emission was not tested.

4.6 DTS Bandwidth	VERDICT: PASS
--------------------------	----------------------

4.6.1 Limit

Standard	FCC Part 15 Subpart C Paragraph 15.247 (a)(2)
Systems using digital modulation techniques operate in the 2400-2483.5 MHz. The minimum 6 dB bandwidth shall be at least 500 kHz	

4.6.2 Test Setup

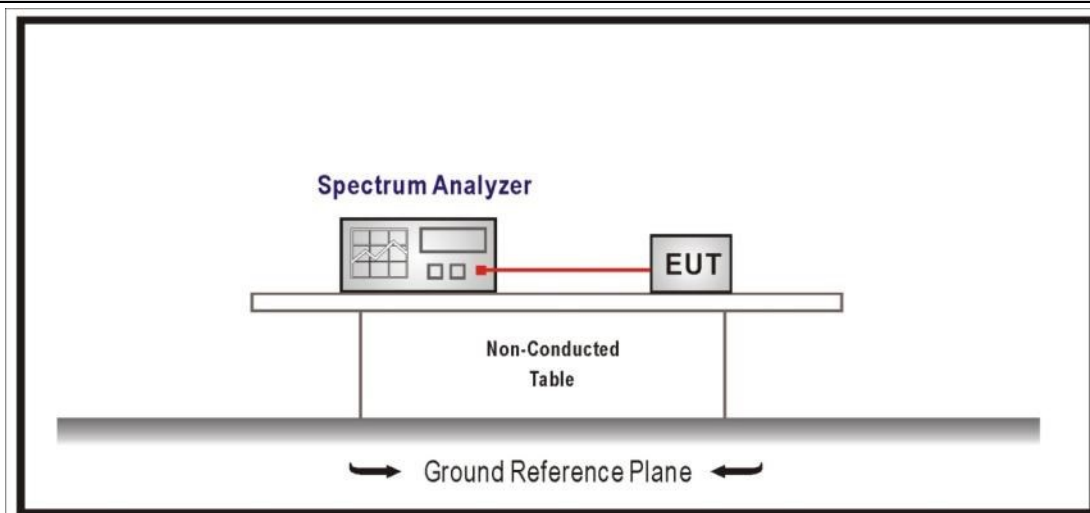

4.6.3 Test Procedure

	Reference Rule	Chapter	Description
<input checked="" type="checkbox"/>	ANSI C63.10	11.8	DTS bandwidth
<input type="checkbox"/>	ANSI C63.10	11.8.1	Option 1
<input checked="" type="checkbox"/>	ANSI C63.10	11.8.2	Option 2

4.6.4 Test Data

Mode	CH.	Test Freq. (MHz)	99% Occupied Bandwidth (kHz)	6dB Occupied Bandwidth (kHz)	Limit (kHz)	Result
1	00	2402	1.054	0.688	>500	Pass
	19	2440	1.051	0.668	>500	Pass
	39	2480	1.057	0.692	>500	Pass
2	00	2402	2.053	1.276	>500	Pass
	19	2440	2.054	1.180	>500	Pass
	39	2480	2.071	1.200	>500	Pass

Note : The worst case of Occupied Bandwidth as below:

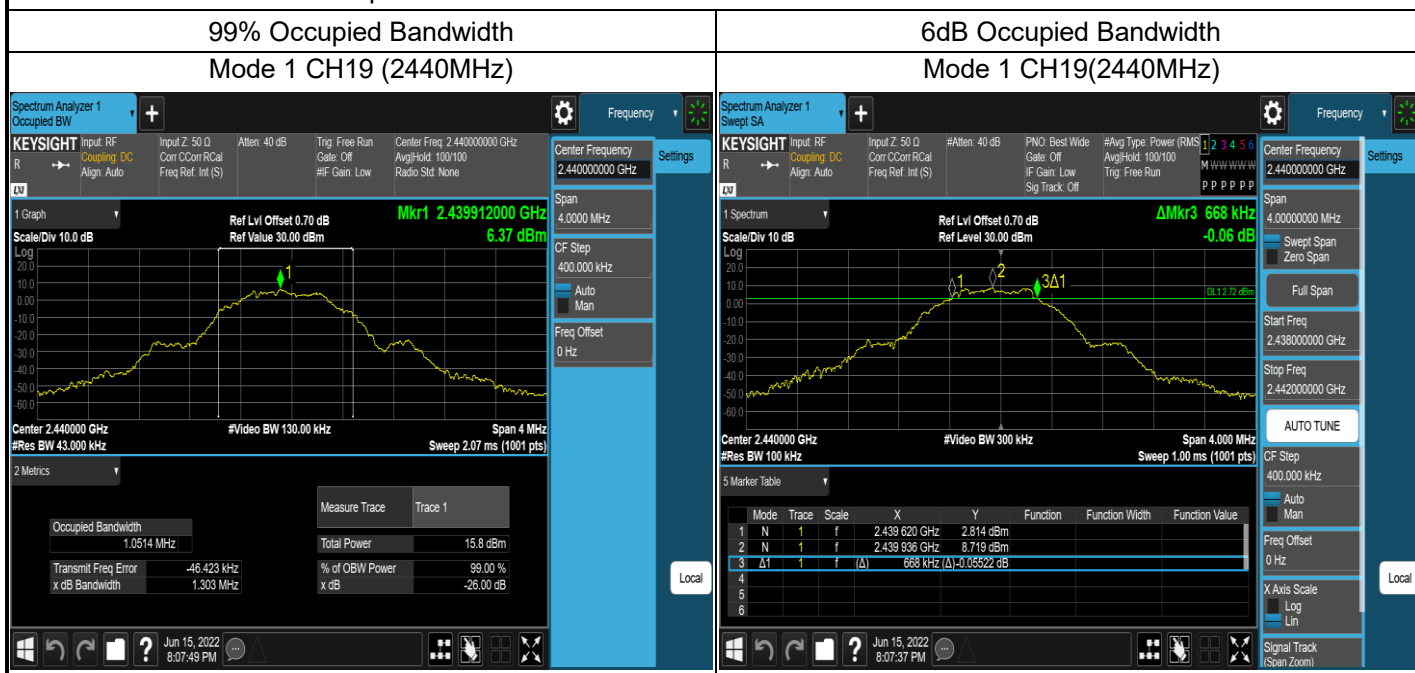

4.7 Fundamental emission output power	VERDICT: PASS
--	----------------------

4.7.1 Limit		
Standard	FCC Part 15 Subpart C Paragraph 15.247 (b)(3)	
<input checked="" type="checkbox"/>	GTX < 6dBi	Pout ≤ 30dBm
<input type="checkbox"/>	GTX > 6dBi	
<input type="checkbox"/>	Non-Fix point-point	Pout ≤ 30 - (GTX - 6)
<input type="checkbox"/>	Fix point-point	Pout ≤ 30 - [(GTX - 6)]/3
<input type="checkbox"/>	Point-to-multipoint	Pout ≤ 30 - (GTX - 6)
<input type="checkbox"/>	Overlap Beams	Pout ≤ 30 - [(GTX - 6)]/3
<input type="checkbox"/>	Aggregate power transmitted simultaneously on all beams	Pout ≤ 30 - [(GTX - 6)]/3
<input type="checkbox"/>	single directional beam	Pout ≤ 30 - [(GTX - 6)]/3 + 8dB

Note 1 : GTX directional gain of transmitting antennas.
 Note 2 : Pout is maximum peak conducted output power .

4.7.2 Test Setup

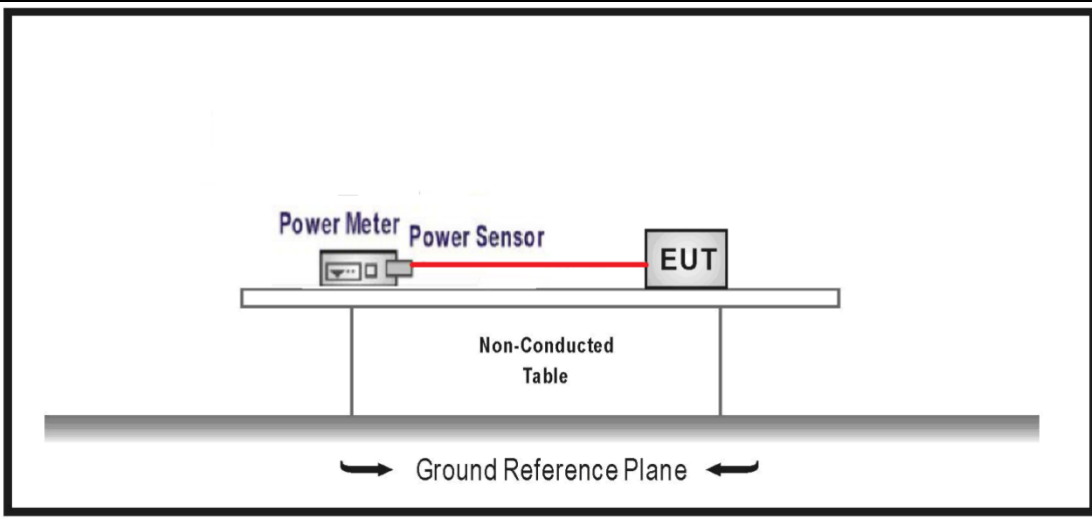

4.7.3 Test Procedure				
	References Rule		Chapter	Description
<input checked="" type="checkbox"/>	ANSI C63.10		11.9	Fundamental emission output power
<input checked="" type="checkbox"/>	ANSI C63.10		11.9.1	Maximum peak conducted output power
	<input type="checkbox"/>	ANSI C63.10	11.9.1.1	RBW \geq DTS bandwidth
	<input type="checkbox"/>	ANSI C63.10	11.9.1.2	Integrated band power method
	<input checked="" type="checkbox"/>	ANSI C63.10	11.9.1.3	PKPM1 Peak power meter method
	<input type="checkbox"/>	ANSI C63.10	11.9.2	Maximum conducted (average) output power
	<input type="checkbox"/>	ANSI C63.10	11.9.2.2	Measurement using a spectrum analyzer (SA)
		<input type="checkbox"/>	ANSI C63.10	11.9.2.2.2 Method AVGSA-1(Duty cycle \geq 98%)
		<input type="checkbox"/>	ANSI C63.10	11.9.2.2.3 Method AVGSA-1A(Duty cycle \geq 98%)
		<input type="checkbox"/>	ANSI C63.10	11.9.2.2.4 Method AVGSA-2(Duty cycle \leq 98%)
		<input type="checkbox"/>	ANSI C63.10	11.9.2.2.5 Method AVGSA-2A(Duty cycle \leq 98%)
		<input type="checkbox"/>	ANSI C63.10	11.9.2.2.4 Method AVGSA-3
		<input type="checkbox"/>	ANSI C63.10	11.9.2.2.5 Method AVGSA-3A
	<input type="checkbox"/>	ANSI C63.10	11.9.2.3	Measurement using a power meter (PM)
		<input type="checkbox"/>	ANSI C63.10	11.9.2.3.1 Method AVGPM
		<input type="checkbox"/>	ANSI C63.10	11.9.2.3.2 Method AVGPM-G

4.7.4 Test Data

ESY0014

Mode	Channel	Test Frequency (MHz)	Conducted Power (dBm)	EIRP (dBm)	Conducted Power Limit (dBm)	EIRP Limit (dBm)	Result
Mode 1	00	2402	5.85	7.85	≤30	≤36	Pass
	19	2440	5.27	7.27	≤30	≤36	Pass
	39	2480	4.53	6.53	≤30	≤36	Pass
Mode 2	00	2402	5.51	7.51	≤30	≤36	Pass
	19	2440	4.84	6.84	≤30	≤36	Pass
	39	2480	4.12	6.12	≤30	≤36	Pass

4.8 Power Density	VERDICT: PASS
--------------------------	----------------------

4.8.1 Limit:	
Standard	FCC Part 15 Subpart C Paragraph 15.247 (b)(3)
Power Spectral Density $\leq 8\text{dBm}/3\text{kHz}$	

4.8.2 Test Setup

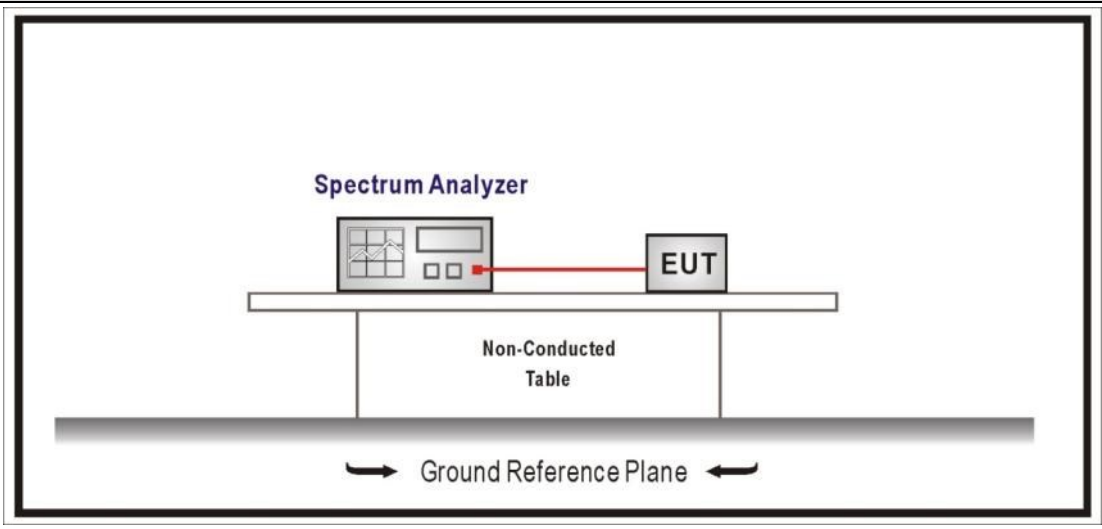

4.8.3 Test Procedure

	References Rule	Chapter	Description
<input checked="" type="checkbox"/>	ANSI C63.10	11.10	Maximum power spectral density level in the fundamental emission
<input checked="" type="checkbox"/>	ANSI C63.10	11.10.2	Method PKPSD (peak PSD)
<input type="checkbox"/>	ANSI C63.10	11.10.3	Method AVGPSD-1(Duty cycle $\geq 98\%$)
<input type="checkbox"/>	ANSI C63.10	11.10.4	Method AVGPSD-1A(Duty cycle $\geq 98\%$)
<input type="checkbox"/>	ANSI C63.10	11.10.5	Method AVGPSD-2(Duty cycle $< 98\%$)
<input type="checkbox"/>	ANSI C63.10	11.10.6	Method AVGPSD-2A(Duty cycle $< 98\%$)
<input type="checkbox"/>	ANSI C63.10	11.10.7	Method AVGPSD-3
<input type="checkbox"/>	ANSI C63.10	11.10.8	Method AVGPSD-3A

4.8.4 Test Data

Mode	Channel	Test Frequency (MHz)	Measurement PSD (dBm/3kHz)	Limit (dBm/3kHz)	Result
Mode 1	00	2402		≤8	Pass
	19	2440		≤8	Pass
	39	2480		≤8	Pass
Mode 2	00	2402		≤8	Pass
	19	2440		≤8	Pass
	39	2480		≤8	Pass

Note : The worst case of PSD as below:

Mode 1 CH39(2480MHz)

4.9 Antenna Requirement	VERDICT: PASS
--------------------------------	----------------------

4.9.1 Limit:	
Standard	FCC Part 15 Subpart C Paragraph 15.203
<p>An intentional radiator shall be designed to ensure that no antenna other than that furnished by the responsible party shall be used with the device. The use of a permanently attached antenna or of an antenna that uses a unique coupling to the intentional radiator shall be considered sufficient to comply with the provisions of this section. The manufacturer may design the unit so that a broken antenna can be replaced by the user, but the use of a standard antenna jack or electrical connector is prohibited. This requirement does not apply to carrier current devices or to devices operated under the provisions of §15.211, §15.213, §15.217, §15.219, or §15.221. Further, this requirement does not apply to intentional radiators that must be professionally installed, such as perimeter protection systems and some field disturbance sensors, or to other intentional radiators which, in accordance with §15.31(d), must be measured at the installation site. However, the installer shall be responsible for ensuring that the proper antenna is employed so that the limits in this part are not exceeded.</p>	

4.9.2 Antenna Connector Construction:	
<input checked="" type="checkbox"/>	The use of a permanently attached antenna
<input type="checkbox"/>	The antenna use of a unique coupling to the intentional radiator
<input type="checkbox"/>	The use of a nonstandard antenna jack or electrical connector
Please refer to the attached document "Internal Photograph" to show the antenna connector.	

5 TEST SETUP PHOTO AND EUT PHOTO

Remark: The test setup photo and EUT Photo please see appendix.

_____ The End _____