



# FCC RADIO TEST REPORT

Applicant : Elo Touch Solutions, Inc.  
Address : 670 N. McCarthy Blvd., Suite 100 Milpitas, CA 95035  
USA  
Equipment : Computer Box  
Model No. : ESY0011  
Trade Name : Elo or   
FCC ID : RBWESY0011

**I HEREBY CERTIFY THAT :**

The sample was received on Apr. 23, 2021 and the testing was completed on Sep. 29, 2022 at CerpPASS Technology Corp. The test result refers exclusively to the test presented test model / sample. Without written approval of CerpPASS Technology Corp., the test report shall not be reproduced except in full.

Approved by:

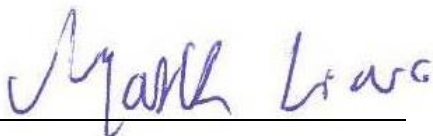

Mark Liao / Supervisor

Laboratory Accreditation:

CerpPASS Technology Corporation Test Laboratory





## Contents

<b>1. Summary of Test Procedure and Test Results</b>	<b>5</b>
1.1 Applicable Standards	5
<b>2. Test Configuration of Equipment under Test</b>	<b>6</b>
2.1 Feature of Equipment under Test	6
2.2 Carrier Frequency of Channels	7
2.3 Test Mode and Test Software	8
2.4 Description of Test System	9
2.5 General Information of Test	10
2.6 Measurement Uncertainty	11
<b>3. Test Equipment and Ancillaries Used for Tests</b>	<b>12</b>
<b>4. Antenna Requirements</b>	<b>14</b>
4.1 Standard Applicable	14
4.2 Antenna Construction and Directional Gain	14
<b>5. Test of AC Power Line Conducted Emission</b>	<b>15</b>
5.1 Test Limit	15
5.2 Test Procedures	15
5.3 Typical Test Setup	16
5.4 Test Result and Data	17
5.5 Test Photographs	19
<b>6. Test of Radiated Spurious Emission</b>	<b>20</b>
6.1 Test Limit	20
6.2 Test Procedures	21
6.3 Typical Test Setup	22
6.4 Test Result and Data (9KHz ~ 30MHz)	23
6.5 Test Result and Data (30MHz ~ 1GHz)	23
6.6 Test Result and Data (1GHz ~ 25GHz)	25
6.7 Restricted Bands of Operation	43
6.8 Test Photographs (30MHz ~ 1GHz)	44
6.9 Test Photographs (1GHz ~ 25GHz)	45
<b>7. Test of Conducted Spurious Emission</b>	<b>47</b>
7.1 Test Limit	47
7.2 Test Procedure	47
7.3 Test Setup Layout	47
7.4 Test Result and Data	47
<b>8. On Time, Duty Cycle and Measurement methods</b>	<b>56</b>
8.1 Test Limit	56
8.2 Test Procedure	56
8.3 Test Setup Layout	56
8.4 Test Result and Data	56
<b>9. 6dB Bandwidth Measurement Data</b>	<b>58</b>
9.1 Test Limit	58
9.2 Test Procedures	58



9.3 Test Setup Layout ..... 58

9.4 Test Result and Data ..... 58

**10. Maximum Peak and Average Output Power ..... 61**

10.1 Test Limit ..... 61

10.2 Test Procedures ..... 61

10.3 Test Setup Layout ..... 61

10.4 Test Result and Data ..... 62

**11. Power Spectral Density ..... 65**

11.1 Test Limit ..... 65

11.2 Test Procedures ..... 65

11.3 Test Setup Layout ..... 65

11.4 Test Result and Data ..... 65

**12. Radio Frequency Exposure ..... 68**

12.1 Applicable Standards ..... 68

12.2 EUT Specification ..... 68

12.3 Result ..... 69





# 1. Summary of Test Procedure and Test Results

## 1.1 Applicable Standards

ANSI C63.10:2013

FCC Rules and Regulations Part 15 Subpart C §15.247

FCC Rule	Description of Test	Result
15.203	. Antenna Requirement	PASS
15.207	. AC Power Line Conducted Emission	PASS
15.209 15.205	. Radiated Spurious Emission	PASS
15.247(d)	. Conducted Spurious Emission	PASS
15.247(a)(2)	. 6dB Bandwidth	PASS
15.247(b)	. Output Power	PASS
15.247(e)	. Power Spectral Density	PASS
2.1091	. Radio Frequency Exposure	PASS

\*The lab has reduced the uncertainty risk factor from test equipment, environment and staff technicians which according to the standard on contract. Therefore, the test result will only be determined by standard requirement.



## 2. Test Configuration of Equipment under Test

### 2.1 Feature of Equipment under Test

Operation Frequency Range	BT / BLE: 2400-2483.5MHz 802.11b/g/n: 2400-2483.5MHz 802.11a/n/ac: 5150-5250MHz, 5725-5850MHz
Center Frequency Range	BT / BLE: 2402MHz-2480MHz 802.11b/g/n: 2412MHz-2462MHz 802.11a/n/ac: 5180-5240MHz, 5745-5825MHz
Modulation Type	BT: GFSK, $\pi/4$ -DQPSK, 8DPSK BLE: GFSK WLAN: 2.4GHz: 802.11b: CCK, DQPSK, DBPSK 802.11g/n: BPSK, QPSK, 16QAM, 64QAM 5GHz: 802.11n/a: BPSK, QPSK, 16QAM, 64QAM 802.11ac: BPSK, QPSK, 16QAM, 64QAM, 256QAM
Modulation Technology	DSSS, OFDM, FHSS, DTS
Data Rate	BT: GFSK: 1Mbps, $\pi/4$ -DQPSK: 2Mbps, 8DPSK: 3Mbps BLE: GFSK: 1Mbps WLAN: 2.4GHz: 802.11b: 1, 2, 5.5, 11Mbps 802.11g: 6, 9, 12, 18, 24, 36, 48, 54Mbps 802.11n: MCS0 – MCS15, HT20 5GHz: 802.11a: 6, 9, 12, 18, 24, 36, 48, 54Mbps 802.11n: MCS0 – MCS15, HT20/40 802.11ac: MCS0 – MCS9, VHT20/40/80
Antenna Type	Dipole Antenna
Antenna Gain	For BT / BLE: 2400-2500MHz: ANT A 1.8 dBi For WLAN: 2400-2500MHz: ANT A: 1.8 dBi, ANT B: 1.8 dBi 5150-5250MHz: ANT A: 2.37dBi, ANT B: 2.37dBi 5725-5850MHz: ANT A: 2.34dBi, ANT B: 2.34dBi
Adapter	Brand: DELTA Model: ADP-65JH HB

Note:

1. EUT support TPC Function.
2. EUT support Client Mode.
3. EUT WLAN 2.4GHz 802.11b and 802.11g 1TX diversity
4. WLAN and BT can simultaneously transmission.
5. For more details, please refer to the User's manual of the EUT.



## 2.2 Carrier Frequency of Channels

802.11b, 802.11g, 802.11n HT20(2412MHz-2462MHz)

Channel	Frequency(MHz)	Channel	Frequency(MHz)
<b>*01</b>	<b>2412</b>	07	2442
02	2417	08	2447
03	2422	09	2452
04	2427	10	2457
05	2432	<b>*11</b>	<b>2462</b>
<b>*06</b>	<b>2437</b>	---	---

Note: Channels remarked \* are selected to perform test.



**2.3 Test Mode and Test Software**

- a. During testing, the interface cables and equipment positions were varied according to ANSI C63.10.
- b. The complete test system included remote workstation and EUT for RF test. The remote workstation included Notebook.
- c. An executive program, " QRCT ver. 4.0.00193.0" under Windows OS system was executed to transmit and receive data via WLAN.
- d. The following test modes were performed for the test:

Conducted Emissions from the AC mains power ports	
Test Mode	Operating Description
1	802.11b (1Mbps) , From Adapter ,ANT A
2	802.11g (6Mbps) , From Adapter ,ANT A
3	802.11b (1Mbps) , From Adapter ,ANT B
4	802.11g (6Mbps) , From Adapter ,ANT B
5	802.11n HT20 (6.5Mbps) From Adapter
caused "Test Mode 5" generated the worst case, it was reported as the final data.	
Radiation Emissions (Below 1GHz)	
Test Mode	Operating Description
1	802.11b (1Mbps) , From Adapter ,ANT A
2	802.11g (6Mbps) , From Adapter ,ANT A
3	802.11b (1Mbps) , From Adapter ,ANT B
4	802.11g (6Mbps) , From Adapter ,ANT B
5	802.11n HT20 (6.5Mbps) From Adapter
caused "Test Mode 5" generated the worst case, they were reported as the final data.	
Radiation Emissions (1GHz ~ 25GHz)	
Test Mode	Operating Description
1	802.11b (1Mbps) , From Adapter ,ANT A
2	802.11g (6Mbps) , From Adapter ,ANT A
3	802.11b (1Mbps) , From Adapter ,ANT B
4	802.11g (6Mbps) , From Adapter ,ANT B
5	802.11n HT20 (6.5Mbps) From Adapter
caused "Test Mode 3~5" generated the worst case, they were reported as the final data.	

Note: There are two kinds of test voltage: AC 120V / 60Hz and AC 240V / 60Hz.  
 For AC Power Line Conducted Emission, AC 240V / 60Hz is worst case.  
 For Radiated Spurious Emission, (Below 1GHz), AC 240V / 60Hz is worst case.  
 For Radiated Spurious Emission, (1GHz ~ 25GHz), AC 120V / 60Hz is worst case.

The EUT incorporates a MIMO function

Modulation Type	TX CONFIGURATION
802.11b	1TX diversity
802.11g	1TX diversity
802.11n HT20	2TX





### 2.4 Description of Test System

RF Conducted				
Equipment	Brand	Model	Length/Type	Power cord/Length/Type
Notebook	lenovo	S1GL2W	N/A	Adapter / 1.8m / NS
USB cable	BENEVO	E210567AWM	N/A	0.6m / NS
Radiated Emissions				
Equipment	Brand	Model	Length/Type	Power cord/Length/Type
Notebook	lenovo	S1GL2W	N/A	Adapter / 1.8m / NS
USB cable	BENEVO	E210567AWM	N/A	0.6m / NS
AC Power Line Conducted Emission				
Equipment	Brand	Model	Length/Type	Power cord/Length/Type
Notebook	lenovo	S1GL2W	N/A	Adapter / 1.8m / NS
USB cable	BENEVO	E210567AWM	N/A	0.6m / NS

**2.5 General Information of Test**

Test Site	<b>CerpPASS Technology Corporation Test Laboratory</b> Address: No.10, Ln. 2, Lianfu St., Luzhu Dist., Taoyuan City 33848, Taiwan (R.O.C.) Tel:+886-3-3226-888 Fax:+886-3-3226-881	
	FCC	TW1439, TW1079
	IC	4934E-1, 4934E-2
	VCCI	T-2205 for Telecommunication test C-4663 for Conducted emission test R-4218 for Radiated emission test G-10812, G-10813 for radiated disturbance above 1GHz
Frequency Range Investigated:	Conducted: from 150kHz to 30 MHz Radiation: from 30 MHz to 25,000MHz	
Test Distance:	The test distance of radiated emission from antenna to EUT is 3 M.	

Test Item	Test Site	Test period	Environmental Conditions	Tested By
RF Conducted	RFCON01-NK	2022/9/22~2022/9/29	27.1~28.3°C / 45~47%	Leon Huang
Radiated Emissions	3M02-NK	2022/09/26~2022/09/28	25~26°C / 34~43%	Leon Huang
AC Power Line Conducted Emission	CON01-NK	2022/09/27	25°C / 61%	Leon Huang



## 2.6 Measurement Uncertainty

ISO/IEC 17025 requires that an estimate of the measurement uncertainties associated with the emissions test results be included in the report. The measurement uncertainties given below are based on a 95% confidence level (based on a coverage factor (k=2))

Measurement Item	Uncertainty
AC Power Line Conduction(150K~30MHz)	±3.12dB
Radiated Spurious Emission(9KHz~30MHz)	±3.4dB
Radiated Spurious Emission(30MHz~1GHz)	±5.7dB
Radiated Spurious Emission(1GHz~25GHz)	±6.8dB
Conducted Spurious Emission	±1.8dB
6dB Bandwidth	±4.4%
20dB Bandwidth	±4.4%
Occupied Bandwidth	±4.4%
Peak Output Power(Conducted Power Meter)	±1.1dB
Dwell Time / Deactivation Time	±1.2%
Power Spectral Density	±1.8dB
Duty Cycle	±1.2%



### 3. Test Equipment and Ancillaries Used for Tests

Test Item	Radiated Emissions				
Test Site	Semi Anechoic Room(3M02-NK)				
Instrument	Manufacturer	Model No	Serial No	Calibration Date	Valid Date
Bilog Antenna	Schwarzbeck	VULB9168	275	2021/11/05	2022/11/04
Active Loop Antenna	EMCO	6507	40855	2022/05/25	2023/05/24
Horn Antenna	EMCO	3115	31601	2021/10/14	2022/10/13
Horn Antenna	EMCO	3116	31970	2022/03/18	2023/03/17
EMI Receiver	ROHDE & SCHWARZ	ESCI	101423	2022/07/05	2023/07/04
Spectrum Analyzer	ROHDE & SCHWARZ	FSV 40-N	102151	2022/08/19	2023/08/18
Preamplifier	EM Electronics corp.	EM330	60658	2021/10/13	2022/10/12
Preamplifier	Agilent	8449B	3008A01954	2022/03/17	2023/03/16
Preamplifier	EMC INSTRUMENTS	EMC184045	980065	2021/11/16	2022/11/15
Cable-3in1(30M-1G)	HARBOUR INDUSTRIES	LL142	CCE1315	2022/03/21	2023/03/20
Cable-0.5m(30M-40G)	HUBER SUHNER	SUCOFLEX 102	28420/2	2022/4/9	2023/04/08
Cable-3m(30M-40G)	HUBER SUHNER	SUCOFLEX 102	MY2608/2	2022/4/9	2023/04/08
Cable-0.5m(1G-40G)	Rapidtek	40GHZ 50CM	38MS-38MS50314	2022/4/9	2023/04/08
Cable-3m(1G-40G)	Rapidtek	40GHZ 300CM	38MS-38MS300314	2022/4/9	2023/04/08
Cable-0.5m(1G-40G)	HUBER SUHNER	SUCOFLEX 104	805443/4	2022/01/11	2023/01/10
Cable-3m(1G-40G)	HUBER SUHNER	SUCOFLEX 104	805796/4	2022/01/11	2023/01/10
Cable-8m(1G-26.5G)	WOKEN	WCBA-WCA203SM	CCE1374	2022/04/25	2023/04/24
E3	AUDIX	v8.2014-8-6	RK-000529	NA	NA

Test Item	RF Conducted				
Test Site	RFCON01-NK				
Instrument	Manufacturer	Model No	Serial No	Calibration Date	Valid Date
CAX Signal Analyzer	KEYSIGHT	N9000B	MY57100339	2022/01/10	2023/01/09
Power Meter	Anritsu	ML2495A	1224005	2022/04/12	2023/04/11
Power Sensor	Anritsu	MA2411B	1207295	2022/04/12	2023/04/11
Attenuator	KEYSIGHT	8491B	MY39250703	2022/04/12	2023/04/11



<b>Test Item</b>	AC Power Line Conducted Emission				
<b>Test Site</b>	CON01-NK				
<b>Instrument</b>	<b>Manufacturer</b>	<b>Model No</b>	<b>Serial No</b>	<b>Calibration Date</b>	<b>Valid Date</b>
EMI Receiver	ROHDE & SCHWARZ	ESCI	101200	2022/08/22	2023/08/21
Line Impedance Stabilization Network	Schwarzbeck	NSLK 8127	8127-740	2022/08/21	2023/08/20
Pulse Limiter	ROHDE & SCHWARZ	ESH3-Z2	101934	2022/03/21	2023/03/20
Cable-6m(9k~300M)	NA	EMC5D-BM-BM-6	130606	2022/03/21	2023/03/20
E3	AUDIX	v8.2014-8-6	RK-000531	NA	NA



## 4. Antenna Requirements

### 4.1 Standard Applicable

For intentional device, according to FCC 47 CFR Section 15.203, an intentional radiator shall be designed to ensure that no antenna other than that furnished by the responsible party shall be used with the device.

And according to FCC 47 CFR Section 15.247 (b), if transmitting antennas of directional gain greater than 6dBi are used, the power shall be reduced by the amount in dB that the directional gain of the antenna exceeds 6dBi.

### 4.2 Antenna Construction and Directional Gain

Antenna Type	Dipole Antenna
Antenna Gain	2400-2500MHz: ANT A: 1.8 dBi, ANT B: 1.8 dBi

2400-2500MHz:

802.11b and 802.11g

For Power directional gain=  $G_{ant}= 1.8$  dBi

For PSD directional gain =  $G_{ant}=1.8$  dBi

802. 11nHT20

For Power directional gain=  $G_{ant}= 1.8$  dBi

For PSD directional gain =  $10 \log[(10^{G1/20} + 10^{G2/20} + \dots + 10^{GN/20})^2 / N_{ANT}]$   
= 4.81 dBi

\*MIMO type: Cyclic Delay Diversity (CDD) mode.



## 5. Test of AC Power Line Conducted Emission

### 5.1 Test Limit

Conducted Emissions were measured from 150 kHz to 30 MHz with a bandwidth of 9 KHz, according to the methods defined in ANSI C63.10-2013. The EUT was placed on a nonmetallic stand in a shielded room 0.8 meters above the ground plane. The interface cables and equipment positioning were varied within limits of reasonable applications to determine the position produced maximum conducted emissions.

Frequency (MHz)	Quasi Peak (dB $\mu$ V)	Average (dB $\mu$ V)
0.15 – 0.5	66-56*	56-46*
0.5 – 5.0	56	46
5.0 – 30.0	60	50

\*Decreases with the logarithm of the frequency.

### 5.2 Test Procedures

- a. The EUT was placed 0.4 meter from the conducting wall of the shielding room was kept at least 80 centimeters from any other grounded conducting surface.
- b. Connect EUT to the power mains through a line impedance stabilization network (LISN).
- c. All the support units are connecting to the other LISN.
- d. The LISN provides 50 ohm coupling impedance for the measuring instrument.
- e. The FCC states that a 50 ohm, 50 micro-Henry LISN should be used.
- f. Both sides of AC line were checked for maximum conducted interference.
- g. The frequency range from 150 kHz to 30 MHz was searched.
- h. Set the test-receiver system to Peak Detect Function and Specified Bandwidth with Maximum Hold Mode.



### 5.3 Typical Test Setup

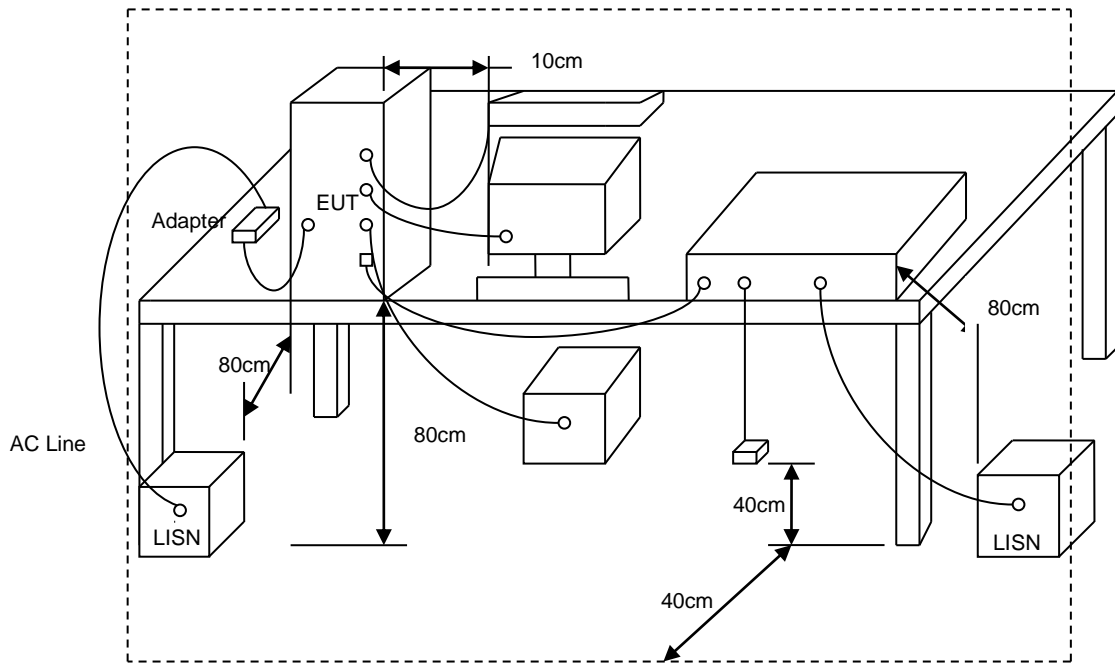





5.4 Test Result and Data

Power	: From Adapter (AC 240V / 60Hz)	Pol/Phase	: LINE
Test Mode	: Mode 5		:

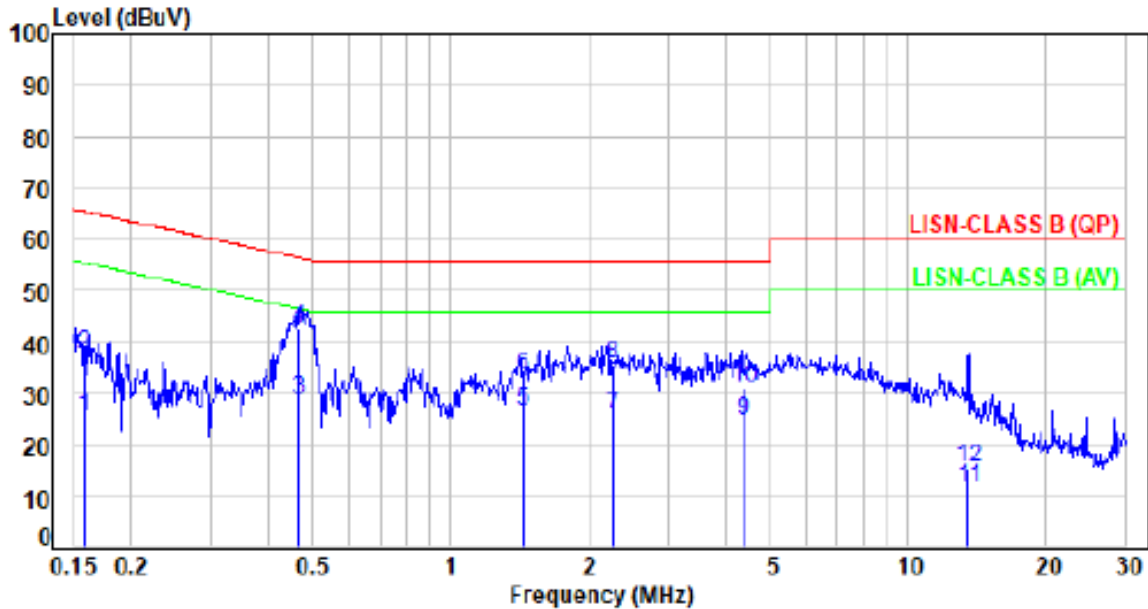

No.	Frequency (MHz)	Factor (dB)	Reading (dBuV)	Level (dBuV)	Limit (dBuV)	Margin (dB)	Detector	P/F
1	0.16	9.89	15.66	25.55	55.58	-30.03	Average	P
2	0.16	9.89	27.81	37.70	65.58	-27.88	QP	P
3	0.47	9.89	18.92	28.81	46.58	-17.77	Average	P
4	0.47	9.89	32.59	42.48	56.58	-14.10	QP	P
5	1.43	9.87	16.62	26.49	46.00	-19.51	Average	P
6	1.43	9.87	23.63	33.50	56.00	-22.50	QP	P
7	2.26	9.85	15.92	25.77	46.00	-20.23	Average	P
8	2.26	9.85	25.89	35.74	56.00	-20.26	QP	P
9	4.37	9.84	14.75	24.59	46.00	-21.41	Average	P
10	4.37	9.84	21.28	31.12	56.00	-24.88	QP	P
11	13.56	9.93	1.80	11.73	50.00	-38.27	Average	P
12	13.56	9.93	5.65	15.58	60.00	-44.42	QP	P

Note: Level=Reading+Factor  
 Margin=Level-Limit  
 Factor=(LISN or ISN or Current Probe)Factor + Cable Loss



Power	:	From Adapter (AC 240V / 60Hz)	Pol/Phase	:	NEUTRAL
Test Mode	:	Mode 5		:	

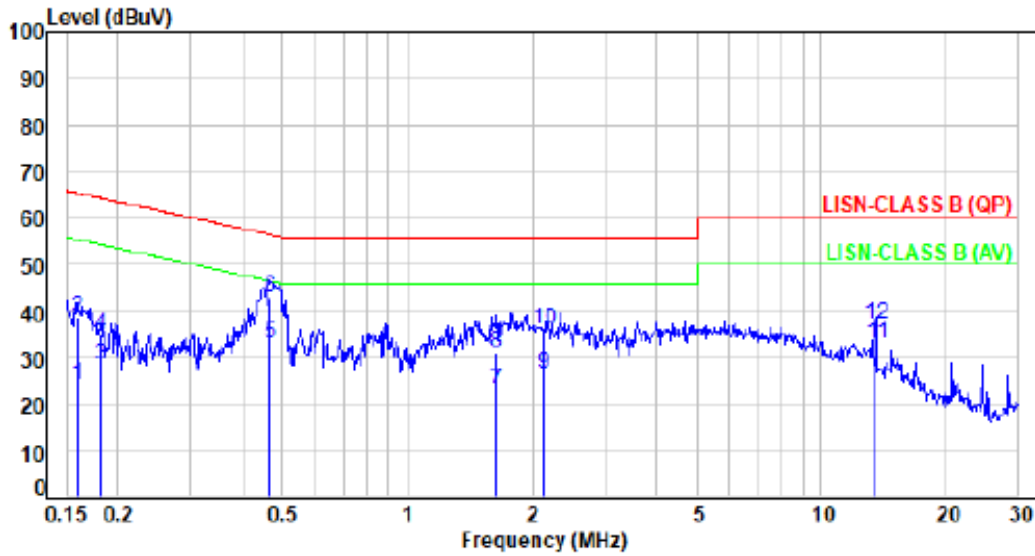

No.	Frequency (MHz)	Factor (dB)	Reading (dBuV)	Level (dBuV)	Limit (dBuV)	Margin (dB)	Detector	P/F
1	0.16	9.90	14.56	24.46	55.53	-31.07	Average	P
2	0.16	9.90	29.02	38.92	65.53	-26.61	QP	P
3	0.18	9.90	18.61	28.51	54.41	-25.90	Average	P
4	0.18	9.90	25.23	35.13	64.41	-29.28	QP	P
5	0.47	9.89	23.01	32.90	46.57	-13.67	Average	P
6	0.47	9.89	33.03	42.92	56.57	-13.65	QP	P
7	1.63	9.86	13.48	23.34	46.00	-22.66	Average	P
8	1.63	9.86	21.16	31.02	56.00	-24.98	QP	P
9	2.13	9.85	16.94	26.79	46.00	-19.21	Average	P
10	2.13	9.85	26.32	36.17	56.00	-19.83	QP	P
11	13.56	9.93	23.20	33.13	50.00	-16.87	Average	P
12	13.56	9.93	27.20	37.13	60.00	-22.87	QP	P

Note: Level=Reading+Factor  
 Margin=Level-Limit  
 Factor=(LISN or ISN or Current Probe)Factor + Cable Loss



## 6. Test of Radiated Spurious Emission

### 6.1 Test Limit

In any 100kHz bandwidth outside the frequency band in which the spread spectrum or digitally modulated intentional radiator is operating, the radio frequency power that is produced by the intentional radiator shall be at least 20dB below that in the 100kHz bandwidth within the band that contains the highest level of the desired power, based on either an RF conducted or a radiated measurement. If the transmitter measurement is based on the maximum conducted output power, the attenuation required under this paragraph shall be 30dB instead of 20dB. In addition, radiated emissions which fall in section 15.205(a) the restricted bands must also comply with the radiated emission limit specified in section 15.209(a).

Frequency (MHz)	Field Strength (microvolt/meter)	Measurement Distance (meters)
0.009 ~ 0.490	2400/F(kHz)	300
0.490 ~ 1.705	24000/F(kHz)	30
1.705 ~ 30.0	30	30
30 ~ 88	100	3
88 ~ 216	150	3
216 ~ 960	200	3
Above 960	500	3



## 6.2 Test Procedures

- a. The EUT was placed on a rotatable table top 0.8 meter above ground.
- b. The EUT was set 3 meters from the interference receiving antenna which was mounted on the top of a variable height antenna tower.
- c. The table was rotated 360 degrees to determine the position of the highest radiation.
- d. The antenna is a broadband antenna and its height is varied between one meter and four meters above ground to find the maximum value of the field strength both horizontal polarization and vertical polarization of the antenna are set to make the measurement.
- e. For each suspected emission the EUT was arranged to its worst case and then tune the antenna tower (from 1 M to 4 M) and turn table (from 0 degree to 360 degrees) to find the maximum reading.
- f. Set the test-receiver system to Peak or CISPR quasi-peak Detect Function and specified bandwidth with Maximum Hold Mode.
- g. If the emission level of the EUT in peak mode was 3 dB lower than the limit specified, then testing will be stopped and peak values of EUT will be reported, otherwise, the emissions which do not have 3 dB margin will be repeated one by one using the quasi-peak method and reported.
- h. For testing above 1GHz, the emission level of the EUT in peak mode was 20dB lower than average limit (that means the emission level in peak mode also complies with the limit in average mode), then testing will be stopped and peak values of EUT will be reported, otherwise, the emissions will be measured in average mode again and reported.
- i. "Cone of radiation" has been considered to be 3dB bandwidth of the measurement antenna.

Note:

- 1.The supporting fixture shall permit orientation of the EUT in each of three orthogonal axis positions such that emissions from the EUT are maximized.  
(X -AXIS is the worst.)
- 2.Due to the test software function limit the operation band setting(200dBuV/m).  
There's no corresponding limitation in the actual test item.



### 6.3 Typical Test Setup

Below 30MHz test setup

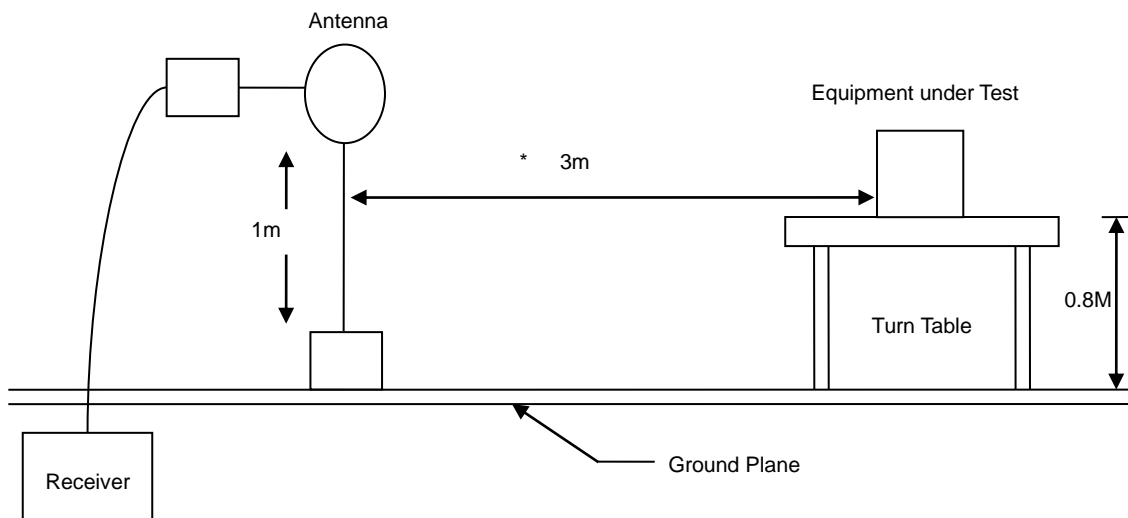

30MHz- 1GHz Test Setup

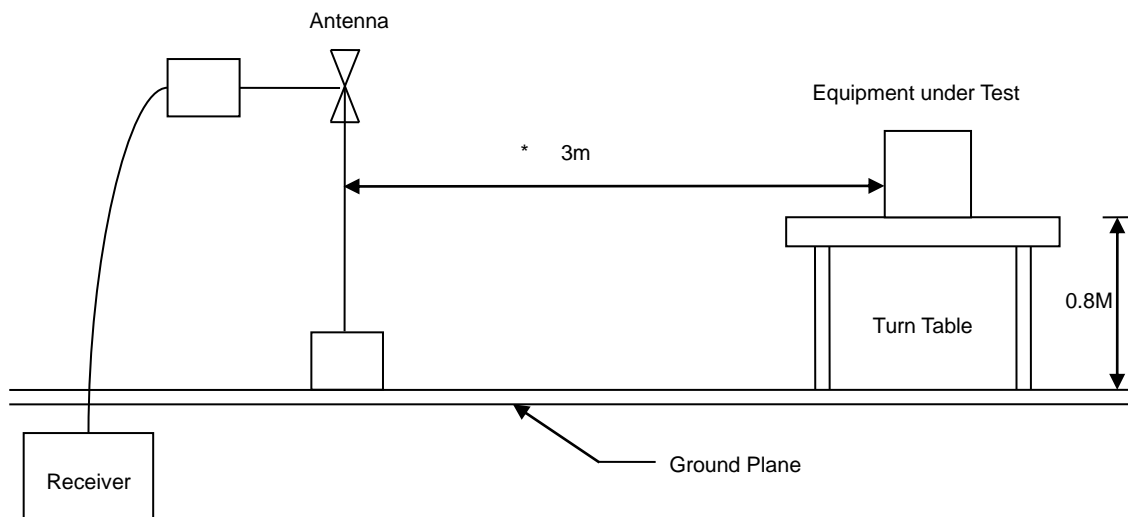

Above 1GHz Test Setup

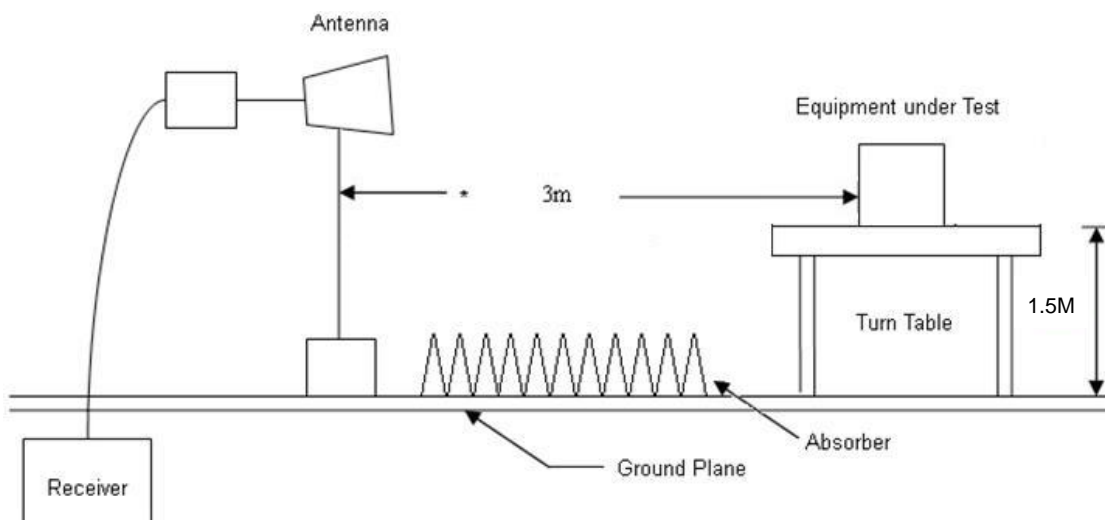



### 6.4 Test Result and Data (9KHz ~ 30MHz)

The 9kHz - 30MHz spurious emission is under limit 20dB more.

### 6.5 Test Result and Data (30MHz ~ 1GHz)

Power	:	From Adapter (AC 240V / 60Hz)	Pol/Phase	:	VERTICAL
Test Mode	:	Mode 5		:	

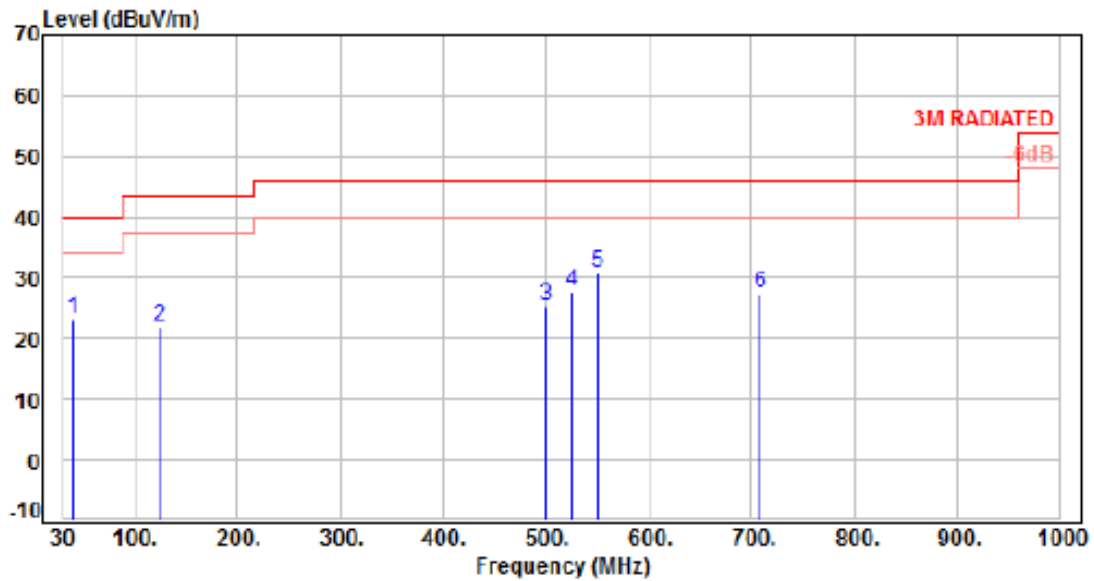

No.	Frequency (MHz)	Factor (dB)	Reading (dBuV)	Level (dBuV/m)	Limit (dBuV/m)	Margin (dB)	Detector	Height (cm)	Azimuth (deg)	P/F
1	39.70	-11.84	34.85	23.01	40.00	-16.99	Peak	400	0	P
2	123.12	-13.53	35.36	21.83	43.50	-21.67	Peak	400	0	P
3	499.48	-5.27	30.43	25.16	46.00	-20.84	Peak	400	0	P
4	524.70	-4.76	32.54	27.78	46.00	-18.22	Peak	400	0	P
5	549.92	-4.33	35.10	30.77	46.00	-15.23	Peak	400	0	P
6	709.00	-1.20	28.54	27.34	46.00	-18.66	Peak	400	0	P

Note: Level=Reading+Factor  
 Margin=Level-Limit  
 Factor=Antenna Factor + cable loss - Amplifier Factor



Power	: From Adapter (AC 240V / 60Hz)	Pol/Phase	: HORIZONTAL
Test Mode	: Mode 5		:

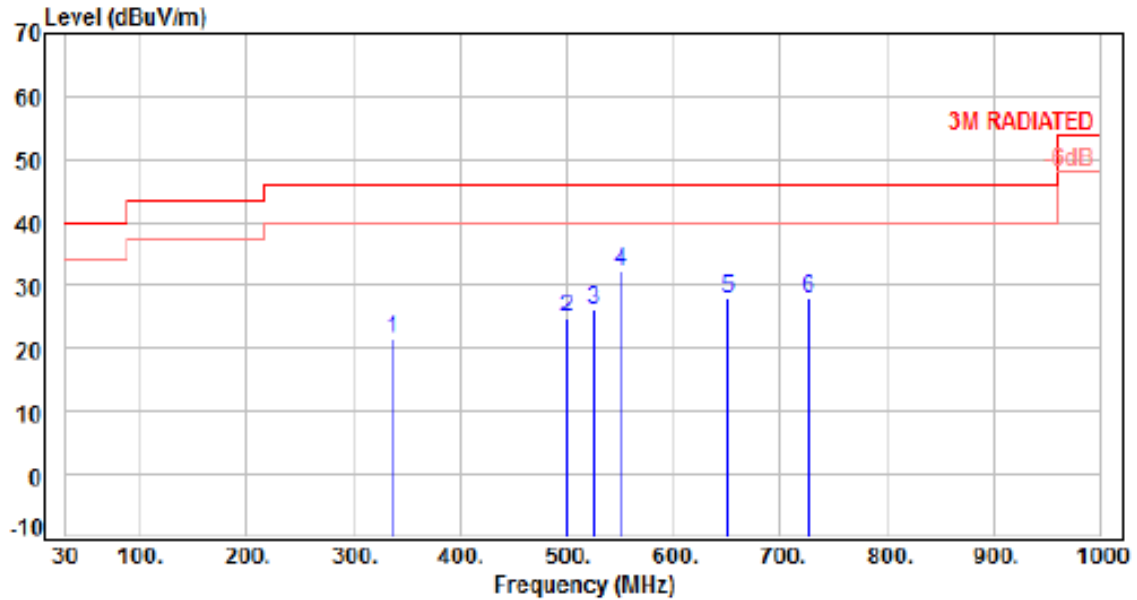

No.	Frequency (MHz)	Factor (dB)	Reading (dBuV)	Level (dBuV/m)	Limit (dBuV/m)	Margin (dB)	Detector	Height (cm)	Azimuth (deg)	P/F
1	336.52	-9.34	31.06	21.72	46.00	-24.28	Peak	400	360	P
2	499.48	-5.27	30.27	25.00	46.00	-21.00	Peak	400	360	P
3	524.78	-4.76	30.91	26.15	46.00	-19.85	Peak	400	360	P
4	549.92	-4.33	36.72	32.39	46.00	-13.61	Peak	400	360	P
5	658.80	-1.89	30.01	28.12	46.00	-17.88	Peak	400	360	P
6	726.46	-1.03	28.95	27.92	46.00	-18.08	Peak	400	360	P

Note: Level=Reading+Factor  
Margin=Level-Limit  
Factor=Antenna Factor + cable loss - Amplifier Factor



6.6 Test Result and Data (1GHz ~ 25GHz)

Power	:	From Adapter (AC 120V / 60Hz)	Pol/Phase	:	VERTICAL
Test Mode	:	Mode 3, CH01		:	

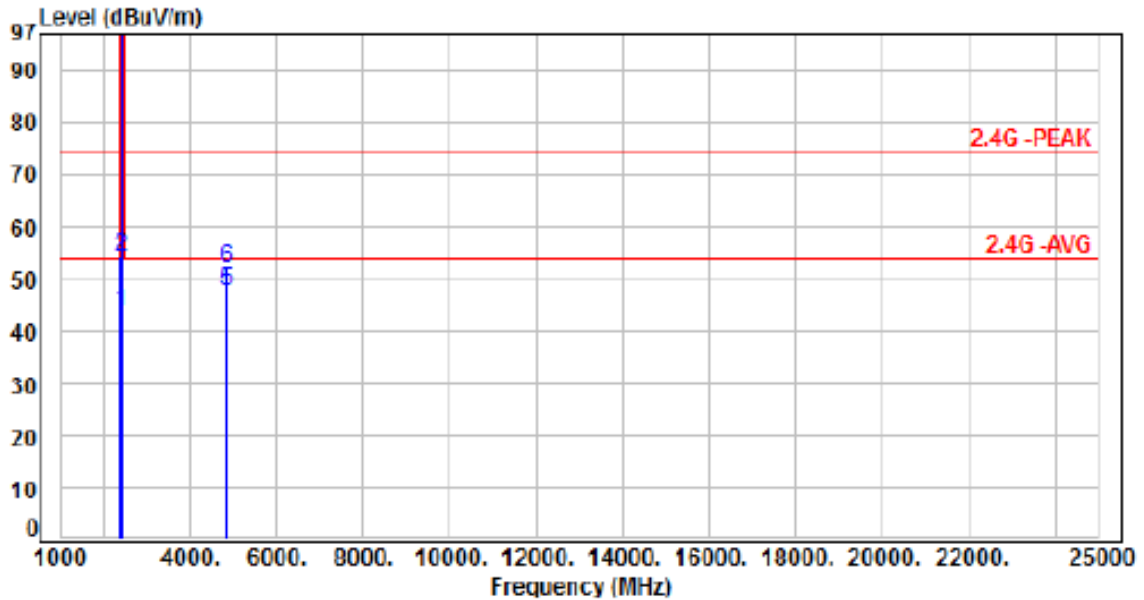

No.	Frequency (MHz)	Factor (dB)	Reading (dBuV)	Level (dBuV/m)	Limit (dBuV/m)	Margin (dB)	Detector	Height (cm)	Azimuth (deg)	P/F
1	2390.00	-2.64	46.08	43.44	54.00	-10.56	Average	126	84	P
2	2390.00	-2.64	56.72	54.08	74.00	-19.92	Peak	126	84	P
3	2412.00	-2.60	106.12	103.52	200.00	-96.48	Average	126	84	P
4	2412.00	-2.60	109.11	106.51	200.00	-93.49	Peak	126	84	P
5	4824.00	5.03	42.68	47.71	54.00	-6.29	Average	188	139	P
6	4824.00	5.03	47.06	52.09	74.00	-21.91	Peak	188	139	P

Note: Level-Reading+Factor  
 Margin=Level-Limit  
 Factor=Antenna Factor + cable loss - Amplifier Factor





Power	: From Adapter (AC 120V / 60Hz)	Pol/Phase	: HORIZONTAL
Test Mode	: Mode 3, CH01		:

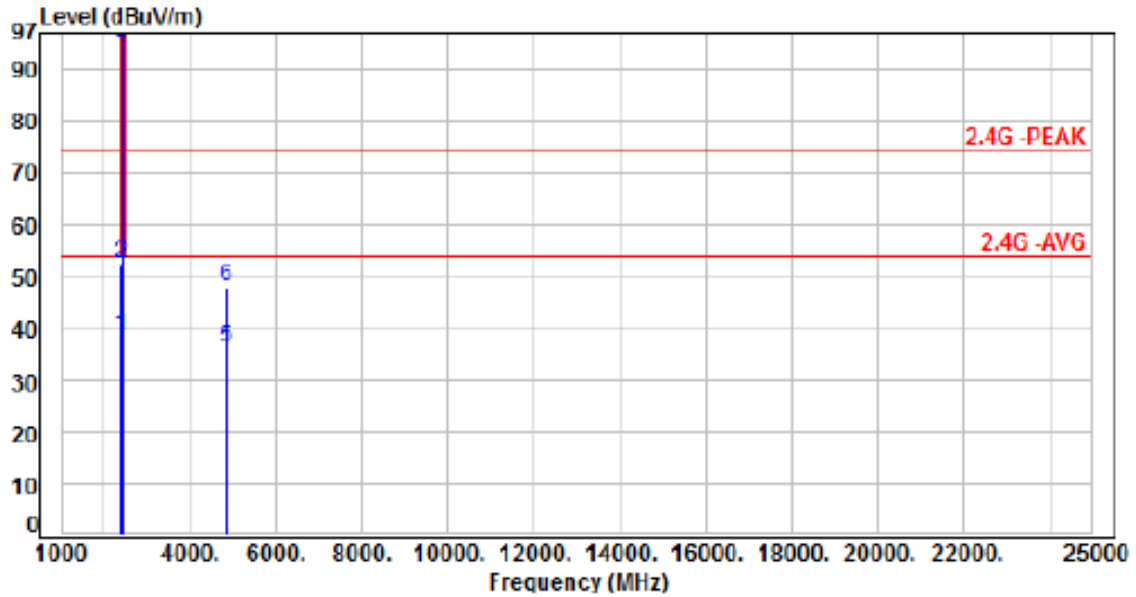

No.	Frequency (MHz)	Factor (dB)	Reading (dBuV)	Level (dBuV/m)	Limit (dBuV/m)	Margin (dB)	Detector	Height (cm)	Azimuth (deg)	P/F
1	2390.00	-2.64	41.14	38.50	54.00	-15.50	Average	100	323	P
2	2390.00	-2.64	54.85	52.21	74.00	-21.79	Peak	100	323	P
3	2412.00	-2.60	97.85	95.25	200.00	-104.75	Average	100	323	P
4	2412.00	-2.60	100.81	98.21	200.00	-101.79	Peak	100	323	P
5	4824.00	5.03	31.24	36.27	54.00	-17.73	Average	100	192	P
6	4824.00	5.03	43.01	48.04	74.00	-25.96	Peak	100	192	P

Note: Level=Reading+Factor  
 Margin=Level-Limit  
 Factor=Antenna Factor + cable loss - Amplifier Factor



Power	:	From Adapter (AC 120V / 60Hz)	Pol/Phase	:	VERTICAL
Test Mode	:	Mode 3, CH06		:	

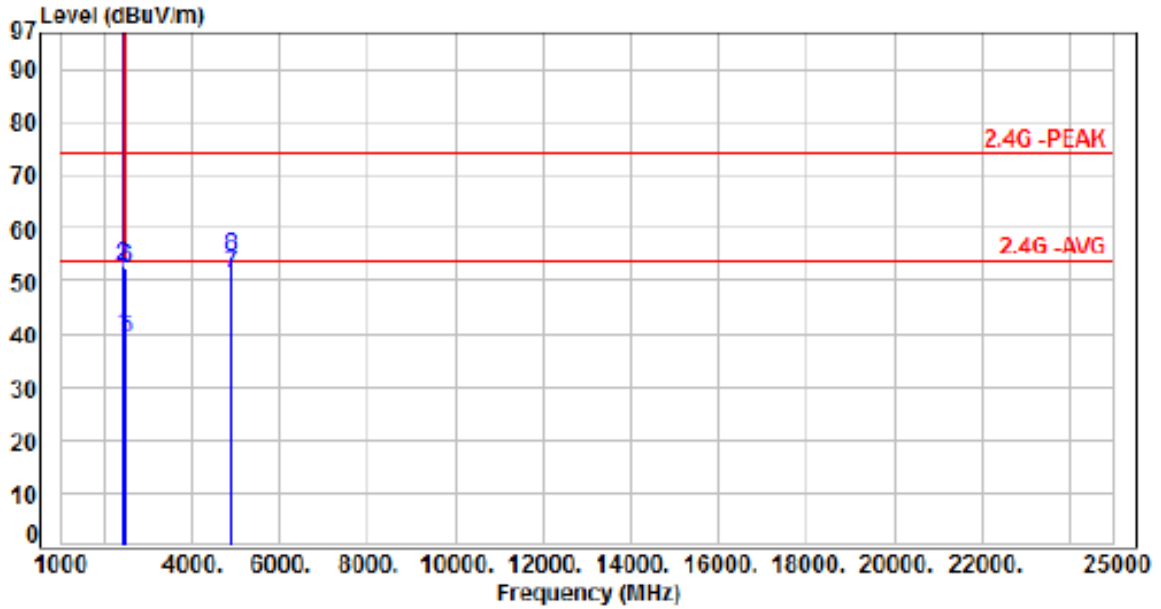

No.	Frequency (MHz)	Factor (dB)	Reading (dBUV)	Level (dBUV/m)	Limit (dBUV/m)	Margin (dB)	Detector	Height (cm)	Azimuth (deg)	P/F
1	2398.00	-2.64	42.38	39.74	54.00	-14.26	Average	40	100	P
2	2398.00	-2.64	55.31	52.67	74.00	-21.33	Peak	40	100	P
3	2437.00	-2.57	106.79	104.22	200.00	-95.78	Average	40	100	P
4	2437.00	-2.57	109.37	106.80	200.00	-93.20	Peak	40	100	P
5	2483.50	-2.39	41.47	39.08	54.00	-14.92	Average	40	100	P
6	2483.50	-2.39	54.60	52.21	74.00	-21.79	Peak	40	100	P
7	4874.00	5.18	46.13	51.31	54.00	-2.69	Average	182	140	P
8	4874.00	5.18	49.27	54.45	74.00	-19.55	Peak	182	140	P

Note: Level=Reading+Factor  
 Margin=Level-limit  
 Factor=Antenna Factor + cable loss - Amplifier Factor



Power	:	From Adapter (AC 120V / 60Hz)	Pol/Phase	:	HORIZONTAL
Test Mode	:	Mode 3, CH06		:	

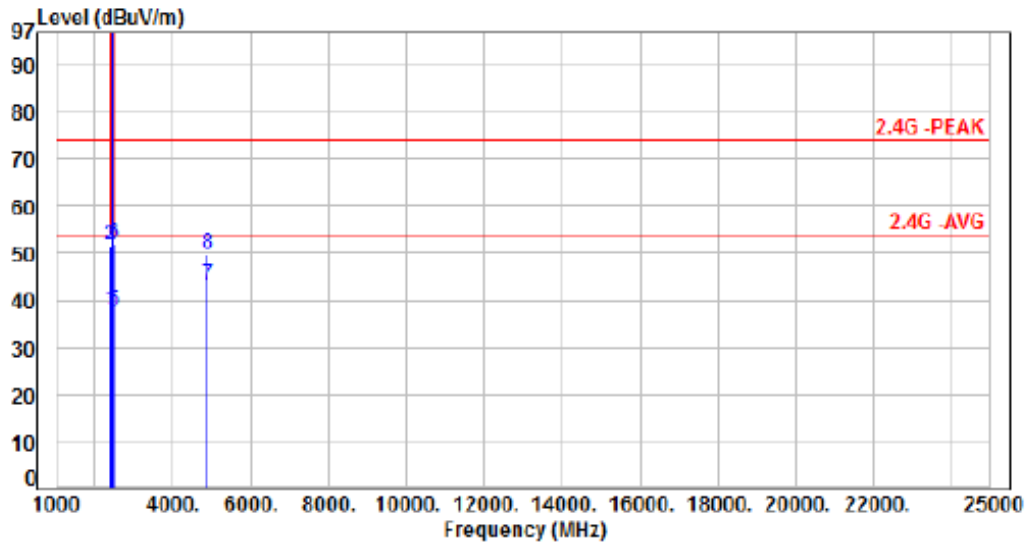

No.	Frequency (MHz)	Factor (dB)	Reading (dBuV)	Level (dBuV/m)	Limit (dBuV/m)	Margin (dB)	Detector	Height (cm)	Azimuth (deg)	P/F
1	2390.00	-2.64	40.33	37.69	54.00	-16.31	Average	110	320	P
2	2390.00	-2.64	54.12	51.48	74.00	-22.52	Peak	110	320	P
3	2437.00	-2.57	99.54	96.97	200.00	-103.03	Average	110	320	P
4	2437.00	-2.57	102.11	99.54	200.00	-100.46	Peak	110	320	P
5	2483.50	-2.39	40.13	37.74	54.00	-16.26	Average	110	320	P
6	2483.50	-2.39	54.42	52.03	74.00	-21.97	Peak	110	320	P
7	4874.00	5.18	38.08	43.26	54.00	-10.74	Average	308	130	P
8	4874.00	5.18	44.58	49.76	74.00	-24.24	Peak	308	130	P

Note: Level=Reading+Factor  
 Margin=Level-Limit  
 Factor=Antenna Factor + cable loss - Amplifier Factor



Power	:	From Adapter (AC 120V / 60Hz)	Pol/Phase	:	VERTICAL
Test Mode	:	Mode 3, CH11		:	

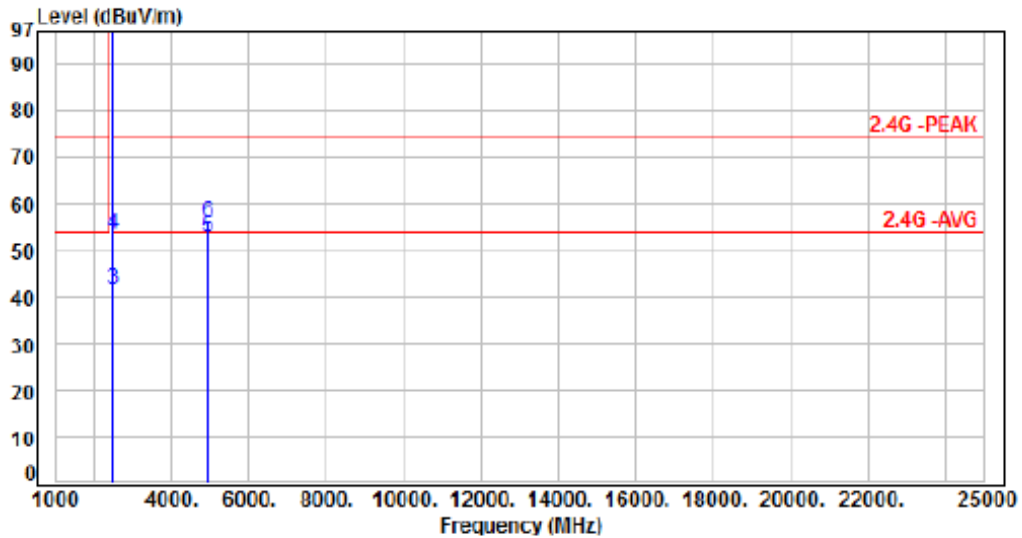

No.	Frequency (MHz)	Factor (dB)	Reading (dBuV)	Level (dBuV/m)	Limit (dBuV/m)	Margin (dB)	Detector	Height (cm)	Azimuth (deg)	P/F
1	2452.00	-2.49	105.97	103.48	200.00	-96.52	Average	120	71	P
2	2452.00	-2.49	108.55	106.06	200.00	-93.94	Peak	120	71	P
3	2483.50	-2.39	44.25	41.86	54.00	-12.14	Average	120	71	P
4	2483.50	-2.39	55.98	53.59	74.00	-20.41	Peak	120	71	P
5	4924.00	5.39	47.53	52.92	54.00	-1.08	Average	185	150	P
6	4924.00	5.39	50.65	56.04	74.00	-17.96	Peak	185	150	P

Note: Level-Reading+Factor  
 Margin-Level-Limit  
 Factor=Antenna Factor + cable loss - Amplifier Factor



Power	:	From Adapter (AC 120V / 60Hz)	Pol/Phase	:	HORIZONTAL
Test Mode	:	Mode 3, CH11		:	

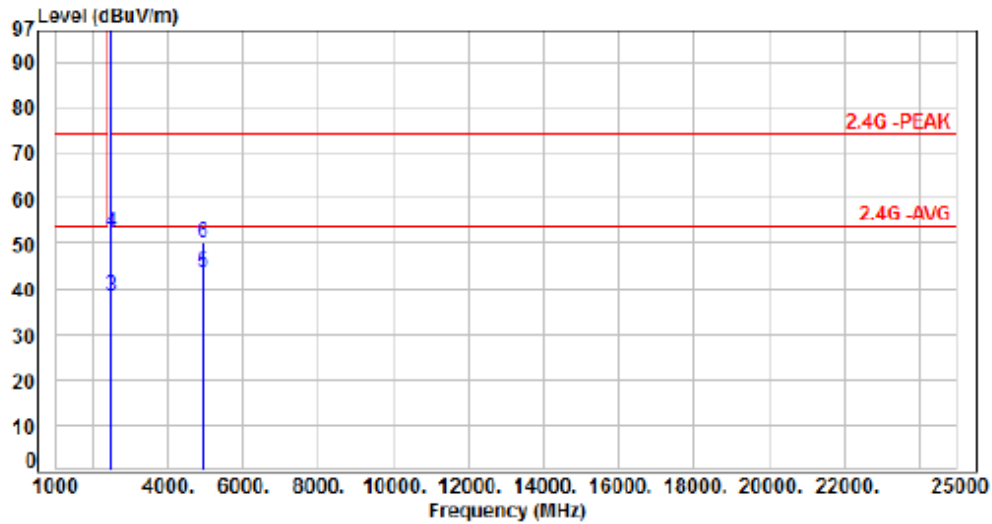

No.	Frequency (MHz)	Factor (dB)	Reading (dBuV)	Level (dBuV/m)	Limit (dBuV/m)	Margin (dB)	Detector	Height (cm)	Azimuth (deg)	P/F
1	2462.00	-2.49	98.15	95.66	200.00	-104.34	Average	100	320	P
2	2462.00	-2.49	100.76	98.27	200.00	-101.73	Peak	100	320	P
3	2483.50	-2.39	40.76	38.37	54.00	-15.63	Average	100	320	P
4	2483.50	-2.39	54.72	52.33	74.00	-21.67	Peak	100	320	P
5	4924.00	5.39	38.16	43.55	54.00	-10.45	Average	303	131	P
6	4924.00	5.39	44.78	50.17	74.00	-23.83	Peak	303	131	P

Note: Level=Reading+Factor  
 Margin=Level-Limit  
 Factor=Antenna Factor + cable loss - Amplifier Factor



Power	: From Adapter (AC 120V / 60Hz)	Pol/Phase	: VERTICAL
Test Mode	: Mode 4, CH01		:

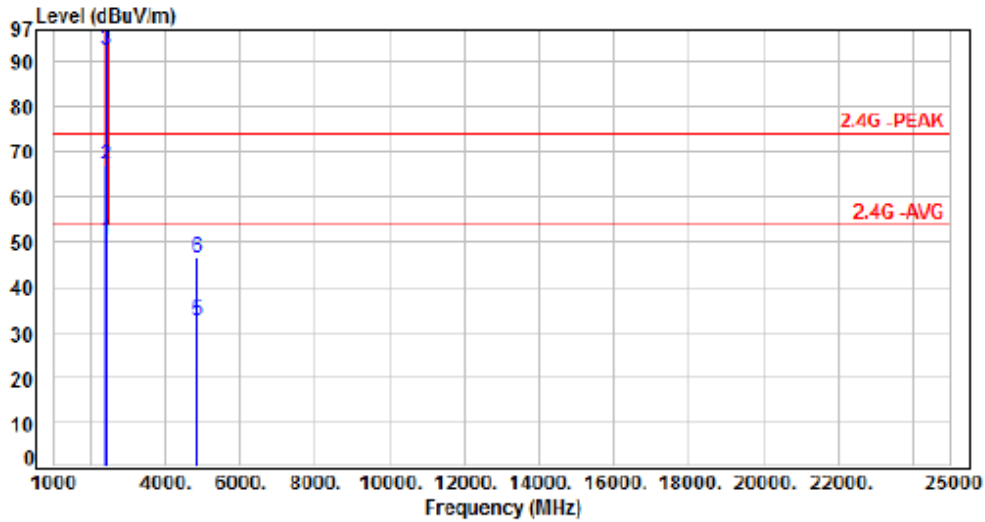

No.	Frequency (MHz)	Factor (dB)	Reading (dBuV)	Level (dBuV/m)	Limit (dBuV/m)	Margin (dB)	Detector	Height (cm)	Azimuth (deg)	P/F
1	2390.00	-2.64	53.01	50.37	54.00	-3.63	Average	123	85	P
2	2390.00	-2.64	69.75	67.11	74.00	-6.89	Peak	123	85	P
3	2412.00	-2.60	95.34	92.74	200.00	-107.26	Average	123	85	P
4	2412.00	-2.60	106.78	104.18	200.00	-95.82	Peak	123	85	P
5	4824.00	5.03	27.50	32.53	54.00	-21.47	Average	100	209	P
6	4824.00	5.03	41.41	46.44	74.00	-27.56	Peak	100	209	P

Note: Level=Reading+Factor  
 Margin=Level-Limit  
 Factor=Antenna Factor + cable loss - Amplifier Factor



Power	:	From Adapter (AC 120V / 60Hz)	Pol/Phase	:	HORIZONTAL
Test Mode	:	Mode 4, CH01		:	

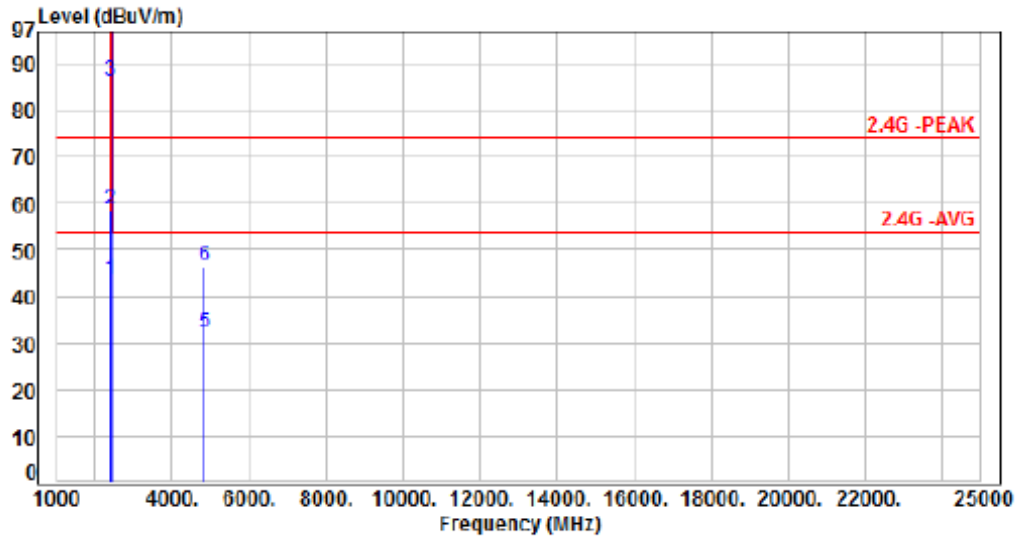

No.	Frequency (MHz)	Factor (dB)	Reading (dBuV)	Level (dBuV/m)	Limit (dBuV/m)	Margin (dB)	Detector	Height (cm)	Azimuth (deg)	P/F
1	2390.00	-2.64	46.13	43.49	54.00	-10.51	Average	111	321	P
2	2390.00	-2.64	61.23	58.59	74.00	-15.41	Peak	111	321	P
3	2412.00	-2.60	88.99	86.39	200.00	-113.61	Average	111	321	P
4	2412.00	-2.60	100.42	97.82	200.00	-102.18	Peak	111	321	P
5	4824.00	5.03	27.20	32.23	54.00	-21.77	Average	100	266	P
6	4824.00	5.03	41.28	46.31	74.00	-27.69	Peak	100	266	P

Note: Level=Reading+Factor  
 Margin=Level-Limit  
 Factor=Antenna Factor + cable loss - Amplifier Factor



Power	:	From Adapter (AC 120V / 60Hz)	Pol/Phase	:	VERTICAL
Test Mode	:	Mode 4, CH06		:	

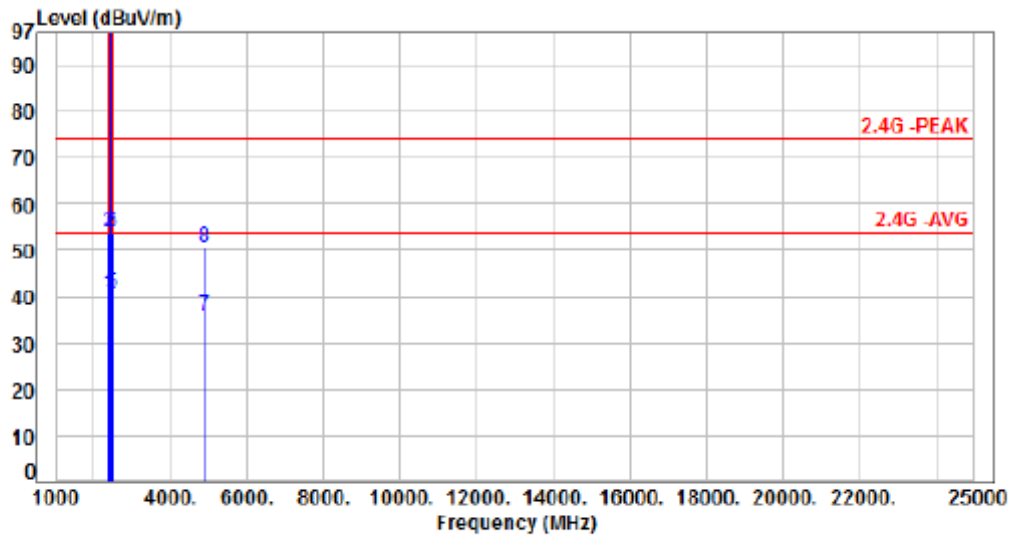

NO.	Frequency (MHz)	Factor (dB)	Reading (dBuV)	Level (dBuV/m)	Limit (dBuV/m)	Margin (dB)	Detector	Height (cm)	Azimuth (deg)	P/F
1	2390.00	-2.64	43.27	40.63	54.00	-13.37	Average	146	60	P
2	2390.00	-2.64	56.51	53.87	74.00	-20.13	Peak	146	60	P
3	2437.00	-2.57	100.79	98.22	200.00	-101.78	Average	146	60	P
4	2437.00	-2.57	112.34	109.77	200.00	-90.23	Peak	146	60	P
5	2483.50	-2.39	42.93	40.54	54.00	-13.46	Average	146	60	P
6	2483.50	-2.39	56.18	53.79	74.00	-20.21	Peak	146	60	P
7	4874.00	5.18	30.46	35.64	54.00	-18.36	Average	185	143	P
8	4874.00	5.18	45.32	50.50	74.00	-23.50	Peak	185	143	P

Note: Level=Reading+Factor  
 Margin=Level-Limit  
 Factor=Antenna Factor + cable loss - Amplifier Factor





Power	:	From Adapter (AC 120V / 60Hz)	Pol/Phase	:	HORIZONTAL
Test Mode	:	Mode 4, CH06		:	

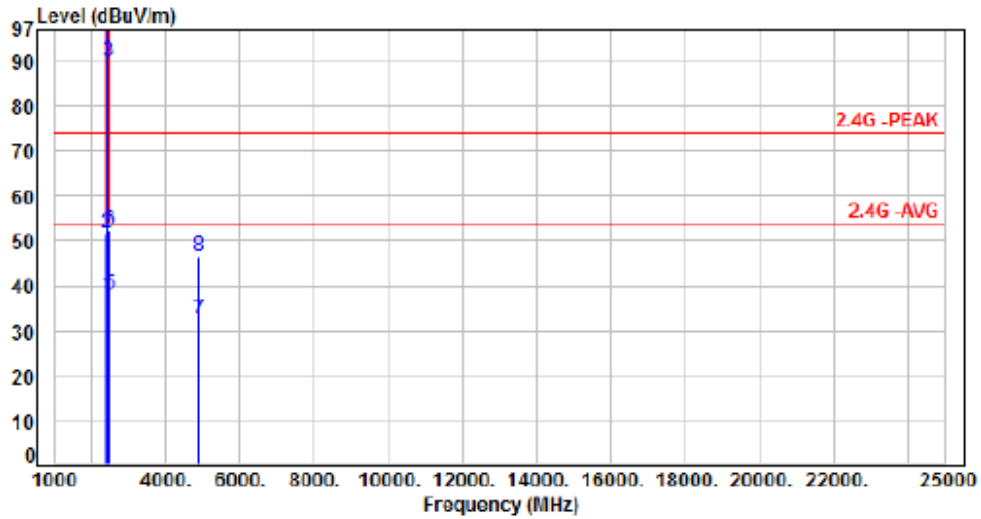

No.	Frequency (MHz)	Factor (dB)	Reading (dBuV)	Level (dBuV/m)	Limit (dBuV/m)	Margin (dB)	Detector	Height (cm)	Azimuth (deg)	P/F
1	2390.00	-2.64	40.41	37.77	54.00	-16.23	Average	100	319	P
2	2390.00	-2.64	54.45	51.81	74.00	-22.19	Peak	100	319	P
3	2437.00	-2.57	92.49	89.92	200.00	-110.08	Average	100	319	P
4	2437.00	-2.57	103.06	101.29	200.00	-98.71	Peak	100	319	P
5	2483.50	-2.39	40.49	38.10	54.00	-15.90	Average	100	319	P
6	2483.50	-2.39	54.75	52.36	74.00	-21.64	Peak	100	319	P
7	4874.00	5.18	27.11	32.29	54.00	-21.71	Average	100	292	P
8	4874.00	5.18	41.12	46.30	74.00	-27.70	Peak	100	292	P

Note: Level=Reading+Factor  
 Margin=Level-Limit  
 Factor=Antenna Factor + cable loss - Amplifier Factor



Power	:	From Adapter (AC 120V / 60Hz)	Pol/Phase	:	VERTICAL
Test Mode	:	Mode 4, CH11		:	

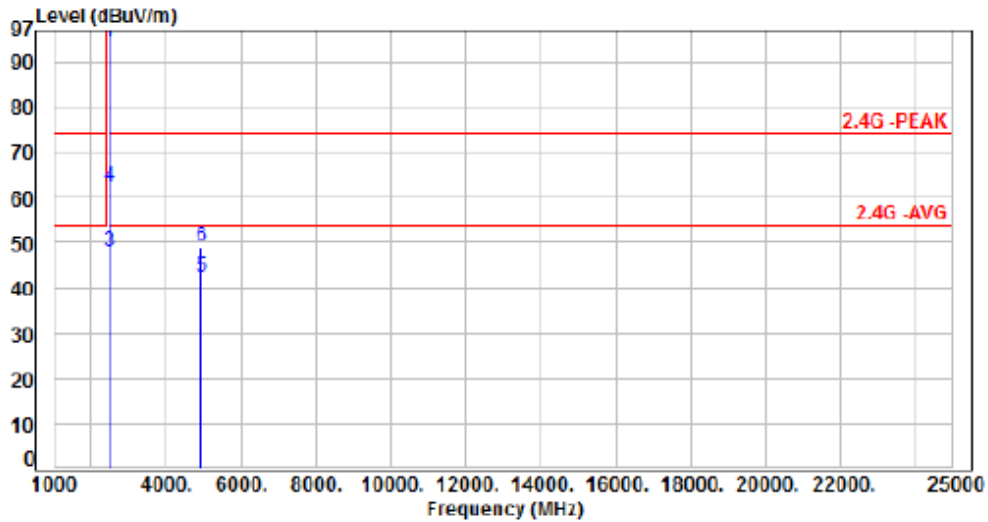

No.	Frequency (MHz)	Factor (dB)	Reading (dBUV)	Level (dBUV/m)	Limit (dBUV/m)	Margin (dB)	Detector	Height (cm)	Azimuth (deg)	P/F
1	2462.00	-2.49	97.08	94.59	200.00	-105.41	Average	100	78	P
2	2462.00	-2.49	108.16	105.67	200.00	-94.33	Peak	100	78	P
3	2483.50	-2.39	50.16	47.77	54.00	-6.23	Average	100	78	P
4	2483.50	-2.39	64.63	62.24	74.00	-11.76	Peak	100	78	P
5	4924.00	5.39	37.17	42.56	54.00	-11.44	Average	190	144	P
6	4924.00	5.39	43.74	49.13	74.00	-24.87	Peak	190	144	P

Note: Level=Reading+Factor  
Margin=Level-Limit  
Factor=Antenna Factor + cable loss - Amplifier Factor



Power	:	From Adapter (AC 120V / 60Hz)	Pol/Phase	:	HORIZONTAL
Test Mode	:	Mode 4, CH11		:	

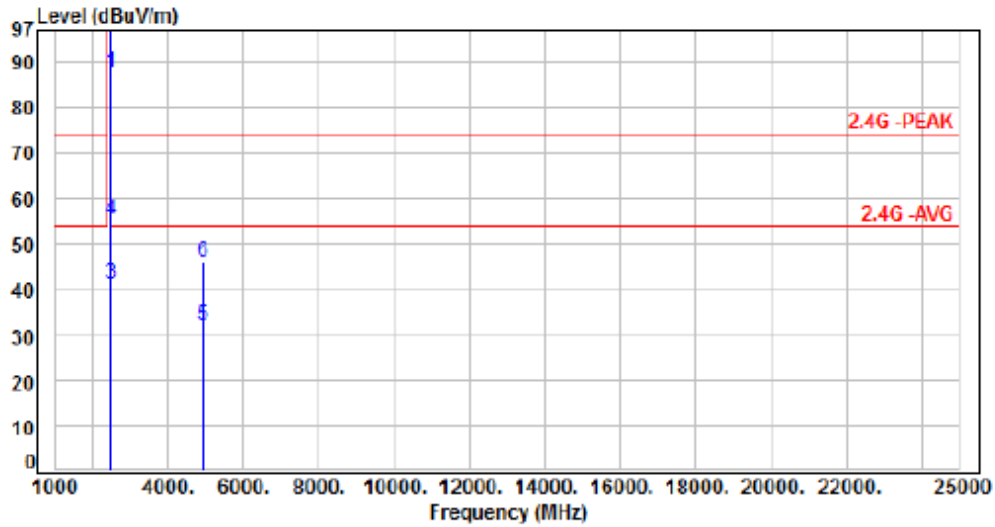

No.	Frequency (MHz)	Factor (dB)	Reading (dBuV)	Level (dBuV/m)	Limit (dBuV/m)	Margin (dB)	Detector	Height (cm)	Azimuth (deg)	P/F
1	2462.00	-2.49	90.43	87.94	200.00	-112.06	Average	100	318	P
2	2462.00	-2.49	101.17	98.68	200.00	-101.32	Peak	100	318	P
3	2483.50	-2.39	43.83	41.44	54.00	-12.56	Average	100	318	P
4	2483.50	-2.39	57.56	55.17	74.00	-18.83	Peak	100	318	P
5	4924.00	5.39	26.74	32.13	54.00	-21.87	Average	100	119	P
6	4924.00	5.39	40.66	46.05	74.00	-27.95	Peak	100	119	P

Note: Level=Reading+Factor  
 Margin=Level-Limit  
 Factor=Antenna Factor + cable loss - Amplifier Factor



Power	:	From Adapter (AC 120V / 60Hz)	Pol/Phase	:	VERTICAL
Test Mode	:	Mode 5, CH01		:	

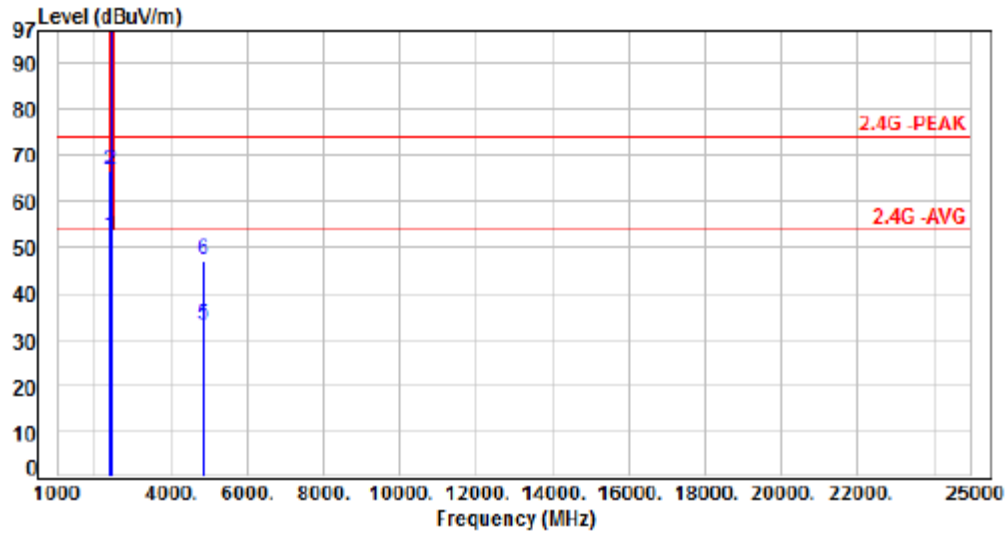

No.	Frequency (MHz)	Factor (dB)	Reading (dBuV)	Level (dBuV/m)	Limit (dBuV/m)	Margin (dB)	Detector	Height (cm)	Azimuth (deg)	P/F
1	2390.00	-2.64	54.86	52.22	54.00	-1.78	Average	121	97	P
2	2390.00	-2.64	69.22	66.58	74.00	-7.42	Peak	121	97	P
3	2412.00	-2.60	98.72	96.12	200.00	-103.88	Average	121	97	P
4	2412.00	-2.60	108.86	106.26	200.00	-93.74	Peak	121	97	P
5	4824.00	5.03	28.08	33.11	54.00	-20.89	Average	100	248	P
6	4824.00	5.03	42.31	47.34	74.00	-26.66	Peak	100	248	P

Note: Level=Reading+Factor  
 Margin=Level-Limit  
 Factor=Antenna Factor + cable loss - Amplifier Factor



Power	:	From Adapter (AC 120V / 60Hz)	Pol/Phase	:	HORIZONTAL
Test Mode	:	Mode 5, CH01		:	

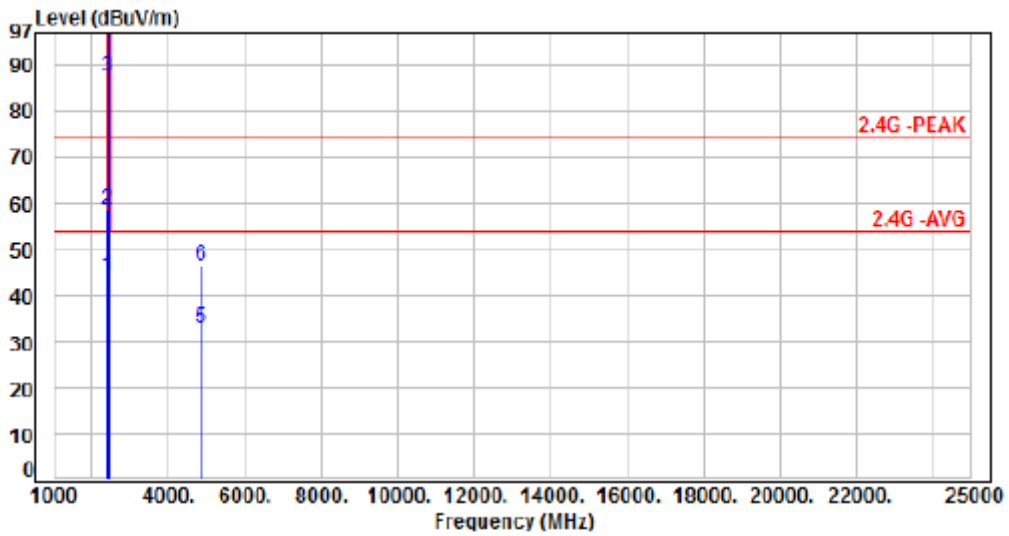

No.	Frequency (MHz)	Factor (dB)	Reading (dBuV)	Level (dBuV/m)	Limit (dBuV/m)	Margin (dB)	Detector	Height (cm)	Azimuth (deg)	P/F
1	2390.00	-2.64	46.75	44.11	54.00	-9.89	Average	140	185	P
2	2390.00	-2.64	61.21	58.57	74.00	-15.43	Peak	140	185	P
3	2412.00	-2.60	89.91	87.31	200.00	-112.69	Average	140	185	P
4	2412.00	-2.60	100.32	97.72	200.00	-102.28	Peak	140	185	P
5	4824.00	5.03	27.85	32.88	54.00	-21.12	Average	100	279	P
6	4824.00	5.03	41.53	46.56	74.00	-27.44	Peak	100	279	P

Note: Level=Reading+Factor  
 Margin=Level-Limit  
 Factor=Antenna Factor + cable loss - Amplifier Factor



Power	:	From Adapter (AC 120V / 60Hz)	Pol/Phase	:	VERTICAL
Test Mode	:	Mode 5, CH06		:	

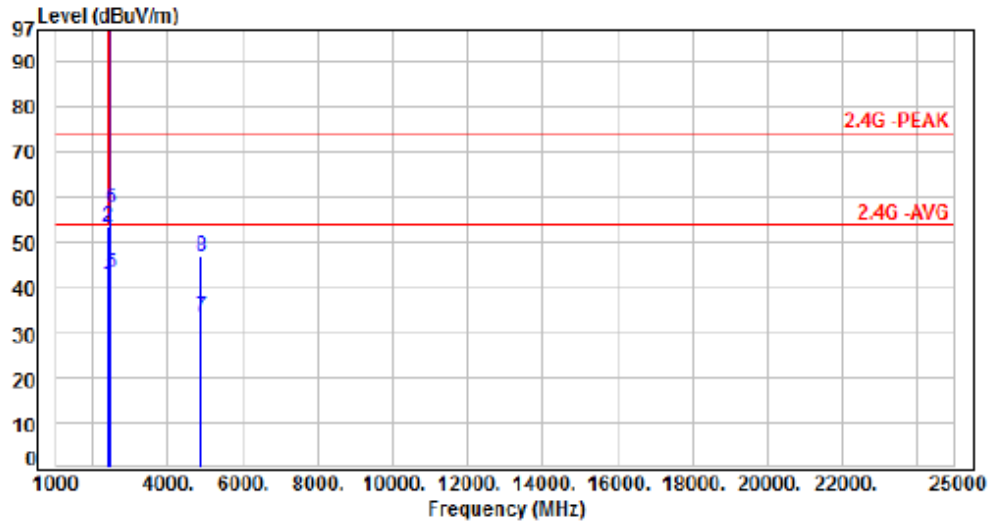

No.	Frequency (MHz)	Factor (dB)	Reading (dBuV)	Level (dBuV/m)	Limit (dBuV/m)	Margin (dB)	Detector	Height (cm)	Azimuth (deg)	P/F
1	2390.00	-2.64	43.38	40.74	54.00	-13.26	Average	239	160	P
2	2390.00	-2.64	56.22	53.58	74.00	-20.42	Peak	239	160	P
3	2437.00	-2.57	103.14	100.57	200.00	-99.43	Average	239	160	P
4	2437.00	-2.57	113.38	110.81	200.00	-89.19	Peak	239	160	P
5	2483.50	-2.39	45.54	43.15	54.00	-10.85	Average	239	160	P
6	2483.50	-2.39	59.80	57.41	74.00	-16.59	Peak	239	160	P
7	4874.00	5.18	28.31	33.49	54.00	-20.51	Average	100	212	P
8	4874.00	5.18	41.54	46.72	74.00	-27.28	Peak	100	212	P

Note: Level=Reading+Factor  
 Margin=Level-Limit  
 Factor=Antenna Factor + cable loss - Amplifier Factor



Power	:	From Adapter (AC 120V / 60Hz)	Pol/Phase	:	HORIZONTAL
Test Mode	:	Mode 5, CH06		:	

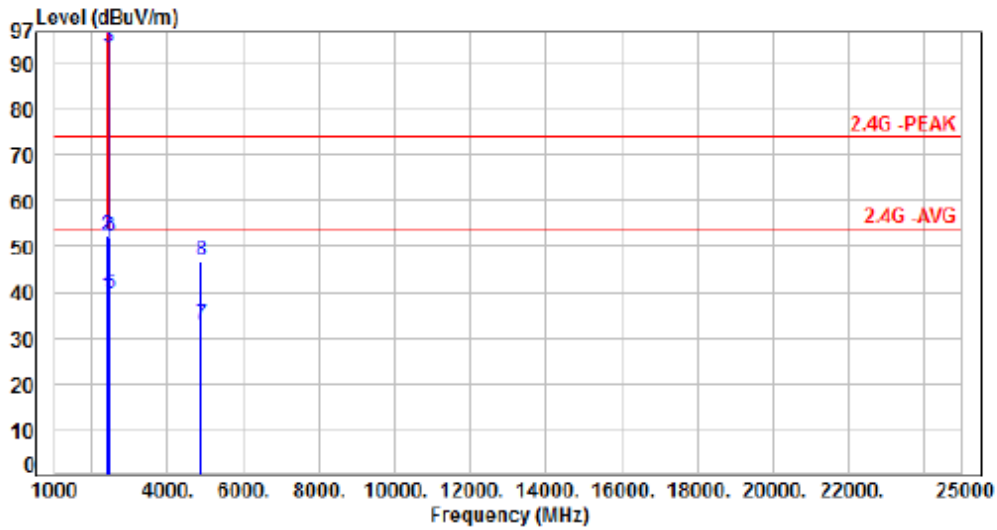

No.	Frequency (MHz)	Factor (dB)	Reading (dBuV)	Level (dBuV/m)	Limit (dBuV/m)	Margin (dB)	Detector	Height (cm)	Azimuth (deg)	P/F
1	2390.00	-2.64	41.63	38.99	54.00	-15.01	Average	145	184	P
2	2390.00	-2.64	54.98	52.34	74.00	-21.66	Peak	145	184	P
3	2437.00	-2.57	96.39	93.82	200.00	-106.18	Average	145	184	P
4	2437.00	-2.57	106.30	103.81	200.00	-96.19	Peak	145	184	P
5	2483.50	-2.39	41.68	39.29	54.00	-14.71	Average	145	184	P
6	2483.50	-2.39	54.39	52.00	74.00	-22.00	Peak	145	184	P
7	4874.00	5.18	27.76	32.94	54.00	-21.06	Average	100	295	P
8	4874.00	5.18	41.65	46.83	74.00	-27.17	Peak	100	295	P

Note: Level=Reading+Factor  
 Margin=Level-Limit  
 Factor=Antenna Factor + cable loss - Amplifier Factor



Power	:	From Adapter (AC 120V / 60Hz)	Pol/Phase	:	VERTICAL
Test Mode	:	Mode 5, CH11		:	

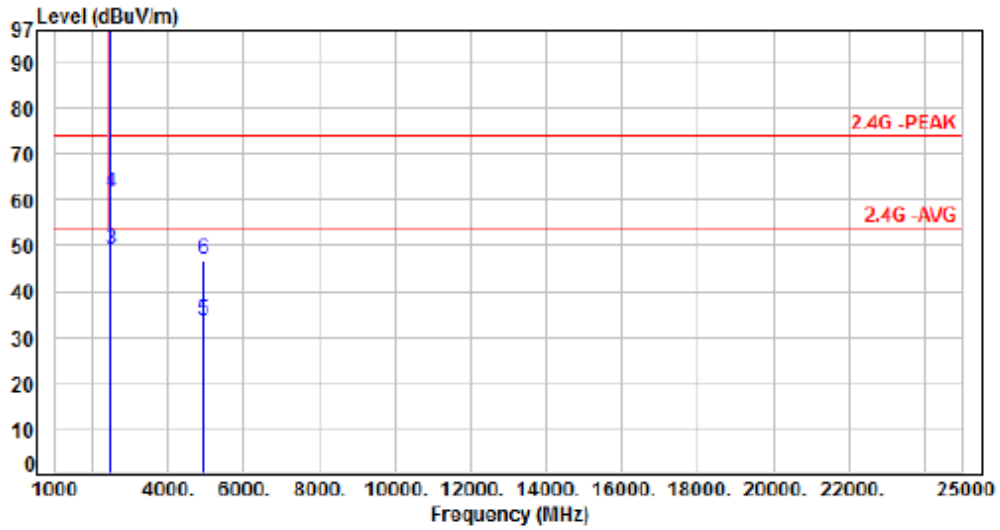

No.	Frequency (MHz)	Factor (dB)	Reading (dBuV)	Level (dBuV/m)	Limit (dBuV/m)	Margin (dB)	Detector	Height (cm)	Azimuth (deg)	P/F
1	2462.00	-2.49	105.21	102.72	200.00	-97.28	Average	116	45	P
2	2462.00	-2.49	116.39	113.90	200.00	-86.10	Peak	116	45	P
3	2483.50	-2.39	51.37	48.98	54.00	-5.02	Average	116	45	P
4	2483.50	-2.39	64.04	61.65	74.00	-12.35	Peak	116	45	P
5	4924.00	5.39	28.15	33.54	54.00	-20.46	Average	100	201	P
6	4924.00	5.39	41.52	46.91	74.00	-27.09	Peak	100	201	P

Note: Level=Reading+Factor  
 Margin=Level-Limit  
 Factor=Antenna Factor + cable loss - Amplifier Factor





Power	:	From Adapter (AC 120V / 60Hz)	Pol/Phase	:	HORIZONTAL
Test Mode	:	Mode 5, CH11		:	

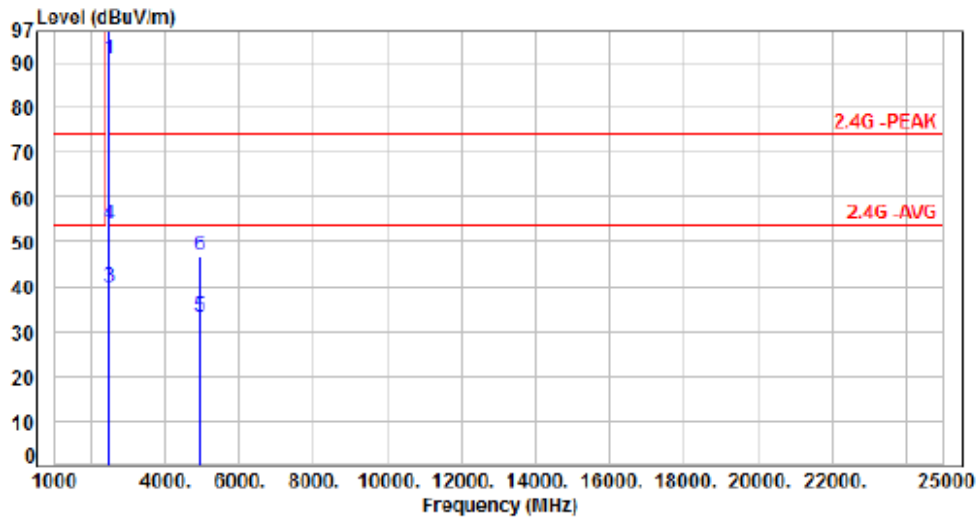

No.	Frequency (MHz)	Factor (dB)	Reading (dBuV)	Level (dBuV/m)	Limit (dBuV/m)	Margin (dB)	Detector	Height (cm)	Azimuth (deg)	P/F
1	2462.00	-2.49	93.12	90.63	200.00	-109.37	Average	303	167	P
2	2462.00	-2.49	102.84	100.35	200.00	-99.65	Peak	303	167	P
3	2483.50	-2.39	42.26	39.87	54.00	-14.13	Average	303	167	P
4	2483.50	-2.39	56.10	53.71	74.00	-20.29	Peak	303	167	P
5	4924.00	5.39	27.88	33.27	54.00	-20.73	Average	100	288	P
6	4924.00	5.39	41.29	46.68	74.00	-27.32	Peak	100	288	P

Note: Level=Reading+Factor  
 Margin=Level-Limit  
 Factor=Antenna Factor + cable loss - Amplifier Factor



### 6.7 Restricted Bands of Operation

Only spurious emissions are permitted in any of the frequency bands listed below:

MHz	MHz	MHz	GHz
0.09000 – 0.11000	16.42000 – 16.42300	399.9 – 410.0	4.500 – 5.250
0.49500 – 0.505**	16.69475 – 16.69525	608.0 – 614.0	5.350 – 5.460
2.17350 – 2.19050	16.80425 – 16.80475	960.0 – 1240.0	7.250 – 7.750
4.12500 – 4.12800	25.50000 – 25.67000	1300.0 – 1427.0	8.025 – 8.500
4.17725 – 4.17775	37.50000 – 38.25000	1435.0 – 1626.5	9.000 – 9.200
4.20725 – 4.20775	73.00000 – 74.60000	1645.5 – 1646.5	9.300 – 9.500
6.21500 – 6.21800	74.80000 – 75.20000	1660.0 – 1710.0	10.600 – 12.700
6.26775 – 6.26825	108.00000 – 121.94000	1718.8 – 1722.2	13.250 – 13.400
6.31175 – 6.31225	123.00000 – 138.00000	2200.0 – 2300.0	14.470 – 14.500
8.29100 – 8.29400	149.90000 – 150.05000	2310.0 – 2390.0	15.350 – 16.200
8.36200 – 8.36600	156.52475 – 156.52525	2483.5 – 2500.0	17.700 – 21.400
8.37625 – 8.38675	156.70000 – 156.90000	2655.0 – 2900.0	22.010 – 23.120
8.41425 – 8.41475	162.01250 – 167.17000	3260.0 – 3267.0	23.600 – 24.000
12.29000 – 12.29300	167.72000 – 173.20000	3332.0 – 3339.0	31.200 – 31.800
12.51975 – 12.52025	240.00000 – 285.00000	3345.8 – 3358.0	36.430 – 36.500
12.57675 – 12.57725	322.00000 – 335.40000	3600.0 – 4400.0	Above 38.6
13.36000 – 13.41000			

\*\* : Until February 1, 1999, this restricted band shall be 0.490-0.510 MHz



## 7. Test of Conducted Spurious Emission

### 7.1 Test Limit

According to the methods defined in ANSI C63.10-2013 Section 11.11.1

Below -30dB of the highest emission level of operating band (In 100 kHz Resolution Bandwidth)

### 7.2 Test Procedure

According to the methods defined in ANSI C63.10-2013 Section 11.11.2 & 11.11.3

- a. The transmitter output was connected to the spectrum analyzer via a low loss cable.
- b. Set RBW of spectrum analyzer to 100 KHz and VBW of spectrum analyzer to 300 KHz with convenient frequency span including 100 KHz bandwidth from band edge.
- c. Peak conducted output power measured within any 100 kHz outside the authorized frequency band shall be attenuated by at least 30dB relative to the maximum measured in-band peak PSD level.
- d. The band edges was measured and recorded.

### 7.3 Test Setup Layout

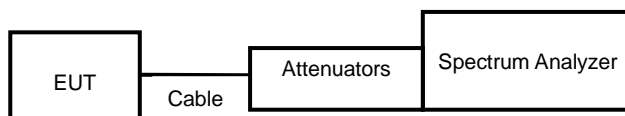

### 7.4 Test Result and Data

Note: Test plots refers to the following pages.



ANT B

Modulation Type: 802.11b, CH 01

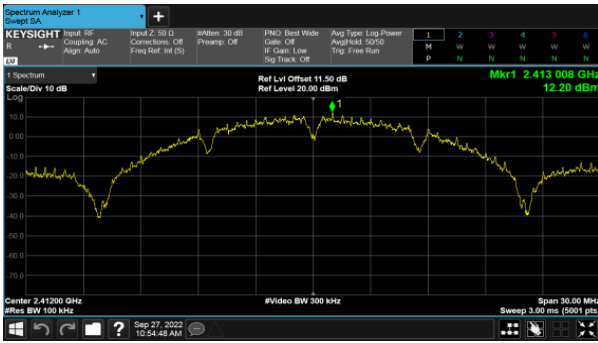

Modulation Type: 802.11b, CH 06

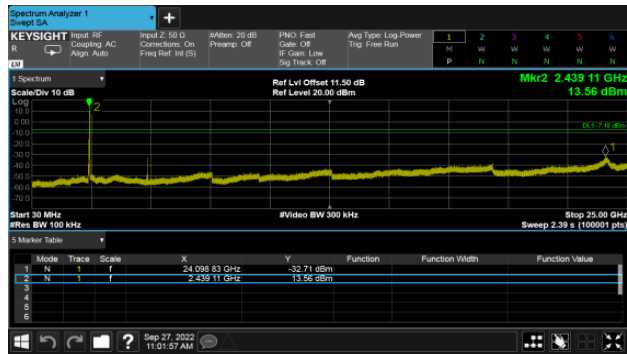
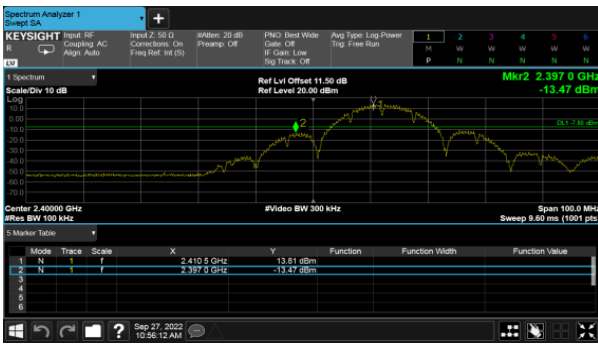
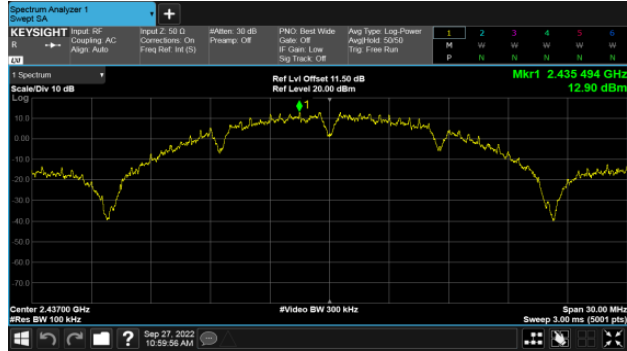



ANT B

Modulation Type: 802.11b, CH 11

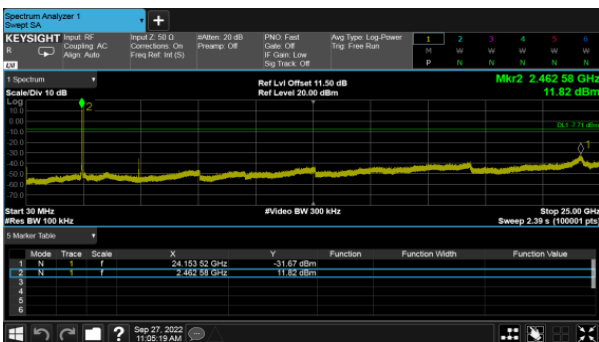
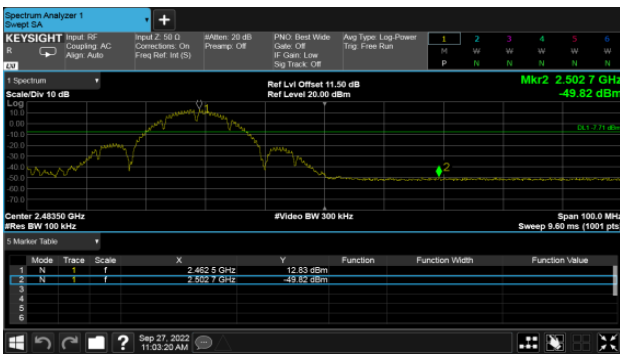
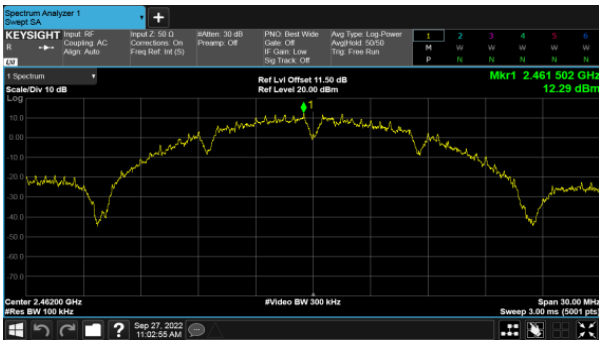



ANT B

Modulation Type: 802.11g, CH 01

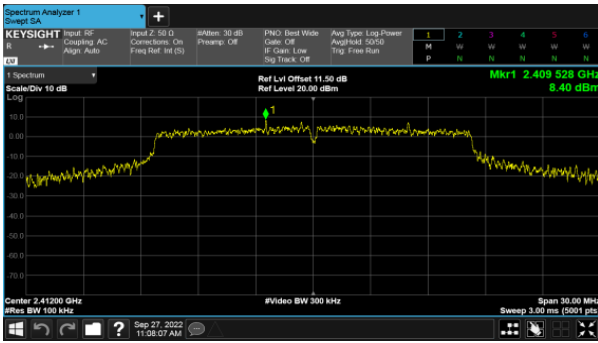

Modulation Type: 802.11g, CH 06

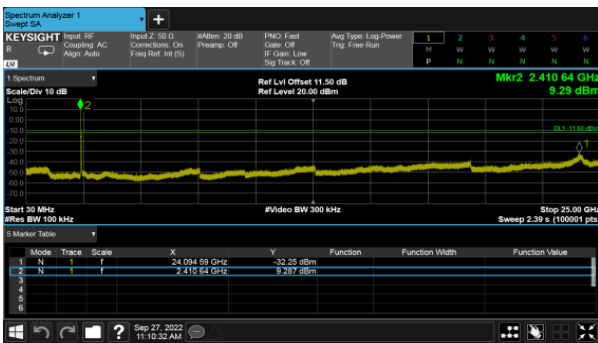
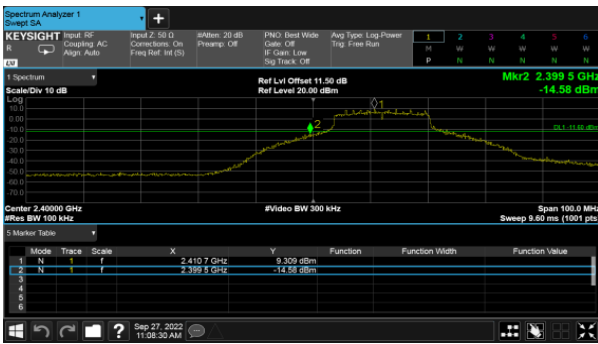
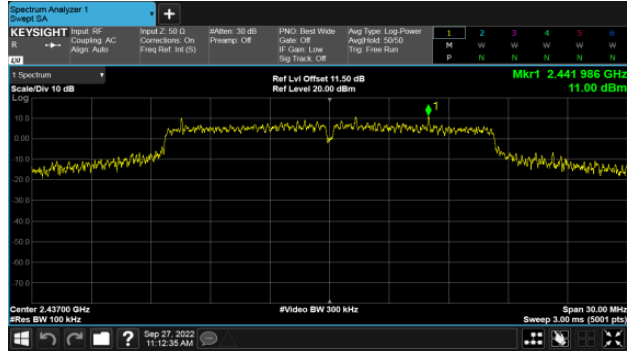



ANT B

Modulation Type: 802.11g, CH 11

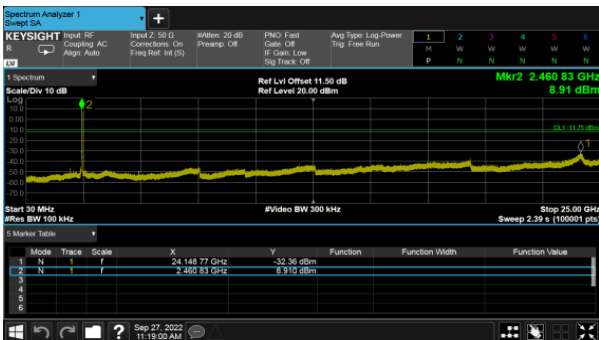
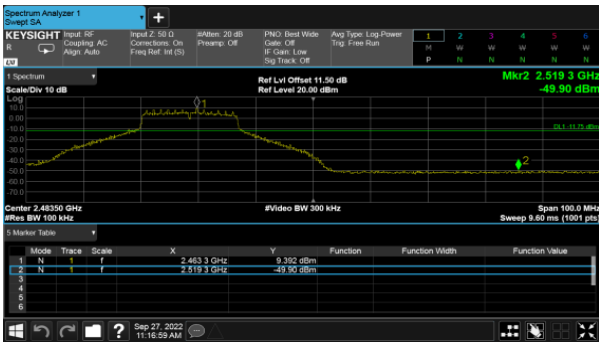
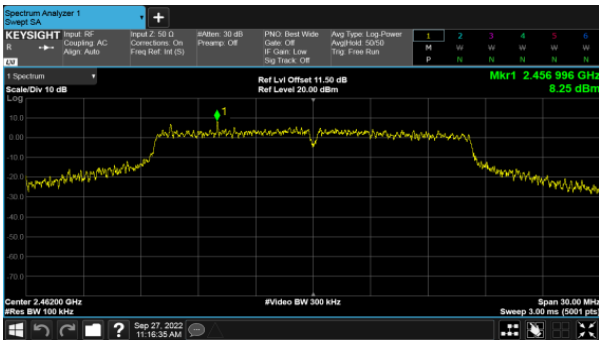



ANT A

Modulation Type: 802.11n HT20, CH01

Modulation Type: 802.11n HT20, CH06

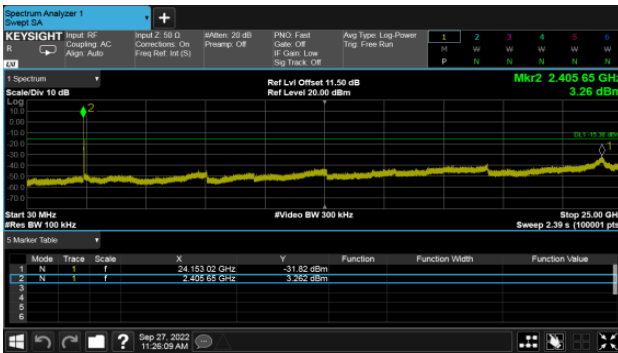
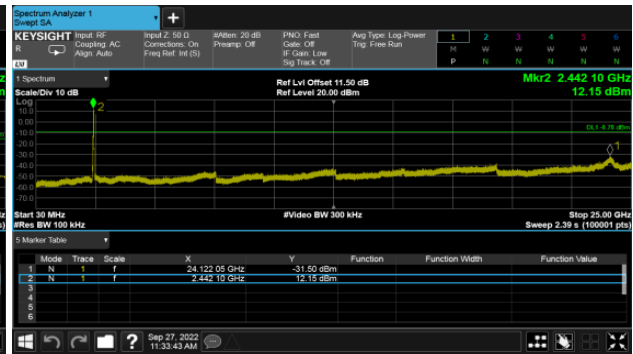
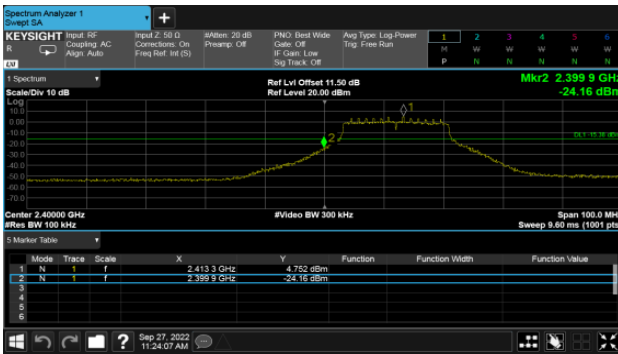
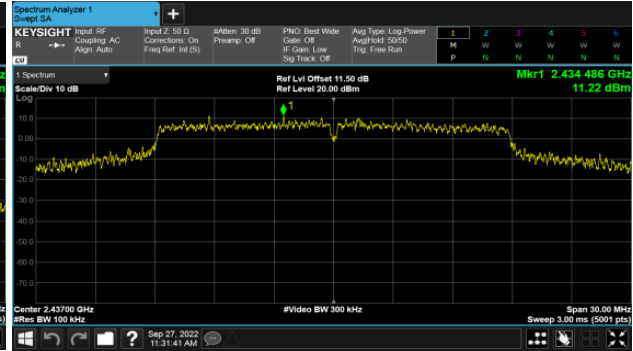
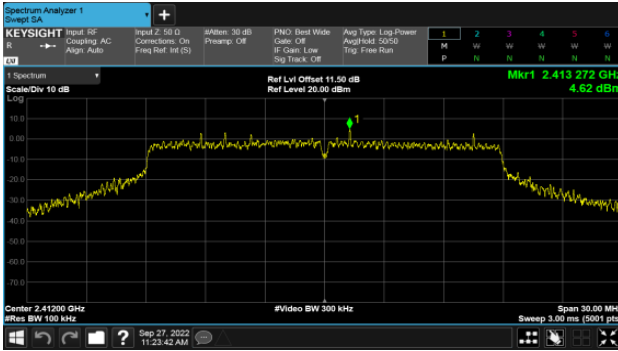





ANT A

Modulation Type: 802.11n HT20, CH11

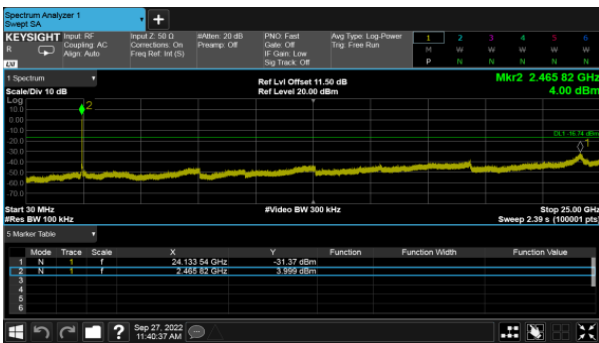
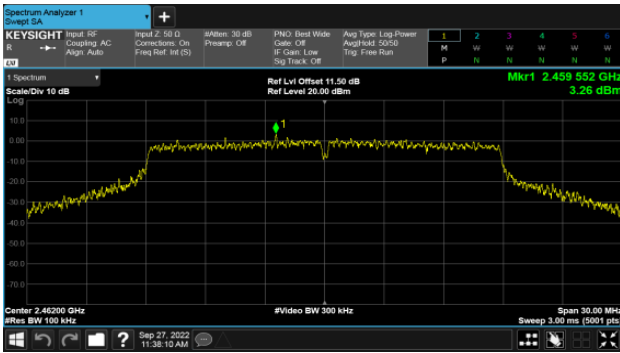



ANT B

Modulation Type: 802.11n HT20, CH01

Modulation Type: 802.11n HT20, CH06

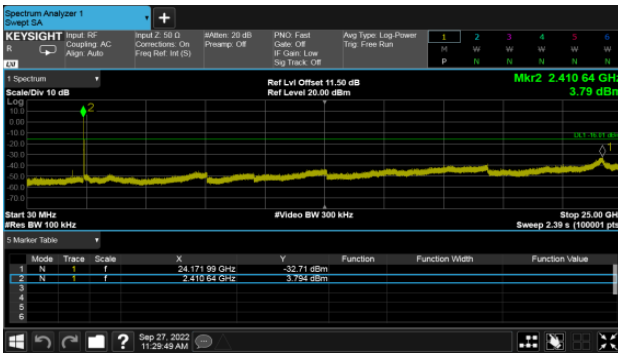
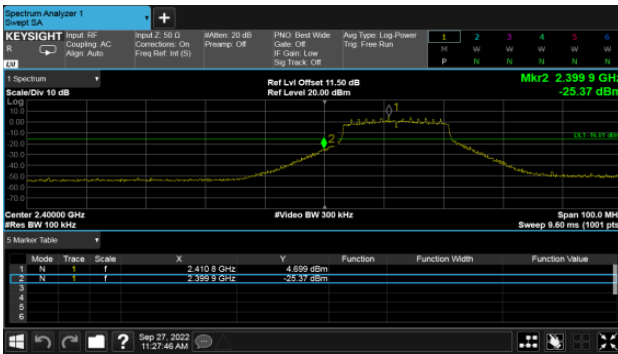
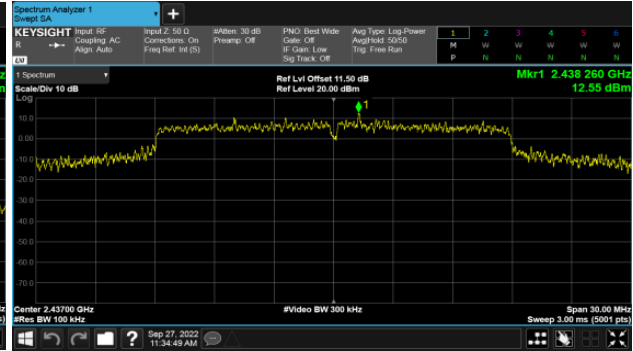
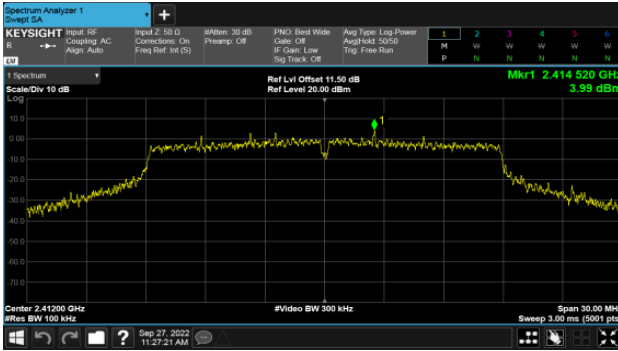



ANT B

Modulation Type: 802.11n HT20, CH11

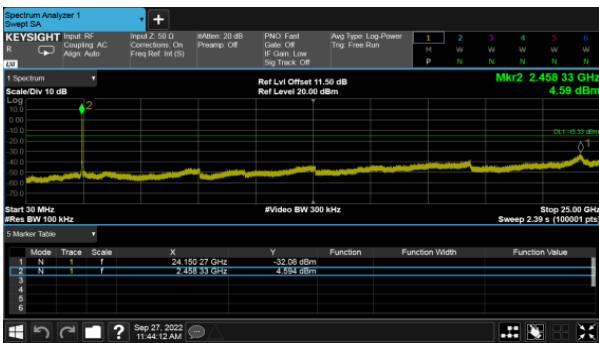
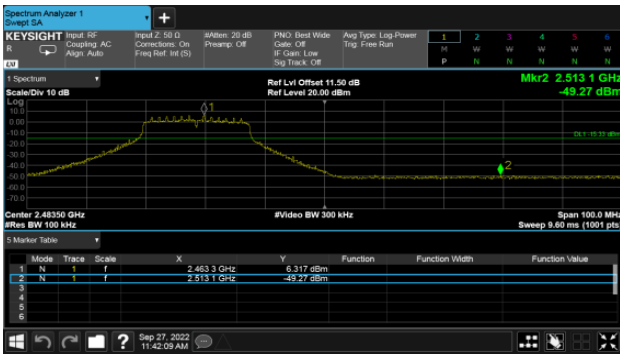
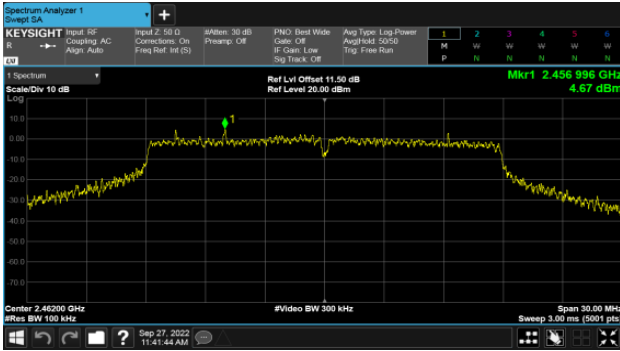



## 8. On Time, Duty Cycle and Measurement methods

### 8.1 Test Limit

None; for reporting purposes only.

### 8.2 Test Procedure

According to the methods defined in ANSI C63.10-2013 Section 11.6  
Zero-Span Spectrum Analyzer Method.

### 8.3 Test Setup Layout

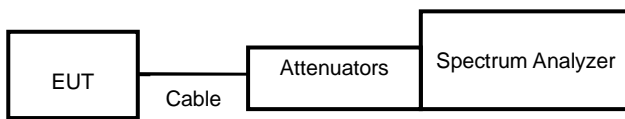

### 8.4 Test Result and Data

Modulation Type	On Time (ms)	Period Time (ms)	Duty Cycle (%)
11b,1M	12.26	12.31	99.59%
11g,6M	2.03	2.07	98.45%
11n HT20	1.90	1.93	98.44%



### Modulation Type: 802.11b(1Mbps)

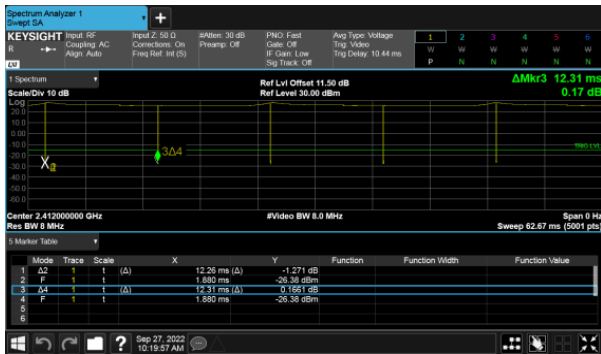

### Modulation Type: 802.11g(6Mbps)

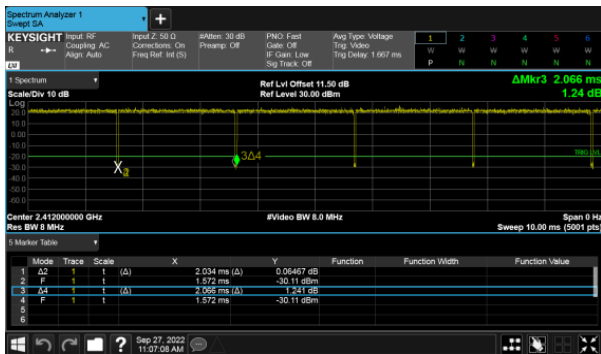

### Modulation Type: 802.11n HT20(6.5Mbps)

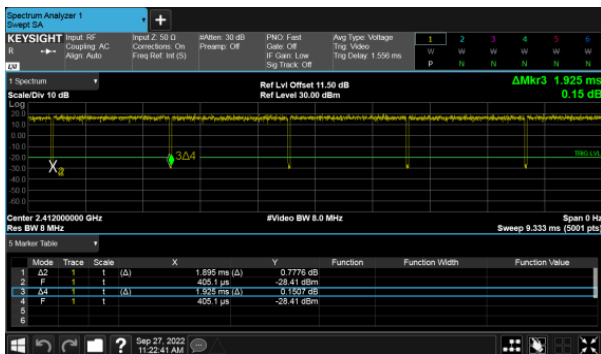



### 9. 6dB Bandwidth Measurement Data

#### 9.1 Test Limit

The minimum of 6dB Bandwidth Measurement is 0.5 MHz.

#### 9.2 Test Procedures

According to the methods defined in ANSI C63.10-2013 Section 11.8

- a. The transmitter output was connected to the spectrum analyzer.
- b. Set RBW of spectrum analyzer to 100 KHz and VBW to 300 KHz.
- c. The 6 dB bandwidth is defined as the total spectrum the power of which is higher than peak power minus 6 dB.
- d. The 6dB Bandwidth was measured and recorded.

#### 9.3 Test Setup Layout

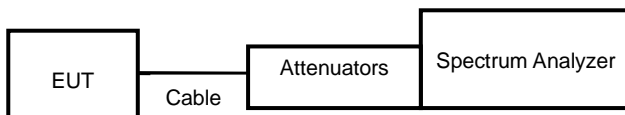

#### 9.4 Test Result and Data

Modulation Type	Channel	Frequency (MHz)	6dB Bandwidth (MHz)		Limit (MHz)
			ANT A	ANT B	
11b	1	2412	-	9.10	0.5
	6	2437	-	10.06	0.5
	11	2462	-	9.08	0.5
11g	1	2412	-	15.50	0.5
	6	2437	-	16.33	0.5
	11	2462	-	15.92	0.5
11n HT20	1	2412	16.19	15.72	0.5
	6	2437	15.92	17.56	0.5
	11	2462	15.95	15.99	0.5



ANT B 6dB Bandwidth  
Modulation Type: 802.11b  
CH01

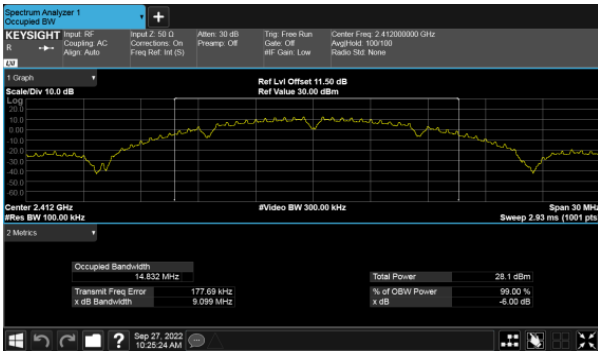

Modulation Type: 802.11g  
CH01

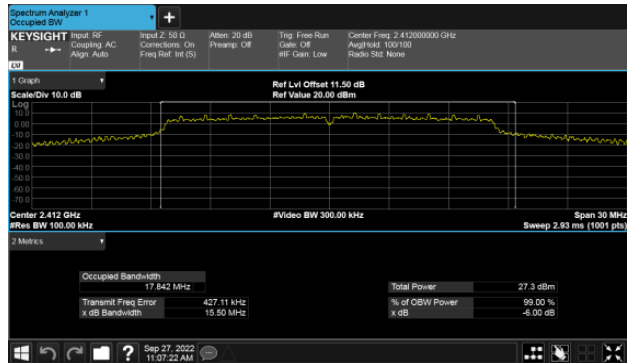

CH06

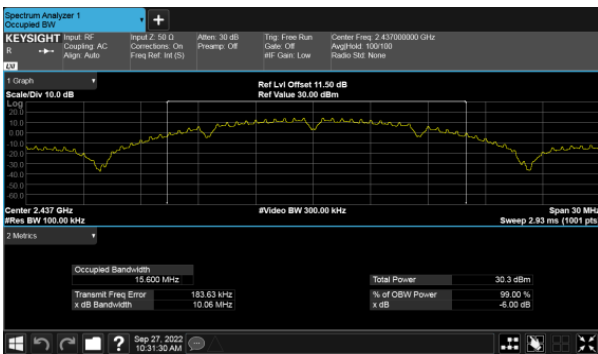

CH06

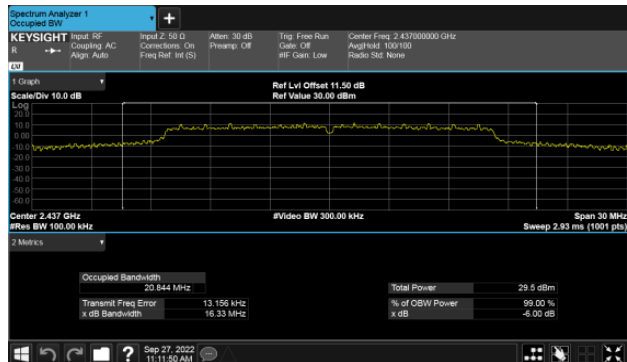

CH11

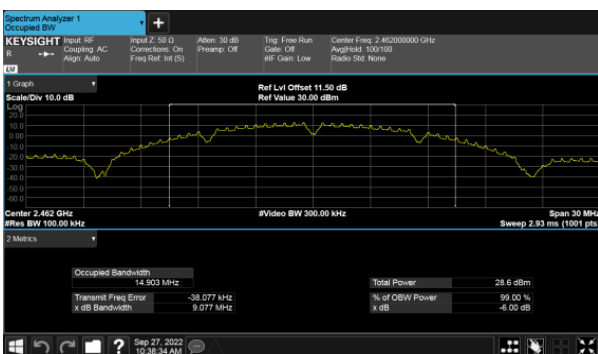

CH11

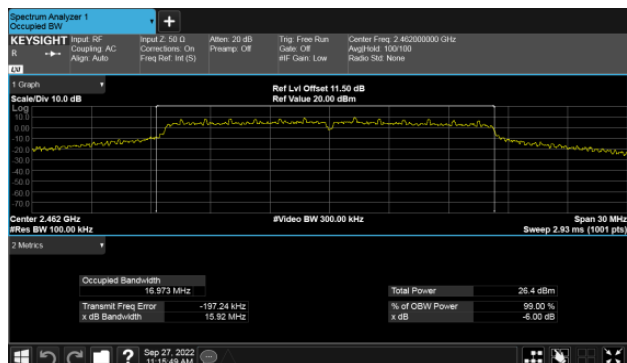



ANT A 6dB Bandwidth  
Modulation Type: 802.11n HT20  
CH01

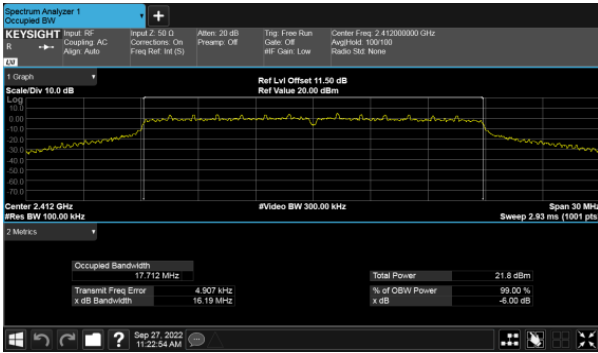

ANT B 6dB Bandwidth  
Modulation Type: 802.11n HT20  
CH01

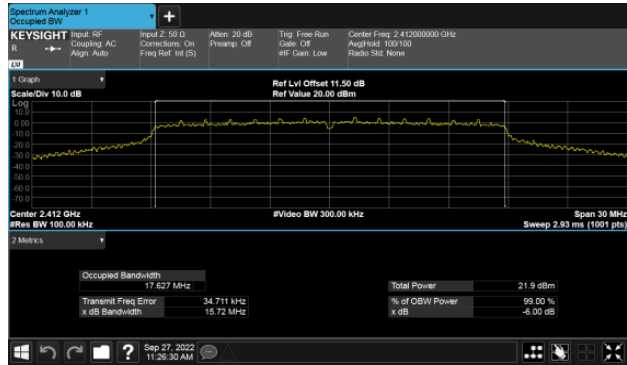

CH06

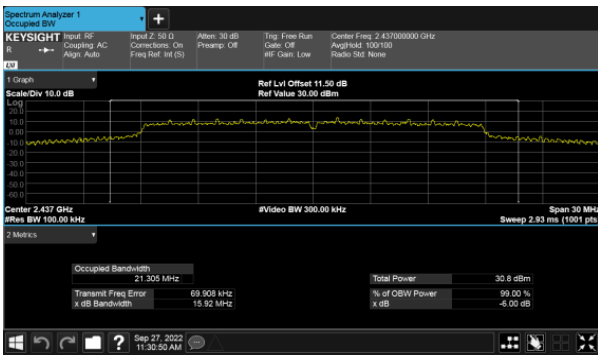

CH06

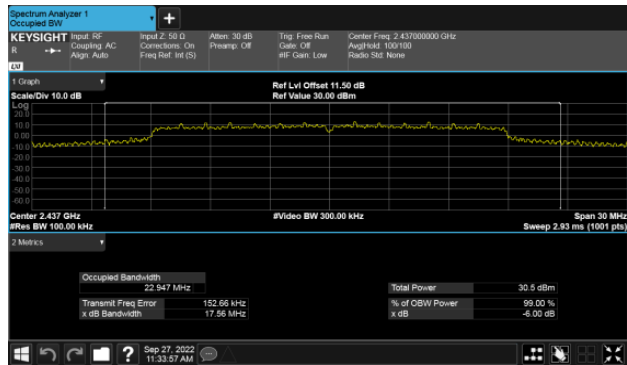

CH11

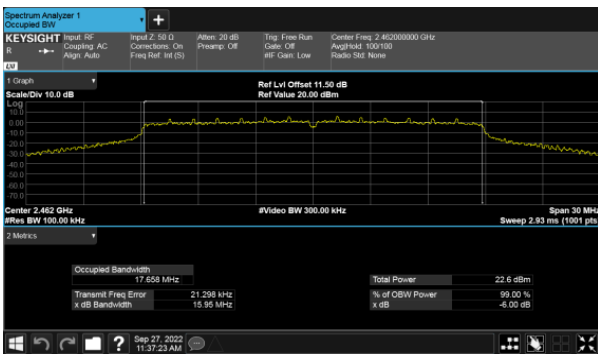

CH11

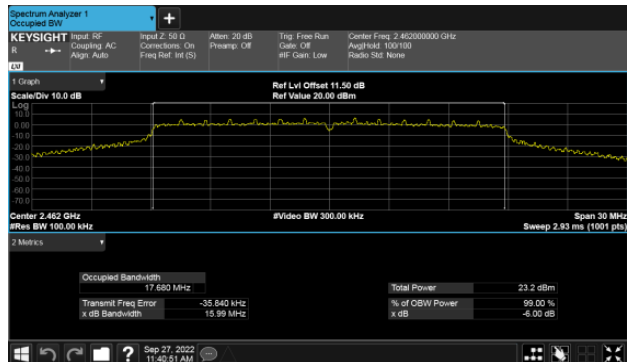





## 10. Maximum Peak and Average Output Power

### 10.1 Test Limit

The Maximum Peak Output Power Measurement is 30dBm.

If transmitting antennas of directional gain greater than 6 dBi are used, the peak output power shall be reduced by the amount in dB that the directional gain of the antenna exceeds 6 dBi

### 10.2 Test Procedures

According to the methods defined in ANSI C63.10-2013 Section 11.9.2.3.2

The antenna port (RF output) of the EUT was connected to the input (RF input) of a power meter. Power was read directly from the meter and cable loss connection was added to the reading to obtain power at the EUT antenna terminal. The EUT Output Power was set to maximum to produce the worse case test result.

### 10.3 Test Setup Layout

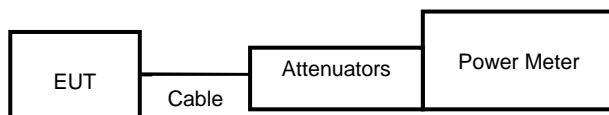



## 10.4 Test Result and Data

Setting	Modulation Mode	Channel	Frequency (MHz)	Conducted(peak) output power (dBm)	Total PK power (dBm)	Total PK power (mW)	Powe Limit (dBm)
				ANT A			
22	11b	1	2412	24.39	24.39	274.789	30.00
23		6	2437	25.02	25.02	317.687	30.00
20		11	2462	22.50	22.50	177.828	30.00
19	11g	1	2412	23.38	23.38	217.771	30.00
22		6	2437	25.18	25.18	329.610	30.00
18		11	2462	22.45	22.45	175.792	30.00

Setting	Modulation Mode	Channel	Frequency (MHz)	Conducted(average) output power (dBm)	Total AV power (dBm)	Total AV power (mW)	Powe Limit (dBm)
				ANT A			
22	11b	1	2412	22.77	22.77	189.234	NA
23		6	2437	22.81	22.81	190.985	NA
20		11	2462	20.40	20.40	109.648	NA
19	11g	1	2412	19.10	19.10	81.283	NA
22		6	2437	22.07	22.07	161.065	NA
18		11	2462	18.19	18.19	65.917	NA

Note: Average power is for reference only.



Setting	Modulation Mode	Channel	Frequency (MHz)	Conducted(peak) output power (dBm)	Total PK power (dBm)	Total PK power (mW)	Powe Limit (dBm)
				ANT B			
22	11b	1	2412	24.49	24.49	281.190	30.00
23		6	2437	24.52	24.52	283.139	30.00
20		11	2462	23.09	23.09	203.704	30.00
19	11g	1	2412	22.64	22.64	183.654	30.00
22		6	2437	25.55	25.55	358.922	30.00
18		11	2462	22.33	22.33	171.002	30.00

Setting	Modulation Mode	Channel	Frequency (MHz)	Conducted(average) output power (dBm)	Total AV power (dBm)	Total AV power (mW)	Powe Limit (dBm)
				ANT B			
22	11b	1	2412	22.81	22.81	190.985	NA
23		6	2437	22.85	22.85	192.752	NA
20		11	2462	21.12	21.12	129.420	NA
19	11g	1	2412	19.43	19.43	87.700	NA
22		6	2437	23.65	23.65	231.739	NA
18		11	2462	18.57	18.57	71.945	NA

Note: Average power is for reference only.



Setting	Modulation Mode	Channel	Frequency (MHz)	Conducted(peak) output power (dBm)		Total PK power (dBm)	Total PK power (mW)	Powe Limit (dBm)
				ANT A	ANT B			
14	11n HT20	1	2412	19.12	18.52	21.84	152.780	30.00
23		6	2437	25.48	24.82	28.17	656.572	30.00
15		11	2462	19.79	18.64	22.26	168.394	30.00

Setting	Modulation Mode	Channel	Frequency (MHz)	Conducted(average) output power (dBm)		Total AV power (dBm)	Total AV power (mW)	Powe Limit (dBm)
				ANT A	ANT B			
14	11n HT20	1	2412	14.26	13.83	17.06	50.823	NA
23		6	2437	22.63	22.44	25.55	358.619	NA
15		11	2462	15.03	14.03	17.57	57.135	NA

Note: Average power is for reference only.



### 11. Power Spectral Density

#### 11.1 Test Limit

The Maximum of Power Spectral Density Measurement is 8dBm.

If transmitting antennas of directional gain greater than 6 dBi are used, the power spectral density shall be reduced by the amount in dB that the directional gain of the antenna exceeds 6 dBi

#### 11.2 Test Procedures

According to the methods defined in ANSI C63.10-2013 Section 11.10

- a. The transmitter output was connected to spectrum analyzer.
- b. The spectrum analyzer’s resolution bandwidth were set at 3kHz RBW and 10KHz VBW as that of the fundamental frequency. Set the sweep time=auto couple.
- c. The power spectral density was measured and recorded.

#### 11.3 Test Setup Layout

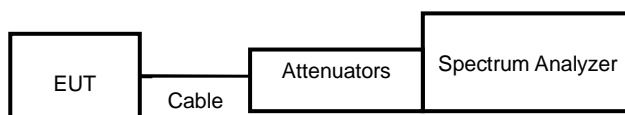

#### 11.4 Test Result and Data

Modulation Type	Channel	Frequency (MHz)	Maximum Power Density of 3KHz Bandwidth(dBm)		Sum chain (dBm)	Duty Cycle CF(dB)	Total PSD (dBm)	Limit (dBm)
			ANT A	ANT B				
11b	1	2412	-	-0.46	-0.46	0.00	-0.46	8.00
	6	2437	-	-0.5	-0.50	0.00	-0.50	8.00
	11	2462	-	-0.26	-0.26	0.00	-0.26	8.00
11g	1	2412	-	-5.96	-5.96	0.00	-5.96	8.00
	6	2437	-	-3.02	-3.02	0.00	-3.02	8.00
	11	2462	-	-7.24	-7.24	0.00	-7.24	8.00
11n HT20	1	2412	-12.52	-10.79	-8.56	0.00	-8.56	8.00
	6	2437	-2.34	-4.36	-0.22	0.00	-0.22	8.00
	11	2462	-8.63	-9.86	-6.19	0.00	-6.19	8.00



ANT B  
Modulation Type: 802.11b  
CH01

Modulation Type: 802.11g  
CH01

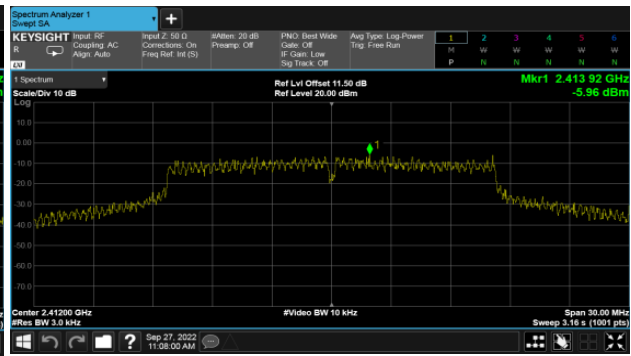
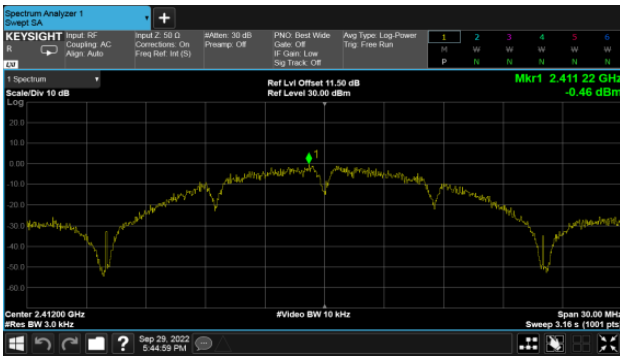

CH06

CH06

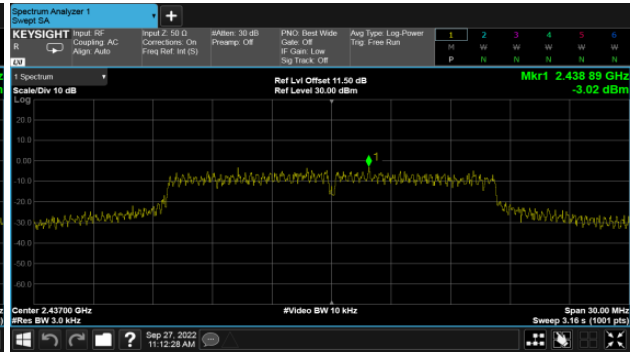
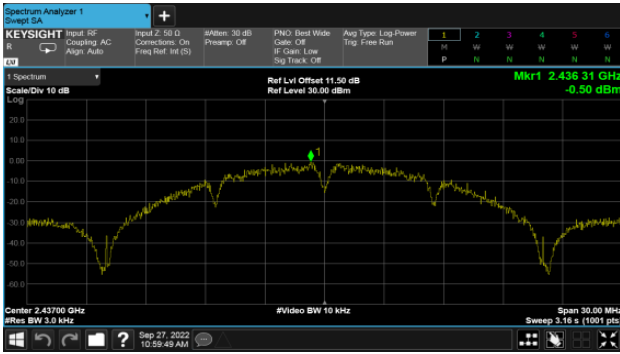

CH11

CH11

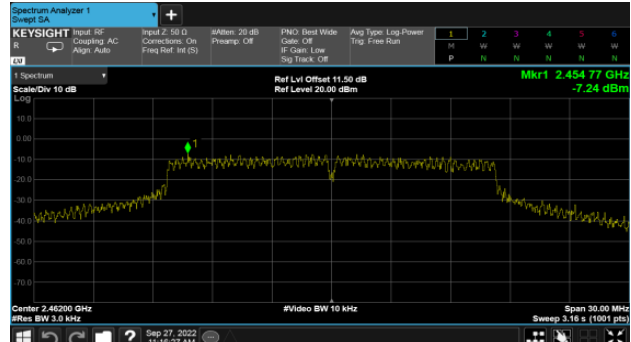
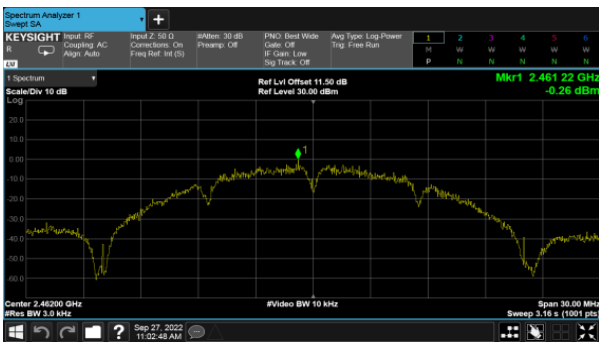



ANT A  
Modulation Type: 802.11n HT20  
CH01

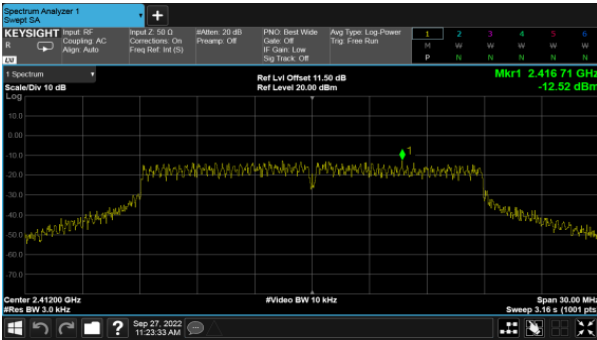

ANT B  
Modulation Type: 802.11n HT20  
CH01

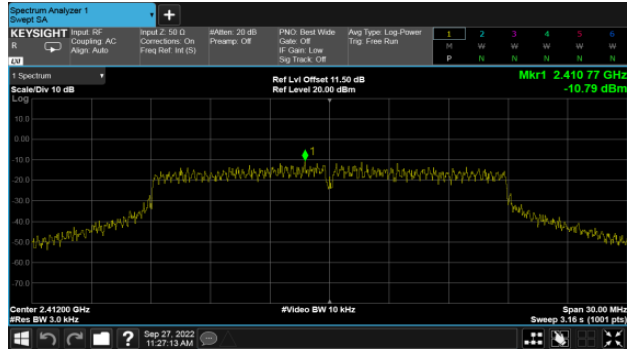

CH06

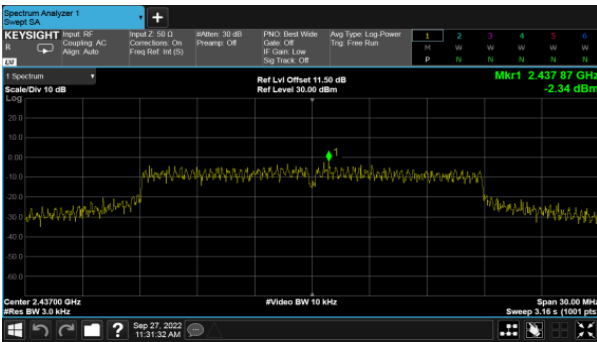

CH06

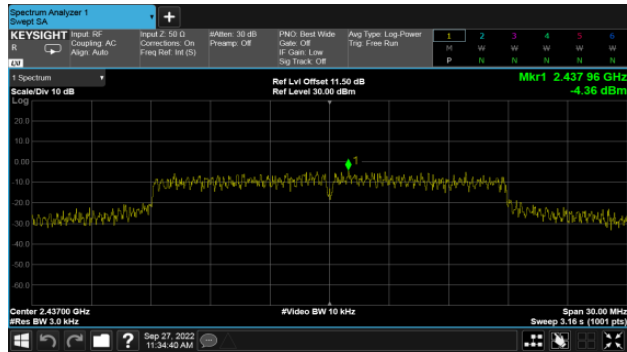

CH11

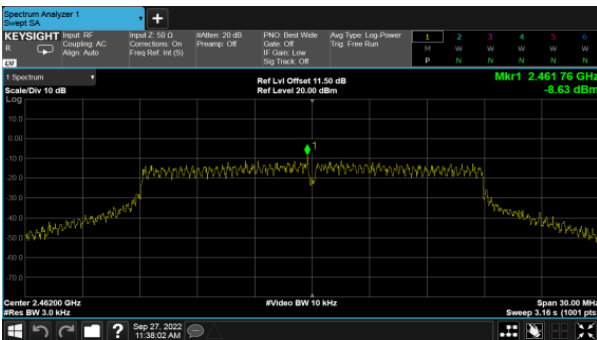

CH11

