



Test report No:
2390387R-RF-US-P06V01

FCC&IC TEST REPORT

Product Name	POS
Trademark	Elo
Model and /or type reference	EMC-M100C
FCC ID	RBWEMCM100C
IC	10757B-EMCM100C
Applicant's name / address	Elo Touch Solutions, Inc 670 N. McCarthy Blvd., Suite 100, Milpitas, CA 95035, USA.
Test method requested, standard	47 CFR FCC Part 15 (Section 15.225) ANSI C63.10: 2013 RSS-210 Issue 10 RSS-Gen Issue 5
Verdict Summary	IN COMPLIANCE
Documented by (name / position & signature)	Jun Xu/ Project Manager 
Approved by (name / position & signature)	Jack Zhang/ Manager 
Date of issue	2024-05-28
Report Version	V1.0
Report template No	Template_FCC 15.225-RF-V1.0

INDEX

	page
Competences and Guarantees.....	4
General conditions.....	4
Environmental conditions.....	4
Possible test case verdicts	5
Abbreviations	5
Document History	6
Remarks and Comments	6
Used Equipment	7
Uncertainty.....	8
1 General Information.....	9
1.1 General Description of the Item(s)	9
1.2. Antenna information	10
1.3. Channel List	11
2 Description of Test Setup	12
2.1 Operating mode(s) used for tests.....	12
2.2 Support / Auxiliary equipment / unit / Test software for the EUT	12
2.3 Test Configuration / Block diagram used for tests	13
2.4 Testing process	14
3 Verdict summary section	15
3.1 Standards	15
3.2 Overview of results.....	16
3.3 Test Matrix.....	17
3.4 Test Facility	18
4 Test Results.....	19
4.1 AC Power Line Conducted Emission	19
4.1.1 Limit.....	19
4.1.2 Test Setup.....	19
4.1.3 Test Procedure	19
4.2 E-field Emission.....	20
4.2.1 Limit.....	20
4.2.2 Test Setup.....	20
4.2.3 Test Procedure	20
4.3 Field Strength of Spurious.....	21
4.3.1 Limit.....	21

4.3.2	Test Setup.....	22
4.3.3	Test Procedure	23
4.4	Emission bandwidth	24
4.4.1	Limit.....	24
4.4.2	Test Setup.....	24
4.4.3	Test Procedure	24
4.5	Frequency Stability.....	25
4.5.1	Limit:.....	25
4.5.2	Test Setup.....	25
4.5.3	Test Procedure	25
4.6	Antenna Requirement	26
4.6.1	Limit:.....	26
4.6.2	Antenna Connector Construction:.....	26
5	Test setup photo and EUT Photo	27
	Appendix A: AC Power Line Conducted Emission	28
	Appendix B: E-field Emission	30
	Appendix C: Field Strength of Spurious	33
	Appendix D: Emission Bandwidth.....	39
	Appendix E: Frequency Stability.....	40

COMPETENCES AND GUARANTEES

DEKRA is a testing laboratory competent to carry out the tests described in this report.

In order to assure the traceability to other national and international laboratories, DEKRA has a calibration and maintenance program for its measurement equipment.

DEKRA guarantees the reliability of the data presented in this report, which is the result of the measurements and the tests performed to the item under test on the date and under the conditions stated in the report and it is based on the knowledge and technical facilities available at DEKRA at the time of performance of the test.

DEKRA is liable to the client for the maintenance of the confidentiality of all information related to the item under test and the results of the test.

The results presented in this Test Report apply only to the particular item under test established in this document.

IMPORTANT: No parts of this report may be reproduced or quoted out of context, in any form or by any means, except in full, without the previous written permission of DEKRA.

GENERAL CONDITIONS

Test Location	No. 99, Hongye Road, Suzhou Industrial Park Suzhou, 215006, P.R. China
Date(receive sample)	Dec. 26, 2023
Date (start test)	Dec. 29, 2023
Date (finish test)	Feb. 22, 2024

1. This report is only referred to the item that has undergone the test.
2. This report does not constitute or imply on its own an approval of the product by the Certification Bodies or Competent Authorities.
3. This document is only valid if complete; no partial reproduction can be made without previous written permission of DEKRA.
4. This test report cannot be used partially or in full for publicity and/or promotional purposes without previous written permission of DEKRA.

ENVIRONMENTAL CONDITIONS

The climatic conditions during the tests are within the limits specified by the manufacturer for the operation of the EUT and the test equipment. The climatic conditions during the tests were within the following limits:

Ambient temperature	15 °C – 35 °C
Relative Humidity air	30% - 60%

If explicitly required in the basic standard or applied product / product family standard the climatic values are recorded and documented separately in this test report.

POSSIBLE TEST CASE VERDICTS

Test case does not apply to test object	N/A
Test object does meet requirement	P (Pass) / PASS
Test object does not meet requirement	F (Fail) / FAIL
Not measured	N/M

ABBREVIATIONS

For the purposes of the present document, the following abbreviations apply:

EUT	: Equipment Under Test
QP	: Quasi-Peak
CAV	: CISPR Average
AV	: Average
CDN	: Coupling Decoupling Network
SAC	: Semi-Anechoic Chamber
OATS	: Open Area Test Site
BW	: Bandwidth
AM	: Amplitude Modulation
PM	: Pulse Modulation
HCP	: Horizontal Coupling Plane
VCP	: Vertical Coupling Plane
U_N	: Nominal voltage
T_x	: Transmitter
R_x	: Receiver
N/A	: Not Applicable
N/M	: Not Measured

DOCUMENT HISTORY

Report No.	Version	Description	Issued Date
2390387R-RF-US-P06V01	V1.0	Initial issue of report.	2024-05-28

REMARKS AND COMMENTS

1. The equipment under test (EUT) does meet the essential requirements of the stated standard(s)/test(s).
2. These test results on a sample of the device are for the purpose of demonstrating Compliance with 47 CFR FCC Part 15 (Section 15.225) and RSS-210 Issue 10, RSS-Gen Issue 5.
3. The measurement result is considered in conformance with the requirement if it is within the prescribed limit, It is not necessary to account the uncertainty associated with the measurement result.
4. The test results presented in this report relate only to the object tested.
5. The test report shall not be reproduced without the written approval of DEKRA Testing and Certification (Suzhou) Co., Ltd.
6. This report will not be used for social proof function in China market.
7. DEKRA declines any responsibility with the following test data provided by customer that may affect the validity of result:
 - Chapter 1.1 General Description of the Item(s);
 - Chapter 1.2 Antenna Informaion;
 - Chapter 1.3 Channel List.

USED EQUIPMENT

AC Power Line Conducted Emission / TR1

Instrument	Manufacturer	Model No.	Serial No.	Cal. Date	Next Cal. Date	Firmware Versiom	Software version
EMI Test Receiver	R&S	ESCI	100726	2023.08.26	2024.08.25	4.42 SP1	N/A
Two-Line V-Network	R&S	ENV 216	101044	2023.11.08	2024.11.07	N/A	N/A
Two-Line V-Network	R&S	ENV 216	101189	2023.05.14	2024.05.13	N/A	N/A
50ohm Coaxial Switch	Anritsu	MP59B	6200464462	2023.05.14	2024.05.13	N/A	N/A
Coaxial Cable	Huber+Suhner	RG 223	TR1-C1	2023.05.14	2024.05.13	N/A	N/A
Impedance Stabilization Network	Teseq GmbH	ISN T800	57318	2023.03.07	2024.03.06	N/A	N/A
Temperature/Humidity Meter	RTS	RTS-8S	EMC01	2023.05.19	2024.05.18	N/A	N/A
Dekra test software	Dekra	N/A	N/A	N/A	N/A	N/A	N/A

Field Strength of Fundamental, E-field Emission/ Field Strength of Spurious/ Frequency Stability/ Emission Bandwidth (9KHz-1GHz) / AC2

Instrument	Manufacturer	Model No.	Serial No.	Cal. Date	Next Cal. Date	Firmware Versiom	Software version
EMI Test Receiver	R&S	ESCI	100573	2023.09.15	2024.09.14	4.42 SP3	N/A
Loop Antenna	R&S	HFH2-Z2E	101149	2023.04.25	2024.04.24	N/A	N/A
Bilog Antenna	Teseq GmbH	CBL6112D	27611	2023.09.13	2024.09.12	N/A	N/A
Temperature/Humidity Meter	RTS	RTS-8S	AC2-TH	2023.05.19	2024.05.18	N/A	N/A
Coaxial Cable	Huber+Suhner	SUCOFLEX 106	AC2-C	2023.05.21	2024.05.20	N/A	N/A
Dekra test software	Dekra	N/A	N/A	N/A	N/A	N/A	3

UNCERTAINTY

Uncertainties have been calculated according to the DEKRA internal document. The reported expanded uncertainties are based on a standard uncertainty multiplied by a coverage factor of $k=2$, providing a level of confidence of approximately 95%.

Test item	Uncertainty
AC Power Line Conducted Emission	± 2.02 dB
Radiated Emission(9KHz~30MHz)	Horizontal: 9KHz~30MHz: 2.10 dB Vertical: 30MHz~200MHz: 2.30 dB
Radiated Emission(30MHz~1GHz)	± 3.80 dB
Occupied Bandwidth	± 1 kHz

1 GENERAL INFORMATION

1.1 General Description of the Item(s)

Product Name.....:	POS
Model No.:	EMC-M100C
Trademark.:	Elo
FCC ID	RBWEMCM100C
IC	10757B-EMCM100C
Hardware Version	V1.00
Software Version	T14
Manufacturer.....:	Elo Touch Solutions, Inc
Manufacturer Address	670 N. McCarthy Blvd., Suite 100, Milpitas, CA 95035, USA.
Factory	ShuoGe Intelligent Technology Co.,Ltd.
Factory address	Room 308-310, Building 1, No.2 8th Road, Baiyang Street, Qiantang New Area, Hangzhou City, Zhejiang Province, P.R. China(310018)

Wireless Specification.....:	NFC
Operating frequency range(s).....:	13.56 MHz
Type of modulation	ASK
Number of channel	1

Rated power supply	Voltage and Frequency	
	<input type="checkbox"/>	AC: 220 - 240 V, 50/60 Hz
	<input type="checkbox"/>	AC: 100 - 240 V, 50/60 Hz
	<input type="checkbox"/>	DC: 24 Vdc
	<input type="checkbox"/>	Poe:
	<input checked="" type="checkbox"/>	Adapter:
Adapter Model	UES45LCP-SPC	
	Input: 100-240V ~ 50/60Hz, 1.3A Output: 5.0V/3.0A, 15.0W; 9.0V/3.0A, 27.0W; 12.0V/3.0A, 36.0W; 15V/3.0A, 45W; 20V/2.25A, 45W Max	
Mounting position.....:	<input type="checkbox"/>	Tabletop equipment
	<input type="checkbox"/>	Wall/Ceiling mounted equipment
	<input type="checkbox"/>	Floor standing equipment
	<input checked="" type="checkbox"/>	Hand-held/Portable equipment
	<input type="checkbox"/>	Other:

1.2. Antenna information

Antenna model.....:	N/A		
Antenna Delivery	<input checked="" type="checkbox"/>	1TX + 1RX	
	<input type="checkbox"/>	2TX + 2RX	
	<input type="checkbox"/>	Others:.....	
Antenna technology	<input checked="" type="checkbox"/>	SISO	
	<input type="checkbox"/>	MIMO	<input type="checkbox"/> CDD
			<input type="checkbox"/> Beam-forming
Antenna Type	<input type="checkbox"/>	External	<input type="checkbox"/> Dipole
			<input type="checkbox"/> Sectorized
			<input checked="" type="checkbox"/>
	<input type="checkbox"/>	<input type="checkbox"/> PIFA	
	<input checked="" type="checkbox"/>	<input checked="" type="checkbox"/> LOOP	
	<input type="checkbox"/>	<input type="checkbox"/> Others:	
Antenna Gain.....:	N/A		

1.3. Channel List

Frequency of Each Channel:							
Channel	Frequency	Channel	Frequency	Channel	Frequency	Channel	Frequency
01	13.56 MHz	--	--	--	--	--	--

Note: The general description of the Item(s), antenna information and channel list in clause 1 are provided and confirmed by the client.

2 DESCRIPTION OF TEST SETUP

2.1 Operating mode(s) used for tests

During the tests the following operating mode(s) has(have) been used.

Test Mode	Mode 1: Transmit by NFC
-----------	-------------------------

2.2 Support / Auxiliary equipment / unit / Test software for the EUT

Auxiliary equipment	Type / Version	Manufacturer	Supplied by
NFC Card	N/A	N/A	N/A
software	Type / Version	Manufacturer	Supplied by
N/A	N/A	N/A	N/A

2.3 Test Configuration / Block diagram used for tests

Test setup Diagram- AC Line Conducted Emission Test

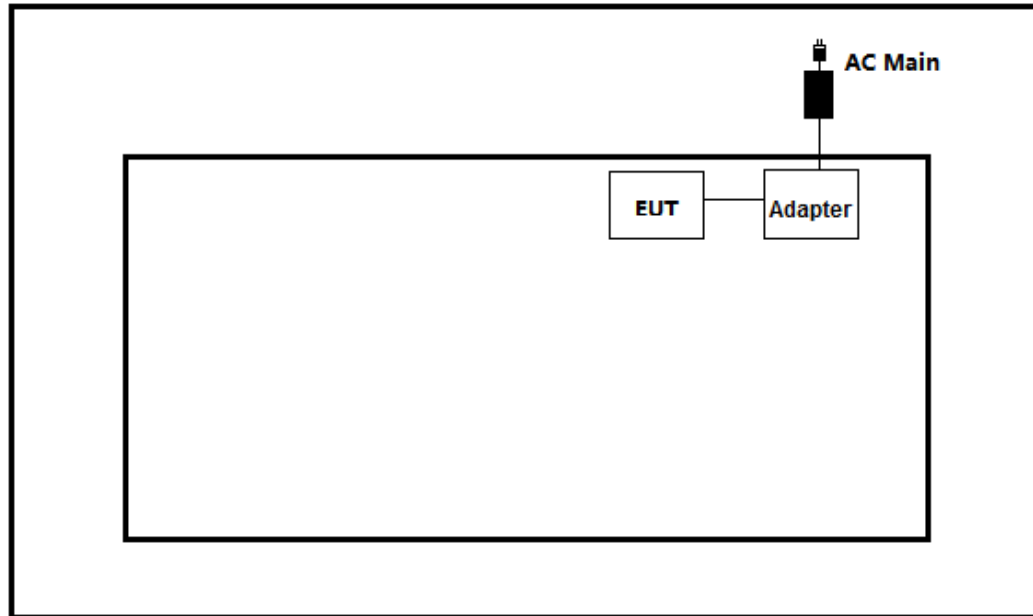

Test setup Diagram- Radiated Emission

Chamber

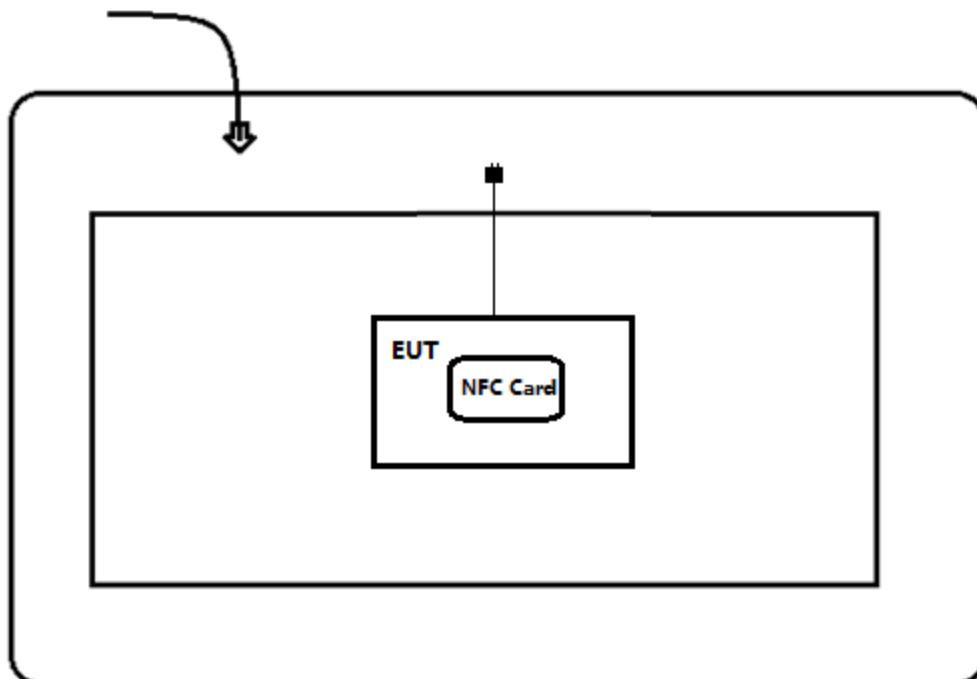

2.4 Testing process

1	Setup the EUT as shown in Section 2.3.
2	Execute the power on the EUT.
3	Verify that the EUT works properly.

3 VERDICT SUMMARY SECTION

This chapter presents an overview of standards and results. Refer to the next chapters for details of measured test results and applied test levels.

3.1 Standards

Standard	Year	Description
FCC CFR Title 47 Part 15 Subpart C Section 15.225	2024	Operation within the band 13.110-14.010 MHz
RSS-210 Issue 10	2019	Band 13.110-14.010 MHz
ANSI C63.10	2013	American National Standard of Procedures for Compliance Testing of Unlicensed Wireless Devices
RSS-Gen Issue 5 Amendment 2	2021	General Requirements for Compliance of Radio Apparatus

3.2 Overview of results

For FCC

Requirement – Test case	Basic standard(s)	Verdict	Remark
AC Power Line Conducted Emission	FCC CFR Title 47 Part 15 Subpart C Section 15.207	PASS	Test data please refer to Appendix A
Field Strength of Fundamental, E-field Emission	FCC CFR Title 47 Part 15 Subpart C Section 15.225(a)(b)(c)	PASS	Test data please refer to Appendix B
Field Strength of Spurious	FCC CFR Title 47 Part 15 Subpart C Section 15.209 & 15.225(d)	PASS	Test data please refer to Appendix C
Emission Bandwidth	FCC CFR Title 47 Part 15 Subpart C Section 15.215(c)	PASS	Test data please refer to Appendix D
Frequency Stability	FCC CFR Title 47 Part 15 Subpart C Section 15.225(e)	PASS	Test data please refer to Appendix E
Antenna Requirement	FCC CFR Title 47 Part 15 Subpart C Section 15.203	PASS	---

For ISED

Requirement – Test case	Basic standard(s)	Verdict	Remark
AC Power Line Conducted Emission	RSS-Gen Issue 5 Section 8.8	PASS	Test data please refer to Appendix A
Field Strength of Fundamental, E-field Emission	RSS-210 Issue 10 Section B.6	PASS	Test data please refer to Appendix B
Field Strength of Spurious	RSS-210 Issue 10, Section B.6 RSS-Gen Issue 5, Section 8.9	PASS	Test data please refer to Appendix C
Emission Bandwidth	RSS-Gen Section 6.7	PASS	Test data please refer to Appendix D
Frequency Stability	RSS-210 Issue 10 Section B.6	PASS	Test data please refer to Appendix E
Antenna Requirement	RSS-Gen Section 8.3	PASS	---

3.3 Test Matrix

Test item	Model: EMC-M100C
	1(#1)
AC Power Line Conducted Emission	<input checked="" type="checkbox"/>
E-field Emission	<input checked="" type="checkbox"/>
Field Strength of Spurious	<input checked="" type="checkbox"/>
Frequency Stability	<input checked="" type="checkbox"/>
Emission Bandwidth	<input checked="" type="checkbox"/>
Field Strength of Fundamental	<input checked="" type="checkbox"/>

3.4 Test Facility

USA	:	FCC Designation Number: CN1199
Canada	:	CAB identifier Number: CN0040

4 TEST RESULTS

4.1 AC Power Line Conducted Emission	VERDICT: PASS
---	----------------------

4.1.1 Limit

Standard	FCC Part 15 Subpart C Paragraph 15.207; RSS-Gen Issue 5 Section 8.8	
Frequency range [MHz]	Limit: QP [dB(μV) ¹⁾	Limit: AV [dB(μV) ¹⁾
0,15 - 0,50	66 - 56 ²⁾	56 - 46 ²⁾
0,50 - 5,0	56	46
5,0 - 30	60	50

¹⁾ At the transition frequency, the lower limit applies.

²⁾ The limit decreases linearly with the logarithm of the frequency.

NOTE 1: The exclusion band for transmitters shall be considered for transmitters operating at frequencies below 30 MHz.

NOTE 2: Where the AC output port is directly connected (or via a circuit breaker) to the AC power input port of the EUT the AC power output port need not to be tested.

4.1.2 Test Setup

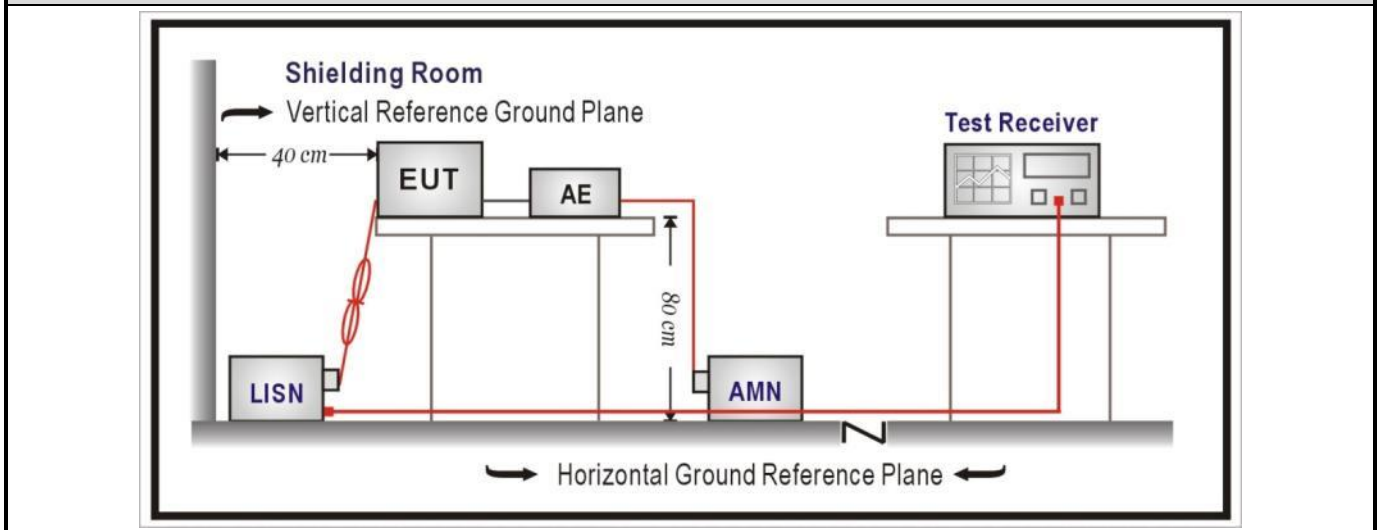

4.1.3 Test Procedure

	References Rule	Chapter	Item
<input checked="" type="checkbox"/>	ANSI C63.10	6.2	Standard test method for ac power-line conducted emissions from unlicensed wireless devices

4.2 E-field Emission	VERDICT: PASS
-----------------------------	----------------------

4.2.1 Limit

Standard	FCC Part 15 Subpart C Paragraph 15.225; RSS-210 Issue 10 Section B.6
<p>(a) The field strength of any emissions within the band 13.553-13.567 MHz shall not exceed 15,848 microvolts/meter at 30 meters.</p> <p>(b) Within the bands 13.410-13.553 MHz and 13.567-13.710 MHz, the field strength of any emissions shall not exceed 334 microvolts/meter at 30 meters.</p> <p>(c) Within the bands 13.110-13.410 MHz and 13.710-14.010 MHz the field strength of any emissions shall not exceed 106 microvolts/meter at 30 meters.</p> <p>(d) The field strength of any emissions appearing outside of the 13.110-14.010 MHz band shall not exceed the general radiated emission limits in §15.209.</p>	

4.2.2 Test Setup

Below 30MHz Test Setup:

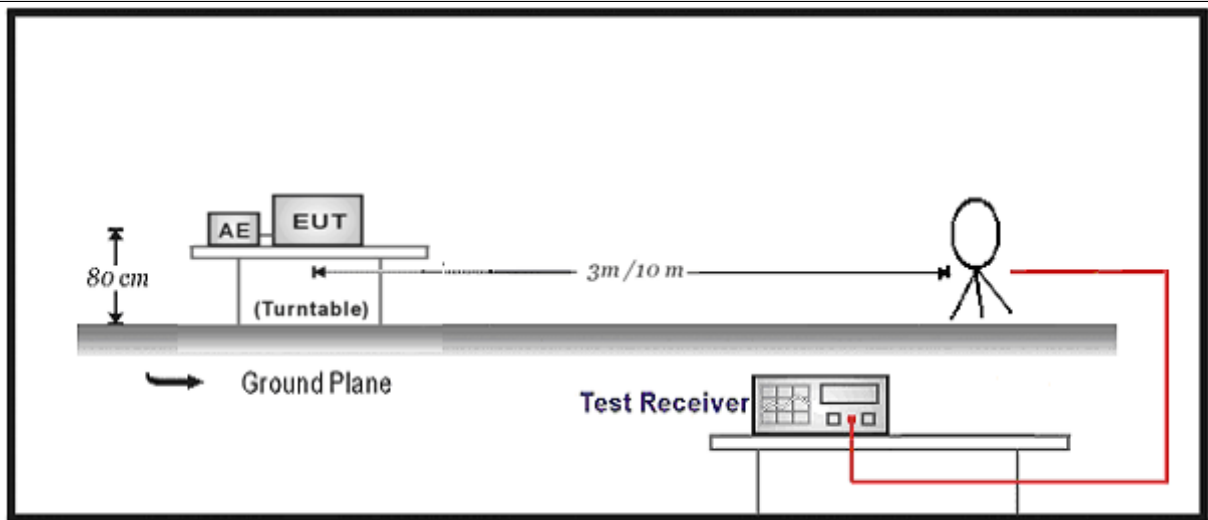

4.2.3 Test Procedure

	References Rule	Chapter	Description
<input checked="" type="checkbox"/>	ANSI C63.10	6.4	Radiated emissions from unlicensed wireless devices below 30 MHz
<input type="checkbox"/>	ANSI C63.10	6.5	Radiated emissions from unlicensed wireless devices in the frequency range of 30 MHz to 1000 MHz
<input type="checkbox"/>	ANSI C63.10	6.6	Radiated emissions from unlicensed wireless devices above 1 GHz

4.3 Field Strength of Spurious	VERDICT: PASS
---------------------------------------	----------------------

4.3.1 Limit	
Standard	FCC Part 15 Subpart C Paragraph 15. 209; RSS-210 Issue 10, Section B.6 RSS-Gen Issue 5, Section 8.9

Restricted Band Emissions Limit			
Frequency (MHz)	Field strength (μ V/m)	Field strength (dB μ V/m)	Measurement distance (m)
0.009 - 0.49	2400/F(kHz)	48.5 – 13.8	300 _(Note 1)
0.49 - 1.705	24000/F(kHz)	33.8 - 23	30 _(Note 1)
1.705 - 30	30	29.5	30 _(Note 1)
30 - 88	100	40	3 _(Note 2)
88 - 216	150	43.5	3 _(Note 2)
216 - 960	200	46	3 _(Note 2)
Above 960	500	54	3 _(Note 2)

Note 1: At frequencies below 30 MHz, measurements may be performed at a distance closer than that specified in the regulations; however, an attempt should be made to avoid making measurements in the near field. Pending the development of an appropriate measurement procedure for measurements performed below 30 MHz, when performing measurements at a closer distance than specified, the results shall be extrapolated to the specified distance by either making measurements at a minimum of two distances on at least one radial to determine the proper extrapolation factor or by using the square of an inverse linear distance extrapolation factor (40 dB/decade).

Note 2: At frequencies at or above 30 MHz, measurements may be performed at a distance other than what is specified provided: measurements are not made in the near field except where it can be shown that near field measurements are appropriate due to the characteristics of the device; and it can be demonstrated that the signal levels needed to be measured at the distance employed can be detected by the measurement equipment. Measurements shall not be performed at a distance greater than 30 meters unless it can be further demonstrated that measurements at a distance of 30 meters or less are impractical. When performing measurements at a distance other than that specified, the results shall be extrapolated to the specified distance using an extrapolation factor of 20 dB/decade (inverse linear-distance for field strength measurements; inverse-linear-distance-squared for power density measurements).

4.3.2 Test Setup

Below 30MHz Test Setup:

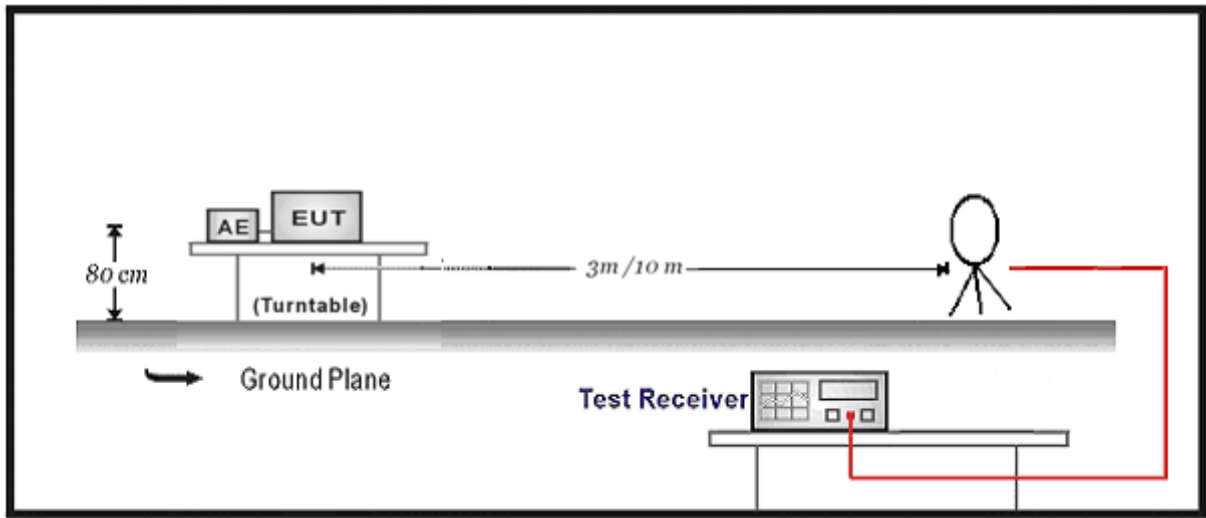

30MHz-1GHz Test Setup:

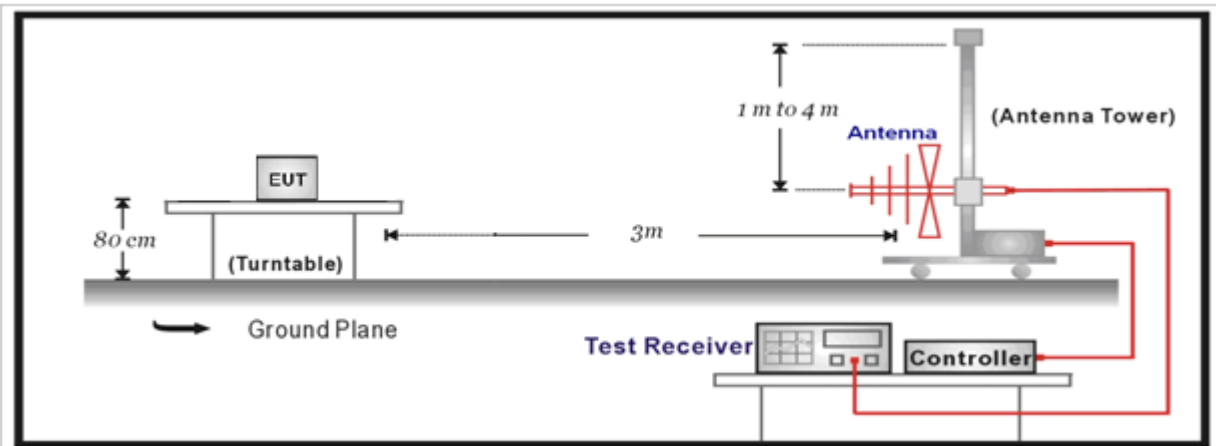

4.3.3 Test Procedure

	References Rule	Chapter	Description
<input checked="" type="checkbox"/>	ANSI C63.10	6.4	Radiated emissions from unlicensed wireless devices below 30 MHz
<input checked="" type="checkbox"/>	ANSI C63.10	6.5	Radiated emissions from unlicensed wireless devices in the frequency range of 30 MHz to 1000 MHz
<input type="checkbox"/>	ANSI C63.10	6.6	Radiated emissions from unlicensed wireless devices above 1 GHz

4.4 Emission bandwidth	VERDICT: PASS
-------------------------------	----------------------

4.4.1 Limit	
Standard	FCC Part 15 Subpart C Paragraph 15.215; RSS-Gen Section 6.7
Within the band.	

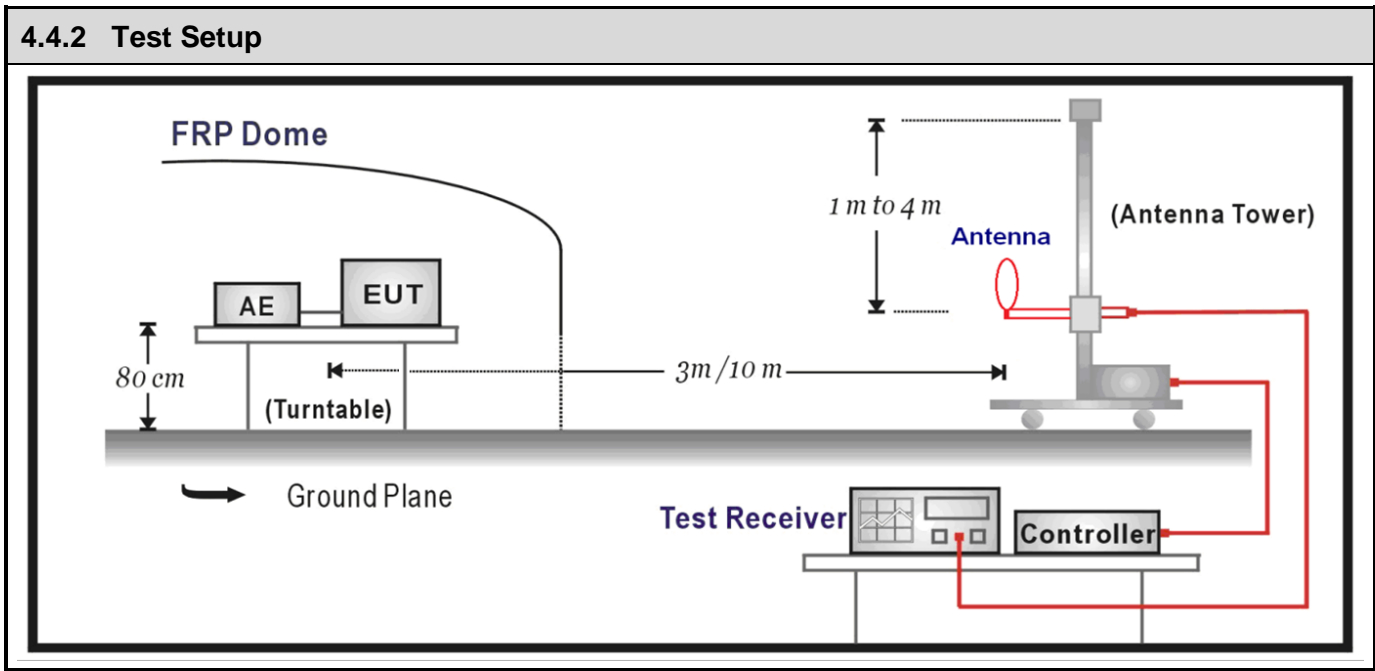

4.4.3 Test Procedure

	Reference Rule	Chapter	Description
<input checked="" type="checkbox"/>	ANSI C63.10	6.9.2	Occupied bandwidth—relative measurement procedure

4.5 Frequency Stability	VERDICT: PASS
--------------------------------	----------------------

4.5.1 Limit:

Standard	FCC Part 15 Subpart C Paragraph 15.225(e); RSS-210 Issue 10 Section B.6
<input checked="" type="checkbox"/>	The frequency tolerance of the carrier signal shall be maintained within $\pm 0.01\%$ of the operating frequency over a temperature variation of -20 degrees to $+ 50$ degrees C at normal supply voltage, and for a variation in the primary supply voltage from 85% to 115% of the rated supply voltage at a temperature of 20 degrees C. For battery operated equipment, the equipment tests shall be performed using a new battery.

4.5.2 Test Setup

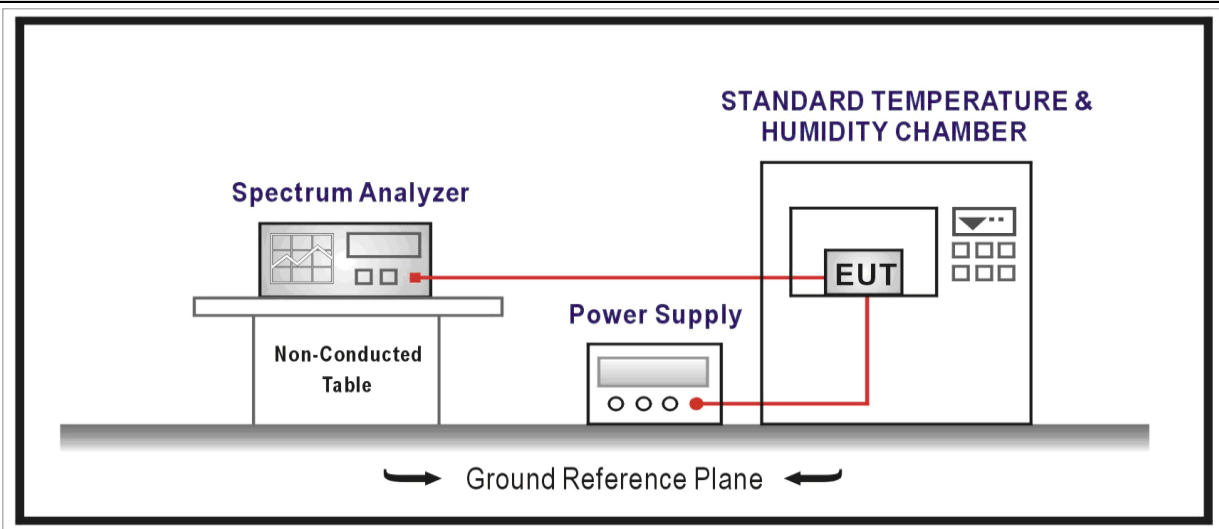

4.5.3 Test Procedure

	References Rule	Chapter	Description
<input checked="" type="checkbox"/>	ANSI C63.10	6.8	Frequency stability tests
<input checked="" type="checkbox"/>	ANSI C63.10	6.8.1	Frequency stability with respect to ambient temperature
<input checked="" type="checkbox"/>	ANSI C63.10	6.8.2	Frequency stability when varying supply voltage

4.6 Antenna Requirement	VERDICT: PASS
--------------------------------	----------------------

4.6.1 Limit:

Standard	FCC Part 15 Subpart E Paragraph 15.203
<p>An intentional radiator shall be designed to ensure that no antenna other than that furnished by the responsible party shall be used with the device. The use of a permanently attached antenna or of an antenna that uses a unique coupling to the intentional radiator shall be considered sufficient to comply with the provisions of this section. The manufacturer may design the unit so that a broken antenna can be replaced by the user, but the use of a standard antenna jack or electrical connector is prohibited. This requirement does not apply to carrier current devices or to devices operated under the provisions of §15.211, §15.213, §15.217, §15.219, or §15.221. Further, this requirement does not apply to intentional radiators that must be professionally installed, such as perimeter protection systems and some field disturbance sensors, or to other intentional radiators which, in accordance with §15.31(d), must be measured at the installation site. However, the installer shall be responsible for ensuring that the proper antenna is employed so that the limits in this part are not exceeded.</p>	

4.6.2 Antenna Connector Construction:

<input checked="" type="checkbox"/>	The use of a permanently attached antenna
<input type="checkbox"/>	The antenna use of a unique coupling to the intentional radiator
<input type="checkbox"/>	The use of a nonstandard antenna jack or electrical connector
Please refer to the attached document "Internal Photograph" to show the antenna connector.	

5 TEST SETUP PHOTO AND EUT PHOTO	VERDICT: PASS
---	----------------------

Remark: The test setup photo and EUT Photo please see appendix.

Appendix A: AC Power Line Conducted Emission

Profile: 2390387R	Page No.: 17
Engineer: Pengchengyang	
Site: TR1	Time: 2024/01/15 - 08:48
Limit: FCC_Part 15.207	Margin: 0
Probe: ENV216_101189(0.009-30MHz)	Polarity: Line
EUT: POS	Power: 120 Vac / 60 Hz
Note: Mode 1: Transmit by NFC	

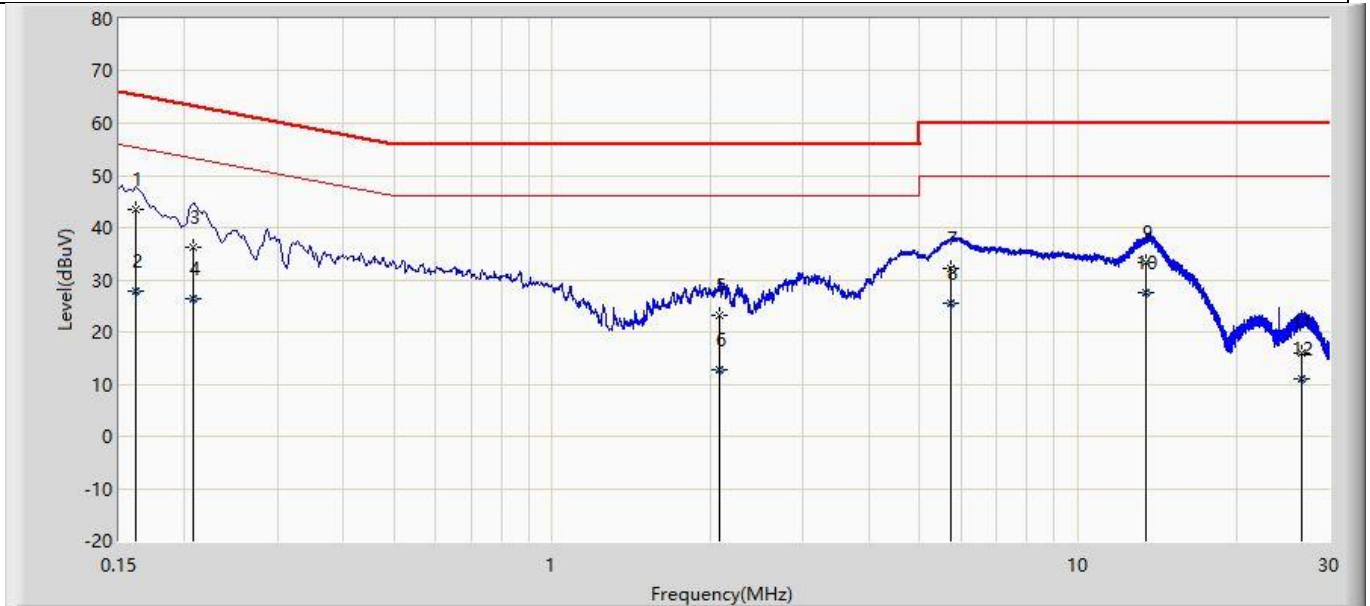

No	Mark	Frequency (MHz)	Measure Level (dBuV)	Reading Level (dBuV)	Over Limit (dB)	Limit (dBuV)	Factor (dB)	Type
1	*	0.161	43.337	33.713	-22.063	65.399	9.624	QP
2		0.161	27.811	18.187	-27.589	55.399	9.624	AV
3		0.208	36.276	26.652	-26.989	63.265	9.623	QP
4		0.208	26.459	16.835	-26.806	53.265	9.623	AV
5		2.080	23.116	13.419	-32.884	56.000	9.697	QP
6		2.080	12.798	3.101	-33.202	46.000	9.697	AV
7		5.741	32.164	22.383	-27.836	60.000	9.781	QP
8		5.741	25.589	15.808	-24.411	50.000	9.781	AV
9		13.506	33.246	23.323	-26.754	60.000	9.923	QP
10		13.506	27.675	17.752	-22.325	50.000	9.923	AV
11		26.655	16.031	5.953	-43.969	60.000	10.078	QP
12		26.655	11.089	1.011	-38.911	50.000	10.078	AV

Note 1: " * ", means this data is the worst emission level.

Note 2: Measurement Level = Reading Level + Factor(Probe+Cable-Amp).

Profile: 2390387R	Page No.: 18
Engineer: Pengchengyang	
Site: TR1	Time: 2024/01/15 - 08:48
Limit: FCC_Part 15.207	Margin: 0
Probe: ENV216_101189(0.009-30MHz)	Polarity: Neutral
EUT: POS	Power: 120 Vac / 60 Hz
Note: Mode 1: Transmit by NFC	

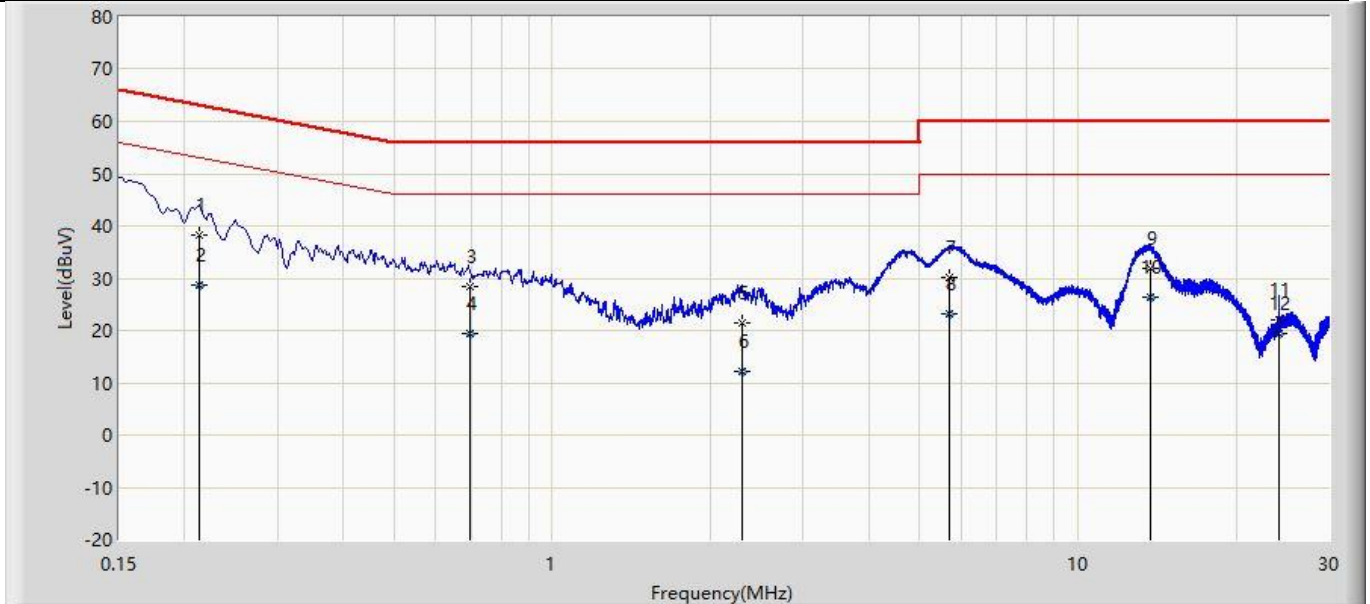

No	Mark	Frequency (MHz)	Measure Level (dBuV)	Reading Level (dBuV)	Over Limit (dB)	Limit (dBuV)	Factor (dB)	Type
1		0.213	38.202	28.568	-24.886	63.088	9.633	QP
2		0.213	28.558	18.925	-24.530	53.088	9.633	AV
3		0.695	28.520	18.865	-27.480	56.000	9.655	QP
4		0.695	19.516	9.861	-26.484	46.000	9.655	AV
5		2.290	21.366	11.661	-34.634	56.000	9.705	QP
6		2.290	12.299	2.594	-33.701	46.000	9.705	AV
7		5.681	30.219	20.433	-29.781	60.000	9.786	QP
8		5.681	23.044	13.258	-26.956	50.000	9.786	AV
9		13.715	31.857	21.911	-28.143	60.000	9.946	QP
10	*	13.715	26.348	16.402	-23.652	50.000	9.946	AV
11		24.112	22.002	11.901	-37.998	60.000	10.101	QP
12		24.112	19.449	9.348	-30.551	50.000	10.101	AV

Note 1: " * ", means this data is the worst emission level.

Note 2: Measurement Level = Reading Level + Factor(Probe+Cable-Amp).

Appendix B: E-field Emission

Profile: 2390387R	Page No.: 7
Engineer: Pengchengyang	
Site: AC2	Time: 2024/01/23 - 14:11
Limit: 13.56 mask	Margin: 0
Probe: RF(0.009-30MHz)	Polarity: X
EUT: POS	Power: 120 Vac / 60 Hz
Note: Mode 1: Transmit by NFC	

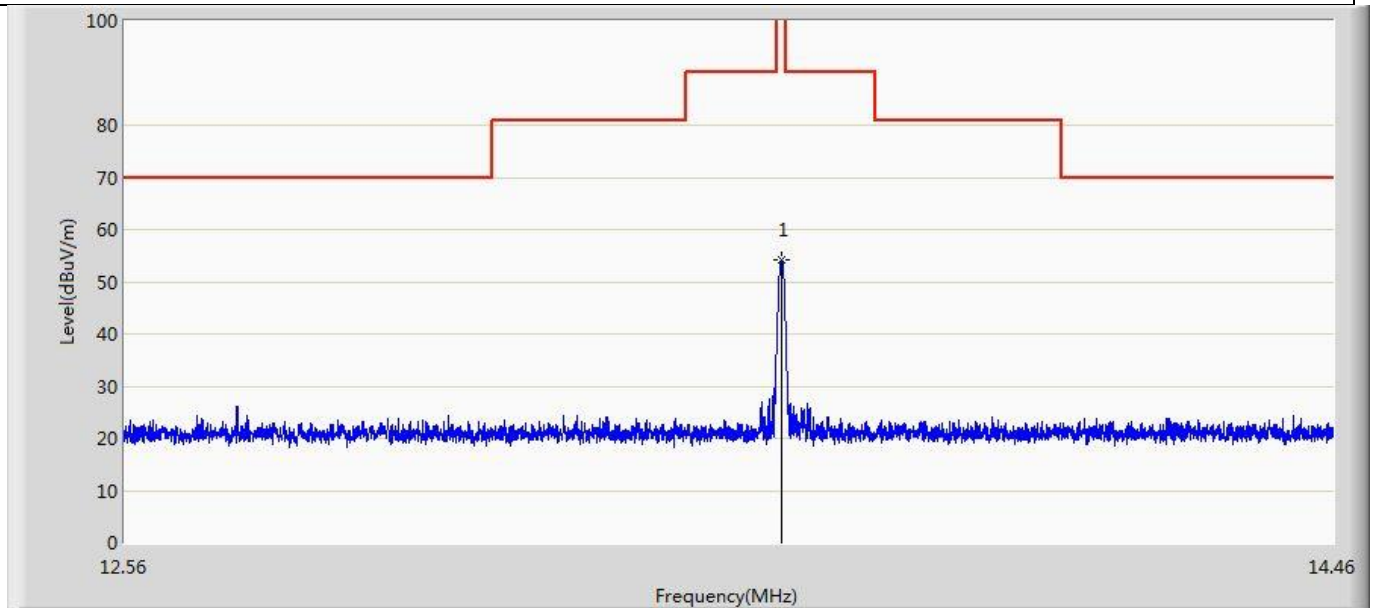

No	Mark	Frequency (MHz)	Measure Level (dBuV/m)	Reading Level (dBuV)	Over Limit (dB)	Limit (dBuV/m)	Factor (dB)	Type
1	*	13.559	54.204	33.152	-69.796	124.000	21.052	QP

Note : Measurement Level = Reading Level + Factor(Probe+Cable-Amp).

Profile: 2390387R	Page No.: 8
Engineer: Pengchengyang	
Site: AC2	Time: 2024/01/23 - 14:15
Limit: 13.56 mask	Margin: 0
Probe: RF(0.009-30MHz)	Polarity: Y
EUT: POS	Power: 120 Vac / 60 Hz
Note: Mode 1: Transmit by NFC	

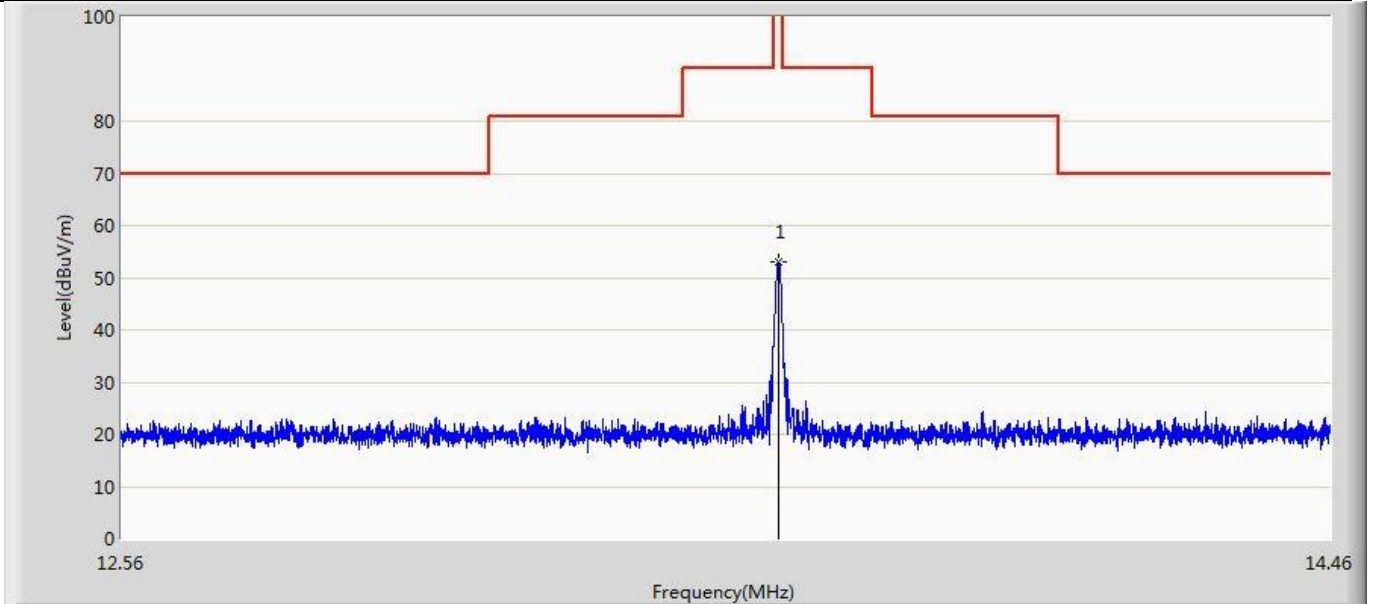

No	Mark	Frequency (MHz)	Measure Level (dBuV/m)	Reading Level (dBuV)	Over Limit (dB)	Limit (dBuV/m)	Factor (dB)	Type
1	*	13.560	52.902	32.350	-71.098	124.000	20.552	QP

Note : Measurement Level = Reading Level + Factor(Probe+Cable-Amp).

Profile: 2390387R	Page No.: 9
Engineer: Pengchengyang	
Site: AC2	Time: 2024/01/23 - 14:18
Limit: 13.56 mask	Margin: 0
Probe: RF(0.009-30MHz)	Polarity: Z
EUT: POS	Power: 120 Vac / 60 Hz
Note: Mode 1: Transmit by NFC	

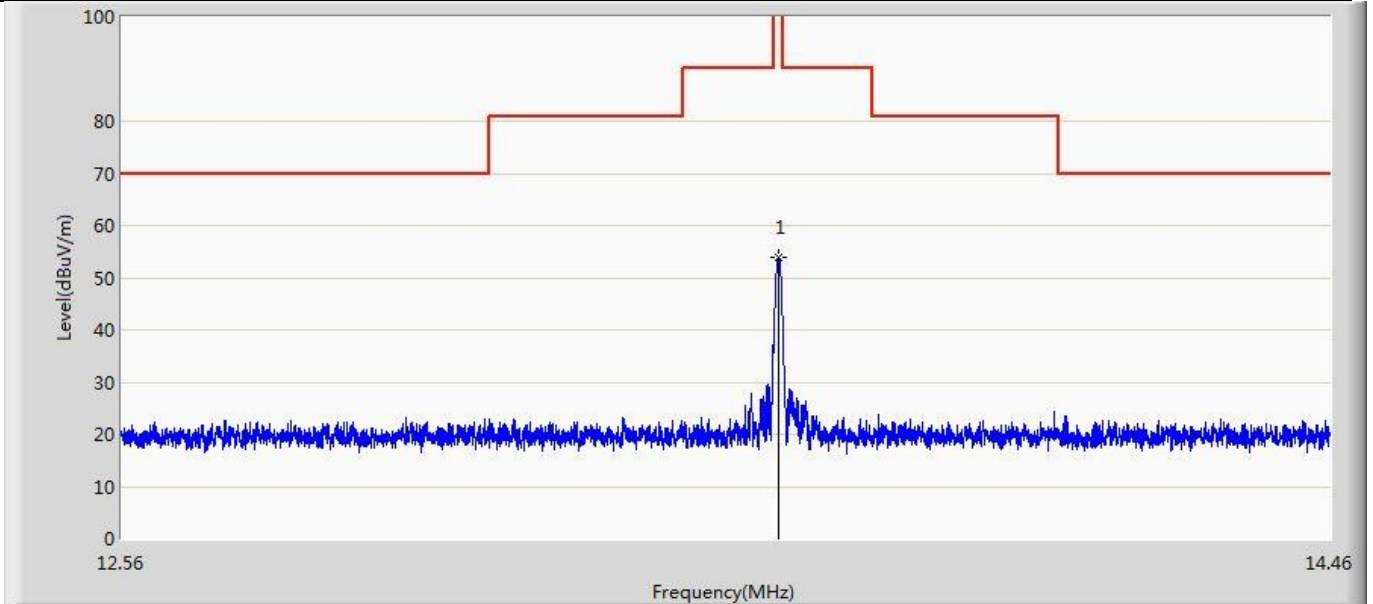

No	Mark	Frequency (MHz)	Measure Level (dBuV/m)	Reading Level (dBuV)	Over Limit (dB)	Limit (dBuV/m)	Factor (dB)	Type
1	*	13.560	54.039	33.487	-69.961	124.000	20.552	QP

Note : Measurement Level = Reading Level + Factor(Probe+Cable-Amp).

Appendix C: Field Strength of Spurious

Profile: 2390387R	Page No.: 1
Engineer: Pengchengyang	
Site: AC2	Time: 2024/01/23 - 13:49
Limit: 15.209	Margin: 0
Probe: RF(0.009-30MHz)	Polarity: X
EUT: POS	Power: 120 Vac / 60 Hz
Note: Mode 1: Transmit by NFC	

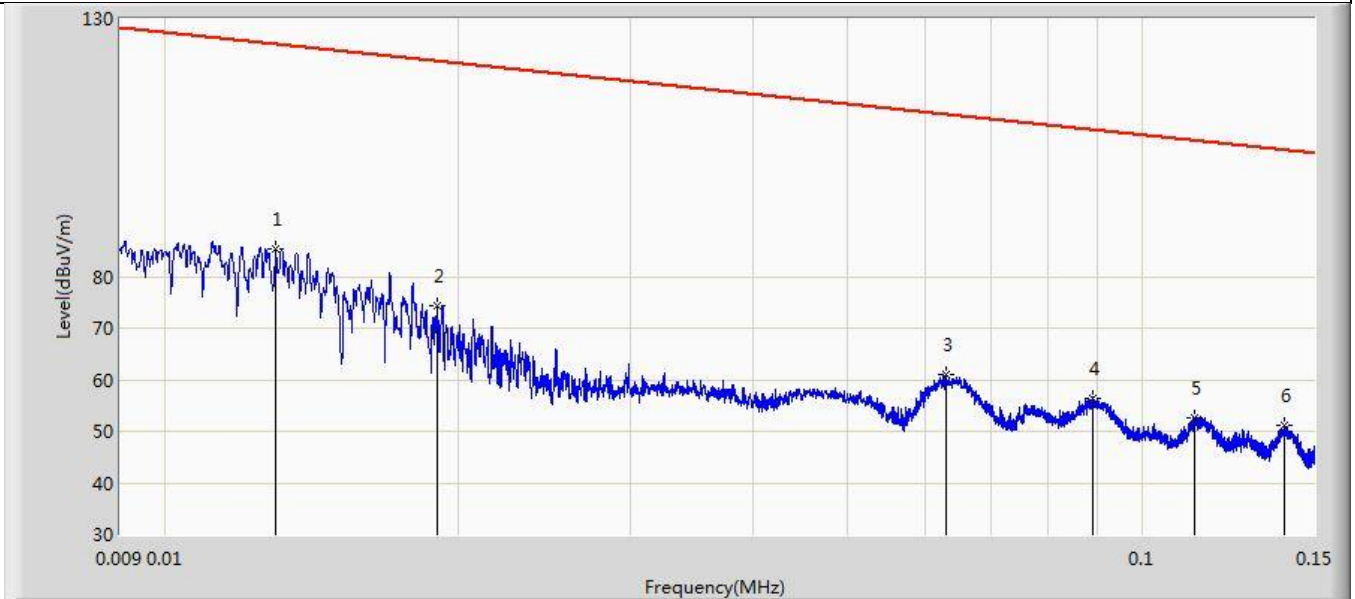

No	Mark	Frequency (MHz)	Measure Level (dBuV/m)	Reading Level (dBuV)	Over Limit (dB)	Limit (dBuV/m)	Factor (dB)	Type
1	*	0.013	85.451	64.295	-39.757	125.208	21.155	PK
2		0.019	74.444	53.102	-47.470	121.913	21.341	PK
3		0.063	61.091	39.155	-50.416	111.507	21.936	PK
4		0.089	56.491	34.585	-52.017	108.508	21.906	PK
5		0.113	52.572	30.694	-53.863	106.435	21.879	PK
6		0.140	51.027	29.175	-53.549	104.575	21.852	PK

Profile: 2390387R	Page No.: 2
Engineer: Pengchengyang	
Site: AC2	Time: 2024/01/23 - 13:52
Limit: 15.209	Margin: 0
Probe: RF(0.009-30MHz)	Polarity: X
EUT: POS	Power: 120 Vac / 60 Hz
Note: Mode 1: Transmit by NFC	

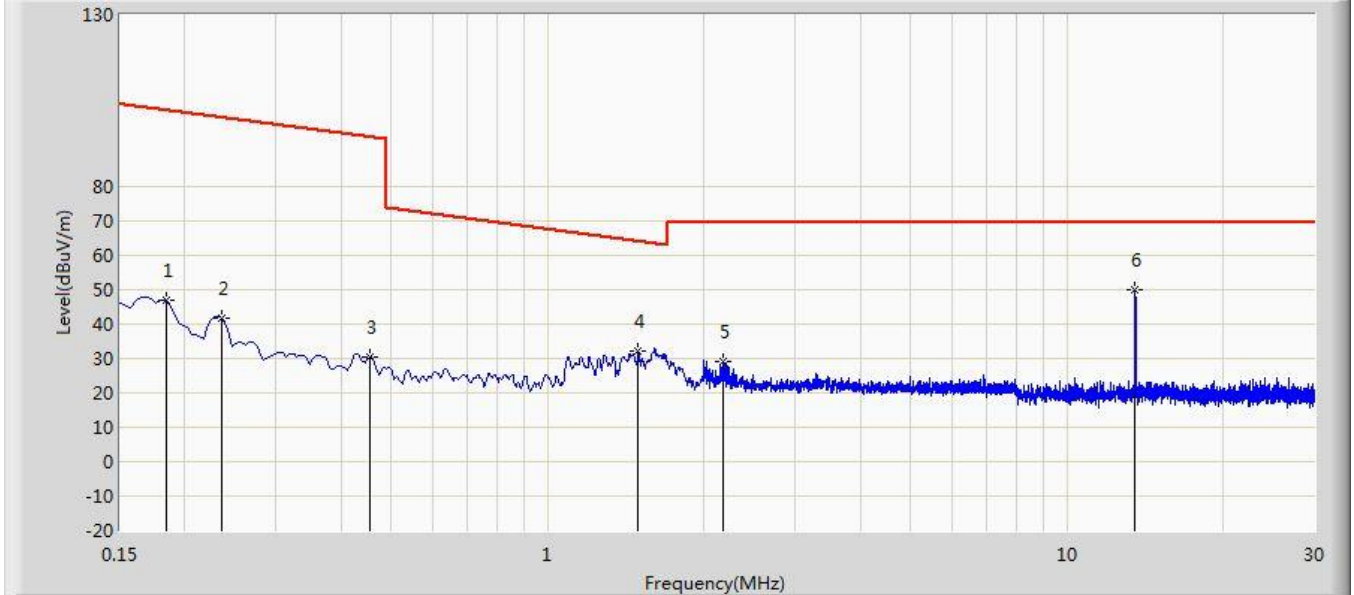

No	Mark	Frequency (MHz)	Measure Level (dBuV/m)	Reading Level (dBuV)	Over Limit (dB)	Limit (dBuV/m)	Factor (dB)	Type
1		0.184	46.848	25.048	-55.355	102.203	21.801	PK
2		0.236	41.658	19.901	-58.384	100.042	21.757	PK
3		0.456	30.633	9.098	-63.691	94.324	21.535	PK
4		1.497	31.962	11.524	-32.065	64.027	20.438	PK
5		2.184	29.087	8.156	-40.313	69.400	20.931	PK
6	*	13.560	50.130	29.078	-19.270	69.400	21.052	PK

Mark 6 is the fundamental emission.

Profile: 2390387R	Page No.: 3
Engineer: Pengchengyang	
Site: AC2	Time: 2024/01/23 - 13:55
Limit: 15.209	Margin: 0
Probe: RF(0.009-30MHz)	Polarity: Y
EUT: POS	Power: 120 Vac / 60 Hz
Note: Mode 1: Transmit by NFC	

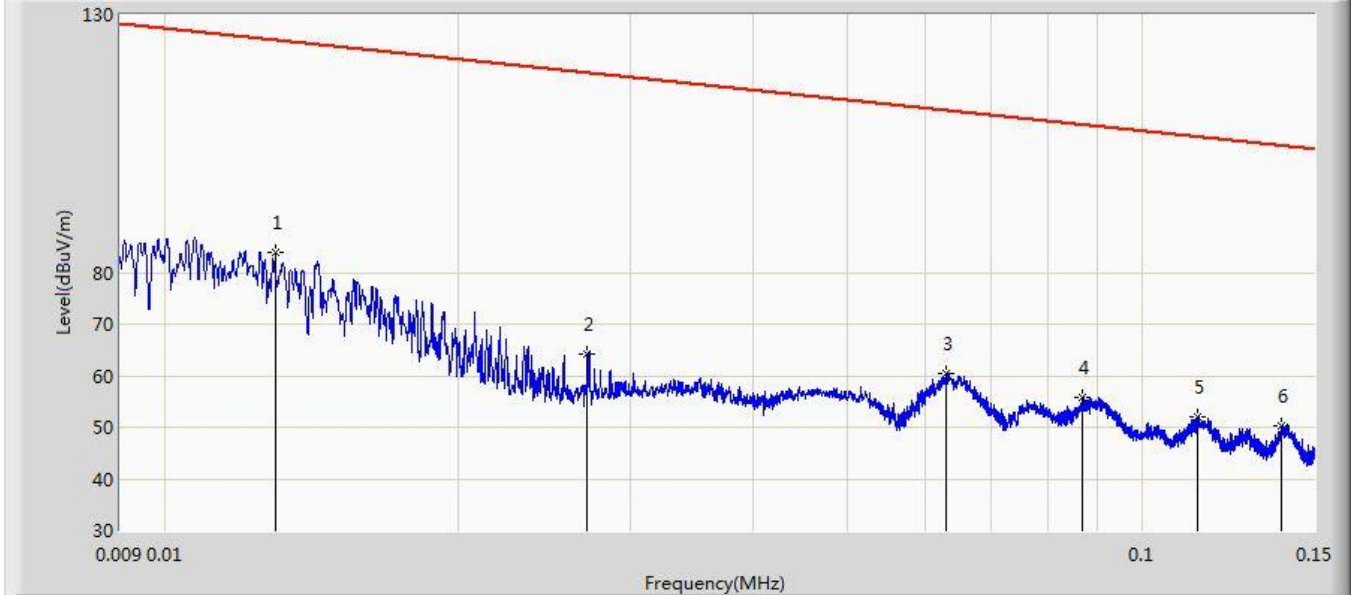

No	Mark	Frequency (MHz)	Measure Level (dBuV/m)	Reading Level (dBuV)	Over Limit (dB)	Limit (dBuV/m)	Factor (dB)	Type
1	*	0.013	83.925	63.269	-41.283	125.208	20.655	PK
2		0.027	64.330	43.240	-54.533	118.863	21.090	PK
3		0.063	60.349	38.913	-51.158	111.507	21.436	PK
4		0.087	55.723	34.315	-52.982	108.705	21.408	PK
5		0.114	51.921	30.544	-54.438	106.359	21.377	PK
6		0.139	50.379	29.026	-54.259	104.638	21.353	PK

Profile: 2390387R	Page No.: 4
Engineer: Pengchengyang	
Site: AC2	Time: 2024/01/23 - 13:59
Limit: 15.209	Margin: 0
Probe: RF(0.009-30MHz)	Polarity: Y
EUT: POS	Power: 120 Vac / 60 Hz
Note: Mode 1: Transmit by NFC	

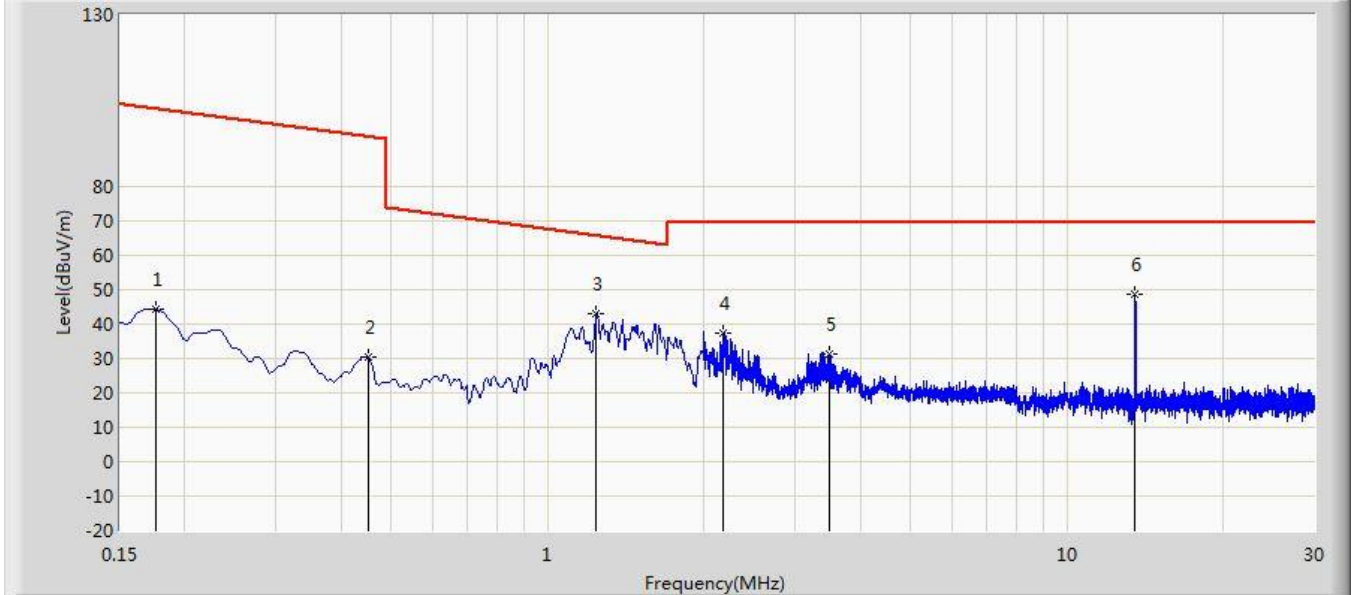

No	Mark	Frequency (MHz)	Measure Level (dBuV/m)	Reading Level (dBuV)	Over Limit (dB)	Limit (dBuV/m)	Factor (dB)	Type
1		0.176	44.418	23.106	-58.171	102.589	21.312	PK
2		0.452	30.298	9.259	-64.103	94.401	21.039	PK
3		1.243	42.903	23.220	-22.734	65.637	19.683	PK
4		2.184	37.312	16.881	-32.088	69.400	20.431	PK
5		3.482	31.141	10.854	-38.259	69.400	20.287	PK
6	*	13.560	48.771	28.219	-20.629	69.400	20.552	PK

Mark 6 is the fundamental emission.

Profile: 2390387R	Page No.: 5
Engineer: Pengchengyang	
Site: AC2	Time: 2024/01/23 - 14:03
Limit: 15.209	Margin: 0
Probe: RF(0.009-30MHz)	Polarity: Z
EUT: POS	Power: 120 Vac / 60 Hz
Note: Mode 1: Transmit by NFC	

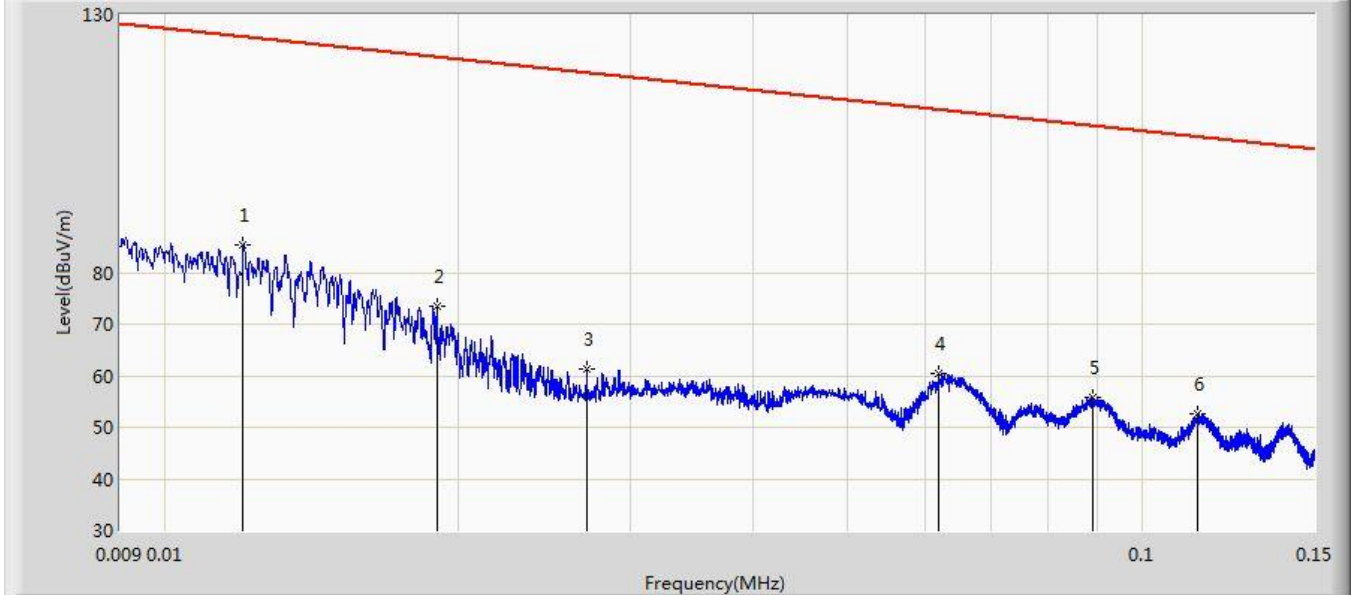

No	Mark	Frequency (MHz)	Measure Level (dBuV/m)	Reading Level (dBuV)	Over Limit (dB)	Limit (dBuV/m)	Factor (dB)	Type
1	*	0.012	85.277	64.652	-40.626	125.903	20.625	PK
2		0.019	73.339	52.497	-48.575	121.913	20.841	PK
3		0.027	61.268	40.178	-57.595	118.863	21.090	PK
4		0.062	60.311	38.874	-51.335	111.646	21.437	PK
5		0.089	55.801	34.395	-52.707	108.508	21.406	PK
6		0.114	52.575	31.198	-53.784	106.359	21.377	PK

Profile: 2390387R	Page No.: 6
Engineer: Pengchengyang	
Site: AC2	Time: 2024/01/23 - 14:08
Limit: 15.209	Margin: 0
Probe: RF(0.009-30MHz)	Polarity: Z
EUT: POS	Power: 120 Vac / 60 Hz
Note: Mode 1: Transmit by NFC	

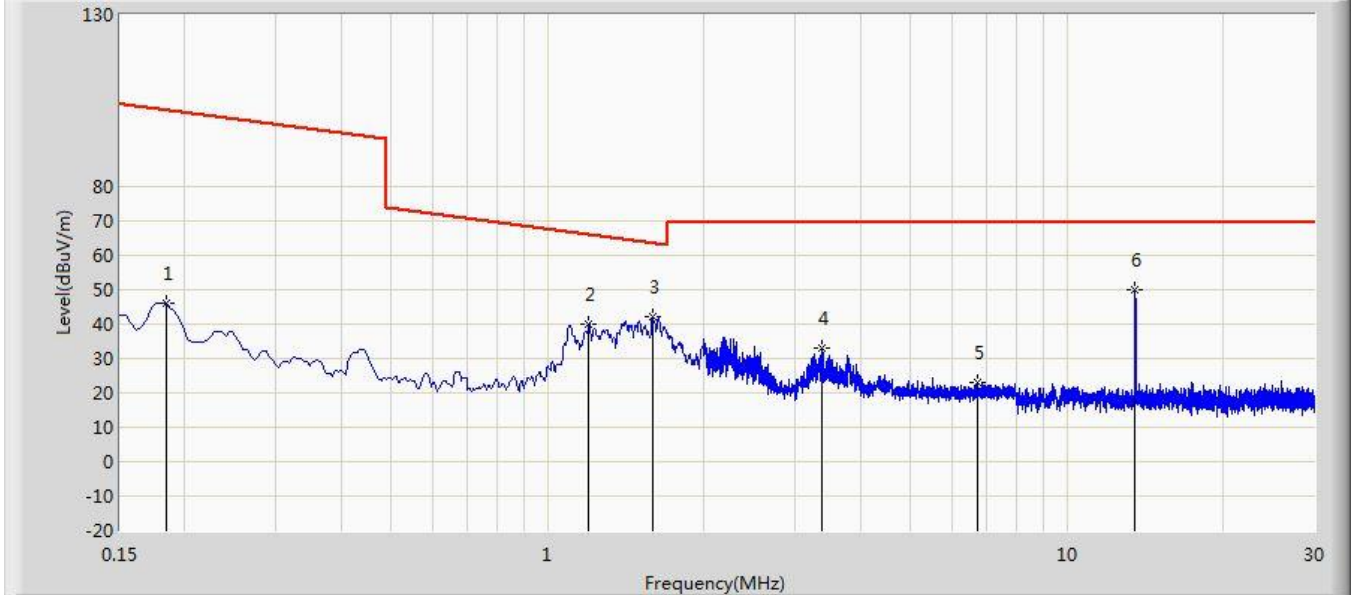

No	Mark	Frequency (MHz)	Measure Level (dBuV/m)	Reading Level (dBuV)	Over Limit (dB)	Limit (dBuV/m)	Factor (dB)	Type
1		0.184	46.030	24.730	-56.173	102.203	21.301	PK
2		1.202	40.051	20.408	-25.877	65.928	19.642	PK
3		1.590	42.333	22.302	-21.171	63.505	20.031	PK
4		3.374	33.181	12.893	-36.219	69.400	20.288	PK
5		6.717	23.116	3.026	-46.284	69.400	20.090	PK
6	*	13.560	49.860	29.308	-19.540	69.400	20.552	PK

Mark 6 is the fundamental emission.

Note 1: " * ", means this data is the worst emission level.

Note 2: Measurement Level = Reading Level + Factor(Probe+Cable-Amp).

Appendix D: Emission Bandwidth

Frequency (MHz)	20dB Bandwidth (Hz)	99% Bandwidth (kHz)	Frequency Range Limit (MHz)	Result
13.56	356	1.465	13.553 ~ 13.567	Pass

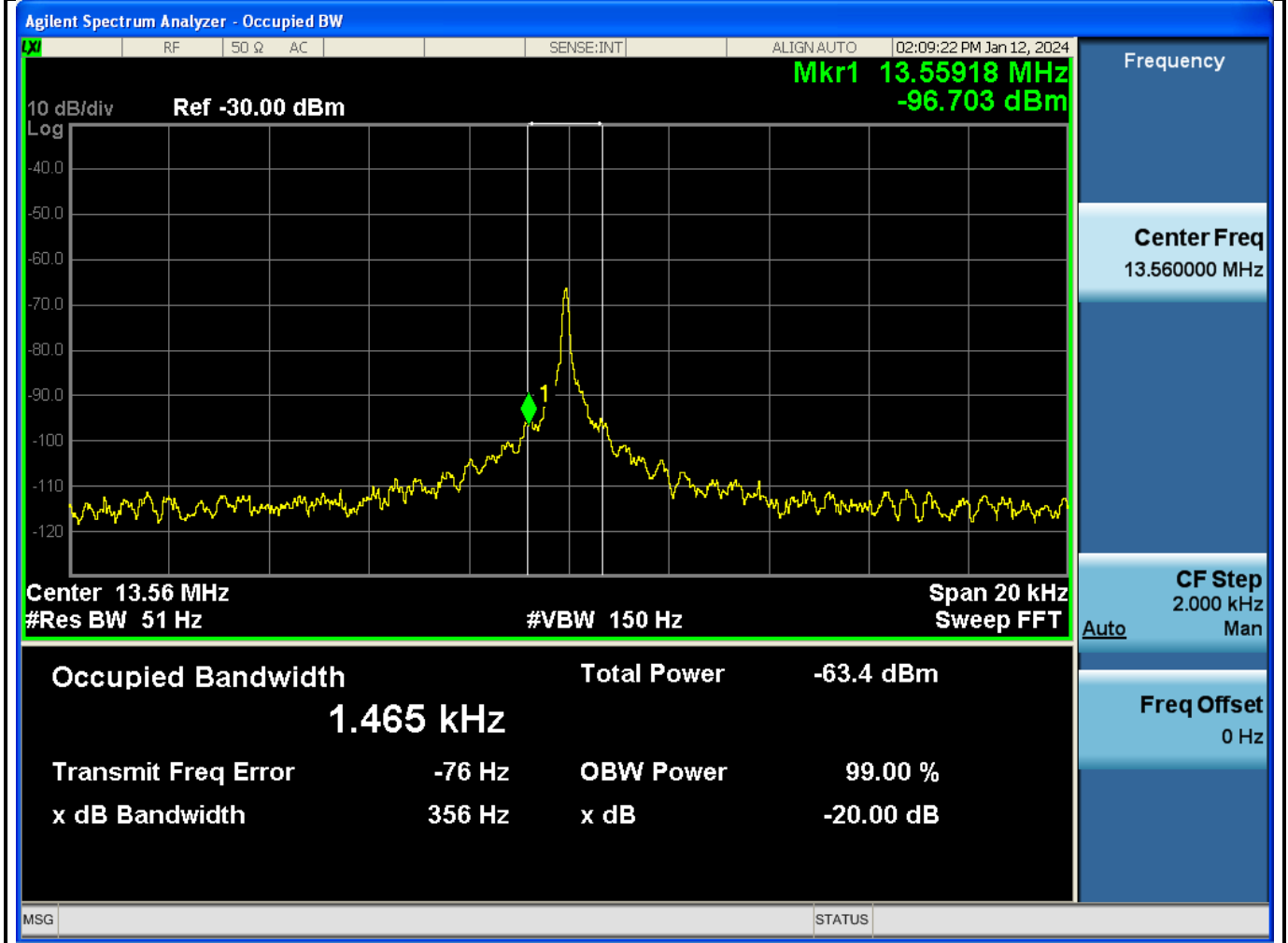

Appendix E: Frequency Stability

Frequency Stability under Temperature at 0min			
Temperature Interval (°C)	Test Frequency (MHz)	Deviation (ppm)	Limit (ppm)
-20	13.56	63.19	±100
-10	13.56	63.21	±100
0	13.56	63.33	±100
10	13.56	63.15	±100
20	13.56	63.22	±100
30	13.56	63.26	±100
40	13.56	63.39	±100
50	13.56	63.55	±100
Frequency Stability under Temperature at 2min			
Temperature Interval (°C)	Test Frequency (MHz)	Deviation (ppm)	Limit (ppm)
-20	13.56	63.52	±100
-10	13.56	63.41	±100
0	13.56	63.18	±100
10	13.56	63.26	±100
20	13.56	63.23	±100
30	13.56	63.21	±100
40	13.56	63.36	±100
50	13.56	63.25	±100
Frequency Stability under Temperature at 5min			
Temperature Interval (°C)	Test Frequency (MHz)	Deviation (ppm)	Limit (ppm)
-20	13.56	63.52	±100
-10	13.56	63.23	±100
0	13.56	63.13	±100
10	13.56	63.22	±100
20	13.56	63.58	±100
30	13.56	63.27	±100
40	13.56	63.33	±100
50	13.56	63.36	±100
Frequency Stability under Temperature at 10min			
Temperature Interval (°C)	Test Frequency (MHz)	Deviation (ppm)	Limit (ppm)

-20	13.56	63.26	±100
-10	13.56	62.63	±100
0	13.56	63.19	±100
10	13.56	63.32	±100
20	13.56	63.28	±100
30	13.56	63.26	±100
40	13.56	63.55	±100
50	13.56	63.15	±100

Frequency Stability under Voltage

DC Voltage (V)	Test Frequency (MHz)	Deviation (ppm)	Limit (ppm)
102	13.56	63.52	±100
120	13.56	63.56	±100
138	13.56	63.53	±100

_____ The End _____