



# FCC RF Test Report

**APPLICANT** : Elo Touch Solutions, Inc.  
**EQUIPMENT** : Mobile POS  
**BRAND NAME** : ELO or   
**MODEL NAME** : EMC0600C  
**FCC ID** : RBWEMC0600C  
**STANDARD** : 47 CFR Part 2, 24(E), 27(L), 27(H), 27(F)  
**CLASSIFICATION** : PCS Licensed Transmitter (PCB)  
**TEST DATE(S)** : May 27, 2021 ~ Jul. 29, 2021

We, Sporton International (Kunshan) Inc., would like to declare that the tested sample has been evaluated in accordance with the procedures given in ANSI C63.26-2015 and shown compliance with the applicable technical standards.

The test results in this report apply exclusively to the tested model / sample. Without written approval of Sporton International (Kunshan) Inc., the test report shall not be reproduced except in full.

*Jason Jia*

Reviewed by: Jason Jia / Supervisor

*Alex Wang*

Approved by: Alex Wang / Manager



**Sporton International (Kunshan) Inc.**

**No. 1098, Pengxi North Road, Kunshan Economic Development Zone Jiangsu Province 215300  
People's Republic of China**



TABLE OF CONTENTS

REVISION HISTORY ..... 3
SUMMARY OF TEST RESULT ..... 4
1 GENERAL DESCRIPTION ..... 5
1.1 Applicant ..... 5
1.2 Manufacturer ..... 5
1.3 Product Feature of Equipment Under Test ..... 5
1.4 Product Specification of Equipment Under Test ..... 5
1.5 Modification of EUT ..... 6
1.6 Maximum ERP/EIRP and Emission Designator ..... 6
1.7 Testing Location ..... 7
1.8 Test Software ..... 7
1.9 Applicable Standards ..... 7
2 TEST CONFIGURATION OF EQUIPMENT UNDER TEST ..... 8
2.1 Test Mode ..... 8
2.2 Connection Diagram of Test System ..... 9
2.3 Support Unit used in test configuration and system ..... 10
2.4 Measurement Results Explanation Example ..... 10
2.5 Frequency List of Low/Middle/High Channels ..... 10
3 CONDUCTED TEST ITEMS ..... 13
3.1 Measuring Instruments ..... 13
3.2 Test Setup ..... 13
3.3 Test Result of Conducted Test ..... 13
3.4 Conducted Output Power and ERP/EIRP ..... 14
3.5 Peak-to-Average Ratio ..... 15
3.6 Occupied Bandwidth ..... 16
3.7 Conducted Band Edge ..... 17
3.8 Conducted Spurious Emission ..... 19
3.9 Frequency Stability ..... 20
4 RADIATED TEST ITEMS ..... 21
4.1 Measuring Instruments ..... 21
4.2 Test Setup ..... 21
4.3 Test Result of Radiated Test ..... 22
4.4 Radiated Spurious Emission ..... 23
5 LIST OF MEASURING EQUIPMENT ..... 24
6 UNCERTAINTY OF EVALUATION ..... 25
APPENDIX A. TEST RESULTS OF CONDUCTED TEST
APPENDIX B. TEST RESULTS OF RADIATED TEST
APPENDIX C. TEST SETUP PHOTOGRAPHS



### REVISION HISTORY

| REPORT NO.   | VERSION | DESCRIPTION             | ISSUED DATE   |
|--------------|---------|-------------------------|---------------|
| FG142804-01B | Rev. 01 | Initial issue of report | Sep. 03, 2021 |
|              |         |                         |               |
|              |         |                         |               |
|              |         |                         |               |
|              |         |                         |               |
|              |         |                         |               |
|              |         |                         |               |
|              |         |                         |               |
|              |         |                         |               |
|              |         |                         |               |
|              |         |                         |               |
|              |         |                         |               |
|              |         |                         |               |
|              |         |                         |               |
|              |         |                         |               |
|              |         |                         |               |
|              |         |                         |               |
|              |         |                         |               |
|              |         |                         |               |
|              |         |                         |               |



## SUMMARY OF TEST RESULT

| Report Section | FCC Rule   | Description   | Limit                               | Result | Remark  |
|----------------|--|---|-------------------------------------|--------|---|
| 3.4            | §2.1046  | Conducted Output Power  | Reporting Only                      | PASS   | -   |
|                | §27.50(b)(10)<br>§27.50(c)(10)   | Effective Radiated Power<br>(Band 12) (Band 13)                                       | ERP < 3 Watt                        |        |   |
|                | §24.232(c)   | Equivalent Isotropic Radiated Power<br>(Band 2)                                       | EIRP < 2Watt                        |        |   |
|                | §27.50(d)(4)   | Equivalent Isotropic Radiated Power<br>(Band 4) (Band 66)                             | EIRP < 1Watt                        |        |   |
| 3.5            | §24.232(d)   | Peak-to-Average Ratio   | <13 dB                              | PASS   | -   |
| 3.6            | §2.1049  | Occupied Bandwidth  | Reporting Only                      | PASS   | -   |
| 3.7            | §2.1051<br>§24.238(a)<br>§27.53(c)(2)(4)<br>§27.53(g)<br>§27.53(h)           | Conducted Band Edge Measurement<br>(Band 2) (Band 4) (Band 12)<br>(Band 13) (Band 66) | < 43+10log <sub>10</sub> (P[Watts]) | PASS   | -   |
| 3.8            | §2.1051<br>§24.238(a)<br>§27.53(c)(2)<br>§27.53(g)<br>§27.53(h)              | Conducted Spurious Emission<br>(Band 2) (Band 4) (Band 12)<br>(Band 13) (Band 66)     | < 43+10log <sub>10</sub> (P[Watts]) | PASS   | -   |
| 3.9            | §2.1055<br>§24.235<br>§27.54   | Frequency Stability<br>Temperature & Voltage  | Within Authorized Band              | PASS   | -   |
| 4.4            | §2.1053<br>§24.238(a)<br>§27.53(c)(2)<br>§27.53(f)<br>§27.53(g)<br>§27.53(h) | Radiated Spurious Emission<br>(Band 2) (Band 4) (Band 12)<br>(Band 13) (Band 66)      | < 43+10log <sub>10</sub> (P[Watts]) | PASS   | Under limit<br>22.73 dB at<br>1560.000<br>MHz |

**Declaration of Conformity:**

The test results with all measurement uncertainty excluded are presented in accordance with the regulation limits or requirements declared by manufacturers.

**Comments and Explanations:**

The declared of product specification for EUT presented in the report are provided by the manufacturer, and the manufacturer takes all the responsibilities for the accuracy of product specification.



# 1 General Description

## 1.1 Applicant

Elo Touch Solutions, Inc.  
670 N. McCarthy Blvd. Suite 100, Milpitas, CA 95035, United States

## 1.2 Manufacturer

Elo Touch Solutions, Inc.  
670 N. McCarthy Blvd. Suite 100, Milpitas, CA 95035, United States

## 1.3 Product Feature of Equipment Under Test

| Product Feature |                 |
|-----------------|-----------------|
| Equipment       | Mobile POS      |
| Brand Name      | ELO or          |
| Model Name      | EMC0600C        |
| FCC ID          | RBWEMC0600C     |
| HW Version      | A01             |
| SW Version      | 5.07.100        |
| EUT Stage       | Production Unit |

## 1.4 Product Specification of Equipment Under Test

| Standards-related Product Specification |  |
|---|--|
| Tx Frequency                            | LTE Band 2 : 1850 MHz ~ 1910 MHz<br>LTE Band 4 : 1710 MHz ~ 1755 MHz<br>LTE Band 12 : 699 MHz ~ 716 MHz<br>LTE Band 13 : 777 MHz ~ 787 MHz<br>LTE Band 66 : 1710 MHz ~ 1780 MHz  |
| Rx Frequency                            | LTE Band 2 : 1930 MHz ~ 1990 MHz<br>LTE Band 4 : 2110 MHz ~ 2155 MHz<br>LTE Band 12 : 729 MHz ~ 746 MHz<br>LTE Band 13 : 746 MHz ~ 756 MHz<br>LTE Band 66 : 2110 MHz~ 2180 MHz   |
| Bandwidth                               | LTE Band 2 : 1.4MHz / 3MHz / 5MHz / 10MHz / 15MHz / 20MHz<br>LTE Band 4 : 1.4MHz / 3MHz / 5MHz / 10MHz / 15MHz / 20MHz<br>LTE Band 12 : 1.4MHz / 3MHz / 5MHz / 10MHz<br>LTE Band 13 : 5MHz / 10MHz<br>LTE Band 66 : 1.4MHz / 3MHz / 5MHz / 10MHz / 15MHz / 20MHz |
| Maximum Output Power to Antenna         | LTE Band 2 : 22.77 dBm<br>LTE Band 4 : 22.89 dBm<br>LTE Band 12 : 22.84 dBm<br>LTE Band 13 : 23.04 dBm<br>LTE Band 66 : 22.91 dBm  |
| Antenna Gain                            | LTE Band 2 : 4.29 dBi  |



|                    |  |
|--------------------|--|
|                    | LTE Band 4 : 2.94 dBi<br>LTE Band 12 : -0.1 dBi<br>LTE Band 13 : -1.49 dBi<br>LTE Band 66 : 2.94 dBi |
| Type of Modulation | QPSK / 16QAM   |

### 1.5 Modification of EUT

No modifications are made to the EUT during all test items.

### 1.6 Maximum ERP/EIRP and Emission Designator

| LTE Band 2  |                       | QPSK            |                              | 16QAM           |                              |
|-------------|-----------------------|-----------------|------------------------------|-----------------|------------------------------|
| BW (MHz)    | Frequency Range (MHz) | Maximum EIRP(W) | Emission Designator (99%OBW) | Maximum EIRP(W) | Emission Designator (99%OBW) |
| 20          | 1860.0 ~ 1900.0       | 0.5082          | 17M8G7D                      | 0.4055          | 17M8W7D                      |
| LTE Band 4  |                       | QPSK            |                              | 16QAM           |                              |
| BW (MHz)    | Frequency Range (MHz) | Maximum EIRP(W) | Emission Designator (99%OBW) | Maximum EIRP(W) | Emission Designator (99%OBW) |
| 20          | 1720.0 ~ 1745.0       | 0.3828          | 17M7G7D                      | 0.3006          | 18M0W7D                      |
| LTE Band 12 |                       | QPSK            |                              | 16QAM           |                              |
| BW (MHz)    | Frequency Range (MHz) | Maximum ERP(W)  | Emission Designator (99%OBW) | Maximum ERP(W)  | Emission Designator (99%OBW) |
| 10          | 704.0 ~ 711.0         | 0.1146          | 9M05G7D                      | 0.0927          | 8M99W7D                      |
| LTE Band 13 |                       | QPSK            |                              | 16QAM           |                              |
| BW (MHz)    | Frequency Range (MHz) | Maximum ERP(W)  | Emission Designator (99%OBW) | Maximum ERP(W)  | Emission Designator (99%OBW) |
| 10          | 782.0                 | 0.0871          | 8M99G7D                      | 0.0640          | 8M99W7D                      |
| LTE Band 66 |                       | QPSK            |                              | 16QAM           |                              |
| BW (MHz)    | Frequency Range (MHz) | Maximum EIRP(W) | Emission Designator (99%OBW) | Maximum EIRP(W) | Emission Designator (99%OBW) |
| 20          | 1720.0 ~ 1770.0       | 0.3846          | 17M7G7D                      | 0.2911          | 18M0W7D                      |

**Note:** LTE Band 66 overlaps the entire frequency range of LTE Band 4. Therefore, the test results provided in this report covers Band 66 as well as Band 4.



### 1.7 Testing Location

Sporton International (Kunshan) Inc. is accredited to ISO/IEC 17025:2017 by American Association for Laboratory Accreditation with Certificate Number 5145.02.

|                           |  |                            |                                       |
|---------------------------|--|----------------------------|---------------------------------------|
| <b>Test Firm</b>          | Sporton International (Kunshan) Inc.   |                            |                                       |
| <b>Test Site Location</b> | No. 1098, Pengxi North Road, Kunshan Economic Development Zone<br>Jiangsu Province 215300 People's Republic of China<br>TEL : +86-512-57900158<br>FAX : +86-512-57900958 |                            |                                       |
| <b>Test Site No.</b>      | <b>Sporton Site No.</b>  | <b>FCC Designation No.</b> | <b>FCC Test Firm Registration No.</b> |
|                           | 03CH04-KS<br>TH01-KS   | CN1257                     | 314309                                |

### 1.8 Test Software

| Item | Site      | Manufacturer | Name | Version      |
|------|-----------|--------------|------|--------------|
| 1.   | 03CH04-KS | AUDIX        | E3   | 6.2009-8-24a |

### 1.9 Applicable Standards

According to the specifications of the manufacturer, the EUT must comply with the requirements of the following standards:

- 47 CFR Part 2, 24(E), 27(L), 27(H), 27(F)
- ANSI C63.26-2015
- FCC KDB 971168 D01 Power Meas License Digital Systems v03r01
- FCC KDB 412172 D01 Determining ERP and EIRP v01r01

**Remark:**

1. All test items were verified and recorded according to the standards and without any deviation during the test.
2. This EUT has also been tested and complied with the requirements of FCC Part 15, Subpart B, recorded in a separate test report.



## 2 Test Configuration of Equipment Under Test

### 2.1 Test Mode

Antenna port conducted and radiated test items listed below are performed according to KDB 971168 D01 Power Meas License Digital Systems v03r01 with maximum output power.

Radiated measurements are performed by rotating the EUT in three different orthogonal test planes to find the maximum emission.

| Test Items                  | Band | Bandwidth (MHz) |   |   |    |    |    | Modulation |       |  | RB # |      |      | Test Channel |   |   |
|-----------------------------|------|-----------------|---|---|----|----|----|------------|-------|--|------|------|------|--------------|---|---|
|                             |      | 1.4             | 3 | 5 | 10 | 15 | 20 | QPSK       | 16QAM |  | 1    | Half | Full | L            | M | H |
| Max. Output Power           | 2    | v               | v | v | v  | v  | v  | v          | v     |  | v    | v    | v    | v            | v | v |
|                             | 4    | v               | v | v | v  | v  | v  | v          | v     |  | v    | v    | v    | v            | v | v |
|                             | 12   | v               | v | v | v  | -  | -  | v          | v     |  | v    | v    | v    | v            | v | v |
|                             | 13   | -               | - | v | v  | -  | -  | v          | v     |  | v    | v    | v    | v            | v | v |
|                             | 66   | v               | v | v | v  | v  | v  | v          | v     |  | v    | v    | v    | v            | v | v |
| Peak-to-Average Ratio       | 2    |                 |   |   |    |    | v  | v          | v     |  |      |      | v    |              | v |   |
|                             | 12   |                 |   |   | v  | -  | -  | v          | v     |  |      |      | v    |              | v |   |
|                             | 13   | -               | - |   | v  | -  | -  | v          | v     |  |      |      | v    |              | v |   |
|                             | 66   |                 |   |   |    |    | v  | v          | v     |  |      |      | v    |              | v |   |
| 26dB and 99% Bandwidth      | 2    |                 |   |   |    |    | v  | v          | v     |  |      |      | v    |              | v |   |
|                             | 12   |                 |   |   | v  | -  | -  | v          | v     |  |      |      | v    |              | v |   |
|                             | 13   | -               | - |   | v  | -  | -  | v          | v     |  |      |      | v    |              | v |   |
|                             | 66   |                 |   |   |    |    | v  | v          | v     |  |      |      | v    |              | v |   |
| Conducted Band Edge         | 2    | v               | v | v | v  | v  | v  | v          |       |  | v    |      | v    | v            |   | v |
|                             | 12   | v               | v | v | v  | -  | -  | v          | v     |  | v    |      | v    | v            |   | v |
|                             | 13   | -               | - | v | v  | -  | -  | v          | v     |  | v    |      | v    | v            |   | v |
|                             | 66   | v               | v | v | v  | v  | v  | v          | v     |  | v    |      | v    | v            |   | v |
| Conducted Spurious Emission | 2    | v               | v | v | v  | v  | v  | v          |       |  | v    |      |      | v            | v | v |
|                             | 12   | v               | v | v | v  | -  | -  | v          |       |  | v    |      |      | v            | v | v |
|                             | 13   | -               | - | v | v  | -  | -  | v          |       |  | v    |      |      | v            | v | v |
|                             | 66   | v               | v | v | v  | v  | v  | v          |       |  | v    |      |      | v            | v | v |
| Frequency Stability         | 2    |                 |   |   | v  |    |    | v          |       |  |      |      | v    |              | v |   |
|                             | 12   |                 |   |   | v  | -  | -  | v          |       |  |      |      | v    |              | v |   |
|                             | 13   | -               | - |   | v  | -  | -  | v          |       |  |      |      | v    |              | v |   |
|                             | 66   |                 |   |   | v  |    |    | v          |       |  |      |      | v    |              | v |   |



| Test Items                       | Band  | Bandwidth (MHz) |   |   |    |    |    | Modulation |       |  | RB # |      |      | Test Channel |   |   |   |  |
|----------------------------------|---|-----------------|---|---|----|----|----|------------|-------|--|------|------|------|--------------|---|---|---|--|
|                                  |   | 1.4             | 3 | 5 | 10 | 15 | 20 | QPSK       | 16QAM |  | 1    | Half | Full | L            | M | H |   |  |
| E.R.P /<br>E.I.R.P               | 2   | v               | v | v | v  | v  | v  | v          | v     |  | v    |      |      | v            | v | v |   |  |
|                                  | 4   | v               | v | v | v  | v  | v  | v          | v     |  | v    |      |      | v            | v | v |   |  |
|                                  | 12  | v               | v | v | v  | -  | -  | v          | v     |  | v    |      |      | v            | v | v |   |  |
|                                  | 13  | -               | - | v | v  | -  | -  | v          | v     |  | v    |      |      | v            | v | v |   |  |
|                                  | 66  | v               | v | v | v  | v  | v  | v          | v     |  | v    |      |      | v            | v | v |   |  |
| Radiated<br>Spurious<br>Emission | 2   | Worst Case      |   |   |    |    |    |            |       |  |      |      |      |              |   |   | v |  |
|                                  | 12  | Worst Case      |   |   |    |    |    |            |       |  |      |      |      |              |   |   | v |  |
|                                  | 13  | Worst Case      |   |   |    |    |    |            |       |  |      |      |      |              |   |   | v |  |
|                                  | 66  | Worst Case      |   |   |    |    |    |            |       |  |      |      |      |              |   |   | v |  |
| Note                             | <ol style="list-style-type: none"> <li>The mark "v" means that this configuration is chosen for testing</li> <li>The mark "-" means that this bandwidth is not supported.</li> <li>The device is investigated from 30MHz to 10 times of fundamental signal for radiated spurious emission test under different RB size/offset and modulations in exploratory test. Subsequently, only the worst case emissions are reported.</li> <li>LTE Band 66 overlaps the entire frequency range of LTE Band 4. Therefore, the test results provided in this report covers Band 66 as well as Band 4.</li> </ol> |                 |   |   |    |    |    |            |       |  |      |      |      |              |   |   |   |  |

## 2.2 Connection Diagram of Test System

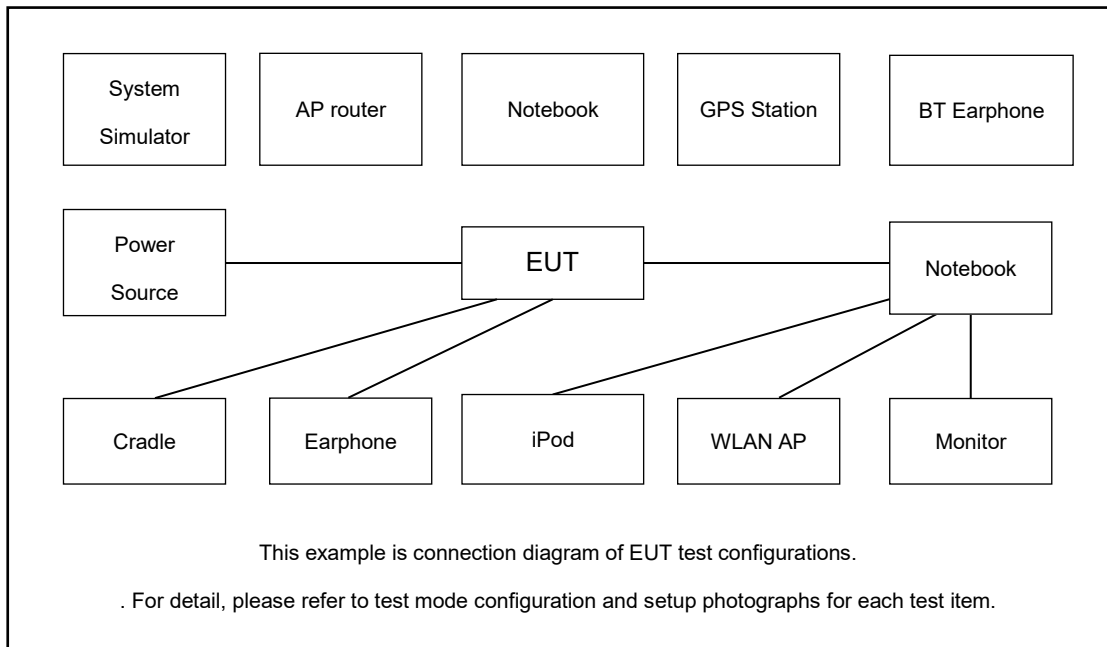



### 2.3 Support Unit used in test configuration and system

| Item | Equipment        | Trade Name | Model No.      | FCC ID | Data Cable | Power Cord        |
|------|------------------|------------|----------------|--------|------------|-------------------|
| 1.   | System Simulator | Anritsu    | MT8821C/MT8000 | N/A    | N/A        | Unshielded, 1.8 m |
| 2.   | Power Supply     | GWINSTEK   | PSS-2002       | N/A    | N/A        | Unshielded, 1.8 m |

### 2.4 Measurement Results Explanation Example

For all conducted test items:

The offset level is set in the spectrum analyzer to compensate the RF cable loss between EUT conducted output port and spectrum analyzer. With the offset compensation, the spectrum analyzer reading level is exactly the EUT RF output level.

The spectrum analyzer offset is derived from RF cable loss.

*Offset = RF cable loss + attenuator factor.*

Following shows an offset computation example with cable loss 5.6 dB.

Example :

$$\begin{aligned}
 \text{Offset(dB)} &= \text{RF cable loss(dB)}. \\
 &= 5.6 \text{ (dB)}
 \end{aligned}$$

### 2.5 Frequency List of Low/Middle/High Channels

| LTE Band 2 Channel and Frequency List |                        |        |        |         |
|---------------------------------------|------------------------|--------|--------|---------|
| BW [MHz]                              | Channel/Frequency(MHz) | Lowest | Middle | Highest |
| 20                                    | Channel                | 18700  | 18900  | 19100   |
|                                       | Frequency              | 1860   | 1880   | 1900    |
| 15                                    | Channel                | 18675  | 18900  | 19125   |
|                                       | Frequency              | 1857.5 | 1880   | 1902.5  |
| 10                                    | Channel                | 18650  | 18900  | 19150   |
|                                       | Frequency              | 1855   | 1880   | 1905    |
| 5                                     | Channel                | 18625  | 18900  | 19175   |
|                                       | Frequency              | 1852.5 | 1880   | 1907.5  |
| 3                                     | Channel                | 18615  | 18900  | 19185   |
|                                       | Frequency              | 1851.5 | 1880   | 1908.5  |
| 1.4                                   | Channel                | 18607  | 18900  | 19193   |
|                                       | Frequency              | 1850.7 | 1880   | 1909.3  |



| LTE Band 4 Channel and Frequency List |                        |        |        |         |
|---------------------------------------|------------------------|--------|--------|---------|
| BW [MHz]                              | Channel/Frequency(MHz) | Lowest | Middle | Highest |
| 20                                    | Channel                | 20050  | 20175  | 20300   |
|                                       | Frequency              | 1720   | 1732.5 | 1745    |
| 15                                    | Channel                | 20025  | 20175  | 20325   |
|                                       | Frequency              | 1717.5 | 1732.5 | 1747.5  |
| 10                                    | Channel                | 20000  | 20175  | 20350   |
|                                       | Frequency              | 1715   | 1732.5 | 1750    |
| 5                                     | Channel                | 19975  | 20175  | 20375   |
|                                       | Frequency              | 1712.5 | 1732.5 | 1752.5  |
| 3                                     | Channel                | 19965  | 20175  | 20385   |
|                                       | Frequency              | 1711.5 | 1732.5 | 1753.5  |
| 1.4                                   | Channel                | 19957  | 20175  | 20393   |
|                                       | Frequency              | 1710.7 | 1732.5 | 1754.3  |

| LTE Band 12 Channel and Frequency List |                        |        |        |         |
|--|------------------------|--------|--------|---------|
| BW [MHz]                               | Channel/Frequency(MHz) | Lowest | Middle | Highest |
| 10                                     | Channel                | 23060  | 23095  | 23130   |
|  | Frequency              | 704    | 707.5  | 711     |
| 5                                      | Channel                | 23035  | 23095  | 23155   |
|  | Frequency              | 701.5  | 707.5  | 713.5   |
| 3                                      | Channel                | 23025  | 23095  | 23165   |
|  | Frequency              | 700.5  | 707.5  | 714.5   |
| 1.4                                    | Channel                | 23017  | 23095  | 23173   |
|  | Frequency              | 699.7  | 707.5  | 715.3   |

| LTE Band 13 Channel and Frequency List |                        |        |        |         |
|--|------------------------|--------|--------|---------|
| BW [MHz]                               | Channel/Frequency(MHz) | Lowest | Middle | Highest |
| 10                                     | Channel                | -      | 23230  | -       |
|  | Frequency              | -      | 782    | -       |
| 5                                      | Channel                | 23205  | 23230  | 23255   |
|  | Frequency              | 779.5  | 782    | 784.5   |



| LTE Band 66 Channel and Frequency List |                        |        |        |         |
|--|------------------------|--------|--------|---------|
| BW [MHz]                               | Channel/Frequency(MHz) | Lowest | Middle | Highest |
| 20                                     | Channel                | 132072 | 132322 | 132572  |
|  | Frequency              | 1720   | 1745   | 1770    |
| 15                                     | Channel                | 132047 | 132322 | 132597  |
|  | Frequency              | 1717.5 | 1745   | 1772.5  |
| 10                                     | Channel                | 132022 | 132322 | 132622  |
|  | Frequency              | 1715   | 1745   | 1775    |
| 5                                      | Channel                | 131997 | 132322 | 132647  |
|  | Frequency              | 1712.5 | 1745   | 1777.5  |
| 3                                      | Channel                | 131987 | 132322 | 132657  |
|  | Frequency              | 1711.5 | 1745   | 1778.5  |
| 1.4                                    | Channel                | 131979 | 132322 | 132665  |
|  | Frequency              | 1710.7 | 1745   | 1779.3  |

### 3 Conducted Test Items

#### 3.1 Measuring Instruments

See list of measuring instruments of this test report.

#### 3.2 Test Setup

##### 3.2.1 Conducted Output Power

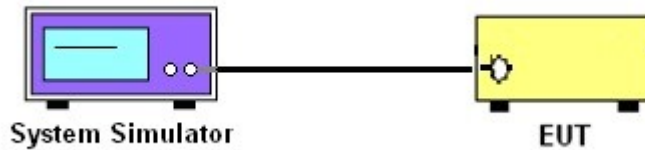

##### 3.2.2 Peak-to-Average Ratio, Occupied Bandwidth ,Conducted Band-Edge and Conducted Spurious Emission

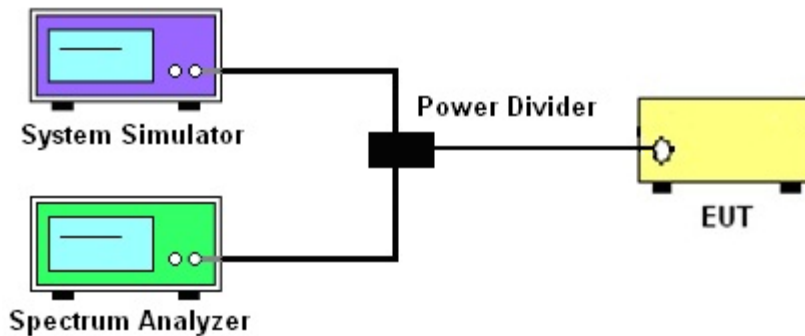

##### 3.2.3 Frequency Stability

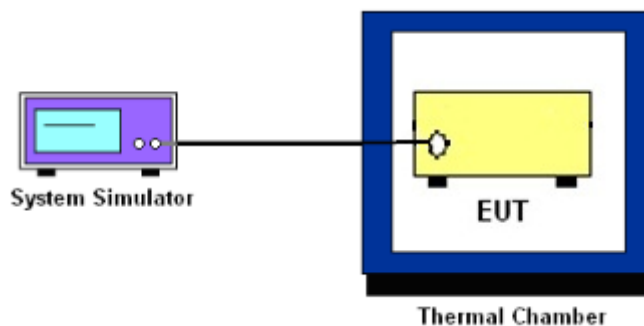

### 3.3 Test Result of Conducted Test

Please refer to Appendix A.



### 3.4 Conducted Output Power and ERP/EIRP

#### 3.4.1 Description of the Conducted Output Power Measurement and ERP/EIRP Measurement

A system simulator was used to establish communication with the EUT. Its parameters were set to force the EUT transmitting at maximum output power. The measured power in the radio frequency on the transmitter output terminals shall be reported.

The ERP of mobile transmitters must not exceed 3 Watts for LTE Band 12, Band 13.

The EIRP of mobile transmitters must not exceed 2 Watts for LTE Band 2

The EIRP of mobile transmitters must not exceed 1 Watts for LTE Band 4 and Band 66.

According to KDB 412172 D01 Power Approach,

$EIRP = P_T + G_T - L_C$ ,  $ERP = EIRP - 2.15$ , where

$P_T$  = transmitter output power in dBm

$G_T$  = gain of the transmitting antenna in dBi

$L_C$  = signal attenuation in the connecting cable between the transmitter and antenna in dB

#### 3.4.2 Test Procedures

1. The testing follows ANSI C63.26 Section 5.2
2. The transmitter output port was connected to the system simulator.
3. Set EUT at maximum power through the system simulator.
4. Select lowest, middle, and highest channels for each band and different modulation.
5. Measure and record the power level from the system simulator.



## **3.5 Peak-to-Average Ratio**

### **3.5.1 Description of the PAR Measurement**

Power Complementary Cumulative Distribution Function (CCDF) curves provide a means for characterizing the power peaks of a digitally modulated signal on a statistical basis. A CCDF curve depicts the probability of the peak signal amplitude exceeding the average power level. Most contemporary measurement instrumentation include the capability to produce CCDF curves for an input signal provided that the instrument's resolution bandwidth can be set wide enough to accommodate the entire input signal bandwidth. In measuring transmissions in this band using an average power technique, the peak-to-average ratio (PAR) of the transmission may not exceed 13 dB.

### **3.5.2 Test Procedures**

1. The testing follows ANSI C63.26 Section 5.2.3.4 (CCDF).
2. The EUT was connected to spectrum and system simulator via a power divider.
3. Set the CCDF (Complementary Cumulative Distribution Function) option in spectrum analyzer.
4. The highest RF powers were measured and recorded the maximum PAPR level associated with a probability of 0.1 %.
5. Record the deviation as Peak to Average Ratio.



### 3.6 Occupied Bandwidth

#### 3.6.1 Description of Occupied Bandwidth Measurement

The occupied bandwidth is the width of a frequency band such that, below the lower and above the upper frequency limits, the mean powers emitted are each equal to a specified percentage 0.5% of the total mean transmitted power.

The 26 dB emission bandwidth is defined as the frequency range between two points, one above and one below the carrier frequency, at which the spectral density of the emission is attenuated 26 dB below the maximum in-band spectral density of the modulated signal. Spectral density (power per unit bandwidth) is to be measured with a detector of resolution bandwidth equal to approximately 1.0% of the emission bandwidth.

#### 3.6.2 Test Procedures

1. The testing follows ANSI C63.26 Section 5.4
2. The EUT was connected to spectrum analyzer and system simulator via a power divider.
3. The spectrum analyzer center frequency is set to the nominal EUT channel center frequency. The span range for the spectrum analyzer shall be between two and five times the anticipated OBW.
4. The nominal resolution bandwidth (RBW) shall be in the range of 1 to 5 % of the anticipated OBW, and the VBW shall be at least 3 times the RBW.
5. Set the detection mode to peak, and the trace mode to max hold.
6. Determine the reference value: Set the EUT to transmit a modulated signal. Allow the trace to stabilize. Set the spectrum analyzer marker to the highest level of the displayed trace.  
(this is the reference value)
7. Determine the “-26 dB down amplitude” as equal to (Reference Value – X).
8. Place two markers, one at the lowest and the other at the highest frequency of the envelope of the spectral display such that each marker is at or slightly below the “-X dB down amplitude” determined in step 6. If a marker is below this “-X dB down amplitude” value it shall be placed as close as possible to this value. The OBW is the positive frequency difference between the two markers.
9. Use the 99 % power bandwidth function of the spectrum analyzer and report the measured bandwidth.





### **3.7 Conducted Band Edge**

#### **3.7.1 Description of Conducted Band Edge Measurement**

24.238 (a)

For operations in the 1850-1910 and 1930-1990 MHz band, the FCC limit is  $43 + 10\log_{10}(P[\text{Watts}])$  dB below the transmitter power  $P(\text{Watts})$  in a 1MHz bandwidth. However, in the 1 MHz bands immediately outside and adjacent to the frequency block a resolution bandwidth of at least one percent of the emission bandwidth of the fundamental emission of the transmitter may be employed.

27.53 (c)

For operations in the 776-788 MHz band, the FCC limit is  $43 + 10\log_{10}(P[\text{Watts}])$  dB below the transmitter power  $P(\text{Watts})$  in a 100 kHz bandwidth. However, in the 100 kHz bands immediately outside and adjacent to the frequency block, a resolution bandwidth of at least 30 kHz may be employed. In addition, the power of any unwanted emissions in any 6.25 kHz bandwidth for all frequencies between 763-775 MHz and 793-806 MHz shall be attenuated below the transmitter power,  $P$  (dBW), by at least  $65 + 10 \log_{10} p(\text{watts})$ , dB, for mobile and portable equipment.

27.53 (g)

For operations in the 600MHz band and 698 -746 MHz band, the FCC limit is  $43 + 10\log_{10}(P[\text{Watts}])$  dB below the transmitter power  $P(\text{Watts})$  in a 100 kHz bandwidth. However, in the 100 kilohertz bands immediately outside and adjacent to a licensee's frequency block, a resolution bandwidth of at least 30 kHz may be employed.

27.53 (h)

For operations in the 1710 – 1755 MHz band, the FCC limit is  $43 + 10\log_{10}(P[\text{Watts}])$  dB below the transmitter power  $P(\text{Watts})$  in a 1 MHz bandwidth. However, in the 1MHz bands immediately outside and adjacent to the licensee's frequency block, a resolution bandwidth of at least one percent of the emission bandwidth of the fundamental emission of the transmitter may be employed.



### 3.7.2 Test Procedures

1. The testing follows ANSI C63.26 section 5.7
2. The EUT was connected to spectrum analyzer and system simulator via a power divider.
3. The band edges of low and high channels for the highest RF powers were measured.
4. Set RBW  $\geq$  1% EBW in the 1MHz band immediately outside and adjacent to the band edge.
5. Beyond the 1 MHz band from the band edge, RBW=1MHz was used or a narrower RBW was used and the measured power was integrated over the full required measurement bandwidth of 1 MHz.
6. Set spectrum analyzer with RMS detector.
7. The RF fundamental frequency should be excluded against the limit line in the operating frequency band.
8. Checked that all the results comply with the emission limit line.

Example:

The limit line is derived from  $43 + 10\log(P)$ dB below the transmitter power P(Watts)

$$= P(W) - [43 + 10\log(P)] \text{ (dB)}$$

$$= [30 + 10\log(P)] \text{ (dBm)} - [43 + 10\log(P)] \text{ (dB)} = -13\text{dBm}.$$



### 3.8 Conducted Spurious Emission

#### 3.8.1 Description of Conducted Spurious Emission Measurement

The power of any emission outside of the authorized operating frequency ranges must be lower than the transmitter power (P) by a factor of at least  $43 + 10 \log (P)$  dB.

It is measured by means of a calibrated spectrum analyzer and scanned from 30 MHz up to a frequency including its 10<sup>th</sup> harmonic.

#### 3.8.2 Test Procedures

1. The testing follows ANSI C63.26 section 5.7
2. The EUT was connected to spectrum analyzer and system simulator via a power divider.
3. The RF output of EUT was connected to the spectrum analyzer by RF cable and attenuator. The path loss was compensated to the results for each measurement.
4. The middle channel for the highest RF power within the transmitting frequency was measured.
5. The conducted spurious emission for the whole frequency range was taken.
6. Make the measurement with the spectrum analyzer's RBW = 1MHz, VBW = 3MHz.
7. Set spectrum analyzer with RMS detector.
8. Taking the record of maximum spurious emission.
9. The RF fundamental frequency should be excluded against the limit line in the operating frequency band.
10. The limit line is derived from  $43 + 10\log(P)$ dB below the transmitter power P(Watts)  
= P(W)- [43 + 10log(P)] (dB)  
= [30 + 10log(P)] (dBm) - [43 + 10log(P)] (dB)  
= -13dBm.



## 3.9 Frequency Stability

### 3.9.1 Description of Frequency Stability Measurement

The frequency stability shall be measured by variation of ambient temperature and variation of primary supply voltage to ensure that the fundamental emission stays within the authorized frequency block. The frequency stability of the transmitter shall be maintained within  $\pm 0.00025\%$  ( $\pm 2.5\text{ppm}$ ) of the center frequency.

### 3.9.2 Test Procedures for Temperature Variation

1. The testing follows ANSI C63.26 section 5.6.4
2. The EUT was set up in the thermal chamber and connected with the system simulator.
3. With power OFF, the temperature was decreased to  $-30^{\circ}\text{C}$  and the EUT was stabilized before testing. Power was applied and the maximum change in frequency was recorded within one minute.
4. With power OFF, the temperature was raised in  $10^{\circ}\text{C}$  step up to  $50^{\circ}\text{C}$ . The EUT was stabilized at each step for at least half an hour. Power was applied and the maximum frequency change was recorded within one minute.

### 3.9.3 Test Procedures for Voltage Variation

1. The testing follows ANSI C63.26 section 5.6.5
2. The EUT was placed in a temperature chamber at  $20\pm 5^{\circ}\text{C}$  and connected with the system simulator.
3. The power supply voltage to the EUT was varied from 85% to 115% of the nominal value for other than hand carried battery equipment.
4. For hand carried, battery powered equipment, reduce the primary ac or dc supply voltage to the battery operating end point, which shall be specified by the manufacturer.
5. The variation in frequency was measured for the worst case.

## 4 Radiated Test Items

### 4.1 Measuring Instruments

See list of measuring instruments of this test report.

### 4.2 Test Setup

#### 4.2.1 For radiated test below 30MHz

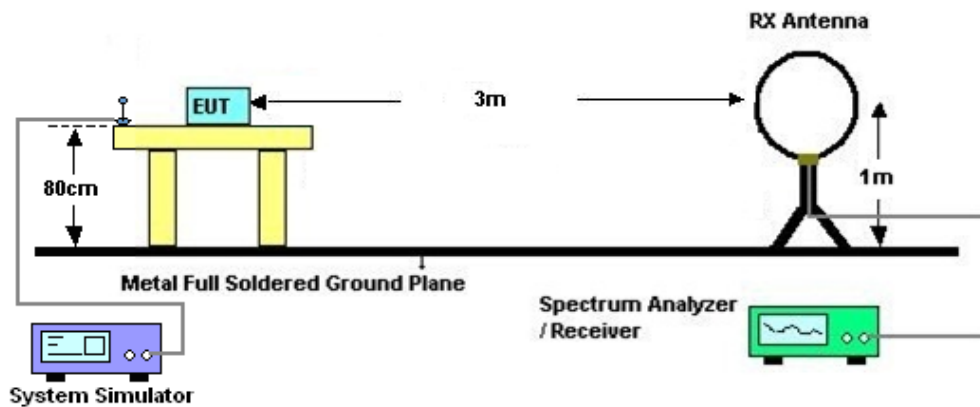

#### 4.2.2 For radiated test from 30MHz to 1GHz

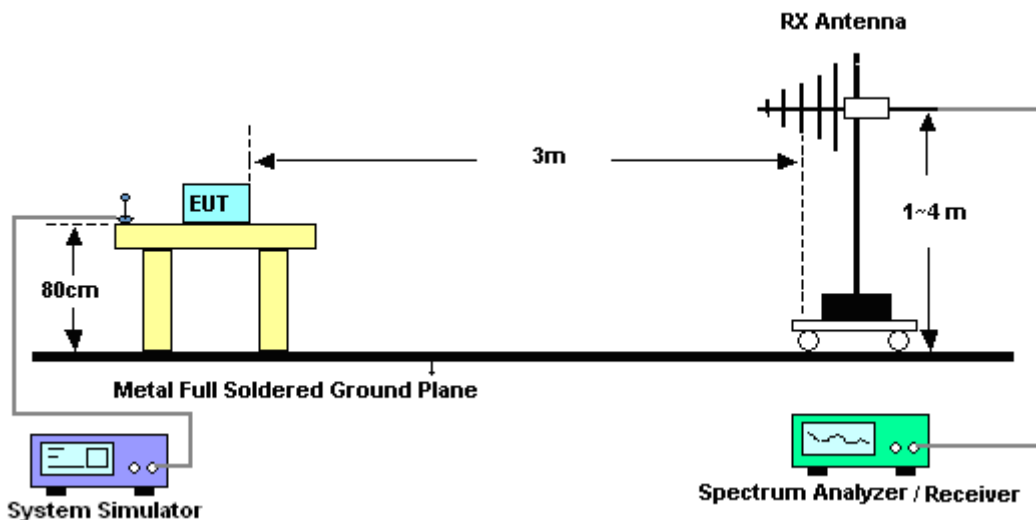

#### 4.2.3 For radiated test above 1GHz

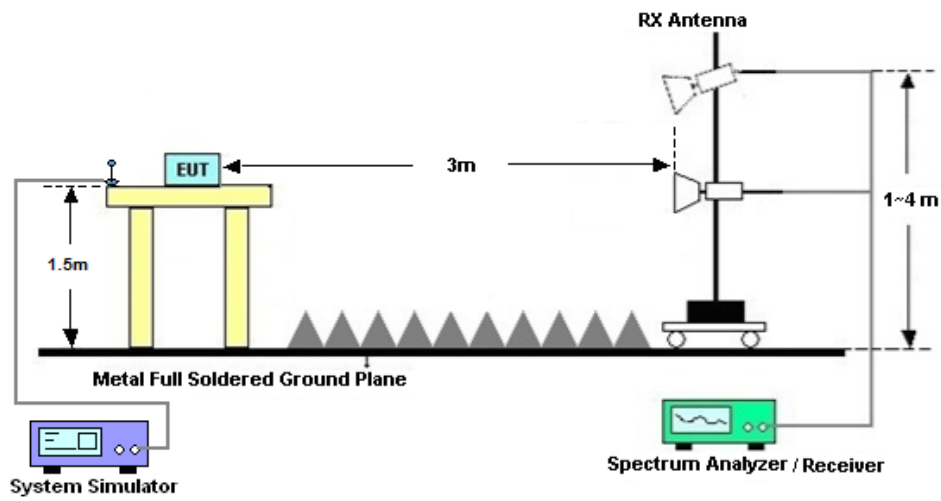

#### 4.3 Test Result of Radiated Test

The low frequency, which started from 9 kHz to 30MHz, was pre-scanned and the result which was 20dB lower than the limit line was not reported.

Please refer to Appendix B.



## 4.4 Radiated Spurious Emission

### 4.4.1 Description of Radiated Spurious Emission

The radiated spurious emission was measured by substitution method according to ANSI C63.26. The power of any emission outside of the authorized operating frequency ranges must be attenuated below the transmitter power (P) by a factor of at least  $43 + 10 \log (P)$  dB.

For LTE Band 13

For operations in the 746-758 MHz, 775-788 MHz, and 805-806 MHz bands, emissions in the band 1559-1610 MHz shall be limited to  $-70$  dBW/MHz equivalent isotropically radiated power (EIRP) for wideband signals, and  $-80$  dBW EIRP for discrete emissions of less than 700 Hz bandwidth.

The spectrum is scanned from 30 MHz up to a frequency including its 10th harmonic.

### 4.4.2 Test Procedures

1. The testing follows ANSI C63.26 Section 5.5
2. The EUT was placed on a turntable with 0.8 meter height for frequency below 1GHz and 1.5 meter height for frequency above 1GHz respectively above ground.
3. The EUT was set 3 meters from the receiving antenna mounted on the antenna tower.
4. The table was rotated 360 degrees to determine the position of the highest spurious emission.
5. The height of the receiving antenna is varied between 1m to 4m to search the maximum spurious emission for both horizontal and vertical polarizations.
6. During the measurement, the system simulator parameters were set to force the EUT transmitting at maximum output power.
7. Make the measurement with the spectrum analyzer's RBW = 1MHz, VBW = 3MHz, taking the record of maximum spurious emission.
8. A horn antenna was substituted in place of the EUT and was driven by a signal generator.
9. Tune the output power of signal generator to the same emission level with EUT maximum spurious emission.
10.  $EIRP \text{ (dBm)} = S.G. \text{ Power} - Tx \text{ Cable Loss} + Tx \text{ Antenna Gain}$
11.  $ERP \text{ (dBm)} = EIRP - 2.15$
12. The RF fundamental frequency should be excluded against the limit line in the operating frequency band.

The limit line is derived from  $43 + 10\log(P)$ dB below the transmitter power P(Watts)  
 $= P(W) - [43 + 10\log(P)] \text{ (dB)}$   
 $= [30 + 10\log(P)] \text{ (dBm)} - [43 + 10\log(P)] \text{ (dB)}$   
 $= -13\text{dBm}.$



## 5 List of Measuring Equipment

| Instrument                     | Manufacturer | Model No.                      | Serial No.  | Characteristics         | Calibration Date | Test Date                      | Due Date      | Remark                |
|--------------------------------|--------------|--------------------------------|-------------|-------------------------|------------------|--------------------------------|---------------|-----------------------|
| Spectrum Analyzer              | R&S          | FSV40                          | 101040      | 10Hz~40GHz              | Nov. 01, 2020    | May 27, 2021~<br>Jul. 29, 2021 | Oct. 31, 2021 | Conducted (TH01-KS)   |
| Power divider                  | STI          | STI08-0055                     | -           | 0.5~40GHz               | Aug. 27, 2020    | May 27, 2021~<br>Jul. 29, 2021 | Aug. 26, 2021 | Conducted (TH01-KS)   |
| Temperature & humidity chamber | Hongzhan     | LP-150U                        | H2014011440 | -40~+150°C<br>20%~95%RH | Jul. 03, 2020    | May 27, 2021~<br>Jul. 29, 2021 | Jul. 02, 2021 | Conducted (TH01-KS)   |
| Temperature & humidity chamber | Hongzhan     | LP-150U                        | H2014011440 | -40~+150°C<br>20%~95%RH | Jul. 02, 2021    |                                | Jul. 01, 2022 | Conducted (TH01-KS)   |
| EXA Spectrum Analyzer          | Keysight     | N9010A                         | MY55150244  | 10Hz-44G,MAX<br>30dB    | Apr. 13, 2021    | Jun. 08, 2021                  | Apr. 12, 2022 | Radiation (03CH04-KS) |
| Loop Antenna                   | R&S          | HFH2-Z2                        | 100321      | 9kHz~30MHz              | Nov. 01, 2020    | Jun. 08, 2021                  | Oct. 31, 2021 | Radiation (03CH04-KS) |
| Bilog Antenna                  | TeseQ        | CBL6111D                       | 49922       | 30MHz-1GHz              | May 30, 2021     | Jun. 08, 2021                  | May 29, 2022  | Radiation (03CH04-KS) |
| Horn Antenna                   | Schwarzbeck  | BBHA9120D                      | 1356        | 1GHz~18GHz              | Apr. 18, 2021    | Jun. 08, 2021                  | Apr. 17, 2022 | Radiation (03CH04-KS) |
| SHF-EHF Horn                   | Com-power    | AH-840                         | 101115      | 18GHz~40GHz             | Jan. 06, 2021    | Jun. 08, 2021                  | Jan. 05, 2022 | Radiation (03CH04-KS) |
| Amplifier                      | SONOMA       | 310N                           | 187289      | 9KHz-1GHz               | Jan. 06, 2021    | Jun. 08, 2021                  | Jan. 05, 2022 | Radiation (03CH04-KS) |
| Amplifier                      | MITEQ        | EM18G40G<br>GA                 | 060728      | 18~40GHz                | Jan. 07, 2021    | Jun. 08, 2021                  | Jan. 06, 2022 | Radiation (03CH04-KS) |
| high gain Amplifier            | MITEQ        | AMF-7D-00<br>101800-30-1<br>0P | 2025788     | 1Ghz-18Ghz              | Jan. 06, 2021    | Jun. 08, 2021                  | Jan. 05, 2022 | Radiation (03CH04-KS) |
| Amplifier                      | Keysight     | 83017A                         | MY57280106  | 500MHz~26.5GHz          | Oct. 14, 2020    | Jun. 08, 2021                  | Oct. 13, 2021 | Radiation (03CH04-KS) |
| AC Power Source                | Chroma       | 61601                          | F104090004  | N/A                     | NCR              | Jun. 08, 2021                  | NCR           | Radiation (03CH04-KS) |
| Turn Table                     | ChamPro      | EM 1000-T                      | 060762-T    | 0~360 degree            | NCR              | Jun. 08, 2021                  | NCR           | Radiation (03CH04-KS) |
| Antenna Mast                   | ChamPro      | EM 1000-A                      | 060762-A    | 1 m~4 m                 | NCR              | Jun. 08, 2021                  | NCR           | Radiation (03CH04-KS) |





## 6 Uncertainty of Evaluation

The measurement uncertainties shown below were calculated in accordance with the requirements of ANSI 63.26-2015. All the measurement uncertainty value were shown with a coverage K=2 to indicate 95% level of confidence. The measurement data show herein meets or exceeds the CISPR measurement uncertainty values specified in CISPR 16-4-2 and can be compared directly to specified limit to determine compliance.

### Uncertainty of Radiated Emission Measurement (30 MHz ~ 1000 MHz)

|   |        |
|---|--------|
| Measuring Uncertainty for a Level of Confidence of 95% (U = 2Uc(y)) | 5.0 dB |
|---|--------|

### Uncertainty of Radiated Emission Measurement (1 GHz ~ 40 GHz)

|   |       |
|---|-------|
| Measuring Uncertainty for a Level of Confidence of 95% (U = 2Uc(y)) | 5.1dB |
|---|-------|



## Appendix A. Test Results of Conducted Test

### Conducted Output Power(Average power) and ERP/EIRP

| LTE Band 2      |            |         |           |                       |                          |                        |         |        |        |
|-----------------|------------|---------|-----------|-----------------------|--------------------------|------------------------|---------|--------|--------|
| BW [MHz]        | Modulation | RB Size | RB Offset | Power Low Ch. / Freq. | Power Middle Ch. / Freq. | Power High Ch. / Freq. | EIRP(W) |        |        |
| Channel         |            |         |           | 18700                 | 18900                    | 19100                  | EIRP(W) |        |        |
| Frequency (MHz) |            |         |           | 1860                  | 1880                     | 1900                   | L       | M      | H      |
| 20              | QPSK       | 1       | 0         | 22.60                 | 22.77                    | 22.56                  | 0.4887  | 0.5082 | 0.4842 |
| 20              | QPSK       | 1       | 99        | 22.58                 | 22.54                    | 22.46                  | 0.4864  | 0.4819 | 0.4732 |
| 20              | QPSK       | 100     | 0         | 21.78                 | 21.66                    | 21.73                  | 0.4046  | 0.3936 | 0.3999 |
| 20              | 16QAM      | 1       | 0         | 21.44                 | 21.58                    | 21.79                  | 0.3741  | 0.3864 | 0.4055 |
| Channel         |            |         |           | 18675                 | 18900                    | 19125                  | EIRP(W) |        |        |
| Frequency (MHz) |            |         |           | 1857.5                | 1880                     | 1902.5                 | L       | M      | H      |
| 15              | QPSK       | 1       | 0         | 22.71                 | 22.29                    | 22.60                  | 0.5012  | 0.4550 | 0.4887 |
| 15              | 16QAM      | 1       | 0         | 21.52                 | 21.79                    | 21.60                  | 0.3811  | 0.4055 | 0.3882 |
| Channel         |            |         |           | 18650                 | 18900                    | 19150                  | EIRP(W) |        |        |
| Frequency (MHz) |            |         |           | 1855                  | 1880                     | 1905                   | L       | M      | H      |
| 10              | QPSK       | 1       | 0         | 22.57                 | 22.72                    | 22.70                  | 0.4853  | 0.5023 | 0.5000 |
| 10              | 16QAM      | 1       | 0         | 21.60                 | 21.70                    | 21.66                  | 0.3882  | 0.3972 | 0.3936 |
| Channel         |            |         |           | 18625                 | 18900                    | 19175                  | EIRP(W) |        |        |
| Frequency (MHz) |            |         |           | 1852.5                | 1880                     | 1907.5                 | L       | M      | H      |
| 5               | QPSK       | 1       | 0         | 22.66                 | 22.74                    | 22.61                  | 0.4955  | 0.5047 | 0.4898 |
| 5               | 16QAM      | 1       | 0         | 21.37                 | 21.52                    | 21.68                  | 0.3681  | 0.3811 | 0.3954 |
| Channel         |            |         |           | 18615                 | 18900                    | 19185                  | EIRP(W) |        |        |
| Frequency (MHz) |            |         |           | 1851.5                | 1880                     | 1908.5                 | L       | M      | H      |
| 3               | QPSK       | 1       | 0         | 22.61                 | 22.69                    | 22.56                  | 0.4898  | 0.4989 | 0.4842 |
| 3               | 16QAM      | 1       | 0         | 21.32                 | 21.47                    | 21.63                  | 0.3639  | 0.3767 | 0.3908 |
| Channel         |            |         |           | 18607                 | 18900                    | 19193                  | EIRP(W) |        |        |
| Frequency (MHz) |            |         |           | 1850.7                | 1880                     | 1909.3                 | L       | M      | H      |
| 1.4             | QPSK       | 1       | 0         | 22.49                 | 22.74                    | 22.58                  | 0.4764  | 0.5047 | 0.4864 |
| 1.4             | 16QAM      | 1       | 0         | 21.51                 | 21.63                    | 21.58                  | 0.3802  | 0.3908 | 0.3864 |



| LTE Band 4      |            |         |           |                       |                          |                        |         |        |        |
|-----------------|------------|---------|-----------|-----------------------|--------------------------|------------------------|---------|--------|--------|
| BW [MHz]        | Modulation | RB Size | RB Offset | Power Low Ch. / Freq. | Power Middle Ch. / Freq. | Power High Ch. / Freq. | EIRP(W) |        |        |
| Channel         |            |         |           | 20050                 | 20175                    | 20300                  |         |        |        |
| Frequency (MHz) |            |         |           | 1720                  | 1732.5                   | 1745                   | L       | M      | H      |
| 20              | QPSK       | 1       | 0         | 22.87                 | 22.89                    | 22.51                  | 0.3811  | 0.3828 | 0.3508 |
| 20              | QPSK       | 1       | 99        | 22.67                 | 22.61                    | 22.58                  | 0.3639  | 0.3589 | 0.3565 |
| 20              | QPSK       | 100     | 0         | 21.71                 | 21.75                    | 21.89                  | 0.2917  | 0.2944 | 0.3041 |
| 20              | 16QAM      | 1       | 0         | 21.36                 | 21.60                    | 21.84                  | 0.2692  | 0.2844 | 0.3006 |
| Channel         |            |         |           | 20025                 | 20175                    | 20325                  | EIRP(W) |        |        |
| Frequency (MHz) |            |         |           | 1717.5                | 1732.5                   | 1747.5                 | L       | M      | H      |
| 15              | QPSK       | 1       | 0         | 22.84                 | 22.58                    | 22.61                  | 0.3784  | 0.3565 | 0.3589 |
| 15              | 16QAM      | 1       | 0         | 21.82                 | 21.55                    | 21.53                  | 0.2992  | 0.2812 | 0.2799 |
| Channel         |            |         |           | 20000                 | 20175                    | 20350                  | EIRP(W) |        |        |
| Frequency (MHz) |            |         |           | 1715                  | 1732.5                   | 1750                   | L       | M      | H      |
| 10              | QPSK       | 1       | 0         | 22.69                 | 22.66                    | 22.71                  | 0.3656  | 0.3631 | 0.3673 |
| 10              | 16QAM      | 1       | 0         | 21.77                 | 21.80                    | 21.74                  | 0.2958  | 0.2979 | 0.2938 |
| Channel         |            |         |           | 19975                 | 20175                    | 20375                  | EIRP(W) |        |        |
| Frequency (MHz) |            |         |           | 1712.5                | 1732.5                   | 1752.5                 | L       | M      | H      |
| 5               | QPSK       | 1       | 0         | 22.60                 | 22.74                    | 22.78                  | 0.3581  | 0.3698 | 0.3733 |
| 5               | 16QAM      | 1       | 0         | 21.62                 | 21.83                    | 21.61                  | 0.2858  | 0.2999 | 0.2851 |
| Channel         |            |         |           | 19965                 | 20175                    | 20385                  | EIRP(W) |        |        |
| Frequency (MHz) |            |         |           | 1711.5                | 1732.5                   | 1753.5                 | L       | M      | H      |
| 3               | QPSK       | 1       | 0         | 22.55                 | 22.69                    | 22.73                  | 0.3540  | 0.3656 | 0.3690 |
| 3               | 16QAM      | 1       | 0         | 21.57                 | 21.78                    | 21.56                  | 0.2825  | 0.2965 | 0.2818 |
| Channel         |            |         |           | 19950                 | 20175                    | 20393                  | EIRP(W) |        |        |
| Frequency (MHz) |            |         |           | 1710                  | 1732.5                   | 1754.3                 | L       | M      | H      |
| 1.4             | QPSK       | 1       | 0         | 22.84                 | 22.48                    | 22.55                  | 0.3784  | 0.3483 | 0.3540 |
| 1.4             | 16QAM      | 1       | 0         | 21.74                 | 21.47                    | 21.45                  | 0.2938  | 0.2761 | 0.2748 |



| LTE Band 12     |            |         |           |                                |                                   |                                 |         |        |        |
|-----------------|------------|---------|-----------|--------------------------------|-----------------------------------|---------------------------------|---------|--------|--------|
| BW [MHz]        | Modulation | RB Size | RB Offset | Power<br>Low<br>Ch. /<br>Freq. | Power<br>Middle<br>Ch. /<br>Freq. | Power<br>High<br>Ch. /<br>Freq. | ERP(W)  |        |        |
| Channel         |            |         |           | 23060                          | 23095                             | 23160                           |         |        |        |
| Frequency (MHz) |            |         |           | 704                            | 707.5                             | 714                             | L       | M      | H      |
| 10              | QPSK       | 1       | 0         | 22.42                          | 22.84                             | 22.76                           | 0.1040  | 0.1146 | 0.1125 |
| 10              | QPSK       | 1       | 49        | 22.69                          | 22.58                             | 22.61                           | 0.1107  | 0.1079 | 0.1086 |
| 10              | QPSK       | 50      | 0         | 21.86                          | 21.79                             | 21.76                           | 0.0914  | 0.0899 | 0.0893 |
| 10              | 16QAM      | 1       | 0         | 21.90                          | 21.92                             | 21.75                           | 0.0923  | 0.0927 | 0.0891 |
| Channel         |            |         |           | 23035                          | 23095                             | 23205                           | EIRP(W) |        |        |
| Frequency (MHz) |            |         |           | 701.5                          | 707.5                             | 718.5                           | L       | M      | H      |
| 5               | QPSK       | 1       | 0         | 22.65                          | 22.75                             | 22.51                           | 0.1096  | 0.1122 | 0.1062 |
| 5               | 16QAM      | 1       | 0         | 21.67                          | 21.62                             | 21.54                           | 0.0875  | 0.0865 | 0.0849 |
| Channel         |            |         |           | 23025                          | 23095                             | 23195                           | EIRP(W) |        |        |
| Frequency (MHz) |            |         |           | 700.5                          | 707.5                             | 717.5                           | L       | M      | H      |
| 3               | QPSK       | 1       | 0         | 22.60                          | 22.70                             | 22.46                           | 0.1084  | 0.1109 | 0.1050 |
| 3               | 16QAM      | 1       | 0         | 21.62                          | 21.57                             | 21.49                           | 0.0865  | 0.0855 | 0.0839 |
| Channel         |            |         |           | 23017                          | 23095                             | 23173                           | EIRP(W) |        |        |
| Frequency (MHz) |            |         |           | 699.7                          | 707.5                             | 715.3                           | L       | M      | H      |
| 1.4             | QPSK       | 1       | 0         | 22.57                          | 22.67                             | 22.43                           | 0.1076  | 0.1102 | 0.1042 |
| 1.4             | 16QAM      | 1       | 0         | 21.65                          | 21.63                             | 21.26                           | 0.0871  | 0.0867 | 0.0796 |



| LTE Band 13     |            |         |           |                       |                          |                        |         |        |        |
|-----------------|------------|---------|-----------|-----------------------|--------------------------|------------------------|---------|--------|--------|
| BW [MHz]        | Modulation | RB Size | RB Offset | Power Low Ch. / Freq. | Power Middle Ch. / Freq. | Power High Ch. / Freq. | ERP(W)  |        |        |
| Channel         |            |         |           | 23230                 |                          |                        |         |        |        |
| Frequency (MHz) |            |         |           | 782                   |                          |                        |         | M      |        |
| 10              | QPSK       | 1       | 0         |                       | 23.04                    |                        |         | 0.0871 |        |
| 10              | QPSK       | 1       | 49        |                       | 22.76                    |                        |         | 0.0817 |        |
| 10              | QPSK       | 50      | 0         |                       | 21.93                    |                        |         | 0.0675 |        |
| 10              | 16QAM      | 1       | 0         |                       | 21.70                    |                        |         | 0.0640 |        |
| Channel         |            |         |           | 23205                 | 23230                    | 23255                  | EIRP(W) |        |        |
| Frequency (MHz) |            |         |           | 779.5                 | 782                      | 784.5                  | L       | M      | H      |
| 5               | QPSK       | 1       | 0         | 23.00                 | 22.88                    | 22.96                  | 0.0863  | 0.0839 | 0.0855 |
| 5               | 16QAM      | 1       | 0         | 21.56                 | 21.59                    | 21.64                  | 0.0619  | 0.0624 | 0.0631 |



| LTE Band 66     |            |         |           |                       |                          |                        |         |        |        |
|-----------------|------------|---------|-----------|-----------------------|--------------------------|------------------------|---------|--------|--------|
| BW [MHz]        | Modulation | RB Size | RB Offset | Power Low Ch. / Freq. | Power Middle Ch. / Freq. | Power High Ch. / Freq. | EIRP(W) |        |        |
| Channel         |            |         |           | 132072                | 132322                   | 132572                 |         |        |        |
| Frequency (MHz) |            |         |           | 1720                  | 1745                     | 1770                   | L       | M      | H      |
| 20              | QPSK       | 1       | 0         | 22.55                 | 22.91                    | 22.52                  | 0.3540  | 0.3846 | 0.3516 |
| 20              | QPSK       | 1       | 99        | 22.46                 | 22.26                    | 22.61                  | 0.3467  | 0.3311 | 0.3589 |
| 20              | QPSK       | 100     | 0         | 21.55                 | 21.72                    | 21.75                  | 0.2812  | 0.2924 | 0.2944 |
| 20              | 16QAM      | 1       | 0         | 21.15                 | 21.70                    | 21.45                  | 0.2564  | 0.2911 | 0.2748 |
| Channel         |            |         |           | 132047                | 132322                   | 132597                 | EIRP(W) |        |        |
| Frequency (MHz) |            |         |           | 1717.5                | 1745                     | 1772.5                 | L       | M      | H      |
| 15              | QPSK       | 1       | 0         | 22.48                 | 22.63                    | 22.51                  | 0.3483  | 0.3606 | 0.3508 |
| 15              | 16QAM      | 1       | 0         | 21.34                 | 21.69                    | 21.54                  | 0.2679  | 0.2904 | 0.2805 |
| Channel         |            |         |           | 132022                | 132322                   | 132622                 | EIRP(W) |        |        |
| Frequency (MHz) |            |         |           | 1715                  | 1745                     | 1775                   | L       | M      | H      |
| 10              | QPSK       | 1       | 0         | 22.56                 | 22.64                    | 22.41                  | 0.3548  | 0.3614 | 0.3428 |
| 10              | 16QAM      | 1       | 0         | 21.66                 | 21.64                    | 21.70                  | 0.2884  | 0.2871 | 0.2911 |
| Channel         |            |         |           | 131997                | 132322                   | 132647                 | EIRP(W) |        |        |
| Frequency (MHz) |            |         |           | 1712.5                | 1745                     | 1777.5                 | L       | M      | H      |
| 5               | QPSK       | 1       | 0         | 22.57                 | 22.50                    | 22.42                  | 0.3556  | 0.3499 | 0.3436 |
| 5               | 16QAM      | 1       | 0         | 21.44                 | 21.42                    | 21.53                  | 0.2742  | 0.2729 | 0.2799 |
| Channel         |            |         |           | 131987                | 132322                   | 132657                 | EIRP(W) |        |        |
| Frequency (MHz) |            |         |           | 1711.5                | 1745                     | 1778.5                 | L       | M      | H      |
| 3               | QPSK       | 1       | 0         | 22.51                 | 22.59                    | 22.36                  | 0.3508  | 0.3573 | 0.3388 |
| 3               | 16QAM      | 1       | 0         | 21.61                 | 21.59                    | 21.65                  | 0.2851  | 0.2838 | 0.2877 |
| Channel         |            |         |           | 131979                | 132322                   | 132665                 | EIRP(W) |        |        |
| Frequency (MHz) |            |         |           | 1710.7                | 1745                     | 1779.3                 | L       | M      | H      |
| 1.4             | QPSK       | 1       | 0         | 22.40                 | 22.55                    | 22.43                  | 0.3420  | 0.3540 | 0.3443 |
| 1.4             | 16QAM      | 1       | 0         | 21.26                 | 21.61                    | 21.46                  | 0.2630  | 0.2851 | 0.2754 |



## LTE Band 2

### Peak-to-Average Ratio

| Mode      | LTE Band 2 / 20MHz |         |             |
|-----------|--------------------|---------|-------------|
| Mod.      | QPSK               | 16QAM   | Limit: 13dB |
| RB Size   | Full RB            | Full RB | Result      |
| Middle CH | 4.78               | 5.91    | PASS        |

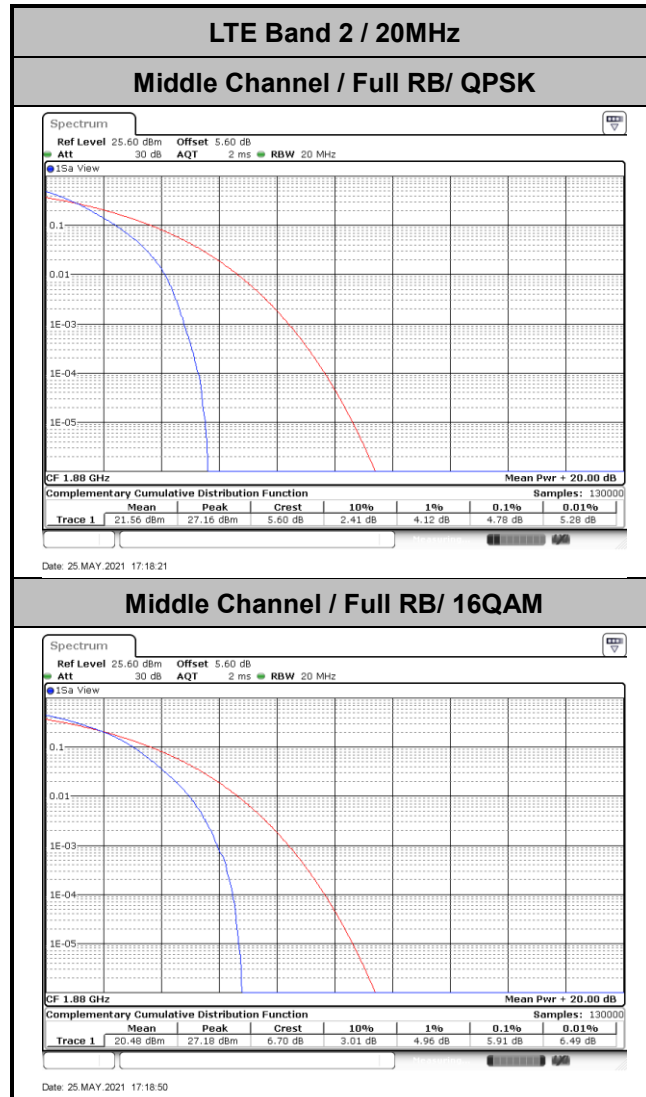





## 26dB Bandwidth

|                  |                                  |              |
|------------------|----------------------------------|--------------|
| <b>Mode</b>      | <b>LTE Band 2 : 26dB BW(MHz)</b> |              |
| <b>BW</b>        | <b>20MHz</b>                     |              |
| <b>Mod.</b>      | <b>QPSK</b>                      | <b>16QAM</b> |
| <b>Middle CH</b> | 19.02                            | 18.86        |

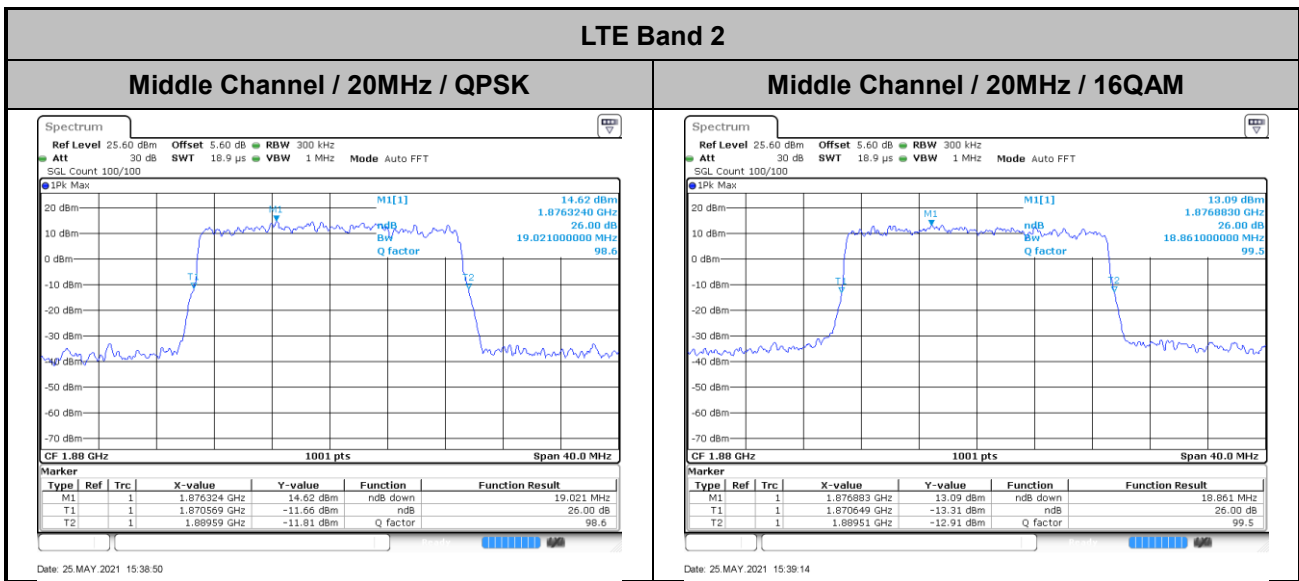



# Occupied Bandwidth

|           |                          |       |
|-----------|--------------------------|-------|
| Mode      | LTE Band 2 : 99%OBW(MHz) |       |
| BW        | 20MHz                    |       |
| Mod.      | QPSK                     | 16QAM |
| Middle CH | 17.82                    | 17.78 |

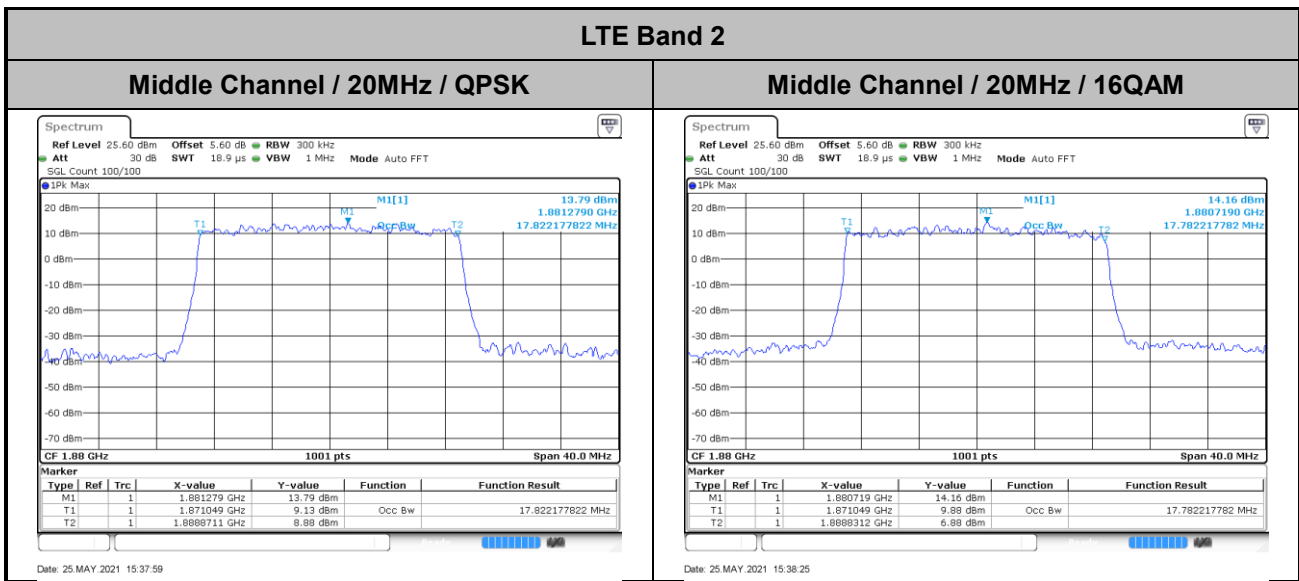



# Conducted Band Edge

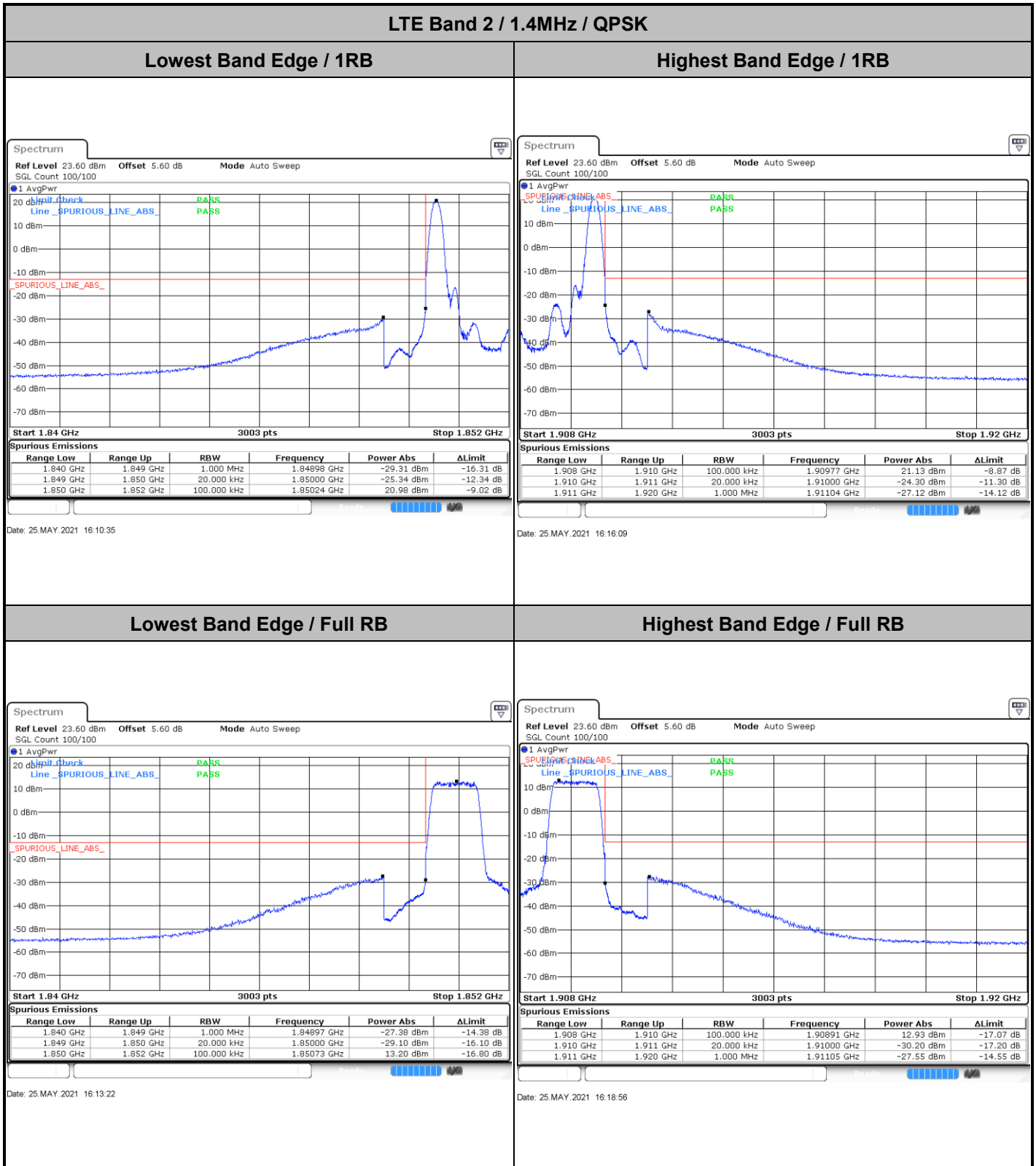



LTE Band 2 / 1.4MHz / 16QAM

Lowest Band Edge / 1 RB

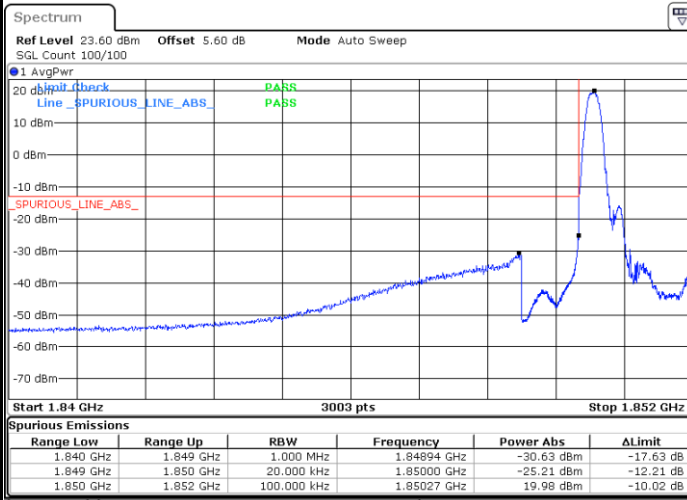

Date: 25 MAY 2021 16:11:59

Highest Band Edge / 1 RB



Date: 25 MAY 2021 16:17:33

Lowest Band Edge / Full RB

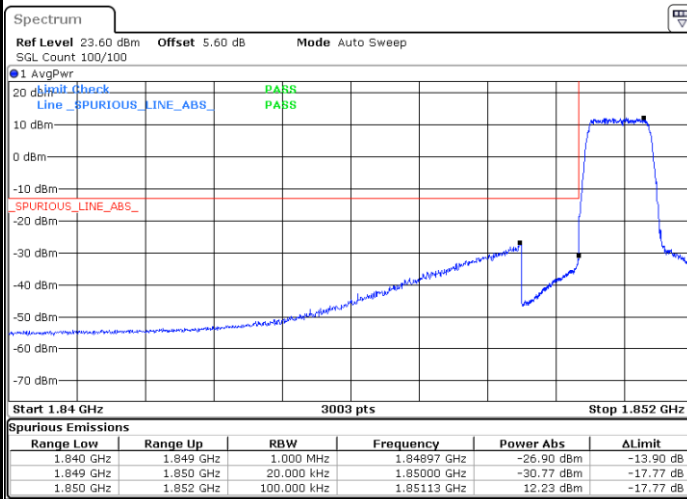

Date: 25 MAY 2021 16:14:46

Highest Band Edge / Full RB

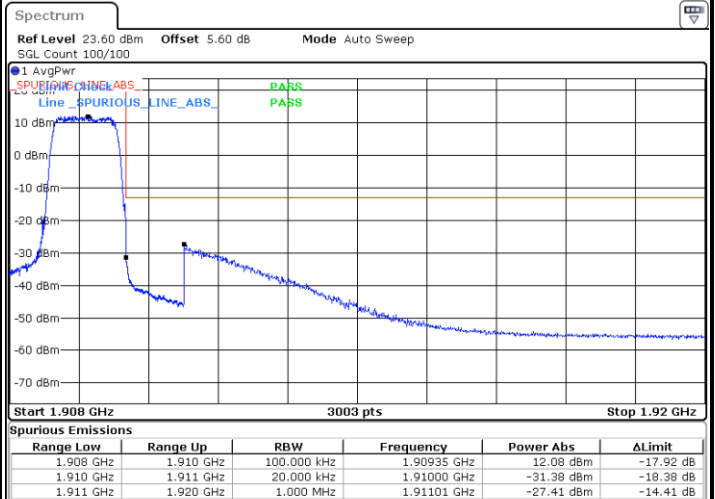

Date: 25 MAY 2021 16:20:19



LTE Band 2 / 3MHz / QPSK

Lowest Band Edge / 1RB

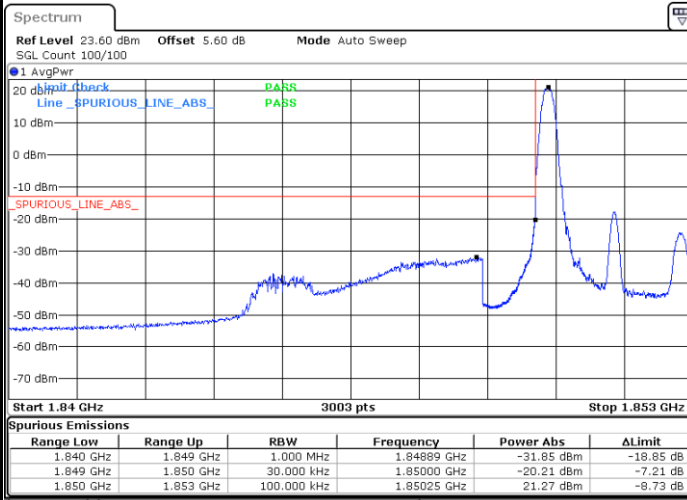

Date: 25 MAY 2021 14:17:30

Highest Band Edge / 1 RB

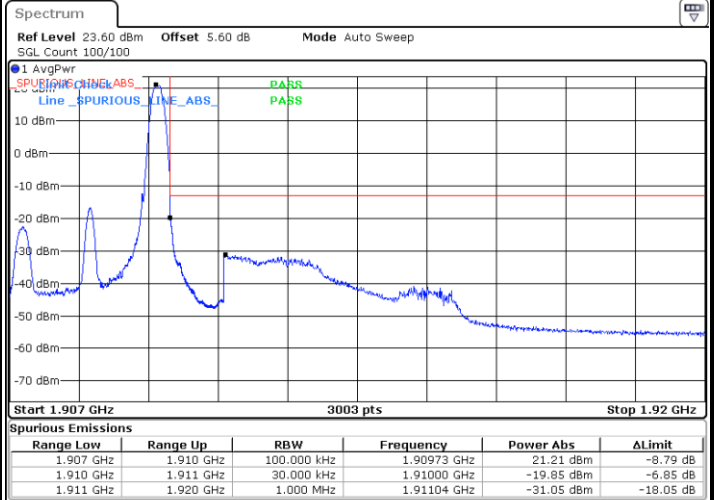

Date: 25 MAY 2021 14:31:54

Lowest Band Edge / Full RB

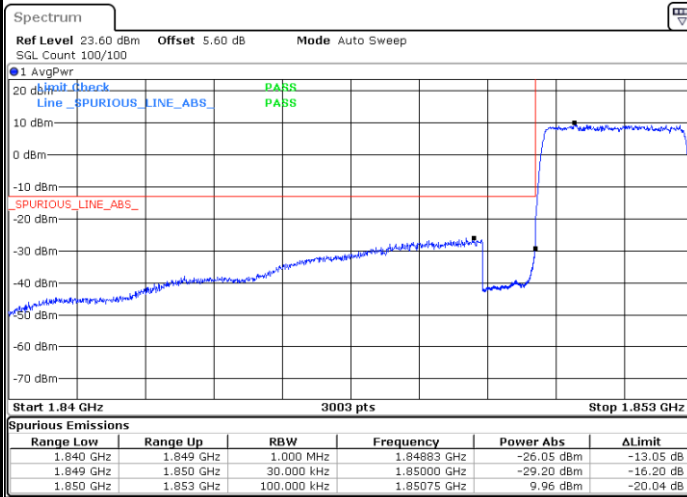

Date: 25 MAY 2021 14:23:50

Highest Band Edge / Full RB

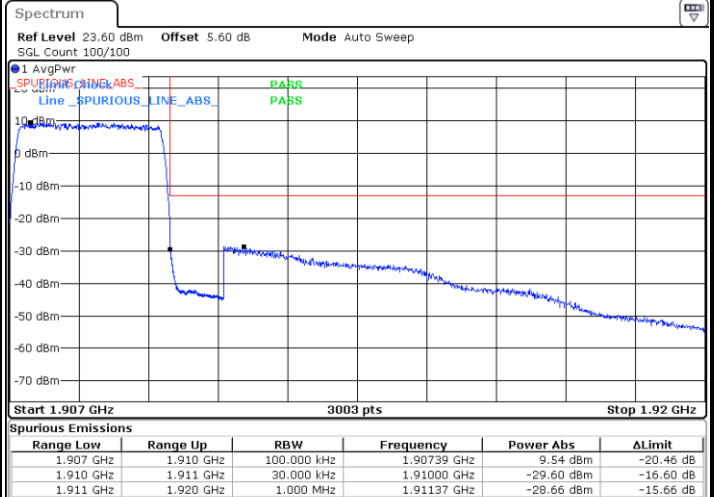

Date: 25 MAY 2021 14:48:48



LTE Band 2 / 3MHz / 16QAM

Lowest Band Edge / 1 RB

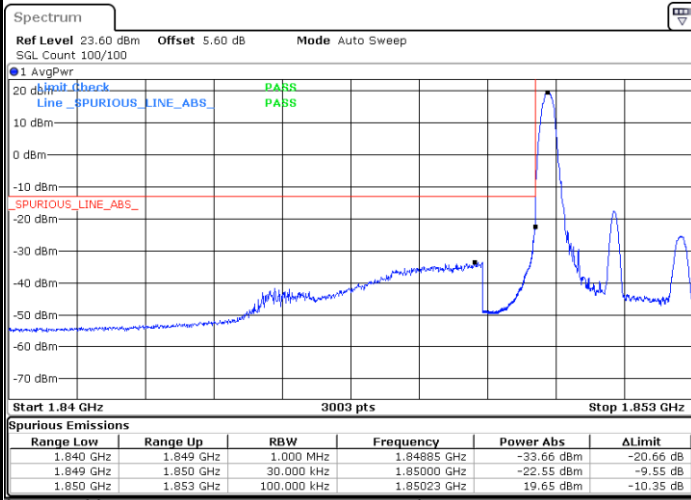

Date: 25 MAY 2021 14:20:42

Highest Band Edge / 1 RB

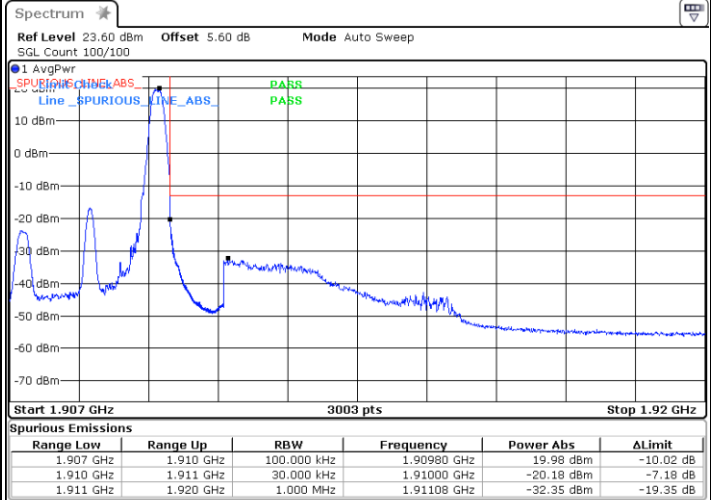

Date: 25 MAY 2021 14:33:18

Lowest Band Edge / Full RB

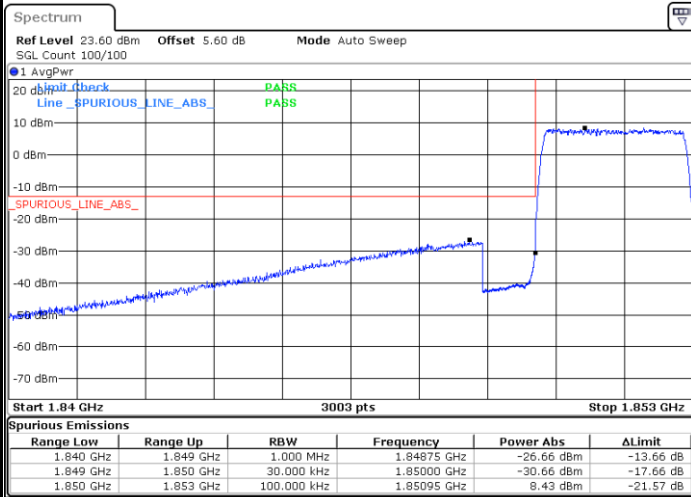

Date: 25 MAY 2021 14:26:57

Highest Band Edge / Full RB

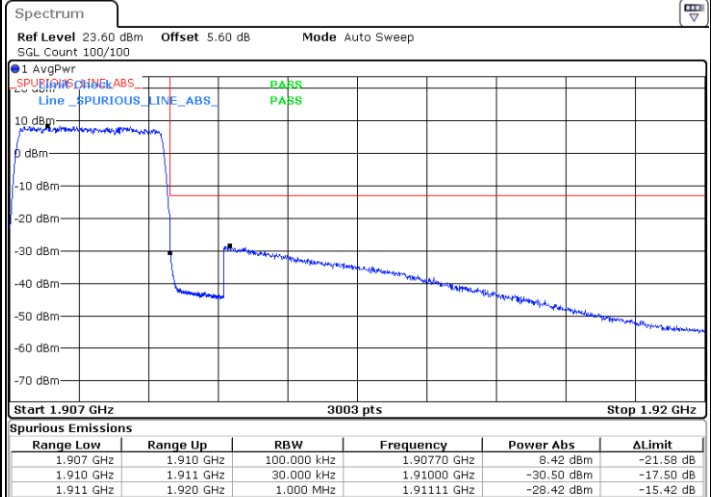

Date: 25 MAY 2021 14:50:12



LTE Band 2 / 5MHz / QPSK

Lowest Band Edge / 1 RB

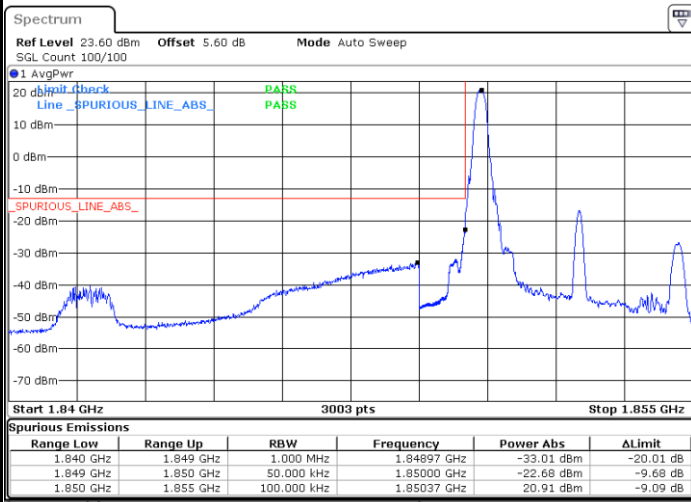

Date: 25 MAY 2021 14:51:36

Highest Band Edge / 1 RB

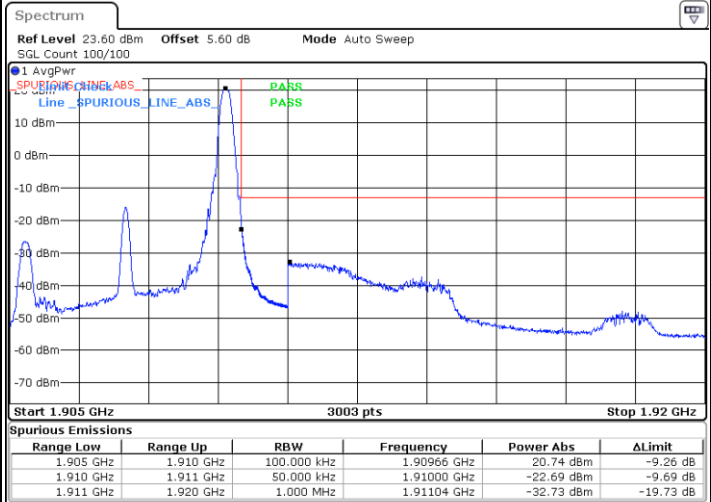

Date: 25 MAY 2021 14:57:10

Lowest Band Edge / Full RB

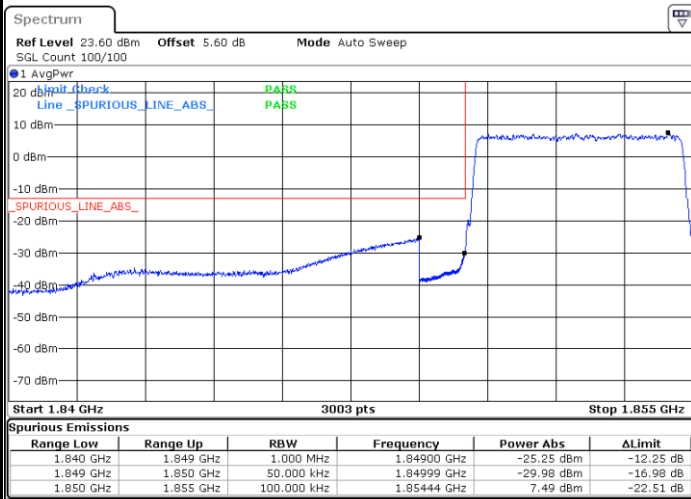

Date: 25 MAY 2021 14:54:23

Highest Band Edge / Full RB

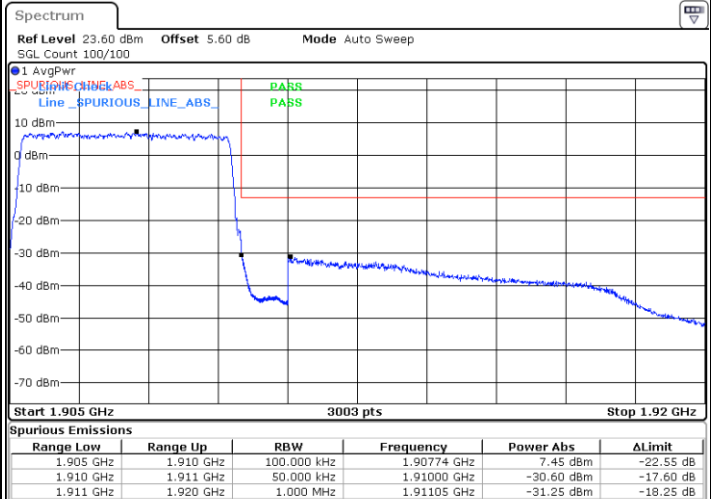

Date: 25 MAY 2021 14:59:57



LTE Band 2 / 5MHz / 16QAM

Lowest Band Edge / 1RB

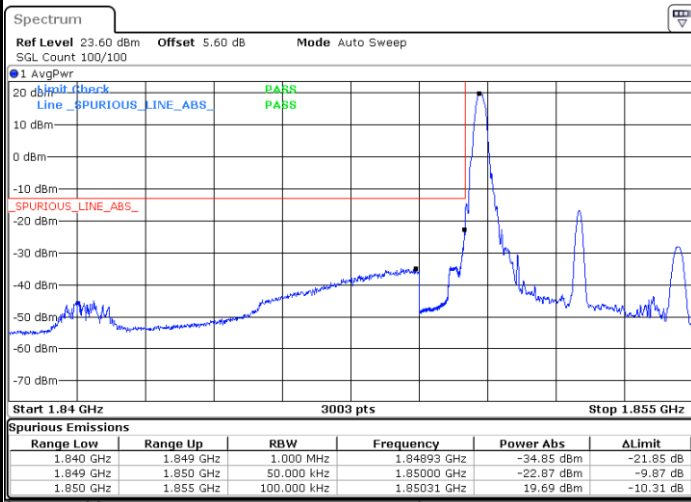

Date: 25 MAY 2021 14:52:59

Highest Band Edge / 1 RB

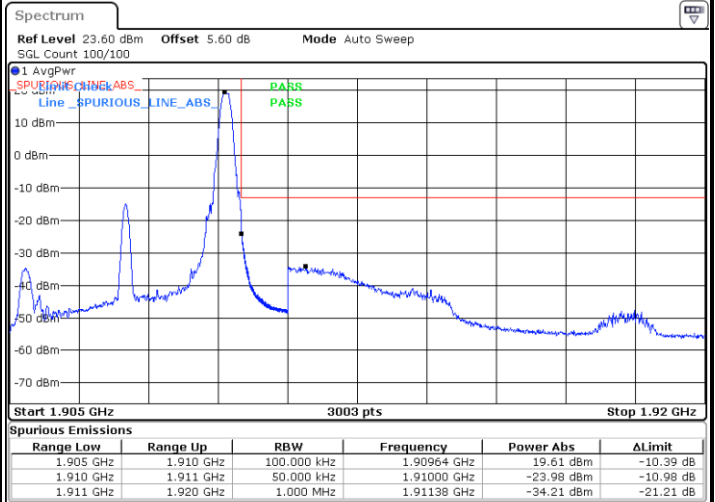

Date: 25 MAY 2021 14:58:33

Lowest Band Edge / Full RB

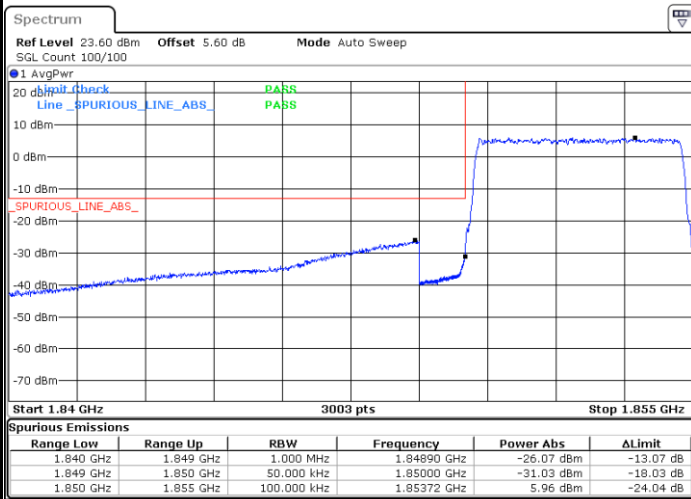

Date: 25 MAY 2021 14:55:46

Highest Band Edge / Full RB

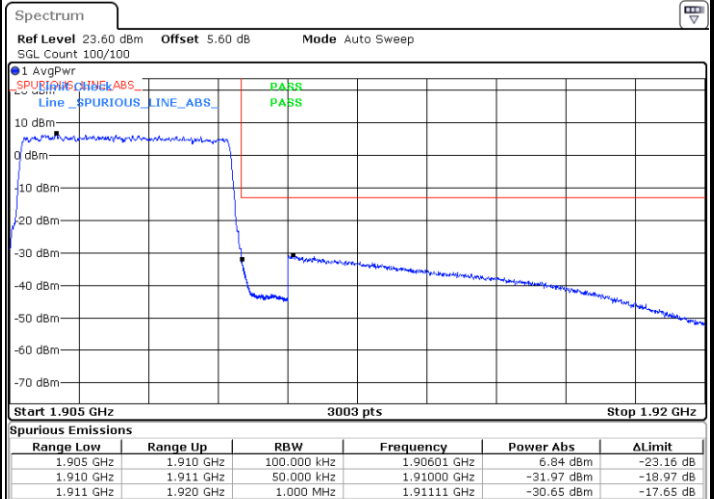

Date: 25 MAY 2021 15:01:20





**LTE Band 2 / 10MHz / QPSK**

**Lowest Band Edge / 1 RB**

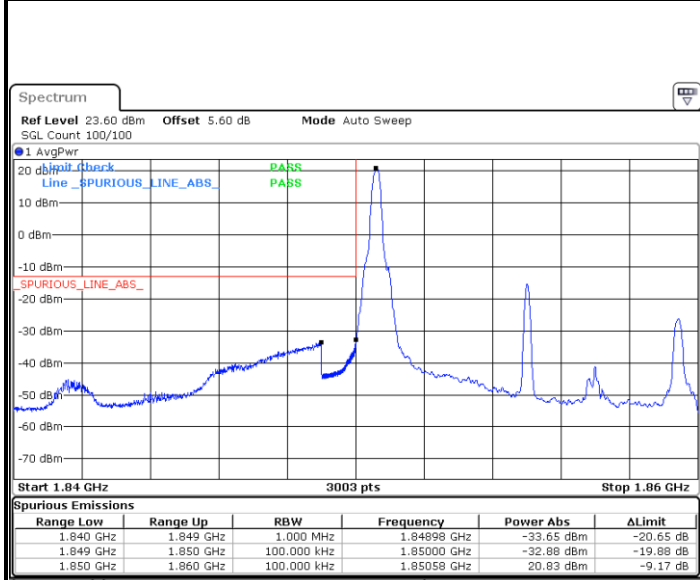

Date: 25 MAY 2021 15:02:44

**Highest Band Edge / 1 RB**

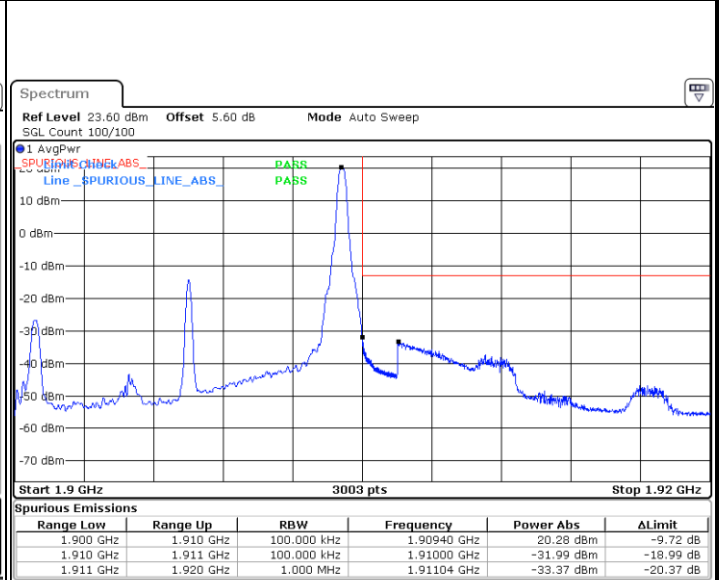

Date: 25 MAY 2021 15:08:17

**Lowest Band Edge / Full RB**

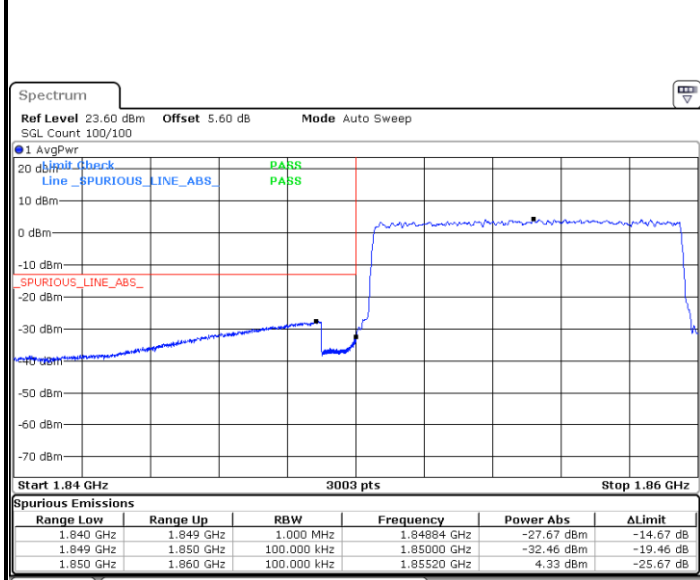

Date: 25 MAY 2021 15:05:31

**Highest Band Edge / Full RB**

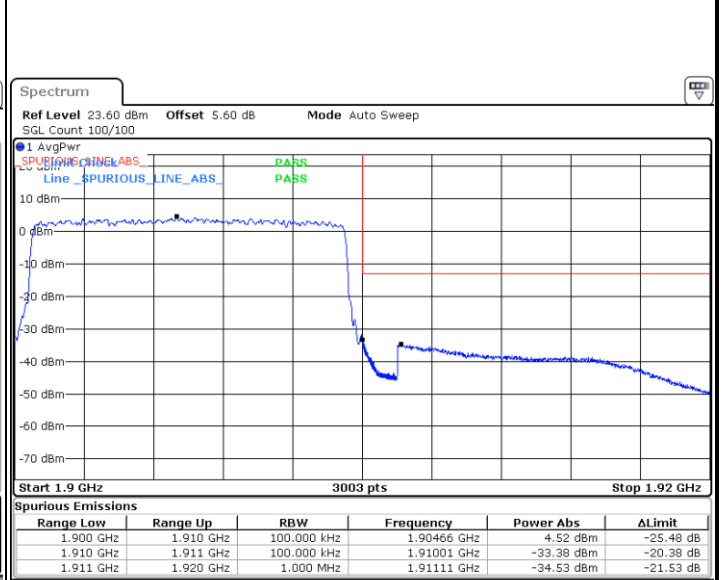

Date: 25 MAY 2021 15:11:05



LTE Band 2 / 10MHz / 16QAM

Lowest Band Edge / 1 RB

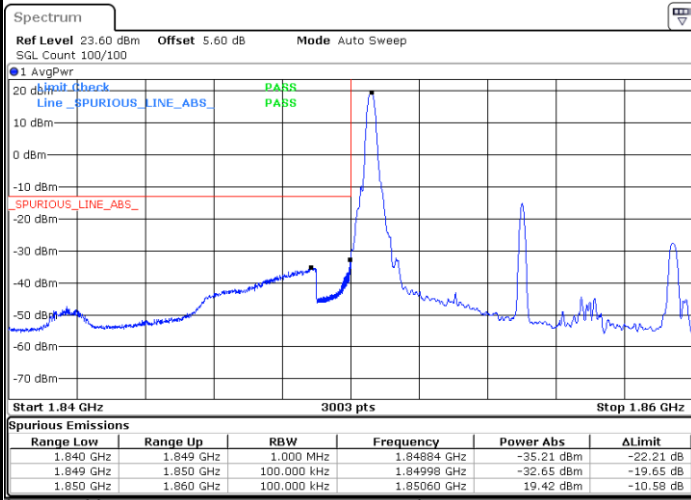

Date: 25 MAY 2021 15:04:07

Highest Band Edge / 1 RB

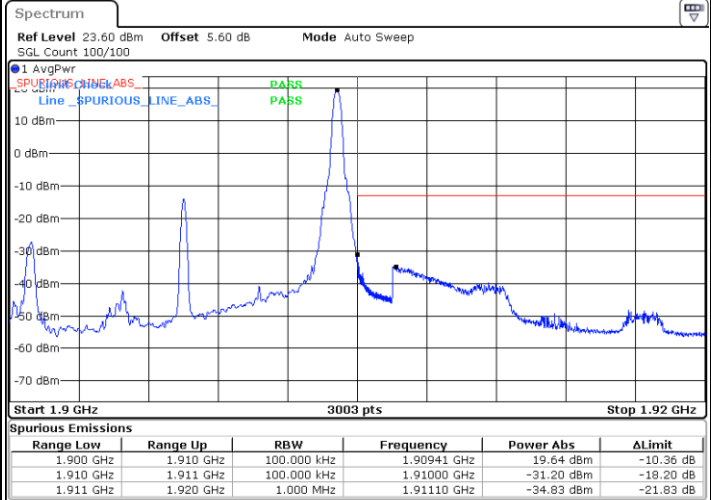

Date: 25 MAY 2021 15:09:41

Lowest Band Edge / Full RB

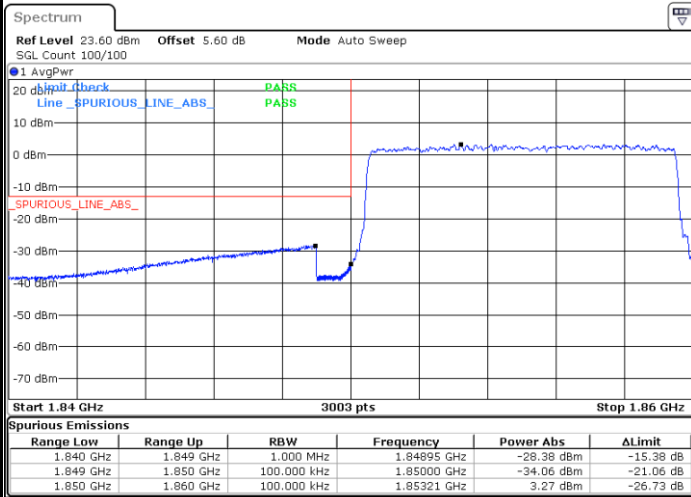

Date: 25 MAY 2021 15:06:54

Highest Band Edge / Full RB

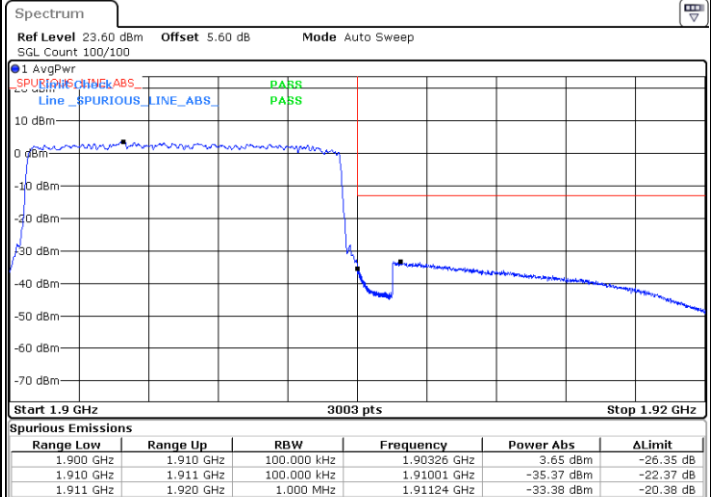

Date: 25 MAY 2021 15:12:29



LTE Band 2 / 15MHz / QPSK

Lowest Band Edge / 1 RB

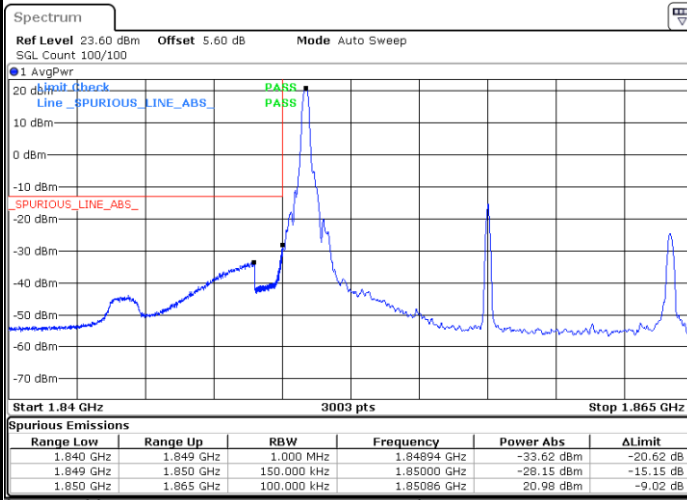

Date: 25.MAY.2021 15:13:53

Highest Band Edge / 1 RB

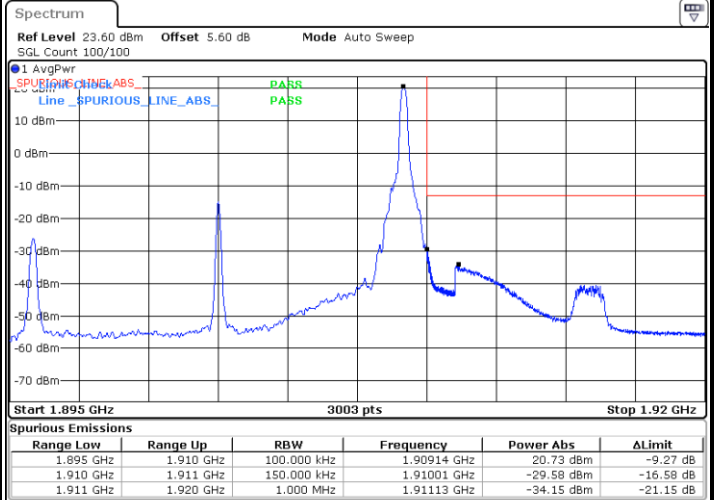

Date: 25.MAY.2021 15:19:27

Lowest Band Edge / Full RB

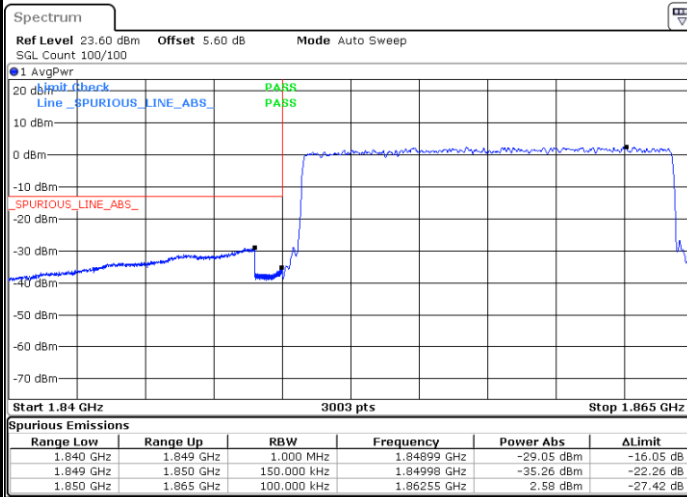

Date: 25.MAY.2021 15:16:40

Highest Band Edge / Full RB

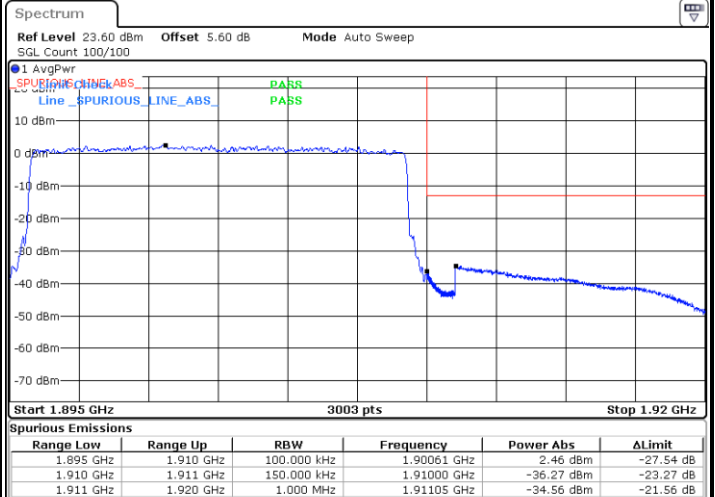

Date: 25.MAY.2021 15:22:14



LTE Band 2 / 15MHz / 16QAM

Lowest Band Edge / 1 RB

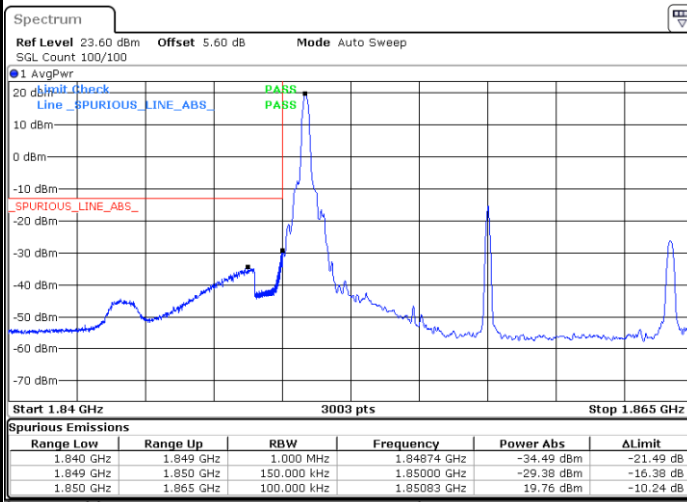

Date: 25.MAY.2021 15:15:16

Highest Band Edge / 1 RB

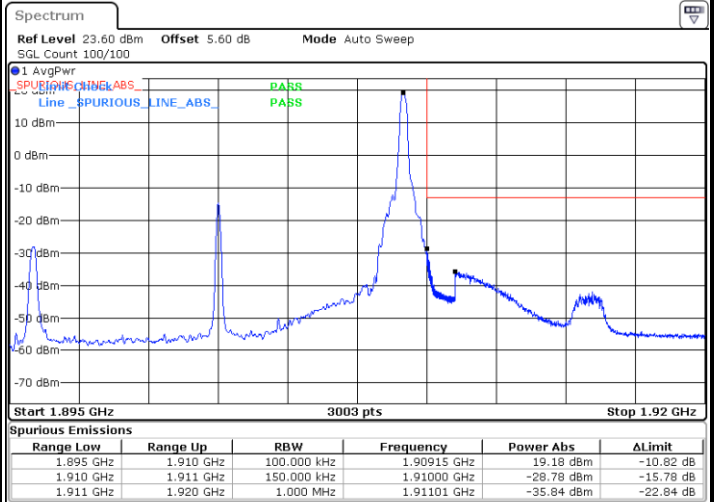

Date: 25.MAY.2021 15:20:50

Lowest Band Edge / Full RB

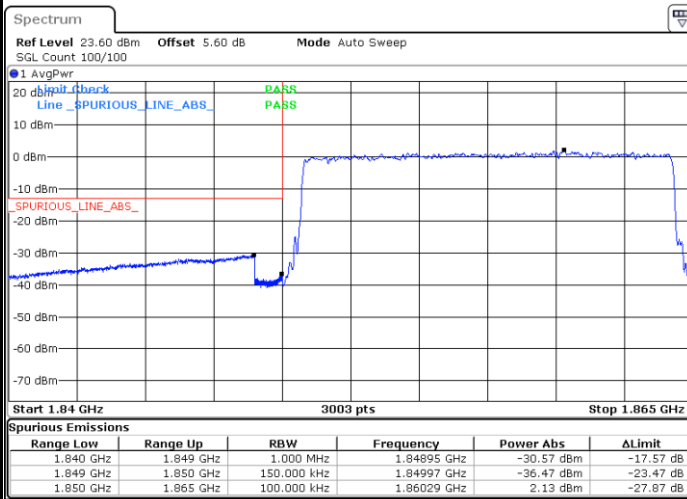

Date: 25.MAY.2021 15:18:03

Highest Band Edge / Full RB

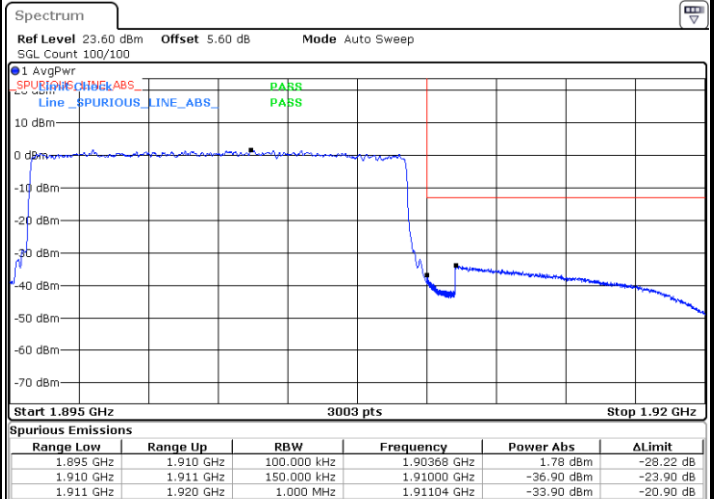

Date: 25.MAY.2021 15:23:38



LTE Band 2 / 20MHz / QPSK

Lowest Band Edge / 1 RB

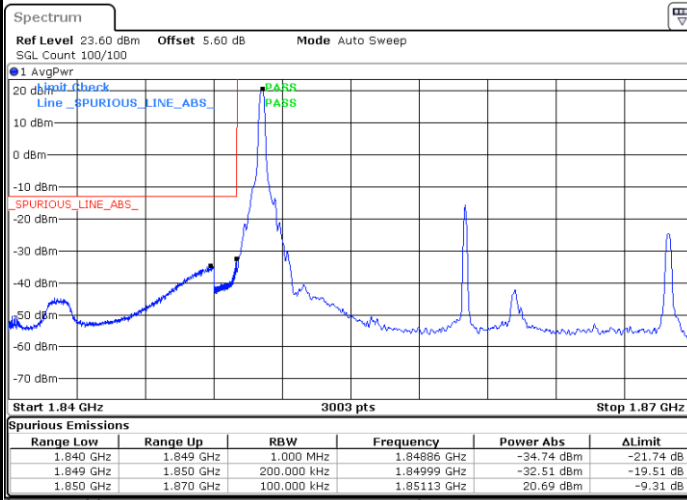

Date: 25 MAY 2021 15:25:02

Highest Band Edge / 1 RB

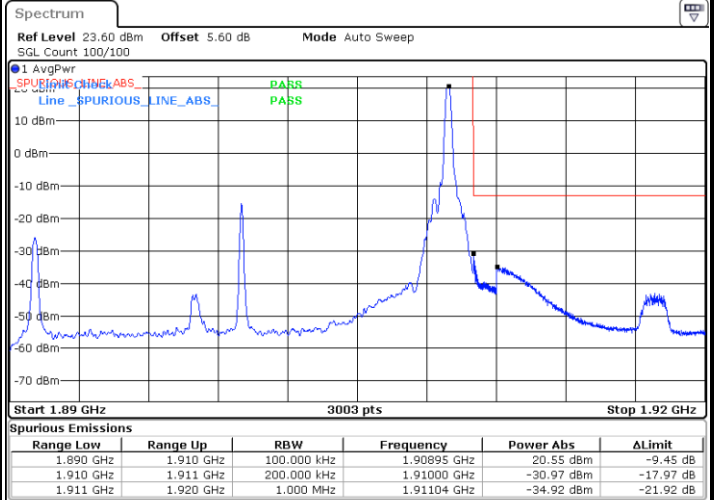

Date: 25 MAY 2021 15:30:35

Lowest Band Edge / Full RB

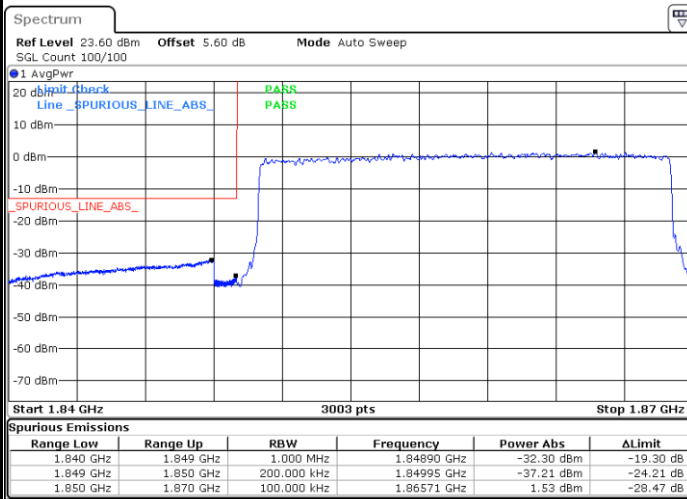

Date: 25 MAY 2021 15:27:49

Highest Band Edge / Full RB

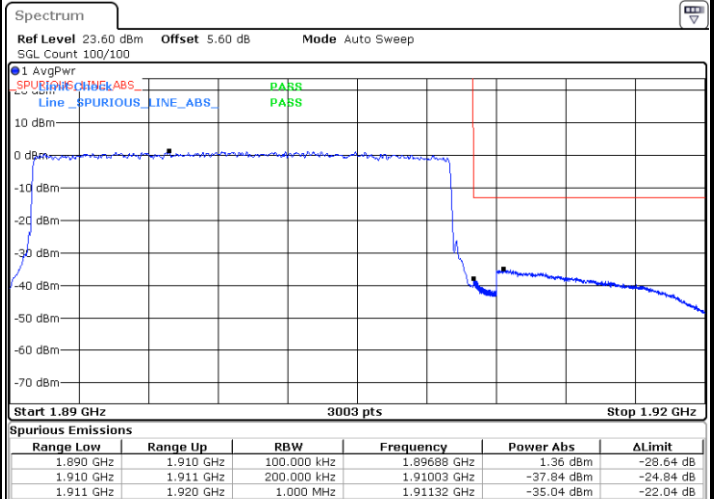

Date: 25 MAY 2021 15:33:22



LTE Band 2 / 20MHz / 16QAM

Lowest Band Edge / 1 RB

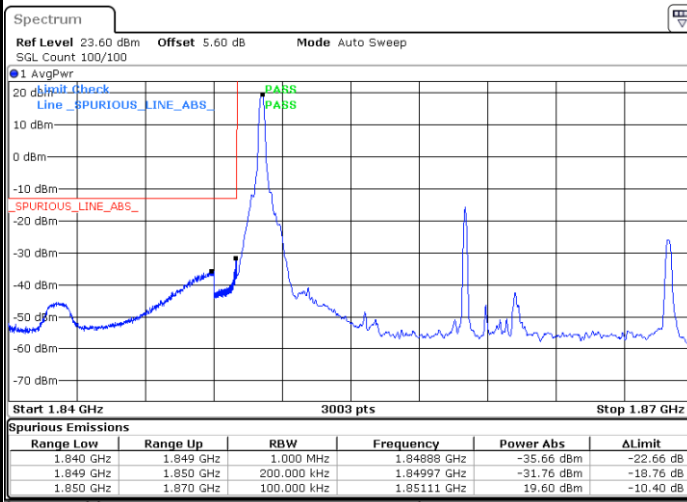

Date: 25 MAY 2021 15:28:25

Highest Band Edge / 1 RB

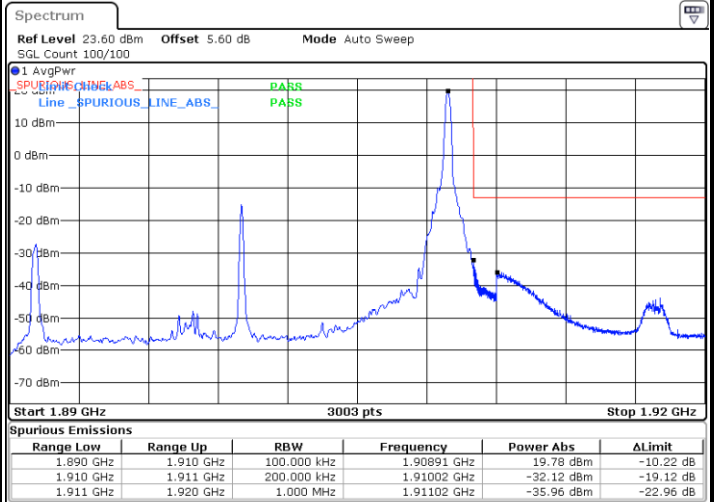

Date: 25 MAY 2021 15:31:58

Lowest Band Edge / Full RB

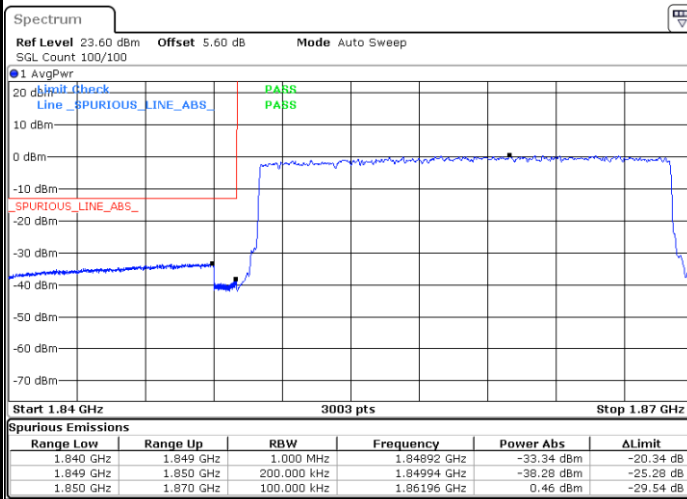

Date: 25 MAY 2021 15:29:12

Highest Band Edge / Full RB

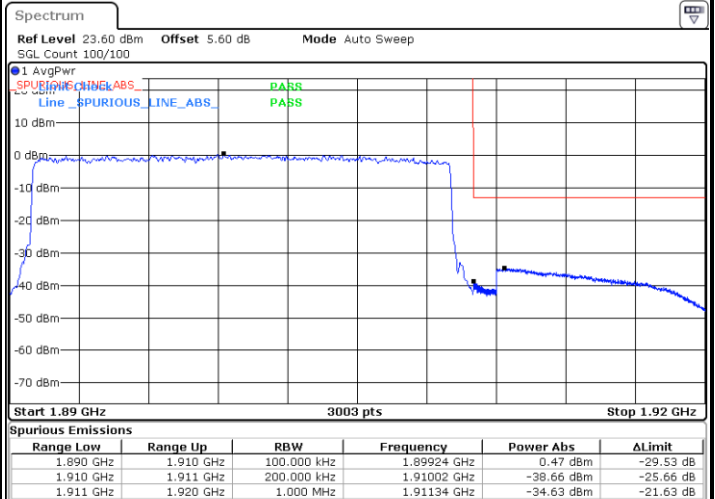

Date: 25 MAY 2021 15:34:45



# Conducted Spurious Emission





LTE Band 2 / 3MHz

Lowest Channel / QPSK

Middle Channel / QPSK

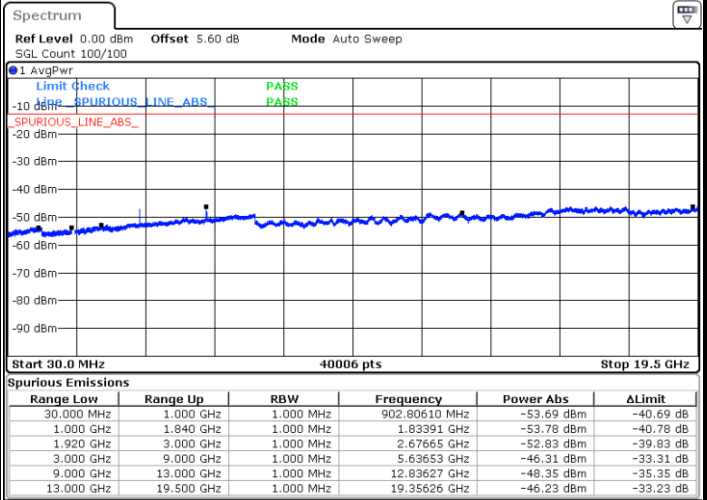
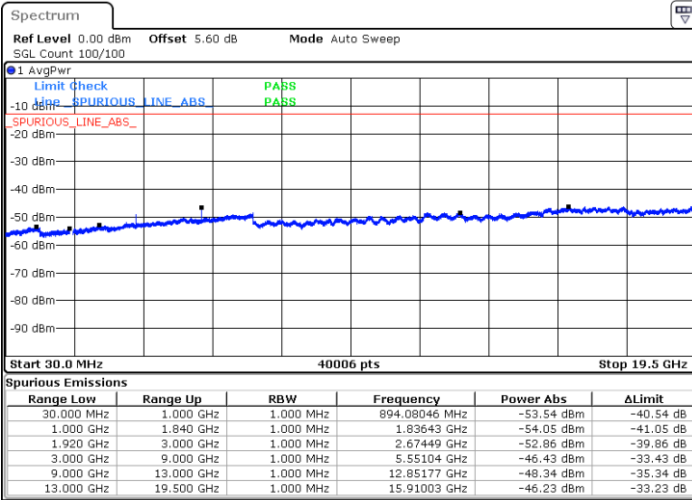

Date: 25 MAY 2021 15:36:10

Date: 25 MAY 2021 15:37:33

Highest Channel / QPSK

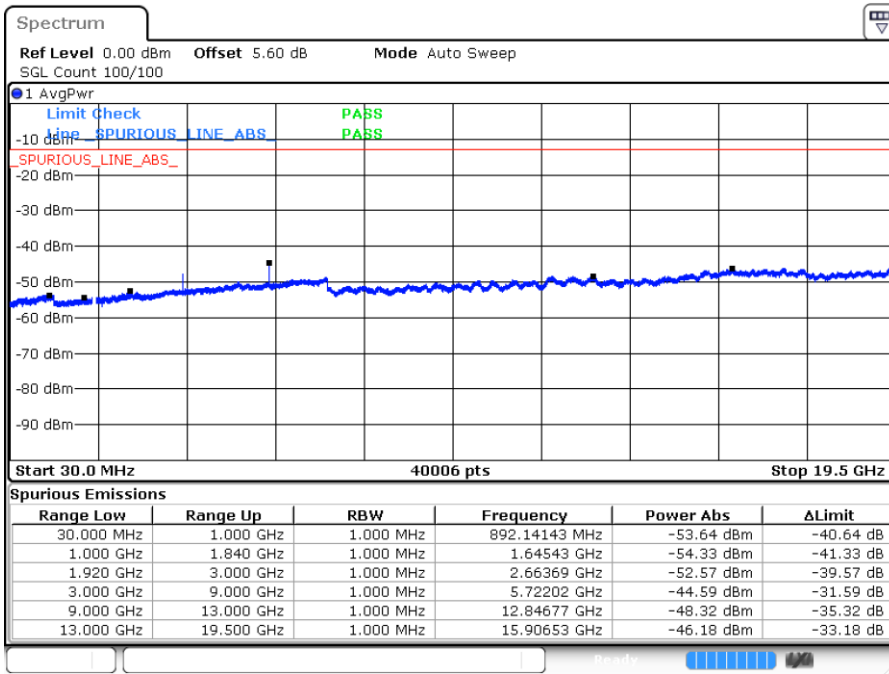

Date: 25 MAY 2021 15:40:38





LTE Band 2 / 5MHz

Lowest Channel / QPSK

Middle Channel / QPSK

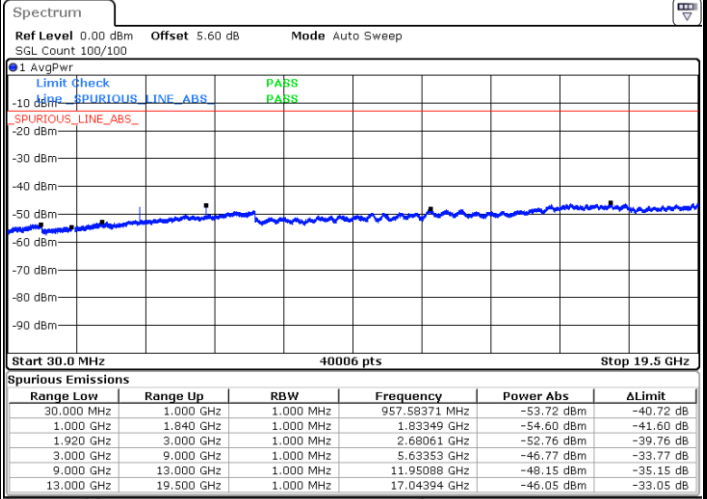
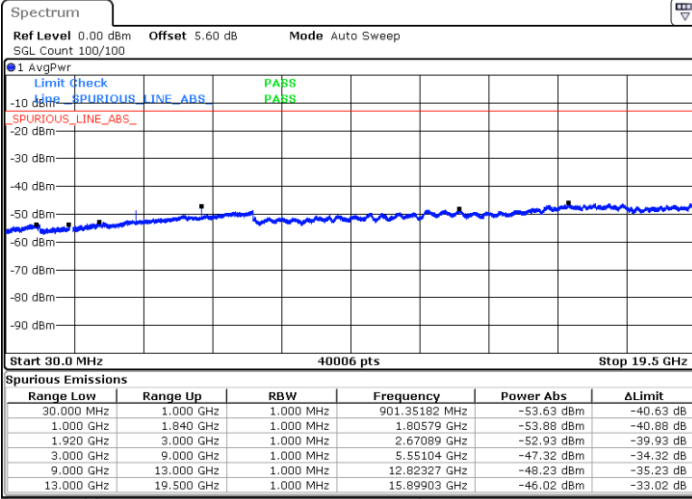

Date: 25.MAY.2021 15:42:02

Date: 25.MAY.2021 15:43:26

Highest Channel / QPSK

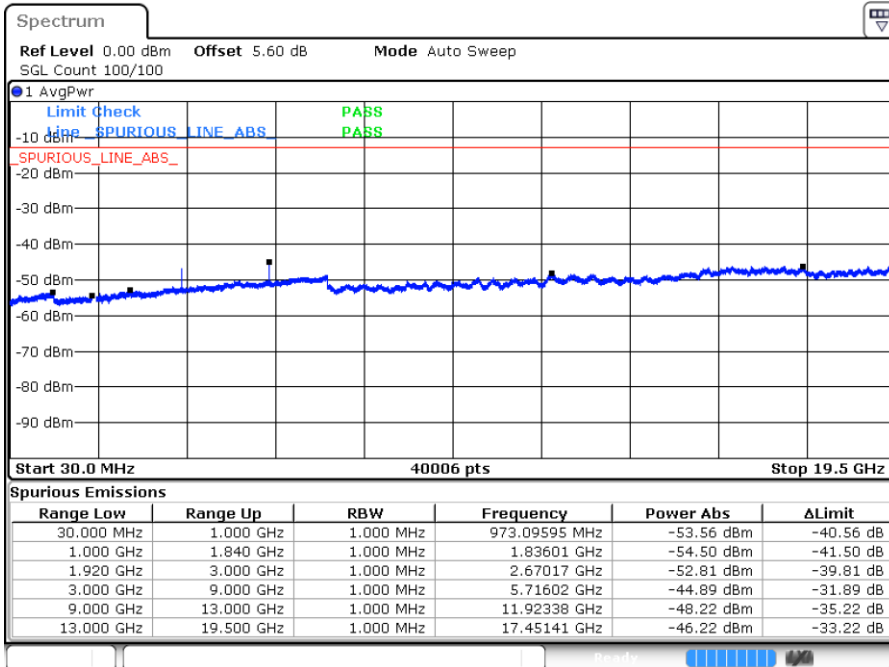

Date: 25.MAY.2021 15:44:49



**LTE Band 2 / 10MHz**

**Lowest Channel / QPSK**

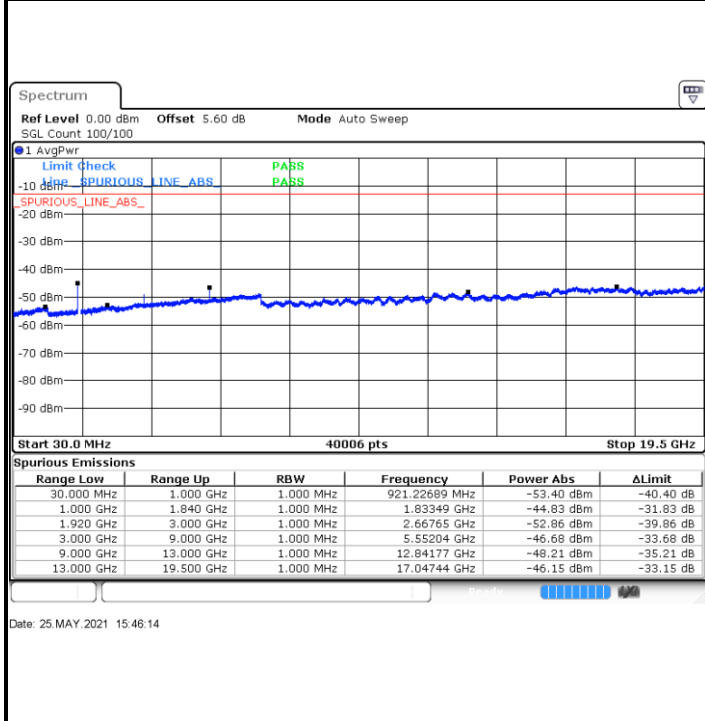

**Middle Channel / QPSK**

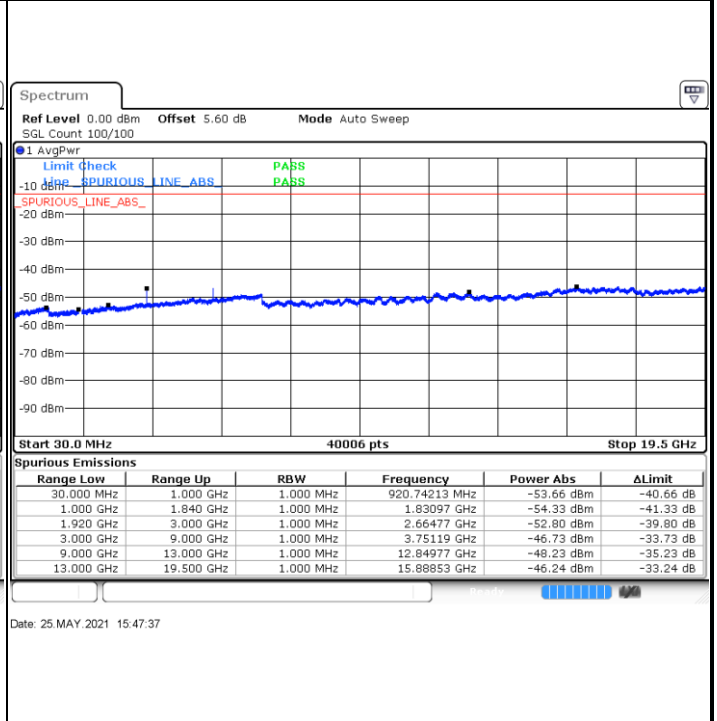

**Highest Channel / QPSK**

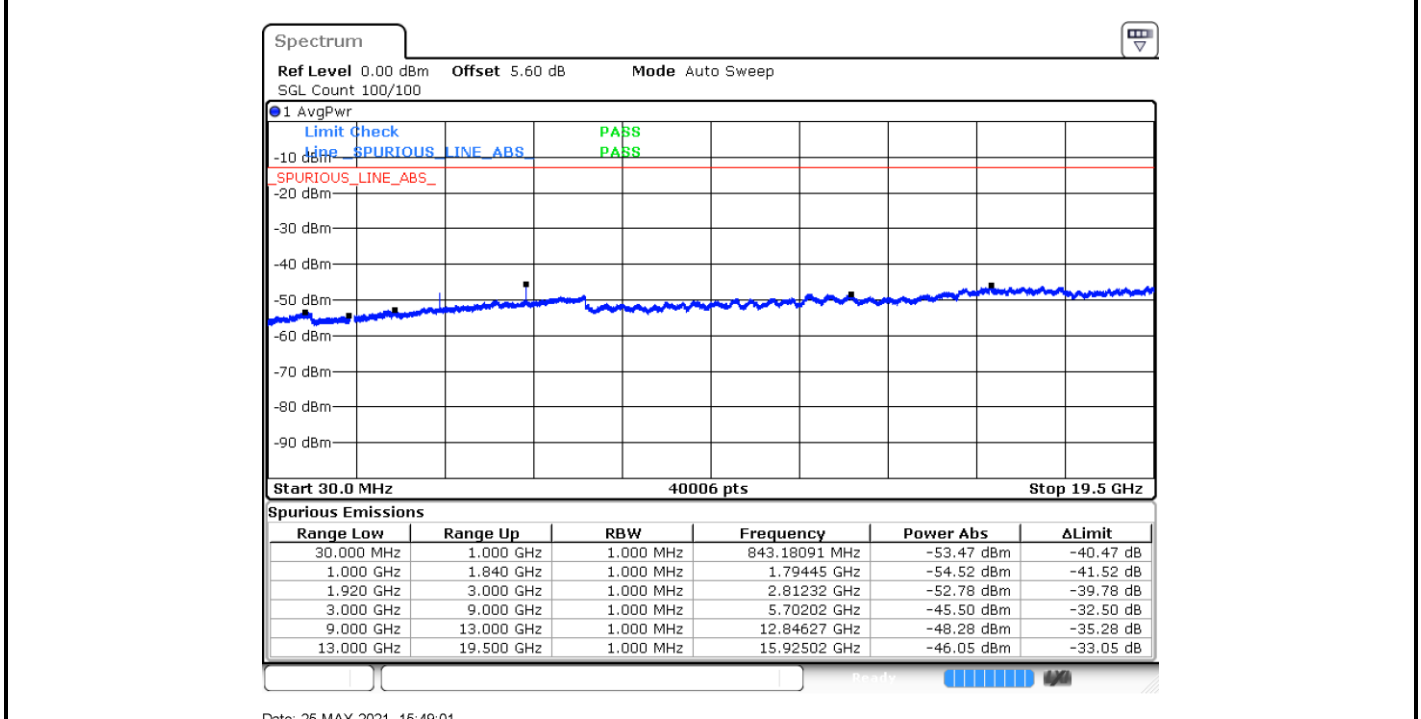



**LTE Band 2 / 15MHz**

**Lowest Channel / QPSK**

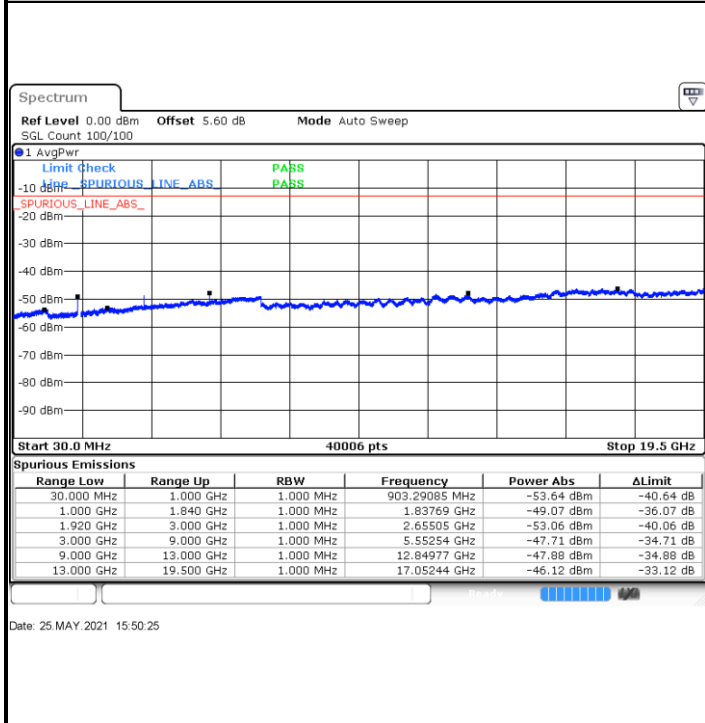

**Middle Channel / QPSK**

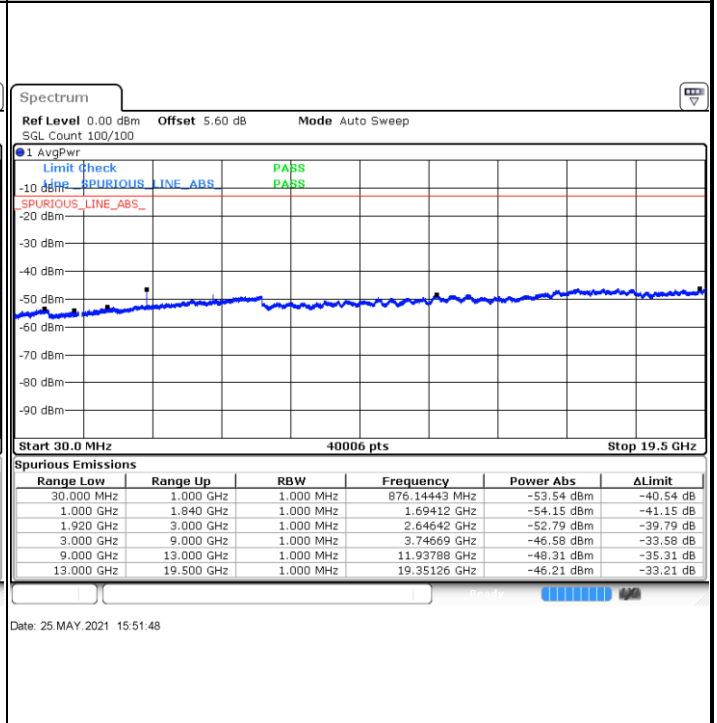

**Highest Channel / QPSK**

