



# FCC RF Test Report

**APPLICANT** : Elo Touch Solutions, Inc.  
**EQUIPMENT** : Mobile POS  
**BRAND NAME** : ELO or   
**MODEL NAME** : EMC0600C  
**FCC ID** : RBWEMC0600C  
**STANDARD** : FCC Part 15 Subpart E §15.407  
**CLASSIFICATION** : (NII) Unlicensed National Information Infrastructure  
**TEST DATE(S)** : Jun. 01, 2021 ~ Jun. 25, 2021

We, Sporton International (Kunshan) Inc., would like to declare that the tested sample has been evaluated in accordance with the test procedures and has been in compliance with the applicable technical standards.

The test results in this report apply exclusively to the tested model / sample. Without written approval of Sporton International (Kunshan) Inc., the test report shall not be reproduced except in full.

*Jason Jia*

Reviewed by: Jason Jia / Supervisor

*Alex Wang*

Approved by: Alex Wang / Manager



**Sporton International (Kunshan) Inc.**  
 No. 1098, Pengxi North Road, Kunshan Economic Development Zone Jiangsu Province 215300  
 People's Republic of China



# TABLE OF CONTENTS

**REVISION HISTORY..... 3**

**SUMMARY OF TEST RESULT ..... 4**

**1 GENERAL DESCRIPTION ..... 5**

    1.1 Applicant ..... 5

    1.2 Manufacturer ..... 5

    1.3 Product Feature of Equipment Under Test ..... 5

    1.4 Product Specification of Equipment Under Test ..... 6

    1.5 Modification of EUT ..... 7

    1.6 Testing Location ..... 7

    1.7 Test Software ..... 8

    1.8 Applicable Standards ..... 8

**2 TEST CONFIGURATION OF EQUIPMENT UNDER TEST ..... 9**

    2.1 Carrier Frequency and Channel ..... 9

    2.2 Test Mode ..... 10

    2.3 Connection Diagram of Test System ..... 12

    2.4 Support Unit used in test configuration and system ..... 12

    2.5 EUT Operation Test Setup ..... 13

    2.6 Measurement Results Explanation Example ..... 13

**3 TEST RESULT ..... 14**

    3.1 26dB & 99% Occupied Bandwidth Measurement ..... 14

    3.2 Maximum Conducted Output Power Measurement ..... 16

    3.3 Power Spectral Density Measurement ..... 18

    3.4 Unwanted Emissions Measurement ..... 21

    3.5 AC Conducted Emission Measurement ..... 27

    3.6 Antenna Requirements ..... 29

**4 LIST OF MEASURING EQUIPMENT ..... 30**

**5 UNCERTAINTY OF EVALUATION ..... 31**

**APPENDIX A. CONDUCTED TEST RESULTS**

**APPENDIX B. AC CONDUCTED EMISSION TEST RESULT**

**APPENDIX C. RADIATED SPURIOUS EMISSION**

**APPENDIX D. DUTY CYCLE PLOTS**

**APPENDIX E. SETUP PHOTOGRAPHS**



### REVISION HISTORY

REPORT NO.	VERSION	DESCRIPTION	ISSUED DATE
FR142804-01E	Rev. 01	Initial issue of report	Sep. 03, 2021



### SUMMARY OF TEST RESULT

Report Section	FCC Rule	Description	Limit	Result	Remark
3.1	2.1049 & 15.403(i)	26dB & 99% Bandwidth	-	N/A	Report only
3.2	15.407(a)	Maximum Conducted Output Power	≤ 24 dBm	Pass	-
3.3	15.407(a)	Power Spectral Density	≤ 11 dBm	Pass	-
3.4	15.407(b)	Unwanted Emissions	15.407(b) & 15.209(a)	Pass	Under limit 3.14 dB at 5450.480 MHz
3.5	15.207	AC Conducted Emission	15.207(a)	Pass	Under limit 10.01 dB at 0.576 MHz
3.6	15.203 & 15.407(a)	Antenna Requirement	N/A	N/A	-

<b>Declaration of Conformity:</b>
The test results with all measurement uncertainty excluded are presented in accordance with the regulation limits or requirements declared by manufacturers.
<b>Comments and Explanations:</b>
The declared of product specification for EUT presented in the report are provided by the manufacturer, and the manufacturer takes all the responsibilities for the accuracy of product specification.



# 1 General Description

## 1.1 Applicant

Elo Touch Solutions, Inc.  
670 N. McCarthy Blvd. Suite 100, Milpitas, CA 95035, United States

## 1.2 Manufacturer

Elo Touch Solutions, Inc.  
670 N. McCarthy Blvd. Suite 100, Milpitas, CA 95035, United States

## 1.3 Product Feature of Equipment Under Test

Product Feature	
Equipment	Mobile POS
Brand Name	ELO or 
Model Name	EMC0600C
FCC ID	RBWEMC0600C
IMEI Code	Conducted: NA Conduction: 357830300003036 Radiation: NA
HW Version	A01
SW Version	5.07.100
EUT Stage	Production Unit

Remark: The above EUT's information was declared by manufacturer. Please refer to the specifications or user's manual for more detailed description.



### 1.4 Product Specification of Equipment Under Test

Standards-related Product Specification	
<b>Tx/Rx Frequency Range</b>	5180 MHz ~ 5240 MHz 5260 MHz ~ 5320 MHz 5500 MHz ~ 5700 MHz
<b>Maximum Output Power to Antenna</b>	<b>SISO &lt;Ant.2&gt;</b> <b>&lt;5180 MHz ~ 5240 MHz&gt;</b> 802.11a : 12.27 dBm / 0.0169 W <b>&lt;5260 MHz ~ 5320 MHz&gt;</b> 802.11a : 12.52 dBm / 0.0179 W <b>&lt;5500 MHz ~ 5700 MHz &gt;</b> 802.11a : 12.01 dBm / 0.0159 W <b>MIMO &lt;Ant.1+2&gt;</b> <b>&lt;5180 MHz ~ 5240 MHz&gt;</b> 802.11n HT20 : 15.24 dBm / 0.0334 W 802.11n HT40 : 14.43 dBm / 0.0277 W 802.11ac VHT20 : 13.19 dBm / 0.0208 W 802.11ac VHT40 : 13.31 dBm / 0.0214 W 802.11ac VHT80 : 13.00 dBm / 0.0200 W <b>&lt;5260 MHz ~ 5320 MHz&gt;</b> 802.11n HT20 : 15.45 dBm / 0.0351 W 802.11n HT40 : 14.58 dBm / 0.0287 W 802.11ac VHT20 : 13.31 dBm / 0.0214 W 802.11ac VHT40 : 13.65 dBm / 0.0232 W 802.11ac VHT80 : 13.42 dBm / 0.0220 W <b>&lt;5500 MHz ~ 5700 MHz &gt;</b> 802.11n HT20 : 15.15 dBm / 0.0327 W 802.11n HT40 : 14.32 dBm / 0.0270 W 802.11ac VHT20 : 12.96 dBm / 0.0198 W 802.11ac VHT40 : 13.33 dBm / 0.0215 W 802.11ac VHT80 : 13.11 dBm / 0.0205 W
<b>99% Occupied Bandwidth</b>	<b>SISO &lt;Ant.2&gt;</b> <b>&lt;5180 MHz ~ 5240 MHz&gt;</b> 802.11a : 17.63 MHz <b>&lt;5260 MHz ~ 5320 MHz&gt;</b> 802.11a : 17.58 MHz <b>&lt;5500 MHz ~ 5700 MHz &gt;</b> 802.11a : 17.58 MHz <b>MIMO &lt;Ant.1+2&gt;</b> <b>&lt;5180 MHz ~ 5240 MHz&gt;</b> 802.11n HT20 : 18.83 MHz 802.11n HT40 : 36.56 MHz 802.11ac VHT80 : 75.64 MHz <b>&lt;5260 MHz ~ 5320 MHz &gt;</b> 802.11n HT20 : 18.98 MHz 802.11n HT40 : 36.56 MHz 802.11ac VHT80 : 75.64 MHz <b>&lt;5500 MHz ~ 5700 MHz &gt;</b> 802.11n HT20 : 18.98 MHz 802.11n HT40 : 36.56 MHz 802.11ac VHT80 : 75.52 MHz
<b>Antenna Type / Gain</b>	<b>&lt;5150 MHz ~ 5250 MHz&gt;</b>



	<Ant. 1> : PIFA Antenna with gain 2.19 dBi <Ant. 2> : PIFA Antenna with gain 2.47 dBi <b>&lt;5250 MHz ~ 5350 MHz&gt;</b> <Ant. 1> : PIFA Antenna with gain 2.17 dBi <Ant. 2> : PIFA Antenna with gain 3.50 dBi <b>&lt;5470 MHz ~ 5725 MHz&gt;</b> <Ant. 1> : PIFA Antenna with gain 1.78 dBi <Ant. 2> : PIFA Antenna with gain 3.74 dBi		
<b>Type of Modulation</b>	802.11a/n : OFDM (BPSK / QPSK / 16QAM / 64QAM) 802.11ac : OFDM (BPSK / QPSK / 16QAM / 64QAM / 256QAM)		
<b>Antenna Function Description</b>		<b>Ant. 1</b>	<b>Ant. 2</b>
	802.11 a SISO	V	V
	802.11 n/ac MIMO	V	V

**Note:**

1. WLAN operation in 5600 MHz ~ 5650 MHz is notched.
2. Note: For 802.11n HT20 / ac VHT20 and 802.11n HT40 / ac VHT40 mode, the whole testing have assessed only 802.11n HT20/HT40 by referring to their maximum conducted power.
3. Manufacturer declares that 802.11n/ac supports Tx beamforming mode, the power/EIRP of TX BF mode is lower than non-Tx BF mode, so only non-Tx BF test data show in the report.
4. The EUT only supports SISO mode for 802.11ac VHT80 + VHT80 mode, the power lower than the Single carrier, so only the RSE were tested and show in the report.

### 1.5 Modification of EUT

No modifications are made to the EUT during all test items.

### 1.6 Testing Location

Sporton International (Kunshan) Inc. is accredited to ISO/IEC 17025:2017 by American Association for Laboratory Accreditation with Certificate Number 5145.02.

<b>Test Firm</b>	Sporton International (Kunshan) Inc.		
<b>Test Site Location</b>	No. 1098, Pengxi North Road, Kunshan Economic Development Zone Jiangsu Province 215300 People's Republic of China TEL : +86-512-57900158 FAX : +86-512-57900958		
<b>Test Site No.</b>	<b>Sporton Site No.</b>	<b>FCC Designation No.</b>	<b>FCC Test Firm Registration No.</b>
	CO01-KS 03CH05-KS TH01-KS	CN1257	314309



### 1.7 Test Software

Item	Site	Manufacturer	Name	Version
1.	03CH05-KS	AUDIX	E3	6.2009-8-24al
2.	CO01-KS	AUDIX	E3	6.2009-8-24

### 1.8 Applicable Standards

According to the specifications of the manufacturer, the EUT must comply with the requirements of the following standards:

- ♦ 47 CFR Part 15 Subpart E
- ♦ FCC KDB 789033 D02 General UNII Test Procedures New Rules v02r01.
- ♦ FCC KDB 662911 D01 Multiple Transmitter Output v02r01.
- ♦ ANSI C63.10-2013

**Remark:**

1. All test items were verified and recorded according to the standards and without any deviation during the test.
2. This EUT has also been tested and complied with the requirements of FCC Part 15, Subpart B, recorded in a separate test report.





## 2 Test Configuration of Equipment Under Test

- a. The EUT has been associated with peripherals and configuration operated in a manner tended to maximize its emission characteristics in a typical application. Frequency range investigated: conduction emission (150 kHz to 30 MHz), radiation emission (9 kHz to the 10th harmonic of the highest fundamental frequency or to 40 GHz, whichever is lower). For radiated measurement, pre-scanned in three orthogonal panels, X, Y, Z. The worst cases were recorded in this report.
- b. AC power line Conducted Emission was tested under maximum output power.

### 2.1 Carrier Frequency and Channel

Frequency Band	Channel	Freq. (MHz)	Channel	Freq. (MHz)
5150-5250 MHz U-NII-1	36	5180	44	5220
	38*	5190	46*	5230
	40	5200	48	5240
	42 <sup>#</sup>	5210		

Frequency Band	Channel	Freq. (MHz)	Channel	Freq. (MHz)
5250-5350 MHz U-NII-2A	52	5260	60	5300
	54*	5270	62*	5310
	56	5280	64	5320
	58 <sup>#</sup>	5290		

Frequency Band	Channel	Freq. (MHz)	Channel	Freq. (MHz)
5470-5725 MHz U-NII-2C	100	5500	112	5560
	102*	5510	116	5580
	104	5520	132	5660
	106 <sup>#</sup>	5530	134*	5670
	108	5540	136	5680
	110*	5550	140	5700

**Note:**

- 1. The above Frequency and Channel in "\*" were 802.11n HT40 and 802.11ac VHT40.
- 2. The above Frequency and Channel in "<sup>#</sup>" were 802.11ac VHT80.



## 2.2 Test Mode

Final test modes are considering the modulation and worse data rates as below table.

### Single Mode

Modulation	Data Rate
802.11a	6 Mbps

### MIMO Mode

Modulation	Data Rate
802.11a	6 Mbps
802.11n HT20	MCS0
802.11n HT40	MCS0
802.11ac VHT80	MCS0
802.11ac VHT(80+80)	MCS0

Co-Location
802.11a_CH36 ANT2 + 802.11g_CH01 ANT1
802.11ac80_CH106 MIMO + BT5.0_CH39

Test Cases	
<b>AC Conducted Emission</b>	Mode 1 : WCDMA 850 Idle + Bluetooth Link + WLAN Link(5G) + Adapter
<b>Remark:</b> For Radiated Test Cases, The tests were performance with Adapter	



Ch. #		U-NII-1 : 5150-5250 MHz	U-NII-2A : 5250-5350 MHz	U-NII-2C : 5470-5725MHz
		802.11a	802.11a	802.11a
L	Low	36	52	100
M	Middle	44	60	116
H	High	48	64	140

Ch. #		U-NII-1 : 5150-5250 MHz	U-NII-2A : 5250-5350 MHz	U-NII-2C : 5470-5725MHz
		802.11n HT20	802.11n HT20	802.11n HT20
L	Low	36	52	100
M	Middle	44	60	116
H	High	48	64	140

Ch. #		U-NII-1 : 5150-5250 MHz	U-NII-2A : 5250-5350 MHz	U-NII-2C : 5470-5725MHz
		802.11n HT40	802.11n HT40	802.11n HT40
L	Low	38	54	102
M	Middle	-	-	110
H	High	46	62	134

Ch. #		U-NII-1 : 5150-5250 MHz	U-NII-2A : 5250-5350 MHz	U-NII-2C : 5470-5725MHz
		802.11ac VHT80	802.11ac VHT80	802.11ac VHT80
L	Low	-	-	106
M	Middle	42	58	-
H	High	-	-	-

Ch. #	U-NII-1 ~ 2C		
	802.11ac VHT80+ VHT80		
Ch. #	42+106		
	42+155		
	42+58		

### 2.3 Connection Diagram of Test System

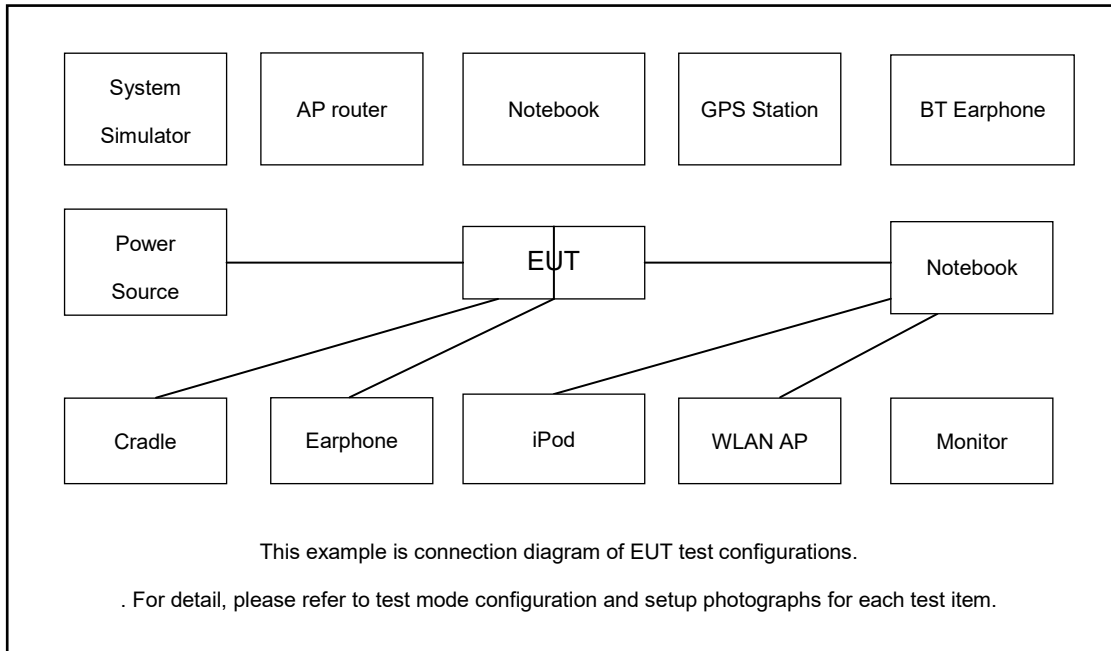

### 2.4 Support Unit used in test configuration and system

Item	Equipment	Trade Name	Model Name	FCC ID	Data Cable	Power Cord
1.	LTE Base Station	Anritus	MT8820C	N/A	N/A	Unshielded,1.8m
2.	Bluetooth Earphone	Lenovo	LBH308	N/A	N/A	N/A
3.	Notebook	Lenovo	G480	QDS-BRCM1050I	N/A	shielded cable DC O/P 1.8m , Unshielded AC I/P cable 1.8m
4.	WLAN AP	D-link	DIR-655	KA21R655B1	N/A	Unshielded,1.8m
5.	SD Card	Kingston	8GB	N/A	N/A	N/A



## 2.5 EUT Operation Test Setup

For WLAN RF test items, an engineering test program was provided and enabled to make EUT continuously transmit/receive.

For AC power line conducted emissions, the EUT was set to connect with the WLAN AP under large package sizes transmission.

## 2.6 Measurement Results Explanation Example

**For all conducted test items:**

The offset level is set in the spectrum analyzer to compensate the RF cable loss between EUT conducted output port and spectrum analyzer. With the offset compensation, the spectrum analyzer reading level is exactly the EUT RF output level.

Example :

The spectrum analyzer offset is derived from RF cable loss.

*Offset = RF cable loss.*

Following shows an offset computation example with cable loss 6.80 dB.

$$\begin{aligned} \text{Offset(dB)} &= \text{RF cable loss(dB)}. \\ &= 6.80 \text{ (dB)} \end{aligned}$$

### 3 Test Result

#### 3.1 26dB & 99% Occupied Bandwidth Measurement

##### 3.1.1 Description of 26dB & 99% Occupied Bandwidth

This section is for reporting purpose only.

There is no restriction limits for bandwidth.

##### 3.1.2 Measuring Instruments

The measuring equipment is listed in the section 4 of this test report.

##### 3.1.3 Test Procedures

1. The testing follows FCC KDB 789033 D02 General UNII Test Procedures New Rules v02r01. Section C) Emission bandwidth
2. Set RBW = approximately 1% of the emission bandwidth.
3. Set the VBW > RBW.
4. Detector = Peak.
5. Trace mode = max hold
6. Measure the maximum width of the emission that is 26 dB down from the peak of the emission. Compare this with the RBW setting of the analyzer. Readjust RBW and repeat measurement as needed until the RBW/EBW ratio is approximately 1%.
7. For 99% Bandwidth Measurement, the spectrum analyzer's resolution bandwidth (RBW) is set 1MHz and set the Video bandwidth (VBW)  $\geq 3 * RBW$ .
8. Measure and record the results in the test report.

##### 3.1.4 Test Setup

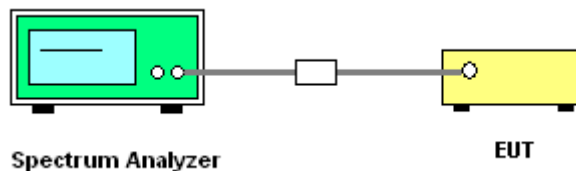

##### 3.1.5 Test Result of 26dB & 99% Occupied Bandwidth

Please refer to Appendix A.



<CDD Mode>

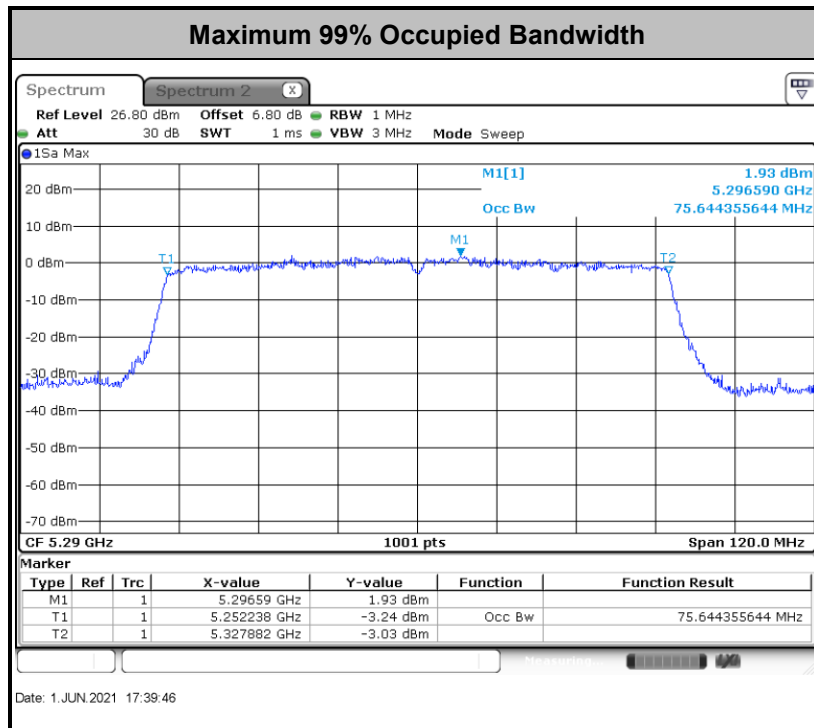
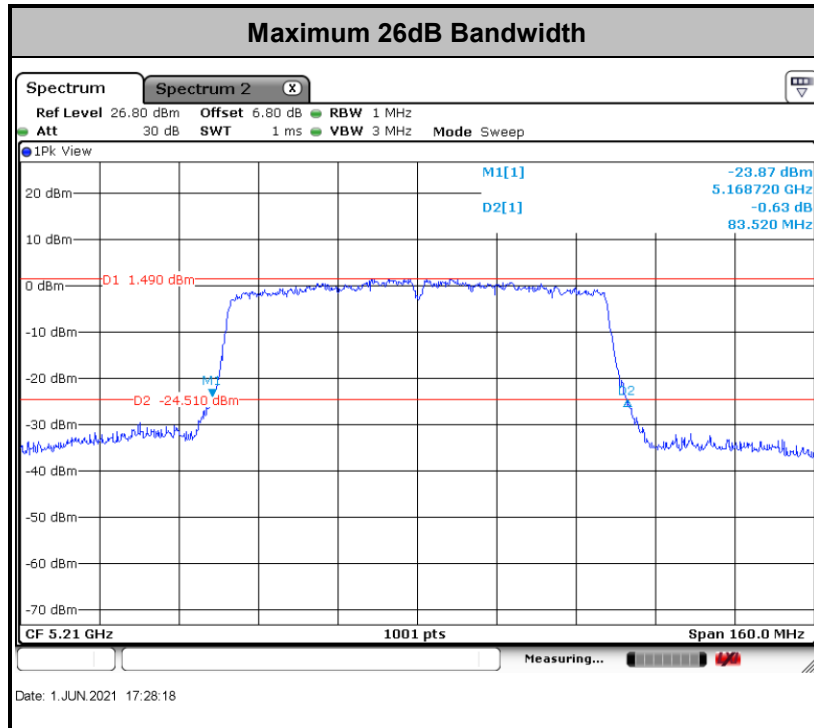

**Note:** The occupied channel bandwidth is maintained within the band of operation for all of the modulations.



## 3.2 Maximum Conducted Output Power Measurement

### 3.2.1 Limit of Maximum Conducted Output Power

<FCC 14-30 CFR 15.407>

For mobile and portable client devices in the 5.15–5.25 GHz band, the maximum conducted output power over the frequency band of operation shall not exceed 250 mW.

For the 5.25–5.725 GHz bands, the maximum conducted output power over the frequency bands of operation shall not exceed the lesser of 250 mW or  $11 + 10 \log B$ , dBm, where B is the 26 dB emission bandwidth in megahertz.

For the 5.47–5.6 GHz and 5.65–5.725 GHz band, the maximum conducted output power shall not exceed 250 mW or  $11 + 10 \log_{10} B$ , dBm, whichever power is less. The maximum e.i.r.p. shall not exceed 1.0 W or  $17 + 10 \log_{10} B$ , dBm, whichever is less. B is the 99% emission bandwidth in megahertz.

If transmitting antennas of directional gain greater than 6 dBi are used, the peak output power shall be reduced by the amount in dB that the directional gain of the antenna exceeds 6 dBi.

Note that U-NII-2 band, devices with a maximum e.i.r.p. greater than 500 mW shall implement TPC in order to have the capability to operate at least 6 dB below the maximum permitted e.i.r.p. of 1 W.

### 3.2.2 Measuring Instruments

The measuring equipment is listed in the section 4 of this test report.



### 3.2.3 Test Procedures

The testing follows Method PM of FCC KDB 789033 D02 General UNII Test Procedures New Rules v02r01.

Method PM (Measurement using an RF average power meter):

1. Measurement is performed using a wideband RF power meter.
2. The EUT is configured to transmit continuously with a consistent duty cycle at its maximum power control level.
3. Measure the average power of the transmitter, and the average power is corrected with duty factor,  $10 \log(1/x)$ , where  $x$  is the duty cycle.

### 3.2.4 Test Setup

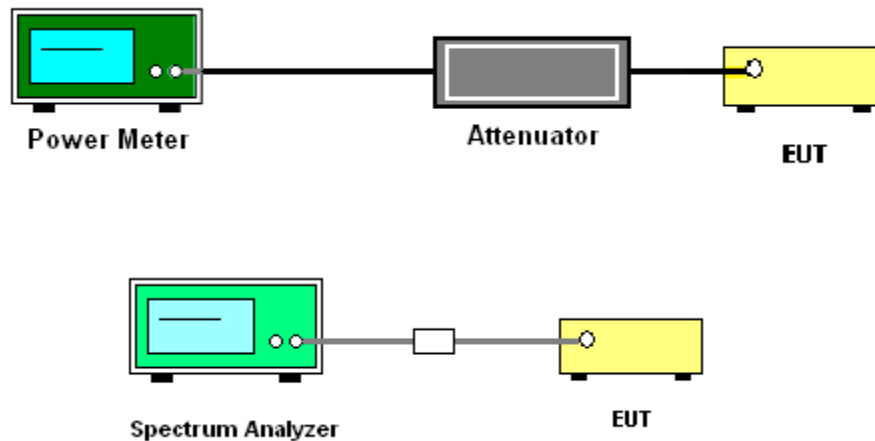

### 3.2.5 Test Result of Maximum Conducted Output Power

Please refer to Appendix A.



### 3.3 Power Spectral Density Measurement

#### 3.3.1 Limit of Power Spectral Density

<FCC 14-30 CFR 15.407>

For mobile and portable client devices in the 5.15–5.25 GHz band, the maximum power spectral density shall not exceed 11dBm in any 1 megahertz band.

For the 5.25–5.725 GHz bands, the maximum power spectral density shall not exceed 11 dBm in any 1 megahertz band.

If transmitting antennas of directional gain greater than 6 dBi are used, the peak output power shall be reduced by the amount in dB that the directional gain of the antenna exceeds 6 dBi.

#### 3.3.2 Measuring Instruments

The measuring equipment is listed in the section 4 of this test report.

### 3.3.3 Test Procedures

The testing follows FCC KDB 789033 D02 General UNII Test Procedures New Rules v02r01.

Section F) Maximum power spectral density.

#### # Method SA-2 #

(trace averaging across on and off times of the EUT transmissions, followed by duty cycle correction).

- Measure the duty cycle.
  - Set span to encompass the entire emission bandwidth (EBW) of the signal.
  - Set RBW = 1 MHz.
  - Set VBW  $\geq$  3 MHz.
  - Number of points in sweep  $\geq$  2 Span / RBW.
  - Sweep time = auto.
  - Detector = RMS
  - Trace average at least 100 traces in power averaging mode.
  - Add  $10 \log(1/x)$ , where  $x$  is the duty cycle, to the measured power in order to compute the average power during the actual transmission times. For example, add  $10 \log(1/0.25) = 6$  dB if the duty cycle is 25 percent.
1. The RF output of EUT was connected to the spectrum analyzer by a low loss cable.
  2. Each plot has already offset with cable loss, and attenuator loss. Measure the PPSD and record it.
  3. For MIMO mode, calculation method follows FCC KDB 662911 D01 Multiple Transmitter Output v02r01.

Method (a): Measure and sum the spectra across the outputs.

The total final Power Spectral Density is from a device with 2 transmitter outputs. The spectrum measurements of the individual outputs are all performed with the same span and number of points, the spectrum value in the first spectral bin of output 1 is summed with that in the first spectral bin of output 2 to obtain the value for the first frequency bin of the summed spectrum.

### 3.3.4 Test Setup

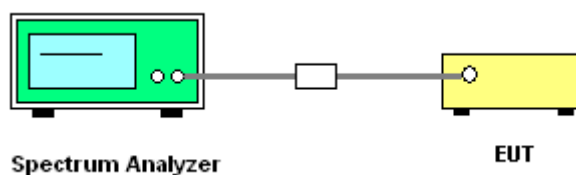



### 3.3.5 Test Result of Power Spectral Density

Please refer to Appendix A.

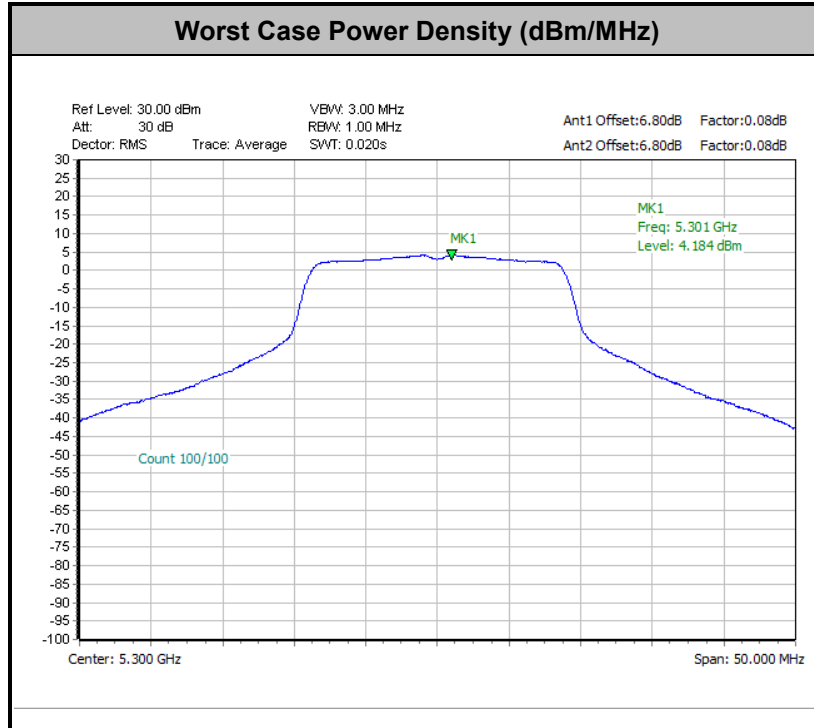



### 3.4 Unwanted Emissions Measurement

This section is to measure unwanted emissions through radiated measurement for band edge spurious emissions and out of band emissions measurement.

#### 3.4.1 Limit of Unwanted Emissions

- (1) For transmitters operating in the 5150-5250 MHz band: all emissions outside of the 5150-5350 MHz band shall not exceed an EIRP of -27dBm/MHz.

For transmitters operating in the 5250-5350 MHz band: all emissions outside of the 5150-5350 MHz band shall not exceed an EIRP of -27 dBm/MHz. Devices operating in the 5250-5350 MHz band that generate emissions in the 5150-5250 MHz band must meet all applicable technical requirements for operation in the 5150-5250 MHz band (including indoor use) or alternatively meet an out-of-band emission EIRP limit of -27 dBm/MHz in the 5150-5250 MHz band.

For transmitters operating in the 5470-5600 MHz and 5650-5725MHz band: all emissions outside of the 5470-5600 MHz and 5650-5725MHz band shall not exceed an EIRP of -27 dBm/MHz.

- (2) Unwanted spurious emissions fallen in restricted bands shall comply with the general field strength limits as below table,

Frequency (MHz)	Field Strength (microvolts/meter)	Measurement Distance (meters)
0.009 – 0.490	2400/F(kHz)	300
0.490 – 1.705	24000/F(kHz)	30
1.705 – 30.0	30	30
30 – 88	100	3
88 – 216	150	3
216 - 960	200	3
Above 960	500	3



EIRP (dBm)	Field Strength at 3m (dBμV/m)
- 27	68.3

**Note:** The following formula is used to convert the EIRP to field strength.

$$EIRP = E_{Meas} + 20\log (d_{Meas}) - 104.7$$

where

EIRP is the equivalent isotropically radiated power, in dBm

$E_{Meas}$  is the field strength of the emission at the measurement distance, in dBμV/m

$d_{Meas}$  is the measurement distance, in m

### 3.4.2 Measuring Instruments

The measuring equipment is listed in the section 4 of this test report.



### 3.4.3 Test Procedures

1. The testing follows FCC KDB 789033 D02 General UNII Test Procedures New Rules v02r01. Section G) Unwanted emissions measurement.
  - (1) Procedure for Unwanted Emissions Measurements Below 1000MHz
    - RBW = 120 kHz
    - VBW = 300 kHz
    - Detector = Peak
    - Trace mode = max hold
  - (2) Procedure for Peak Unwanted Emissions Measurements Above 1000 MHz
    - RBW = 1 MHz
    - VBW  $\geq$  3 MHz
    - Detector = Peak
    - Sweep time = auto
    - Trace mode = max hold
  - (3) Procedures for Average Unwanted Emissions Measurements Above 1000MHz
    - RBW = 1 MHz
    - VBW = 10 Hz, when duty cycle is no less than 98 percent.
    - VBW  $\geq$  1/T, when duty cycle is less than 98 percent where T is the minimum transmission duration over which the transmitter is on and is transmitting at its maximum power control level for the tested mode of operation.
2. The EUT was placed on a turntable with 0.8 meter for frequency below 1GHz and 1.5 meter for frequency above 1GHz respectively above ground.
3. The EUT was set 3 meters from the interference receiving antenna which was mounted on the top of a variable height antenna tower.
4. The antenna is a broadband antenna and its height is adjusted between one meter and four meters above ground to find the maximum value of the field strength for both horizontal polarization and vertical polarization of the antenna.
5. For each suspected emission, the EUT was arranged to its worst case and then adjust the antenna tower (from 1 m to 4 m) and turntable (from 0 degree to 360 degrees) to find the maximum reading.
6. For testing below 1GHz, if the emission level of the EUT in peak mode was 3 dB lower than the limit specified, then peak values of EUT will be reported, otherwise, the emissions will be repeated one by one using the CISPR quasi-peak method and reported.
7. For testing above 1GHz, the emission level of the EUT in peak mode was 20dB lower than peak limit (that means the emission level in average mode also complies with the limit in average mode), then peak values of EUT will be reported, otherwise, the emissions will be measured in average mode again and reported.

### 3.4.4 Test Setup

For radiated emissions below 30MHz

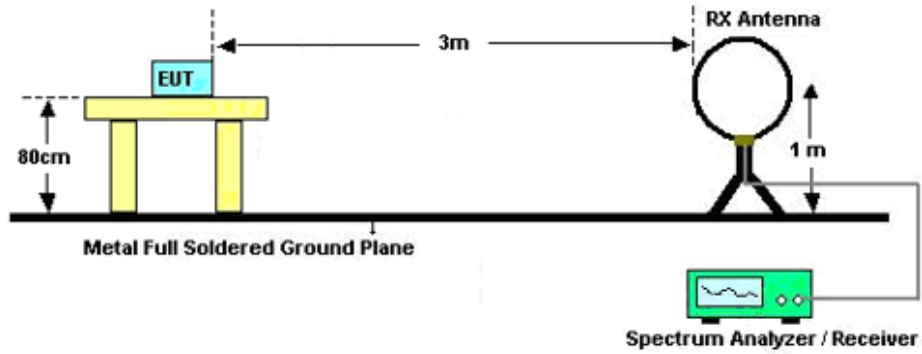

For radiated emissions from 30MHz to 1GHz

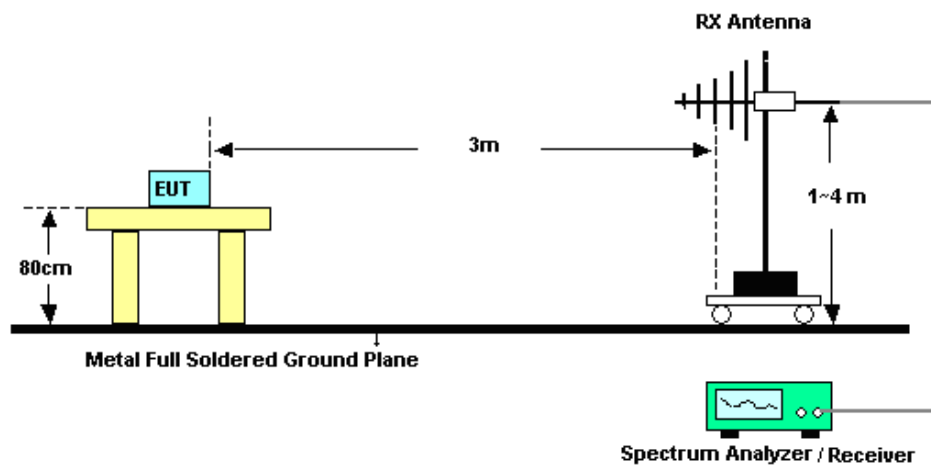



For radiated emissions above 1GHz

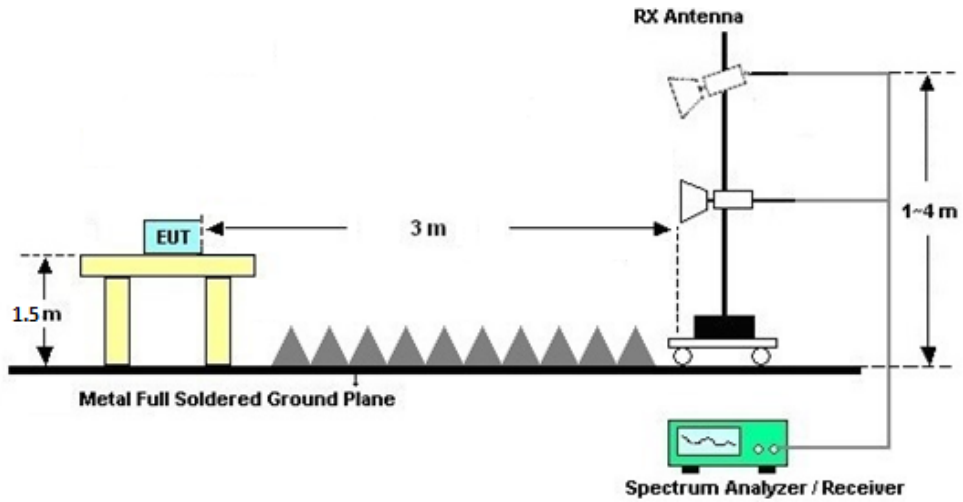



### **3.4.5 Test Results of Radiated Spurious Emissions (9 kHz ~ 30 MHz)**

The low frequency, which started from 9 kHz to 30MHz, was pre-scanned and the result which was 20dB lower than the limit line was not reported.

There is a comparison data of both open-field test site and semi-Anechoic chamber, and the result came out very similar.

### **3.4.6 Test Result of Radiated Spurious at Band Edges**

Please refer to Appendix C.

### **3.4.7 Duty Cycle**

Please refer to Appendix D.

### **3.4.8 Test Result of Radiated Spurious Emissions (30MHz ~ 10th Harmonic or 40GHz, whichever is lower)**

Please refer to Appendix C.



### 3.5 AC Conducted Emission Measurement

#### 3.5.1 Limit of AC Conducted Emission

For equipment that is designed to be connected to the public utility (AC) power line, the radio frequency voltage that is conducted back onto the AC power line on any frequency or frequencies within the band 150 kHz to 30 MHz shall not exceed the limits in the following table.

Frequency of emission (MHz)	Conducted limit (dBµV)	
	Quasi-peak	Average
0.15-0.5	66 to 56*	56 to 46*
0.5-5	56	46
5-30	60	50

\*Decreases with the logarithm of the frequency.

#### 3.5.2 Measuring Instruments

The measuring equipment is listed in the section 4 of this test report.

#### 3.5.3 Test Procedures

1. The EUT was placed 0.4 meter from the conducting wall of the shielding room was kept at least 80 centimeters from any other grounded conducting surface.
2. Connect EUT to the power mains through a line impedance stabilization network (LISN).
3. All the support units are connecting to the other LISN.
4. The LISN provides 50 ohm coupling impedance for the measuring instrument.
5. The FCC states that a 50 ohm, 50 microhenry LISN should be used.
6. Both sides of AC line were checked for maximum conducted interference.
7. The frequency range from 150 kHz to 30 MHz was searched.
8. Set the test-receiver system to Peak Detect Function and specified bandwidth with Maximum Hold Mode.

### 3.5.4 Test Setup

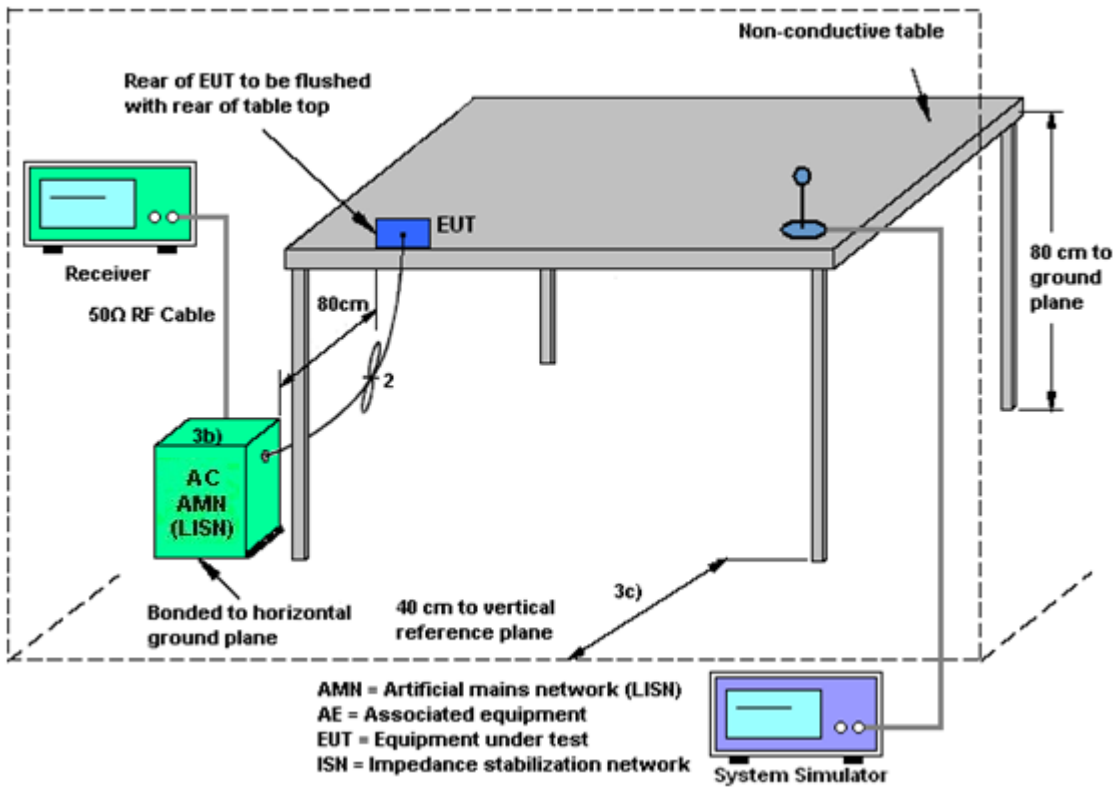

### 3.5.5 Test Result of AC Conducted Emission

Please refer to Appendix B.



### 3.6 Antenna Requirements

#### 3.6.1 Standard Applicable

If transmitting antenna directional gain is greater than 6 dBi, both the peak transmit power and the peak power spectral density shall be reduced by the amount in dB that the directional gain of the antenna exceeds 6 dBi.

#### 3.6.2 Antenna Anti-Replacement Construction

An embedded-in antenna design is used.

#### 3.6.3 Antenna Gain

<CDD Modes >

FCC KDB 662911 D01 Multiple Transmitter Output v02r01

For CDD transmissions, directional gain is calculated as

Directional gain = GANT + Array Gain, where Array Gain is as follows.

For power spectral density (PSD) measurements on all devices,

Array Gain = 10 log(NANT/NSS=1) dB.

For power measurements on IEEE 802.11 devices,

Array Gain = 0 dB (i.e., no array gain) for NANT ≤ 4.

Directional gain may be calculated by using the formulas applicable to equal gain antennas with GANT set equal to the gain of the antenna having the highest gain;

The EUT supports CDD mode.

For power, the directional gain GANT is set equal to the antenna having the highest gain, i.e., F)2)f)i).

For PSD, the directional gain calculation is following F)2)f)ii) of KDB 662911 D01 v02r01.

The power and PSD limit should be modified if the directional gain of EUT is over 6 dBi,

The directional gain "DG" is calculated as following table.

<CDD Modes>						
	Ant. 1 (dBi)	Ant. 2 (dBi)	DG for Power (dBi)	DG for PSD (dBi)	Power Limit Reduction (dB)	PSD Limit Reduction (dB)
Band I	2.19	2.47	2.47	5.34	0.00	0.00
Band II	2.17	3.50	3.50	5.87	0.00	0.00
Band III	1.78	3.74	3.74	5.83	0.00	0.00

Power limit reduction = Composite gain – 6dBi, ( min = 0 )

PSD limit reduction = Composite gain + PSD Array gain – 6dBi, ( min = 0 )



## 4 List of Measuring Equipment

Instrument	Manufacturer	Model No.	Serial No.	Characteristics	Calibration Date	Test Date	Due Date	Remark
Spectrum Analyzer	R&S	FSV40	101040	10Hz~40GHz	Nov. 01, 2020	Jun. 01, 2021~ Jun. 02, 2021	Oct. 31, 2021	Conducted (TH01-KS)
Pulse Power Sensor	Anritsu	MA2411B	0917070	300MHz~40GHz	Jan. 07, 2021	Jun. 01, 2021~ Jun. 02, 2021	Jan. 06, 2022	Conducted (TH01-KS)
Power Meter	Anritsu	ML2495A	1005002	50MHz Bandwidth	Jan. 07, 2021	Jun. 01, 2021~ Jun. 02, 2021	Jan. 06, 2022	Conducted (TH01-KS)
EMI Test Receiver	Keysight	N9038A	MY56400004	3Hz~8.5GHz;Max 30dBm	Oct. 17, 2020	Jun. 13, 2021	Oct. 16, 2021	Radiation (03CH05-KS)
EXA Spectrum Analyzer	Keysight	N9010A	MY55150244	10Hz~44G,MAX 30dB	Apr.13, 2021	Jun. 13, 2021	Apr. 12, 2022	Radiation (03CH05-KS)
Loop Antenna	R&S	HFH2-Z2	100321	9kHz~30MHz	Nov. 1, 2020	Jun. 13, 2021	Oct. 31, 2021	Radiation (03CH05-KS)
Bilog Antenna	TeseQ	CBL6111D	49922	30MHz~1GHz	May 30, 2021	Jun. 13, 2021	May 29, 2022	Radiation (03CH05-KS)
Double Ridge Horn Antenna	ETS-Lindgren	3117	00218652	1GHz~18GHz	Apr. 24, 2021	Jun. 13, 2021	Apr. 23, 2022	Radiation (03CH05-KS)
SHF-EHF Horn	Com-power	AH-840	101115	18GHz~40GHz	Nov. 10, 2020	Jun. 13, 2021	Nov. 09, 2021	Radiation (03CH05-KS)
Amplifier	SONOMA	310N	187289	9KHz~1GHz	Apr. 12, 2021	Jun. 13, 2021	Apr. 11, 2022	Radiation (03CH05-KS)
Amplifier	MITEQ	EM18G40GGA	060728	18~40GHz	Jan. 07, 2021	Jun. 13, 2021	Jan. 06, 2022	Radiation (03CH05-KS)
high gain Amplifier	MITEQ	AMF-7D-00101800-30-10P	2012228	1Ghz~18Ghz	Oct. 17, 2020	Jun. 13, 2021	Oct. 16, 2021	Radiation (03CH05-KS)
Amplifier	Keysight	83017A	MY53270316	500MHz~26.5GHz	Oct. 17, 2020	Jun. 13, 2021	Oct. 16, 2021	Radiation (03CH05-KS)
AC Power Source	Chroma	61601	F104090004	N/A	NCR	Jun. 13, 2021	NCR	Radiation (03CH05-KS)
Turn Table	ChamPro	EM 1000-T	060762-T	0~360 degree	NCR	Jun. 13, 2021	NCR	Radiation (03CH05-KS)
Antenna Mast	ChamPro	EM 1000-A	060762-A	1 m~4 m	NCR	Jun. 13, 2021	NCR	Radiation (03CH05-KS)
EMI Receiver	R&S	ESCI7	100768	9kHz~7GHz;	Apr. 21, 2021	Jun. 25, 2021	Apr. 20, 2022	Conduction (CO01-KS)
AC LISN (for auxiliary equipment)	MessTec	AN3016	060103	9kHz~30MHz	Oct. 17, 2020	Jun. 25, 2021	Oct. 16, 2021	Conduction (CO01-KS)
AC LISN	R&S	ENV216	100334	9kHz~30MHz	Oct. 17, 2020	Jun. 25, 2021	Oct. 16, 2021	Conduction (CO01-KS)
AC Power Source	Chroma	61602	ABP000000811	AC 0V~300V, 45Hz~1000Hz	Oct. 17, 2020	Jun. 25, 2021	Oct. 16, 2021	Conduction (CO01-KS)

NCR: No Calibration Required.



## 5 Uncertainty of Evaluation

The measurement uncertainties shown below were calculated in accordance with the requirements of ANSI 63.10-2013. All the measurement uncertainty value were shown with a coverage K=2 to indicate 95% level of confidence. The measurement data show herein meets or exceeds the CISPR measurement uncertainty values specified in CISPR 16-4-2 and can be compared directly to specified limit to determine compliance.

### Uncertainty of Conducted Emission Measurement (150kHz ~ 30MHz)

Measuring Uncertainty for a Level of Confidence of 95% (U = 2Uc(y))	2.94dB
---	--------

### Uncertainty of Radiated Emission Measurement (30 MHz ~ 1000 MHz)

Measuring Uncertainty for a Level of Confidence of 95% (U = 2Uc(y))	5.0dB
---	-------

### Uncertainty of Radiated Emission Measurement (1000 MHz ~ 18000 MHz)

Measuring Uncertainty for a Level of Confidence of 95% (U = 2Uc(y))	5.0dB
---	-------

### Uncertainty of Radiated Emission Measurement (18000 MHz ~ 40000 MHz)

Measuring Uncertainty for a Level of Confidence of 95% (U = 2Uc(y))	5.0dB
---	-------

----- THE END -----



## **Appendix A. Conducted Test Results**



**A1. Conducted Test Results**

Test Engineer:	HeYong	Temperature:	21~25	°C
Test Date:	2021/6/1~2021/6/2	Relative Humidity:	51~54	%

**TEST RESULTS DATA**  
**26dB and 99% OBW**

U-NII-1 single antenna													
Mod.	Data Rate	NTX	CH.	Freq. (MHz)	99% Bandwidth (MHz)		26 dB Bandwidth (MHz)		IC 99% Bandwidth Power Limit (dBm)		IC 99% Bandwidth EIRP Limit (dBm)		Note
					Ant 1	Ant 2	Ant 1	Ant 2	Ant 1	Ant 2	Ant 1	Ant 2	
11a	6Mbps	1	36	5180	17.58	17.43	25.20	24.65	-	-	22.45	22.41	
11a	6Mbps	1	44	5220	17.63	17.53	24.85	25.00	-	-	22.46	22.44	
11a	6Mbps	1	48	5240	17.58	17.63	25.00	25.15	-	-	22.45	22.46	

U-NII-1 MIMO													
Mod.	Data Rate	NTX	CH.	Freq. (MHz)	99% Bandwidth (MHz)		26 dB Bandwidth (MHz)		IC 99% Bandwidth Power Limit (dBm)		IC 99% Bandwidth EIRP Limit (dBm)		Note
					Ant 1	Ant 2	Ant 1	Ant 2	Ant 1	Ant 2	Ant 1	Ant 2	
HT20	MCS0	2	36	5180	18.73	18.78	26.00	25.50	-	-	22.73		
HT20	MCS0	2	44	5220	18.83	18.83	26.65	25.85	-	-	22.75		
HT20	MCS0	2	48	5240	18.83	18.83	25.35	25.85	-	-	22.75		
HT40	MCS0	2	38	5190	36.46	36.46	41.67	41.85	-	-	23.01		
HT40	MCS0	2	46	5230	36.56	36.46	42.03	41.85	-	-	23.01		
VHT80	MCS0	2	42	5210	75.64	75.52	83.52	83.20	-	-	23.01		

**TEST RESULTS DATA**  
**Average Power Table**

FCC U-NII-1 single antenna												
Mod.	Data Rate	NTX	CH.	Freq. (MHz)	Average Conducted Power with duty factor (dBm)			FCC Conducted Power Limit (dBm)		DG (dBi)		Pass/Fail
					Ant 1	Ant 2	SUM	Ant 1	Ant 2	Ant 1	Ant 2	
11a	6Mbps	1	36	5180	11.80	11.93		24.00	24.00	2.19	2.47	Pass
11a	6Mbps	1	44	5220	11.75	12.13		24.00	24.00	2.19	2.47	Pass
11a	6Mbps	1	48	5240	11.88	12.27		24.00	24.00	2.19	2.47	Pass

FCC U-NII-1 MIMO												
Mod.	Data Rate	NTX	CH.	Freq. (MHz)	Average Conducted Power with duty factor (dBm)			FCC Conducted Power Limit (dBm)		DG (dBi)		Pass/Fail
					Ant 1	Ant 2	SUM	Ant 1	Ant 2	Ant 1	Ant 2	
HT20	MCS0	2	36	5180	11.90	12.15	15.04	24.00		2.47		Pass
HT20	MCS0	2	44	5220	11.81	12.39	15.12	24.00		2.47		Pass
HT20	MCS0	2	48	5240	11.96	12.49	15.24	24.00		2.47		Pass
HT40	MCS0	2	38	5190	11.16	11.44	14.31	24.00		2.47		Pass
HT40	MCS0	2	46	5230	11.11	11.71	14.43	24.00		2.47		Pass
VHT20	MCS0	2	36	5180	9.79	9.95	12.88	24.00		2.47		Pass
VHT20	MCS0	2	44	5220	9.81	10.36	13.11	24.00		2.47		Pass
VHT20	MCS0	2	48	5240	9.96	10.39	13.19	24.00		2.47		Pass
VHT40	MCS0	2	38	5190	10.10	10.41	13.27	24.00		2.47		Pass
VHT40	MCS0	2	46	5230	10.01	10.58	13.31	24.00		2.47		Pass
VHT80	MCS0	2	42	5210	10.12	9.84	13.00	24.00		2.47		Pass

**TEST RESULTS DATA**  
**Power Spectral Density**

FCC U-NII-1 single antenna												
Mod.	Data Rate	NTX	CH.	Freq. (MHz)	Average Power Density (dBm/MHz)			Average PSD Limit (dBm/MHz)		DG (dBi)		Pass /Fail
					Ant 1	Ant 2	SUM	Ant 1	Ant 2	Ant 1	Ant 2	
11a	6Mbps	1	36	5180	1.36	1.73		11.00	11.00	2.19	2.47	Pass
11a	6Mbps	1	44	5220	1.88	2.27		11.00	11.00	2.19	2.47	Pass
11a	6Mbps	1	48	5240	1.57	1.96		11.00	11.00	2.19	2.47	Pass

FCC U-NII-1 MIMO												
Mod.	Data Rate	NTX	CH.	Freq. (MHz)	Average Power Density (dBm/MHz)			Average PSD Limit (dBm/MHz)		DG (dBi)		Pass /Fail
					Ant 1	Ant 2	SUM	Ant 1	Ant 2	Ant 1	Ant 2	
HT20	MCS0	2	36	5180			3.94	11.00	5.34		Pass	
HT20	MCS0	2	44	5220			3.68	11.00	5.34		Pass	
HT20	MCS0	2	48	5240			4.06	11.00	5.34		Pass	
HT40	MCS0	2	38	5190			0.20	11.00	5.34		Pass	
HT40	MCS0	2	46	5230			0.42	11.00	5.34		Pass	
VHT80	MCS0	2	42	5210			-3.94	11.00	5.34		Pass	

**TEST RESULTS DATA**  
**26dB and 99% OBW**

U-NII-2A single antenna															
Mod.	Data Rate	NTX	CH.	Freq. (MHz)	99% Bandwidth (MHz)		26 dB Bandwidth (MHz)		IC 99% Bandwidth Power Limit (dBm)		IC 99% Bandwidth EIRP Limit (dBm)		FCC 26dB Bandwidth Power Limit (dBm)		Note
					Ant 1	Ant 2	Ant 1	Ant 2	Ant 1	Ant 2	Ant 1	Ant 2	Ant 1	Ant 2	
11a	6Mbps	1	52	5260	17.43	17.58	24.85	25.10	23.41	23.45	29.41	29.45	23.98	23.98	
11a	6Mbps	1	60	5300	17.48	17.58	24.85	25.85	23.43	23.45	29.43	29.45	23.98	23.98	
11a	6Mbps	1	64	5320	17.53	17.53	25.25	25.25	23.44	23.44	29.44	29.44	23.98	23.98	

U-NII-2A MIMO															
Mod.	Data Rate	NTX	CH.	Freq. (MHz)	99% Bandwidth (MHz)		26 dB Bandwidth (MHz)		IC 99% Bandwidth Power Limit (dBm)		IC 99% Bandwidth EIRP Limit (dBm)		FCC 26dB Bandwidth Power Limit (dBm)		Note
					Ant 1	Ant 2	Ant 1	Ant 2	Ant 1	Ant 2	Ant 1	Ant 2	Ant 1	Ant 2	
HT20	MCS0	2	52	5260	18.73	18.98	26.10	27.35	23.73	23.73	29.73	29.73	23.98	23.98	
HT20	MCS0	2	60	5300	18.78	18.93	25.90	26.55	23.74	23.74	29.74	29.74	23.98	23.98	
HT20	MCS0	2	64	5320	18.78	18.93	25.95	25.95	23.74	23.74	29.74	29.74	23.98	23.98	
HT40	MCS0	2	54	5270	36.56	36.56	41.67	41.67	23.98	23.98	30.00	30.00	23.98	23.98	
HT40	MCS0	2	62	5310	36.56	36.46	41.94	41.76	23.98	23.98	30.00	30.00	23.98	23.98	
VHT80	MCS0	2	58	5290	75.64	75.64	83.20	83.04	23.98	23.98	30.00	30.00	23.98	23.98	

**TEST RESULTS DATA**  
**Average Power Table**

FCC U-NII-2A single antenna													
Mod.	Data Rate	NTX	CH.	Freq. (MHz)	Average Conducted Power with duty factor (dBm)			FCC Conducted Power Limit (dBm)		DG (dBi)		EIRP Power Limit (dBm)	Pass/Fail
					Ant 1	Ant 2	SUM	Ant 1	Ant 2	Ant 1	Ant 2		
11a	6Mbps	1	52	5260	12.03	12.47		23.98	23.98	2.17	3.50	26.99	Pass
11a	6Mbps	1	60	5300	12.08	12.52		23.98	23.98	2.17	3.50	26.99	Pass
11a	6Mbps	1	64	5320	12.06	12.39		23.98	23.98	2.17	3.50	26.99	Pass

FCC U-NII-2A MIMO													
Mod.	Data Rate	NTX	CH.	Freq. (MHz)	Average Conducted Power with duty factor (dBm)			FCC Conducted Power Limit (dBm)		DG (dBi)		EIRP Power Limit (dBm)	Pass/Fail
					Ant 1	Ant 2	SUM	Ant 1	Ant 2	Ant 1	Ant 2		
HT20	MCS0	2	52	5260	12.11	12.74	15.45	23.98		3.50		26.99	Pass
HT20	MCS0	2	60	5300	12.19	12.68	15.45	23.98		3.50		26.99	Pass
HT20	MCS0	2	64	5320	12.08	12.62	15.37	23.98		3.50		26.99	Pass
HT40	MCS0	2	54	5270	11.31	11.82	14.58	23.98		3.50		26.99	Pass
HT40	MCS0	2	62	5310	11.13	11.83	14.50	23.98		3.50		26.99	Pass
VHT20	MCS0	2	52	5260	10.07	10.52	13.31	23.98		3.50		26.99	Pass
VHT20	MCS0	2	60	5300	9.88	10.53	13.23	23.98		3.50		26.99	Pass
VHT20	MCS0	2	64	5320	10.09	10.43	13.28	23.98		3.50		26.99	Pass
VHT40	MCS0	2	54	5270	10.37	10.90	13.65	23.98		3.50		26.99	Pass
VHT40	MCS0	2	62	5310	9.98	10.79	13.41	23.98		3.50		26.99	Pass
VHT80	MCS0	2	58	5290	10.39	10.42	13.42	23.98		3.50		26.99	Pass

**TEST RESULTS DATA**  
**Power Spectral Density**

U-NII-2A single antenna												
Mod.	Data Rate	NTX	CH.	Freq. (MHz)	Average Power Density (dBm/MHz)			Average PSD Limit (dBm/MHz)		DG (dBi)		Pass /Fail
					Ant 1	Ant 2	SUM	Ant 1	Ant 2	Ant 1	Ant 2	
11a	6Mbps	1	52	5260	1.74	2.23		11.00	11.00	2.17	3.50	Pass
11a	6Mbps	1	60	5300	1.53	2.08		11.00	11.00	2.17	3.50	Pass
11a	6Mbps	1	64	5320	1.69	1.97		11.00	11.00	2.17	3.50	Pass

U-NII-2A MIMO												
Mod.	Data Rate	NTX	CH.	Freq. (MHz)	Average Power Density (dBm/MHz)			Average PSD Limit (dBm/MHz)		DG (dBi)		Pass /Fail
					Ant 1	Ant 2	SUM	Ant 1	Ant 2	Ant 1	Ant 2	
HT20	MCS0	2	52	5260			4.18	11.00	5.87		Pass	
HT20	MCS0	2	60	5300			4.18	11.00	5.87		Pass	
HT20	MCS0	2	64	5320			4.16	11.00	5.87		Pass	
HT40	MCS0	2	54	5270			0.41	11.00	5.87		Pass	
HT40	MCS0	2	62	5310			0.31	11.00	5.87		Pass	
VHT80	MCS0	2	58	5290			-3.58	11.00	5.87		Pass	

**TEST RESULTS DATA**  
**26dB and 99% OBW**

U-NII-2C single antenna																
Mod.	Data Rate	NTX	CH.	Freq. (MHz)	99% Bandwidth In U-NII 2C (MHz)		26 dB Bandwidth In U-NII 2C (MHz)		IC 99% Bandwidth Power Limit (dBm)		IC 99% Bandwidth EIRP Limit (dBm)		FCC 26dB Bandwidth Power Limit (dBm)		6 dB Bandwidth for Straddle Channel (MHz)	
					Ant 1	Ant 2	Ant 1	Ant 2	Ant 1	Ant 2	Ant 1	Ant 2	Ant 1	Ant 2	Ant 1	Ant 2
11a	6Mbps	1	100	5500	17.53	17.58	25.10	25.80	23.44	23.45	29.44	29.45	23.98	23.98	----	----
11a	6Mbps	1	116	5580	17.53	17.53	25.05	25.30	23.44	23.44	29.44	29.44	23.98	23.98	----	----
11a	6Mbps	1	140	5700	17.48	17.58	25.25	25.55	23.43	23.45	29.43	29.45	23.98	23.98	----	----

U-NII-2C MIMO																
Mod.	Data Rate	NTX	CH.	Freq. (MHz)	99% Bandwidth In U-NII 2C (MHz)		26 dB Bandwidth In U-NII 2C (MHz)		IC 99% Bandwidth Power Limit (dBm)		IC 99% Bandwidth EIRP Limit (dBm)		FCC 26dB Bandwidth Power Limit (dBm)		6 dB Bandwidth for Straddle Channel (MHz)	
					Ant 1	Ant 2	Ant 1	Ant 2	Ant 1	Ant 2	Ant 1	Ant 2	Ant 1	Ant 2	Ant 1	Ant 2
HT20	MCS0	2	100	5500	18.88	18.98	26.30	26.95	23.76	23.76	29.76	29.76	23.98	23.98	----	----
HT20	MCS0	2	116	5580	18.73	18.98	26.40	25.95	23.73	23.73	29.73	29.73	23.98	23.98	----	----
HT20	MCS0	2	140	5700	18.83	18.98	26.70	26.30	23.75	23.75	29.75	29.75	23.98	23.98	----	----
HT40	MCS0	2	102	5510	36.56	36.56	41.76	42.03	23.98	23.98	30.00	30.00	23.98	23.98	----	----
HT40	MCS0	2	110	5550	36.56	36.56	41.85	41.85	23.98	23.98	30.00	30.00	23.98	23.98	----	----
HT40	MCS0	2	134	5670	36.56	36.46	41.76	41.94	23.98	23.98	30.00	30.00	23.98	23.98	----	----
VHT80	MCS0	2	106	5530	75.52	75.52	83.20	82.56	23.98	23.98	30.00	30.00	23.98	23.98	----	----



**TEST RESULTS DATA**  
**Average Power Table**

FCC U-NII-2C single antenna													
Mod.	Data Rate	NTX	CH.	Freq. (MHz)	Average Conducted Power with duty factor (dBm)			FCC Conducted Power Limit (dBm)		DG (dBi)		EIRP Power Limit (dBm)	Pass/Fail
					Ant 1	Ant 2	SUM	Ant 1	Ant 2	Ant 1	Ant 2		
11a	6Mbps	1	100	5500	11.78	11.97		23.98	23.98	1.78	3.74	26.99	Pass
11a	6Mbps	1	116	5580	11.87	12.01		23.98	23.98	1.78	3.74	26.99	Pass
11a	6Mbps	1	140	5700	11.46	11.97		23.98	23.98	1.78	3.74	26.99	Pass

FCC U-NII-2C MIMO													
Mod.	Data Rate	NTX	CH.	Freq. (MHz)	Average Conducted Power with duty factor (dBm)			FCC Conducted Power Limit (dBm)		DG (dBi)		EIRP Power Limit (dBm)	Pass/Fail
					Ant 1	Ant 2	SUM	Ant 1	Ant 2	Ant 1	Ant 2		
HT20	MCS0	2	100	5500	11.71	12.24	14.99	23.98		3.74		26.99	Pass
HT20	MCS0	2	116	5580	12.04	12.23	15.15	23.98		3.74		26.99	Pass
HT20	MCS0	2	140	5700	11.76	12.15	14.97	23.98		3.74		26.99	Pass
HT40	MCS0	2	102	5510	11.24	11.19	14.22	23.98		3.74		26.99	Pass
HT40	MCS0	2	110	5550	10.98	11.30	14.15	23.98		3.74		26.99	Pass
HT40	MCS0	2	134	5670	11.16	11.46	14.32	23.98		3.74		26.99	Pass
VHT20	MCS0	2	100	5500	9.57	9.92	12.76	23.98		3.74		26.99	Pass
VHT20	MCS0	2	116	5580	9.96	9.93	12.96	23.98		3.74		26.99	Pass
VHT20	MCS0	2	140	5700	9.62	9.92	12.78	23.98		3.74		26.99	Pass
VHT40	MCS0	2	102	5510	9.96	10.17	13.08	23.98		3.74		26.99	Pass
VHT40	MCS0	2	110	5550	9.74	10.26	13.02	23.98		3.74		26.99	Pass
VHT40	MCS0	2	134	5670	10.18	10.45	13.33	23.98		3.74		26.99	Pass
VHT80	MCS0	2	106	5530	10.22	9.97	13.11	23.98		3.74		26.99	Pass

**TEST RESULTS DATA**  
**Power Spectral Density**

U-NII-2C single antenna												
Mod.	Data Rate	NTX	CH.	Freq. (MHz)	Average Power Density (dBm/MHz)			Average PSD Limit (dBm/MHz)		DG (dBi)		Pass /Fail
					Ant 1	Ant 2	SUM	Ant 1	Ant 2	Ant 1	Ant 2	
11a	6Mbps	1	100	5500	1.48	1.51		11.00	11.00	1.78	3.74	Pass
11a	6Mbps	1	116	5580	1.31	1.27		11.00	11.00	1.78	3.74	Pass
11a	6Mbps	1	140	5700	1.26	1.67		11.00	11.00	1.78	3.74	Pass

U-NII-2C MIMO												
Mod.	Data Rate	NTX	CH.	Freq. (MHz)	Average Power Density (dBm/MHz)			Average PSD Limit (dBm/MHz)		DG (dBi)		Pass /Fail
					Ant 1	Ant 2	SUM	Ant 1	Ant 2	Ant 1	Ant 2	
HT20	MCS0	2	100	5500			3.82	11.00	5.83		Pass	
HT20	MCS0	2	116	5580			3.96	11.00	5.83		Pass	
HT20	MCS0	2	140	5700			3.69	11.00	5.83		Pass	
HT40	MCS0	2	102	5510			0.32	11.00	5.83		Pass	
HT40	MCS0	2	110	5550			0.39	11.00	5.83		Pass	
HT40	MCS0	2	134	5670			0.12	11.00	5.83		Pass	
VHT80	MCS0	2	106	5530			-4.01	11.00	5.83		Pass	



## Appendix B. AC Conducted Emission Test Results

Test Engineer :	Amos Zhang	Temperature :	24.2~25.6°C
		Relative Humidity :	37~39%
Test Voltage :	120Vac / 60Hz	Phase :	Line
Remark :	All emissions not reported here are more than 10 dB below the prescribed limit.		

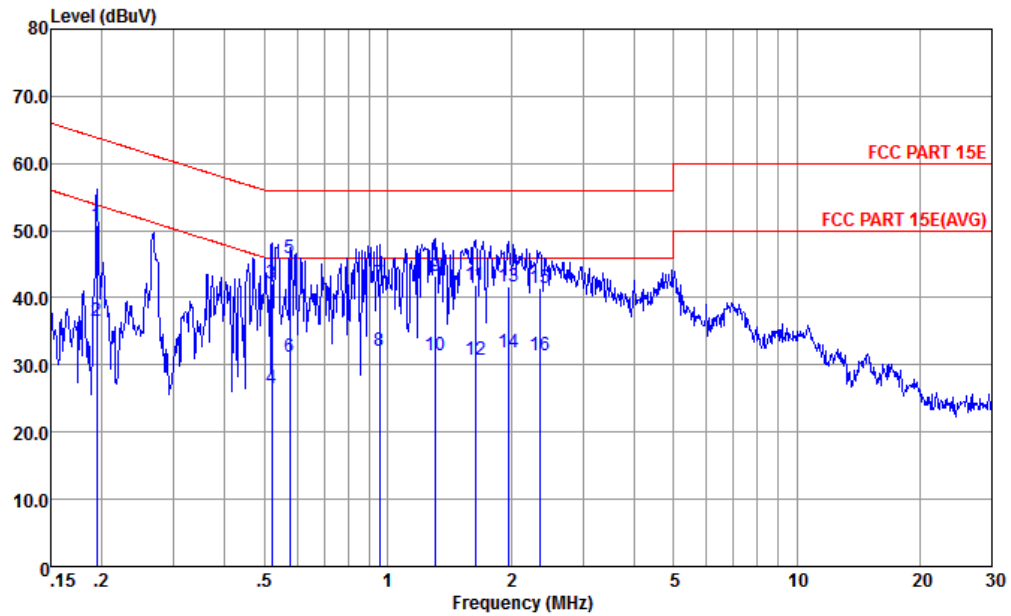

Site : CO01-KS  
 Condition : FCC PART 15E TWO-LISN-CN02-L LINE

	Freq	Level	Over	Limit	Read	LISN	Cable	Remark
	MHz	dBuV	Limit	Line	Level	Factor	Loss	
			dB	dBuV	dBuV	dB	dB	
1	0.194	50.92	-12.92	63.84	30.91	9.64	10.37	QP
2	0.194	36.62	-17.22	53.84	16.61	9.64	10.37	Average
3	0.521	42.09	-13.91	56.00	22.20	9.65	10.24	QP
4	0.521	26.49	-19.51	46.00	6.60	9.65	10.24	Average
5 *	0.576	45.99	-10.01	56.00	26.10	9.65	10.24	QP
6	0.576	31.19	-14.81	46.00	11.30	9.65	10.24	Average
7	0.953	42.14	-13.86	56.00	22.20	9.70	10.24	QP
8	0.953	32.14	-13.86	46.00	12.20	9.70	10.24	Average
9	1.310	43.33	-12.67	56.00	23.30	9.80	10.23	QP
10	1.310	31.53	-14.47	46.00	11.50	9.80	10.23	Average
11	1.636	42.00	-14.00	56.00	21.90	9.87	10.23	QP
12	1.636	30.70	-15.30	46.00	10.60	9.87	10.23	Average
13	1.970	41.66	-14.34	56.00	21.50	9.93	10.23	QP
14	1.970	31.76	-14.24	46.00	11.60	9.93	10.23	Average
15	2.358	41.42	-14.58	56.00	21.20	9.99	10.23	QP
16	2.358	31.52	-14.48	46.00	11.30	9.99	10.23	Average



Test Engineer :	Amos Zhang	Temperature :	24.2~25.6°C
		Relative Humidity :	37~39%
Test Voltage :	120Vac / 60Hz	Phase :	Neutral
Remark :	All emissions not reported here are more than 10 dB below the prescribed limit.		

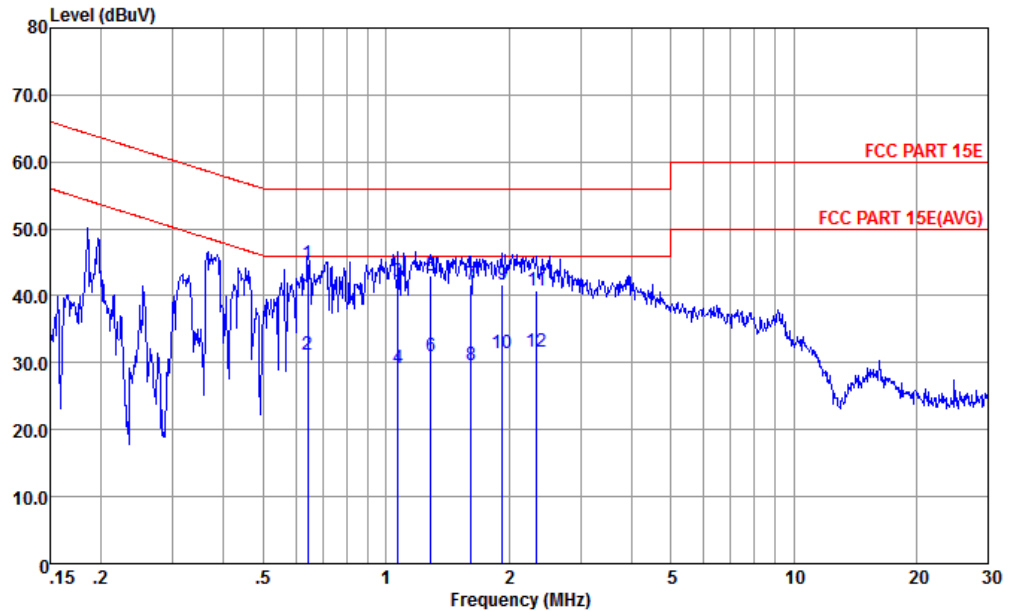

Site : CO01-KS  
 Condition : FCC PART 15E TWO-LISN-CN02-N NEUTRAL

	Freq	Level	Over	Limit	Read	LISN	Cable	Remark
	MHz	dBuV	Limit	Line	Level	Factor	Loss	
			dB	dBuV	dBuV	dB	dB	
1 *	0.644	44.86	-11.14	56.00	24.89	9.73	10.24	QP
2	0.644	31.26	-14.74	46.00	11.29	9.73	10.24	Average
3	1.071	42.16	-13.84	56.00	22.20	9.73	10.23	QP
4	1.071	29.16	-16.84	46.00	9.20	9.73	10.23	Average
5	1.289	42.92	-13.08	56.00	22.90	9.79	10.23	QP
6	1.289	30.92	-15.08	46.00	10.90	9.79	10.23	Average
7	1.619	41.69	-14.31	56.00	21.60	9.86	10.23	QP
8	1.619	29.69	-16.31	46.00	9.60	9.86	10.23	Average
9	1.928	41.74	-14.26	56.00	21.59	9.92	10.23	QP
10	1.928	31.44	-14.56	46.00	11.29	9.92	10.23	Average
11	2.346	40.82	-15.18	56.00	20.61	9.98	10.23	QP
12	2.346	31.72	-14.28	46.00	11.51	9.98	10.23	Average

Note:

- Level(dBμV) = Read Level(dBμV) + LISN Factor(dB) + Cable Loss(dB)
- Over Limit(dB) = Level(dBμV) – Limit Line(dBμV)



## Appendix C. Radiated Spurious Emission

### UNII 1 - 5150~5250MHz

#### WIFI 802.11a ANT 1 (Band Edge @ 3m)

WIFI Ant.	Note	Frequency	Level	Over Limit	Limit Line	Read Level	Antenna Factor	Cable Loss	Preamp Factor	Ant Pos	Table Pos	Peak Avg.	Pol.
1		( MHz )	( dBμV/m )	( dB )	( dBμV/m )	( dBμV )	( dB/m )	( dB )	( dB )	( cm )	( deg )	( P/A )	( H/V )
802.11a CH 36 5180MHz		5116.48	57.4	-16.6	74	42.26	34.58	11.16	30.6	100	113	P	H
		5146.08	46.78	-7.22	54	31.57	34.62	11.2	30.61	100	113	A	H
	*	5182	101.48	-	-	86.19	34.67	11.24	30.62	100	113	P	H
		5182	94.11	-	-	78.82	34.67	11.24	30.62	100	113	A	H
		5123.68	56.16	-17.84	74	40.98	34.6	11.18	30.6	104	82	P	V
		5148.96	46.65	-7.35	54	31.44	34.62	11.2	30.61	104	82	A	V
	*	5176	98.99	-	-	83.7	34.67	11.24	30.62	104	82	P	V
		5176	91.73	-	-	76.44	34.67	11.24	30.62	104	82	A	V
Remark	1. No other spurious found. 2. All results are PASS against Peak and Average limit line.												



UNII 1 5150~5250MHz
WIFI 802.11a ANT 1 (Harmonic @ 3m)

Table with 14 columns: WIFI Ant. 1, Note, Frequency (MHz), Level (dBµV/m), Over Limit (dB), Limit Line (dBµV/m), Read Level (dBµV), Antenna Factor (dB/m), Cable Loss (dB), Preamp Factor (dB), Ant Pos (cm), Table Pos (deg), Peak Avg. (P/A), Pol. (H/V). Rows include data for channels 36, 44, and 48 at various frequencies.

Remark
1. No other spurious found.
2. All results are PASS against Peak and Average limit line.



UNII 1 5150~5250MHz
WIFI 802.11a ANT 2 (Band Edge @ 3m)

Table with 14 columns: WIFI Ant. 2, Note, Frequency (MHz), Level (dBµV/m), Over Limit (dB), Limit Line (dBµV/m), Read Level (dBµV), Antenna Factor (dB/m), Cable Loss (dB), Preamp Factor (dB), Ant Pos (cm), Table Pos (deg), Peak Avg. (P/A), Pol. (H/V). Rows include test results for 802.11a CH 36 5180MHz and a Remark section.



UNII 1 5150~5250MHz
WIFI 802.11a ANT 2 (Harmonic @ 3m)

Table with 14 columns: WIFI Ant. 2, Note, Frequency (MHz), Level (dBµV/m), Over Limit (dB), Limit Line (dBµV/m), Read Level (dBµV), Antenna Factor (dB/m), Cable Loss (dB), Preamp Factor (dB), Ant Pos (cm), Table Pos (deg), Peak Avg. (P/A), Pol. (H/V). Rows include data for channels 36, 44, and 48 at various frequencies.

Remark
1. No other spurious found.
2. All results are PASS against Peak and Average limit line.





UNII 1 5150~5250MHz
WIFI 802.11n HT20 ANT 1+2 (Band Edge @ 3m)

Table with 14 columns: WIFI Ant. 1+2, Note, Frequency (MHz), Level (dBµV/m), Over Limit (dB), Limit Line (dBµV/m), Read Level (dBµV), Antenna Factor (dB/m), Cable Loss (dB), Preamp Factor (dB), Ant Pos (cm), Table Pos (deg), Peak Avg. (P/A), Pol. (H/V). Rows include test results for 802.11n HT20 CH 36 5180MHz and a Remark section.



UNII 1 5150~5250MHz
WIFI 802.11n HT20 ANT 1+2 (Harmonic @ 3m)

Table with 14 columns: WIFI Ant. 1+2, Note, Frequency (MHz), Level (dBµV/m), Over Limit (dB), Limit Line (dBµV/m), Read Level (dBµV), Antenna Factor (dB/m), Cable Loss (dB), Preamp Factor (dB), Ant Pos (cm), Table Pos (deg), Peak Avg. (P/A), Pol. (H/V). Rows include data for channels 36 (5180MHz), 44 (5220MHz), and 48 (5240MHz). A Remark section at the bottom states: '1. No other spurious found. 2. All results are PASS against Peak and Average limit line.'



**UNII 1 5150~5250MHz**  
**WIFI 802.11n HT40 ANT 1+2 (Band Edge @ 3m)**

WIFI Ant. 1+2	Note	Frequency ( MHz )	Level ( dBμV/m )	Over Limit ( dB )	Limit Line ( dBμV/m )	Read Level (dBμV)	Antenna Factor ( dB/m )	Cable Loss ( dB )	Preamp Factor ( dB )	Ant Pos ( cm )	Table Pos ( deg )	Peak Avg. (P/A)	Pol. (H/V)
802.11n HT40 CH 38 5190MHz		5143.2	58.97	-15.03	74	43.76	34.62	11.2	30.61	100	243	P	H
		5144	50.02	-3.98	54	34.81	34.62	11.2	30.61	100	243	A	H
	*	5200	99.4	-	-	84.07	34.7	11.26	30.63	100	243	P	H
		5200	91.09	-	-	75.76	34.7	11.26	30.63	100	243	A	H
		5398.92	56.05	-17.95	74	40.56	34.7	11.49	30.7	100	243	P	H
		5398.74	45.89	-8.11	54	30.4	34.7	11.49	30.7	100	243	A	H
		5148.96	58.1	-15.9	74	42.89	34.62	11.2	30.61	100	119	P	V
		5149.92	50.09	-3.91	54	34.88	34.62	11.2	30.61	100	119	A	V
	*	5194	97.05	-	-	81.72	34.7	11.26	30.63	100	119	P	V
		5194	88.98	-	-	73.65	34.7	11.26	30.63	100	119	A	V
		5397.12	55.02	-18.98	74	39.52	34.7	11.49	30.69	100	119	P	V
		5373.18	45.96	-8.04	54	30.5	34.7	11.45	30.69	100	119	A	V
<b>Remark</b>	1. No other spurious found. 2. All results are PASS against Peak and Average limit line.												



UNII 1 5150~5250MHz
WIFI 802.11n HT40 ANT 1+2 (Harmonic @ 3m)

Table with 14 columns: WIFI Ant. 1+2, Note, Frequency (MHz), Level (dBµV/m), Over Limit (dB), Limit Line (dBµV/m), Read Level (dBµV), Antenna Factor (dB/m), Cable Loss (dB), Preamp Factor (dB), Ant Pos (cm), Table Pos (deg), Peak Avg. (P/A), Pol. (H/V). Rows include test results for 802.11n HT40 CH 38 5190MHz and CH 46 5230MHz, plus a Remark section.



UNII 1 5150~5250MHz
WIFI 802.11ac VHT80 ANT 1+2 (Band Edge @ 3m)

Table with 14 columns: WIFI Ant. 1+2, Note, Frequency (MHz), Level (dBµV/m), Over Limit (dB), Limit Line (dBµV/m), Read Level (dBµV), Antenna Factor (dB/m), Cable Loss (dB), Preamp Factor (dB), Ant Pos (cm), Table Pos (deg), Peak Avg. (P/A), Pol. (H/V). Rows include test results for 802.11ac VHT80 CH 42 5210MHz and a Remark section.



UNII 1 5150~5250MHz
WIFI 802.11ac VHT80 ANT 1+2 (Harmonic @ 3m)

Table with 14 columns: WIFI Ant. 1+2, Note, Frequency (MHz), Level (dBµV/m), Over Limit (dB), Limit Line (dBµV/m), Read Level (dBµV), Antenna Factor (dB/m), Cable Loss (dB), Preamp Factor (dB), Ant Pos (cm), Table Pos (deg), Peak Avg. (P/A), Pol. (H/V). Rows include test results for 802.11ac VHT80 CH 42 5210MHz and a Remark section.



UNII 2A - 5250~5350MHz

WIFI 802.11a ANT 1 (Band Edge @ 3m)

WIFI	Note	Frequency	Level	Over	Limit	Read	Antenna	Cable	Preamp	Ant	Table	Peak	Pol.
Ant.				Limit	Line	Level	Factor	Loss	Factor	Pos	Pos	Avg.	
1		( MHz )	( dBμV/m )	( dB )	( dBμV/m )	(dBμV)	( dB/m )	( dB )	( dB )	( cm )	( deg )	(P/A)	(H/V)
802.11a CH 64 5320MHz		5350.6	55.7	-18.3	74	40.25	34.7	11.43	30.68	100	152	P	H
		5351.3	46.26	-7.74	54	30.81	34.7	11.43	30.68	100	152	A	H
	*	5320	101.57	-	-	86.15	34.7	11.39	30.67	100	152	P	H
		5320	94.05	-	-	78.63	34.7	11.39	30.67	100	152	A	H
		5370.3	56.01	-17.99	74	40.55	34.7	11.45	30.69	326	292	P	V
		5352.3	45.94	-8.06	54	30.49	34.7	11.43	30.68	326	292	A	V
	*	5320	98.59	-	-	83.17	34.7	11.39	30.67	326	292	P	V
		5320	91.53	-	-	76.11	34.7	11.39	30.67	326	292	A	V
Remark	1. No other spurious found. 2. All results are PASS against Peak and Average limit line.												



UNII 2A 5250~5350MHz

WIFI 802.11a ANT 1 (Harmonic @ 3m)

WIFI Ant. 1	Note	Frequency ( MHz )	Level ( dBμV/m )	Over Limit ( dB )	Limit Line ( dBμV/m )	Read Level (dBμV)	Antenna Factor ( dB/m )	Cable Loss ( dB )	Preamp Factor ( dB )	Ant Pos ( cm )	Table Pos ( deg )	Peak Avg. (P/A)	Pol. (H/V)
802.11a CH 52		10518.52	43.84	-24.46	68.3	50.42	37.71	16.36	60.65	300	0	P	H
5260MHz		10518.52	44.36	-23.94	68.3	50.94	37.71	16.36	60.65	300	0	P	V
802.11a CH 60		10600.01	44.01	-29.99	74	50.47	37.74	16.43	60.63	300	0	P	H
5300MHz		10600.01	44.26	-29.74	74	50.72	37.74	16.43	60.63	300	0	P	V
802.11a CH 64		10638.63	43.42	-30.58	74	49.83	37.76	16.45	60.62	300	0	P	H
5320MHz		10638.63	43.74	-30.26	74	50.15	37.76	16.45	60.62	300	0	P	V
<b>Remark</b>	1. No other spurious found. 2. All results are PASS against Peak and Average limit line.												





UNII 2A 5250~5350MHz
WIFI 802.11a ANT 2 (Band Edge @ 3m)

Table with 14 columns: WIFI Ant. 2, Note, Frequency (MHz), Level (dBµV/m), Over Limit (dB), Limit Line (dBµV/m), Read Level (dBµV), Antenna Factor (dB/m), Cable Loss (dB), Preamp Factor (dB), Ant Pos (cm), Table Pos (deg), Peak Avg. (P/A), Pol. (H/V). Rows include test data for 802.11a CH 64 5320MHz and a Remark section.



**UNII 2A 5250~5350MHz**  
**WIFI 802.11a ANT 2 (Harmonic @ 3m)**

WIFI Ant. 2	Note	Frequency ( MHz )	Level ( dBμV/m )	Over Limit ( dB )	Limit Line ( dBμV/m )	Read Level (dBμV)	Antenna Factor ( dB/m )	Cable Loss ( dB )	Preamp Factor ( dB )	Ant Pos ( cm )	Table Pos ( deg )	Peak Avg. (P/A)	Pol. (H/V)
802.11a CH 52 5260MHz		10518.52	44.62	-23.68	68.3	51.2	37.71	16.36	60.65	300	0	P	H
		10518.52	47.85	-20.45	68.3	54.43	37.71	16.36	60.65	300	0	P	V
802.11a CH 60 5300MHz		10600.01	44.59	-29.41	74	51.05	37.74	16.43	60.63	300	0	P	H
		10600.01	48.31	-25.69	74	54.77	37.74	16.43	60.63	300	0	P	V
802.11a CH 64 5320MHz		10638.63	45.04	-28.96	74	51.45	37.76	16.45	60.62	300	0	P	H
		10638.63	47.41	-26.59	74	53.82	37.76	16.45	60.62	300	0	P	V
<b>Remark</b>	1. No other spurious found. 2. All results are PASS against Peak and Average limit line.												



UNII 2A 5250~5350MHz
WIFI 802.11n HT20 ANT 1+2 (Band Edge @ 3m)

Table with 14 columns: WIFI Ant. 1+2, Note, Frequency (MHz), Level (dBµV/m), Over Limit (dB), Limit Line (dBµV/m), Read Level (dBµV), Antenna Factor (dB/m), Cable Loss (dB), Preamp Factor (dB), Ant Pos (cm), Table Pos (deg), Peak Avg. (P/A), Pol. (H/V). Rows include test results for 802.11n HT20 CH 64 5320MHz and a Remark section.



UNII 2A 5250~5350MHz

WIFI 802.11n HT20 ANT 1+2 (Harmonic @ 3m)

WIFI Ant. 1+2	Note	Frequency ( MHz )	Level ( dBμV/m )	Over Limit ( dB )	Limit Line ( dBμV/m )	Read Level (dBμV)	Antenna Factor ( dB/m )	Cable Loss ( dB )	Preamp Factor ( dB )	Ant Pos ( cm )	Table Pos ( deg )	Peak Avg. (P/A)	Pol. (H/V)
802.11n HT20 CH 52 5260MHz		10520	44.53	-23.77	68.3	51.11	37.71	16.36	60.65	300	0	P	H
802.11n HT20 CH 60 5300MHz		10600	45.04	-28.96	74	51.5	37.74	16.43	60.63	300	0	P	H
802.11n HT20 CH 64 5320MHz		10600	50.08	-23.92	74	56.54	37.74	16.43	60.63	300	0	P	V
802.11n HT20 CH 64 5320MHz		10640	44.29	-29.71	74	50.7	37.76	16.45	60.62	300	0	P	H
802.11n HT20 CH 64 5320MHz		10640	48.17	-25.83	74	54.58	37.76	16.45	60.62	300	0	P	V
<b>Remark</b>	1. No other spurious found. 2. All results are PASS against Peak and Average limit line.												



UNII 2A 5250~5350MHz
WIFI 802.11n HT40 ANT 1+2 (Band Edge @ 3m)

Table with 14 columns: WIFI Ant. 1+2, Note, Frequency (MHz), Level (dBµV/m), Over Limit (dB), Limit Line (dBµV/m), Read Level (dBµV), Antenna Factor (dB/m), Cable Loss (dB), Preamp Factor (dB), Ant Pos (cm), Table Pos (deg), Peak Avg. (P/A), Pol. (H/V). Rows include test results for 802.11n HT40 CH 62 5310MHz and a Remark section.



UNII 2A 5250~5350MHz

WIFI 802.11n HT40 ANT 1+2(Harmonic @ 3m)

WIFI Ant. 1+2	Note	Frequency ( MHz )	Level ( dBμV/m )	Over Limit ( dB )	Limit Line ( dBμV/m )	Read Level (dBμV)	Antenna Factor ( dB/m )	Cable Loss ( dB )	Preamp Factor ( dB )	Ant Pos ( cm )	Table Pos ( deg )	Peak Avg. (P/A)	Pol. (H/V)
802.11n HT40 CH 54 5270MHz		10538.54	43.54	-24.76	68.3	50.09	37.71	16.38	60.64	300	0	P	H
802.11n HT40 CH 62 5310MHz		10618.62	45.01	-28.99	74	51.44	37.75	16.44	60.62	100	360	P	H
		10538.54	45.29	-23.01	68.3	51.84	37.71	16.38	60.64	300	0	P	V
		10618.62	44.81	-29.19	74	51.24	37.75	16.44	60.62	100	360	P	V
<b>Remark</b>	1. No other spurious found. 2. All results are PASS against Peak and Average limit line.												



UNII 2A 5250~5350MHz

WIFI 802.11ac VHT80 ANT 1+2 (Band Edge @ 3m)

WIFI Ant. 1+2	Note	Frequency ( MHz )	Level ( dBμV/m )	Over Limit ( dB )	Limit Line ( dBμV/m )	Read Level (dBμV)	Antenna Factor ( dB/m )	Cable Loss ( dB )	Preamp Factor ( dB )	Ant Pos ( cm )	Table Pos ( deg )	Peak Avg. (P/A)	Pol. (H/V)
802.11ac VHT80 CH 58 5290MHz		5122.88	55.71	-18.29	74	40.53	34.6	11.18	30.6	100	245	P	H
		5140	47.33	-6.67	54	32.12	34.62	11.2	30.61	100	245	A	H
	*	5290	93.95	-	-	78.55	34.7	11.36	30.66	100	245	P	H
		5290	86	-	-	70.6	34.7	11.36	30.66	100	245	A	H
		5367.3	57.59	-16.41	74	42.13	34.7	11.45	30.69	100	245	P	H
		5350.3	50.53	-3.47	54	35.08	34.7	11.43	30.68	100	245	A	H
		5111.84	56.61	-17.39	74	41.47	34.58	11.16	30.6	301	295	P	V
		5108.64	47.12	-6.88	54	31.98	34.58	11.16	30.6	301	295	A	V
	*	5284	90.81	-	-	75.4	34.7	11.36	30.65	301	295	P	V
		5284	83.71	-	-	68.3	34.7	11.36	30.65	301	295	A	V
		5368.2	56.31	-17.69	74	40.85	34.7	11.45	30.69	301	295	P	V
		5356	47.63	-6.37	54	32.18	34.7	11.43	30.68	301	295	A	V
Remark	1. No other spurious found. 2. All results are PASS against Peak and Average limit line.												



UNII 2A 5250~5350MHz

WIFI 802.11ac VHT80 ANT 1+2 (Harmonic @ 3m)

WIFI Ant. 1+2	Note	Frequency ( MHz )	Level ( dBμV/m )	Over Limit ( dB )	Limit Line ( dBμV/m )	Read Level (dBμV)	Antenna Factor ( dB/m )	Cable Loss ( dB )	Preamp Factor ( dB )	Ant Pos ( cm )	Table Pos ( deg )	Peak Avg. (P/A)	Pol. (H/V)
802.11ac VHT80		10578.58	44.08	-24.22	68.3	50.58	37.73	16.4	60.63	100	360	P	H
CH 58 5290MHz		10578.58	44.14	-24.16	68.3	50.64	37.73	16.4	60.63	100	360	P	V
<b>Remark</b>	1. No other spurious found. 2. All results are PASS against Peak and Average limit line.												





UNII 2C - 5470~5725MHz

WIFI 802.11a ANT 1 (Band Edge @ 3m)

WIFI	Note	Frequency	Level	Over	Limit	Read	Antenna	Cable	Preamp	Ant	Table	Peak	Pol.
Ant.				Limit	Line	Level	Factor	Loss	Factor	Pos	Pos	Avg.	
1		( MHz )	( dBμV/m )	( dB )	( dBμV/m )	( dBμV )	( dB/m )	( dB )	( dB )	( cm )	( deg )	( P/A )	( H/V )
802.11a CH 100 5500MHz		5394.32	55.82	-18.18	74	40.34	34.7	11.47	30.69	100	171	P	H
		5463.6	54.88	-13.42	68.3	39.35	34.7	11.55	30.72	100	171	P	H
		5455.28	46.25	-7.75	54	30.73	34.7	11.53	30.71	100	171	A	H
	*	5500	100.21	-	-	84.66	34.7	11.58	30.73	100	171	P	H
		5500	93.27	-	-	77.72	34.7	11.58	30.73	100	171	A	H
		5443.92	55.25	-18.75	74	39.74	34.7	11.52	30.71	378	292	P	V
		5469.52	55.48	-12.82	68.3	39.95	34.7	11.55	30.72	378	292	P	V
		5458.16	46.17	-7.83	54	30.66	34.7	11.53	30.72	378	292	A	V
	*	5500	96.18	-	-	80.63	34.7	11.58	30.73	378	292	P	V
	5500	88.57	-	-	73.02	34.7	11.58	30.73	378	292	A	V	
802.11a CH 140 5700MHz		5761.24	56.43	-11.87	68.3	40.19	35.19	11.89	30.84	100	172	P	H
	*	5704	100	-	-	83.96	35.03	11.82	30.81	100	172	P	H
		5704	92.22	-	-	76.18	35.03	11.82	30.81	100	172	A	H
		5761.64	56.78	-11.52	68.3	40.54	35.19	11.89	30.84	388	292	P	V
	*	5704	93.99	-	-	77.95	35.03	11.82	30.81	388	292	P	V
	5704	86.9	-	-	70.86	35.03	11.82	30.81	388	292	A	V	
<b>Remark</b>	1. No other spurious found. 2. All results are PASS against Peak and Average limit line.												



**UNII 2C - 5470~5725MHz**  
**WIFI 802.11a ANT 1 (Harmonic @ 3m)**

WIFI Ant. 1	Note	Frequency ( MHz )	Level ( dBμV/m )	Over Limit ( dB )	Limit Line ( dBμV/m )	Read Level (dBμV)	Antenna Factor ( dB/m )	Cable Loss ( dB )	Preamp Factor ( dB )	Ant Pos ( cm )	Table Pos ( deg )	Peak Avg. (P/A)	Pol. (H/V)
802.11a CH 100		10999	42.77	-31.23	74	48.7	37.9	16.71	60.54	300	0	P	H
		10999	44.27	-29.73	74	50.2	37.9	16.71	60.54	300	0	P	V
802.11a CH 116		11159.16	44.73	-29.27	74	50.4	38	16.83	60.5	300	0	P	H
		11159.16	43.47	-30.53	74	49.14	38	16.83	60.5	300	0	P	V
802.11a CH 140		11399.39	44.01	-29.99	74	49.31	38.14	17.01	60.45	300	0	P	H
		11399.39	44.98	-29.02	74	50.28	38.14	17.01	60.45	300	0	P	V
<b>Remark</b>	1. No other spurious found. 2. All results are PASS against Peak and Average limit line.												



**UNII 2C - 5470~5725MHz**  
**WIFI 802.11a ANT 2 (Band Edge @ 3m)**

WIFI Ant. 2	Note	Frequency ( MHz )	Level ( dBμV/m )	Over Limit ( dB )	Limit Line ( dBμV/m )	Read Level ( dBμV )	Antenna Factor ( dB/m )	Cable Loss ( dB )	Preamp Factor ( dB )	Ant Pos ( cm )	Table Pos ( deg )	Peak Avg. ( P/A )	Pol. ( H/V )
802.11a CH 100 5500MHz		5450.48	56.49	-17.51	74	40.97	34.7	11.53	30.71	100	186	P	H
		5468.24	55.77	-12.53	68.3	40.24	34.7	11.55	30.72	100	186	P	H
		5460	46.11	-7.89	54	30.6	34.7	11.53	30.72	100	186	A	H
	*	5500	102.06	-	-	86.51	34.7	11.58	30.73	100	186	P	H
		5500	94.78	-	-	79.23	34.7	11.58	30.73	100	186	A	H
		5356.4	55.07	-18.93	74	39.62	34.7	11.43	30.68	388	299	P	V
		5463.12	54.92	-13.38	68.3	39.39	34.7	11.55	30.72	388	299	P	V
		5460	45.67	-8.33	54	30.16	34.7	11.53	30.72	388	299	A	V
	*	5500	97.3	-	-	81.75	34.7	11.58	30.73	388	299	P	V
		5500	89.84	-	-	74.29	34.7	11.58	30.73	388	299	A	V
802.11a CH 140 5700MHz		5737.56	60.7	-7.6	68.3	44.51	35.14	11.87	30.82	118	183	P	H
	*	5698	105.31	-	-	89.35	34.97	11.79	30.8	118	183	P	H
		5698	98.19	-	-	82.23	34.97	11.79	30.8	118	183	A	H
		5738.44	57.05	-11.25	68.3	40.86	35.14	11.87	30.82	321	270	P	V
	*	5698	99.56	-	-	83.6	34.97	11.79	30.8	321	270	P	V
		5698	92.26	-	-	76.3	34.97	11.79	30.8	321	270	A	V
<b>Remark</b>	1. No other spurious found. 2. All results are PASS against Peak and Average limit line.												



**UNII 2C - 5470~5725MHz**  
**WIFI 802.11a ANT 2 (Harmonic @ 3m)**

WIFI Ant. 2	Note	Frequency ( MHz )	Level ( dBμV/m )	Over Limit ( dB )	Limit Line ( dBμV/m )	Read Level (dBμV)	Antenna Factor ( dB/m )	Cable Loss ( dB )	Preamp Factor ( dB )	Ant Pos ( cm )	Table Pos ( deg )	Peak Avg. (P/A)	Pol. (H/V)
802.11a CH 100		10999	43.67	-30.33	74	49.6	37.9	16.71	60.54	300	0	P	H
5500MHz		10999	44.56	-29.44	74	50.49	37.9	16.71	60.54	300	0	P	V
802.11a CH 116		11159.16	44.04	-29.96	74	49.71	38	16.83	60.5	300	0	P	H
5580MHz		11159.16	45.61	-28.39	74	51.28	38	16.83	60.5	300	0	P	V
802.11a CH 140		11399.39	44.37	-29.63	74	49.67	38.14	17.01	60.45	300	0	P	H
5700MHz		11399.39	47.83	-26.17	74	53.13	38.14	17.01	60.45	300	0	P	V
<b>Remark</b>	1. No other spurious found. 2. All results are PASS against Peak and Average limit line.												



UNII 2C - 5470~5725MHz

WIFI 802.11n HT20 ANT 1+2 (Band Edge @ 3m)

WIFI Ant. 1+2	Note	Frequency ( MHz )	Level ( dBμV/m )	Over Limit ( dB )	Limit Line ( dBμV/m )	Read Level (dBμV)	Antenna Factor ( dB/m )	Cable Loss ( dB )	Preamp Factor ( dB )	Ant Pos ( cm )	Table Pos ( deg )	Peak Avg. (P/A)	Pol. (H/V)
802.11n HT20 CH 100 5500MHz		5452.56	56.18	-17.82	74	40.66	34.7	11.53	30.71	102	186	P	H
		5462.64	57.14	-11.16	68.3	41.61	34.7	11.55	30.72	102	186	P	H
		5459.98	46.39	-7.61	54	30.88	34.7	11.53	30.72	102	186	A	H
	*	5494	105.16	-	-	89.63	34.7	11.56	30.73	102	186	P	H
		5494	98.2	-	-	82.67	34.7	11.56	30.73	102	186	A	H
		5353.68	55.73	-18.27	74	40.28	34.7	11.43	30.68	367	298	P	V
		5463.6	55.55	-12.75	68.3	40.02	34.7	11.55	30.72	367	298	P	V
		5458.8	45.77	-8.23	54	30.26	34.7	11.53	30.72	367	298	A	V
	*	5500	99.55	-	-	84	34.7	11.58	30.73	367	298	P	V
	5500	92.37	-	-	76.82	34.7	11.58	30.73	367	298	A	V	
802.11n HT20 CH 140 5700MHz		5725	61.54	-6.76	68.3	45.44	35.08	11.84	30.82	100	185	P	H
	*	5698	106.5	-	-	90.54	34.97	11.79	30.8	100	185	P	H
		5698	100.06	-	-	84.1	34.97	11.79	30.8	100	185	A	H
		5725.56	56.77	-11.53	68.3	40.67	35.08	11.84	30.82	321	256	P	V
	*	5698	100.82	-	-	84.86	34.97	11.79	30.8	321	256	P	V
	5698	94.53	-	-	78.57	34.97	11.79	30.8	321	256	A	V	
Remark	1. No other spurious found. 2. All results are PASS against Peak and Average limit line.												



UNII 2C - 5470~5725MHz

WIFI 802.11n HT20 ANT 1+2 (Harmonic @ 3m)

WIFI Ant. 1+2	Note	Frequency ( MHz )	Level ( dBμV/m )	Over Limit ( dB )	Limit Line ( dBμV/m )	Read Level (dBμV)	Antenna Factor ( dB/m )	Cable Loss ( dB )	Preamp Factor ( dB )	Ant Pos ( cm )	Table Pos ( deg )	Peak Avg. (P/A)	Pol. (H/V)
802.11n HT20 CH 100		10999	44.06	-29.94	74	49.99	37.9	16.71	60.54	300	0	P	H
5500MHz		10999	47.3	-26.7	74	53.23	37.9	16.71	60.54	300	0	P	V
802.11n HT20 CH 116		11159.16	44.22	-29.78	74	49.89	38	16.83	60.5	300	0	P	H
5580MHz		11159.16	48.11	-25.89	74	53.78	38	16.83	60.5	300	0	P	V
802.11n HT20 CH 140		11399.39	44.64	-29.36	74	49.94	38.14	17.01	60.45	300	0	P	H
5700MHz		11399.39	47.57	-26.43	74	52.87	38.14	17.01	60.45	300	0	P	V
Remark	1. No other spurious found. 2. All results are PASS against Peak and Average limit line.												



UNII 2C - 5470~5725MHz

WIFI 802.11n HT40 ANT 1+2 (Band Edge @ 3m)

WIFI Ant. 1+2	Note	Frequency ( MHz )	Level ( dBμV/m )	Over Limit ( dB )	Limit Line ( dBμV/m )	Read Level ( dBμV )	Antenna Factor ( dB/m )	Cable Loss ( dB )	Preamp Factor ( dB )	Ant Pos ( cm )	Table Pos ( deg )	Peak Avg. ( P/A )	Pol. ( H/V )
802.11n HT40 CH 102 5510MHz		5459.44	60.69	-13.31	74	45.18	34.7	11.53	30.72	100	185	P	H
		5468.08	63.66	-4.64	68.3	48.13	34.7	11.55	30.72	100	185	P	H
		5459.92	50.36	-3.64	54	34.85	34.7	11.53	30.72	100	185	A	H
	*	5512	102.2	-	-	86.65	34.7	11.58	30.73	100	185	P	H
		5512	94.33	-	-	78.78	34.7	11.58	30.73	100	185	A	H
		5734.44	57.19	-11.11	68.3	41.09	35.08	11.84	30.82	100	185	P	H
		5379.76	55.14	-18.86	74	39.66	34.7	11.47	30.69	291	252	P	V
		5469.84	56.66	-11.64	68.3	41.13	34.7	11.55	30.72	291	252	P	V
		5459.28	46.65	-7.35	54	31.14	34.7	11.53	30.72	291	252	A	V
	*	5512	95.97	-	-	80.42	34.7	11.58	30.73	291	252	P	V
		5512	87.79	-	-	72.24	34.7	11.58	30.73	291	252	A	V
		5735.48	56.62	-11.68	68.3	40.43	35.14	11.87	30.82	291	252	P	V
802.11n HT40 CH 134 5670MHz		5447.44	56.4	-17.6	74	40.88	34.7	11.53	30.71	100	185	P	H
		5465.04	56.01	-12.29	68.3	40.48	34.7	11.55	30.72	100	185	P	H
		5446.96	47.74	-6.26	54	32.22	34.7	11.53	30.71	100	185	A	H
	*	5668	103.43	-	-	87.53	34.92	11.77	30.79	100	185	P	H
		5668	96.04	-	-	80.14	34.92	11.77	30.79	100	185	A	H
		5733.88	56.75	-11.55	68.3	40.65	35.08	11.84	30.82	100	185	P	H
		5447.92	55.79	-18.21	74	40.27	34.7	11.53	30.71	365	328	P	V
		5462.32	54.65	-13.65	68.3	39.14	34.7	11.53	30.72	365	328	P	V
		5435.76	46.08	-7.92	54	30.56	34.7	11.52	30.7	365	328	A	V
	*	5668	94.9	-	-	79	34.92	11.77	30.79	365	328	P	V
	5668	87.87	-	-	71.97	34.92	11.77	30.79	365	328	A	V	
	5741.8	56.54	-11.76	68.3	40.36	35.14	11.87	30.83	365	328	P	V	
Remark	<ol style="list-style-type: none"> <li>No other spurious found.</li> <li>All results are PASS against Peak and Average limit line.</li> </ol>												



UNII 2C - 5470~5725MHz

WIFI 802.11n HT40 ANT 1+2 (Harmonic @ 3m)

WIFI Ant. 1+2	Note	Frequency ( MHz )	Level ( dBμV/m )	Over Limit ( dB )	Limit Line ( dBμV/m )	Read Level ( dBμV )	Antenna Factor ( dB/m )	Cable Loss ( dB )	Preamp Factor ( dB )	Ant Pos ( cm )	Table Pos ( deg )	Peak Avg. ( P/A )	Pol. ( H/V )
802.11n HT40 CH 102 5510MHz		11019.02	44.12	-29.88	74	50.03	37.91	16.72	60.54	100	360	P	H
802.11n HT40 CH 110 5550MHz		11099.1	43.47	-30.53	74	49.25	37.96	16.78	60.52	300	0	P	H
802.11n HT40 CH 134 5670MHz		11339.33	44.77	-29.23	74	50.18	38.1	16.96	60.47	300	0	P	H
802.11n HT40 CH 102 5510MHz		11019.02	43.25	-30.75	74	49.16	37.91	16.72	60.54	100	360	P	V
802.11n HT40 CH 110 5550MHz		11099.1	43.67	-30.33	74	49.45	37.96	16.78	60.52	300	0	P	V
802.11n HT40 CH 134 5670MHz		11339.33	44.61	-29.39	74	50.02	38.1	16.96	60.47	300	0	P	V
Remark	1. No other spurious found. 2. All results are PASS against Peak and Average limit line.												





UNII 2C - 5470~5725MHz

WIFI 802.11ac VHT80 ANT 1+2 (Band Edge @ 3m)

WIFI Ant. 1+2	Note	Frequency ( MHz )	Level ( dBμV/m )	Over Limit ( dB )	Limit Line ( dBμV/m )	Read Level (dBμV)	Antenna Factor ( dB/m )	Cable Loss ( dB )	Preamp Factor ( dB )	Ant Pos ( cm )	Table Pos ( deg )	Peak Avg. (P/A)	Pol. (H/V)
802.11ac VHT80 CH 106 5530MHz		5451.28	60.09	-13.91	74	44.57	34.7	11.53	30.71	100	184	P	H
		5467.6	61.18	-7.12	68.3	45.65	34.7	11.55	30.72	100	184	P	H
		5450.48	50.86	-3.14	54	35.34	34.7	11.53	30.71	100	184	A	H
	*	5524	95.7	-	-	80.14	34.7	11.6	30.74	100	184	P	H
		5524	87.95	-	-	72.39	34.7	11.6	30.74	100	184	A	H
		5729.88	56.17	-12.13	68.3	40.07	35.08	11.84	30.82	100	184	P	H
		5459.12	57.21	-16.79	74	41.7	34.7	11.53	30.72	100	292	P	V
		5464.56	57.15	-11.15	68.3	41.62	34.7	11.55	30.72	100	292	P	V
		5460	47.73	-6.27	54	32.22	34.7	11.53	30.72	100	292	A	V
	*	5518	89.73	-	-	74.17	34.7	11.6	30.74	100	292	P	V
		5518	82.11	-	-	66.55	34.7	11.6	30.74	100	292	A	V
		5727.16	56.38	-11.92	68.3	40.28	35.08	11.84	30.82	100	292	P	V
Remark	1. No other spurious found. 2. All results are PASS against Peak and Average limit line.												



UNII 2C 5470~5725MHz

WIFI 802.11ac VHT80 ANT 1+2 (Harmonic @ 3m)

WIFI Ant. 1+2	Note	Frequency ( MHz )	Level ( dBμV/m )	Over Limit ( dB )	Limit Line ( dBμV/m )	Read Level (dBμV)	Antenna Factor ( dB/m )	Cable Loss ( dB )	Preamp Factor ( dB )	Ant Pos ( cm )	Table Pos ( deg )	Peak Avg. (P/A)	Pol. (H/V)
802.11ac VHT80		11059.05	43.72	-30.28	74	49.55	37.94	16.76	60.53	300	0	P	H
CH 106 5530MHz		11059.05	44.27	-29.73	74	50.1	37.94	16.76	60.53	300	0	P	V
<b>Remark</b>	1. No other spurious found. 2. All results are PASS against Peak and Average limit line.												



802.11ac VHT(80M+80M)

WIFI 802.11ac VHT(80M+80M)CH42+CH106 (Band Edge @ 3m)

WIFI	Note	Frequency	Level	Over	Limit	Read	Antenna	Cable	Preamp	Ant	Table	Peak	Pol.
Ant.				Limit	Line	Level	Factor	Loss	Factor	Pos	Pos	Avg.	
1+2		( MHz )	( dBμV/m )	( dB )	( dBμV/m )	( dBμV )	( dB/m )	( dB )	( dB )	( cm )	( deg )	( P/A )	( H/V )
802.11ac VHT(80M+80M) CH 42 5210MHz		5132.48	56.75	-17.25	74	41.57	34.6	11.18	30.6	100	299	P	H
		5138.56	47.92	-6.08	54	32.75	34.6	11.18	30.61	100	299	A	H
		5212	92.21	-	-	76.86	34.7	11.28	30.63	100	299	P	H
	*	5212	83.66	-	-	68.31	34.7	11.28	30.63	100	299	A	H
		5380.2	55.29	-18.71	74	39.81	34.7	11.47	30.69	100	299	P	H
		5351.04	46.22	-7.78	54	30.77	34.7	11.43	30.68	100	299	A	H
		5139.04	56.53	-17.47	74	41.36	34.6	11.18	30.61	100	121	P	V
		5146.24	48.02	-5.98	54	32.81	34.62	11.2	30.61	100	121	A	V
		5212	90.09	-	-	74.74	34.7	11.28	30.63	100	121	P	V
	*	5212	82.87	-	-	67.52	34.7	11.28	30.63	100	121	A	V
		5397.12	54.45	-19.55	74	38.95	34.7	11.49	30.69	100	121	P	V
		5391.54	46.34	-7.66	54	30.86	34.7	11.47	30.69	100	121	A	V
802.11ac VHT(80M+80M) CH 106 5530MHz		5459.44	58.09	-15.91	74	42.58	34.7	11.53	30.72	100	187	P	H
	*	5468.72	58.86	-9.44	68.3	43.33	34.7	11.55	30.72	100	187	P	H
		5454	50.46	-3.54	54	34.94	34.7	11.53	30.71	100	187	A	H
		5536	93.22	-	-	77.65	34.7	11.61	30.74	100	187	P	H
		5536	85.46	-	-	69.89	34.7	11.61	30.74	100	187	A	H
		5757.72	56.1	-12.2	68.3	39.85	35.19	11.89	30.83	100	187	P	H
		5429.68	55.7	-18.3	74	40.18	34.7	11.52	30.7	305	270	P	V
	*	5460.72	54.94	-13.36	68.3	39.43	34.7	11.53	30.72	305	270	P	V
		5459.92	47.13	-6.87	54	31.62	34.7	11.53	30.72	305	270	A	V
		5536	88.53	-	-	72.96	34.7	11.61	30.74	305	270	P	V
		5536	80.58	-	-	65.01	34.7	11.61	30.74	305	270	A	V
		5757.96	56.02	-12.28	68.3	39.77	35.19	11.89	30.83	305	270	P	V
<b>Remark</b>	1. No other spurious found. 2. All results are PASS against Peak and Average limit line.												



WIFI 802.11ac VHT(80M+80M)

WIFI 802.11ac VHT(80M+80M)CH42+CH106 (Harmonic @ 3m)

WIFI Ant. 1+2	Note	Frequency ( MHz )	Level ( dBμV/m )	Over Limit ( dB )	Limit Line ( dBμV/m )	Read Level (dBμV)	Antenna Factor ( dB/m )	Cable Loss ( dB )	Preamp Factor ( dB )	Ant Pos ( cm )	Table Pos ( deg )	Peak Avg. (P/A)	Pol. (H/V)
802.11ac VHT(80M+80M) CH 42 5210MHz		10418.42	43.59	-24.71	68.3	50.34	37.63	16.29	60.67	300	0	P	H
		10420	43.39	-24.91	68.3	50.14	37.63	16.29	60.67	300	0	P	V
802.11ac VHT(80M+80M) CH 106 5530MHz		11060	43.58	-30.42	74	49.41	37.94	16.76	60.53	300	0	P	H
		11059.05	43.43	-30.57	74	49.26	37.94	16.76	60.53	300	0	P	V
<b>Remark</b>	<ol style="list-style-type: none"> <li>No other spurious found.</li> <li>All results are PASS against Peak and Average limit line.</li> </ol>												



WIFI 802.11ac VHT(80M+80M)CH42+CH155 (Band Edge @ 3m)

WIFI Ant. 1	Note	Frequency ( MHz )	Level ( dBμV/m )	Over Limit ( dB )	Limit Line ( dBμV/m )	Read Level (dBμV)	Antenna Factor ( dB/m )	Cable Loss ( dB )	Preamp Factor ( dB )	Ant Pos ( cm )	Table Pos ( deg )	Peak Avg. (P/A)	Pol. (H/V)
802.11ac VHT(80M+80M) CH 42 5210MHz		5147.84	59.53	-14.47	74	44.32	34.62	11.2	30.61	100	298	P	H
		5148.32	50.38	-3.62	54	35.17	34.62	11.2	30.61	100	298	A	H
		5218	92.9	-	-	77.55	34.7	11.28	30.63	100	298	P	H
	*	5218	85.43	-	-	70.08	34.7	11.28	30.63	100	298	A	H
		5393.88	56.16	-17.84	74	40.68	34.7	11.47	30.69	100	298	P	H
		5351.76	46.3	-7.7	54	30.85	34.7	11.43	30.68	100	298	A	H
		5141.44	57.87	-16.13	74	42.66	34.62	11.2	30.61	100	120	P	V
		5146.56	49.15	-4.85	54	33.94	34.62	11.2	30.61	100	120	A	V
		5218	91.82	-	-	76.47	34.7	11.28	30.63	100	120	P	V
	*	5218	84.35	-	-	69	34.7	11.28	30.63	100	120	A	V
		5351.4	55.54	-18.46	74	40.09	34.7	11.43	30.68	100	120	P	V
		5376.78	46.2	-7.8	54	30.74	34.7	11.45	30.69	100	120	A	V



WiFi Ant. 1+2	Note	Frequency ( MHz )	Level ( dBµV/m )	Over Limit ( dB )	Limit Line ( dBµV/m )	Read Level ( dBµV )	Antenna Factor ( dB/m )	Path Loss ( dB )	Preamp Factor ( dB )	Ant Pos ( cm )	Table Pos ( deg )	Peak Avg. ( P/A )	Pol. ( H/V )
802.11ac VHT(80M+80M) CH 155 5775MHz		5640.4	56.03	-12.27	68.3	40.27	34.81	11.72	30.77	100	186	P	H
		5691.6	65.8	-33.31	99.11	49.84	34.97	11.79	30.8	100	186	P	H
		5708.4	66.9	-40.75	107.65	50.86	35.03	11.82	30.81	100	186	P	H
		5720.8	68.64	-44.08	112.72	52.53	35.08	11.84	30.81	100	186	P	H
		5854.4	62.22	-50.05	112.27	45.74	35.37	11.98	30.87	100	186	P	H
		5871.2	61.79	-44.57	106.36	45.3	35.38	11.99	30.88	100	186	P	H
		5877.2	59.4	-44.27	103.67	42.92	35.38	11.99	30.89	100	186	P	H
		5957.2	56.77	-11.53	68.3	40.17	35.47	12.04	30.91	100	186	P	H
		5770	98.25	-	-	81.92	35.25	11.92	30.84	100	186	P	H
		5770	90.13	-	-	73.8	35.25	11.92	30.84	100	186	A	H
		5649.6	56.29	-12.01	68.3	40.47	34.86	11.74	30.78	330	271	P	V
		5696.8	57.9	-45.04	102.94	41.94	34.97	11.79	30.8	330	271	P	V
		5716.8	60.01	-50	110.01	43.97	35.03	11.82	30.81	330	271	P	V
		5720.8	60.64	-52.08	112.72	44.53	35.08	11.84	30.81	330	271	P	V
		5854	55.83	-57.35	113.18	39.35	35.37	11.98	30.87	330	271	P	V
		5868.8	58.06	-48.97	107.03	41.59	35.37	11.98	30.88	330	271	P	V
		5910.8	56.31	-22.47	78.78	39.77	35.42	12.01	30.89	330	271	P	V
		5976.8	56.79	-11.51	68.3	40.18	35.48	12.05	30.92	330	271	P	V
		5764	91.97	-	-	75.73	35.19	11.89	30.84	330	271	P	V
	5764	83.71	-	-	67.47	35.19	11.89	30.84	330	271	A	V	
<b>Remark</b>	1. No other spurious found. 2. All results are PASS against Peak and Average limit line.												



WIFI 802.11ac VHT(80M+80M)

WIFI 802.11ac VHT(80M+80M)CH42+CH155 (Harmonic @ 3m)

WIFI Ant. 1+2	Note	Frequency ( MHz )	Level ( dBμV/m )	Over Limit ( dB )	Limit Line ( dBμV/m )	Read Level (dBμV)	Antenna Factor ( dB/m )	Cable Loss ( dB )	Preamp Factor ( dB )	Ant Pos ( cm )	Table Pos ( deg )	Peak Avg. (P/A)	Pol. (H/V)
802.11ac VHT(80M+80M)		10418.42	43.45	-24.85	68.3	50.2	37.63	16.29	60.67	300	0	P	H
CH 42 5210MHz		10420	43.4	-24.9	68.3	50.15	37.63	16.29	60.67	300	0	P	V
802.11ac VHT(80M+80M)		11550	44.33	-29.67	74	49.33	38.27	17.12	60.39	300	0	P	H
CH 155 5775MHz		11549.54	43.89	-30.11	74	48.89	38.27	17.12	60.39	300	0	P	V
<b>Remark</b>	<ol style="list-style-type: none"> <li>No other spurious found.</li> <li>All results are PASS against Peak and Average limit line.</li> </ol>												



WIFI 802.11ac VHT(80M+80M)CH42+CH58 (Band Edge @ 3m)

WIFI Ant. 1	Note	Frequency ( MHz )	Level ( dBμV/m )	Over Limit ( dB )	Limit Line ( dBμV/m )	Read Level (dBμV)	Antenna Factor ( dB/m )	Cable Loss ( dB )	Preamp Factor ( dB )	Ant Pos ( cm )	Table Pos ( deg )	Peak Avg. (P/A)	Pol. (H/V)
802.11ac VHT(80M+80M) CH 42 5210MHz		5148.32	58.68	-15.32	74	43.47	34.62	11.2	30.61	100	298	P	H
		5148.64	50.28	-3.72	54	35.07	34.62	11.2	30.61	100	298	A	H
		5218	93.23	-	-	77.88	34.7	11.28	30.63	100	298	P	H
	*	5218	85.4	-	-	70.05	34.7	11.28	30.63	100	298	A	H
		5356.44	56.32	-17.68	74	40.87	34.7	11.43	30.68	100	298	P	H
		5391.18	46.82	-7.18	54	31.34	34.7	11.47	30.69	100	298	A	H
		5141.76	57.42	-16.58	74	42.21	34.62	11.2	30.61	100	122	P	V
		5149.76	49.79	-4.21	54	34.58	34.62	11.2	30.61	100	122	A	V
		5194	91.28	-	-	75.95	34.7	11.26	30.63	100	122	P	V
	*	5194	84.07	-	-	68.74	34.7	11.26	30.63	100	122	A	V
		5389.92	55.56	-18.44	74	40.08	34.7	11.47	30.69	100	122	P	V
		5395.86	46.62	-7.38	54	31.12	34.7	11.49	30.69	100	122	A	V
802.11ac VHT(80M+80M) CH 58 5290MHz		5141.92	57.18	-16.82	74	41.97	34.62	11.2	30.61	100	167	P	H
	*	5140.96	48.89	-5.11	54	33.68	34.62	11.2	30.61	100	167	A	H
		5296	89.81	-	-	74.39	34.7	11.38	30.66	100	167	P	H
		5296	81.66	-	-	66.24	34.7	11.38	30.66	100	167	A	H
		5356.1	58.78	-15.22	74	43.33	34.7	11.43	30.68	100	167	P	H
		5355.6	50.28	-3.72	54	34.83	34.7	11.43	30.68	100	167	A	H
		5138.24	56.45	-17.55	74	41.28	34.6	11.18	30.61	373	293	P	V
	*	5146.08	47.88	-6.12	54	32.67	34.62	11.2	30.61	373	293	A	V
		5314	89.59	-	-	74.17	34.7	11.39	30.67	373	293	P	V
		5314	82.37	-	-	66.95	34.7	11.39	30.67	373	293	A	V
	5352.5	56.4	-17.6	74	40.95	34.7	11.43	30.68	373	293	P	V	
	5350.1	48.65	-5.35	54	33.2	34.7	11.43	30.68	373	293	A	V	
Remark	1. \\Ks2filesrv\Documentation\报告\2021\Q3\151309_共进_N02012No other spurious found. 2. All results are PASS against Peak and Average limit line.												





WIFI 802.11ac VHT(80M+80M)

WIFI 802.11ac VHT(80M+80M)CH42+CH58 (Harmonic @ 3m)

WIFI Ant. 1+2	Note	Frequency ( MHz )	Level ( dBμV/m )	Over Limit ( dB )	Limit Line ( dBμV/m )	Read Level (dBμV)	Antenna Factor ( dB/m )	Cable Loss ( dB )	Preamp Factor ( dB )	Ant Pos ( cm )	Table Pos ( deg )	Peak Avg. (P/A)	Pol. (H/V)
802.11ac VHT(80M+80M)		10418.42	43.36	-24.94	68.3	50.11	37.63	16.29	60.67	300	0	P	H
CH 42 5210MHz		10420	43.63	-24.67	68.3	50.38	37.63	16.29	60.67	300	0	P	V
802.11ac VHT(80M+80M)		10580	43.73	-24.57	68.3	50.22	37.73	16.41	60.63	300	0	P	H
CH 58 5290MHz		10578.58	44.16	-24.14	68.3	50.66	37.73	16.4	60.63	300	0	P	V
<b>Remark</b>	1. No other spurious found. 2. All results are PASS against Peak and Average limit line.												



Emission below 1GHz

WIFI 802. 11ac(80)\_Tx\_Ch106 (LF @ 3m)

WIFI Ant. 1+2	Note	Frequency ( MHz )	Level ( dBμV/m )	Over Limit ( dB )	Limit Line ( dBμV/m )	Read Level (dBμV)	Antenna Factor ( dB/m )	Cable Loss ( dB )	Preamp Factor ( dB )	Ant Pos ( cm )	Table Pos ( deg )	Peak Avg. (P/A)	Pol. (H/V)
802. 11ac(80) LF		75.59	19.9	-20.1	40	37.85	13.64	1.31	32.9	-	-	P	H
		112.45	27.92	-15.58	43.5	41.25	17.95	1.6	32.88	-	-	P	H
		173.56	35.32	-8.18	43.5	49.32	16.94	2	32.94	200	360	P	H
		307.42	30.71	-15.29	46	40.56	20.38	2.67	32.9	-	-	P	H
		434.49	29.42	-16.58	46	35.65	23.32	3.18	32.73	-	-	P	H
		831.22	28.88	-17.12	46	29.95	27.09	4.4	32.56	-	-	P	H
		38.73	31.56	-8.44	40	42.95	20.5	0.89	32.78	-	-	P	V
		56.19	32.64	-7.36	40	50.66	14.04	1.12	33.18	100	360	P	V
		75.59	30.05	-9.95	40	48	13.64	1.31	32.9	-	-	P	V
		124.09	24.42	-19.08	43.5	37.77	17.81	1.69	32.85	-	-	P	V
		172.59	34.49	-9.01	43.5	48.47	16.96	2	32.94	-	-	P	V
		827.34	31.72	-14.28	46	32.82	27.06	4.39	32.55	-	-	P	V
Remark	1. No other spurious found. 2. All results are PASS against limit line.												



Co-Location

802.11a\_CH36 ANT2 + 802.11g\_CH01 ANT1  
(Band Edge @ 3m)

WIFI Ant.	Note	Frequency ( MHz )	Level ( dBμV/m )	Over Limit ( dB )	Limit Line ( dBμV/m )	Read Level ( dBμV )	Antenna Factor ( dB/m )	Cable Loss ( dB )	Preamp Factor ( dB )	Ant Pos ( cm )	Table Pos ( deg )	Peak Avg. ( P/A )	Pol. ( H/V )
802.11a CH 36 5180MHz		5148.48	59.42	-14.58	74	45.43	34.62	11.6	32.23	114	244	P	H
		5149.92	48.75	-5.25	54	34.76	34.62	11.6	32.23	114	244	A	H
	*	5176	102.59	-	-	88.53	34.67	11.63	32.24	114	244	P	H
		5176	95.54	-	-	81.48	34.67	11.63	32.24	114	244	A	H
		5149.76	59.25	-14.75	74	45.26	34.62	11.6	32.23	332	292	P	V
		5149.98	48.25	-5.75	54	34.26	34.62	11.6	32.23	332	292	A	V
	*	5182	102.4	-	-	88.34	34.67	11.63	32.24	332	292	P	V
		5182	94.24	-	-	80.18	34.67	11.63	32.24	332	292	A	V
802.11g CH 01 2412MHz		2389.56	59.2	-14.8	74	53.99	32.2	7.72	34.71	382	222	P	H
		2389.95	47.54	-6.46	54	42.33	32.2	7.72	34.71	382	222	A	H
	*	2412	104.99	-	-	99.74	32.18	7.75	34.68	382	222	P	H
	*	2410	97.12	-	-	91.9	32.18	7.75	34.71	382	222	A	H
		2389.95	57.02	-16.98	74	51.81	32.2	7.72	34.71	343	163	P	V
		2389.95	46.19	-7.81	54	40.98	32.2	7.72	34.71	343	163	A	V
	*	2410	104.52	-	-	99.3	32.18	7.75	34.71	343	163	P	V
	*	2410	96.77	-	-	91.55	32.18	7.75	34.71	343	163	A	V
Remark	1. No other spurious found. 2. All results are PASS against Peak and Average limit line.												



802.11a\_CH36 ANT2 + 802.11g\_CH01 ANT1

(Harmonic @ 3m)

WIFI Ant. 1	Note	Frequency ( MHz )	Level ( dBμV/m )	Over Limit ( dB )	Limit Line ( dBμV/m )	Read Level (dBμV)	Antenna Factor ( dB/m )	Cable Loss ( dB )	Preamp Factor ( dB )	Ant Pos ( cm )	Table Pos ( deg )	Peak Avg. (P/A)	Pol. (H/V)
802.11a CH 36 5180MHz		10358.36	43.66	-24.64	68.3	49.83	37.58	16.93	60.68	300	0	P	H
		10358.36	45.01	-23.29	68.3	51.18	37.58	16.93	60.68	300	0	P	V
802.11b CH 01 2412MHz		4824	42.28	-31.72	74	56.8	34.31	11.21	60.04	300	0	P	H
		4824	42.4	-31.6	74	56.92	34.31	11.21	60.04	300	360	P	V
Remark	1. No other spurious found. 2. All results are PASS against Peak and Average limit line.												



**802.11ac80\_CH106 MIMO + BT5.0\_CH39**  
**(Band Edge @ 3m)**

WIFI Ant. 1	Note	Frequency ( MHz )	Level ( dBμV/m )	Over Limit ( dB )	Limit Line ( dBμV/m )	Read Level (dBμV)	Antenna Factor ( dB/m )	Cable Loss ( dB )	Preamp Factor ( dB )	Ant Pos ( cm )	Table Pos ( deg )	Peak Avg. (P/A)	Pol. (H/V)
802.11ac VHT80 CH 106 5530MHz		5455.28	57.04	-16.96	74	41.52	34.7	11.53	30.71	100	191	P	H
		5468.88	56.69	-11.61	68.3	41.16	34.7	11.55	30.72	100	191	A	H
	*	5457.36	48.56	-5.44	54	33.05	34.7	11.53	30.72	100	191	P	H
		5536	89.81	-	-	74.24	34.7	11.61	30.74	100	191	A	H
		5536	82.45	-	-	66.88	34.7	11.61	30.74	100	191	P	H
		5735.16	56.16	-12.14	68.3	39.97	35.14	11.87	30.82	100	191	A	H
		5373.84	55.38	-18.62	74	39.92	34.7	11.45	30.69	323	271	P	V
		5466	55.39	-12.91	68.3	39.86	34.7	11.55	30.72	323	271	A	V
	*	5459.76	46.82	-7.18	54	31.31	34.7	11.53	30.72	323	271	P	V
		5536	86.44	-	-	70.87	34.7	11.61	30.74	323	271	A	V
		5536	79.02	-	-	63.45	34.7	11.61	30.74	323	271	P	V
	5733.64	57.47	-10.83	68.3	41.37	35.08	11.84	30.82	323	271	A	V	
BLE CH 39 2480MHz		2491.12	56.33	-17.67	74	48.05	32.1	7.76	31.58	117	245	P	H
		2486.8	46.98	-7.02	54	38.71	32.12	7.73	31.58	117	245	A	H
	*	2480	80.99	-	-	72.72	32.12	7.73	31.58	117	245	P	H
	*	2480	79.28	-	-	71.01	32.12	7.73	31.58	117	245	A	H
		2496.28	56.31	-17.69	74	48.01	32.1	7.76	31.56	375	154	P	V
		2486.14	47.09	-6.91	54	38.82	32.12	7.73	31.58	375	154	A	V
	*	2480	82.76	-	-	74.49	32.12	7.73	31.58	375	154	P	V
	*	2480	81.01	-	-	72.74	32.12	7.73	31.58	375	154	A	V
Remark	1. No other spurious found. 2. All results are PASS against Peak and Average limit line.												



802.11ac80\_CH106 MIMO + BT5.0\_CH39  
(Harmonic @ 3m)

WIFI Ant. 1	Note	Frequency ( MHz )	Level ( dBμV/m )	Over Limit ( dB )	Limit Line ( dBμV/m )	Read Level (dBμV)	Antenna Factor ( dB/m )	Cable Loss ( dB )	Preamp Factor ( dB )	Ant Pos ( cm )	Table Pos ( deg )	Peak Avg. (P/A)	Pol. (H/V)
802.11ac VHT80 CH 106 5530MHz		11059.05	42.94	-31.06	74	48.77	37.94	16.76	60.53	300	0	P	H
		11059.05	43.36	-30.64	74	49.19	37.94	16.76	60.53	300	0	P	V
BLE CH 39 2480MHz		4962	52.53	-21.47	74	67.14	34.38	11.02	60.01	100	70	P	H
		4962	47.86	-6.14	54	62.47	34.38	11.02	60.01	100	70	A	H
		7440	42.18	-31.82	74	53.23	35.91	13.58	60.54	300	0	P	H
		4962	49.97	-24.03	74	64.58	34.38	11.02	60.01	300	0	P	V
		7440	41.72	-32.28	74	52.77	35.91	13.58	60.54	300	0	P	V
Remark	1. No other spurious found. 2. All results are PASS against Peak and Average limit line.												



**Note symbol**

*	<b>Fundamental Frequency</b> which can be ignored. However, the level of any unwanted emissions shall not exceed the level of the fundamental frequency.
!	Test result is <b>over limit</b> line.
P/A	<b>Peak</b> or <b>Average</b>
H/V	<b>Horizontal</b> or <b>Vertical</b>



A calculation example for radiated spurious emission is shown as below:

WIFI	Note	Frequency	Level	Over	Limit	Read	Antenna	Cable	Preamp	Ant	Table	Peak	Pol.
Ant.				Limit	Line	Level	Factor	Loss	Factor	Pos	Pos	Avg.	
1		( MHz )	( dBμV/m )	( dB )	( dBμV/m )	( dBμV )	( dB/m )	( dB )	( dB )	( cm )	( deg )	( P/A )	( H/V )
802.11b		2390	55.45	-18.55	74	54.51	32.22	4.58	35.86	103	308	P	H
CH 01													
2412MHz		2390	43.54	-10.46	54	42.6	32.22	4.58	35.86	103	308	A	H

- Level(dBμV/m) =  
Antenna Factor(dB/m) + Cable Loss(dB) + Read Level(dBμV) - Preamp Factor(dB)
- Over Limit(dB) = Level(dBμV/m) – Limit Line(dBμV/m)

**For Peak Limit @ 2390MHz:**

- Level(dBμV/m)  
= Antenna Factor(dB/m) + Cable Loss(dB) + Read Level(dBμV) - Preamp Factor(dB)  
= 32.22(dB/m) + 4.58(dB) + 54.51(dBμV) – 35.86 (dB)  
= 55.45 (dBμV/m)
- Over Limit(dB)  
= Level(dBμV/m) – Limit Line(dBμV/m)  
= 55.45(dBμV/m) – 74(dBμV/m)  
= -18.55(dB)

**For Average Limit @ 2390MHz:**

- Level(dBμV/m)  
= Antenna Factor(dB/m) + Cable Loss(dB) + Read Level(dBμV) - Preamp Factor(dB)  
= 32.22(dB/m) + 4.58(dB) + 42.6(dBμV) – 35.86 (dB)  
= 43.54 (dBμV/m)
- Over Limit(dB)  
= Level(dBμV/m) – Limit Line(dBμV/m)  
= 43.54(dBμV/m) – 54(dBμV/m)  
= -10.46(dB)

Both peak and average measured complies with the limit line, so test result is “PASS”.





## Appendix D. Duty Cycle Plots

Antenna	Band	Duty Cycle(%)	T(ms)	1/T(kHz)	VBW Setting
1	802.11a	98.10	-	-	10Hz
2	802.11a	98.33	-	-	10Hz
1+2	802.11n HT20	98.21	-	-	10Hz
1+2	802.11n HT40	96.34	0.948	1.055	1.1KHZ
1+2	802.11ac VHT80	92.40	0.462	2.165	2.2KHZ
1+2	802.11ac VHT80 + VHT80	86.52	0.231	4.329	4.7KHZ



< Ant.1>

802.11a

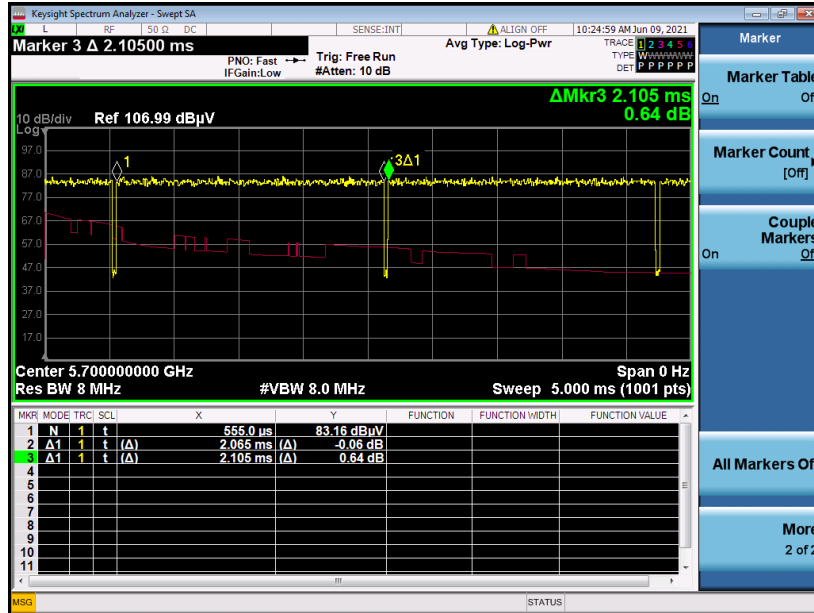

< Ant.2>

802.11a





<MIMO Ant.1+2>

802.11n HT20

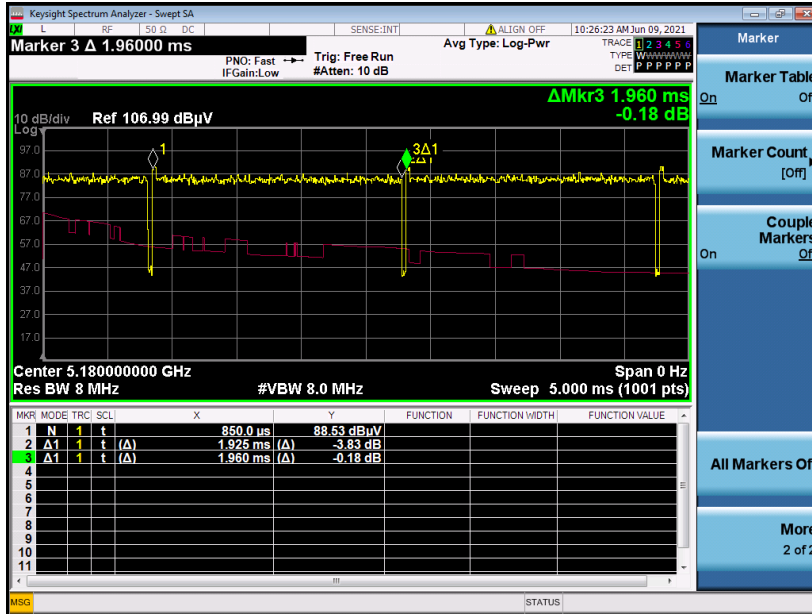

802.11n HT40

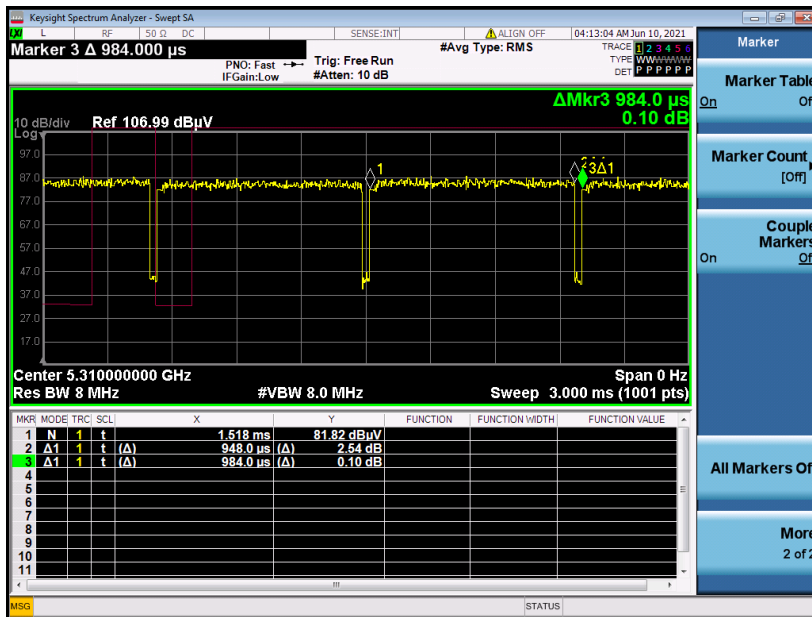



802.11ac VHT80

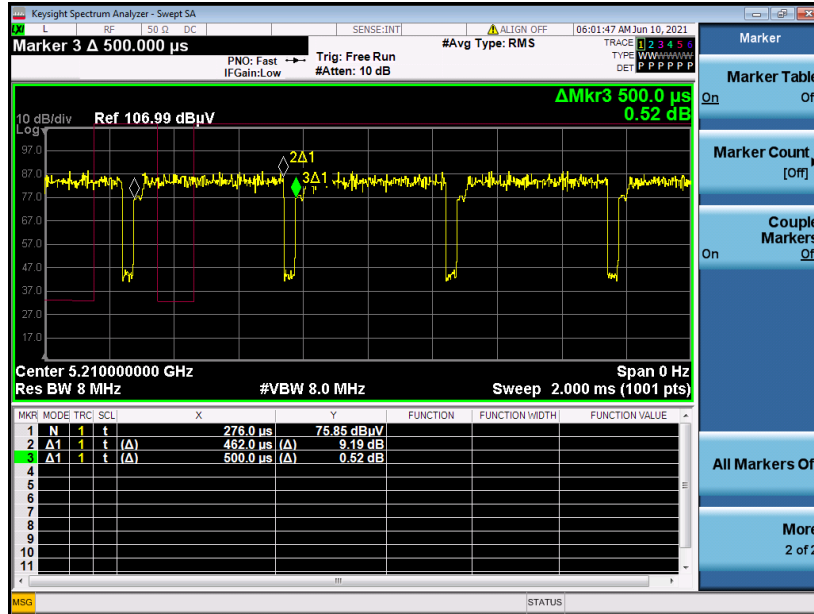

802.11ac VHT80 + VHT80

