



Report No.: TW2206057-03E

File reference No.: 2022-06-21

Applicant: Shenzhen Jingwah Information Technology Co., Ltd.

Product: Tablet PC

Model No.: ST8888, ST8888D, ST8888 CA, ST8888DPK, ST8888DBL

Trademark: Smartab

Test Standards: FCC Part 15.247

Test result: It is herewith confirmed and found to comply with the requirements set up by ANSI C63.10, FCC Part 15.247 for the evaluation of electromagnetic compatibility

Approved By

A handwritten signature in black ink that reads "Terry Tang".

Terry Tang

Manager

Dated: June 21, 2022

Results appearing herein relate only to the sample tested

The technical reports is issued errors and omissions exempt and is subject to withdrawal at

SHENZHEN TIMEWAY TESTING LABORATORIES

Zone C, 1st Floor, Block B, Jun Xiang Da Building, Zhongshan Park Road West, Tong Le Village, Nanshan District, Shenzhen, China

Tel (755) 83448688, Fax (755) 83442996, E-Mail:info@timeway-lab.com

TEST REPORT



Special Statement:

The testing quality ability of our laboratory meet with “Quality Law of People’s Republic of China” Clause 19.

The testing quality system of our laboratory meet with ISO/IEC-17025 requirements, which is approved by CNAL. This approval result is accepted by MRA of APLAC.

Our test facility is recognized, certified, or accredited by the following organizations:

CNAL-LAB Code: L2292

The EMC Laboratory has been assessed and in compliance with CNAL/AC01:2002 accreditation criteria for testing Laboratories (identical to ISO/IEC 17025:2017 General Requirements) for the Competence of testing Laboratories.

FCC-Registration No.: 744189

The EMC Laboratory has been registered and fully described in a report filed with the (FCC) Federal Communications commission. The acceptance letter from the FCC is maintained in our files. Registration No.: 744189.

Industry Canada (IC) —Registration No.:5205A

The EMC Laboratory has been registered by Certification and Engineering Bureau of Industry Canada for radio equipment testing with Registration No.: 5205A.

A2LA (Certification Number:5013.01)

The EMC Laboratory has been accredited by the American Association for Laboratory Accreditation (A2LA). Certification Number:5013.01

The report refers only to the sample tested and does not apply to the bulk.

This report is issued in confidence to the client and it will be strictly treated as such by the SHENZHEN TIMEWAY TESTING LABORATORIES. It may not be reproduced rather in its entirety or in part and it may not be used for adverting. The client to whom the report is issued may, however, show or send it . or a certified copy there of prepared by the SHENZHEN TIMEWAY TESTING LABORATORIES. to his customer. Supplier or others persons directly concerned. SHENZHEN TIMEWAY TESTING LABORATORIES. will not, without the consent of the client enter into any discussion of correspondence with any third party concerning the contents of the report.

In the event of the improper use of the report. The SHENZHEN TIMEWAY TESTING LABORATORIES. reserves the rights to withdraw it and to adopt any other remedies which may be appropriate.



Test Report Conclusion

Content

1.0	General Details	4
1.1	Test Lab Details.....	4
1.2	Applicant Details.....	4
1.3	Description of EUT	4
1.4	Submitted Sample.....	5
1.5	Test Duration.....	5
1.6	Test Uncertainty.....	5
1.7	Test By.....	5
2.0	List of Measurement Equipment	6
3.0	Technical Details	8
3.1	Summary of Test Results.....	8
3.2	Test Standards.....	8
4.0	EUT Modification	8
5.0	Power Line Conducted Emission Test	9
5.1	Schematics of the Test.....	9
5.2	Test Method and Test Procedure.....	9
5.3	Configuration of the EUT.....	9
5.4	EUT Operating Condition	10
5.5	Conducted Emission Limit	10
5.6	Test Result	10
6.0	Radiated Emission test	13
6.1	Test Method and Test Procedure.....	13
6.2	Configuration of the EUT.....	14
6.3	EUT Operation Condition.....	14
6.4	Radiated Emission Limit.....	14
7.0	6dB Bandwidth Measurement.....	24
8.0	Maximum Output Power.....	44
9.0	Power Spectral Density Measurement.....	47
10.0	Out of Band Measurement.....	35
11.0	Antenna Requirement.....	83
12.0	FCC ID Label.....	84
13.0	Photo of Test Setup and EUT View.....	85

The report refers only to the sample tested and does not apply to the bulk.

This report is issued in confidence to the client and it will be strictly treated as such by the SHENZHEN TIMEWAY TESTING LABORATORIES. It may not be reproduced rather in its entirety or in part and it may not be used for advertising. The client to whom the report is issued may, however, show or send it . or a certified copy there of prepared by the SHENZHEN TIMEWAY TESTING LABORATORIES. to his customer. Supplier or others persons directly concerned. SHENZHEN TIMEWAY TESTING LABORATORIES. will not, without the consent of the client enter into any discussion of correspondence with any third party concerning the contents of the report.

In the event of the improper use of the report. The SHENZHEN TIMEWAY TESTING LABORATORIES. reserves the rights to withdraw it and to adopt any other remedies which may be appropriate.



1.0 General Details

1.1 Test Lab Details

Name: SHENZHEN TIMEWAY TESTING LABORATORIES.
Address: Zone C, 1st Floor, Block B, Jun Xiang Da Building, Zhongshan Park Road West, Tong Le Village, Nanshan District, Shenzhen, China
Telephone: (755) 83448688
Fax: (755) 83442996
Site Listed with Federal Communications commission (FCC)
Registration Number:744189
For 3m Anechoic Chamber
Site Listed with Industry Canada of Ottawa, Canada
Registration Number: IC: 5205A
For 3m Anechoic Chamber

1.2 Applicant Details

Applicant: Shenzhen Jingwah Information Technology Co., Ltd.
Address: 6F, Bldg.4, Jinghua Square, No. 168, Zhenzhong Rd., Fuqiang Community, Huaqiangbei, Futian District, Shenzhen
Telephone: --
Fax: --

1.3 Description of EUT

Product: Tablet PC
Manufacturer: Shenzhen Jingwah Information Technology Co., Ltd.
Address: 6F, Bldg.4, Jinghua Square, No. 168, Zhenzhong Rd., Fuqiang Community, Huaqiangbei, Futian District, Shenzhen
Trademark: Smartab
Model Number: ST8888
Additional Model Number: ST8888D, ST8888 CA, ST8888DPK, ST8888DBL
Hardware Version: A863K-68T5F
Software Version: ST8888_V01_22061721
Serial No.: ST8888202205000001
Rating: Input: DC5V, 2A
Battery: DC3.7V, 3500mAh Li-ion battery
Power Supply: Model: TPA-46050200UU
Input: 100-240V~, 50/60Hz, 0.3A; Output: 5V, 2.0A
Type of Modulation IEEE 802.11b: DSSS (CCK, QPSK, DBPSK)
IEEE 802.11g/n (HT20, HT40): OFDM (64QAM, 16QAM, QPSK, BPSK)
Frequency range IEEE 802.11b/g/n (HT20): 2412-2462MHz;

The report refers only to the sample tested and does not apply to the bulk.

This report is issued in confidence to the client and it will be strictly treated as such by the SHENZHEN TIMEWAY TESTING LABORATORIES. It may not be reproduced rather in its entirety or in part and it may not be used for advertising. The client to whom the report is issued may, however, show or send it or a certified copy thereof prepared by the SHENZHEN TIMEWAY TESTING LABORATORIES to his customer. Supplier or others persons directly concerned. SHENZHEN TIMEWAY TESTING LABORATORIES will not, without the consent of the client enter into any discussion of correspondence with any third party concerning the contents of the report.

In the event of the improper use of the report. The SHENZHEN TIMEWAY TESTING LABORATORIES reserves the rights to withdraw it and to adopt any other remedies which may be appropriate.



Channel Spacing IEEE 802.11n HT40: 2422-2452MHz
5MHz for IEEE 802.11b/g/n (HT20, HT40)
Air Data Rate IEEE 802.11b: 11, 5.5, 2, 1 Mbps
IEEE 802.11g: 54, 48, 36, 24, 18, 12, 9, 6 Mbps
IEEE 802.11n HT20/HT40: mcs0-mcs7
Frequency Selection By software
Channel Number IEEE 802.11b/g/n (HT20): 11 Channels;
IEEE 802.11n (HT40): 7 Channels;
Antenna: FPC Antenna. The gain of the antennas is 1.42dBi (Get from the antenna specification)

1.4 Submitted Sample: 2 Samples

1.5 Test Duration
2022-06-07 to 2022-06-20

1.6 Test Uncertainty
Conducted Emissions Uncertainty =3.6dB
Radiated Emissions below 1GHz Uncertainty =4.7dB
Radiated Emissions above 1GHz Uncertainty =6.0dB
Conducted Power Uncertainty =6.0dB
Occupied Channel Bandwidth Uncertainty =5%
Note: The measurement uncertainty is for coverage factor of k=2 and a level of confidence of 95%.

1.7 Test Engineer

The sample tested by

Print Name: Andy Xing



2.0 Test Equipment					
Instrument Type	Manufacturer	Model	Serial No.	Date of Cal.	Due Date
ESPI Test Receiver	R&S	ESPI 3	100379	2022-06-17	2023-06-16
Impuls-Begrenzer	R&S	ESH3-Z2	100281	2022-06-17	2023-06-16
Loop Antenna	EMCO	6507	00078608	2021-06-18	2024-06-17
Spectrum	R&S	FSIQ26	100292	2022-06-17	2023-06-16
Horn Antenna	A-INFO	LB-180400-KF	ANT01060660	2021-07-02	2024-07-02
Horn Antenna	R&S	BBHA 9120D	9120D-631	2021-07-02	2024-07-02
Power meter	Anritsu	ML2487A	6K00003613	2022-06-17	2023-06-16
Power sensor	Anritsu	MA2491A	32263	2022-06-17	2023-06-16
Bilog Antenna	Schwarebeck	VULB9163	9163/340	2021-07-02	2024-07-01
9*6*6 Anechoic	--	--	N/A	2021-07-02	2022-07-01
EMI Test Receiver	RS	ESVB	826156/011	2022-06-17	2023-06-16
EMI Test Receiver	RS	ESH3	860904/006	2022-06-17	2023-06-16
Spectrum	HP/Agilent	ESA-L1500A	US37451154	2022-06-17	2023-06-16
Spectrum	HP/Agilent	E4407B	MY50441392	2022-06-17	2023-06-16
Spectrum	RS	FSP	1164.4391.38	2022-01-14	2023-01-13
RF Cable	Zhengdi	ZT26-NJ-NJ-8 M/FA	--	2022-06-17	2023-06-16
RF Cable	Zhengdi	7m	--	2022-06-17	2023-06-16
RF Switch	EM	EMSW18	060391	2022-06-17	2023-06-16
Pre-Amplifier	Schwarebeck	BBV9743	#218	2022-06-17	2023-06-16
Pre-Amplifier	HP/Agilent	8449B	3008A00160	2022-06-17	2023-06-16
LISN	SCHAFFNER	NNB42	00012	2022-01-05	2023-01-04

2.2 Automation Test Software

For Conducted Emission Test

Name	Version
EZ-EMC	Ver.EMC-CON 3A1.1

For Radiated Emissions

Name	Version
EMI Test Software BL410-EV18.91	V18.905
EMI Test Software BL410-EV18.806 High Frequency	V18.06

The report refers only to the sample tested and does not apply to the bulk.

This report is issued in confidence to the client and it will be strictly treated as such by the SHENZHEN TIMEWAY TESTING LABORATORIES. It may not be reproduced rather in its entirety or in part and it may not be used for advertising. The client to whom the report is issued may, however, show or send it . or a certified copy there of prepared by the SHENZHEN TIMEWAY TESTING LABORATORIES. to his customer. Supplier or others persons directly concerned. SHENZHEN TIMEWAY TESTING LABORATORIES. will not, without the consent of the client enter into any discussion of correspondence with any third party concerning the contents of the report.

In the event of the improper use of the report. The SHENZHEN TIMEWAY TESTING LABORATORIES. reserves the rights to withdraw it and to adopt any other remedies which may be appropriate.



3. DESCRIPTION OF TEST MODES

IEEE 802.11b, 802.11g, 802.11n (HT20) mode

The EUT had been tested under operating condition. There are three channels have been tested as following:

Channel	Frequency (MHz)
Low	2412
Middle	2437
High	2462

IEEE 802.11b mode: 1Mbps data rate (worst case) was chosen for full testing. IEEE 802.11g mode: 6Mbps data rate (worst case) was chosen for full testing. IEEE 802.11n (HT20) mode: mcs0 (worst case) were chosen for full testing;

IEEE 802.11n (HT40) mode

The EUT had been tested under operating condition. There are three channels have been tested as following:

Channel	Frequency (MHz)
Low	2422
Middle	2437
High	2452

IEEE 802.11n (HT40) mode: mcs0 data rate (worst case) were chosen for full testing

Note: During the test, the duty cycle was set up to >98%

The report refers only to the sample tested and does not apply to the bulk.
This report is issued in confidence to the client and it will be strictly treated as such by the SHENZHEN TIMEWAY TESTING LABORATORIES. It may not be reproduced rather in its entirety or in part and it may not be used for advertising. The client to whom the report is issued may, however, show or send it . or a certified copy there of prepared by the SHENZHEN TIMEWAY TESTING LABORATORIES. to his customer. Supplier or others persons directly concerned. SHENZHEN TIMEWAY TESTING LABORATORIES. will not, without the consent of the client enter into any discussion of correspondence with any third party concerning the contents of the report.
In the event of the improper use of the report. The SHENZHEN TIMEWAY TESTING LABORATORIES. reserves the rights to withdraw it and to adopt any other remedies which may be appropriate.



3.0 Technical Details

3.1 Summary of test results

The EUT has been tested according to the following specifications:			
Standard	Test Type	Result	Notes
FCC Part 15, Paragraph 15.203	Antenna Requirement	Pass	Complies
FCC Part 15, Paragraph 15.207	Conducted Emission Test	Pass	Complies
FCC Part 15 Subpart C Paragraph 15.247(a)(2) Limit	Spectrum bandwidth of a Orthogonal Frequency Division Multiplex System Limit: 6dB bandwidth > 500kHz	Pass	Complies
FCC Part 15, Paragraph 15.247(b)	Maximum peak output power Limit: max. 30dBm	Pass	Complies
FCC Part 15, Paragraph 15.109, 15.205 & 15.209	Transmitter Radiated Emission Limit: Table 15.209	Pass	Complies
FCC Part 15, Paragraph 15.247(e)	Power Spectral Density Limit: max. 8dBm/3kHz	Pass	Complies
FCC Part 15, Paragraph 15.247(d)	Out of Band Emission and Restricted Band Radiation Limit: 20dB less than peak value of fundamental frequency Restricted band limit: Table 15.209	Pass	Complies

3.2 Test Standards

FCC Part 15 Subpart & Subpart C, Paragraph 15.247

4.0 EUT Modification

No modification by SHENZHEN TIMEWAY TESTING LABORATORIES.

The report refers only to the sample tested and does not apply to the bulk.

This report is issued in confidence to the client and it will be strictly treated as such by the SHENZHEN TIMEWAY TESTING LABORATORIES. It may not be reproduced in its entirety or in part and it may not be used for advertising. The client to whom the report is issued may, however, show or send it, or a certified copy thereof prepared by the SHENZHEN TIMEWAY TESTING LABORATORIES, to his customer, Supplier or other persons directly concerned. SHENZHEN TIMEWAY TESTING LABORATORIES, will not, without the consent of the client enter into any discussion of correspondence with any third party concerning the contents of the report. In the event of the improper use of the report, the SHENZHEN TIMEWAY TESTING LABORATORIES, reserves the rights to withdraw it and to adopt any other remedies which may be appropriate.



5.0 Power Line Conducted Emission Test

5.1 Schematics of the test

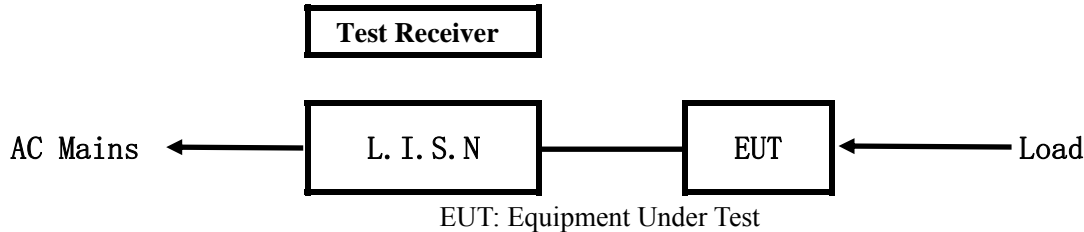

5.2 Test Method and test Procedure

The EUT was tested according to ANSI C63.10-2013. The Frequency spectrum From 0.15MHz to 30MHz was investigated. The LISN used was 50ohm/50uH as specified by section 5.1 of ANSI C63.10 –2013.

Test Voltage: 120V~, 60Hz

Block diagram of Test setup

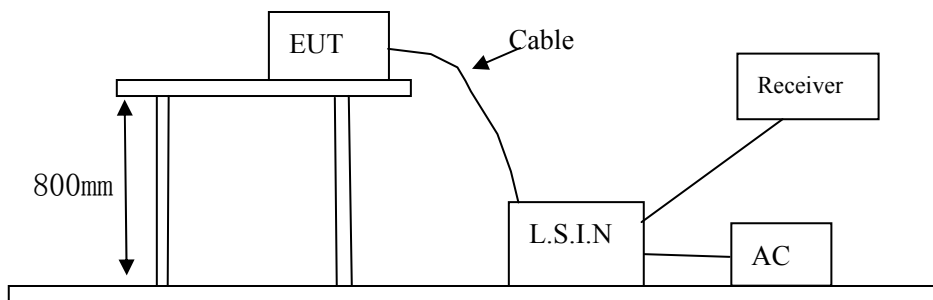

5.3 Configuration of The EUT

The EUT was configured according to ANSI C63.10-2013. All interface ports were connected to the appropriate peripherals. All peripherals and cables are listed below.

A. EUT

Device	Manufacturer	Model	FCC ID
Tablet PC	Shenzhen Jingwah Information Technology Co., Ltd.	ST8888, ST8888D, ST8888 CA, ST8888DPK, ST8888DBL	RBD-W811W

B. Internal Device

Device	Manufacturer	Model	FCC ID/DOC
N/A			

The report refers only to the sample tested and does not apply to the bulk.

This report is issued in confidence to the client and it will be strictly treated as such by the SHENZHEN TIMEWAY TESTING LABORATORIES. It may not be reproduced rather in its entirety or in part and it may not be used for advertising. The client to whom the report is issued may, however, show or send it . or a certified copy there of prepared by the SHENZHEN TIMEWAY TESTING LABORATORIES. to his customer. Supplier or others persons directly concerned. SHENZHEN TIMEWAY TESTING LABORATORIES. will not, without the consent of the client enter into any discussion of correspondence with any third party concerning the contents of the report.

In the event of the improper use of the report. The SHENZHEN TIMEWAY TESTING LABORATORIES. reserves the rights to withdraw it and to adopt any other remedies which may be appropriate.



C. Peripherals

Device	Manufacturer	Model	FCC ID/DOC	Cable
--	--	--	--	--

5.4 EUT Operating Condition

Operating condition is according to ANSI C63.10-2013.

A Setup the EUT and simulators as shown on follow

B Enable AF signal and confirm EUT active to normal condition

5.5 Power line conducted Emission Limit according to Paragraph 15.207

Frequency (MHz)	Limits (dB μ V)	
	Quasi-peak Level	Average Level
0.15 ~ 0.50	66.0~56.0*	56.0~46.0*
0.50 ~ 5.00	56.0	46.0
5.00 ~ 30.00	60.0	50.0

- Notes:
1. *Decreasing linearly with logarithm of frequency.
 2. The tighter limit shall apply at the transition frequencies

5.6 Test Results

The frequency spectrum from 0.15MHz to 30MHz was investigated. All reading are quasi-peak values with a resolution bandwidth of 9kHz.



A: Conducted Emission on Live Terminal (150kHz to 30MHz)

EUT Operating Environment

Temperature: 26°C Humidity: 65%RH Atmospheric Pressure: 101 kPa

EUT set Condition: Keep WIFI Transmitting

Results: Pass

Please refer to following diagram for individual

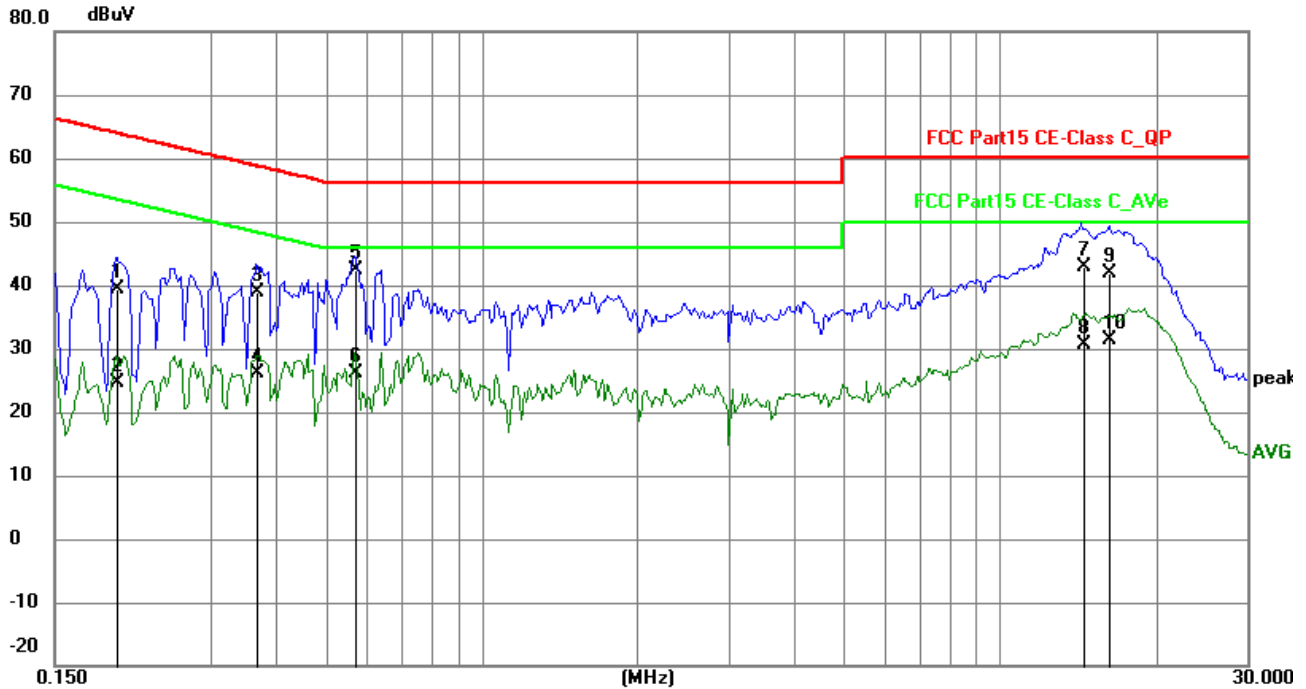

No.	Frequency (MHz)	Reading (dBuV)	Factor (dB)	Level (dBuV)	Limit (dBuV)	Margin (dB)	Detector	P/F
1	0.1986	29.69	9.75	39.44	63.67	-24.23	QP	P
2	0.1986	14.92	9.75	24.67	53.67	-29.00	AVG	P
3	0.3684	29.00	9.76	38.76	58.54	-19.78	QP	P
4	0.3684	16.37	9.76	26.13	48.54	-22.41	AVG	P
5	0.5701	32.69	9.77	42.46	56.00	-13.54	QP	P
6	0.5701	16.45	9.77	26.22	46.00	-19.78	AVG	P
7	14.4816	32.44	10.36	42.80	60.00	-17.20	QP	P
8	14.4816	20.25	10.36	30.61	50.00	-19.39	AVG	P
9	16.1399	31.36	10.45	41.81	60.00	-18.19	QP	P
10	16.1399	20.86	10.45	31.31	50.00	-18.69	AVG	P

The report refers only to the sample tested and does not apply to the bulk.

This report is issued in confidence to the client and it will be strictly treated as such by the SHENZHEN TIMEWAY TESTING LABORATORIES. It may not be reproduced rather in its entirety or in part and it may not be used for advertising. The client to whom the report is issued may, however, show or send it or a certified copy thereof prepared by the SHENZHEN TIMEWAY TESTING LABORATORIES to his customer. Supplier or others persons directly concerned. SHENZHEN TIMEWAY TESTING LABORATORIES will not, without the consent of the client enter into any discussion of correspondence with any third party concerning the contents of the report.

In the event of the improper use of the report. The SHENZHEN TIMEWAY TESTING LABORATORIES reserves the rights to withdraw it and to adopt any other remedies which may be appropriate.



B: Conducted Emission on Neutral Terminal (150kHz to 30MHz)

EUT Operating Environment

Temperature: 26°C Humidity: 65%RH Atmospheric Pressure: 101 kPa

EUT set Condition: Keep WIFI Transmitting

Results: Pass

Please refer to following diagram for individual

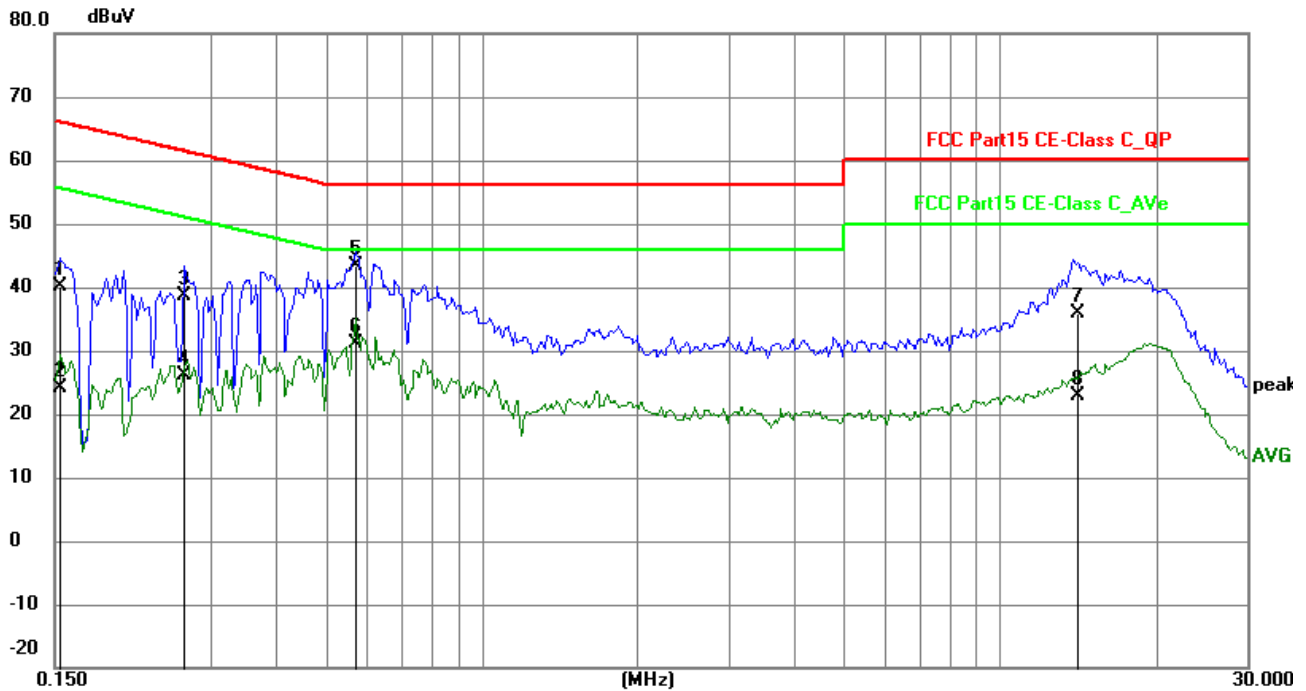

No.	Frequency (MHz)	Reading (dBuV)	Factor (dB)	Level (dBuV)	Limit (dBuV)	Margin (dB)	Detector	P/F
1	0.1539	30.32	9.78	40.10	65.79	-25.69	QP	P
2	0.1539	14.37	9.78	24.15	55.79	-31.64	AVG	P
3	0.2672	28.98	9.75	38.73	61.20	-22.47	QP	P
4	0.2672	16.37	9.75	26.12	51.20	-25.08	AVG	P
5	0.5712	33.49	9.77	43.26	56.00	-12.74	QP	P
6	0.5712	21.36	9.77	31.13	46.00	-14.87	AVG	P
7	14.0629	25.54	10.34	35.88	60.00	-24.12	QP	P
8	14.0629	12.65	10.34	22.99	50.00	-27.01	AVG	P

The report refers only to the sample tested and does not apply to the bulk.

This report is issued in confidence to the client and it will be strictly treated as such by the SHENZHEN TIMEWAY TESTING LABORATORIES. It may not be reproduced rather in its entirety or in part and it may not be used for advertising. The client to whom the report is issued may, however, show or send it, or a certified copy thereof prepared by the SHENZHEN TIMEWAY TESTING LABORATORIES, to his customer. Supplier or others persons directly concerned. SHENZHEN TIMEWAY TESTING LABORATORIES, will not, without the consent of the client enter into any discussion of correspondence with any third party concerning the contents of the report.

In the event of the improper use of the report. The SHENZHEN TIMEWAY TESTING LABORATORIES, reserves the rights to withdraw it and to adopt any other remedies which may be appropriate.



6 Radiated Emission Test

6.1 Test Method and test Procedure:

- (1) The EUT was tested according to ANSI C63.10-2013. The radiated test was performed at Timeway EMC Laboratory. This site is on file with the FCC laboratory division, Registration No. 744189
- (2) The EUT, peripherals were put on the turntable which table size is 1m x 1.5 m, table high 0.8 m. All set up is according to ANSI C63.10-2013.
- (3) The frequency spectrum from 30 MHz to 25 GHz was investigated. All readings from 30 MHz to 1 GHz are Quasi-peak values with a resolution bandwidth of 120 kHz. For measurement above 1GHz, peak values with RBW=1MHz VBW=3MHz and PK detector. AV value with RBW=1MHz, VBW=3MHz and RMS detector. Measurements were made at 3 meters.
- (4) The antenna high is varied from 1 m to 4 m high to find the maximum emission for each frequency.
- (5) Maximizing procedure was performed on the six (6) highest emissions to ensure EUT compliance is with all installation combinations. All data was recorded in the peak detection mode. Quasi-peak readings was performed only when an emission was found to be marginal (within -4 dB of specification limit), and are distinguished with a "QP" in the data table.
- (6) The antenna polarization: Vertical polarization and Horizontal polarization.

Block diagram of Test setup

For radiated emissions from 9kHz to 30MHz

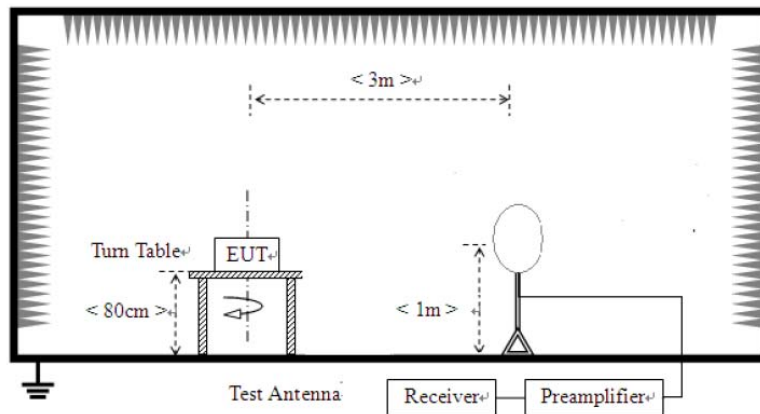

The report refers only to the sample tested and does not apply to the bulk.

This report is issued in confidence to the client and it will be strictly treated as such by the SHENZHEN TIMEWAY TESTING LABORATORIES. It may not be reproduced rather in its entirety or in part and it may not be used for advertising. The client to whom the report is issued may, however, show or send it, or a certified copy thereof prepared by the SHENZHEN TIMEWAY TESTING LABORATORIES, to his customer. Supplier or others persons directly concerned. SHENZHEN TIMEWAY TESTING LABORATORIES, will not, without the consent of the client enter into any discussion of correspondence with any third party concerning the contents of the report.

In the event of the improper use of the report. The SHENZHEN TIMEWAY TESTING LABORATORIES, reserves the rights to withdraw it and to adopt any other remedies which may be appropriate.

For radiated emissions from 30MHz to1GHz

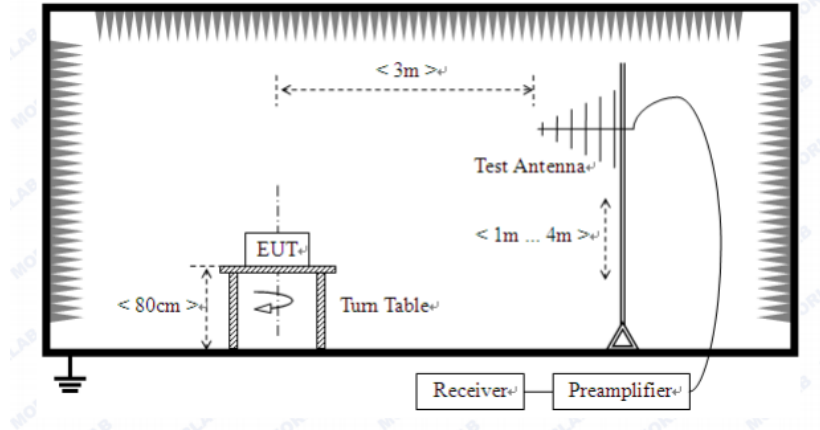

For radiated emissions above 1GHz

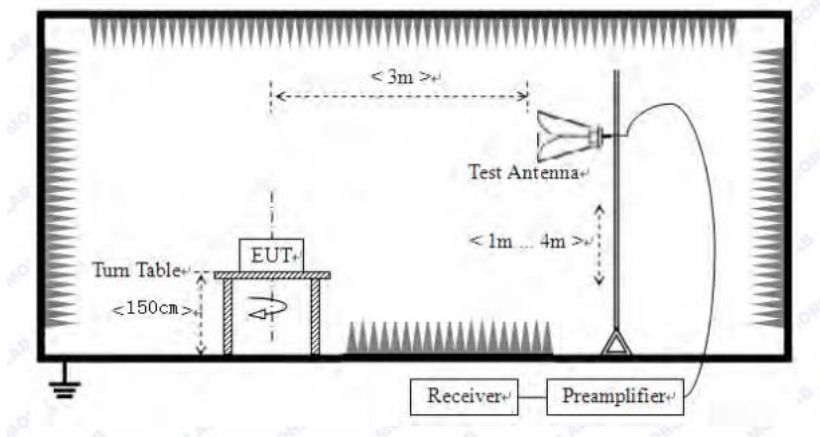

6.2 Configuration of The EUT

Same as section 5.3 of this report

6.3 EUT Operating Condition

Same as section 5.4 of this report.

6.4 Radiated Emission Limit

All emission from a digital device, including any network of conductors and apparatus connected thereto, shall not exceed the level of field strength specified below:

The report refers only to the sample tested and does not apply to the bulk.

This report is issued in confidence to the client and it will be strictly treated as such by the SHENZHEN TIMEWAY TESTING LABORATORIES. It may not be reproduced rather in its entirety or in part and it may not be used for advertising. The client to whom the report is issued may, however, show or send it . or a certified copy there of prepared by the SHENZHEN TIMEWAY TESTING LABORATORIES. to his customer. Supplier or others persons directly concerned. SHENZHEN TIMEWAY TESTING LABORATORIES. will not, without the consent of the client enter into any discussion of correspondence with any third party concerning the contents of the report.

In the event of the improper use of the report. The SHENZHEN TIMEWAY TESTING LABORATORIES. reserves the rights to withdraw it and to adopt any other remedies which may be appropriate.



Frequencies in restricted band are complied to limit on Paragraph 15.209

Frequency Range (MHz)	Distance (m)	Field strength (dB μ V/m)
0.009-0.049	3	$20\log(2400/F(\text{kHz})) + 40\log(300/3)$
0.490-1.705	3	$20\log(24000/F(\text{kHz})) + 40\log(30/3)$
1.705-30	3	69.5
30-88	3	40.0
88-216	3	43.5
216-960	3	46.0
Above 960	3	54.0

- Note:
1. RF Voltage (dBuV) = 20 log RF Voltage (uV)
 2. In the Above Table, the tighter limit applies at the band edges.
 3. Distance refers to the distance in meters between the measuring instrument antenna and the EUT
 4. This is a handheld device. The radiated emissions should be tested under 3-axes position (Lying, Side, and Stand), After pre-test. It was found that the worse radiated emission was get at the lying position.
 5. All scanning using PK detector. And the final emission level was get using QP detector for frequency range from 30-1000MHz.As to 1G-25G, the final emission level got using PK. For fundamental measurement, PK detector used.
 6. For radiated emissions from 9kHz to 30MHz, the emission level is much less than the limit for more than 20dB. No necessary to take down the record.
 7. Battery fully charged was used during tests.
 8. Worse case was recorded in the test report. 802.11g was the worst case.

The report refers only to the sample tested and does not apply to the bulk.
This report is issued in confidence to the client and it will be strictly treated as such by the SHENZHEN TIMEWAY TESTING LABORATORIES. It may not be reproduced rather in its entirety or in part and it may not be used for adverting. The client to whom the report is issued may, however, show or send it . or a certified copy there of prepared by the SHENZHEN TIMEWAY TESTING LABORATORIES. to his customer. Supplier or others persons directly concerned. SHENZHEN TIMEWAY TESTING LABORATORIES. will not, without the consent of the client enter into any discussion of correspondence with any third party concerning the contents of the report.
In the event of the improper use of the report. The SHENZHEN TIMEWAY TESTING LABORATORIES. reserves the rights to withdraw it and to adopt any other remedies which may be appropriate.



Test result

General Radiated Emission Data and Harmonics Radiated Emission Data

Radiated Emission In Horizontal (30MHz----1000MHz)

EUT set Condition: **Keep Transmitting**

Results: Pass

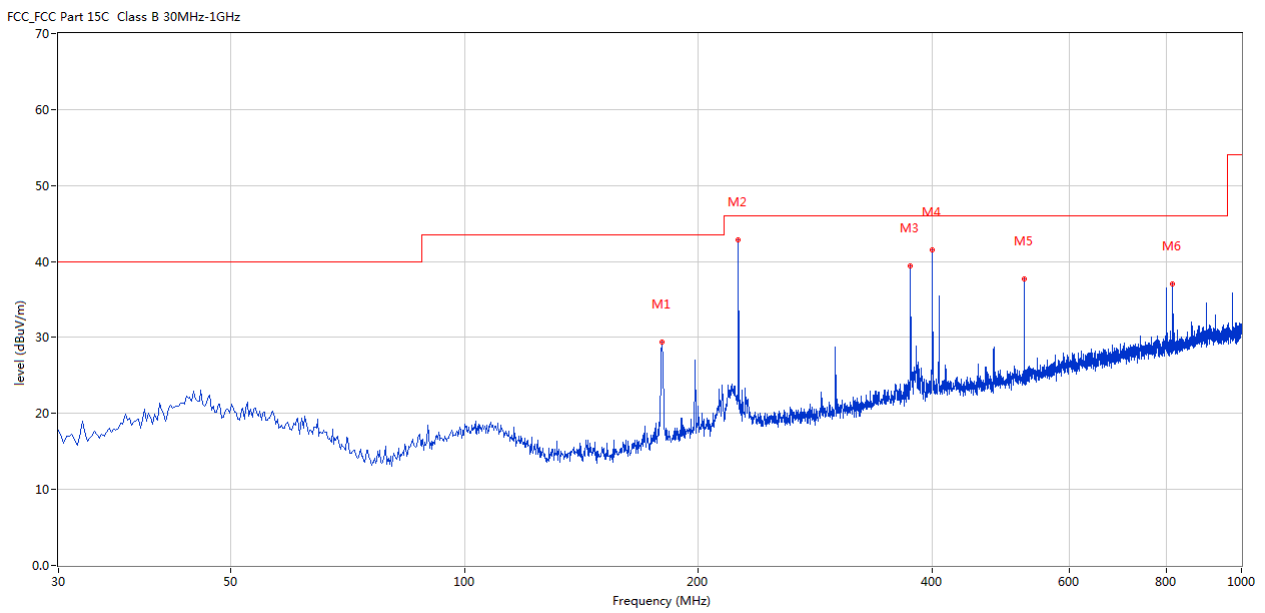

No.	Frequency (MHz)	Results (dBuV/m)	Factor (dB)	Limit (dBuV/m)	Over Limit (dB)	Detector	Table (o)	Height (cm)	ANT	Verdict
1	179.343	29.37	-15.38	43.5	-14.13	Peak	292.00	200	Horizontal	Pass
2	225.164	42.88	-12.91	46.0	-3.12	Peak	0.00	200	Horizontal	Pass
3	374.991	39.46	-9.44	46.0	-6.54	Peak	72.00	100	Horizontal	Pass
4	399.963	41.51	-8.57	46.0	-4.49	Peak	278.00	100	Horizontal	Pass
5	525.061	37.67	-6.55	46.0	-8.33	Peak	0.00	200	Horizontal	Pass
6	815.989	37.08	-2.96	46.0	-8.92	Peak	0.00	200	Horizontal	Pass

The report refers only to the sample tested and does not apply to the bulk.
 This report is issued in confidence to the client and it will be strictly treated as such by the SHENZHEN TIMEWAY TESTING LABORATORIES. It may not be reproduced rather in its entirety or in part and it may not be used for advertising. The client to whom the report is issued may, however, show or send it or a certified copy thereof prepared by the SHENZHEN TIMEWAY TESTING LABORATORIES to his customer. Supplier or others persons directly concerned. SHENZHEN TIMEWAY TESTING LABORATORIES will not, without the consent of the client enter into any discussion of correspondence with any third party concerning the contents of the report.
 In the event of the improper use of the report. The SHENZHEN TIMEWAY TESTING LABORATORIES reserves the rights to withdraw it and to adopt any other remedies which may be appropriate.



Test result

General Radiated Emission Data and Harmonics Radiated Emission Data

Radiated Emission In Vertical (30MHz----1000MHz)

EUT set Condition: **Keep Transmitting**

Results: Pass

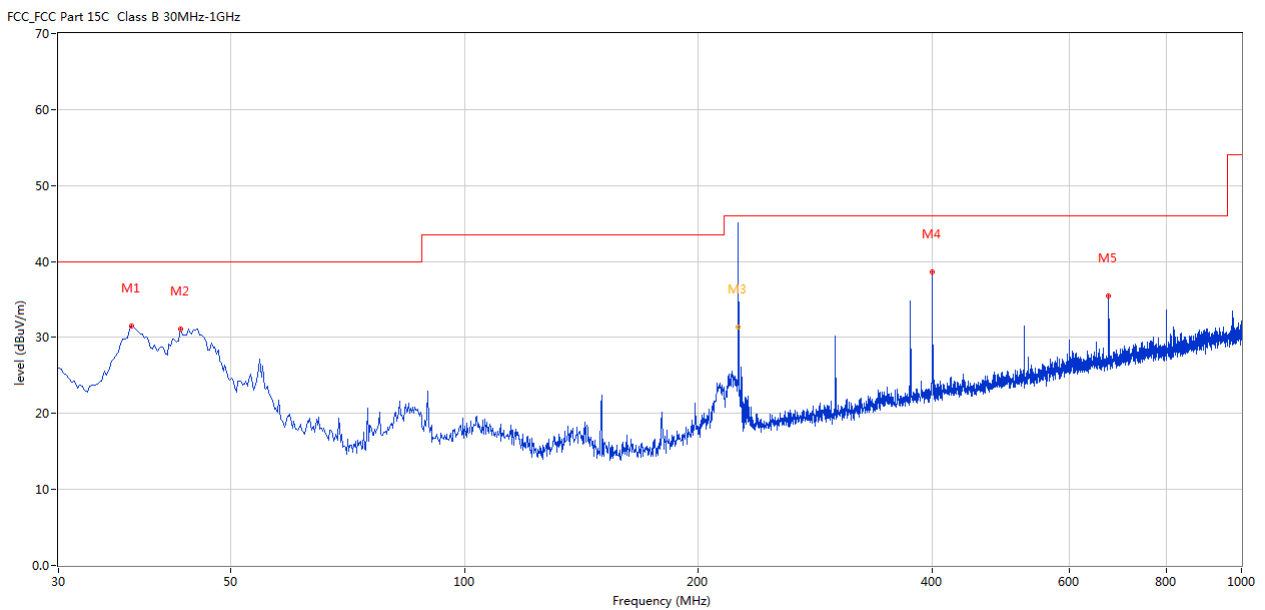

No.	Frequency (MHz)	Results (dBuV/m)	Factor (dB)	Limit (dBuV/m)	Over Limit (dB)	Detector	Table (o)	Height (cm)	ANT	Verdict
1	37.273	31.50	-13.06	40.0	-8.50	Peak	353.00	100	Vertical	Pass
2	43.092	31.18	-11.50	40.0	-8.82	Peak	28.00	100	Vertical	Pass
3	225.023	45.02	-12.91	46.0	-0.98	Peak	360.00	200	Vertical	Pass
3*	225.023	31.42	-12.91	46.0	-14.58	QP	360.00	200	Vertical	Pass
4	399.963	38.58	-8.57	46.0	-7.42	Peak	301.00	100	Vertical	Pass
5	674.889	35.44	-4.37	46.0	-10.56	Peak	360.00	200	Vertical	Pass

The report refers only to the sample tested and does not apply to the bulk.

This report is issued in confidence to the client and it will be strictly treated as such by the SHENZHEN TIMEWAY TESTING LABORATORIES. It may not be reproduced rather in its entirety or in part and it may not be used for advertising. The client to whom the report is issued may, however, show or send it or a certified copy thereof prepared by the SHENZHEN TIMEWAY TESTING LABORATORIES to his customer. Supplier or others persons directly concerned. SHENZHEN TIMEWAY TESTING LABORATORIES will not, without the consent of the client enter into any discussion of correspondence with any third party concerning the contents of the report.

In the event of the improper use of the report. The SHENZHEN TIMEWAY TESTING LABORATORIES reserves the rights to withdraw it and to adopt any other remedies which may be appropriate.



Please refer to the following test plots for details:

CH01 for 11g at 6Mbps: Horizontal

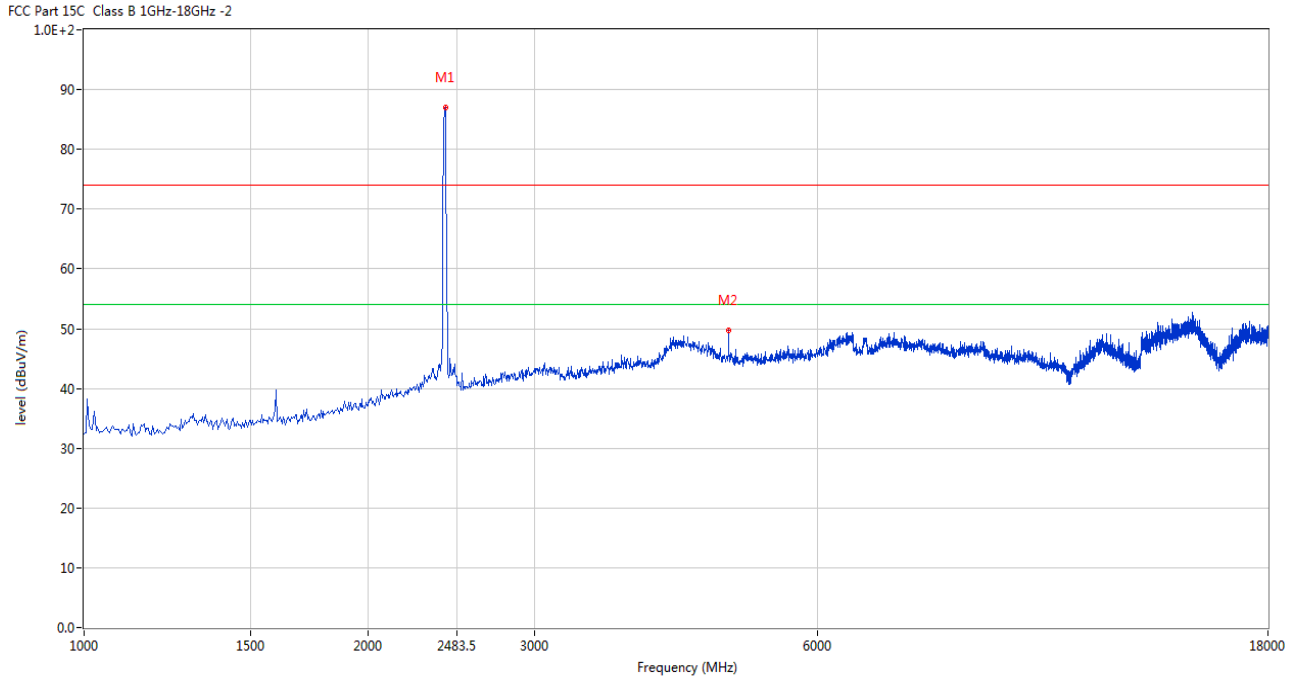

No.	Frequency (MHz)	Results (dBuV/m)	Factor (dB)	Limit (dBuV/m)	Over Limit (dB)	Detector	Table (o)	Height (cm)	ANT	Verdict
1	2412.896	87.05	-3.57	74.0	13.05	Peak	212.00	100	Horizontal	N/A
2	4824.044	49.70	3.14	74.0	-24.30	Peak	156.00	100	Horizontal	Pass

The report refers only to the sample tested and does not apply to the bulk.

This report is issued in confidence to the client and it will be strictly treated as such by the SHENZHEN TIMEWAY TESTING LABORATORIES. It may not be reproduced rather in its entirety or in part and it may not be used for advertising. The client to whom the report is issued may, however, show or send it . or a certified copy there of prepared by the SHENZHEN TIMEWAY TESTING LABORATORIES. to his customer. Supplier or others persons directly concerned. SHENZHEN TIMEWAY TESTING LABORATORIES. will not, without the consent of the client enter into any discussion of correspondence with any third party concerning the contents of the report.

In the event of the improper use of the report. The SHENZHEN TIMEWAY TESTING LABORATORIES. reserves the rights to withdraw it and to adopt any other remedies which may be appropriate.



CH01 for 11g at 6Mbps: Vertical

FCC Part 15C Class B 1GHz-18GHz -2

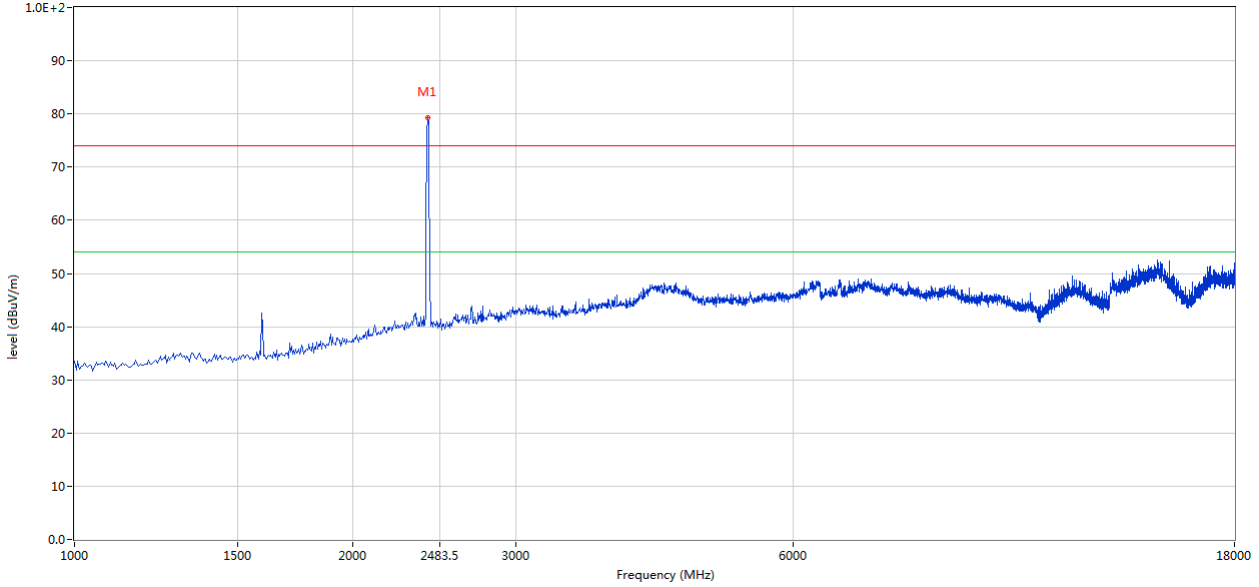

No.	Frequency (MHz)	Results (dBuV/m)	Factor (dB)	Limit (dBuV/m)	Over Limit (dB)	Detector	Table (o)	Height (cm)	ANT	Verdict
1	2410.647	79.24	-3.57	74.0	5.24	Peak	229.00	100	Vertical	N/A

The report refers only to the sample tested and does not apply to the bulk.

This report is issued in confidence to the client and it will be strictly treated as such by the SHENZHEN TIMEWAY TESTING LABORATORIES. It may not be reproduced rather in its entirety or in part and it may not be used for advertising. The client to whom the report is issued may, however, show or send it . or a certified copy there of prepared by the SHENZHEN TIMEWAY TESTING LABORATORIES. to his customer. Supplier or others persons directly concerned. SHENZHEN TIMEWAY TESTING LABORATORIES. will not, without the consent of the client enter into any discussion of correspondence with any third party concerning the contents of the report.

In the event of the improper use of the report. The SHENZHEN TIMEWAY TESTING LABORATORIES. reserves the rights to withdraw it and to adopt any other remedies which may be appropriate.



CH06 for 11g at 6Mbps: Horizontal

FCC Part 15C Class B 1GHz-18GHz -2

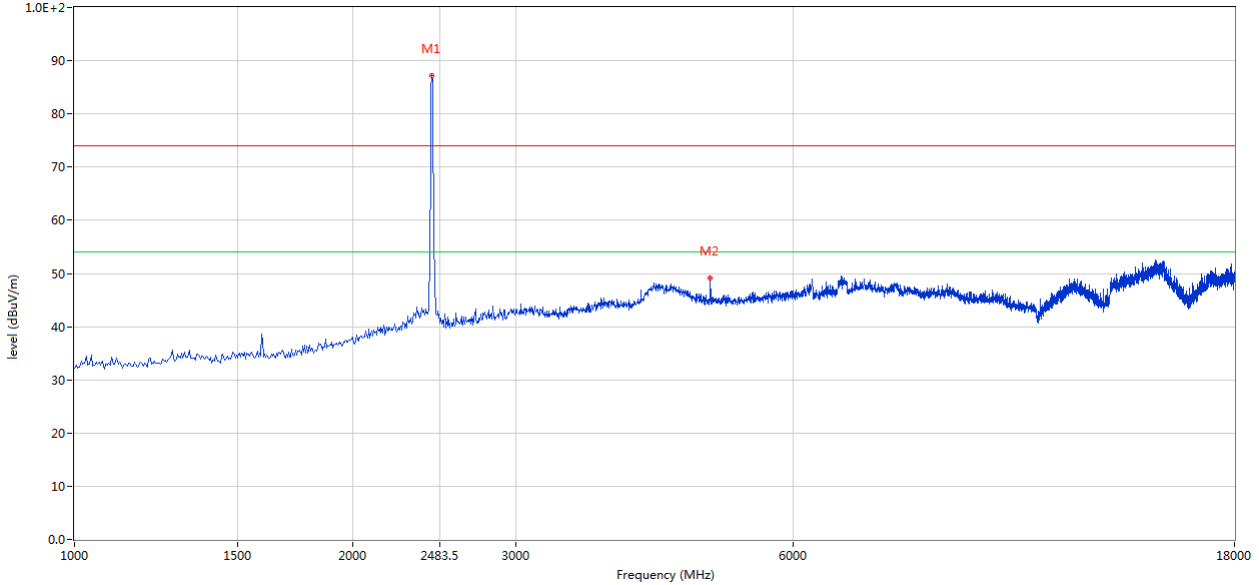

No.	Frequency (MHz)	Results (dBuV/m)	Factor (dB)	Limit (dBuV/m)	Over Limit (dB)	Detector	Table (o)	Height (cm)	ANT	Verdict
1	2436.141	87.25	-3.57	74.0	13.25	Peak	206.00	100	Horizontal	N/A
2	4875.031	49.17	3.19	74.0	-24.83	Peak	216.00	100	Horizontal	Pass

The report refers only to the sample tested and does not apply to the bulk.

This report is issued in confidence to the client and it will be strictly treated as such by the SHENZHEN TIMEWAY TESTING LABORATORIES. It may not be reproduced rather in its entirety or in part and it may not be used for advertising. The client to whom the report is issued may, however, show or send it . or a certified copy there of prepared by the SHENZHEN TIMEWAY TESTING LABORATORIES. to his customer. Supplier or others persons directly concerned. SHENZHEN TIMEWAY TESTING LABORATORIES. will not, without the consent of the client enter into any discussion of correspondence with any third party concerning the contents of the report.

In the event of the improper use of the report. The SHENZHEN TIMEWAY TESTING LABORATORIES. reserves the rights to withdraw it and to adopt any other remedies which may be appropriate.



CH06 for 11g at 6Mbps: Vertical

FCC Part 15C Class B 1GHz-18GHz -2

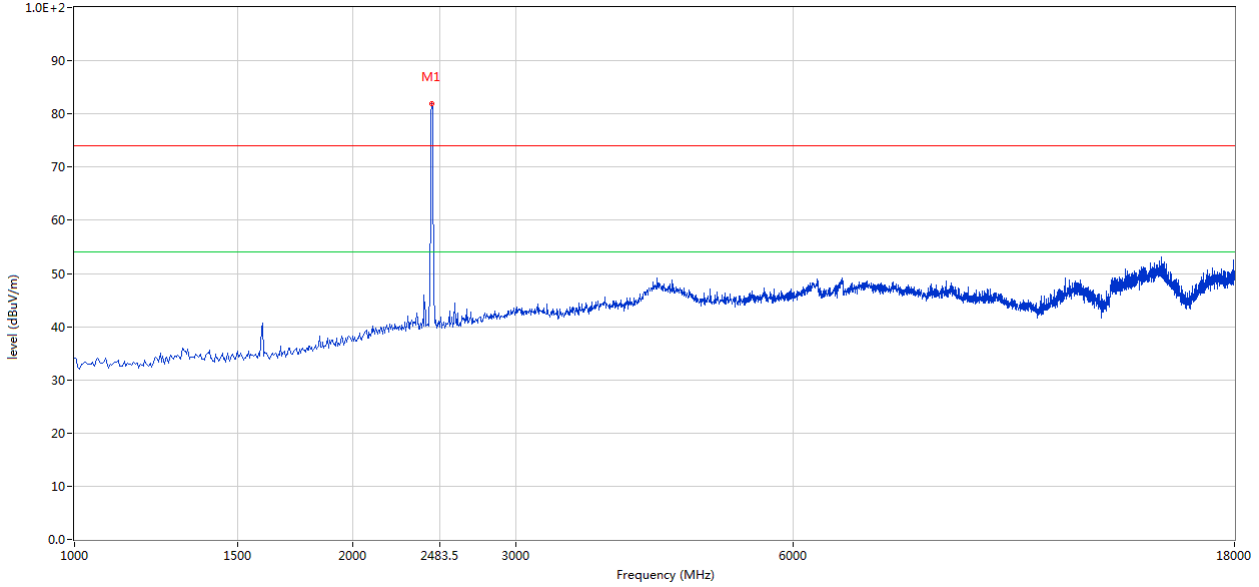

No.	Frequency (MHz)	Results (dBuV/m)	Factor (dB)	Limit (dBuV/m)	Over Limit (dB)	Detector	Table (o)	Height (cm)	ANT	Verdict
1	2436.141	81.96	-3.57	74.0	7.96	Peak	182.00	100	Vertical	N/A

The report refers only to the sample tested and does not apply to the bulk.

This report is issued in confidence to the client and it will be strictly treated as such by the SHENZHEN TIMEWAY TESTING LABORATORIES. It may not be reproduced rather in its entirety or in part and it may not be used for advertising. The client to whom the report is issued may, however, show or send it or a certified copy thereof prepared by the SHENZHEN TIMEWAY TESTING LABORATORIES to his customer. Supplier or others persons directly concerned. SHENZHEN TIMEWAY TESTING LABORATORIES will not, without the consent of the client enter into any discussion of correspondence with any third party concerning the contents of the report.

In the event of the improper use of the report. The SHENZHEN TIMEWAY TESTING LABORATORIES reserves the rights to withdraw it and to adopt any other remedies which may be appropriate.



CH11 for 11g at 6Mbps: Horizontal

FCC Part 15C Class B 1GHz-18GHz -2

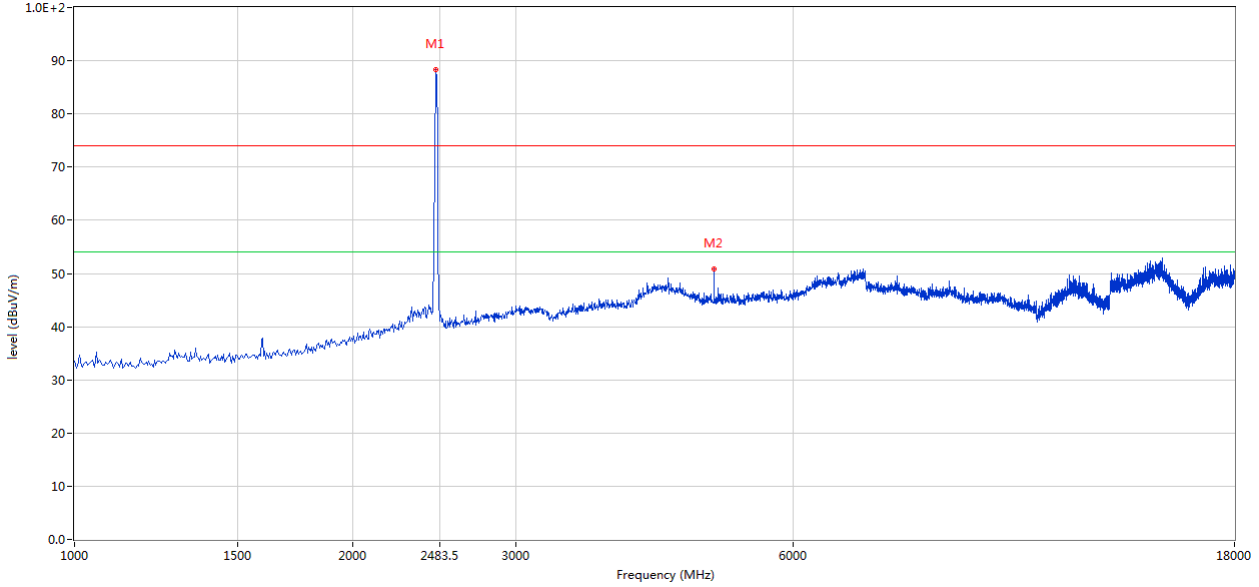

No.	Frequency (MHz)	Results (dBuV/m)	Factor (dB)	Limit (dBuV/m)	Over Limit (dB)	Detector	Table (o)	Height (cm)	ANT	Verdict
1	2461.635	88.29	-3.57	74.0	14.29	Peak	214.00	100	Horizontal	N/A
2	4921.770	50.90	3.27	74.0	-23.10	Peak	214.00	100	Horizontal	Pass

The report refers only to the sample tested and does not apply to the bulk.

This report is issued in confidence to the client and it will be strictly treated as such by the SHENZHEN TIMEWAY TESTING LABORATORIES. It may not be reproduced rather in its entirety or in part and it may not be used for advertising. The client to whom the report is issued may, however, show or send it or a certified copy thereof prepared by the SHENZHEN TIMEWAY TESTING LABORATORIES to his customer. Supplier or others persons directly concerned. SHENZHEN TIMEWAY TESTING LABORATORIES will not, without the consent of the client enter into any discussion of correspondence with any third party concerning the contents of the report.

In the event of the improper use of the report. The SHENZHEN TIMEWAY TESTING LABORATORIES reserves the rights to withdraw it and to adopt any other remedies which may be appropriate.



CH11 for 11g at 6Mbps: Vertical

FCC Part 15C Class B 1GHz-18GHz -2

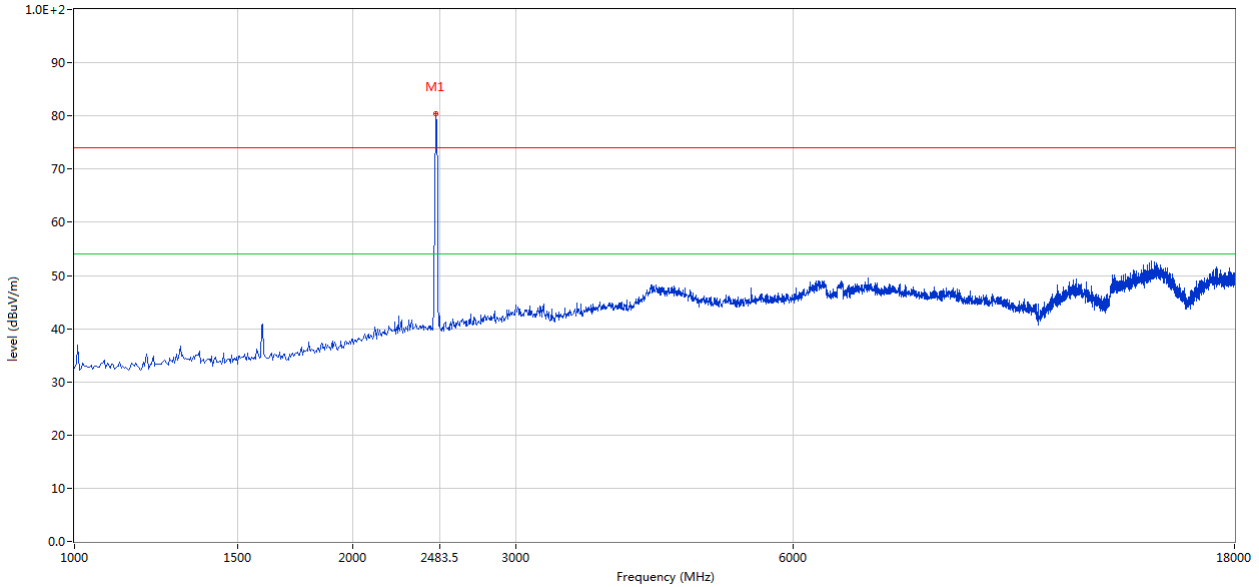

No.	Frequency (MHz)	Results (dBuV/m)	Factor (dB)	Limit (dBuV/m)	Over Limit (dB)	Detector	Table (o)	Height (cm)	ANT	Verdict
1	2461.635	80.43	-3.57	74.0	6.43	Peak	180.00	100	Vertical	N/A

Note: 1. Result Level = Reading + Factor

2. Factor= AF + Cable Loss- Preamp

3. Margin = Result- Limit

4. For radiated Emissions from 18-25GHz and below 30MHz, it is only the floor noise and less than the limit for more than 20dB. No necessary to take down.

5. Note: the final peak measurement results less than the AV limit. No necessary to take down the final AV measurement result

The report refers only to the sample tested and does not apply to the bulk.

This report is issued in confidence to the client and it will be strictly treated as such by the SHENZHEN TIMEWAY TESTING LABORATORIES. It may not be reproduced rather in its entirety or in part and it may not be used for adverting. The client to whom the report is issued may, however, show or send it . or a certified copy there of prepared by the SHENZHEN TIMEWAY TESTING LABORATORIES. to his customer. Supplier or others persons directly concerned. SHENZHEN TIMEWAY TESTING LABORATORIES. will not, without the consent of the client enter into any discussion of correspondence with any third party concerning the contents of the report.

In the event of the improper use of the report. The SHENZHEN TIMEWAY TESTING LABORATORIES. reserves the rights to withdraw it and to adopt any other remedies which may be appropriate.



7.0 6dB Bandwidth Measurement

7.1 Test Setup

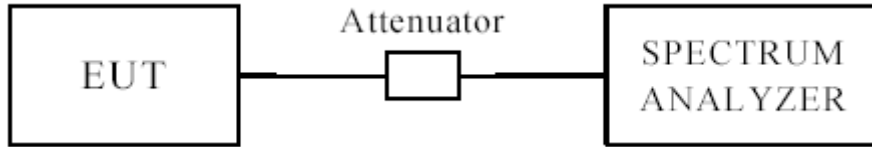

7.2 Limits of 6dB Bandwidth Measurement

The minimum of 6dB Bandwidth Measurement is >500 kHz

7.3 Test Procedure

1. Set resolution bandwidth (RBW) = 100 kHz
2. Set the video bandwidth (VBW) $\geq 3 \times$ RBW.
3. Detector = Peak.
4. Trace mode = max hold.
5. Sweep = auto couple.
6. Allow the trace to stabilize.
7. Measure the maximum width of the emission that is constrained by the frequencies associated with the two outermost amplitude points (upper and lower) that are attenuated by 6 dB relative to the maximum level measured in the fundamental emission.

7.4 Test Result

The report refers only to the sample tested and does not apply to the bulk.

This report is issued in confidence to the client and it will be strictly treated as such by the SHENZHEN TIMEWAY TESTING LABORATORIES. It may not be reproduced rather in its entirety or in part and it may not be used for advertising. The client to whom the report is issued may, however, show or send it, or a certified copy thereof prepared by the SHENZHEN TIMEWAY TESTING LABORATORIES, to his customer, Supplier or others persons directly concerned. SHENZHEN TIMEWAY TESTING LABORATORIES, will not, without the consent of the client enter into any discussion of correspondence with any third party concerning the contents of the report.

In the event of the improper use of the report, The SHENZHEN TIMEWAY TESTING LABORATORIES, reserves the rights to withdraw it and to adopt any other remedies which may be appropriate.



6dB Occupied Bandwidth

EUT		Tablet PC		Model	ST8888
Mode		802.11b		Test Voltage	DC3.7V
Temperature		24 deg. C,		Humidity	56% RH
Channel	Channel Frequency (MHz)	Data Transfer Rate (Mbps)	6 dB Bandwidth (MHz)	Minimum Limit (MHz)	Pass/ Fail
1	2412	1	10.04	0.5	Pass
6	2437	1	10.05	0.5	Pass
11	2462	1	10.04	0.5	Pass
1	2412	11	9.08	0.5	Pass
6	2437	11	9.08	0.5	Pass
11	2462	11	9.08	0.5	Pass

The report refers only to the sample tested and does not apply to the bulk.
 This report is issued in confidence to the client and it will be strictly treated as such by the SHENZHEN TIMEWAY TESTING LABORATORIES. It may not be reproduced rather in its entirety or in part and it may not be used for advertising. The client to whom the report is issued may, however, show or send it . or a certified copy there of prepared by the SHENZHEN TIMEWAY TESTING LABORATORIES. to his customer. Supplier or others persons directly concerned. SHENZHEN TIMEWAY TESTING LABORATORIES. will not, without the consent of the client enter into any discussion of correspondence with any third party concerning the contents of the report.
 In the event of the improper use of the report. The SHENZHEN TIMEWAY TESTING LABORATORIES. reserves the rights to withdraw it and to adopt any other remedies which may be appropriate.



1. 802.11b at 1Mbps of CH01



Ref Lvl	Delta 1 [T1]	RBW	100 kHz	RF Att	20 dB
10 dBm	0.04 dB	VBW	300 kHz	Unit	dBm
	10.04008016 MHz	SWT	7.5 ms		

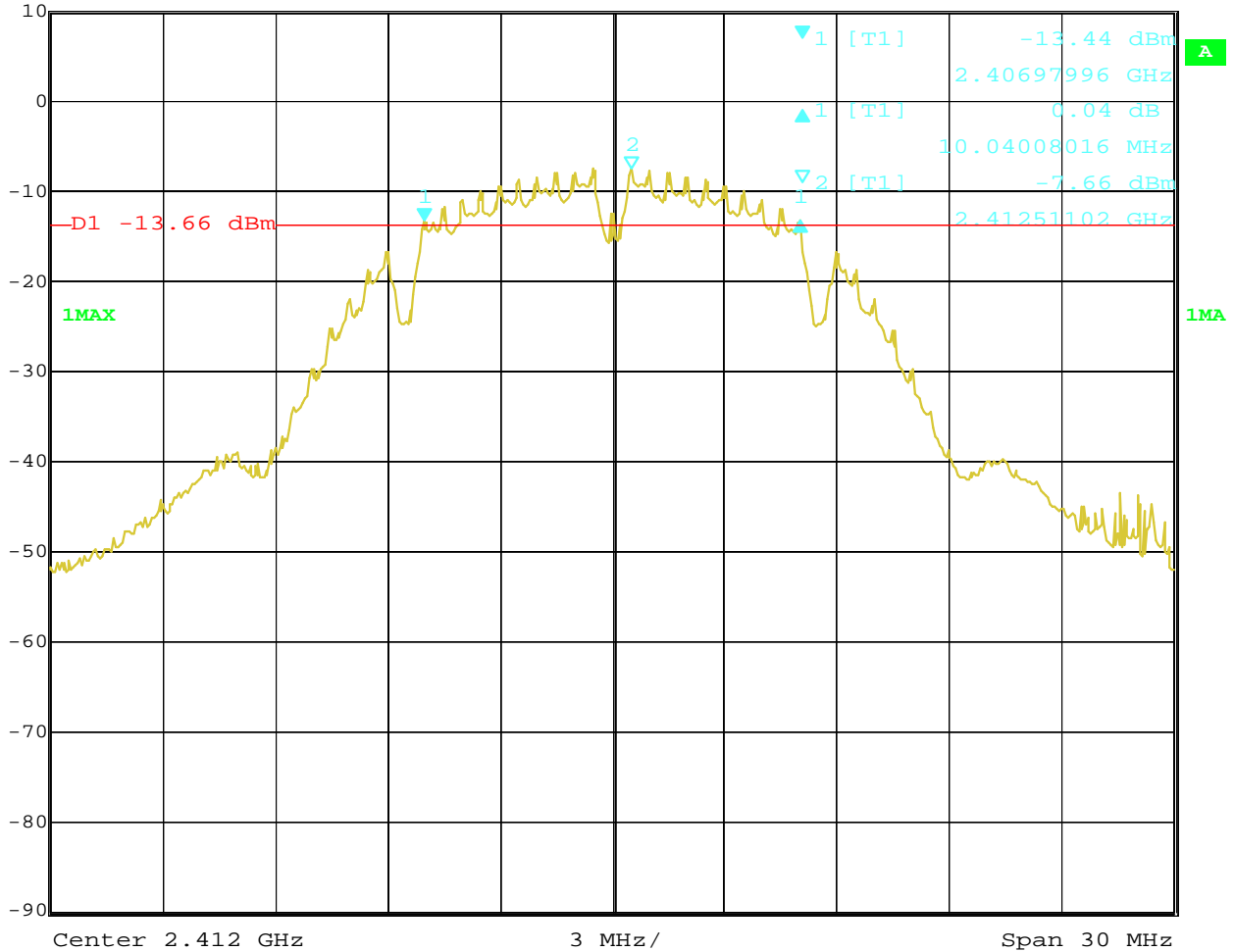

Date: 15.JUN.2022 12:02:36

The report refers only to the sample tested and does not apply to the bulk.
 This report is issued in confidence to the client and it will be strictly treated as such by the SHENZHEN TIMEWAY TESTING LABORATORIES. It may not be reproduced rather in its entirety or in part and it may not be used for advertising. The client to whom the report is issued may, however, show or send it . or a certified copy there of prepared by the SHENZHEN TIMEWAY TESTING LABORATORIES. to his customer. Supplier or others persons directly concerned. SHENZHEN TIMEWAY TESTING LABORATORIES. will not, without the consent of the client enter into any discussion of correspondence with any third party concerning the contents of the report.
 In the event of the improper use of the report. The SHENZHEN TIMEWAY TESTING LABORATORIES. reserves the rights to withdraw it and to adopt any other remedies which may be appropriate.



2. 802.11b at 1Mbps of CH06



Ref Lvl	Delta 1 [T1]	RBW	100 kHz	RF Att	20 dB
10 dBm	-0.02 dB	VBW	300 kHz	Unit	dBm
	10.04509018 MHz	SWT	7.5 ms		

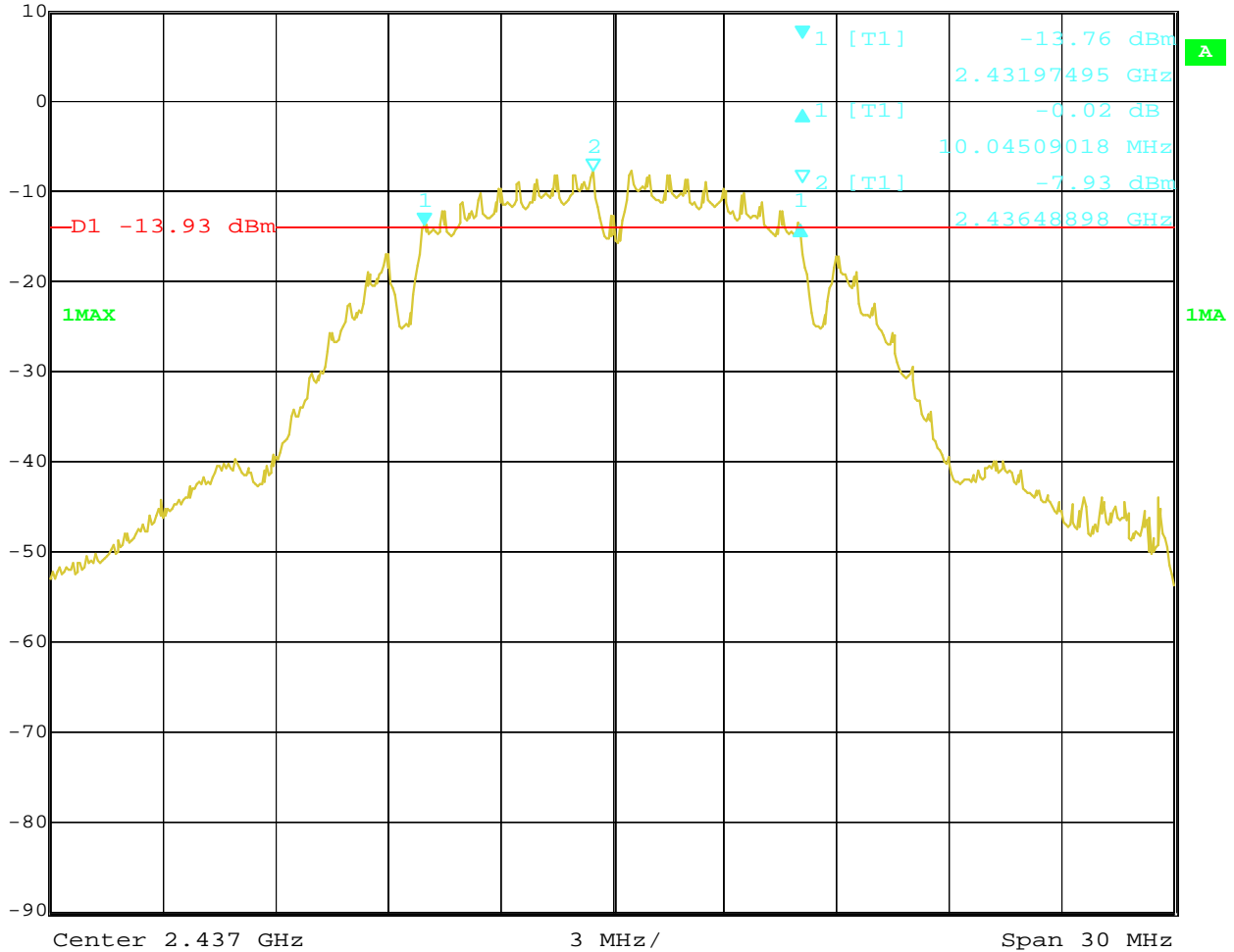

Date: 15.JUN.2022 14:01:23

The report refers only to the sample tested and does not apply to the bulk.
 This report is issued in confidence to the client and it will be strictly treated as such by the SHENZHEN TIMEWAY TESTING LABORATORIES. It may not be reproduced rather in its entirety or in part and it may not be used for advertising. The client to whom the report is issued may, however, show or send it or a certified copy thereof prepared by the SHENZHEN TIMEWAY TESTING LABORATORIES to his customer. Supplier or others persons directly concerned. SHENZHEN TIMEWAY TESTING LABORATORIES will not, without the consent of the client enter into any discussion of correspondence with any third party concerning the contents of the report.
 In the event of the improper use of the report. The SHENZHEN TIMEWAY TESTING LABORATORIES reserves the rights to withdraw it and to adopt any other remedies which may be appropriate.



3. 802.11b at 1Mbps of CH11



	Delta 1 [T1]	RBW	100 kHz	RF Att	20 dB
Ref Lvl	0.46 dB	VBW	300 kHz		
10 dBm	10.04008016 MHz	SWT	7.5 ms	Unit	dBm

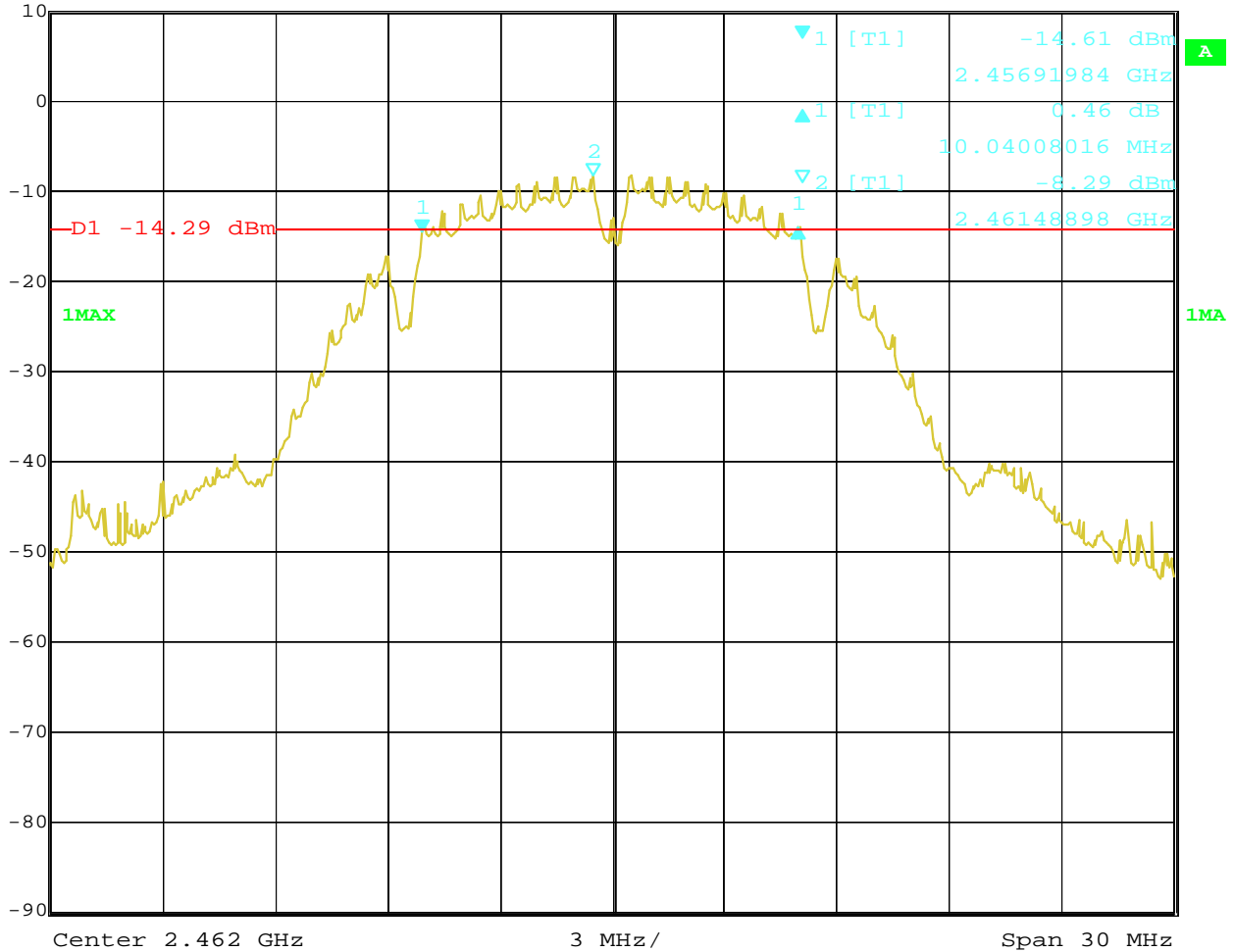

Date: 15.JUN.2022 14:04:36

The report refers only to the sample tested and does not apply to the bulk.
 This report is issued in confidence to the client and it will be strictly treated as such by the SHENZHEN TIMEWAY TESTING LABORATORIES. It may not be reproduced rather in its entirety or in part and it may not be used for advertising. The client to whom the report is issued may, however, show or send it or a certified copy thereof prepared by the SHENZHEN TIMEWAY TESTING LABORATORIES to his customer. Supplier or others persons directly concerned. SHENZHEN TIMEWAY TESTING LABORATORIES will not, without the consent of the client enter into any discussion of correspondence with any third party concerning the contents of the report.
 In the event of the improper use of the report. The SHENZHEN TIMEWAY TESTING LABORATORIES reserves the rights to withdraw it and to adopt any other remedies which may be appropriate.



4. 802.11b at 11Mbps of CH01

	Delta 1 [T1]	RBW	100 kHz	RF Att	20 dB
	Ref Lvl	0.12 dB	VBW	300 kHz	
	10 dBm	9.07815631 MHz	SWT	7.5 ms	Unit

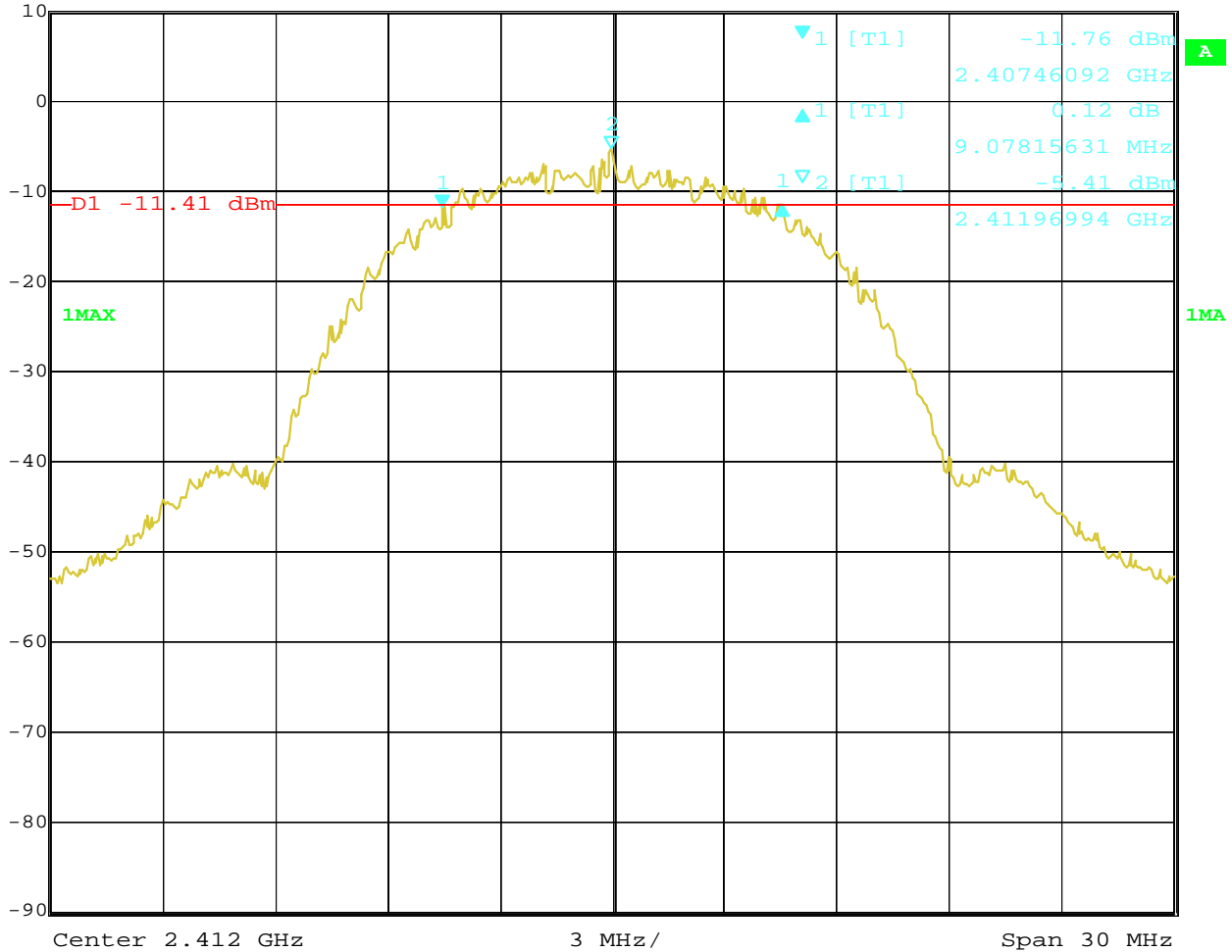

Date: 15.JUN.2022 14:58:22

The report refers only to the sample tested and does not apply to the bulk.
 This report is issued in confidence to the client and it will be strictly treated as such by the SHENZHEN TIMEWAY TESTING LABORATORIES. It may not be reproduced rather in its entirety or in part and it may not be used for adverting. The client to whom the report is issued may, however, show or send it . or a certified copy there of prepared by the SHENZHEN TIMEWAY TESTING LABORATORIES. to his customer. Supplier or others persons directly concerned. SHENZHEN TIMEWAY TESTING LABORATORIES. will not, without the consent of the client enter into any discussion of correspondence with any third party concerning the contents of the report.
 In the event of the improper use of the report. The SHENZHEN TIMEWAY TESTING LABORATORIES. reserves the rights to withdraw it and to adopt any other remedies which may be appropriate.



5. 802.11b at 11Mbps of CH06

	Delta 1 [T1]	RBW	100 kHz	RF Att	20 dB
	Ref Lvl	-0.01 dB	VBW	300 kHz	
	10 dBm	9.07815631 MHz	SWT	7.5 ms	Unit dBm

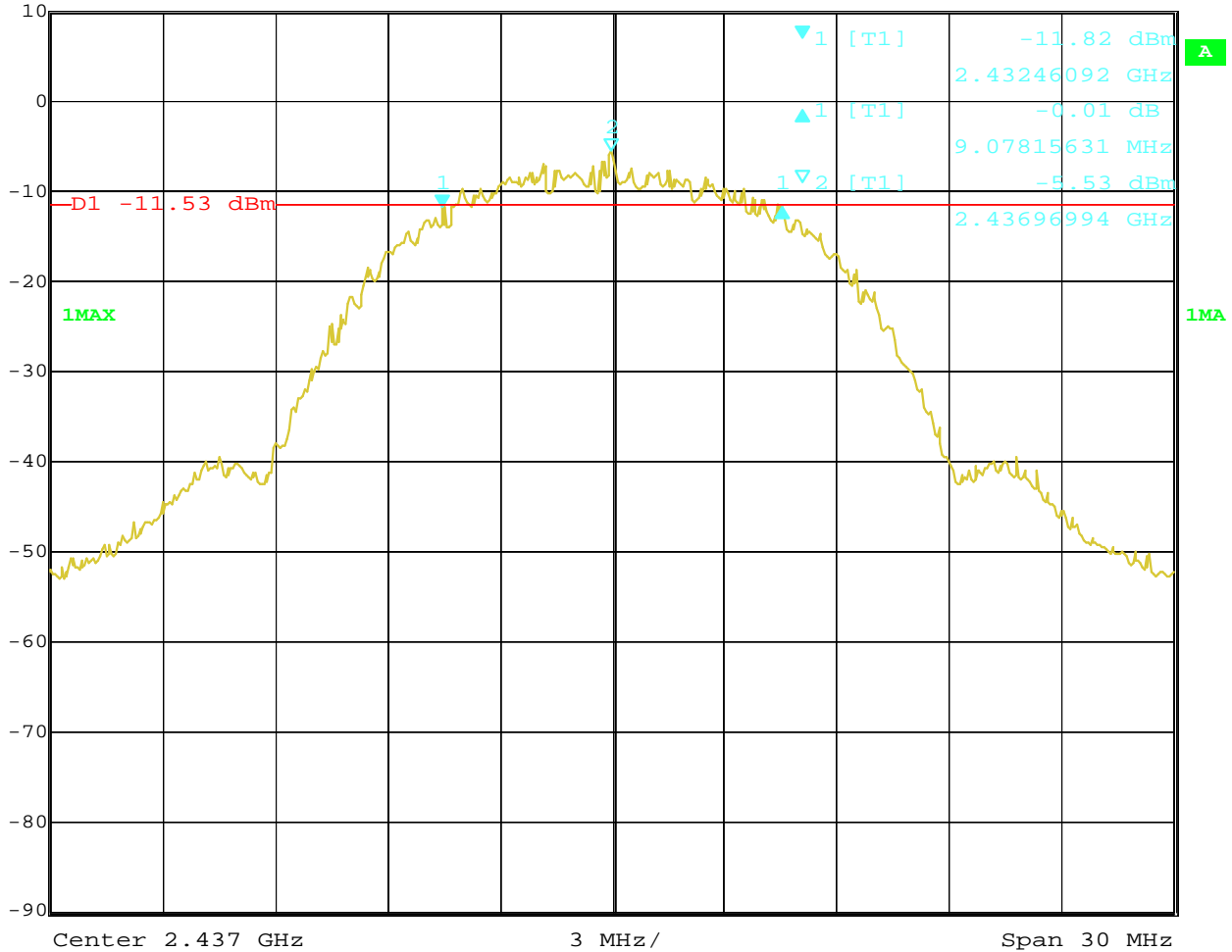

Date: 15.JUN.2022 14:55:41

The report refers only to the sample tested and does not apply to the bulk.
 This report is issued in confidence to the client and it will be strictly treated as such by the SHENZHEN TIMEWAY TESTING LABORATORIES. It may not be reproduced rather in its entirety or in part and it may not be used for advertising. The client to whom the report is issued may, however, show or send it . or a certified copy there of prepared by the SHENZHEN TIMEWAY TESTING LABORATORIES. to his customer. Supplier or others persons directly concerned. SHENZHEN TIMEWAY TESTING LABORATORIES. will not, without the consent of the client enter into any discussion of correspondence with any third party concerning the contents of the report.
 In the event of the improper use of the report. The SHENZHEN TIMEWAY TESTING LABORATORIES. reserves the rights to withdraw it and to adopt any other remedies which may be appropriate.



6. 802.11b at 11Mbps of CH11

	Delta 1 [T1]	RBW	100 kHz	RF Att	20 dB
	Ref Lvl	-0.21 dB	VBW	300 kHz	
	10 dBm	9.07815631 MHz	SWT	7.5 ms	Unit dBm

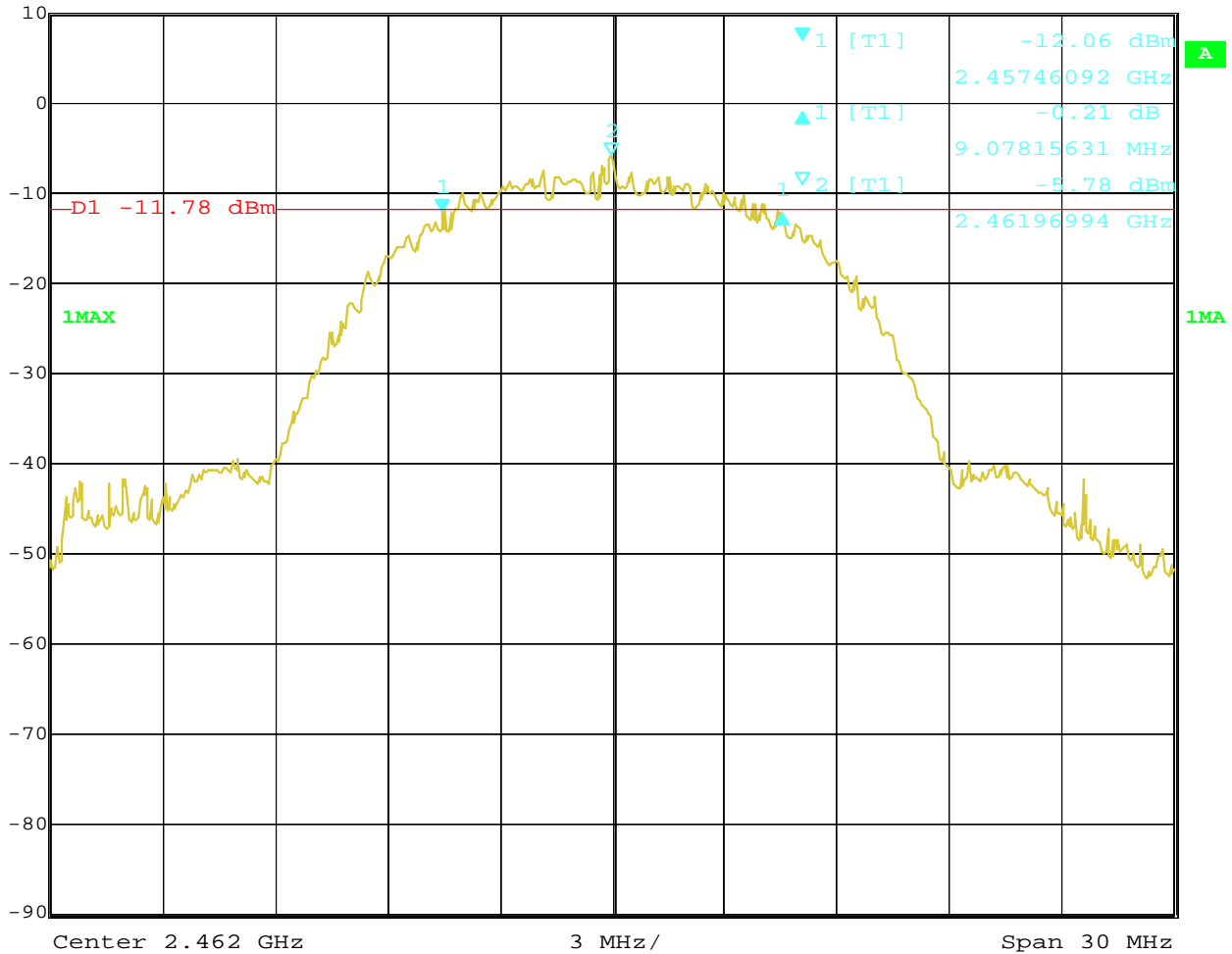

Date: 15.JUN.2022 14:16:02

The report refers only to the sample tested and does not apply to the bulk.
 This report is issued in confidence to the client and it will be strictly treated as such by the SHENZHEN TIMEWAY TESTING LABORATORIES. It may not be reproduced rather in its entirety or in part and it may not be used for adverting. The client to whom the report is issued may, however, show or send it . or a certified copy there of prepared by the SHENZHEN TIMEWAY TESTING LABORATORIES. to his customer. Supplier or others persons directly concerned. SHENZHEN TIMEWAY TESTING LABORATORIES. will not, without the consent of the client enter into any discussion of correspondence with any third party concerning the contents of the report.
 In the event of the improper use of the report. The SHENZHEN TIMEWAY TESTING LABORATORIES. reserves the rights to withdraw it and to adopt any other remedies which may be appropriate.



6dB Occupied Bandwidth

EUT		Tablet PC		Model	ST8888
Mode		802.11g		Test Voltage	DC3.7V
Temperature		24 deg. C,		Humidity	56% RH
Channel	Channel Frequency (MHz)	Data Transfer Rate (Mbps)	6 dB Bandwidth (MHz)	Minimum Limit (MHz)	Pass/ Fail
1	2412	6	16.41	0.5	Pass
6	2437	6	16.41	0.5	Pass
11	2462	6	16.41	0.5	Pass

The report refers only to the sample tested and does not apply to the bulk.
 This report is issued in confidence to the client and it will be strictly treated as such by the SHENZHEN TIMEWAY TESTING LABORATORIES. It may not be reproduced rather in its entirety or in part and it may not be used for advertizing. The client to whom the report is issued may, however, show or send it . or a certified copy there of prepared by the SHENZHEN TIMEWAY TESTING LABORATORIES. to his customer. Supplier or others persons directly concerned. SHENZHEN TIMEWAY TESTING LABORATORIES. will not, without the consent of the client enter into any discussion of correspondence with any third party concerning the contents of the report.
 In the event of the improper use of the report. The SHENZHEN TIMEWAY TESTING LABORATORIES. reserves the rights to withdraw it and to adopt any other remedies which may be appropriate.



Test Plots:

1. 802.11g at 6Mbps of CH01

 Delta 1 [T1] RBW 100 kHz RF Att 20 dB
 Ref Lvl 0.83 dB VBW 300 kHz
 10 dBm 16.41282565 MHz SWT 7.5 ms Unit dBm

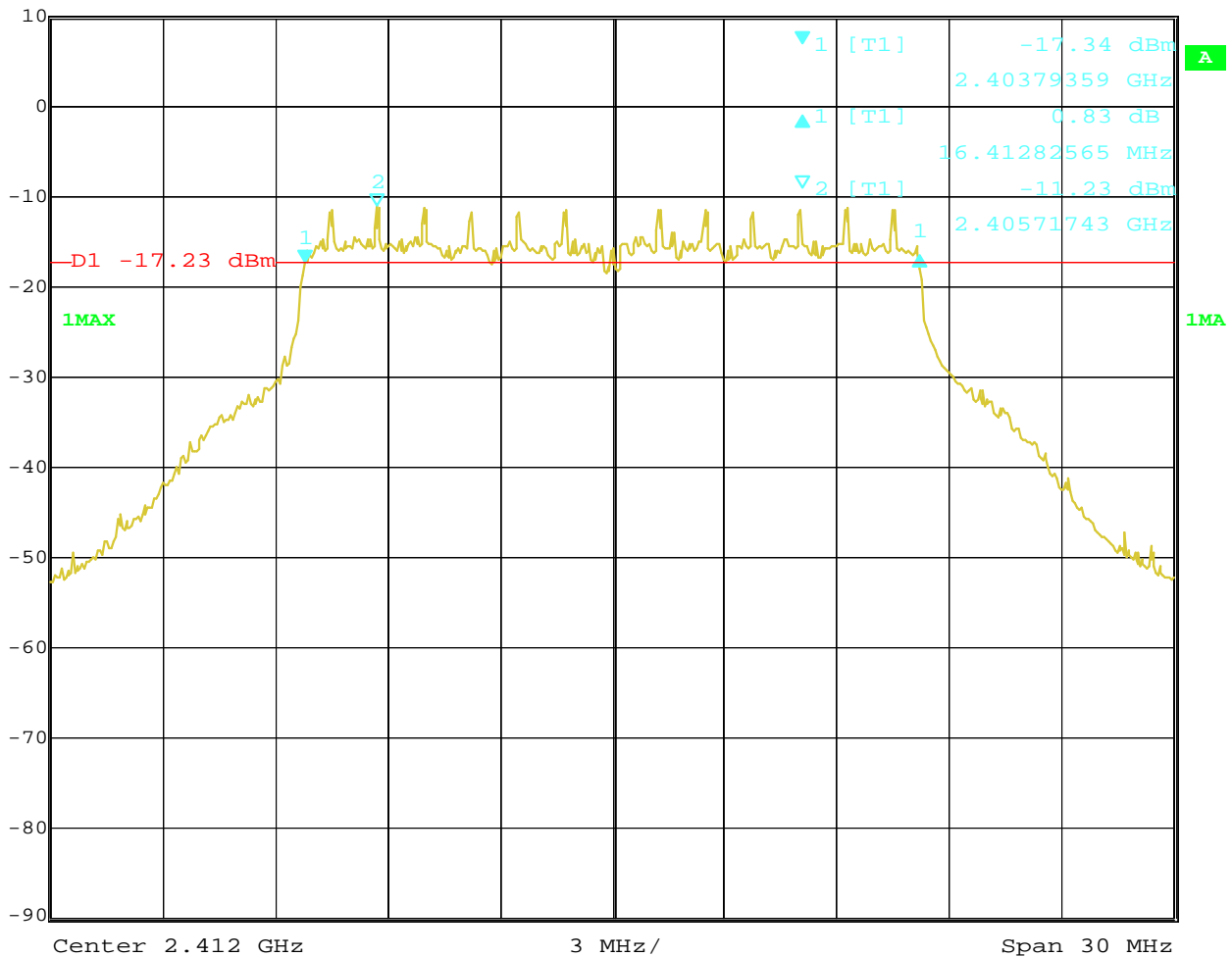

Date: 15.JUN.2022 12:09:08

The report refers only to the sample tested and does not apply to the bulk.
 This report is issued in confidence to the client and it will be strictly treated as such by the SHENZHEN TIMEWAY TESTING LABORATORIES. It may not be reproduced rather in its entirety or in part and it may not be used for advertising. The client to whom the report is issued may, however, show or send it . or a certified copy there of prepared by the SHENZHEN TIMEWAY TESTING LABORATORIES. to his customer. Supplier or others persons directly concerned. SHENZHEN TIMEWAY TESTING LABORATORIES. will not, without the consent of the client enter into any discussion of correspondence with any third party concerning the contents of the report.
 In the event of the improper use of the report. The SHENZHEN TIMEWAY TESTING LABORATORIES. reserves the rights to withdraw it and to adopt any other remedies which may be appropriate.



2. 802.11g at 6Mbps of CH06



Ref Lvl	Delta 1 [T1]	RBW	100 kHz	RF Att	20 dB
10 dBm	0.46 dB	VBW	300 kHz	Unit	dBm
	16.41282565 MHz	SWT	7.5 ms		

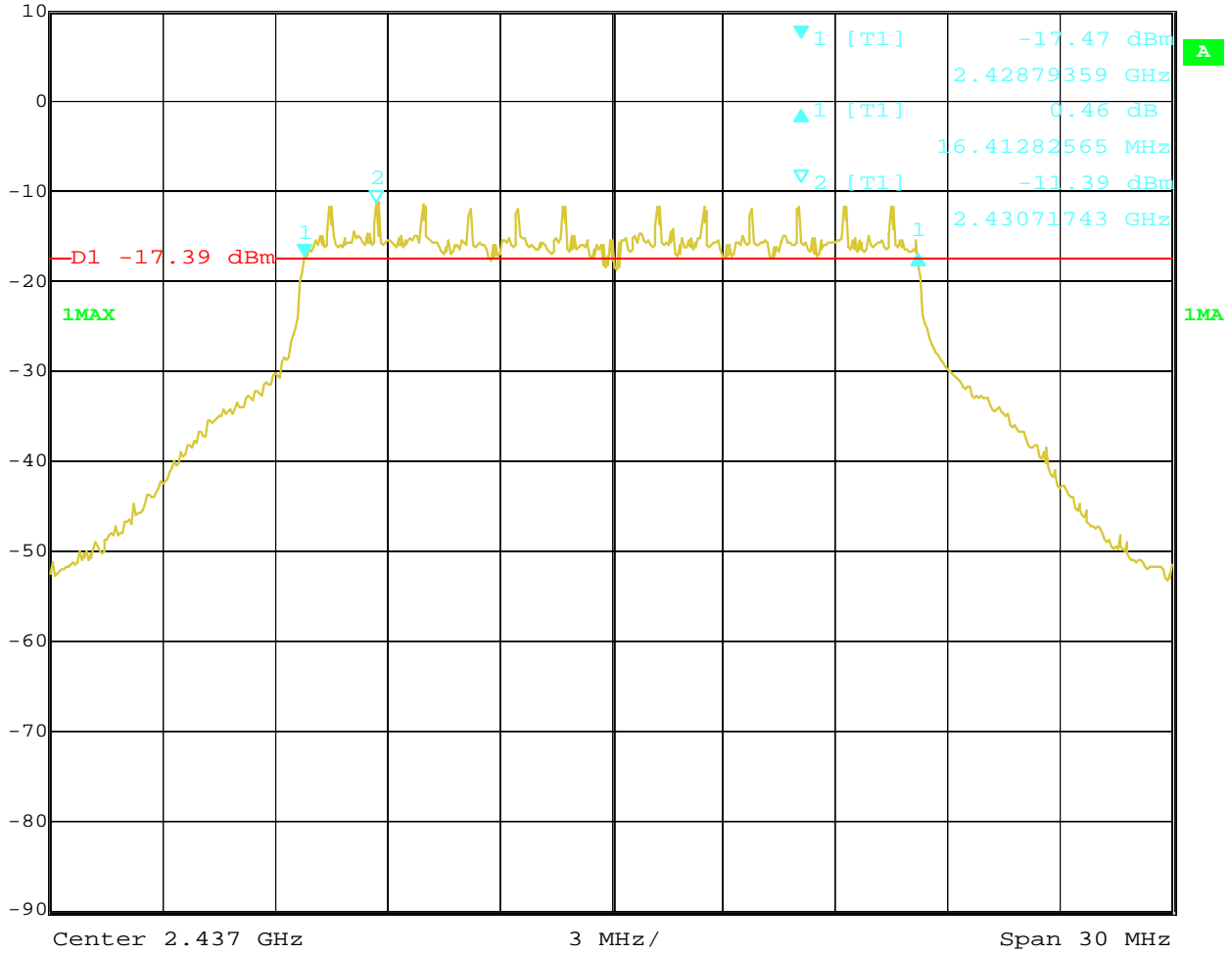

Date: 15.JUN.2022 12:23:30

The report refers only to the sample tested and does not apply to the bulk.
 This report is issued in confidence to the client and it will be strictly treated as such by the SHENZHEN TIMEWAY TESTING LABORATORIES. It may not be reproduced rather in its entirety or in part and it may not be used for advertising. The client to whom the report is issued may, however, show or send it or a certified copy thereof prepared by the SHENZHEN TIMEWAY TESTING LABORATORIES to his customer. Supplier or others persons directly concerned. SHENZHEN TIMEWAY TESTING LABORATORIES will not, without the consent of the client enter into any discussion of correspondence with any third party concerning the contents of the report.
 In the event of the improper use of the report. The SHENZHEN TIMEWAY TESTING LABORATORIES reserves the rights to withdraw it and to adopt any other remedies which may be appropriate.



3. 802.11g at 6Mbps of CH11



Ref Lvl	Delta 1 [T1]	RBW	100 kHz	RF Att	20 dB
10 dBm	0.24 dB	VBW	300 kHz	Unit	dBm
	16.41282565 MHz	SWT	7.5 ms		

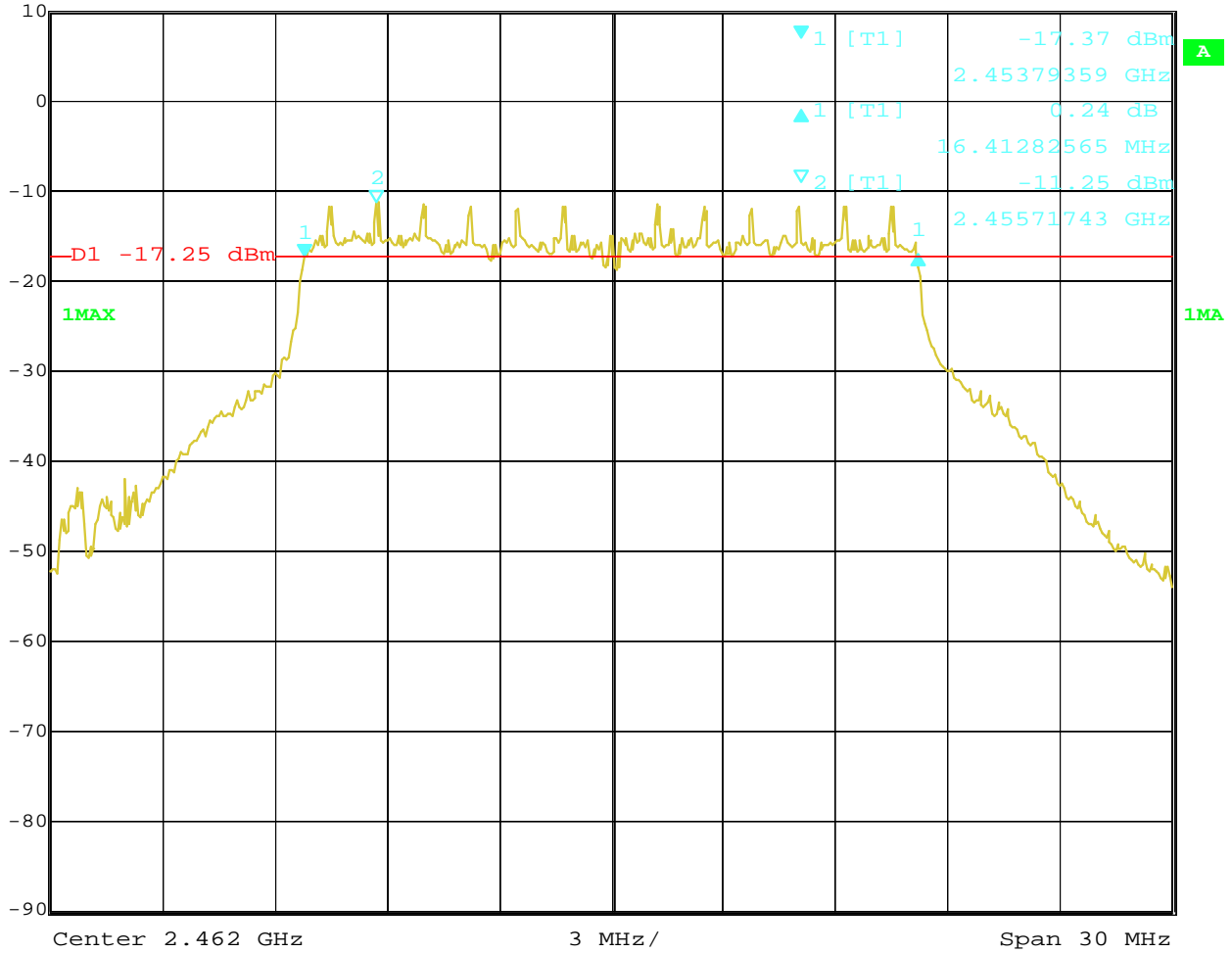

Date: 15.JUN.2022 14:09:18

The report refers only to the sample tested and does not apply to the bulk.
 This report is issued in confidence to the client and it will be strictly treated as such by the SHENZHEN TIMEWAY TESTING LABORATORIES. It may not be reproduced rather in its entirety or in part and it may not be used for advertising. The client to whom the report is issued may, however, show or send it or a certified copy thereof prepared by the SHENZHEN TIMEWAY TESTING LABORATORIES to his customer. Supplier or others persons directly concerned. SHENZHEN TIMEWAY TESTING LABORATORIES will not, without the consent of the client enter into any discussion of correspondence with any third party concerning the contents of the report.
 In the event of the improper use of the report. The SHENZHEN TIMEWAY TESTING LABORATORIES reserves the rights to withdraw it and to adopt any other remedies which may be appropriate.



6dB Occupied Bandwidth

EUT		Tablet PC		Model	ST8888
Mode		802.11n HT20		Test Voltage	DC3.7V
Temperature		24 deg. C,		Humidity	56% RH
Channel	Channel Frequency (MHz)	Data Transfer Rate (Mbps)	6 dB Bandwidth (MHz)	Minimum Limit (MHz)	Pass/ Fail
1	2412	mcs0	17.56	0.5	Pass
6	2437	mcs0	17.56	0.5	Pass
11	2462	mcs0	17.56	0.5	Pass

The report refers only to the sample tested and does not apply to the bulk.
 This report is issued in confidence to the client and it will be strictly treated as such by the SHENZHEN TIMEWAY TESTING LABORATORIES. It may not be reproduced rather in its entirety or in part and it may not be used for advertizing. The client to whom the report is issued may, however, show or send it . or a certified copy there of prepared by the SHENZHEN TIMEWAY TESTING LABORATORIES. to his customer. Supplier or others persons directly concerned. SHENZHEN TIMEWAY TESTING LABORATORIES. will not, without the consent of the client enter into any discussion of correspondence with any third party concerning the contents of the report.
 In the event of the improper use of the report. The SHENZHEN TIMEWAY TESTING LABORATORIES. reserves the rights to withdraw it and to adopt any other remedies which may be appropriate.



Test Plots:

1. 802.11n at HT20 of CH01

	Delta 1 [T1]	RBW	100 kHz	RF Att	20 dB
	Ref Lvl	0.24 dB	VBW	300 kHz	
	10 dBm	17.55511022 MHz	SWT	7.5 ms	Unit dBm

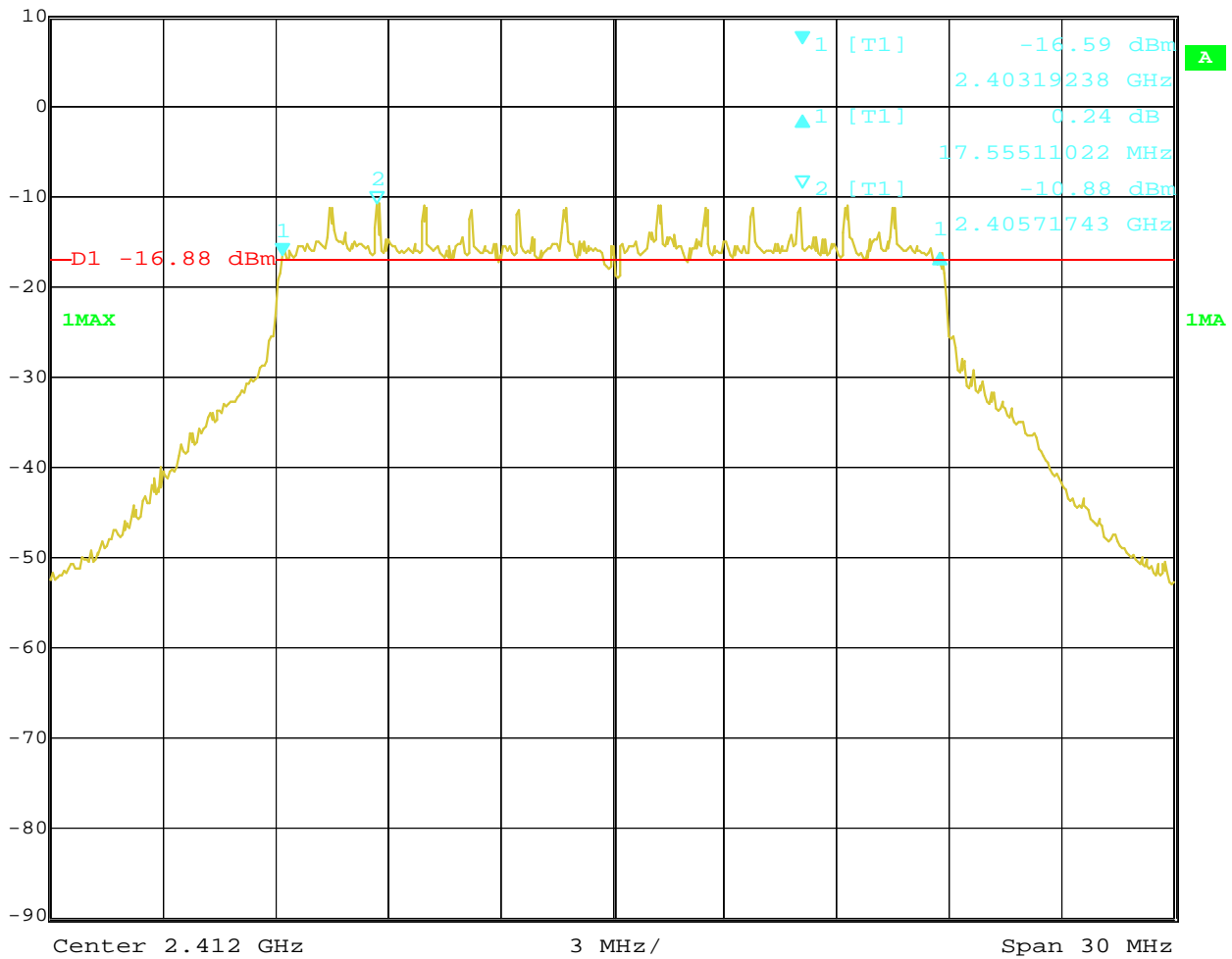

Date: 15.JUN.2022 14:30:17

The report refers only to the sample tested and does not apply to the bulk.
 This report is issued in confidence to the client and it will be strictly treated as such by the SHENZHEN TIMEWAY TESTING LABORATORIES. It may not be reproduced rather in its entirety or in part and it may not be used for advertising. The client to whom the report is issued may, however, show or send it or a certified copy thereof prepared by the SHENZHEN TIMEWAY TESTING LABORATORIES to his customer. Supplier or others persons directly concerned. SHENZHEN TIMEWAY TESTING LABORATORIES will not, without the consent of the client enter into any discussion of correspondence with any third party concerning the contents of the report.
 In the event of the improper use of the report. The SHENZHEN TIMEWAY TESTING LABORATORIES reserves the rights to withdraw it and to adopt any other remedies which may be appropriate.



2. 802.11n at HT20 of CH06

	Delta 1 [T1]	RBW	100 kHz	RF Att	20 dB
	Ref Lvl	0.19 dB	VBW	300 kHz	
	10 dBm	17.55511022 MHz	SWT	7.5 ms	Unit dBm

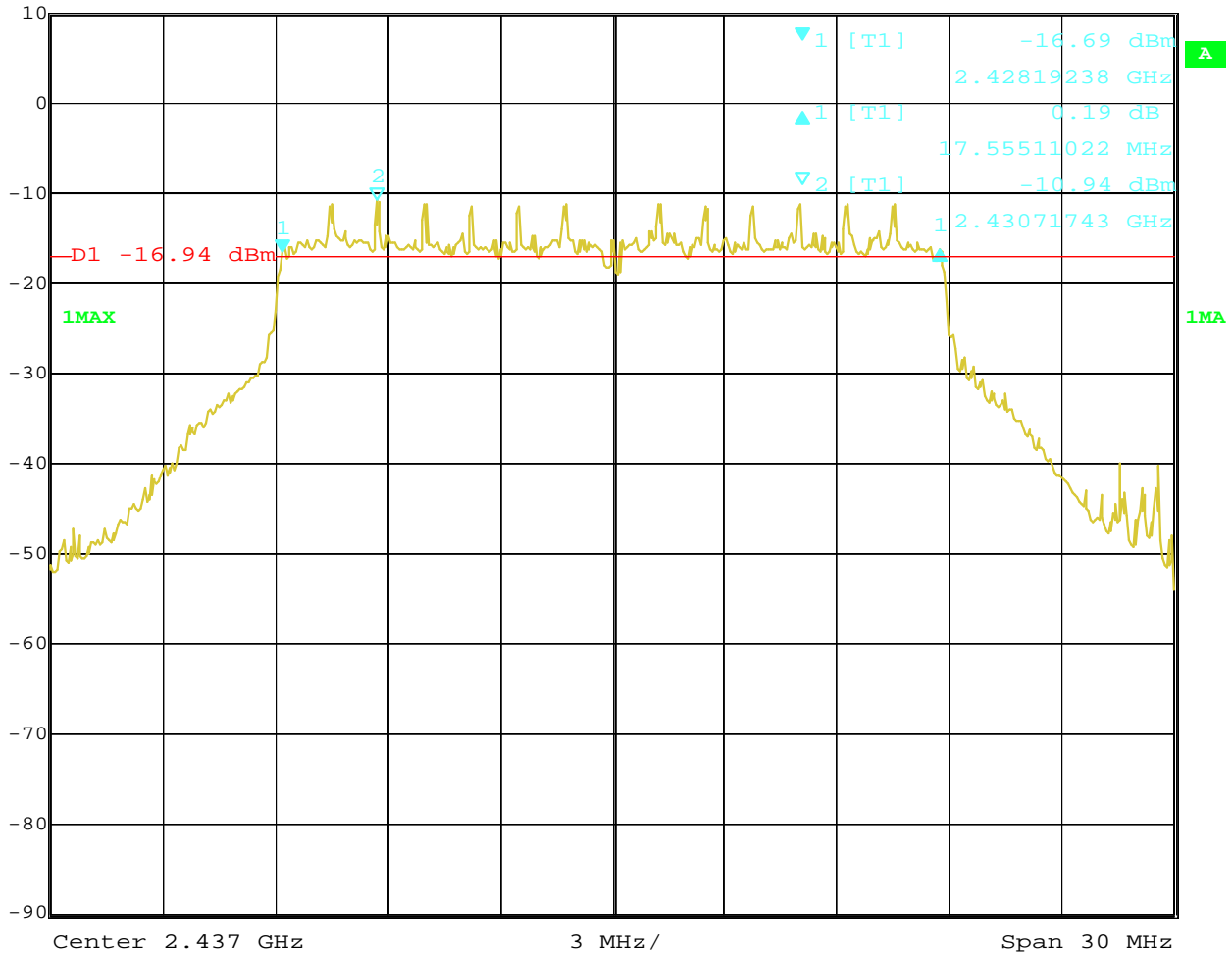

Date: 15.JUN.2022 14:27:06

The report refers only to the sample tested and does not apply to the bulk.
 This report is issued in confidence to the client and it will be strictly treated as such by the SHENZHEN TIMEWAY TESTING LABORATORIES. It may not be reproduced rather in its entirety or in part and it may not be used for advertising. The client to whom the report is issued may, however, show or send it or a certified copy thereof prepared by the SHENZHEN TIMEWAY TESTING LABORATORIES to his customer. Supplier or others persons directly concerned. SHENZHEN TIMEWAY TESTING LABORATORIES will not, without the consent of the client enter into any discussion of correspondence with any third party concerning the contents of the report.
 In the event of the improper use of the report. The SHENZHEN TIMEWAY TESTING LABORATORIES reserves the rights to withdraw it and to adopt any other remedies which may be appropriate.



3. 802.11n at HT20 of CH11

	Delta 1 [T1]	RBW	100 kHz	RF Att	20 dB
	Ref Lvl	-0.69 dB	VBW	300 kHz	
	10 dBm	17.55511022 MHz	SWT	7.5 ms	Unit

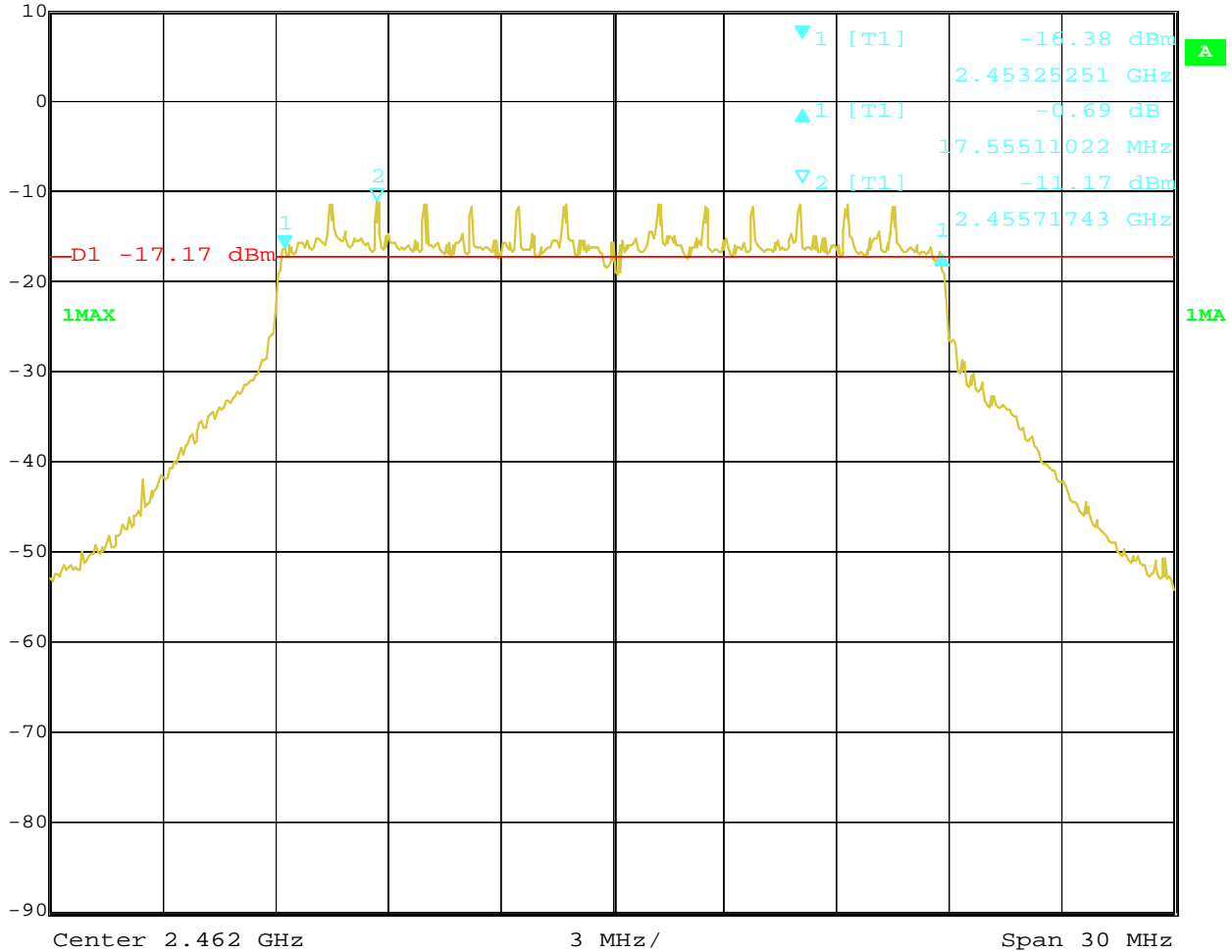

Date: 15.JUN.2022 14:49:25

The report refers only to the sample tested and does not apply to the bulk.
 This report is issued in confidence to the client and it will be strictly treated as such by the SHENZHEN TIMEWAY TESTING LABORATORIES. It may not be reproduced rather in its entirety or in part and it may not be used for advertising. The client to whom the report is issued may, however, show or send it or a certified copy thereof prepared by the SHENZHEN TIMEWAY TESTING LABORATORIES to his customer. Supplier or others persons directly concerned. SHENZHEN TIMEWAY TESTING LABORATORIES will not, without the consent of the client enter into any discussion of correspondence with any third party concerning the contents of the report.
 In the event of the improper use of the report. The SHENZHEN TIMEWAY TESTING LABORATORIES reserves the rights to withdraw it and to adopt any other remedies which may be appropriate.



6dB Occupied Bandwidth

EUT		Tablet PC		Model	ST8888
Mode		802.11n HT40		Test Voltage	DC3.7V
Temperature		24 deg. C,		Humidity	56% RH
Channel	Channel Frequency (MHz)	Data Transfer Rate (Mbps)	6 dB Bandwidth (MHz)	Minimum Limit (MHz)	Pass/ Fail
3	2422	mcs0	35.99	0.5	Pass
6	2437	mcs0	35.99	0.5	Pass
9	2452	mcs0	35.99	0.5	Pass

The report refers only to the sample tested and does not apply to the bulk.
 This report is issued in confidence to the client and it will be strictly treated as such by the SHENZHEN TIMEWAY TESTING LABORATORIES. It may not be reproduced rather in its entirety or in part and it may not be used for advertizing. The client to whom the report is issued may, however, show or send it . or a certified copy there of prepared by the SHENZHEN TIMEWAY TESTING LABORATORIES. to his customer. Supplier or others persons directly concerned. SHENZHEN TIMEWAY TESTING LABORATORIES. will not, without the consent of the client enter into any discussion of correspondence with any third party concerning the contents of the report.
 In the event of the improper use of the report. The SHENZHEN TIMEWAY TESTING LABORATORIES. reserves the rights to withdraw it and to adopt any other remedies which may be appropriate.



Test Plots:

1. 802.11n at HT40 of CH3

	Delta 1 [T1]	RBW	100 kHz	RF Att	20 dB
	Ref Lvl	-0.64 dB	VBW	300 kHz	
	10 dBm	35.99198397 MHz	SWT	12.5 ms	Unit

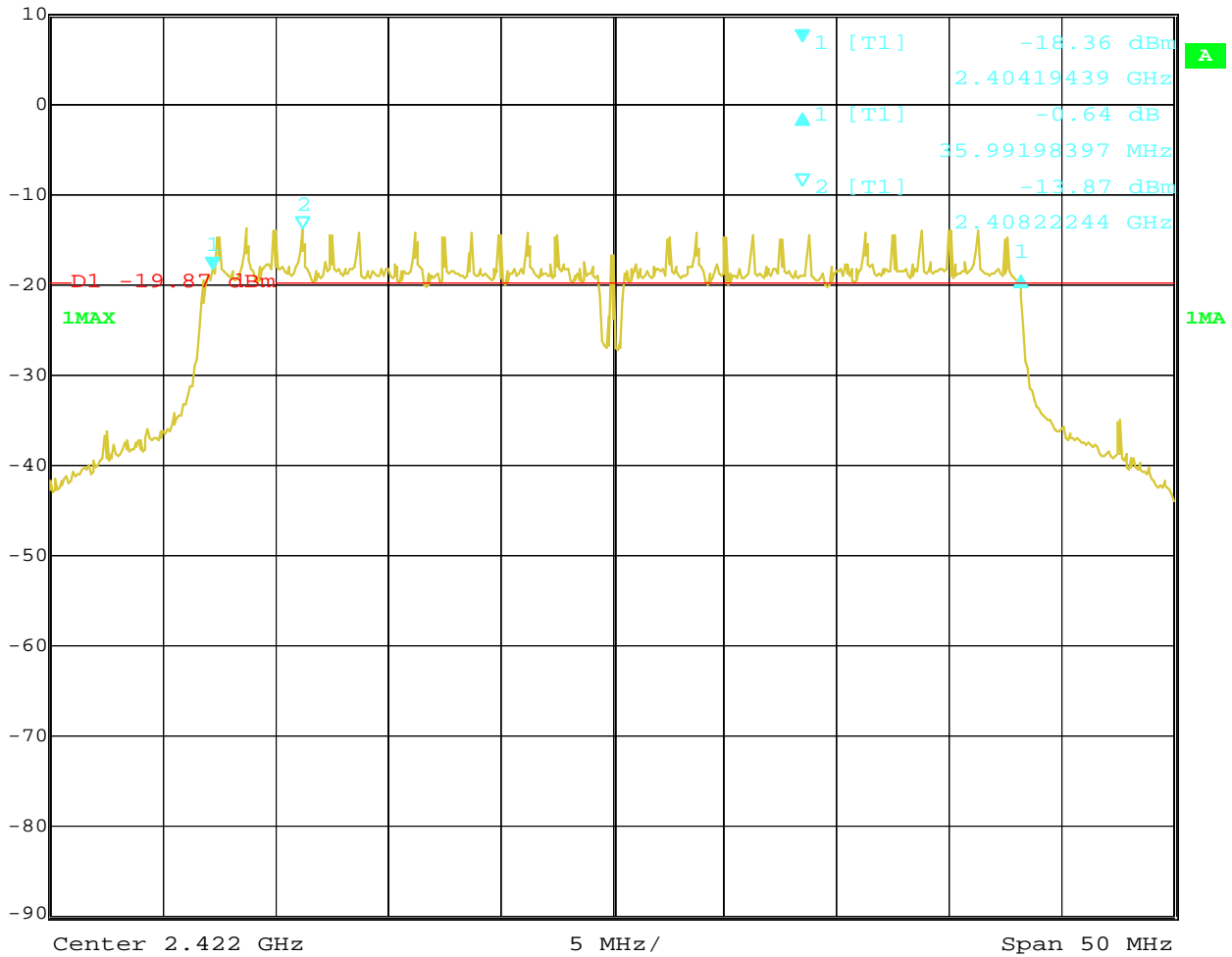

Date: 15.JUN.2022 14:36:28

The report refers only to the sample tested and does not apply to the bulk.
 This report is issued in confidence to the client and it will be strictly treated as such by the SHENZHEN TIMEWAY TESTING LABORATORIES. It may not be reproduced rather in its entirety or in part and it may not be used for advertising. The client to whom the report is issued may, however, show or send it . or a certified copy there of prepared by the SHENZHEN TIMEWAY TESTING LABORATORIES. to his customer. Supplier or others persons directly concerned. SHENZHEN TIMEWAY TESTING LABORATORIES. will not, without the consent of the client enter into any discussion of correspondence with any third party concerning the contents of the report.
 In the event of the improper use of the report. The SHENZHEN TIMEWAY TESTING LABORATORIES. reserves the rights to withdraw it and to adopt any other remedies which may be appropriate.



2. 802.11n at HT40 of CH06



Delta 1 [T1]	RBW	100 kHz	RF Att	20 dB
Ref Lvl	-0.73 dB	VBW	300 kHz	
10 dBm	35.99198397 MHz	SWT	12.5 ms	Unit dBm

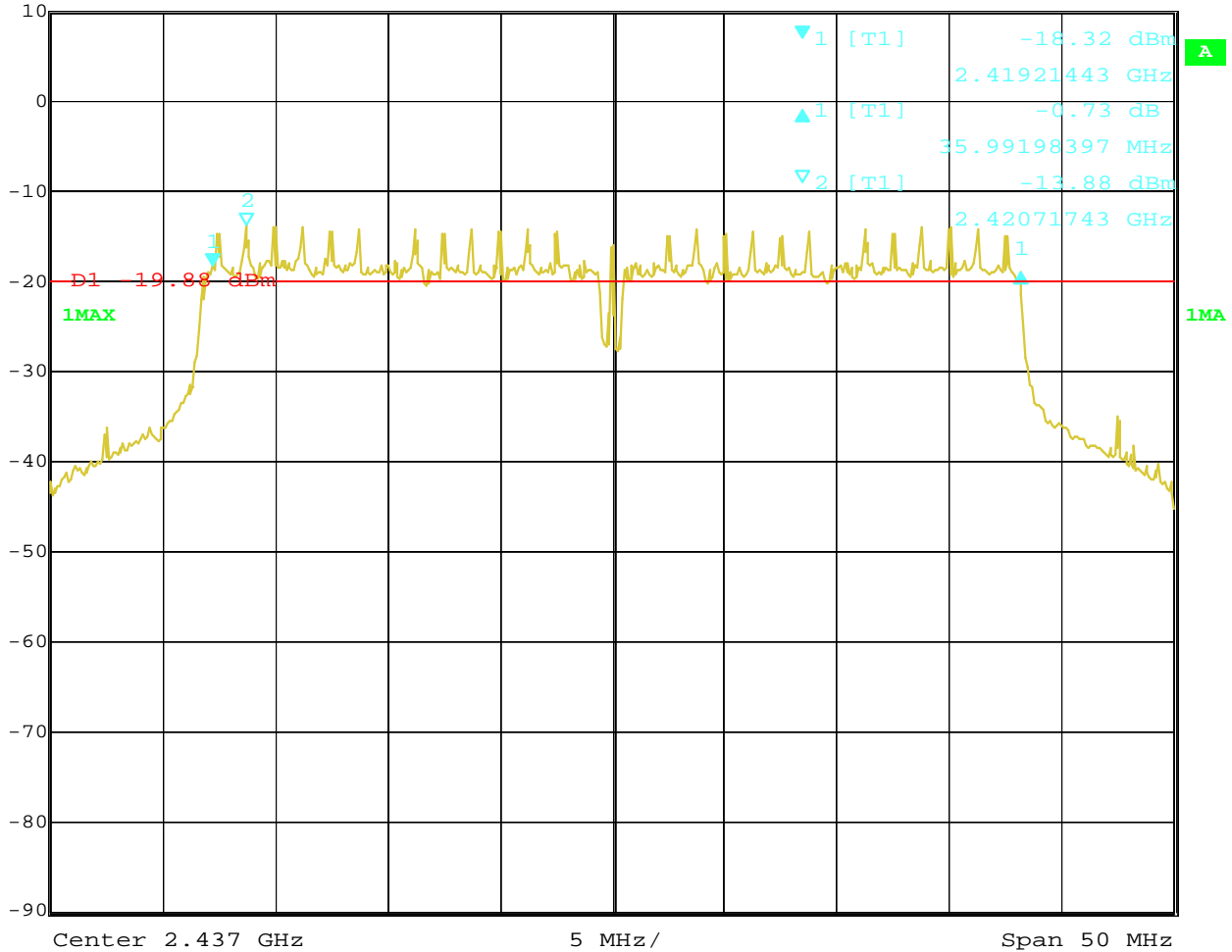

Date: 15.JUN.2022 14:42:26

The report refers only to the sample tested and does not apply to the bulk.
 This report is issued in confidence to the client and it will be strictly treated as such by the SHENZHEN TIMEWAY TESTING LABORATORIES. It may not be reproduced rather in its entirety or in part and it may not be used for advertising. The client to whom the report is issued may, however, show or send it . or a certified copy there of prepared by the SHENZHEN TIMEWAY TESTING LABORATORIES. to his customer. Supplier or others persons directly concerned. SHENZHEN TIMEWAY TESTING LABORATORIES. will not, without the consent of the client enter into any discussion of correspondence with any third party concerning the contents of the report.
 In the event of the improper use of the report. The SHENZHEN TIMEWAY TESTING LABORATORIES. reserves the rights to withdraw it and to adopt any other remedies which may be appropriate.



3. 802.11n at HT40 of CH09

	Delta 1 [T1]	RBW	100 kHz	RF Att	20 dB
	Ref Lvl	-1.06 dB	VBW	300 kHz	
	10 dBm	35.99198397 MHz	SWT	12.5 ms	Unit dBm

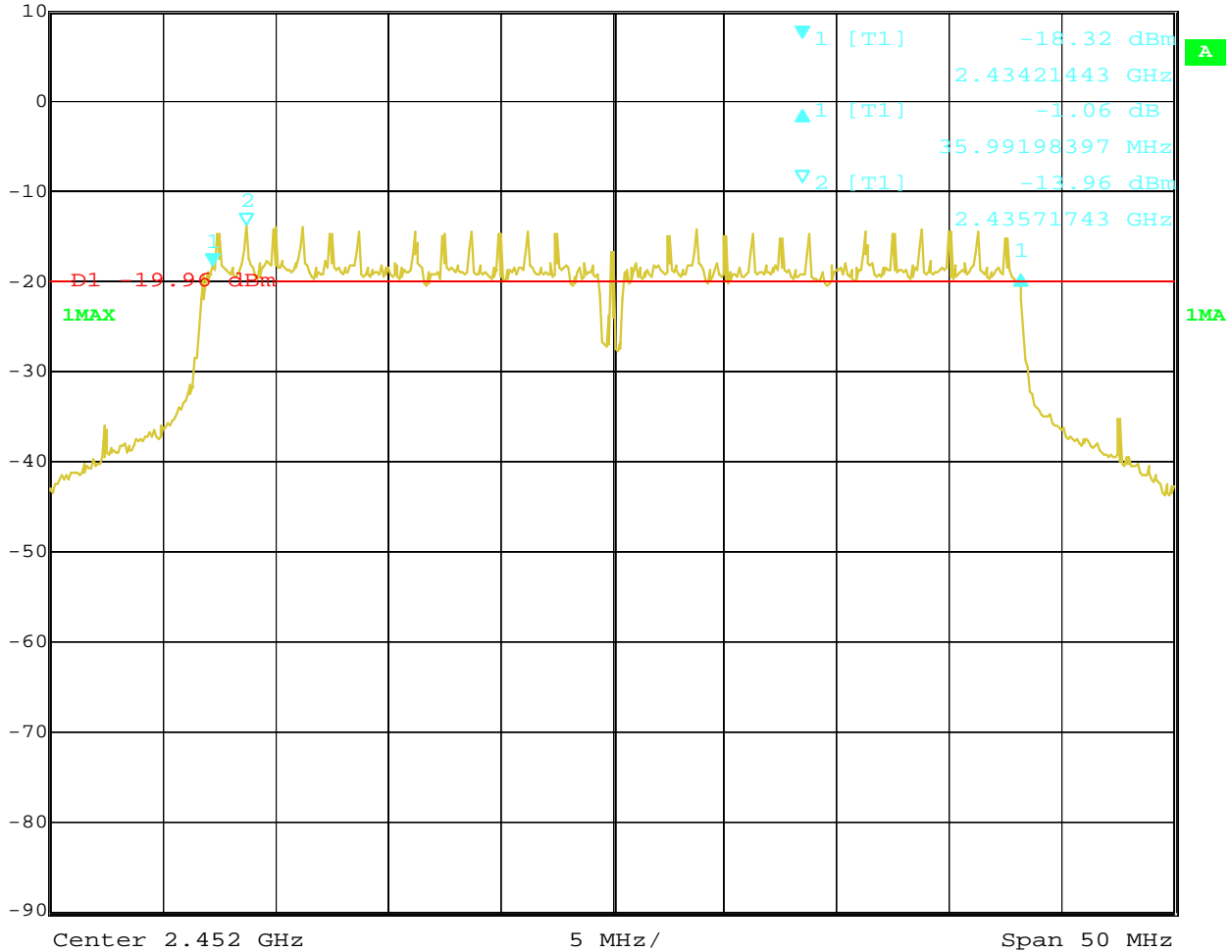

Date: 15.JUN.2022 14:47:21

The report refers only to the sample tested and does not apply to the bulk.
 This report is issued in confidence to the client and it will be strictly treated as such by the SHENZHEN TIMEWAY TESTING LABORATORIES. It may not be reproduced rather in its entirety or in part and it may not be used for advertising. The client to whom the report is issued may, however, show or send it . or a certified copy there of prepared by the SHENZHEN TIMEWAY TESTING LABORATORIES. to his customer. Supplier or others persons directly concerned. SHENZHEN TIMEWAY TESTING LABORATORIES. will not, without the consent of the client enter into any discussion of correspondence with any third party concerning the contents of the report.
 In the event of the improper use of the report. The SHENZHEN TIMEWAY TESTING LABORATORIES. reserves the rights to withdraw it and to adopt any other remedies which may be appropriate.



8. Maximum Output Power

8.1 Test Setup

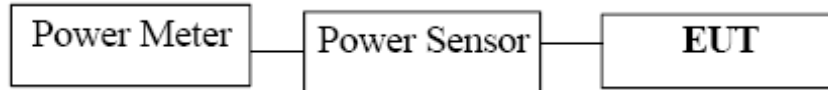

8.2 Limits of Maximum Output Power

The Maximum Output Power Measurement is 30dBm.

8.3 Test Procedure

The RF power output was measured with a Power meter connected to the RF Antenna connector (conducted measurement) while EUT was operating in transmit mode at the appropriate centre frequency.

Note: The Peak power was measured

The report refers only to the sample tested and does not apply to the bulk.

This report is issued in confidence to the client and it will be strictly treated as such by the SHENZHEN TIMEWAY TESTING LABORATORIES. It may not be reproduced rather in its entirety or in part and it may not be used for advertising. The client to whom the report is issued may, however, show or send it or a certified copy thereof prepared by the SHENZHEN TIMEWAY TESTING LABORATORIES to his customer. Supplier or others persons directly concerned. SHENZHEN TIMEWAY TESTING LABORATORIES will not, without the consent of the client enter into any discussion of correspondence with any third party concerning the contents of the report.

In the event of the improper use of the report. The SHENZHEN TIMEWAY TESTING LABORATORIES reserves the rights to withdraw it and to adopt any other remedies which may be appropriate.



8.4 Test Results

EUT		Tablet PC		Model	ST8888
Mode		802.11b		Test Voltage	DC3.7V
Temperature		24 deg. C,		Humidity	56% RH
Channel	Frequency (MHz)	PK Power (dBm)		Power Limit (dBm)	Pass/ Fail
1	2412	2.67		30	Pass
6	2437	2.56		30	Pass
11	2462	2.23		30	Pass

- Note: 1. At final test to get the worst-case emission at 1Mbps for CH01, CH06 and CH11
 2. The result basic equation calculation as follow:
 Power Output = Power Reading + Cable loss + Attenuator
 3. The worse case was recorded

EUT		Tablet PC		Model	ST8888
Mode		802.11g		Test Voltage	DC3.7V
Temperature		24 deg. C,		Humidity	56% RH
Channel	Frequency (MHz)	PK Power (dBm)		Power Limit (dBm)	Pass/ Fail
1	2412	2.52		30	Pass
6	2437	2.53		30	Pass
11	2462	2.28		30	Pass

- Note: 1. At final test to get the worst-case emission at 6Mbps for CH01, CH06 and CH11
 2. The result basic equation calculation as follow:
 Power Output = Power Reading + Cable loss + Attenuator
 3. The worse case was recorded

The report refers only to the sample tested and does not apply to the bulk.
 This report is issued in confidence to the client and it will be strictly treated as such by the SHENZHEN TIMEWAY TESTING LABORATORIES. It may not be reproduced rather in its entirety or in part and it may not be used for advertising. The client to whom the report is issued may, however, show or send it . or a certified copy there of prepared by the SHENZHEN TIMEWAY TESTING LABORATORIES. to his customer. Supplier or others persons directly concerned. SHENZHEN TIMEWAY TESTING LABORATORIES. will not, without the consent of the client enter into any discussion of correspondence with any third party concerning the contents of the report.
 In the event of the improper use of the report. The SHENZHEN TIMEWAY TESTING LABORATORIES. reserves the rights to withdraw it and to adopt any other remedies which may be appropriate.



EUT		Tablet PC		Model	ST8888
Mode		802.11n (HT20)		Test Voltage	DC3.7V
Temperature		24 deg. C,		Humidity	56% RH
Channel	Frequency (MHz)	PK Power (dBm)		Power Limit (dBm)	Pass/ Fail
1	2412	2.47		30	Pass
6	2437	2.48		30	Pass
11	2462	2.21		30	Pass

- Note: 1. At final test to get the worst-case emission at mcs0 of 11n HT20 for CH01, CH06 and CH11
 2. The result basic equation calculation as follow:
 Power Output = Power Reading + Cable loss + Attenuator
 3. The worse case was recorded

EUT		Tablet PC		Model	ST8888
Mode		802.11n (HT40)		Test Voltage	DC3.7V
Temperature		24 deg. C,		Humidity	56% RH
Channel	Frequency (MHz)	PK Power (dBm)		Power Limit (dBm)	Pass/ Fail
3	2422	2.33		30	Pass
6	2437	2.30		30	Pass
9	2452	2.15		30	Pass

- Note: 1. At final test to get the worst-case emission at msc0 of 11n HT40 for CH03, CH06 and CH09
 2. The result basic equation calculation as follow:
 Power Output = Power Reading + Cable loss + Attenuator
 3. The worse case was recorded

The report refers only to the sample tested and does not apply to the bulk.
 This report is issued in confidence to the client and it will be strictly treated as such by the SHENZHEN TIMEWAY TESTING LABORATORIES. It may not be reproduced rather in its entirety or in part and it may not be used for advertising. The client to whom the report is issued may, however, show or send it or a certified copy thereof prepared by the SHENZHEN TIMEWAY TESTING LABORATORIES to his customer. Supplier or others persons directly concerned. SHENZHEN TIMEWAY TESTING LABORATORIES will not, without the consent of the client enter into any discussion of correspondence with any third party concerning the contents of the report.
 In the event of the improper use of the report. The SHENZHEN TIMEWAY TESTING LABORATORIES reserves the rights to withdraw it and to adopt any other remedies which may be appropriate.



9. Power Spectral Density Measurement

9.1 Test Setup

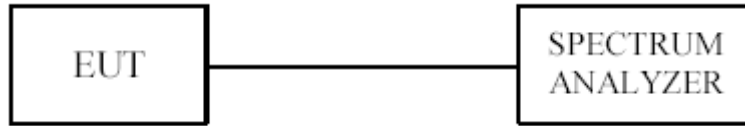

9.2 Limits of Power Spectral Density Measurement

The Maximum Power Spectral Density Measurement is 8dBm/3kHz.

9.3 Test Procedure

1. Use this procedure when the maximum peak conducted output power in the fundamental emission is used to demonstrate compliance.
2. Set the RBW = 10 kHz.
3. Set the VBW \geq 30 kHz.
4. Set the span to 1.5 times the DTS channel bandwidth.
5. Detector = peak.
6. Sweep time = auto couple.
7. Trace mode = max hold.
8. Allow trace to fully stabilize.
9. Use the peak marker function to determine the maximum amplitude level.
10. If measured value exceeds limit, reduce RBW (no less than 3 kHz) and repeat.
11. The resulting peak PSD level must be \leq 8 dBm/3kHz.

The report refers only to the sample tested and does not apply to the bulk.

This report is issued in confidence to the client and it will be strictly treated as such by the SHENZHEN TIMEWAY TESTING LABORATORIES. It may not be reproduced rather in its entirety or in part and it may not be used for advertising. The client to whom the report is issued may, however, show or send it, or a certified copy thereof prepared by the SHENZHEN TIMEWAY TESTING LABORATORIES, to his customer. Supplier or others persons directly concerned. SHENZHEN TIMEWAY TESTING LABORATORIES, will not, without the consent of the client enter into any discussion of correspondence with any third party concerning the contents of the report.

In the event of the improper use of the report. The SHENZHEN TIMEWAY TESTING LABORATORIES, reserves the rights to withdraw it and to adopt any other remedies which may be appropriate.



9.4 Test Result

EUT		Tablet PC		Model	ST8888
Mode		802.11b 11Mbps		Test Voltage	DC3.7V
Temperature		24 deg. C,		Humidity	56% RH
Channel	Frequency (MHz)	Power Spectral Density (dBm/10kHz)		Limit (dBm/3kHz)	Pass/ Fail
1	2412	-16.20		8	Pass
6	2437	-16.26		8	Pass
11	2462	-16.79		8	Pass

EUT		Tablet PC		Model	ST8888
Mode		802.11b 1Mbps		Test Voltage	DC3.7V
Temperature		24 deg. C,		Humidity	56% RH
Channel	Frequency (MHz)	Power Spectral Density (dBm/10kHz)		Limit (dBm/3kHz)	Pass/ Fail
1	2412	-15.89		8	Pass
6	2437	-16.07		8	Pass
11	2462	-15.88		8	Pass

EUT		Tablet PC		Model	ST8888
Mode		802.11g 6Mbps		Test Voltage	DC3.7V
Temperature		24 deg. C,		Humidity	56% RH
Channel	Frequency (MHz)	Power Spectral Density (dBm/10kHz)		Limit (dBm/3kHz)	Pass/ Fail
1	2412	-18.46		8	Pass
6	2437	-18.61		8	Pass
11	2462	-19.04		8	Pass

The report refers only to the sample tested and does not apply to the bulk.
 This report is issued in confidence to the client and it will be strictly treated as such by the SHENZHEN TIMEWAY TESTING LABORATORIES. It may not be reproduced rather in its entirety or in part and it may not be used for advertising. The client to whom the report is issued may, however, show or send it or a certified copy thereof prepared by the SHENZHEN TIMEWAY TESTING LABORATORIES to his customer. Supplier or others persons directly concerned. SHENZHEN TIMEWAY TESTING LABORATORIES will not, without the consent of the client enter into any discussion of correspondence with any third party concerning the contents of the report.
 In the event of the improper use of the report. The SHENZHEN TIMEWAY TESTING LABORATORIES reserves the rights to withdraw it and to adopt any other remedies which may be appropriate.



EUT		Tablet PC		Model	ST8888
Mode		802.11n HT20 mcs0		Test Voltage	DC3.7V
Temperature		24 deg. C,		Humidity	56% RH
Channel	Frequency (MHz)	Power Spectral Density (dBm/10kHz)		Limit (dBm/3kHz)	Pass/ Fail
1	2412	-19.19		8	Pass
6	2437	-19.19		8	Pass
11	2462	-18.89		8	Pass

EUT		Tablet PC		Model	ST8888
Mode		802.11n HT40 mcs0		Test Voltage	DC3.7V
Temperature		24 deg. C,		Humidity	56% RH
Channel	Frequency (MHz)	Power Spectral Density (dBm/10kHz)		Limit (dBm/3kHz)	Pass/ Fail
3	2422	-18.63		8	Pass
6	2437	-19.50		8	Pass
9	2452	-19.04		8	Pass

The report refers only to the sample tested and does not apply to the bulk.
 This report is issued in confidence to the client and it will be strictly treated as such by the SHENZHEN TIMEWAY TESTING LABORATORIES. It may not be reproduced rather in its entirety or in part and it may not be used for advertising. The client to whom the report is issued may, however, show or send it . or a certified copy there of prepared by the SHENZHEN TIMEWAY TESTING LABORATORIES. to his customer. Supplier or others persons directly concerned. SHENZHEN TIMEWAY TESTING LABORATORIES. will not, without the consent of the client enter into any discussion of correspondence with any third party concerning the contents of the report.
 In the event of the improper use of the report. The SHENZHEN TIMEWAY TESTING LABORATORIES. reserves the rights to withdraw it and to adopt any other remedies which may be appropriate.



9.5 Photo of Power Spectral Density Measurement

1.802.11b at 11Mbps of CH01

	Marker 1 [T1]	RBW	10 kHz	RF Att	20 dB
	Ref Lvl	-16.20 dBm	VBW	30 kHz	
	10 dBm	2.41348756 GHz	SWT	350 ms	Unit dBm

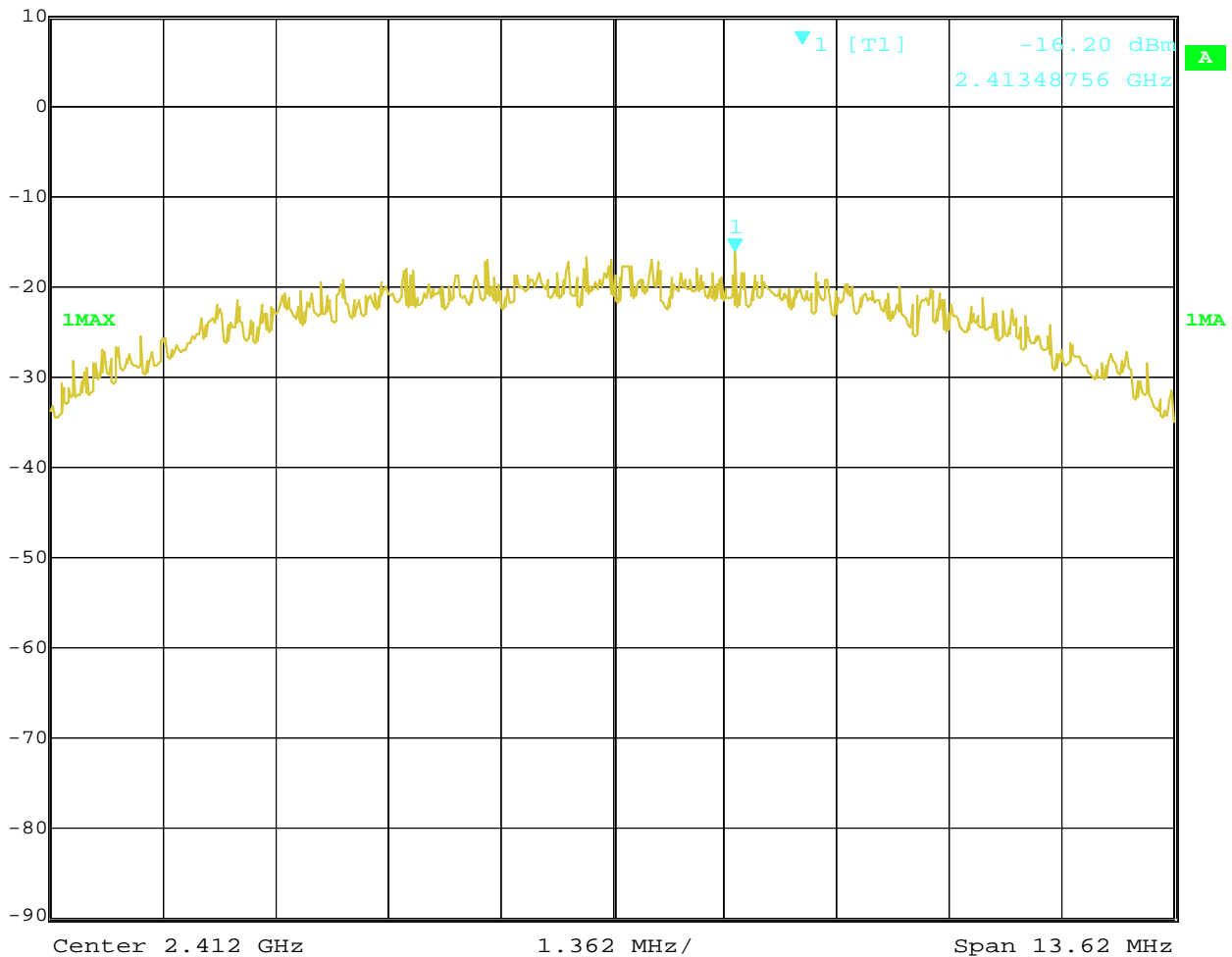

Date: 15.JUN.2022 15:51:32

The report refers only to the sample tested and does not apply to the bulk.
 This report is issued in confidence to the client and it will be strictly treated as such by the SHENZHEN TIMEWAY TESTING LABORATORIES. It may not be reproduced rather in its entirety or in part and it may not be used for advertising. The client to whom the report is issued may, however, show or send it . or a certified copy there of prepared by the SHENZHEN TIMEWAY TESTING LABORATORIES. to his customer. Supplier or others persons directly concerned. SHENZHEN TIMEWAY TESTING LABORATORIES. will not, without the consent of the client enter into any discussion of correspondence with any third party concerning the contents of the report.
 In the event of the improper use of the report. The SHENZHEN TIMEWAY TESTING LABORATORIES. reserves the rights to withdraw it and to adopt any other remedies which may be appropriate.



2. 802.11b at 11Mbps at CH06

	Marker 1 [T1]	RBW	10 kHz	RF Att	20 dB
	Ref Lvl	-16.26 dBm	VBW	30 kHz	
	10 dBm	2.43848756 GHz	SWT	350 ms	Unit dBm

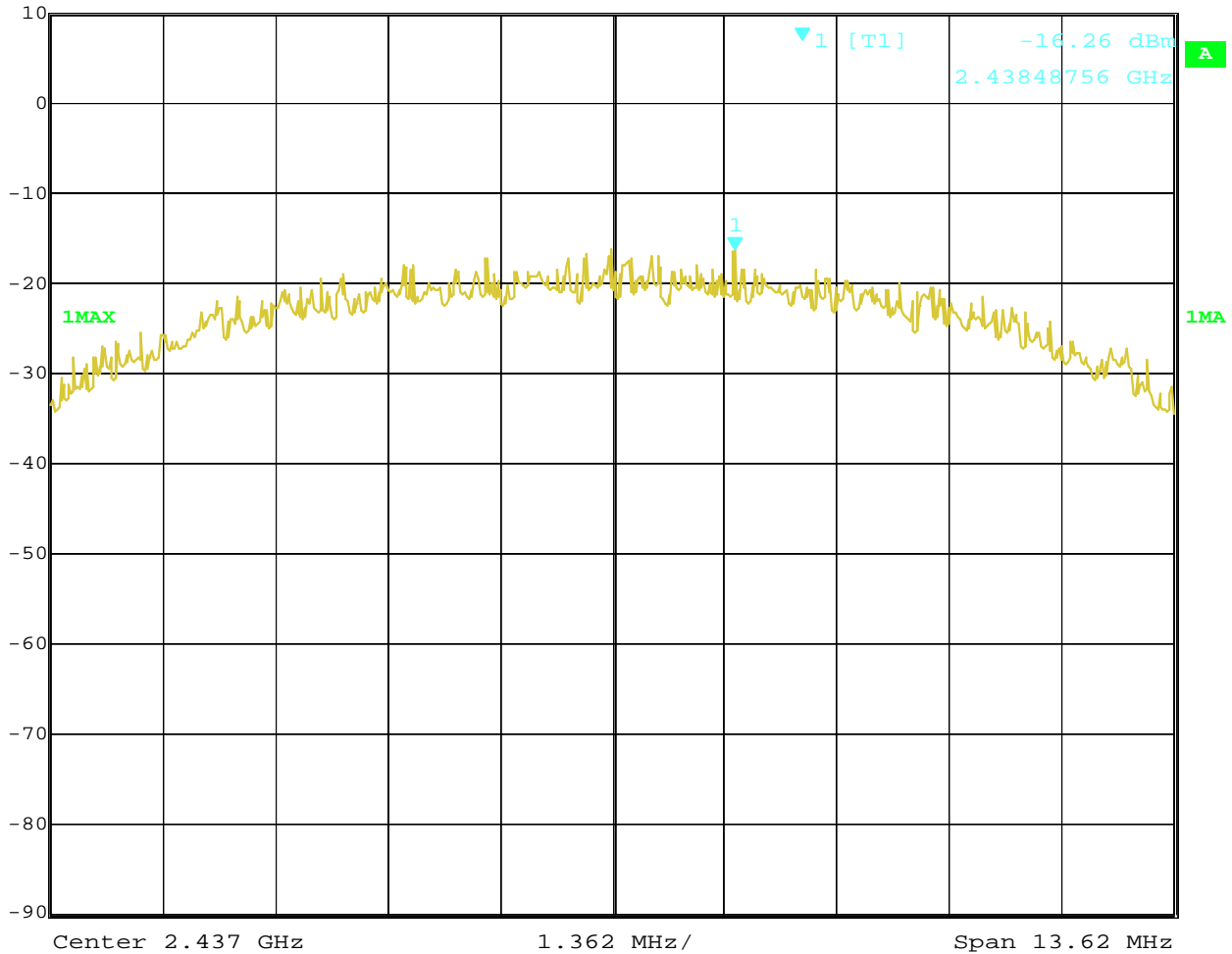

Date: 15.JUN.2022 15:50:19

The report refers only to the sample tested and does not apply to the bulk.
 This report is issued in confidence to the client and it will be strictly treated as such by the SHENZHEN TIMEWAY TESTING LABORATORIES. It may not be reproduced rather in its entirety or in part and it may not be used for adverting. The client to whom the report is issued may, however, show or send it . or a certified copy there of prepared by the SHENZHEN TIMEWAY TESTING LABORATORIES. to his customer. Supplier or others persons directly concerned. SHENZHEN TIMEWAY TESTING LABORATORIES. will not, without the consent of the client enter into any discussion of correspondence with any third party concerning the contents of the report.
 In the event of the improper use of the report. The SHENZHEN TIMEWAY TESTING LABORATORIES. reserves the rights to withdraw it and to adopt any other remedies which may be appropriate.



3. 802.11b at 11Mbps of CH11

	Marker 1 [T1]	RBW	10 kHz	RF Att	20 dB
	Ref Lvl	-16.79 dBm	VBW	30 kHz	
	10 dBm	2.46198635 GHz	SWT	350 ms	Unit dBm

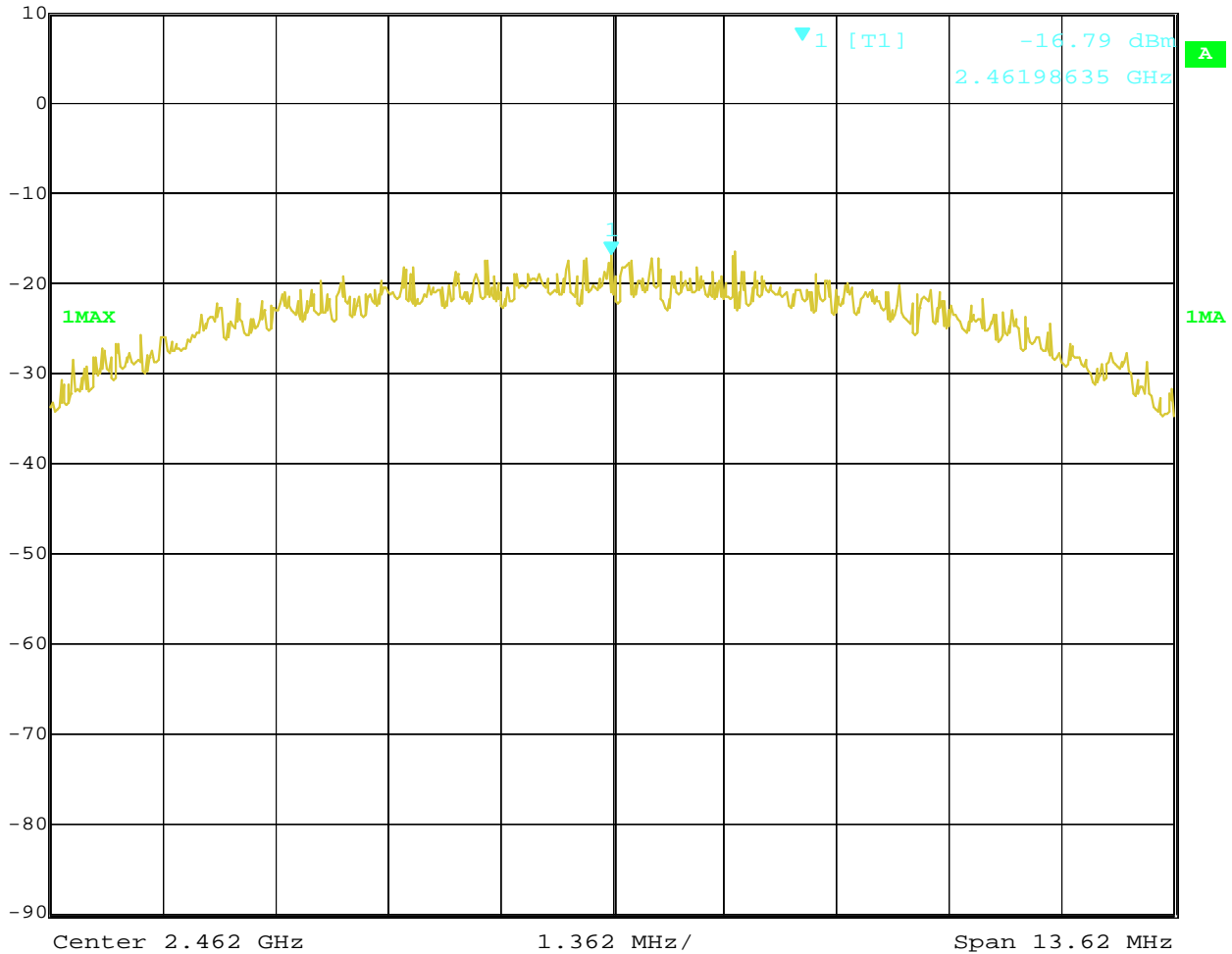

Date: 15.JUN.2022 15:48:56

The report refers only to the sample tested and does not apply to the bulk.
 This report is issued in confidence to the client and it will be strictly treated as such by the SHENZHEN TIMEWAY TESTING LABORATORIES. It may not be reproduced rather in its entirety or in part and it may not be used for advertising. The client to whom the report is issued may, however, show or send it . or a certified copy there of prepared by the SHENZHEN TIMEWAY TESTING LABORATORIES. to his customer. Supplier or others persons directly concerned. SHENZHEN TIMEWAY TESTING LABORATORIES. will not, without the consent of the client enter into any discussion of correspondence with any third party concerning the contents of the report.
 In the event of the improper use of the report. The SHENZHEN TIMEWAY TESTING LABORATORIES. reserves the rights to withdraw it and to adopt any other remedies which may be appropriate.



4. 802.11b at 1Mbps of CH1

	Marker 1 [T1]	RBW	10 kHz	RF Att	20 dB
	Ref Lvl	-15.89 dBm	VBW	30 kHz	
	10 dBm	2.41117004 GHz	SWT	380 ms	Unit dBm

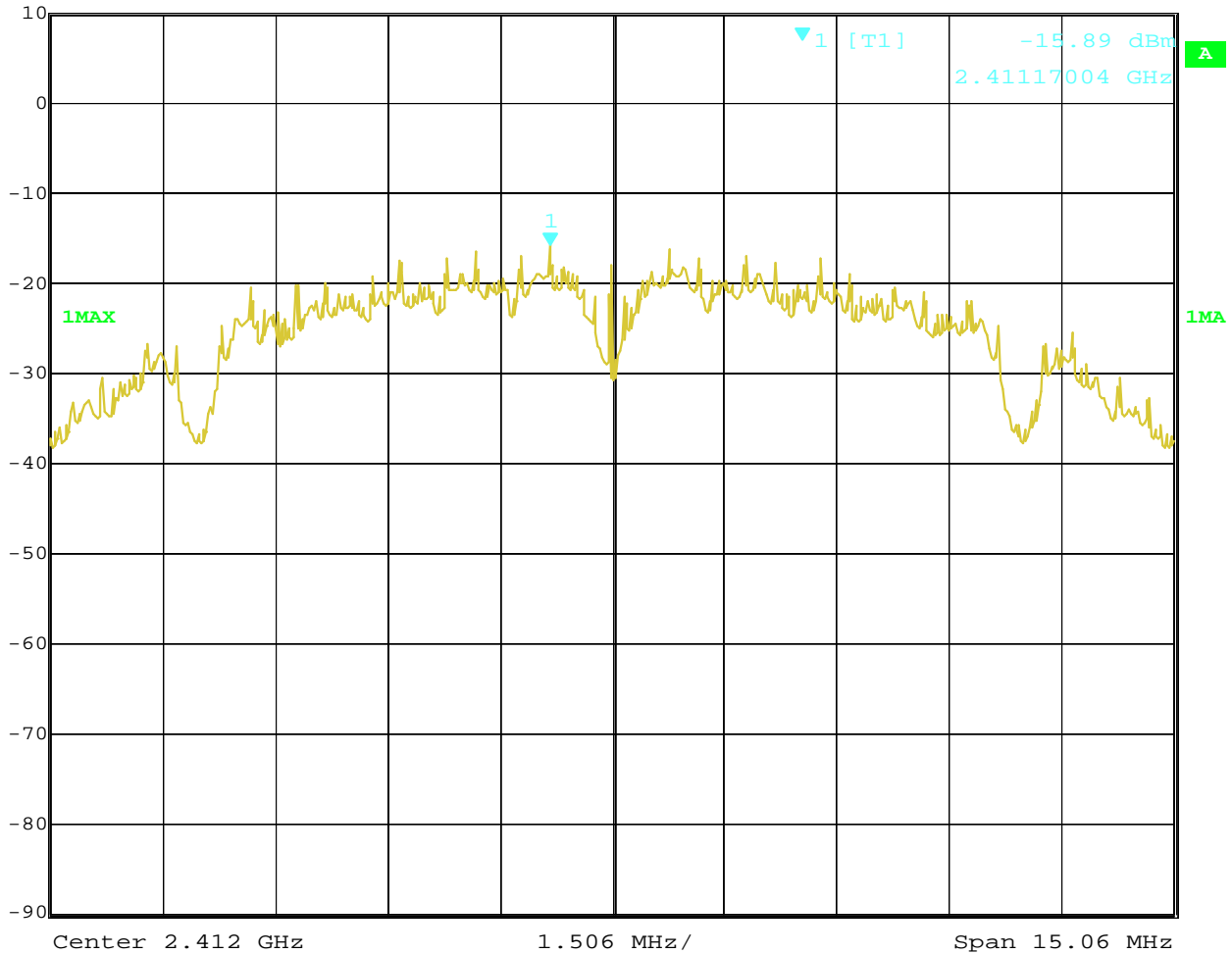

Date: 15.JUN.2022 15:57:17

The report refers only to the sample tested and does not apply to the bulk.
 This report is issued in confidence to the client and it will be strictly treated as such by the SHENZHEN TIMEWAY TESTING LABORATORIES. It may not be reproduced rather in its entirety or in part and it may not be used for advertising. The client to whom the report is issued may, however, show or send it . or a certified copy there of prepared by the SHENZHEN TIMEWAY TESTING LABORATORIES. to his customer. Supplier or others persons directly concerned. SHENZHEN TIMEWAY TESTING LABORATORIES. will not, without the consent of the client enter into any discussion of correspondence with any third party concerning the contents of the report.
 In the event of the improper use of the report. The SHENZHEN TIMEWAY TESTING LABORATORIES. reserves the rights to withdraw it and to adopt any other remedies which may be appropriate.



5. 802.11b at 1Mbps of CH6

	Marker 1 [T1]	RBW	10 kHz	RF Att	20 dB
	Ref Lvl	-16.07 dBm	VBW	30 kHz	
	10 dBm	2.43779978 GHz	SWT	380 ms	Unit dBm

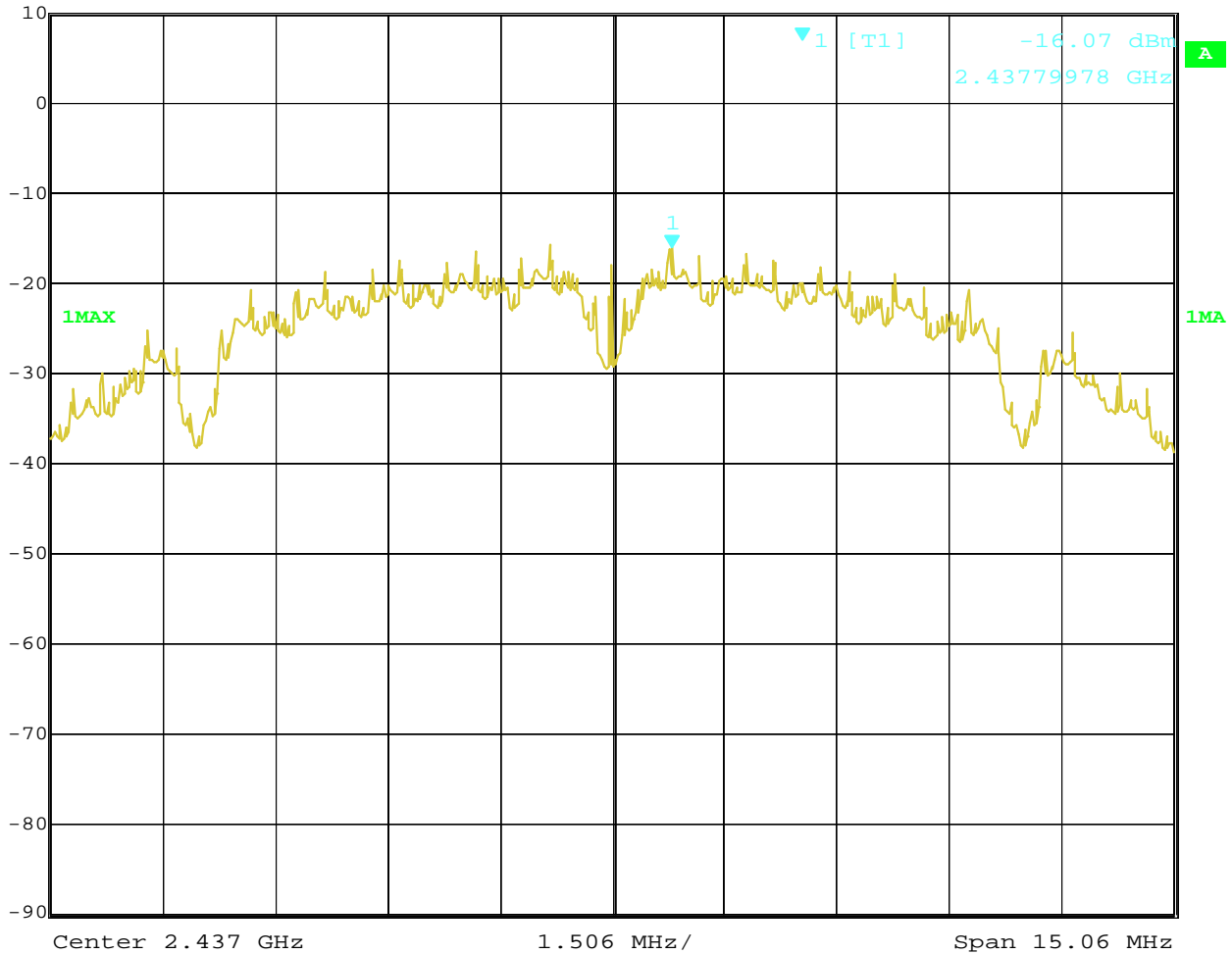

Date: 15.JUN.2022 15:56:52

The report refers only to the sample tested and does not apply to the bulk.
 This report is issued in confidence to the client and it will be strictly treated as such by the SHENZHEN TIMEWAY TESTING LABORATORIES. It may not be reproduced rather in its entirety or in part and it may not be used for advertising. The client to whom the report is issued may, however, show or send it . or a certified copy there of prepared by the SHENZHEN TIMEWAY TESTING LABORATORIES. to his customer. Supplier or others persons directly concerned. SHENZHEN TIMEWAY TESTING LABORATORIES. will not, without the consent of the client enter into any discussion of correspondence with any third party concerning the contents of the report.
 In the event of the improper use of the report. The SHENZHEN TIMEWAY TESTING LABORATORIES. reserves the rights to withdraw it and to adopt any other remedies which may be appropriate.



6. 802.11b at 1Mbps of CH11

	Marker 1 [T1]	RBW	10 kHz	RF Att	20 dB
	Ref Lvl	-15.88 dBm	VBW	30 kHz	
	10 dBm	2.46276960 GHz	SWT	380 ms	Unit dBm

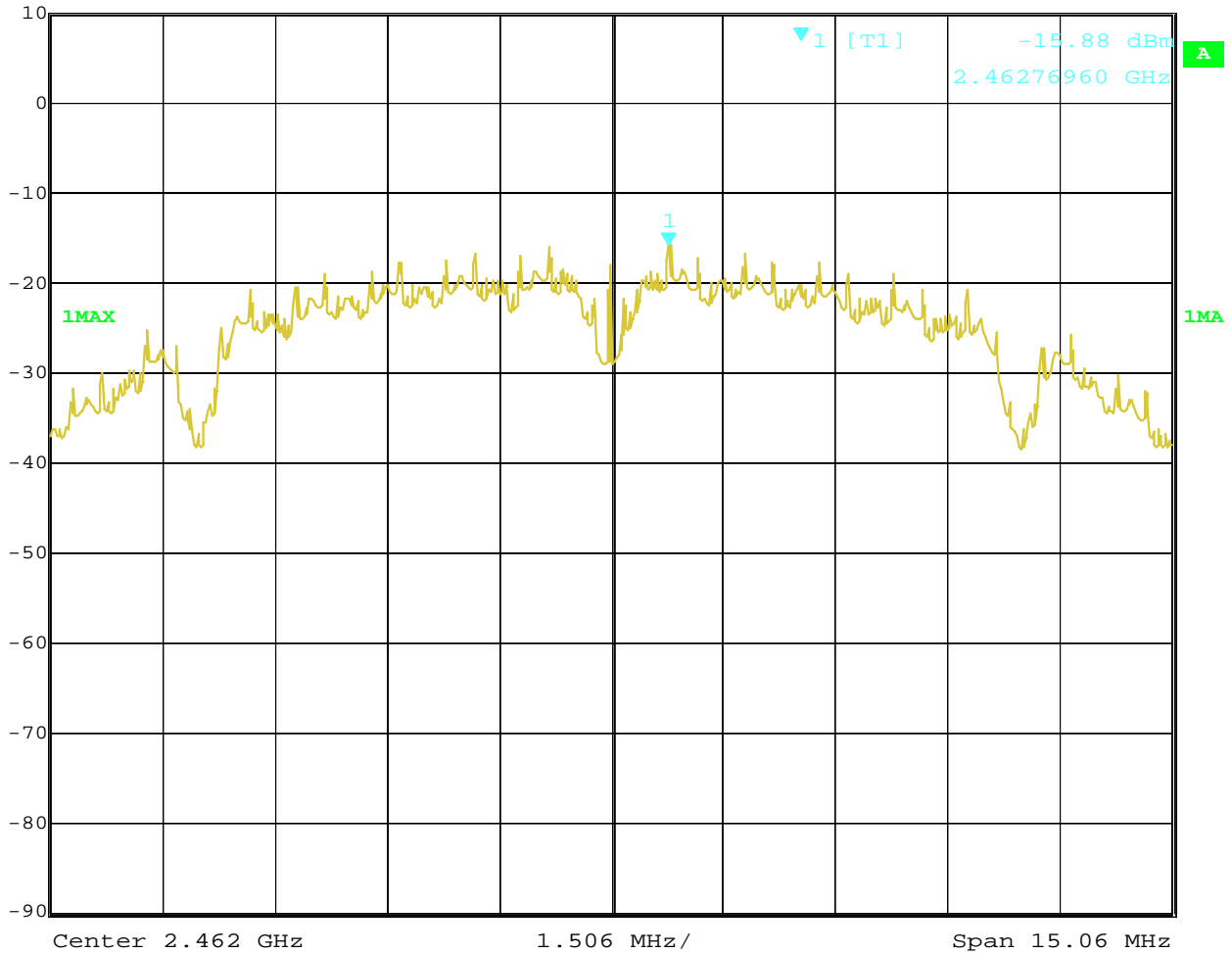

Date: 15.JUN.2022 15:56:28

The report refers only to the sample tested and does not apply to the bulk.
 This report is issued in confidence to the client and it will be strictly treated as such by the SHENZHEN TIMEWAY TESTING LABORATORIES. It may not be reproduced rather in its entirety or in part and it may not be used for adverting. The client to whom the report is issued may, however, show or send it . or a certified copy there of prepared by the SHENZHEN TIMEWAY TESTING LABORATORIES. to his customer. Supplier or others persons directly concerned. SHENZHEN TIMEWAY TESTING LABORATORIES. will not, without the consent of the client enter into any discussion of correspondence with any third party concerning the contents of the report.
 In the event of the improper use of the report. The SHENZHEN TIMEWAY TESTING LABORATORIES. reserves the rights to withdraw it and to adopt any other remedies which may be appropriate.



7. 802.11g at 6Mbps of CH1

	Marker 1 [T1]	RBW	10 kHz	RF Att	20 dB
	Ref Lvl	-18.46 dBm	VBW	30 kHz	
	10 dBm	2.41197533 GHz	SWT	620 ms	Unit dBm

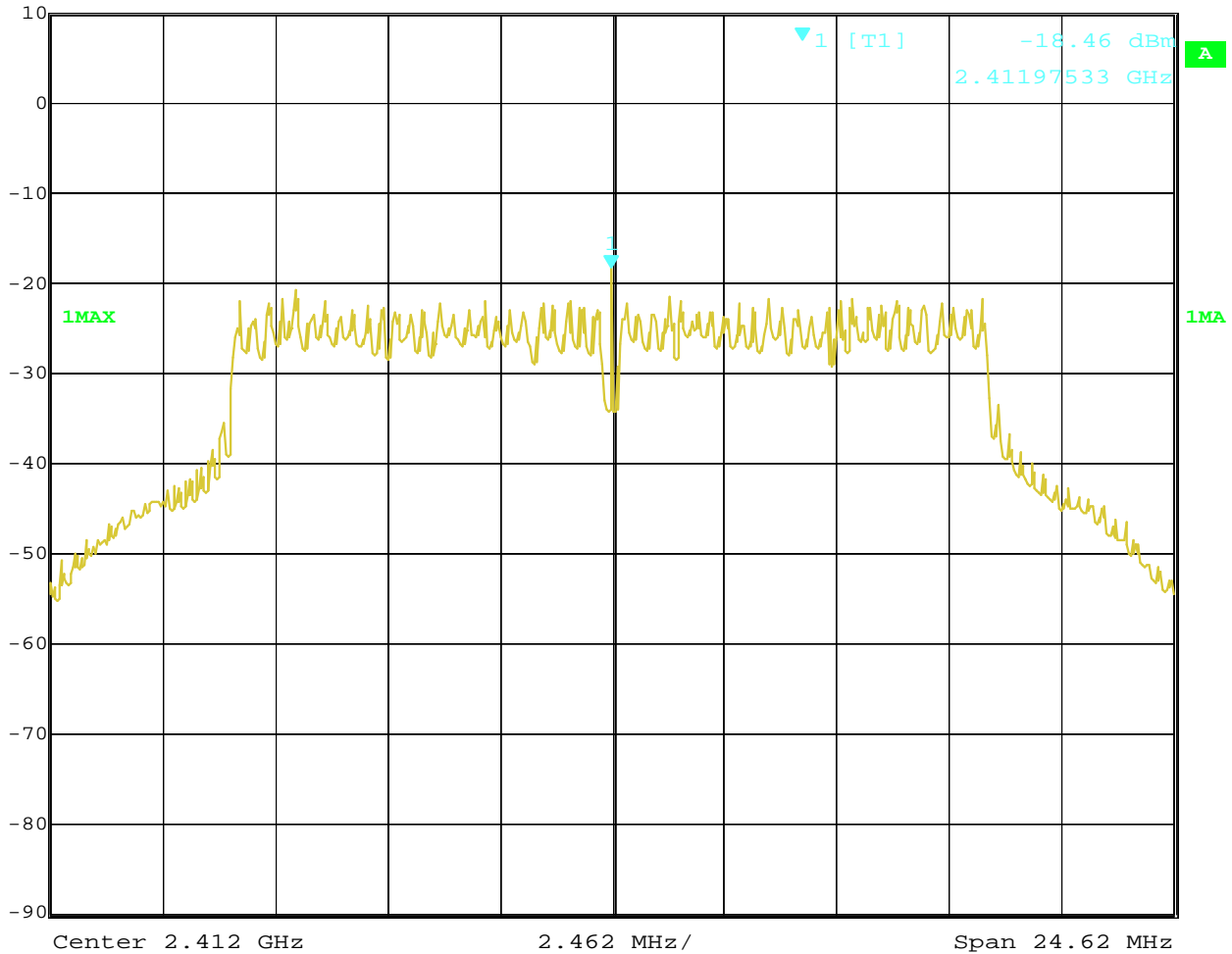

Date: 15.JUN.2022 15:53:32

The report refers only to the sample tested and does not apply to the bulk.
 This report is issued in confidence to the client and it will be strictly treated as such by the SHENZHEN TIMEWAY TESTING LABORATORIES. It may not be reproduced rather in its entirety or in part and it may not be used for advertizing. The client to whom the report is issued may, however, show or send it . or a certified copy there of prepared by the SHENZHEN TIMEWAY TESTING LABORATORIES. to his customer. Supplier or others persons directly concerned. SHENZHEN TIMEWAY TESTING LABORATORIES. will not, without the consent of the client enter into any discussion of correspondence with any third party concerning the contents of the report.
 In the event of the improper use of the report. The SHENZHEN TIMEWAY TESTING LABORATORIES. reserves the rights to withdraw it and to adopt any other remedies which may be appropriate.



8. 802.11g at 6Mbps of CH6

	Marker 1 [T1]	RBW	10 kHz	RF Att	20 dB
	Ref Lvl	-18.61 dBm	VBW	30 kHz	
	10 dBm	2.43697533 GHz	SWT	620 ms	Unit dBm

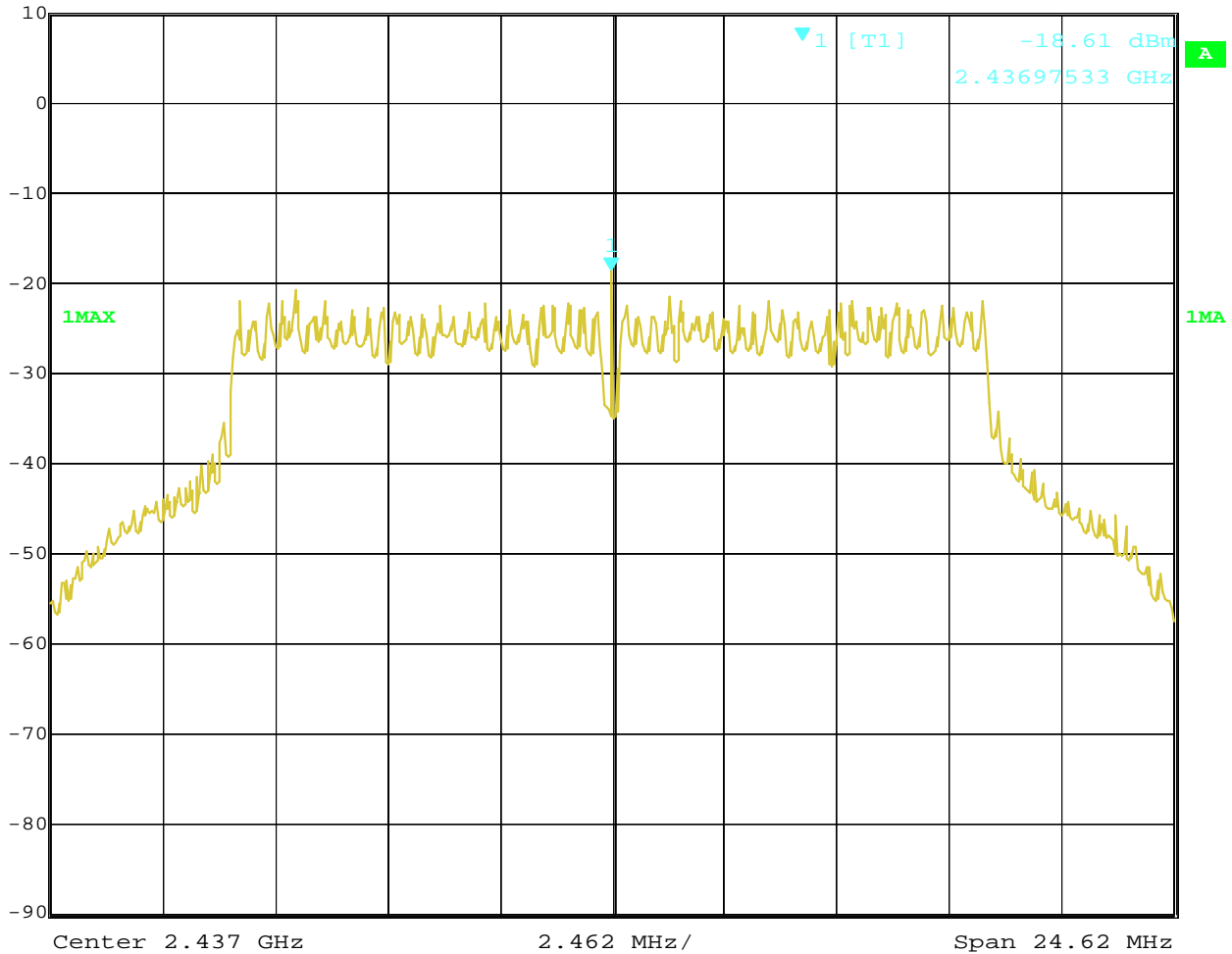

Date: 15.JUN.2022 15:54:19

The report refers only to the sample tested and does not apply to the bulk.
 This report is issued in confidence to the client and it will be strictly treated as such by the SHENZHEN TIMEWAY TESTING LABORATORIES. It may not be reproduced rather in its entirety or in part and it may not be used for advertizing. The client to whom the report is issued may, however, show or send it . or a certified copy there of prepared by the SHENZHEN TIMEWAY TESTING LABORATORIES. to his customer. Supplier or others persons directly concerned. SHENZHEN TIMEWAY TESTING LABORATORIES. will not, without the consent of the client enter into any discussion of correspondence with any third party concerning the contents of the report.
 In the event of the improper use of the report. The SHENZHEN TIMEWAY TESTING LABORATORIES. reserves the rights to withdraw it and to adopt any other remedies which may be appropriate.



9. 802.11g at 6Mbps of CH11

	Marker 1 [T1]	RBW	10 kHz	RF Att	20 dB
	Ref Lvl	-19.04 dBm	VBW	30 kHz	
	10 dBm	2.46197533 GHz	SWT	620 ms	Unit dBm

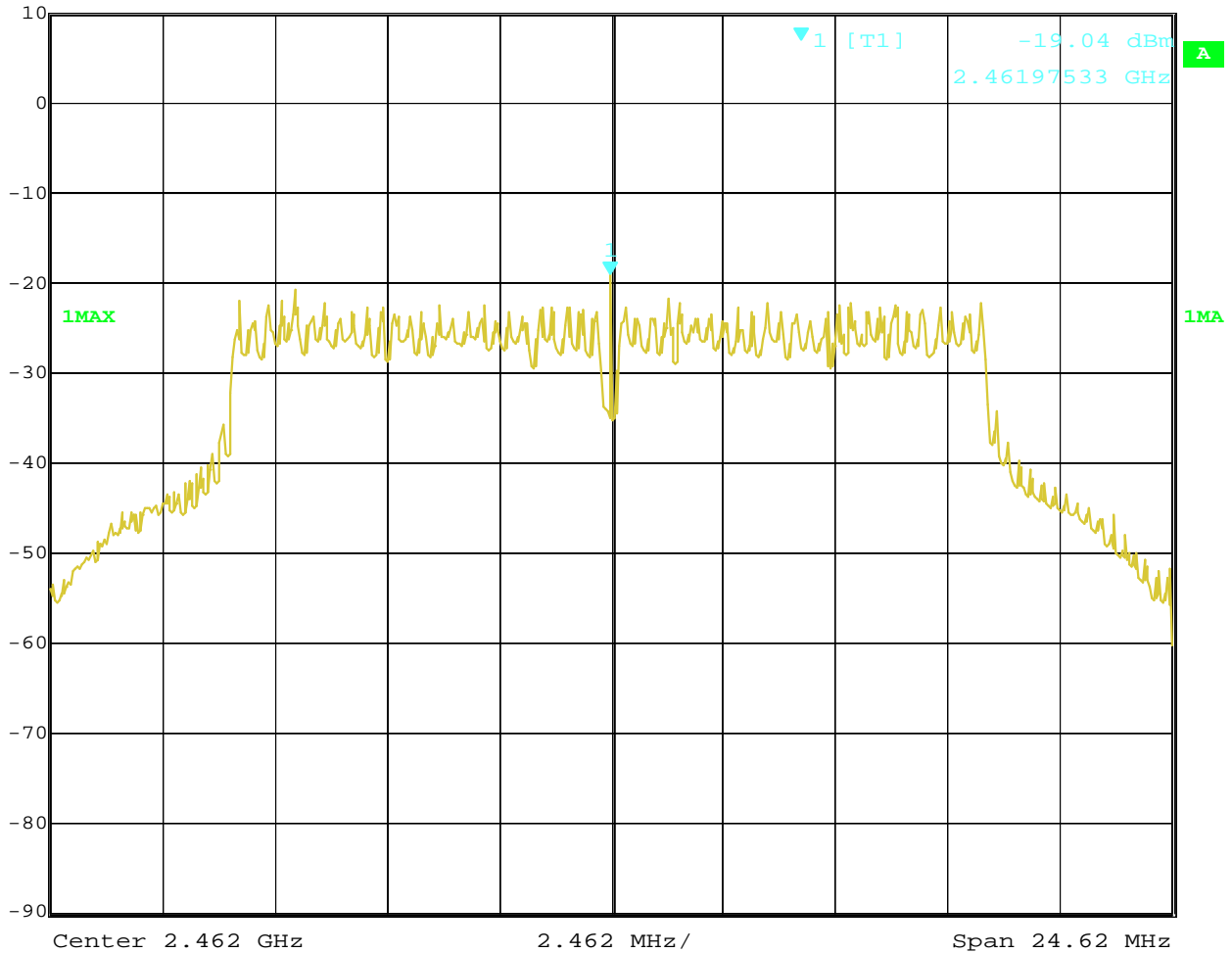

Date: 15.JUN.2022 15:55:11

The report refers only to the sample tested and does not apply to the bulk.
 This report is issued in confidence to the client and it will be strictly treated as such by the SHENZHEN TIMEWAY TESTING LABORATORIES. It may not be reproduced rather in its entirety or in part and it may not be used for adverting. The client to whom the report is issued may, however, show or send it . or a certified copy there of prepared by the SHENZHEN TIMEWAY TESTING LABORATORIES. to his customer. Supplier or others persons directly concerned. SHENZHEN TIMEWAY TESTING LABORATORIES. will not, without the consent of the client enter into any discussion of correspondence with any third party concerning the contents of the report.
 In the event of the improper use of the report. The SHENZHEN TIMEWAY TESTING LABORATORIES. reserves the rights to withdraw it and to adopt any other remedies which may be appropriate.



10. 802.11n at HT20 of CH01

	Marker 1 [T1]	RBW	10 kHz	RF Att	20 dB
	Ref Lvl	-19.19 dBm	VBW	30 kHz	
	10 dBm	2.41197361 GHz	SWT	660 ms	Unit dBm

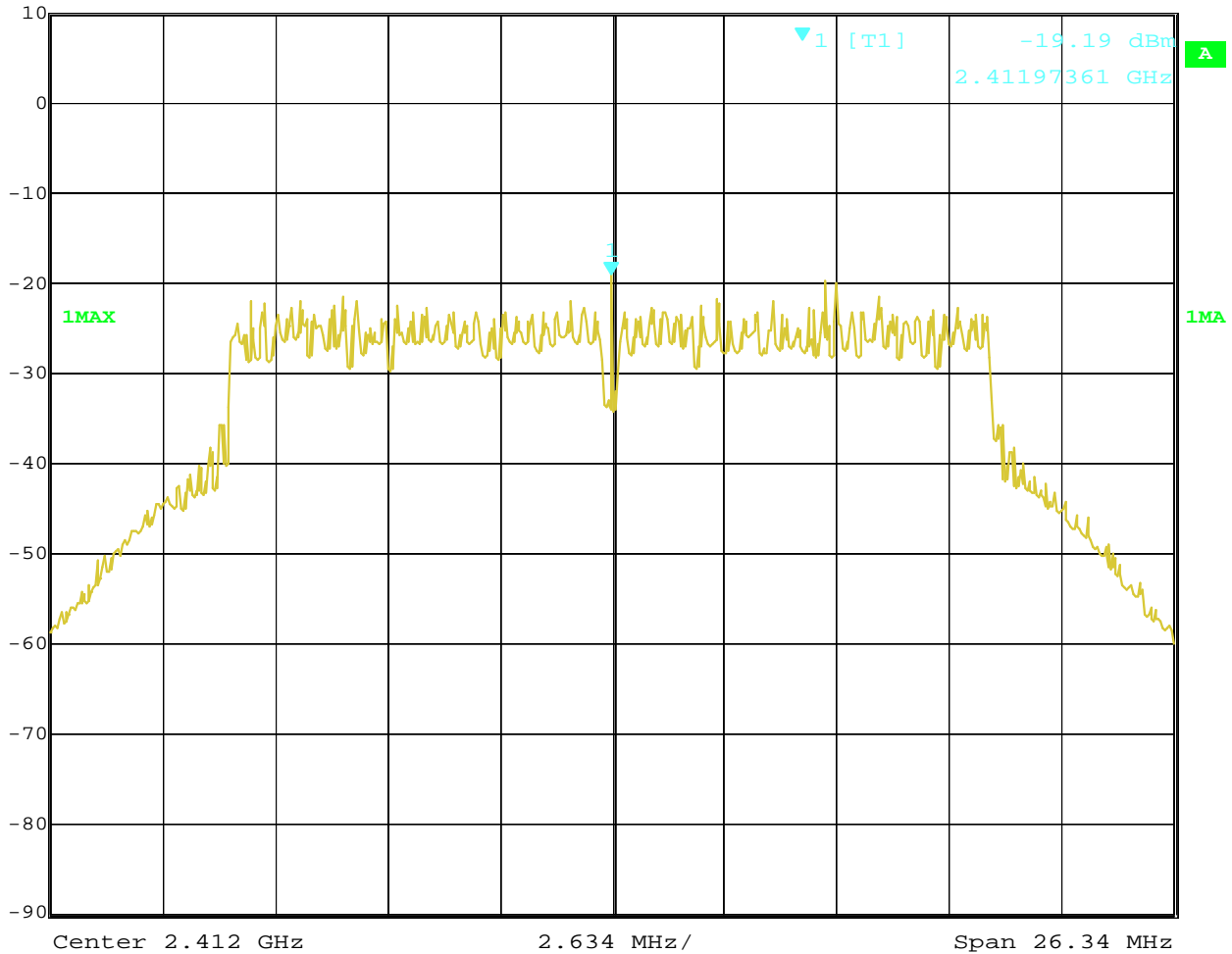

Date: 15.JUN.2022 15:41:40

The report refers only to the sample tested and does not apply to the bulk.
 This report is issued in confidence to the client and it will be strictly treated as such by the SHENZHEN TIMEWAY TESTING LABORATORIES. It may not be reproduced rather in its entirety or in part and it may not be used for advertising. The client to whom the report is issued may, however, show or send it . or a certified copy there of prepared by the SHENZHEN TIMEWAY TESTING LABORATORIES. to his customer. Supplier or others persons directly concerned. SHENZHEN TIMEWAY TESTING LABORATORIES. will not, without the consent of the client enter into any discussion of correspondence with any third party concerning the contents of the report.
 In the event of the improper use of the report. The SHENZHEN TIMEWAY TESTING LABORATORIES. reserves the rights to withdraw it and to adopt any other remedies which may be appropriate.



11. 802.11n at HT20 of CH06

	Marker 1 [T1]	RBW	10 kHz	RF Att	20 dB
	Ref Lvl	-19.19 dBm	VBW	30 kHz	
	10 dBm	2.43697361 GHz	SWT	660 ms	Unit dBm

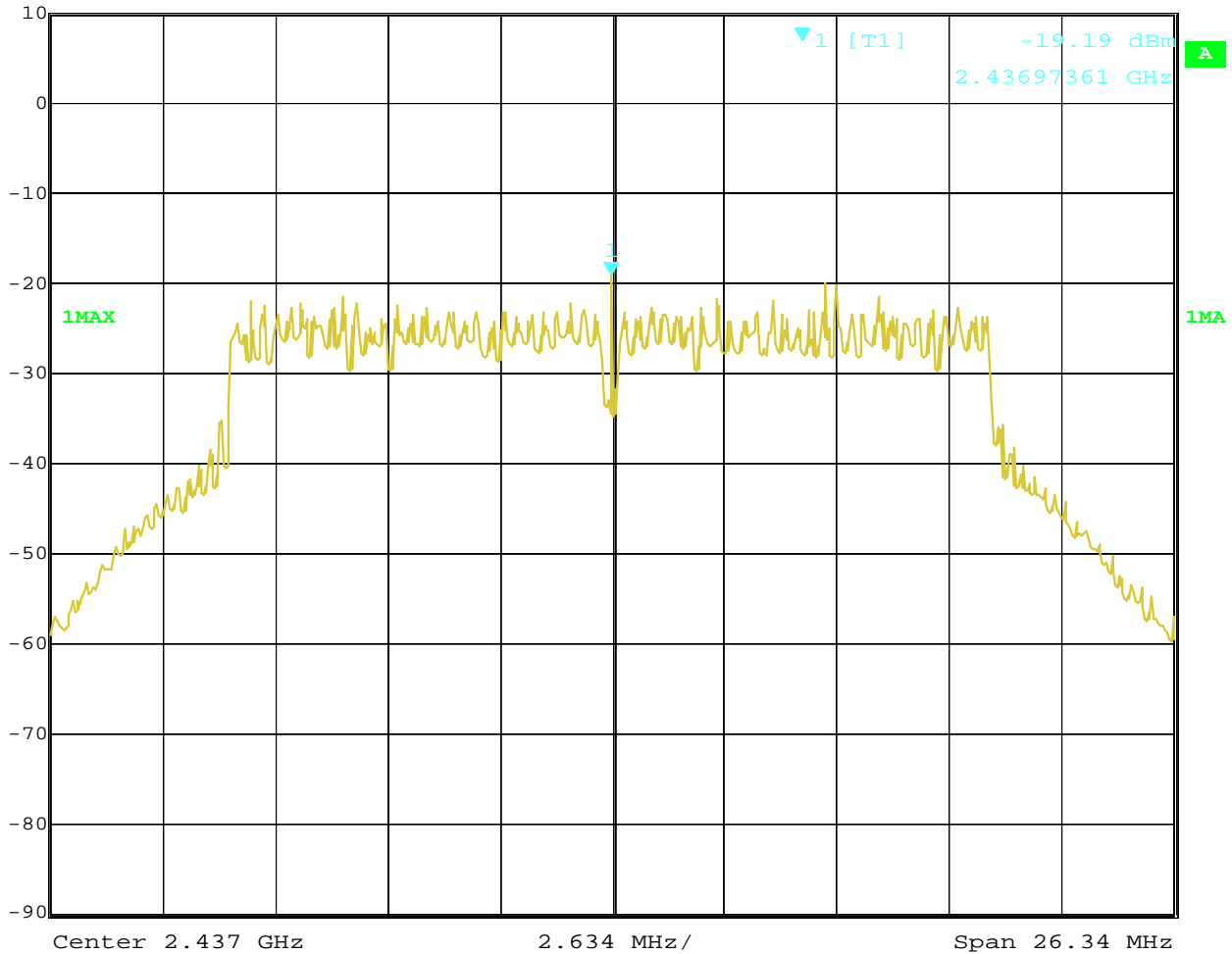

Date: 15.JUN.2022 15:43:00

The report refers only to the sample tested and does not apply to the bulk.
 This report is issued in confidence to the client and it will be strictly treated as such by the SHENZHEN TIMEWAY TESTING LABORATORIES. It may not be reproduced rather in its entirety or in part and it may not be used for advertizing. The client to whom the report is issued may, however, show or send it . or a certified copy there of prepared by the SHENZHEN TIMEWAY TESTING LABORATORIES. to his customer. Supplier or others persons directly concerned. SHENZHEN TIMEWAY TESTING LABORATORIES. will not, without the consent of the client enter into any discussion of correspondence with any third party concerning the contents of the report.
 In the event of the improper use of the report. The SHENZHEN TIMEWAY TESTING LABORATORIES. reserves the rights to withdraw it and to adopt any other remedies which may be appropriate.



12. 802.11n at HT20 of CH11

	Marker 1 [T1]	RBW	10 kHz	RF Att	20 dB
	Ref Lvl	-18.89 dBm	VBW	30 kHz	
	10 dBm	2.46197361 GHz	SWT	660 ms	Unit dBm

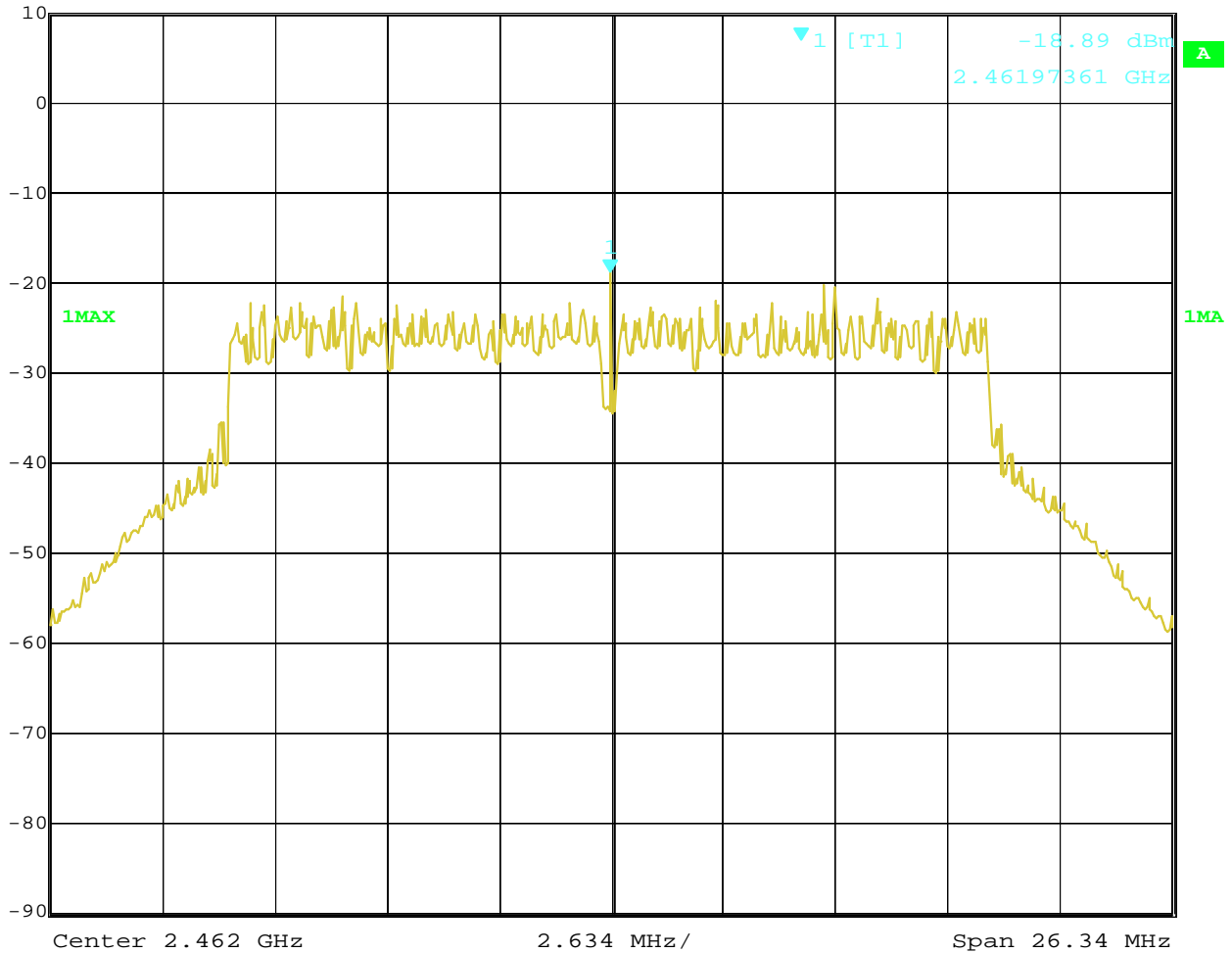

Date: 15.JUN.2022 15:47:07

The report refers only to the sample tested and does not apply to the bulk.
 This report is issued in confidence to the client and it will be strictly treated as such by the SHENZHEN TIMEWAY TESTING LABORATORIES. It may not be reproduced rather in its entirety or in part and it may not be used for adverting. The client to whom the report is issued may, however, show or send it . or a certified copy there of prepared by the SHENZHEN TIMEWAY TESTING LABORATORIES. to his customer. Supplier or others persons directly concerned. SHENZHEN TIMEWAY TESTING LABORATORIES. will not, without the consent of the client enter into any discussion of correspondence with any third party concerning the contents of the report.
 In the event of the improper use of the report. The SHENZHEN TIMEWAY TESTING LABORATORIES. reserves the rights to withdraw it and to adopt any other remedies which may be appropriate.



13. 802.11n at HT40 of CH03

	Ref Lvl	Marker 1 [T1]	RBW	10 kHz	RF Att	20 dB
	10 dBm	-18.63 dBm	VBW	30 kHz		
		2.42194590 GHz	SWT	1.35 s	Unit	dBm

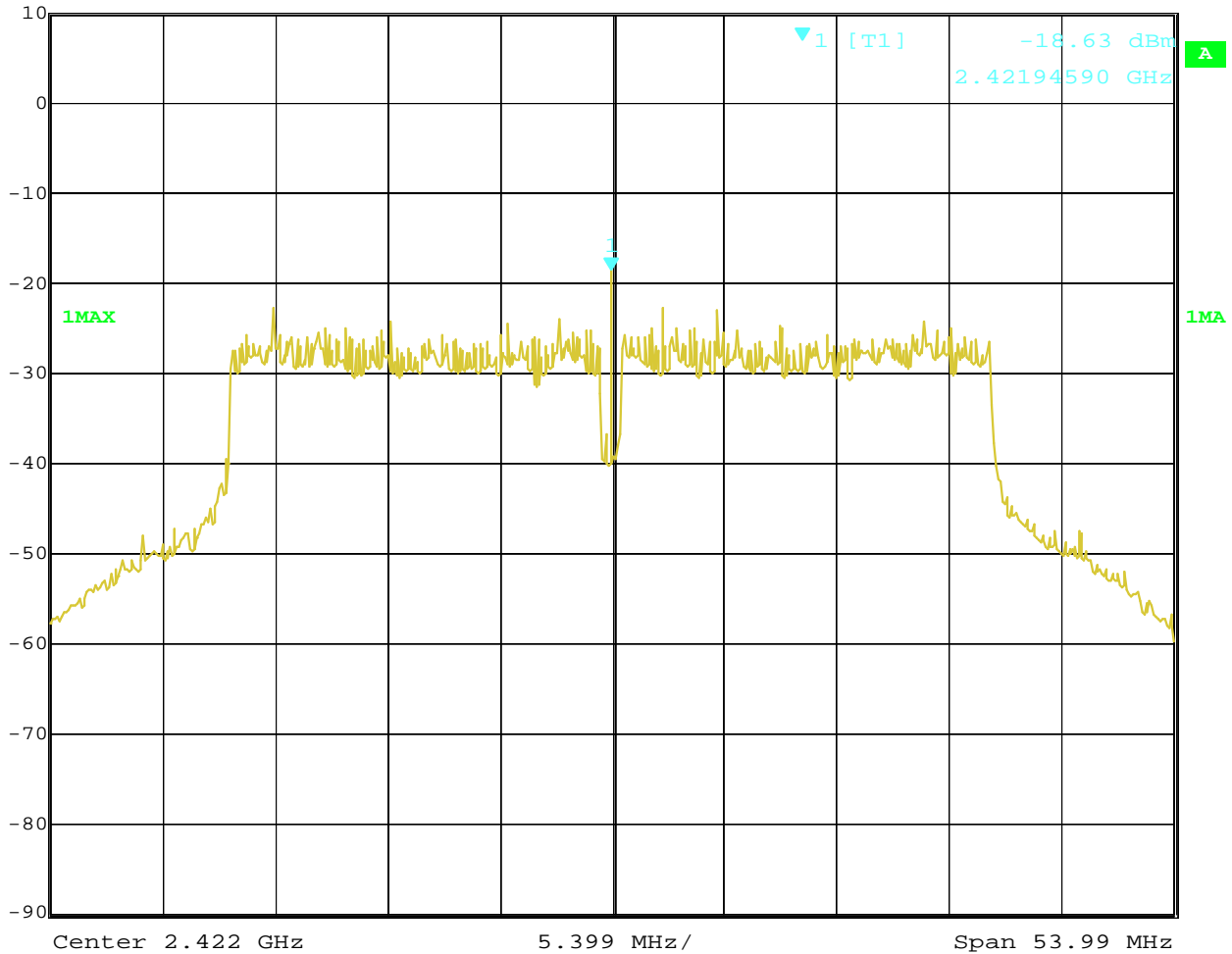

Date: 15.JUN.2022 15:39:27

The report refers only to the sample tested and does not apply to the bulk.
 This report is issued in confidence to the client and it will be strictly treated as such by the SHENZHEN TIMEWAY TESTING LABORATORIES. It may not be reproduced rather in its entirety or in part and it may not be used for advertizing. The client to whom the report is issued may, however, show or send it . or a certified copy there of prepared by the SHENZHEN TIMEWAY TESTING LABORATORIES. to his customer. Supplier or others persons directly concerned. SHENZHEN TIMEWAY TESTING LABORATORIES. will not, without the consent of the client enter into any discussion of correspondence with any third party concerning the contents of the report.
 In the event of the improper use of the report. The SHENZHEN TIMEWAY TESTING LABORATORIES. reserves the rights to withdraw it and to adopt any other remedies which may be appropriate.



14. 802.11n at HT40 of CH06

	Marker 1 [T1]	RBW	10 kHz	RF Att	20 dB
	Ref Lvl	-19.50 dBm	VBW	30 kHz	
	10 dBm	2.43694590 GHz	SWT	1.35 s	Unit dBm

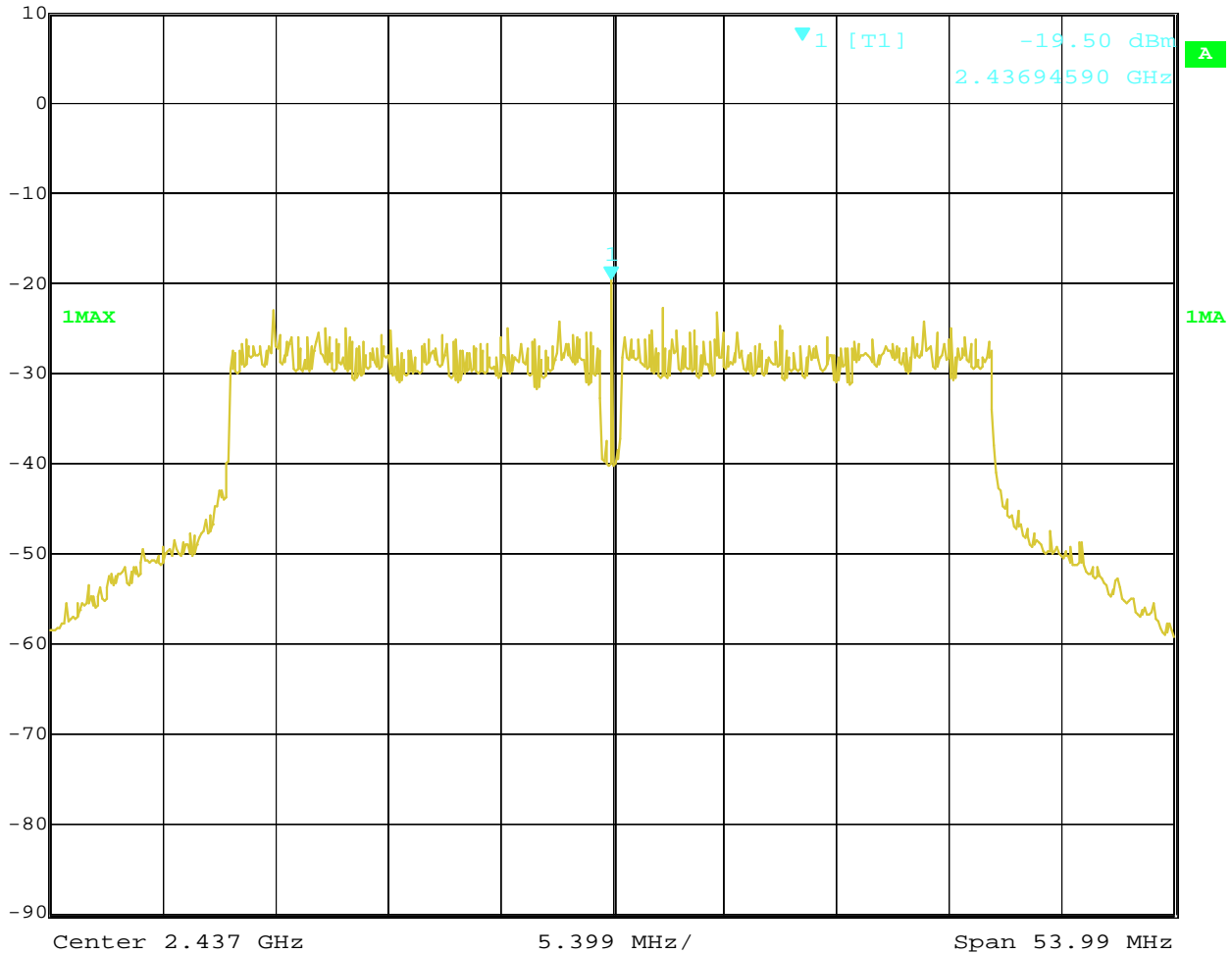

Date: 15.JUN.2022 15:36:12

The report refers only to the sample tested and does not apply to the bulk.
 This report is issued in confidence to the client and it will be strictly treated as such by the SHENZHEN TIMEWAY TESTING LABORATORIES. It may not be reproduced rather in its entirety or in part and it may not be used for advertising. The client to whom the report is issued may, however, show or send it . or a certified copy there of prepared by the SHENZHEN TIMEWAY TESTING LABORATORIES. to his customer. Supplier or others persons directly concerned. SHENZHEN TIMEWAY TESTING LABORATORIES. will not, without the consent of the client enter into any discussion of correspondence with any third party concerning the contents of the report.
 In the event of the improper use of the report. The SHENZHEN TIMEWAY TESTING LABORATORIES. reserves the rights to withdraw it and to adopt any other remedies which may be appropriate.



15. 802.11n at HT40 of CH09

	Marker 1 [T1]	RBW	10 kHz	RF Att	20 dB
	Ref Lvl	-19.04 dBm	VBW	30 kHz	
	10 dBm	2.45194590 GHz	SWT	1.35 s	Unit dBm

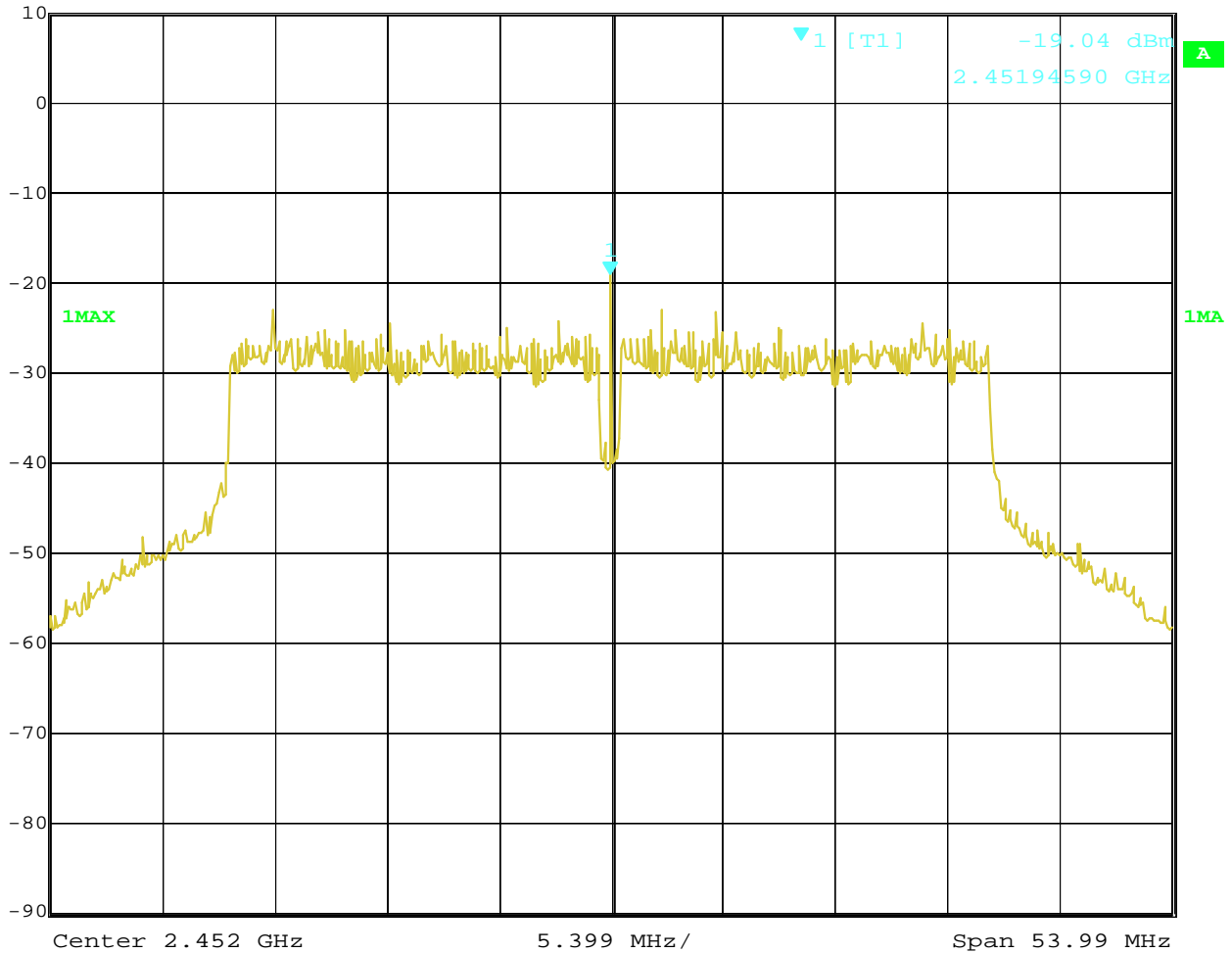

Date: 15.JUN.2022 15:35:01

The report refers only to the sample tested and does not apply to the bulk.
 This report is issued in confidence to the client and it will be strictly treated as such by the SHENZHEN TIMEWAY TESTING LABORATORIES. It may not be reproduced rather in its entirety or in part and it may not be used for adverting. The client to whom the report is issued may, however, show or send it . or a certified copy there of prepared by the SHENZHEN TIMEWAY TESTING LABORATORIES. to his customer. Supplier or others persons directly concerned. SHENZHEN TIMEWAY TESTING LABORATORIES. will not, without the consent of the client enter into any discussion of correspondence with any third party concerning the contents of the report.
 In the event of the improper use of the report. The SHENZHEN TIMEWAY TESTING LABORATORIES. reserves the rights to withdraw it and to adopt any other remedies which may be appropriate.



10 Out of Band Measurement

10.1 Test Setup for band edge

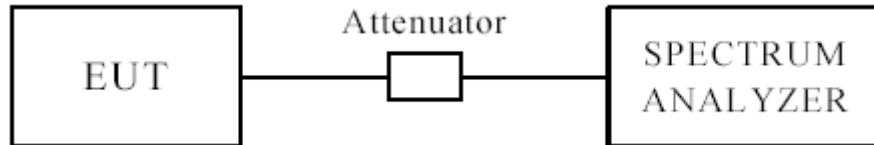

The restricted band requirement based on radiated emission test; please see the clause 6 for the test setup

10.2 Limits of Out of Band Emissions Measurement

1. Below -20dB of the highest emission level of operating band (in 100kHz Resolution Bandwidth).
2. Fall in the restricted bands listed in section 15.205. The maximum permitted average field strength is listed in section 15.209.

10.3 Test Procedure

For signals in the restricted bands above and below the 2.4-2.483GHz allocated band a measurement was made of radiated emission test. (Peak values with RBW=VBW=1MHz and PK detector. AV value with RBW=1MHz, VBW=10Hz and PK detector)

For bandage test, the spectrum set as follows: RBW=100, VBW=300 kHz. A conducted measurement used

10.4 Test Result

Please see next pages

Note: 1. for band-edge measurement, the frequency from 30MHz-25GHz was tested. And It met the FCC rule.

The report refers only to the sample tested and does not apply to the bulk.

This report is issued in confidence to the client and it will be strictly treated as such by the SHENZHEN TIMEWAY TESTING LABORATORIES. It may not be reproduced rather in its entirety or in part and it may not be used for advertising. The client to whom the report is issued may, however, show or send it or a certified copy thereof prepared by the SHENZHEN TIMEWAY TESTING LABORATORIES to his customer. Supplier or others persons directly concerned. SHENZHEN TIMEWAY TESTING LABORATORIES will not, without the consent of the client enter into any discussion of correspondence with any third party concerning the contents of the report.

In the event of the improper use of the report. The SHENZHEN TIMEWAY TESTING LABORATORIES reserves the rights to withdraw it and to adopt any other remedies which may be appropriate.



For 802.11b mode

CH01 at 1Mbps

10.4 Band-edge Measurement

EUT	Tablet PC	Model	ST8888
Mode	Keeping Transmitting	Test Voltage	DC3.7V
Temperature	24 deg. C,	Humidity	56% RH
Test Result:	Pass	Detector	PK

Test Figure:

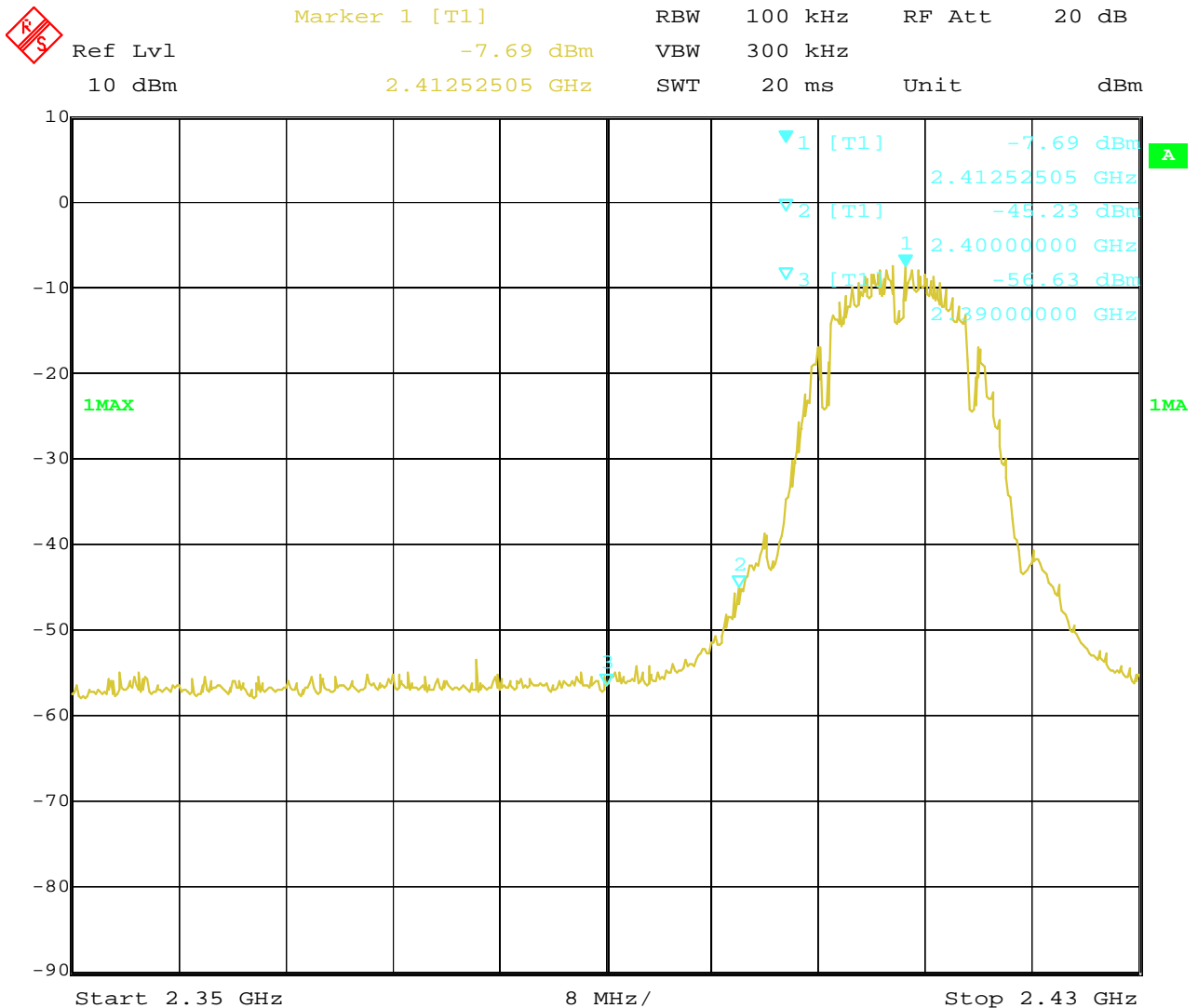

Date: 15.JUN.2022 15:58:34

The report refers only to the sample tested and does not apply to the bulk.
 This report is issued in confidence to the client and it will be strictly treated as such by the SHENZHEN TIMEWAY TESTING LABORATORIES. It may not be reproduced rather in its entirety or in part and it may not be used for advertising. The client to whom the report is issued may, however, show or send it . or a certified copy there of prepared by the SHENZHEN TIMEWAY TESTING LABORATORIES. to his customer. Supplier or others persons directly concerned. SHENZHEN TIMEWAY TESTING LABORATORIES. will not, without the consent of the client enter into any discussion of correspondence with any third party concerning the contents of the report.
 In the event of the improper use of the report. The SHENZHEN TIMEWAY TESTING LABORATORIES. reserves the rights to withdraw it and to adopt any other remedies which may be appropriate.



CH11 at 1Mbps

10.4 Band-edge Measurement

EUT	Tablet PC	Model	ST8888
Mode	Keeping Transmitting	Test Voltage	DC3.7V
Temperature	24 deg. C,	Humidity	56% RH
Test Result:	Pass	Detector	PK

Test Figure:

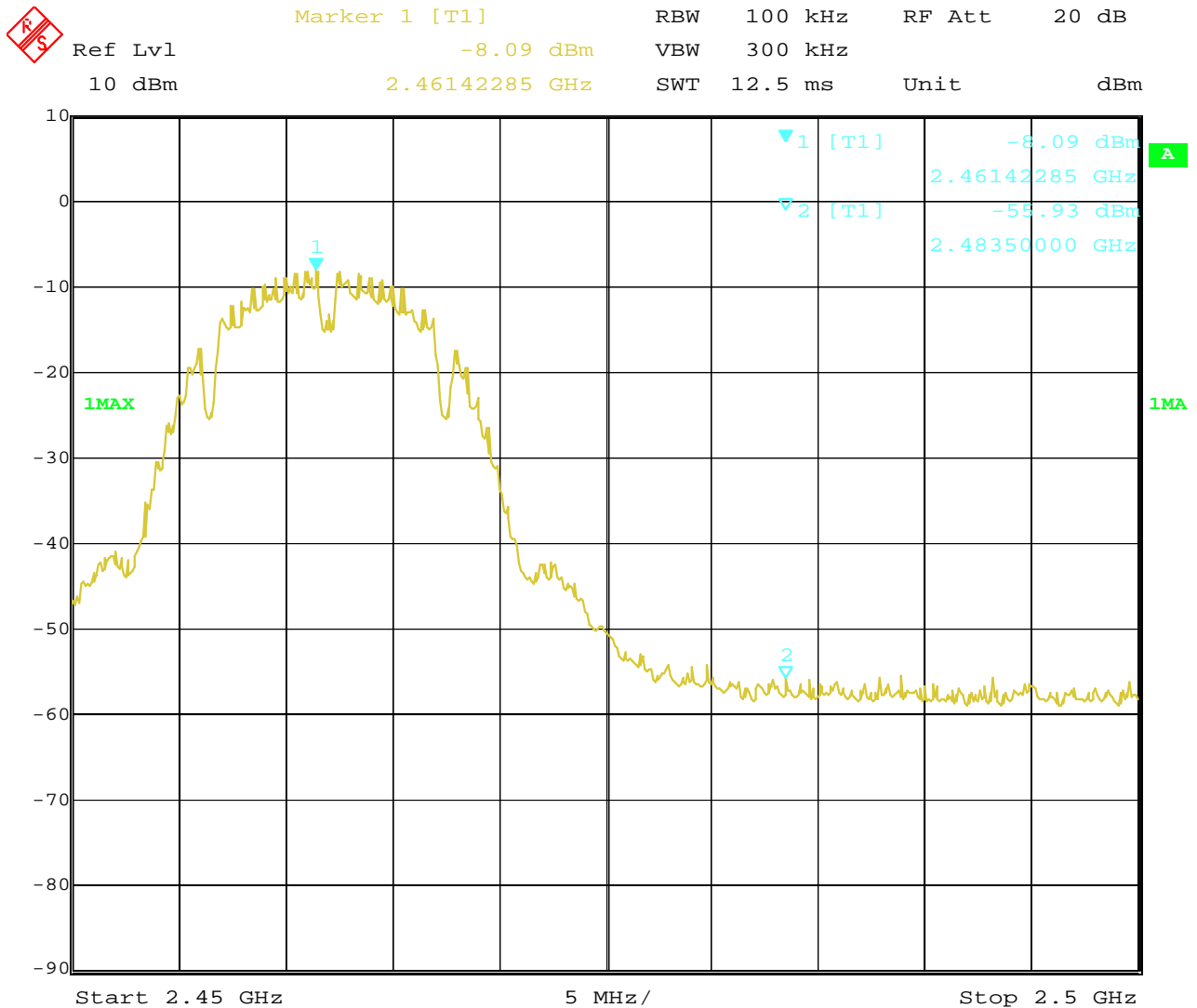

Date: 15.JUN.2022 16:01:43

The report refers only to the sample tested and does not apply to the bulk.
 This report is issued in confidence to the client and it will be strictly treated as such by the SHENZHEN TIMEWAY TESTING LABORATORIES. It may not be reproduced rather in its entirety or in part and it may not be used for advertising. The client to whom the report is issued may, however, show or send it . or a certified copy there of prepared by the SHENZHEN TIMEWAY TESTING LABORATORIES. to his customer. Supplier or others persons directly concerned. SHENZHEN TIMEWAY TESTING LABORATORIES. will not, without the consent of the client enter into any discussion of correspondence with any third party concerning the contents of the report.
 In the event of the improper use of the report. The SHENZHEN TIMEWAY TESTING LABORATORIES. reserves the rights to withdraw it and to adopt any other remedies which may be appropriate.



For 802.11b mode

CH01 at 11Mbps

10.4 Band-edge Measurement

EUT	Tablet PC	Model	ST8888
Mode	Keeping Transmitting	Test Voltage	DC3.7V
Temperature	24 deg. C,	Humidity	56% RH
Test Result:	Pass	Detector	PK

Test Figure:

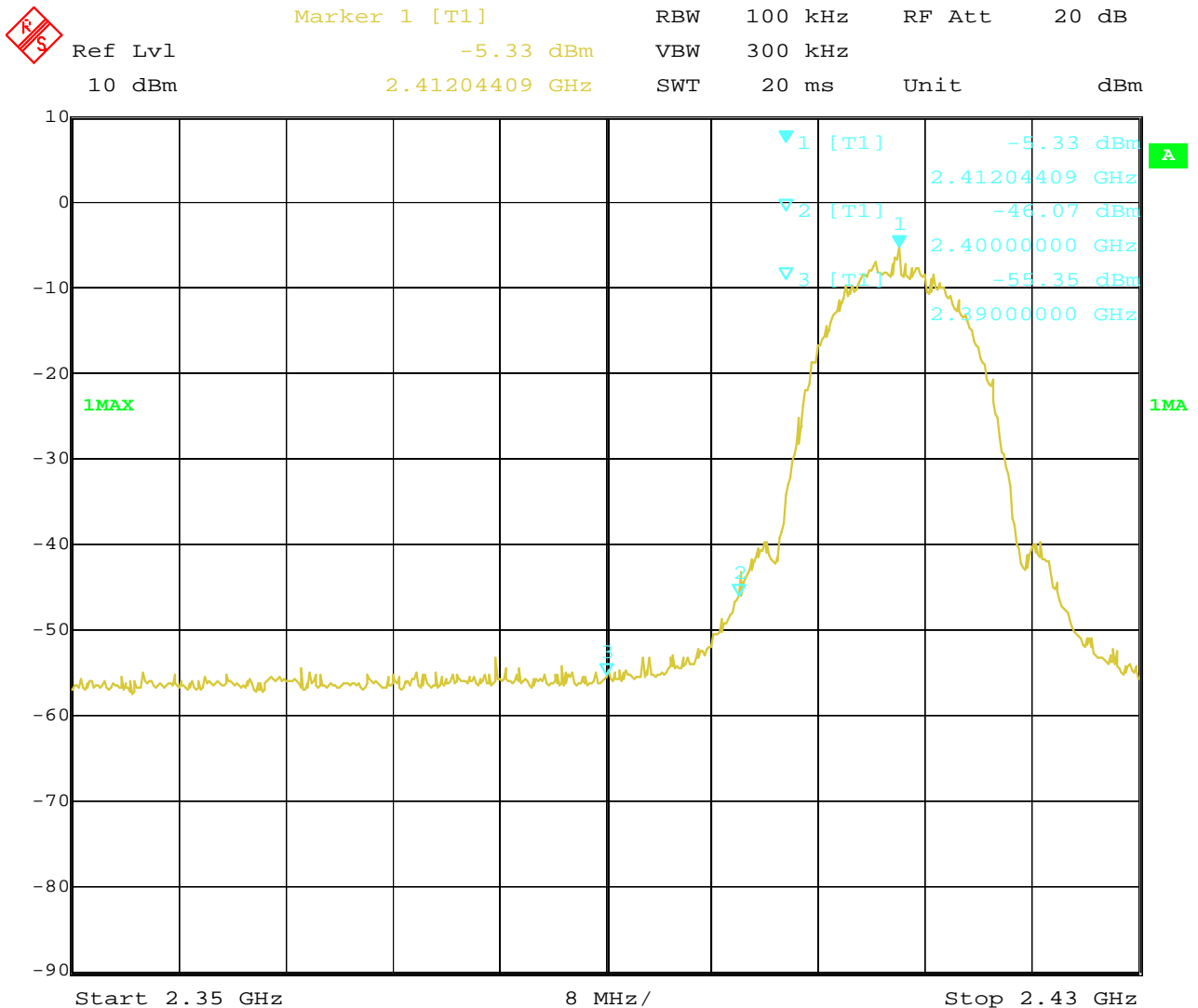

Date: 15.JUN.2022 16:00:07

The report refers only to the sample tested and does not apply to the bulk.
 This report is issued in confidence to the client and it will be strictly treated as such by the SHENZHEN TIMEWAY TESTING LABORATORIES. It may not be reproduced rather in its entirety or in part and it may not be used for advertising. The client to whom the report is issued may, however, show or send it . or a certified copy there of prepared by the SHENZHEN TIMEWAY TESTING LABORATORIES. to his customer. Supplier or others persons directly concerned. SHENZHEN TIMEWAY TESTING LABORATORIES. will not, without the consent of the client enter into any discussion of correspondence with any third party concerning the contents of the report.
 In the event of the improper use of the report. The SHENZHEN TIMEWAY TESTING LABORATORIES. reserves the rights to withdraw it and to adopt any other remedies which may be appropriate.



CH11 at 11Mbps

10.4 Band-edge Measurement

EUT	Tablet PC	Model	ST8888
Mode	Keeping Transmitting	Test Voltage	DC3.7V
Temperature	24 deg. C,	Humidity	56% RH
Test Result:	Pass	Detector	PK

Test Figure:

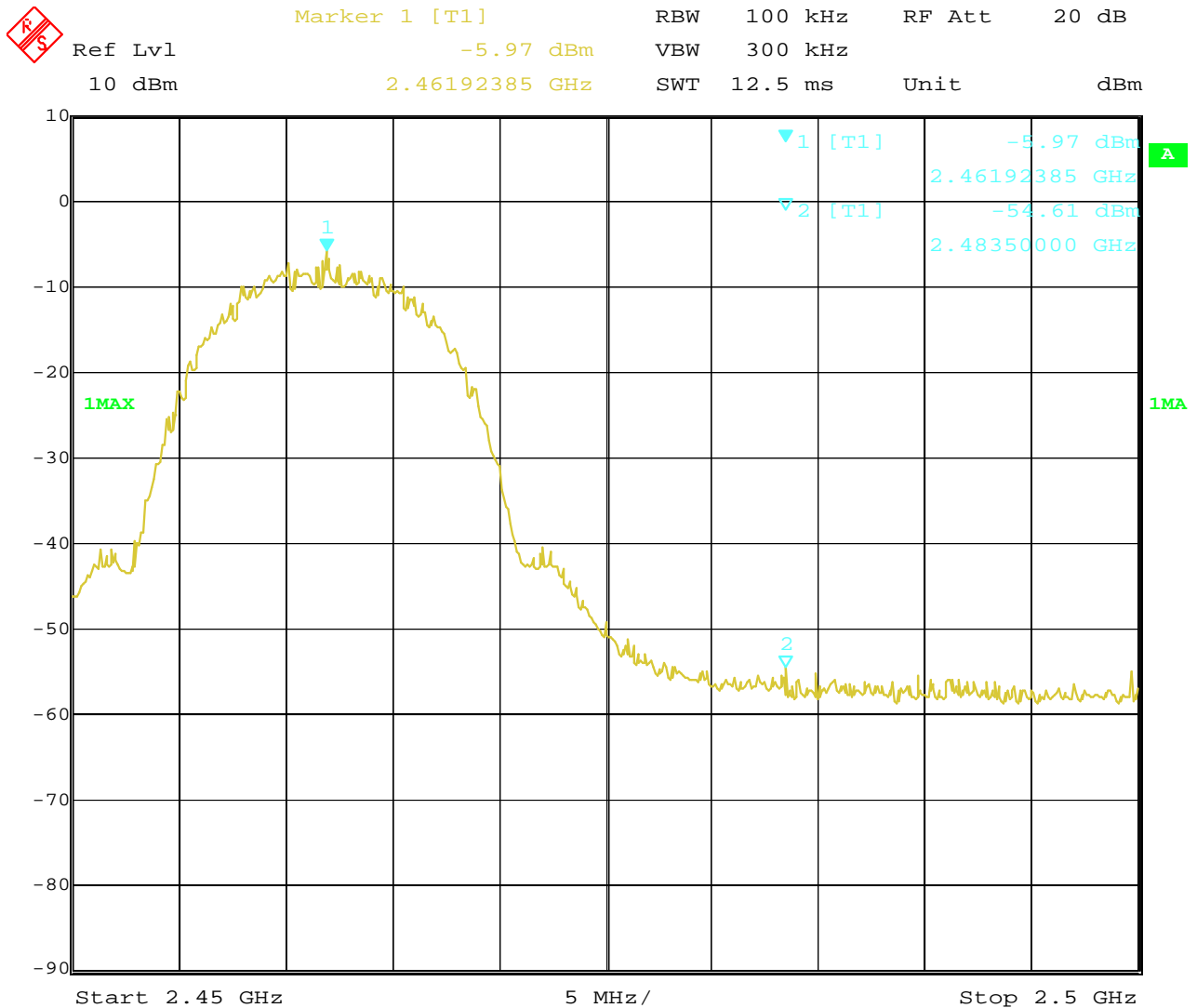

Date: 15.JUN.2022 16:02:41

The report refers only to the sample tested and does not apply to the bulk.
 This report is issued in confidence to the client and it will be strictly treated as such by the SHENZHEN TIMEWAY TESTING LABORATORIES. It may not be reproduced rather in its entirety or in part and it may not be used for advertising. The client to whom the report is issued may, however, show or send it . or a certified copy there of prepared by the SHENZHEN TIMEWAY TESTING LABORATORIES. to his customer. Supplier or others persons directly concerned. SHENZHEN TIMEWAY TESTING LABORATORIES. will not, without the consent of the client enter into any discussion of correspondence with any third party concerning the contents of the report.
 In the event of the improper use of the report. The SHENZHEN TIMEWAY TESTING LABORATORIES. reserves the rights to withdraw it and to adopt any other remedies which may be appropriate.



For 802.11g mode

CH01 at 6Mbps

10.4 Band-edge Measurement

EUT	Tablet PC	Model	ST8888
Mode	Keeping Transmitting	Test Voltage	DC3.7V
Temperature	24 deg. C,	Humidity	56% RH
Test Result:	Pass	Detector	PK

Test Figure:

Marker 1 [T1]
RBW 100 kHz
RF Att 20 dB
Ref Lvl -10.95 dBm
VBW 300 kHz
10 dBm
2.40579158 GHz
SWT 20 ms
Unit dBm

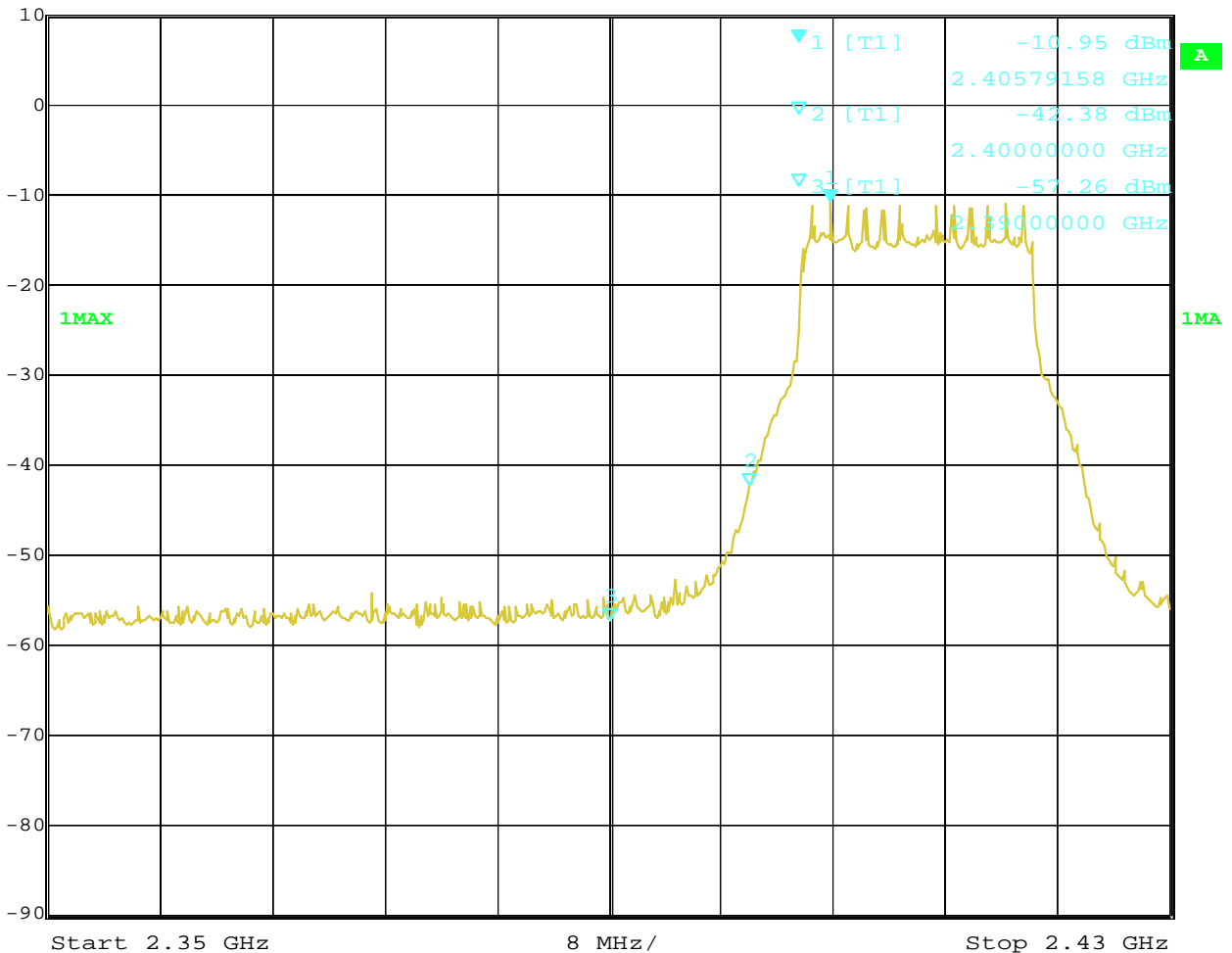

Date: 15.JUN.2022 15:59:04

The report refers only to the sample tested and does not apply to the bulk.
 This report is issued in confidence to the client and it will be strictly treated as such by the SHENZHEN TIMEWAY TESTING LABORATORIES. It may not be reproduced rather in its entirety or in part and it may not be used for advertising. The client to whom the report is issued may, however, show or send it or a certified copy thereof prepared by the SHENZHEN TIMEWAY TESTING LABORATORIES to his customer. Supplier or others persons directly concerned. SHENZHEN TIMEWAY TESTING LABORATORIES will not, without the consent of the client enter into any discussion of correspondence with any third party concerning the contents of the report.
 In the event of the improper use of the report. The SHENZHEN TIMEWAY TESTING LABORATORIES reserves the rights to withdraw it and to adopt any other remedies which may be appropriate.



CH11 at 6Mbps

10.4 Band-edge Measurement

EUT	Tablet PC	Model	ST8888
Mode	Keeping Transmitting	Test Voltage	DC3.7V
Temperature	24 deg. C,	Humidity	56% RH
Test Result:	Pass	Detector	PK

Test Figure:

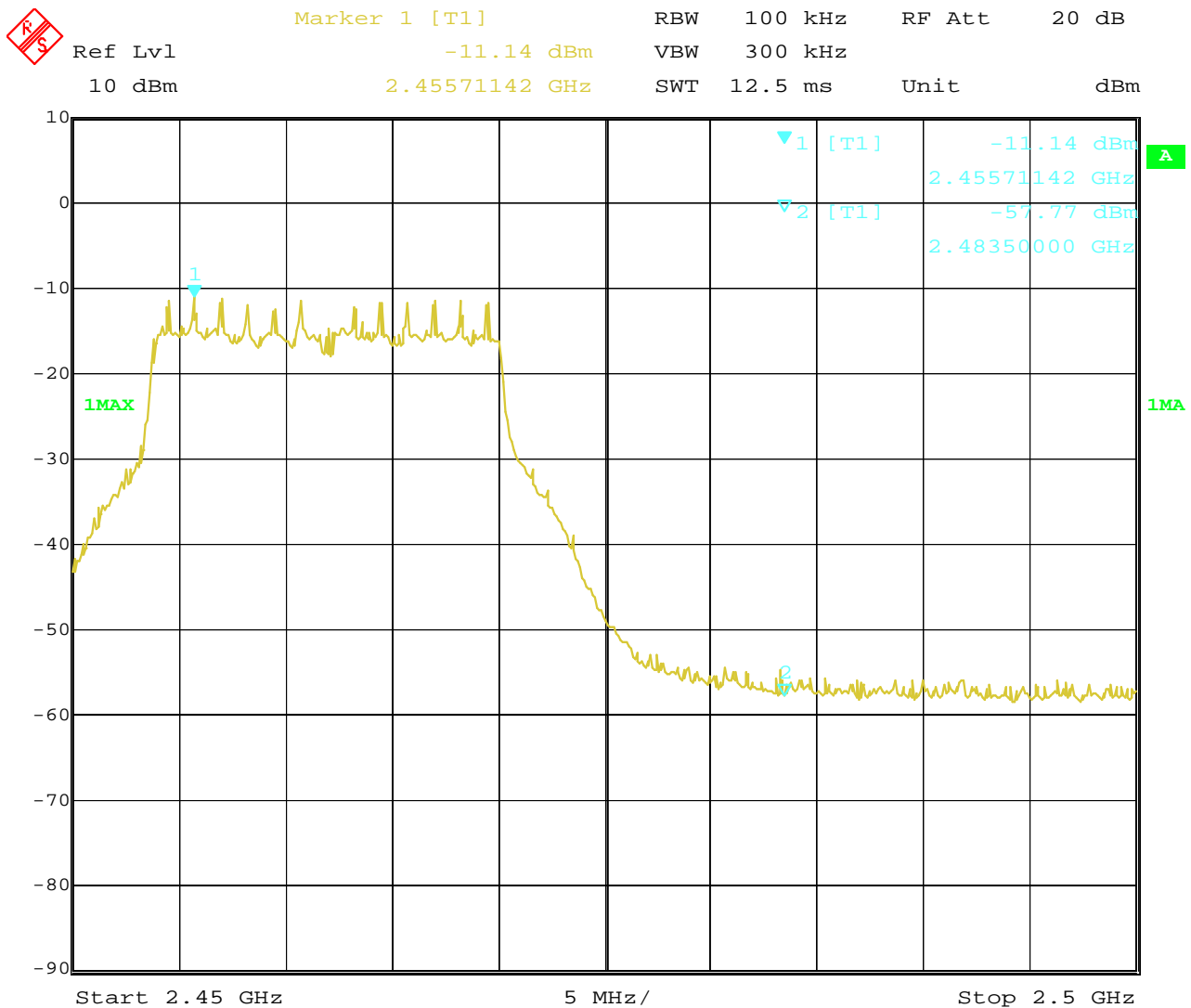

Date: 15.JUN.2022 16:02:13

The report refers only to the sample tested and does not apply to the bulk.
 This report is issued in confidence to the client and it will be strictly treated as such by the SHENZHEN TIMEWAY TESTING LABORATORIES. It may not be reproduced rather in its entirety or in part and it may not be used for advertising. The client to whom the report is issued may, however, show or send it . or a certified copy there of prepared by the SHENZHEN TIMEWAY TESTING LABORATORIES. to his customer. Supplier or others persons directly concerned. SHENZHEN TIMEWAY TESTING LABORATORIES. will not, without the consent of the client enter into any discussion of correspondence with any third party concerning the contents of the report.
 In the event of the improper use of the report. The SHENZHEN TIMEWAY TESTING LABORATORIES. reserves the rights to withdraw it and to adopt any other remedies which may be appropriate.



For 802.11n (HT20) mode

CH01 at mcs0

10.4 Band-edge Measurement

EUT	Tablet PC	Model	ST8888
Mode	Keeping Transmitting	Test Voltage	DC3.7V
Temperature	24 deg. C,	Humidity	56% RH
Test Result:	Pass	Detector	PK

Test Figure:

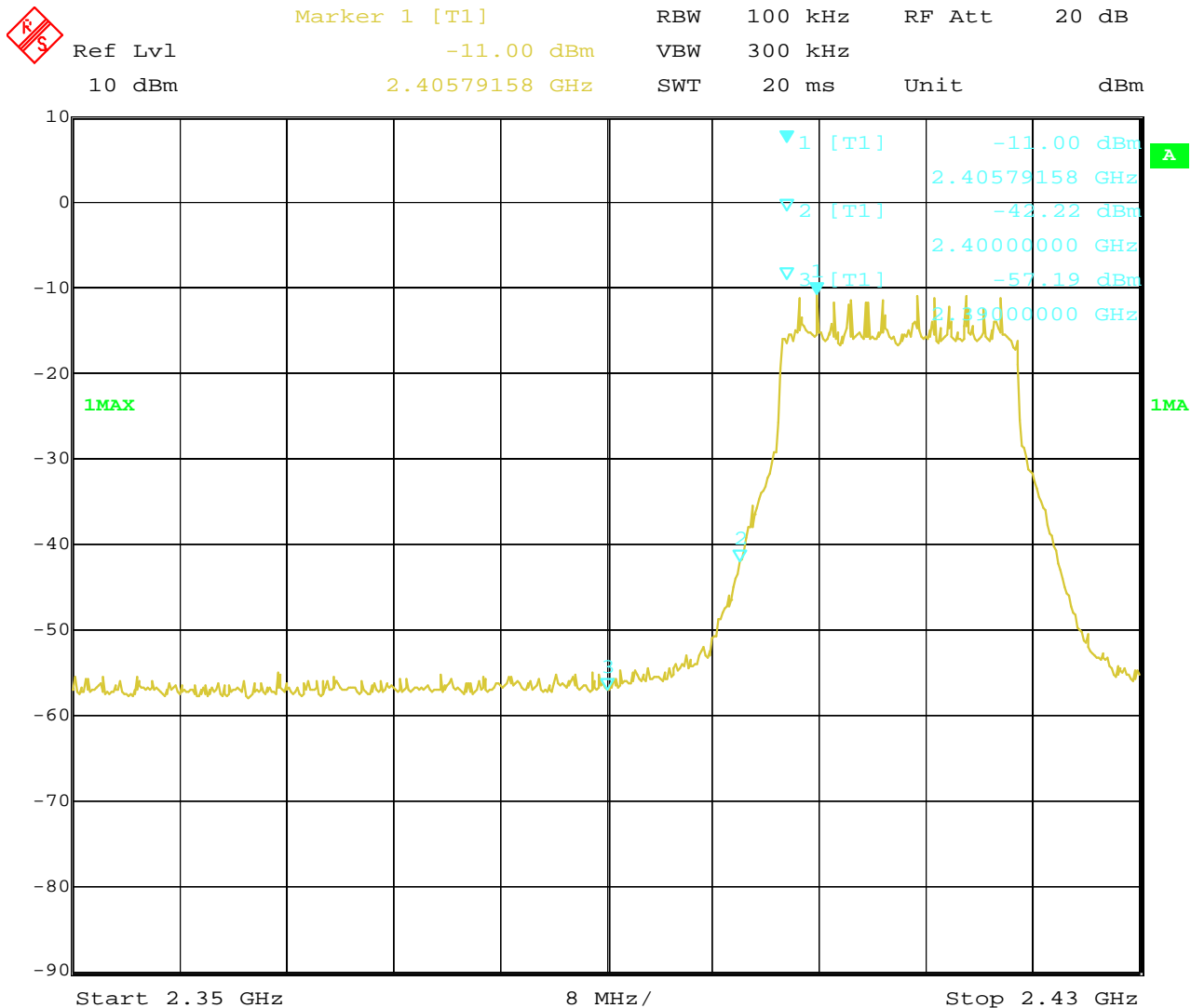

Date: 15.JUN.2022 16:00:35

The report refers only to the sample tested and does not apply to the bulk.
 This report is issued in confidence to the client and it will be strictly treated as such by the SHENZHEN TIMEWAY TESTING LABORATORIES. It may not be reproduced rather in its entirety or in part and it may not be used for advertising. The client to whom the report is issued may, however, show or send it or a certified copy thereof prepared by the SHENZHEN TIMEWAY TESTING LABORATORIES to his customer. Supplier or others persons directly concerned. SHENZHEN TIMEWAY TESTING LABORATORIES will not, without the consent of the client enter into any discussion of correspondence with any third party concerning the contents of the report.
 In the event of the improper use of the report. The SHENZHEN TIMEWAY TESTING LABORATORIES reserves the rights to withdraw it and to adopt any other remedies which may be appropriate.



CH11 at mcs0

10.4 Band-edge Measurement

EUT	Tablet PC	Model	ST8888
Mode	Keeping Transmitting	Test Voltage	DC3.7V
Temperature	24 deg. C,	Humidity	56% RH
Test Result:	Pass	Detector	PK

Test Figure:

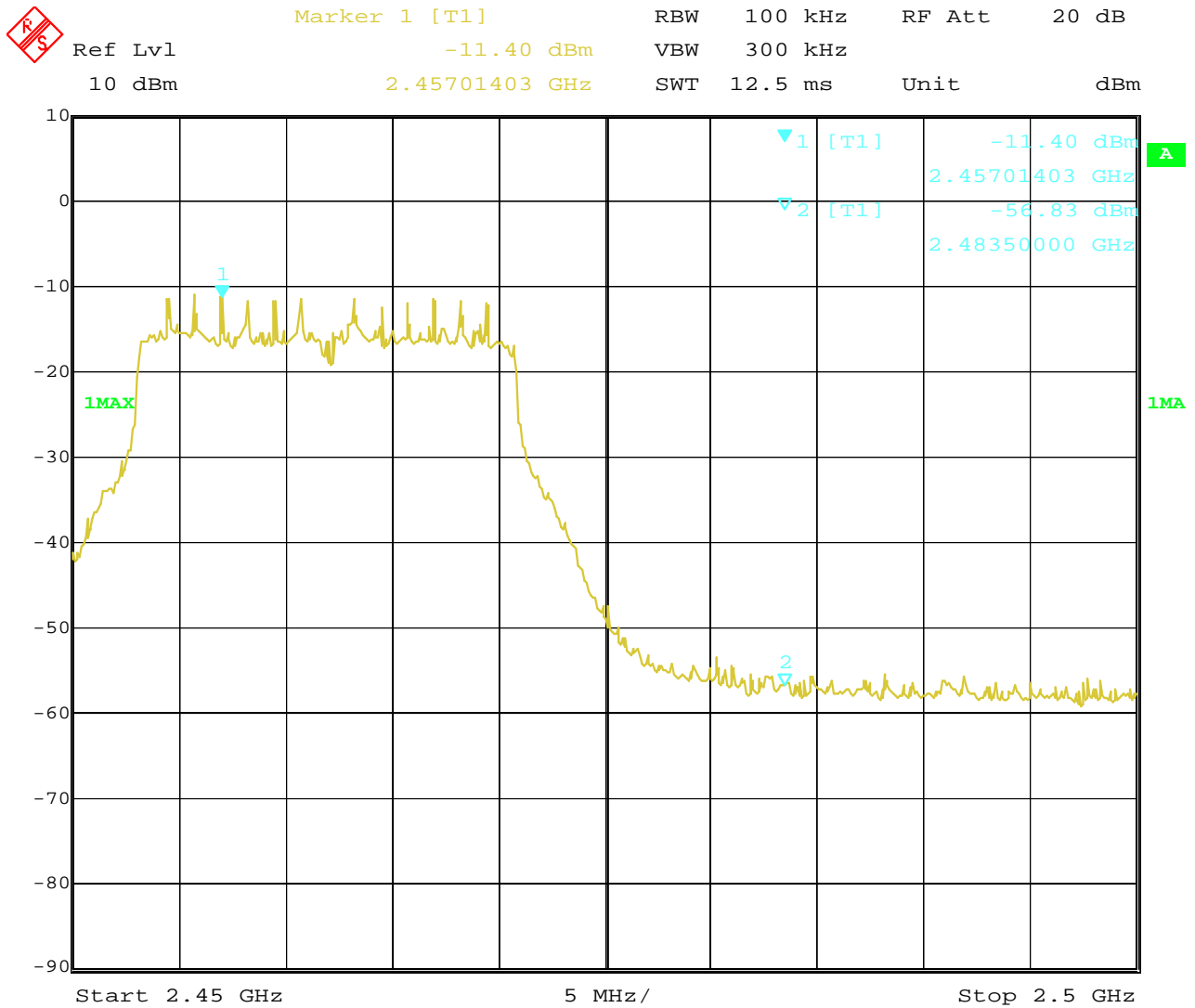

Date: 15.JUN.2022 16:01:09

The report refers only to the sample tested and does not apply to the bulk.
 This report is issued in confidence to the client and it will be strictly treated as such by the SHENZHEN TIMEWAY TESTING LABORATORIES. It may not be reproduced rather in its entirety or in part and it may not be used for advertising. The client to whom the report is issued may, however, show or send it . or a certified copy there of prepared by the SHENZHEN TIMEWAY TESTING LABORATORIES. to his customer. Supplier or others persons directly concerned. SHENZHEN TIMEWAY TESTING LABORATORIES. will not, without the consent of the client enter into any discussion of correspondence with any third party concerning the contents of the report.
 In the event of the improper use of the report. The SHENZHEN TIMEWAY TESTING LABORATORIES. reserves the rights to withdraw it and to adopt any other remedies which may be appropriate.



For 802.11n (HT40) mode

CH03 at msc0

10.4 Band-edge and Restricted band Measurement

EUT	Tablet PC	Model	ST8888
Mode	Keeping Transmitting	Test Voltage	DC3.7V
Temperature	24 deg. C,	Humidity	56% RH
Test Result:	Pass	Detector	PK

Test Figure:

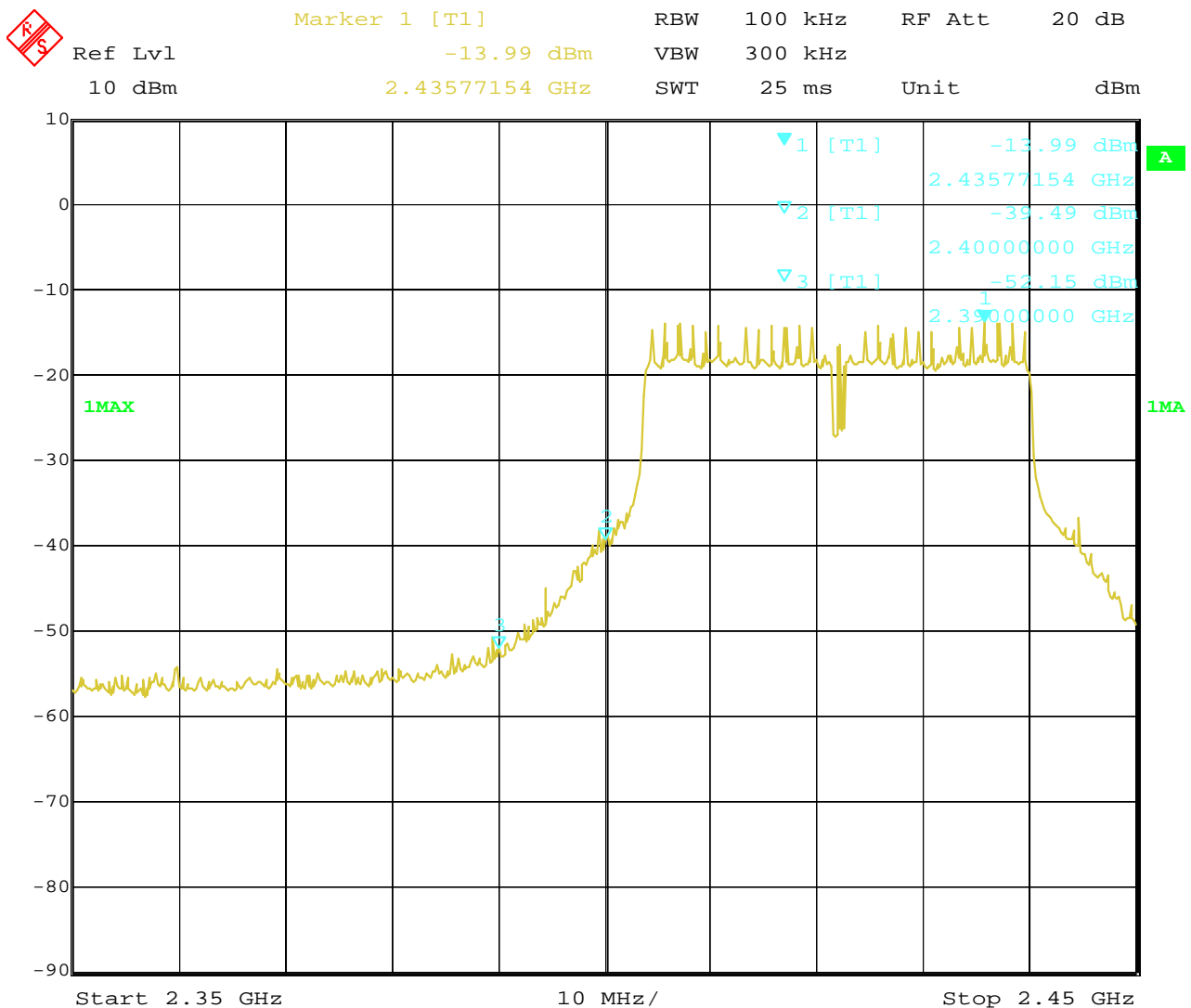

Date: 15.JUN.2022 16:03:57

The report refers only to the sample tested and does not apply to the bulk.
 This report is issued in confidence to the client and it will be strictly treated as such by the SHENZHEN TIMEWAY TESTING LABORATORIES. It may not be reproduced rather in its entirety or in part and it may not be used for advertizing. The client to whom the report is issued may, however, show or send it . or a certified copy there of prepared by the SHENZHEN TIMEWAY TESTING LABORATORIES. to his customer. Supplier or others persons directly concerned. SHENZHEN TIMEWAY TESTING LABORATORIES. will not, without the consent of the client enter into any discussion of correspondence with any third party concerning the contents of the report.
 In the event of the improper use of the report. The SHENZHEN TIMEWAY TESTING LABORATORIES. reserves the rights to withdraw it and to adopt any other remedies which may be appropriate.



CH09 at msc0

10.4 Band-edge and Restricted band Measurement

EUT	Tablet PC	Model	ST8888
Mode	Keeping Transmitting	Test Voltage	DC3.7V
Temperature	24 deg. C,	Humidity	56% RH
Test Result:	Pass	Detector	PK

Test Figure:

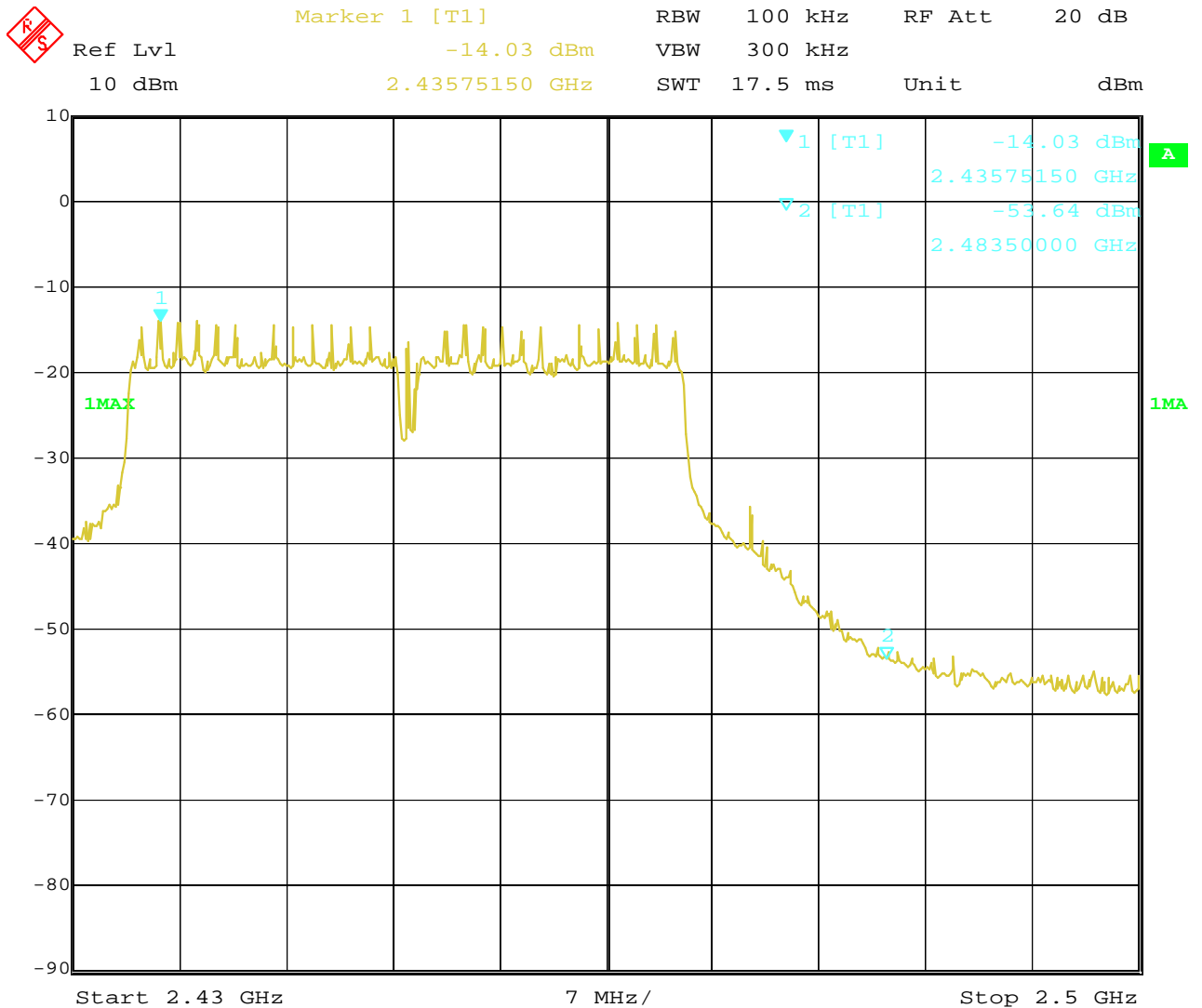

Date: 15.JUN.2022 16:03:17

The report refers only to the sample tested and does not apply to the bulk.
 This report is issued in confidence to the client and it will be strictly treated as such by the SHENZHEN TIMEWAY TESTING LABORATORIES. It may not be reproduced rather in its entirety or in part and it may not be used for advertising. The client to whom the report is issued may, however, show or send it . or a certified copy there of prepared by the SHENZHEN TIMEWAY TESTING LABORATORIES. to his customer. Supplier or others persons directly concerned. SHENZHEN TIMEWAY TESTING LABORATORIES. will not, without the consent of the client enter into any discussion of correspondence with any third party concerning the contents of the report.
 In the event of the improper use of the report. The SHENZHEN TIMEWAY TESTING LABORATORIES. reserves the rights to withdraw it and to adopt any other remedies which may be appropriate.



10.5 Restricted band Measurement

EUT	Tablet PC		Model	ST8888
Mode	Keeping Transmitting		Test Voltage	DC3.7V
Temperature	24 deg. C,		Humidity	56% RH
Test Result:	Pass		Detector	PK
802.11b mode, Low Channel, Horizontal				
2390	PK (dB μ V/m)	43.27	Limit	74(dB μ V/m)
	AV (dB μ V/m)	--		54(dB μ V/m)
802.11b mode, Low Channel, Vertical				
2390	PK (dB μ V/m)	41.06	Limit	74(dB μ V/m)
	AV (dB μ V/m)	--		54(dB μ V/m)

10.5 Restricted band Measurement

EUT	Tablet PC		Model	ST8888
Mode	Keeping Transmitting		Test Voltage	DC3.7V
Temperature	24 deg. C,		Humidity	56% RH
Test Result:	Pass		Detector	PK
802.11b mode, High Channel, Horizontal				
2483.5	PK (dB μ V/m)	43.69	Limit	74(dB μ V/m)
	AV (dB μ V/m)	--		54(dB μ V/m)
802.11b mode, High Channel, Vertical				
2483.5	PK (dB μ V/m)	40.16	Limit	74(dB μ V/m)
	AV (dB μ V/m)	--		54(dB μ V/m)

The report refers only to the sample tested and does not apply to the bulk.

This report is issued in confidence to the client and it will be strictly treated as such by the SHENZHEN TIMEWAY TESTING LABORATORIES. It may not be reproduced rather in its entirety or in part and it may not be used for advertising. The client to whom the report is issued may, however, show or send it . or a certified copy there of prepared by the SHENZHEN TIMEWAY TESTING LABORATORIES. to his customer. Supplier or others persons directly concerned. SHENZHEN TIMEWAY TESTING LABORATORIES. will not, without the consent of the client enter into any discussion of correspondence with any third party concerning the contents of the report.

In the event of the improper use of the report. The SHENZHEN TIMEWAY TESTING LABORATORIES. reserves the rights to withdraw it and to adopt any other remedies which may be appropriate.



10.5 Restricted band Measurement

EUT	Tablet PC		Model	ST8888
Mode	Keeping Transmitting		Test Voltage	DC3.7V
Temperature	24 deg. C,		Humidity	56% RH
Test Result:	Pass		Detector	PK
802.11g mode, Low Channel, Horizontal				
2390	PK (dB μ V/m)	45.58	Limit	74(dB μ V/m)
	AV (dB μ V/m)	--		54(dB μ V/m)
802.11g mode, Low Channel, Vertical				
2390	PK (dB μ V/m)	42.19	Limit	74(dB μ V/m)
	AV (dB μ V/m)	--		54(dB μ V/m)

10.5 Restricted band Measurement

EUT	Tablet PC		Model	ST8888
Mode	Keeping Transmitting		Test Voltage	DC3.7V
Temperature	24 deg. C,		Humidity	56% RH
Test Result:	Pass		Detector	PK
802.11g mode, High Channel, Horizontal				
2483.5	PK (dB μ V/m)	43.25	Limit	74(dB μ V/m)
	AV (dB μ V/m)	--		54(dB μ V/m)
802.11g mode, High Channel, Vertical				
2483.5	PK (dB μ V/m)	40.36	Limit	74(dB μ V/m)
	AV (dB μ V/m)	--		54(dB μ V/m)

The report refers only to the sample tested and does not apply to the bulk.

This report is issued in confidence to the client and it will be strictly treated as such by the SHENZHEN TIMEWAY TESTING LABORATORIES. It may not be reproduced rather in its entirety or in part and it may not be used for advertising. The client to whom the report is issued may, however, show or send it . or a certified copy there of prepared by the SHENZHEN TIMEWAY TESTING LABORATORIES. to his customer. Supplier or others persons directly concerned. SHENZHEN TIMEWAY TESTING LABORATORIES. will not, without the consent of the client enter into any discussion of correspondence with any third party concerning the contents of the report.

In the event of the improper use of the report. The SHENZHEN TIMEWAY TESTING LABORATORIES. reserves the rights to withdraw it and to adopt any other remedies which may be appropriate.



10.5 Restricted band Measurement

EUT	Tablet PC		Model	ST8888
Mode	Keeping Transmitting		Test Voltage	DC3.7V
Temperature	24 deg. C,		Humidity	56% RH
Test Result:	Pass		Detector	PK
802.11n HT20 mode, Low Channel, Horizontal				
2390	PK (dB μ V/m)	46.18	Limit	74(dB μ V/m)
	AV (dB μ V/m)	--		54(dB μ V/m)
802.11n HT20 mode, Low Channel, Vertical				
2390	PK (dB μ V/m)	42.37	Limit	74(dB μ V/m)
	AV (dB μ V/m)	--		54(dB μ V/m)

10.5 Restricted band Measurement

EUT	Tablet PC		Model	ST8888
Mode	Keeping Transmitting		Test Voltage	DC3.7V
Temperature	24 deg. C,		Humidity	56% RH
Test Result:	Pass		Detector	PK
802.11n HT20 mode, High Channel, Horizontal				
2483.5	PK (dB μ V/m)	44.02	Limit	74(dB μ V/m)
	AV (dB μ V/m)	--		54(dB μ V/m)
802.11n HT20 mode, High Channel, Vertical				
2483.5	PK (dB μ V/m)	40.69	Limit	74(dB μ V/m)
	AV (dB μ V/m)	--		54(dB μ V/m)

The report refers only to the sample tested and does not apply to the bulk.
 This report is issued in confidence to the client and it will be strictly treated as such by the SHENZHEN TIMEWAY TESTING LABORATORIES. It may not be reproduced rather in its entirety or in part and it may not be used for advertising. The client to whom the report is issued may, however, show or send it . or a certified copy there of prepared by the SHENZHEN TIMEWAY TESTING LABORATORIES. to his customer. Supplier or others persons directly concerned. SHENZHEN TIMEWAY TESTING LABORATORIES. will not, without the consent of the client enter into any discussion of correspondence with any third party concerning the contents of the report.
 In the event of the improper use of the report. The SHENZHEN TIMEWAY TESTING LABORATORIES. reserves the rights to withdraw it and to adopt any other remedies which may be appropriate.



10.5 Restricted band Measurement

EUT	Tablet PC		Model	ST8888
Mode	Keeping Transmitting		Test Voltage	DC3.7V
Temperature	24 deg. C,		Humidity	56% RH
Test Result:	Pass		Detector	PK
802.11n HT40 mode, Low Channel, Horizontal				
2390	PK (dB μ V/m)	47.57	Limit	74(dB μ V/m)
	AV (dB μ V/m)	--		54(dB μ V/m)
802.11n HT40 mode, Low Channel Vertical				
2390	PK (dB μ V/m)	43.25	Limit	74(dB μ V/m)
	AV (dB μ V/m)	--		54(dB μ V/m)

Test Plots

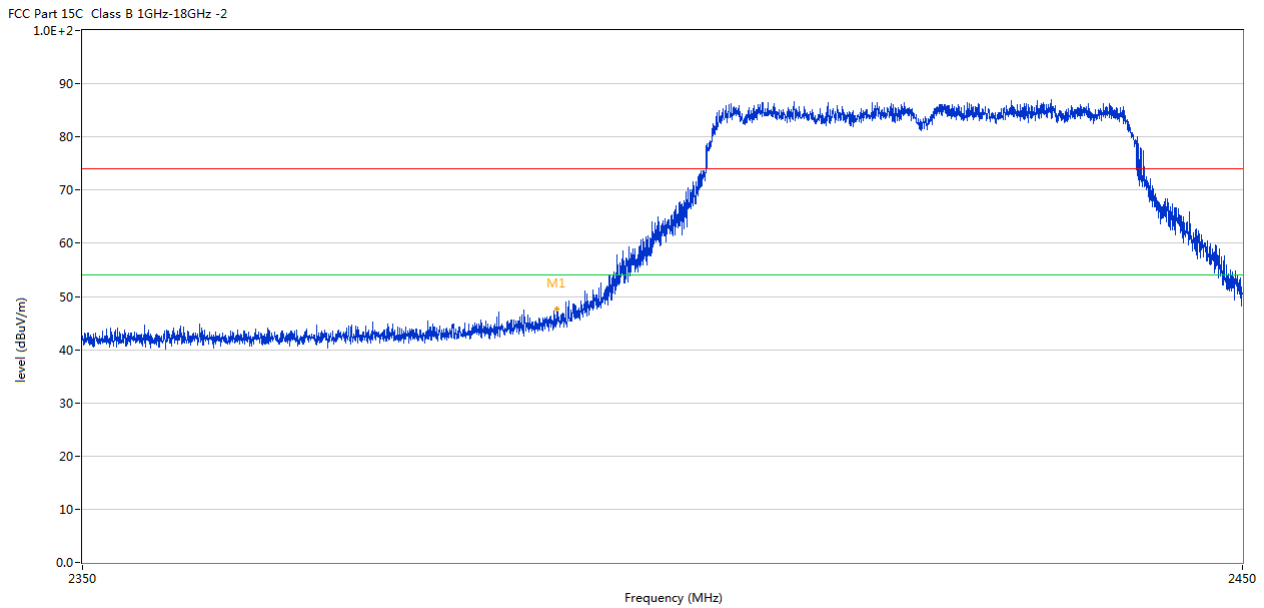

No.	Frequency (MHz)	Results (dBuV/m)	Factor (dB)	Limit (dBuV/m)	Over Limit (dB)	Detector	Table (o)	Height (cm)	ANT	Verdict
1	2390.415	47.57	-3.53	74.0	-26.43	Peak	159.00	100	Horizontal	Pass

The report refers only to the sample tested and does not apply to the bulk.
 This report is issued in confidence to the client and it will be strictly treated as such by the SHENZHEN TIMEWAY TESTING LABORATORIES. It may not be reproduced rather in its entirety or in part and it may not be used for adverting. The client to whom the report is issued may, however, show or send it . or a certified copy there of prepared by the SHENZHEN TIMEWAY TESTING LABORATORIES. to his customer. Supplier or others persons directly concerned. SHENZHEN TIMEWAY TESTING LABORATORIES. will not, without the consent of the client enter into any discussion of correspondence with any third party concerning the contents of the report.
 In the event of the improper use of the report. The SHENZHEN TIMEWAY TESTING LABORATORIES. reserves the rights to withdraw it and to adopt any other remedies which may be appropriate.



FCC Part 15C Class B 1GHz-18GHz -2
 1.0E+2

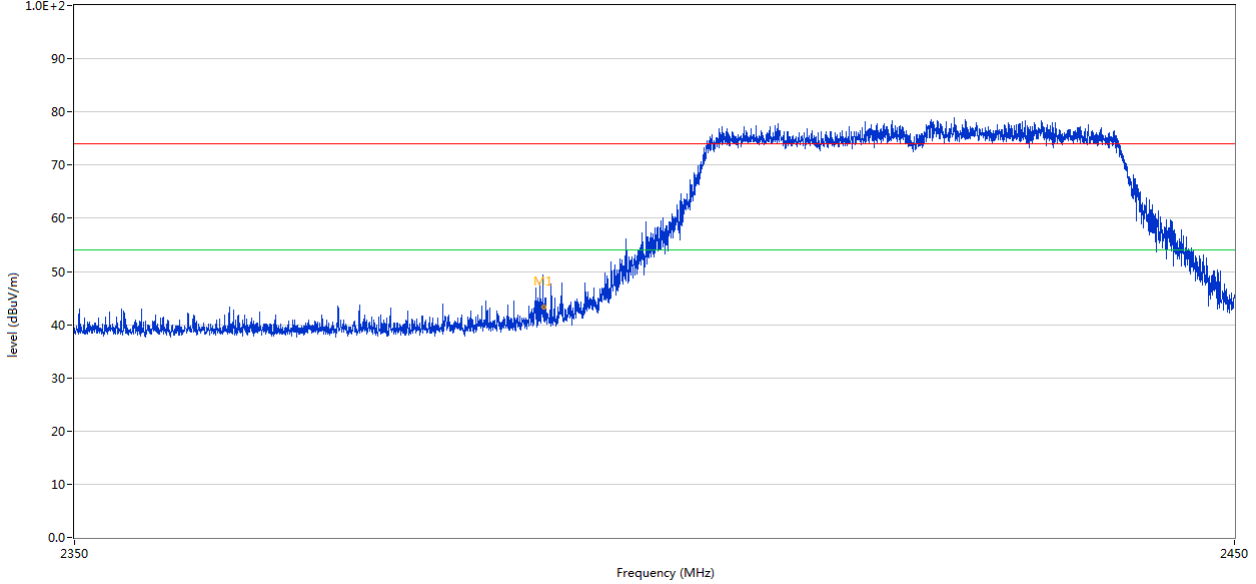

No.	Frequency (MHz)	Results (dBuV/m)	Factor (dB)	Limit (dBuV/m)	Over Limit (dB)	Detector	Table (o)	Height (cm)	ANT	Verdict
1	2389.990	43.25	-3.53	74.0	-30.75	Peak	24.00	100	Vertical	Pass

The report refers only to the sample tested and does not apply to the bulk.

This report is issued in confidence to the client and it will be strictly treated as such by the SHENZHEN TIMEWAY TESTING LABORATORIES. It may not be reproduced rather in its entirety or in part and it may not be used for advertising. The client to whom the report is issued may, however, show or send it or a certified copy thereof prepared by the SHENZHEN TIMEWAY TESTING LABORATORIES to his customer. Supplier or others persons directly concerned. SHENZHEN TIMEWAY TESTING LABORATORIES will not, without the consent of the client enter into any discussion of correspondence with any third party concerning the contents of the report.

In the event of the improper use of the report. The SHENZHEN TIMEWAY TESTING LABORATORIES reserves the rights to withdraw it and to adopt any other remedies which may be appropriate.



10.5 Restricted band Measurement

EUT	Tablet PC		Model	ST8888
Mode	Keeping Transmitting		Test Voltage	DC3.7V
Temperature	24 deg. C,		Humidity	56% RH
Test Result:	Pass		Detector	PK
802.11n HT40 mode, High Channel, Horizontal				
2483.5	PK (dB μ V/m)	44.36	Limit	74(dB μ V/m)
	AV (dB μ V/m)	--		54(dB μ V/m)
802.11n HT40 mode, High Channel, Vertical				
2483.5	PK (dB μ V/m)	40.86	Limit	74(dB μ V/m)
	AV (dB μ V/m)	--		54(dB μ V/m)

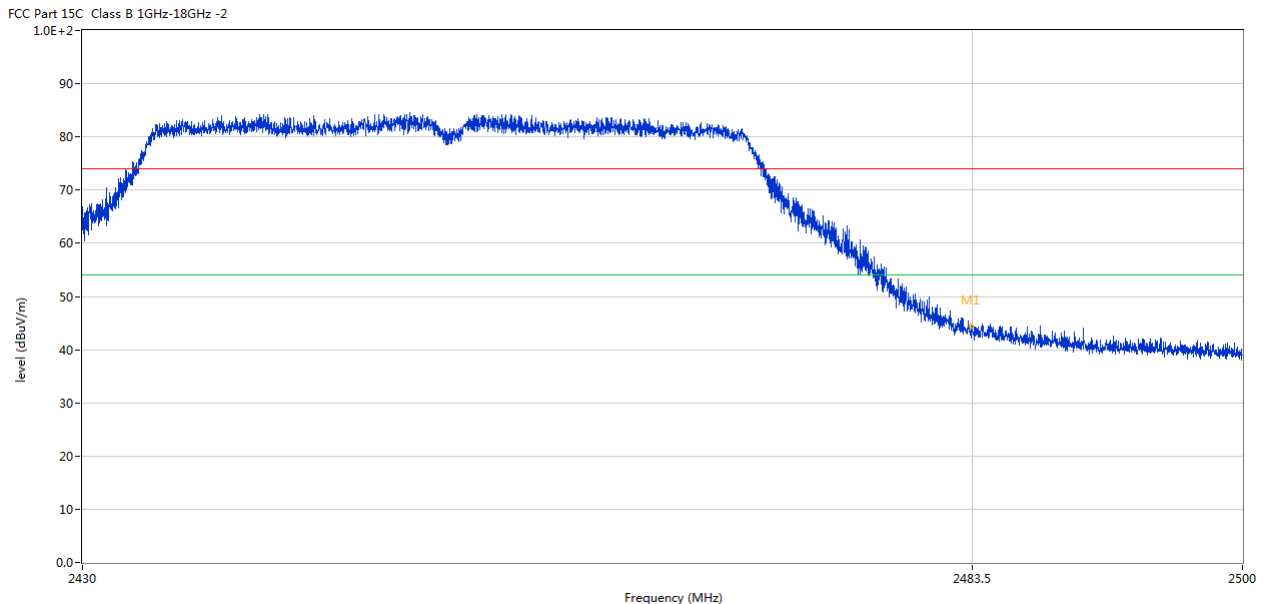

No.	Frequency (MHz)	Results (dBuV/m)	Factor (dB)	Limit (dBuV/m)	Over Limit (dB)	Detector	Table (o)	Height (cm)	ANT	Verdict
1	2483.457	44.36	-3.57	74.0	-29.64	Peak	205.00	100	Horizontal	Pass

The report refers only to the sample tested and does not apply to the bulk.
 This report is issued in confidence to the client and it will be strictly treated as such by the SHENZHEN TIMEWAY TESTING LABORATORIES. It may not be reproduced rather in its entirety or in part and it may not be used for adverting. The client to whom the report is issued may, however, show or send it . or a certified copy there of prepared by the SHENZHEN TIMEWAY TESTING LABORATORIES. to his customer. Supplier or others persons directly concerned. SHENZHEN TIMEWAY TESTING LABORATORIES. will not, without the consent of the client enter into any discussion of correspondence with any third party concerning the contents of the report.
 In the event of the improper use of the report. The SHENZHEN TIMEWAY TESTING LABORATORIES. reserves the rights to withdraw it and to adopt any other remedies which may be appropriate.



FCC Part 15C Class B 1GHz-18GHz -2
 1.0E+2

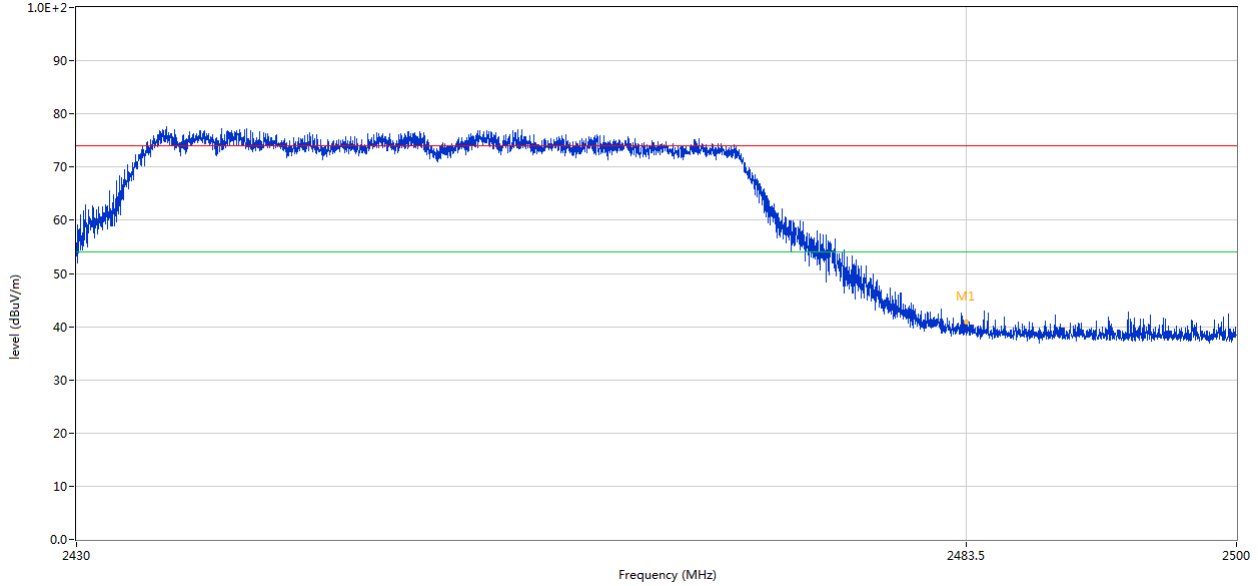

No.	Frequency (MHz)	Results (dBuV/m)	Factor (dB)	Limit (dBuV/m)	Over Limit (dB)	Detector	Table (o)	Height (cm)	ANT	Verdict
1	2483.486	40.86	-3.57	74.0	-33.14	Peak	121.00	100	Vertical	Pass

The report refers only to the sample tested and does not apply to the bulk.

This report is issued in confidence to the client and it will be strictly treated as such by the SHENZHEN TIMEWAY TESTING LABORATORIES. It may not be reproduced rather in its entirety or in part and it may not be used for adverting. The client to whom the report is issued may, however, show or send it . or a certified copy there of prepared by the SHENZHEN TIMEWAY TESTING LABORATORIES. to his customer. Supplier or others persons directly concerned. SHENZHEN TIMEWAY TESTING LABORATORIES. will not, without the consent of the client enter into any discussion of correspondence with any third party concerning the contents of the report.

In the event of the improper use of the report. The SHENZHEN TIMEWAY TESTING LABORATORIES. reserves the rights to withdraw it and to adopt any other remedies which may be appropriate.



11.0 Antenna Requirement

11.1 Standard Applicable

For intentional device, according to FCC 47 CFR Section 15.203, an intentional radiator shall be designed to ensure that no antenna other than that furnished by the responsible party shall be used with the device.

And according to FCC 47 CFR Section 15.247 (b), if transmitter antennas of directional gain greater than 6 dBi are used, the power shall be reduced by the amount in dB that the directional gain of the antenna exceeds 6 dBi.

11.2 Antenna Connected construction

FPC antenna with gain 1.42dBi Max (Get from the antenna specification)

The report refers only to the sample tested and does not apply to the bulk.

This report is issued in confidence to the client and it will be strictly treated as such by the SHENZHEN TIMEWAY TESTING LABORATORIES. It may not be reproduced either in its entirety or in part and it may not be used for advertising. The client to whom the report is issued may, however, show or send it or a certified copy thereof prepared by the SHENZHEN TIMEWAY TESTING LABORATORIES to his customer. Supplier or other persons directly concerned. SHENZHEN TIMEWAY TESTING LABORATORIES will not, without the consent of the client enter into any discussion of correspondence with any third party concerning the contents of the report.

In the event of the improper use of the report. The SHENZHEN TIMEWAY TESTING LABORATORIES reserves the rights to withdraw it and to adopt any other remedies which may be appropriate.



12.0 FCC ID Label

FCC ID: RBD-W811W

This device complies with Part 15 of the FCC Rules. Operation is subject to the following two conditions: (1) this device may not cause harmful interference, and (2) this device must accept any interference received, including interference that may cause undesired operation

The label must not be a stick-on paper label. The label on these products must be permanently affixed to the product and readily visible at the time of purchase and must last the expected lifetime of the equipment not be readily detachable.

Mark Location:

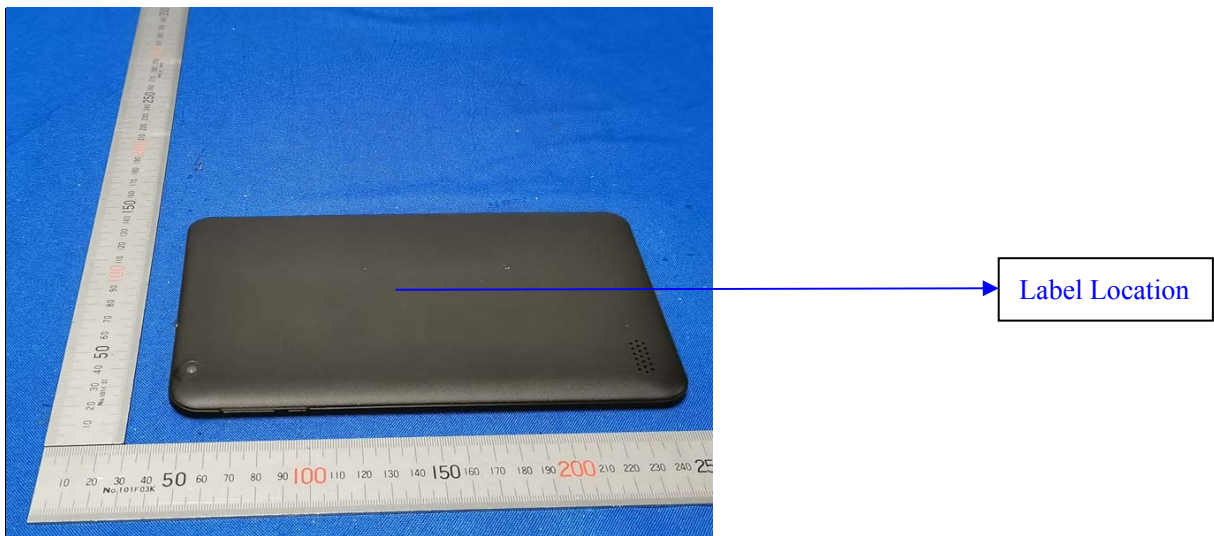

The report refers only to the sample tested and does not apply to the bulk.

This report is issued in confidence to the client and it will be strictly treated as such by the SHENZHEN TIMEWAY TESTING LABORATORIES. It may not be reproduced rather in its entirety or in part and it may not be used for advertising. The client to whom the report is issued may, however, show or send it or a certified copy thereof prepared by the SHENZHEN TIMEWAY TESTING LABORATORIES to his customer. Supplier or others persons directly concerned. SHENZHEN TIMEWAY TESTING LABORATORIES will not, without the consent of the client enter into any discussion of correspondence with any third party concerning the contents of the report.

In the event of the improper use of the report. The SHENZHEN TIMEWAY TESTING LABORATORIES reserves the rights to withdraw it and to adopt any other remedies which may be appropriate.



13.0 Photo of testing

Conducted Emission Test Setup:



The report refers only to the sample tested and does not apply to the bulk.

This report is issued in confidence to the client and it will be strictly treated as such by the SHENZHEN TIMEWAY TESTING LABORATORIES. It may not be reproduced rather in its entirety or in part and it may not be used for advertising. The client to whom the report is issued may, however, show or send it . or a certified copy there of prepared by the SHENZHEN TIMEWAY TESTING LABORATORIES. to his customer. Supplier or others persons directly concerned. SHENZHEN TIMEWAY TESTING LABORATORIES. will not, without the consent of the client enter into any discussion of correspondence with any third party concerning the contents of the report.

In the event of the improper use of the report. The SHENZHEN TIMEWAY TESTING LABORATORIES. reserves the rights to withdraw it and to adopt any other remedies which may be appropriate.



Radiated Emission Test Setup:

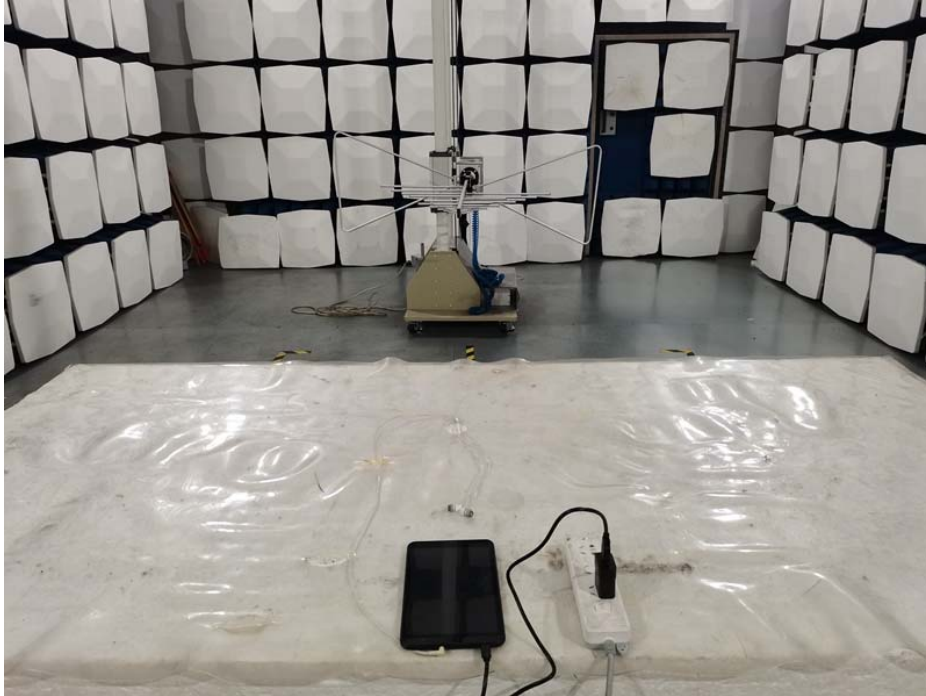

Photographs – EUT

Please refer test report TW2206057-01E

-End of the report-

The report refers only to the sample tested and does not apply to the bulk.

This report is issued in confidence to the client and it will be strictly treated as such by the SHENZHEN TIMEWAY TESTING LABORATORIES. It may not be reproduced rather in its entirety or in part and it may not be used for advertising. The client to whom the report is issued may, however, show or send it . or a certified copy there of prepared by the SHENZHEN TIMEWAY TESTING LABORATORIES. to his customer. Supplier or others persons directly concerned. SHENZHEN TIMEWAY TESTING LABORATORIES. will not, without the consent of the client enter into any discussion of correspondence with any third party concerning the contents of the report.

In the event of the improper use of the report. The SHENZHEN TIMEWAY TESTING LABORATORIES. reserves the rights to withdraw it and to adopt any other remedies which may be appropriate.