



TESTING LABORATORY  
CERTIFICATE #4820.01



FCC PART 15.407  
RSS-247, ISSUE 2, FEBRUARY 2017  
DYNAMIC FREQUENCY SELECTION  
TEST REPORT

For

**Shenzhen Jingwah Information Technology Co., Ltd.**

4F, Bldg 4, Jinghua Square, No.1 Huafa North Road, Shenzhen, China

**FCC ID: RBD-S4005L**  
**IC: 20054-S4005L**

<b>Report Type:</b> Original Report	<b>Product Type:</b> Smart Phone
<b>Report Number:</b>	RGMA190305002-00E
<b>Report Date:</b>	2019-03-22
<b>Reviewed By:</b>	Jerry Zhang EMC Manager <i>Jerry Zhang</i>
<b>Test Laboratory:</b>	Bay Area Compliance Laboratories Corp. (Dongguan) No.69 Pulongcun, Puxinhu Industry Area, Tangxia, Dongguan, Guangdong, China Tel: +86-769-86858888 Fax: +86-769-86858891 <a href="http://www.baclcorp.com.cn">www.baclcorp.com.cn</a>

**Note:** This test report is prepared for the customer shown above and for the device described herein. It may not be duplicated or used in part without prior written consent from Bay Area Compliance Laboratories Corp. (Dongguan). This report must not be used by the customer to claim product certification, approval, or endorsement by A2LA\* or any agency of the Federal Government. \* This report may contain data that are not covered by the A2LA accreditation and are marked with an asterisk “\*\*”.

## TABLE OF CONTENTS

<b>GENERAL INFORMATION.....</b>	<b>3</b>
PRODUCT DESCRIPTION FOR EQUIPMENT UNDER TEST (EUT) .....	3
OBJECTIVE .....	3
TEST METHODOLOGY .....	3
TEST FACILITY .....	3
<b>SYSTEM TEST CONFIGURATION.....</b>	<b>4</b>
DESCRIPTION OF TEST CONFIGURATION .....	4
EUT EXERCISE SOFTWARE .....	4
EQUIPMENT MODIFICATIONS .....	4
SUPPORT EQUIPMENT LIST AND DETAILS .....	4
EXTERNAL CABLE.....	4
<b>SUMMARY OF TEST RESULTS .....</b>	<b>5</b>
<b>APPLICABLE STANDARDS.....</b>	<b>6</b>
DFS REQUIREMENT .....	6
DFS MEASUREMENT SYSTEM .....	10
SYSTEM BLOCK DIAGRAM .....	10
CONDUCTED METHOD .....	11
RADIATED METHOD.....	12
TEST PROCEDURE .....	12
<b>TEST RESULTS.....</b>	<b>13</b>
DESCRIPTION OF EUT .....	13
TEST EQUIPMENT LIST AND DETAILS.....	13
RADAR WAVEFORM CALIBRATION .....	14
TEST ENVIRONMENTAL CONDITIONS .....	14
<b>CHANNEL MOVE TIME AND CHANNEL CLOSING TRANSMISSION TIME .....</b>	<b>17</b>
TEST PROCEDURE .....	17
TEST RESULTS .....	17
<b>NON-OCCUPANCY PERIOD .....</b>	<b>26</b>
TEST PROCEDURE .....	26
TEST RESULT .....	26

## GENERAL INFORMATION

### Product Description for Equipment under Test (EUT)

<b>EUT Name:</b>		Smart Phone
<b>EUT Model :</b>		S4005L
<b>Multiple Model:</b>		A4000-PB
<b>Rated Input Voltage:</b>		DC3.7V from Battery or DC5V from adapter
<b>Adapter Information</b>	<b>Model:</b>	TPA-95A050100UU
	<b>Input:</b>	AC 100-240V, 50/60Hz, 0.15A
	<b>Output:</b>	DC5V, 1000mA
<b>Serial Number:</b>		A4000181200001
<b>EUT Received Date:</b>		2019.03.05

*Notes: This series products model: A4000-PB and S4005L are identical; they have the same or similar appearance, structure, PCB, Material and function to the testing products, Model S4005L was selected for fully testing, the detailed information can be referred to the attached declaration which was stated and guaranteed by the applicant.*

### Objective

This report is prepared on behalf of *Shenzhen Jingwah Information Technology Co., Ltd.* in accordance with Part 2-Subpart J, Part 15-Subparts E of the Federal Communications Commission's rules, and RSS-247, Issue 2, February 2017 of the Innovation, Science and Economic Development Canada.

The objective is to determine compliance with FCC Part 15, Subpart E, section 15.407 and RSS-247, Issue 2, February 2017 of the Innovation, Science and Economic Development Canada Dynamic Frequency Selection (DFS) for devices operating in the bands 5250-5350 MHz, 5470-5725 MHz.

### Test Methodology

FCC KDB 905462 D02 UNII DFS Compliance Procedures New Rules v02.

### Test Facility

The Test site used by Bay Area Compliance Laboratories Corp. (Dongguan) to collect test data is located on the No.69 Pulongcun, Puxinhu Industry Area, Tangxia, Dongguan, Guangdong, China.

The lab has been recognized as the FCC accredited lab under the KDB 974614 D01 and is listed in the FCC Public Access Link (PAL) database, FCC Registration No. : 897218, the FCC Designation No. : CN1220.

The lab has been recognized by Innovation, Science and Economic Development Canada to test to Canadian radio equipment requirements, the CAB identifier: CN0022.

## SYSTEM TEST CONFIGURATION

---

### Description of Test Configuration

The EUT was configured for testing in an engineering mode which was provided by the manufacturer.

### EUT Exercise Software

The test was performed under: DOS command, which was provided by the manufacturer.

### Equipment Modifications

N/A

### Support Equipment List and Details

Manufacturer	Description	Model	Serial Number
ThinkPad	Laptop	E450	PF-0MR8KV 16/08
Huawei	Wireless Router	HG8245Q2	N/A

Note: The master AP model: HG8245Q2, FCC ID: QISHG8245Q2

### External Cable

Cable Description	Shielding Type	Ferrite Core	Length (m)	From Port	To
RJ45 Cable	No	No	10	RJ45 Port of Laptop	Wireless Router

## SUMMARY OF TEST RESULTS

The following result table represents the list of measurements required under the CFR §47 Part 15.407(h), RSS-247 Clause 6.3 and KDB: 905462 D02 UNII DFS Compliance Procedures New Rules v02

Items	Description of Test	Result
Detection Bandwidth	UNII Detection Bandwidth	Not applicable
Performance Requirements Check	Initial Channel Availability Check Time (CAC)	Not applicable
	Radar Burst at the Beginning of the CAC	Not applicable
	Radar Burst at the End of the CAC	Not applicable
In-Service Monitoring	Channel Move Time	Compliant
	Channel Closing Transmission Time	Compliant
	Non-Occupancy Period	Compliant
Radar Detection	Statistical Performance Check	Not applicable

Note:

- 1) Not applicable: the EUT is a client unit without radar detection.

## APPLICABLE STANDARDS

### DFS Requirement

CFR §47 Part 15.407(h)&RSS-247 Clause 6.3

FCC KDB 905462 D02 UNII DFS Compliance Procedures New Rules v02

**Table 1: Applicability of DFS Requirements Prior to Use of a Channel**

Requirement	Operational Mode		
	Master	Client Without Radar Detection	Client With Radar Detection
<i>Non-Occupancy Period</i>	Yes	Not required	Yes
<i>DFS Detection Threshold</i>	Yes	Not required	Yes
<i>Channel Availability Check Time</i>	Yes	Not required	Not required
<i>U-NII Detection Bandwidth</i>	Yes	Not required	Yes

**Table 2: Applicability of DFS requirements during normal operation**

Requirement	Operational Mode	
	Master Device or Client with Radar Detection	Client Without Radar Detection
<i>DFS Detection Threshold</i>	Yes	Not required
<i>Channel Closing Transmission Time</i>	Yes	Yes
<i>Channel Move Time</i>	Yes	Yes
<i>U-NII Detection Bandwidth</i>	Yes	Not required

Additional requirements for devices with multiple bandwidth modes	Master Device or Client with Radar Detection	Client Without Radar Detection
<i>U-NII Detection Bandwidth and Statistical Performance Check</i>	All BW modes must be tested	Not required
<i>Channel Move Time and Channel Closing Transmission Time</i>	Test using widest BW mode available	Test using the widest BW mode available for the link
<i>All other tests</i>	Any single BW mode	Not required
<b>Note:</b> Frequencies selected for statistical performance check (Section 7.8.4) should include several frequencies within the radar detection bandwidth and frequencies near the edge of the radar detection bandwidth. For 802.11 devices it is suggested to select frequencies in each of the bonded 20 MHz channels and the channel center frequency.		

**Table 3: DFS Detection Thresholds for Master Devices and Client Devices With Radar Detection**

Maximum Transmit Power	Value (See Notes 1, 2, and 3)
EIRP $\geq$ 200 milliwatt	-64 dBm
EIRP < 200 milliwatt and power spectral density < 10 dBm/MHz	-62 dBm
EIRP < 200 milliwatt that do not meet the power spectral density requirement	-64 dBm
<p><b>Note 1:</b> This is the level at the input of the receiver assuming a 0 dBi receive antenna.</p> <p><b>Note 2:</b> Throughout these test procedures an additional 1 dB has been added to the amplitude of the test transmission waveforms to account for variations in measurement equipment. This will ensure that the test signal is at or above the detection threshold level to trigger a DFS response.</p> <p><b>Note3:</b> EIRP is based on the highest antenna gain. For MIMO devices refer to KDB Publication 662911 D01.</p>	

**Table 4: DFS Response Requirement Values**

Parameter	Value
<i>Non-occupancy period</i>	Minimum 30 minutes
<i>Channel Availability Check Time</i>	60 seconds
<i>Channel Move Time</i>	10 seconds See Note 1.
<i>Channel Closing Transmission Time</i>	200 milliseconds + an aggregate of 60 milliseconds over remaining 10 second period. See Notes 1 and 2.
<i>U-NII Detection Bandwidth</i>	Minimum 100% of the U-NII 99% transmission power bandwidth. See Note 3.
<p><b>Note 1:</b> <i>Channel Move Time</i> and the <i>Channel Closing Transmission Time</i> should be performed with Radar Type 0. The measurement timing begins at the end of the Radar Type 0 burst.</p> <p><b>Note 2:</b> The <i>Channel Closing Transmission Time</i> is comprised of 200 milliseconds starting at the beginning of the <i>Channel Move Time</i> plus any additional intermittent control signals required to facilitate a <i>Channel move</i> (an aggregate of 60 milliseconds) during the remainder of the 10 second period. The aggregate duration of control signals will not count quiet periods in between transmissions.</p> <p><b>Note 3:</b> During the <i>U-NII Detection Bandwidth</i> detection test, radar type 0 should be used. For each frequency step the minimum percentage of detection is 90 percent. Measurements are performed with no data traffic.</p>	

**Table 5 – Short Pulse Radar Test Waveforms**

Radar Type	Pulse Width (μsec)	PRI (μsec)	Number of Pulses	Minimum Percentage of Successful Detection	Minimum Number of Trials
0	1	1428	18	See Note 1	See Note 1
1	1	Test A: 15 unique PRI values randomly selected from the list of 23 PRI values in Table 5a	Roundup $\left\{ \left( \frac{1}{360} \right) \cdot \left( \frac{19 \cdot 10^6}{\text{PRI}_{\mu\text{sec}}} \right) \right\}$	60%	30
		Test B: 15 unique PRI values randomly selected within the range of 518-3066 μsec, with a minimum increment of 1 μsec, excluding PRI values selected in Test A			
2	1-5	150-230	23-29	60%	30
3	6-10	200-500	16-18	60%	30
4	11-20	200-500	12-16	60%	30
Aggregate (Radar Types 1-4)				80%	120
<b>Note 1:</b> Short Pulse Radar Type 0 should be used for the detection bandwidth test, channel move time, and channel closing time tests.					

A minimum of 30 unique waveforms are required for each of the Short Pulse Radar Types 2 through 4. If more than 30 waveforms are used for Short Pulse Radar Types 2 through 4, then each additional waveform must also be unique and not repeated from the previous waveforms. If more than 30 waveforms are used for Short Pulse Radar Type 1, then each additional waveform is generated with Test B and must also be unique and not repeated from the previous waveforms in Tests A or B.

For example if in Short Pulse Radar Type 1 Test B a PRI of 3066 usec is selected, the number of pulses

would be  $\text{Roundup} \left\{ \left( \frac{1}{360} \right) \cdot \left( \frac{19 \cdot 10^6}{3066} \right) \right\} = \text{Roundup} \{17.2\} = 18.$



**Table 5a - Pulse Repetition Intervals Values for Test A**

<b>Pulse Repetition Frequency Number</b>	<b>Pulse Repetition Frequency (Pulses Per Second)</b>	<b>Pulse Repetition Interval (Microseconds)</b>
1	1930.5	518
2	1858.7	538
3	1792.1	558
4	1730.1	578
5	1672.2	598
6	1618.1	618
7	1567.4	638
8	1519.8	658
9	1474.9	678
10	1432.7	698
11	1392.8	718
12	1355	738
13	1319.3	758
14	1285.3	778
15	1253.1	798
16	1222.5	818
17	1193.3	838
18	1165.6	858
19	1139	878
20	1113.6	898
21	1089.3	918
22	1066.1	938
23	326.2	3066

The aggregate is the average of the percentage of successful detections of Short Pulse Radar Types 1-4. For example, the following table indicates how to compute the aggregate of percentage of successful detections.

<b>Radar Type</b>	<b>Number of Trials</b>	<b>Number of Successful Detections</b>	<b>Minimum Percentage of Successful Detection</b>
1	35	29	82.9%
2	30	18	60%
3	30	27	90%
4	50	44	88%
Aggregate $(82.9\% + 60\% + 90\% + 88\%)/4 = 80.2\%$			

**Table 6 – Long Pulse Radar Test Waveform**

Radar Type	Pulse Width (μsec)	Chirp Width (MHz)	PRI (μsec)	Number of Pulses per <i>Burst</i>	Number of <i>Bursts</i>	Minimum Percentage of Successful Detection	Minimum Number of Trials
5	50-100	5-20	1000-2000	1-3	8-20	80%	30

**Table 7 – Frequency Hopping Radar Test Waveform**

Radar Type	Pulse Width (μsec)	PRI (μsec)	Pulses per Hop	Hopping Rate (kHz)	Hopping Sequence Length (msec)	Minimum Percentage of Successful Detection	Minimum Number of Trials
6	1	333	9	0.333	300	70%	30

**DFS Measurement System**

BACL DFS measurement system consists of two subsystems: (1) The radar signal generating subsystem and (2) the traffic monitoring subsystem.

**System Block Diagram**

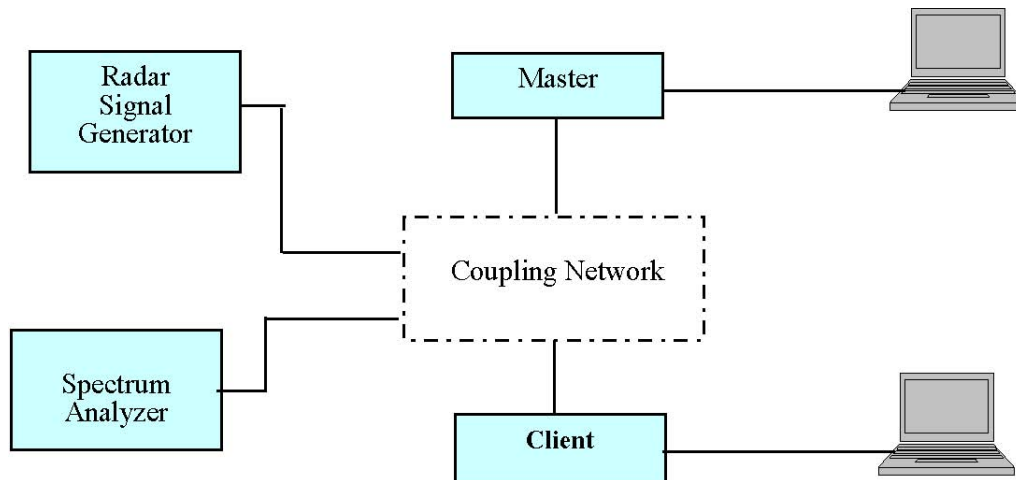

**Conducted Method**

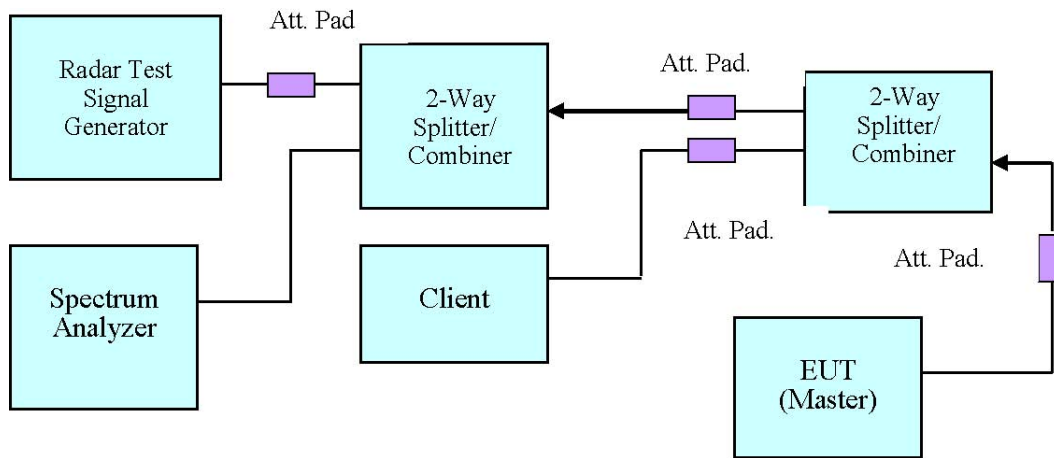

**Setup for Master with injection at the Master**

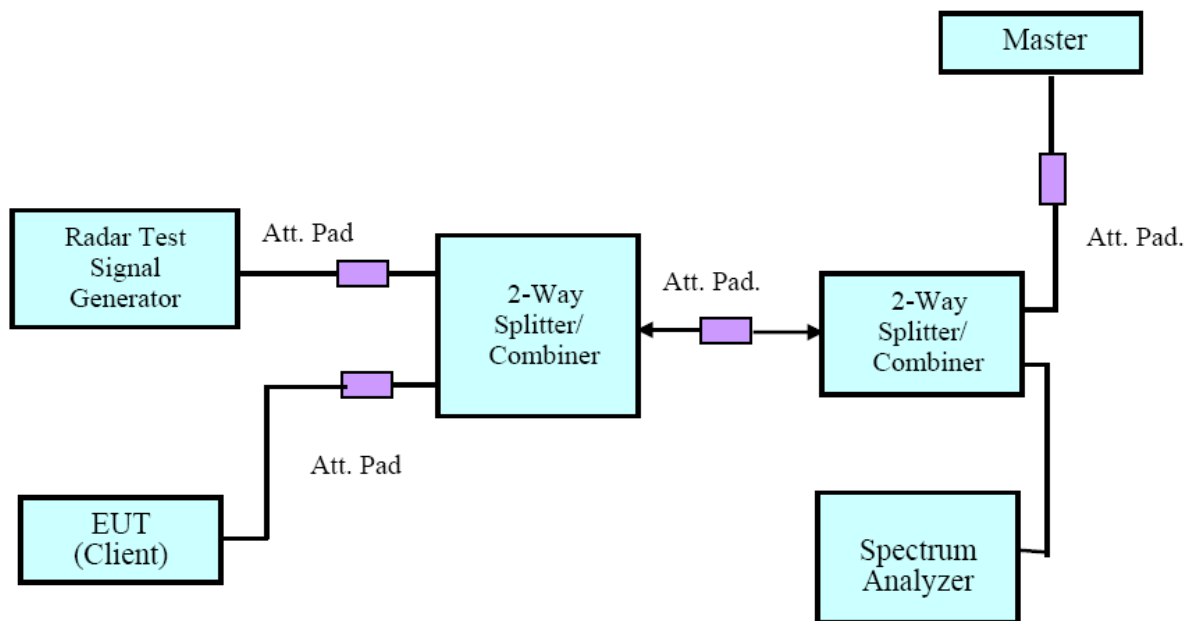

**Setup for Client with injection at the Master**

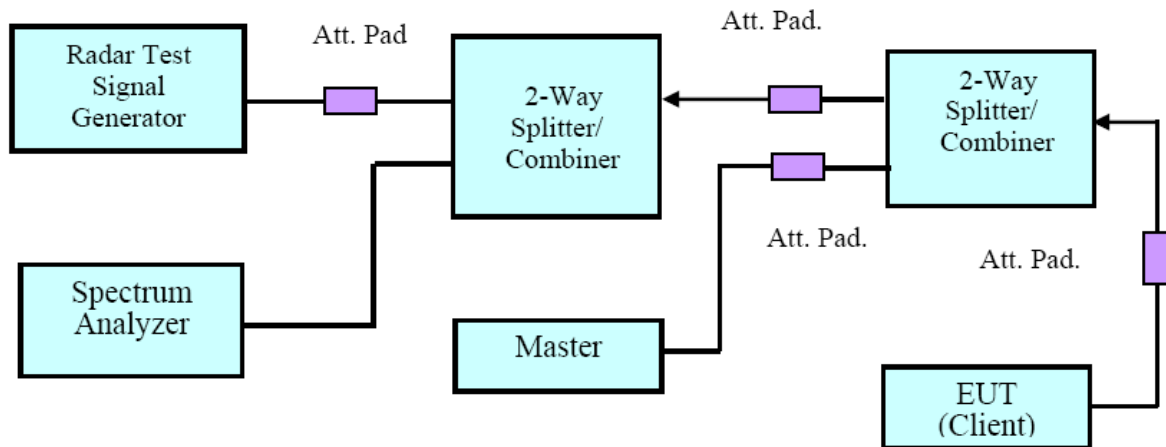

**Setup for Client with injection at the Client**

**Radiated Method**

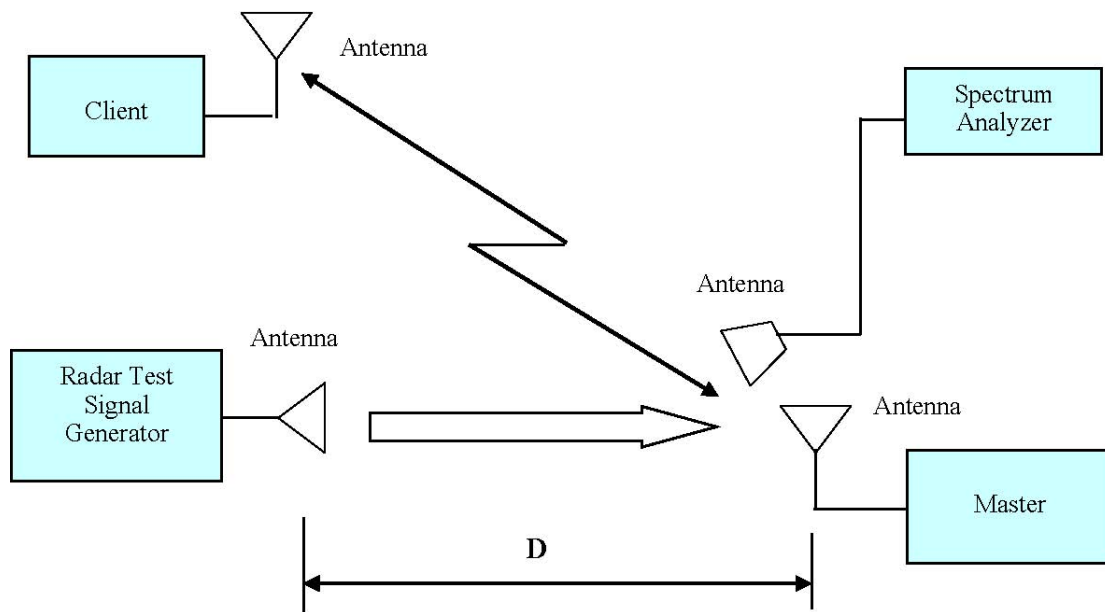

**Test Procedure**

A spectrum analyzer is used as a monitor verifies that the EUT status including Channel Closing Transmission Time and Channel Move Time, and does not transmit on a Channel during the Non-Occupancy Period after the diction and Channel move. It is also used to monitor EUT transmissions during the Channel Availability Check Time.

## TEST RESULTS

### Description of EUT

The calibrated radiated DFS detection threshold level is set to -64 dBm is more stringent.

WLAN traffic is generated by software “Tfgen”, software is used by IP and Frame based systems for loading the test channel during the In-service compliance testing of the U-NII device. Datapackage streamed from the Access Point to the Client using the software “Tfgen”.

### Test Equipment List and Details

Manufacturer	Description	Model	Serial Number	Calibration Date	Calibration Due Date
National Instruments	NI PXI-1042 8-Slot chassis	PXI-1042	VOBX40FBD	N/A	N/A
National Instruments	Arbitrary Waveform Generator	PXI-5421	N/A	N/A	N/A
National Instruments	RF Upconverter	PXI-5610	N/A	N/A	N/A
ASCOR	Upconverter	AS-7202	N/A	N/A	N/A
Agilent	Spectrum Analyzer	E4440A	SG43360054	2019-01-04	2020-01-04
Ditorn	Splitter/Combiner	D3C4080	SN2244	N/A	N/A
TDK RF	horn antenna	HRN-0118	130 084	2019-01-05	2022-01-04
ETS LINDGREN	horn antenna	3115	000 527 35	2019-01-05	2022-01-04

\* **Statement of Traceability:** Bay Area Compliance Laboratories Corp. (Dongguan) attests that all calibrations have been performed, traceable to National Primary Standards and International System of Units (SI).

### Radar Waveform Calibration

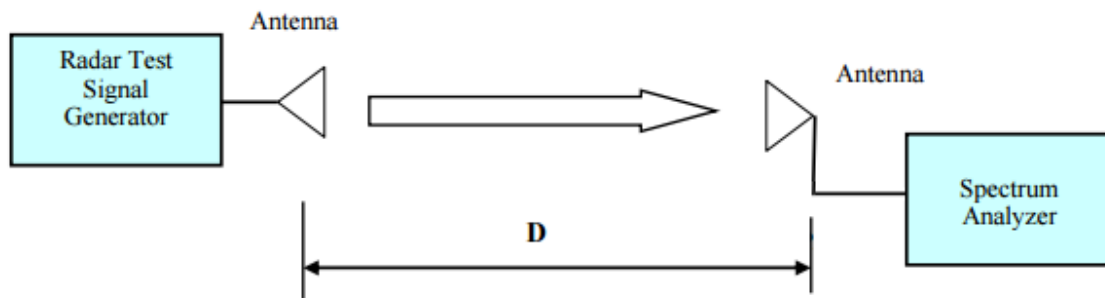

**Radiated Calibration Setup Block Diagram**

### Test Environmental Conditions

<b>Temperature:</b>	24.9 °C
<b>Relative Humidity:</b>	54 %
<b>ATM Pressure:</b>	101.2 kPa

*The testing was performed by Elena Lei on 2019-03-18.*

Plots of Radar Waveforms

5270 MHz: Radar Type 0

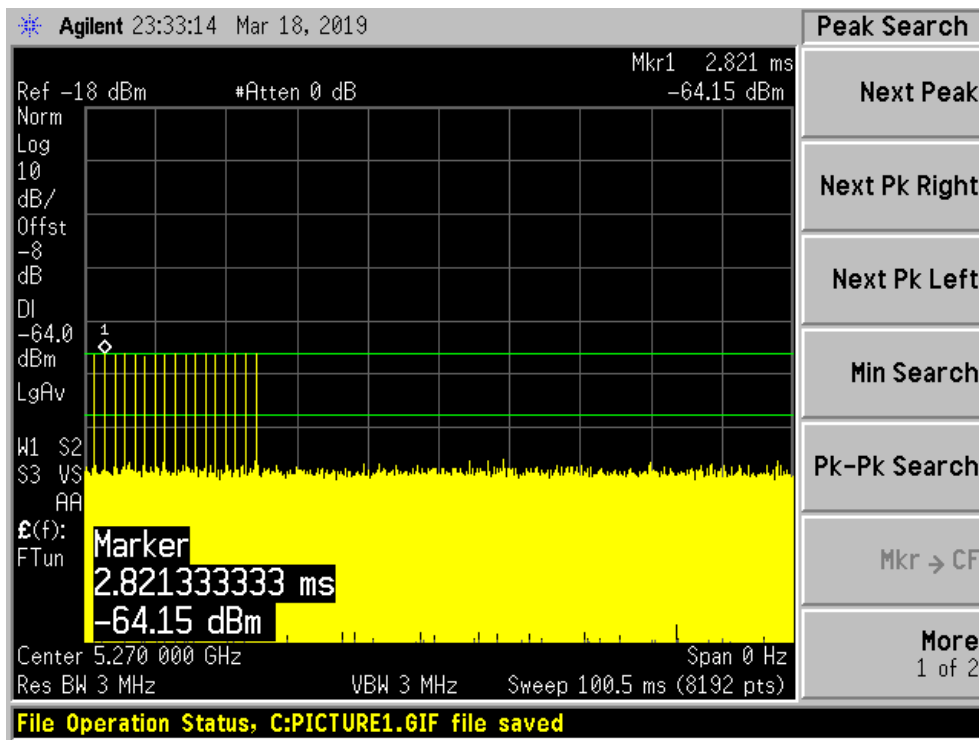

5280 MHz: Radar Type 0

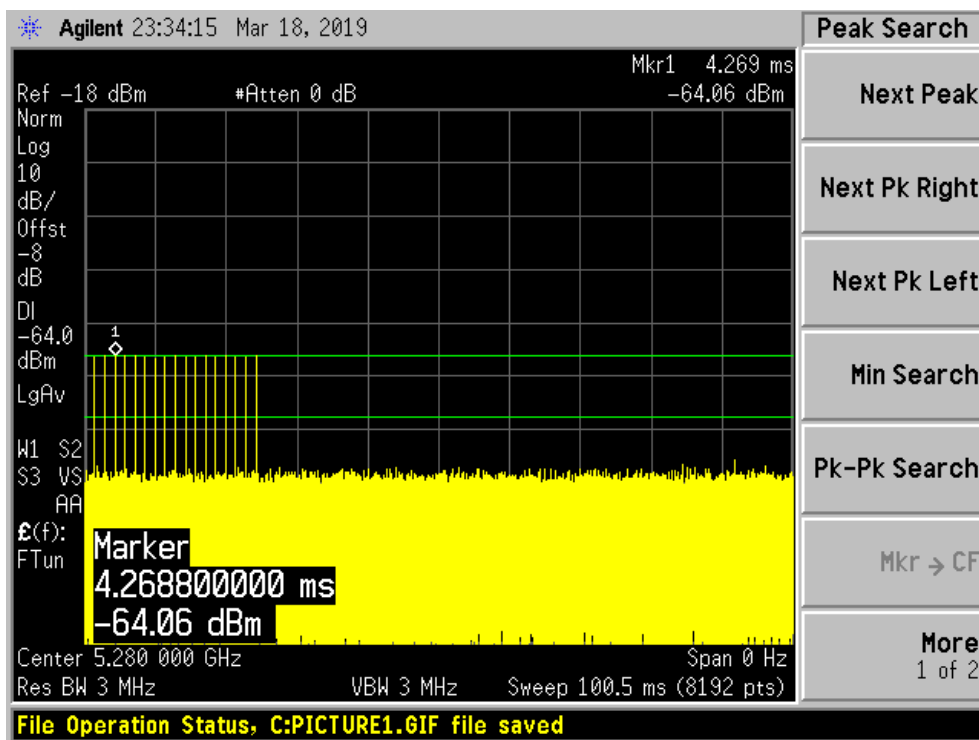

5510 MHz: Radar Type 0

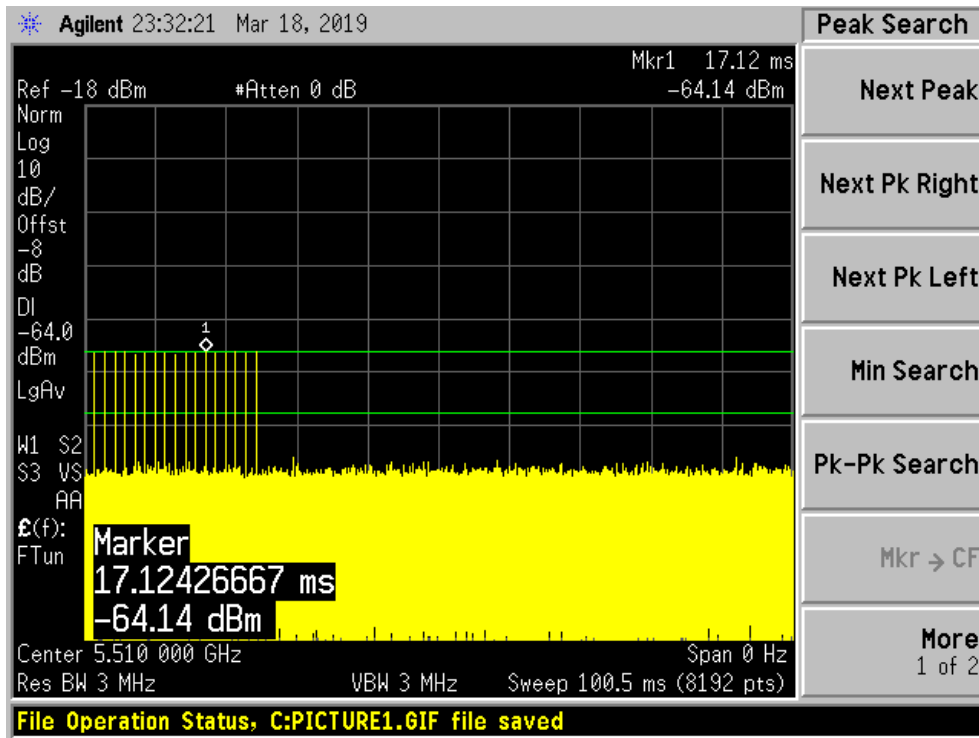

5520 MHz: Radar Type 0

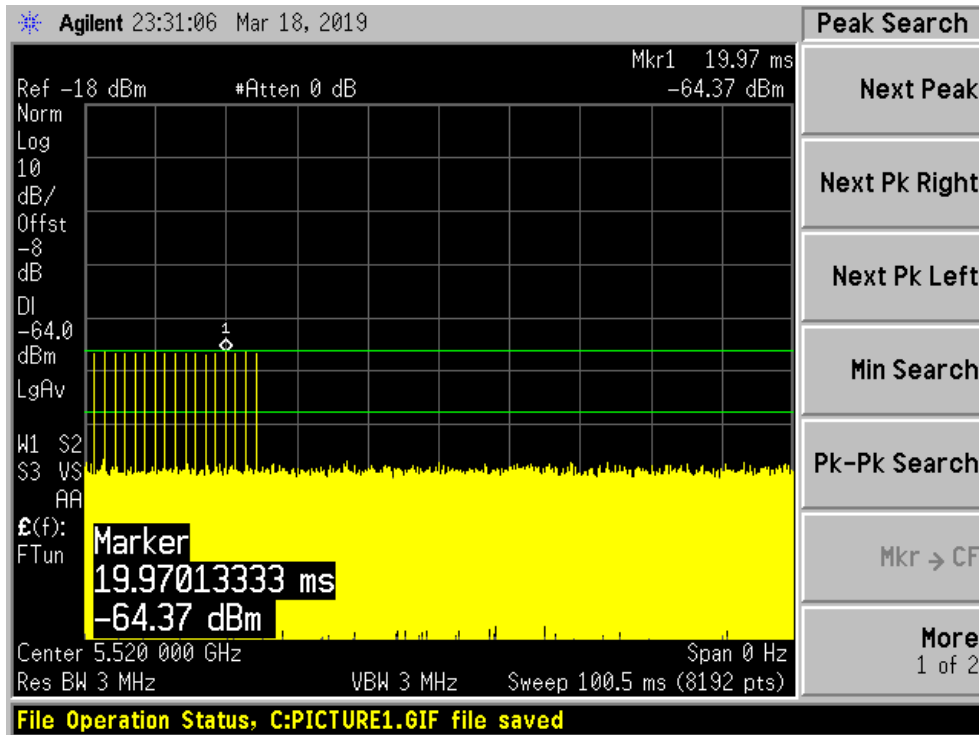



## CHANNEL MOVE TIME AND CHANNEL CLOSING TRANSMISSION TIME

### Test Procedure

Channel Move Time and the Channel Closing Transmission Time should be performed with Radar Type 0. The measurement timing begins at the end of the Radar Type 0 burst. repeat using a long pulse radar type5 waveform.

The Channel Closing Transmission Time is comprised of 200 milliseconds starting at the beginning of the Channel Move Time plus any additional intermittent control signals required to facilitate a Channel move (an aggregate of 60 milliseconds) during the remainder of the 10 second period. The aggregate duration of control signals will not count quiet periods in between transmissions.

The aggregate channel closing transmission time is calculated as follows:

Aggregate Transmission Time = N\*Dwell Time

N is the number of spectrum analyzer bins showing a device transmission Dwell Time is the dwell time per bin (i.e. Dwell Time = S/B, S is the sweep time and B is the number of bin, i.e. 8192)

### Test Results

Frequency (MHz)	Bandwidth (MHz)	Radar Type	Results
5270	40	Type 0	Compliant
5280	20	Type 0	Compliant
5510	20	Type 0	Compliant
5520	40	Type 0	Compliant

Please refer to the following tables and plots.

**5270 MHz**

Type 0 radar channel move time result:

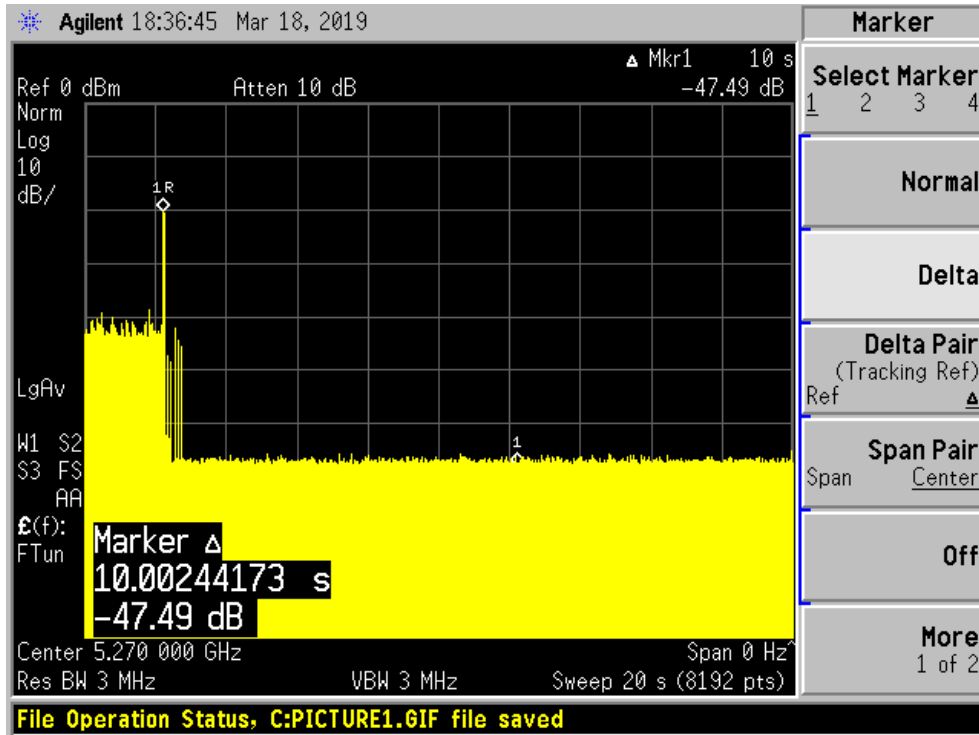

Type0 radar channel closing transmission time result:

Transmission After 200ms	Aggregate Transmission Time After 200ms Delay (ms)	Limit for Aggregate Transmission Time After 200ms Delay (ms)	Result
Yes	9.766	60	Pass

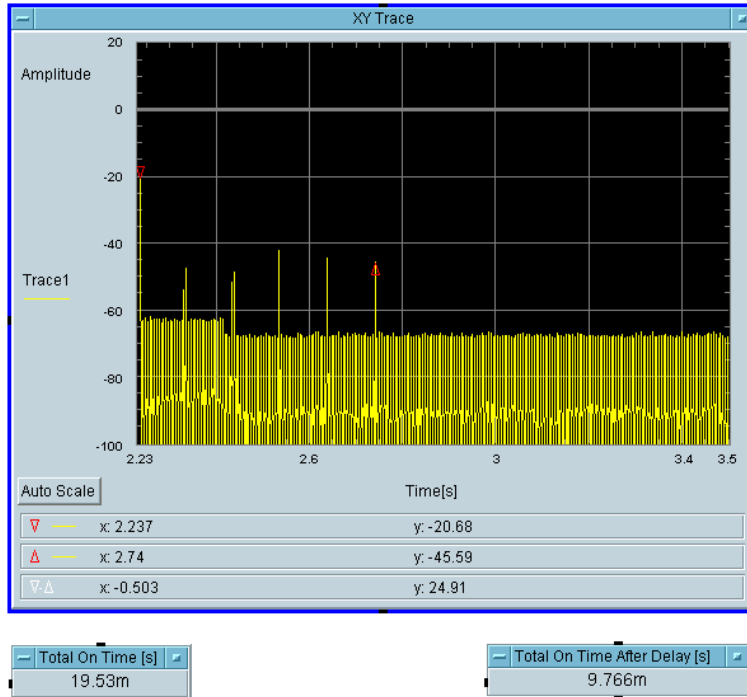

**5280 MHz**

Type 0 radar channel move time result:

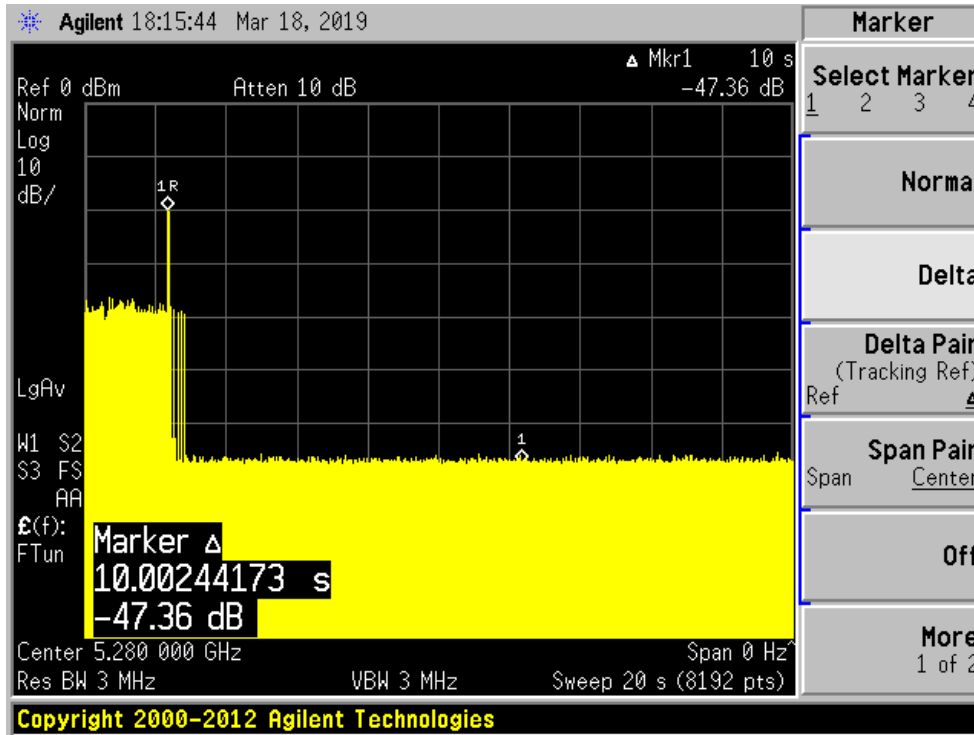

Type0 radar channel closing transmission time result:

Transmission After 200ms	Aggregate Transmission Time After 200ms Delay (ms)	Limit for Aggregate Transmission Time After 200ms Delay (ms)	Result
Yes	7.324	60	Pass

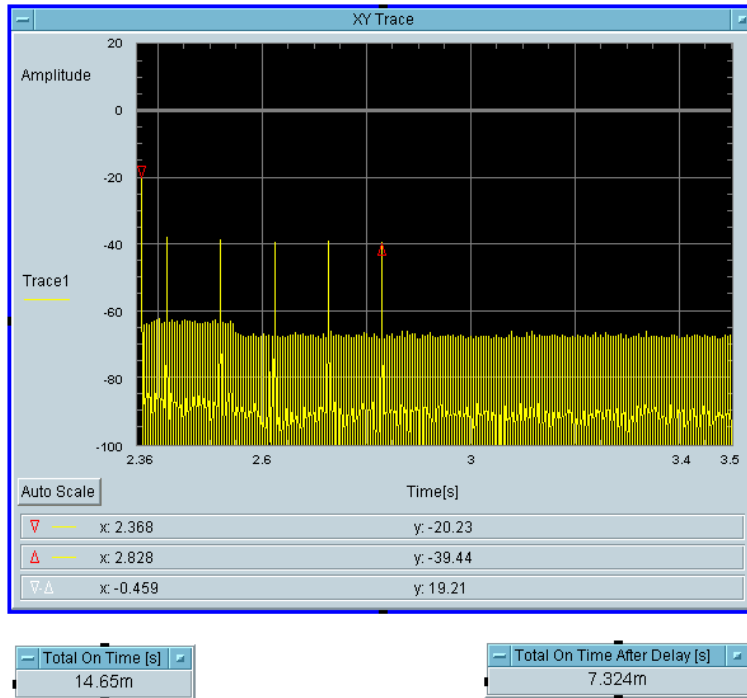

**5510 MHz**

Type 0 radar channel move time result:

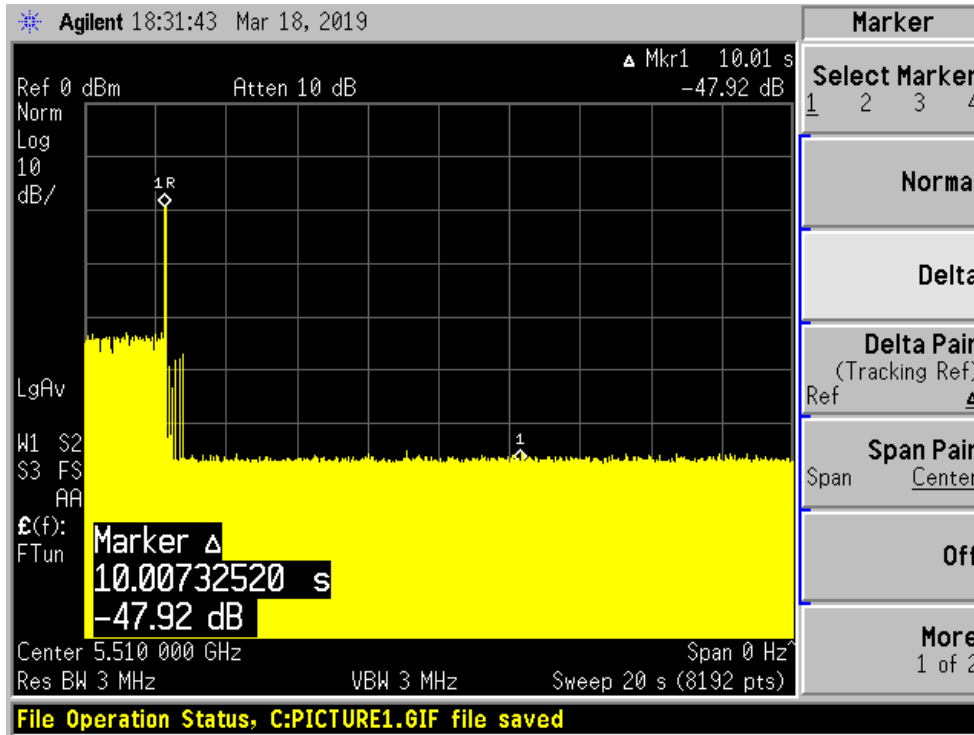

Type0 radar channel closing transmission time result:

Transmission After 200ms	Aggregate Transmission Time After 200ms Delay (ms)	Limit for Aggregate Transmission Time After 200ms Delay (ms)	Result
Yes	7.324	60	Pass

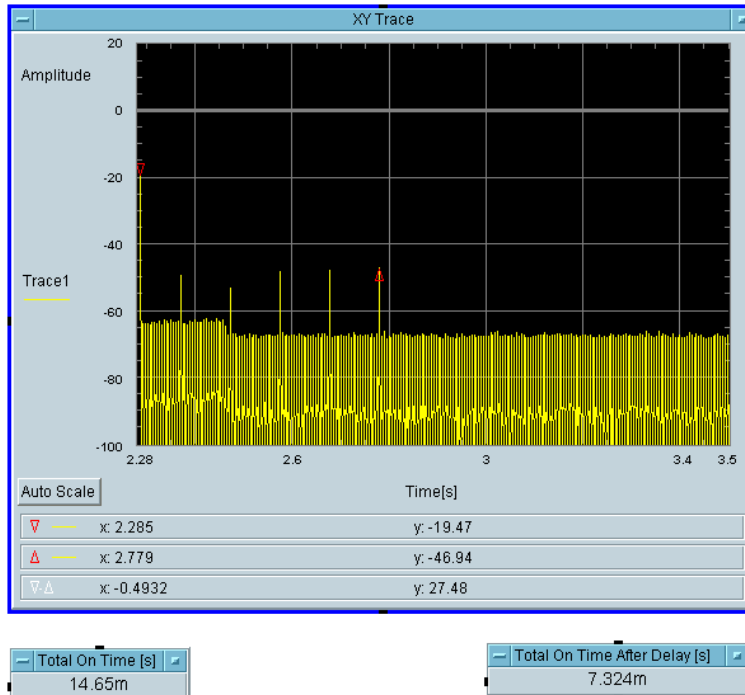

**5520 MHz**

Type 0 radar channel move time result:

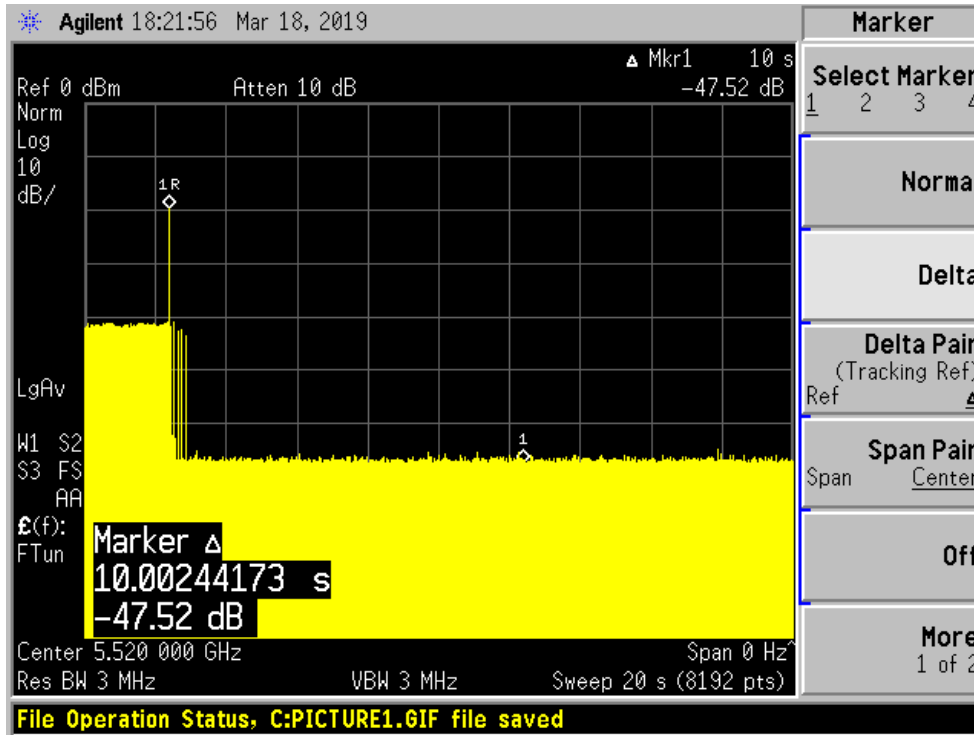



Type0 radar channel closing transmission time result:

Transmission After 200ms	Aggregate Transmission Time After 200ms Delay (ms)	Limit for Aggregate Transmission Time After 200ms Delay (ms)	Result
Yes	7.324	60	Pass

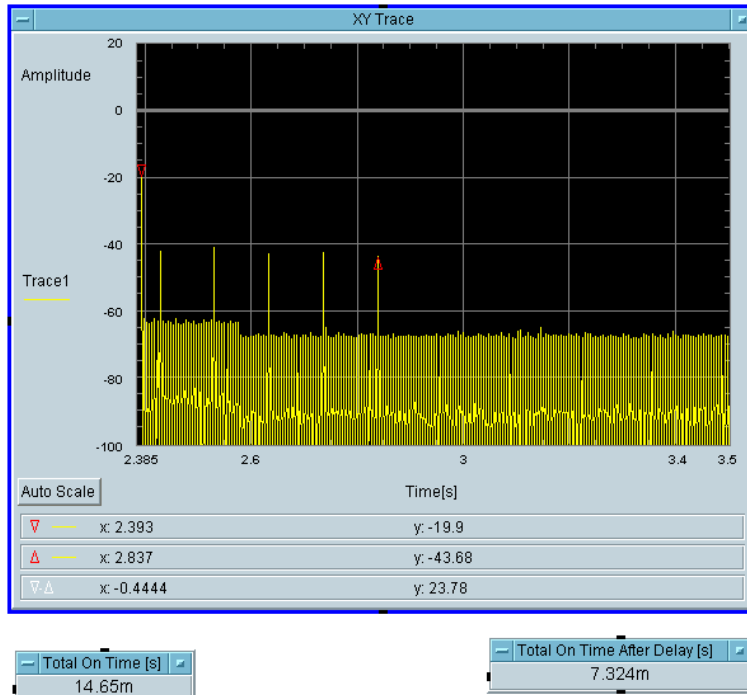

## NON-OCCUPANCY PERIOD

### Test Procedure

Measure the EUT for more than 30 minutes following the channel close/move time to verify that the EUT does not resume any transmissions on this channel. Provide one plot to demonstrate no transmission on the channel for the non-occupancy period (30 minutes observation time)

### Test Result

Frequency(MHz)	Bandwidth (MHz)	Spectrum Analyzer Display
5270	40	No transmission within 30 minutes
5280	20	No transmission within 30 minutes
5510	20	No transmission within 30 minutes
5520	40	No transmission within 30 minutes

Please refer to the following plots.

#### 5270 MHz

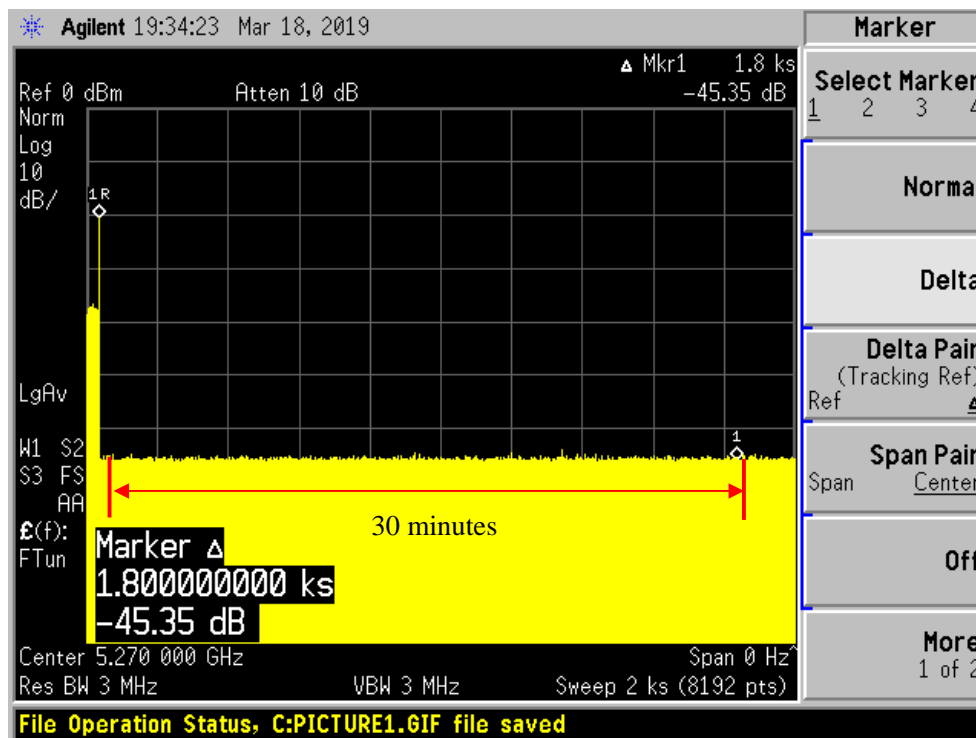

5280 MHz

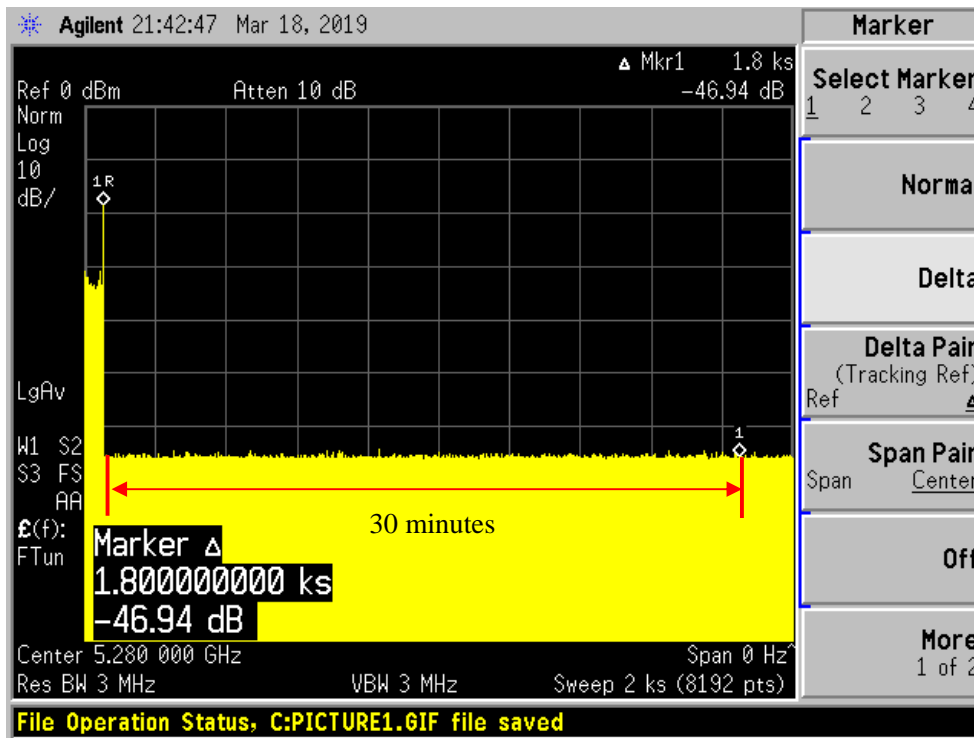

5510 MHz

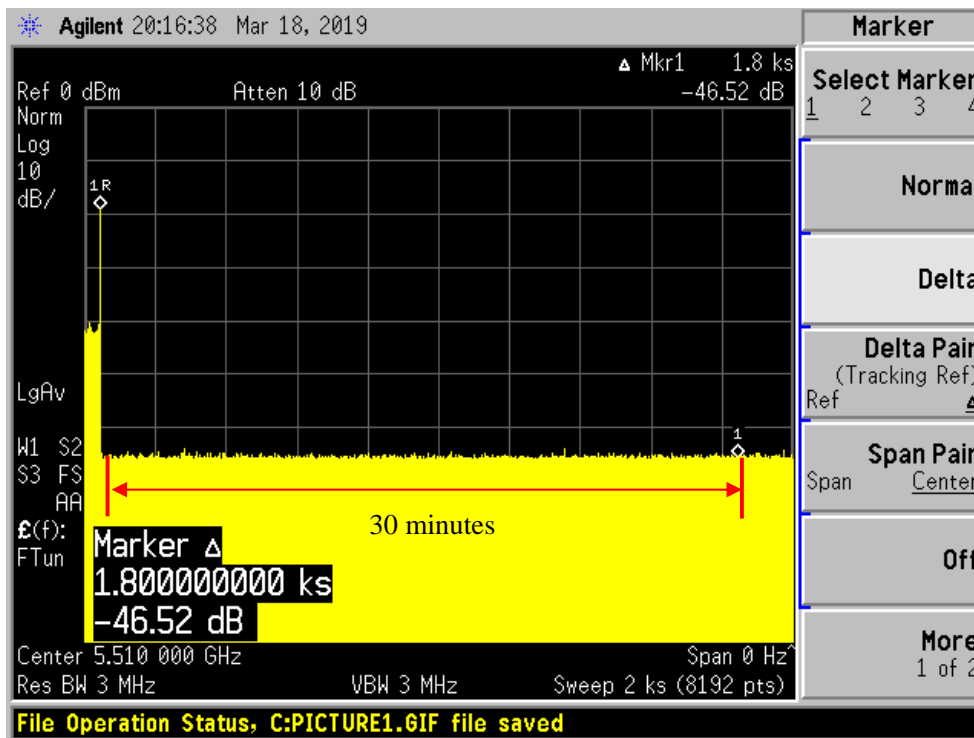

5520 MHz

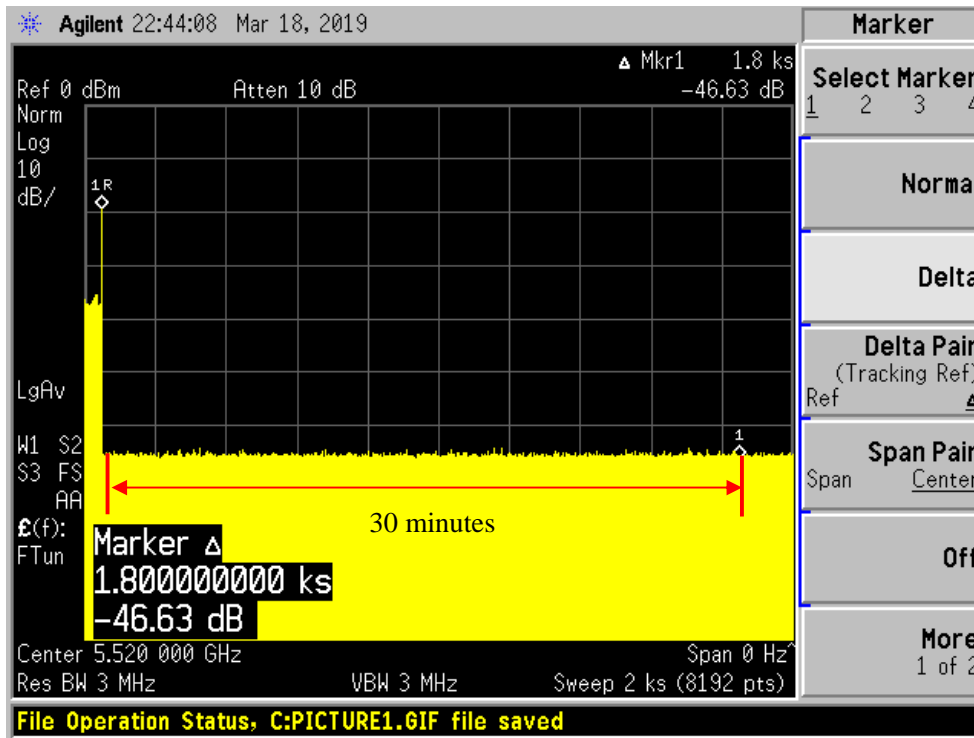

\*\*\*\*\* END OF REPORT \*\*\*\*\*