

FCC

SAR

TEST REPORT

ISSUED BY
Shenzhen BALUN Technology Co., Ltd.



FOR
Tablet PC

ISSUED TO
Shenzhen Jingwah Information Technology Co., Ltd.

4F, Bldg 4, Jinghua Square, No.1 Huafa North Road, Futian District, Shenzhen



Prepared by: *Peng Shimeng*
Peng Shimeng
(Reporting Specialist)

Date: *2014.4.17*

Approved by: *Wei Yequn*
Wei Yequn
(Lab Director)

Date: *2014.4.17*

Report No: BL-SZ1430057-701

EUT Type: Tablet PC

Model Name: D70J10-2G, D70J10-2N, D70J10-2P,
D70J10-2B, D70J10-2R, D70J10-2W,
D70J10-2M

Brand Name: AOC

FCC ID: RBD-D70J10

Test Standard: FCC 47 CFR Part 2.1093
ANSI C95.1-1992, IEEE 1528-2003

Maximum SAR: Body: 0.880W/kg

Test conclusion: PASS

Test Date: Apr. 2, 2014~Apr. 3, 2014

Date of Issue: Apr. 17, 2014

NOTE: This test report can be duplicated completely for the legal use with the approval of the applicant; it shall not be reproduced except in full, without the written approval of Shenzhen BALUN Technology Co., Ltd. BALUN Laboratory. Any objections should be raised within thirty days from the date of issue. To validate the report, please visit BALUN website.

Revision History

<u>Version</u>	<u>Issue Date</u>	<u>Revisions</u>
<u>Rev. 01</u>	<u>Apr. 4, 2014</u>	<u>Initial Issue</u>
<u>Rev.02</u>	<u>Apr.14, 2014</u>	<u>Update EUT diagram, redefine test edge.</u>
<u>Rev.03</u>	<u>Apr.17, 2014</u>	<u>Add Average power measurement result.</u>

TABLE OF CONTENTS

1 GENERAL INFORMATION 4

 1.1 Identification of the Testing Laboratory 4

 1.2 Identification of the Responsible Testing Location 4

 1.3 Test Environment Condition 4

 1.4 Announce 4

2 PRODUCT INFORMATION 6

 2.1 Manufacturer 6

 2.2 General Description for Equipment under Test (EUT) 6

 2.3 Technical Information 6

 2.4 Ancillary Equipment 6

3 SUMMARY OF TEST RESULTS 8

 3.1 Test Standards 8

 3.2 Summary Of SAR Value 8

 3.3 Device Category And SAR Limit 9

 3.4 SAR Test Uncertainty 10

4 SAR MEASUREMENT SYSTEM 11

 4.1 Definition of Specific Absorption Rate (SAR) 11

 4.2 SATIMO SAR System 11

5 SYSTEM VERIFICATION 19

 5.1 Antenna Port Test Requirement 19

 5.2 Purpose of System Check 19

 5.3 System Check Setup 19

 5.4 System Verification Results 20

6 EUT TEST POSITION CONFIGURATUONS 21

 6.1 Head Exposure Conditions 21

6.2	Body-worn Position Conditions	22
6.3	Hotspot Mode Exposure Position Conditions	23
7	SAR MEASUREMENT PROCEDURES	24
7.1	SAR Measurement Process Diagram	24
7.2	SAR Scan General Requirements	25
7.3	SAR Measurement Procedure	26
7.4	Area & Zoom Scan Procedures	26
8	CONDUCTED RF OUPUT POWER	27
9	EUT ANTENNA LOCATION SKETCH	34
9.1	SAR Test Exclusion Consider Table	35
10	SAR TEST RESULTS.....	36
10.1	Body SAR	36
10.2	SAR Measurement Variability	37
11	SIMULTANEOUS TRANSMISSION	38
11.1	Simultaneous Transmission Mode Consider	38
11.2	Estimated SAR Calculation.....	38
11.3	Sum SAR of Simultaneous Transmission	39
12	TEST EQUIPMENTS LIST	40
13	REFERENCES	41
ANNEX A	SAR TEST RESULT OF SYSTEM VERIFICATION.....	42
ANNEX B	SAR TEST SETUP PHOTOS.....	44
ANNEX C	SAR MEASUREMENT RESULT	47
ANNEX D	CALIBRATION FOR PROBE AND DIPOLE	78

1 GENERAL INFORMATION

1.1 Identification of the Testing Laboratory

Company Name	Shenzhen BALUN Technology Co., Ltd.
Address	Block B, 1st FL, Baisha Science and Technology Park, Shahe Xi Road, Nanshan District, Shenzhen, Guangdong Province, P. R. China
Phone Number	+86 755 6683 3402
Fax Number	+86 755 6182 4271

1.2 Identification of the Responsible Testing Location

Test Location	Shenzhen BALUN Technology Co., Ltd.
Address	Block B, 1st FL, Baisha Science and Technology Park, Shahe Xi Road, Nanshan District, Shenzhen, Guangdong Province, P. R. China
Accreditation Certificate	<p>The laboratory has been listed by Industry Canada to perform electromagnetic emission measurements. The recognition numbers of test site are 11524A-1.</p> <p>The laboratory has been listed by US Federal Communications Commission to perform electromagnetic emission measurements. The recognition numbers of test site are 832625.</p> <p>The laboratory has met the requirements of the IAS Accreditation Criteria for Testing Laboratories (AC89), has demonstrated compliance with ISO/IEC Standard 17025:2005. The accreditation certificate number is TL-588.</p> <p>The laboratory is a testing organization accredited by China National Accreditation Service for Conformity Assessment (CNAS) according to ISO/IEC 17025. The accreditation certificate number is L6791.</p>
Description	All measurement facilities used to collect the measurement data are located at Block B, FL 1, Baisha Science and Technology Park, Shahe Xi Road, Nanshan District, Shenzhen, Guangdong Province, P. R. China 518055

1.3 Test Environment Condition

Ambient Temperature	20 to 22 °C
Ambient Relative Humidity	30 to 60 %
Ambient Pressure	86 to 106 kPa

1.4 Announce

- (1) The test report is invalid if not marked with the signatures of the persons responsible for preparing and approving the test report.
- (2) The test report is invalid if there is any evidence and/or falsification.
- (3) The results documented in this report apply only to the tested sample, under the conditions and modes of

operation as described herein.

- (4) This document may not be altered or revised in any way unless done so by BALUN and all revisions are duly noted in the revisions section.
- (5) Content of the test report, in part or in full, cannot be used for publicity and/or promotional purposes without prior written approval from the laboratory.

2 PRODUCT INFORMATION

2.1 Manufacturer

Manufacturer	Shenzhen Jingwah Information Technology Co., Ltd.
Address	4F, Bldg 4, Jinghua Square, No.1 Huafa North Road, Futian District, Shenzhen

2.2 General Description for Equipment under Test (EUT)

EUT Type	Tablet PC
Model Under the test	D70J10-2G
Series Model Name	D70J10-2N, D70J10-2P, D70J10-2B, D70J10-2R, D70J10-2W, D70J10-2M
Difference description	only different in appearance color: “G”—“Green”, “N”—“Neutral”, “P”—“Pink”, “B”—“Blue”, “R”—“Red” “W”—“White”, “M”—“Magenta”
Hardware Version	V 1.1
Software Version	D70J10-201403
Dimensions	191×109×10mm
Weight	295 g
Network and Wireless connectivity	WIFI, Bluetooth
Display	7" TFT-LCD, 1024x600 pixels
Chipset	RK3026 1.0GHz (Dual core, cortex-A9)

2.3 Technical Information

The requirement for the following technical information of the EUT was tested in this report:

Operating Mode	WLAN: 802.11 b/g/n(HT20/HT40); Bluetooth: V2.1+EDR
Frequency Range	WLAN 802.11b/g/n(HT20): 2412MHz ~ 2462MHz; WLAN 802.11n(HT40): 2422MHz ~ 2452MHz; Bluetooth: 2402MHz ~ 2480MHz
Antenna Type	WLAN: PIFA Antenna Bluetooth: PIFA Antenna
DTM	Not Support
Hotspot Function	Not Support
Environment	Uncontrolled
EUT Stage	Portable Device

2.4 Ancillary Equipment

Ancillary Equipment 1	Battery	
	Brand Name	SouthRiver

	Model No	SR3067A0
	Serial No	(n.a. marked #1 by test site)
	Capacitance	2600mAh
	Rated Voltage	3.7V
	Extreme Voltage	Low: 3.5V / High:4.2V
Ancillary Equipment 2	AC Adapter (Charger for Battery)	
	Brand Name	FJ
	Model No	FJ-SW0502000DU
	Serial No	(n.a. marked #1 by test site)
	Rated Input	~ 100-240V, 200mA, 50/60Hz
	Rated Output	≡ 5V, 2000mA
Ancillary Equipment 3	Stereo Headset	
Ancillary Equipment 4	USB Data Cable	

3 SUMMARY OF TEST RESULTS

3.1 Test Standards

No.	Identity	Document Title
1	47 CFR Part 2	Frequency Allocations and Radio Treaty Matters; General Rules and Regulations
2	ANSI/IEEE Std. C95.1-1992	IEEE Standard for Safety Levels with Respect to Human Exposure to Radio Frequency Electromagnetic Fields, 3 kHz to 300 GHz
3	IEEE Std. 1528-2003	Recommended Practice for Determining the Peak Spatial-Average Specific Absorption Rate (SAR) in the Human Head from Wireless Communications Devices: Measurement Techniques
4	FCC KDB 447498 D01 v05r01	Mobile and Portable Device RF Exposure Procedures and Equipment Authorization Policies
5	FCC KDB 616217 D04 v01r01	SAR Evaluation Considerations for Laptop, Notebook, Netbook and Tablet Computers
6	FCC KDB 248227 D01 v01r02	SAR Measurement Procedures for 802.11 a/b/g Transmitters

3.2 Summary Of SAR Value

Highest SAR

Position	Band	Maximum Measurement SAR (W/kg)	Maximum Report SAR (W/kg)
Body	DTS (WLAN 2.4G)	0.880	0.880
	Bluetooth	0.054	

Highest Simultaneous SAR

Position	Simultaneous Configuration	Maximum Sum. 1-g Report SAR (W/kg)
Body	WLAN + Bluetooth	0.934

3.3 Device Category And SAR Limit

This device belongs to portable device category because its radiating structure is allowed to be used within 20 centimeters of the body of the user. Limit for General Population/Uncontrolled exposure should be applied for this device, it is 1.6 W/kg as averaged over any 1 gram of tissue.

Table Of Exposure Limits:

	SAR Value (W/Kg)	
	General Population/Uncontrolled Exposure	Occupational/Controlled Exposure
Whole-Body SAR (averaged over the entire body)	0.08	0.4
partial-body SAR (averaged over any 1 gram of tissue)	1.60	8.0
SAR for hands, wrists, feet and ankles (averaged over any 10 grams of tissue)	4.0	20.0

NOTE:

General Population/Uncontrolled: Locations where there is the exposure of individuals who have no knowledge or control of their exposure. General population/uncontrolled exposure limits are applicable to situations in which the general public may be exposed or in which persons who are exposed as a consequence of their employment may not be made fully aware of the potential for exposure or cannot exercise control over their exposure. Members of the general public would come under this category when exposure is not employment-related; for example, in the case of a wireless transmitter that exposes persons in its vicinity.

Occupational/Controlled: Locations where there is exposure that may be incurred by persons who are aware of the potential for exposure, In general, occupational/controlled exposure limits are applicable to situations in which persons are exposed as a consequence of their employment, who have been made fully aware of the potential for exposure and can exercise control over their exposure. This exposure category is also applicable when the exposure is of a transient nature due to incidental passage through a location where the exposure levels may be higher than the general population/uncontrolled limits, but the exposed person is fully aware of the potential for exposure and can exercise control over his or her exposure by leaving the area or by some other appropriate means.

3.4 SAR Test Uncertainty

The following measurement uncertainty levels have been estimated for tests performed on the EUT as specified in IEEE 1528: 2003. This uncertainty represents an expanded uncertainty expressed at approximately the 95% confidence level using a coverage factor of $k=2$.

Uncertainty Component	Tol (+-%)	Prob. Dist.	Div.	Ci (1g)	Ci (10g)	1g Ui (+-%)	10g Ui (+-%)	V_i
Measurement System								
Probe calibration	5.8	N	1	1	1	5.80	5.80	∞
Axial Isotropy	3.5	R	$\sqrt{3}$	0.7	0.7	1.41	1.41	∞
Hemispherical Isotropy	5.9	R	$\sqrt{3}$	0.7	0.7	2.38	2.38	∞
Boundary effect	1.0	R	$\sqrt{3}$	1	1	0.58	0.58	∞
Linearity	4.7	R	$\sqrt{3}$	1	1	2.71	2.71	∞
System detection limits	1.0	R	$\sqrt{3}$	1	1	0.58	0.58	∞
Readout Electronics	0.5	N	1	1	1	0.50	0.50	∞
Reponse Time	0.0	R	$\sqrt{3}$	1	1	0.00	0.00	∞
Integration Time	1.4	R	$\sqrt{3}$	1	1	0.81	0.81	∞
RF ambient Conditions - Noise	3.0	R	$\sqrt{3}$	1	1	1.73	1.73	∞
RF ambient Conditions - Reflections	3.0	R	$\sqrt{3}$	1	1	1.73	1.73	∞
Probe positioner Mechanical Tolerance	1.4	R	$\sqrt{3}$	1	1	0.81	0.81	∞
Probe positioning with respect to Phantom Shell	1.4	R	$\sqrt{3}$	1	1	0.81	0.81	∞
Extrapolation, interpolation and integration Algorithms for Max. SAR Evaluation	2.3	R	$\sqrt{3}$	1	1	1.33	1.33	∞
Test sample Related								
Test sample positioning	2.6	N	1	1	1	2.60	2.60	$N-1$
Device Holder Uncertainty	1.0	N	1	1	1	1.00	1.00	$N-1$
Output power Variation - SAR drift measurement	5.0	R	$\sqrt{3}$	1	1	2.89	2.89	∞
SAR scaling	2.00	R	$\sqrt{3}$	1	1	1.15	1.15	∞
Phantom and Tissue Parameters								
Phantom Uncertainty (Shape and thickness tolerances)	4.0	R	$\sqrt{3}$	1	1	2.31	2.31	∞
Liquid conductivity (deviation from target values)	2.5	N	$\sqrt{3}$	0.64	0.43	0.92	0.62	∞
Liquid conductivity - measurement uncertainty	5.0	N	1	0.64	0.43	3.20	2.15	M
Liquid permittivity (deviation from target values)	2.5	N	$\sqrt{3}$	0.60	0.49	0.87	0.71	∞
Liquid permittivity - measurement uncertainty	5.0	N	1	0.60	0.49	3.00	2.45	M
Combined Standard Uncertainty		RSS				10.14	9.67	
Expanded Uncertainty (95% Confidence interval)		k				20.29	19.35	

4 SAR MEASUREMENT SYSTEM

4.1 Definition of Specific Absorption Rate (SAR)

SAR is related to the rate at which energy is absorbed per unit mass in an object exposed to a radio field. The SAR distribution in a biological body is complicated and is usually carried out by experimental techniques or numerical modeling. The standard recommends limits for two tiers of groups, occupational/controlled and general population/uncontrolled, based on a person's awareness and ability to exercise control over his or her exposure. In general, occupational / controlled exposure limits are higher than the limits for general population /uncontrolled.

The SAR definition is the time derivative (rate) of the incremental energy (dW) absorbed by (dissipated in) an incremental mass (dm) contained in a volume element (dv) of a given density (ρ). The equation description is as below:

$$\text{SAR} = \frac{d}{dt} \left(\frac{dW}{dm} \right) = \frac{d}{dt} \left(\frac{dW}{\rho dv} \right)$$

SAR is expressed in units of Watts per kilogram (W/kg) SAR measurement can be related to the electrical field in the tissue by

$$\text{SAR} = \frac{\sigma E^2}{\rho}$$

Where: σ is the conductivity of the tissue,

ρ is the mass density of the tissue and E is the RMS electrical field strength.

4.2 SATIMO SAR System

SATIMO SAR System Diagram:

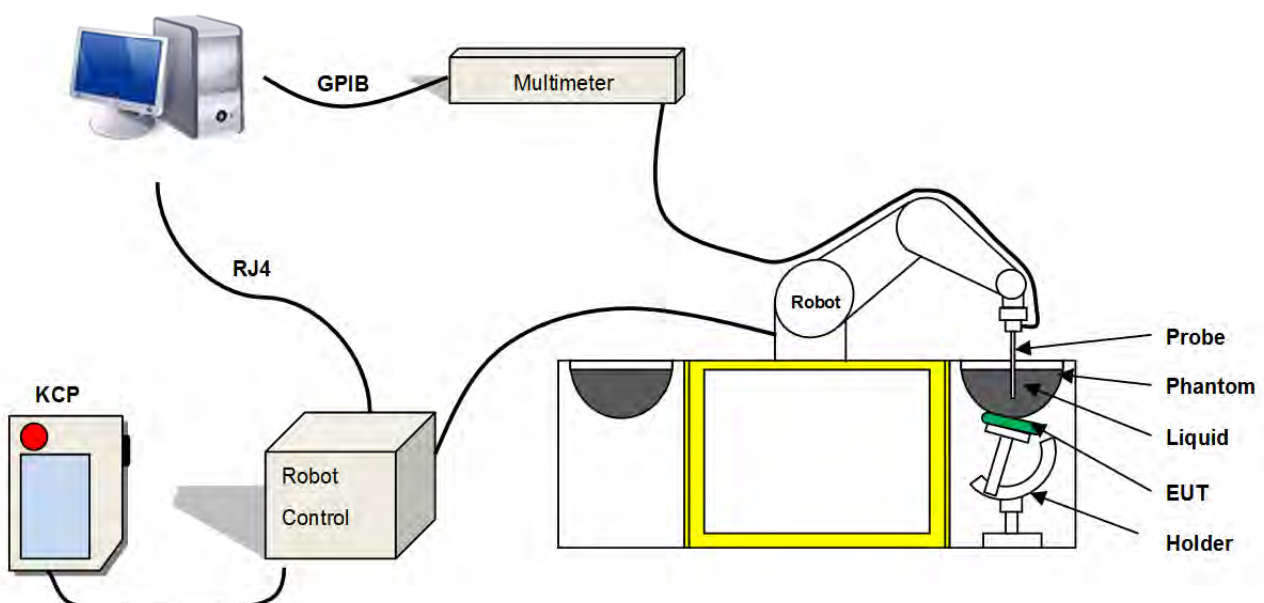

These measurements were performed with the automated near-field scanning system OPENSAR from SATIMO. The system is based on a high precision robot (working range: 850 mm), which positions the probes with a positional repeatability of better than ± 0.02 mm. Special E- and H-field probes have been developed for measurements close to material discontinuity, the sensors of which are directly loaded with a Schottky diode and connected via highly resistive lines to the data acquisition unit.

The SAR measurements were conducted with dosimetric probe (manufactured by SATIMO), designed in the classical triangular configuration and optimized for dosimetric evaluation. The probe has been calibrated according to the procedure described in SAR standard with accuracy of better than $\pm 10\%$. The spherical isotropy was evaluated with the procedure described in SAR standard and found to be better than ± 0.25 dB. The phantom used was the SAM Phantom as described in FCC supplement C, IEEE P1528 and CENELEC EN62209-1/-2.

4.2.1 Robot

The SATIMO SAR system uses the high precision robots from KUKA. For the 6-axis controller system, the robot controller version (KUKA) from KUKA is used. The KUKA robot series have many features that are important for our application:



- High precision (repeatability ± 0.035 mm)
- High reliability (industrial design)
- Jerk-free straight movements
- Low ELF interference (the closed metallic construction shields against motor control fields)

4.2.2 E-Field Probe

For the measurements the Specific Dosimetric E-Field Probe SN 17/13 EPG177 with following specifications is used

- Dynamic range: 0.01-100 W/kg
- Tip Diameter : 2.5 mm
- Distance between probe tip and sensor center: 1.0mm

- Distance between sensor center and the inner phantom surface: 4 mm
(repeatability better than +/- 1mm)
 - Probe linearity: +/- 0.06 dB
 - Axial Isotropy: <0.15 dB
 - Spherical Isotropy: <0.15 dB
 - Calibration range: 450MHz to 5800MHz for head & body simulating liquid.
- Angle between probe axis (evaluation axis) and surface normal line: less than 30°



E-Field Probe Calibration Process

Probe calibration is realized, in compliance with CENELEC EN 62209-1/-2 and IEEE 1528 std, with CALISAR, Antennessa proprietary calibration system. The calibration is performed with the EN 62209-1/2 annexe technique using reference guide at the five frequencies.

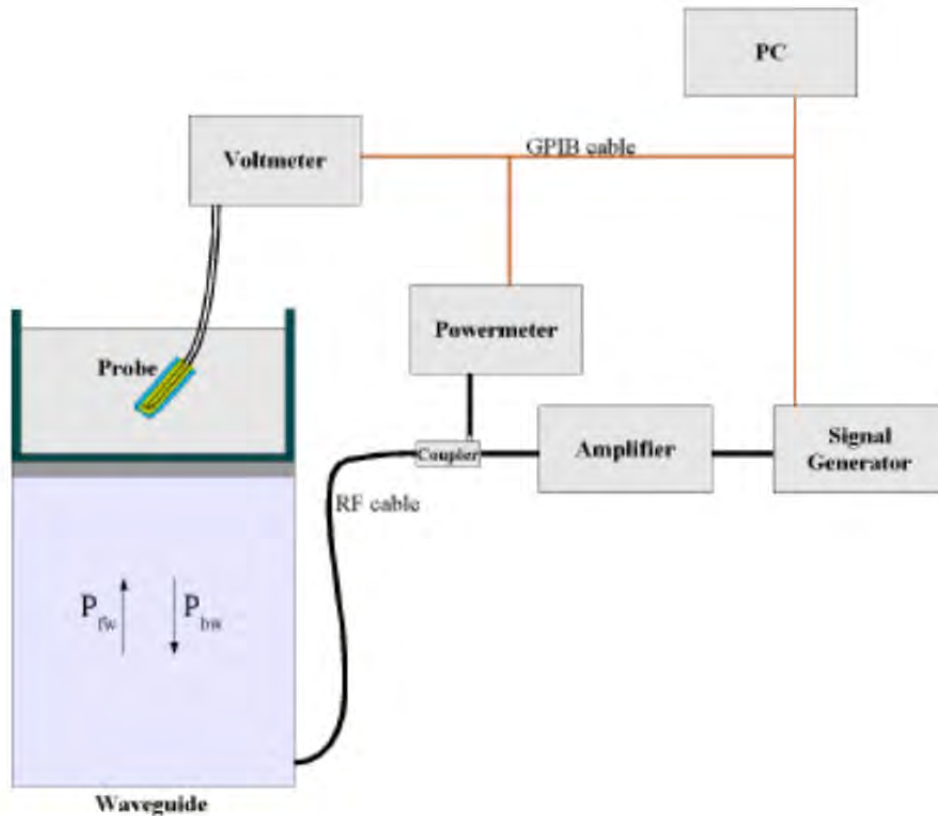

$$SAR = \frac{4(P_{fw} - P_{bw})}{ab\sigma} \cos^2 \left(\pi \frac{y}{a} \right) c^{(2\pi/\sigma)}$$

Where :

P_{fw} = Forward Power

P_{bw} = Backward Power

a and b = Waveguide dimensions

l = Skin depth

Keithley configuration:

Rate = Medium; Filter =ON; RDGS=10; FILTER TYPE =MOVING AVERAGE; RANGE AUTO After each calibration, a SAR measurement is performed on a validation dipole and compared with a NPL calibrated probe, to verify it.

The calibration factors, CF(N), for the 3 sensors corresponding to dipole 1, dipole 2 and dipole 3 are:

$$CF(N)=SAR(N)/V_{lin}(N) \quad (N=1,2,3)$$

The linearised output voltage $V_{lin}(N)$ is obtained from the displayed output voltage $V(N)$ using

$$V_{lin}(N)=V(N)*(1+V(N)/DCP(N)) \quad (N=1,2,3)$$

Where the DCP is the diode compression point in mV.

4.2.3 Phantoms

For the measurements the Specific Anthropomorphic Mannequin (SAM) defined by the IEEE SCC-34/SC2 group is used. The phantom is a polyurethane shell integrated in a wooden table. The thickness of the phantom amounts to 2mm +/- 0.2mm. It enables the dosimetric evaluation of left and right phone usage and includes an additional flat phantom part for the simplified performance check. The phantom set-up includes a cover, which prevents the evaporation of the liquid.

Photo of Phantom SN 30/13 SAM103



Photo of Phantom SN 30/13 SAM104



Serial Number	Positionner Material	Permittivity	Loss Tangent
SN 30/13 SAM103	Gelcoat with fiberglass	3.4	0.02
SN 30/13 SAM104	Gelcoat with fiberglass	3.4	0.02

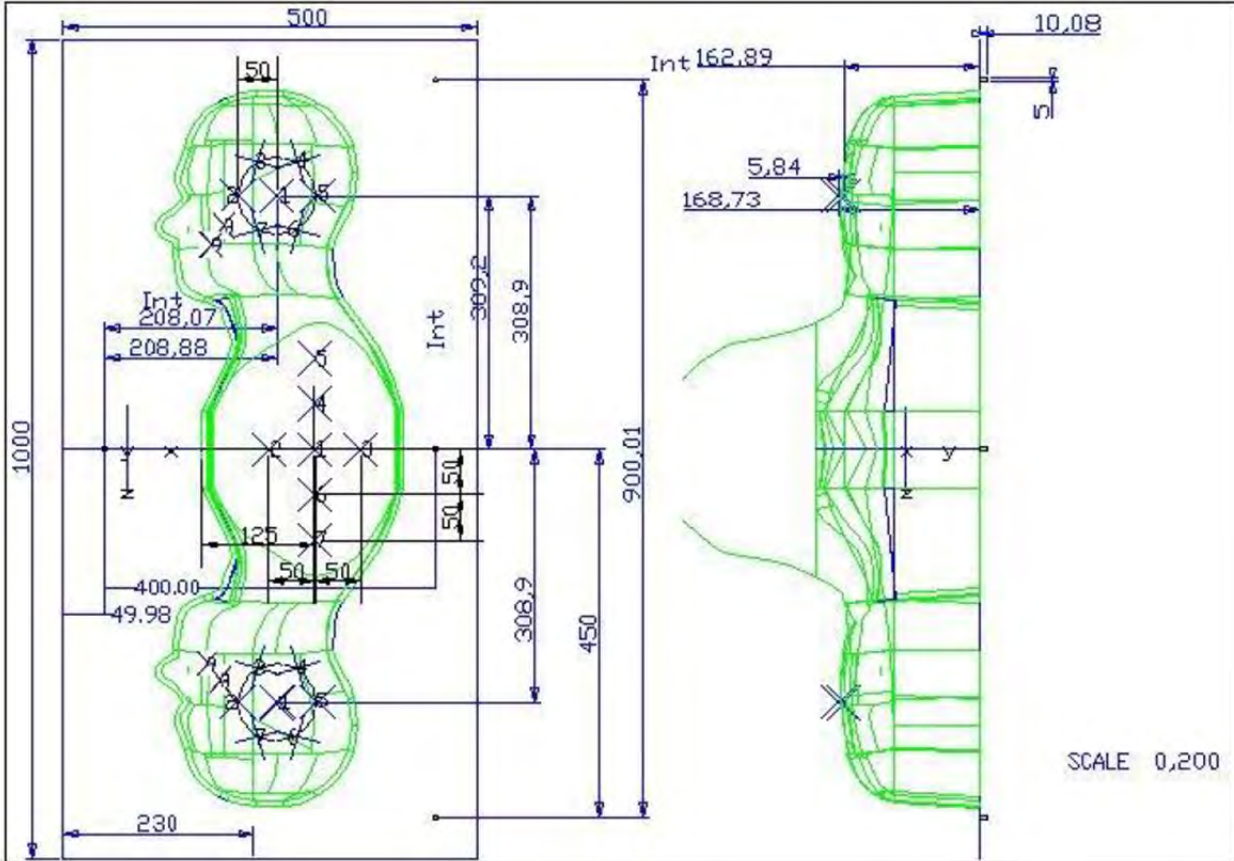

Serial Number	Left Head		Right Head		Flat Part	
SN 30/13 SAM103	2	2.00	2	2.03	1	2.09
	3	2.02	3	2.05	2	2.10
	4	2.04	4	2.04	3	2.09
	5	2.04	5	2.07	4	2.11
	6	2.02	6	2.07	5	2.11
	7	2.01	7	2.09	6	2.09
	8	2.04	8	2.10	7	2.11
	9	2.02	9	2.09	-	-
	SN 30/13 SAM104	2	2.05	2	2.06	1
3		2.08	3	2.03	2	2.03
4		2.05	4	2.03	3	2.01
5		2.06	5	2.02	4	2.03
6		2.08	6	2.02	5	2.03
7		2.06	7	2.04	6	2.00
8		2.07	8	2.04	7	1.98
9		2.07	9	2.05	-	-

4.2.4 Device Holder

The SAR in the phantom is approximately inversely proportional to the square of the distance between the source and the liquid surface. For a source at 5 mm distance, a positioning uncertainty of ± 0.5 mm would produce a SAR uncertainty of ± 20 %. Accurate device positioning is therefore crucial for accurate and repeatable measurements. The positions in which the devices must be measured are defined by the standards.

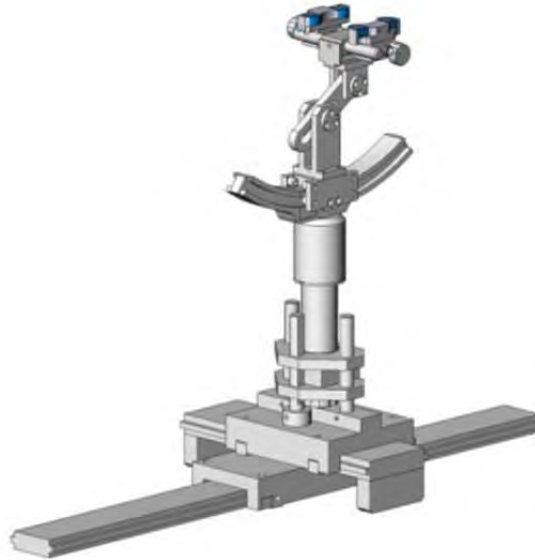

Serial Number	Holder Material	Permittivity	Loss Tangent
SN 25/13 MSH87	Deirin	3.7	0.005
SN 25/13 MSH88	Deirin	3.7	0.005

The positioning system allows obtaining cheek and tilting position with a very good accuracy. In compliance with CENELEC, the tilt angle uncertainty is lower than 1° .

4.2.5 Simulating Liquid

For SAR measurement of the field distribution inside the phantom, the phantom must be filled with homogeneous tissue simulating liquid to a depth of at least 15 cm. For head SAR testing, the liquid height from the ear reference point (ERP) of the phantom to the liquid top surface is larger than 15 cm. For body SAR testing, the liquid height from the center of the flat phantom to the liquid top surface is larger than 15 cm. The nominal dielectric values of the tissue simulating liquids in the phantom and the tolerance of 5%.

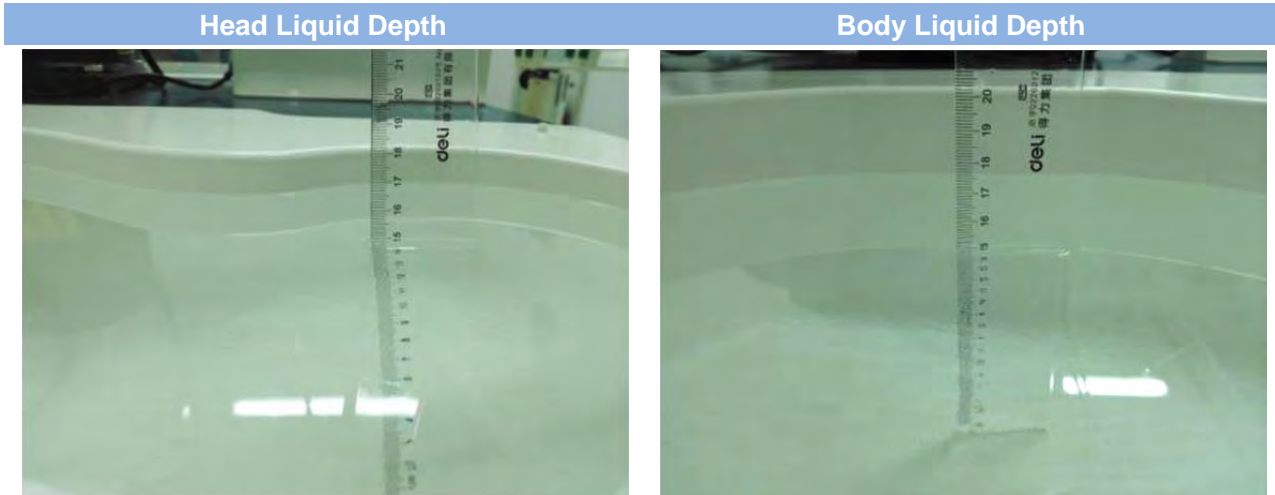

The following table gives the recipes for tissue simulating liquid.

Frequency (MHz)	Water	Sugar	Cellulose	Salt	Preventol	DGBE	Conductivity	Permittivity
	%	%	%	%	%	%	σ	ϵ
Head								
750	41.1	57.0	0.2	1.4	0.2	0	0.89	41.9
835	40.3	57.9	0.2	1.4	0.2	0	0.90	41.5
900	40.3	57.9	0.2	1.4	0.2	0	0.97	41.5
1800, 1900, 2000	55.2	0	0	0.3	0	44.5	1.4	40.0
2450	55.0	0	0	0	0	45.0	1.80	39.2
Body								
750	51.7	47.2	0	0.9	0.1	0	0.96	55.5
835	50.8	48.2	0	0.9	0.1	0	0.97	55.2
900	50.8	48.2	0	0.9	0.1	0	1.05	55.0
1800, 1900, 2000	70.2	0	0	0.4	0	29.4	1.52	53.3
2450	68.6	0	0	0	0	31.4	1.95	52.7

4.2.6 Simulating Liquid Validation

The dielectric parameters of the liquids were verified prior to the SAR evaluation using an SATIMO SCLMP Dielectric Probe Kit and an RS Network Analyzer.

Date	Liquid Type	Freq. (MHz)	Temp. (°C)	Meas. Conductivity (σ)	Meas. Permittivity (ϵ)	Target conductivity (σ)	Target Permittivity (ϵ)	Conductivity tolerance (%)	Permittivity tolerance (%)
2014/2/4	Body	2450	22	1.96	52.45	1.95	52.70	0.51	-0.38%

Note:

1. The tolerances limit of Conductivity and Permittivity is $\pm 5\%$.

5 SYSTEM VERIFICATION

5.1 Antenna Port Test Requirement

The SATIMO SAR system is equipped with one or more system validation kits. These units together with the predefined measurement procedures within the SATIMO software enable the user to conduct the system performance check and system validation. System validation kit includes a dipole, tripod holder to fix it underneath the flat phantom and a corresponding distance holder.

5.2 Purpose of System Check

The system performance check verifies that the system operates within its specifications. System and operator errors can be detected and corrected. It is recommended that the system performance check be performed prior to any usage of the system in order to guarantee reproducible results. The system performance check uses normal SAR measurements in a simplified setup with a well characterized source. This setup was selected to give a high sensitivity to all parameters that might fail or vary over time. The system check does not intend to replace the calibration of the components, but indicates situations where the system uncertainty is exceeded due to drift or failure.

5.3 System Check Setup

In the simplified setup for system evaluation, the EUT is replaced by a calibrated dipole and the power source is replaced by a continuous wave that comes from a signal generator. The calibrated dipole must be placed beneath the flat phantom section of the SAM twin phantom with the correct distance holder. The distance holder should touch the phantom surface with a light pressure at the reference marking and be oriented parallel to the long side of the phantom. The equipment setup is shown below:

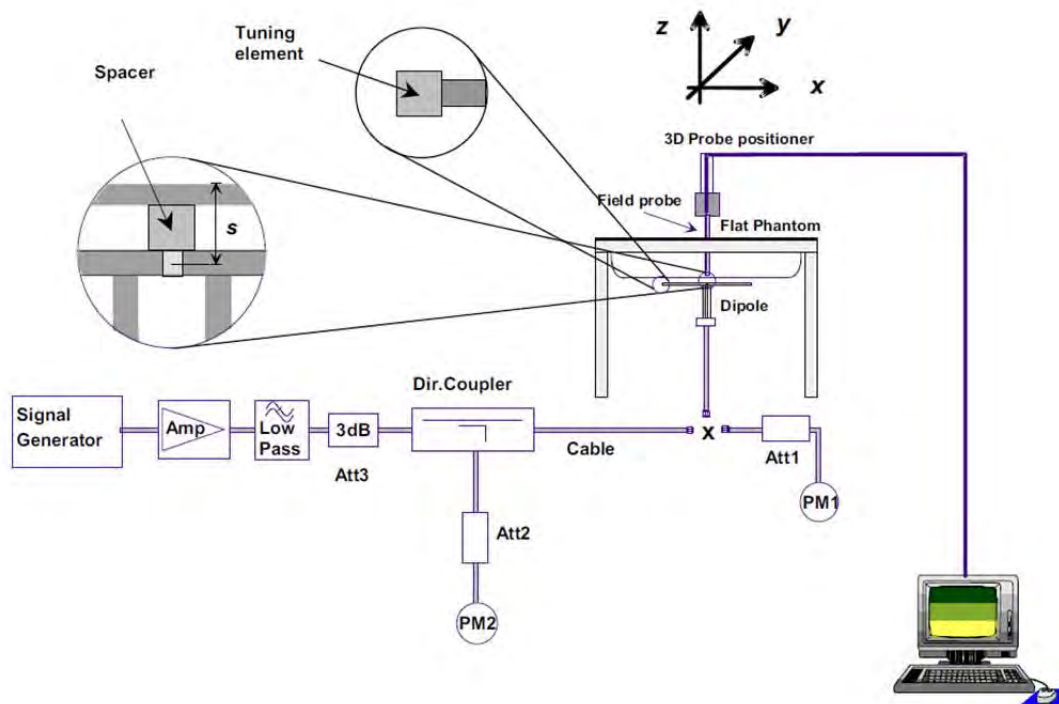

5.4 System Verification Results

Comparing to the original SAR value provided by SATIMO, the validation data should be within its specification of 10 %.

Date	Liquid Type	Freq. (MHz)	Power (mW)	Measured SAR (W/kg)	Normalized SAR (W/kg)	Dipole SAR (W/kg)	Tolerance (%)	Targeted SAR(W/kg)	Tolerance (%)
2014/2/4	Body	2450	250	13.563	54.252	55.60	-2.42%	52.40	3.53%

Note:

1. The tolerance limit of System validation $\pm 10\%$.

6 EUT TEST POSITION CONFIGURATIONS

According to KDB 648474 D04 Handset v01r01, handsets are tested for SAR compliance in head, body-worn accessory and other use configurations described in the following subsections.

6.1 Head Exposure Conditions

Head exposure is limited to next to the ear voice mode operations. Head SAR compliance is tested according to the test positions defined in IEEE Std 1528-2003 using the SAM phantom illustrated as below.

6.1.1 Define two imaginary lines on the handset

- The vertical centerline passes through two points on the front side of the handset - the midpoint of the width w_t of the handset at the level of the acoustic output, and the midpoint of the width w_b of the bottom of the handset.
- The horizontal line is perpendicular to the vertical centerline and passes through the center of the acoustic output. The horizontal line is also tangential to the face of the handset at point A.
- The two lines intersect at point A. Note that for many handsets, point A coincides with the center of the acoustic output; however, the acoustic output may be located elsewhere on the horizontal line. Also note that the vertical centerline is not necessarily parallel to the front face of the handset, especially for clamshell handsets, handsets with flip covers, and other irregularly shaped handsets.

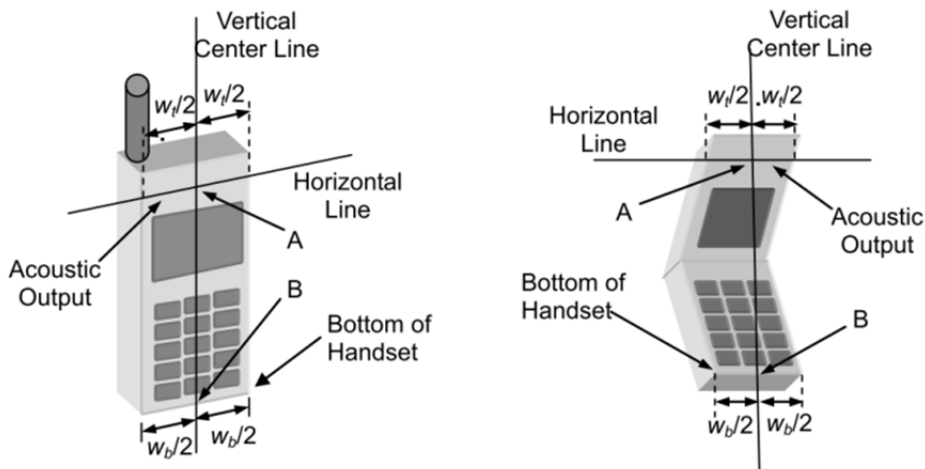

6.1.2 Cheek Position

- To position the device with the vertical center line of the body of the device and the horizontal line crossing the center piece in a plane parallel to the sagittal plane of the phantom. While maintaining the device in this plane, align the vertical center line with the reference plane containing the three ear and mouth reference point (M: Mouth, RE: Right Ear, and LE: Left Ear) and align the center of the ear piece with the line RE-LE.
- To move the device towards the phantom with the ear piece aligned with the line LE-RE until the phone touched the ear. While maintaining the device in the reference plane and maintaining the phone contact with the ear, move the bottom of the phone until any point on the front side is in contact with the cheek of the phantom or until contact with the ear is lost.

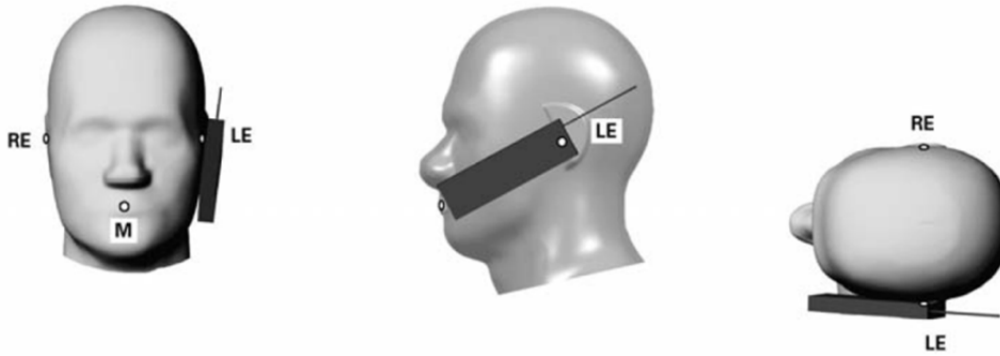

6.1.3 Tilted Position

- (a) To position the device in the “cheek” position described above.
- (b) While maintaining the device the reference plane described above and pivoting against the ear, moves it outward away from the mouth by an angle of 15 degrees or until contact with the ear is lost.

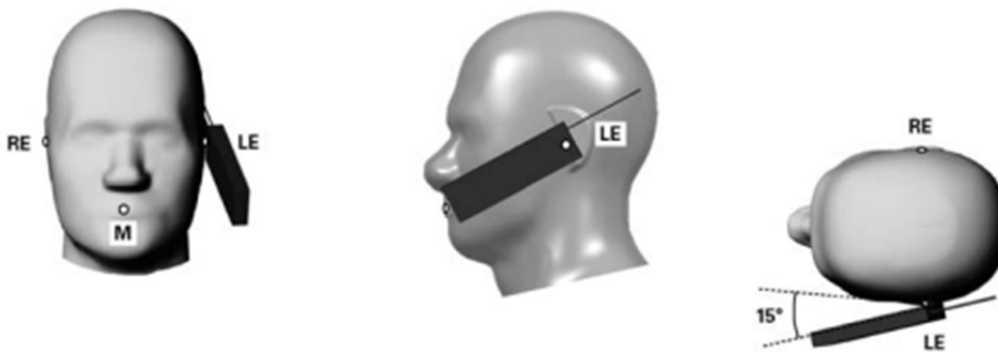

6.2 Body-worn Position Conditions

Body-worn accessory exposure is typically related to voice mode operations when handsets are carried in body-worn accessories. The body-worn accessory procedures in KDB 447498 are used to test for body-worn accessory SAR compliance, without a headset connected to it. This enables the test results for such configuration to be compatible with that required for hotspot mode when the body-worn accessory test separation distance is greater than or equal to that required for hotspot mode. When the reported SAR for a body-worn accessory, measured without a headset connected to the handset, is > 1.2 W/kg, the highest reported SAR configuration for that wireless mode and frequency band should be repeated for that body-worn accessory with a headset attached to the handset.

Body-worn accessories that do not contain metallic or conductive components may be tested according to worst-case exposure configurations, typically according to the smallest test separation distance required for the group of body-worn accessories with similar operating and exposure characteristics. All body-worn accessories containing metallic components are tested in conjunction with the host device.

Body-worn accessory SAR compliance is based on a single minimum test separation distance for all wireless and operating modes applicable to each body-worn accessory used by the host, and according to the relevant voice and/or data mode transmissions and operations. If a body-worn accessory supports voice only operations in its normal and expected use conditions, testing of data mode for body-worn compliance is not required. A conservative minimum test separation distance for supporting off-the-shelf body-worn accessories that may be

acquired by users of consumer handsets is used to test for body-worn accessory SAR compliance. This distance is determined by the handset manufacturer, according to the requirements of Supplement C 01-01. Devices that are designed to operate on the body of users using lanyards and straps, or without requiring additional body-worn accessories, will be tested using a conservative minimum test separation distance ≤ 5 mm to support compliance.

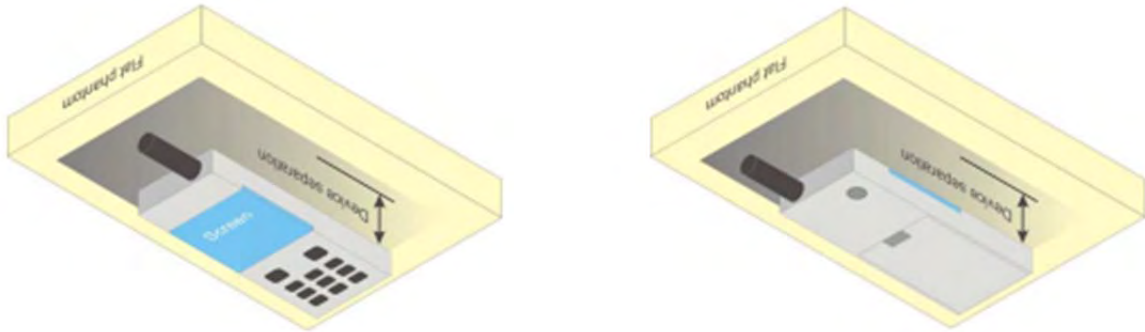

6.3 Hotspot Mode Exposure Position Conditions

For handsets that support hotspot mode operations, with wireless router capabilities and various web browsing functions, the relevant hand and body exposure conditions are tested according to the hotspot SAR procedures in KDB 941225. A test separation distance of 10 mm is required between the phantom and all surfaces and edges with a transmitting antenna located within 25 mm from that surface or edge. When the form factor of a handset is smaller than 9 cm x 5 cm, a test separation distance of 5 mm (instead of 10 mm) is required for testing hotspot mode. When the separation distance required for body-worn accessory testing is larger than or equal to that tested for hotspot mode, in the same wireless mode and for the same surface of the phone, the hotspot mode SAR data may be used to support body-worn accessory SAR compliance for that particular configuration (surface).

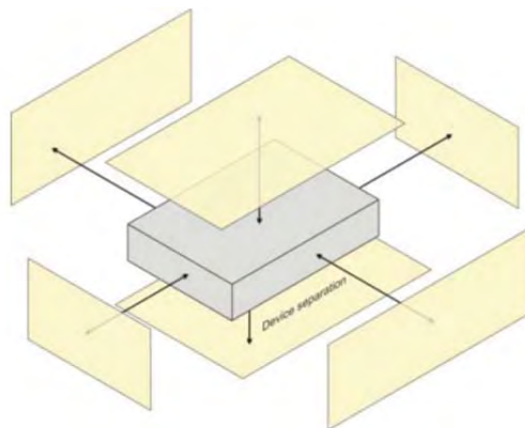

7 SAR MEASUREMENT PROCEDURES

7.1 SAR Measurement Process Diagram

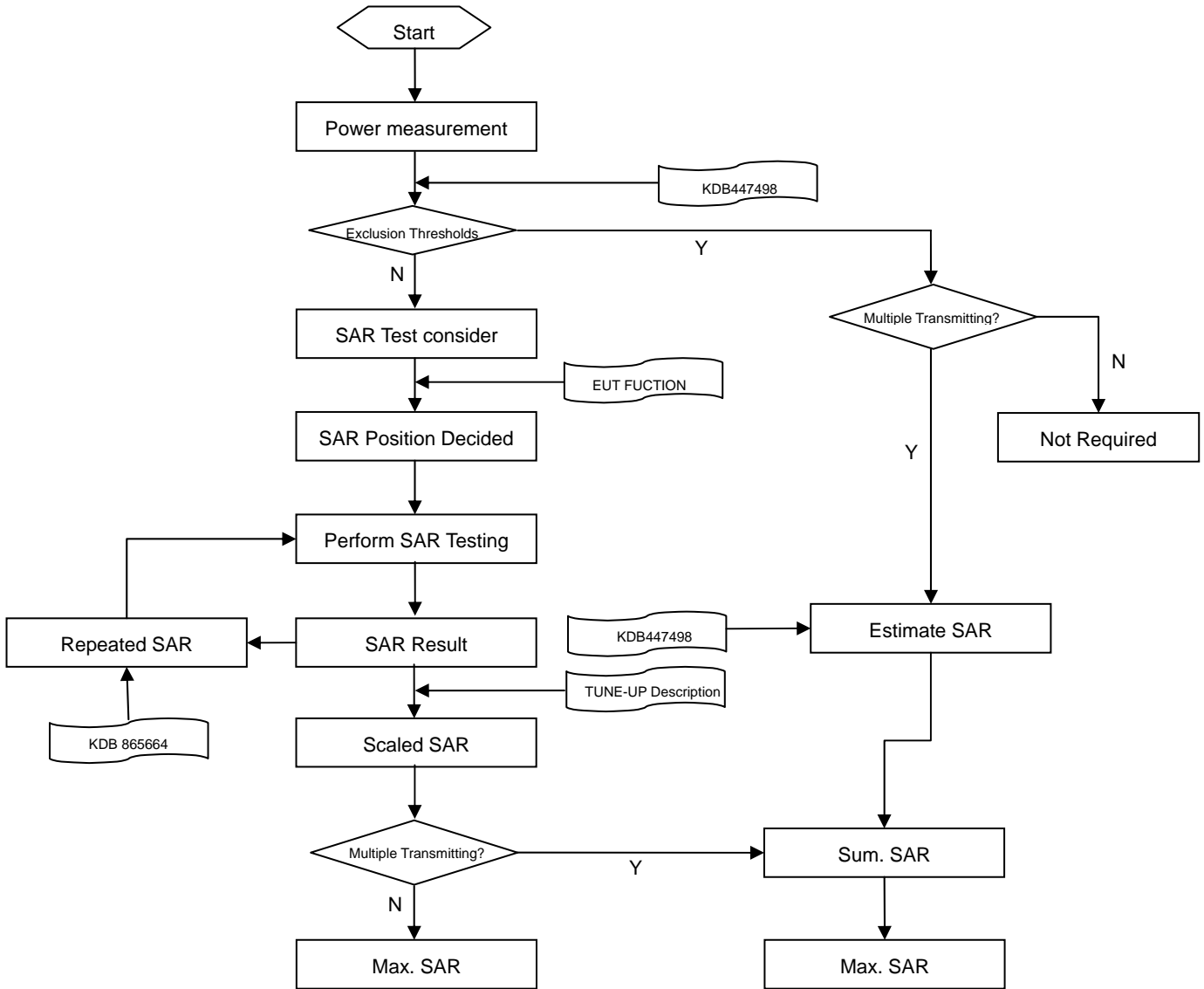

7.2 SAR Scan General Requirements

Probe boundary effect error compensation is required for measurements with the probe tip closer than half a probe tip diameter to the phantom surface. Both the probe tip diameter and sensor offset distance must satisfy measurement protocols; to ensure probe boundary effect errors are minimized and the higher fields closest to the phantom surface can be correctly measured and extrapolated to the phantom surface for computing 1-g SAR. Tolerances of the post-processing algorithms must be verified by the test laboratory for the scan resolutions used in the SAR measurements, according to the reference distribution functions specified in IEEE Std 1528-2003.

			≤3GHz	>3GHz	
Maximum distance from closest measurement point (geometric center of probe sensors) to phantom surface			5±1 mm	$\frac{1}{2} \cdot \delta \cdot \ln(2) \pm 0.5$ mm	
Maximum probe angle from probe axis to phantom surface normal at the measurement location			30°±1°	20°±1°	
Maximum area scan spatial resolution: Δx Area , Δy Area			≤ 2 GHz: ≤ 15 mm 2 – 3 GHz: ≤ 12 mm	3–4 GHz: ≤ 12 mm 4 – 6 GHz: ≤ 10 mm	
			When the x or y dimension of the test device, in the measurement plane orientation, is smaller than the above, the measurement resolution must be ≤ the corresponding x or y dimension of the test device with at least one measurement point on the test device.		
Maximum zoom scan spatial resolution: Δx Zoom , Δy Zoom			≤ 2 GHz: ≤ 8 mm 2 – 3 GHz: ≤ 5 mm*	3–4 GHz: ≤ 5 mm* 4 – 6 GHz: ≤ 4 mm*	
Maximum zoom scan spatial resolution, normal to phantom surface	uniform grid: Δz Zoom (n)		≤ 5 mm	3–4 GHz: ≤ 4 mm	
	graded grid			≤ 4 mm	4–5 GHz: ≤ 3 mm
					5–6 GHz: ≤ 2 mm
	Δz Zoom (1): between 1st two points closest to phantom surface Δz Zoom (n>1): between subsequent points		3–4 GHz: ≤ 3 mm 4–5 GHz: ≤ 2.5 mm 5–6 GHz: ≤ 2 mm		
Minimum zoom scan volume	x, y, z		≥30 mm	3–4 GHz: ≥ 28 mm	
				4–5 GHz: ≥ 25 mm	
				5–6 GHz: ≥ 22 mm	

Note:

- δ is the penetration depth of a plane-wave at normal incidence to the tissue medium; see draft standard IEEE P1528-2011 for details.
- * When zoom scan is required and the reported SAR from the area scan based 1-g SAR estimation procedures of KDB 447498 is ≤ 1.4 W/kg, ≤ 8 mm, ≤ 7 mm and ≤ 5 mm zoom scan resolution may be applied, respectively, for 2 GHz to 3GHz, 3 GHz to 4 GHz and 4 GHz to 6 GHz.

7.3 SAR Measurement Procedure

The following steps are used for each test position

- Establish a call with the maximum output power with a base station simulator. The connection between the mobile and the base station simulator is established via air interface
- Measurement of the local E-field value at a fixed location. This value serves as a reference value for calculating a possible power drift.
- Measurement of the SAR distribution with a grid of 8 to 16mm * 8 to 16 mm and a constant distance to the inner surface of the phantom. Since the sensors cannot directly measure at the inner phantom surface, the values between the sensors and the inner phantom surface are extrapolated. With these values the area of the maximum SAR is calculated by an interpolation scheme.
- Around this point, a cube of 30 * 30 * 30 mm or 32 * 32 * 32 mm is assessed by measuring 5 or 8 * 5 or 8*4 or 5 mm. With these data, the peak spatial-average SAR value can be calculated.

7.4 Area & Zoom Scan Procedures

First Area Scan is used to locate the approximate location(s) of the local peak SAR value(s). The measurement grid within an Area Scan is defined by the grid extent, grid step size and grid offset. Next, in order to determine the EM field distribution in a three-dimensional spatial extension, Zoom Scan is required. The Zoom Scan is performed around the highest E-field value to determine the averaged SAR-distribution over 10 g. Area scan and zoom scan resolution setting follows KDB 865664 D01v01r01 quoted below.

When the 1-g SAR of the highest peak is within 2 dB of the SAR limit, additional zoom scans are required for other peaks within 2 dB of the highest peak that have not been included in any zoom scan to ensure there is no increase in SAR.

8 CONDUCTED RF OUPUT POWER

WLAN 2.4G mode:

Mode	802.11b			802.11g		
Channel	1	6	11	1	6	11
Frequency (MHz)	2412	2437	2462	2412	2437	2462
Peak Power (dBm)	16.46	16.76	15.41	16.13	15.66	15.59
Average Power (dBm)	15.38	15.21	14.68	14.16	14.09	13.64
Mode	802.11n(HT-20)			802.11n(HT-40)		
Channel	1	6	11	3	6	9
Frequency (MHz)	2412	2437	2462	2422	2437	2452
Peak Power (dBm)	16.08	15.98	15.50	15.51	15.57	15.26
Average Power (dBm)	14.36	14.07	13.44	14.74	14.28	13.98

Note:

1. Per KDB 248227 D01 v01r02, choose the highest output power channel to test SAR and determine further SAR exclusion.
2. For each frequency band, testing at higher data rates and higher order modulations is not required when the maximum average output power for each of these configurations is less than 1/4dB higher than those measured at the lowest data rate
3. Apply the test exclusion rule in KDB 248227 D01 v01r02 11g, 11n-HT20 and HT40 output power is less than 1/4dB higher than 11b mode, thus the SAR can be excluded.

Average Power measurement plots

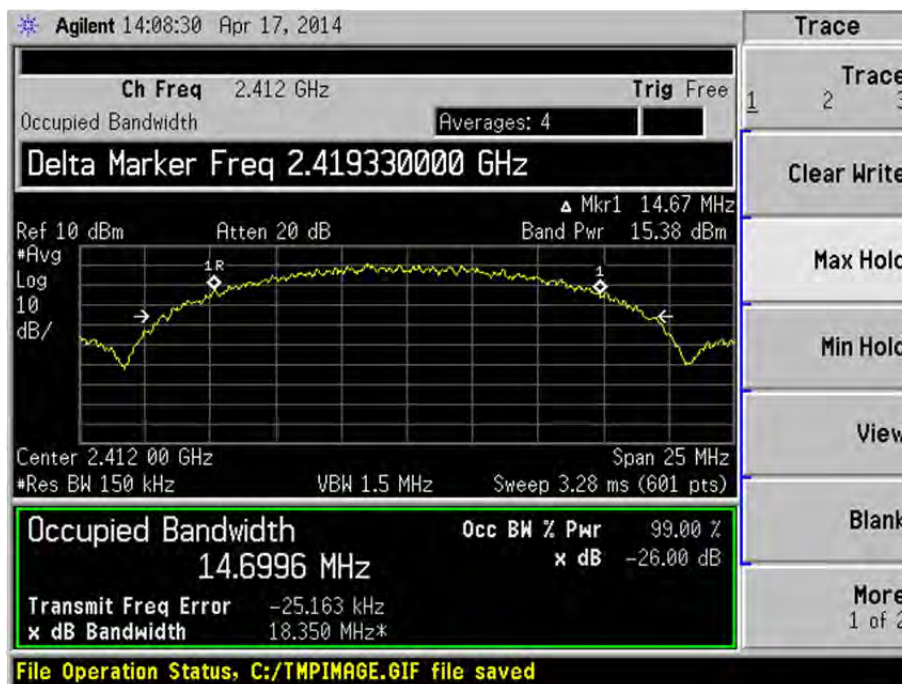

802.11 b (Channel 1)

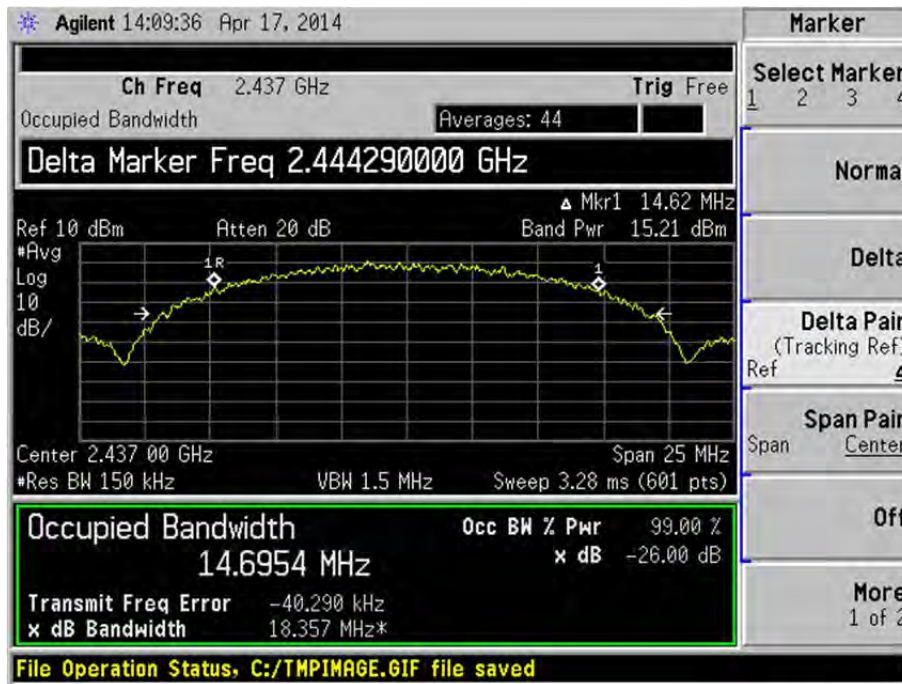

802.11 b (Channel 6)

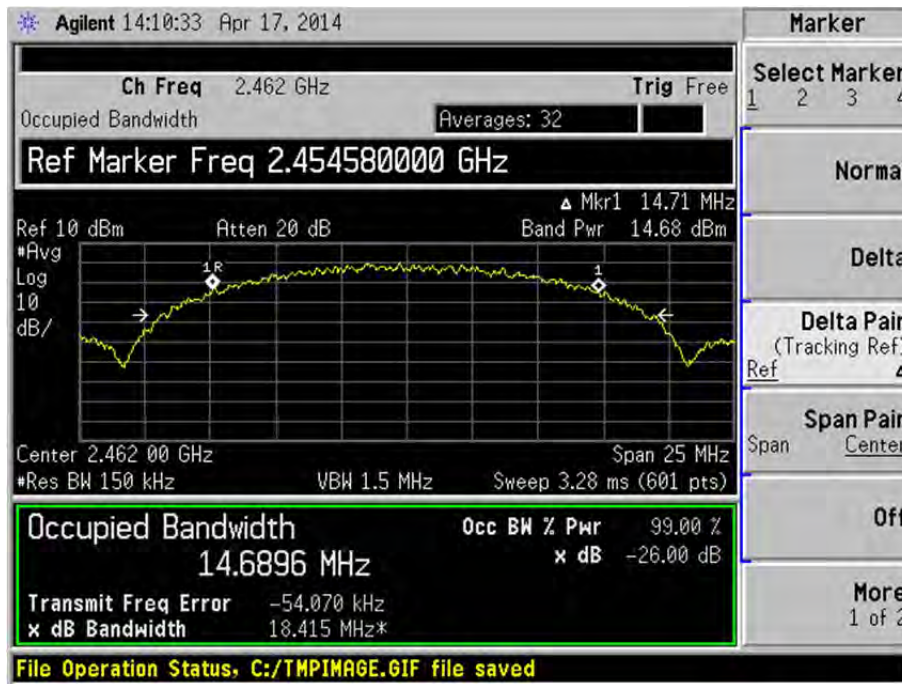

802.11 b (Channel 11)

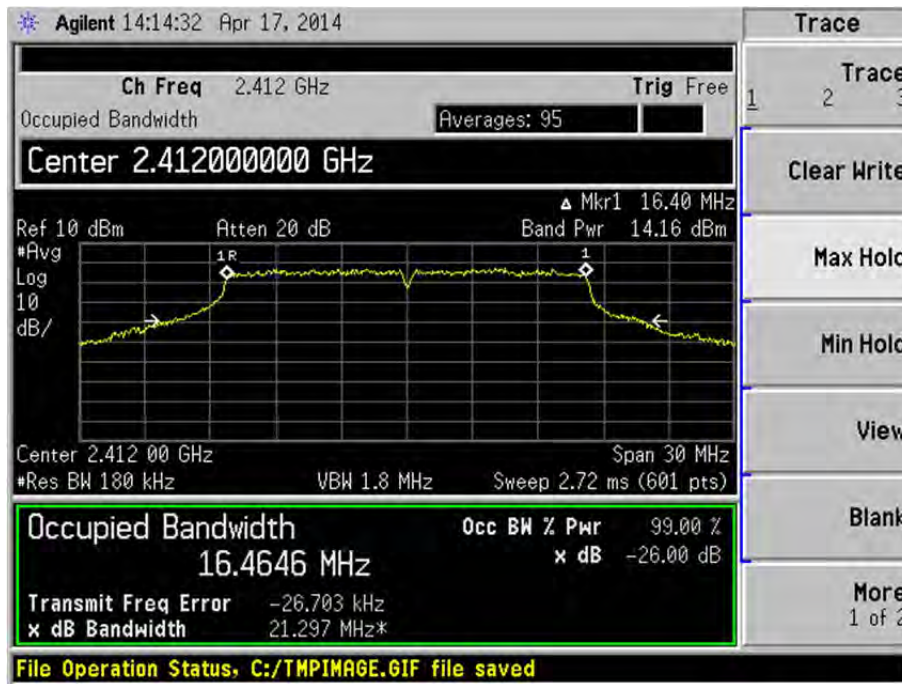

802.11 g (Channel 1)

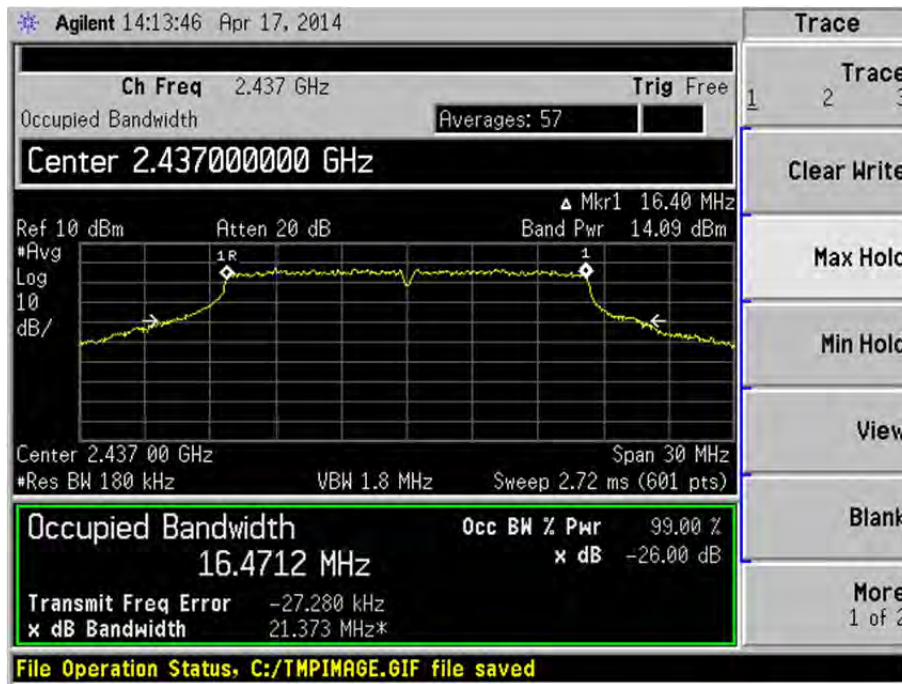

802.11 g (Channel 6)

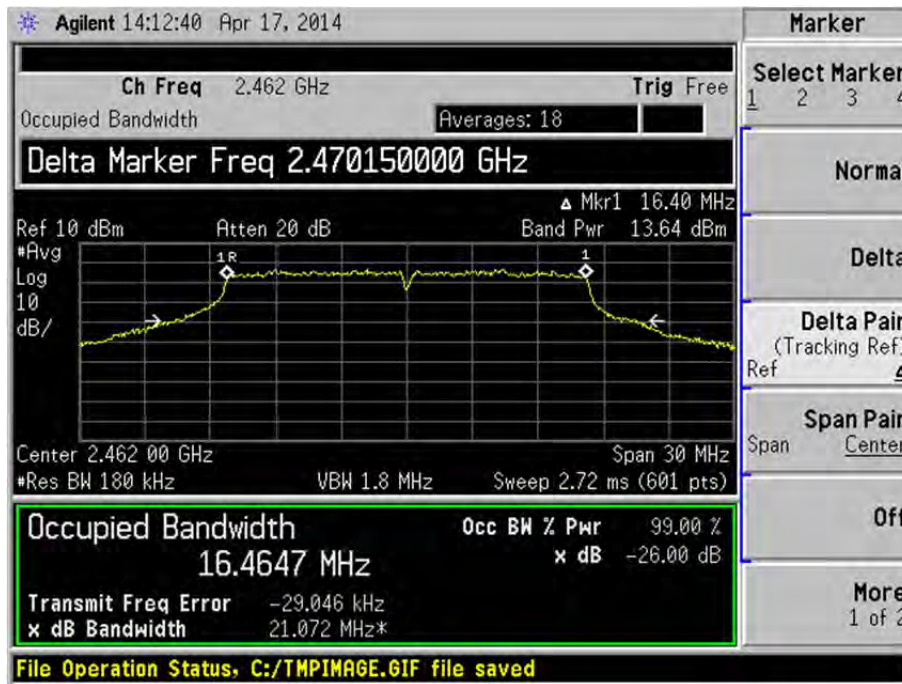

802.11 g (Channel 11)

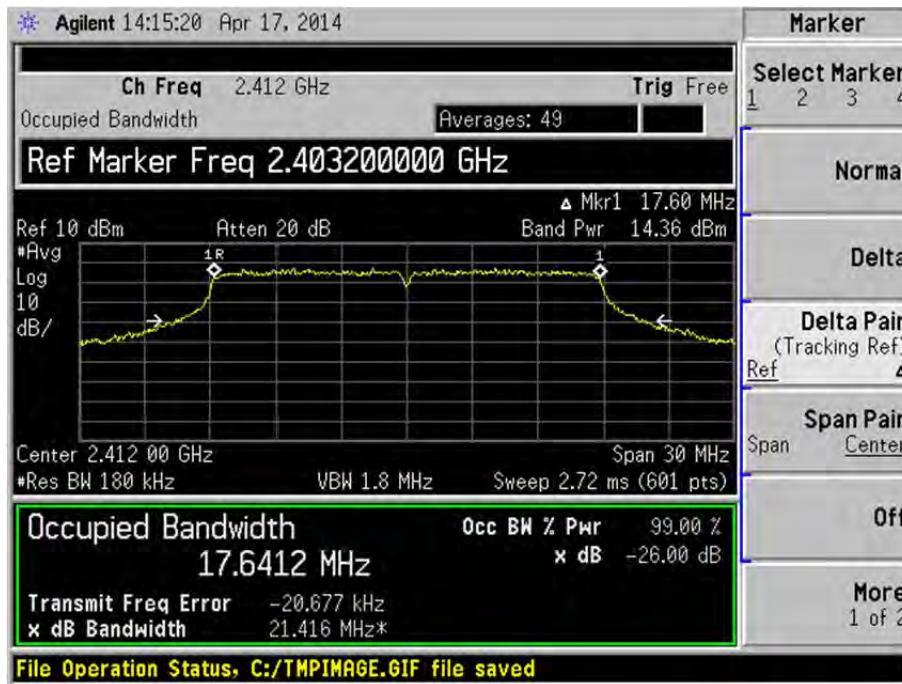

802.11 n-HT20 (Channel 1)

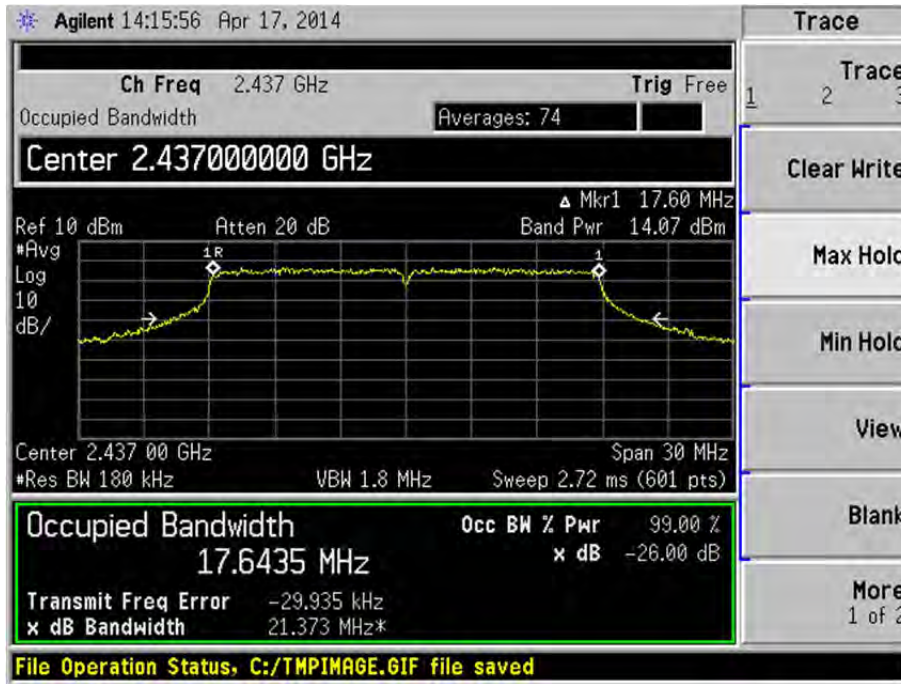

802.11 n-HT20 (Channel 6)

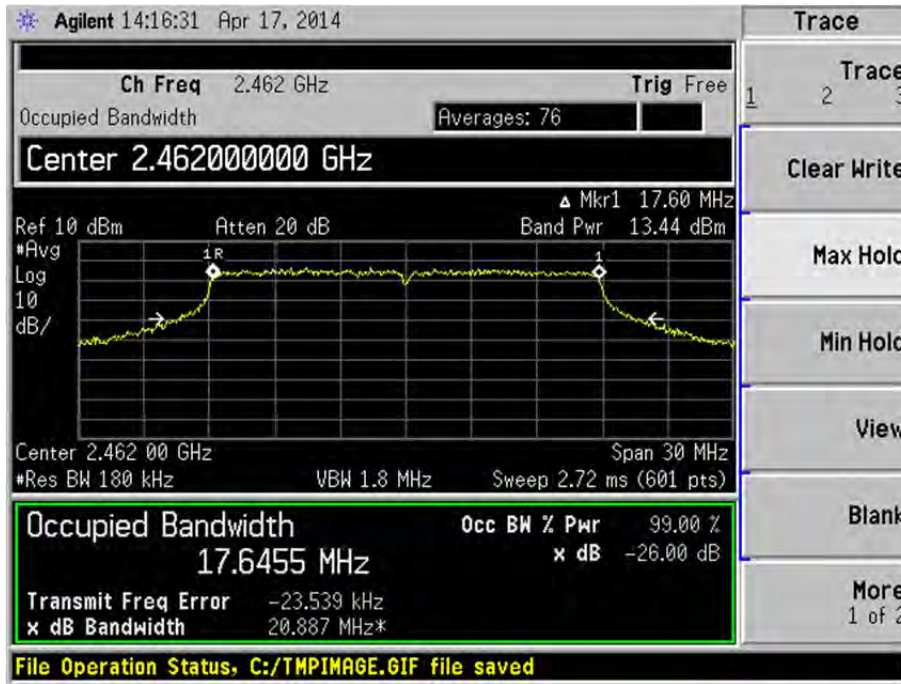

802.11 n-HT20 (Channel 11)

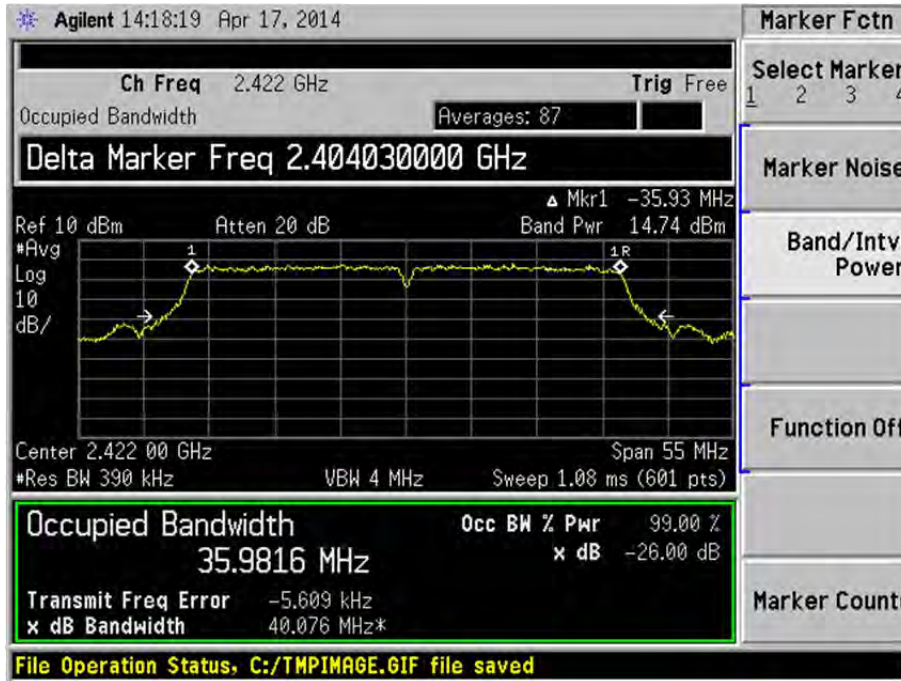

802.11 n-HT40 (Channel 3)

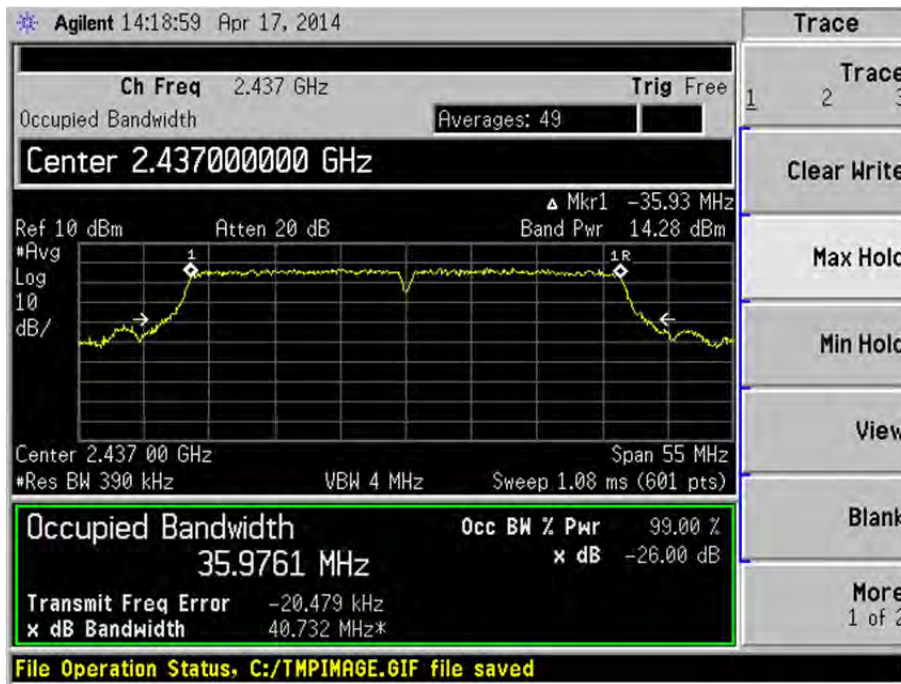

802.11 n-HT20 (Channel 6)

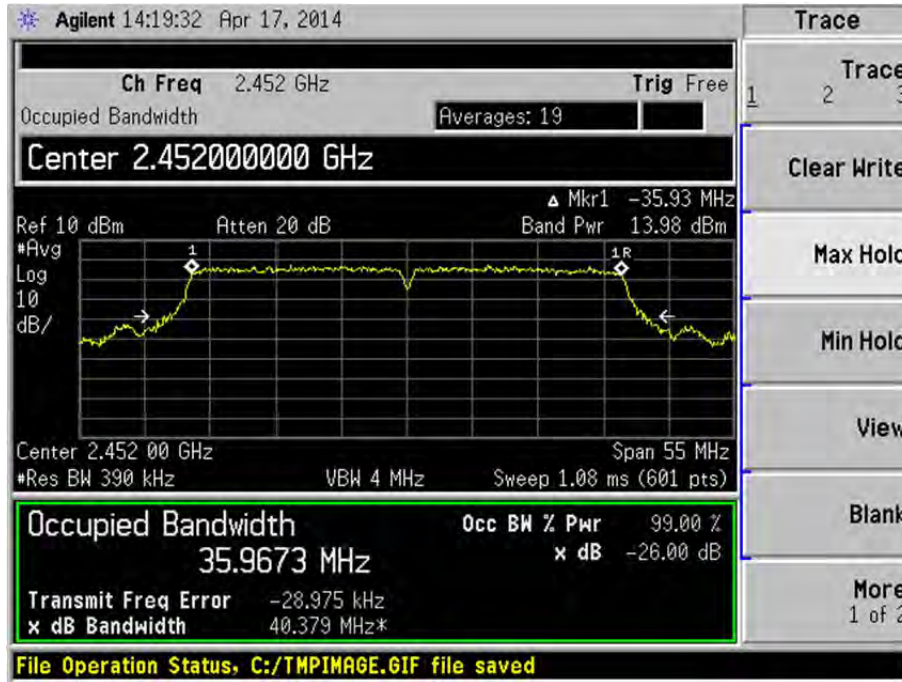

802.11 n-HT20 (Channel 9)

Bluetooth mode:

Mode	GFSK			$\pi/4$ -DQPSK		
Channel	1	39	79	1	39	79
Frequency (MHz)	2402	2441	2480	2402	2441	2480
Peak Power (dBm)	-0.37	-0.31	0.18	0.67	0.62	1.12
Mode	8-DPSK			BLE		
Channel	1	39	79	1	19	40
Frequency (MHz)	2402	2441	2480	2402	2441	2480
Peak Power (dBm)	0.56	0.56	1.05	/	/	/

Note:

- Per KDB 447498 D01v05r01, the 1-g and 10-g SAR test exclusion thresholds for 100 MHz to 6 GHz at test separation distances ≤ 50 mm are determined by:

$$[(\text{max. power of channel, including tune-up tolerance, mW}) / (\text{min. test separation distance, mm})] \cdot [\sqrt{f(\text{GHz})}] \leq 3.0$$
 for 1-g SAR and ≤ 7.5 for 10-g extremity SAR
 f(GHz) is the RF channel transmit frequency in GHz
 Power and distance are rounded to the nearest mW and mm before calculation
 The result is rounded to one decimal place for comparison
- The Max. power of Bluetooth is: 1.12(dBm)=1.294(mW), Which is less than the exclusion threshold limit(10mW), The SAR evaluation test for blue test is not required

9 EUT ANTENNA LOCATION SKETCH

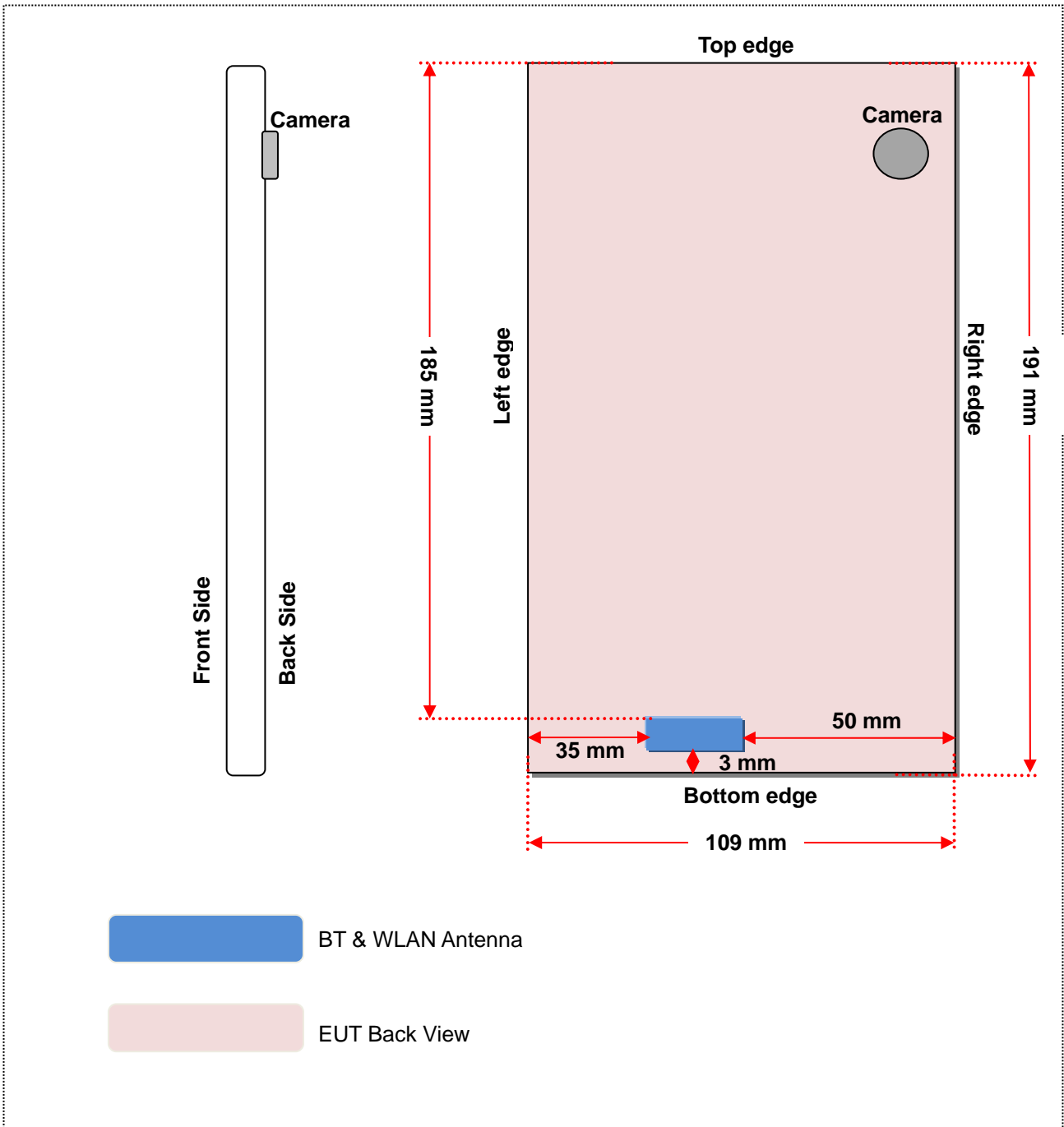

9.1 SAR Test Exclusion Consider Table

According with FCC KDB 447498 D01v05r01, Appendix A, <SAR Test Exclusion Thresholds for 100 MHz - 6 GHz and ≤ 50 mm> Table, this Device SAR test configurations consider as following :

Band	Mode	Max. Average Power		Test Position Configurations					
		dBm	mW	Head	Front/Back	Left Edge	Right Edge	Top Edge	Bottom Edge
WLAN 2.4 G	Distance to User			<5mm	<5mm	35mm	50mm	185mm	3mm
	802.11b			No	Yes	No	No	No	Yes
	802.11g			No	No	No	No	No	No
	802.11n(HT20)			No	No	No	No	No	No
	802.11n(HT40)			No	No	No	No	No	No
Bluetooth	Distance to User			<5mm	<5mm	35mm	50mm	185mm	3mm
	BT			No	No	No	No	No	No

Note:

- WLAN not support Voice function, Head SAR for WLAN is unnecessary.
- Maximum power is the source-based time-average power and represents the maximum RF output power among production units
- Per KDB 447498 D01v05r01, for larger devices, the test separation distance of adjacent edge configuration is determined by the closest separation between the antenna and the user.
- Per KDB 447498 D01v05r01, standalone SAR test exclusion threshold is applied; If the distance of the antenna to the user is < 5mm, 5mm is used to determine SAR exclusion threshold
- Per KDB 447498 D01v05r01, the 1-g and 10-g SAR test exclusion thresholds for 100 MHz to 6 GHz at test separation distances ≤ 50 mm are determined by:

$$[(\text{max. power of channel, including tune-up tolerance, mW}) / (\text{min. test separation distance, mm})] \cdot [\sqrt{f(\text{GHz})}] \leq 3.0$$
 for 1-g SAR and ≤ 7.5 for 10-g extremity SAR
 f(GHz) is the RF channel transmit frequency in GHz
 Power and distance are rounded to the nearest mW and mm before calculation
 The result is rounded to one decimal place for comparison
 For < 50 mm distance, we just calculate mW of the exclusion threshold value (3.0) to do compare.
 This formula is $[3.0] / [\sqrt{f(\text{GHz})}] \cdot [(\text{min. test separation distance, mm})] = \text{exclusion threshold of mW}$.
- Per KDB 447498 D01v05r01, at 100 MHz to 6 GHz and for test separation distances > 50 mm, the SAR test exclusion threshold is determined according to the following
 - [Threshold at 50 mm in step 1) + (test separation distance - 50 mm) · (f(MHz)/150)] mW, at 100 MHz to 1500 MHz
 - [Threshold at 50 mm in step 1) + (test separation distance - 50 mm) · 10] mW at > 1500 MHz and ≤ 6 GHz
- Per KDB 248227 D01 v01r02, choose the highest output power channel to test SAR and determine further SAR exclusion.
- Apply the test exclusion rule in KDB 248227 D01 v01r02 11g, 11n-HT20 and HT40 output power is less than 1/4dB higher than 11b mode, the SAR can be excluded.

10 SAR TEST RESULTS

10.1 Body SAR

WLAN BODY SAR

Band	Mode	Position	Ch.	Freq. (MHz)	Power Drift	Meas. SAR(W/Kg)	Scaling Factor	Scaled SAR(W/Kg)	Meas. No.
WLAN (2.4GHz)	802.11 b	Front side	1	2412	1.20	0.484	1.081	0.523	5#
		Back Side			0.45	0.515	1.081	0.557	1#
		Left Edge			-3.83	0.047	1.081	0.051	3#
		Right Edge			-2.31	0.034	1.081	0.037	4#
		Bottom Edge			-1.82	0.155	1.081	0.168	2#
		Top Edge			-	-	-	-	-
		Front side	6	2437	-0.03	0.465	1.009	0.469	10#
		Back Side			0.81	0.725	1.009	0.732	6#
		Left Edge			-0.19	0.052	1.009	0.052	8#
		Right Edge			1.60	0.038	1.009	0.038	9#
		Bottom Edge			2.12	0.154	1.009	0.155	7#
		Top Edge			-	-	-	-	-
		Front side	11	2462	2.36	0.441	1.268	0.559	15#
		Back Side			1.19	0.694	1.268	0.880	11#
		Left Edge			0.03	0.055	1.268	0.070	13#
		Right Edge			-1.22	0.041	1.268	0.052	14#
		Bottom Edge			0.33	0.133	1.268	0.169	12#
		Top Edge			-	-	-	-	-

Note:

1. Refer above SAR Test exclusion table, "-" fill in the table means this configuration is not required.

10.2 SAR Measurement Variability

According to KDB 865664 D01v01, SAR measurement variability was assessed for each frequency band, which is determined by the SAR probe calibration point and tissue-equivalent medium used for the device measurements. When both head and body tissue-equivalent media are required for SAR measurements in a frequency band, the variability measurement procedures should be applied to the tissue medium with the highest measured SAR, using the highest measured SAR configuration for that tissue-equivalent medium. Alternatively, if the highest measured SAR for both head and body tissue-equivalent media are ≤ 1.45 W/kg and the ratio of these highest SAR values, i.e., largest divided by smallest value, is ≤ 1.10 , the highest SAR configuration for either head or body tissue-equivalent medium may be used to perform the repeated measurement. These additional measurements are repeated after the completion of all measurements requiring the same head or body tissue-equivalent medium in a frequency band. The test device should be returned to ambient conditions (normal room temperature) with the battery fully charged before it is re-mounted on the device holder for the repeated measurement(s) to minimize any unexpected variations in the repeated results.

SAR repeated measurement procedure:

1. When the highest measured SAR is < 0.80 W/kg, repeated measurement is not required.
2. When the highest measured SAR is ≥ 0.80 W/kg, repeat that measurement once.
3. If the ratio of largest to smallest SAR for the original and first repeated measurements is > 1.20 , or when the original or repeated measurement is ≥ 1.45 W/kg, perform a second repeated measurement.
4. If the ratio of largest to smallest SAR for the original, first and second repeated measurements is > 1.20 , and the original, first or second repeated measurement is ≥ 1.5 W/kg, perform a third repeated measurement.

SAR Repeated Measurement

Band	Mode	Position	Ch.	Freq.	Original	first repeated	ratio	second repeated	ratio	Third repeated	ratio
-	-	Front side	-	-	-	-	-	-	-	-	
-	-	Back Side	-	-	-	-	-	-	-	-	
-	-	Left Edge	-	-	-	-	-	-	-	-	
-	-	Right Edge	-	-	-	-	-	-	-	-	
-	-	Top Edge	-	-	-	-	-	-	-	-	
-	-	Bottom Edge	-	-	-	-	-	-	-	-	

Note:

1. The highest measured SAR is < 0.80 W/kg, repeated measurement is not required.

11 SIMULTANEOUS TRANSMISSION

11.1 Simultaneous Transmission Mode Consider

Simultaneous Transmitting (Yes/NO)	BT
WLAN	YES

11.2 Estimated SAR Calculation

According to KDB 447498 D01v05, when standalone SAR test exclusion applies to an antenna that transmits simultaneously with other antennas, the standalone SAR was estimated according to following formula to result in substantially conservative SAR values of ≤ 0.4 W/kg to determine simultaneous transmission SAR test exclusion.

$$\text{Estimated SAR} = \frac{\text{Max. Tune Up Power}_{(mW)}}{\text{Min. Test Separation Distance}_{(mm)}} * \frac{\sqrt{f_{GHz}}}{7.5}$$

If the minimum test separation distance is < 5 mm, a distance of 5 mm is used for estimated SAR calculation. When the test separation distance is > 50 mm, the 0.4 W/kg is used for SAR-1g.

Band	Mode	Position	Antenna To user (mm)	SAR Testing	Max. Tune-up Power (dBm)	Max. Tune-up Power (mW)	Frequency (GHz)	Calculation Distance/Gap (mm)	Estimated SAR (W/kg)
		Front side	5	NO	1.12	1.294	2.480	5	0.054
		Back Side	5	NO	1.12	1.294	2.480	5	0.054
		Left Edge	5	NO	1.12	1.294	2.480	5	0.054
		Right Edge	5	NO	1.12	1.294	2.480	5	0.054
		Top Edge	5	NO	1.12	1.294	2.480	5	0.054
		Bottom Edge	5	NO	1.12	1.294	2.480	5	0.054

11.3 Sum SAR of Simultaneous Transmission

Simultaneous Mode	Position	Mode	Max. SAR (W/kg)	1-g Sum SAR (W/kg)
WLAN + Bluetooth	Body	WLAN	0.880	0.934
		BT	0.054	

Simultaneous transmission SAR test exclusion is determined for each operating configuration and exposure condition according to the reported standalone SAR of each applicable simultaneous transmitting antenna. When the sum of SAR 1g of all simultaneously transmitting antennas in an operating mode and exposure condition combination is within the SAR limit (SAR 1g 1.6 W/kg), the simultaneous transmission SAR is not required. When the sum of SAR 1g is greater than the SAR limit (SAR 1g 1.6 W/kg), SAR test exclusion is determined by the SPLSR.

12 TEST EQUIPMENTS LIST

Description	Manufacturer	Model	Serial No.	Cal. Date	Cal. Due
PC	Dell	N/A	N/A	N/A	N/A
835MHz Dipole	SATIMO	SID835	S/N 25/13 DIP 0G835-246	2013/08/07	2014/08/07
1800MHz Dipole	SATIMO	SID1800	S/N 25/13 DIP 1G800-248	2013/08/07	2014/08/07
1900MHz Dipole	SATIMO	SID1800	S/N 25/13 DIP 1G900-249	2013/08/07	2014/08/07
2450MHz Dipole	SATIMO	SID2450	S/N 25/13 DIP 2G450-251	2013/08/07	2014/08/07
E-Field Probe	SATIMO	SSE2	SN 17/13 EPG177	2013/08/07	2014/08/07
Antenna	SATIMO	ANTA3	SN XXXXX	2013/08/07	2014/08/07
Phantom1	SATIMO	SAM	SN 30/13 SAM013	2013/08/07	2014/08/07
Phantom2	SATIMO	SAM	SN 30/13 SAM014	2013/08/07	2014/08/07
Dielectric Probe Kit	RS	T4321	D288312	2013/08/07	2014/08/07
MultiMeter	Keithley	MultiMeter 2000	229384	2013/08/07	2014/08/07
Signal Generator	Agilent	88763-330	27874A	2013/08/07	2014/08/07
Power Meter	Agilent	5738A	11290	2013/08/07	2014/08/07
Power Sensor	Agilent	5776A	11289	2013/08/07	2014/08/07
Power Amplifier	Agilent	6552B	22374	2013/08/07	2014/08/07
Wireless Communication Test Set	Agilent	8960	342332444	2013/08/07	2014/08/07
Network Analyzer	RS	8765	90976	2013/08/07	2014/08/07

13 REFERENCES

- 1 FCC 47 CFR Part 2 “Frequency Allocations and Radio Treaty Matters; General Rules and Regulations”
- 2 ANSI/IEEE Std. C95.1-1992, “IEEE Standard for Safety Levels with Respect to Human Exposure to Radio Frequency Electromagnetic Fields, 3 kHz to 300 GHz”, September 1992
- 3 IEEE Std. 1528-2003, “Recommended Practice for Determining the Peak Spatial-Average Specific Absorption Rate (SAR) in the Human Head from Wireless Communications Devices: Measurement Techniques”, December 2003
- 4 FCC KDB 248227 D01 v01r02, “SAR Measurement Procedures for 802.11 a/b/g Transmitters”, May 2007
- 5 FCC KDB 447498 D01 v05r01, “Mobile and Portable Device RF Exposure Procedures and Equipment Authorization Policies”, May 2013
- 6 FCC KDB 648474 D04 v01r01, “SAR Evaluation Considerations for Wireless Handsets”, May 2013
- 7 FCC KDB 941225 D03 v01, “Recommended SAR Test Reduction Procedures for GSM / GPRS / EDGE”, December 2008
- 8 FCC KDB 941225 D01 v02, “SAR Measurement Procedures for 3G Devices – CDMA 2000 / Ev-Do / WCDMA / HSDPA / HSPA”, October 2007
- 9 FCC KDB 941225 D02 v02r02, “SAR Guidance for HSPA, HSPA+, DC-HSDPA and 1x-Advanced”, May 2013.
- 10 FCC KDB 616217 D04 v01r01, “SAR Evaluation Considerations for Laptop, Notebook, Netbook and Tablet Computers”, May 2013
- 11 FCC KDB 865664 D01 v01r01, "SAR Measurement Requirements for 100 MHz to 6 GHz", May 2013.
- 12 FCC KDB 865664 D02 v01r01, “RF Exposure Compliance Reporting and Documentation Considerations”, May 2013
- 13 SATIMO COMOSAR_V4
- 14 SATIMO OPENSAR_V4

ANNEX A SAR TEST RESULT OF SYSTEM VERIFICATION

System Performance Check Data(2450MHz Body)

Type: Phone measurement (Complete)
 Area scan resolution: dx=8mm,dy=8mm
 Zoom scan resolution: dx=8mm, dy=8mm, dz=5mm
 Date of measurement: 2/4/2014
 Measurement duration: 13 minutes 27 seconds

Experimental conditions.

Phantom File	surf_sam_plan.txt
Phantom	Validation plane
Device Position	-
Band	2450MHz
Channels	-
Signal	CW
Frequency (MHz)	2450MHz
Relative permittivity (real part)	52.450668
Relative permittivity	14.275111
Conductivity (S/m)	1.962865
Power drift (%)	-0.170000
Ambient Temperature:	22.6°C
Liquid Temperature:	21.2°C
ConvF:	4.51
Crest factor:	1:1

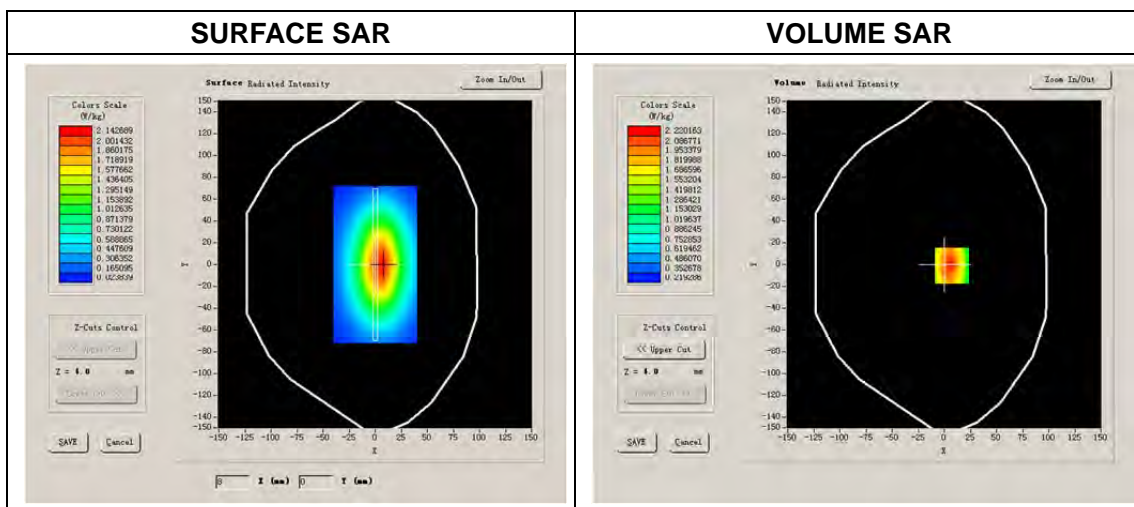

Maximum location: X=7.00, Y=-1.00

SAR 10g (W/Kg)	7.543663
SAR 1g (W/Kg)	13.563384

Z Axis Scan

Z (mm)	0.00	4.00	9.00	14.00	19.00	24.00	29.00
SAR (W/Kg)	0.0000	2.5209	1.6629	1.1437	0.8075	0.5889	0.4143

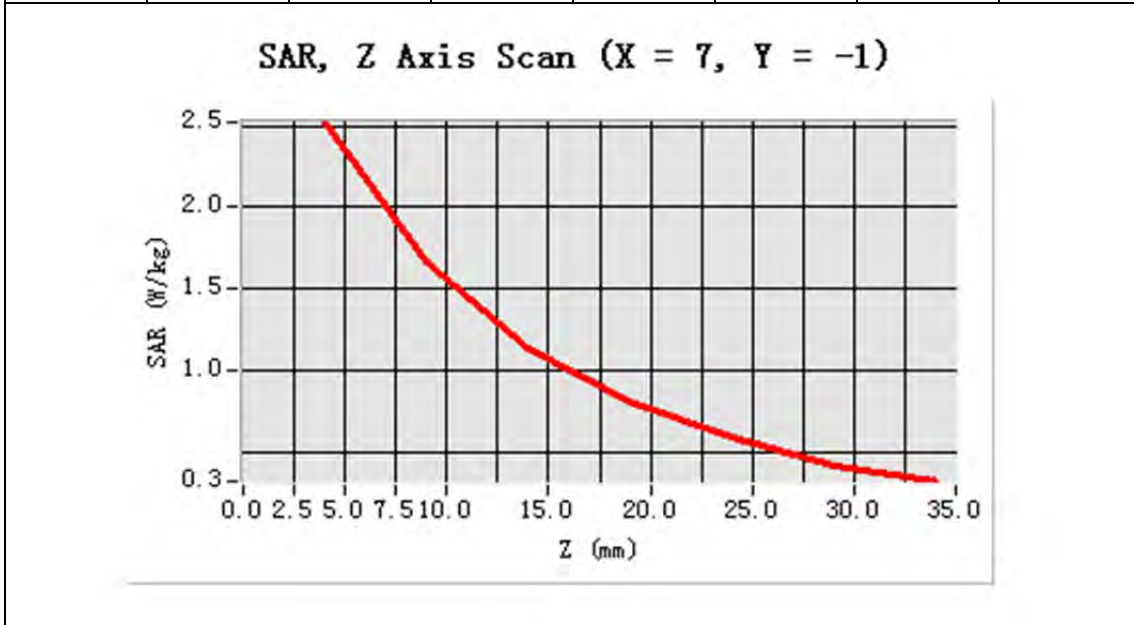

<p>3D scen shot</p>	<p>Hot spot position</p>

ANNEX B SAR TEST SETUP PHOTOS

Back Side



Front Side



Bottom Edge



Left Edge



Right Edge



ANNEX C SAR MEASUREMENT RESULT

TABLE OF MEASUREMENT RESULT LIST

<u>Band</u>	<u>POSITION</u>	<u>PARAMETERS</u>
802.11 b	BODY	<u>Measurement 1:</u> Body Plane with Body device position on Low Channel in DSSS mode (Back side)
		<u>Measurement 2:</u> Body Plane with Body device position on Low Channel in DSSS mode (Bottom edge)
		<u>Measurement 3:</u> Body Plane with Body device position on Low Channel in DSSS mode (Left edge)
		<u>Measurement 4:</u> Body Plane with Body device position on Low Channel in DSSS mode (Right edge)
		<u>Measurement 5:</u> Body Plane with Body device position on Low Channel in DSSS mode (Front side)
		<u>Measurement 6:</u> Body Plane with Body device position on Middle Channel in DSSS mode (Back side)
		<u>Measurement 7:</u> Body Plane with Body device position on Middle Channel in DSSS mode (Bottom edge)
		<u>Measurement 8:</u> Body Plane with Body device position on Middle Channel in DSSS mode (Left edge)
		<u>Measurement 9:</u> Body Plane with Body device position on Middle Channel in DSSS mode (Right edge)
		<u>Measurement 10:</u> Body Plane with Body device position on Middle Channel in DSSS mode (Front side)
		<u>Measurement 11:</u> Body Plane with Body device position on High Channel in DSSS mode (Back side)
		<u>Measurement 12:</u> Body Plane with Body device position on High Channel in DSSS mode (Bottom side)
		<u>Measurement 13:</u> Body Plane with Body device position on High Channel in DSSS mode (Left edge)
		<u>Measurement 14:</u> Body Plane with Body device position on High Channel in DSSS mode (Right edge)
		<u>Measurement 15:</u> Body Plane with Body device position on High Channel in DSSS mode (Front side)

MEASUREMENT 1

Type: Phone measurement (Complete)

Date of measurement: 2/4/2014

Measurement duration: 15 minutes 40 seconds

Experimental conditions.

Area Scan	surf_sam_plan.txt
ZoomScan	5x5x7,dx=8mm dy=8mm dz=5mm,Complete
Phantom	Body plane
Device Position	Body
Band	IEEE 802.11b ISM
Channels	Low
Signal	DSSS
Frequency (MHz)	2412.000000
Relative permittivity (real part)	52.750668
Relative permittivity	14.275111
Conductivity (S/m)	1.912865
Power drift (%)	0.450000
Ambient Temperature:	22.6°C
Liquid Temperature:	21.2°C
ConvF:	4.51
Crest factor:	1:1

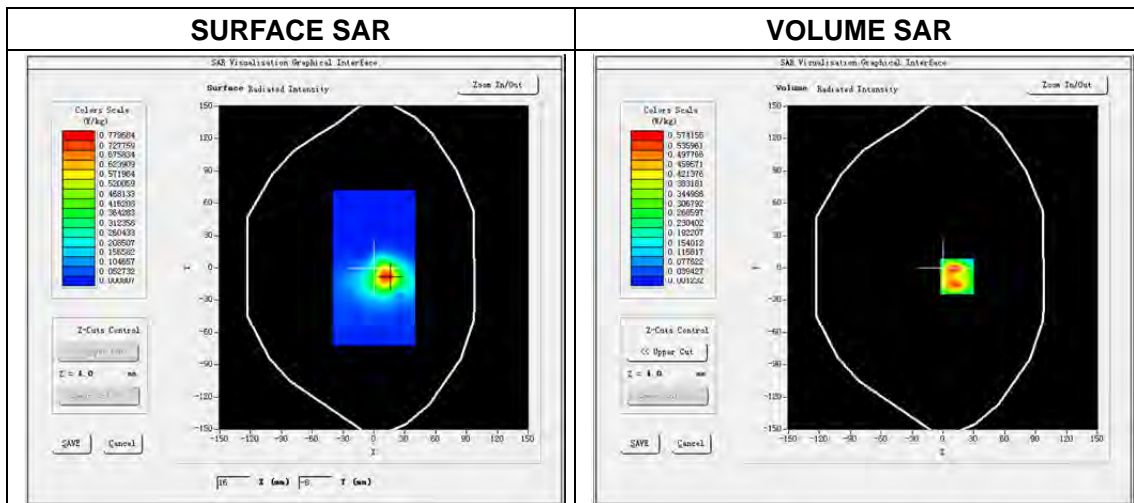

Maximum location: X=14.00, Y=-8.00

SAR Peak: 1.04 W/kg

SAR 10g (W/Kg)	0.247146
SAR 1g (W/Kg)	0.515015

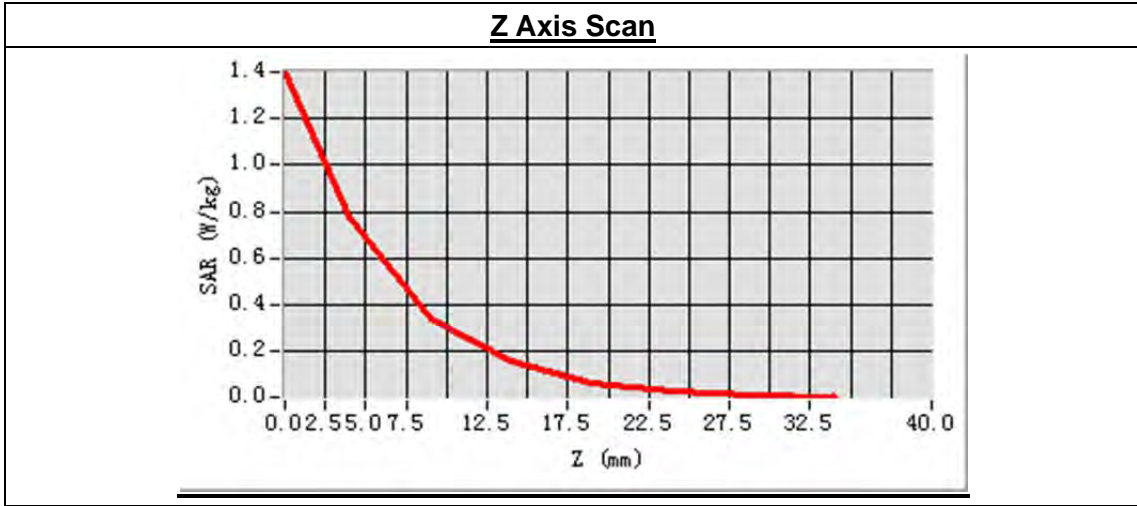

3D scene shot	Hot spot position

MEASUREMENT 2

Type: Phone measurement (Complete)

Date of measurement: 3/4/2014

Measurement duration: 15 minutes 5 seconds

Experimental conditions.

Area Scan	surf_sam_plan.txt
ZoomScan	5x5x7,dx=8mm dy=8mm dz=5mm,Complete
Phantom	Body plane
Device Position	Body
Band	IEEE 802.11b ISM
Channels	Low
Signal	DSSS
Frequency (MHz)	2412.000000
Relative permittivity (real part)	52.750668
Relative permittivity	14.275111
Conductivity (S/m)	1.912865
Power drift (%)	-1.8200000
Ambient Temperature:	22.6°C
Liquid Temperature:	21.2°C
ConvF:	4.51
Crest factor:	1:1

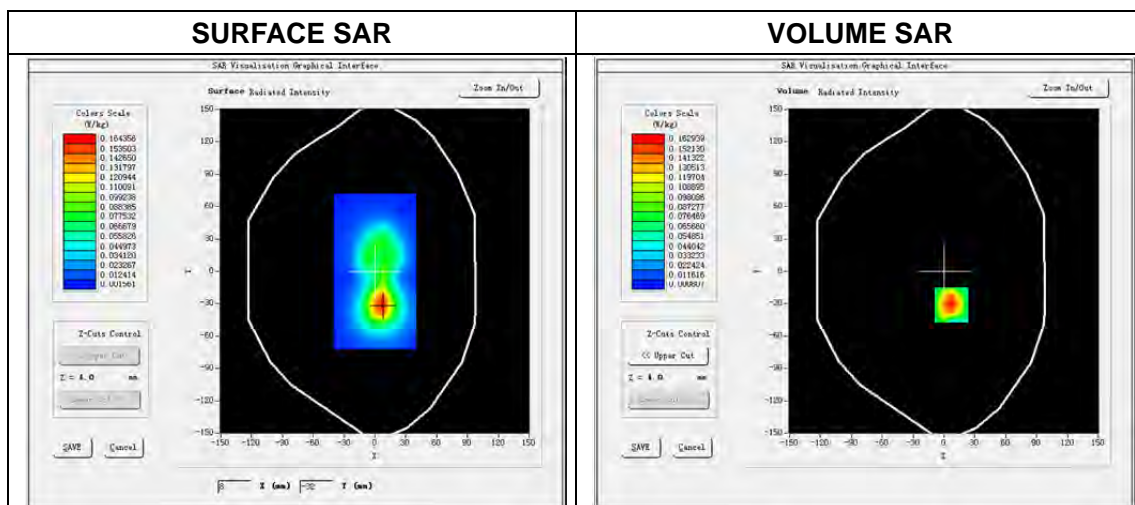

Maximum location: X=7.00, Y=-31.00

SAR Peak: 0.26 W/kg

SAR 10g (W/Kg)	0.076891
SAR 1g (W/Kg)	0.154665

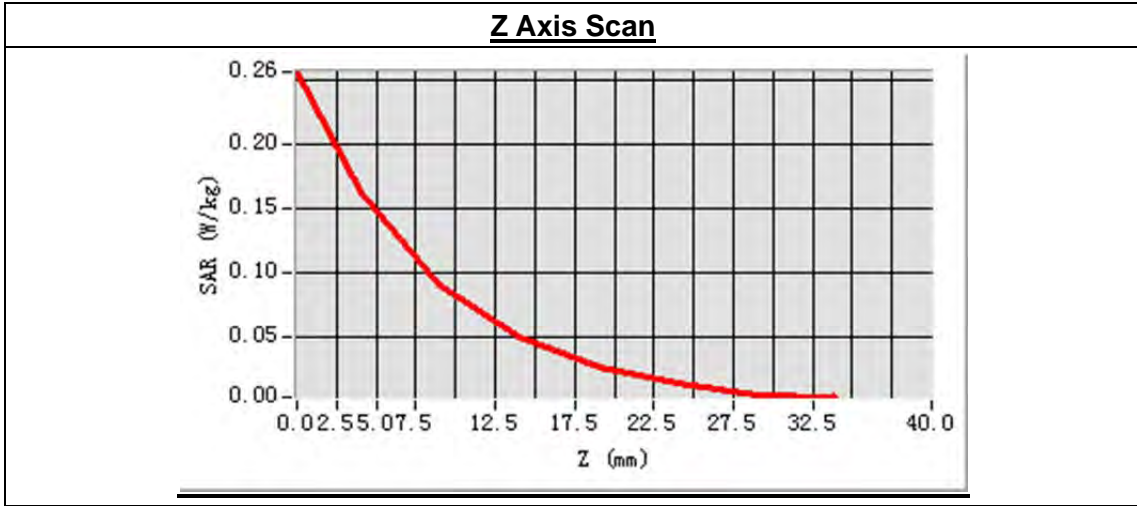

3D scen shot	Hot spot position

MEASUREMENT 3

Type: Phone measurement (Complete)

Date of measurement: 2/4/2014

Measurement duration: 14 minutes 35 seconds

Experimental conditions.

Area Scan	surf_sam_plan.txt
ZoomScan	5x5x7,dx=8mm dy=8mm dz=5mm,Complete
Phantom	Body plane
Device Position	Body
Band	IEEE 802.11b ISM
Channels	Low
Signal	DSSS
Frequency (MHz)	2412.000000
Relative permittivity (real part)	52.750668
Relative permittivity	14.275111
Conductivity (S/m)	1.912865
Power drift (%)	-3.830000
Ambient Temperature:	22.6°C
Liquid Temperature:	21.2°C
ConvF:	4.51
Crest factor:	1:1

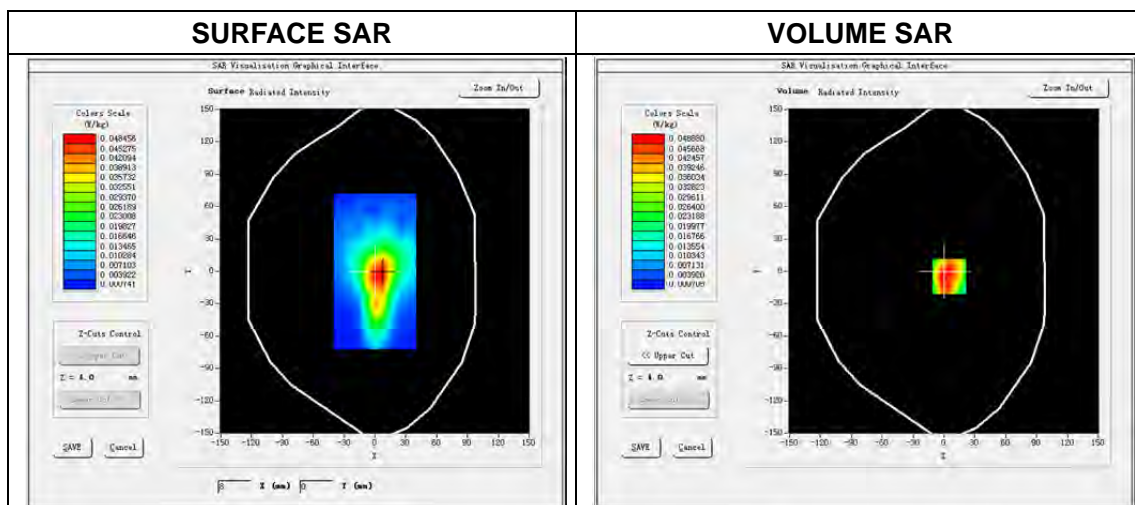

Maximum location: X=5.00, Y=-5.00
 SAR Peak: 0.09 W/kg

SAR 10g (W/Kg)	0.023049
SAR 1g (W/Kg)	0.047593

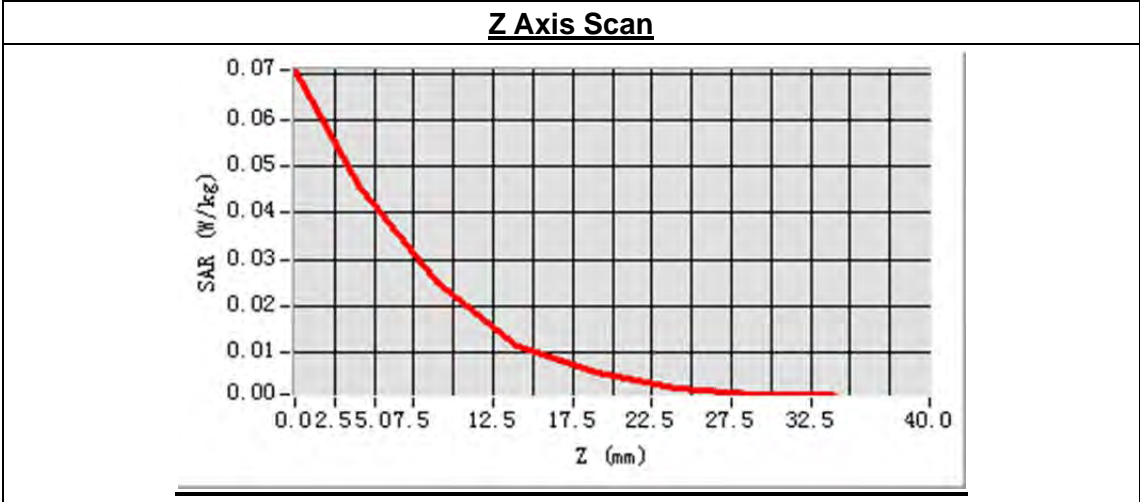

3D scene shot	Hot spot position

MEASUREMENT 4

Type: Phone measurement (Complete)

Date of measurement: 2/4/2014

Measurement duration: 9 minutes 11 seconds

Experimental conditions.

Area Scan	surf_sam_plan.txt
ZoomScan	5x5x7,dx=8mm dy=8mm dz=5mm,Complete
Phantom	Body plane
Device Position	Body
Band	IEEE 802.11b ISM
Channels	Low
Signal	DSSS
Frequency (MHz)	2412.000000
Relative permittivity (real part)	52.750668
Relative permittivity	14.275111
Conductivity (S/m)	1.912865
Power drift (%)	-2.309999
Ambient Temperature:	22.6°C
Liquid Temperature:	21.2°C
ConvF:	4.51
Crest factor:	1:1

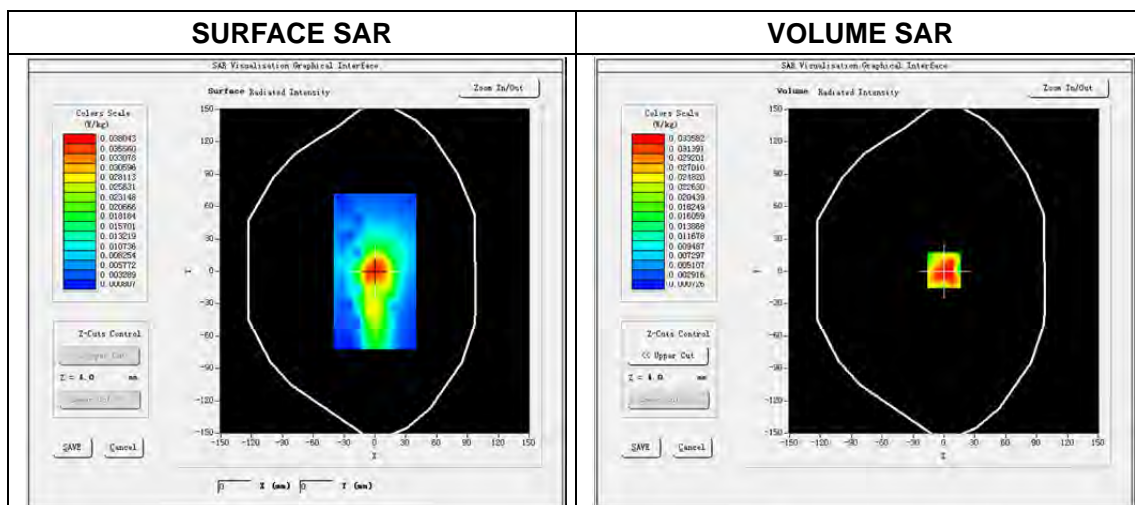

Maximum location: X=0.00, Y=1.00
 SAR Peak: 0.07 W/kg

SAR 10g (W/Kg)	0.016483
SAR 1g (W/Kg)	0.034124

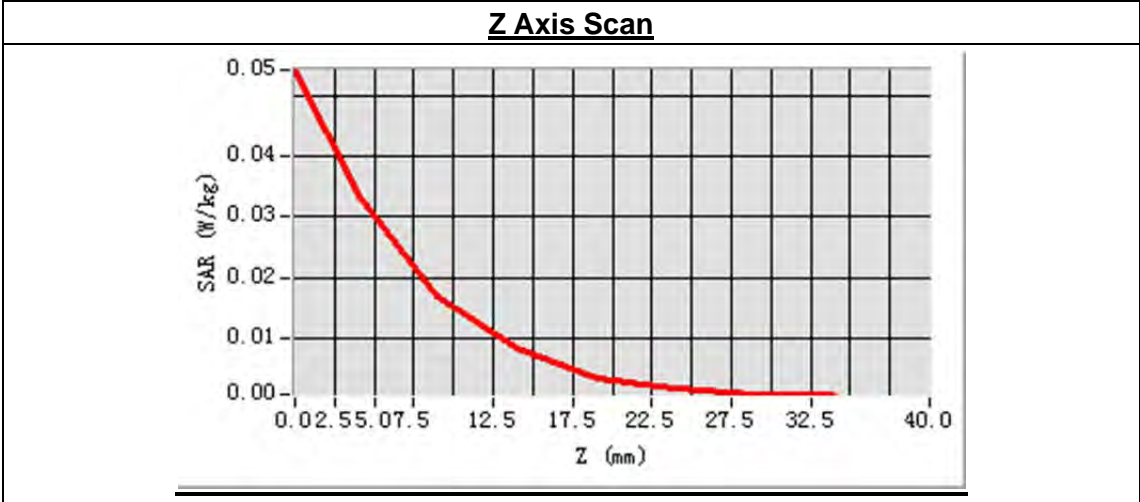

3D scene shot	Hot spot position

MEASUREMENT 5

Type: Phone measurement (Complete)

Date of measurement: 2/4/2014

Measurement duration: 15 minutes 1 seconds

Experimental conditions.

Area Scan	surf_sam_plan.txt
ZoomScan	5x5x7,dx=8mm dy=8mm dz=5mm,Complete
Phantom	Body plane
Device Position	Body
Band	IEEE 802.11b ISM
Channels	Low
Signal	DSSS
Frequency (MHz)	2412.000000
Relative permittivity (real part)	52.750668
Relative permittivity	14.275111
Conductivity (S/m)	1.912865
Power drift (%)	1.200000
Ambient Temperature:	22.6°C
Liquid Temperature:	21.2°C
ConvF:	4.51
Crest factor:	1:1

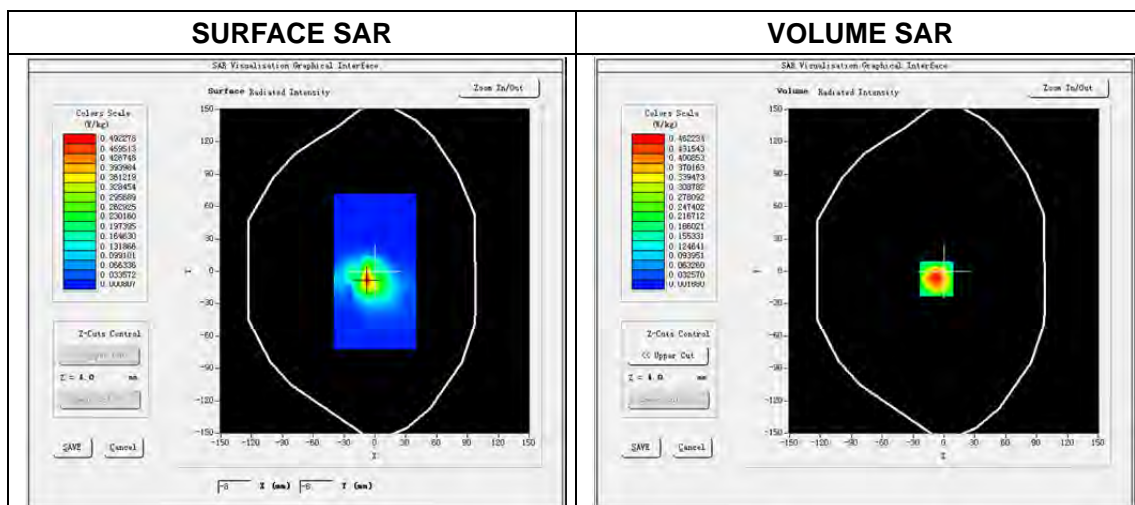

Maximum location: X=-7.00, Y=-7.00
 SAR Peak: 1.09 W/kg

SAR 10g (W/Kg)	0.201622
SAR 1g (W/Kg)	0.483829

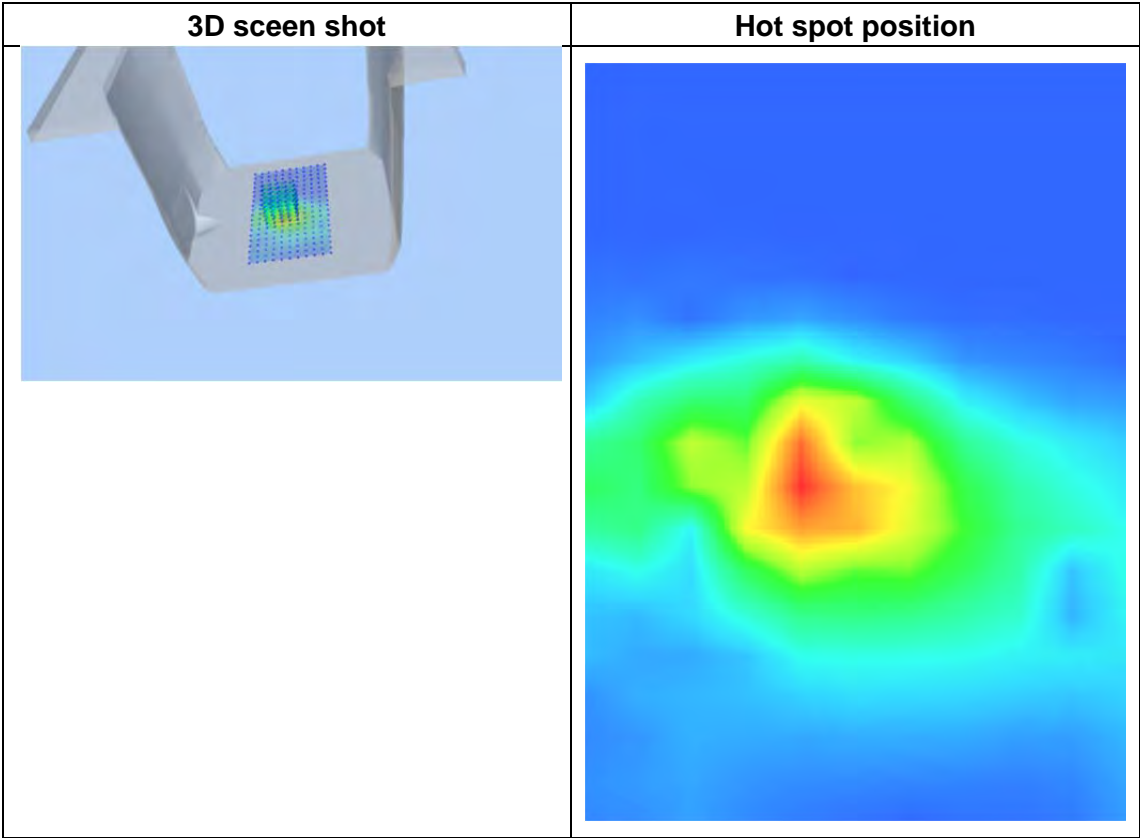
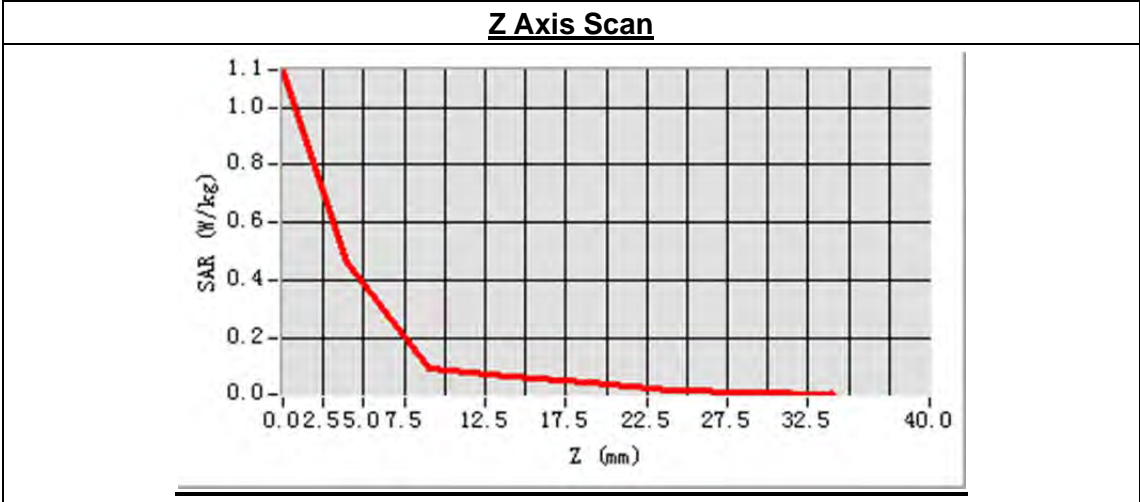

MEASUREMENT 6

Type: Phone measurement (Complete)

Date of measurement: 2/4/2014

Measurement duration: 14 minutes 29 seconds

Experimental conditions.

Area Scan	surf_sam_plan.txt
ZoomScan	5x5x7,dx=8mm dy=8mm dz=5mm,Complete
Phantom	Body plane
Device Position	Body
Band	IEEE 802.11b ISM
Channels	Middle
Signal	DSSS
Frequency (MHz)	2437.000000
Relative permittivity (real part)	52.717335
Relative permittivity	14.311222
Conductivity (S/m)	1.937580
Power drift (%)	0.810000
Ambient Temperature:	22.6°C
Liquid Temperature:	21.2°C
ConvF:	4.51
Crest factor:	1:1

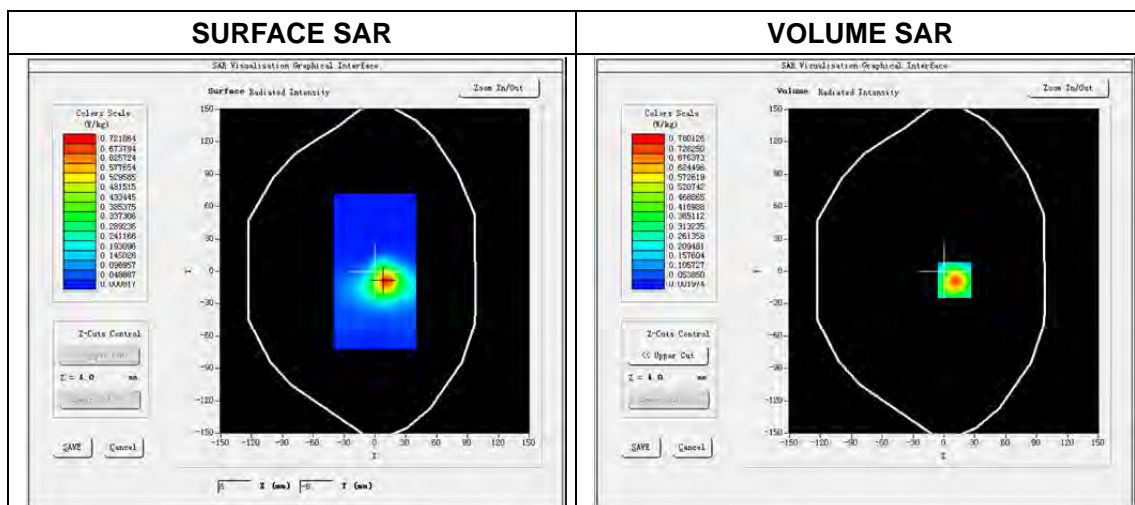

Maximum location: X=10.00, Y=-8.00
 SAR Peak: 1.41 W/kg

SAR 10g (W/Kg)	0.316358
SAR 1g (W/Kg)	0.725095

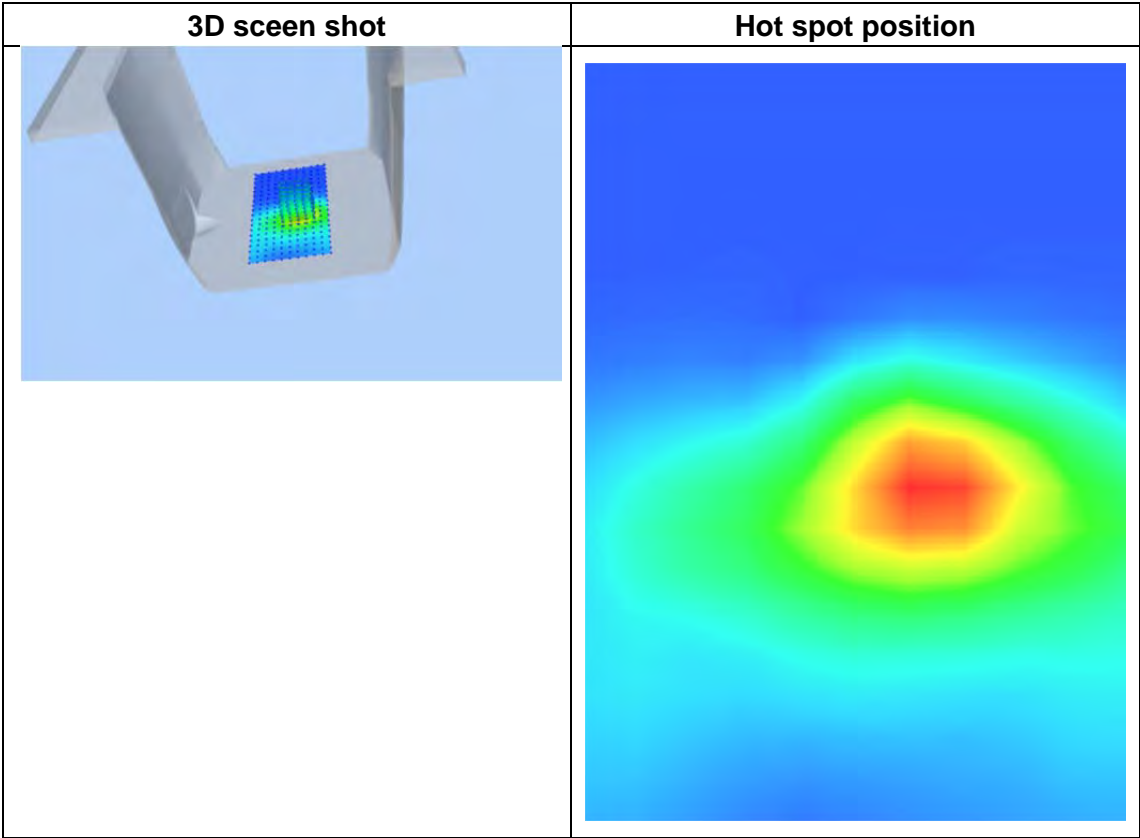
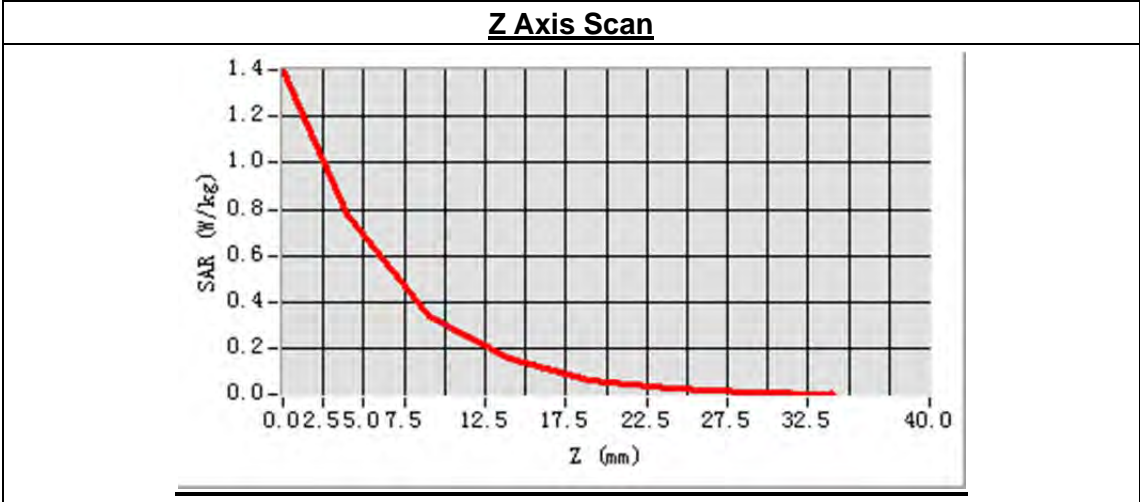

MEASUREMENT 7

Type: Phone measurement (Complete)

Date of measurement: 2/4/2014

Measurement duration: 14 minutes 14 seconds

Experimental conditions.

Area Scan	surf_sam_plan.txt
ZoomScan	5x5x7,dx=8mm dy=8mm dz=5mm,Complete
Phantom	Body plane
Device Position	Body
Band	IEEE 802.11b ISM
Channels	Middle
Signal	DSSS
Frequency (MHz)	2437.000000
Relative permittivity (real part)	52.717335
Relative permittivity	14.311222
Conductivity (S/m)	1.937580
Power drift (%)	2.120000
Ambient Temperature:	22.6°C
Liquid Temperature:	21.2°C
ConvF:	4.51
Crest factor:	1:1

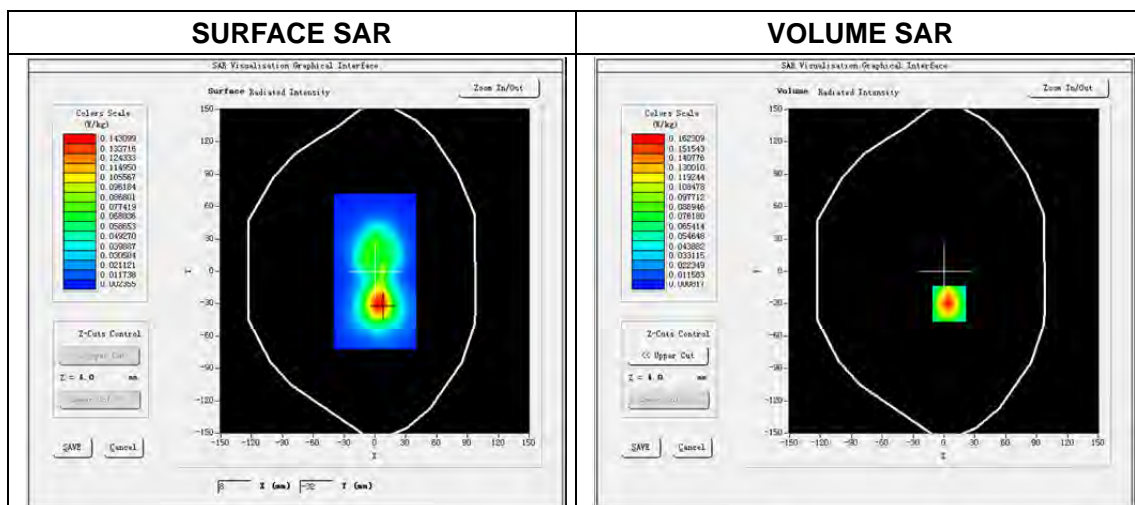

Maximum location: X=5.00, Y=-30.00
 SAR Peak: 0.28 W/kg

SAR 10g (W/Kg)	0.072954
SAR 1g (W/Kg)	0.153595

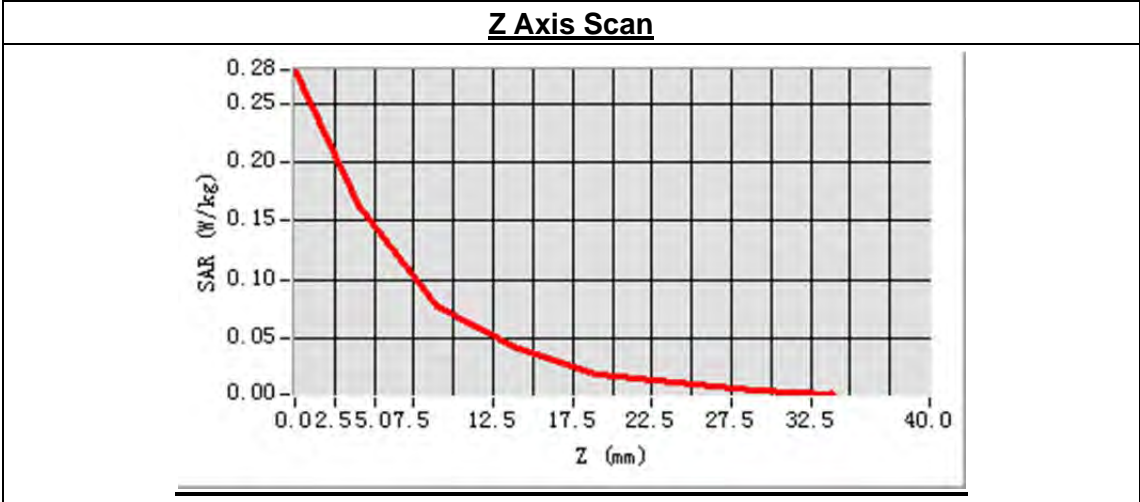

3D scen shot	Hot spot position

MEASUREMENT 8

Type: Phone measurement (Complete)

Date of measurement: 2/4/2014

Measurement duration: 14 minutes 7 seconds

Experimental conditions.

Area Scan	surf_sam_plan.txt
ZoomScan	5x5x7,dx=8mm dy=8mm dz=5mm,Complete
Phantom	Body plane
Device Position	Body
Band	IEEE 802.11b ISM
Channels	Middle
Signal	DSSS
Frequency (MHz)	2437.000000
Relative permittivity (real part)	52.717335
Relative permittivity	14.311222
Conductivity (S/m)	1.937580
Power drift (%)	-0.190000
Ambient Temperature:	22.6°C
Liquid Temperature:	21.2°C
ConvF:	4.51
Crest factor:	1:1

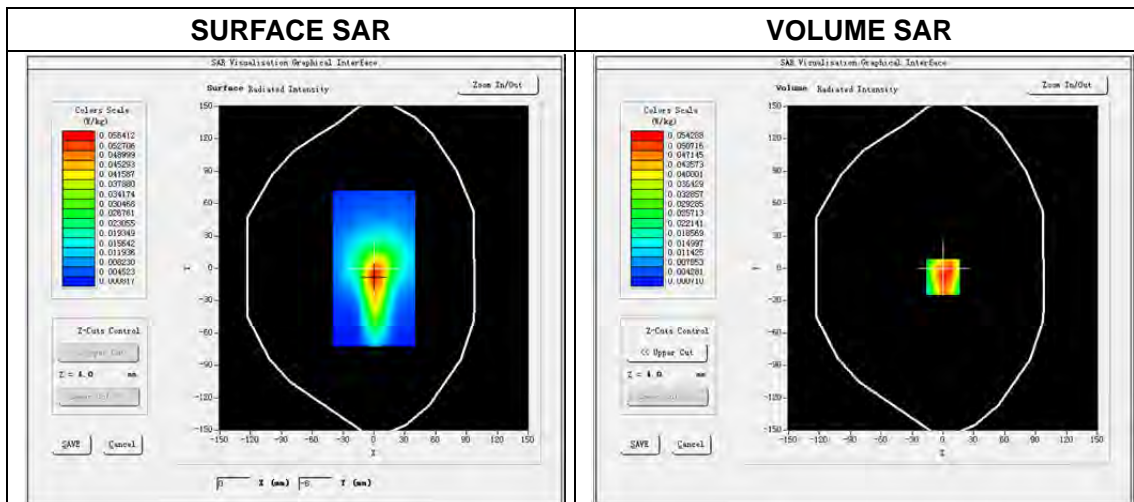

Maximum location: X=0.00, Y=-8.00
 SAR Peak: 0.09 W/kg

SAR 10g (W/Kg)	0.025972
SAR 1g (W/Kg)	0.051883

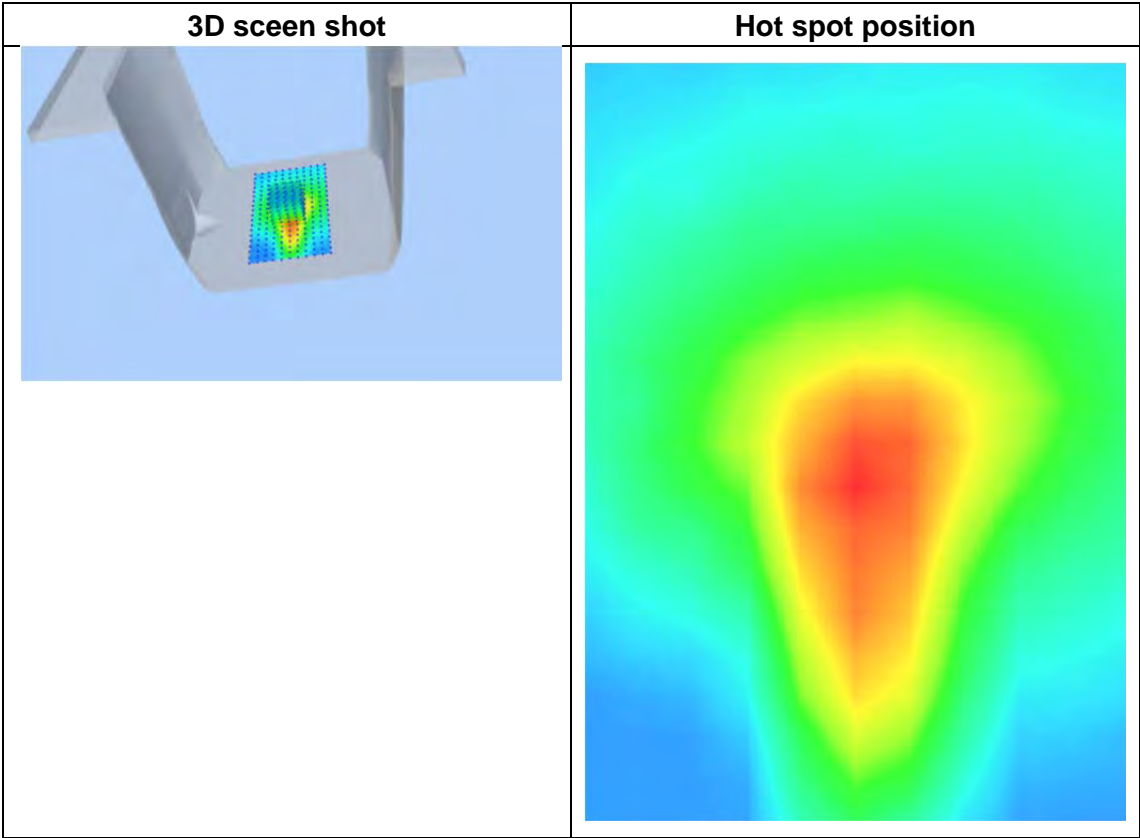
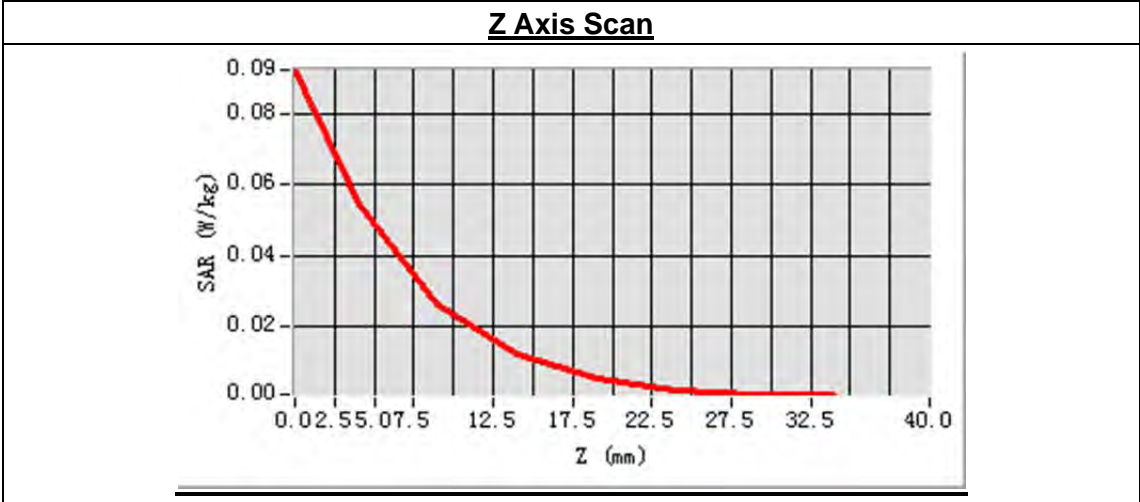

MEASUREMENT 9

Type: Phone measurement (Complete)

Date of measurement: 2/4/2014

Measurement duration: 10 minutes 41 seconds

Experimental conditions.

Area Scan	<u>surf_sam_plan.txt</u>
ZoomScan	<u>5x5x7,dx=8mm dy=8mm</u> <u>dz=5mm,Complete</u>
Phantom	Body plane
Device Position	Body
Band	IEEE 802.11b ISM
Channels	Middle
Signal	DSSS
Frequency (MHz)	2437.000000
Relative permittivity (real part)	52.717335
Relative permittivity	14.311222
Conductivity (S/m)	1.937580
Power drift (%)	1.600000
Ambient Temperature:	22.6°C
Liquid Temperature:	21.2°C
ConvF:	4.51
Crest factor:	1:1

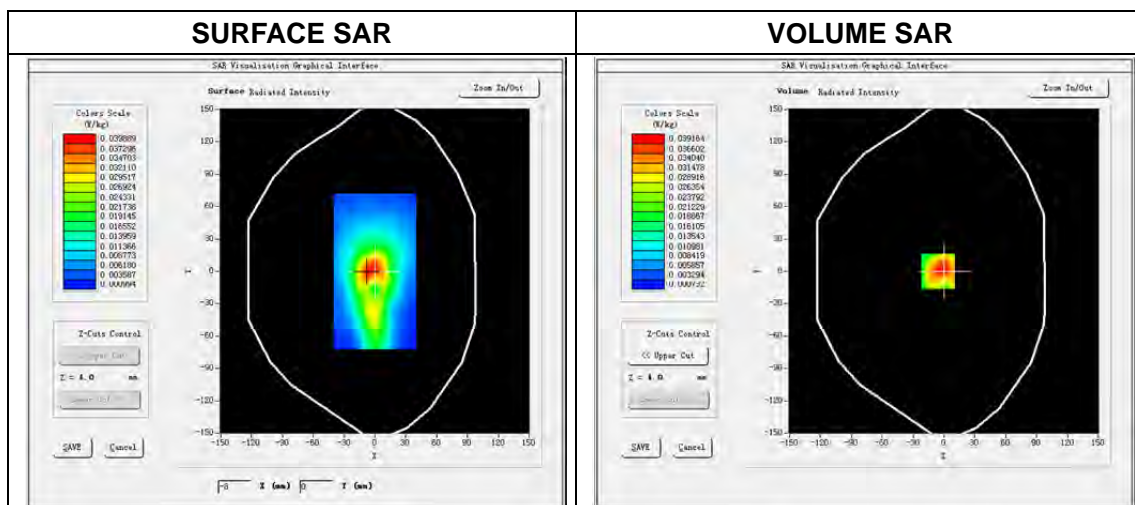

Maximum location: X=-6.00, Y=0.00
 SAR Peak: 0.07 W/kg

SAR 10g (W/Kg)	0.018617
SAR 1g (W/Kg)	0.038242

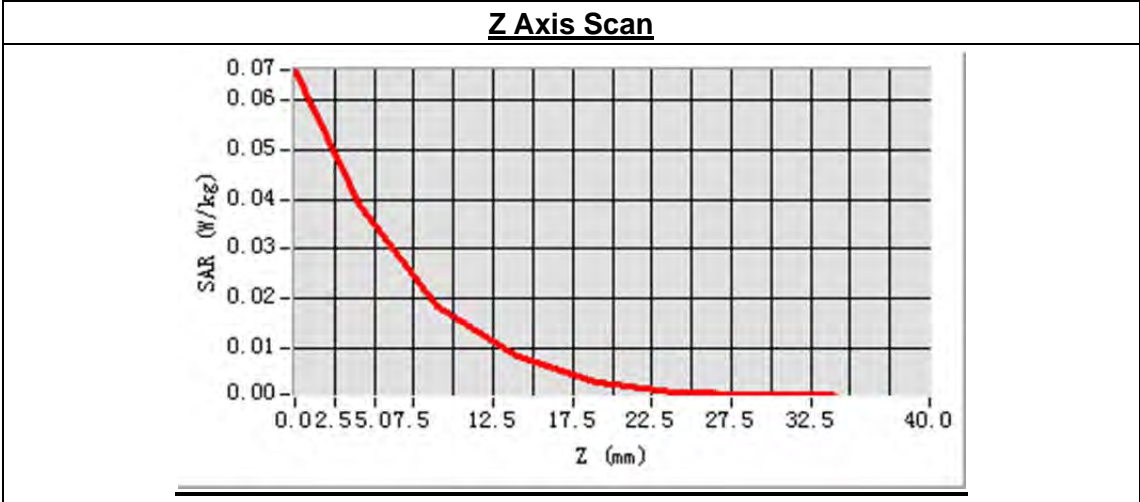

3D scene shot	Hot spot position

MEASUREMENT 10

Type: Phone measurement (Complete)

Date of measurement: 2/4/2014

Measurement duration: 12 minutes 42 seconds

Experimental conditions.

Area Scan	surf_sam_plan.txt
ZoomScan	5x5x7,dx=8mm dy=8mm dz=5mm,Complete
Phantom	Body plane
Device Position	Body
Band	IEEE 802.11b ISM
Channels	Middle
Signal	DSSS
Frequency (MHz)	2437.000000
Relative permittivity (real part)	52.717335
Relative permittivity	14.311222
Conductivity (S/m)	1.937580
Power drift (%)	-0.030000
Ambient Temperature:	22.6°C
Liquid Temperature:	21.2°C
ConvF:	4.51
Crest factor:	1:1

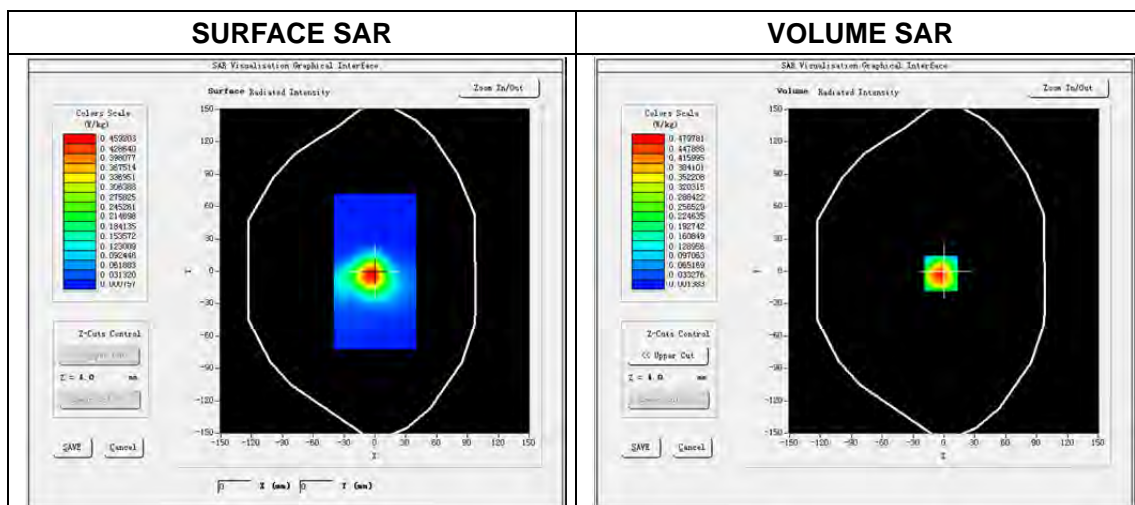

Maximum location: X=-3.00, Y=-2.00
 SAR Peak: 0.87 W/kg

SAR 10g (W/Kg)	0.212011
SAR 1g (W/Kg)	0.464991

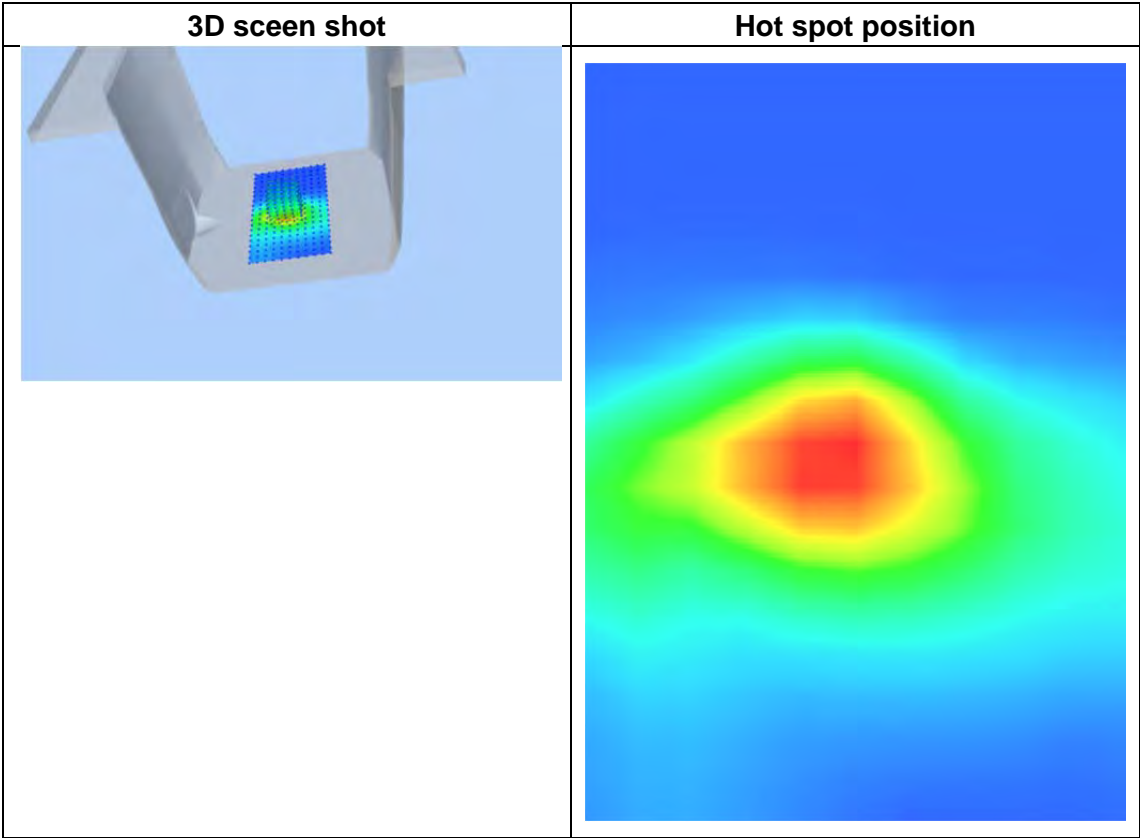
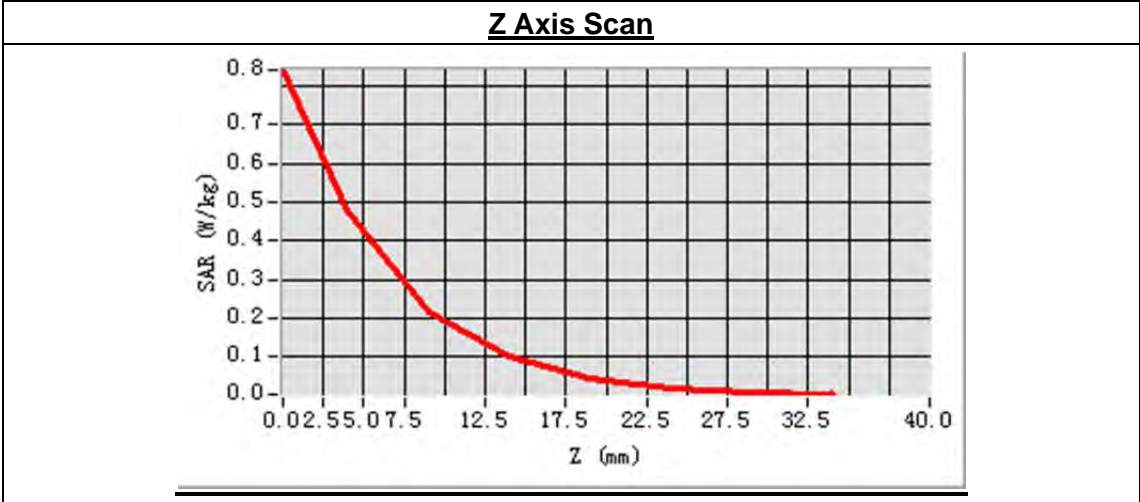

MEASUREMENT 11

Type: Phone measurement (Complete)

Date of measurement: 2/4/2014

Measurement duration: 14 minutes 16 seconds

Experimental conditions.

Area Scan	surf_sam_plan.txt
ZoomScan	5x5x7,dx=8mm dy=8mm dz=5mm,Complete
Phantom	Body plane
Device Position	Body
Band	IEEE 802.11b ISM
Channels	High
Signal	DSSS
Frequency (MHz)	2462.000000
Relative permittivity (real part)	52.684727
Relative permittivity	14.374727
Conductivity (S/m)	1.966143
Power drift (%)	1.190000
Ambient Temperature:	22.6°C
Liquid Temperature:	21.2°C
ConvF:	4.51
Crest factor:	1:1

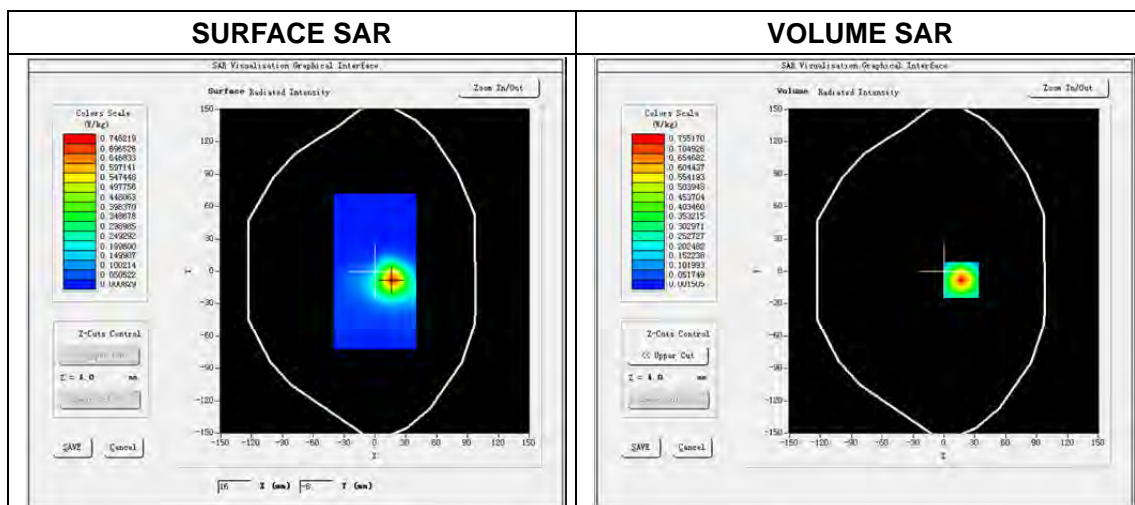

Maximum location: X=17.00, Y=-8.00

SAR Peak: 1.34 W/kg

SAR 10g (W/Kg)	0.303552
SAR 1g (W/Kg)	0.694234

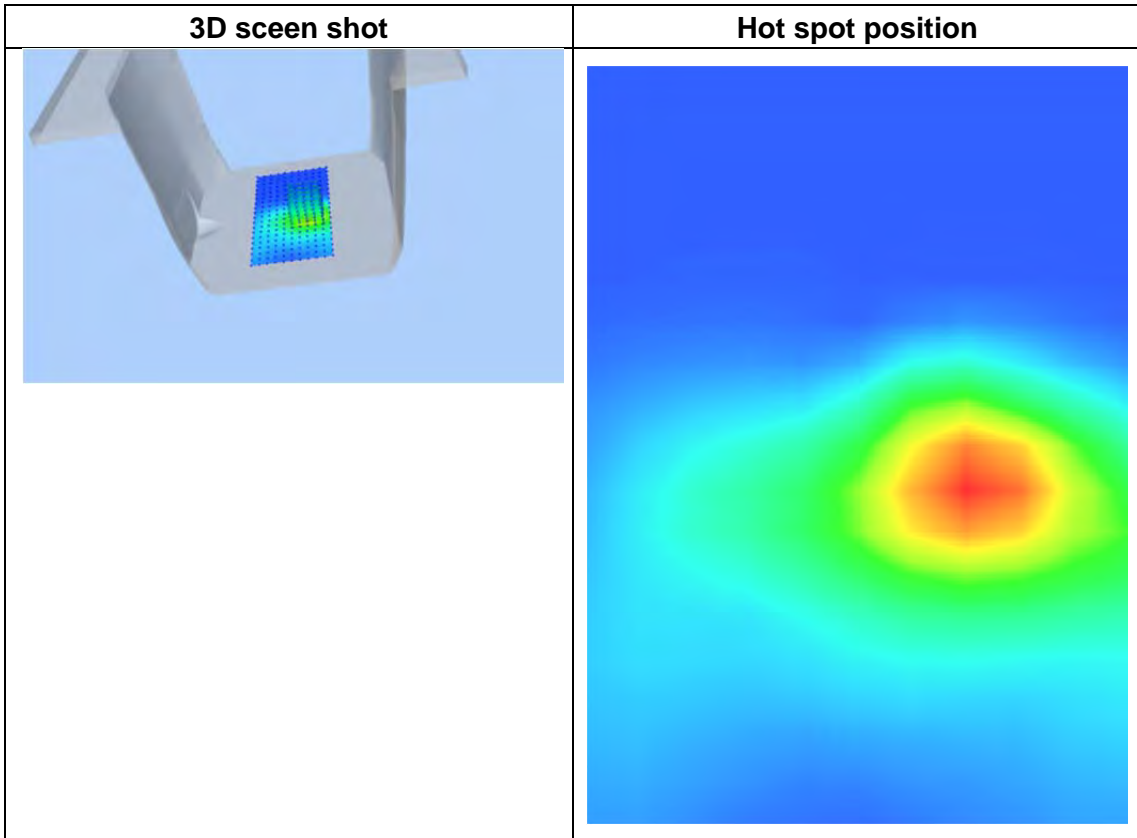
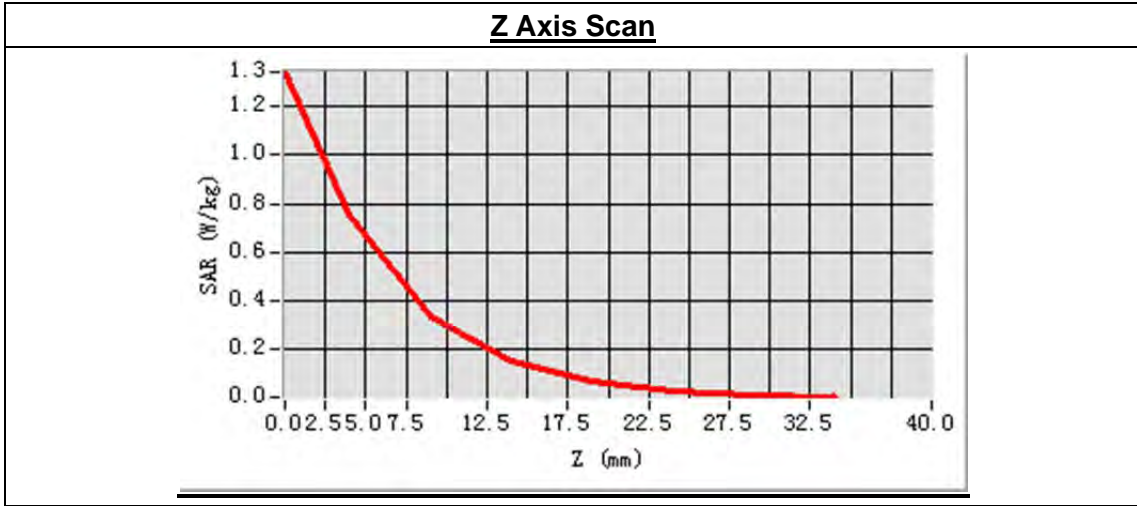

MEASUREMENT 12

Type: Phone measurement (Complete)

Date of measurement: 2/4/2014

Measurement duration: 14 minutes 43 seconds

Experimental conditions.

Area Scan	surf_sam_plan.txt
ZoomScan	5x5x7,dx=8mm dy=8mm dz=5mm,Complete
Phantom	Body plane
Device Position	Body
Band	IEEE 802.11b ISM
Channels	High
Signal	DSSS
Frequency (MHz)	2462.000000
Relative permittivity (real part)	52.684727
Relative permittivity	14.374727
Conductivity (S/m)	1.966143
Power drift (%)	0.330000
Ambient Temperature:	22.6°C
Liquid Temperature:	21.2°C
ConvF:	4.51
Crest factor:	1:1

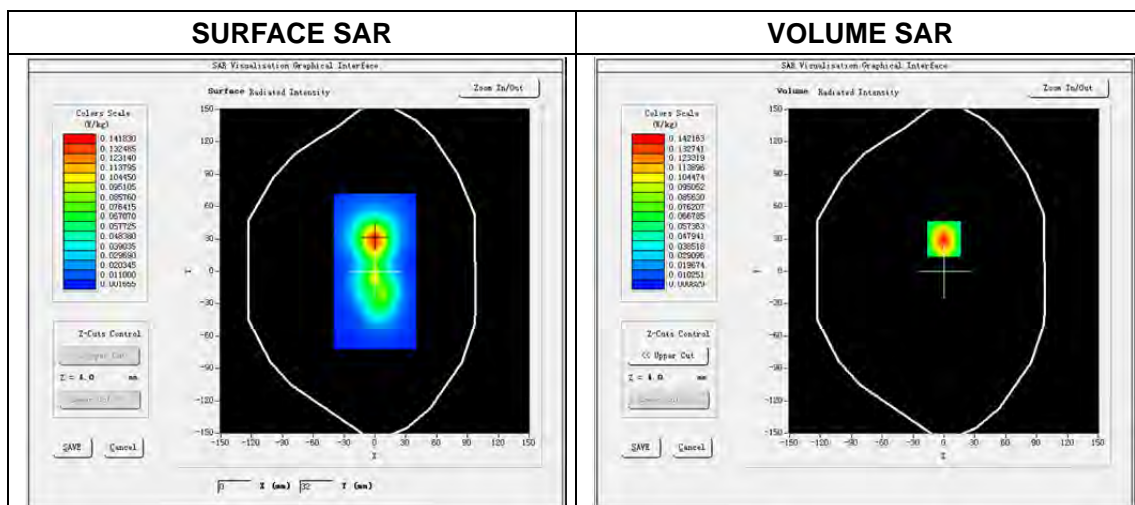

Maximum location: X=0.00, Y=30.00

SAR Peak: 0.22 W/kg

SAR 10g (W/Kg)	0.066530
SAR 1g (W/Kg)	0.132516

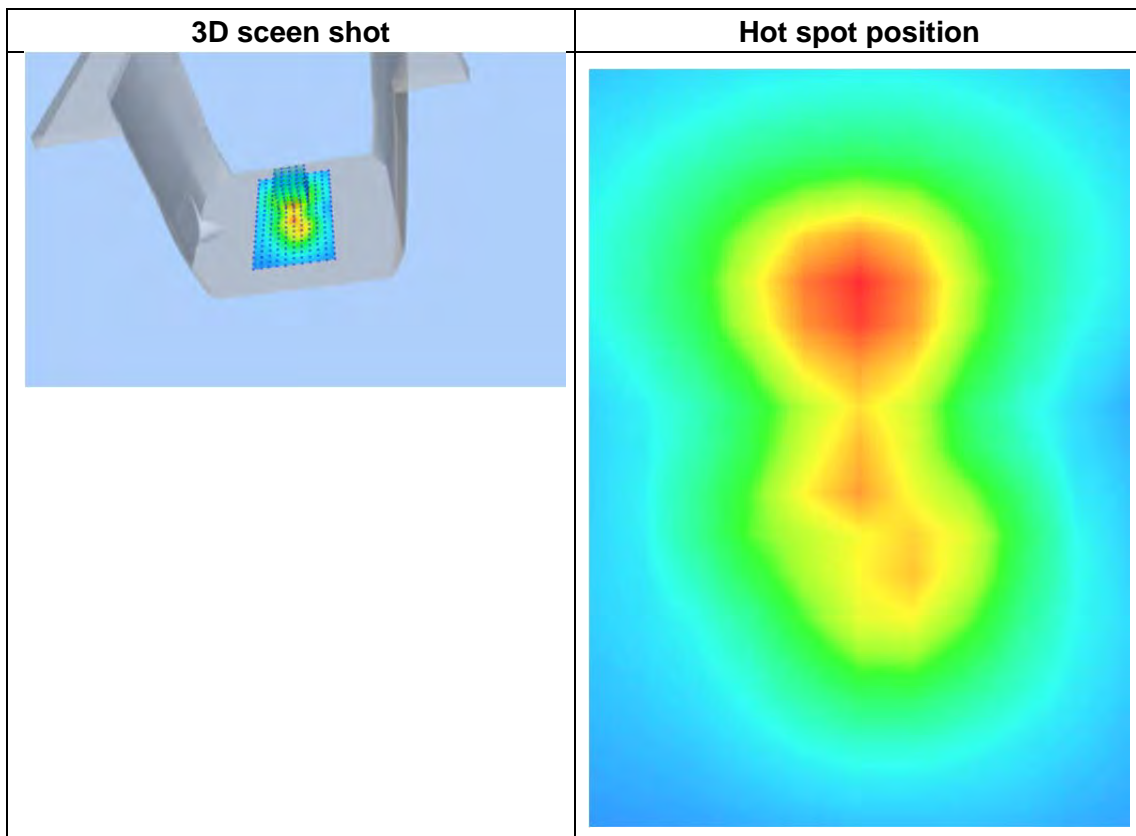

MEASUREMENT 13

Type: Phone measurement (Complete)

Date of measurement: 2/4/2014

Measurement duration: 14 minutes 50 seconds

Experimental conditions.

Area Scan	surf_sam_plan.txt
ZoomScan	5x5x7,dx=8mm dy=8mm dz=5mm,Complete
Phantom	Body plane
Device Position	Body
Band	IEEE 802.11b ISM
Channels	High
Signal	DSSS
Frequency (MHz)	2462.000000
Relative permittivity (real part)	52.684727
Relative permittivity	14.374727
Conductivity (S/m)	1.966143
Power drift (%)	0.030000
Ambient Temperature:	22.6°C
Liquid Temperature:	21.2°C
ConvF:	4.51
Crest factor:	1:1

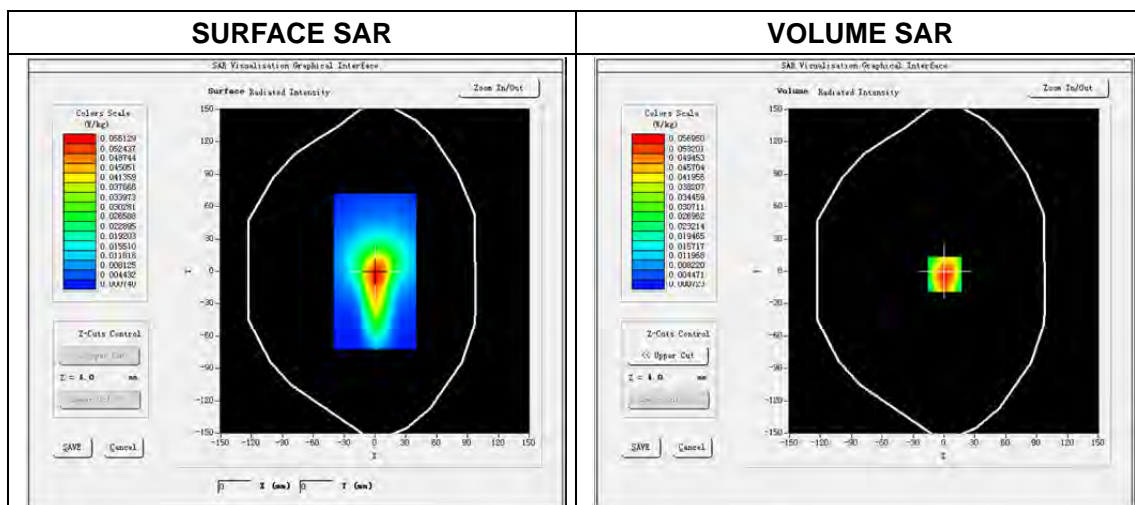

Maximum location: X=1.00, Y=-3.00

SAR Peak: 0.10 W/kg

SAR 10g (W/Kg)	0.027291
SAR 1g (W/Kg)	0.054718

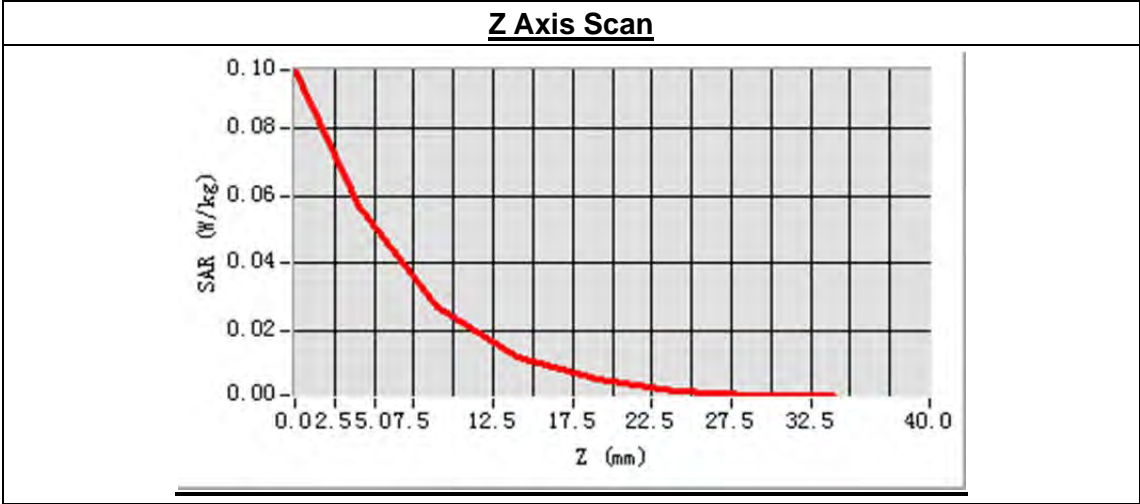

3D scene shot	Hot spot position

MEASUREMENT 14

Type: Phone measurement (Complete)

Date of measurement: 2/4/2014

Measurement duration: 14 minutes 20 seconds

Experimental conditions.

Area Scan	surf_sam_plan.txt
ZoomScan	5x5x7,dx=8mm dy=8mm dz=5mm,Complete
Phantom	Body plane
Device Position	Body
Band	IEEE 802.11b ISM
Channels	High
Signal	DSSS
Frequency (MHz)	2462.000000
Relative permittivity (real part)	52.684727
Relative permittivity	14.374727
Conductivity (S/m)	1.966143
Power drift (%)	-1.220000
Ambient Temperature:	22.6°C
Liquid Temperature:	21.2°C
ConvF:	4.51
Crest factor:	1:1

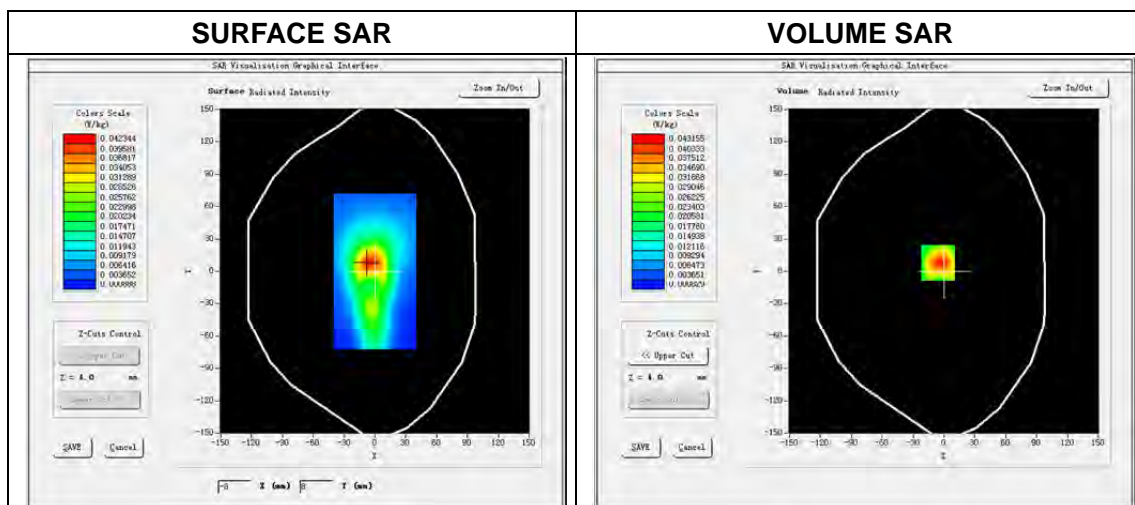

Maximum location: X=-6.00, Y=8.00
 SAR Peak: 0.08 W/kg

SAR 10g (W/Kg)	0.019872
SAR 1g (W/Kg)	0.041152

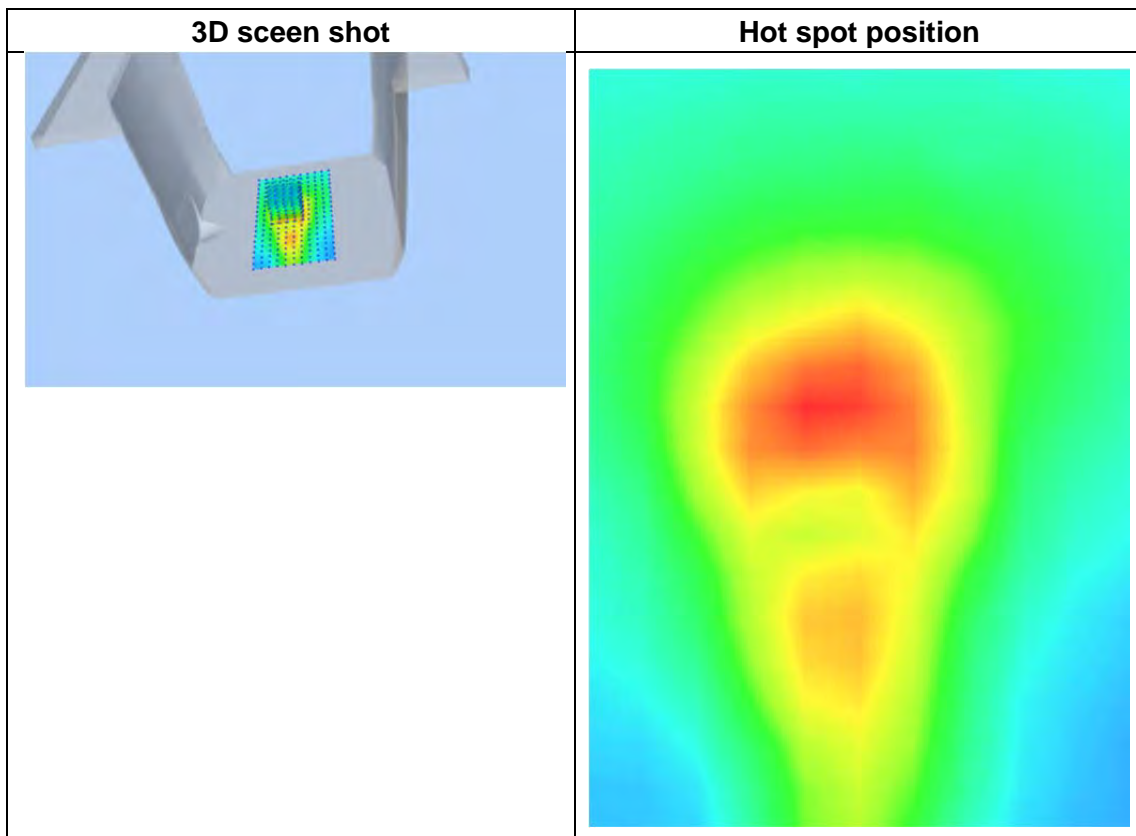
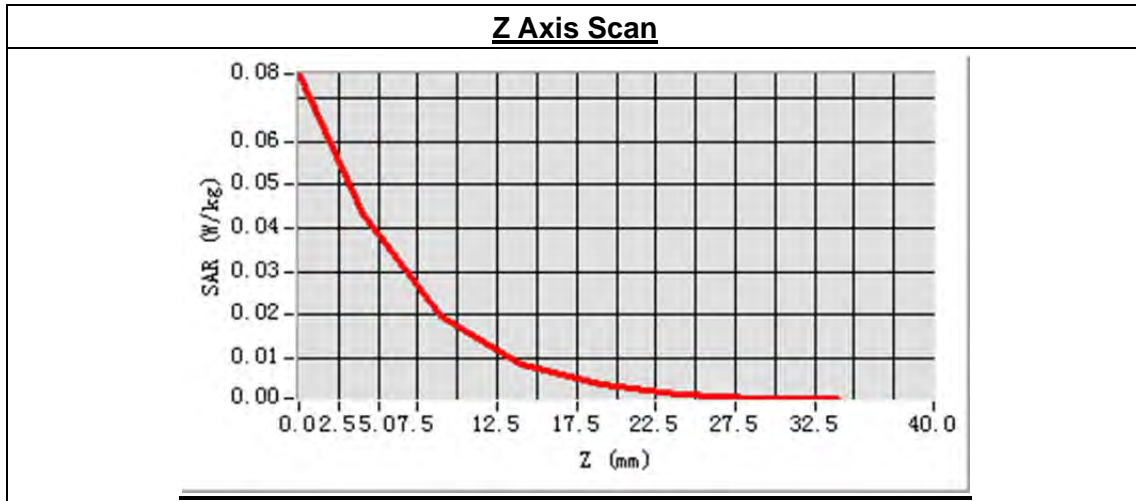

MEASUREMENT 15

Type: Phone measurement (Complete)

Date of measurement: 2/4/2014

Measurement duration: 13 minutes 48 seconds

Experimental conditions.

Area Scan	surf_sam_plan.txt
ZoomScan	5x5x7,dx=8mm dy=8mm dz=5mm,Complete
Phantom	Body plane
Device Position	Body
Band	IEEE 802.11b ISM
Channels	High
Signal	DSSS
Frequency (MHz)	2462.000000
Relative permittivity (real part)	52.684727
Relative permittivity	14.374727
Conductivity (S/m)	1.966143
Power drift (%)	2.360000
Ambient Temperature:	22.6°C
Liquid Temperature:	21.2°C
ConvF:	4.51
Crest factor:	1:1

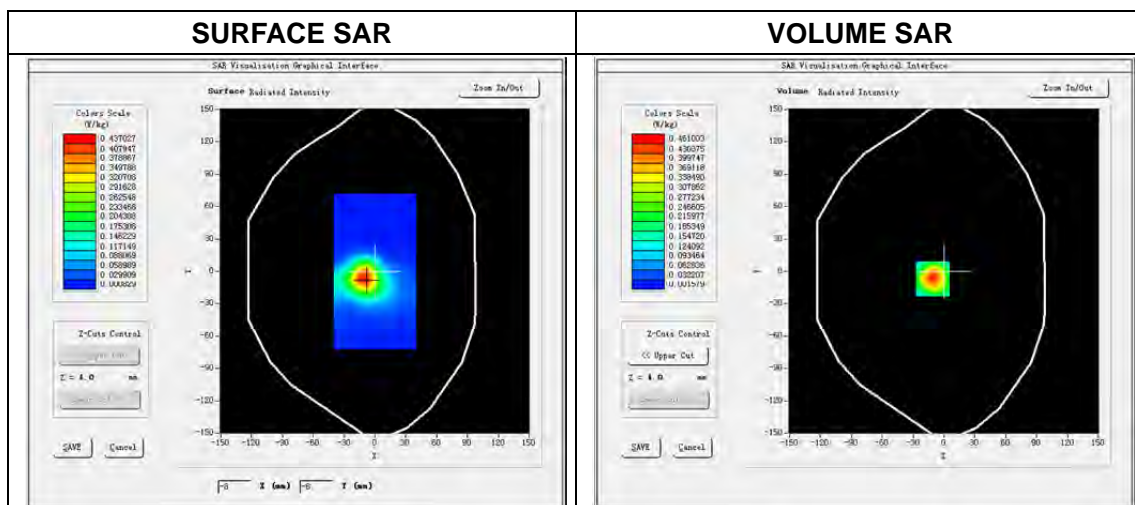

Maximum location: X=-11.00, Y=-7.00

SAR Peak: 0.83 W/kg

SAR 10g (W/Kg)	0.199365
SAR 1g (W/Kg)	0.440790

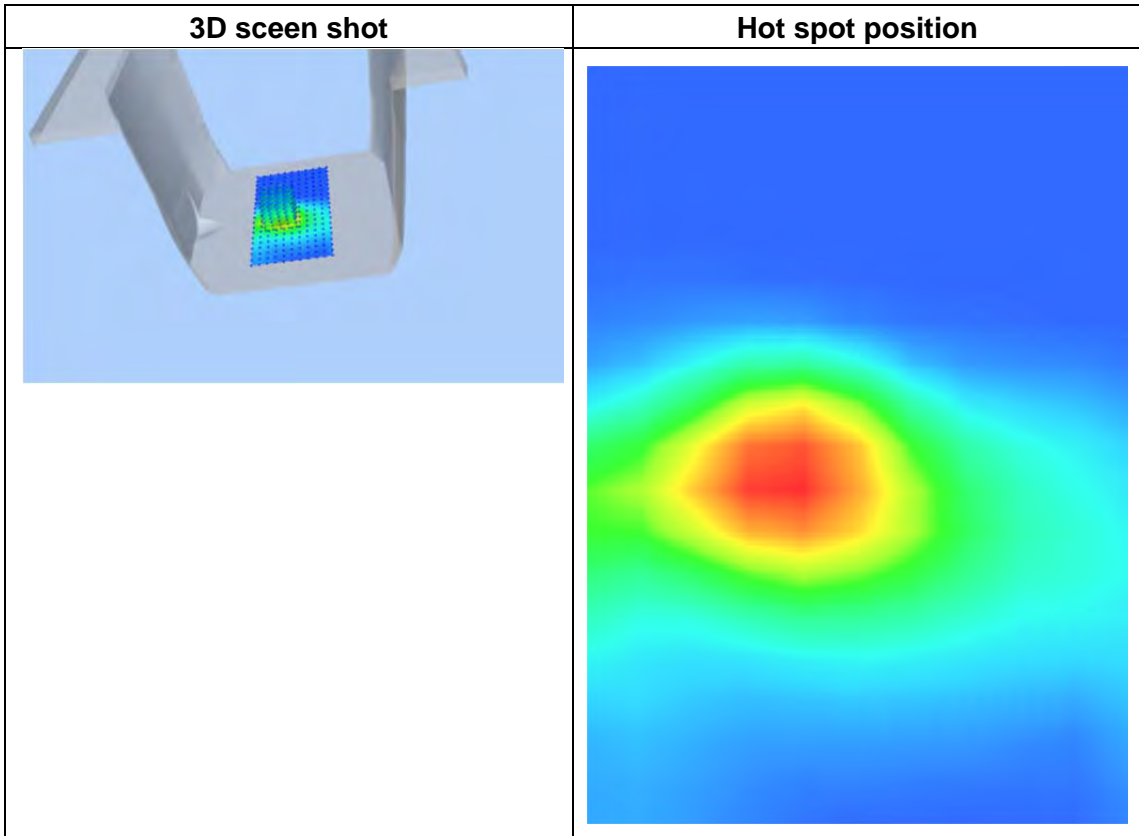
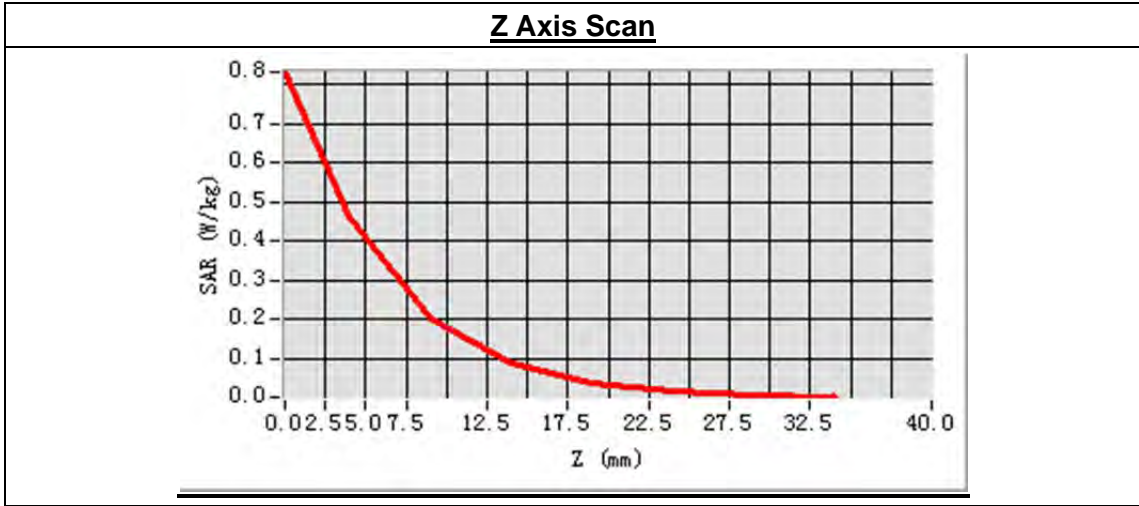

ANNEX D CALIBRATION FOR PROBE AND DIPOLE

**受控文件**

COMOSAR E-Field Probe Calibration Report

Ref: ACR.219.1.13.SATU.A

**SHENZHEN BALUN TECHNOLOGY CO., LTD.
BLOCK B, FL 1, BAISHA SCIENCE AND TECHNOLOGY
PARK, SHAHE XI ROAD, NANSHAN DISTRICT,
SHENZHEN, GUANGDONG PROVINCE, 518055 P. R. CHINA
SATIMO COMOSAR DOSIMETRIC E-FIELD PROBE
SERIAL NO.: SN 17/13 EPG177**

**Calibrated at SATIMO US
2105 Barrett Park Dr. - Kennesaw, GA 30144**

**07/08/2013**

Summary:

This document presents the method and results from an accredited COMOSAR Dosimetric E-Field Probe calibration performed in SATIMO USA using the CALISAR / CALIBAIR test bench, for use with a SATIMO COMOSAR system only. All calibration results are traceable to national metrology institutions.



COMOSAR E-FIELD PROBE CALIBRATION REPORT

Ref: ACR.219.1.13.SATU.A

	<i>Name</i>	<i>Function</i>	<i>Date</i>	<i>Signature</i>
<i>Prepared by :</i>	Jérôme LUC	Product Manager	8/7/2013	<i>JL</i>
<i>Checked by :</i>	Jérôme LUC	Product Manager	8/7/2013	<i>JL</i>
<i>Approved by :</i>	Kim RUTKOWSKI	Quality Manager	8/7/2013	<i>Kim Rutkowski</i>

	<i>Customer Name</i>
<i>Distribution :</i>	Shenzhen Balun Technology Co.,Ltd.

<i>Issue</i>	<i>Date</i>	<i>Modifications</i>
A	8/7/2013	Initial release



**TABLE OF CONTENTS**

1	Device Under Test	4
2	Product Description	4
2.1	General Information	4
3	Measurement Method	4
3.1	Linearity	4
3.2	Sensitivity	5
3.3	Lower Detection Limit	5
3.4	Isotropy	5
3.5	Boundary Effect	5
4	Measurement Uncertainty	5
5	Calibration Measurement Results	6
5.1	Sensitivity in air	6
5.2	Linearity	7
5.3	Sensitivity in liquid	7
5.4	Isotropy	8
6	List of Equipment	10



1 DEVICE UNDER TEST

Device Under Test	
Device Type	COMOSAR DOSIMETRIC E FIELD PROBE
Manufacturer	Satimo
Model	SSE2
Serial Number	SN 17/13 EPG177
Product Condition (new / used)	New
Frequency Range of Probe	0.7 GHz-6GHz
Resistance of Three Dipoles at Connector	Dipole 1: R1=0.221 MΩ Dipole 2: R2=0.234 MΩ Dipole 3: R3=0.234 MΩ

A yearly calibration interval is recommended.

2 PRODUCT DESCRIPTION

2.1 GENERAL INFORMATION

Satimo's COMOSAR E field Probes are built in accordance to the IEEE 1528, OET 65 Bulletin C and CEI/IEC 62209 standards.



Figure 1 – Satimo COMOSAR Dosimetric E field Dipole

Probe Length	330 mm
Length of Individual Dipoles	2 mm
Maximum external diameter	8 mm
Probe Tip External Diameter	2.5 mm
Distance between dipoles / probe extremity	1 mm

3 MEASUREMENT METHOD

The IEEE 1528, OET 65 Bulletin C, CENELEC EN50361 and CEI/IEC 62209 standards provide recommended practices for the probe calibrations, including the performance characteristics of interest and methods by which to assess their affect. All calibrations / measurements performed meet the fore mentioned standards.

3.1 LINEARITY

The evaluation of the linearity was done in free space using the waveguide, performing a power sweep to cover the SAR range 0.01W/kg to 100W/kg.

3.2 SENSITIVITY

The sensitivity factors of the three dipoles were determined using a two step calibration method (air and tissue simulating liquid) using waveguides as outlined in the standards.

3.3 LOWER DETECTION LIMIT

The lower detection limit was assessed using the same measurement set up as used for the linearity measurement. The required lower detection limit is 10 mW/kg.

3.4 ISOTROPY

The axial isotropy was evaluated by exposing the probe to a reference wave from a standard dipole with the dipole mounted under the flat phantom in the test configuration suggested for system validations and checks. The probe was rotated along its main axis from 0 - 360 degrees in 15 degree steps. The hemispherical isotropy is determined by inserting the probe in a thin plastic box filled with tissue-equivalent liquid, with the plastic box illuminated with the fields from a half wave dipole. The dipole is rotated about its axis (0°–180°) in 15° increments. At each step the probe is rotated about its axis (0°–360°).

3.5 BOUNDARY EFFECT

The boundary effect is defined as the deviation between the SAR measured data and the expected exponential decay in the liquid when the probe is oriented normal to the interface. To evaluate this effect, the liquid filled flat phantom is exposed to fields from either a reference dipole or waveguide. With the probe normal to the phantom surface, the peak spatial average SAR is measured and compared to the analytical value at the surface.

4 MEASUREMENT UNCERTAINTY

The guidelines outlined in the IEEE 1528, OET 65 Bulletin C, CENELEC EN50361 and CEI/IEC 62209 standards were followed to generate the measurement uncertainty associated with an E-field probe calibration using the waveguide technique. All uncertainties listed below represent an expanded uncertainty expressed at approximately the 95% confidence level using a coverage factor of $k=2$, traceable to the Internationally Accepted Guides to Measurement Uncertainty.

Uncertainty analysis of the probe calibration in waveguide					
ERROR SOURCES	Uncertainty value (%)	Probability Distribution	Divisor	ci	Standard Uncertainty (%)
Incident or forward power	3.00%	Rectangular	$\sqrt{3}$	1	1.732%
Reflected power	3.00%	Rectangular	$\sqrt{3}$	1	1.732%
Liquid conductivity	5.00%	Rectangular	$\sqrt{3}$	1	2.887%
Liquid permittivity	4.00%	Rectangular	$\sqrt{3}$	1	2.309%
Field homogeneity	3.00%	Rectangular	$\sqrt{3}$	1	1.732%
Field probe positioning	5.00%	Rectangular	$\sqrt{3}$	1	2.887%
Field probe linearity	3.00%	Rectangular	$\sqrt{3}$	1	1.732%

Page: 5/10

Combined standard uncertainty					5.831%
Expanded uncertainty 95 % confidence level k = 2					12.0%

5 CALIBRATION MEASUREMENT RESULTS

Calibration Parameters	
Liquid Temperature	21 °C
Lab Temperature	21 °C
Lab Humidity	45 %

5.1 SENSITIVITY IN AIR

Normx dipole 1 ($\mu\text{V}/(\text{V}/\text{m})^2$)	Normy dipole 2 ($\mu\text{V}/(\text{V}/\text{m})^2$)	Normz dipole 3 ($\mu\text{V}/(\text{V}/\text{m})^2$)
0.59	0.58	0.57

DCP dipole 1 (mV)	DCP dipole 2 (mV)	DCP dipole 3 (mV)
102	96	98

Calibration curves $e_i=f(V)$ ($i=1,2,3$) allow to obtain H-field value using the formula:

$$E = \sqrt{E_1^2 + E_2^2 + E_3^2}$$

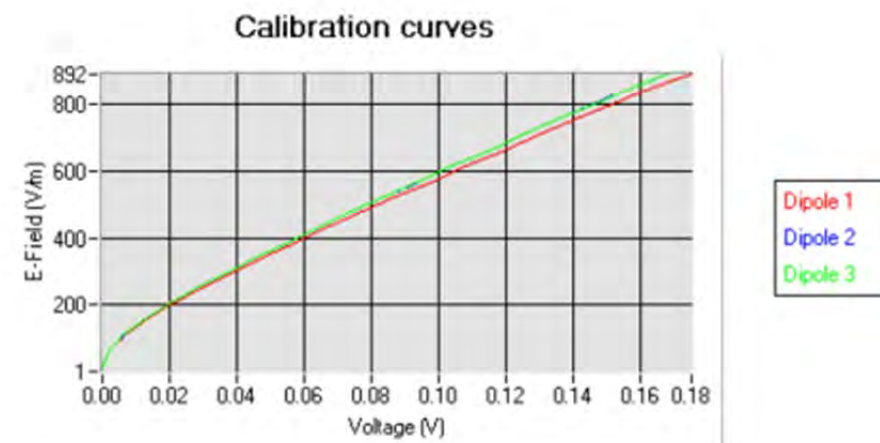

Page: 6/10

5.2 LINEARITY

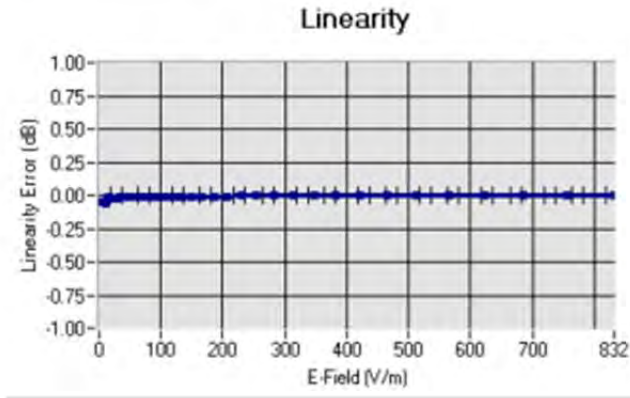

Linearity: $\pm 1.42\%$ ($\pm 0.06\text{dB}$)

5.3 SENSITIVITY IN LIQUID

Liquid	Frequency (MHz +/- 100MHz)	Permittivity	Epsilon (S/m)	ConvF
HI450	450	42.47	0.86	3.19
BL450	450	57.64	0.98	3.28
HL750	750	42.36	0.88	3.35
BL750	750	55.73	0.96	3.48
HL850	835	42.56	0.88	3.48
BL850	835	55.26	0.96	3.61
HL900	900	41.79	0.96	3.37
BL900	900	55.98	1.04	3.48
HL1800	1800	40.17	1.38	3.73
BL1800	1800	52.05	1.48	3.84
HL1900	1900	39.80	1.43	4.32
BL1900	1900	52.55	1.50	4.49
HL2000	2000	38.93	1.44	4.12
BL2000	2000	53.12	1.51	4.26
HL2450	2450	38.64	1.82	4.41
BL2450	2450	52.02	1.94	4.51
HL2600	2600	38.31	1.95	4.74
BL2600	2600	51.97	2.17	4.89
HL5200	5200	36.11	4.81	4.95
BL5200	5200	49.87	4.99	5.08
HL5400	5400	36.61	5.08	5.45
BL5400	5400	49.09	5.64	5.59
HL5600	5600	35.97	5.37	5.55
BL5600	5600	48.64	5.99	5.71
HL5800	5800	35.33	5.59	5.58
BL5800	5800	47.76	6.21	5.80

LOWER DETECTION LIMIT: 9mW/kg

Page: 7/10



This document shall not be reproduced, except in full or in part, without the written approval of SATIMO. The information contained herein is to be used only for the purpose for which it is submitted and is not to be released in whole or part without written approval of SATIMO.





5.4 ISOTROPY

HL900 MHz

- Axial isotropy: 0.04 dB
- Hemispherical isotropy: 0.05 dB

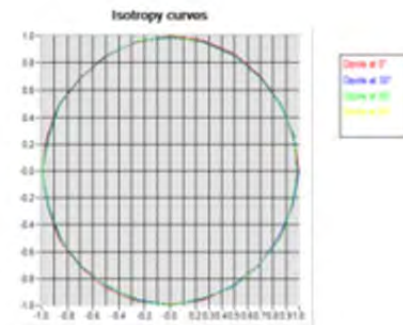

HL1800 MHz

- Axial isotropy: 0.05 dB
- Hemispherical isotropy: 0.08 dB

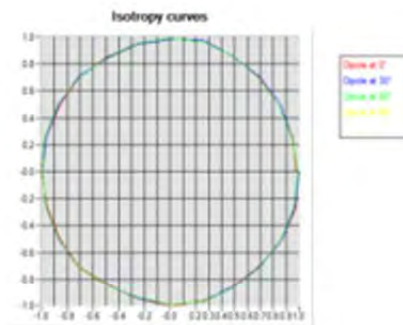



HL2450 MHz

- Axial isotropy: 0.06 dB
- Hemispherical isotropy: 0.08 dB

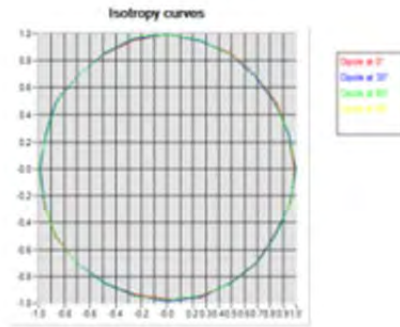

HL5800 MHz

- Axial isotropy: 0.09 dB
- Hemispherical isotropy: 0.11 dB

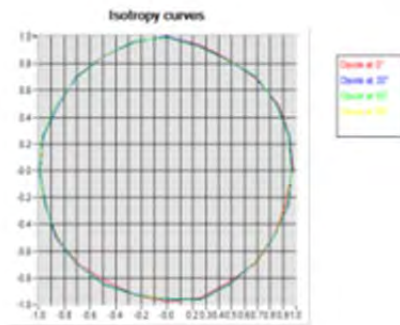

6 LIST OF EQUIPMENT

Equipment Summary Sheet				
Equipment Description	Manufacturer / Model	Identification No.	Current Calibration Date	Next Calibration Date
Flat Phantom	Satimo	SN-20/09-SAM71	Validated. No cal required.	Validated. No cal required.
COMOSAR Test Bench	Version 3	NA	Validated. No cal required.	Validated. No cal required.
Network Analyzer	Rhode & Schwarz ZVA	SN100132	02/2013	02/2016
Reference Probe	Satimo	EP 94 SN 37/08	Characterized prior to test. No cal required.	Characterized prior to test. No cal required.
Multimeter	Keithley 2000	1188656	11/2010	11/2013
Signal Generator	Agilent E4438C	MY49070581	12/2010	12/2013
Amplifier	Aethercomm	SN 046	Characterized prior to test. No cal required.	Characterized prior to test. No cal required.
Power Meter	HP E4418A	US38261498	11/2010	11/2013
Power Sensor	HP ECP-E26A	US37181460	11/2010	11/2013
Directional Coupler	Narda 4216-20	01386	Characterized prior to test. No cal required.	Characterized prior to test. No cal required.
Waveguide	Mega Industries	069Y7-158-13-712	Validated. No cal required.	Validated. No cal required.
Waveguide Transition	Mega Industries	069Y7-158-13-701	Validated. No cal required.	Validated. No cal required.
Waveguide Termination	Mega Industries	069Y7-158-13-701	Validated. No cal required.	Validated. No cal required.
Temperature / Humidity Sensor	Control Company	11-661-9	3/2012	3/2014

Page: 10/10



This document shall not be reproduced, except in full or in part, without the written approval of SATIMO. The information contained herein is to be used only for the purpose for which it is submitted and is not to be released in whole or part without written approval of SATIMO.



**受控文件**

SAR Reference Dipole Calibration Report

Ref: ACR.219.5.13.SATU.A

SHENZHEN BALUN TECHNOLOGY CO., LTD.
BLOCK B, FL 1, BAISHA SCIENCE AND TECHNOLOGY
PARK, SHAHE XI ROAD, NANSHAN DISTRICT,
SHENZHEN, GUANGDONG PROVINCE, 518055 P. R. CHINA
SATIMO COMOSAR REFERENCE DIPOLE
FREQUENCY: 900 MHZ
SERIAL NO.: SN 25/13 DIP 0G900-247

Calibrated at SATIMO US
2105 Barrett Park Dr. - Kennesaw, GA 30144

**07/08/2013**

Summary:

This document presents the method and results from an accredited SAR reference dipole calibration performed in SATIMO USA using the COMOSAR test bench. All calibration results are traceable to national metrology institutions.



SAR REFERENCE DIPOLE CALIBRATION REPORT

Ref: ACR.219.5.13.SATU.A

	<i>Name</i>	<i>Function</i>	<i>Date</i>	<i>Signature</i>
<i>Prepared by :</i>	Jérôme LUC	Product Manager	8/7/2013	<i>JS</i>
<i>Checked by :</i>	Jérôme LUC	Product Manager	8/7/2013	<i>JS</i>
<i>Approved by :</i>	Kim RUTKOWSKI	Quality Manager	8/7/2013	<i>Kim Rutkowski</i>

	<i>Customer Name</i>
<i>Distribution :</i>	Shenzhen Balun Technology Co.,Ltd.

<i>Issue</i>	<i>Date</i>	<i>Modifications</i>
A	8/7/2013	Initial release



**TABLE OF CONTENTS**

1	Introduction.....	4
2	Device Under Test	4
3	Product Description	4
3.1	General Information	4
4	Measurement Method	5
4.1	Return Loss Requirements	5
4.2	Mechanical Requirements	5
5	Measurement Uncertainty	5
5.1	Return Loss	5
5.2	Dimension Measurement	5
5.3	Validation Measurement	5
6	Calibration Measurement Results	6
6.1	Return Loss	6
6.2	Mechanical Dimensions	6
7	Validation measurement	7
7.1	Measurement Condition	7
7.2	Head Liquid Measurement	7
7.3	Measurement Result	8
7.4	Body Measurement Result	9
8	List of Equipment	10





1 INTRODUCTION

This document contains a summary of the requirements set forth by the IEEE 1528, OET 65 Bulletin C and CEI/IEC 62209 standards for reference dipoles used for SAR measurement system validations and the measurements that were performed to verify that the product complies with the fore mentioned standards.

2 DEVICE UNDER TEST

Device Under Test	
Device Type	COMOSAR 900 MHz REFERENCE DIPOLE
Manufacturer	Satimo
Model	SID900
Serial Number	SN 25/13 DIP 0G900-247
Product Condition (new / used)	New

A yearly calibration interval is recommended.

3 PRODUCT DESCRIPTION

3.1 GENERAL INFORMATION

Satimo’s COMOSAR Validation Dipoles are built in accordance to the IEEE 1528, OET 65 Bulletin C and CEI/IEC 62209 standards. The product is designed for use with the COMOSAR test bench only.



Figure 1 – Satimo COMOSAR Validation Dipole





4 MEASUREMENT METHOD

The IEEE 1528, OET 65 Bulletin C and CEI/IEC 62209 standards provide requirements for reference dipoles used for system validation measurements. The following measurements were performed to verify that the product complies with the fore mentioned standards.

4.1 RETURN LOSS REQUIREMENTS

The dipole used for SAR system validation measurements and checks must have a return loss of -20 dB or better. The return loss measurement shall be performed against a liquid filled flat phantom, with the phantom constructed as outlined in the fore mentioned standards.

4.2 MECHANICAL REQUIREMENTS

The IEEE Std. 1528 and CEI/IEC 62209 standards specify the mechanical components and dimensions of the validation dipoles, with the dimensions frequency and phantom shell thickness dependent. The COMOSAR test bench employs a 2 mm phantom shell thickness therefore the dipoles sold for use with the COMOSAR test bench comply with the requirements set forth for a 2 mm phantom shell thickness.

5 MEASUREMENT UNCERTAINTY

All uncertainties listed below represent an expanded uncertainty expressed at approximately the 95% confidence level using a coverage factor of k=2, traceable to the Internationally Accepted Guides to Measurement Uncertainty.

5.1 RETURN LOSS

The following uncertainties apply to the return loss measurement:

Frequency band	Expanded Uncertainty on Return Loss
400-6000MHz	0.1 dB

5.2 DIMENSION MEASUREMENT

The following uncertainties apply to the dimension measurements:

Length (mm)	Expanded Uncertainty on Length
3 - 300	0.05 mm

5.3 VALIDATION MEASUREMENT

The guidelines outlined in the IEEE 1528, OET 65 Bulletin C, CENELEC EN50361 and CEI/IEC 62209 standards were followed to generate the measurement uncertainty for validation measurements.

Scan Volume	Expanded Uncertainty
1 g	20.3 %
10 g	20.1 %

6 CALIBRATION MEASUREMENT RESULTS

6.1 RETURN LOSS

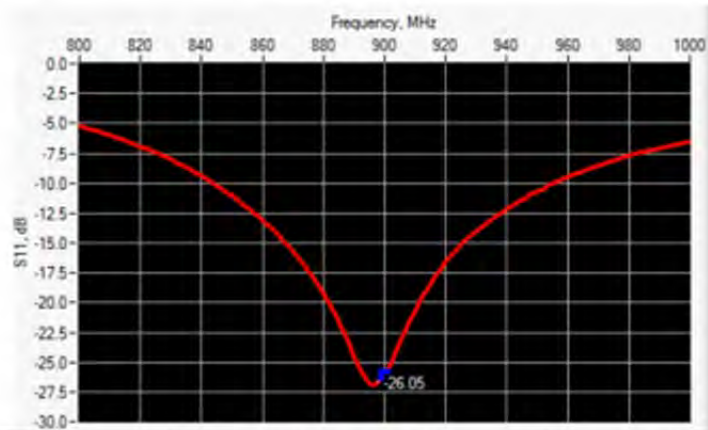

Frequency (MHz)	Return Loss (dB)	Requirement (dB)
900	-26.05	-20

6.2 MECHANICAL DIMENSIONS

Frequency MHz	L mm		h mm		d mm	
	required	measured	required	measured	required	measured
300	420.0 ±1 %		250.0 ±1 %		6.35 ±1 %	
450	290.0 ±1 %		166.7 ±1 %		6.35 ±1 %	
750	176.0 ±1 %		100.0 ±1 %		6.35 ±1 %	
835	161.0 ±1 %		89.8 ±1 %		3.6 ±1 %	
900	149.0 ±1 %	PASS	83.3 ±1 %	PASS	3.6 ±1 %	PASS
1450	89.1 ±1 %		51.7 ±1 %		3.6 ±1 %	
1500	80.5 ±1 %		50.0 ±1 %		3.6 ±1 %	
1640	79.0 ±1 %		45.7 ±1 %		3.6 ±1 %	
1750	75.2 ±1 %		42.9 ±1 %		3.6 ±1 %	
1800	72.0 ±1 %		41.7 ±1 %		3.6 ±1 %	
1900	68.0 ±1 %		39.5 ±1 %		3.6 ±1 %	
1950	66.3 ±1 %		38.5 ±1 %		3.6 ±1 %	
2000	64.5 ±1 %		37.5 ±1 %		3.6 ±1 %	
2100	61.0 ±1 %		35.7 ±1 %		3.6 ±1 %	
2300	55.5 ±1 %		32.6 ±1 %		3.6 ±1 %	
2450	51.5 ±1 %		30.4 ±1 %		3.6 ±1 %	
2600	48.5 ±1 %		28.8 ±1 %		3.6 ±1 %	
3000	41.5 ±1 %		25.0 ±1 %		3.6 ±1 %	
3500	37.0 ±1 %		26.4 ±1 %		3.6 ±1 %	
3700	34.7 ±1 %		26.4 ±1 %		3.6 ±1 %	

Page: 6/10

7 VALIDATION MEASUREMENT

The IEEE Std. 1528, OET 65 Bulletin C and CEI/IEC 62209 standards state that the system validation measurements must be performed using a reference dipole meeting the fore mentioned return loss and mechanical dimension requirements. The validation measurement must be performed against a liquid filled flat phantom, with the phantom constructed as outlined in the fore mentioned standards. Per the standards, the dipole shall be positioned below the bottom of the phantom, with the dipole length centered and parallel to the longest dimension of the flat phantom, with the top surface of the dipole at the described distance from the bottom surface of the phantom.

7.1 MEASUREMENT CONDITION

Software	OPENSAR V4
Phantom	SN 20/09 SAM71
Probe	SN 18/11 EPG122
Liquid	Head Liquid Values: ϵ_r' : 41.8 σ : 0.96
Distance between dipole center and liquid	15.0 mm
Area scan resolution	dx=8mm/dy=8mm
Zoon Scan Resolution	dx=8mm/dy=8m/dz=5mm
Frequency	900 MHz
Input power	20 dBm
Liquid Temperature	21 °C
Lab Temperature	21 °C
Lab Humidity	45 %

7.2 HEAD LIQUID MEASUREMENT

Frequency MHz	Relative permittivity (ϵ_r')		Conductivity (σ) S/m	
	required	measured	required	measured
300	45.3 ±5 %		0.87 ±5 %	
450	43.5 ±5 %		0.87 ±5 %	
750	41.9 ±5 %		0.89 ±5 %	
835	41.5 ±5 %		0.90 ±5 %	
900	41.5 ±5 %	PASS	0.97 ±5 %	PASS
1450	40.5 ±5 %		1.20 ±5 %	
1500	40.4 ±5 %		1.23 ±5 %	
1640	40.2 ±5 %		1.31 ±5 %	
1750	40.1 ±5 %		1.37 ±5 %	
1800	40.0 ±5 %		1.40 ±5 %	
1900	40.0 ±5 %		1.40 ±5 %	
1950	40.0 ±5 %		1.40 ±5 %	
2000	40.0 ±5 %		1.40 ±5 %	
2100	39.8 ±5 %		1.49 ±5 %	
2300	39.5 ±5 %		1.67 ±5 %	
2450	39.2 ±5 %		1.80 ±5 %	
2600	39.0 ±5 %		1.96 ±5 %	
3000	38.5 ±5 %		2.40 ±5 %	
3500	37.9 ±5 %		2.91 ±5 %	

Page: 7/10

7.3 MEASUREMENT RESULT

The IEEE Std. 1528 and CEI/IEC 62209 standards state that the system validation measurements should produce the SAR values shown below (for phantom thickness of 2 mm), within the uncertainty for the system validation. All SAR values are normalized to 1 W forward power. In bracket, the measured SAR is given with the used input power.

Frequency MHz	1 g SAR (W/kg/W)		10 g SAR (W/kg/W)	
	required	measured	required	measured
300	2.85		1.94	
450	4.58		3.06	
750	8.49		5.55	
835	9.56		6.22	
900	10.9	10.71 (1.07)	6.99	6.64 (0.66)
1450	29		16	
1500	30.5		16.8	
1640	34.2		18.4	
1750	36.4		19.3	
1800	38.4		20.1	
1900	39.7		20.5	
1950	40.5		20.9	
2000	41.1		21.1	
2100	43.6		21.9	
2300	48.7		23.3	
2450	52.4		24	
2600	55.3		24.6	
3000	63.8		25.7	
3500	67.1		25	

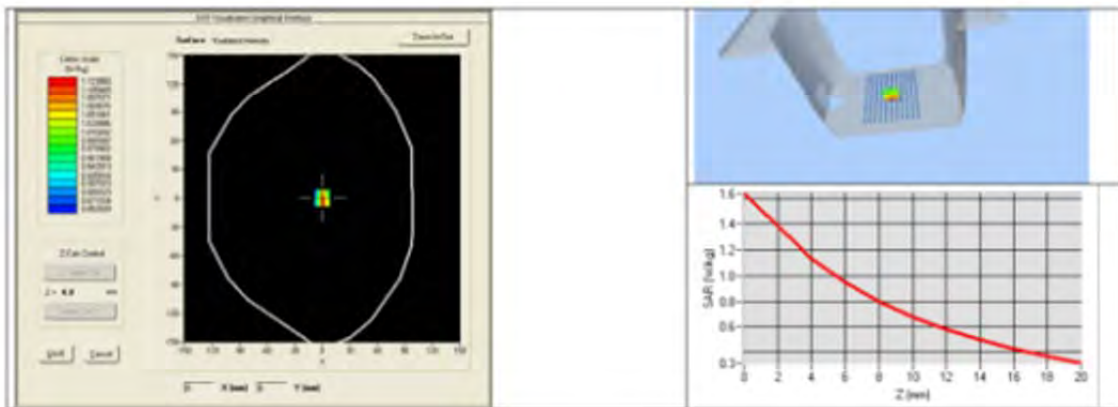



7.4 BODY MEASUREMENT RESULT

Software	OPENSAR V4
Phantom	SN 20/09 SAM71
Probe	SN 18/11 EPG122
Liquid	Body Liquid Values: $\epsilon_p' : 56.0$ $\sigma : 1.04$
Distance between dipole center and liquid	15.0 mm
Area scan resolution	$dx=8mm/dy=8mm$
Zoon Scan Resolution	$dx=8mm/dy=8m/dz=5mm$
Frequency	900 MHz
Input power	20 dBm
Liquid Temperature	21 °C
Lab Temperature	21 °C
Lab Humidity	45 %

Frequency MHz	1 g SAR (W/kg/W)	10 g SAR (W/kg/W)
	measured	measured
900	11.21 (1.12)	7.09 (0.71)

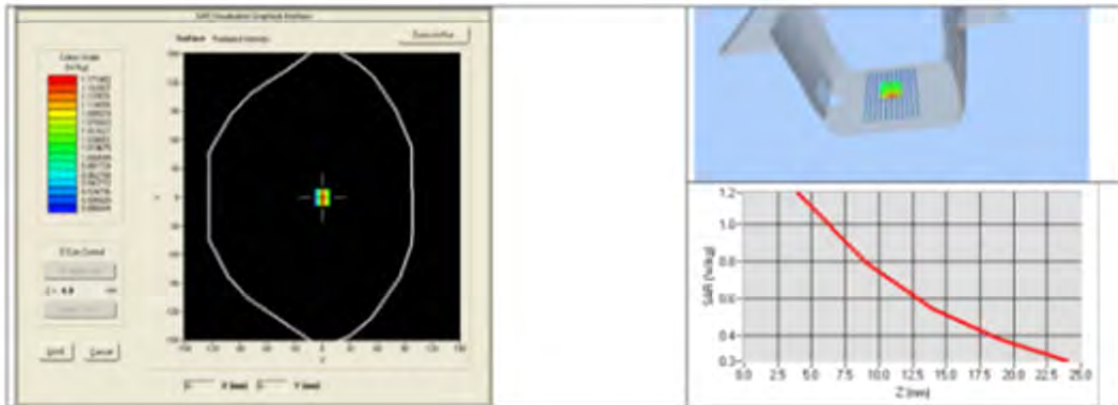

8 LIST OF EQUIPMENT

Equipment Summary Sheet				
Equipment Description	Manufacturer / Model	Identification No.	Current Calibration Date	Next Calibration Date
SAM Phantom	Satimo	SN-20/09-SAM71	Validated. No cal required.	Validated. No cal required.
COMOSAR Test Bench	Version 3	NA	Validated. No cal required.	Validated. No cal required.
Network Analyzer	Rhode & Schwarz ZVA	SN100132	02/2013	02/2016
Calipers	Carrera	CALIPER-01	12/2010	12/2013
Reference Probe	Satimo	EPG122 SN 18/11	Characterized prior to test. No cal required.	Characterized prior to test. No cal required.
Multimeter	Keithley 2000	1188656	11/2010	11/2013
Signal Generator	Agilent E4438C	MY49070581	12/2010	12/2013
Amplifier	Aethercomm	SN 046	Characterized prior to test. No cal required.	Characterized prior to test. No cal required.
Power Meter	HP E4418A	US38261498	11/2010	11/2013
Power Sensor	HP ECP-E26A	US37181460	11/2010	11/2013
Directional Coupler	Narda 4216-20	01386	Characterized prior to test. No cal required.	Characterized prior to test. No cal required.
Temperature and Humidity Sensor	Control Company	11-661-9	3/2012	3/2014





受控文件

SAR Reference Dipole Calibration Report

Ref: ACR.219.9.13.SATU.A

SHENZHEN BALUN TECHNOLOGY CO., LTD.
BLOCK B, FL 1, BAISHA SCIENCE AND TECHNOLOGY
PARK, SHAHE XI ROAD, NANSHAN DISTRICT,
SHENZHEN, GUANGDONG PROVINCE, 518055 P. R. CHINA
SATIMO COMOSAR REFERENCE DIPOLE
FREQUENCY: 2450 MHZ
SERIAL NO.: SN 25/13 DIP 2G450-251

Calibrated at SATIMO US
2105 Barrett Park Dr. - Kennesaw, GA 30144



07/08/2013

Summary:

This document presents the method and results from an accredited SAR reference dipole calibration performed in SATIMO USA using the COMOSAR test bench. All calibration results are traceable to national metrology institutions.



SAR REFERENCE DIPOLE CALIBRATION REPORT

Ref: ACR.219.9.13.SATU.A

	<i>Name</i>	<i>Function</i>	<i>Date</i>	<i>Signature</i>
<i>Prepared by :</i>	Jérôme LUC	Product Manager	8/7/2013	<i>JS</i>
<i>Checked by :</i>	Jérôme LUC	Product Manager	8/7/2013	<i>JS</i>
<i>Approved by :</i>	Kim RUTKOWSKI	Quality Manager	8/7/2013	<i>Kim Rutkowski</i>

	<i>Customer Name</i>
<i>Distribution :</i>	Shenzhen Balun Technology Co.,Ltd.

<i>Issue</i>	<i>Date</i>	<i>Modifications</i>
A	8/7/2013	Initial release



**TABLE OF CONTENTS**

1	Introduction.....	4
2	Device Under Test	4
3	Product Description	4
3.1	General Information	4
4	Measurement Method	5
4.1	Return Loss Requirements	5
4.2	Mechanical Requirements	5
5	Measurement Uncertainty	5
5.1	Return Loss	5
5.2	Dimension Measurement	5
5.3	Validation Measurement	5
6	Calibration Measurement Results	6
6.1	Return Loss	6
6.2	Mechanical Dimensions	6
7	Validation measurement	7
7.1	Measurement Condition	7
7.2	Head Liquid Measurement	7
7.3	Measurement Result	8
7.4	Body Measurement Result	9
8	List of Equipment	10



1 INTRODUCTION

This document contains a summary of the requirements set forth by the IEEE 1528, OET 65 Bulletin C and CEI/IEC 62209 standards for reference dipoles used for SAR measurement system validations and the measurements that were performed to verify that the product complies with the fore mentioned standards.

2 DEVICE UNDER TEST

Device Under Test	
Device Type	COMOSAR 2450 MHz REFERENCE DIPOLE
Manufacturer	Satimo
Model	SID2450
Serial Number	SN 25/13 DIP 2G450-251
Product Condition (new / used)	New

A yearly calibration interval is recommended.

3 PRODUCT DESCRIPTION

3.1 GENERAL INFORMATION

Satimo's COMOSAR Validation Dipoles are built in accordance to the IEEE 1528, OET 65 Bulletin C and CEI/IEC 62209 standards. The product is designed for use with the COMOSAR test bench only.



Figure 1 – Satimo COMOSAR Validation Dipole



4 MEASUREMENT METHOD

The IEEE 1528, OET 65 Bulletin C and CEI/IEC 62209 standards provide requirements for reference dipoles used for system validation measurements. The following measurements were performed to verify that the product complies with the fore mentioned standards.

4.1 RETURN LOSS REQUIREMENTS

The dipole used for SAR system validation measurements and checks must have a return loss of -20 dB or better. The return loss measurement shall be performed against a liquid filled flat phantom, with the phantom constructed as outlined in the fore mentioned standards.

4.2 MECHANICAL REQUIREMENTS

The IEEE Std. 1528 and CEI/IEC 62209 standards specify the mechanical components and dimensions of the validation dipoles, with the dimensions frequency and phantom shell thickness dependent. The COMOSAR test bench employs a 2 mm phantom shell thickness therefore the dipoles sold for use with the COMOSAR test bench comply with the requirements set forth for a 2 mm phantom shell thickness.

5 MEASUREMENT UNCERTAINTY

All uncertainties listed below represent an expanded uncertainty expressed at approximately the 95% confidence level using a coverage factor of $k=2$, traceable to the Internationally Accepted Guides to Measurement Uncertainty.

5.1 RETURN LOSS

The following uncertainties apply to the return loss measurement:

Frequency band	Expanded Uncertainty on Return Loss
400-6000MHz	0.1 dB

5.2 DIMENSION MEASUREMENT

The following uncertainties apply to the dimension measurements:

Length (mm)	Expanded Uncertainty on Length
3 - 300	0.05 mm

5.3 VALIDATION MEASUREMENT

The guidelines outlined in the IEEE 1528, OET 65 Bulletin C, CENELEC EN50361 and CEI/IEC 62209 standards were followed to generate the measurement uncertainty for validation measurements.

Scan Volume	Expanded Uncertainty
1 g	20.3 %
10 g	20.1 %

6 CALIBRATION MEASUREMENT RESULTS

6.1 RETURN LOSS

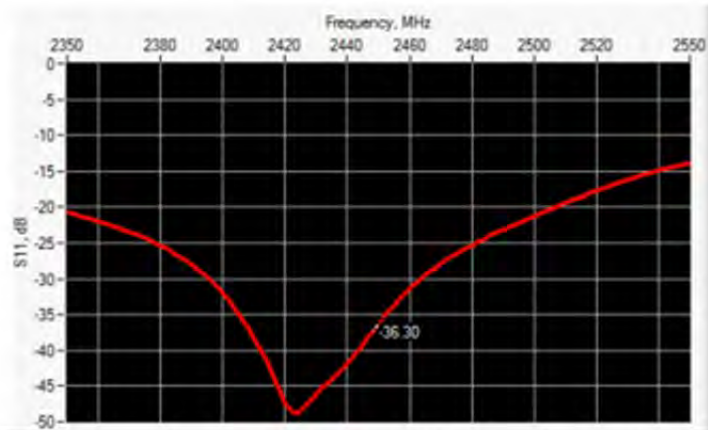

Frequency (MHz)	Return Loss (dB)	Requirement (dB)
2450	-36.30	-20

6.2 MECHANICAL DIMENSIONS

Frequency MHz	L mm		h mm		d mm	
	required	measured	required	measured	required	measured
300	420.0 ±1 %		250.0 ±1 %		6.35 ±1 %	
450	290.0 ±1 %		166.7 ±1 %		6.35 ±1 %	
750	176.0 ±1 %		100.0 ±1 %		6.35 ±1 %	
835	161.0 ±1 %		89.8 ±1 %		3.6 ±1 %	
900	149.0 ±1 %		83.3 ±1 %		3.6 ±1 %	
1450	89.1 ±1 %		51.7 ±1 %		3.6 ±1 %	
1500	80.5 ±1 %		50.0 ±1 %		3.6 ±1 %	
1640	79.0 ±1 %		45.7 ±1 %		3.6 ±1 %	
1750	75.2 ±1 %		42.9 ±1 %		3.6 ±1 %	
1800	72.0 ±1 %		41.7 ±1 %		3.6 ±1 %	
1900	68.0 ±1 %		39.5 ±1 %		3.6 ±1 %	
1950	66.3 ±1 %		38.5 ±1 %		3.6 ±1 %	
2000	64.5 ±1 %		37.5 ±1 %		3.6 ±1 %	
2100	61.0 ±1 %		35.7 ±1 %		3.6 ±1 %	
2300	55.5 ±1 %		32.6 ±1 %		3.6 ±1 %	
2450	51.5 ±1 %	PASS	30.4 ±1 %	PASS	3.6 ±1 %	PASS
2600	48.5 ±1 %		28.8 ±1 %		3.6 ±1 %	
3000	41.5 ±1 %		25.0 ±1 %		3.6 ±1 %	
3500	37.0 ±1 %		26.4 ±1 %		3.6 ±1 %	
3700	34.7 ±1 %		26.4 ±1 %		3.6 ±1 %	

Page: 6/10



This document shall not be reproduced, except in full or in part, without the written approval of SATIMO. The information contained herein is to be used only for the purpose for which it is submitted and is not to be released in whole or part without written approval of SATIMO.



7 VALIDATION MEASUREMENT

The IEEE Std. 1528, OET 65 Bulletin C and CEI/IEC 62209 standards state that the system validation measurements must be performed using a reference dipole meeting the fore mentioned return loss and mechanical dimension requirements. The validation measurement must be performed against a liquid filled flat phantom, with the phantom constructed as outlined in the fore mentioned standards. Per the standards, the dipole shall be positioned below the bottom of the phantom, with the dipole length centered and parallel to the longest dimension of the flat phantom, with the top surface of the dipole at the described distance from the bottom surface of the phantom.

7.1 MEASUREMENT CONDITION

Software	OPENSAR V4
Phantom	SN 20/09 SAM71
Probe	SN 18/11 EPG122
Liquid	Head Liquid Values: ϵ_s' : 38.6 sigma : 1.82
Distance between dipole center and liquid	10.0 mm
Area scan resolution	dx=8mm/dy=8mm
Zoon Scan Resolution	dx=8mm/dy=8m/dz=5mm
Frequency	2450 MHz
Input power	20 dBm
Liquid Temperature	21 °C
Lab Temperature	21 °C
Lab Humidity	45 %

7.2 HEAD LIQUID MEASUREMENT

Frequency MHz	Relative permittivity (ϵ_r')		Conductivity (σ) S/m	
	required	measured	required	measured
300	45.3 ±5 %		0.87 ±5 %	
450	43.5 ±5 %		0.87 ±5 %	
750	41.9 ±5 %		0.89 ±5 %	
835	41.5 ±5 %		0.90 ±5 %	
900	41.5 ±5 %		0.97 ±5 %	
1450	40.5 ±5 %		1.20 ±5 %	
1500	40.4 ±5 %		1.23 ±5 %	
1640	40.2 ±5 %		1.31 ±5 %	
1750	40.1 ±5 %		1.37 ±5 %	
1800	40.0 ±5 %		1.40 ±5 %	
1900	40.0 ±5 %		1.40 ±5 %	
1950	40.0 ±5 %		1.40 ±5 %	
2000	40.0 ±5 %		1.40 ±5 %	
2100	39.8 ±5 %		1.49 ±5 %	
2300	39.5 ±5 %		1.67 ±5 %	
2450	39.2 ±5 %	PASS	1.80 ±5 %	PASS
2600	39.0 ±5 %		1.96 ±5 %	
3000	38.5 ±5 %		2.40 ±5 %	
3500	37.9 ±5 %		2.91 ±5 %	

Page: 7/10

7.3 MEASUREMENT RESULT

The IEEE Std. 1528 and CEI/IEC 62209 standards state that the system validation measurements should produce the SAR values shown below (for phantom thickness of 2 mm), within the uncertainty for the system validation. All SAR values are normalized to 1 W forward power. In bracket, the measured SAR is given with the used input power.

Frequency MHz	1 g SAR (W/kg/W)		10 g SAR (W/kg/W)	
	required	measured	required	measured
300	2.85		1.94	
450	4.58		3.06	
750	8.49		5.55	
835	9.56		6.22	
900	10.9		6.99	
1450	29		16	
1500	30.5		16.8	
1640	34.2		18.4	
1750	36.4		19.3	
1800	38.4		20.1	
1900	39.7		20.5	
1950	40.5		20.9	
2000	41.1		21.1	
2100	43.6		21.9	
2300	48.7		23.3	
2450	52.4	53.96 (5.40)	24	23.92 (2.39)
2600	55.3		24.6	
3000	63.8		25.7	
3500	67.1		25	

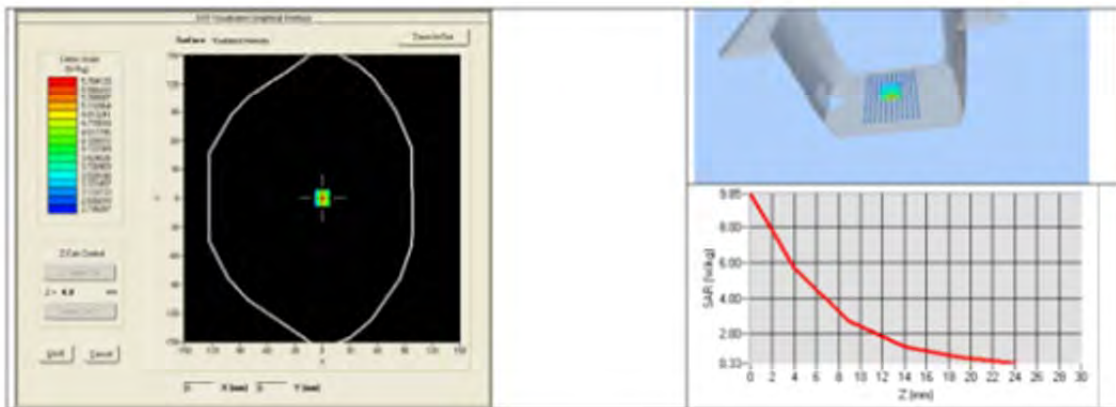



7.4 BODY MEASUREMENT RESULT

Software	OPENSAR V4
Phantom	SN 20/09 SAM71
Probe	SN 18/11 EPG122
Liquid	Body Liquid Values: eps' : 52.0 sigma : 1.94
Distance between dipole center and liquid	10.0 mm
Area scan resolution	dx=8mm/dy=8mm
Zoon Scan Resolution	dx=8mm/dy=8m/dz=5mm
Frequency	2450 MHz
Input power	20 dBm
Liquid Temperature	21 °C
Lab Temperature	21 °C
Lab Humidity	45 %

Frequency MHz	1 g SAR (W/kg/W)	10 g SAR (W/kg/W)
	measured	measured
2450	52.37 (5.24)	24.26 (2.43)

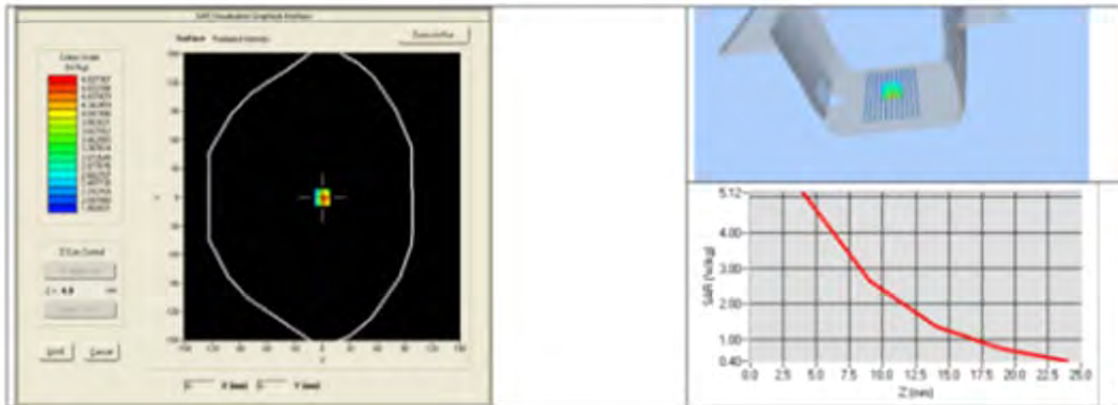

8 LIST OF EQUIPMENT

Equipment Summary Sheet				
Equipment Description	Manufacturer / Model	Identification No.	Current Calibration Date	Next Calibration Date
SAM Phantom	Satimo	SN-20/09-SAM71	Validated. No cal required.	Validated. No cal required.
COMOSAR Test Bench	Version 3	NA	Validated. No cal required.	Validated. No cal required.
Network Analyzer	Rhode & Schwarz ZVA	SN100132	02/2013	02/2016
Calipers	Carrera	CALIPER-01	12/2010	12/2013
Reference Probe	Satimo	EPG122 SN 18/11	Characterized prior to test. No cal required.	Characterized prior to test. No cal required.
Multimeter	Keithley 2000	1188656	11/2010	11/2013
Signal Generator	Agilent E4438C	MY49070581	12/2010	12/2013
Amplifier	Aethercomm	SN 046	Characterized prior to test. No cal required.	Characterized prior to test. No cal required.
Power Meter	HP E4418A	US38261498	11/2010	11/2013
Power Sensor	HP ECP-E26A	US37181460	11/2010	11/2013
Directional Coupler	Narda 4216-20	01386	Characterized prior to test. No cal required.	Characterized prior to test. No cal required.
Temperature and Humidity Sensor	Control Company	11-661-9	3/2012	3/2014

Page: 10/10



This document shall not be reproduced, except in full or in part, without the written approval of SATIMO. The information contained herein is to be used only for the purpose for which it is submitted and is not to be released in whole or part without written approval of SATIMO.



--END OF REPORT--