

# SAR

## Dipole & Waveguide

# Performance Measurement Report

ISSUED BY  
Shenzhen BALUN Technology Co., Ltd.



FOR  
Validation Dipoles & Waveguide

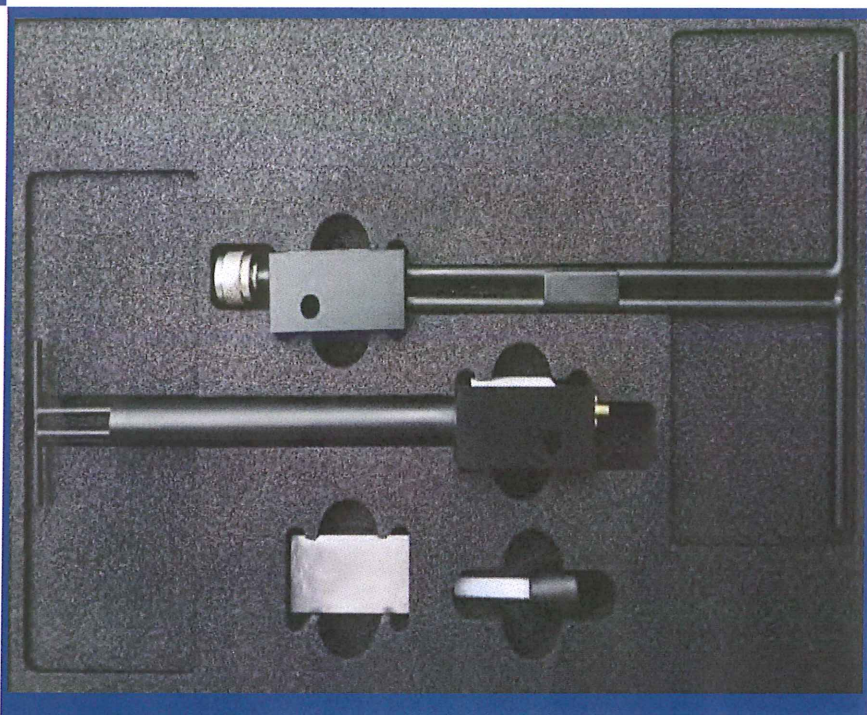

Tested by: Zong Liyao  
Zong Liyao  
(Engineer)

Approved by: Liao Jianming  
Liao Jianming  
(Technical Director)

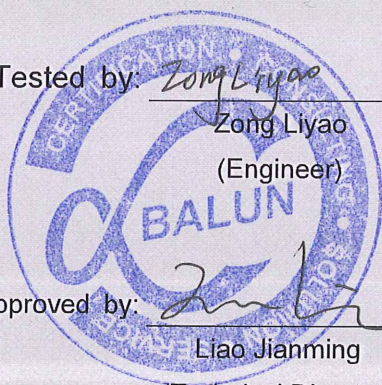

Report No.: LW-SZ1830947

EUT Type: SAR Validation Dipole and Waveguide

Model Name: DIP 0G750-446, DIP 0G835-447  
DIP 0G900-448, DIP 1G800-449  
DIP 1G900-450, DIP 2G000-451  
DIP 2G450-452, DIP 2G600-453  
SWG5500-WGA 42

Brand Name: SATIMO

Test Conclusion: Pass

Test Date: Mar. 17, 2018 ~ Mar. 19, 2018

Date of Issue: Mar. 25, 2018

*NOTE: This test report can be duplicated completely for the legal use with the approval of the applicant; it shall not be reproduced except in full, without the written approval of Shenzhen BALUN Technology Co., Ltd. BALUN Laboratory. Any objections should be raised within thirty days from the date of issue. To validate the report, please visit BALUN website.*



# 1 GENERAL INFORMATION

## 1.1 Introduction

This document contains a summary of the requirements set forth by the IEEE 1528, FCC KDB 865664 D01 for reference dipoles used for SAR measurement system validations. Instead of the typical annual calibration recommended by measurement standards, the reference dipoles were demonstrated that the SAR target, impedance and return loss have remain stable, so the longer calibration interval is acceptable.

## 1.2 General Description for Equipment under Test (EUT)

Model	Frequency	Serial Number	Product Condition(New/Used)	Last Cal. Date	Last Meas. Date
<b>Dipole</b>					
DIP 0G750	750 MHz	SN 11/17 DIP 0G750-446	Used	2017/03/22	2018/03/17
DIP 0G835	835 MHz	SN 11/17 DIP 0G835-447	Used	2017/03/22	2018/03/17
DIP 0G900	900 MHz	SN 11/17 DIP 0G900-448	Used	2017/03/22	2018/03/17
DIP 1G800	1800 MHz	SN 11/17 DIP 1G900-449	Used	2017/03/22	2018/03/18
DIP 1G900	1900 MHz	SN 11/17 DIP 1G900-450	Used	2017/03/22	2018/03/18
DIP 2G000	2000 MHz	SN 11/17 DIP 2G000-451	Used	2017/03/22	2018/03/18
DIP 2G450	2450 MHz	SN 11/17 DIP 2G450-452	Used	2017/03/22	2018/03/18
DIP 2G600	2600 MHz	SN 11/17 DIP 2G600-453	Used	2017/03/22	2018/03/18
<b>Waveguide</b>					
SWG5500	5GHz-6GHz	SN 49/16 WGA42	Used	2017/03/22	2017/03/19



### 1.3 Test Equipment List

Description	Manufacturer	Model	Serial No.	Cal. Date	Cal. Due
PC	Dell	N/A	N/A	N/A	N/A
E-Field Probe	MVG	SSE2	SN 08/16 SSE2 EPGO295	2017/03/22	2018/03/21
Phantom1	SATIMO	SAM	SN 30/13 SAM103	N/A	N/A
Phantom2	SATIMO	SAM	SN 30/13 SAM104	N/A	N/A
MultiMeter	Keithley	MultiMeter 2000	4024022	2017/06/12	2018/06/11
Signal Generator	R&S	SMBV100A	260592	2017/06/12	2018/06/11
Power Meter	Agilent	E4419B	GB40201833	2017/11/02	2018/11/01
Power Sensor	Agilent	E9300A	MY41498012	2017/11/02	2018/11/01
Power Sensor	Agilent	E9300A	MY41499891	2017/11/02	2018/11/01
Network Analyzer	R&S	ZVL-6	101380	2017/06/12	2018/06/11
Thermometer	Elitech	RC-4HC	N/A	2017/11/13	2018/11/12
Power Amplifier	SATIMO	6552B	22374	N/A	N/A
Dielectric Probe Kit	SATIMO	SCLMP	SN 25/13 OCPG56	N/A	N/A
Attenuator	COM-MW	ZA-S1-31	1305003187	N/A	N/A
Directional coupler	AA-MCS	AAMCS-UDC	000272	N/A	N/A

## 1.4 EUT Photos

DIP 0G750-446



DIP 0G835-447



DIP 0G900-448



DIP 1G800-449



DIP 1G900-450



DIP 2G000-451



DIP 2G450-452



DIP 2G600-453



Waveguide SWG5500





## 2 DIPOLE IMPEDANCE AND RETURN LOSS

The dipoles are designed to have low return loss when presented against a flat phantom at the specified distance. A Vector Network Analyzer was used to perform a return loss measurement on the specific dipole when in the measurement location against the phantom and the distance was specified by the manufacturer with a special, low loss and low relative permittivity spacer.

The impedance was measured at the SMA-connector with the network analyzer.

The measurement of verification with return loss should not deviate by more than 20% and minimum of 20 dB of the return loss, and the impedance (real or imaginary parts) should not deviate by more than 5 Ohms from the previous measurement using network analyzer.

Note:

The "Previous Meas." in the following table refer to dipoles or other equivalent RF sources calibration reports.



## 2.1 DIP 0G750

### RETURN LOSS AND IMPEDANCE IN HEAD LIQUID

Meas. Results	Current Meas.	Previous Meas.	Max. Deviation
Return Loss(dB)	-26.40	-32.48	18.7 %
Impedance	53.7 $\Omega$ + 1.9 j $\Omega$	51.6 $\Omega$ +1.7 j $\Omega$	2.1 $\Omega$ (Real part)

#### Return Loss

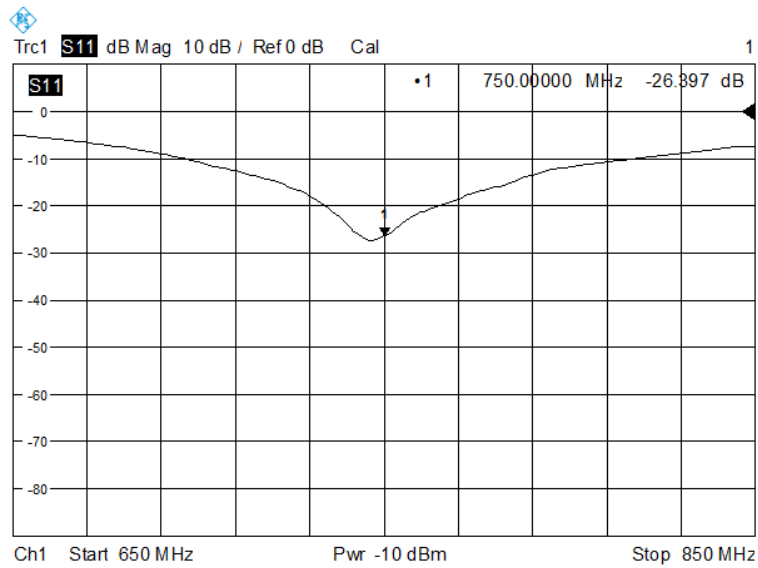

#### Impedance

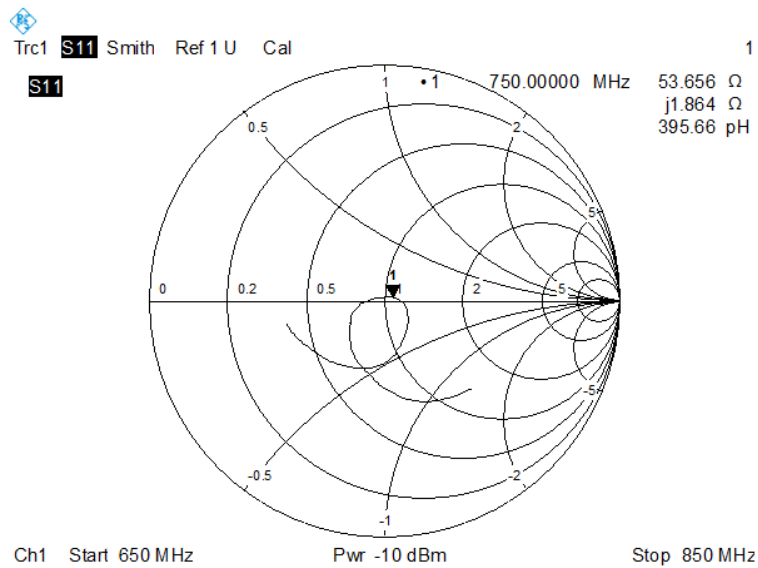





**RETURN LOSS AND IMPEDANCE IN BODY LIQUID**

Meas. Results	Current Meas.	Previous Meas.	Max. Deviation
Return Loss(dB)	-27.73	-23.50	18.0 %
Impedance	51.1 $\Omega$ + 5.9 j $\Omega$	48.8 $\Omega$ + 6.6 j $\Omega$	2.3 $\Omega$ (Real part)

**Return Loss**

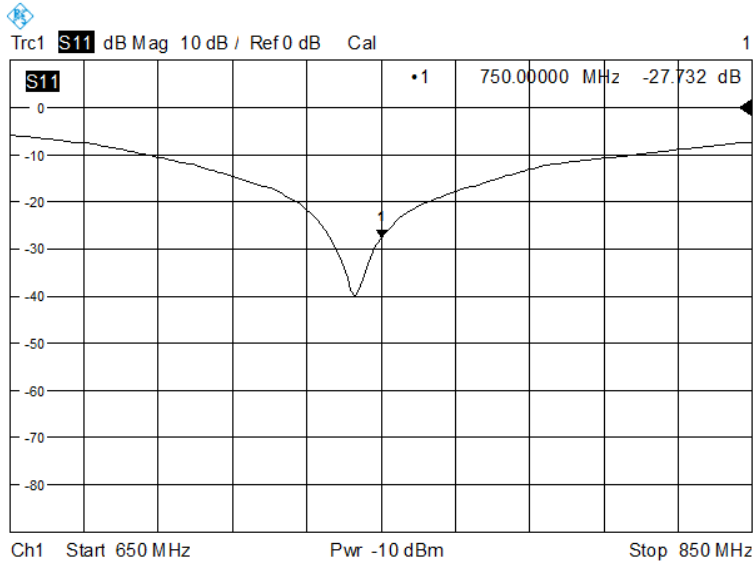

**Impedance**

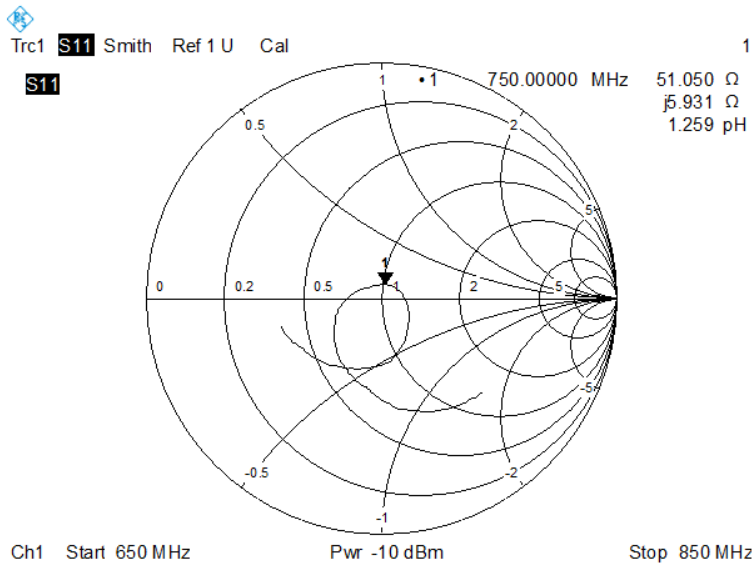



## 2.2 DIP 0G835

### RETURN LOSS AND IMPEDANCE IN HEAD LIQUID

Meas. Results	Current Meas.	Previous Meas.	Max. Deviation
Return Loss(dB)	-30.45	-34.07	11.7%
Impedance	53.5 $\Omega$ - 1.1 j $\Omega$	49.3 $\Omega$ + 1.8 j $\Omega$	4.2 $\Omega$ (Real part)

#### Return Loss

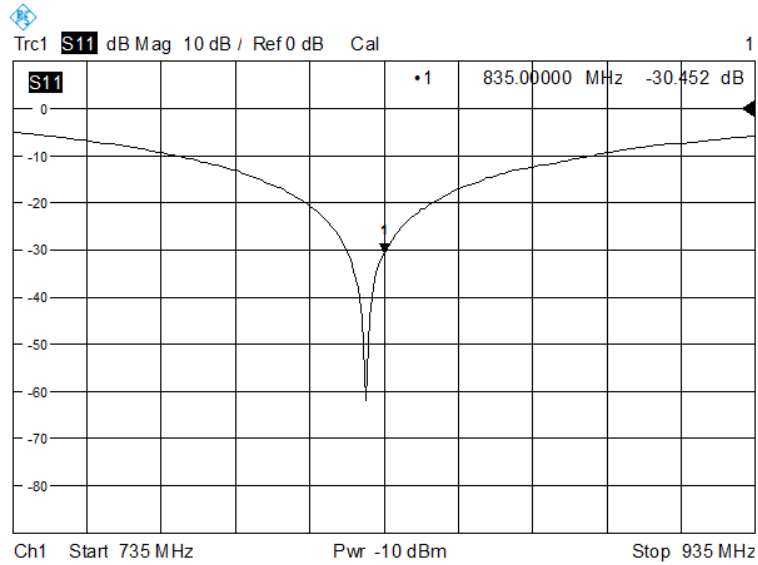

#### Impedance

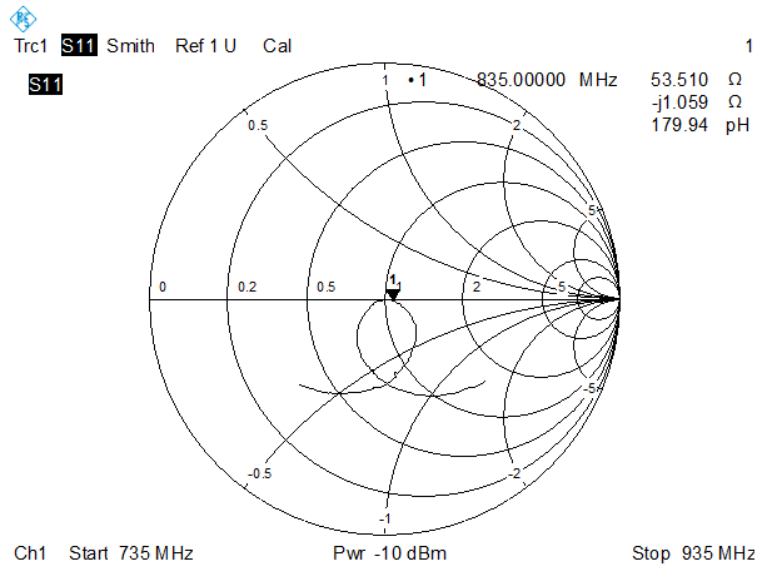



**RETURN LOSS AND IMPEDANCE IN BODY LIQUID**

Meas. Results	Current Meas.	Previous Meas.	Max. Deviation
Return Loss(dB)	-23.10	-22.96	0.6 %
Impedance	48.2Ω+5.2 jΩ	45.3 Ω +5.3 jΩ	2.9 Ω (Real part)

**Return Loss**

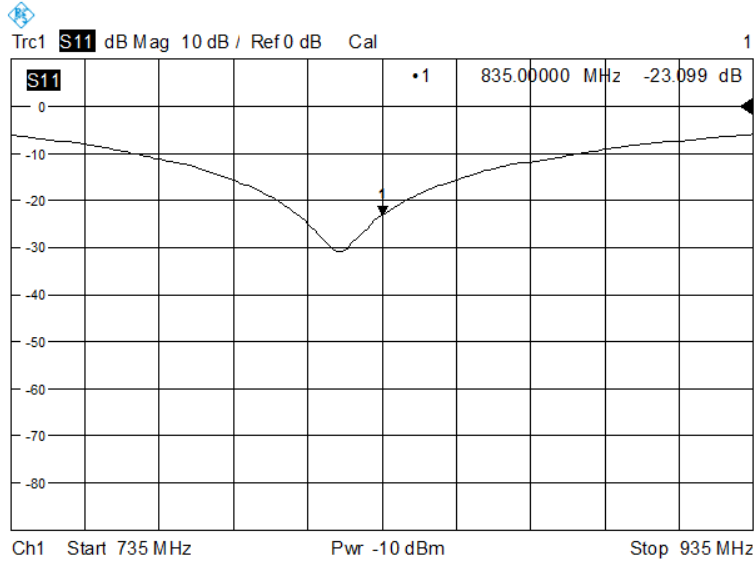

**Impedance**

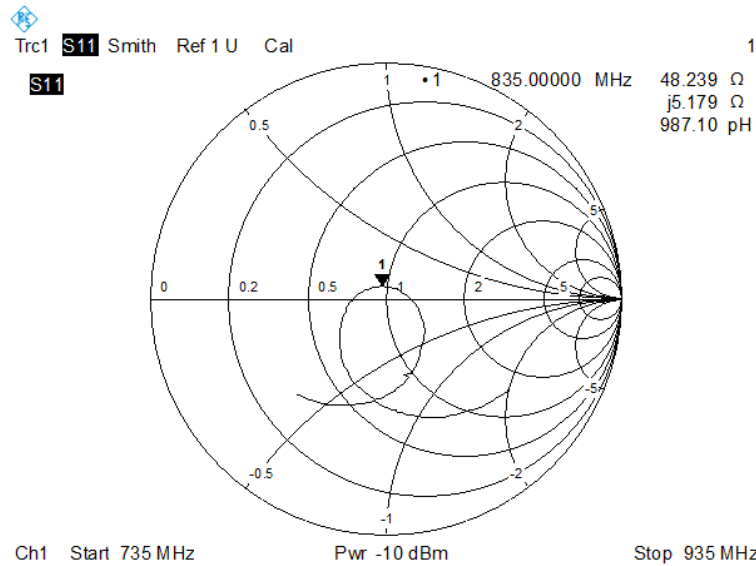



## 2.3 DIP 0G900

### RETURN LOSS AND IMPEDANCE IN HEAD LIQUID

Meas. Results	Current Meas.	Previous Meas.	Max. Deviation
Return Loss(dB)	-31.55	-30.38	3.9%
Impedance	51.8 $\Omega$ - 2.1 j $\Omega$	51.8 $\Omega$ - 2.4 j $\Omega$	0.3 $\Omega$ (Imaginary part)

#### Return Loss

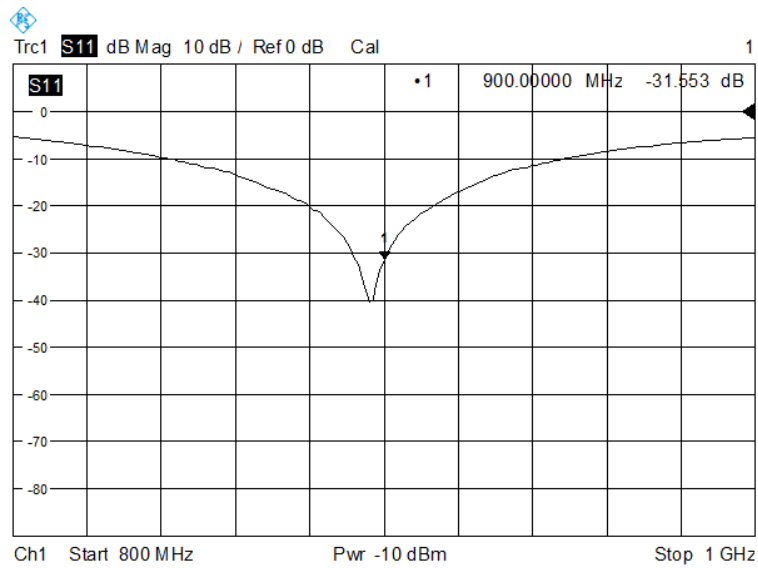

#### Impedance

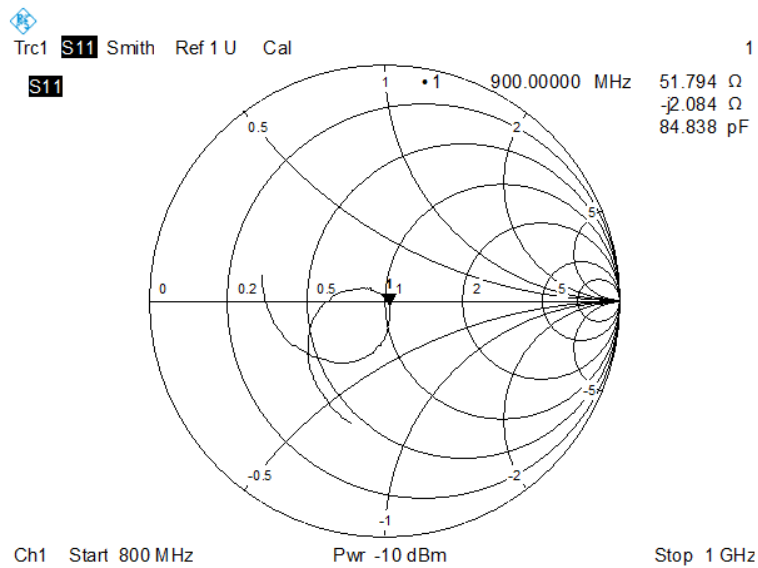

**RETURN LOSS AND IMPEDANCE IN BODY LIQUID**

Meas. Results	Current Meas.	Previous Meas.	Max. Deviation
Return Loss(dB)	-27.62	-27.29	1.2%
Impedance	54.7 $\Omega$ + 2.2 j $\Omega$	53.4 $\Omega$ + 2.6 j $\Omega$	1.3 $\Omega$ (Real part)

**Return Loss**

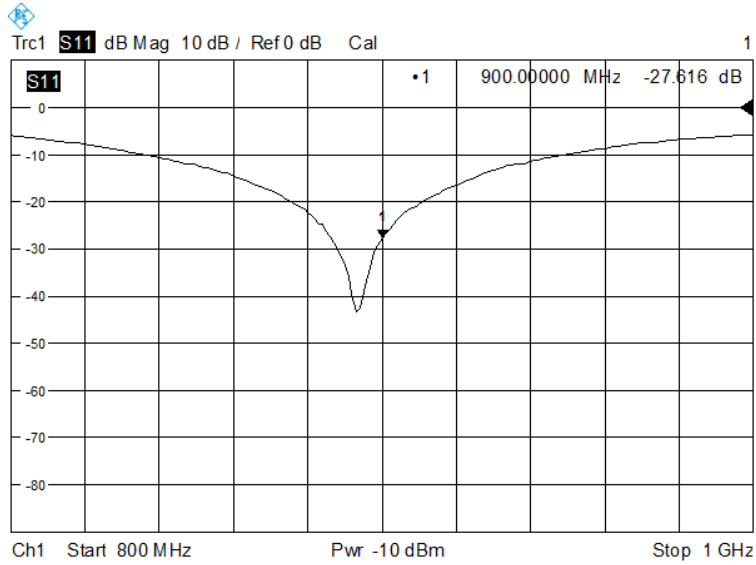

**Impedance**

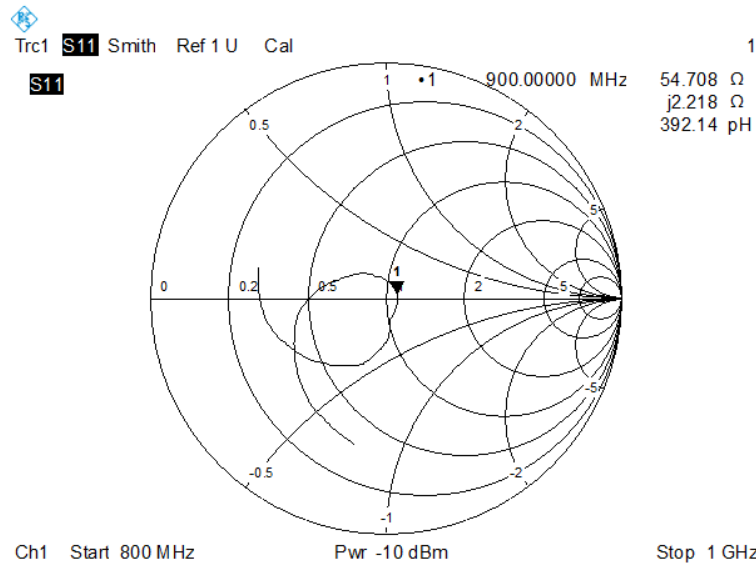



## 2.4 DIP 1G800

### RETURN LOSS AND IMPEDANCE IN HEAD LIQUID

Meas. Results	Current Meas.	Previous Meas.	Max. Deviation
Return Loss(dB)	-24.28	-25.49	4.7%
Impedance	44.8Ω + 3.9 jΩ	45.4 Ω + 2.6 jΩ	1.3 Ω (Imaginary part)

#### Return Loss

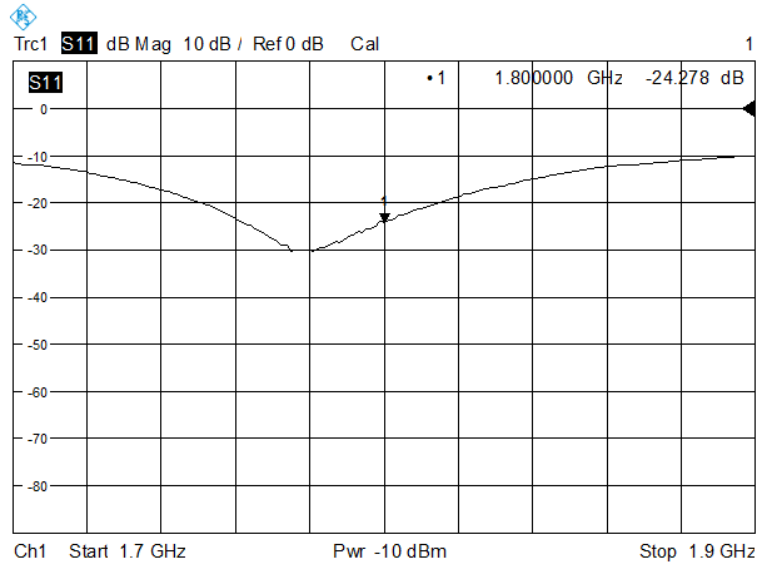

#### Impedance

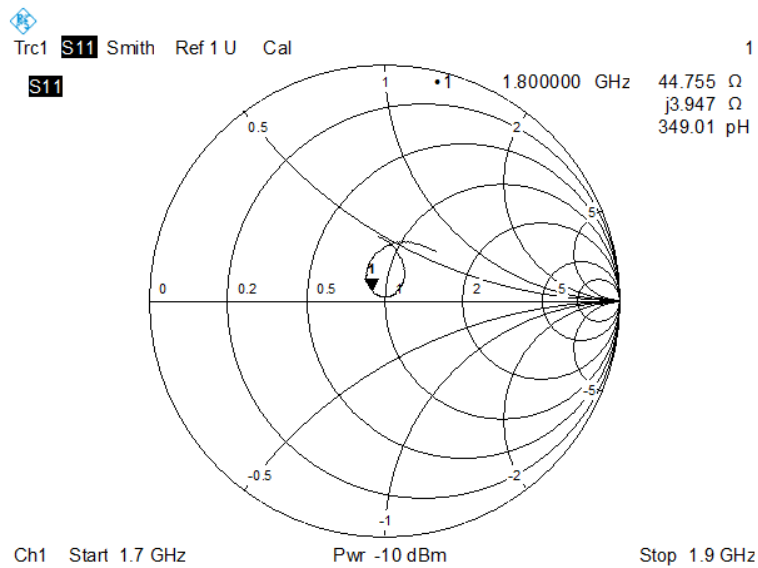



**RETURN LOSS AND IMPEDANCE IN BODY LIQUID**

Meas. Results	Current Meas.	Previous Meas.	Max. Deviation
Return Loss(dB)	-27.41	-26.35	4.1%
Impedance	47.8Ω + 3.4 jΩ	45.4Ω -1.5 jΩ	4.9 Ω (Imaginary part)

**Return Loss**

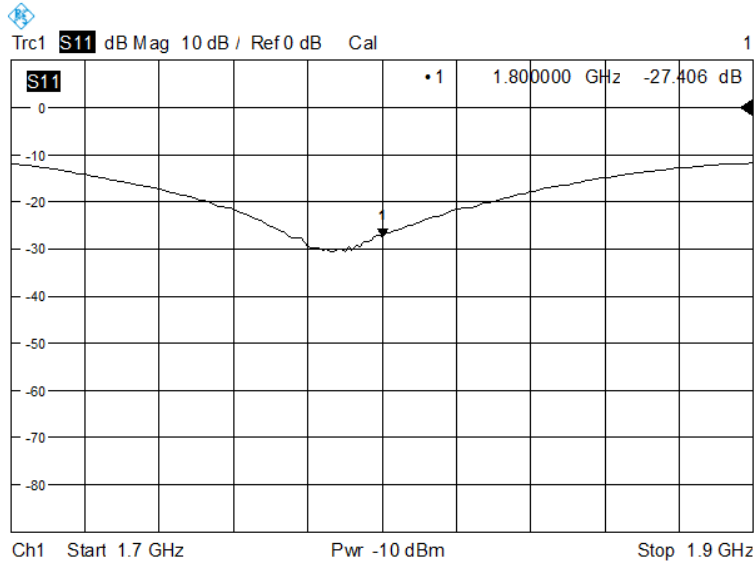

**Impedance**

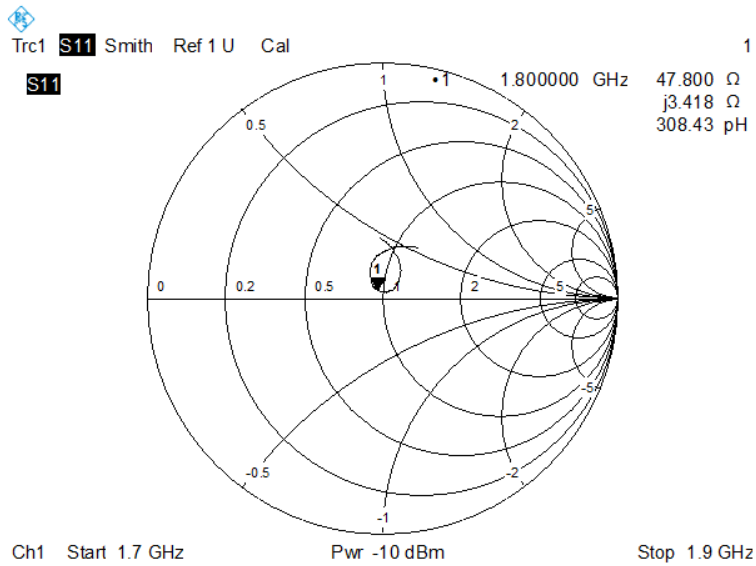



## 2.5 DIP 1G900

### RETURN LOSS AND IMPEDANCE IN HEAD LIQUID

Meas. Results	Current Meas.	Previous Meas.	Max. Deviation
Return Loss(dB)	-23.59	-24.2	2.5 %
Impedance	52.7Ω+8.0 jΩ	51.2 Ω +6.0 jΩ	2 Ω (Imaginary part)

#### Return Loss

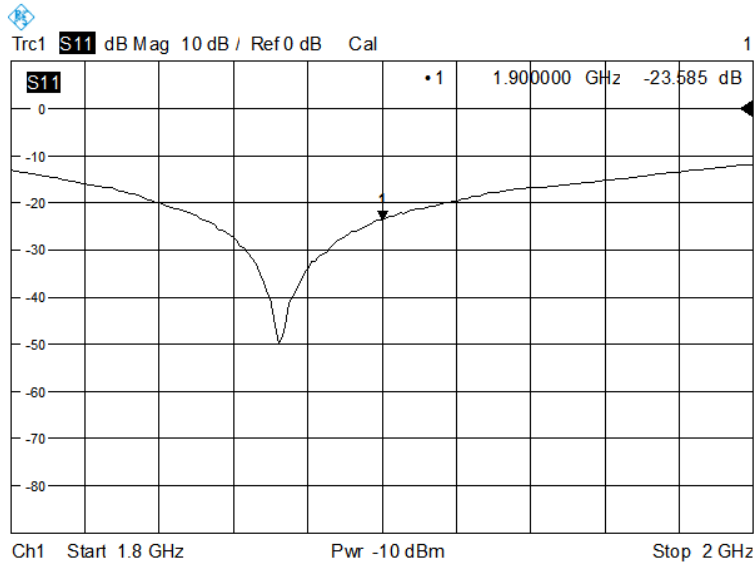

#### Impedance

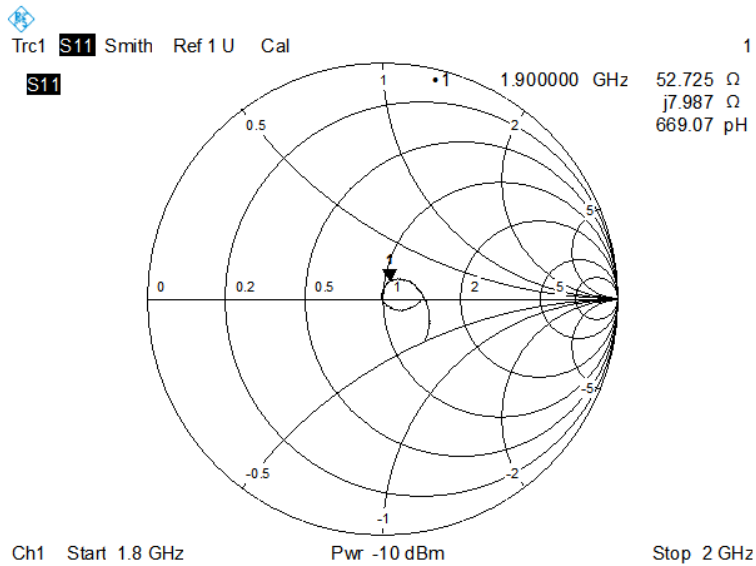





**RETURN LOSS AND IMPEDANCE IN BODY LIQUID**

Meas. Results	Current Meas.	Previous Meas.	Max. Deviation
Return Loss(dB)	-22.29	-22.45	0.7 %
Impedance	47.6 $\Omega$ + 4.5 j $\Omega$	46.7 $\Omega$ + 6.7 j $\Omega$	2.2 $\Omega$ (Imaginary part)

**Return Loss**

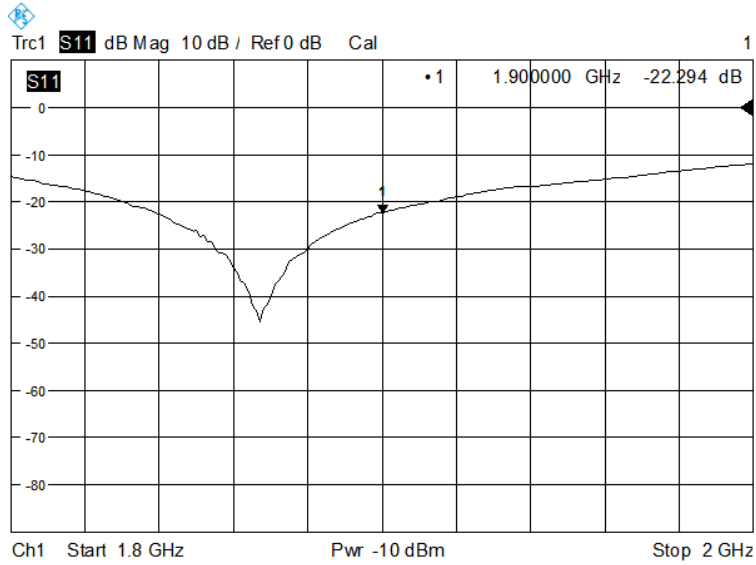

**Impedance**

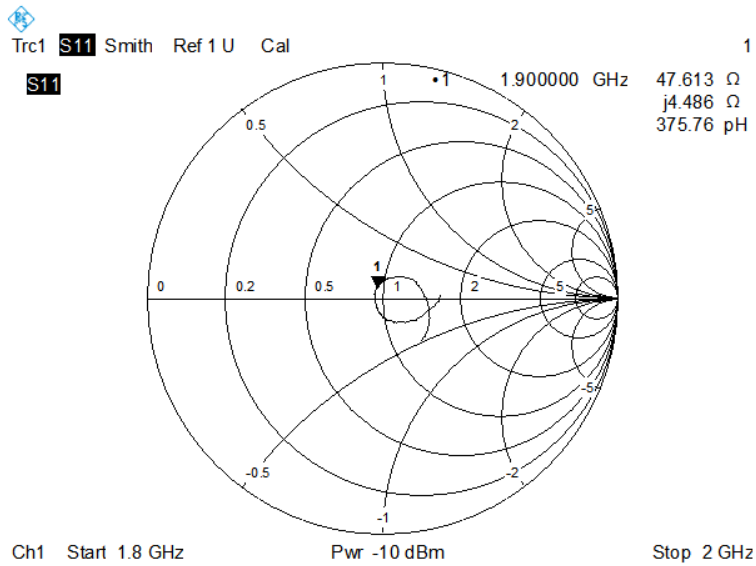

## 2.6 DIP 2G000

### RETURN LOSS AND IMPEDANCE IN HEAD LIQUID

Meas. Results	Current Meas.	Previous Meas.	Max. Deviation
Return Loss(dB)	-25.10	-24.61	2.0 %
Impedance	55.7Ω – 1.2 jΩ	54.3 Ω - 4.0 jΩ	2.8 Ω (Imaginary part)

#### Return Loss

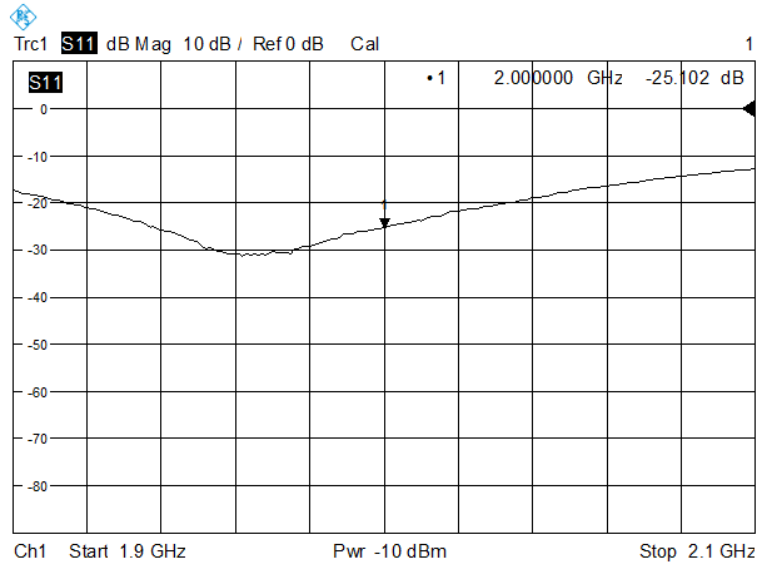

#### Impedance

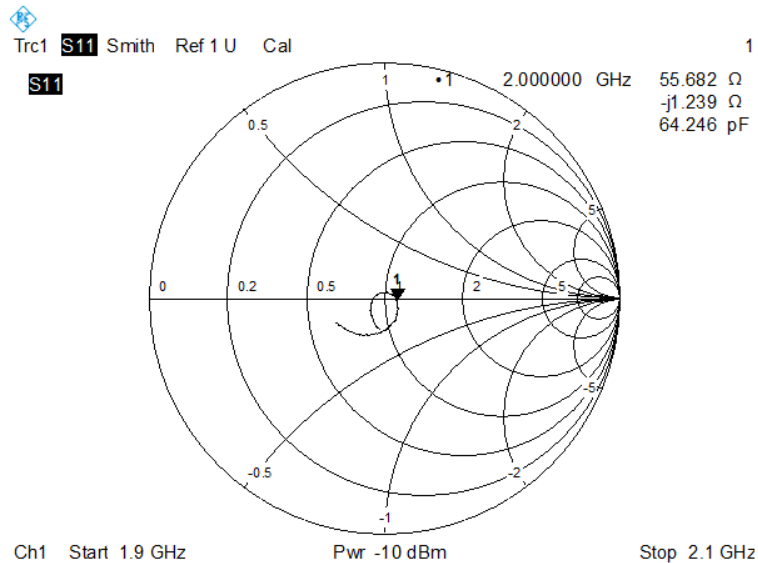



**RETURN LOSS AND IMPEDANCE IN BODY LIQUID**

Meas. Results	Current Meas.	Previous Meas.	Max. Deviation
Return Loss(dB)	-25.32	-24.74	2.3 %
Impedance	54.8Ω-0.4 jΩ	55.8 Ω - 0.3 jΩ	1.0 Ω (Real part)

**Return Loss**

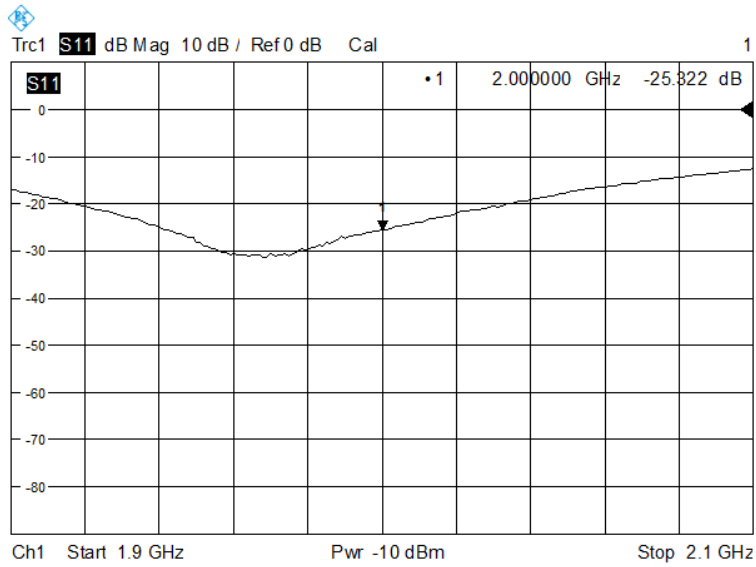

**Impedance**

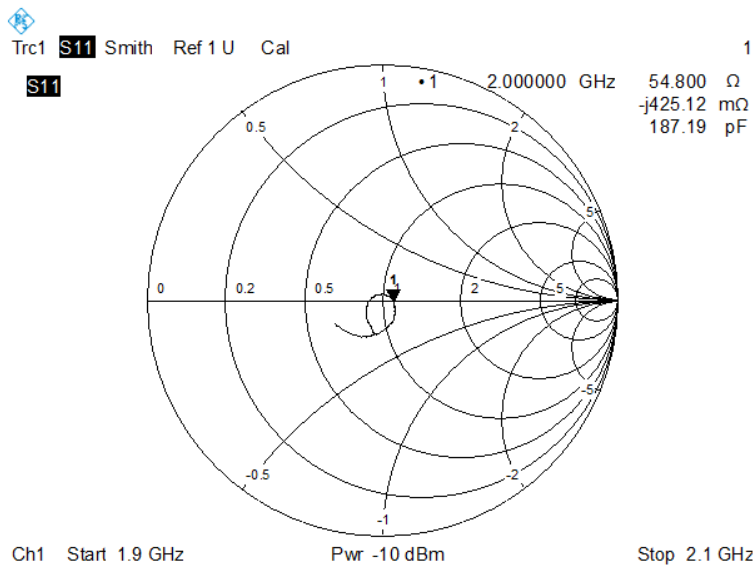



## 2.7 DIP 2G450

### RETURN LOSS AND IMPEDANCE IN HEAD LIQUID

Meas. Results	Current Meas.	Previous Meas.	Max. Deviation
Return Loss(dB)	-25.06	-24.82	1.0 %
Impedance	44.3 $\Omega$ + 1.4 j $\Omega$	44.3 $\Omega$ + 0.2 j $\Omega$	1.2 $\Omega$ (Imaginary part)

#### Return Loss

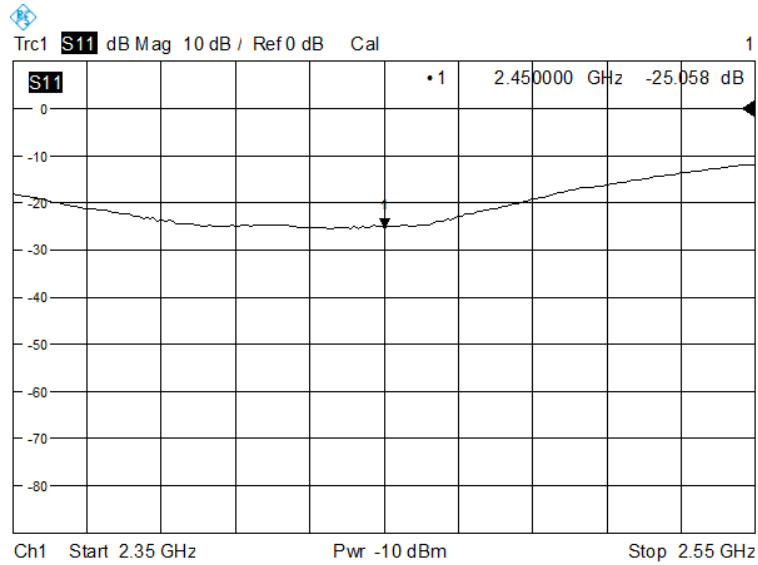

#### Impedance

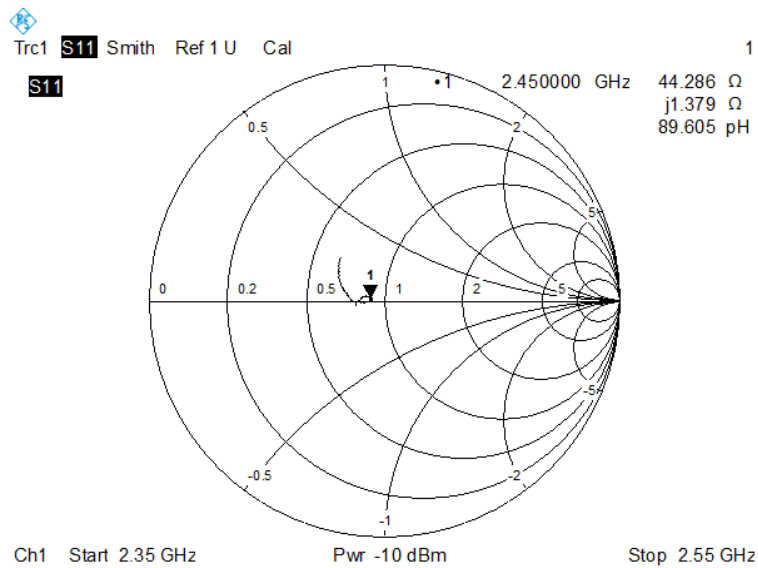



**RETURN LOSS AND IMPEDANCE IN BODY LIQUID**

Meas. Results	Current Meas.	Previous Meas.	Max. Deviation
Return Loss(dB)	-31.03	-31.92	0.3%
Impedance	48.7 $\Omega$ - 1.2 j $\Omega$	47.5 $\Omega$ - 0.4 j $\Omega$	1.2 $\Omega$ (Real part)

**Return Loss**

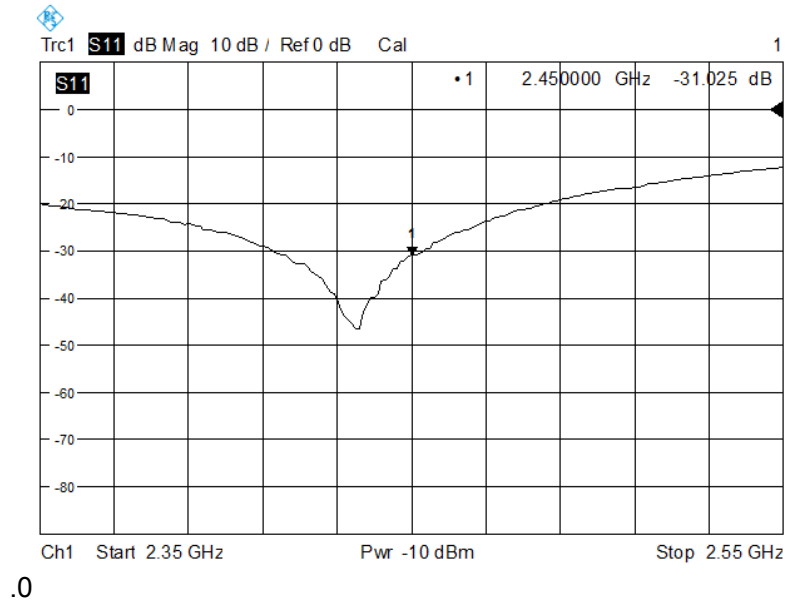

**Impedance**

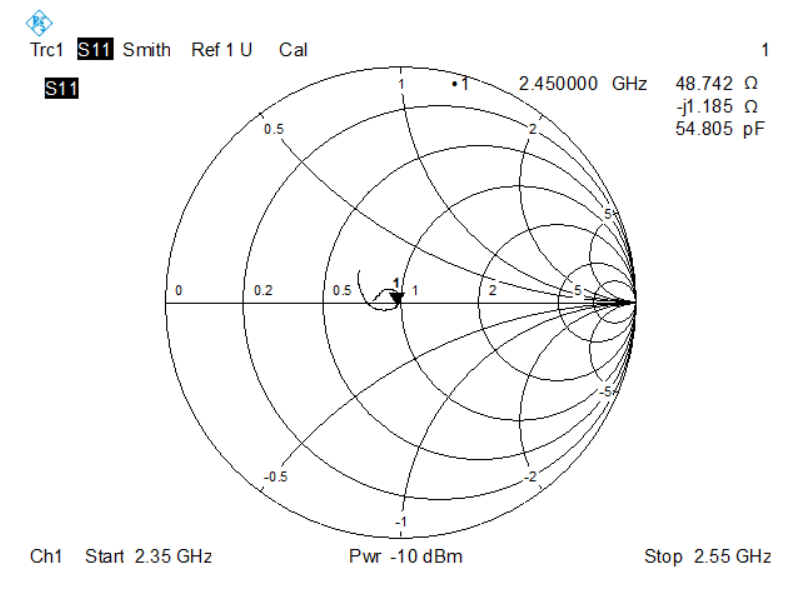



## 2.8 DIP 2G600

### RETURN LOSS AND IMPEDANCE IN HEAD LIQUID

Meas. Results	Current Meas.	Previous Meas.	Max. Deviation
Return Loss(dB)	-22.30	-21.53	3.8%
Impedance	47 Ω +7.8 jΩ	46.1 Ω +7.4 jΩ	0.9 Ω (Real part)

#### Return Loss

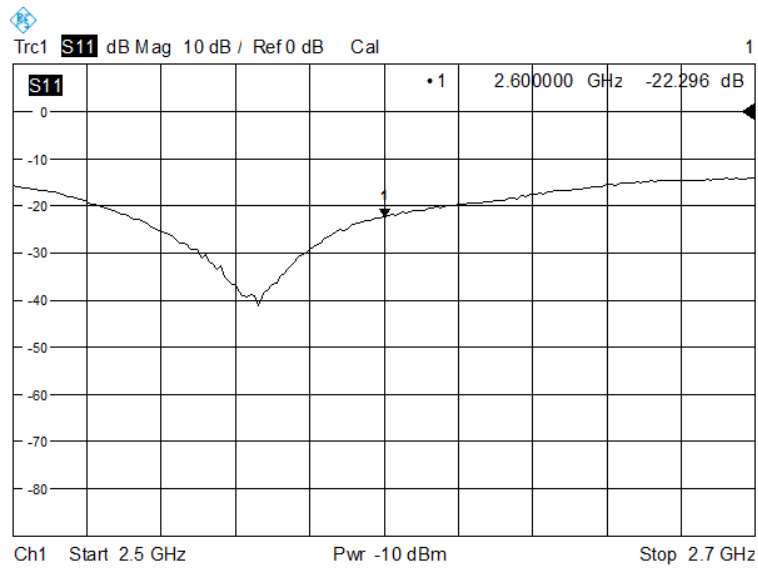

#### Impedance

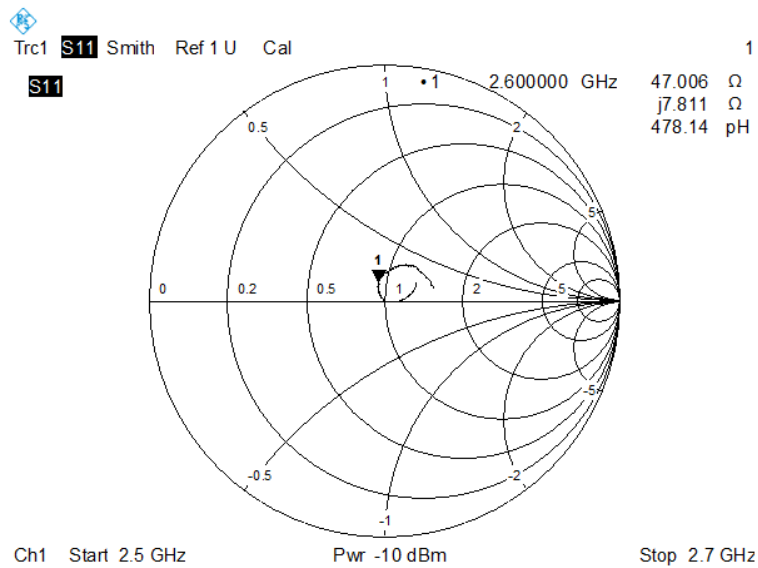

**RETURN LOSS AND IMPEDANCE IN BODY LIQUID**

Meas. Results	Current Meas.	Previous Meas.	Max. Deviation
Return Loss(dB)	-22.37	-21.76	2.8 %
Impedance	46.1Ω + 6.4 jΩ	44.2 Ω + 5.7 jΩ	1.9 Ω (Real part)

**Return Loss**

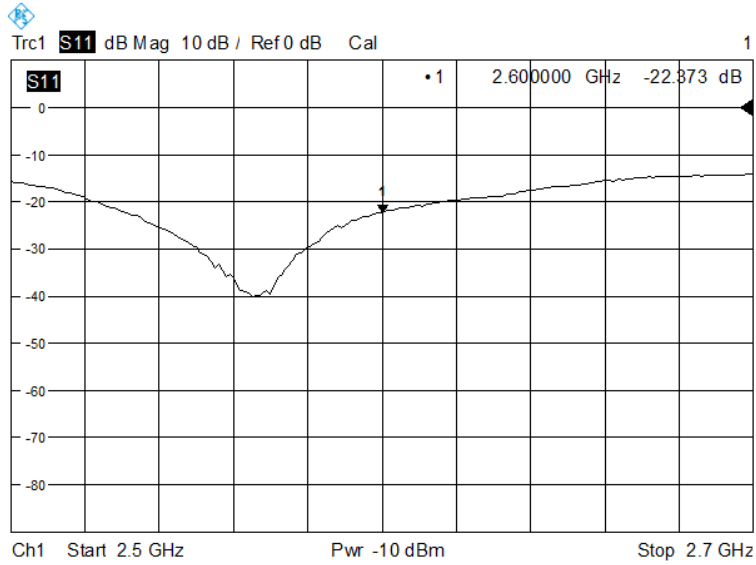

**Impedance**

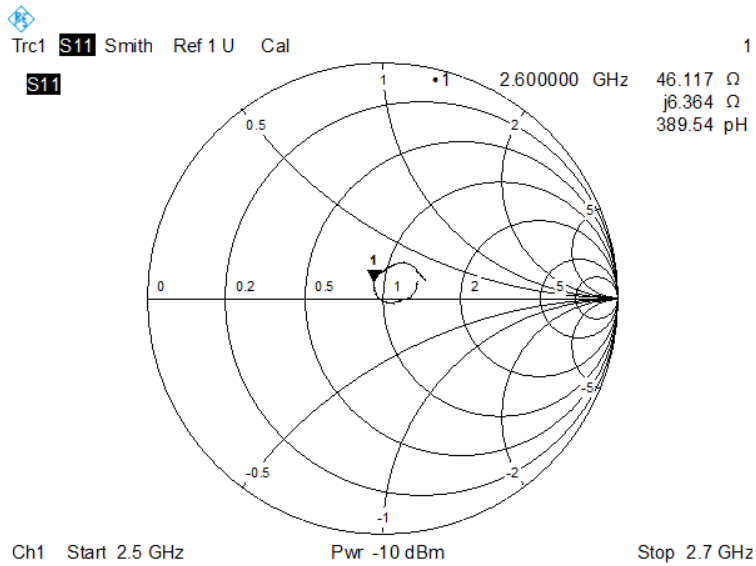

### 3 WAVEGUIDE IMPEDANCE AND RETURN LOSS

The waveguide are designed to have low return loss when presented against a flat phantom at the specified distance. A Vector Network Analyzer was used to perform a return loss measurement on the specific waveguide when in the measurement location against the phantom and the distance was specified by the manufacturer with a special, low loss and low relative permittivity spacer.

The impedance was measured at the SMA-connector with the network analyzer.

#### 3.1 SWG5500

##### RETURN LOSS AND IMPEDANCE IN HEAD LIQUID

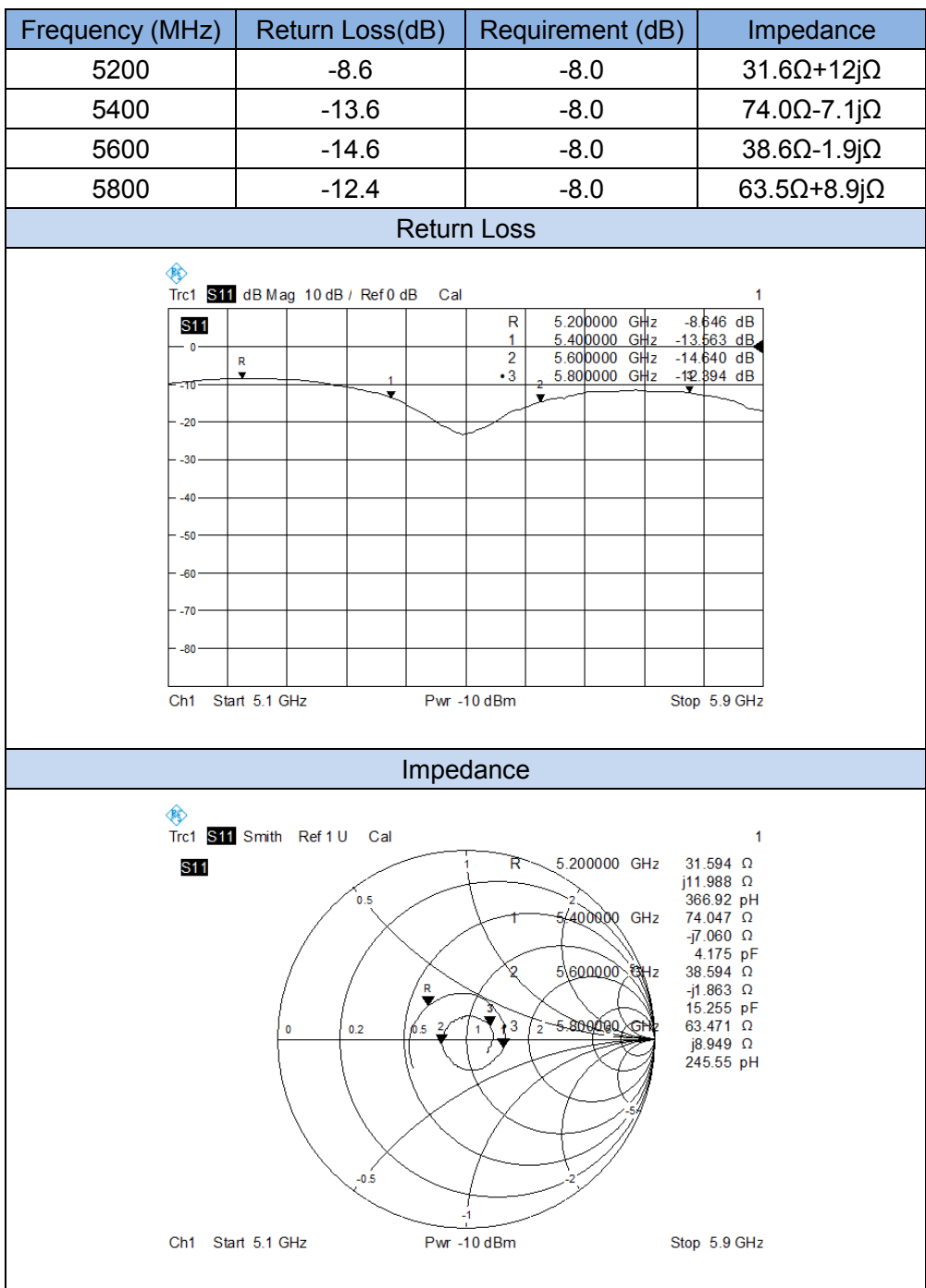





**RETURN LOSS AND IMPEDANCE IN BODY LIQUID**

Frequency (MHz)	Return Loss(dB)	Requirement (dB)	Impedance
5200	-10.8	-8.0	29.8Ω+13.9jΩ
5400	-13.0	-8.0	79.7Ω-9.5jΩ
5600	-16.3	-8.0	35.9Ω-3.6jΩ
5800	-15.9	-8.0	62.5Ω+15.2jΩ

**Return Loss**

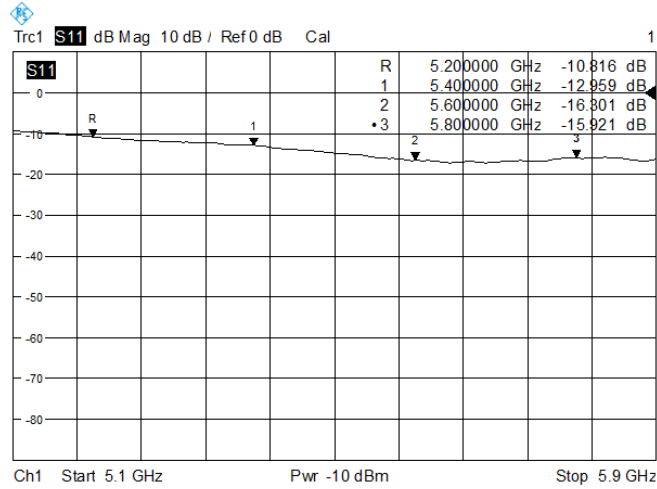

**Impedance**

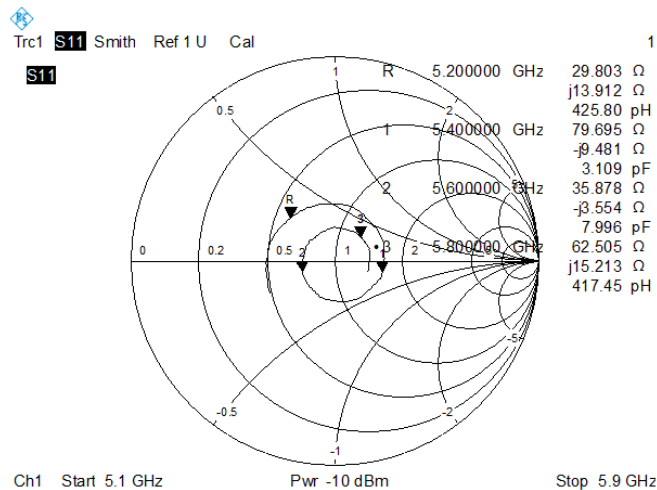

## 4 VALIDATION MEASUREMENT

The IEEE Std. 1528, FCC KDBs and CEI/IEC 62209 standards state that the system validation measurements must be performed using a reference dipole meeting the fore mentioned return loss and mechanical dimension requirements. The validation measurement must be performed against a liquid filled flat phantom, with the phantom constructed as outlined in the fore mentioned standards. Per the standards, the dipole shall be positioned below the bottom of the phantom, with the dipole length centered and parallel to the longest dimension of the flat phantom, with the top surface of the dipole at the described distance from the bottom surface of the phantom.

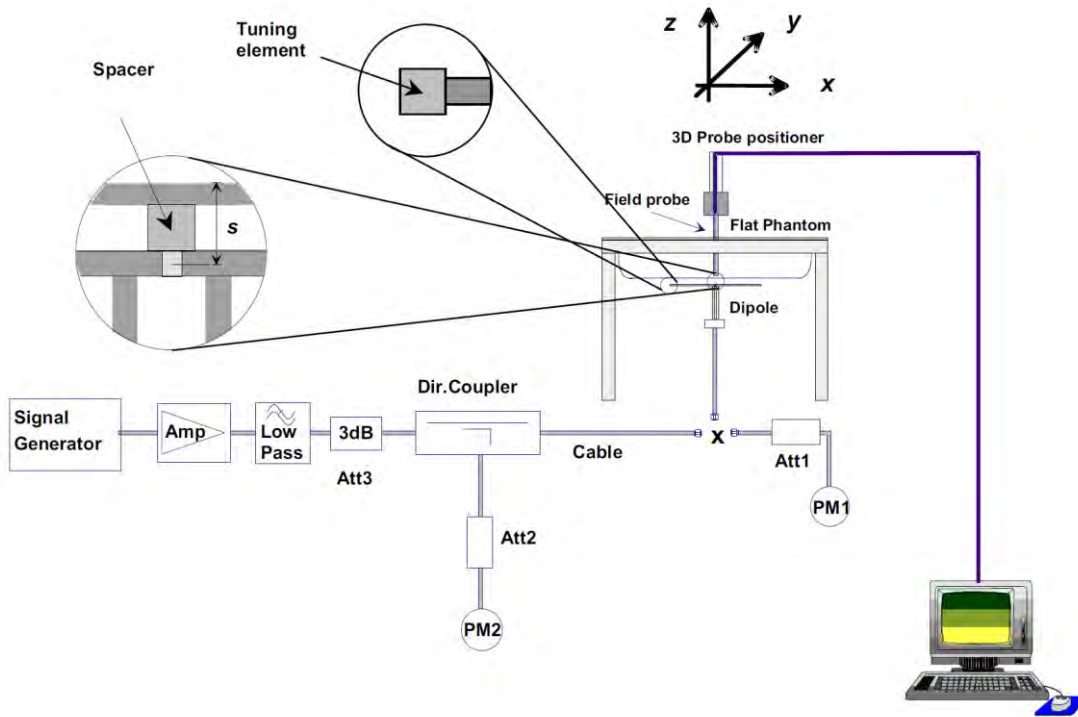



## 4.1 Simulating Liquid Verification

Liquid Type	Fre. (MHz)	Meas. Conductivity ( $\sigma$ ) (S/m)	Meas. Permittivity ( $\epsilon$ )	Target Conductivity ( $\sigma$ ) (S/m)	Target Permittivity ( $\epsilon$ )	Conductivity Tolerance (%)	Permittivity Tolerance (%)
Head	750	0.90	40.98	0.89	41.94	1.12	-2.29
Body		0.96	56.87	0.96	55.53	0.00	2.41
Head	835	0.92	40.91	0.90	41.50	2.22	-1.42
Body		0.99	56.27	0.97	55.20	2.06	1.94
Head	900	0.98	40.70	0.97	41.50	1.03	-1.93
Body		1.08	55.36	1.05	55.00	2.86	0.65
Head	1800	1.37	40.91	1.40	40.00	-2.14	2.27
Body		1.54	52.63	1.52	53.30	1.32	-1.26
Head	1900	1.39	40.89	1.40	40.00	-0.71	2.23
Body		1.52	52.28	1.52	53.30	0.00	-1.91
Head	2000	1.44	40.63	1.40	40.00	2.86	1.58
Body		1.55	51.98	1.52	53.30	1.97	-2.48
Head	2450	1.84	38.64	1.80	39.20	2.22	-1.43
Body		1.97	52.54	1.95	52.70	1.03	-0.30
Head	2600	1.89	38.19	1.96	39.01	-3.57	-2.10
Body		2.13	52.14	2.16	52.51	-1.39	-0.70
Head	5200	4.74	36.41	4.66	35.99	1.72	1.17
Body		5.49	48.08	5.30	49.01	3.58	-1.90
Head	5400	5.01	35.84	4.86	35.76	3.09	0.22
Body		5.61	47.46	5.53	48.74	1.45	-2.63
Head	5600	5.18	34.92	5.07	35.53	2.17	-1.72
Body		5.92	47.36	5.77	48.47	2.60	-2.29
Head	5800	5.30	34.13	5.27	35.30	0.57	-3.31
Body		6.13	47.31	6.00	48.20	2.17	-1.85



## 4.2 Dipole and Waveguide SAR Validation Measurement Result

Freq. (MHz)	Liquid Type	Power (mW)	1 g Measured SAR (W/kg)	Normalized SAR (W/kg)	10 g Measured SAR (W/kg)	Normalized SAR (W/kg)	1 g Targeted SAR (W/kg)	Tolerance (%)	10 g Targeted SAR (W/kg)	Tolerance (%)
750	Head	100	0.824	8.24	0.577	5.77	8.78	-6.15	5.72	0.87
	Body	100	0.877	8.77	0.586	5.86	8.59	2.10	5.74	2.09
835	Head	100	0.909	9.09	0.593	5.93	9.58	-5.11	6.10	-2.79
	Body	100	1.040	10.40	0.676	6.76	9.78	6.34	6.39	5.79
900	Head	100	1.082	10.82	0.662	6.62	11.31	-4.33	6.98	-5.16
	Body	100	1.149	11.49	0.737	7.37	11.29	1.77	7.21	2.22
1800	Head	100	4.078	40.78	2.126	21.26	38.76	5.21	20.29	4.78
	Body	100	3.945	39.45	2.096	20.96	38.90	1.41	20.84	0.58
1900	Head	100	3.880	38.80	2.042	20.42	39.49	-1.75	20.25	0.84
	Body	100	4.024	40.24	2.061	20.61	40.01	0.57	20.84	-1.10
2000	Head	100	4.174	41.74	2.094	20.94	43.26	-3.51	21.18	-1.13
	Body	100	4.389	43.89	2.208	22.08	41.93	4.67	21.11	4.59
2450	Head	100	5.219	52.19	2.388	23.88	54.31	-3.90	24.20	-1.32
	Body	100	5.190	51.90	2.428	24.28	53.67	-3.30	24.37	-0.37
2600	Head	100	5.469	54.69	2.496	24.96	56.32	-2.89	24.55	1.67
	Body	100	5.235	52.35	2.447	24.47	55.20	-5.16	24.62	-0.61
5200	Head	100	16.372	163.72	5.593	55.93	161.03	1.67	56.23	-0.53
	Body	100	15.882	158.82	5.453	54.53	158.91	-0.06	56.35	-3.23
5400	Head	100	17.240	172.40	5.818	58.18	168.17	2.52	57.98	0.34
	Body	100	17.553	175.53	5.964	59.64	164.39	6.78	57.72	3.33
5600	Head	100	17.434	174.34	5.851	58.51	175.43	-0.62	59.94	-2.39
	Body	100	18.258	182.58	5.562	55.62	170.90	6.83	59.37	-6.32
5800	Head	100	18.470	184.70	6.037	60.37	182.30	1.32	61.84	-2.38
	Body	100	18.654	186.54	6.172	61.72	177.09	5.34	61.19	0.87

### 4.3 DIP 0G750

#### 4.3.1 Dipole 750 MHz Validation Measurement for Head Tissue

## System Performance Check Data(750 MHz Head)

Type: Phone measurement (Complete)  
 E-Field Probe: SN 08/16 SSE2 EPGO295  
 Area scan resolution: dx=8mm,dy=8mm  
 Zoom scan resolution: dx=8mm, dy=8mm, dz=5mm  
 Date of measurement: 2018.03.17  
 Measurement duration: 13 minutes 28 seconds

### Experimental conditions.

<b>Phantom File</b>	surf_sam_plan.txt
<b>Phantom</b>	Validation plane
<b>Band</b>	750MHz
<b>Signal</b>	CW
<b>Frequency (MHz)</b>	750MHz
<b>Relative permittivity (real part)</b>	40.975182
<b>Conductivity (S/m)</b>	0.901352
<b>Power drift (%)</b>	-0.200000
<b>Ambient Temperature:</b>	22.5°C
<b>Liquid Temperature:</b>	21.8°C
<b>ConvF:</b>	1.52
<b>Crest factor:</b>	1:1

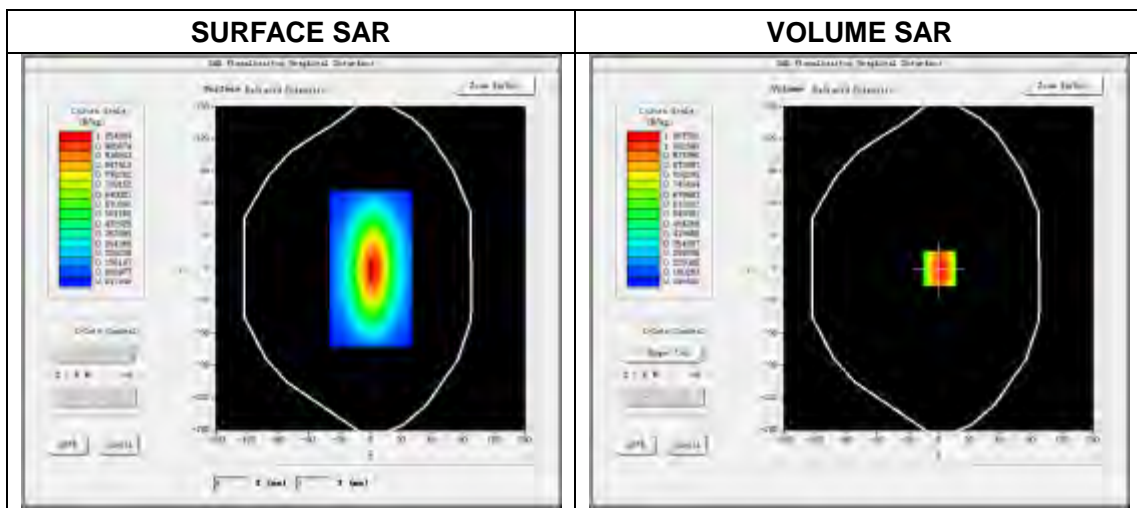

Maximum location: X=1.00, Y=0.00

SAR Peak: 1.17 W/kg

SAR 10g (W/Kg)	0.576947
SAR 1g (W/Kg)	0.824215

### Z Axis Scan

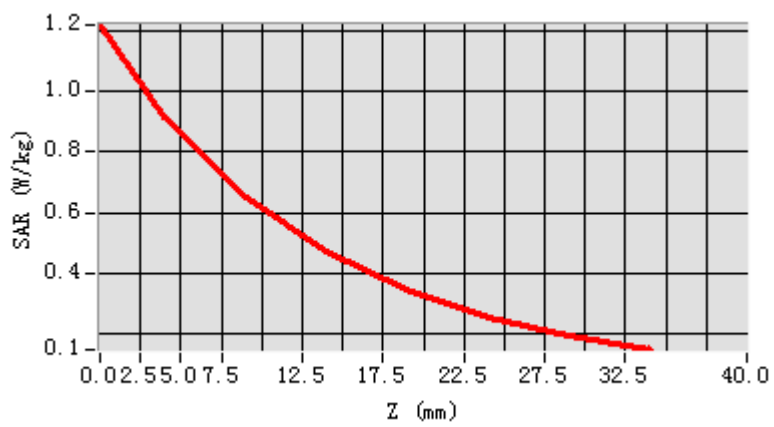

### 3D screen shot

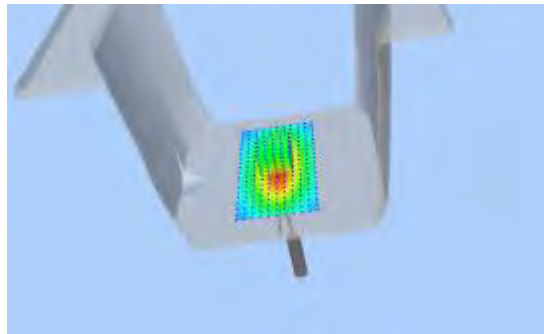

### Hot spot position

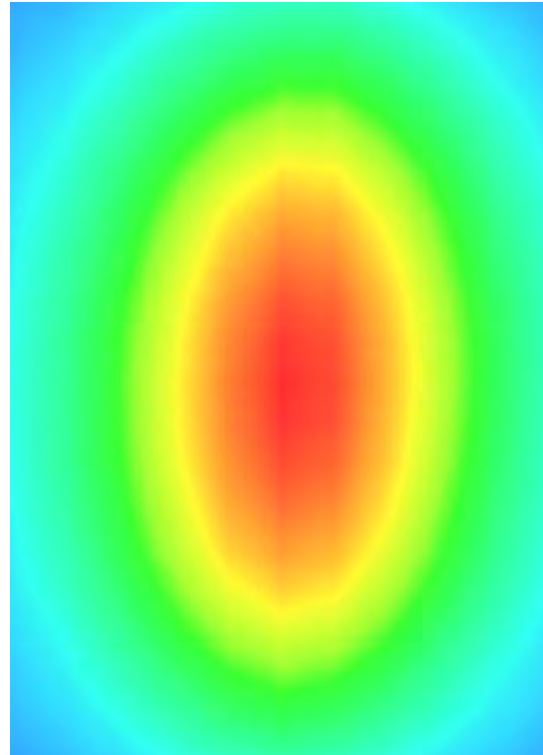

### 4.3.2 Dipole 750 MHz Validation Measurement for Body Tissue

## System Performance Check Data(750 MHz Body)

Type: Phone measurement (Complete)  
 E-Field Probe: SN 08/16 SSE2 EPGO295  
 Area scan resolution: dx=8mm,dy=8mm  
 Zoom scan resolution: dx=8mm, dy=8mm, dz=5mm  
 Date of measurement: 2018.03.17  
 Measurement duration: 13 minutes 19 seconds

### Experimental conditions.

Phantom File	surf_sam_plan.txt
Phantom	Validation plane
Band	750MHz
Signal	CW
Frequency (MHz)	750MHz
Relative permittivity (real part)	56.873354
Conductivity (S/m)	0.964528
Power drift (%)	0.250000
Ambient Temperature:	22.5°C
Liquid Temperature:	21.4°C
ConvF:	1.56
Crest factor:	1:1

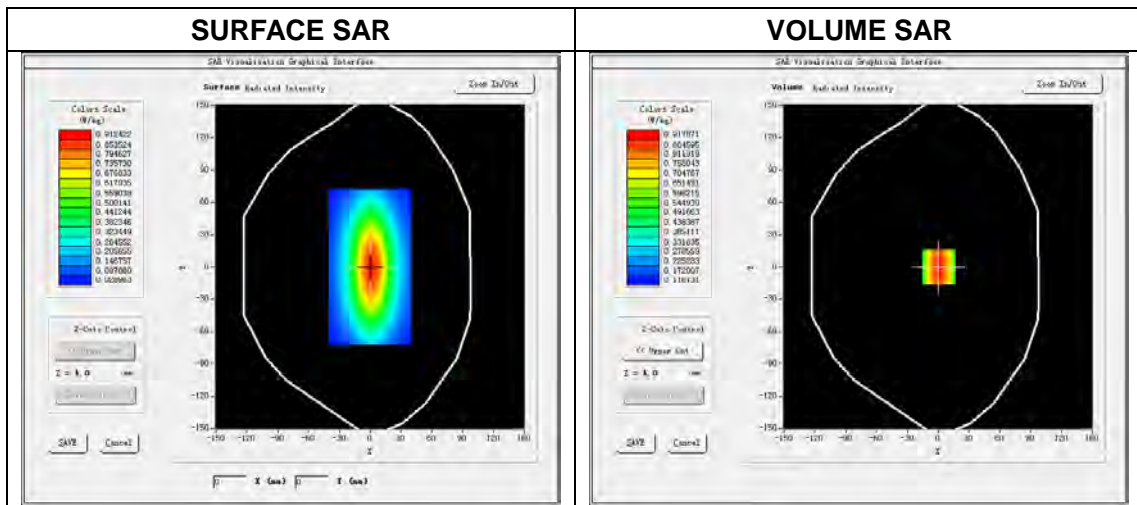

Maximum location: X=1.00, Y=0.00

SAR Peak: 1.27 W/kg

SAR 10g (W/Kg)	0.586138
SAR 1g (W/Kg)	0.876721

### Z Axis Scan

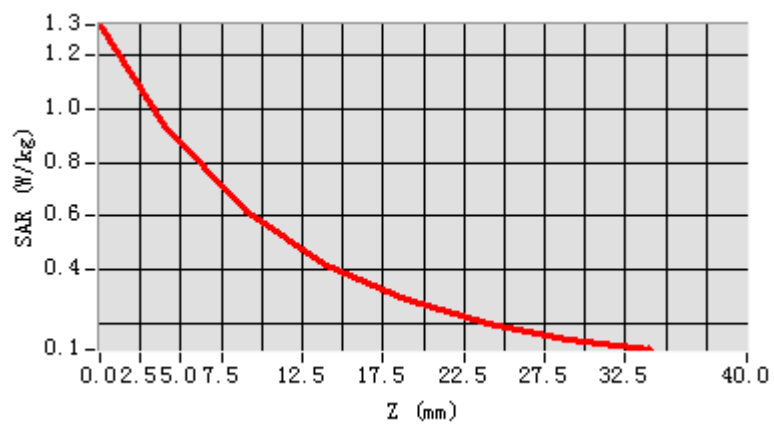

3D screen shot

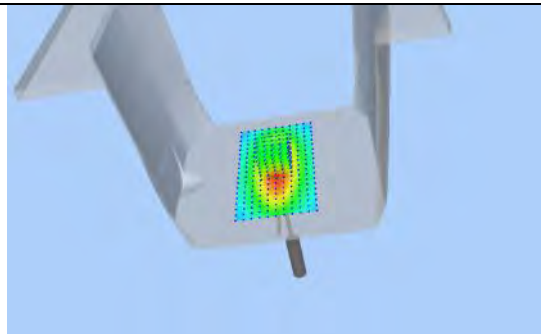

Hot spot position

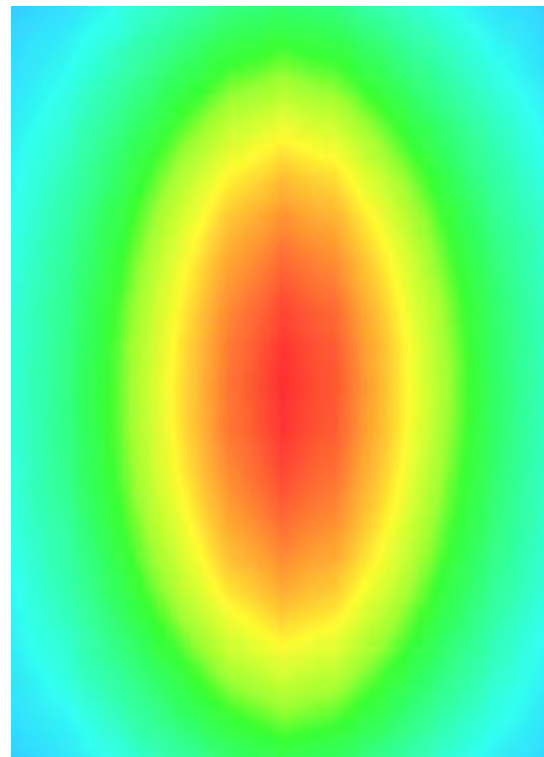



## 4.4 DIP 0G835

### 4.4.1 Dipole 835 MHz Validation Measurement for Head Tissue

# System Performance Check Data(835 MHz Head)

Type: Phone measurement (Complete)  
 E-Field Probe: SN 08/16 SSE2 EPGO295  
 Area scan resolution: dx=8mm,dy=8mm  
 Zoom scan resolution: dx=8mm, dy=8mm, dz=5mm  
 Date of measurement: 2018.03.17  
 Measurement duration: 14 minutes 17 seconds

### Experimental conditions.

Phantom File	surf_sam_plan.txt
Phantom	Validation plane
Band	835 MHz
Signal	CW
Frequency (MHz)	835.000000
Relative permittivity (real part)	40.906431
Conductivity (S/m)	0.917665
Power drift (%)	0.080000
Ambient Temperature:	22.5°C
Liquid Temperature:	21.8°C
ConvF:	1.78
Crest factor:	1:1

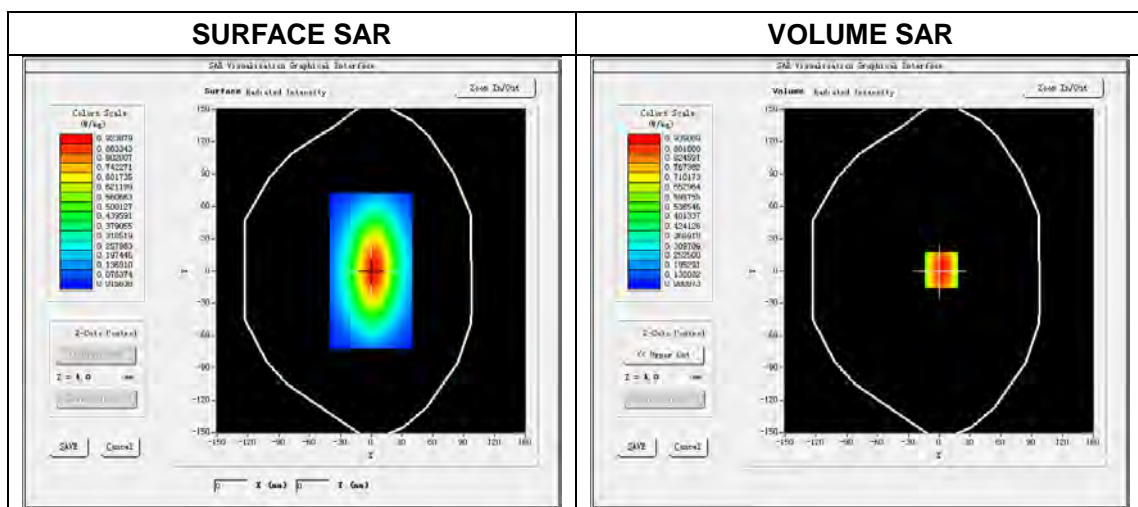

Maximum location: X=0.00, Y=0.00

SAR Peak: 1.32 W/kg

SAR 10 g (W/Kg)	0.592673
SAR 1g (W/Kg)	0.909439

### Z Axis Scan

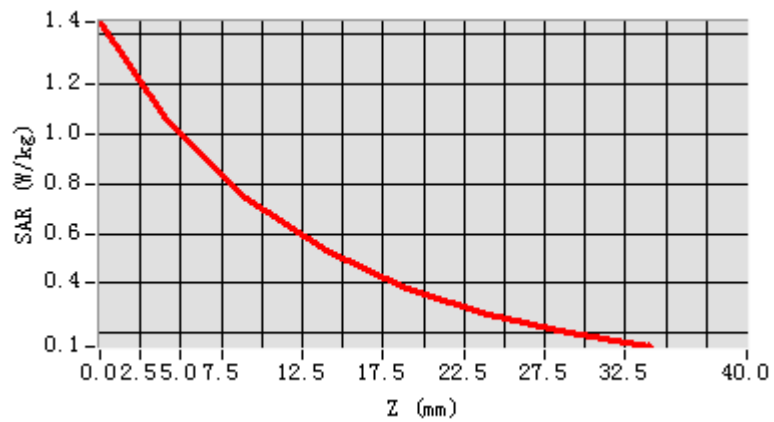

### 3D screen shot

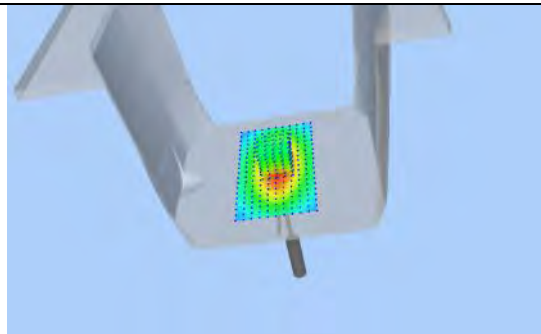

### Hot spot position

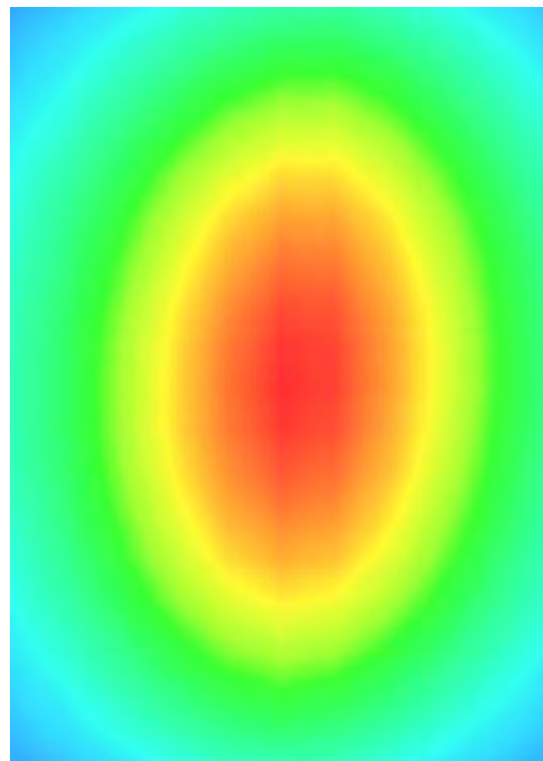

#### 4.4.2 Dipole 835 MHz Validation Measurement for Body Tissue

## System Performance Check Data(835 MHz Body)

Type: Phone measurement (Complete)  
 E-Field Probe: SN 08/16 SSE2 EPGO295  
 Area scan resolution: dx=8mm,dy=8mm  
 Zoom scan resolution: dx=8mm, dy=8mm, dz=5mm  
 Date of measurement: 2018.03.17  
 Measurement duration: 13 minutes 52 seconds

### Experimental conditions.

Phantom File	surf_sam_plan.txt
Phantom	Validation plane
Band	835 MHz
Signal	CW
Frequency (MHz)	835.000000
Relative permittivity (real part)	56.274324
Conductivity (S/m)	0.986865
Power drift (%)	0.170000
Ambient Temperature:	22.5°C
Liquid Temperature:	21.4°C
ConvF:	1.85
Crest factor:	1:1

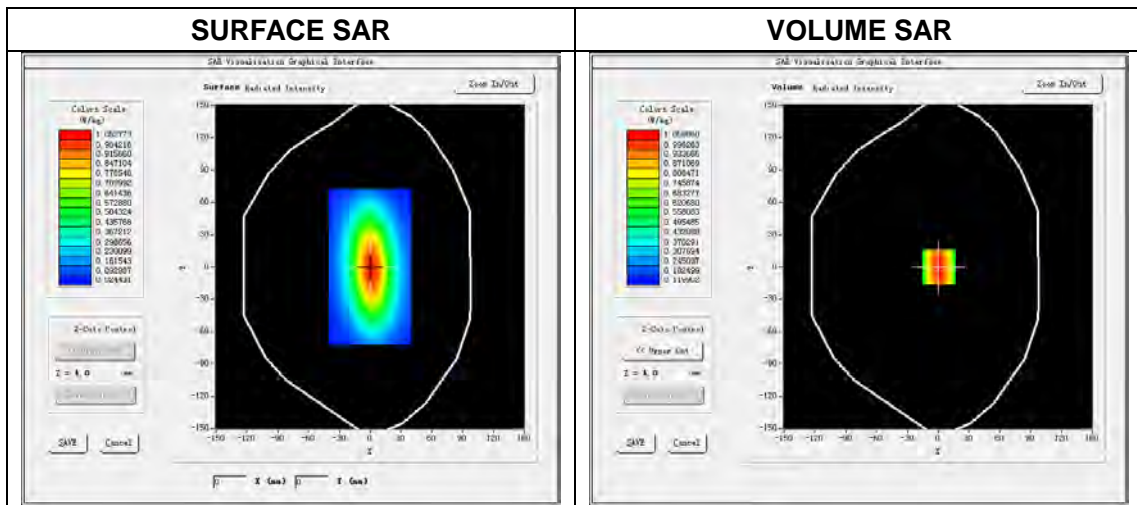

Maximum location: X=0.00, Y=0.00

SAR Peak: 1.47 W/kg

SAR 10 g (W/Kg)	0.675963
SAR 1g (W/Kg)	1.035769

### Z Axis Scan

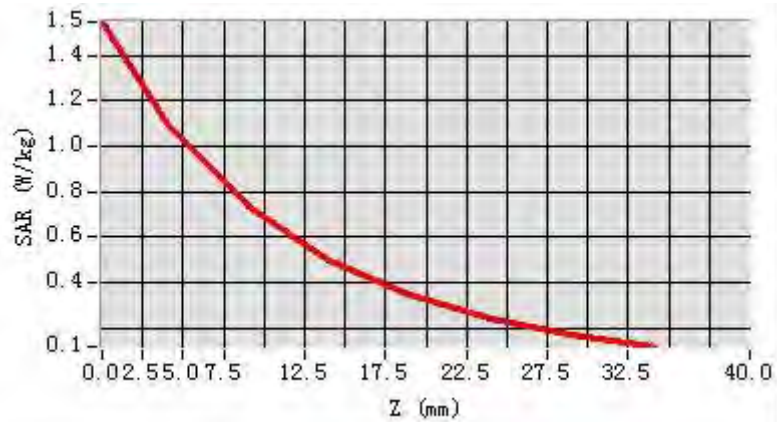

3D screen shot

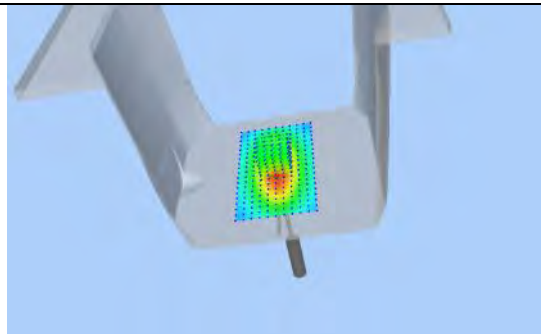

Hot spot position

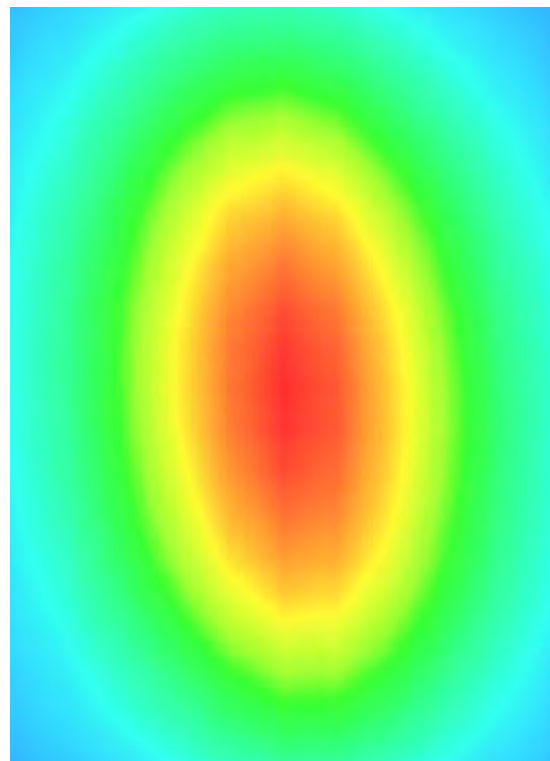

## 4.5 DIP 0G900

### 4.5.1 Dipole 900 MHz Validation Measurement for Head Tissue

# System Performance Check Data(900 MHz Head)

Type: Phone measurement (Complete)  
 E-Field Probe: SN 08/16 SSE2 EPGO295  
 Area scan resolution: dx=8mm,dy=8mm  
 Zoom scan resolution: dx=8mm, dy=8mm, dz=5mm  
 Date of measurement: 2018.03.17  
 Measurement duration: 14 minutes 17 seconds

### Experimental conditions.

<b>Phantom File</b>	surf_sam_plan.txt
<b>Phantom</b>	Validation plane
<b>Band</b>	900 MHz
<b>Signal</b>	CW
<b>Frequency (MHz)</b>	900.000000
<b>Relative permittivity (real part)</b>	40.702185
<b>Conductivity (S/m)</b>	0.982138
<b>Power drift (%)</b>	-0.070000
<b>Ambient Temperature:</b>	22.5°C
<b>Liquid Temperature:</b>	21.8°C
<b>ConvF:</b>	1.62
<b>Crest factor:</b>	1:1

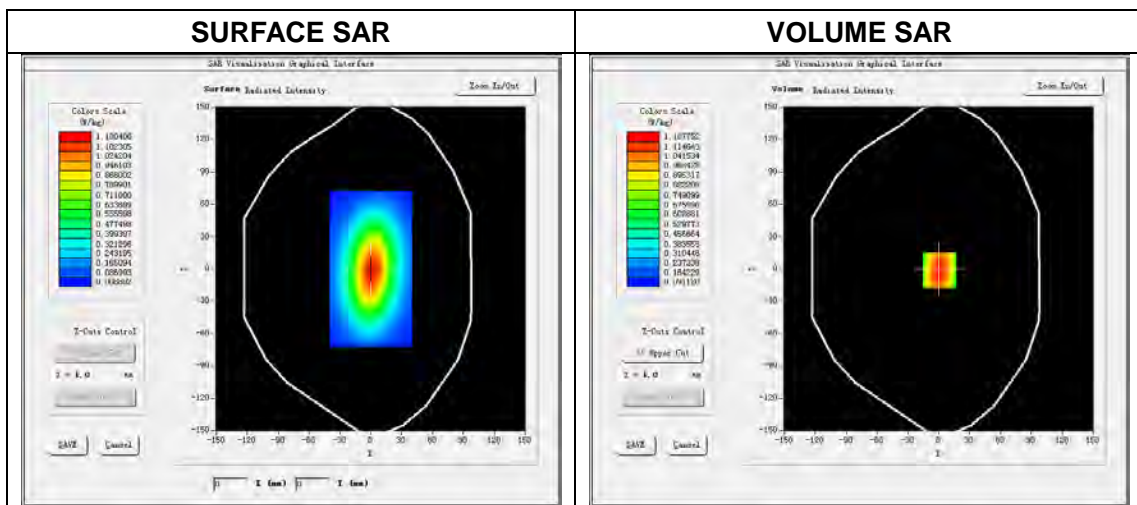

Maximum location: X=0.00, Y=0.00

SAR Peak: 1.49 W/kg

SAR 10 g (W/Kg)	0.662144
SAR 1g (W/Kg)	1.081505

### Z Axis Scan

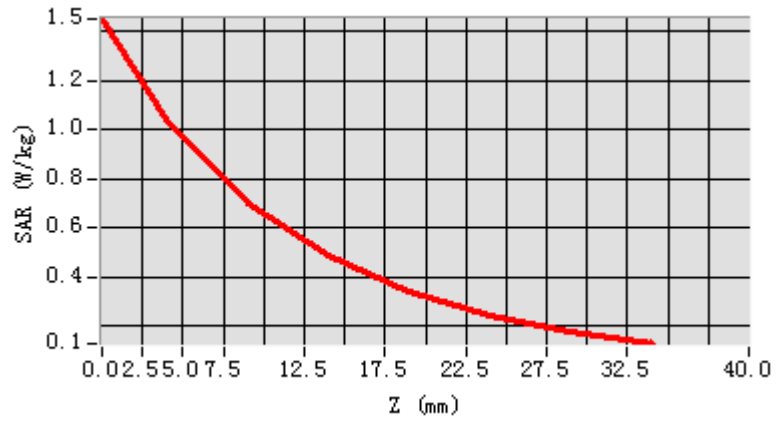

### 3D screen shot

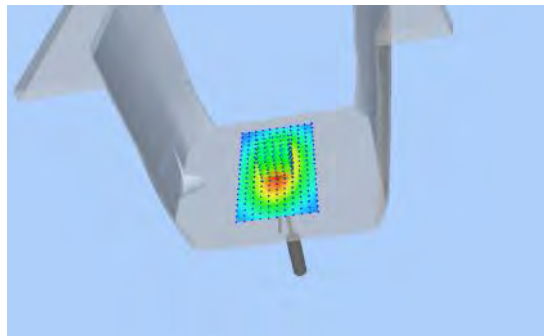

### Hot spot position

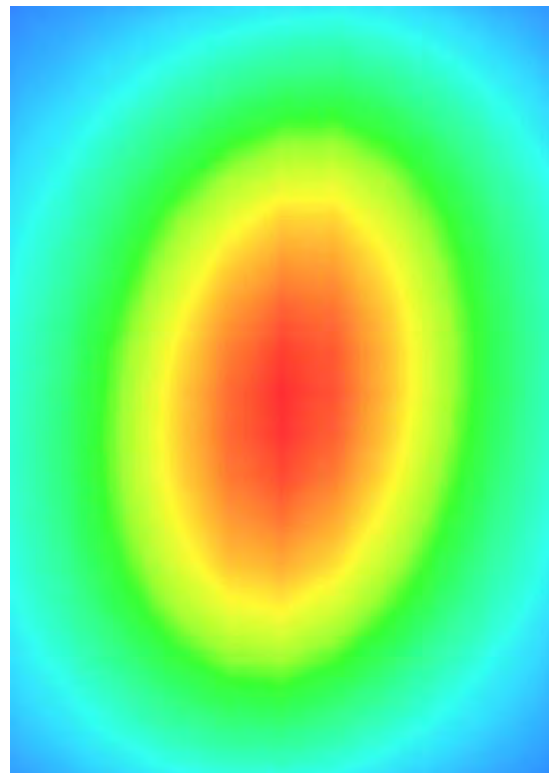

## 4.5.2 Dipole 900 MHz Validation Measurement for Body Tissue

# System Performance Check Data(900 MHz Body)

Type: Phone measurement (Complete)

E-Field Probe: SN 08/16 SSE2 EPGO295

Area scan resolution: dx=8mm,dy=8mm

Zoom scan resolution: dx=8mm, dy=8mm, dz=5mm

Date of measurement: 2018.03.17

Measurement duration: 13 minutes 56 seconds

### Experimental conditions.

<b>Phantom File</b>	surf_sam_plan.txt
<b>Phantom</b>	Validation plane
<b>Band</b>	900 MHz
<b>Signal</b>	CW
<b>Frequency (MHz)</b>	900.000000
<b>Relative permittivity (real part)</b>	55.362571
<b>Conductivity (S/m)</b>	1.08195
<b>Power drift (%)</b>	-0.120000
<b>Ambient Temperature:</b>	22.5°C
<b>Liquid Temperature:</b>	21.4°C
<b>ConvF:</b>	1.68
<b>Crest factor:</b>	1:1

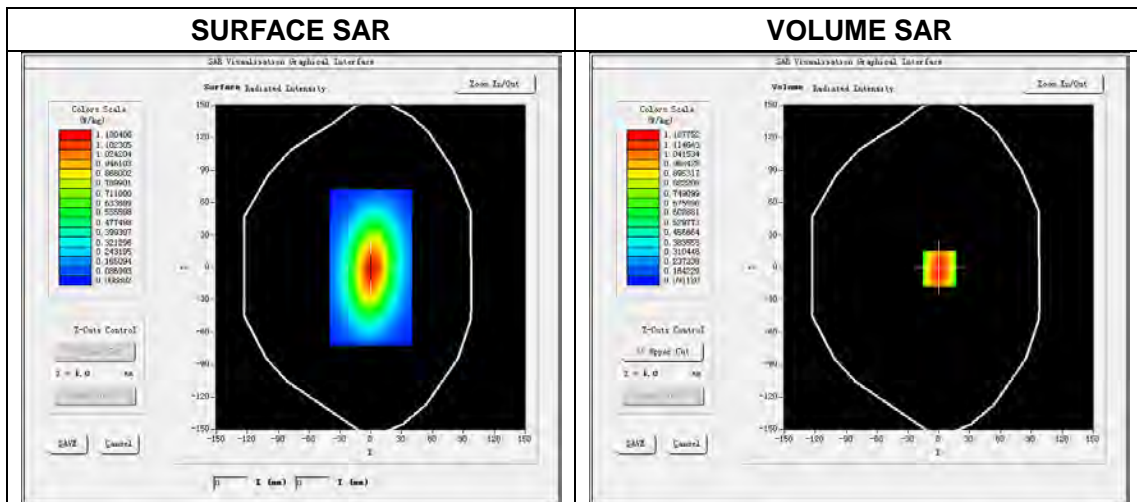

Maximum location: X=0.00, Y=0.00

SAR Peak: 1.66 W/kg

SAR 10 g (W/Kg)	0.736807
SAR 1g (W/Kg)	1.149340

### Z Axis Scan

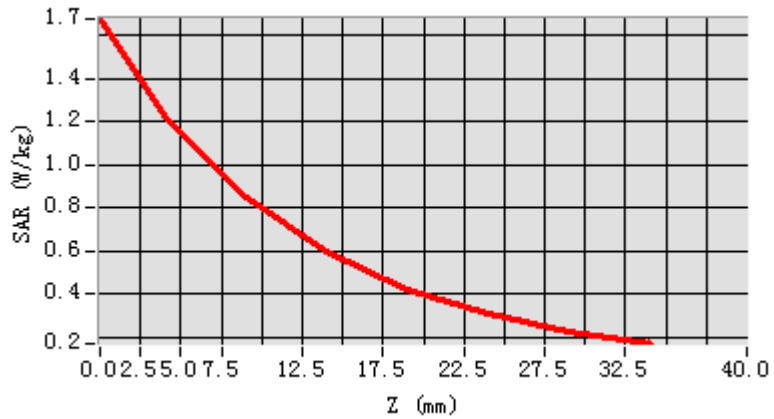

3D screen shot

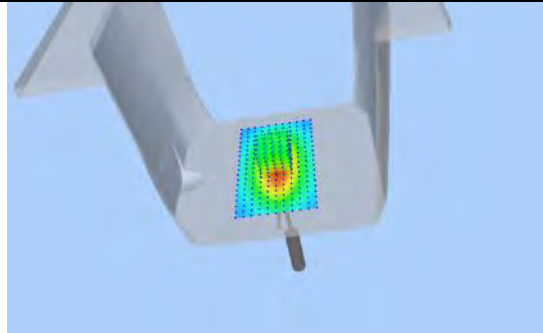

Hot spot position

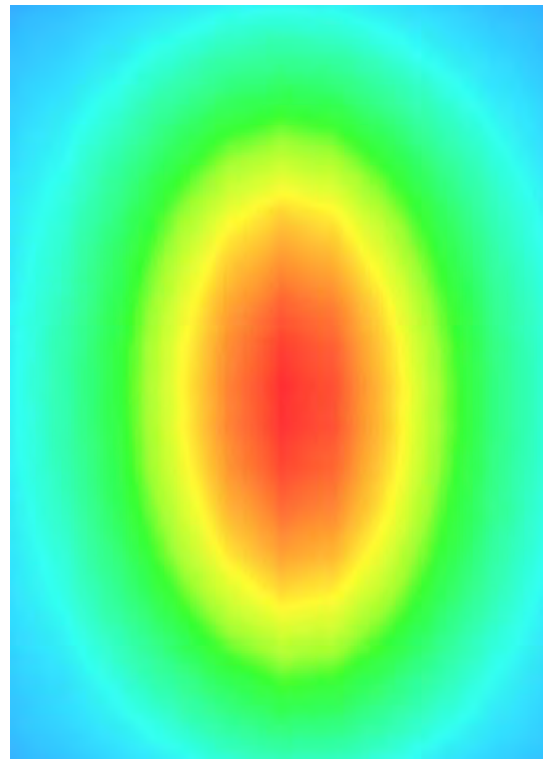



## 4.6 DIP 1G800

### 4.6.1 Dipole 1800 MHz Validation Measurement for Head Tissue

## System Performance Check Data(1800 MHz Head)

Type: Phone measurement (Complete)  
 E-Field Probe: SN 08/16 SSE2 EPGO295  
 Area scan resolution: dx=8mm,dy=8mm  
 Zoom scan resolution: dx=8mm, dy=8mm, dz=5mm  
 Date of measurement:2018.03.18  
 Measurement duration: 13 minutes 51 seconds

### Experimental conditions.

<b>Phantom File</b>	surf_sam_plan.txt
<b>Phantom</b>	Validation plane
<b>Band</b>	1800MHz
<b>Signal</b>	CW
<b>Frequency (MHz)</b>	1800.000000
<b>Relative permittivity (real part)</b>	40.914161
<b>Conductivity (S/m)</b>	1.374326
<b>Power drift (%)</b>	0.160000
<b>Ambient Temperature:</b>	22.7°C
<b>Liquid Temperature:</b>	21.6°C
<b>ConvF:</b>	1.88
<b>Crest factor:</b>	1:1

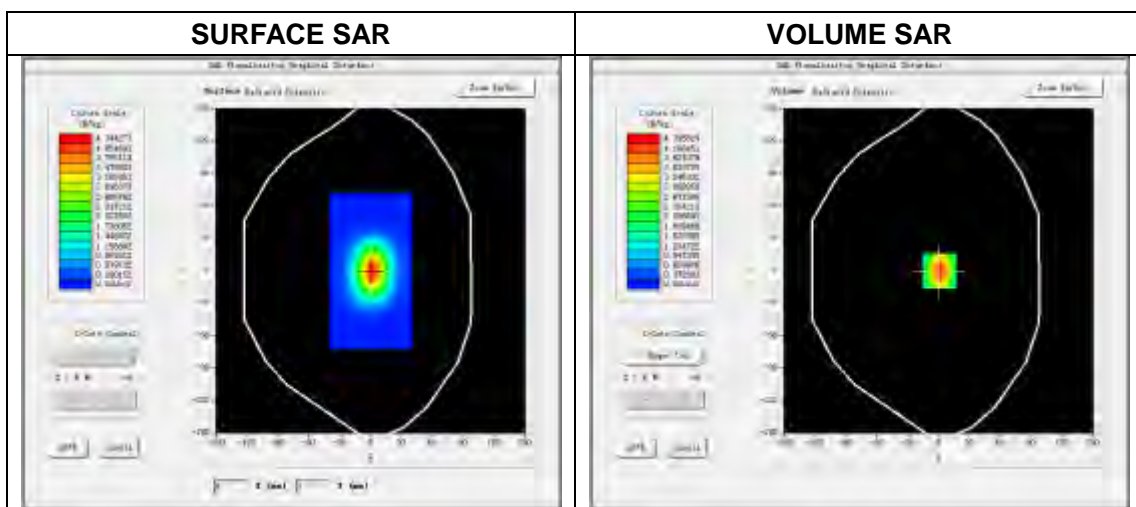

Maximum location: X=0.00, Y=0.00

SAR Peak: 6.83 W/kg

SAR 10 g (W/Kg)	2.126010
SAR 1g (W/Kg)	4.078166

### Z Axis Scan

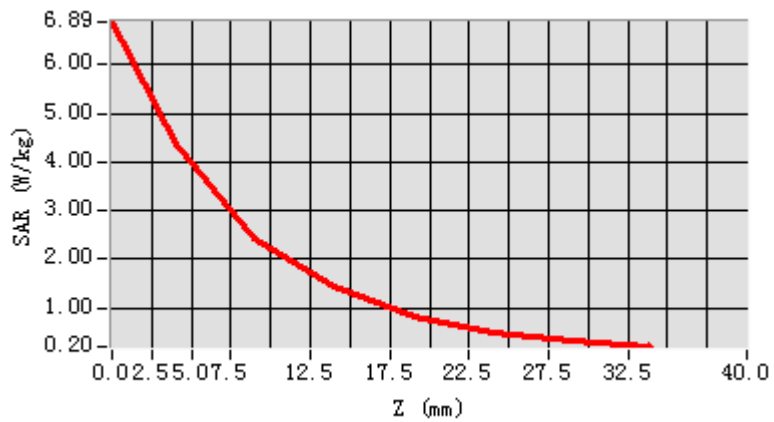

3D screen shot

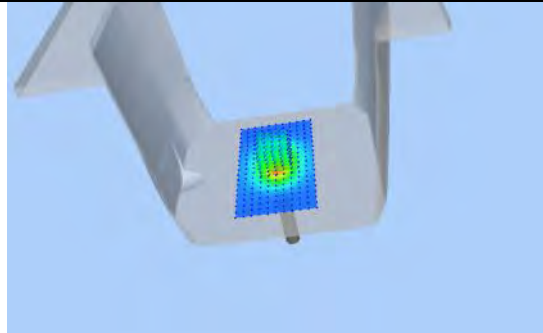

Hot spot position

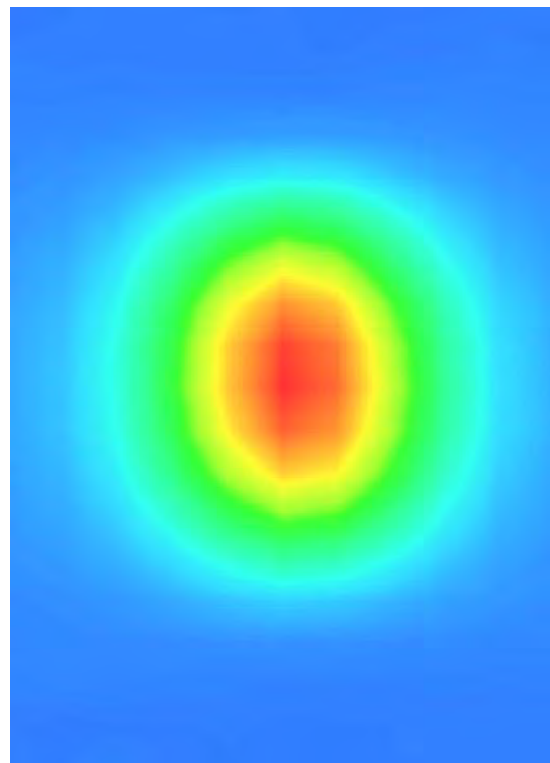

#### 4.6.2 Dipole 1800 MHz Validation Measurement for Body Tissue

### System Performance Check Data(1800 MHz Body)

Type: Phone measurement (Complete)  
 E-Field Probe: SN 08/16 SSE2 EPGO295  
 Area scan resolution: dx=8mm,dy=8mm  
 Zoom scan resolution: dx=8mm, dy=8mm, dz=5mm  
 Date of measurement:2018.03.18  
 Measurement duration: 13 minutes 47 seconds

#### Experimental conditions.

<b>Phantom File</b>	surf_sam_plan.txt
<b>Phantom</b>	Validation plane
<b>Band</b>	1800MHz
<b>Signal</b>	CW
<b>Frequency (MHz)</b>	1800.000000
<b>Relative permittivity (real part)</b>	52.634251
<b>Conductivity (S/m)</b>	1.535684
<b>Power drift (%)</b>	-0.130000
<b>Ambient Temperature:</b>	22.7°C
<b>Liquid Temperature:</b>	21.2°C
<b>ConvF:</b>	1.94
<b>Crest factor:</b>	1:1

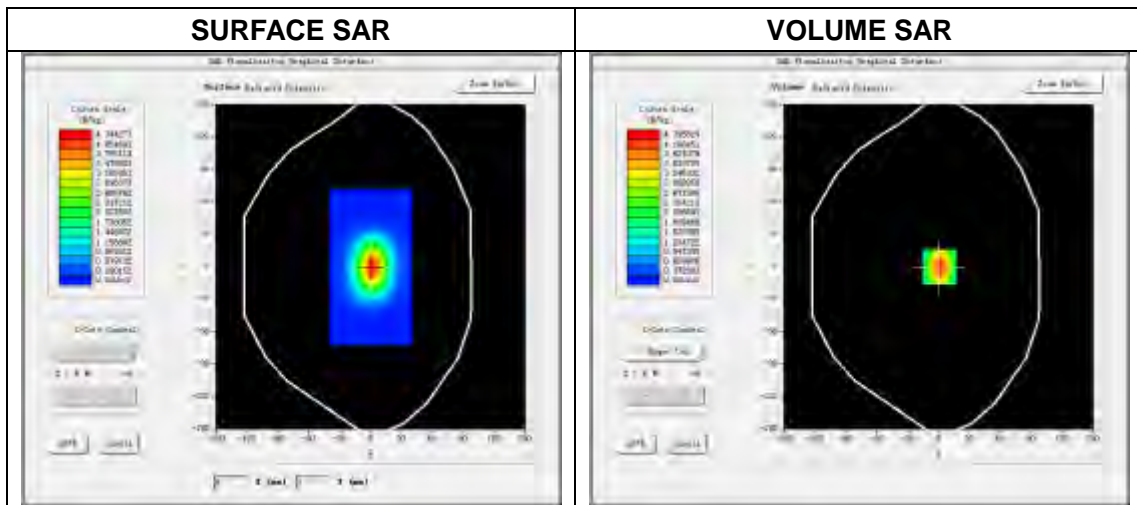

Maximum location: X=0.00, Y=0.00

SAR Peak: 6.63 W/kg

SAR 10 g (W/Kg)	2.096133
SAR 1g (W/Kg)	3.945247

### Z Axis Scan

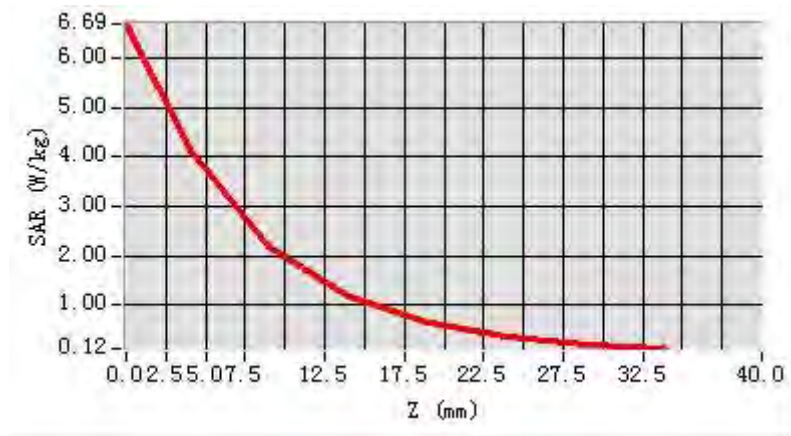

### 3D screen shot

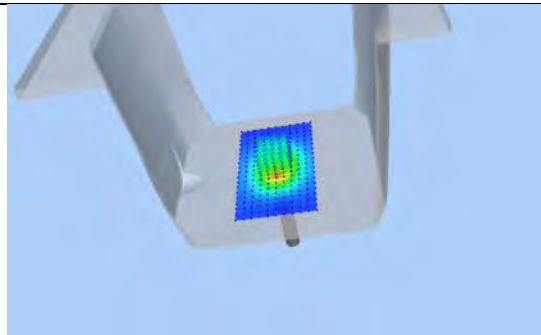

### Hot spot position

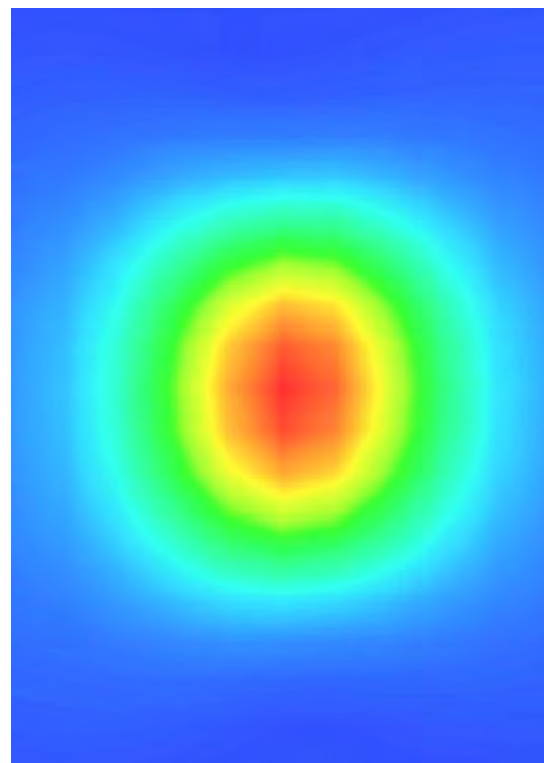

## 4.7 DIP 1G900

### 4.7.1 Dipole 1900 MHz Validation Measurement for Head Tissue

## System Performance Check Data(1900 MHz Head)

Type: Phone measurement (Complete)  
 E-Field Probe: SN 08/16 SSE2 EPGO295  
 Area scan resolution: dx=8mm,dy=8mm  
 Zoom scan resolution: dx=8mm, dy=8mm, dz=5mm  
 Date of measurement: 2018.03.18  
 Measurement duration: 13 minutes 57 seconds

### Experimental conditions.

<b>Phantom File</b>	surf_sam_plan.txt
<b>Phantom</b>	Validation plane
<b>Band</b>	1900MHz
<b>Signal</b>	CW
<b>Frequency (MHz)</b>	1900.000000
<b>Relative permittivity (real part)</b>	40.887526
<b>Conductivity (S/m)</b>	1.394326
<b>Power drift (%)</b>	0.290000
<b>Ambient Temperature:</b>	22.7°C
<b>Liquid Temperature:</b>	21.0°C
<b>ConvF:</b>	2.19
<b>Crest factor:</b>	1:1

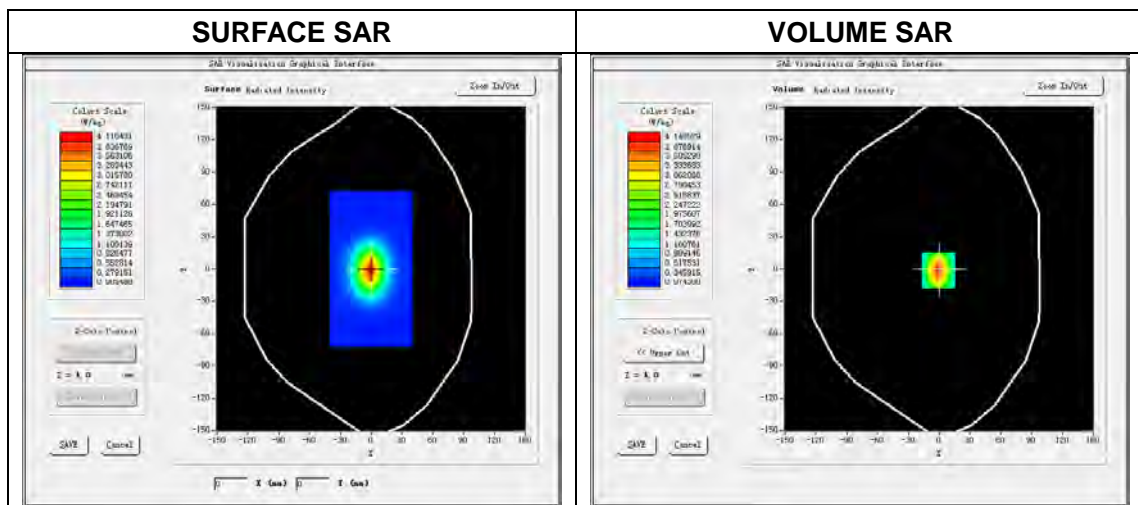

Maximum location: X=0.00, Y=0.00

SAR Peak: 6.59W/kg

SAR 10g (W/Kg)	2.041917
SAR 1g (W/Kg)	3.880035

### Z Axis Scan

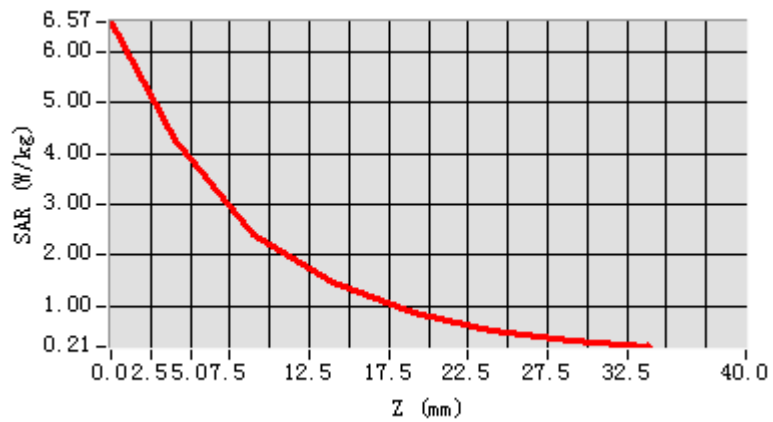

3D screen shot

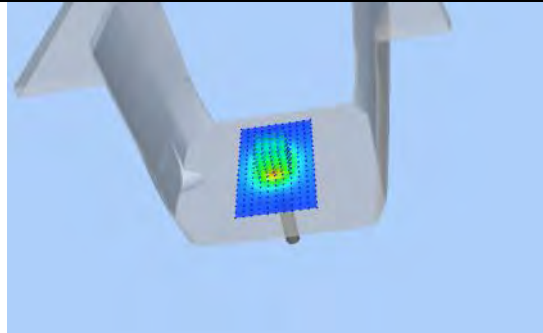

Hot spot position

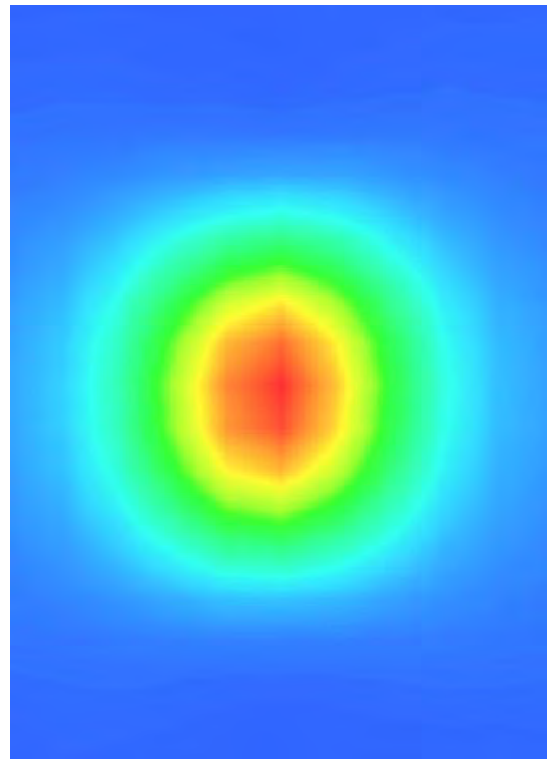

#### 4.7.2 Dipole 1900 MHz Validation Measurement for Body Tissue

### System Performance Check Data(1900MHz Body)

Type: Phone measurement (Complete)  
 E-Field Probe: SN 08/16 SSE2 EPGO295  
 Area scan resolution: dx=8mm,dy=8mm  
 Zoom scan resolution: dx=8mm, dy=8mm, dz=5mm  
 Date of measurement: 2018.03.18  
 Measurement duration: 13 minutes 51 seconds

#### Experimental conditions.

Phantom File	surf_sam_plan.txt
Phantom	Validation plane
Band	1900MHz
Signal	CW
Frequency (MHz)	1900.000000
Relative permittivity (real part)	52.284138
Conductivity (S/m)	1.521952
Power drift (%)	0.060000
Ambient Temperature:	22.7°C
Liquid Temperature:	21.4°C
ConvF:	2.24
Crest factor:	1:1



Maximum location: X=0.00, Y=0.00

SAR Peak: 6.57W/kg

SAR 10g (W/Kg)	2.061345
SAR 1g (W/Kg)	4.024135

### Z Axis Scan

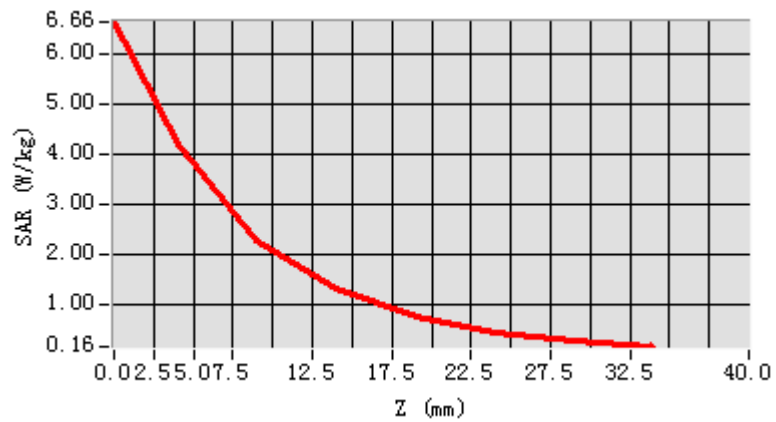

3D screen shot

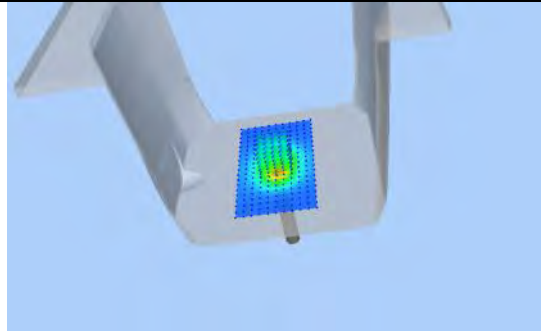

Hot spot position

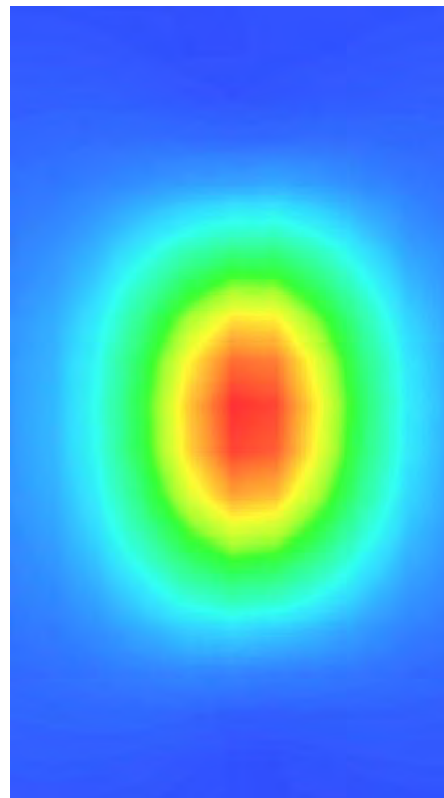





## 4.8 DIP 2G000

### 4.8.1 Dipole 2000 MHz Validation Measurement for Head Tissue

## System Performance Check Data(2000 MHz Head)

Type: Phone measurement (Complete)  
 E-Field Probe: SN 08/16 SSE2 EPGO295  
 Area scan resolution: dx=8mm,dy=8mm  
 Zoom scan resolution: dx=8mm, dy=8mm, dz=5mm  
 Date of measurement: 2018.03.18  
 Measurement duration: 14 minutes 7 seconds

### Experimental conditions.

<b>Phantom File</b>	surf_sam_plan.txt
<b>Phantom</b>	Validation plane
<b>Band</b>	2000 MHz
<b>Signal</b>	CW
<b>Frequency (MHz)</b>	2000.000000
<b>Relative permittivity (real part)</b>	40.628431
<b>Conductivity (S/m)</b>	1.435543
<b>Power drift (%)</b>	-0.420000
<b>Ambient Temperature:</b>	22.7°C
<b>Liquid Temperature:</b>	21.6°C
<b>ConvF:</b>	1.97
<b>Crest factor:</b>	1:1

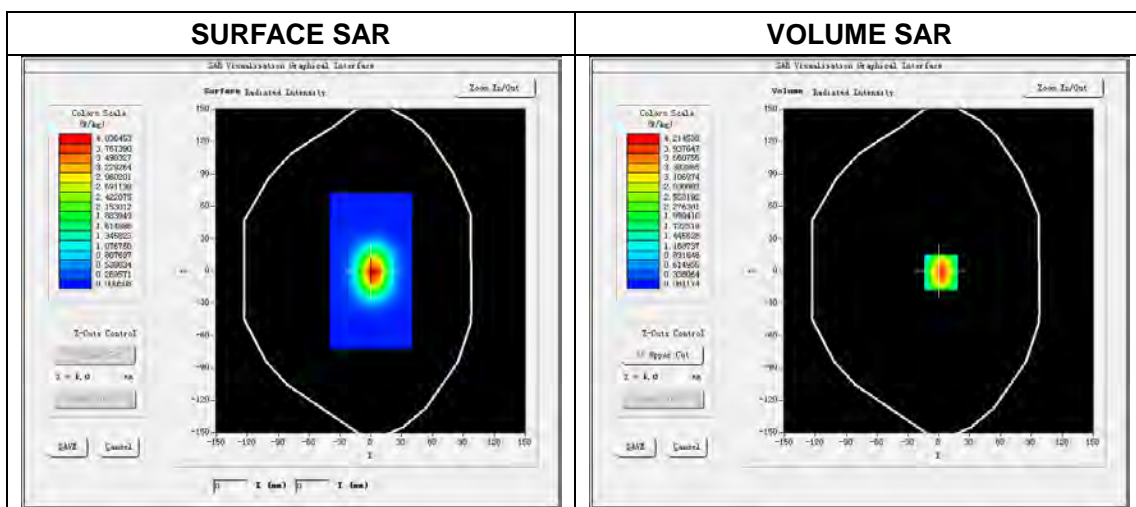

Maximum location: X=0.00, Y=0.00

SAR Peak: 6.97 W/kg

SAR 10 g (W/Kg)	2.094246
SAR 1g (W/Kg)	4.173987

### Z Axis Scan

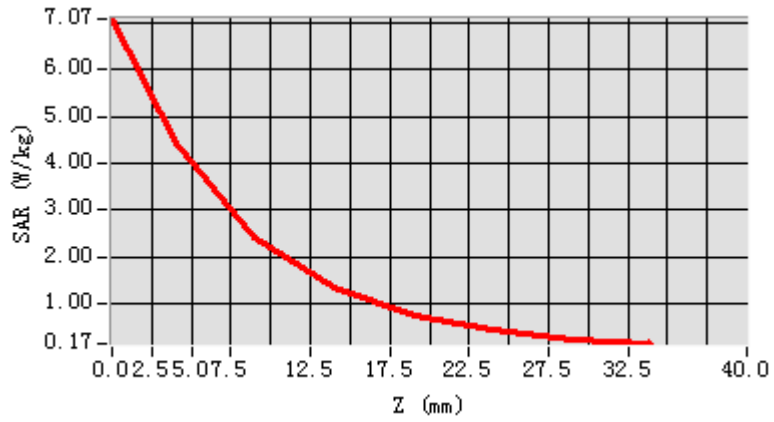

### 3D screen shot

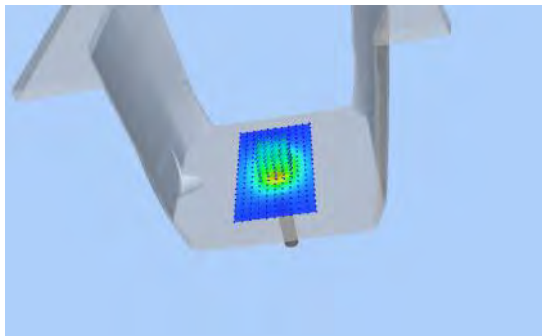

### Hot spot position

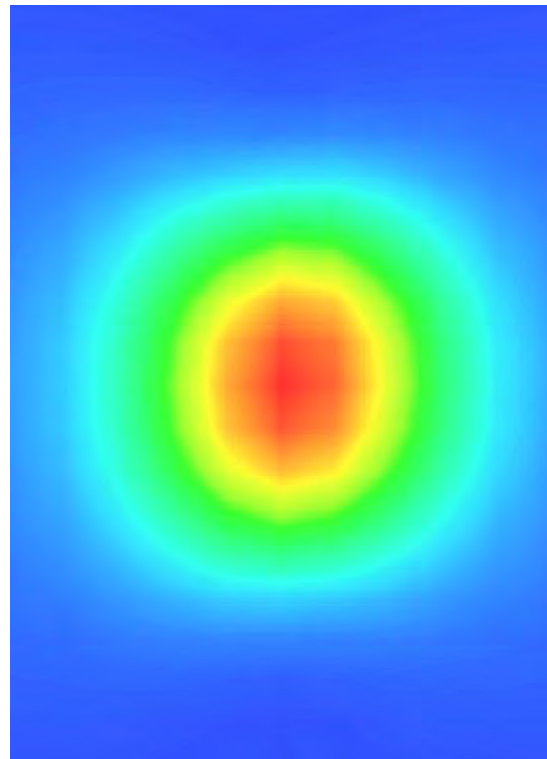

## 4.8.2 Dipole 2000 MHz Validation Measurement for Body Tissue

# System Performance Check Data(2000 MHz Body)

Type: Phone measurement (Complete)  
 E-Field Probe: SN 08/16 SSE2 EPGO295  
 Area scan resolution: dx=8mm,dy=8mm  
 Zoom scan resolution: dx=8mm, dy=8mm, dz=5mm  
 Date of measurement: 2018.03.18  
 Measurement duration: 13 minutes 56 seconds

### Experimental conditions.

<b>Phantom File</b>	surf_sam_plan.txt
<b>Phantom</b>	Validation plane
<b>Band</b>	2000 MHz
<b>Signal</b>	CW
<b>Frequency (MHz)</b>	2000.000000
<b>Relative permittivity (real part)</b>	51.981354
<b>Conductivity (S/m)</b>	1.549655
<b>Power drift (%)</b>	0.210000
<b>Ambient Temperature:</b>	22.7°C
<b>Liquid Temperature:</b>	21.3°C
<b>ConvF:</b>	2.03
<b>Crest factor:</b>	1:1

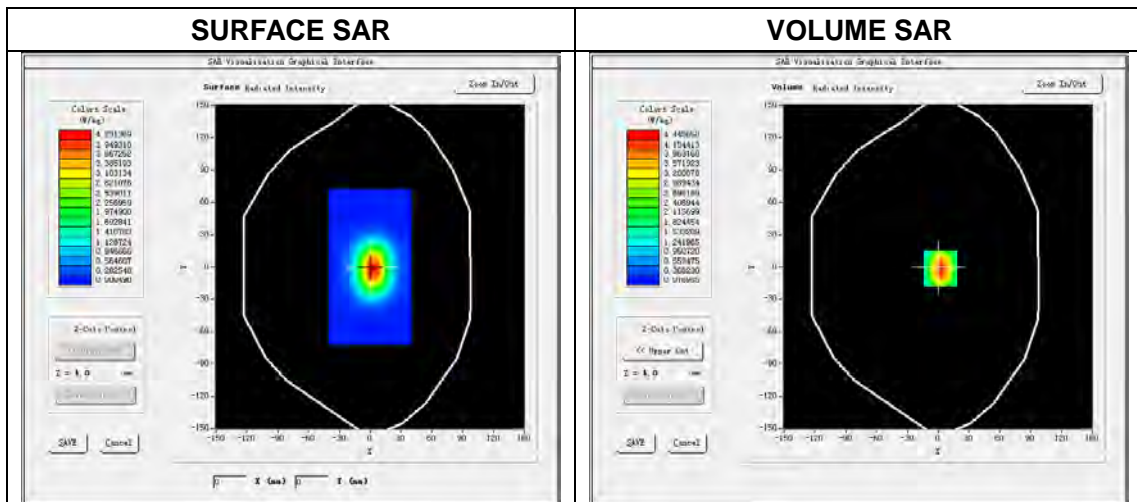

Maximum location: X=0.00, Y=0.00

SAR Peak: 6.95 W/kg

SAR 10 g (W/Kg)	2.208066
SAR 1g (W/Kg)	4.388941

### Z Axis Scan

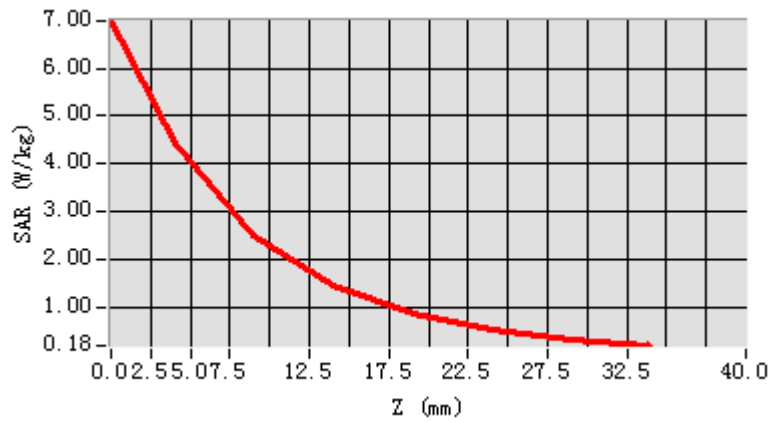

3D screen shot

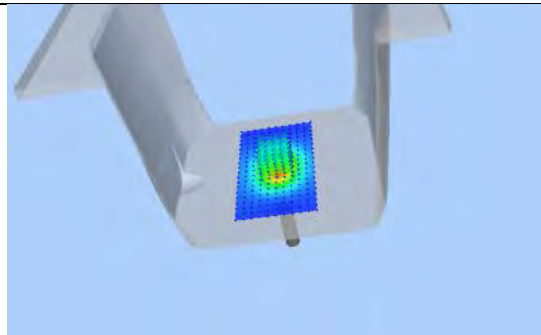

Hot spot position

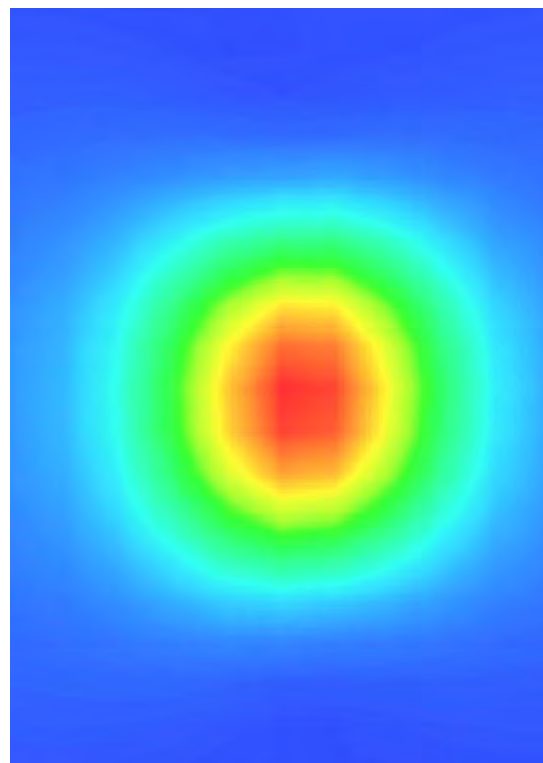

## 4.9 DIP 2G450

### 4.9.1 Dipole 2450 MHz Validation Measurement for Head Tissue

# System Performance Check Data(2450MHz Head)

Type: Phone measurement (Complete)  
 E-Field Probe: SN 08/16 SSE2 EPGO295  
 Area scan resolution: dx=8mm,dy=8mm  
 Zoom scan resolution: dx=5mm, dy=5mm, dz=5mm  
 Date of measurement: 2018.03.18  
 Measurement duration: 18 minutes 42 seconds

### Experimental conditions.

<b>Phantom File</b>	surf_sam_plan.txt
<b>Phantom</b>	Validation plane
<b>Band</b>	2450MHz
<b>Signal</b>	CW
<b>Frequency (MHz)</b>	2450.000000
<b>Relative permittivity (real part)</b>	38.641724
<b>Conductivity (S/m)</b>	1.841662
<b>Power drift (%)</b>	-1.010000
<b>Ambient Temperature:</b>	22.1°C
<b>Liquid Temperature:</b>	21.4°C
<b>ConvF:</b>	2.21
<b>Crest factor:</b>	1:1

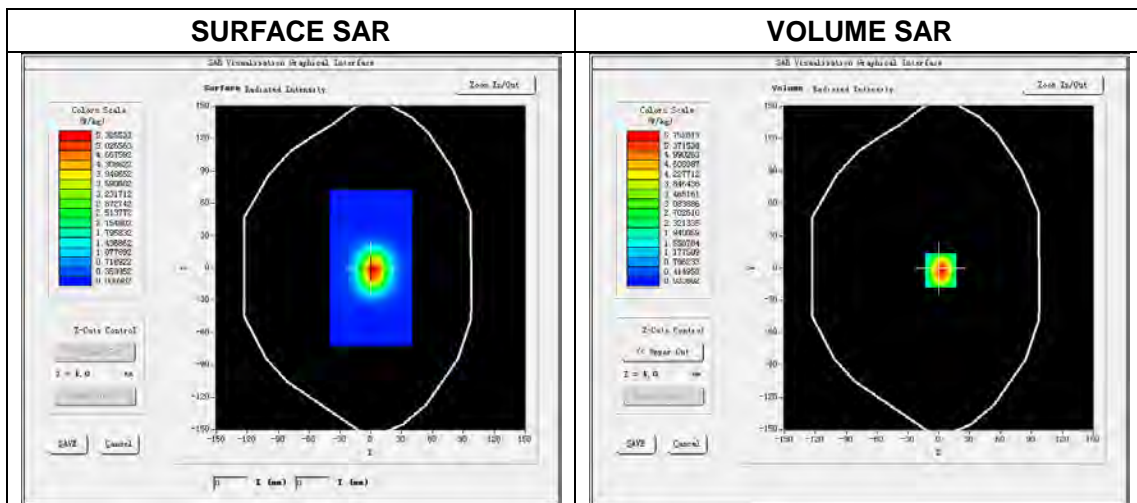

Maximum location: X=0.00, Y=0.00

SAR Peak: 9.77 W/kg

SAR 10g (W/Kg)	2.387686
SAR 1g (W/Kg)	5.219030

### Z Axis Scan

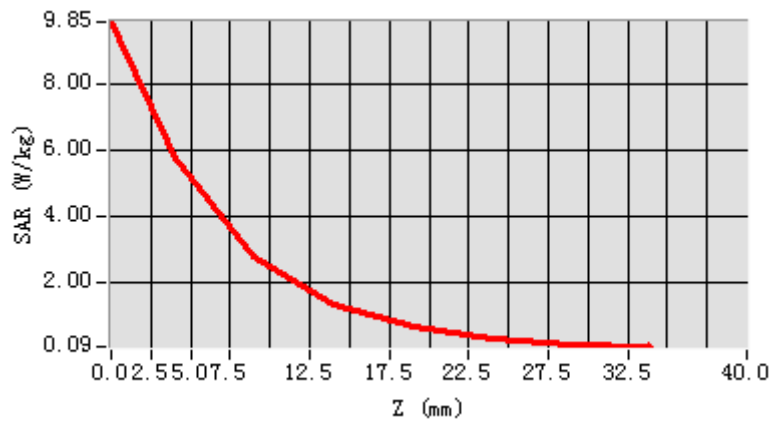

3D screen shot

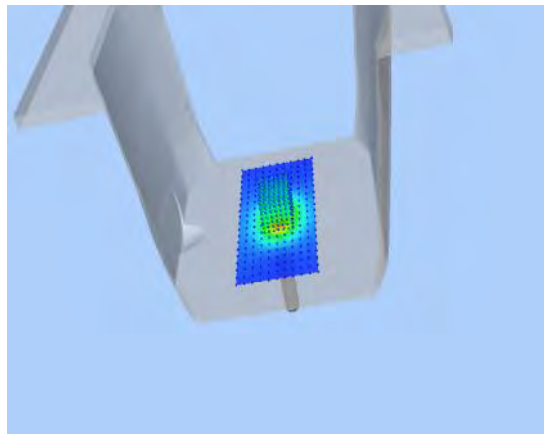

Hot spot position

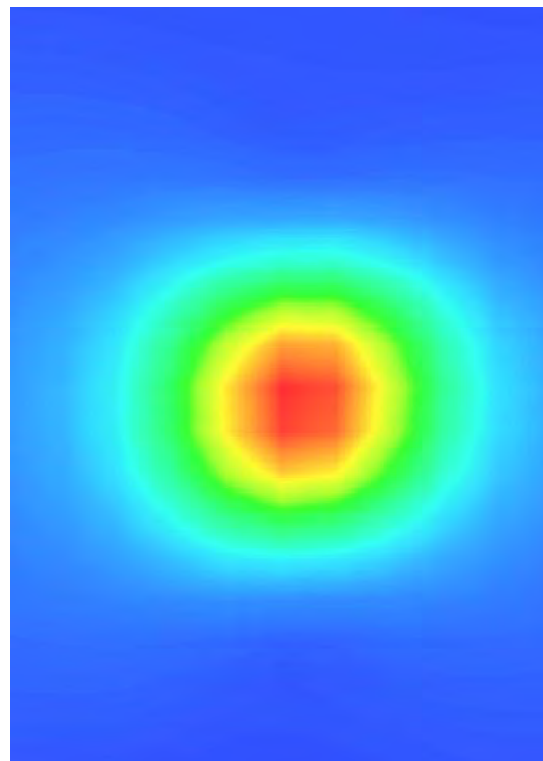

## 4.9.2 Dipole 2450 MHz Validation Measurement for Body Tissue

# System Performance Check Data(2450 MHz Body)

Type: Phone measurement (Complete)

E-Field Probe: SN 08/16 SSE2 EPGO295

Area scan resolution: dx=8mm,dy=8mm

Zoom scan resolution: dx=5 mm, dy=5 mm, dz=5mm

Date of measurement: 2018.03.18

Measurement duration: 19 minutes 4 seconds

### Experimental conditions.

<b>Phantom File</b>	surf_sam_plan.txt
<b>Phantom</b>	Validation plane
<b>Band</b>	2450 MHz
<b>Signal</b>	CW
<b>Frequency (MHz)</b>	2450.000000
<b>Relative permittivity (real part)</b>	52.536841
<b>Conductivity (S/m)</b>	1.974254
<b>Power drift (%)</b>	-0.330000
<b>Ambient Temperature:</b>	22.1°C
<b>Liquid Temperature:</b>	21.5°C
<b>ConvF:</b>	2.30
<b>Crest factor:</b>	1:1

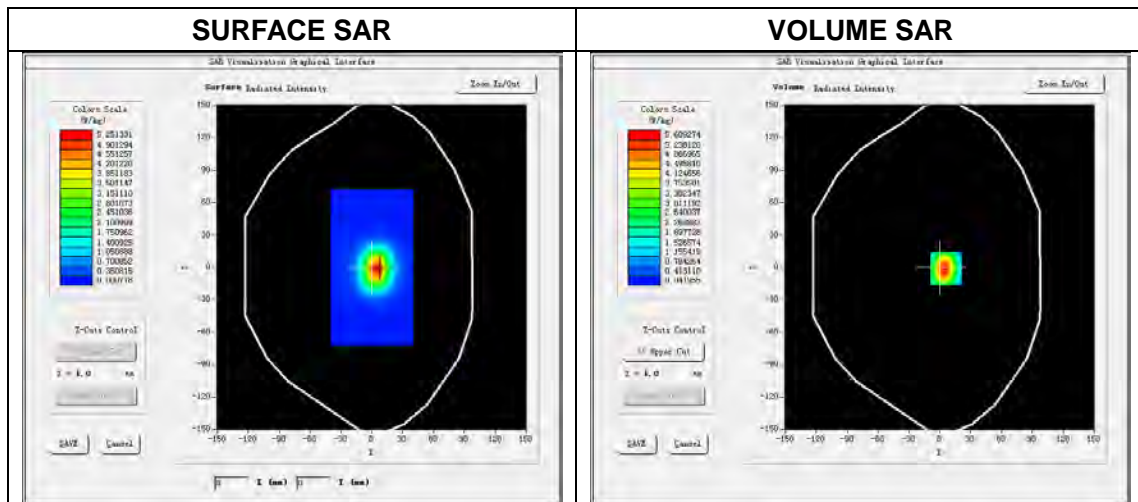

Maximum location: X=0.00, Y=0.00

SAR Peak: 9.35 W/kg

SAR 10 g (W/Kg)	2.427765
SAR 1g (W/Kg)	5.190488

### Z Axis Scan

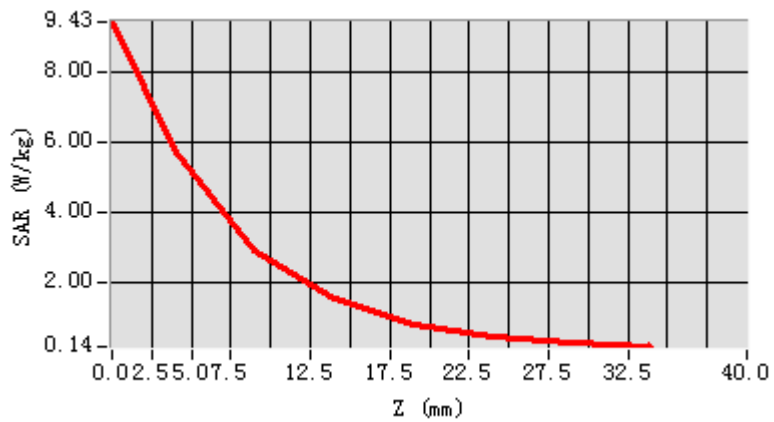

3D screen shot

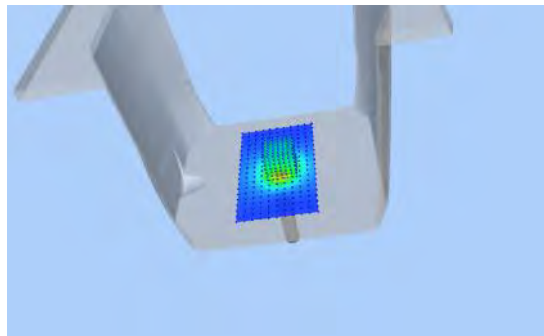

Hot spot position

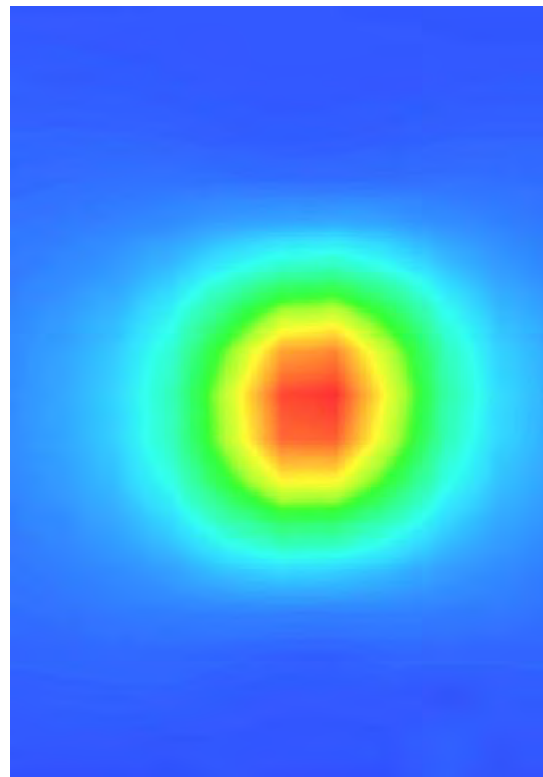



## 4.10DIP 2G600

### 4.10.1 Dipole 2600 MHz Validation Measurement for Head Tissue

# System Performance Check Data(2600 MHz Head)

Type: Phone measurement (Complete)

E-Field Probe: SN 08/16 SSE2 EPGO295

Area scan resolution: dx=8mm,dy=8mm

Zoom scan resolution: dx=5 mm, dy=5 mm, dz=5mm

Date of measurement: 2018.03.18

Measurement duration: 19 minutes 11 seconds

## Experimental conditions.

<b>Phantom File</b>	surf_sam_plan.txt
<b>Phantom</b>	Validation plane
<b>Band</b>	2600 MHz
<b>Signal</b>	CW
<b>Frequency (MHz)</b>	2600.000000
<b>Relative permittivity (real part)</b>	38.187134
<b>Conductivity (S/m)</b>	1.886846
<b>Power drift (%)</b>	0.550000
<b>Ambient Temperature:</b>	22.1°C
<b>Liquid Temperature:</b>	21.4°C
<b>ConvF:</b>	2.20
<b>Crest factor:</b>	1:1

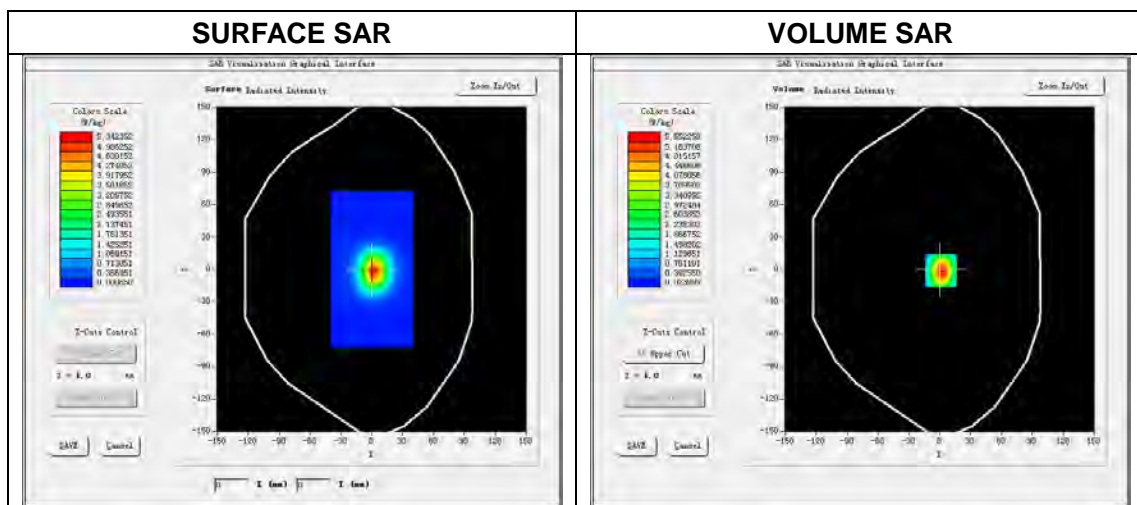

Maximum location: X=0.00, Y=0.00  
 SAR Peak: 9.71 W/kg

SAR 10 g (W/Kg)	2.495522
SAR 1g (W/Kg)	5.469008

### Z Axis Scan

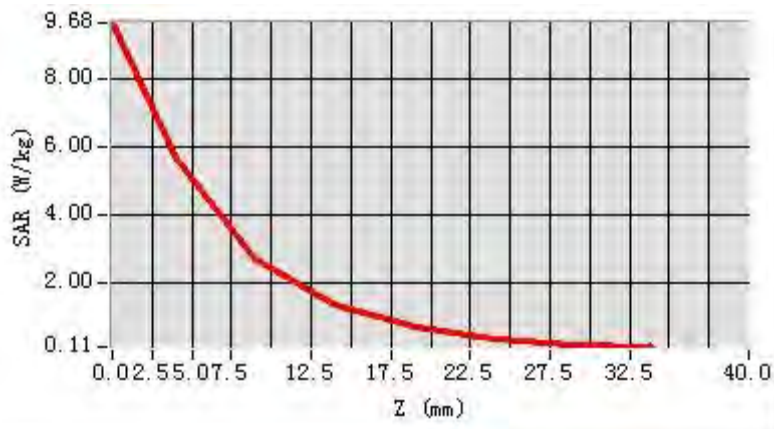

3D screen shot

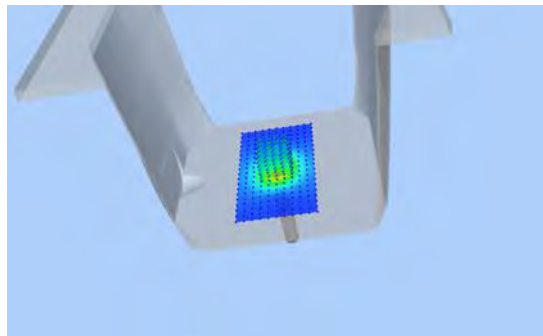

Hot spot position

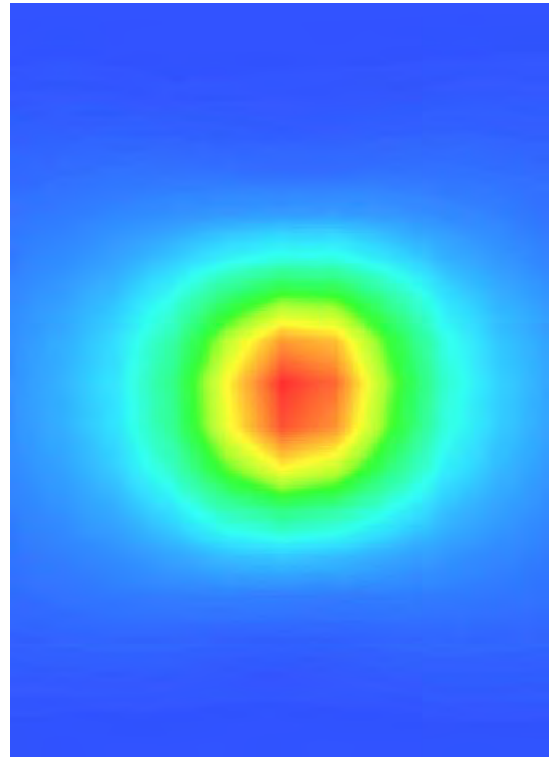

#### 4.10.2 Dipole 2600 MHz Validation Measurement for Body Tissue

### System Performance Check Data(2600 MHz Body)

Type: Phone measurement (Complete)  
 E-Field Probe: SN 08/16 SSE2 EPGO295  
 Area scan resolution: dx=8mm,dy=8mm  
 Zoom scan resolution: dx=5 mm, dy=5 mm, dz=5mm  
 Date of measurement: 2018.03.18  
 Measurement duration: 19 minutes 2 seconds

#### Experimental conditions.

<b>Phantom File</b>	surf_sam_plan.txt
<b>Phantom</b>	Validation plane
<b>Band</b>	2600 MHz
<b>Signal</b>	CW
<b>Frequency (MHz)</b>	2600.000000
<b>Relative permittivity (real part)</b>	52.141672
<b>Conductivity (S/m)</b>	2.134385
<b>Power drift (%)</b>	0.260000
<b>Ambient Temperature:</b>	22.1°C
<b>Liquid Temperature:</b>	21.5°C
<b>ConvF:</b>	2.27
<b>Crest factor:</b>	1:1

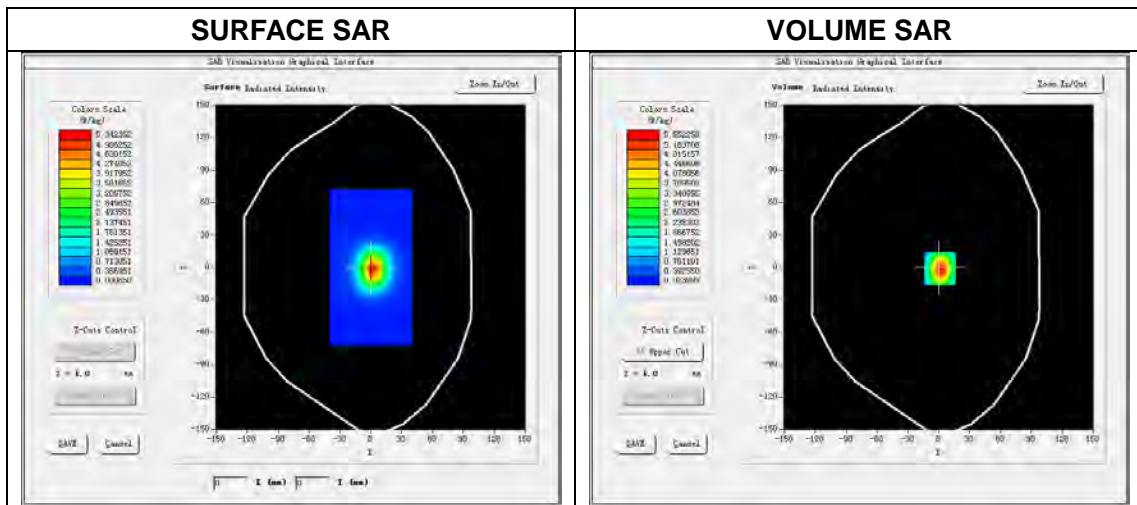

Maximum location: X=0.00, Y=0.00

SAR Peak: 9.27 W/kg

SAR 10 g (W/Kg)	2.447007
SAR 1g (W/Kg)	5.235320

### Z Axis Scan

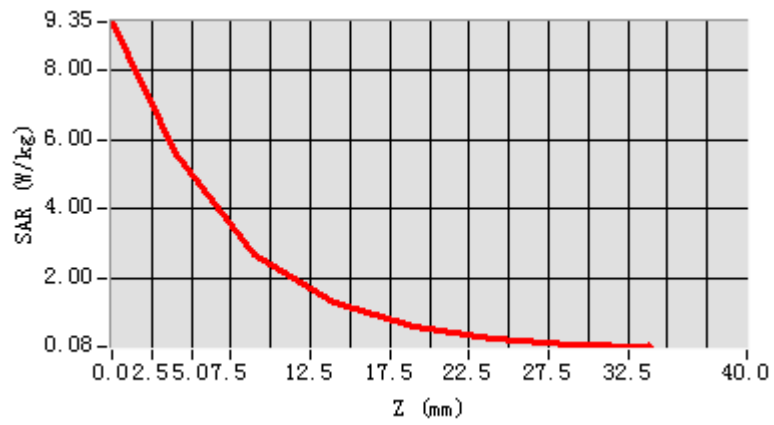

### 3D screen shot

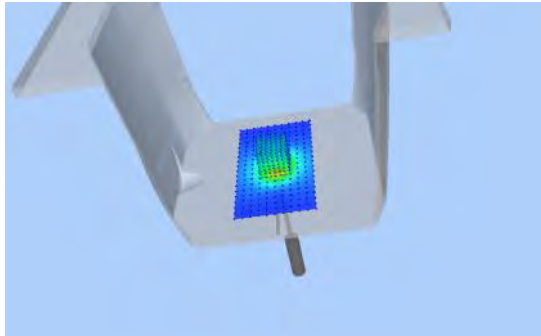

### Hot spot position

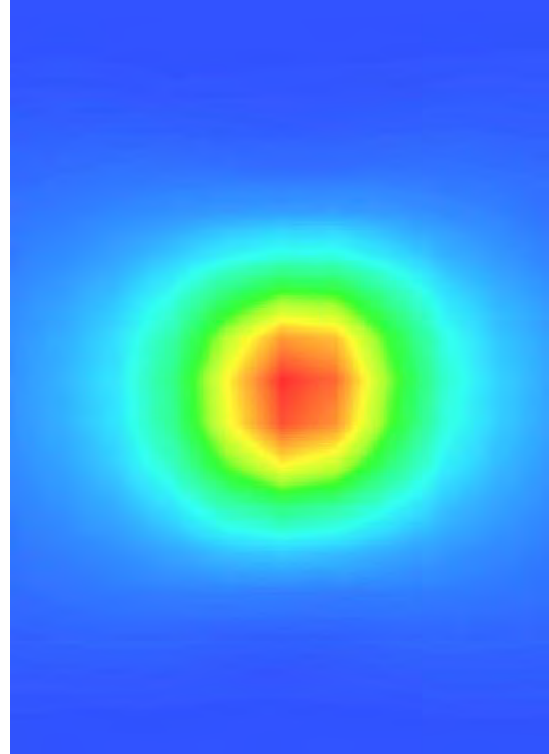

## 4.11 SWG5500

### 4.11.1 Waveguide 5 GHz Validation Measurement for Head Tissue

# System Performance Check Data(5200 MHz Head)

Type: Phone measurement (Complete)  
 E-Field Probe: SN 08/16 SSE2 EPGO295  
 Area scan resolution: dx=8mm,dy=8mm  
 Zoom scan resolution: dx=4mm, dy=4mm, dz=2mm  
 Date of measurement: 2018.03.19  
 Measurement duration: 29 minutes 38 seconds

### Experimental conditions.

<b>Phantom File</b>	surf_sam_plan.txt
<b>Phantom</b>	Validation plane
<b>Band</b>	5200 MHz
<b>Signal</b>	CW
<b>Frequency (MHz)</b>	5200.000000
<b>Relative permittivity (real part)</b>	36.408324
<b>Conductivity (S/m)</b>	4.744352
<b>Power drift (%)</b>	-0.940000
<b>Ambient Temperature:</b>	22.5°C
<b>Liquid Temperature:</b>	21.3°C
<b>ConvF:</b>	1.32
<b>Crest factor:</b>	1:1

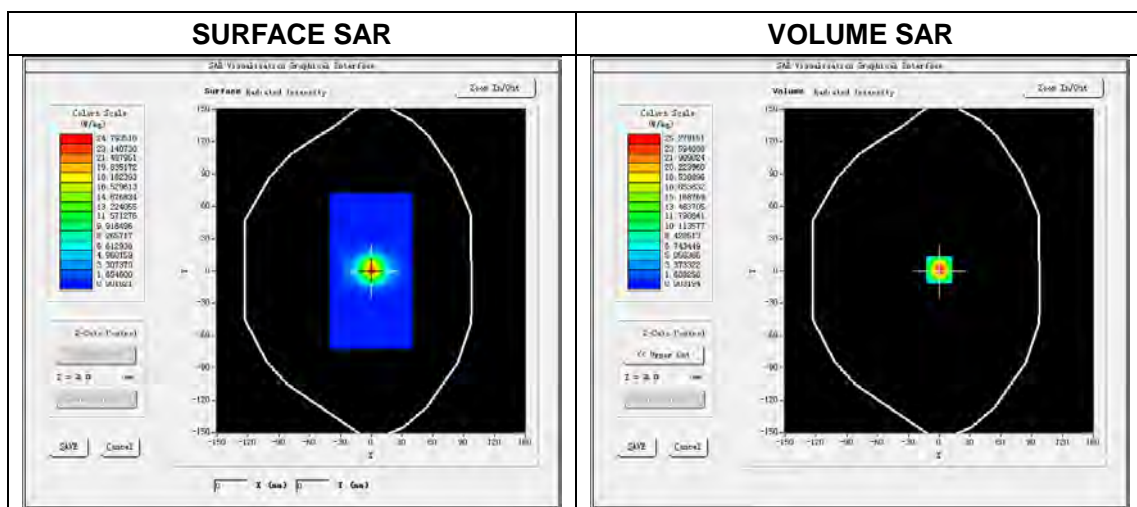

Maximum location: X=3.00, Y=1.00

SAR Peak: 46.84 W/kg

SAR 10g (W/Kg)	5.592867
SAR 1g (W/Kg)	16.372122

### Z Axis Scan

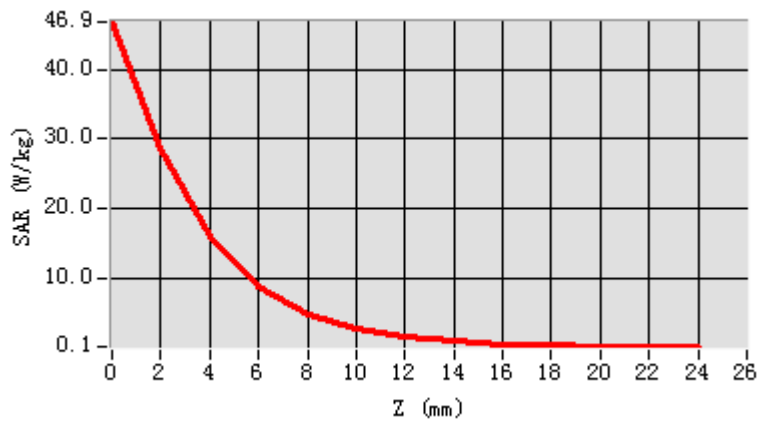

3D screen shot

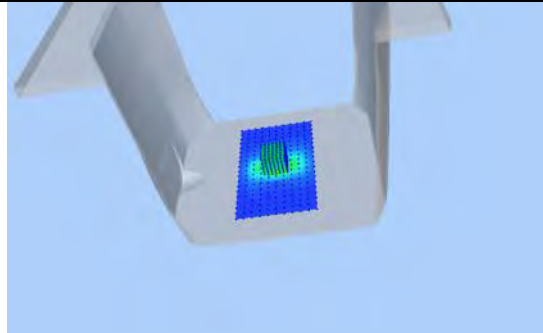

Hot spot position

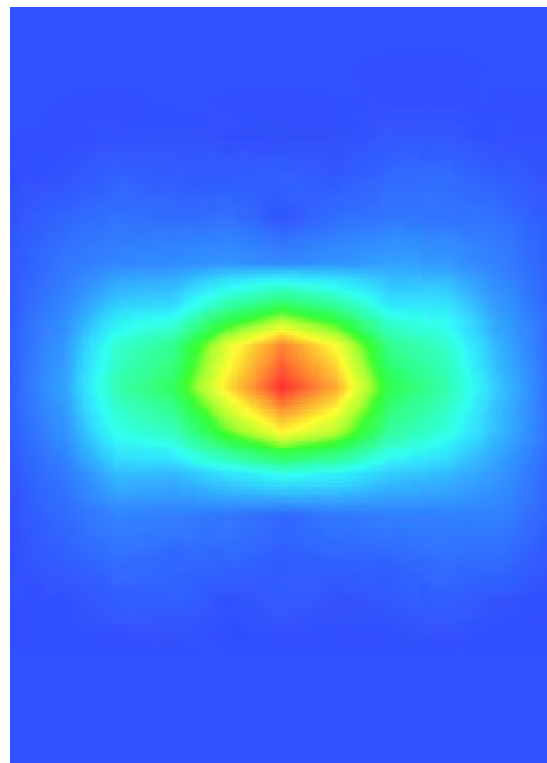

# System Performance Check Data(5400 MHz Head)

Type: Phone measurement (Complete)  
 E-Field Probe: SN 08/16 SSE2 EPGO295  
 Area scan resolution: dx=8mm,dy=8mm  
 Zoom scan resolution: dx=4mm, dy=4mm, dz=2mm  
 Date of measurement: 2018.03.19  
 Measurement duration: 29 minutes 44 seconds

## Experimental conditions.

Phantom File	surf_sam_plan.txt
Phantom	Validation plane
Band	5400 MHz
Signal	CW
Frequency (MHz)	5400.000000
Relative permittivity (real part)	35.837514
Conductivity (S/m)	5.014322
Power drift (%)	-1.240000
Ambient Temperature:	22.5°C
Liquid Temperature:	21.3°C
ConvF:	1.88
Crest factor:	1:1

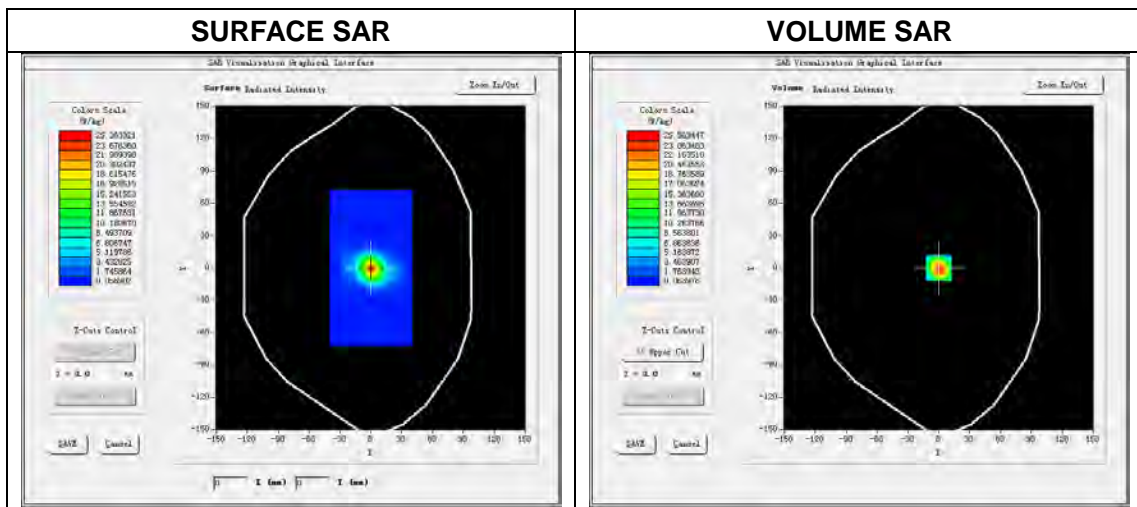

Maximum location: X=0.00, Y=0.00

SAR Peak: 50.6 W/kg

SAR 10g (W/Kg)	5.818205
SAR 1g (W/Kg)	17.240731

### Z Axis Scan

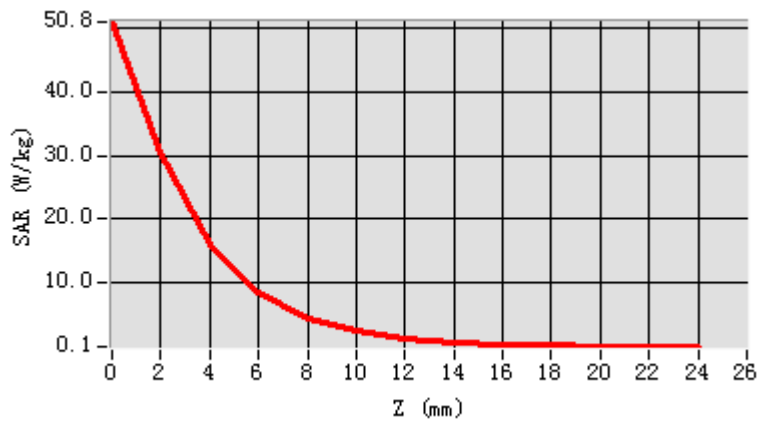

3D screen shot

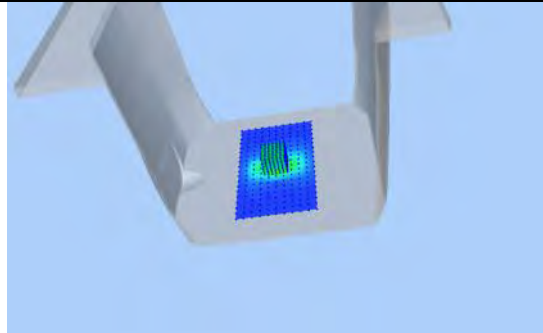

Hot spot position

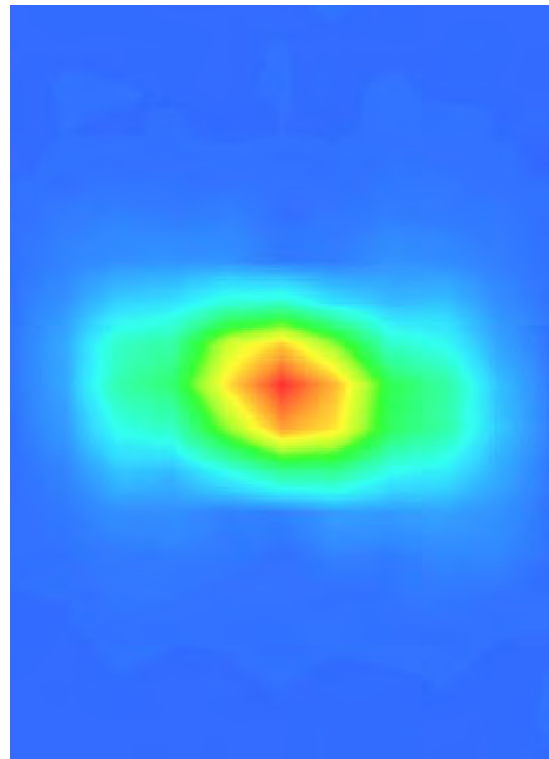



# System Performance Check Data(5600 MHz Head)

Type: Phone measurement (Complete)  
 E-Field Probe: SN 08/16 SSE2 EPGO295  
 Area scan resolution: dx=8mm,dy=8mm  
 Zoom scan resolution: dx=4mm, dy=4mm, dz=2mm  
 Date of measurement: 2018.03.19  
 Measurement duration: 29 minutes 32 seconds

## Experimental conditions.

Phantom File	surf_sam_plan.txt
Phantom	Validation plane
Band	5600 MHz
Signal	CW
Frequency (MHz)	5600.000000
Relative permittivity (real part)	34.916125
Conductivity (S/m)	5.182485
Power drift (%)	-0.780000
Ambient Temperature:	22.5°C
Liquid Temperature:	21.3°C
ConvF:	1.94
Crest factor:	1:1

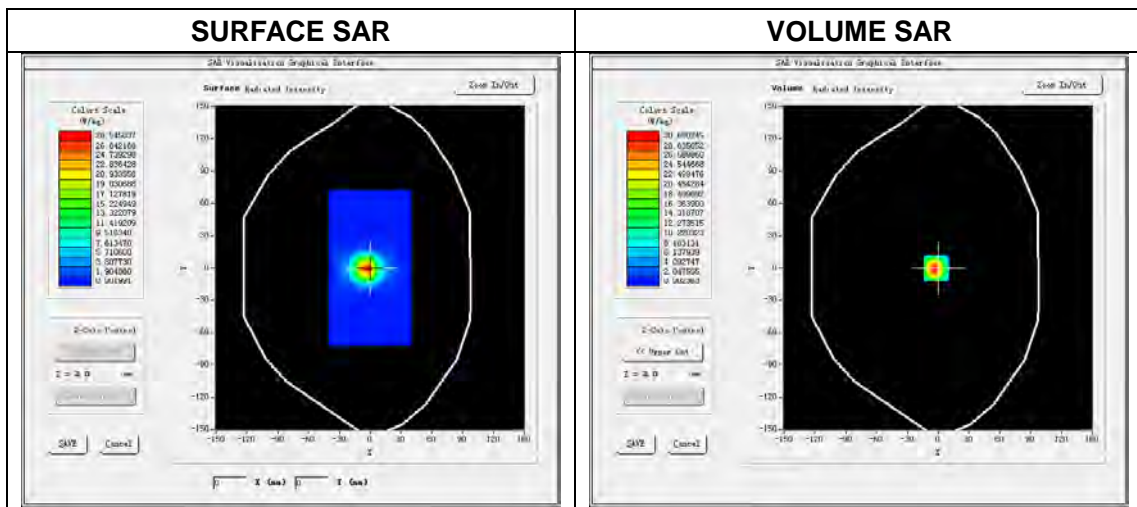

Maximum location: X=1.00, Y=1.00

SAR Peak: 50.57 W/kg

SAR 10g (W/Kg)	5.851483
SAR 1g (W/Kg)	17.434273

### Z Axis Scan

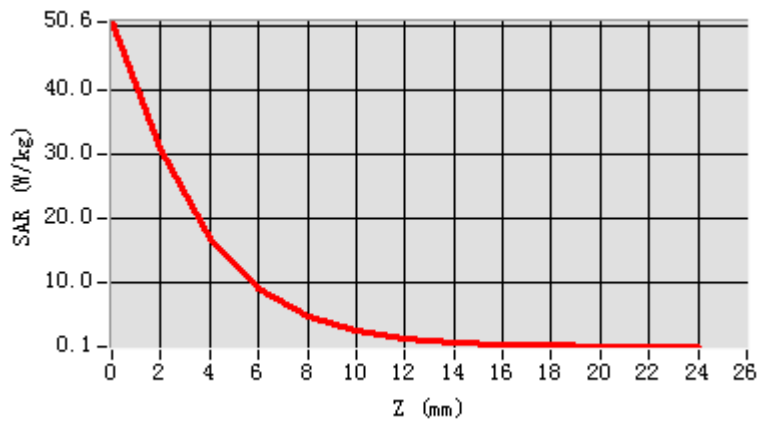

3D screen shot

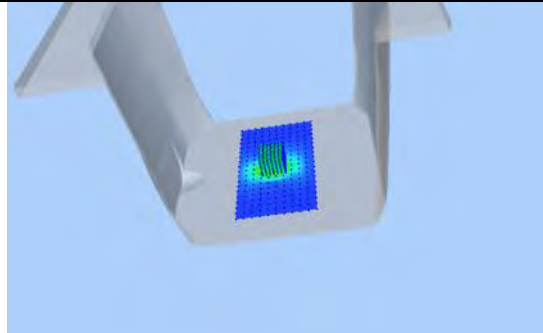

Hot spot position

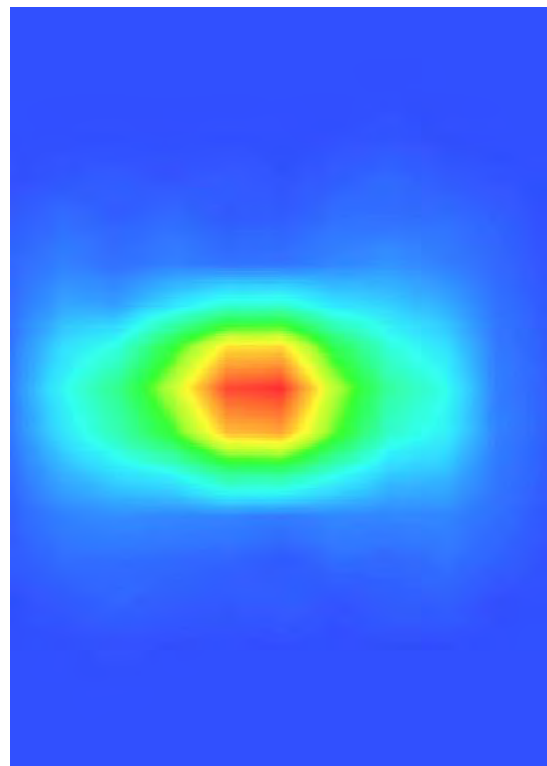

# System Performance Check Data(5800 MHz Head)

Type: Phone measurement (Complete)  
 E-Field Probe: SN 08/16 SSE2 EPGO295  
 Area scan resolution: dx=8mm,dy=8mm  
 Zoom scan resolution: dx=4mm, dy=4mm, dz=2mm  
 Date of measurement: 2018.03.19  
 Measurement duration: 29 minutes 36 seconds

## Experimental conditions.

Phantom File	surf_sam_plan.txt
Phantom	Validation plane
Band	5800 MHz
Signal	CW
Frequency (MHz)	5800.000000
Relative permittivity (real part)	34.134295
Conductivity (S/m)	5.295178
Power drift (%)	-0.180000
Ambient Temperature:	22.5°C
Liquid Temperature:	21.3°C
ConvF:	1.76
Crest factor:	1:1

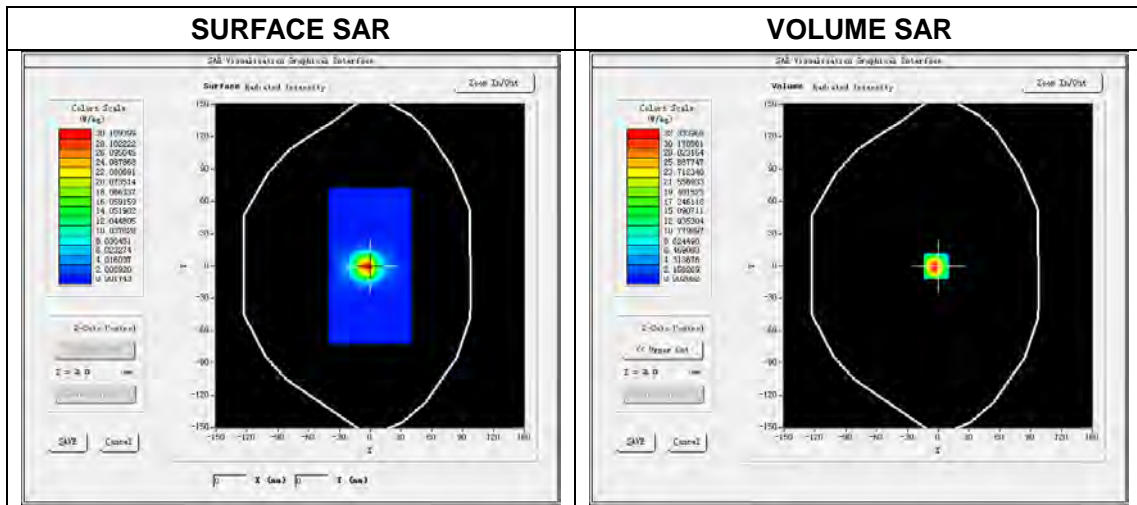

Maximum location: X=0.00, Y=0.00

SAR Peak: 56.73 W/kg

SAR 10g (W/Kg)	6.037190
SAR 1g (W/Kg)	18.470412

### Z Axis Scan

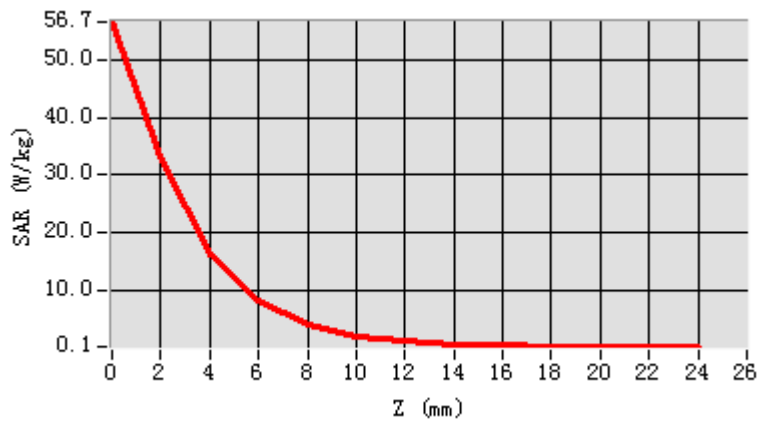

3D screen shot

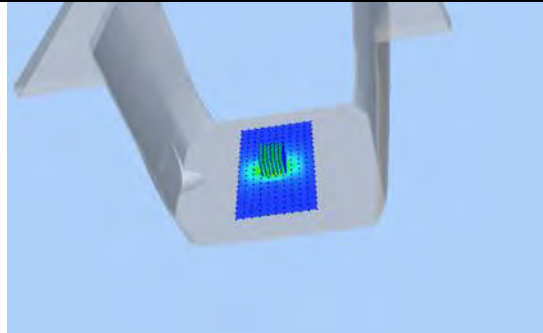

Hot spot position

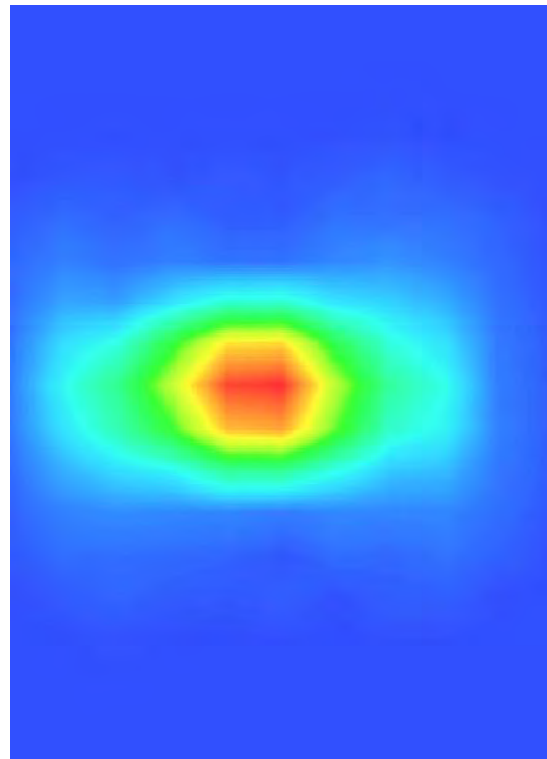

#### 4.11.2 Waveguide 5 GHz Validation Measurement for Body Tissue

### System Performance Check Data(5200MHz Body)

Type: Phone measurement (Complete)  
 E-Field Probe: SN 08/16 SSE2 EPGO295  
 Area scan resolution: dx=8mm,dy=8mm  
 Zoom scan resolution: dx=4mm, dy=4mm, dz=2mm  
 Date of measurement: 2018.03.19  
 Measurement duration: 29 minutes 32 seconds

#### Experimental conditions.

Phantom File	surf_sam_plan.txt
Phantom	Validation plane
Band	5200 MHz
Signal	CW
Frequency (MHz)	5200.000000
Relative permittivity (real part)	48.084385
Conductivity (S/m)	5.485217
Power drift (%)	-1.140000
Ambient Temperature:	22.5°C
Liquid Temperature:	21.1°C
ConvF:	1.36
Crest factor:	1:1

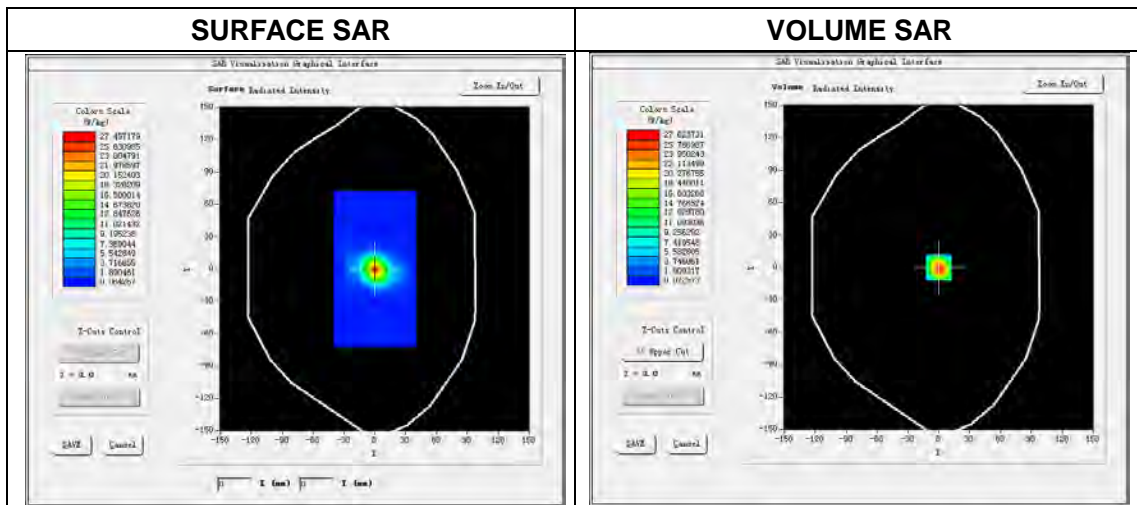

Maximum location: X=0.00, Y=0.00

SAR Peak: 44.16 W/kg

SAR 10g (W/Kg)	5.453471
SAR 1g (W/Kg)	15.882424

### Z Axis Scan

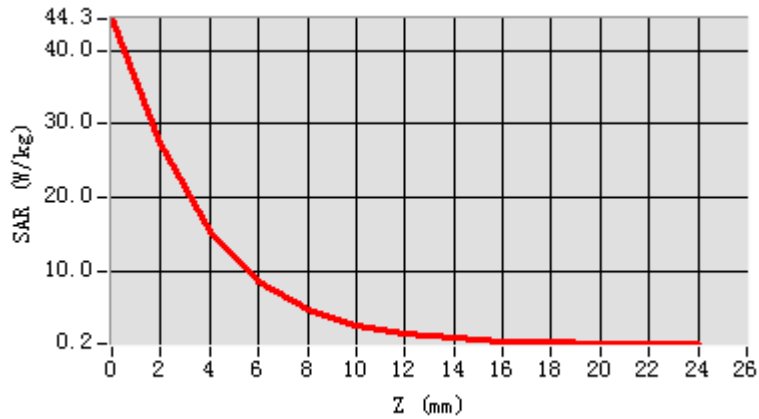

3D screen shot

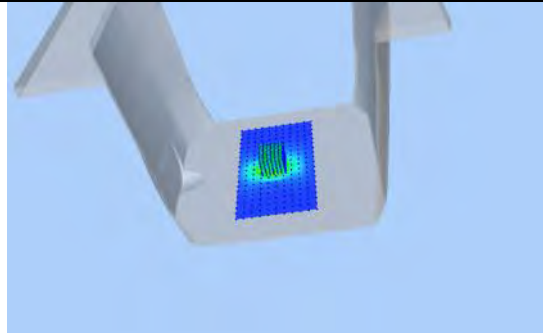

Hot spot position

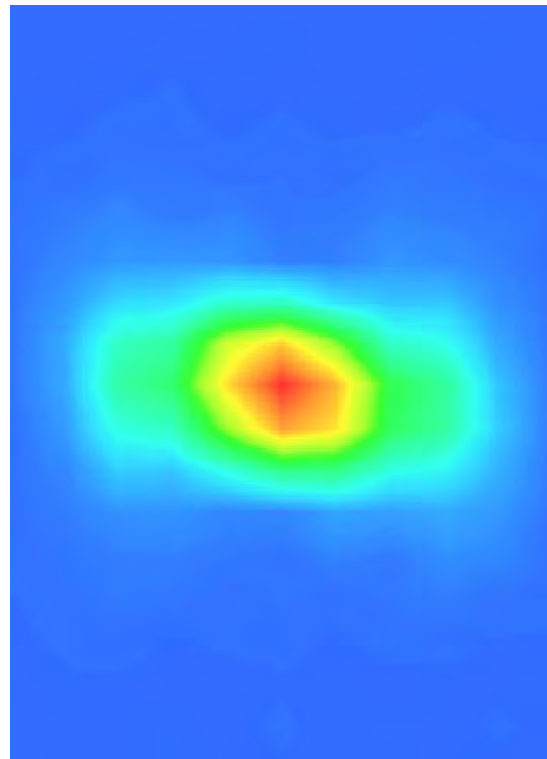

# System Performance Check Data (5400MHz Body)

Type: Phone measurement (Complete)  
 E-Field Probe: SN 08/16 SSE2 EPGO295  
 Area scan resolution: dx=8mm,dy=8mm  
 Zoom scan resolution: dx=4mm, dy=4mm, dz=2mm  
 Date of measurement: 2018.03.19  
 Measurement duration: 29 minutes 51 seconds

## Experimental conditions.

Phantom File	surf_sam_plan.txt
Phantom	Validation plane
Band	5400 MHz
Signal	CW
Frequency (MHz)	5400.000000
Relative permittivity (real part)	47.457628
Conductivity (S/m)	5.609439
Power drift (%)	-0.160000
Ambient Temperature:	22.5°C
Liquid Temperature:	21.1°C
ConvF:	1.92
Crest factor:	1:1

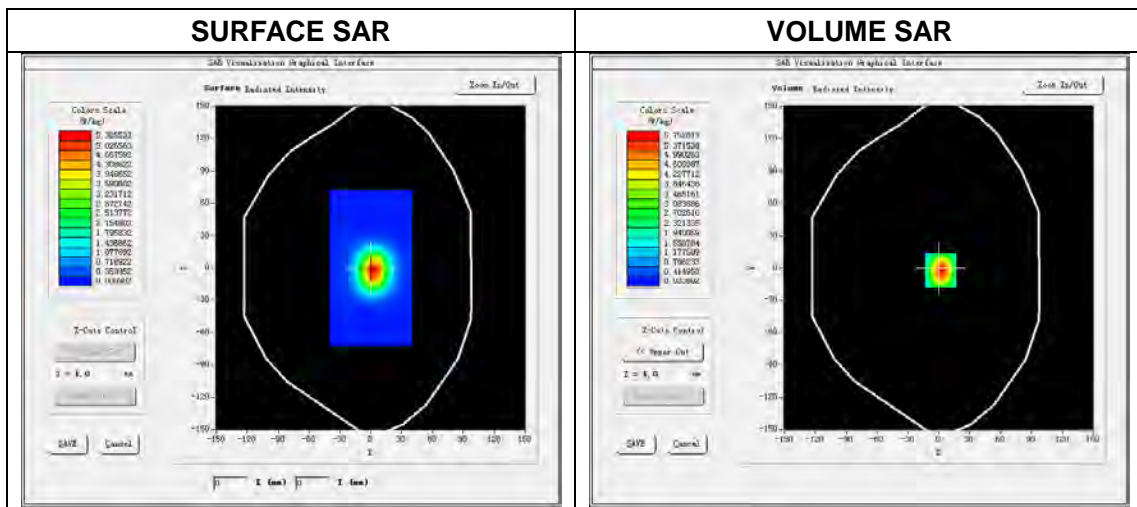

Maximum location: X=0.00, Y=0.00

SAR Peak: 50.54 W/kg

SAR 10g (W/Kg)	5.963962
SAR 1g (W/Kg)	17.552991

### Z Axis Scan

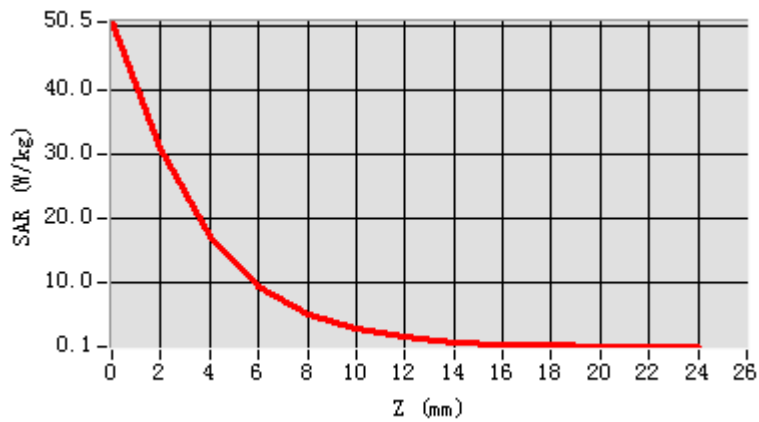

3D screen shot

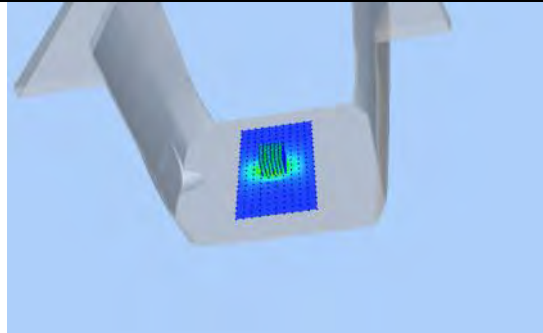

Hot spot position

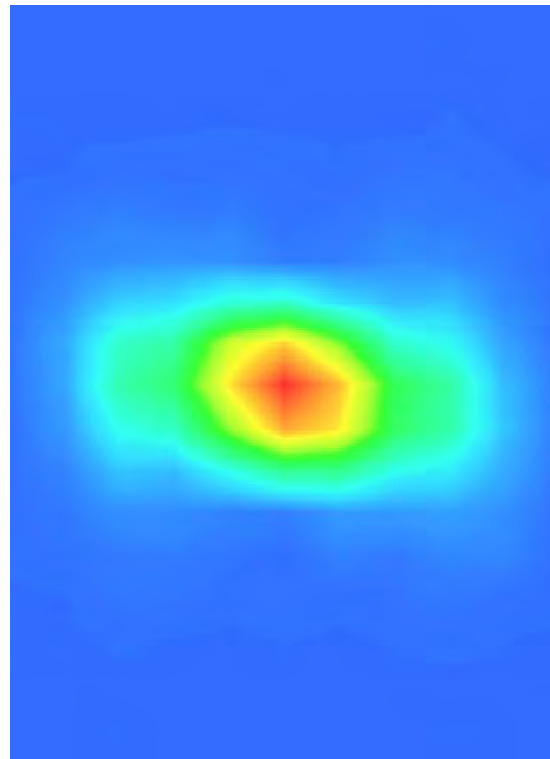



# System Performance Check Data (5600MHz Body )

Type: Phone measurement (Complete)  
 E-Field Probe: SN 08/16 SSE2 EPGO295  
 Area scan resolution: dx=8mm,dy=8mm  
 Zoom scan resolution: dx=4mm, dy=4mm, dz=2mm  
 Date of measurement: 2018.03.19  
 Measurement duration: 29 minutes 41 seconds

## Experimental conditions.

Phantom File	surf_sam_plan.txt
Phantom	Validation plane
Band	5600 MHz
Signal	CW
Frequency (MHz)	5600.000000
Relative permittivity (real part)	47.356184
Conductivity (S/m)	5.923357
Power drift (%)	0.440000
Ambient Temperature:	22.5°C
Liquid Temperature:	21.1°C
ConvF:	2.00
Crest factor:	1:1

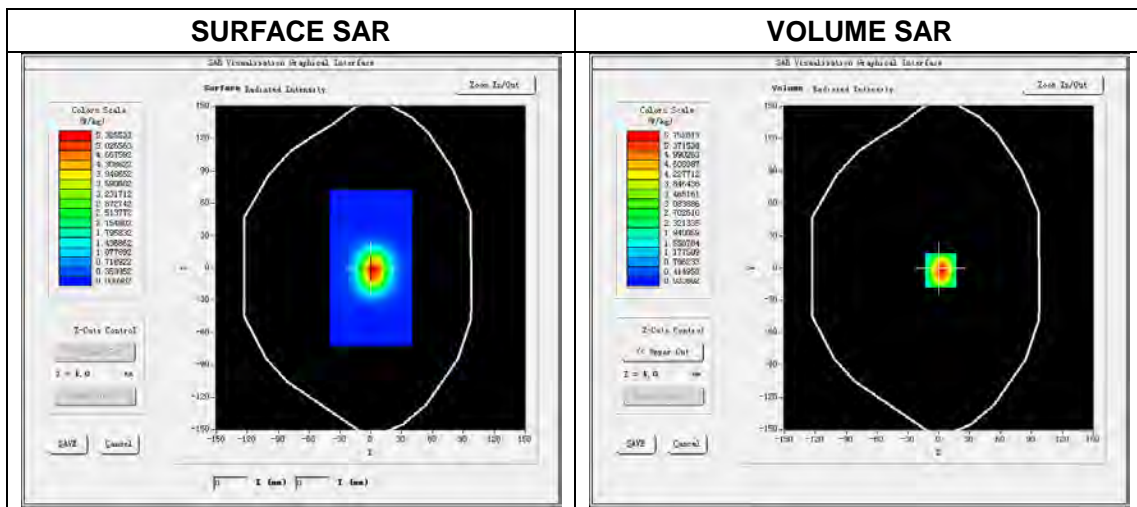

Maximum location: X=0.00, Y=0.00

SAR Peak: 47.04W/kg

SAR 10g (W/Kg)	5.561507
SAR 1g (W/Kg)	18.257726

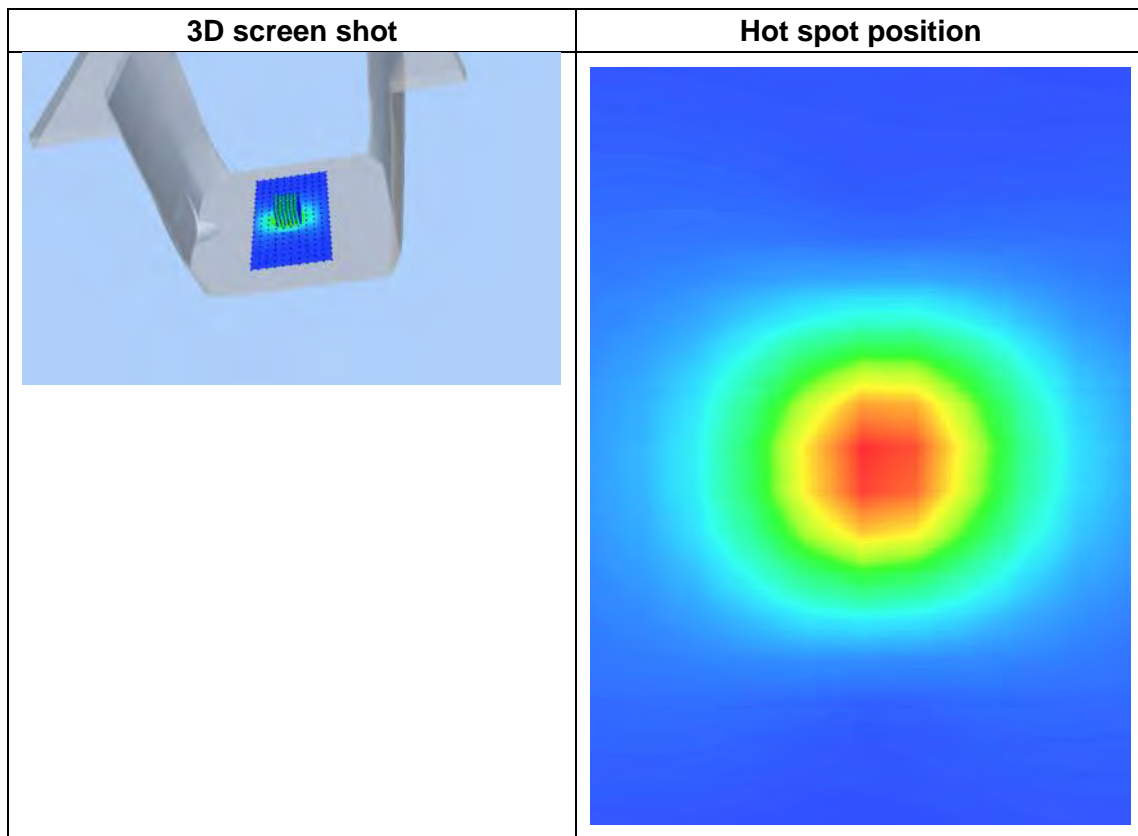
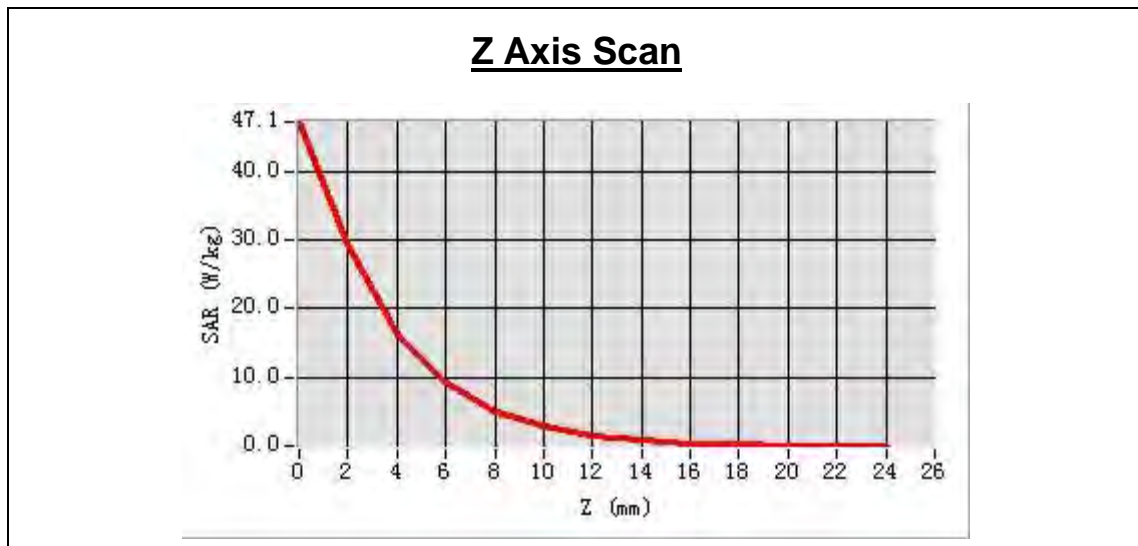

# System Performance Check Data (5800MHz Body )

Type: Phone measurement (Complete)  
 E-Field Probe: SN 08/16 SSE2 EPGO295  
 Area scan resolution: dx=8mm,dy=8mm  
 Zoom scan resolution: dx=4mm, dy=4mm, dz=2mm  
 Date of measurement: 2018.03.19  
 Measurement duration: 29 minutes 27 seconds

## Experimental conditions.

Phantom File	surf_sam_plan.txt
Phantom	Validation plane
Band	5800 MHz
Signal	CW
Frequency (MHz)	5800.000000
Relative permittivity (real part)	47.312495
Conductivity (S/m)	6.131967
Power drift (%)	-0.300000
Ambient Temperature:	22.5°C
Liquid Temperature:	21.1°C
ConvF:	1.82
Crest factor:	1:1

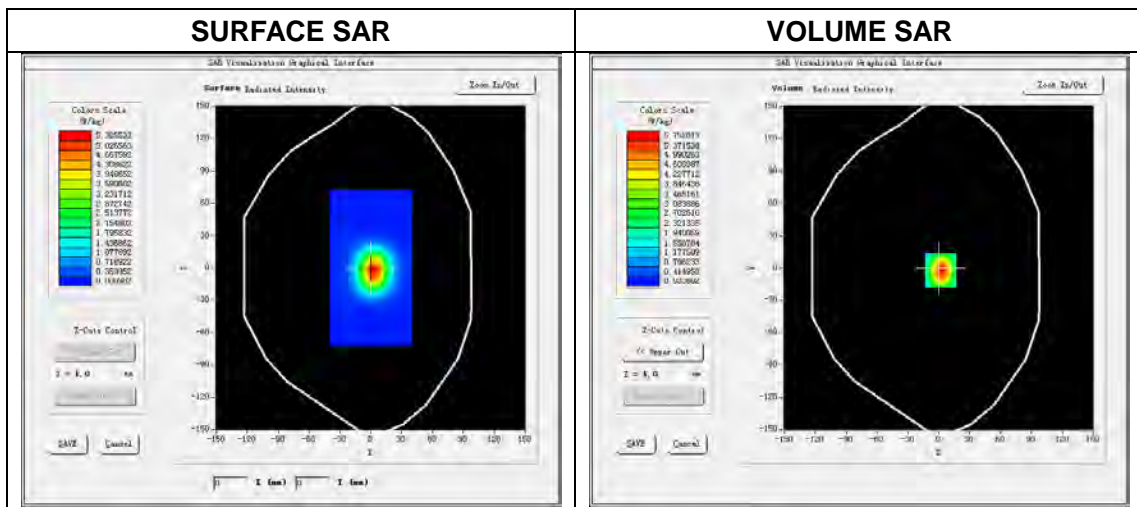

Maximum location: X=0.00, Y=0.00

SAR Peak: 55.86W/kg

SAR 10g (W/Kg)	6.172244
SAR 1g (W/Kg)	18.653954

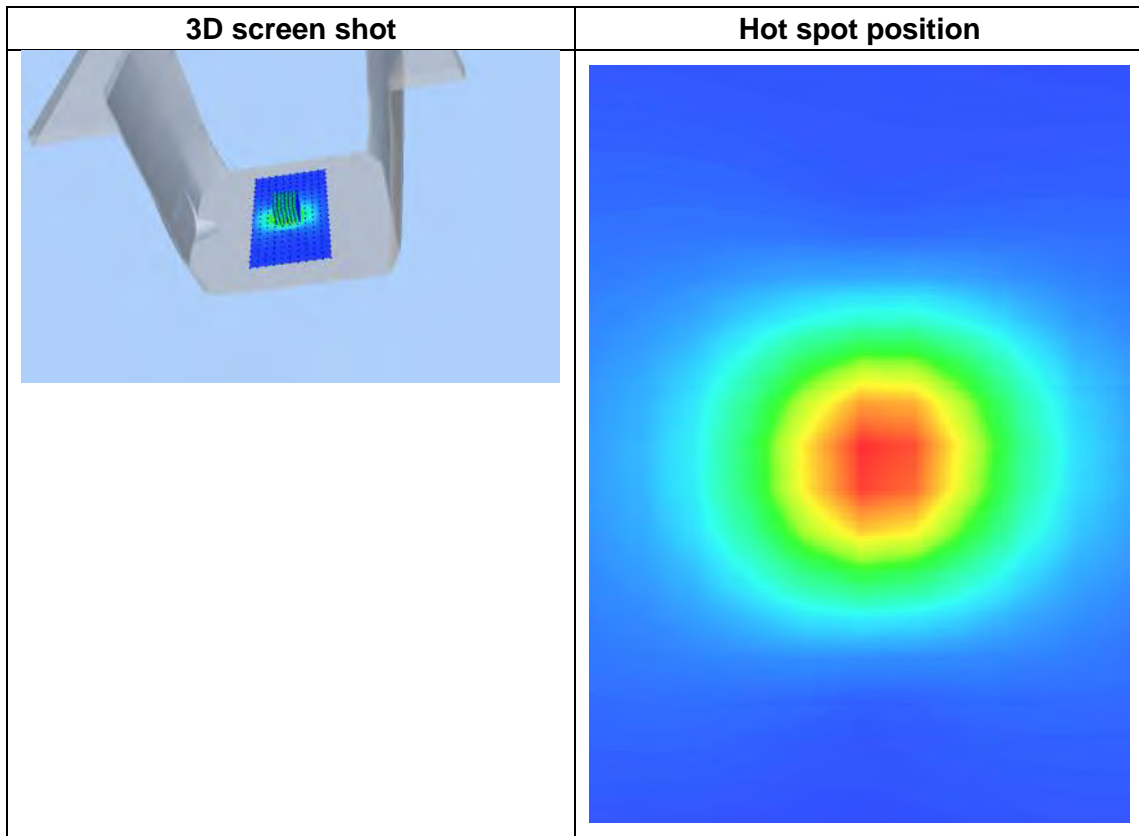
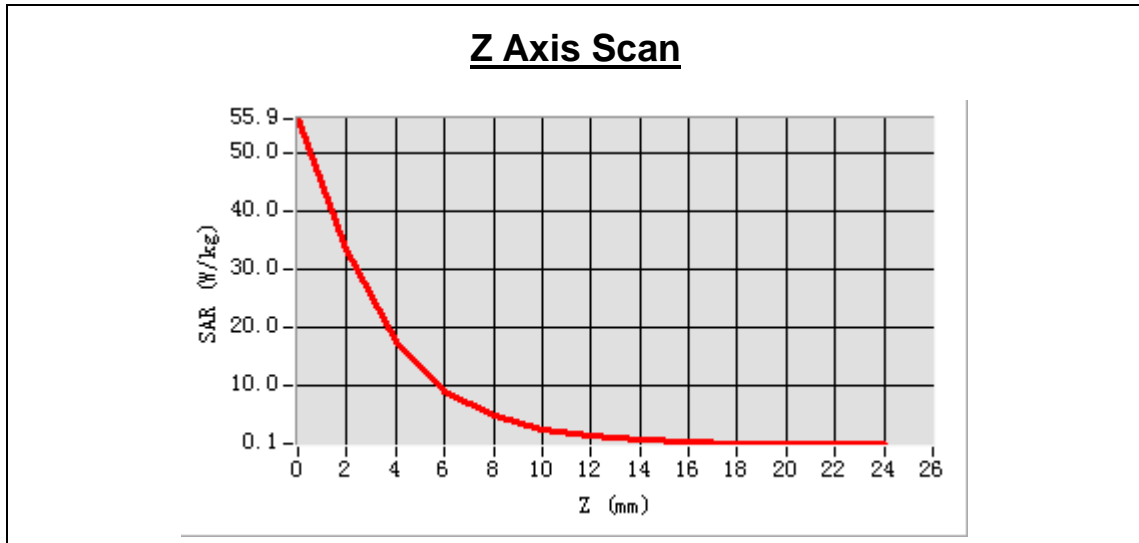

--END OF REPORT--