

# HCT CO., LTD.

## CERTIFICATE OF COMPLIANCE FCC Certification

<b>Applicant Name:</b> Franklin Wireless Corp	<b>Date of Issue:</b> October 4, 2012
<b>Address:</b> 6205 Lusk Blvd, San Diego CA 92121	<b>Location:</b> HCT CO., LTD., 105-1, Jangam-ri, Majang-Myeon, Icheon-si, Kyunggi-Do, Korea
	<b>Test Report No.:</b> HCTR1208FR26-3
	<b>HCT FRN:</b> 0005866421

**FCC ID:** RB2-U772

**APPLICANT:** Franklin Wireless Corp

**FCC Model(s):** U772

**EUT Type:** Cellular/PCS CDMA & LTE USB Dongle with WLAN

**Tx Frequency:** 817.9 — 823.1 MHz (CDMA)

**Max. RF Output Power:** When connected to the USB port of the computer :  
0.146 W ERP CDMA (21.63 dBm)/ 0.172 W ERP CDMA EVDO (22.35 dBm)

When connected to the AC-USB adaptor :  
0.396 W ERP CDMA (25.98 dBm)/ 0.406 W ERP CDMA EVDO (26.09 dBm)

**Emission Designator(s):** 1M28F9W (CDMA)/ 1M26F9W (CDMA EVDO)

**FCC Classification:** PCS Licensed Transmitter (PCB)

**FCC Rule Part(s):** §90.691

The measurements shown in this report were made in accordance with the procedures specified in §2.947. I assume full responsibility for the accuracy and completeness of these measurements, and for the qualifications of all persons taking them.

HCT CO., LTD. Certifies that no party to this application has subject to a denial of Federal benefits that includes FCC benefits pursuant to section 5301 of the Anti-Drug Abuse Act of 1998, 21 U.S. C.853(a)

  
Report prepared by  
: Hyo Sun Kwak  
Test engineer of RF Team

  
Approved by  
: Chang Seok Choi  
Manager of RF Team

This report only responds to the tested sample and may not be reproduced, except in full, without written approval of the HCT Co., Ltd.

FCC CERTIFICATION REPORT			<a href="http://www.hct.co.kr">www.hct.co.kr</a>
Test Report No. HCTR1208FR26-3	Date of Issue: October 4, 2012	EUT Type: Cellular/PCS CDMA & LTE USB Dongle with WLAN	FCC ID: RB2-U772

# Version

TEST REPORT NO.	DATE	DESCRIPTION
HCTR1208FR26	August 16, 2012	- First Approval Report
HCTR1208FR26-1	September 13, 2012	-Revise the ERP Table on page 17
HCTR1208FR26-2	September 18, 2012	-Add EIRP and RSE test results for the case that the EUT is connected to AC-USB adaptor.
HCTR1208FR26-3	October 4, 2012	-Revise antenna specification.

FCC CERTIFICATION REPORT			<a href="http://www.hct.co.kr">www.hct.co.kr</a>
<b>Test Report No.</b> HCTR1208FR26-3	<b>Date of Issue:</b> October 4, 2012	<b>EUT Type:</b> Cellular/PCS CDMA & LTE USB Dongle with WLAN	<b>FCC ID:</b> RB2-U772

# Table of Contents

1. GENERAL INFORMATION .....	4
2. INTRODUCTION .....	5
2.1. EUT DESCRIPTION.....	5
2.2. MEASURING INSTRUMENT CALIBRATION.....	5
2.3. TEST FACILITY .....	5
3. DESCRIPTION OF TESTS .....	6
3.1 EFFECTIVE RADIATED POWER/EQUIVALENT ISOTROPIC RADIATED POWER.....	6
3.2 PEAK- TO- AVERAGE RATIO .....	7
3.3 OCCUPIED BANDWIDTH. ....	8
3.4 SPURIOUS AND HARMONIC EMISSIONS AT ANTENNA TERMINAL.....	9
3.5 RADIATED SPURIOUS AND HARMONIC EMISSIONS.....	10
3.6 FREQUENCY STABILITY / VARIATION OF AMBIENT TEMPERATURE .....	11
4. LIST OF TEST EQUIPMENT .....	12
5. SUMMARY OF TEST RESULTS .....	13
6. SAMPLE CALCULATION .....	14
7. TEST DATA .....	15
7.1 CONDUCTED OUTPUT POWER .....	15
7.2 OCCUPIED BANDWIDTH .....	16
7.3 CONDUCTED SPURIOUS EMISSIONS .....	16
7.3.1 Band Edge .....	16
7.4 EFFECTIVE RADIATED POWER OUTPUT .....	17
7.5 RADIATED SPURIOUS EMISSIONS.....	19
7.5.1 RADIATED SPURIOUS EMISSIONS(CDMA Mode).....	19
7.6 FREQUENCY STABILITY / VARIATION OF AMBIENT TEMPERATURE .....	21
7.6.1 FREQUENCY STABILITY (CDMA).....	21
8. TEST PLOTS.....	22

<b>FCC CERTIFICATION REPORT</b>			<a href="http://www.hct.co.kr">www.hct.co.kr</a>
Test Report No. HCTR1208FR26-3	Date of Issue: October 4, 2012	EUT Type: Cellular/PCS CDMA & LTE USB Dongle with WLAN	FCC ID: RB2-U772



# MEASUREMENT REPORT

## 1. GENERAL INFORMATION

**Applicant Name:** Franklin Wireless Corp

**Address:** 6205 Lusk Blvd, San Diego CA 92121

**FCC ID:** RB2-U772

**Application Type:** Certification

**FCC Classification:** PCS Licensed Transmitter (PCB)

**FCC Rule Part(s):** §90.691

**EUT Type:** Cellular/PCS CDMA/EVDO & LTE Phone with Bluetooth & WLAN

**FCC Model(s):** U772

**Tx Frequency:** 817.9 — 823.1 MHz (CDMA)

**Max. RF Output Power:** When connected to the USB port of the computer :  
0.146 W ERP CDMA (21.63 dBm)/ 0.172 W ERP CDMA EVDO (22.35 dBm)

When connected to the AC-USB adaptor :  
0.396 W ERP CDMA (25.98 dBm)/ 0.406 W ERP CDMA EVDO (26.09 dBm)

**Emission Designator(s):** 1M28F9W (CDMA)/ 1M26F9W (CDMA EVDO)

**Date(s) of Tests:** August 03, 2012 ~ September 18, 2012

**Antenna Specification** Manufacturer: KWANG HYUN AIRTECH  
Antenna type: Monopole Antenna  
Peak Gain: -3.8 dBi

FCC CERTIFICATION REPORT			<a href="http://www.hct.co.kr">www.hct.co.kr</a>
<b>Test Report No.</b> HCTR1208FR26-3	<b>Date of Issue:</b> October 4, 2012	<b>EUT Type:</b> Cellular/PCS CDMA & LTE USB Dongle with WLAN	<b>FCC ID:</b> RB2-U772

## 2. INTRODUCTION

### 2.1. EUT DESCRIPTION

The U772 Cellular/PCS CDMA & LTE USB Dongle with WLAN consists of Cellular CDMA, PCS CDMA, 1xRTT and EVDO Rev.0,A.

### 2.2. MEASURING INSTRUMENT CALIBRATION

The measuring equipment, which was utilized in performing the tests documented herein, has been calibrated in accordance with the manufacturer's recommendations for utilizing calibration equipment, which is traceable to recognized national standards.

### 2.3. TEST FACILITY

The SAC(Semi-Anechoic Chamber) and conducted measurement facility used to collect the radiated data are located at the 105-1, Jangam-ri, Majang-Myeon, Icheon-si, Kyunggi-Do, 467-811, Korea. The site is constructed in conformance with the requirements of ANSI C63.4 and CISPR Publication 22. Detailed description of test facility was submitted to the Commission and accepted dated March 02, 2011 (Registration Number: 90661)

FCC CERTIFICATION REPORT			<a href="http://www.hct.co.kr">www.hct.co.kr</a>
<b>Test Report No.</b> HCTR1208FR26-3	<b>Date of Issue:</b> October 4, 2012	<b>EUT Type:</b> Cellular/PCS CDMA & LTE USB Dongle with WLAN	<b>FCC ID:</b> RB2-U772

### 3. DESCRIPTION OF TESTS

#### 3.1 EFFECTIVE RADIATED POWER/EQUIVALENT ISOTROPIC RADIATED POWER

##### Test Set-up

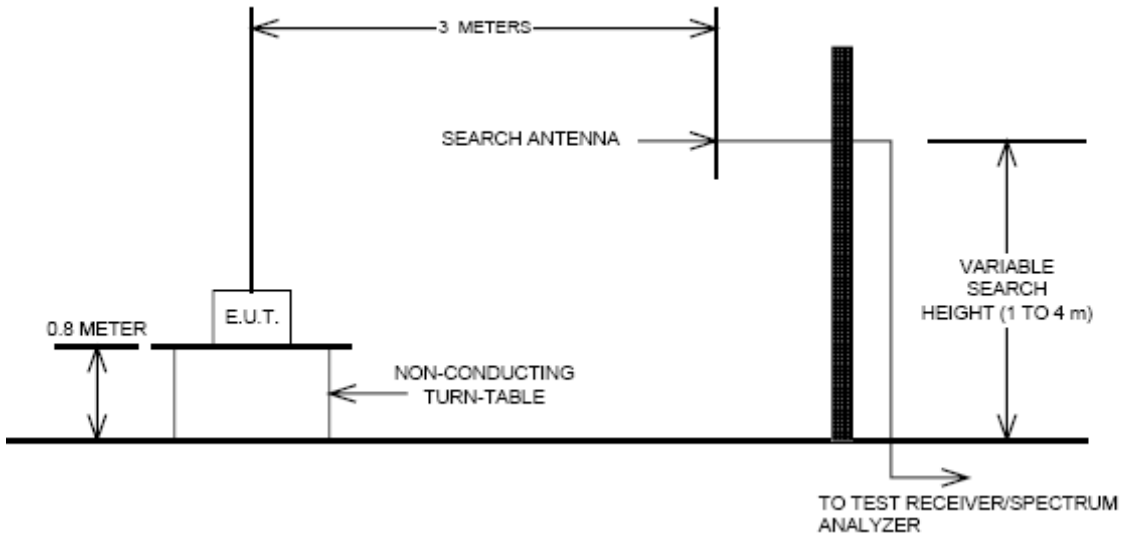

##### Test Procedure

emission measurements were performed at an Fully-anechoic chamber.

The equipment under test is placed on a non-conductive table 3-meters from the receive antenna. A turntable was rotated 360° and the receiving antenna scanned from 1-4m in order to capture the maximum emission. A half wave dipole was substituted in place of the EUT. This dipole antenna was driven by a signal generator and the previously recorded signal was duplicated.

The maximum EIRP was calculated by adding the forward power to the calibrated source plus its appropriate gain value. These steps were carried out with the receiving antenna in both vertical and horizontal polarization. For readings above 1GHz, the above procedure is repeated using horn antennas and the difference between the gain of the horn and an isotropic antenna are taken into consideration

Note : This device was tested under all R.C.s and S.O.s and worst case is reported with RC1/SO2(CDMA) with 'All Up' power control bits.

FCC CERTIFICATION REPORT			<a href="http://www.hct.co.kr">www.hct.co.kr</a>
Test Report No. HCTR1208FR26-3	Date of Issue: October 4, 2012	EUT Type: Cellular/PCS CDMA & LTE USB Dongle with WLAN	FCC ID: RB2-U772

### 3.2 PEAK- TO- AVERAGE RATIO

A peak to average ratio measurement is performed at the conducted port of the EUT. For CDMA and WCDMA signals, the spectrum analyzers Complementary Cumulative Distribution Function ( CCDF ) measurement profile is used to determine the largest deviation between the average and the peak power of the EUT in a given bandwidth. The CCDF curve shows how much time the peak waveform spends at or above a given average power level. The percent of time the signal spends at or above the level defines the probability for that particular power level. For GSM signals, an average and a peak trace are used on a spectrum analyzer to determine the largest deviation between the average and the peak power of the EUT in a bandwidth greater than the emission bandwidth. Plots of the EUT's Peak- to- Average Ratio are shown herein.

Note : This device was tested under all R.C.s and S.O.s and worst case is reported with RC1/SO2(CDMA) with 'All Up' power control bits.

FCC CERTIFICATION REPORT			<a href="http://www.hct.co.kr">www.hct.co.kr</a>
<b>Test Report No.</b> HCTR1208FR26-3	<b>Date of Issue:</b> October 4, 2012	<b>EUT Type:</b> Cellular/PCS CDMA & LTE USB Dongle with WLAN	<b>FCC ID:</b> RB2-U772

### 3.3 OCCUPIED BANDWIDTH.

#### Test set-up

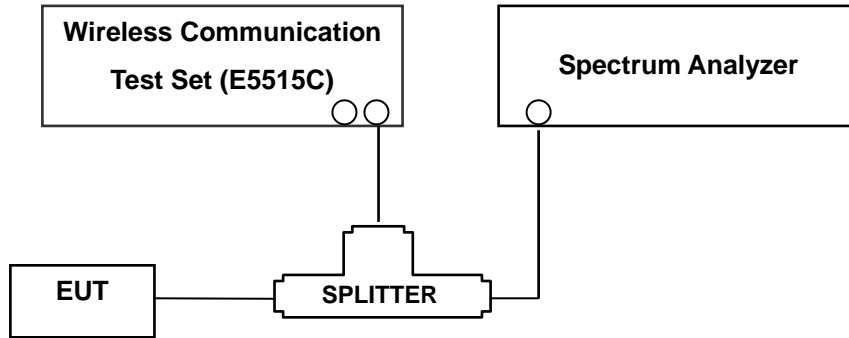

(Configuration of conducted Emission measurement)

The width of a frequency band such that, below the lower and above the upper frequency limits, the mean powers emitted are each equal to a specified percentage 0.5 % of the total mean power of a given emission.

#### Test Procedure

The EUT makes a call to the communication simulator. The power was measured with R&S Spectrum Analyzer. All measurements were done at 3 channels(low, middle and high operational range.)

The conducted occupied bandwidth used the power splitter via EUT RF power connector between simulation base station and spectrum analyzer.

The communication simulator station system controlled a EUT to export maximum output power under transmission mode and specific channel frequency. Use OBW measurement function of Spectrum analyzer to measure 99 % occupied bandwidth

Note : This device was tested under all R.C.s and S.O.s and worst case is reported with RC1/SO2(CDMA) with 'All Up' power control bits.

FCC CERTIFICATION REPORT			<a href="http://www.hct.co.kr">www.hct.co.kr</a>
Test Report No. HCTR1208FR26-3	Date of Issue: October 4, 2012	EUT Type: Cellular/PCS CDMA & LTE USB Dongle with WLAN	FCC ID: RB2-U772



### 3.4 SPURIOUS AND HARMONIC EMISSIONS AT ANTENNA TERMINAL.

#### Test Procedure

The level of the carrier and the various conducted spurious and harmonic frequencies is measured by means of a calibrated spectrum analyzer.

The EUT was setup to maximum output power at its lowest channel. The Resolution BW of the analyzer is set to < 1 % of the emission bandwidth to show compliance with the – 13 dBm limit, in the 1 MHz bands immediately outside and adjacent to the edge of the frequency block. The 1 MHz RBW was used to scan from 10 MHz to 10 GHz. (GSM1900 Mode: 10 MHz to 20 GHz). A display line was placed at – 13 dBm to show compliance. The high, lowest and a middle channel were tested for out of band measurements.

- Band Edge Requirement : In the 1MHz bands immediately outside and adjacent to the frequency block, a resolution bandwidth of at least 1 percent of the emission bandwidth of the fundamental emission of the transmitter may be employed to measure the out of band Emissions. Limit, -13dBm.

Note : This device was tested under all R.C.s and S.O.s and worst case is reported with RC1/SO2(CDMA) with 'All Up' power control bits.

FCC CERTIFICATION REPORT			<a href="http://www.hct.co.kr">www.hct.co.kr</a>
<b>Test Report No.</b> HCTR1208FR26-3	<b>Date of Issue:</b> October 4, 2012	<b>EUT Type:</b> Cellular/PCS CDMA & LTE USB Dongle with WLAN	<b>FCC ID:</b> RB2-U772

### 3.5 RADIATED SPURIOUS AND HARMONIC EMISSIONS

#### Test Set-up

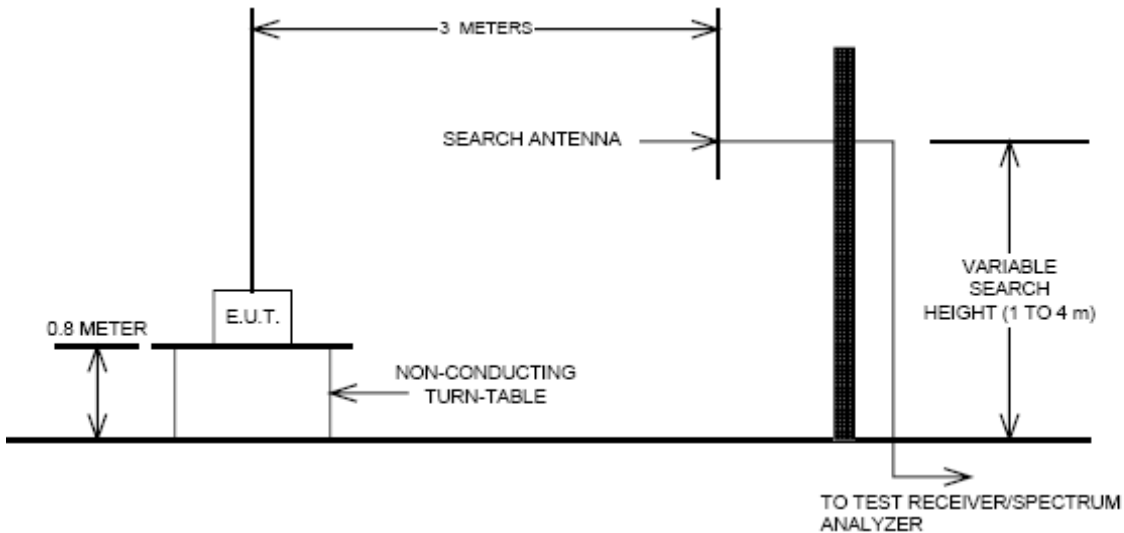

The measurement facilities used for this test have been documented in previous filings with the commission pursuant to section § 2.948. The Fully-anechoic chamber meets requirements in ANSI C63.4 –2003. A mast capable of lifting the receiving antenna from a height of one to four meters is used together with a rotatable platform mounted at three from the antenna mast.

- 1) The unit mounted on a turntable 1.5 m × 1.0 m × 0.80 m is 0.8 meter above test site ground level.
- 2) During the emission test, the turntable is rotated and the EUT is manipulated to find the configuration resulting in maximum emission under normal condition of installation and operation.
- 3) The antenna height and polarization are also varied from 1 to 4 meters until the maximum signal is found.
- 4) The spectrum shall be scanned up to the 10<sup>th</sup> harmonic of the fundamental frequency.

#### Test Procedure

The equipment under test is placed on a non-conductive table 3-meters from the receive antenna. A turntable was rotated 360° and the receiving antenna scanned from 1-4m in order to capture the maximum emission. A half wave dipole was substituted in place of the EUT. This dipole antenna was driven by a signal generator and the previously recorded signal was duplicated.

The maximum EIRP was calculated by adding the forward power to the calibrated source plus its appropriate gain value. These steps were carried out with the receiving antenna in both vertical and horizontal polarization. For readings above 1GHz, the above procedure is repeated using horn antennas and the difference between the gain of the horn and an isotropic antenna are taken into consideration.

Note : This device was tested under all R.C.s and S.O.s and worst case is reported with RC1/SO2(CDMA) with 'All Up' power control bits.

FCC CERTIFICATION REPORT			<a href="http://www.hct.co.kr">www.hct.co.kr</a>
Test Report No. HCTR1208FR26-3	Date of Issue: October 4, 2012	EUT Type: Cellular/PCS CDMA & LTE USB Dongle with WLAN	FCC ID: RB2-U772

### 3.6 FREQUENCY STABILITY / VARIATION OF AMBIENT TEMPERATURE

#### Test Set-up

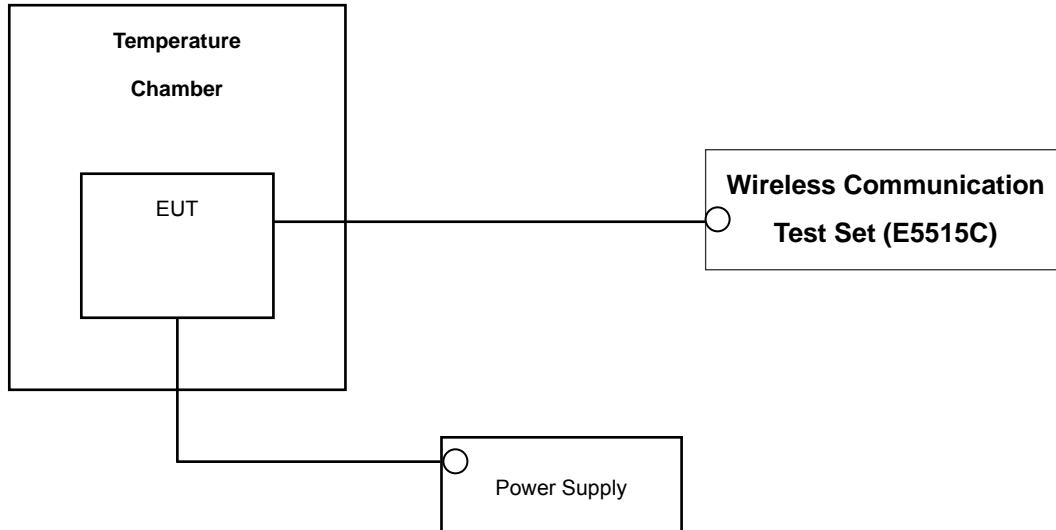

\* Nominal Operating Voltage

#### Test Procedure

The frequency stability of the transmitter is measured by:

- a.) **Temperature:** The temperature is varied from - 30 °C to + 50 °C using an environmental chamber.
- b.) **Primary Supply Voltage:** The primary supply voltage is varied from battery end point to 115 % of the voltage normally at the input to the device or at the power supply terminals if cables are not normally supplied.

Specification — the frequency stability shall be sufficient to ensure that the fundamental emission stays within the authorized frequency block. The frequency stability of the transmitter shall be maintained within  $\pm 0.00025\%$  ( $\pm 2.5$  ppm) of the center frequency.

#### Time Period and Procedure:

The carrier frequency of the transmitter is measured at room temperature (20°C to provide a reference).

1. The equipment is turned on in a “standby” condition for one minute before applying power to the transmitter. Measurement of the carrier frequency of the transmitter is made within one minute after applying power to the transmitter.
2. Frequency measurements are made at 10°C intervals ranging from -30°C to +50°C. A period of at least one half-hour is provided to allow stabilization of the equipment at each temperature level.

Note : This device was tested under all R.C.s and S.O.s and worst case is reported with RC1/SO2(CDMA) with 'All Up' power control bits.

FCC CERTIFICATION REPORT			<a href="http://www.hct.co.kr">www.hct.co.kr</a>
Test Report No. HCTR1208FR26-3	Date of Issue: October 4, 2012	EUT Type: Cellular/PCS CDMA & LTE USB Dongle with WLAN	FCC ID: RB2-U772

## 4. LIST OF TEST EQUIPMENT

Manufacture	Model/ Equipment	Serial Number	Calibration Interval	Calibration Due
Agilent	E9327A/ Power Sensor	MY4442009	Annual	05/02/2013
R&S	CMW500/ Base Station	1201.0002K50_116858	Annual	01/17/2013
MITEQ	AMF-6D-001180-35-20P/AMP	1081666	Annual	09/11/2013
Wainwright	WHK1.2/15G-10EF/H.P.F	2	Annual	05/02/2013
Wainwright	WHK3.3/18G-10EF/H.P.F	1	Annual	05/02/2013
Hewlett Packard	11667B / Power Splitter	10126	Annual	11/04/2012
Digital	EP-3010/ Power Supply	3110117	Annual	11/07/2012
Schwarzbeck	UHAP/ Dipole Antenna	557	Biennial	03/11/2013
Schwarzbeck	UHAP/ Dipole Antenna	558	Biennial	03/11/2013
Korea Engineering	KR-1005L / Chamber	KRAB05063-3CH	Annual	11/07/2012
Schwarzbeck	BBHA 9120D/ Horn Antenna	296	Biennial	02/20/2014
Agilent	E4440A/Spectrum Analyzer	US45303008	Annual	05/02/2013
WEINSCHTEL	ATTENUATOR	BR0592	Annual	11/07/2012
REOHDE&SCHWARZ	FSV40/Spectrum Analyzer	1307.9002K40-100931-NK	Annual	06/11/2013
Agilent	8960 (E5515C)/ Base Station	GB44400269	Annual	02/10/2013

FCC CERTIFICATION REPORT			<a href="http://www.hct.co.kr">www.hct.co.kr</a>
Test Report No. HCTR1208FR26-3	Date of Issue: October 4, 2012	EUT Type: Cellular/PCS CDMA & LTE USB Dongle with WLAN	FCC ID: RB2-U772

## 5. SUMMARY OF TEST RESULTS

FCC Part Section(s)	Test Description	Test Limit	Test Condition	Test Result
2.1051, 90.691	Occupied Bandwidth	N/A	CONDUCTED	PASS
2.1051, 90.691	Band Edge / Spurious and Harmonic Emissions at Antenna Terminal.	< 50 + 10log <sub>10</sub> (P[Watts]) at Band Edge and for all out-of-band emissions within 37.5Khz of Block Edge		PASS
2.1046	Conducted Output Power	N/A		PASS
2.1055, 90.213	Frequency stability / variation of ambient temperature	< 2.5 ppm		PASS
90.635	Effective Radiated Power	< 100 Watts max. ERP	RADIATED	PASS
2.1053, 90.691	Radiated Spurious and Harmonic Emissions	< 43 + 10log <sub>10</sub> (P[Watts]) for all out-of band emissions		PASS

FCC CERTIFICATION REPORT			<a href="http://www.hct.co.kr">www.hct.co.kr</a>
<b>Test Report No.</b> HCTR1208FR26-3	<b>Date of Issue:</b> October 4, 2012	<b>EUT Type:</b> Cellular/PCS CDMA & LTE USB Dongle with WLAN	<b>FCC ID:</b> RB2-U772

## 6. SAMPLE CALCULATION

### A. ERP Sample Calculation

Mode	Ch./ Freq.		Measured Level(dBm)	Substitute LEVEL(dBm)	Ant. Gain (dBd)	C.L	Pol.	ERP	
	channel	Freq.(MHz)						W	dBm
CDMA	580	820.50	-10.96	24.81	2.50	1.19	H	0.41	26.12

**ERP = SubstituteLEVEL(dBm) + Ant. Gain – CL(Cable Loss)**

- 1) The EUT mounted on a wooden tripod is 0.8 meter above test site ground level.
- 2) During the test , the turn table is rotated and the antenna height is also varied from 1 to 4 meters until the maximum signal is found.
- 3) Record the field strength meter's level.
- 4) Replace the EUT with dipole/Horn antenna that is connected to a calibrated signal generator.
- 5) Increase the signal generator output till the field strength meter's level is equal to the item (3).
- 6) The signal generator output level with Ant. Gain and cable loss are the rating of effective radiated power (**ERP**).

### B. Emission Designator

#### CDMA Emission Designator

**Emission Designator = 1M27F9W**

CDMA BW = 1.27 MHz (Measured at the 99% power bandwidth)

F = Frequency Modulation

9 = Composite Digital Info

W = Combination (Audio/Data)

FCC CERTIFICATION REPORT			<a href="http://www.hct.co.kr">www.hct.co.kr</a>
Test Report No. HCTR1208FR26-3	Date of Issue: October 4, 2012	EUT Type: Cellular/PCS CDMA & LTE USB Dongle with WLAN	FCC ID: RB2-U772

## 7. TEST DATA

### 7.1 CONDUCTED OUTPUT POWER

A base station simulator was used to establish communication with The EUT. The base station simulator parameters were set to produce the maximum power from the EUT. This device was tested under all configurations and the highest power is reported. Conducted Output Powers of EUT are reported below.

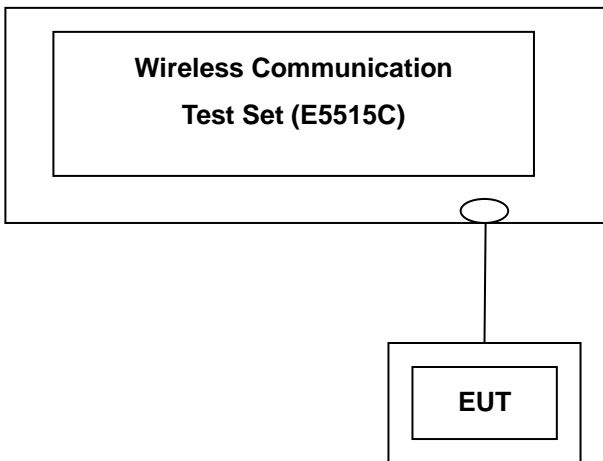

Band	Channel	SO2	SO2	SO55	SO55	TDSO SO32	1xEvDO Rev.O	1xEvDO Rev.O	1xEvDO Rev.1	1xEvDO Rev.1
		RC1/1 (dBm)	RC3/3 (dBm)	RC1/1 (dBm)	RC3/3 (dBm)	RC3/3 (dBm)	(FTAP)	(RTAP)	(FETAP)	(RETAP)
CDMA	476	23.66	23.59	23.56	23.56	23.62	23.62	23.80	23.79	23.70
	580	23.67	23.67	23.65	23.71	23.72	23.70	23.83	23.77	23.65
	684	23.98	23.93	24.00	23.99	23.97	23.92	24.00	23.95	23.90

(Maximum Conducted Output Powers)

Note : Detecting mode is average.

FCC CERTIFICATION REPORT			<a href="http://www.hct.co.kr">www.hct.co.kr</a>
Test Report No. HCTR1208FR26-3	Date of Issue: October 4, 2012	EUT Type: Cellular/PCS CDMA & LTE USB Dongle with WLAN	FCC ID: RB2-U772

## 7.2 OCCUPIED BANDWIDTH

Band	Channel	Frequency(MHz)	Data (MHz)
CDMA	476	817.90	1.2762
	580	820.50	1.2758
	684	823.10	1.2686
CDMA EVDO	476	817.90	1.2579

- Plots of the EUT's Occupied Bandwidth are shown Page 23 ~ 25.

## 7.3 CONDUCTED SPURIOUS EMISSIONS

Band	Channel	Frequency of Maximum Harmonic (GHz)	Maximum Data (dBm)
CDMA	476	7.055	-30.889
	580	7.003	-31.211
	684	8.018	-31.042

- Plots of the EUT's Conducted Spurious Emissions are shown Page 34 ~ 39.

### 7.3.1 Band Edge

- Plots of the EUT's Band Edge are shown Page 26 ~ 33.



## 7.4 EFFECTIVE RADIATED POWER OUTPUT

When connected to the USB port of the computer

(CDMA Mode)

Mode	Ch./ Freq.		Measured Level(dBm)	Substitute LEVEL (dBm)	Ant. Gain (dBd)	C.L	Pol.	ERP	
	channel	Freq.(MHz)						W	dBm
CDMA	476	817.90	-14.87	33.82	-10.56	1.63	V	0.146	21.63
	580	820.50	-15.54	33.15	-10.56	1.63	V	0.125	20.96
	684	823.10	-15.28	33.66	-10.55	1.61	V	0.141	21.50
EVDO	476	817.90	-14.28	34.41	-10.56	1.63	V	0.167	22.22
	580	820.50	-14.88	33.81	-10.56	1.63	V	0.145	21.62
	684	823.10	-14.43	34.51	-10.55	1.61	V	0.172	22.35

### NOTES:

Effective Radiated Power Output Measurements by Substitution Method

according to ANSI/TIA/EIA-603-C-2004, Aug. 17, 2004:

The EUT was placed on a non-conductive styrofoam resin table 3-meters from the receive antenna. The receive antenna height and turntable rotation was adjusted for the highest reading on the receive spectrum analyzer. For CDMA signals, a peak detector is used, with RBW = VBW = 3 MHz. For WCDMA signals, a peak detector is used, with RBW = VBW = 5MHz. For AMPS, GSM, and NADC TDMA signals, a peak detector is used, with RBW = VBW = 1 MHz. A half-wave dipole was substituted in place of the EUT. This dipole antenna was driven by a signal generator and the level of the signal generator was adjusted to obtain the same receive spectrum analyzer reading. The conducted power at the terminals of the dipole is measured. The ERP is recorded.

This device was tested under all configurations and the highest power is reported. Also, we have done x, y, z planes in EUT and horizontal and vertical polarization in detecting antenna. The worst case of the EUT is in y plane in CDMA mode. Also worst case of detecting Antenna is in vertical polarization in CDMA mode.

The EVDO mode testing were performed using RTAP on Rev.0 because RTAP on Rev.0 is highest power in EVDO mode.

FCC CERTIFICATION REPORT			<a href="http://www.hct.co.kr">www.hct.co.kr</a>
Test Report No. HCTR1208FR26-3	Date of Issue: October 4, 2012	EUT Type: Cellular/PCS CDMA & LTE USB Dongle with WLAN	FCC ID: RB2-U772

**When connected to the AC-USB adaptor  
(CDMA Mode)**

Mode	Ch./ Freq.		Measured Level(dBm)	Substitute LEVEL (dBm)	Ant. Gain (dBd)	C.L	Pol.	ERP	
	channel	Freq.(MHz)						W	dBm
CDMA	476	817.90	-11.41	37.28	-10.56	1.63	H	0.323	25.09
	580	820.50	-11.11	37.58	-10.56	1.63	H	0.346	25.39
	684	823.10	-10.80	38.14	-10.55	1.61	H	0.396	25.98
EVDO	476	817.90	-11.20	37.49	-10.56	1.63	H	0.339	25.30
	580	820.50	-10.96	37.73	-10.56	1.63	H	0.358	25.54
	684	823.10	-10.69	38.25	-10.55	1.61	H	0.406	26.09

**NOTES:**

Effective Radiated Power Output Measurements by Substitution Method according to ANSI/TIA/EIA-603-C-2004, Aug. 17, 2004:

The EUT was placed on a non-conductive styrofoam resin table 3-meters from the receive antenna. The receive antenna height and turntable rotation was adjusted for the highest reading on the receive spectrum analyzer. For CDMA signals, a peak detector is used, with RBW = VBW = 3 MHz. For WCDMA signals, a peak detector is used, with RBW = VBW = 5MHz. For AMPS, GSM, and NADC TDMA signals, a peak detector is used, with RBW = VBW = 1 MHz. A half-wave dipole was substituted in place of the EUT. This dipole antenna was driven by a signal generator and the level of the signal generator was adjusted to obtain the same receive spectrum analyzer reading. The conducted power at the terminals of the dipole is measured. The ERP is recorded.

This device was tested under all configurations and the highest power is reported. Also, we have done x, y, z planes in EUT and horizontal and vertical polarization in detecting antenna. The worst case of the EUT is in x plane in CDMA mode. Also worst case of detecting Antenna is in horizontal polarization in CDMA mode.

The EVDO mode testing were performed using RTAP on Rev.0 because RTAP on Rev.0 is highest power in EVDO mode.

FCC CERTIFICATION REPORT			<a href="http://www.hct.co.kr">www.hct.co.kr</a>
Test Report No. HCTR1208FR26-3	Date of Issue: October 4, 2012	EUT Type: Cellular/PCS CDMA & LTE USB Dongle with WLAN	FCC ID: RB2-U772

## 7.5 RADIATED SPURIOUS EMISSIONS

### 7.5.1 RADIATED SPURIOUS EMISSIONS(CDMA Mode)

#### When connected to the USB port of the computer

MEASURED OUTPUT POWER: \_\_\_\_\_ 22.35 dBm = 0.172 W

MODULATION SIGNAL: \_\_\_\_\_ CDMA EVDO

DISTANCE: \_\_\_\_\_ 3 meters

LIMIT: - (43 + 10 log<sub>10</sub> (W)) = \_\_\_\_\_ -35.35 dBc

Ch.	Freq.(MHz)	Measured Level [dBm]	Ant. Gain [dBd]	Substitute Level [dBm]	C.L	Pol.	ERP (dBm)	dBc
476	1,635.80	-35.52	9.62	-44.71	1.70	V	-36.79	-59.14
	2,453.70	-50.05	10.56	-56.23	2.09	H	-47.76	-70.11
	3,271.60	-	-	-	-	-	-	-
580	1,640.20	-33.56	9.62	-42.75	1.70	V	-34.83	-57.18
	2,460.30	-50.34	10.56	-56.05	2.08	H	-47.57	-69.92
	3,280.40	-	-	-	-	-	-	-
684	1,646.20	-32.12	11.84	-41.41	1.71	V	-31.28	-53.63
	2,469.30	-50.11	10.56	-55.95	2.08	H	-47.47	-69.82
	3,292.40	-	-	-	-	-	-	-

- NOTES:**
1. Radiated Spurious Emission Measurements at 3 meters by Substitution Method according to ANSI/TIA/EIA-603-C-2004, Aug. 17, 2004:
  2. The magnitude of spurious emissions attenuated more than 20dB below the limit above 5<sup>th</sup> Harmonic for all channel.
  3. we have done x, y, z planes in EUT and horizontal and vertical polarization in detecting antenna.

FCC CERTIFICATION REPORT			<a href="http://www.hct.co.kr">www.hct.co.kr</a>
Test Report No. HCTR1208FR26-3	Date of Issue: October 4, 2012	EUT Type: Cellular/PCS CDMA & LTE USB Dongle with WLAN	FCC ID: RB2-U772

**When connected to the AC-USB adaptor**

MEASURED OUTPUT POWER: 26.09 dBm = 0.406 W  
 MODULATION SIGNAL: CDMA EVDO  
 DISTANCE: 3 meters  
 LIMIT: - (43 + 10 log10 (W)) = -39.09 dBc

Ch.	Freq.(MHz)	Measured Level [dBm]	Ant. Gain [dBd]	Substitute Level [dBm]	C.L	Pol.	ERP (dBm)	dBc
476	1,635.80	-40.24	9.62	-49.43	1.70	V	-41.51	-67.60
	2,453.70	-54.63	10.56	-60.81	2.09	H	-52.34	-78.43
	3,271.60	-	-	-	-	-	-	-
580	1,640.20	-38.81	9.62	-48.00	1.70	V	-40.08	-66.17
	2,460.30	-56.24	10.56	-61.95	2.08	H	-53.47	-79.56
	3,280.40	-	-	-	-	-	-	-
684	1,646.20	-36.65	11.84	-45.94	1.71	V	-35.81	-61.90
	2,469.30	-39.30	10.56	-45.14	2.08	V	-36.66	-62.75
	3,292.40	-	-	-	-	-	-	-

- NOTES:**
1. Radiated Spurious Emission Measurements at 3 meters by Substitution Method according to ANSI/TIA/EIA-603-C-2004, Aug. 17, 2004:
  2. The magnitude of spurious emissions attenuated more than 20dB below the limit above 5<sup>th</sup> Harmonic for all channel.
  3. we have done x, y, z planes in EUT and horizontal and vertical polarization in detecting antenna.

FCC CERTIFICATION REPORT			<a href="http://www.hct.co.kr">www.hct.co.kr</a>
Test Report No. HCTR1208FR26-3	Date of Issue: October 4, 2012	EUT Type: Cellular/PCS CDMA & LTE USB Dongle with WLAN	FCC ID: RB2-U772

## 7.6 FREQUENCY STABILITY / VARIATION OF AMBIENT TEMPERATURE

### 7.6.1 FREQUENCY STABILITY (CDMA)

OPERATING FREQUENCY: 820.500.000 Hz  
 CHANNEL: 580  
 REFERENCE VOLTAGE: 5 VDC  
 DEVIATION LIMIT: ± 0.000 25 % or 2.5 ppm

Voltage (%)	Power (VDC)	Temp. ( )	Frequency (Hz)	Frequency Error (Hz)	Deviation (%)	ppm
100%	5.00	+20(Ref)	820 500 008	0	0.000 000	0.000
100%		-30	820 499 998	-10.35	-0.000 001	-0.013
100%		-20	820 499 997	-10.89	-0.000 001	-0.013
100%		-10	820 499 998	-9.87	-0.000 001	-0.012
100%		0	820 499 998	-10.23	-0.000 001	-0.012
100%		+10	820 499 999	-9.22	-0.000 001	-0.011
100%		+30	820 500 004	-4.42	-0.000 001	-0.005
100%		+40	820 500 002	-5.81	-0.000 001	-0.007
100%		+50	820 500 001	-7.22	-0.000 001	-0.009
115%	5.75	+20	820 500 000	-8.04	-0.000 001	-0.010

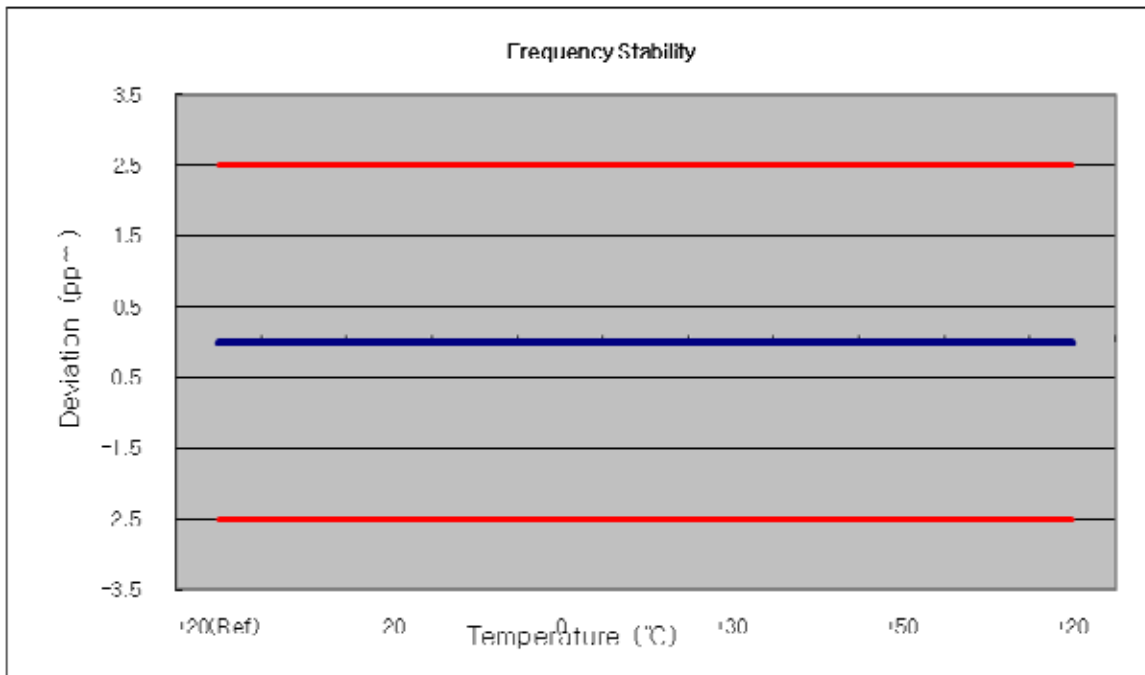

## 8. TEST PLOTS

FCC CERTIFICATION REPORT			<a href="http://www.hct.co.kr">www.hct.co.kr</a>
<b>Test Report No.</b> HCTR1208FR26-3	<b>Date of Issue:</b> October 4, 2012	<b>EUT Type:</b> Cellular/PCS CDMA & LTE USB Dongle with WLAN	<b>FCC ID:</b> RB2-U772

■ Secondary MODE (476 CH.) Occupied Bandwidth

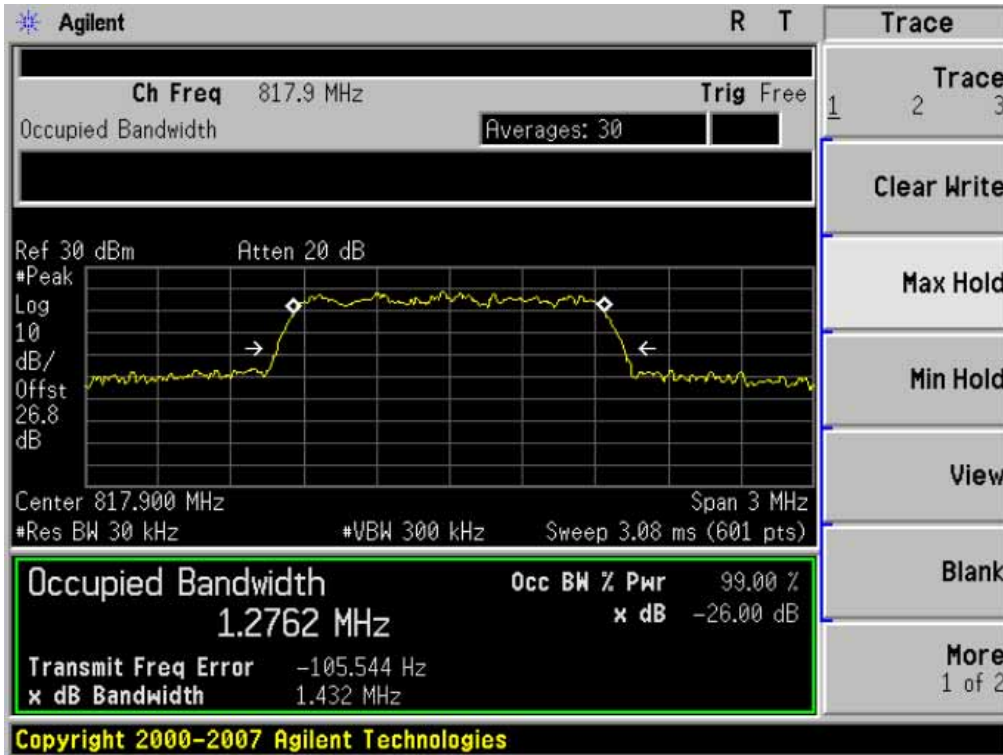

■ Secondary MODE (580 CH.) Occupied Bandwidth

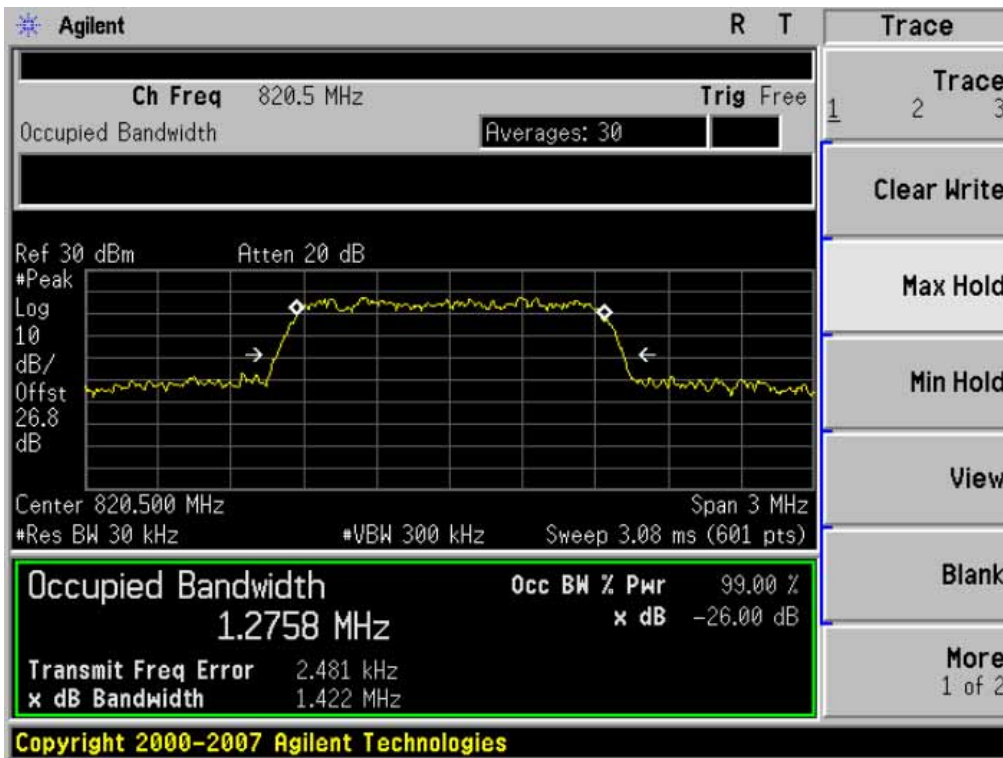

FCC CERTIFICATION REPORT			<a href="http://www.hct.co.kr">www.hct.co.kr</a>
Test Report No. HCTR1208FR26-3	Date of Issue: October 4, 2012	EUT Type: Cellular/PCS CDMA & LTE USB Dongle with WLAN	FCC ID: RB2-U772

■ Secondary MODE (684 CH.) Occupied Bandwidth

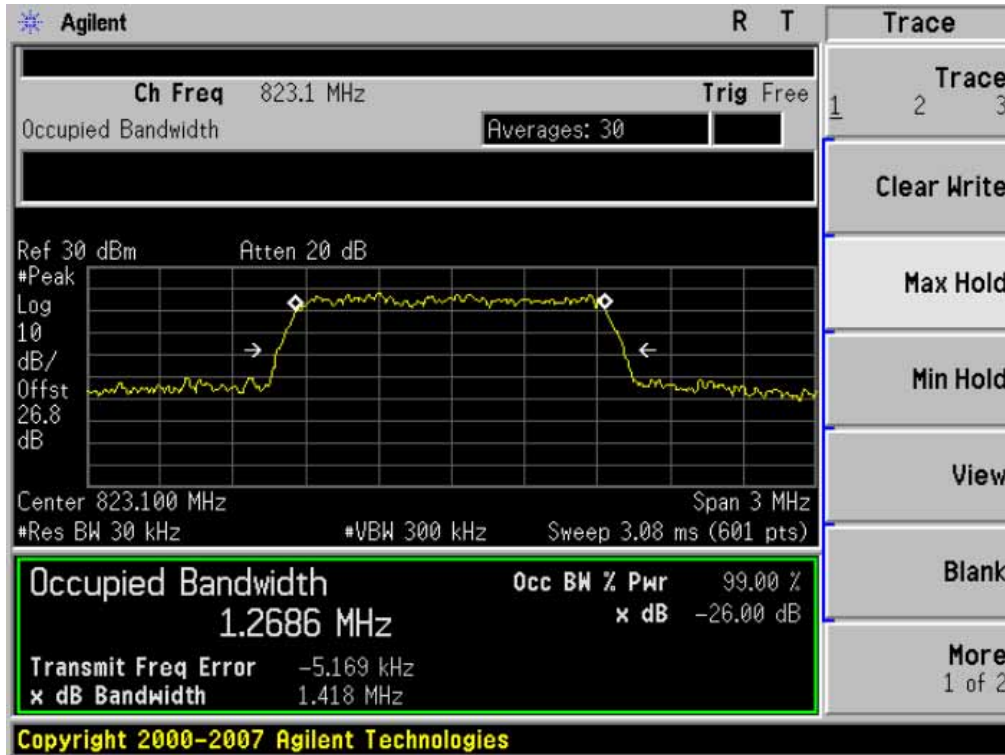

■ Secondary EVDO MODE (476 CH.) Occupied Bandwidth



FCC CERTIFICATION REPORT			<a href="http://www.hct.co.kr">www.hct.co.kr</a>
Test Report No. HCTR1208FR26-3	Date of Issue: October 4, 2012	EUT Type: Cellular/PCS CDMA & LTE USB Dongle with WLAN	FCC ID: RB2-U772



■ Secondary EVDO MODE (580 CH.) Occupied Bandwidth

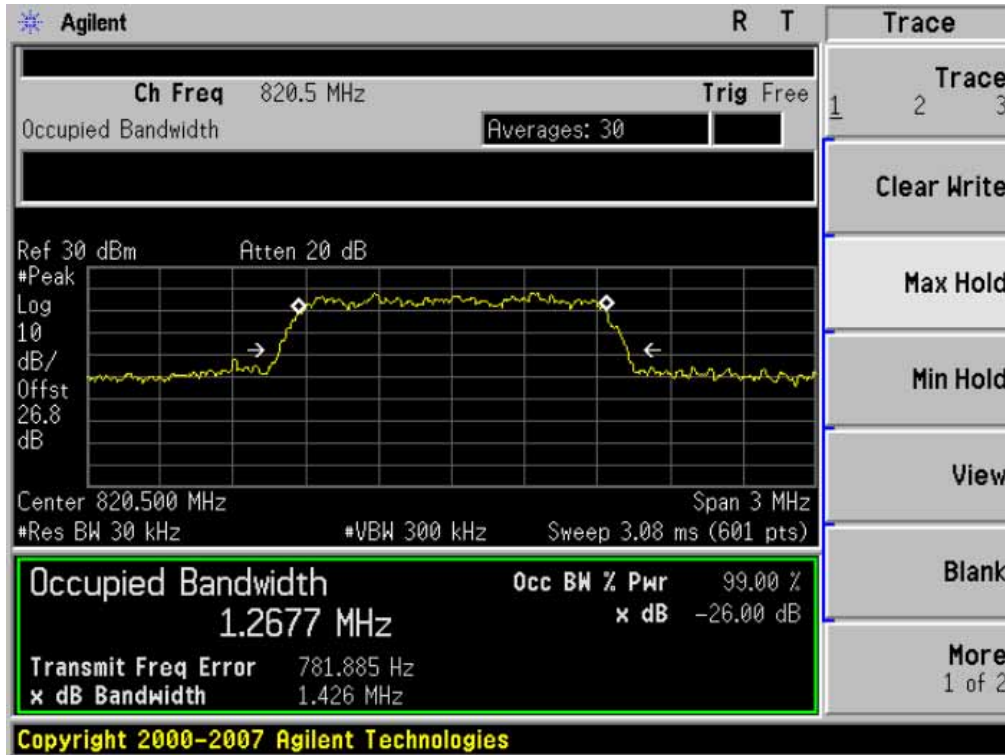

■ Secondary EVDO MODE (684 CH.) Occupied Bandwidth

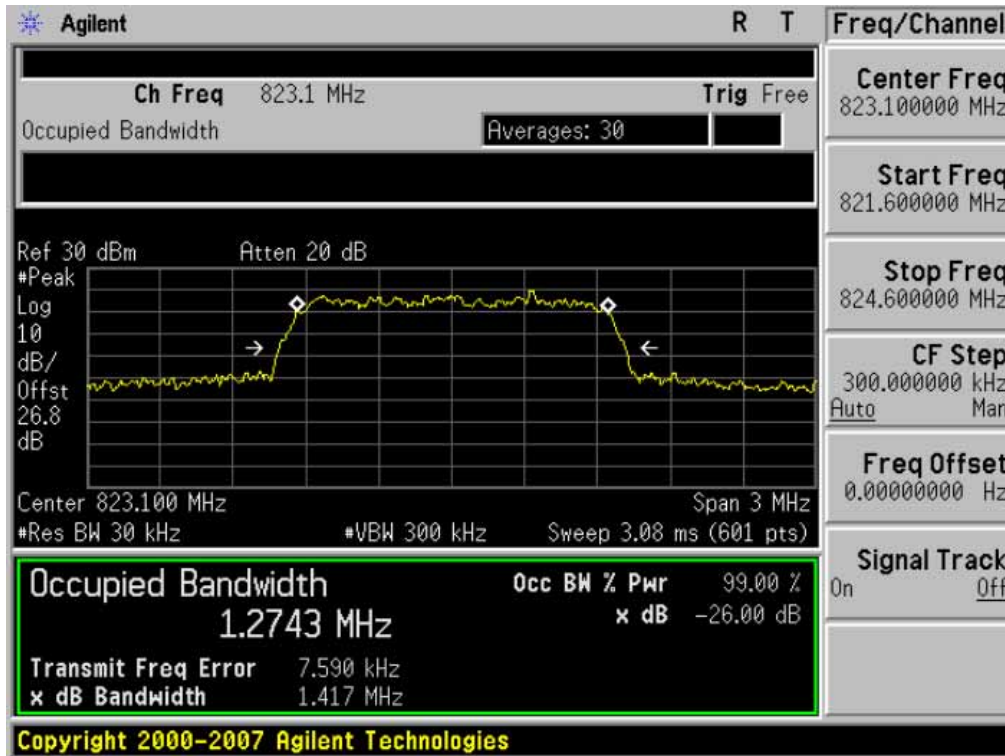

FCC CERTIFICATION REPORT			<a href="http://www.hct.co.kr">www.hct.co.kr</a>
Test Report No. HCTR1208FR26-3	Date of Issue: October 4, 2012	EUT Type: Cellular/PCS CDMA & LTE USB Dongle with WLAN	FCC ID: RB2-U772

■ Secondary MODE (476 CH.) Block Edge-1

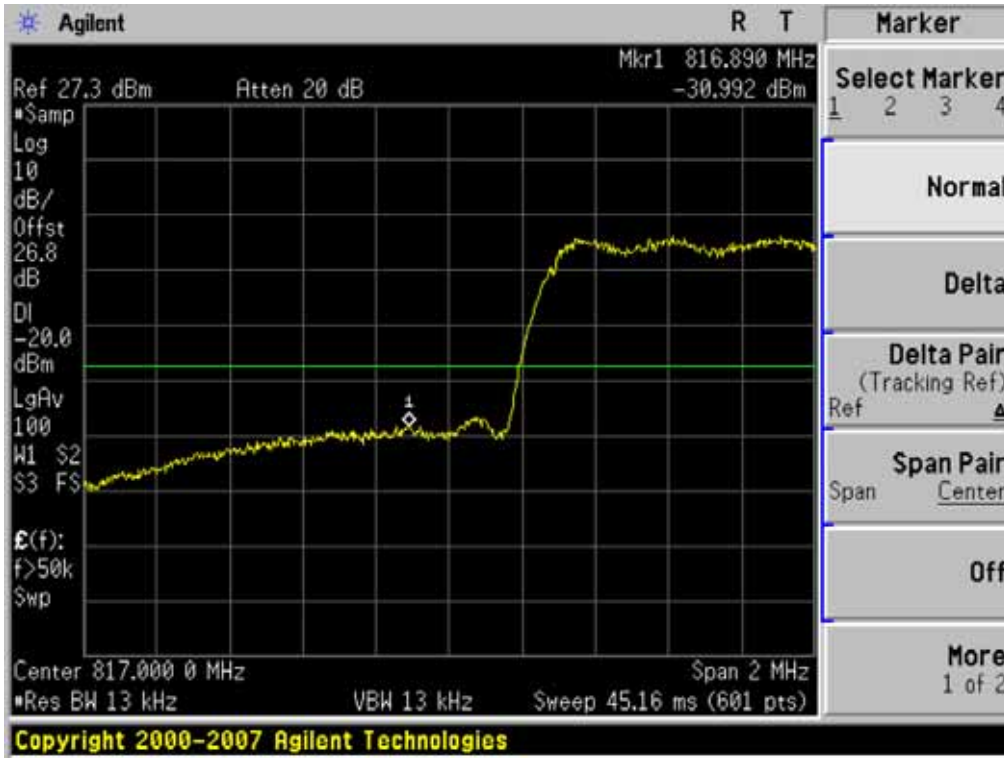

■ Secondary MODE (476 CH.) Block Edge-2

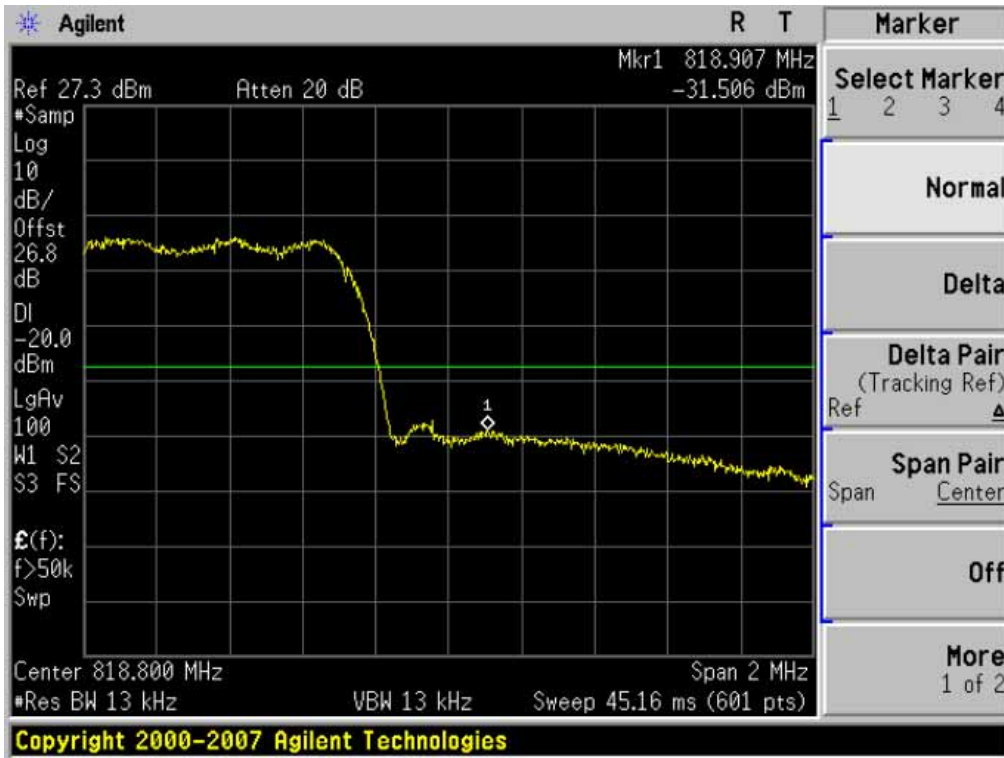

FCC CERTIFICATION REPORT			<a href="http://www.hct.co.kr">www.hct.co.kr</a>
Test Report No. HCTR1208FR26-3	Date of Issue: October 4, 2012	EUT Type: Cellular/PCS CDMA & LTE USB Dongle with WLAN	FCC ID: RB2-U772

■ Secondary MODE (580 CH.) Block Edge-1

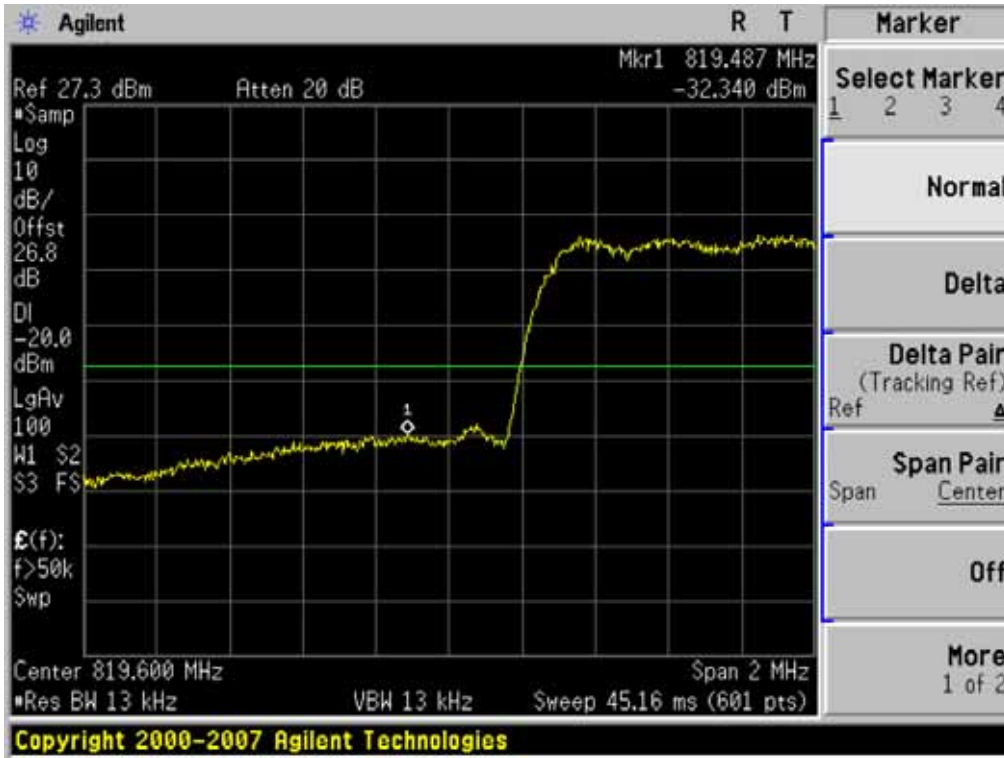

■ Secondary MODE (580 CH.) Block Edge-2

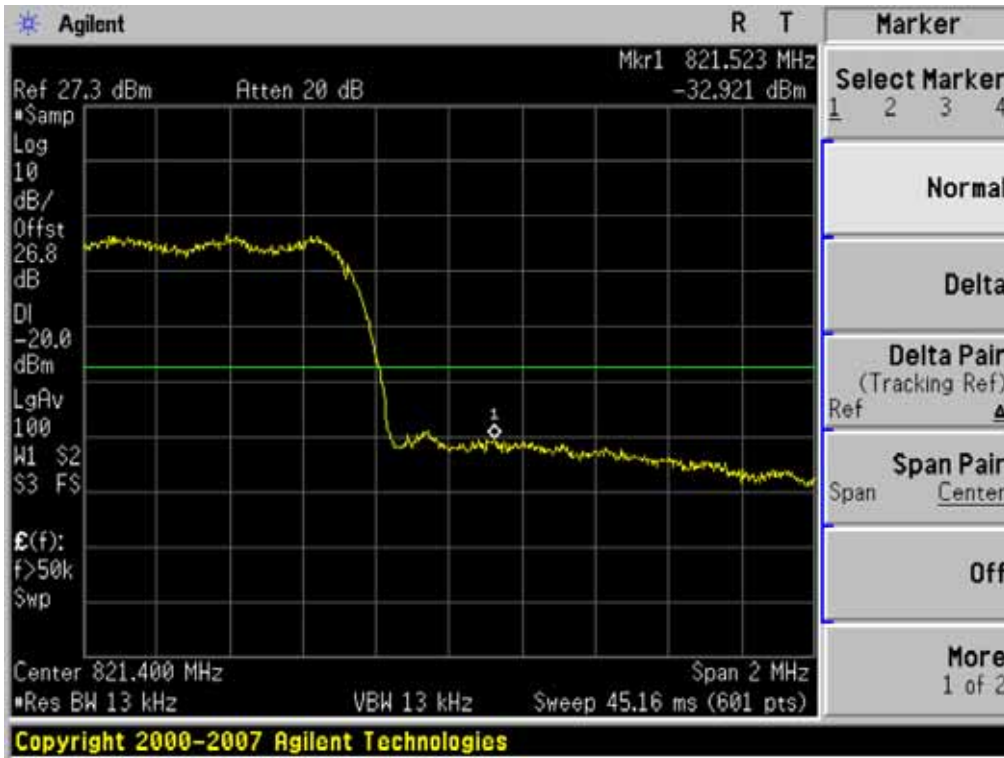

FCC CERTIFICATION REPORT			<a href="http://www.hct.co.kr">www.hct.co.kr</a>
Test Report No. HCTR1208FR26-3	Date of Issue: October 4, 2012	EUT Type: Cellular/PCS CDMA & LTE USB Dongle with WLAN	FCC ID: RB2-U772

■ Secondary MODE (684 CH.) Block Edge-1

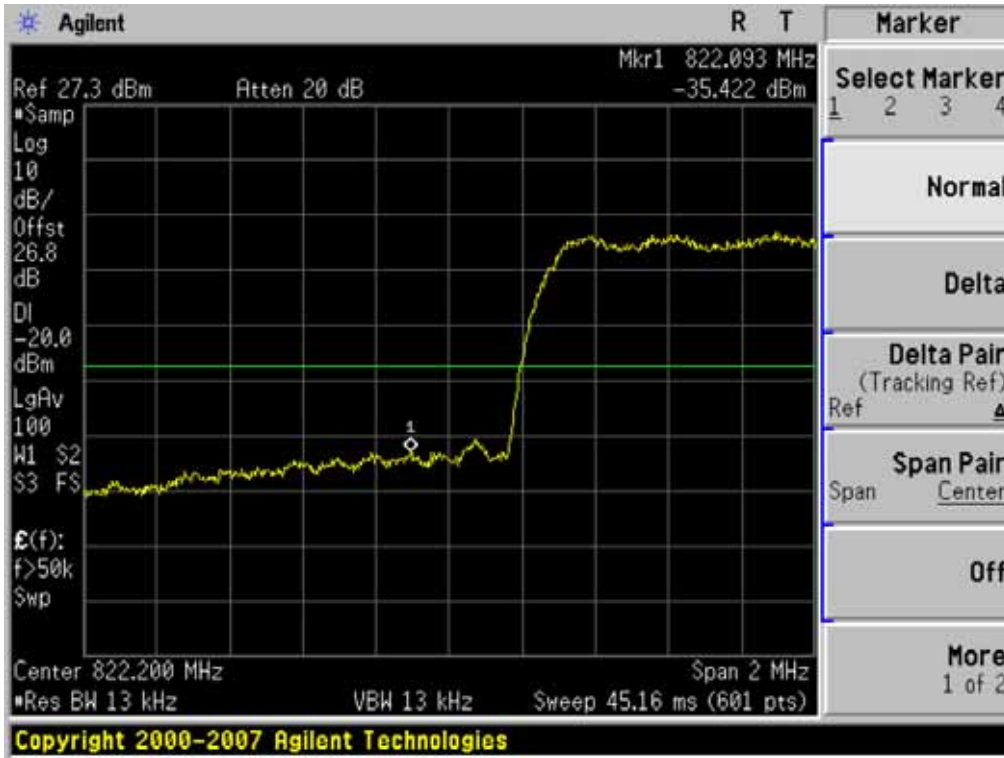

■ Secondary MODE (684 CH.) Block Edge-2

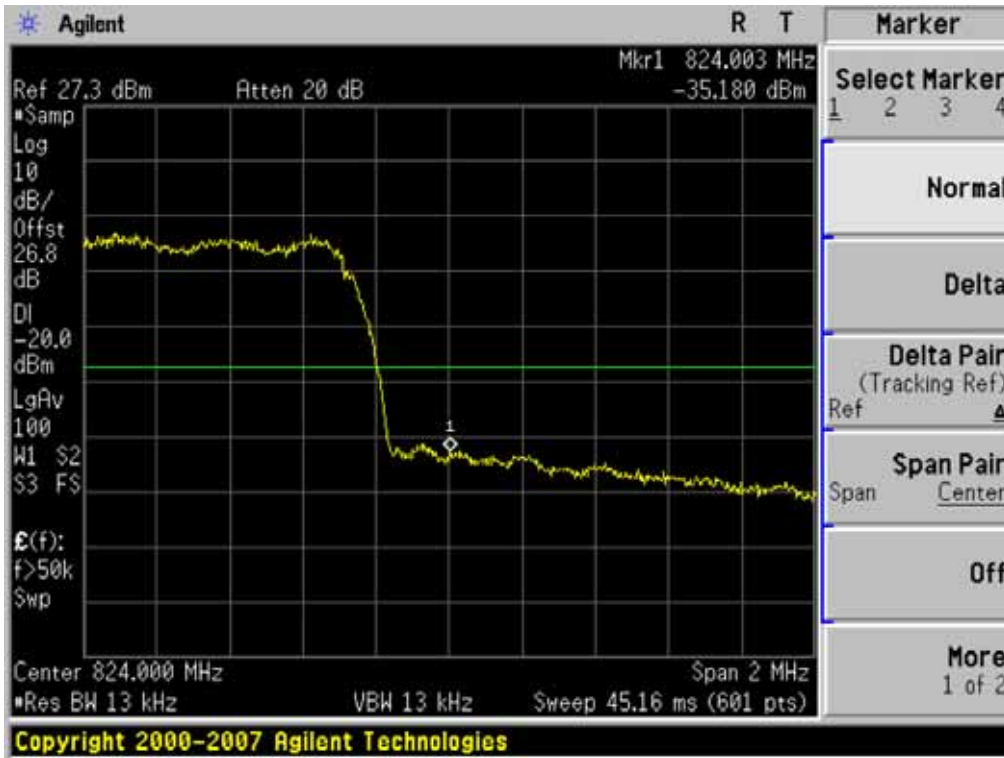

FCC CERTIFICATION REPORT			<a href="http://www.hct.co.kr">www.hct.co.kr</a>
Test Report No. HCTR1208FR26-3	Date of Issue: October 4, 2012	EUT Type: Cellular/PCS CDMA & LTE USB Dongle with WLAN	FCC ID: RB2-U772

■ Secondary EVDO MODE (476 CH.) Block Edge-1

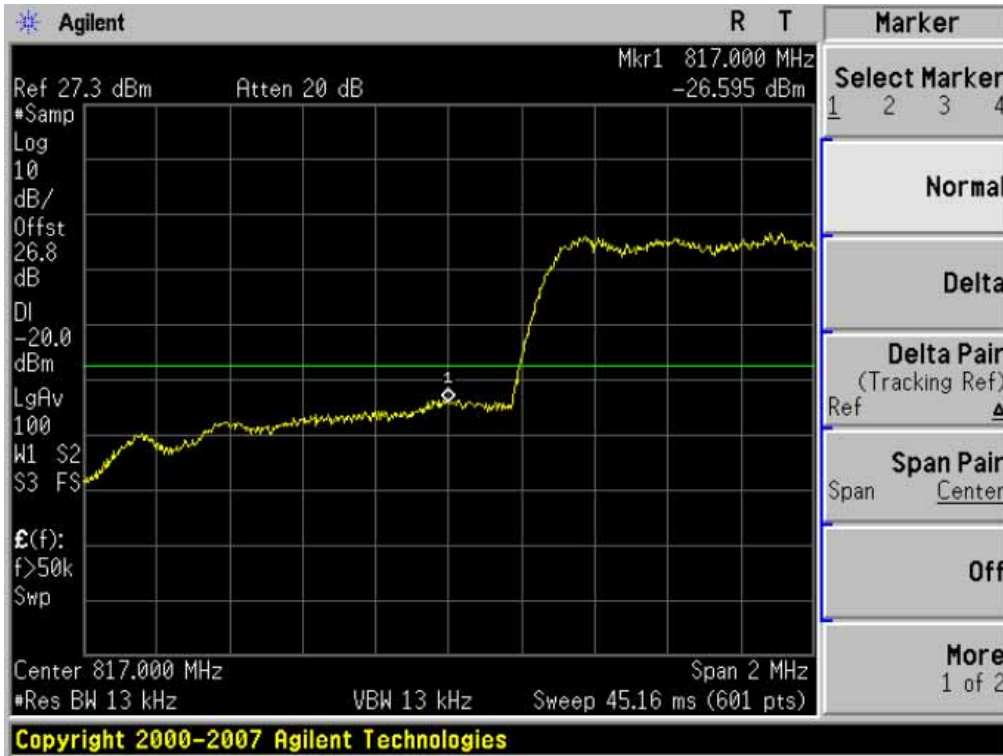

■ Secondary EVDO MODE (476 CH.) Block Edge-2

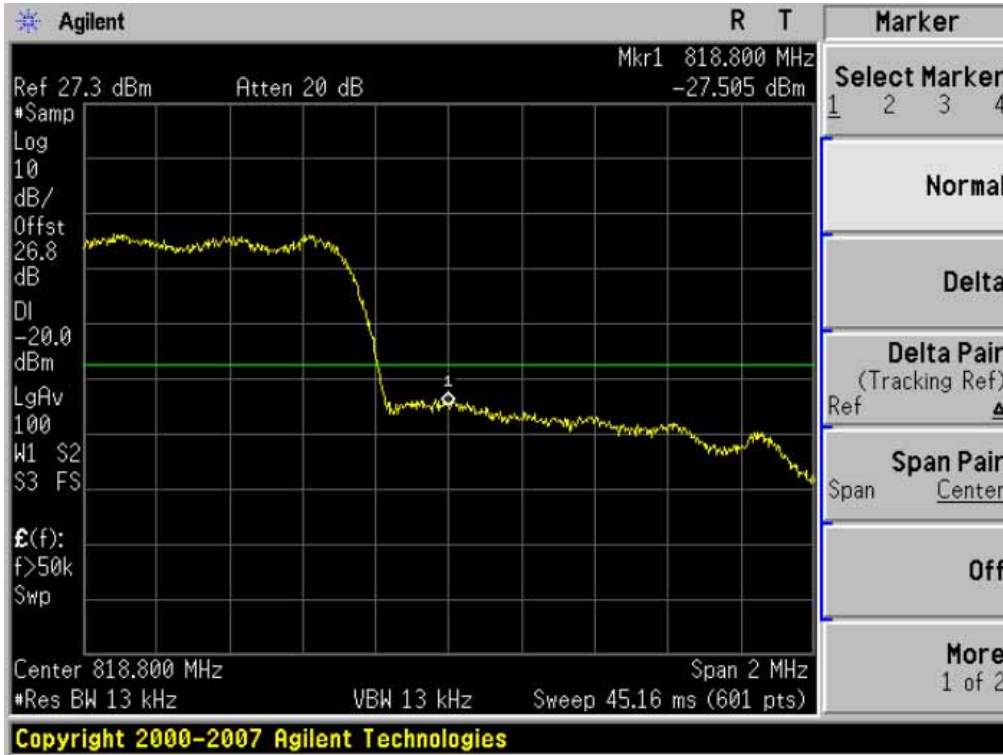

FCC CERTIFICATION REPORT			<a href="http://www.hct.co.kr">www.hct.co.kr</a>
Test Report No. HCTR1208FR26-3	Date of Issue: October 4, 2012	EUT Type: Cellular/PCS CDMA & LTE USB Dongle with WLAN	FCC ID: RB2-U772



■ Secondary EVDO MODE (580 CH.) Block Edge-1

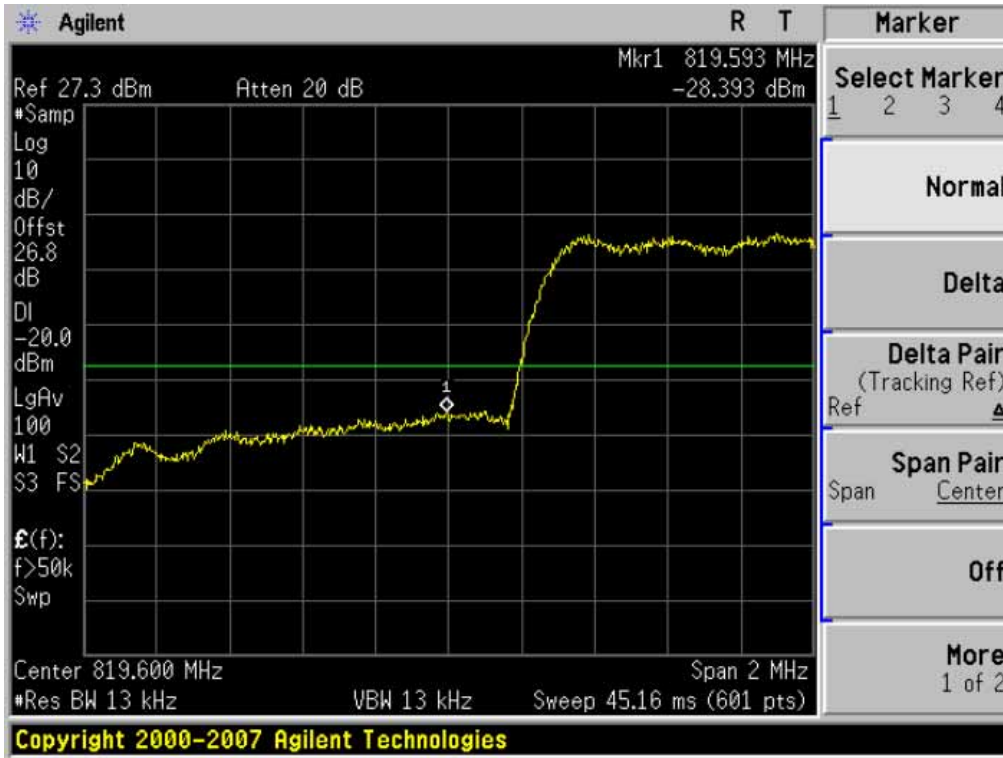

■ Secondary EVDO MODE (580 CH.) Block Edge-2

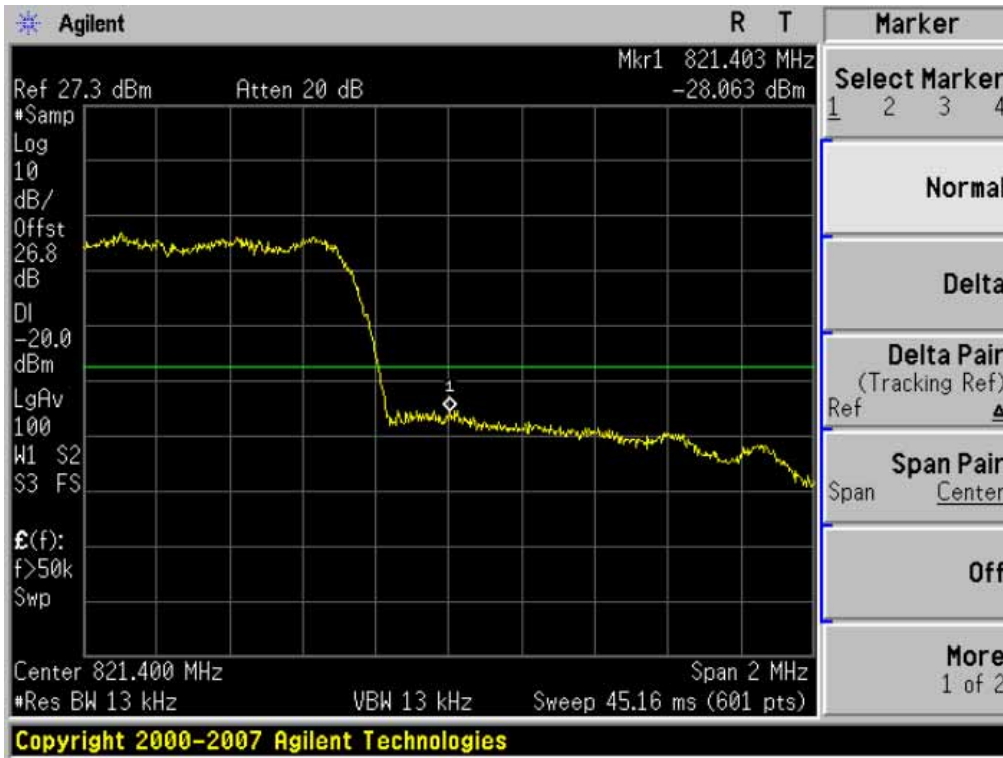

FCC CERTIFICATION REPORT			<a href="http://www.hct.co.kr">www.hct.co.kr</a>
Test Report No. HCTR1208FR26-3	Date of Issue: October 4, 2012	EUT Type: Cellular/PCS CDMA & LTE USB Dongle with WLAN	FCC ID: RB2-U772

■ Secondary EVDO MODE (684 CH.) Block Edge-1

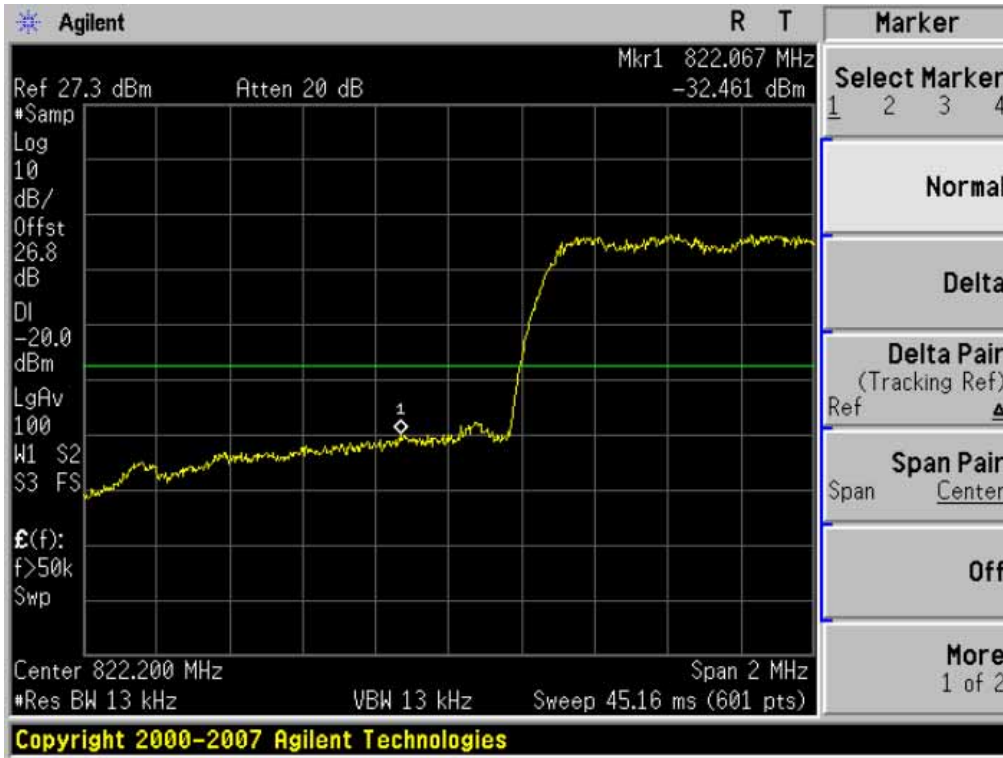

■ Secondary EVDO MODE (684 CH.) Block Edge-2

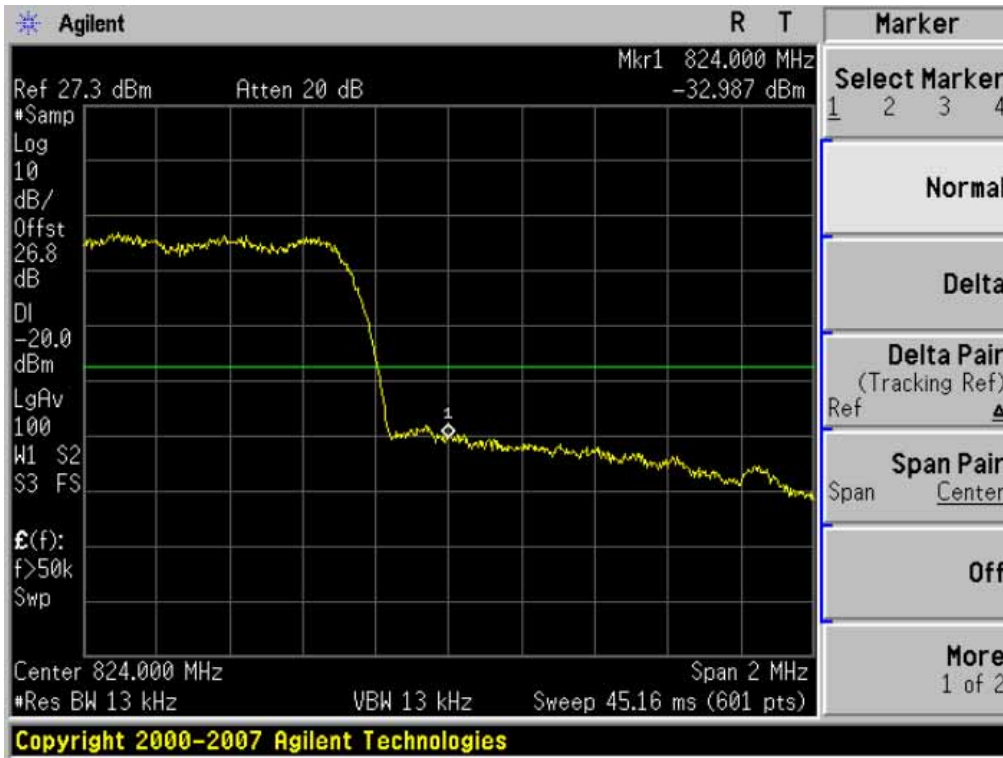

FCC CERTIFICATION REPORT			<a href="http://www.hct.co.kr">www.hct.co.kr</a>
Test Report No. HCTR1208FR26-3	Date of Issue: October 4, 2012	EUT Type: Cellular/PCS CDMA & LTE USB Dongle with WLAN	FCC ID: RB2-U772

■ Secondary MODE (476 CH.) 4 MHz Span

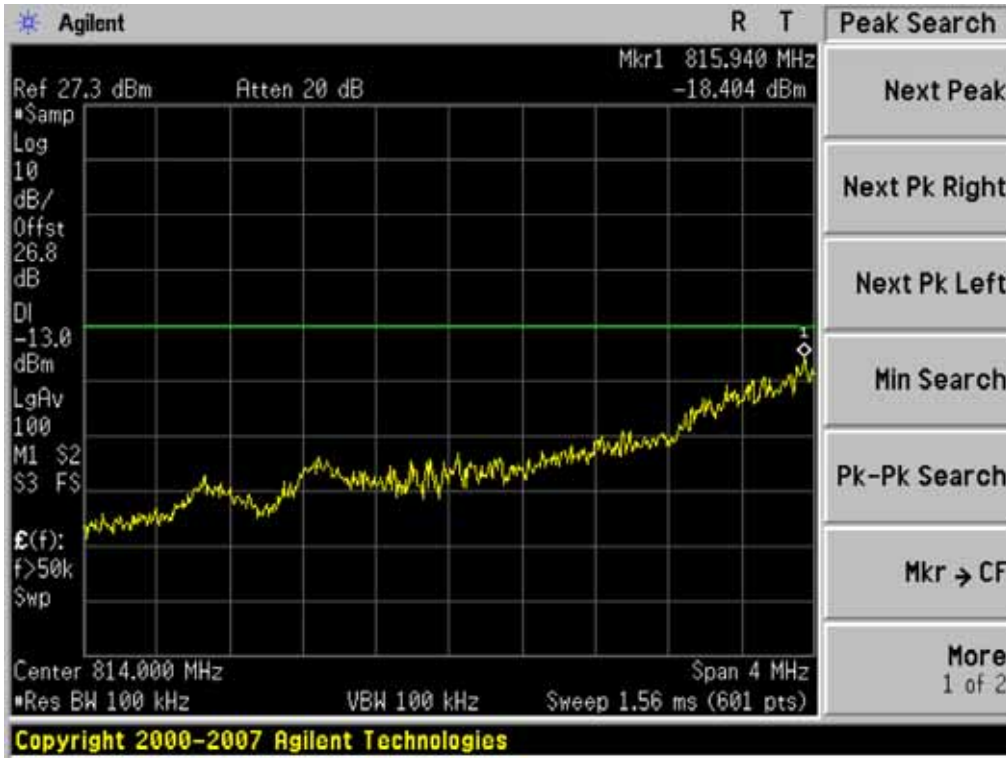

■ Secondary MODE (684 CH.) 4 MHz Span

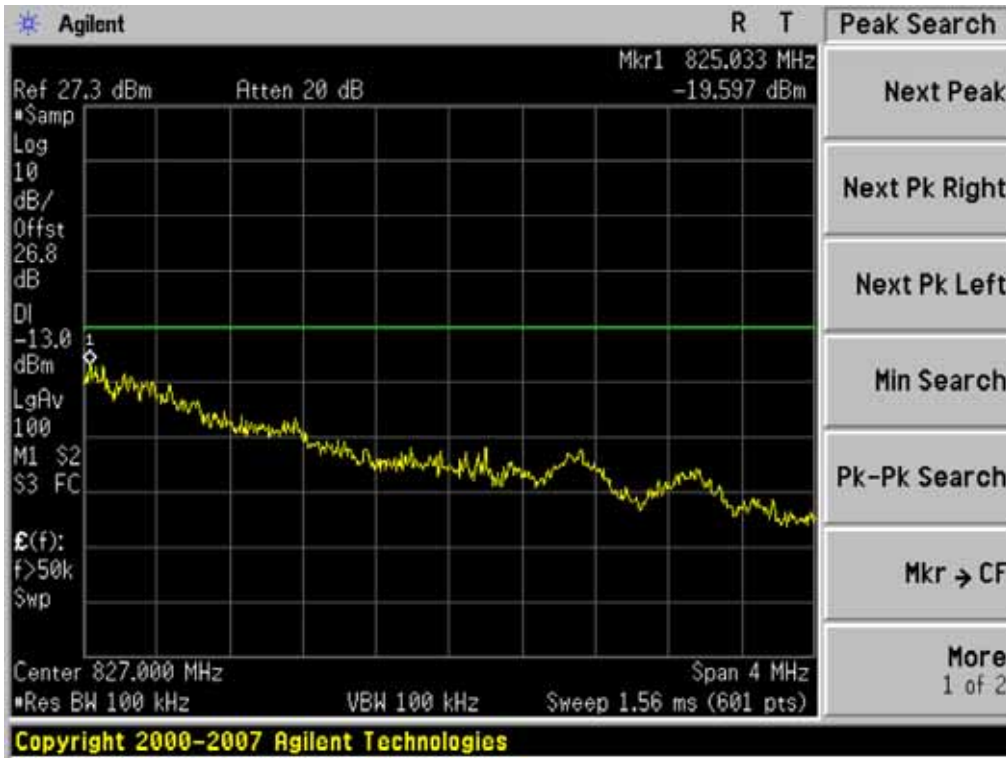

FCC CERTIFICATION REPORT			<a href="http://www.hct.co.kr">www.hct.co.kr</a>
Test Report No. HCTR1208FR26-3	Date of Issue: October 4, 2012	EUT Type: Cellular/PCS CDMA & LTE USB Dongle with WLAN	FCC ID: RB2-U772



■ Secondary EVDO MODE (476 CH.) 4 MHz Span

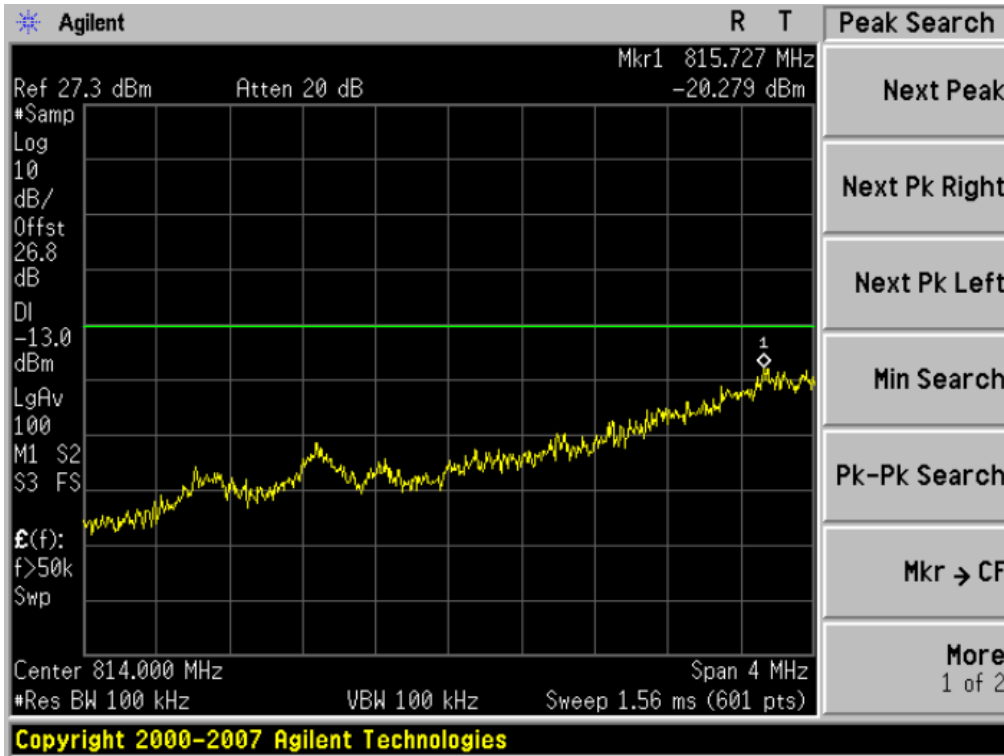

■ Secondary EVDO MODE (684 CH.) 4 MHz Span

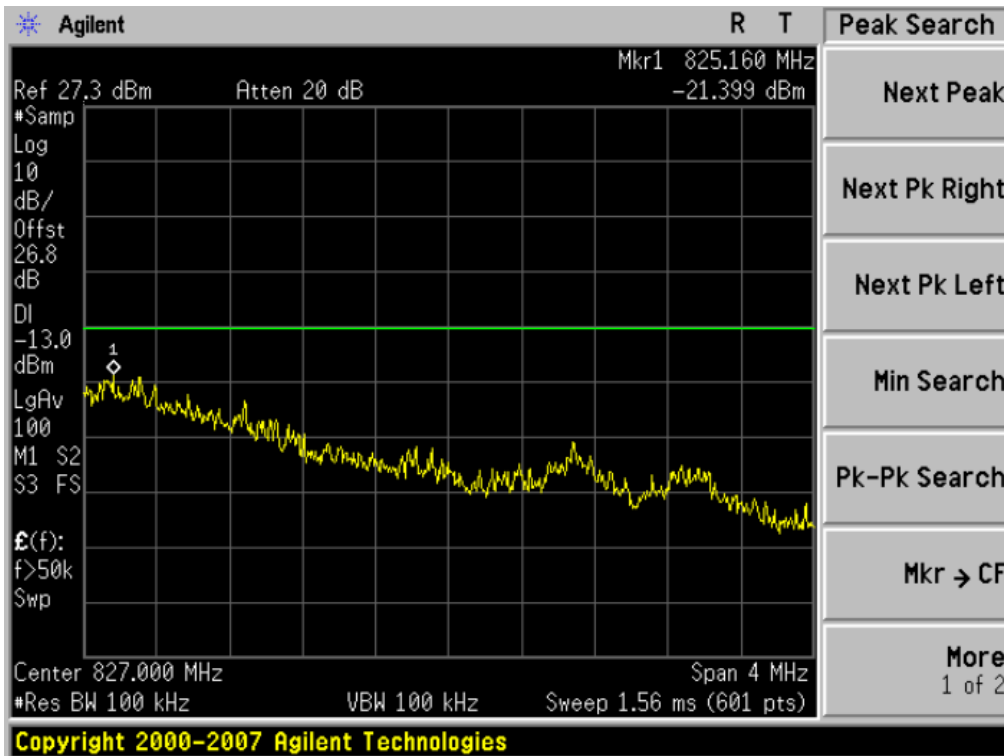

FCC CERTIFICATION REPORT			<a href="http://www.hct.co.kr">www.hct.co.kr</a>
Test Report No. HCTR1208FR26-3	Date of Issue: October 4, 2012	EUT Type: Cellular/PCS CDMA & LTE USB Dongle with WLAN	FCC ID: RB2-U772

■ Secondary MODE (476 CH.) Conducted Spurious Emissions - 1

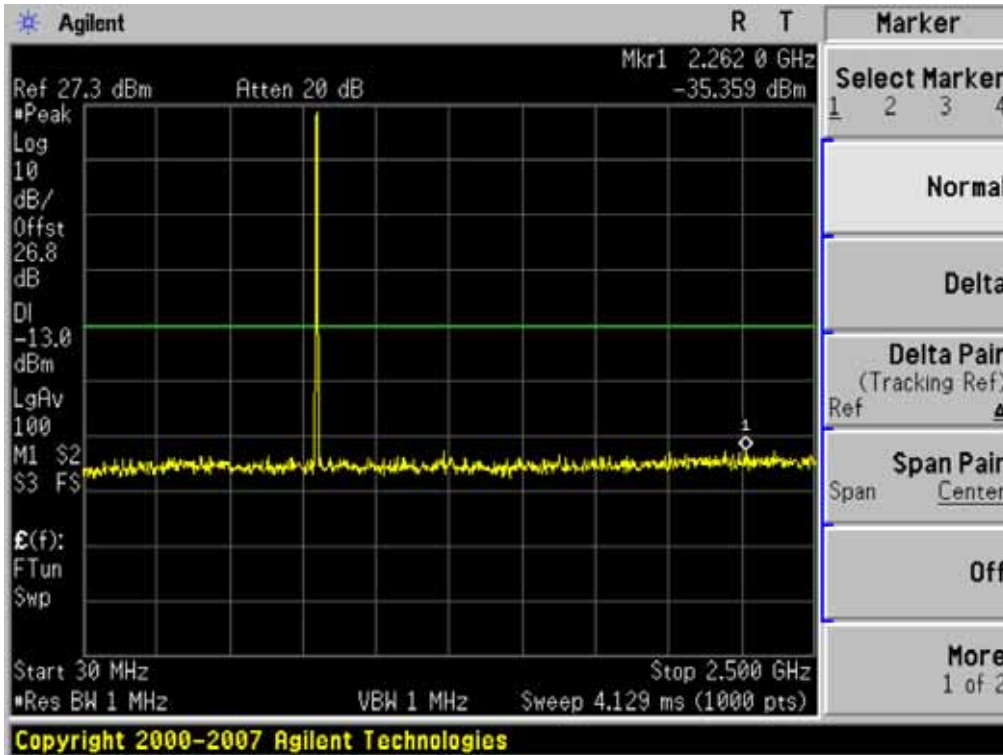

■ Secondary MODE (476 CH.) Conducted Spurious Emissions - 2

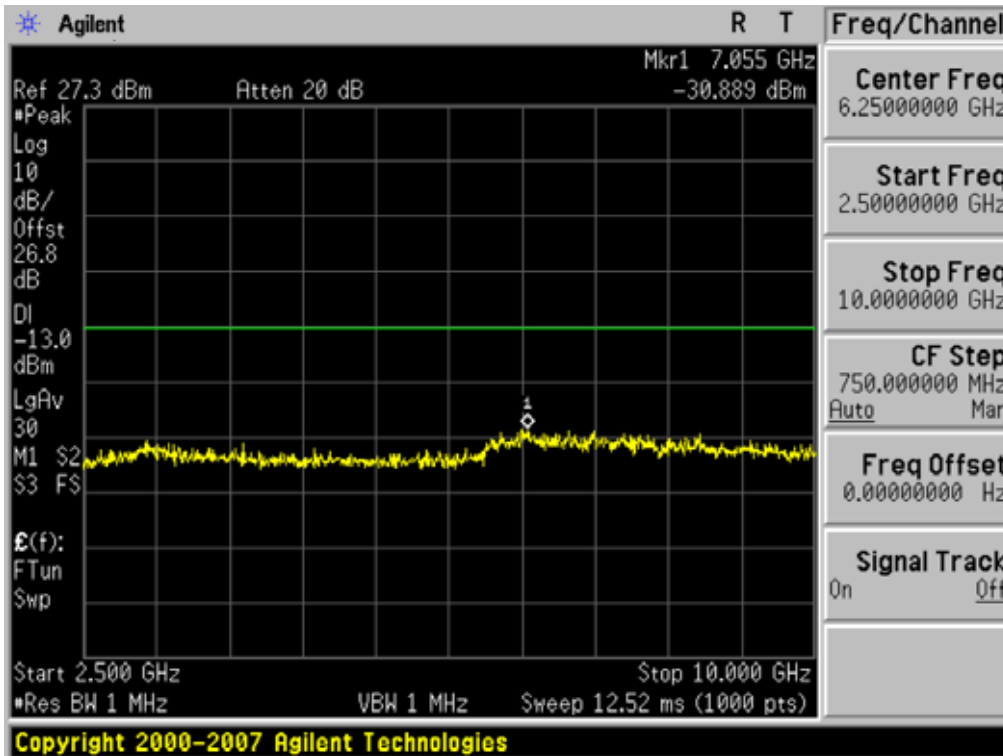

FCC CERTIFICATION REPORT			<a href="http://www.hct.co.kr">www.hct.co.kr</a>
Test Report No. HCTR1208FR26-3	Date of Issue: October 4, 2012	EUT Type: Cellular/PCS CDMA & LTE USB Dongle with WLAN	FCC ID: RB2-U772

■ Secondary MODE (580 CH.) Conducted Spurious Emissions - 1

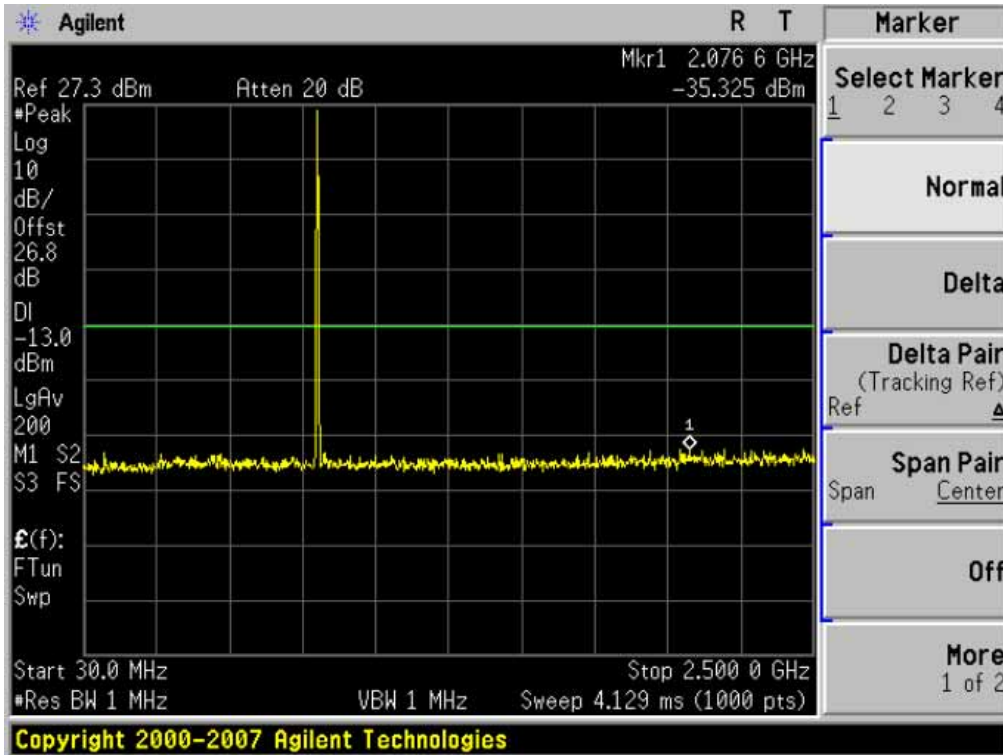

■ Secondary MODE (580 CH.) Conducted Spurious Emissions - 2

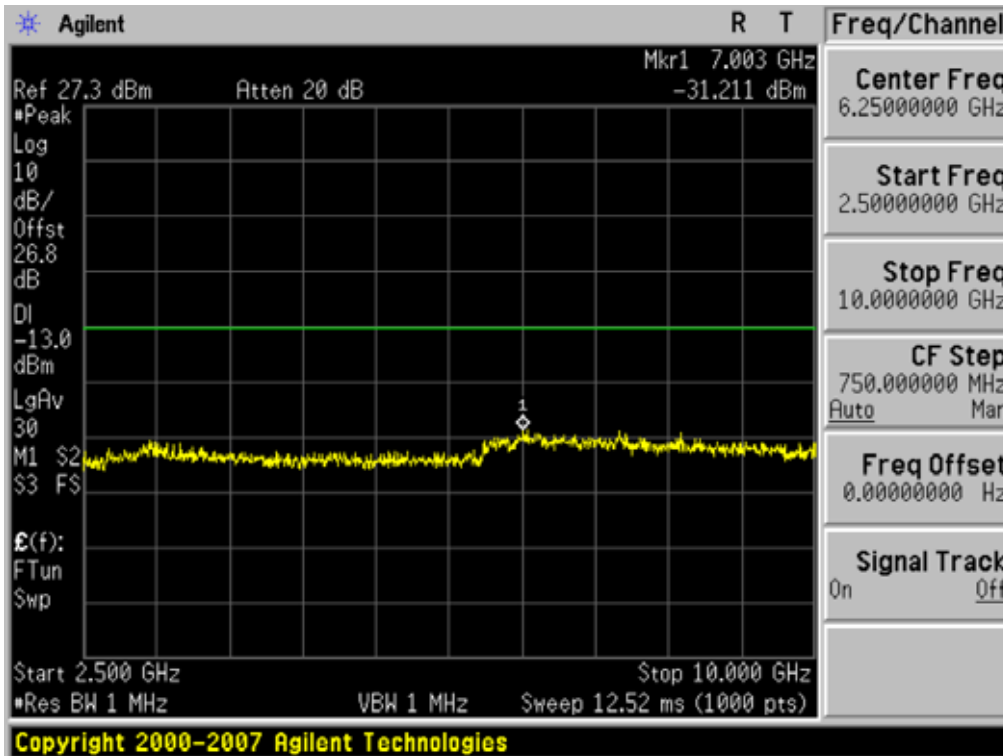

FCC CERTIFICATION REPORT			<a href="http://www.hct.co.kr">www.hct.co.kr</a>
Test Report No. HCTR1208FR26-3	Date of Issue: October 4, 2012	EUT Type: Cellular/PCS CDMA & LTE USB Dongle with WLAN	FCC ID: RB2-U772

■ Secondary MODE (684 CH.) Conducted Spurious Emissions - 1

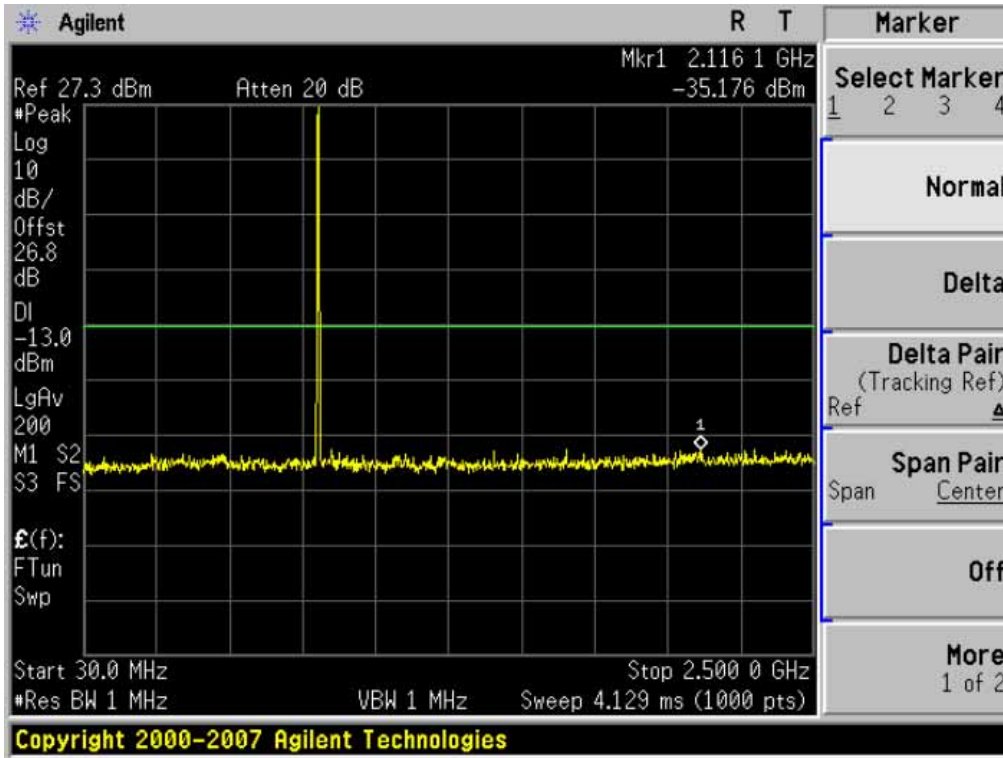

■ Secondary MODE (684 CH.) Conducted Spurious Emissions - 2

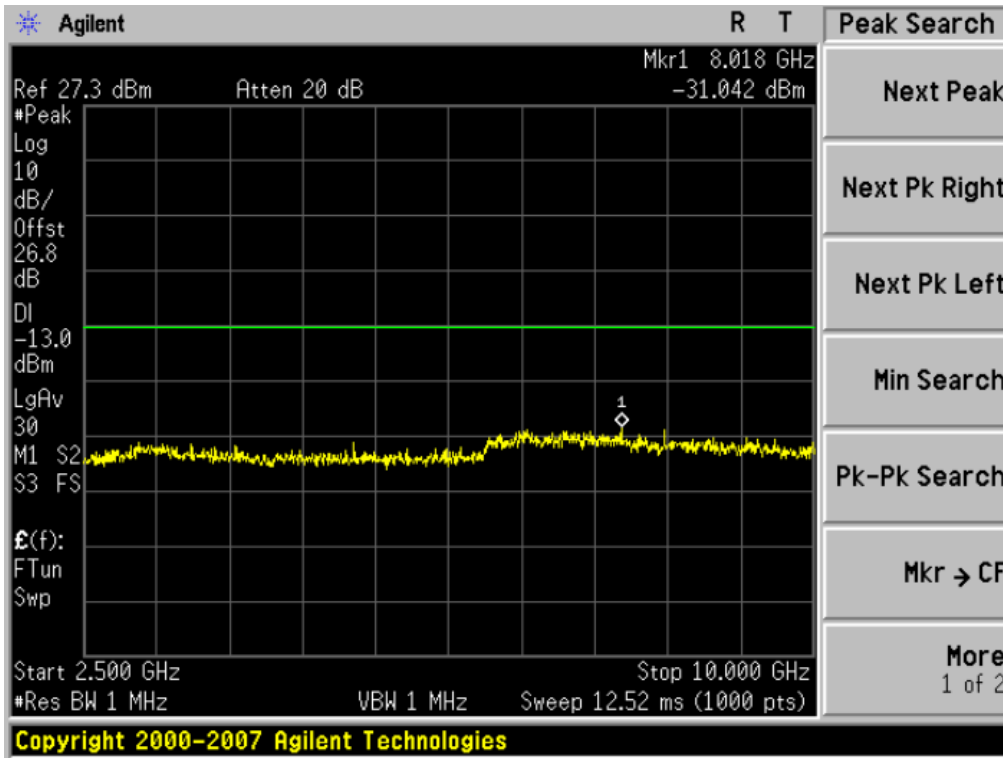

FCC CERTIFICATION REPORT			<a href="http://www.hct.co.kr">www.hct.co.kr</a>
Test Report No. HCTR1208FR26-3	Date of Issue: October 4, 2012	EUT Type: Cellular/PCS CDMA & LTE USB Dongle with WLAN	FCC ID: RB2-U772

■ Secondary EVDO MODE (476 CH.) Conducted Spurious Emissions - 1

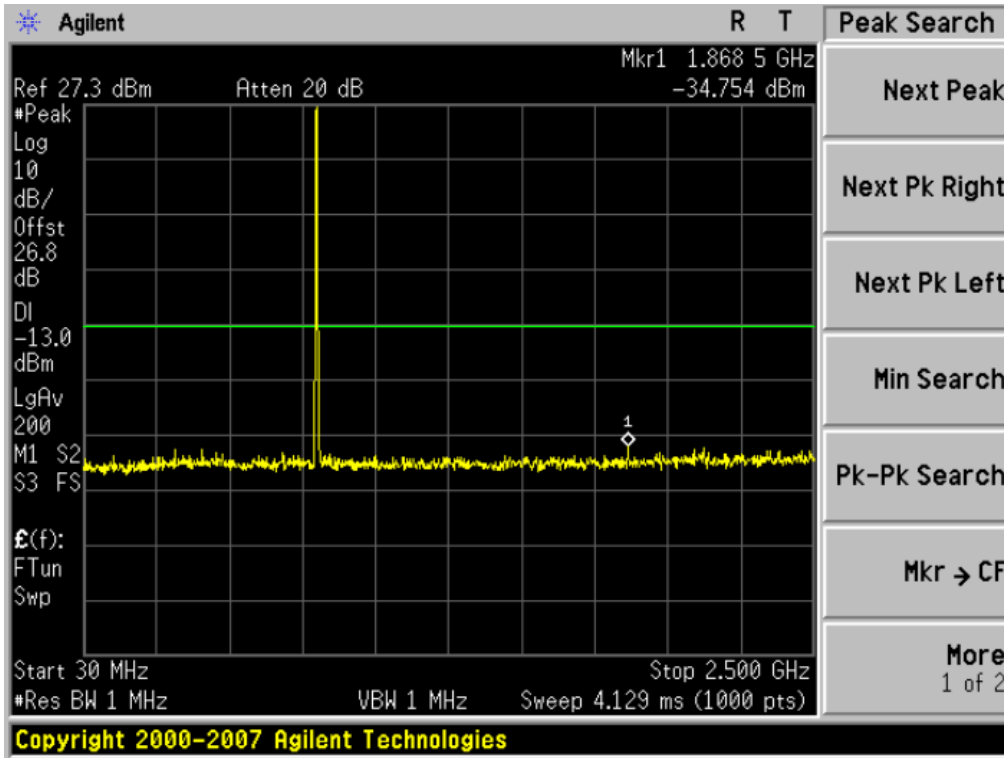

■ Secondary EVDO MODE (476 CH.) Conducted Spurious Emissions - 2

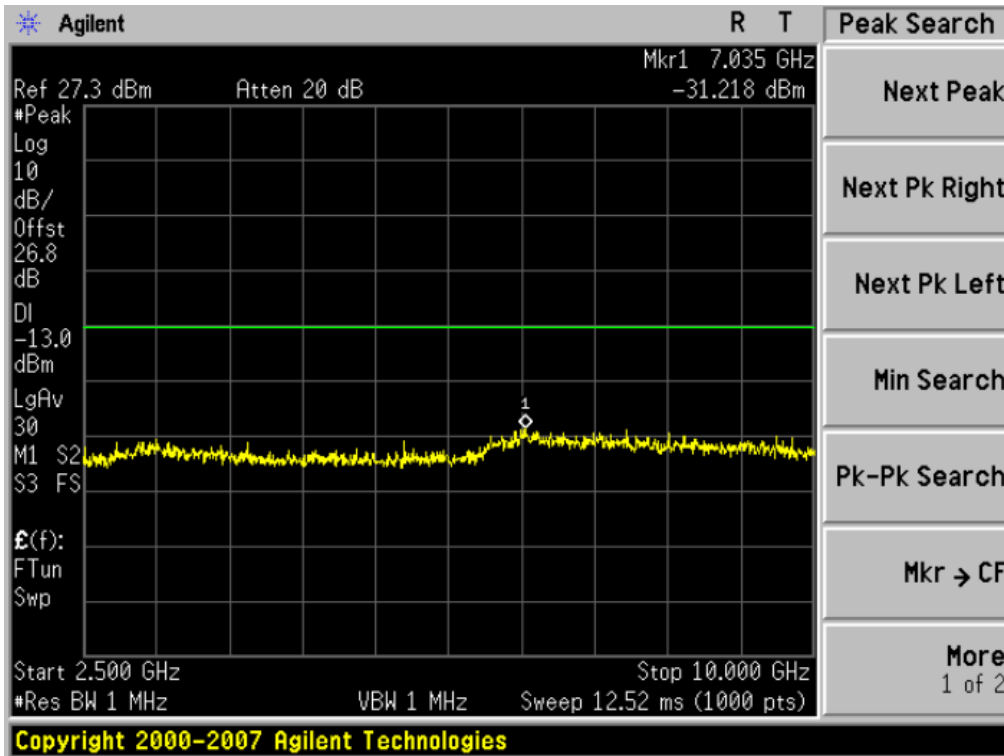

FCC CERTIFICATION REPORT			<a href="http://www.hct.co.kr">www.hct.co.kr</a>
Test Report No. HCTR1208FR26-3	Date of Issue: October 4, 2012	EUT Type: Cellular/PCS CDMA & LTE USB Dongle with WLAN	FCC ID: RB2-U772

■ Secondary EVDO MODE (580 CH.) Conducted Spurious Emissions - 1

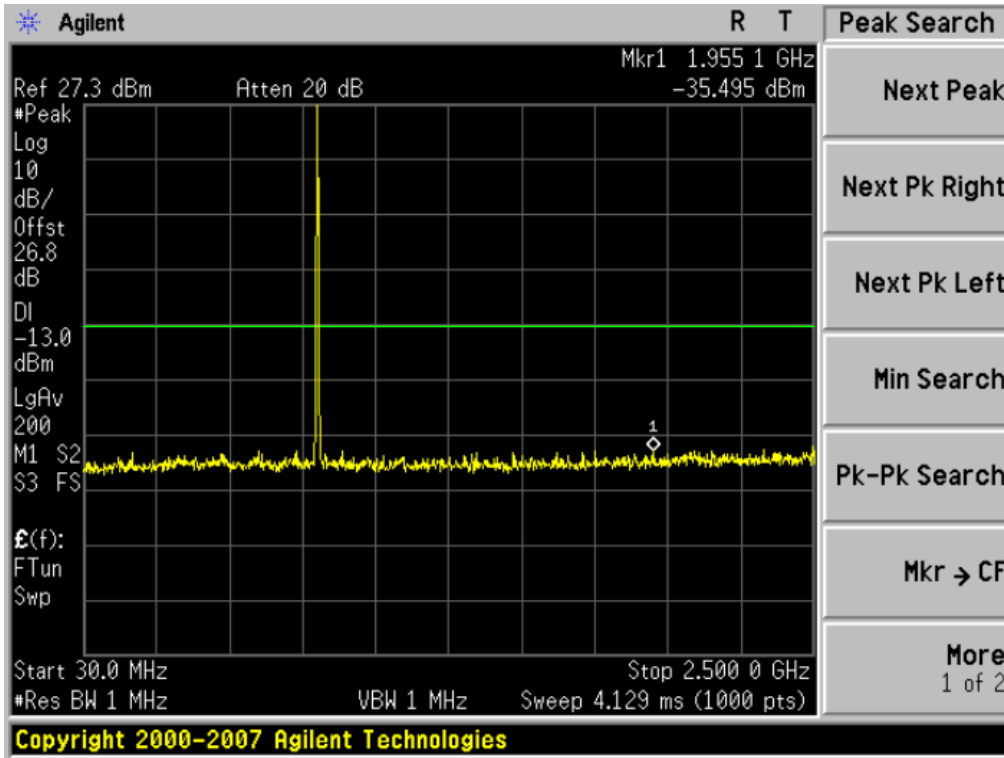

■ Secondary EVDO MODE (580 CH.) Conducted Spurious Emissions - 2

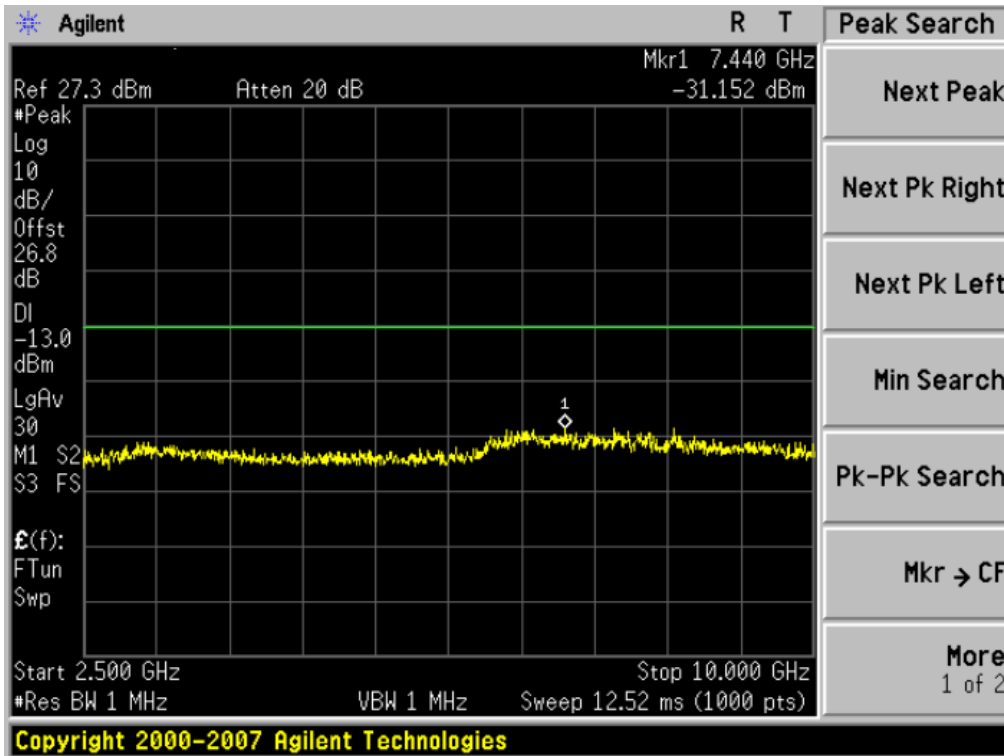

FCC CERTIFICATION REPORT			<a href="http://www.hct.co.kr">www.hct.co.kr</a>
Test Report No. HCTR1208FR26-3	Date of Issue: October 4, 2012	EUT Type: Cellular/PCS CDMA & LTE USB Dongle with WLAN	FCC ID: RB2-U772

■ Secondary EVDO MODE (684 CH.) Conducted Spurious Emissions - 1

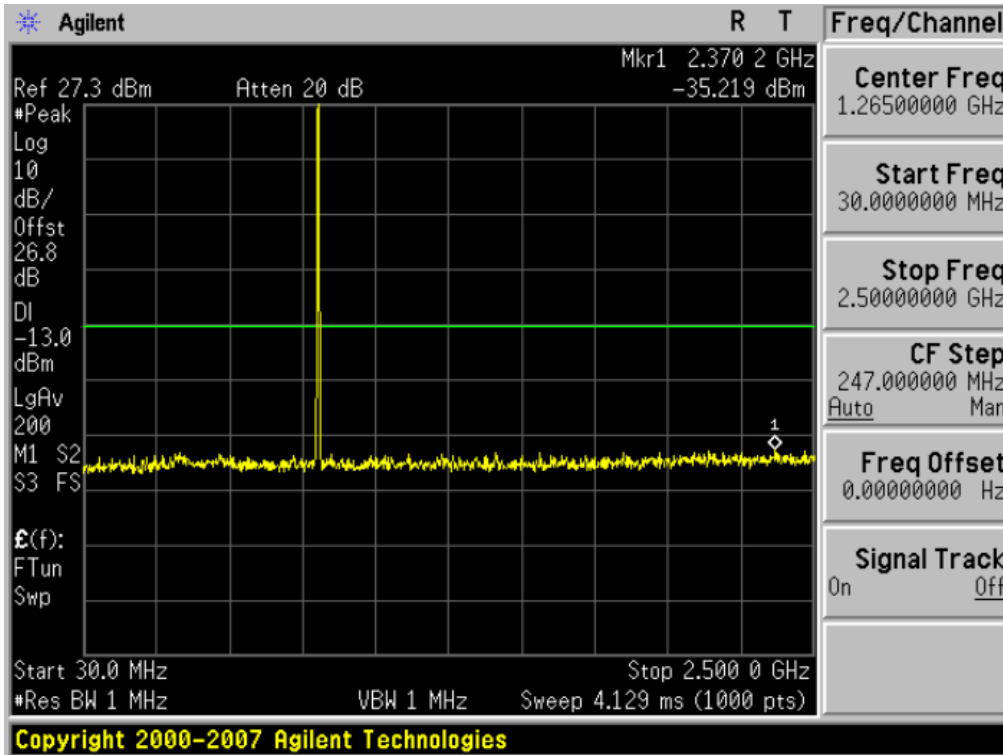

■ Secondary EVDO MODE (684 CH.) Conducted Spurious Emissions - 2

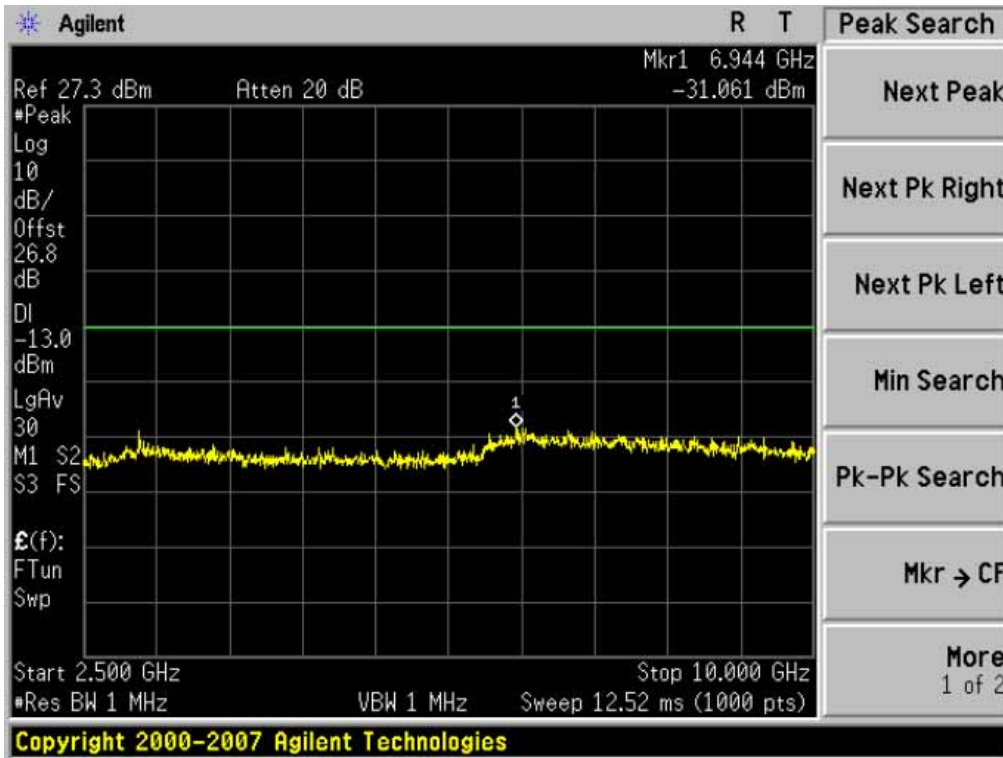

FCC CERTIFICATION REPORT			<a href="http://www.hct.co.kr">www.hct.co.kr</a>
Test Report No. HCTR1208FR26-3	Date of Issue: October 4, 2012	EUT Type: Cellular/PCS CDMA & LTE USB Dongle with WLAN	FCC ID: RB2-U772