



No. 1 Workshop, M-10, Middle section, Science & Technology Park,
Shenzhen, Guangdong, China 518057

Telephone: +86 (0) 755 2601 2053
Fax: +86 (0) 755 2671 0594
Email: ee.shenzhen@sgs.com

Report No.: SZEM180900844703
Page: 1 of 92

TEST REPORT

Application No. : SZEM1809008447CR
Applicant: Navico Inc.
Address of Applicant: 4500 S. 129th East Avenue, Ste. 200, Tulsa, Oklahoma, 74134 United States
Manufacturer: Navico Auckland Limited
Address of Manufacturer: Arrenway Drive, Rosedale, Auckland, 0632 New Zealand
Factory: Shenzhen Hytera Communications Corporation Limited
Address of Factory: Hytera Technology Park, Baolong Industrial City, Longgang District, Shenzhen, China

Equipment Under Test (EUT):

EUT Name: Marine VHF Radio

Model No.: V60, RS40 ♣

♣

Please refer to section 2 of this report which indicates which model was actually tested and which were electrically identical.

Trade mark: B&G, SIMRAD

Standards: IEC 62238:2003

Date of Receipt: 2018-09-20

Date of Test: 2018-09-26 to 2018-10-19

Date of Issue: 2018-10-29

Test Result :	Pass*
----------------------	--------------

* In the configuration tested, the EUT complied with the standards specified above.

The CE mark as shown below can be used, under the responsibility of the manufacturer, after completion of an EC Declaration of Conformity and compliance with all relevant EU Directives.



Keny Xu

EMC Laboratory Manager



The manufacturer should ensure that all products in series production are in conformity with the product sample detailed in this report. If the product in this report is used in any configuration other than that detailed in the report, the manufacturer must ensure the new system complies with all relevant standards. Any mention of SGS International Electrical Approvals or testing done by SGS International Electrical Approvals in connection with, distribution or use of the product described in this report must be approved by SGS International Electrical Approvals in writing.

This document is issued by the Company subject to its General Conditions of Service printed overleaf, available on request or accessible at <http://www.sgs.com/en/Terms-and-Conditions.aspx> and, for electronic format documents, subject to Terms and Conditions for Electronic Documents at <http://www.sgs.com/en/Terms-and-Conditions/Terms-e-Documents.aspx>. Attention is drawn to the limitation of liability, indemnification and jurisdiction issues defined therein. Any holder of this document is advised that information contained hereon reflects the Company's findings at the time of its intervention only and within the limits of Client's instructions, if any. The Company's sole responsibility is to its Client and this document does not exonerate parties to a transaction from exercising all their rights and obligations under the transaction documents. This document cannot be reproduced except in full, without prior written approval of the Company. Any unauthorized alteration, forgery or falsification of the content or appearance of this document is unlawful and offenders may be prosecuted to the fullest extent of the law. Unless otherwise stated the results shown in this test report refer only to the sample(s) tested and such sample(s) are retained for 30 days only.



Revision Record				
Version	Chapter	Date	Modifier	Remark
01		2018-10-29		Original

Authorized for issue by:			
			
	<hr/>		
	Edison Li /Project Engineer		
			
	<hr/>		
	Eric Fu /Reviewer		

2 Test Summary

Transmitter				
Item	Standard	Method	Requirement	Result
Frequency error	EN 301 025 V2.2.1	EN 301 025 clause 8.1.2	EN 301 025 clause 8.1.1	Pass
Carrier power	EN 301 025 V2.2.1	EN 301 025 clause 8.2.2	EN 301 025 clause 8.2.1	Pass
Frequency deviation	EN 301 025 V2.2.1	EN 301 025 clause 8.3.2	EN 301 025 clause 8.3.1	Pass
Reduction of frequency deviation at modulation frequencies above 3 kHz	EN 301 025 V2.2.1	EN 301 025 clause 8.3.3	EN 301 025 clause 8.3.3.1	Pass
Sensitivity of the modulator, including microphone	EN 301 025 V2.2.1	EN 301 025 clause 8.4.2	EN 301 025 clause 8.4.1	Pass
Audio frequency response	EN 301 025 V2.2.1	EN 301 025 clause 8.5.2	EN 301 025 clause 8.5.1	Pass
Audio frequency harmonic distortion of the emission	EN 301 025 V2.2.1	EN 301 025 clause 8.6.2	EN 301 025 clause 8.6.1	Pass
Adjacent channel power	EN 301 025 V2.2.1	EN 301 025 clause 8.7.2	EN 301 025 clause 8.7.1	Pass
Conducted spurious emissions conveyed to the antenna	EN 301 025 V2.2.1	EN 301 025 clause 8.8.2	EN 301 025 clause 8.8.1	Pass
Cabinet radiation and conducted spurious emissions other than those conveyed to the antenna	EN 301 025 V2.2.1	EN 301 025 clause 8.9.2	EN 301 025 clause 8.9.1	Pass
Transient frequency behaviour of the transmitter	EN 301 025 V2.2.1	EN 301 025 clause 8.10.2	EN 301 025 clause 8.10.1	Pass
Residual modulation of the transmitter	EN 301 025 V2.2.1	EN 301 025 clause 8.11.2	EN 301 025 clause 8.11.1	Pass
Frequency error (demodulated DSC signal)	EN 301 025 V2.2.1	EN 301 025 clause 8.12.2	EN 301 025 clause 8.12.1	Pass
Modulation index for DSC	EN 301 025 V2.2.1	EN 301 025 clause 8.13.2	EN 301 025 clause 8.13.1	Pass
Modulation rate for DSC	EN 301 025 V2.2.1	EN 301 025 clause 8.14.2	EN 301 025 clause 8.14.1	Pass
Testing of free channel transmission on DSC channel 70	EN 301 025 V2.2.1	EN 301 025 clause 8.15.2	EN 301 025 clause 8.15.1	Pass

Radiotelephone receiver				
Harmonic distortion and rated audio-frequency output power	EN 301 025 V2.2.1	EN 301 025 clause 9.1.2	EN 301 025 clause 9.1.1	Pass
Audio frequency response	EN 301 025 V2.2.1	EN 301 025 clause 8.7.2	EN 301 025 clause 9.2.1	Pass
Maximum usable sensitivity	EN 301 025 V2.2.1	EN 301 025 clause 9.3.2	EN 301 025 clause 9.3.1	Pass
Co-channel rejection	EN 301 025 V2.2.1	EN 301 025 clause 9.4.2	EN 301 025 clause 9.4.1	Pass
Adjacent channel selectivity	EN 301 025 V2.2.1	EN 301 025 clause 9.5.2	EN 301 025 clause 9.5.1	Pass



Spurious response rejection	EN 301 025 V2.2.1	EN 301 025 clause 9.6.2	EN 301 025 clause 9.6.1	Pass
Intermodulation response	EN 301 025 V2.2.1	EN 301 025 clause 9.7.2	EN 301 025 clause 9.7.1	Pass
Blocking or desensitization	EN 301 025 V2.2.1	EN 301 025 clause 9.8.2	EN 301 025 clause 9.8.1	Pass
Spurious emissions	EN 301 025 V2.2.1	EN 301 025 clause 9.9.2	EN 301 025 clause 9.9.1	Pass
Receiver radiated spurious emissions	EN 301 025 V2.2.1	EN 301 025 clause 9.10.2	EN 301 025 clause 9.10.1	Pass
Receiver residual noise level	EN 301 025 V2.2.1	EN 301 025 clause 9.11.2	EN 301 025 clause 9.11.1	Pass
Squelch operation	EN 301 025 V2.2.1	EN 301 025 clause 9.12.2	EN 301 025 clause 9.12.1	Pass
Squelch hysteresis	EN 301 025 V2.2.1	EN 301 025 clause 9.13.2	EN 301 025 clause 9.13.1	Pass
Multiple watch characteristic	EN 301 025 V2.2.1	EN 301 025 clause 9.14.2	EN 301 025 clause 9.14.1	Pass

Receiver for DSC decoder				
Item	Standard	Method	Requirement	Result
Maximum usable sensitivity	EN 301 025 V2.2.1	EN 301 025 clause 10.1.2	EN 301 025 clause 10.1.1	Pass
Co-channel rejection	EN 301 025 V2.2.1	EN 301 025 clause 10.2.2	EN 301 025 clause 10.2.1	Pass
Adjacent channel selectivity	EN 301 025 V2.2.1	EN 301 025 clause 10.3.2	EN 301 025 clause 10.3.1	Pass
Spurious response and blocking immunity	EN 301 025 V2.2.1	EN 301 025 clause 10.4.2	EN 301 025 clause 10.4.1	Pass
Intermodulation response	EN 301 025 V2.2.1	EN 301 025 clause 10.5.2	EN 301 025 clause 10.5.1	Pass
Dynamic range	EN 301 025 V2.2.1	EN 301 025 clause 10.6.2	EN 301 025 clause 10.6.1	Pass
Spurious emissions	EN 301 025 V2.2.1	EN 301 025 clause 10.7.2	EN 301 025 clause 10.7.1	Pass
Simultaneous reception	EN 301 025 V2.2.1	EN 301 025 clause 10.8.2	EN 301 025 clause 10.8.1	Pass

N/A: Not applicable.



EN 301 025, Electromagnetic compatibility and Radio Spectrum Matters (ERM); Technical characteristics and methods of measurement for VHF radiotelephone equipment for general communications and associated equipment for Class "D" Digital Selective Calling (DSC).

- The requirement for a dedicated channel 70 watchkeeping receiver for DSC decoder has been replaced by a channel 70 watchkeeping facility in order to permit alternative design methods. This facility, however, is still required to achieve continuous DSC monitoring (except when the transmitter is in use). A new test has been added to test that DSC reception is achieved simultaneously with radiotelephone reception.
- The requirement for a Numeric Keypad has been replaced by a more general means of easily entering a MMSI to allow more flexibility in design.
- The requirement for the transmitter to work for 30 min continuously in the high power transmit condition has been replaced by a period of 5 min to permit the use of a lower cost transmitter. Facilities have also been added to limit transmission time to 5 min.
- The requirement to protect information in volatile memories from interruptions in the power supply of up to 60 s duration has been removed as not being of practical benefit.
- A requirement to transmit and receive enhanced position information with a distress call has been added.
- EMC requirements have been added.

Remark:

Model No.: V60, RS40

Only the model V60 was tested, since the electrical circuit design, layout, components used, internal wiring and functions were identical for the above models, with only differences are the trade name and model no. for trading purpose.



3 Contents

	Page
1 COVER PAGE	1
2 TEST SUMMARY	3
3 CONTENTS	6
4 GENERAL INFORMATION.....	10
4.1 DETAILS OF E.U.T.	10
4.2 DESCRIPTION OF SUPPORT UNITS.....	11
4.3 TEST ENVIRONMENT.....	11
4.4 MEASUREMENT UNCERTAINTY.....	11
4.5 TEST LOCATION	12
4.6 TEST FACILITY	12
4.7 DEVIATION FROM STANDARDS.....	12
4.8 ABNORMALITIES FROM STANDARD CONDITIONS	12
5 EQUIPMENT LIST.....	13
6 RADIO SPECTRUM MATTER TEST RESULTS	15
6.1 FREQUENCY ERROR	15
6.1.1 E.U.T. Operation.....	15
6.1.2 Test Setup Diagram.....	15
6.1.3 Measurement Data	15
6.2 CARRIER POWER	16
6.2.1 E.U.T. Operation.....	16
6.2.2 Test Setup Diagram.....	16
6.2.3 Measurement Data	16
6.3 FREQUENCY DEVIATION.....	17
6.3.1 E.U.T. Operation.....	17
6.3.2 Test Setup Diagram.....	17
6.3.3 Measurement Data	17
6.4 REDUCTION OF FREQUENCY DEVIATION AT MODULATION FREQUENCIES ABOVE 3 KHZ	18
6.4.1 E.U.T. Operation.....	19
6.4.2 Test Setup Diagram.....	19
6.4.3 Measurement Data	19
6.5 SENSITIVITY OF THE MODULATOR, INCLUDING MICROPHONE	20
6.5.1 E.U.T. Operation.....	20
6.5.2 Test Setup Diagram.....	20
6.5.3 Measurement Data	20
6.6 AUDIO FREQUENCY RESPONSE	21
6.6.1 E.U.T. Operation.....	22
6.6.2 Test Setup Diagram.....	22
6.6.3 Measurement Data	22
6.7 AUDIO FREQUENCY HARMONIC DISTORTION OF THE EMISSION	23
6.7.1 E.U.T. Operation.....	23
6.7.2 Test Setup Diagram.....	23
6.7.3 Measurement Data	23
6.8 ADJACENT CHANNEL POWER.....	24
6.8.1 E.U.T. Operation.....	24



6.8.2	Test Setup Diagram.....	24
6.8.3	Measurement Data.....	24
6.9	CONDUCTED SPURIOUS EMISSIONS CONVEYED TO THE ANTENNA.....	25
6.9.1	E.U.T. Operation.....	25
6.9.2	Test Setup Diagram.....	25
6.9.3	Measurement Procedure and Data.....	25
6.10	CABINET RADIATION SPURIOUS EMISSIONS.....	26
6.10.1	E.U.T. Operation.....	26
6.10.2	Test Setup Diagram.....	26
6.10.3	Measurement Data.....	27
6.11	TRANSIENT FREQUENCY BEHAVIOUR OF THE TRANSMITTER.....	28
6.11.1	E.U.T. Operation.....	28
6.11.2	Test Setup Diagram.....	28
6.11.3	Measurement Procedure and Data.....	28
6.12	RESIDUAL MODULATION OF THE TRANSMITTER.....	29
6.12.1	E.U.T. Operation.....	29
6.12.2	Test Setup Diagram.....	29
6.12.3	Measurement Procedure and Data.....	29
6.13	FREQUENCY ERROR (DEMODULATED DSC SIGNAL).....	30
6.13.1	E.U.T. Operation.....	30
6.13.2	Test Setup Diagram.....	30
6.13.3	Measurement Data.....	30
6.14	MODULATION INDEX FOR DSC.....	31
6.14.1	E.U.T. Operation.....	31
6.14.2	Test Setup Diagram.....	31
6.14.3	Measurement Data.....	31
6.15	MODULATION RATE FOR DSC.....	32
6.15.1	E.U.T. Operation.....	32
6.15.2	Test Setup Diagram.....	32
6.15.3	Measurement Data.....	32
6.16	TESTING OF FREE CHANNEL TRANSMISSION ON DSC CHANNEL 70.....	33
6.16.1	E.U.T. Operation.....	33
6.16.2	Test Setup Diagram.....	33
6.16.3	Measurement Data.....	33
6.17	HARMONIC DISTORTION AND RATED AUDIO-FREQUENCY OUTPUT POWER.....	34
6.17.1	E.U.T. Operation.....	34
6.17.2	Test Setup Diagram.....	34
6.17.3	Measurement Data.....	34
6.18	AUDIO FREQUENCY RESPONSE.....	35
6.18.1	E.U.T. Operation.....	36
6.18.2	Test Setup Diagram.....	36
6.18.3	Measurement Data.....	36
6.19	MAXIMUM USABLE SENSITIVITY.....	37
6.19.1	E.U.T. Operation.....	37
6.19.2	Test Setup Diagram.....	37
6.19.3	Measurement Data.....	37
6.20	CO-CHANNEL REJECTION.....	38
6.20.1	E.U.T. Operation.....	38
6.20.2	Test Setup Diagram.....	38
6.20.3	Measurement Data.....	38
6.21	ADJACENT CHANNEL SELECTIVITY.....	39
6.21.1	E.U.T. Operation.....	39
6.21.2	Test Setup Diagram.....	39
6.21.3	Measurement Data.....	39
6.22	SPURIOUS RESPONSE REJECTION.....	40



6.22.1	<i>E.U.T. Operation</i>	40
6.22.2	<i>Test Setup Diagram</i>	40
6.22.3	<i>Measurement Data</i>	40
6.23	INTERMODULATION RESPONSE	41
6.23.1	<i>E.U.T. Operation</i>	41
6.23.2	<i>Test Setup Diagram</i>	41
6.23.3	<i>Measurement Data</i>	41
6.24	BLOCKING OR DESENSITIZATION	42
6.24.1	<i>E.U.T. Operation</i>	42
6.24.2	<i>Test Setup Diagram</i>	42
6.24.3	<i>Measurement Data</i>	42
6.25	SPURIOUS EMISSION	43
6.25.1	<i>E.U.T. Operation</i>	43
6.25.2	<i>Test Setup Diagram</i>	43
6.25.3	<i>Measurement Data</i>	43
6.26	RECEIVER RADIATED SPURIOUS EMISSIONS	44
6.26.1	<i>E.U.T. Operation</i>	44
6.26.2	<i>Test Setup Diagram</i>	44
6.26.3	<i>Measurement Data</i>	45
6.27	RECEIVER RESIDUAL NOISE LEVEL	46
6.27.1	<i>E.U.T. Operation</i>	46
6.27.2	<i>Test Setup Diagram</i>	46
6.27.3	<i>Measurement Procedure and Data</i>	46
6.28	SQUELCH OPERATION	47
6.28.1	<i>E.U.T. Operation</i>	47
6.28.2	<i>Test Setup Diagram</i>	47
6.28.3	<i>Measurement Procedure and Data</i>	47
6.29	SQUELCH HYSTERESIS	48
6.29.1	<i>E.U.T. Operation</i>	48
6.29.2	<i>Test Setup Diagram</i>	48
6.29.3	<i>Measurement Procedure and Data</i>	48
6.30	MULTIPLE WATCH CHARACTERISTIC	49
6.30.1	<i>E.U.T. Operation</i>	49
6.30.2	<i>Test Setup Diagram</i>	49
6.30.3	<i>Measurement Procedure and Data</i>	49
6.31	MAXIMUM USABLE SENSITIVITY	50
6.31.1	<i>E.U.T. Operation</i>	50
6.31.2	<i>Test Setup Diagram</i>	50
6.31.3	<i>Measurement Data</i>	50
6.32	CO-CHANNEL REJECTION	51
6.32.1	<i>E.U.T. Operation</i>	51
6.32.2	<i>Test Setup Diagram</i>	51
6.32.3	<i>Measurement Data</i>	51
6.33	ADJACENT CHANNEL SELECTIVITY	52
6.33.1	<i>E.U.T. Operation</i>	52
6.33.2	<i>Test Setup Diagram</i>	52
6.33.3	<i>Measurement Data</i>	52
6.34	SPURIOUS RESPONSE AND BLOCKING IMMUNITY	53
6.34.1	<i>E.U.T. Operation</i>	53
6.34.2	<i>Test Setup Diagram</i>	53
6.34.3	<i>Measurement Data</i>	53
6.35	INTERMODULATION RESPONSE	54
6.35.1	<i>E.U.T. Operation</i>	54
6.35.2	<i>Test Setup Diagram</i>	54
6.35.3	<i>Measurement Data</i>	54



6.36	DYNAMIC RANGE	55
6.36.1	<i>E.U.T. Operation</i>	55
6.36.2	<i>Test Setup Diagram</i>	55
6.36.3	<i>Measurement Data</i>	55
6.37	SPURIOUS EMISSIONS	56
6.37.1	<i>E.U.T. Operation</i>	56
6.37.2	<i>Test Setup Diagram</i>	56
6.37.3	<i>Measurement Data</i>	56
6.38	SIMULTANEOUS RECEPTION	57
6.38.1	<i>E.U.T. Operation</i>	57
6.38.2	<i>Test Setup Diagram</i>	57
6.38.3	<i>Measurement Data</i>	57
7	PHOTOGRAPHS	58
7.1	TRANSMITTER SPURIOUS EMISSIONS(30MHZ-2GHZ) TEST SETUP.....	58
7.2	RECEIVER SPURIOUS EMISSIONS(30MHZ-2GHZ) TEST SETUP	58
8	APPENDIX	59
8.1	APPENDIX EN301 025 TEST DATA	59-92



4 General Information

4.1 Details of E.U.T.

Power supply:	12 VDC battery system
Cable:	DC cable: longer than 300cm unshielded
Sample Type:	Mobile device
Transmitter Frequency Range:	156.025MHz-157.425MHz
Receiver Frequency Range:	156.05MHz-163.275MHz
AIS Receiver Frequency Range:	161.975MHz(CH87), 162.025MHz(CH88)
Modulation Type:	FM for Analog
Frequency Spacing:	25KHz
Rated Output Power:	25W/1W
VHF Antenna Connectors:	SO-239(50 ohm, External Antenna)
VHF Antenna Gain:	6dBi

Test Channel

Modulation Type	Channel Separation	Test Channel	Test Frequency (MHz)	
			TX	RX
Analog/FM	25KHz	L	156.025	156.050
		M(Channel 16)	156.800	156.800
		H	157.425	163.275
		Channel 70	156.525	156.525

4.2 Description of Support Units

Description	Manufacturer	Model No.	Serial No.
DC power	ZHAOXIN	RXN-305D	REF. No.SEA2700
Coaxial Attenuator	Provided by client	TS4	HYT168793

4.3 Test Environment

Environment Parameter	Selected Values During Tests	
Relative Humidity	Ambient	
Value	Temperature(°C)	Voltage(V)
TNVN	25	12
TLVL	-20	10.2
TLVH	-20	13.8
THVL	55	10.2
THVH	55	13.8

Note:

- The EUT just work in such extreme temperature of -20°C~+55°C and the extreme voltage of 10.2V~13.8V, so here the EUT is tested in the temperature of -20°C~+55°C and the voltage of 10.2V~13.8V.
- | |
|----------------------------------|
| VN: Normal Voltage |
| VL: Low Extreme Test Voltage |
| TL: Low Extreme Test Temperature |

TN: Normal Temperature
VH: High Extreme Test Voltage
TH: High Extreme Test Temperature

4.4 Measurement Uncertainty

No.	Item	Measurement Uncertainty
1	Radio Frequency	±7.25 x 10 ⁻⁸
3	Duty cycle	±0.37%
4	Occupied Bandwidth	±3%
5	RF conducted power	±0.75dB
6	Conducted Spurious emissions	±0.75dB
7	Radiated Spurious emission test	±4.5dB (30MHz-1GHz)
		±4.8dB (1GHz-18GHz)
8	Temperature test	±1 °C
9	Humidity test	±3%
10	Supply voltages	±1.5%
11	Time	±3%



4.5 Test Location

All tests were performed at:

SGS-CSTC Standards Technical Services Co., Ltd., Shenzhen Branch

No. 1 Workshop, M-10, Middle Section, Science & Technology Park, Shenzhen, Guangdong, China.
518057.

Tel: +86 755 2601 2053 Fax: +86 755 2671 0594

No tests were sub-contracted.

4.6 Test Facility

The test facility is recognized, certified, or accredited by the following organizations:

- **CNAS (No. CNAS L2929)**

CNAS has accredited SGS-CSTC Standards Technical Services Co., Ltd. Shenzhen Branch EMC Lab to ISO/IEC 17025:2005 General Requirements for the Competence of Testing and Calibration Laboratories (CNAS-CL01 Accreditation Criteria for the Competence of Testing and Calibration Laboratories) for the competence in the field of testing.

- **A2LA (Certificate No. 3816.01)**

SGS-CSTC Standards Technical Services Co., Ltd., Shenzhen EMC Laboratory is accredited by the American Association for Laboratory Accreditation(A2LA). Certificate No. 3816.01.

- **VCCI**

The 3m Fully-anechoic chamber for above 1GHz, 10m Semi-anechoic chamber for below 1GHz, Shielded Room for Mains Port Conducted Interference Measurement and Telecommunication Port Conducted Interference Measurement of SGS-CSTC Standards Technical Services Co., Ltd. have been registered in accordance with the Regulations for Voluntary Control Measures with Registration No.: G-20026, R-14188, C-12383 and T-11153 respectively.

- **FCC –Designation Number: CN1178**

SGS-CSTC Standards Technical Services Co., Ltd., Shenzhen EMC Laboratory has been recognized as an accredited testing laboratory.

Designation Number: CN1178. Test Firm Registration Number: 406779.

- **Innovation, Science and Economic Development Canada**

SGS-CSTC Standards Technical Services Co., Ltd., Shenzhen EMC Laboratory has been recognized by ISED as an accredited testing laboratory.

CAB identifier: CN0006.

IC#: 4620C.

4.7 Deviation from Standards

None

4.8 Abnormalities from Standard Conditions

None



5 Equipment List

RF conducted test					
Test Equipment	Manufacturer	Model No.	Inventory No.	Cal Date	Cal Due Date
Cell Site Test Set	HP	8921A	3715A04970	2018.04.11	2019.04.10
DC Power Supply	HP	6652A	3347A01324	2018.04.11	2019.04.10
Spectrum Analyzer	R&S	FSV	103067	2017.11.09	2018.11.08
Spectrum Analyzer	R&S	FSU	101389	2018.04.12	2019.04.11
Signal Generator	HP	8656B	7076166	2018.04.12	2019.04.11
Signal Generator	R&S	SMB100A	102316	2018.04.12	2019.04.11
Frequency Meter	Agilent	53220A	MY50000312	2018.03.17	2019.03.16
Attenuator	Huaxiang	WDTS500-40dB-8G	16051603	N/A	N/A
SPLITTER	Mini-Circuits	ZFSC-3+	BUU47601527	N/A	N/A
High-pass Filter	Mini-Circuits	NHP-300+	N/A	N/A	N/A
Cell Site Test Set	HP	8921A	3633A04615	2018-04-11	2019-04-10
Signal Generator	HP	8656B	3334U13373	2018-04-12	2019-04-11
Signal Generator	R&S	SMA100A	102174	2018-04-12	2019-04-11
Audio Analyzer	Rohde & Schwarz	UPV	SEM008-03	2018-09-25	2019-09-24
Oscilloscope	Tektronix	MSO 4104	SEM022-02	2018-09-25	2019-09-24

Transmitter unwanted emissions					
Equipment	Manufacturer	Model No	Inventory No	Cal Date	Cal Due Date
Fully-Anechoic Chamber 1	SAEMC	MFAC	SEM001-04	2018-05-13	2021-05-13
Measurement Software	Rohde & Schwarz	EMC32 V9.21.00	N/A	N/A	N/A
Coaxial Cable	SGS	N/A	SEM027-01	2018-07-13	2019-07-12
FSV-Signal Analyzer(10Hz-40GHz)	Rohde & Schwarz	FSV40	SEM008-04	2018-04-14	2019-04-13
BiConiLog Antenna (30MHz-3GHz)	Schwarzbeck	VULB9163	SEM003-05	2015-10-19	2018-10-18
				2018-10-17	2021-10-16
Pre-amplifier (100MHz-18GHz)	Black Diamond Series	BDLNA-0118-352810	SEM005-06	2017-09-27	2018-09-26
				2018-09-25	2019-09-24
Active Loop Antenna	ETS-Lindgren	6502	SEM003-08	2017-08-22	2020-08-21



Receiver spurious emissions					
Equipment	Manufacturer	Model No	Inventory No	Cal Date	Cal Due Date
Fully-Anechoic Chamber 1	SAEMC	MFAC	SEM001-04	2018-05-13	2021-05-13
Measurement Software	Rohde & Schwarz	EMC32 V9.21.00	N/A	N/A	N/A
Coaxial Cable	SGS	N/A	SEM027-01	2018-07-13	2019-07-12
FSV·Signal Analyzer (10Hz-40GHz)	Rohde & Schwarz	FSV40	SEM008-04	2018-04-14	2019-04-13
BiConiLog Antenna (30MHz-3GHz)	Schwarzbeck	VULB9163	SEM003-05	2015-10-19	2018-10-18
				2018-10-17	2021-10-16
Horn Antenna (800MHz-18GHz)	Rohde & Schwarz	HF907	SEM003-06	2018-06-14	2021-06-13
Pre-amplifier (100MHz-18GHz)	Black Diamond Series	BDLNA-0118- 352810	SEM005-06	2017-09-27	2018-09-26
				2018-09-25	2019-09-24
Active Loop Antenna	ETS-Lindgren	6502	SEM003-08	2017-08-22	2020-08-21

General used equipment					
Equipment	Manufacturer	Model No	Inventory No	Cal Date	Cal Due Date
Humidity/ Temperature Indicator	Shanghai Meteorological Industry Factory	ZJ1-2B	SEM002-03	2017-09-29	2018-09-28
				2018-09-27	2019-09-26
Humidity/ Temperature Indicator	Shanghai Meteorological Industry Factory	ZJ1-2B	SEM002-04	2017-09-29	2018-09-28
				2018-09-27	2019-09-26
Humidity/ Temperature Indicator	Mingle	N/A	SEM002-08	2017-09-29	2018-09-28
				2018-09-27	2019-09-26
Barometer	Changchun Meteorological Industry Factory	DYM3	SEM002-01	2018-04-08	2019-04-07

6 Radio Spectrum Matter Test Results

6.1 Frequency error

Test Requirement: EN 301 025 clause 8.1.1
Test Method: EN 301 025 clause 8.1.2
Limit: The frequency error shall be within $\pm 1,5$ kHz.

6.1.1 E.U.T. Operation

Operating Environment:
Temperature: 25.0 °C Humidity: 54 % RH Atmospheric Pressure: 1010 mbar
Test mode: d: TX mode, Keep the EUT in transmitting mode.

6.1.2 Test Setup Diagram

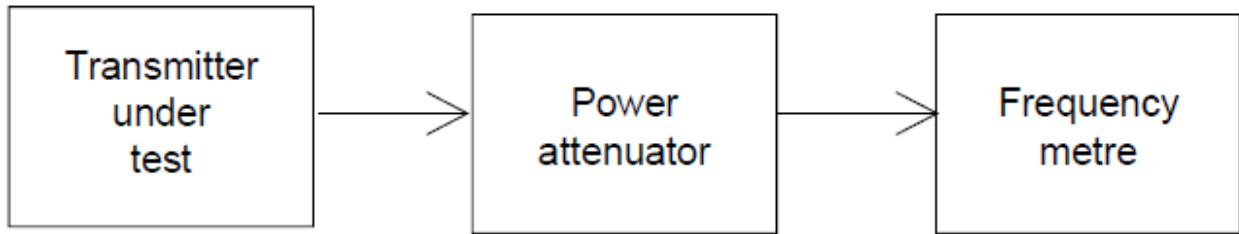

6.1.3 Measurement Data

The detailed test data see: Appendix 301 025.

6.2 Carrier power

Test Requirement: EN 301 025 clause 8.2.1
 Test Method: EN 301 025 clause 8.2.2
 Limit: Normal test conditions

The rated output power of the equipment shall be between 6 W and 25 W.
 With the output power switch set at maximum, the carrier power shall be within $\pm 1,5$ dB of the rated output power under normal test conditions. The output power shall never however exceed 25 W.
 With the output power switch set at minimum the carrier power shall remain between 0,1 W and 1 W.
 The maximum continuous transmission time shall be between 5 min and 6 min.

Extreme test conditions

With the output power switch set at maximum, the carrier power shall remain between 6 W and 25 W and be within +2 dB, -3 dB of the rated output power under extreme conditions. The output power shall never however exceed 25 W.
 With the output power switch set at minimum the carrier power shall remain between 0,1 W and 1 W.
 The maximum continuous transmission time shall be between 5 min and 6 min.

6.2.1 E.U.T. Operation

Operating Environment:
 Temperature: 25.0 °C Humidity: 54 % RH Atmospheric Pressure: 1010 mbar
 Test mode: d: TX mode, Keep the EUT in transmitting mode.

6.2.2 Test Setup Diagram

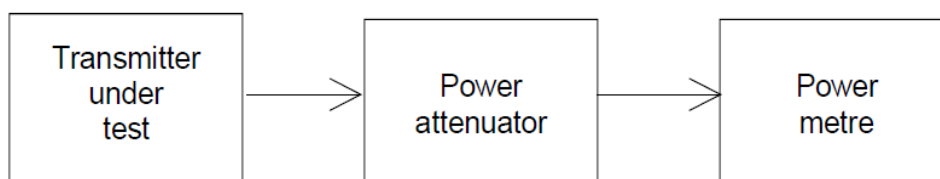

6.2.3 Measurement Data

The detailed test data see: Appendix 301 025.

6.3 Frequency deviation

Test Requirement EN 301 025 clause 8.3.1
Test Method: EN 301 025 clause 8.3.2
Limit: The maximum permissible frequency deviation shall be:

- 25 kHz channels: ± 5 kHz.
- 12,5 kHz channels: $\pm 2,5$ kHz.

6.3.1 E.U.T. Operation

Operating Environment:
Temperature: 25.0 °C Humidity: 56 % RH Atmospheric Pressure: 1010 mbar
Test mode: d: TX mode, Keep the EUT in transmitting mode.

6.3.2 Test Setup Diagram

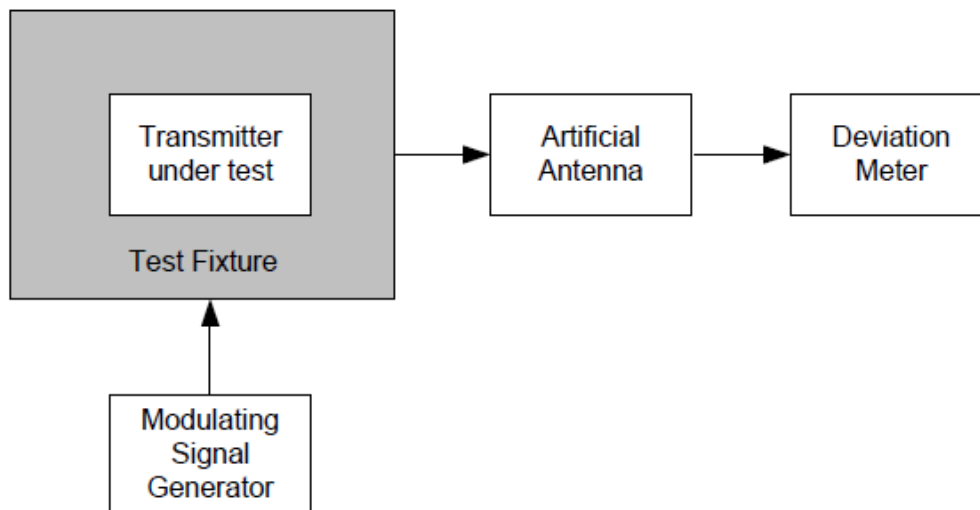

6.3.3 Measurement Data

The detailed test data see: Appendix 301 025.

6.4 Reduction of frequency deviation at modulation frequencies above 3 kHz

Test Requirement EN 301 025 clause 8.3.3
 Test Method: EN 301 025 clause 8.3.3.1
 Limit:

The frequency deviation at modulation frequencies between 3,0 kHz (for equipment operating with 20 kHz or 25 kHz channel separations) and 2,55 kHz (for equipment operating with 12,5 kHz channel separation) and 6,0 kHz shall not exceed the frequency deviation at a modulation frequency of 3,0 kHz/2,55 kHz. At 6,0 kHz the deviation shall be not more than 30,0 % of the maximum permissible frequency deviation.

The frequency deviation at modulation frequencies between 6,0 kHz and a frequency equal to the channel separation for which the equipment is intended shall not exceed that given by a linear representation of the frequency deviation (dB) relative to the modulation frequency, starting at the 6,0 kHz limit and having a slope of -14,0 dB per octave. These limits are illustrated in figure 1.

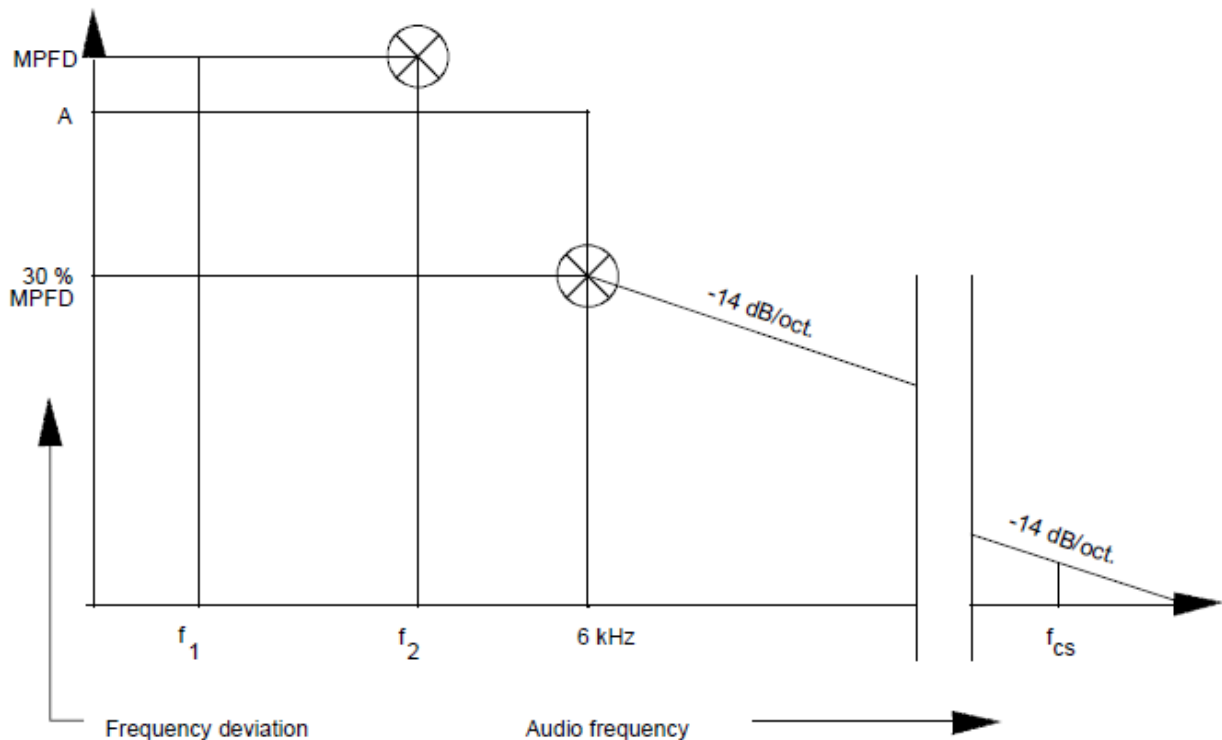

NOTE:

Abbreviations:

- f_1 lowest appropriate frequency
- f_2 3,0 kHz (for 25 kHz channel separation), or
2,55 kHz (for 12,5 kHz channel separation)
- MPFD maximum permissible frequency deviation, clause 8.3.2.1
- A measured frequency deviation at f_2
- f_{cs} frequency equal to channel separation

Figure 1: Frequency deviation

6.4.1 E.U.T. Operation

Operating Environment:

Temperature: 25.0 °C Humidity: 56 % RH Atmospheric Pressure: 1010 mbar

Test mode: d: TX mode, Keep the EUT in transmitting mode.

6.4.2 Test Setup Diagram

The transmitter shall be placed in the test fixture connected as below. The frequency deviation shall be measured by means of a deviation meter capable of measuring the maximum permissible frequency deviation, including that due to any harmonics and intermodulation products, which may be produced in the transmitter. The deviation meter bandwidth shall be suitable to accommodate the highest modulating frequency and to achieve the required dynamic range.

The transmitter shall be operated under normal test conditions.

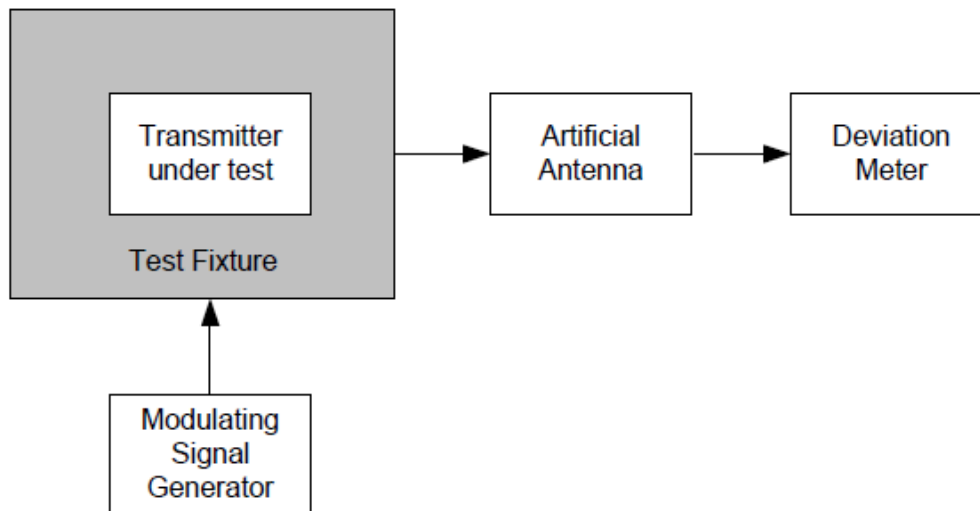

Response of the transmitter to modulation frequencies above 3 kHz

- a) The modulation frequency shall be varied between f_2 (see note) and a frequency equal to the channel separation for which the equipment is intended. The level of this signal shall correspond to a deviation at 1 000 Hz of 12 % of the channel separation.
- b) The maximum (positive or negative) frequency deviation shall be measured by means of the deviation meter.

NOTE: f_2 is equal to 3 kHz, for transmitters intended for 20 kHz and 25 kHz channel separation, or to 2,55 kHz for transmitters intended for 12,5 kHz channel separations.

6.4.3 Measurement Data

The detailed test data see: Appendix 301 025.

6.5 Sensitivity of the modulator, including microphone

Test Requirement EN 301 025 clause 8.4.1
Test Method: EN 301 025 clause 8.4.2
Limit: The resulting frequency deviation shall be between $\pm 1,5$ kHz and ± 3 kHz.

6.5.1 E.U.T. Operation

Operating Environment:
Temperature: 23.0 °C Humidity: 56 % RH Atmospheric Pressure: 1010 mbar
Test mode: d: TX mode, Keep the EUT in transmitting mode.

6.5.2 Test Setup Diagram

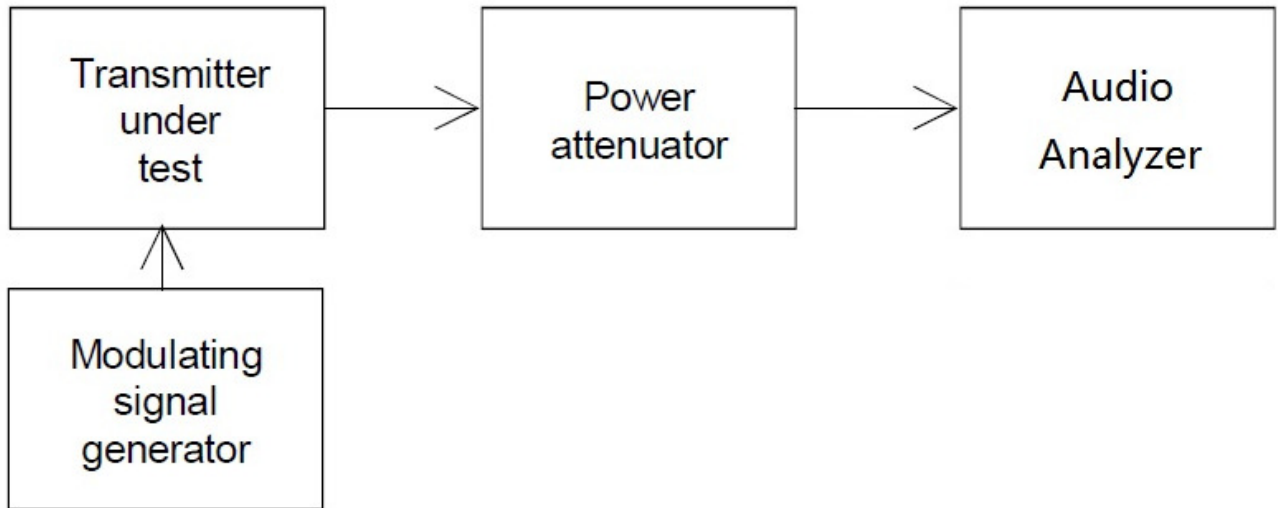

6.5.3 Measurement Data

The detailed test data see: Appendix 301 025.

6.6 Audio frequency response

Test Requirement EN 301 025 clause 8.5.1
 Test Method: EN 301 025 clause 8.5.2
 Limit: The audio frequency response shall be within +1 dB and -3 dB of a 6 dB/octave line passing through the reference point. The upper limit frequency shall be 2,55 kHz for 12,5 kHz channels.

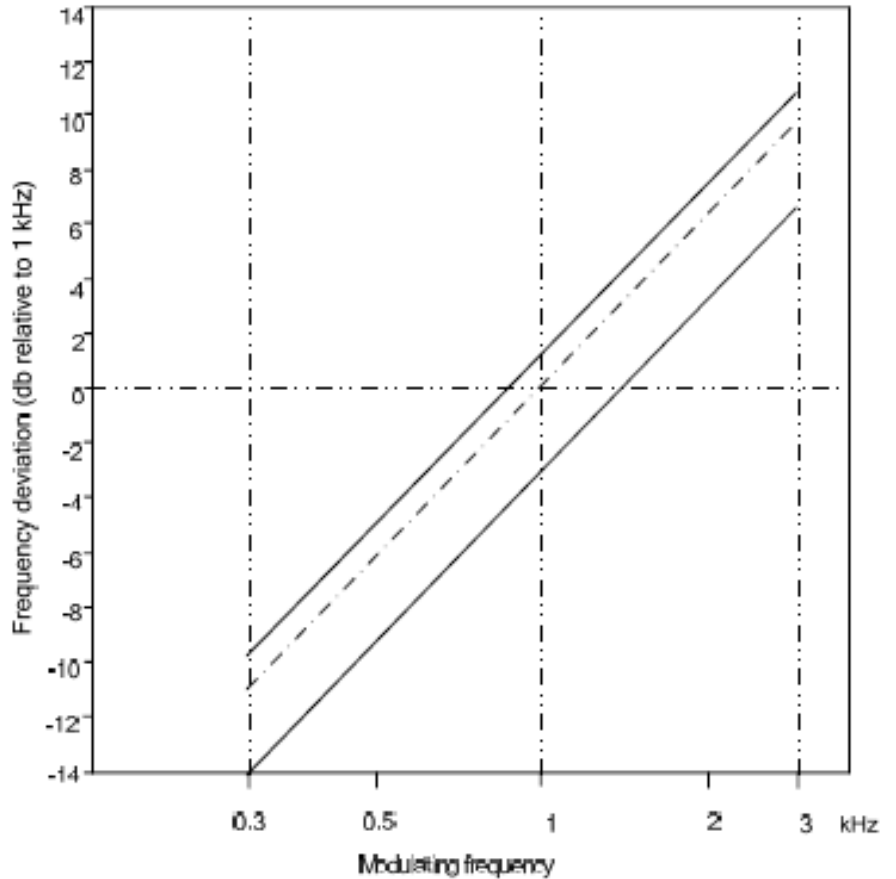

Figure 2: Audio frequency response

6.6.1 E.U.T. Operation

Operating Environment:

Temperature: 23.0 °C Humidity: 56 % RH Atmospheric Pressure: 1010 mbar

Test mode: d: TX mode, Keep the EUT in transmitting mode.

6.6.2 Test Setup Diagram

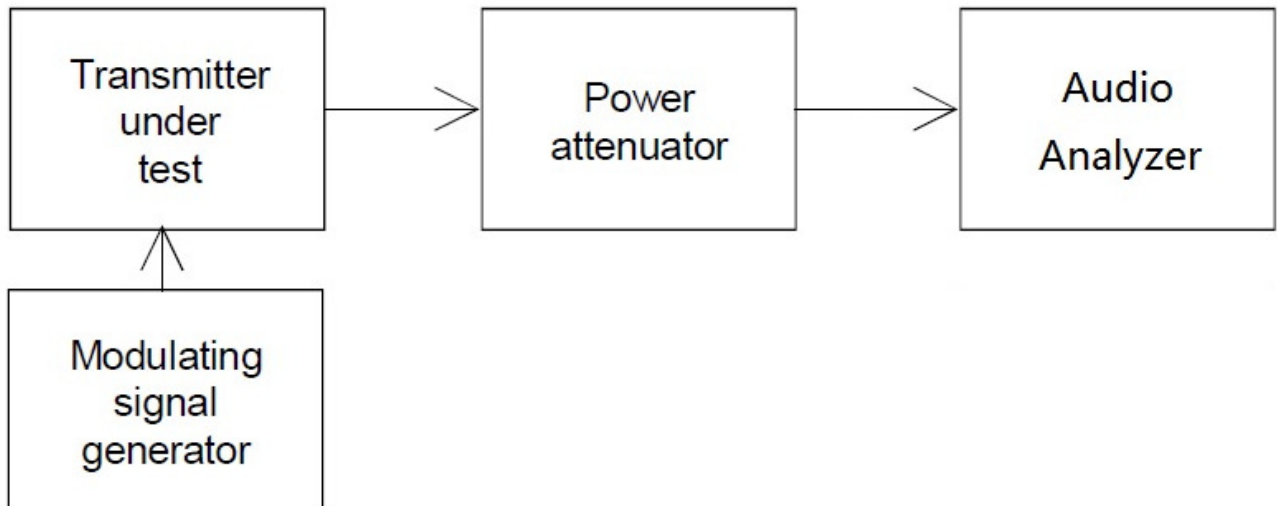

6.6.3 Measurement Data

The detailed test data see: Appendix 301 025.

6.7 Audio frequency harmonic distortion of the emission

Test Requirement EN 301 025 clause 8.6.1
Test Method: EN 301 025 clause 8.6.2
Limit: The harmonic distortion shall not exceed 10 %.

6.7.1 E.U.T. Operation

Operating Environment:
Temperature: 23.0 °C Humidity: 56 % RH Atmospheric Pressure: 1010 mbar
Test mode: d: TX mode, Keep the EUT in transmitting mode.

6.7.2 Test Setup Diagram

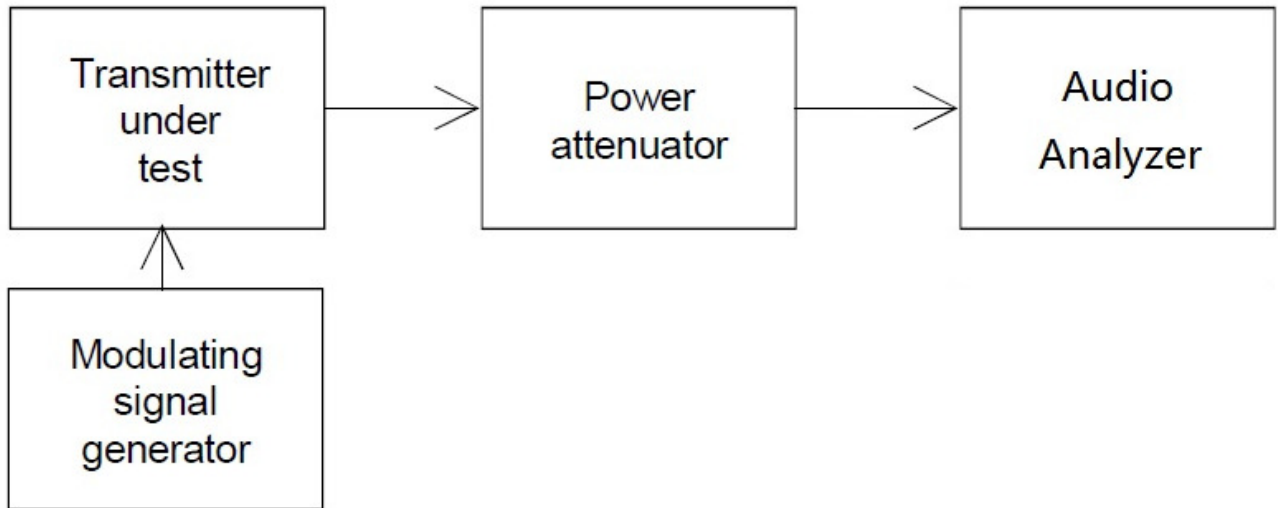

6.7.3 Measurement Data

The detailed test data see: Appendix 301 025.

6.8 Adjacent channel power

Test Requirement	EN 301 025 clause 8.7.1
Test Method:	EN 301 025 clause 8.7.2
Limit:	The adjacent channel power shall not exceed a value of: <ul style="list-style-type: none"> • 25 kHz channel: 70 dB below the carrier power of the transmitter without any need to be below the spurious emission limit of 0,25 uW. • 12,5 kHz channel: 60 dB below the carrier power of the transmitter without any need to be below the spurious emission limit of 0,25 uW.

6.8.1 E.U.T. Operation

Operating Environment:

Temperature: 23.0 °C Humidity: 56 % RH Atmospheric Pressure: 1010 mbar

Test mode: f: TX mode, Keep the EUT in tx mode.

6.8.2 Test Setup Diagram

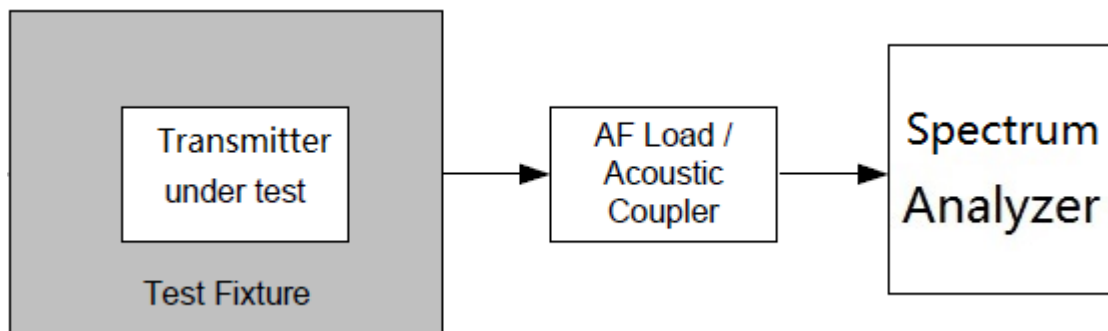

6.8.3 Measurement Data

The detailed test data see: Appendix 301 025.

6.9 Conducted spurious emissions conveyed to the antenna

Test Requirement EN 301 025 clause 8.8.1
 Test Method: EN 301 025 clause 8.8.2
 Limit: The power of any conducted spurious emission on any discrete frequency shall not exceed 0,25 uW.

6.9.1 E.U.T. Operation

Operating Environment:
 Temperature: 18.7 °C Humidity: 41.1 % RH Atmospheric Pressure: 1010 mbar
 Test mode: d: TX mode, Keep the EUT in transmitting mode.

6.9.2 Test Setup Diagram

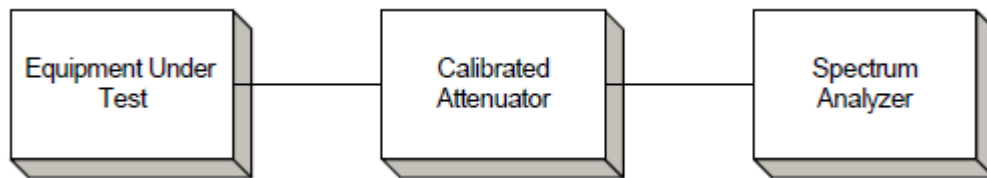

6.9.3 Measurement Procedure and Data

The detailed test data see: Appendix 301 025.

6.10 Cabinet radiation spurious emissions

Test Requirement EN 301 025 clause 8.9.1
 Test Method: EN 301 025 clause 8.9.2
 Measurement Distance: 3m
 Limit: When the transmitter is in stand-by the cabinet radiation and spurious emissions shall not exceed 2 nW.
 When the transmitter is in operation the cabinet radiation and spurious emissions shall not exceed 0,25 uW.

6.10.1 E.U.T. Operation

Operating Environment:
 Temperature: 23.0 °C Humidity: 56 % RH Atmospheric Pressure: 1010 mbar
 Test mode: d: TX mode, Keep the EUT in transmitting mode.

6.10.2 Test Setup Diagram

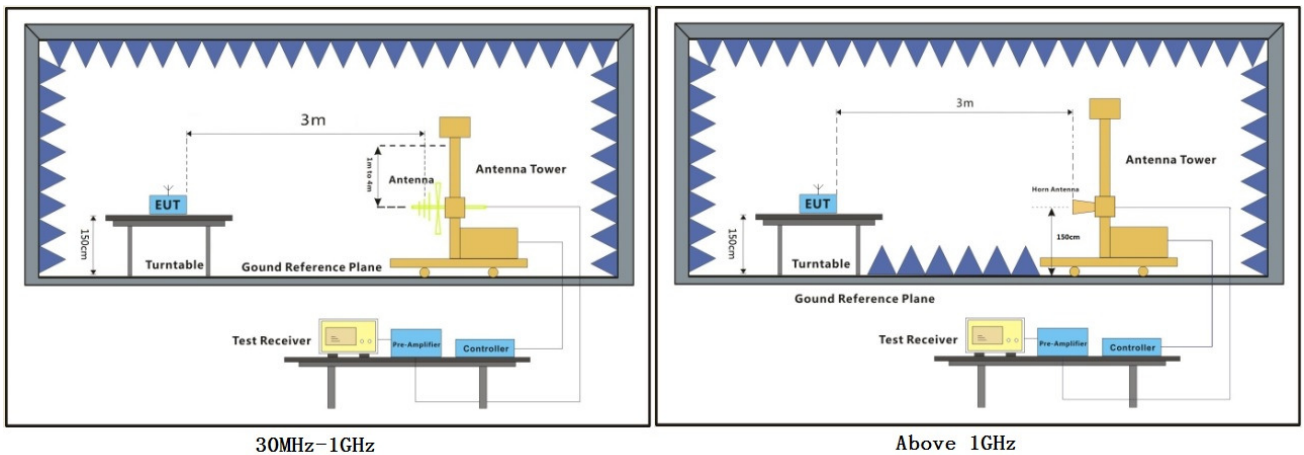



6.10.3 Measurement Data

1. Scan from 30MHz to 12.75GHz, find the maximum radiation frequency to measure.
2. The technique used to find the Spurious Emissions of the transmitter was the antenna substitution method. Substitution method was performed to determine the actual ERP/EIRP emission levels of the EUT.

Below 1GHz test procedure as below:

- 1) The EUT was powered on and placed on a table in the chamber. The antenna of the transmitter was extended to its maximum length. modulation mode and the measuring receiver shall be tuned to the frequency of the transmitter under test.
- 2) Rotating through 360° the turntable. After the fundamental emission was maximized, a field strength measurement was made.
- 3) Steps 1) and 2) were performed with the EUT and the receive antenna in both vertical and horizontal polarization.
- 4) The transmitter was then removed and replaced with another antenna. The center of the antenna was approximately at the same location as the center of the transmitter.
- 5) A signal at the disturbance was fed to the substitution antenna by means of a non-radiating cable. With both the substitution and the receive antennas horizontally polarized, the receive antenna was raised and lowered to obtain a maximum reading at the test receiver. The level of the signal generator was adjusted until the measured field strength level in step 2) is obtained for this set of conditions.
- 6) The output power into the substitution antenna was then measured.
- 7) Steps 5) and 6) were repeated with both antennas vertically polarized.
- 8) Calculate power in dBm by the following formula:

$$\text{ERP(dBm)} = \text{Pg(dBm)} - \text{cable loss (dB)} + \text{antenna gain (dBi)}$$

where:

Pg is the generator output power into the substitution antenna.

Above 1GHz test procedure as below:

- 1) Different between above is the test site, change from Semi- Anechoic Chamber to fully Anechoic Chamber.
- 2) Calculate power in dBm by the following formula:

$$\text{EIRP(dBm)} = \text{Pg(dBm)} - \text{cable loss (dB)} + \text{antenna gain (dBi)}$$

$$\text{EIRP} = \text{ERP} + 2.15\text{dB}$$

where:

Pg is the generator output power into the substitution antenna.

The detailed test data see: Appendix 301 025.

6.11 Transient frequency behaviour of the transmitter

Test Requirement EN 301 025 clause 8.10.1
Test Method: EN 301 025 clause 8.10.2
Limit: During the periods of time t1 and t3 the frequency difference shall not exceed ± 25 kHz.
The frequency difference after the end of t2 shall be within the limit of the frequency error given in clause 8.1.
During the period of time t2 the frequency difference shall not exceed $\pm 12,5$ kHz.
Before the start of t3 the frequency difference shall be within the limit of the frequency error given in clause 8.1.

6.11.1 E.U.T. Operation

Operating Environment:
Temperature: 18.7 °C Humidity: 41.1 % RH Atmospheric Pressure: 1010 mbar
Test mode: d: TX mode, Keep the EUT in transmitting mode.

6.11.2 Test Setup Diagram

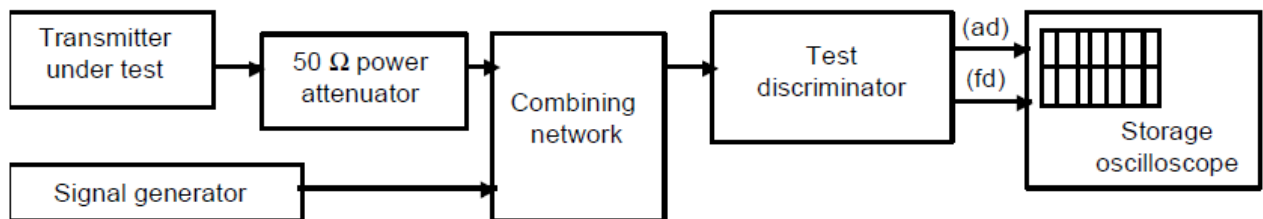

6.11.3 Measurement Procedure and Data

The detailed test data see: Appendix 301 025.

6.12 Residual modulation of the transmitter

Test Requirement	EN 301 025 clause 8.11.1
Test Method:	EN 301 025 clause 8.11.2
Limit:	The residual modulation shall not exceed -40 dB on either 12,5 kHz or 25 kHz channels.

6.12.1 E.U.T. Operation

Operating Environment:

Temperature: 18.7 °C Humidity: 41.1 % RH Atmospheric Pressure: 1010 mbar

Test mode: d: TX mode, Keep the EUT in transmitting mode.

6.12.2 Test Setup Diagram

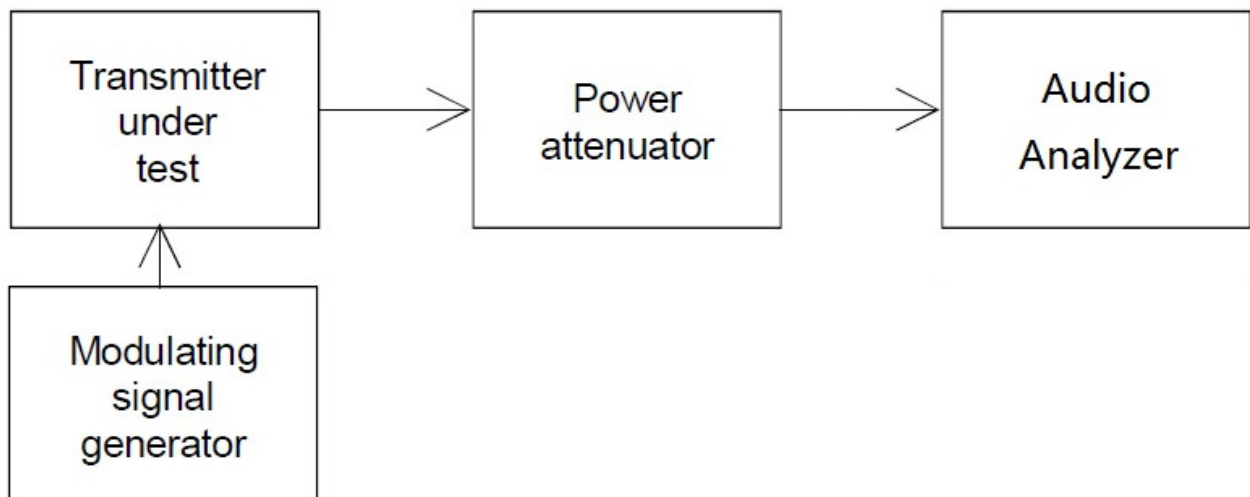

6.12.3 Measurement Procedure and Data

The detailed test data see: Appendix 301 025.

6.13 Frequency error (demodulated DSC signal)

Test Requirement: EN 301 025 clause 8.12.1
Test Method: EN 301 025 clause 8.12.2
Limit: The measured frequency from the demodulator at any time for the B-state shall be within $2\ 100\ \text{Hz} \pm 10\ \text{Hz}$ and for the Y-state within $1\ 300\ \text{Hz} \pm 10\ \text{Hz}$.

6.13.1 E.U.T. Operation

Operating Environment:
Temperature: 25.0 °C Humidity: 54 % RH Atmospheric Pressure: 1010 mbar
Test mode: d: TX mode, Keep the EUT in transmitting mode.

6.13.2 Test Setup Diagram

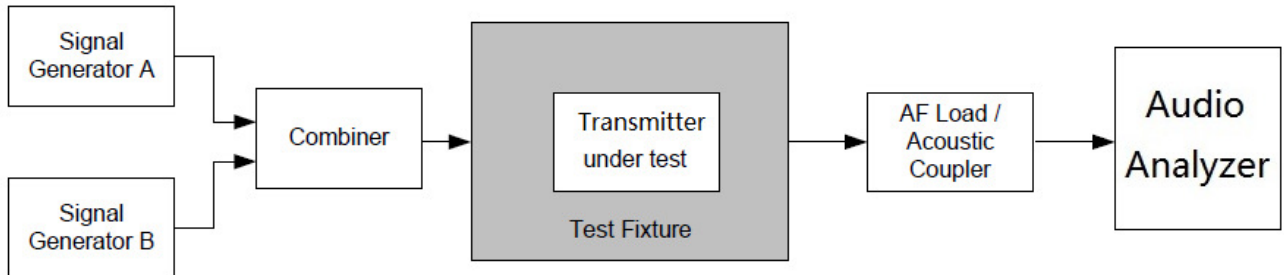

6.13.3 Measurement Data

The detailed test data see: Appendix 301 025.

6.14 Modulation index for DSC

Test Requirement: EN 301 025 clause 8.13.1
 Test Method: EN 301 025 clause 8.13.2
 Limit: The modulation index shall be $2,0 \pm 10 \%$.

6.14.1 E.U.T. Operation

Operating Environment:
 Temperature: 25.0 °C Humidity: 54 % RH Atmospheric Pressure: 1010 mbar
 Test mode: d: TX mode, Keep the EUT in transmitting mode.

6.14.2 Test Setup Diagram

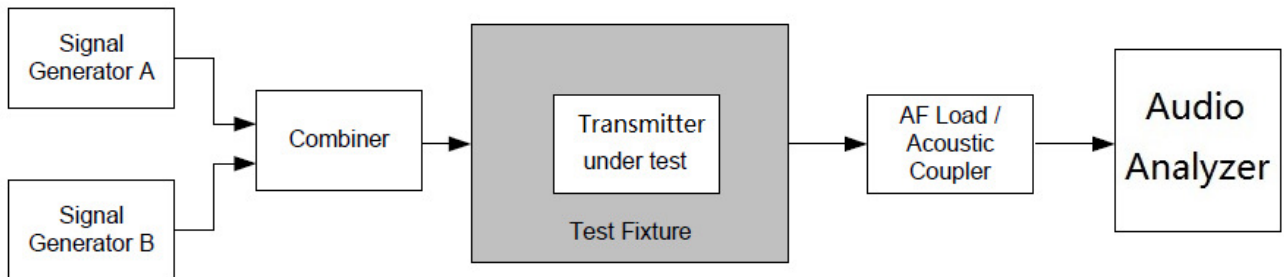

6.14.3 Measurement Data

The detailed test data see: Appendix 301 025.

6.15 Modulation rate for DSC

Test Requirement: EN 301 025 clause 8.14.1
 Test Method: EN 301 025 clause 8.14.2
 Limit: The frequency shall be 600 Hz \pm 30 ppm corresponding to a modulation rate of 1 200 baud.

6.15.1 E.U.T. Operation

Operating Environment:
 Temperature: 25.0 °C Humidity: 54 % RH Atmospheric Pressure: 1010 mbar
 Test mode: d: TX mode, Keep the EUT in transmitting mode.

6.15.2 Test Setup Diagram

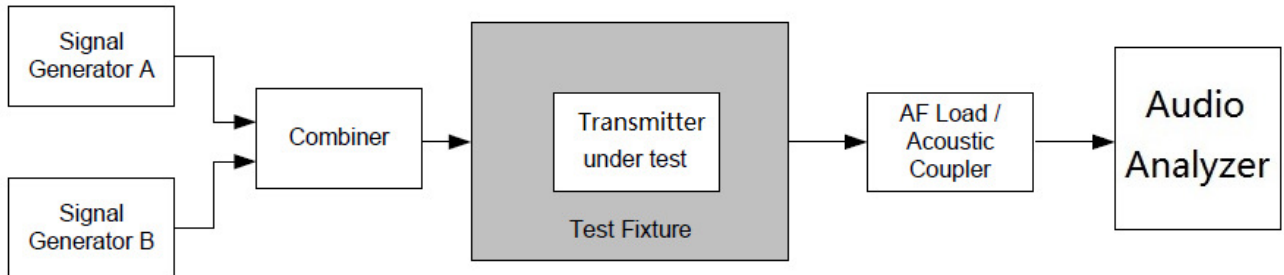

6.15.3 Measurement Data

The detailed test data see: Appendix 301 025.

6.16 Testing of free channel transmission on DSC channel 70

Test Requirement: EN 301 025 clause 8.15.1
Test Method: EN 301 025 clause 8.15.2
Limit: If the format specifier is distress or the category is either distress, urgency or safety in the transmitted DSC call, the call shall be transmitted while the signal generator output is still on. Otherwise the call shall not be transmitted until the signal generator output has been turned off.

6.16.1 E.U.T. Operation

Operating Environment:
Temperature: 25.0 °C Humidity: 54 % RH Atmospheric Pressure: 1010 mbar
Test mode: d: TX mode, Keep the EUT in transmitting mode.

6.16.2 Test Setup Diagram

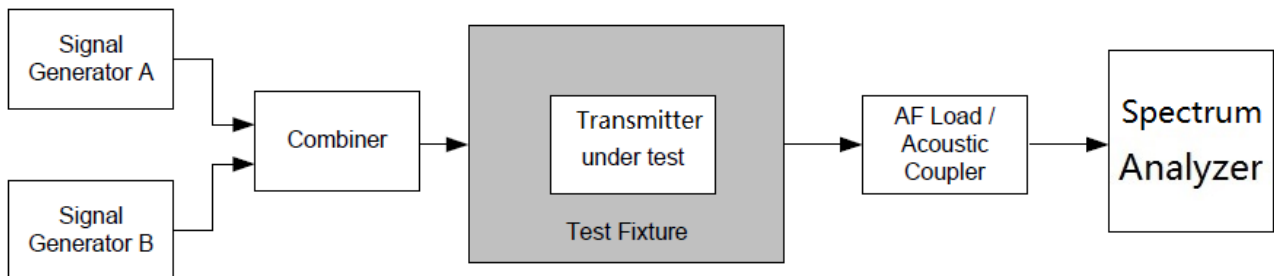

6.16.3 Measurement Data

It shall be verified that, after transmission of a DSC call, the transmitter re-tunes to the original channel. However in the case of a distress call the transmitter shall tune to channel 16 and automatically select the maximum power.

6.17 Harmonic distortion and rated audio-frequency output power

Test Requirement: EN 301 025 clause 9.1.1
 Test Method: EN 301 025 clause 9.1.2
 Limit: The rated audio-frequency output power shall be at least:

- 2 W in a loudspeaker;
- 1 mW in the handset earphone.

The harmonic distortion shall not exceed 10 %.

6.17.1 E.U.T. Operation

Operating Environment:
 Temperature: 23.0 °C Humidity: 56 % RH Atmospheric Pressure: 1010 mbar
 Test mode: e: RX mode, Keep the EUT in receiving mode.

6.17.2 Test Setup Diagram

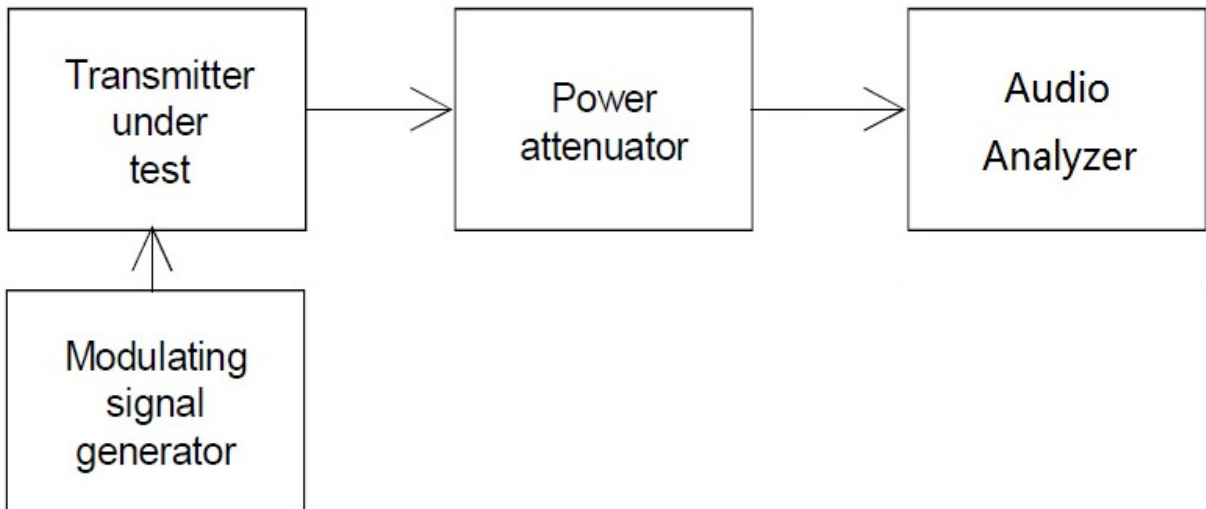

6.17.3 Measurement Data

The detailed test data see: Appendix 301 025.

6.18 Audio frequency response

Test Requirement: EN 301 025 clause 9.2.1

Test Method: EN 301 025 clause 9.2.2

Limit: The audio frequency response shall not deviate by more than +1 dB or -3 dB from a characteristic giving the output level as a function of the audio frequency, decreasing by 6 dB per octave and passing through the measured point at 1 kHz (see figure 5).

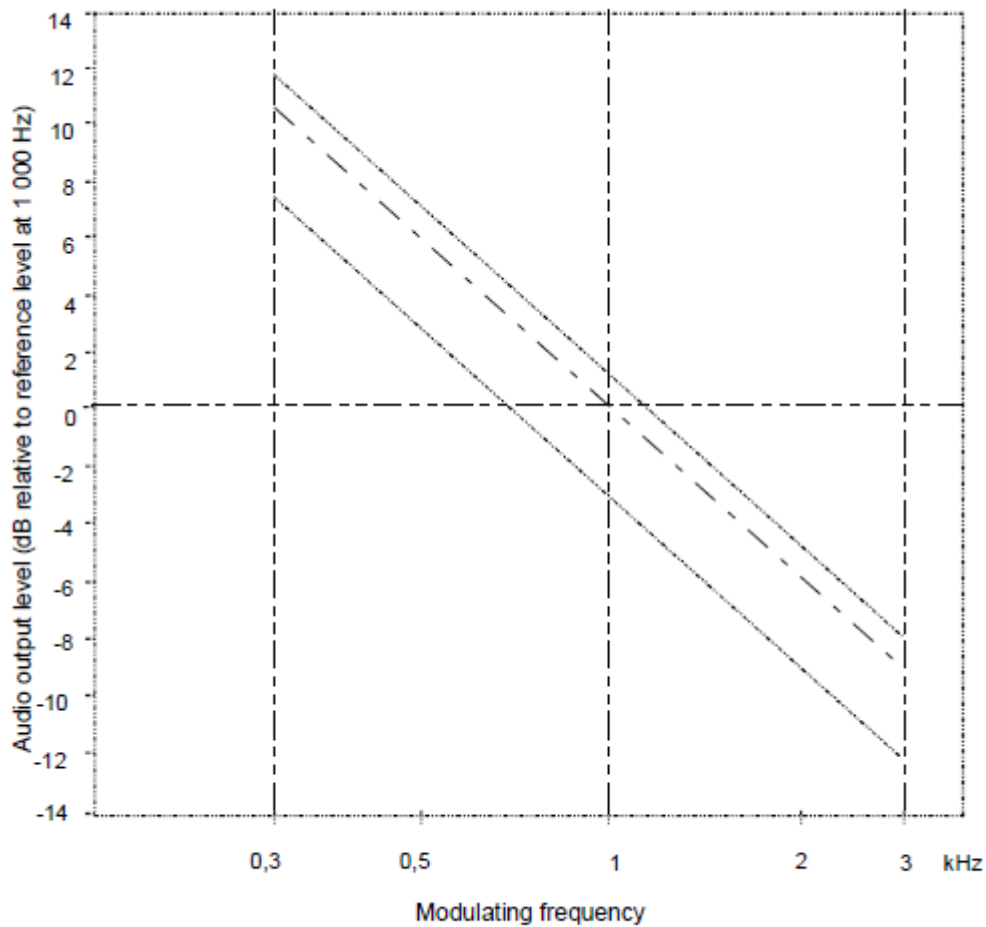

Figure 5: Audio frequency response

6.18.1 E.U.T. Operation

Operating Environment:

Temperature: 23.0 °C Humidity: 56 % RH Atmospheric Pressure: 1010 mbar

Test mode: e: RX mode, Keep the EUT in receiving mode.

6.18.2 Test Setup Diagram

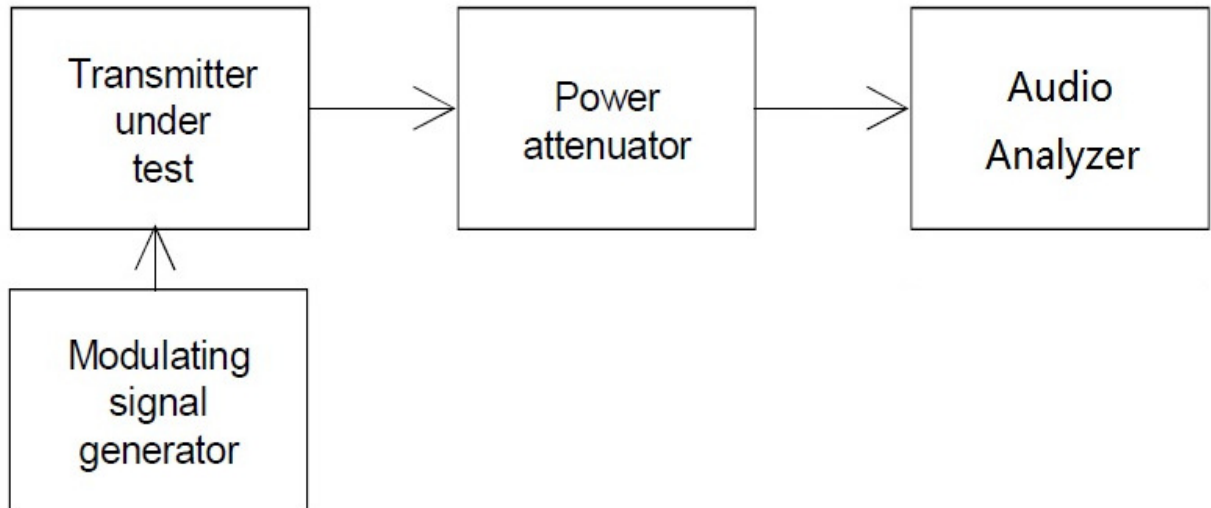

A test signal of +60 dB μ V (e.m.f.), at a carrier frequency equal to the nominal frequency of the receiver and modulated with normal test modulation (see clause 6.4) shall be applied to the receiver antenna port under the conditions specified in clause 6.1.

The receiver's audiofrequency power control shall be set so as to produce a power level equal to 50 % of the rated output power (see clause 9.1). This setting shall remain unchanged during the test.

The frequency deviation shall then be reduced to ± 1 kHz and the audio output is the reference point in figure 5 (1 kHz corresponds to 0 dB).

The frequency deviation shall remain constant while the modulation frequency is varied between 300 Hz and 3 kHz and the output level shall then be measured.

The measurement shall be repeated with a test signal at frequencies 1,5 kHz above and below the nominal frequency of the receiver.

6.18.3 Measurement Data

The detailed test data see: Appendix 301 025.

6.19 Maximum usable sensitivity

Test Requirement: EN 301 025 clause 9.3.1
Test Method: EN 301 025 clause 9.3.2
Limit: The maximum usable sensitivity for either 25 kHz or 12,5 kHz channels shall not exceed +6 dBuV (e.m.f.) under normal test conditions and +12 dBuV (e.m.f.) under extreme test conditions.

6.19.1 E.U.T. Operation

Operating Environment:
Temperature: 23.0 °C Humidity: 56 % RH Atmospheric Pressure: 1010 mbar
Test mode: e: RX mode, Keep the EUT in receiving mode.

6.19.2 Test Setup Diagram

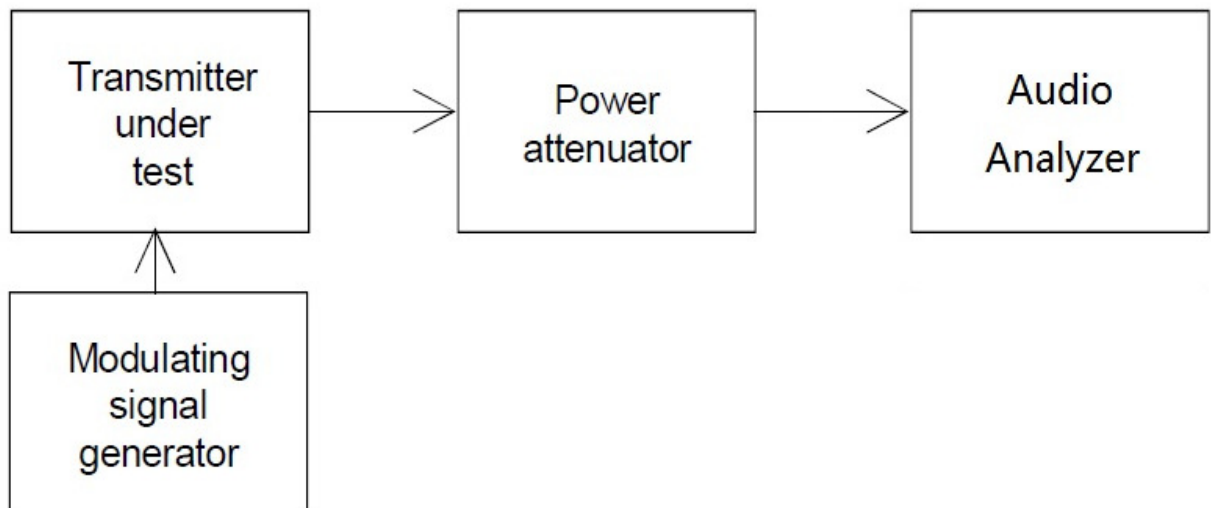

A test signal at a carrier frequency equal to the nominal frequency of the receiver, modulated by the normal test modulation (see clause 6.4) shall be applied to the receiver input. An audio frequency load and a measuring instrument for measuring SINAD ratio (through a psophometric network as specified in clause 9.3.1) shall be connected to the receiver output terminals.

The level of the test signal shall be adjusted until a SINAD ratio of 20 dB is obtained, using the psophometric network and with the receiver's audio-frequency power control adjusted to produce 50 % of the rated output power. Under these conditions, the level of the test signal at the input is the value of the maximum usable sensitivity.

The measurements shall be made under normal test conditions (see clause 6.13) and under extreme test conditions (see clauses 6.14.1 and 6.14.2 applied simultaneously).

A receiver output power variation of ± 3 dB relative to 50 % of the rated output power may be allowed for sensitivity measurements under extreme test conditions.

6.19.3 Measurement Data

The detailed test data see: Appendix 301 025.

6.20 Co-channel rejection

Test Requirement	EN 301 025 clause 9.4.1
Test Method:	EN 301 025 clause 9.4.2
Limit:	The co-channel rejection ratio, at any frequency of the unwanted signal within the specified range, shall be between: <ul style="list-style-type: none"> • -10 dB and 0 dB for 25 kHz channels; • -12 dB and 0 dB for 12,5 kHz channels.

6.20.1 E.U.T. Operation

Operating Environment:

Temperature: 23.0 °C Humidity: 56 % RH Atmospheric Pressure: 1010 mbar

Test mode: e: RX mode, Keep the EUT in receiving mode.

6.20.2 Test Setup Diagram

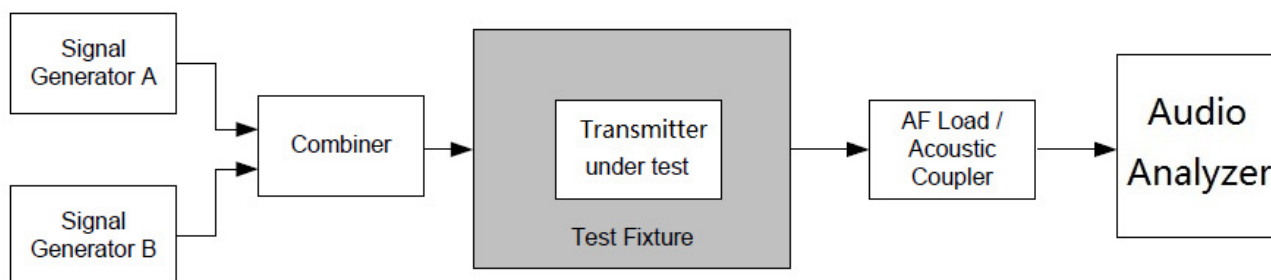

6.20.3 Measurement Data

The detailed test data see: Appendix 301 025.

6.21 Adjacent channel selectivity

Test Requirement	EN 301 025 clause 9.5.1
Test Method:	EN 301 025 clause 9.5.2
Limit:	25 kHz channels: the adjacent channel selectivity shall be not less than 70 dB under normal test conditions and not less than 60 dB under extreme test conditions. 12,5 kHz channels: the adjacent channel selectivity shall be not less than 60 dB under normal test conditions and not less than 50 dB under extreme test conditions.

6.21.1 E.U.T. Operation

Operating Environment:
Temperature: 23.0 °C Humidity: 56 % RH Atmospheric Pressure: 1010 mbar
Test mode: e: RX mode, Keep the EUT in receiving mode.

6.21.2 Test Setup Diagram

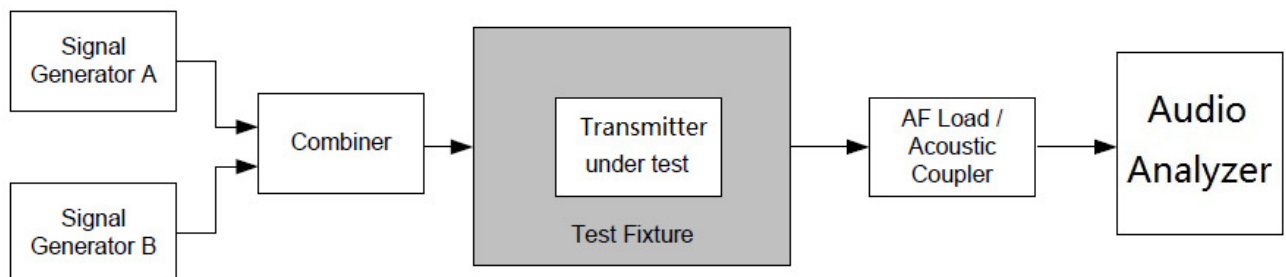

6.21.3 Measurement Data

The detailed test data see: Appendix 301 025.

6.22 Spurious response rejection

Test Requirement EN 301 025 clause 9.6.1
 Test Method: EN 301 025 clause 9.6.2
 Limit: At any frequency separated from the nominal frequency of the receiver by more than 25 kHz, the spurious response rejection ratio shall be not less than 70 dB.

6.22.1 E.U.T. Operation

Operating Environment:
 Temperature: 23.0 °C Humidity: 56 % RH Atmospheric Pressure: 1010 mbar
 Test mode: e: RX mode, Keep the EUT in receiving mode.

6.22.2 Test Setup Diagram

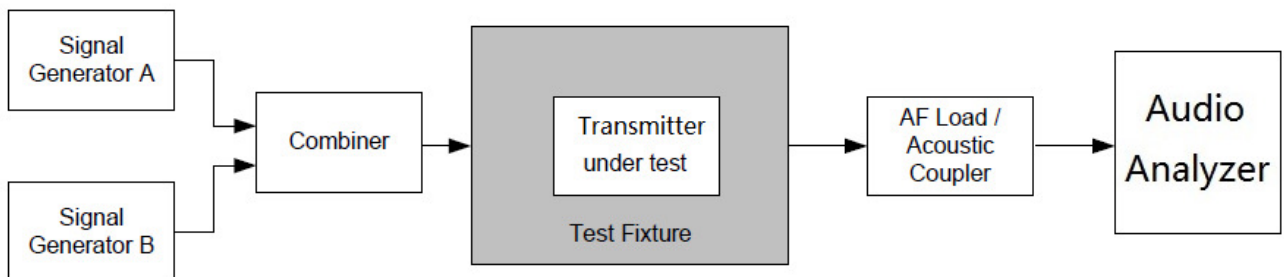

6.22.3 Measurement Data

The detailed test data see: Appendix 301 025.

6.23 Intermodulation response

Test Requirement EN 301 025 clause 9.7.1
Test Method: EN 301 025 clause 9.7.2
Limit: The intermodulation response ratio shall be greater than 68 dB.

6.23.1 E.U.T. Operation

Operating Environment:
Temperature: 23.0 °C Humidity: 56 % RH Atmospheric Pressure: 1010 mbar
Test mode: e: RX mode, Keep the EUT in receiving mode.

6.23.2 Test Setup Diagram

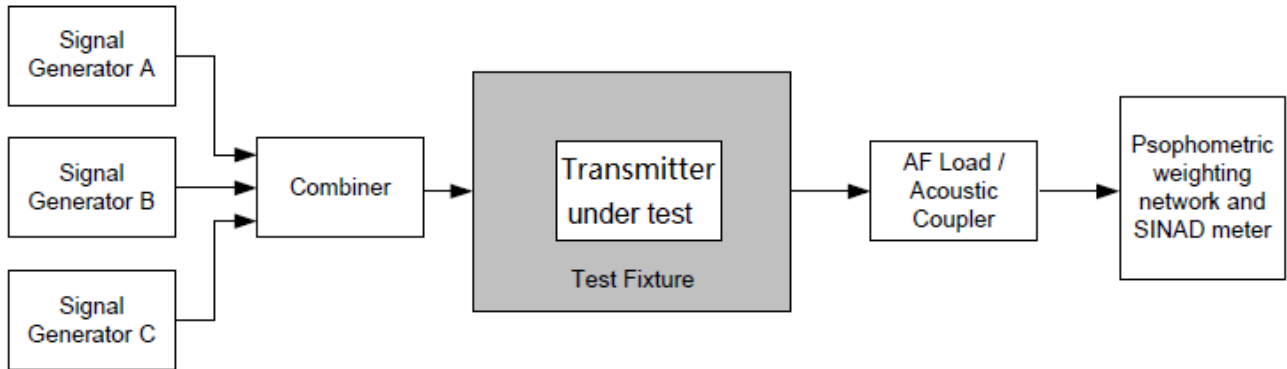

6.23.3 Measurement Data

The detailed test data see: Appendix 301 025.

6.24 Blocking or desensitization

Test Requirement	EN 301 025 clause 9.8.1
Test Method:	EN 301 025 clause 9.8.2
Limit:	The blocking level for any frequency within the specified ranges, shall be not less than 90 dBuV (e.m.f.), except at frequencies on which spurious responses are found.

6.24.1 E.U.T. Operation

Operating Environment:					
Temperature:	23.0 °C	Humidity:	56 % RH	Atmospheric Pressure:	1010 mbar
Test mode:	e: RX mode, Keep the EUT in receiving mode.				

6.24.2 Test Setup Diagram

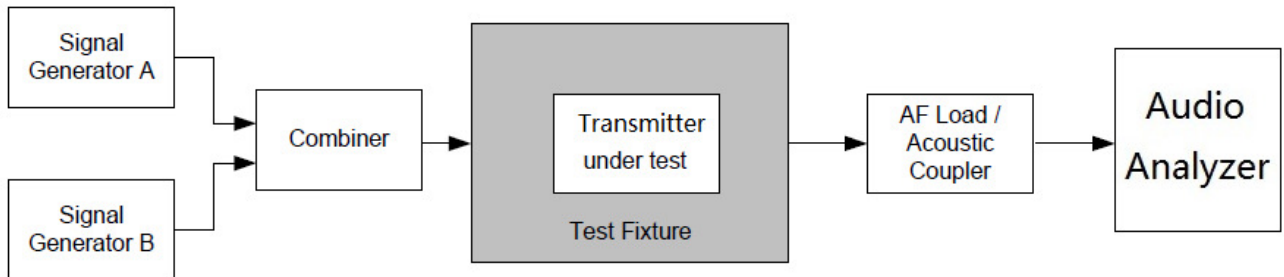

6.24.3 Measurement Data

The detailed test data see: Appendix 301 025.

6.25 Spurious emission

Test Requirement	EN 301 025 clause 9.9.1
Test Method:	EN 301 025 clause 9.9.2
Limit:	The power of any spurious emission shall not exceed 2 nW at any frequency in the range between 9 kHz and 2 GHz.

6.25.1 E.U.T. Operation

Operating Environment:

Temperature: 23.0 °C Humidity: 56 % RH Atmospheric Pressure: 1010 mbar

Test mode: e: RX mode, Keep the EUT in receiving mode.

6.25.2 Test Setup Diagram

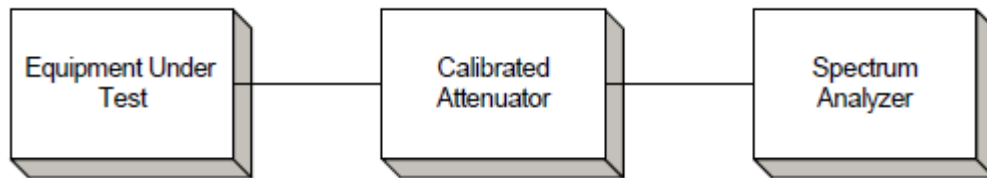

6.25.3 Measurement Data

The detailed test data see: Appendix 301 025.

6.26 Receiver radiated spurious emissions

Test Requirement	EN 301 025 clause 9.10.1
Test Method:	EN 301 025 clause 9.10.2
Limit:	The power of any spurious emission shall not exceed 2 nW at any frequency in the range between 9 kHz and 2 GHz.

6.26.1 E.U.T. Operation

Operating Environment:			
Temperature:	23.0 °C	Humidity:	56 % RH
		Atmospheric Pressure:	1010 mbar
Test mode:	e: RX mode, Keep the EUT in receiving mode.		

6.26.2 Test Setup Diagram

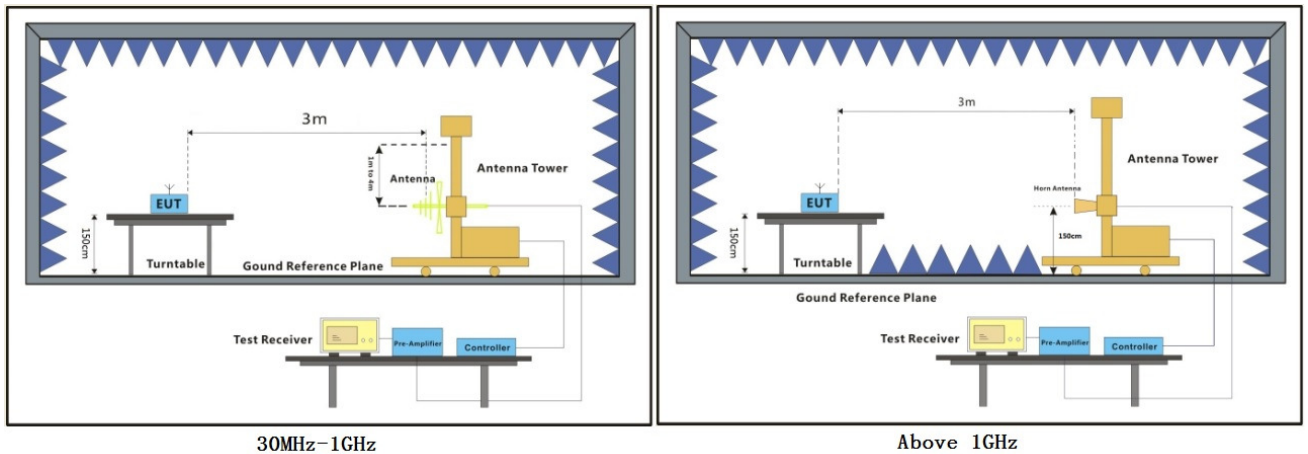



6.26.3 Measurement Data

1. Scan from 30MHz to 2GHz, find the maximum radiation frequency to measure.
2. The technique used to find the Spurious Emissions of the transmitter was the antenna substitution method. Substitution method was performed to determine the actual ERP/EIRP emission levels of the EUT.

Below 1GHz test procedure as below:

- 1) The EUT was powered on and placed on a table in the chamber. The antenna of the transmitter was extended to its maximum length. Receiver mode and the measuring receiver shall be tuned to the frequency of the transmitter under test.
- 2) Rotating through 360° the turntable. After the fundamental emission was maximized, a field strength measurement was made.
- 3) Steps 1) and 2) were performed with the EUT and the receive antenna in both vertical and horizontal polarization.
- 4) The transmitter was then removed and replaced with another antenna. The center of the antenna was approximately at the same location as the center of the transmitter.
- 5) A signal at the disturbance was fed to the substitution antenna by means of a non-radiating cable. With both the substitution and the receive antennas horizontally polarized, the receive antenna was raised and lowered to obtain a maximum reading at the test receiver. The level of the signal generator was adjusted until the measured field strength level in step 2) is obtained for this set of conditions.
- 6) The output power into the substitution antenna was then measured.
- 7) Steps 5) and 6) were repeated with both antennas vertically polarized.
- 8) Calculate power in dBm by the following formula:

$$\text{ERP(dBm)} = \text{Pg(dBm)} - \text{cable loss (dB)} + \text{antenna gain (dBi)}$$

where:

Pg is the generator output power into the substitution antenna.

Above 1GHz test procedure as below:

- 1) Different between above is the test site, change from Semi- Anechoic Chamber to fully Anechoic Chamber.
- 2) Calculate power in dBm by the following formula:

$$\text{EIRP(dBm)} = \text{Pg(dBm)} - \text{cable loss (dB)} + \text{antenna gain (dBi)}$$

$$\text{EIRP} = \text{ERP} + 2.15\text{dB}$$

where:

Pg is the generator output power into the substitution antenna.

The detailed test data see: Appendix 301 025.

6.27 Receiver residual noise level

Test Requirement EN 301 025 clause 9.11.1
 Test Method: EN 301 025 clause 9.11.2
 Limit: The receiver residual noise level shall not exceed -40 dB.

6.27.1 E.U.T. Operation

Operating Environment:
 Temperature: 18.7 °C Humidity: 41.1 % RH Atmospheric Pressure: 1010 mbar
 Test mode: e: RX mode, Keep the EUT in receiving mode.

6.27.2 Test Setup Diagram

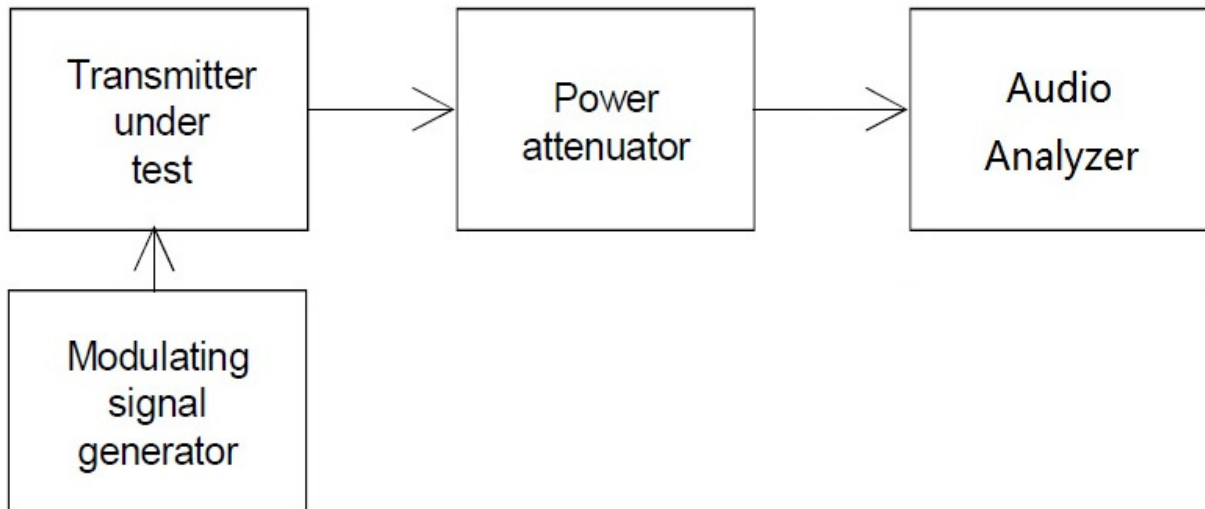

6.27.3 Measurement Procedure and Data

The detailed test data see: Appendix 301 025.

6.28 Squelch operation

Test Requirement	EN 301 025 clause 9.12.1
Test Method:	EN 301 025 clause 9.12.2
Limit:	Under the conditions specified in a) clause 9.12.2, the audio frequency output power shall not exceed -40 dB relative to the rated output power. Under the conditions specified in b) clause 9.12.2, the input level shall not exceed +6 dBuV (e.m.f.) and the SINAD ratio shall be at least 20 dB. Under the conditions specified in c) clause 9.12.2, the input signal shall not exceed +6 dBuV (e.m.f.) when the control is set at maximum.

6.28.1 E.U.T. Operation

Operating Environment:

Temperature: 18.7 °C Humidity: 41.1 % RH Atmospheric Pressure: 1010 mbar

Test mode: e: RX mode, Keep the EUT in receiving mode.

6.28.2 Test Setup Diagram

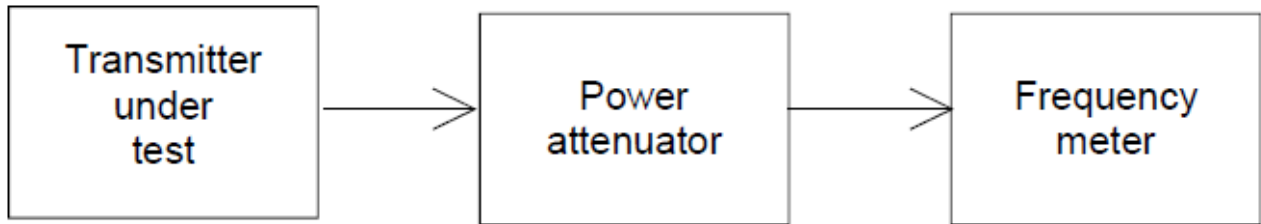

6.28.3 Measurement Procedure and Data

The detailed test data see: Appendix 301 025.

6.29 Squelch hysteresis

Test Requirement	EN 301 025 clause 9.13.1
Test Method:	EN 301 025 clause 9.13.2
Limit:	The squelch hysteresis shall be between 3 dB and 6 dB.

6.29.1 E.U.T. Operation

Operating Environment:

Temperature: 18.7 °C Humidity: 41.1 % RH Atmospheric Pressure: 1010 mbar

Test mode: e: RX mode, Keep the EUT in receiving mode.

6.29.2 Test Setup Diagram

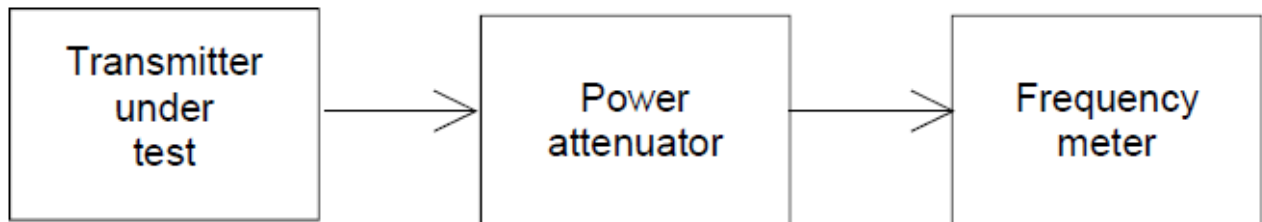

6.29.3 Measurement Procedure and Data

The detailed test data see: Appendix 301 025.

6.30 Multiple watch characteristic

Test Requirement	EN 301 025 clause 9.14.1
Test Method:	EN 301 025 clause 9.14.2
Limit:	The scanning period shall not exceed 2 s. The dwell time on the priority channel shall not exceed 150 ms. The dwell time on the additional channel shall be between 850 ms and 2 s as indicated by the time of the gap between two output bursts.

6.30.1 E.U.T. Operation

Operating Environment:
 Temperature: 18.7 °C Humidity: 41.1 % RH Atmospheric Pressure: 1010 mbar
 Test mode: e: RX mode, Keep the EUT in receiving mode.

6.30.2 Test Setup Diagram

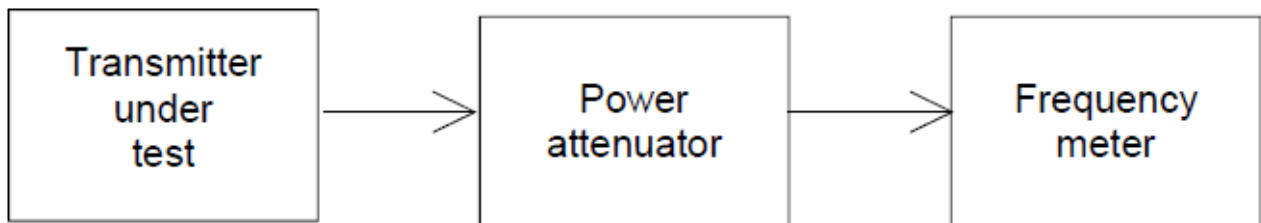

6.30.3 Measurement Procedure and Data

The detailed test data see: Appendix 301 025.



6.31 Maximum usable sensitivity

Test Requirement: EN 301 025 clause 10.1.1
Test Method: EN 301 025 clause 10.1.2
Limit: The bit error ratio shall be equal to or less than 10^{-2} .

6.31.1 E.U.T. Operation

Operating Environment:
Temperature: 23.0 °C Humidity: 56 % RH Atmospheric Pressure: 1010 mbar
Test mode: f: RX mode, Keep the EUT in DSC receiving mode.

6.31.2 Test Setup Diagram

DSC standard test signal containing DSC calls shall be applied to the receiver input. The input level shall be 0 dBuV under normal test conditions and +6 dBuV under extreme test conditions.

The measurement shall be repeated under normal test conditions at the nominal carrier frequency $\pm 1,5$ kHz. The bit error ratio in the decoder output shall be determined.

6.31.3 Measurement Data

The detailed test data see: Appendix 301 025.

6.32 Co-channel rejection

Test Requirement EN 301 025 clause 10.2.1
Test Method: EN 301 025 clause 10.2.2
Limit: The bit error ratio shall be equal to or less than 10^{-2} .

6.32.1 E.U.T. Operation

Operating Environment:
Temperature: 23.0 °C Humidity: 56 % RH Atmospheric Pressure: 1010 mbar
Test mode: f: RX mode, Keep the EUT in DSC receiving mode.

6.32.2 Test Setup Diagram

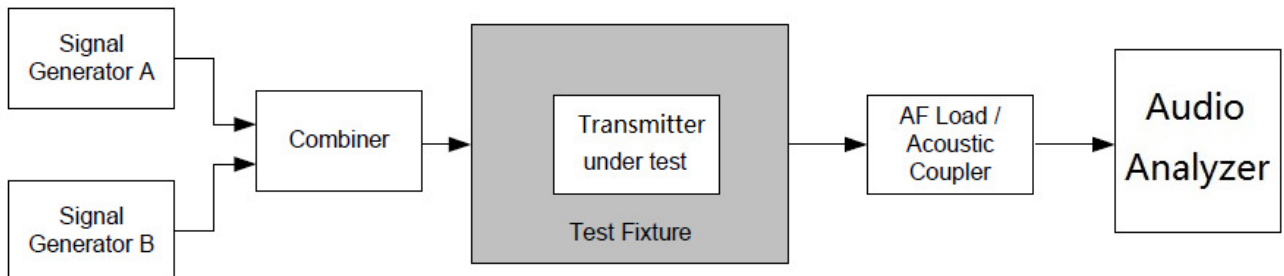

6.32.3 Measurement Data

The detailed test data see: Appendix 301 025.

6.33 Adjacent channel selectivity

Test Requirement EN 301 025 clause 10.3.1
Test Method: EN 301 025 clause 10.3.2
Limit: The bit error ratio shall be equal to or less than 10^{-2} .

6.33.1 E.U.T. Operation

Operating Environment:
Temperature: 23.0 °C Humidity: 56 % RH Atmospheric Pressure: 1010 mbar
Test mode: f: RX mode, Keep the EUT in DSC receiving mode.

6.33.2 Test Setup Diagram

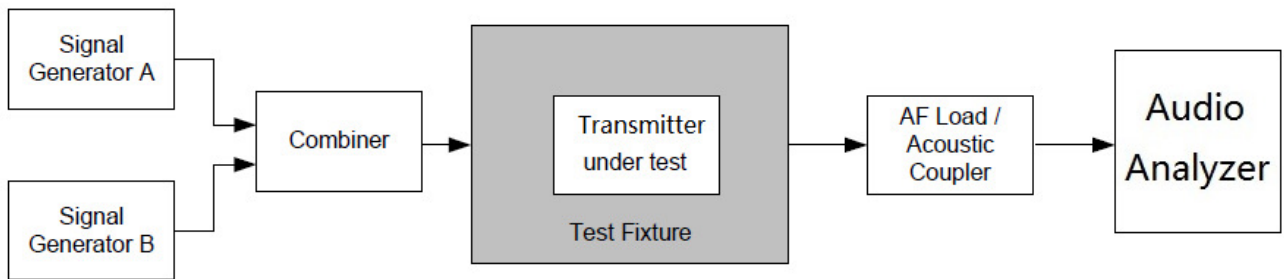

6.33.3 Measurement Data

The detailed test data see: Appendix 301 025.

6.34 Spurious response and blocking immunity

Test Requirement EN 301 025 clause 10.4.1
Test Method: EN 301 025 clause 10.4.2
Limit: The bit error ratio shall be equal to or less than 10^{-2} .

6.34.1 E.U.T. Operation

Operating Environment:
Temperature: 23.0 °C Humidity: 56 % RH Atmospheric Pressure: 1010 mbar
Test mode: f: RX mode, Keep the EUT in DSC receiving mode.

6.34.2 Test Setup Diagram

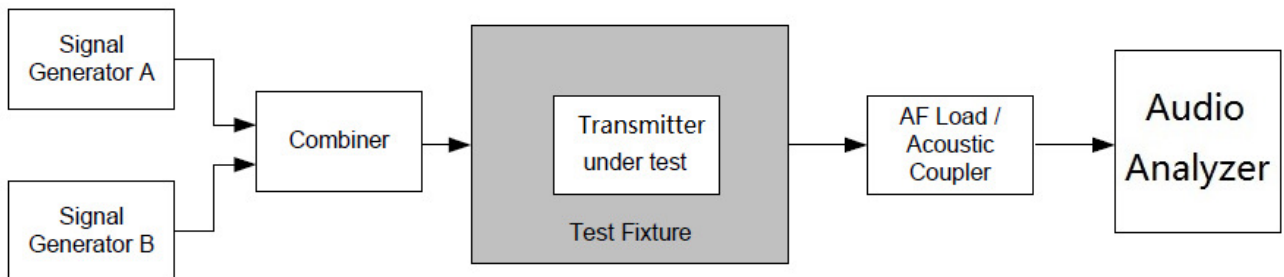

6.34.3 Measurement Data

The detailed test data see: Appendix 301 025.

6.35 Intermodulation response

Test Requirement EN 301 025 clause 10.5.1
 Test Method: EN 301 025 clause 10.5.2
 Limit: The bit error ratio shall be equal to or less than 10^{-2} .

6.35.1 E.U.T. Operation

Operating Environment:
 Temperature: 23.0 °C Humidity: 56 % RH Atmospheric Pressure: 1010 mbar
 Test mode: f: RX mode, Keep the EUT in DSC receiving mode.

6.35.2 Test Setup Diagram

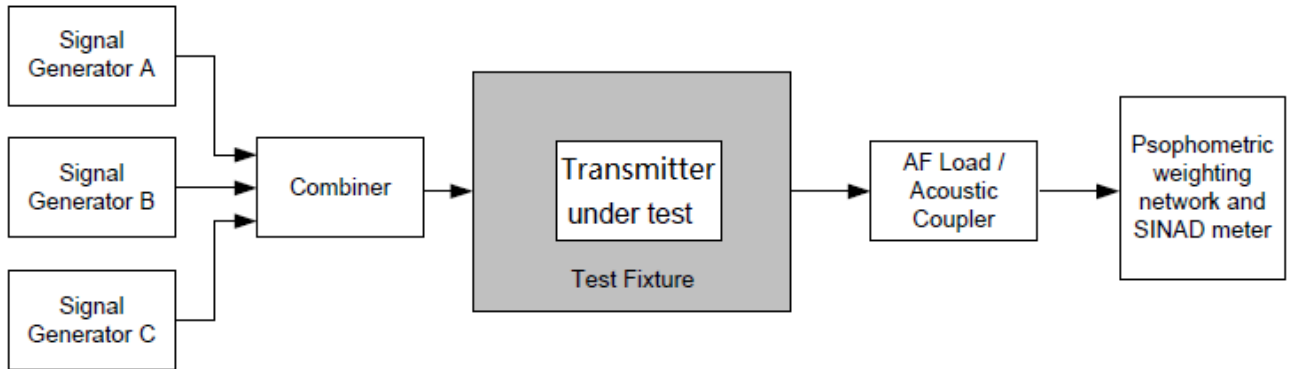

6.35.3 Measurement Data

The detailed test data see: Appendix 301 025.

6.36 Dynamic range

Test Requirement EN 301 025 clause 10.6.1
 Test Method: EN 301 025 clause 10.6.2
 Limit: The bit error ratio shall be equal to or less than 10^{-2} .

6.36.1 E.U.T. Operation

Operating Environment:
 Temperature: 23.0 °C Humidity: 56 % RH Atmospheric Pressure: 1010 mbar
 Test mode: f: RX mode, Keep the EUT in DSC receiving mode.

6.36.2 Test Setup Diagram

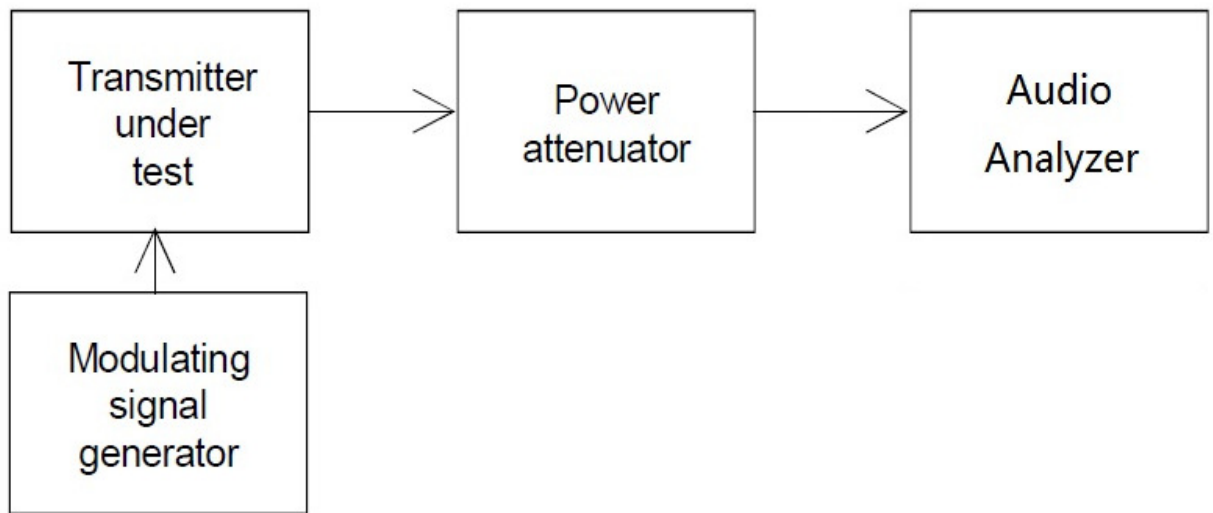

A test signal in accordance with the DSC standard test signal containing consecutive DSC calls, shall be applied to the receiver input. The level of the test signal shall alternate between 100 dBuV and 0 dBuV. The bit error ratio in the decoder output shall be determined.

6.36.3 Measurement Data

The detailed test data see: Appendix 301 025.

6.37 Spurious emissions

Test Requirement EN 301 025 clause 10.7.1
 Test Method: EN 301 025 clause 10.7.2
 Limit: The power of any spurious emission shall not exceed 2 nW at any frequency in the range between 9 kHz and 2 GHz.

6.37.1 E.U.T. Operation

Operating Environment:
 Temperature: 23.0 °C Humidity: 56 % RH Atmospheric Pressure: 1010 mbar
 Test mode: f: RX mode, Keep the EUT in DSC receiving mode.

6.37.2 Test Setup Diagram

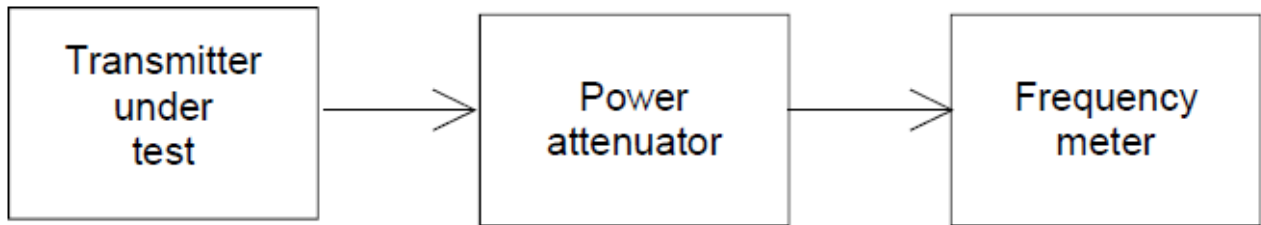

6.37.3 Measurement Data

The detailed test data see: Appendix 301 025.



6.38 Simultaneous reception

Test Requirement	EN 301 025 clause 10.8.1
Test Method:	EN 301 025 clause 10.8.2
Limit:	For radiotelephony operation the SINAD ratio shall be no less than 20 dB in the presence of the DSC test signal. The DSC bit error ratio shall be equal to or less than 10^{-2} .

6.38.1 E.U.T. Operation

Operating Environment:

Temperature: 23.0 °C Humidity: 56 % RH Atmospheric Pressure: 1010 mbar

Test mode: f: RX mode, Keep the EUT in DSC receiving mode.

6.38.2 Test Setup Diagram

The radiotelephone shall be set for operation on channel 16.

Two input signals shall be connected to the receiver input terminal via combining network.

The radiotelephone test signal shall be at a carrier frequency equal to the nominal frequency of the receiver, modulated by the normal test modulation shall be applied to the receiver input.

An audiofrequency load and a measuring instrument for measuring SINAD ratio (through a psophometric network) shall be connected to the receiver output terminals.

The radiotelephone test signal level shall be set for +20 dBuV.

The SINAD shall be measured with and without the presence of the DSC test signal.

The DSC standard test signal input level shall be 0 dBuV containing DSC calls.

The bit error ratio in the decoder output shall be determined.

6.38.3 Measurement Data

The detailed test data see: Appendix 301 025.

7 Photographs

7.1 Transmitter spurious emissions(30MHz-2GHz) Test Setup

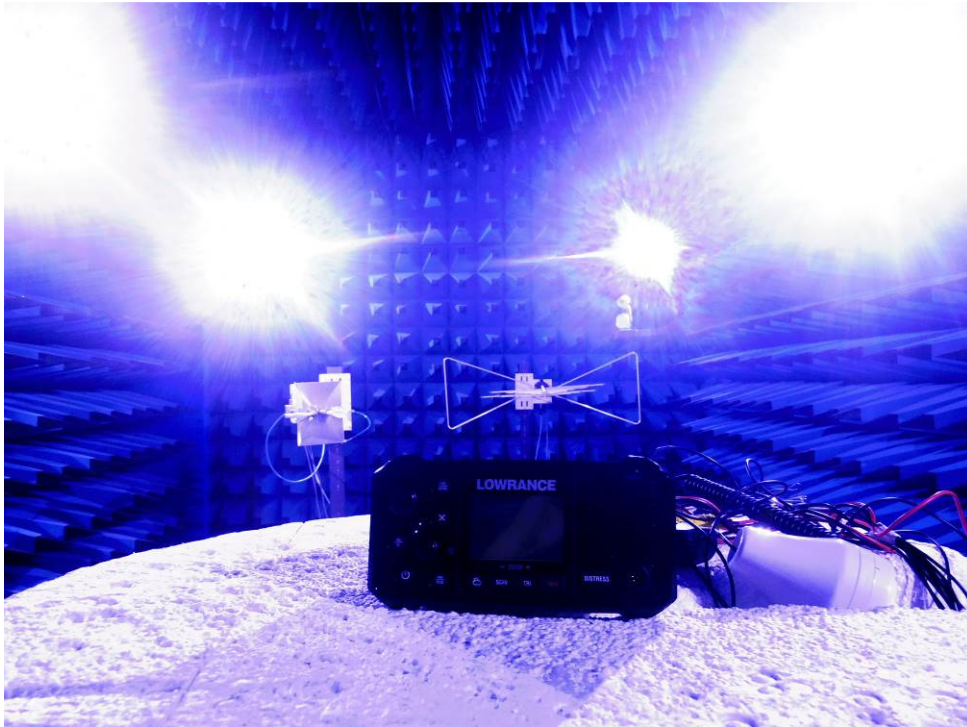

7.2 Receiver spurious emissions(30MHz-2GHz) Test Setup

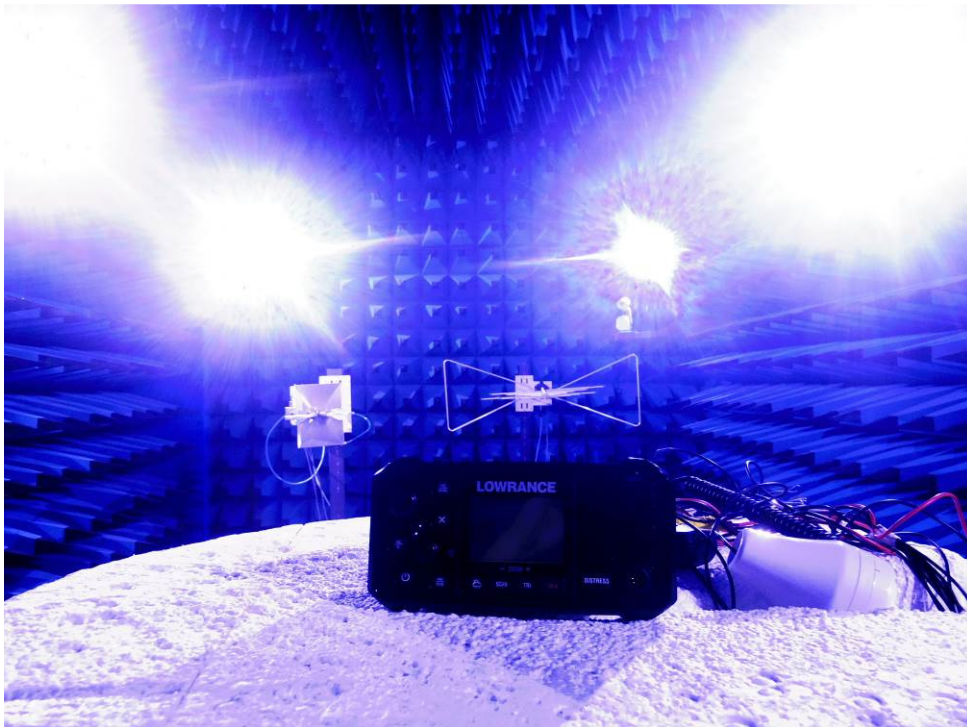

8 Appendix

8.1 Appendix EN301 025 Test data.

1. Transmitter/Frequency error

Test Frequency (MHz)	Temperature (°C)	Power Supplied (V Dc)	Measured Result for High Power (KHz)	Measured Result for Low Power (KHz)	Limit (KHz)	Verdict
Normal condition						
156.8	Tnor=25	Vnor=12	0.047	0.048	±1.5	Pass
Extreme condition						
156.8	Tmin=-20	Vmin=10.2	0.053	0.054	±1.5	Pass
	Tmin =-20	Vmax=13.8	0.049	0.050	±1.5	Pass
	Tmax=55	Vmin=10.2	-0.056	-0.057	±1.5	Pass
	Tmax =55	Vmax=13.8	-0.062	-0.063	±1.5	Pass

2. Transmitter/Carrier power

Test Channel	Temperature (°C)	Power Supplied (V Dc)	Channel Separation (KHz)	Measured Result (dBm)	Limit (dBm)	Verdict
Highest RF output power (conducted)						
Normal condition						
L	Tnor=25	Vnor=12	25	43.97	6 W to 25 W	Pass
M				43.90	6 W to 25 W	Pass
H				43.89	6 W to 25 W	Pass
Extreme condition						
L	Tmin=-20	Vmin=10.2	25	42.28	6 W to 25 W	Pass
	Tmin =-20	Vmax=13.8		43.37	6 W to 25 W	Pass
	Tmax=55	Vmin=10.2		42.15	6 W to 25 W	Pass
	Tmax =55	Vmax=13.8		42.62	6 W to 25 W	Pass
M	Tmin=-20	Vmin=10.2	25	42.31	6 W to 25 W	Pass
	Tmin =-20	Vmax=13.8		43.55	6 W to 25 W	Pass



H	Tmax=55	Vmin=10.2	25	41.78	6 W to 25 W	Pass
	Tmax =55	Vmax=13.8		42.81	6 W to 25 W	Pass
	Tmin=-20	Vmin=10.2		42.36	6 W to 25 W	Pass
	Tmin =-20	Vmax=13.8		43.55	6 W to 25 W	Pass
	Tmax=55	Vmin=10.2		41.42	6 W to 25 W	Pass
	Tmax =55	Vmax=13.8		42.80	6 W to 25 W	Pass
Lowest RF output power (conducted)						
Normal condition						
L	Tnor=25	Vnor=12	25	29.05	0.1W to 1W	Pass
M				29.01	0.1W to 1W	Pass
H				28.89	0.1W to 1W	Pass
Extreme condition						
L	Tmin=-20	Vmin=10.2	25	28.13	0.1W to 1W	Pass
	Tmin =-20	Vmax=13.8		28.62	0.1W to 1W	Pass
	Tmax=55	Vmin=10.2		27.99	0.1W to 1W	Pass
	Tmax =55	Vmax=13.8		28.53	0.1W to 1W	Pass
M	Tmin=-20	Vmin=10.2		27.92	0.1W to 1W	Pass
	Tmin =-20	Vmax=13.8		28.85	0.1W to 1W	Pass
	Tmax=55	Vmin=10.2		27.85	0.1W to 1W	Pass
	Tmax =55	Vmax=13.8		28.92	0.1W to 1W	Pass
H	Tmin=-20	Vmin=10.2		28.13	0.1W to 1W	Pass
	Tmin =-20	Vmax=13.8		29.12	0.1W to 1W	Pass
	Tmax=55	Vmin=10.2		27.92	0.1W to 1W	Pass
	Tmax =55	Vmax=13.8		28.62	0.1W to 1W	Pass

Note: The rated high power: 25W=43.98dBm, The rated low power: 1W=30dBm

3. Transmitter/Frequency deviation

Test Frequency (MHz)	Modulation Frequency (Hz)	Input level	Maximum Deviation(KHz)		Limit (KHz)	Verdict
			High Power	Low Power		
156.8	100	20dB 3KHz	1.243	1.253	±5.0	Pass
	200	20dB 3KHz	3.895	3.908	±5.0	Pass
	300	20dB 3KHz	4.296	4.295	±5.0	Pass
	400	20dB 3KHz	4.054	4.056	±5.0	Pass
	500	20dB 3KHz	4.408	4.426	±5.0	Pass
	1000	20dB 3KHz	4.256	4.237	±5.0	Pass
	1500	20dB 3KHz	3.805	3.804	±5.0	Pass
	2000	20dB 3KHz	4.17	4.016	±5.0	Pass
	2500	20dB 3KHz	4.457	4.498	±5.0	Pass
	3000	20dB 3KHz	4.423	4.437	±5.0	Pass

4. Transmitter/Reduction of frequency deviation at modulation freq. above 3KHz

Test Frequency (MHz)	Modulation Frequency (Hz)	Input level	Maximum Deviation(KHz)		Limit (KHz)	Verdict
			High Power	Low Power		
156.8	3000	/	/	/	5	/
	3000	3KHz	4.632	4.639	5	Pass
	3100	3KHz	4.466	4.473	5	Pass
	4000	3KHz	1.948	1.954	3.92	Pass
	5000	3KHz	0.574	0.578	3.92	Pass
	6000	3KHz	0.210	0.215	1.5	Pass
	8000	3KHz	0.142	0.146	0.77	Pass
	10000	3KHz	0.133	0.137	0.46	Pass
	12000	3KHz	0.126	0.128	0.30	Pass
	15000	3KHz	0.120	0.126	0.18	Pass
	20000	3KHz	0.006	0.002	0.09	Pass
	25000	3KHz	0.001	0.002	0.05	Pass

5. Transmitter/Sensitivity of the modulator, including microphone

Test Frequency (MHz)	Sound Level dB(A)	Frequency Deviation(KHz)		Limit(KHz)		Verdict
		High Power	Low Power	High	Low	
156.8	94	2.153	2.189	±3.0	±1.5	Pass

6. Transmitter/Audio Frequency Response

Test Frequency (MHz)	Modulation Frequency (Hz)	Upper Limit	Lower Limit	Modulation Index(dB) Relative. To 1KHz	Verdict
156.8	300	-9.5	-13.5	-13.18	Pass
	500	-5	-9	-7.58	Pass
	800	-0.9	-4.9	-2.31	Pass
	1000	1	-3	0.02	Pass
	1500	4.5	0.5	3.86	Pass
	1800	6.1	2.1	5.54	Pass
	2000	7	3	6.53	Pass
	2500	9	5	8.41	Pass
	3000	10.5	6.5	8.56	Pass

7. Transmitter/Audio frequency harmonic distortion of the emission

Test Frequency (MHz)	Temperature (°C)	Power Supplied (V Dc)	Modulation Frequency (Hz)	AF Distortion(%)		Limit (%)	Verdict
				High Power	Low Power		
Normal condition							
156.8	Tnor=25	Vnor=12	300	3.4	3.2	≤10	Pass
			500	3.2	3.1	≤10	Pass
			1000	2.7	2.8	≤10	Pass
Extreme condition							
156.8	Tmin=-20	Vmin=10.2	1000	1.8	1.9	≤10	Pass
	Tmin =-20	Vmax=13.8	1000	1.8	1.7	≤10	Pass
	Tmax=55	Vmin=10.2	1000	2.8	2.7	≤10	Pass
	Tmax =55	Vmax=13.8	1000	2.8	2.8	≤10	Pass

8. Transmitter/Adjacent channel power

Test Channel	Adjacent Channel	Adjacent channel Power(dBc)		Limit	Verdict
		High Power	Low High		
L	Fn + 25KHz	-74.1	-75.4	25 kHz channel: 70 dB below the carrier power of the transmitter without any need to be below the spurious emission limit of 0,25 μW.	Pass
M		-74.1	-75.2		Pass
H		-74.4	-75.1		Pass
L	Fn - 25KHz	-73.8	-75.2	12,5 kHz channel: 60 dB below the carrier power of the transmitter without any need to be below the spurious emission limit of 0,25 μW.	Pass
M		-74.1	-74.8		Pass
H		-73.6	-74.6		Pass



9. Transmitter/Conducted spurious emissions conveyed to the antenna

25KHz, Low Power, Assigned Frequency:156.025MHz, 9KHz-150KHz

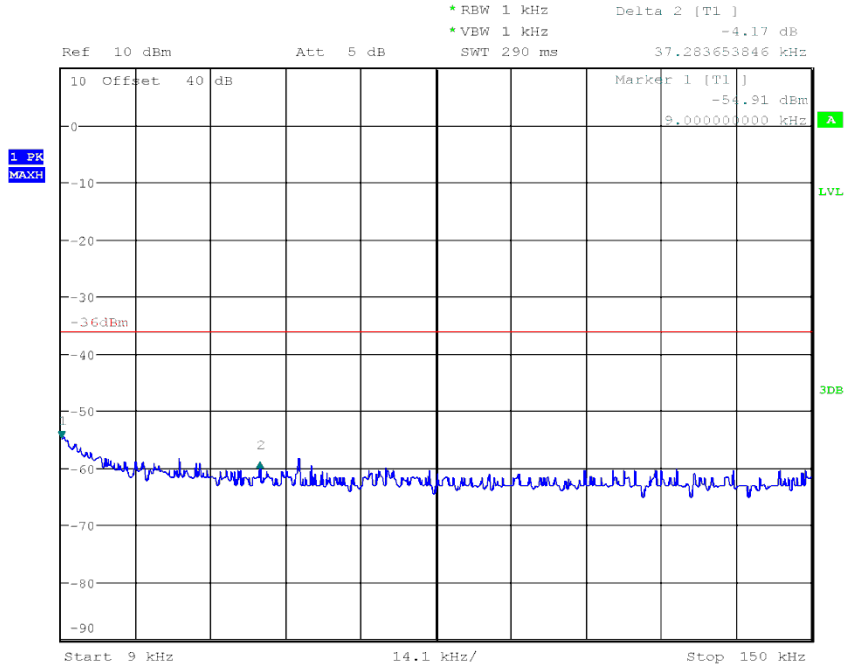

Date: 19.OCT.2018 17:13:30

25KHz, Low Power, Assigned Frequency:156.025MHz, 150KHz-30MHz

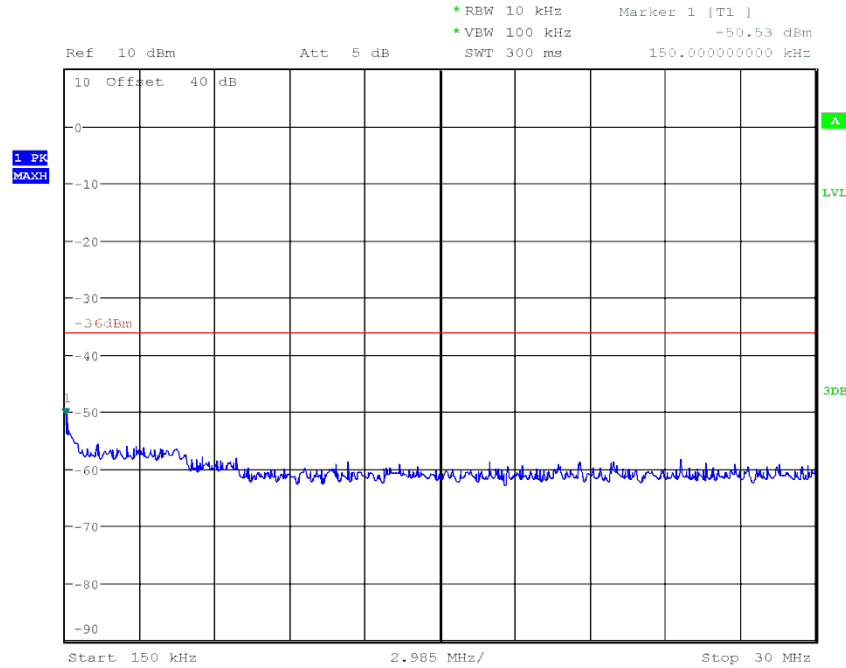

Date: 19.OCT.2018 17:30:36



25KHz, Low Power, Assigned Frequency:156.025MHz, 30MHz-1GHz

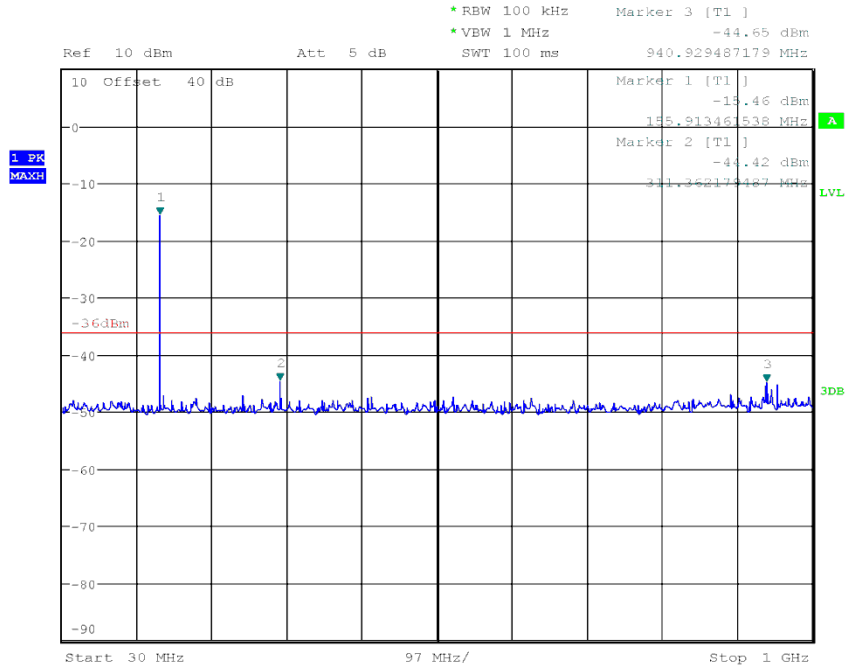

Date: 19.OCT.2018 17:16:54

25KHz, Low Power, Assigned Frequency:156.025MHz, 1GHz-2GHz

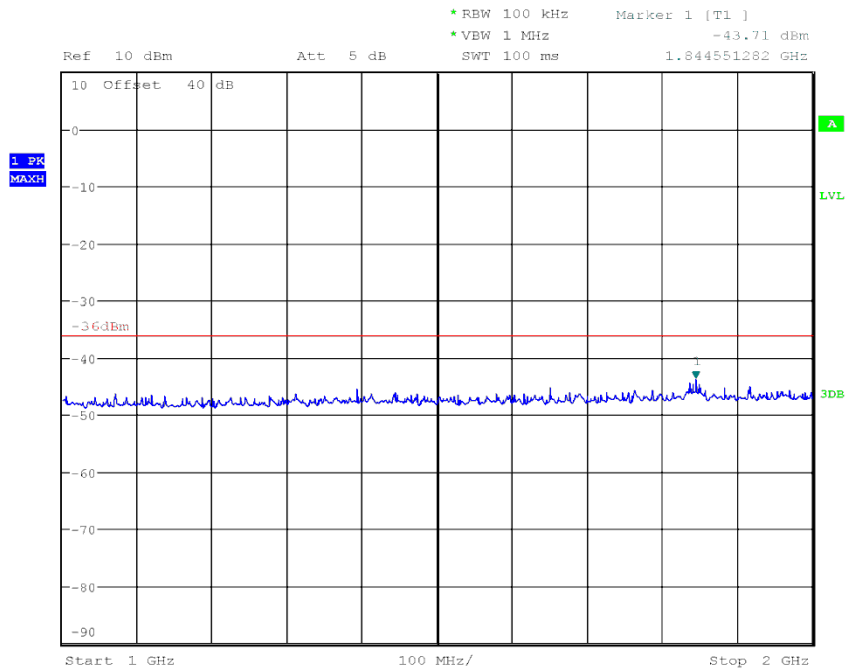

Date: 19.OCT.2018 17:19:34



25KHz, Low Power, Assigned Frequency:156.8MHz, 9KHz-150KHz

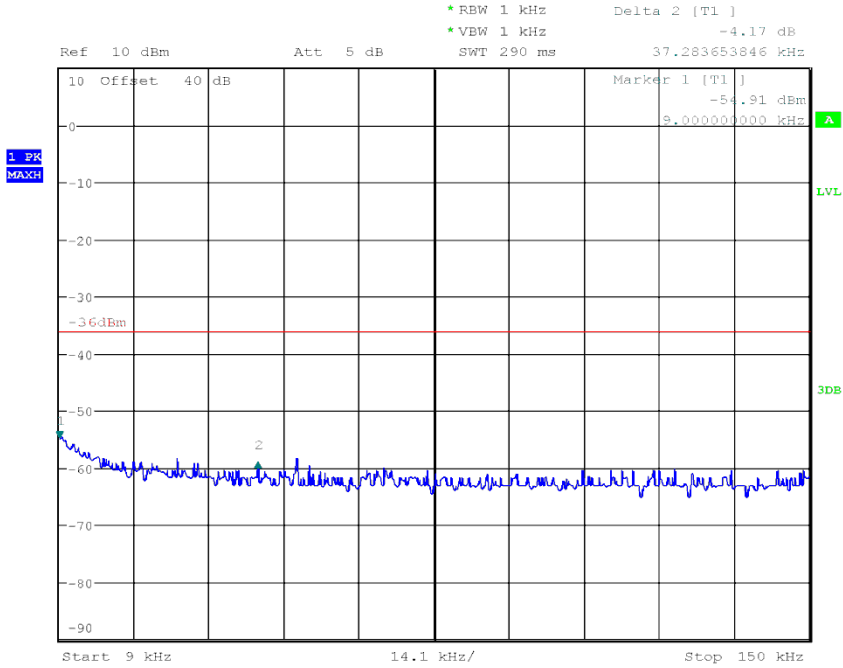

Date: 19.OCT.2018 17:13:30

25KHz, Low Power, Assigned Frequency:156.8MHz, 150KHz-30MHz

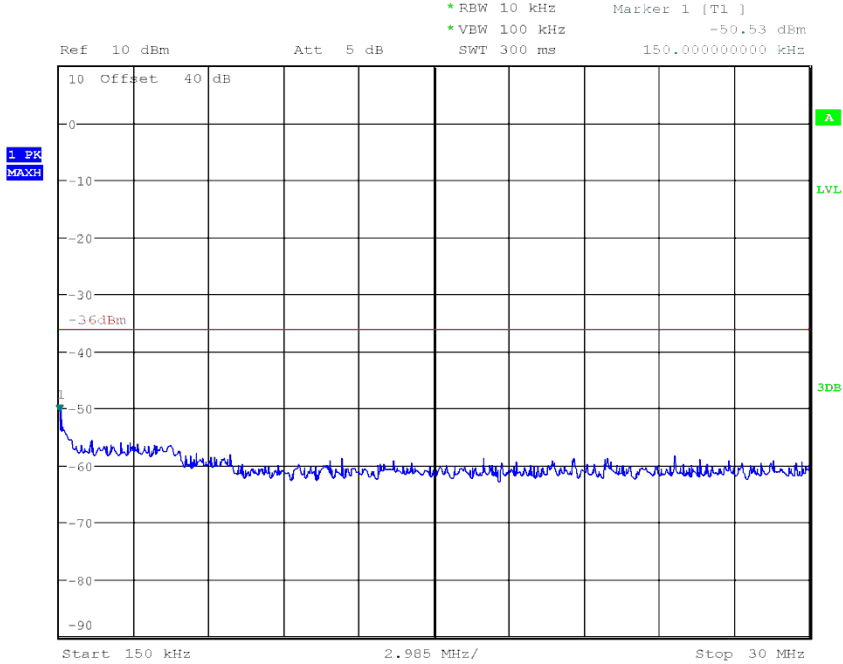

Date: 19.OCT.2018 17:30:36



25KHz, Low Power, Assigned Frequency:156.8MHz, 30MHz-1GHz

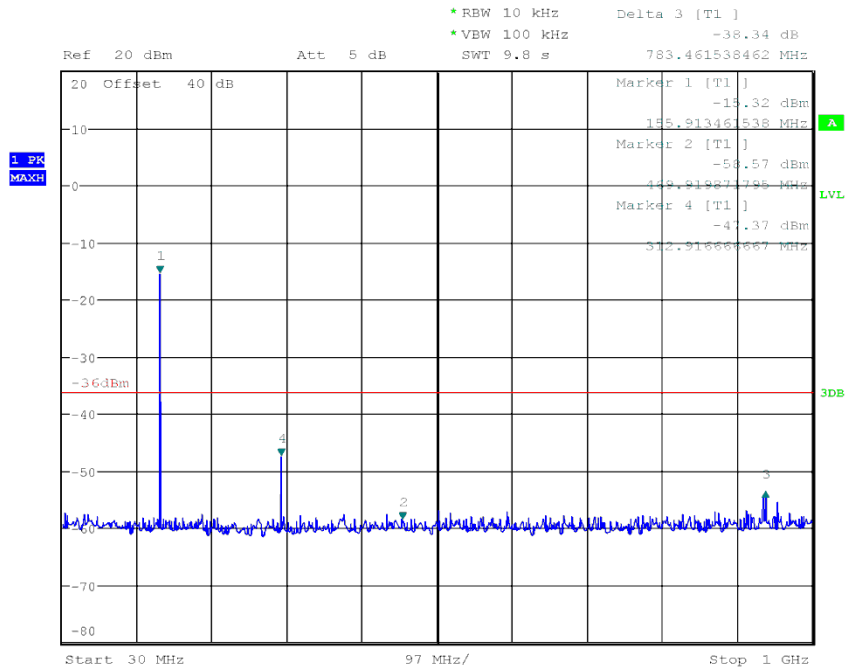

Date: 19.OCT.2018 18:02:16

25KHz, Low Power, Assigned Frequency:156.8MHz, 1GHz-2GHz

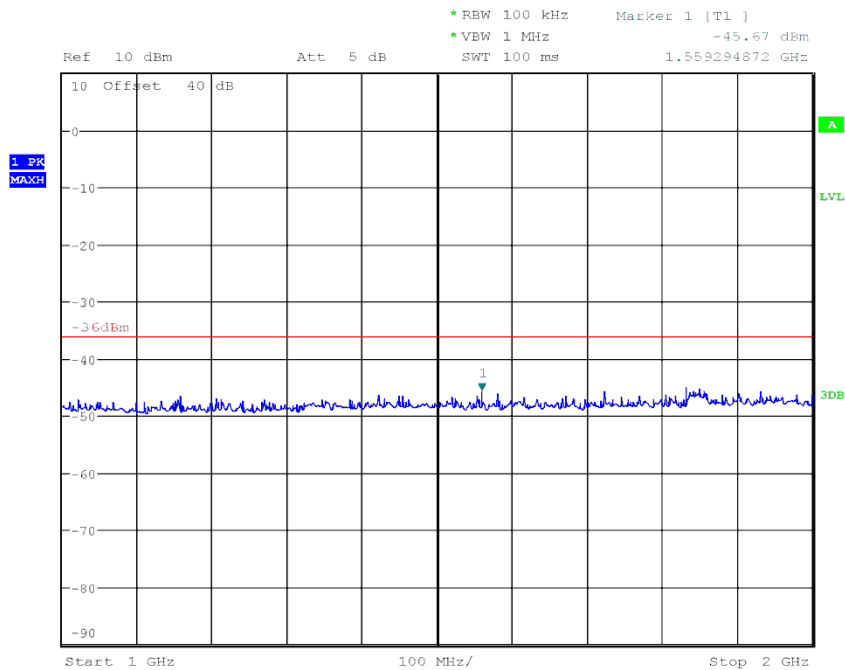

Date: 19.OCT.2018 17:20:14



25KHz, Low Power, Assigned Frequency:157.425MHz, 9KHz-150KHz

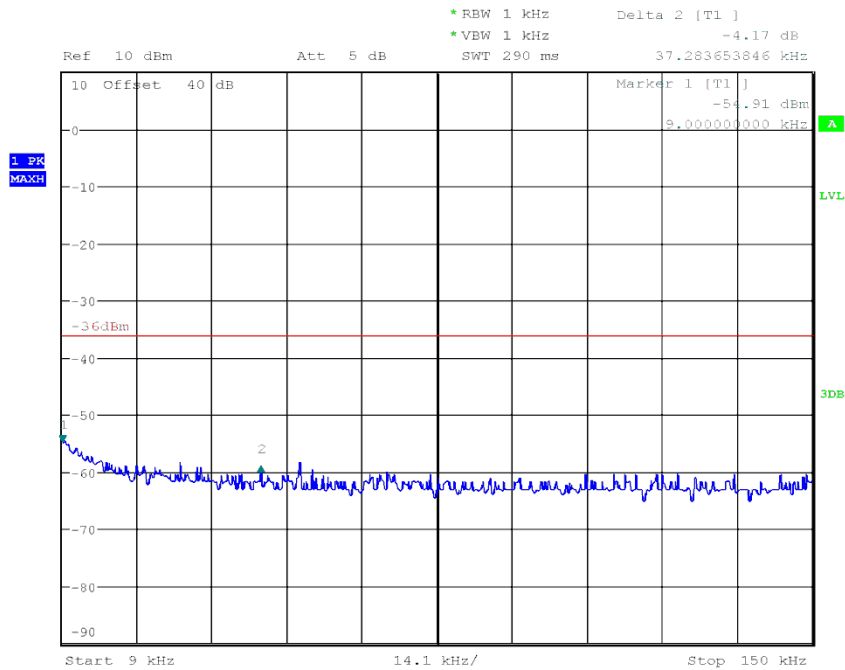

Date: 19.OCT.2018 17:13:30

25KHz, Low Power, Assigned Frequency:157.425MHz, 150KHz-30MHz

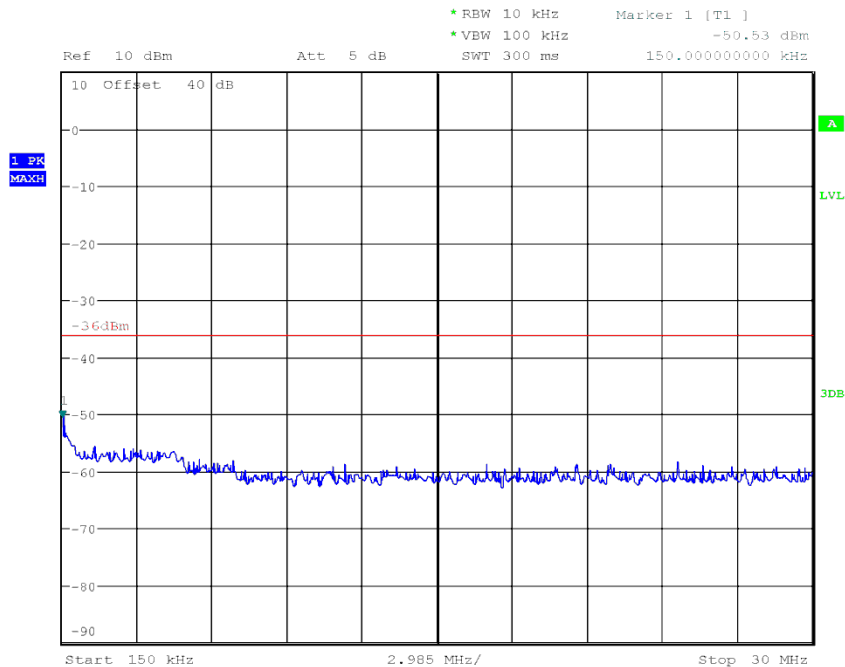

Date: 19.OCT.2018 17:30:36



25KHz, Low Power, Assigned Frequency:157.425MHz, 30MHz-1GHz

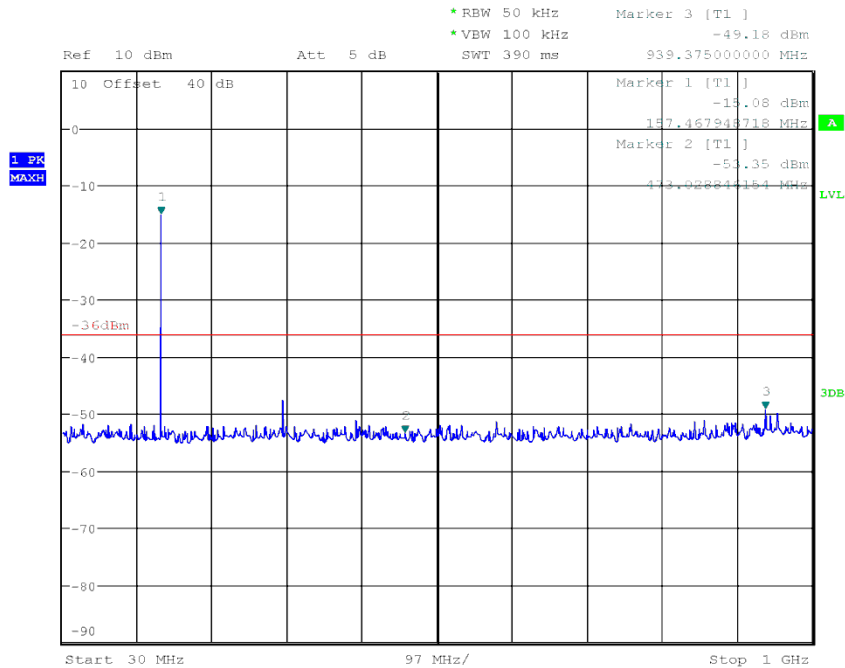

Date: 19.OCT.2018 17:34:49

25KHz, Low Power, Assigned Frequency:157.425MHz, 1GHz-2GHz

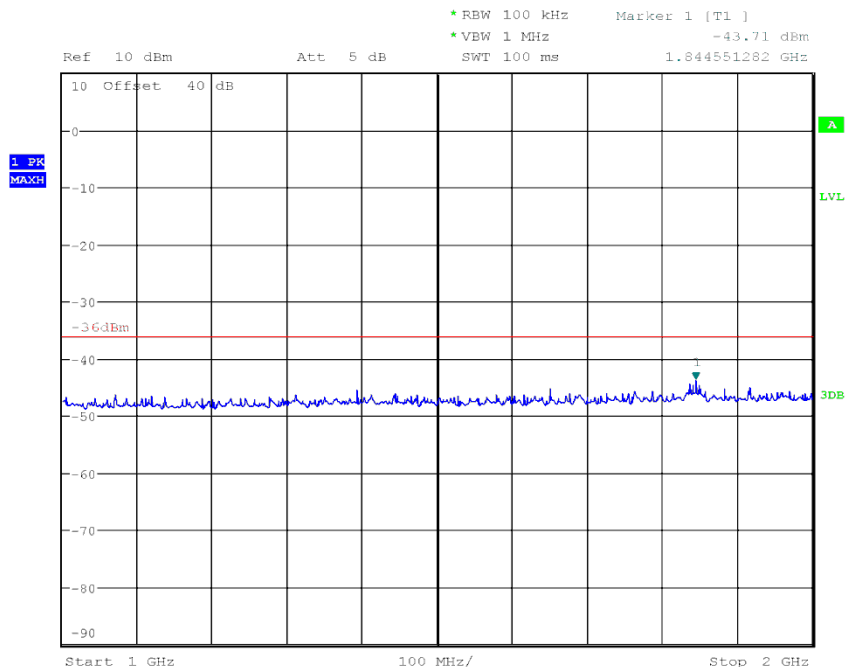

Date: 19.OCT.2018 17:19:34



25KHz, High Power, Assigned Frequency:156.025MHz, 9KHz-150KHz

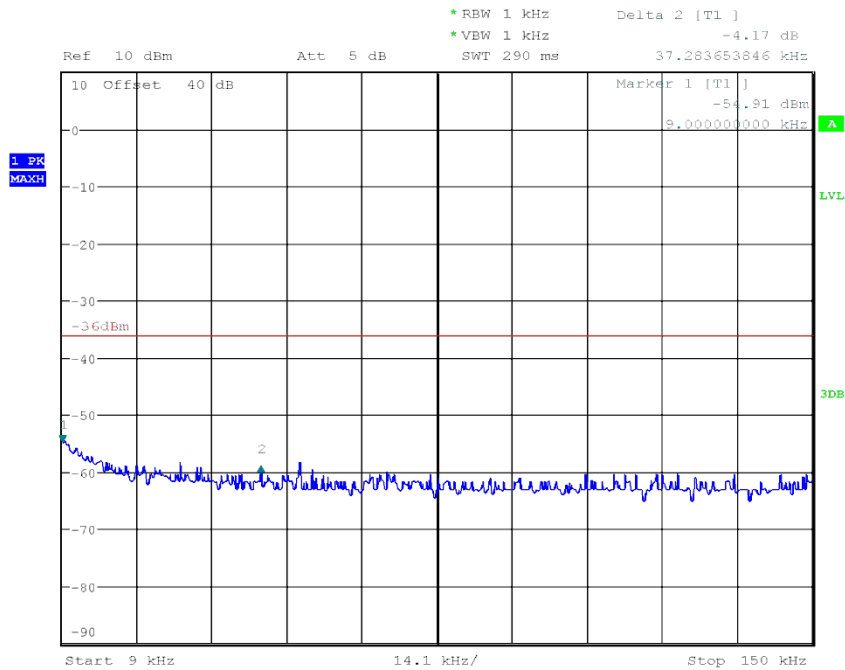

Date: 19.OCT.2018 17:13:30

25KHz, High Power, Assigned Frequency:156.025MHz, 150KHz-30MHz

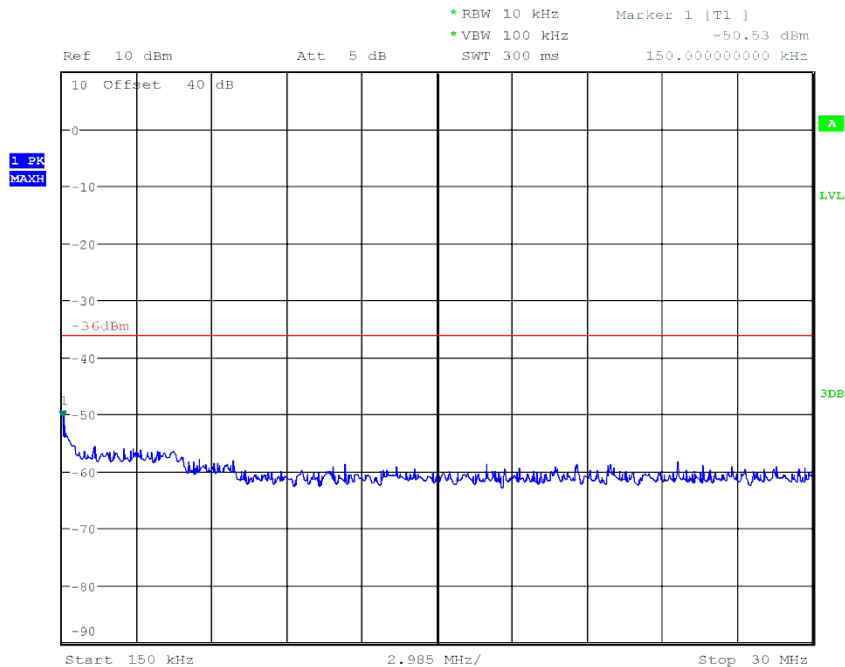

Date: 19.OCT.2018 17:30:36



25KHz, High Power, Assigned Frequency:156.025MHz, 30MHz-1GHz

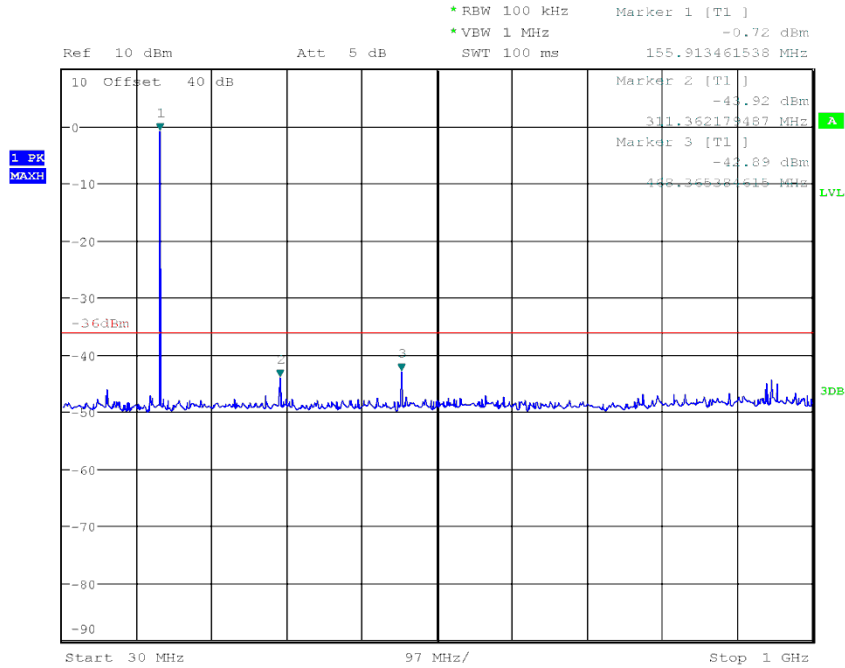

Date: 19.OCT.2018 17:16:25

25KHz, High Power, Assigned Frequency:156.025MHz, 1GHz-2GHz

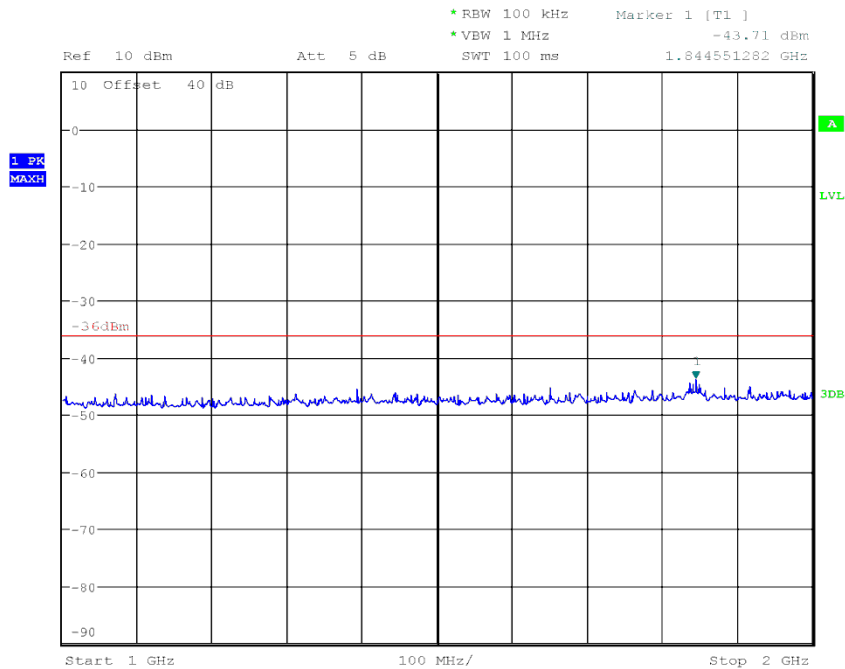

Date: 19.OCT.2018 17:19:34



25KHz, High Power, Assigned Frequency:156.8MHz, 9KHz-150KHz

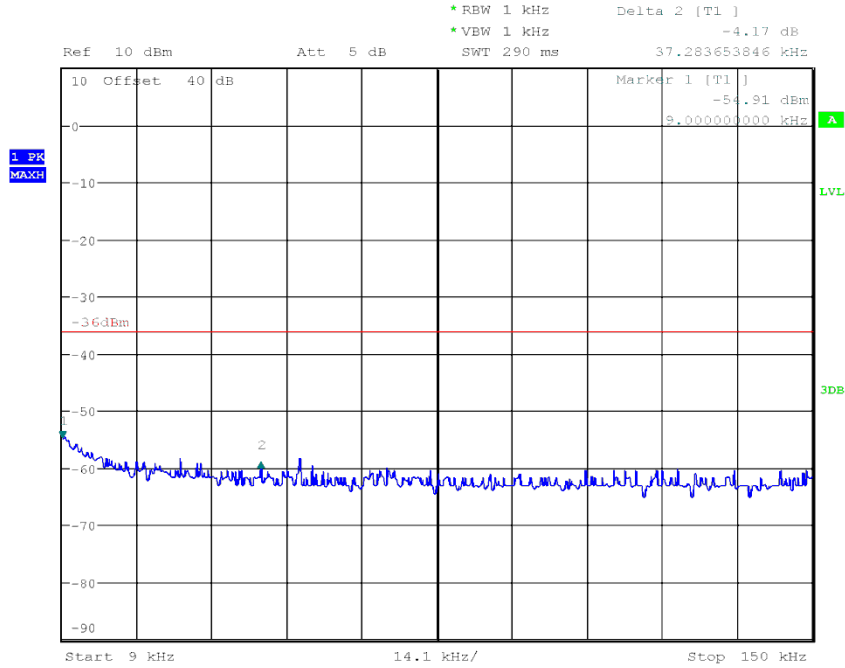

Date: 19.OCT.2018 17:13:30

25KHz, High Power, Assigned Frequency:156.8MHz, 150KHz-30MHz

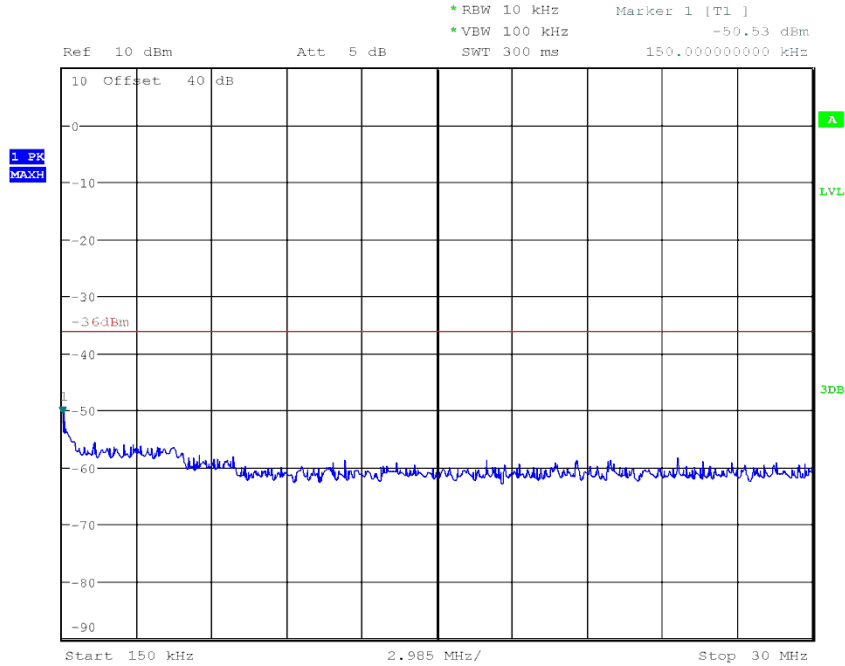

Date: 19.OCT.2018 17:30:36



25KHz, High Power, Assigned Frequency:156.8MHz, 30MHz-1GHz

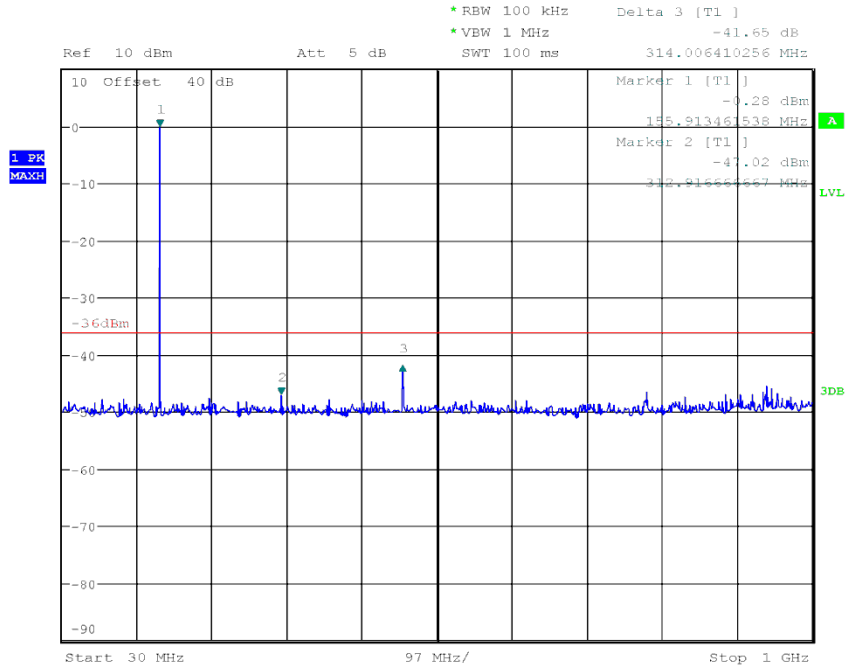

Date: 19.OCT.2018 17:29:00

25KHz, High Power, Assigned Frequency:156.8MHz, 1GHz-2GHz

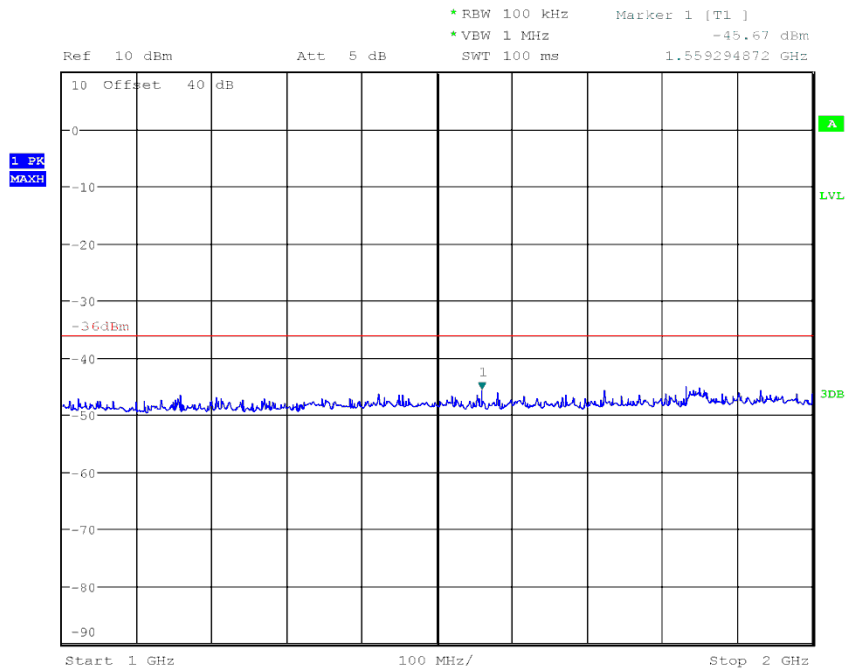

Date: 19.OCT.2018 17:20:14



25KHz, High Power, Assigned Frequency:157.425MHz, 9KHz-150KHz

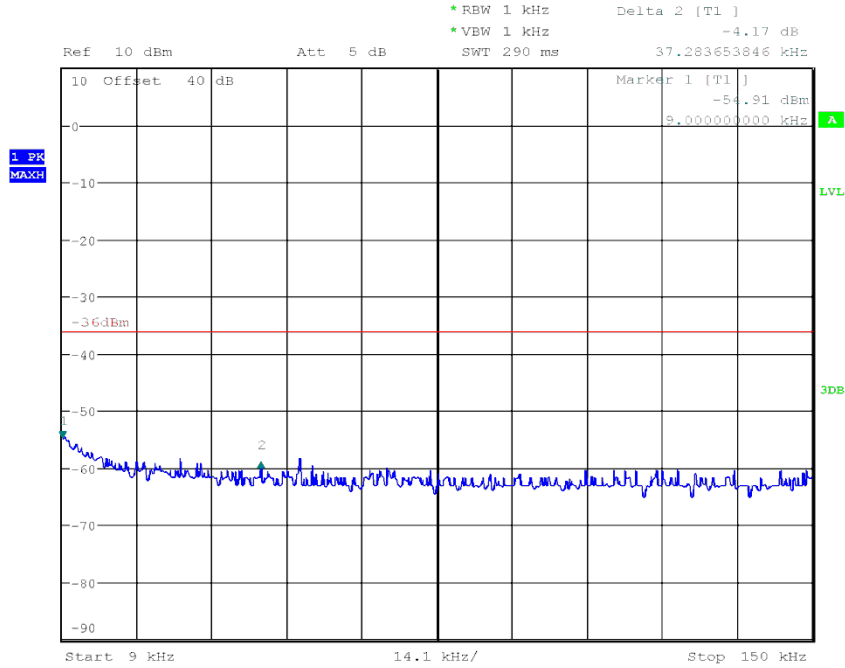

Date: 19.OCT.2018 17:13:30

25KHz, High Power, Assigned Frequency:157.425MHz, 150KHz-30MHz

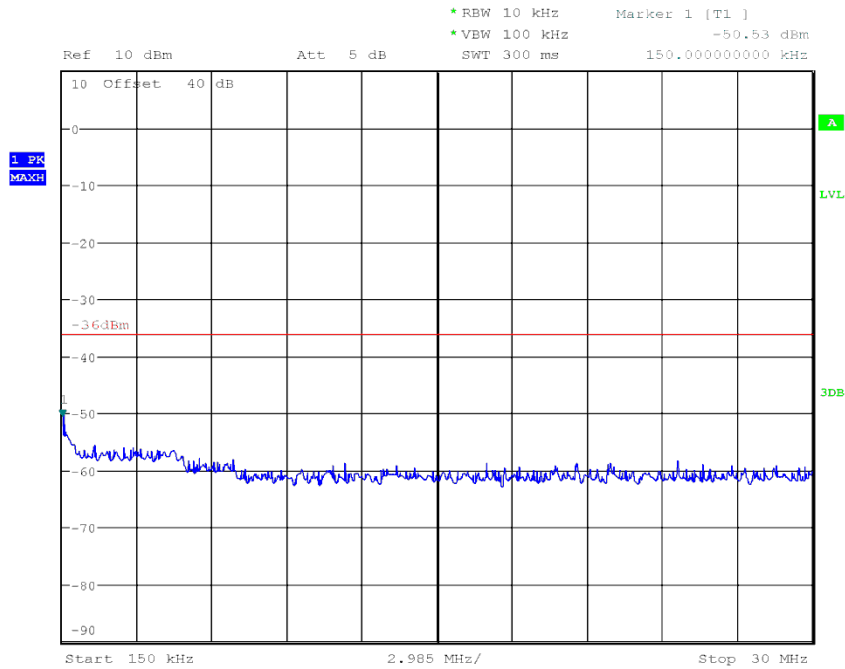

Date: 19.OCT.2018 17:30:36



25KHz, High Power, Assigned Frequency:157.425MHz, 30MHz-1GHz

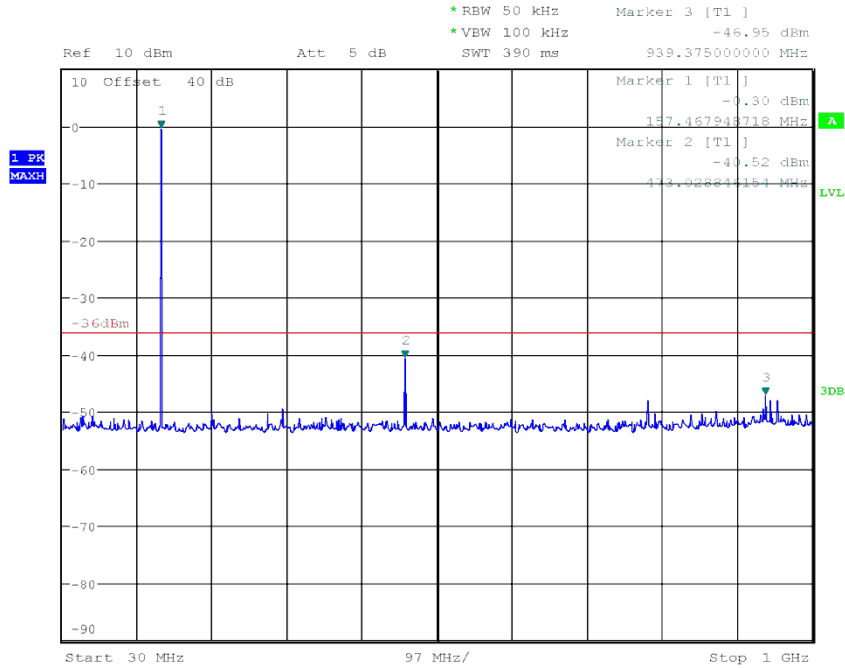

Date: 19.OCT.2018 17:34:36

25KHz, High Power, Assigned Frequency:157.425MHz, 1GHz-2GHz

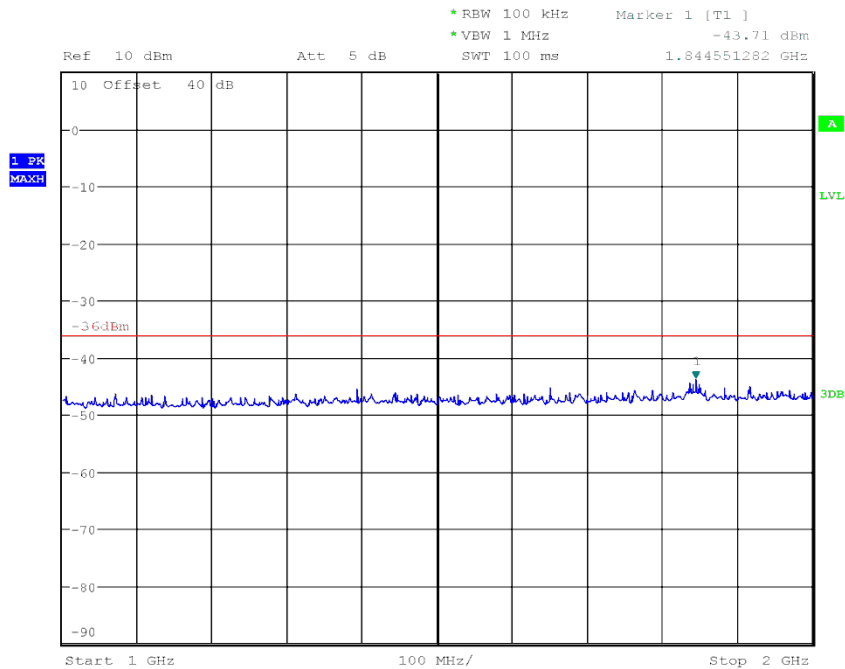

Date: 19.OCT.2018 17:19:34



10. Cabinet radiation and conducted spurious emissions other than those conveyed to the antenna

Assigned Frequency:156.8MHz, High Power, Stand-by mode				
Frequency MHz	Polarity H/V	Emission Level dBm	Limit dBm	Over Limit dBm
50.392	H	-71.46	-57	-14.46
106.256	H	-74.55	-57	-17.55
209.57	H	-70.78	-57	-13.78
432.752	H	-69.74	-57	-12.74
588.564	H	-65.29	-57	-8.29
1746.586	H	-62.81	-57	-5.81
171.319	V	-72.65	-57	-15.65
209.57	V	-70.98	-57	-13.98
353.428	V	-71.31	-57	-14.31
487.329	V	-68.39	-57	-11.39
686.465	V	-65.19	-57	-8.19
1832.12	V	-63.48	-57	-6.48

Assigned Frequency:156.8MHz, High Power, Operation mode				
Frequency MHz	Polarity H/V	Emission Level dBm	Limit dBm	Over Limit dBm
48.715	H	-71.18	-36	-35.18
68.687	H	-67.66	-36	-31.66
314.996	H	-51.78	-36	-15.78
472.243	H	-46.76	-36	-10.76
784.065	H	-47.1	-36	-11.1
1943.851	H	-40.85	-36	-4.85
48.715	V	-71.29	-36	-35.29
71.565	V	-78.15	-36	-42.15
314.996	V	-53.21	-36	-17.21
472.243	V	-50.71	-36	-14.71
784.065	V	-48.46	-36	-12.46
1943.851	V	-42.83	-36	-6.83

11. Transmitter/Transient frequency behaviour of the transmitter

Assigned Frequency:156.8MHz, Turn On

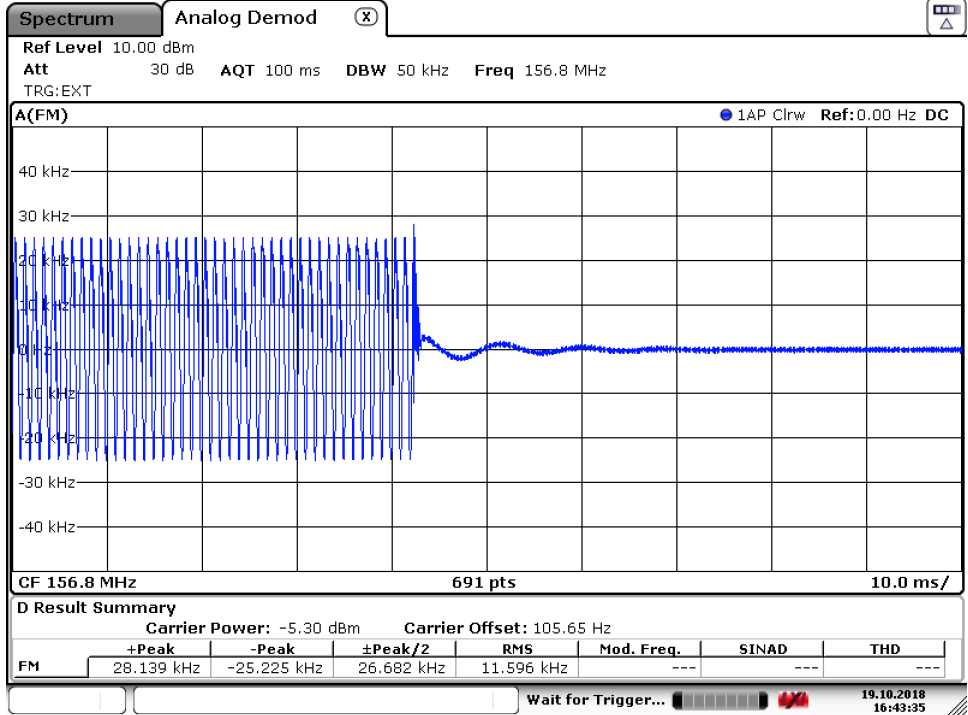

Date: 19.OCT.2018 16:43:35

Assigned Frequency:156.8MHz, Turn Off

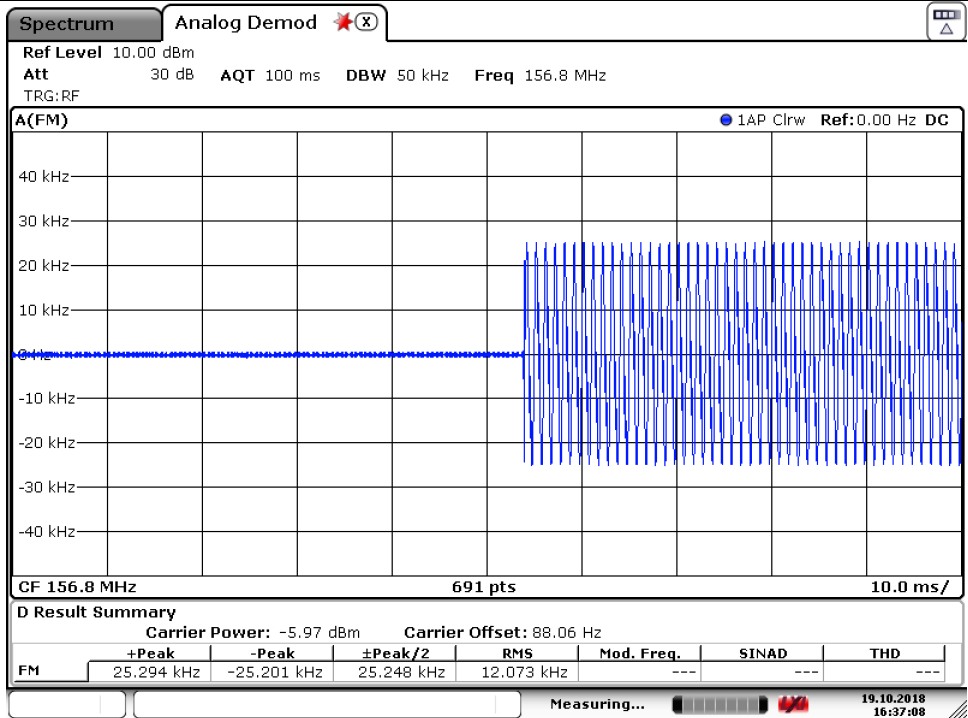

Date: 19.OCT.2018 16:37:09

12. Transmitter/Residual modulation of the transmitter

Test Frequency (MHz)	Residual modulation (dB)	Residual modulation limit (dB)	Verdict
156.8	-41.67	≤-40	Pass

13. Transmitter/Frequency error (demodulated DSC signal)

Test State	Temperature (°C)	Power Supplied (V Dc)	Measured Frequency (Hz)	Tolerance	Measured Result (Hz)	Verdict
Normal condition, Assigned Frequency:156.525MHz(Channel 70)						
B-state	Tnor=25	Vnor=12	2100	±10	2098	Pass
Y-state	Tnor=25	Vnor=12	1300	±10	1301	Pass
Extreme condition, Assigned Frequency:156.525MHz(Channel 70)						
B-state	Tmin=-20	Vmin=10.2	2100	±10	2098	Pass
	Tmin =-20	Vmax=13.8	2100	±10	2098	Pass
	Tmax=55	Vmin=10.2	2100	±10	2098	Pass
	Tmax =55	Vmax=13.8	2100	±10	2098	Pass
Y-state	Tmin=-20	Vmin=10.2	1300	±10	1301	Pass
	Tmin =-20	Vmax=13.8	1300	±10	1301	Pass
	Tmax=55	Vmin=10.2	1300	±10	1301	Pass
	Tmax =55	Vmax=13.8	1300	±10	1301	Pass

14. Transmitter/Modulation index for DSC

Test State	Temp. (°C)	Power Supplied (V Dc)	Measured Frequency (Hz)	Measured Result (Hz)	Modulation index	Limit	Verdict
Normal condition, Assigned Frequency:156.525MHz(Channel 70)							
B-state	Tnor=25	Vnor=12	2100	4160	1.981	2±10%	Pass
Y-state	Tnor=25	Vnor=12	1300	2562	1.971	2±10%	Pass

15. Transmitter/Modulation rate for DSC

Test Frequency (MHz)	Temperature (°C)	Power Supplied (V Dc)	Modulation Rate (bit/s)	Frequency Error (ppm)	Limit (ppm)	Verdict
156.525	Tnor=25	Vnor=12	1200	19.6	≤30	Pass



16. Transmitter/Occupied Bandwidth(Testing of free channel transmission on DSC channel 70)

DSC mode, Assigned Frequency:156.525MHz

High-dsc-1300Hz

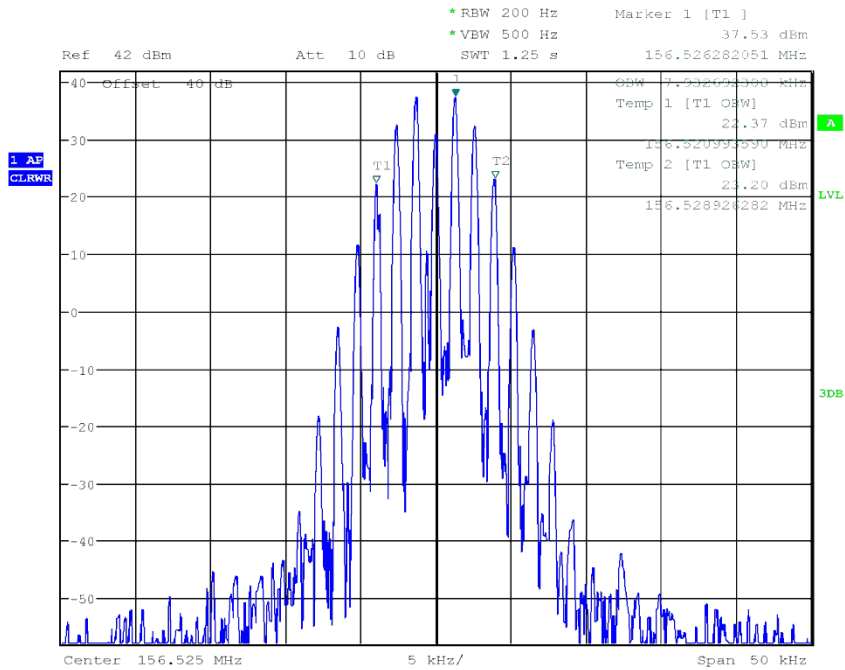

Low-dsc-1300Hz

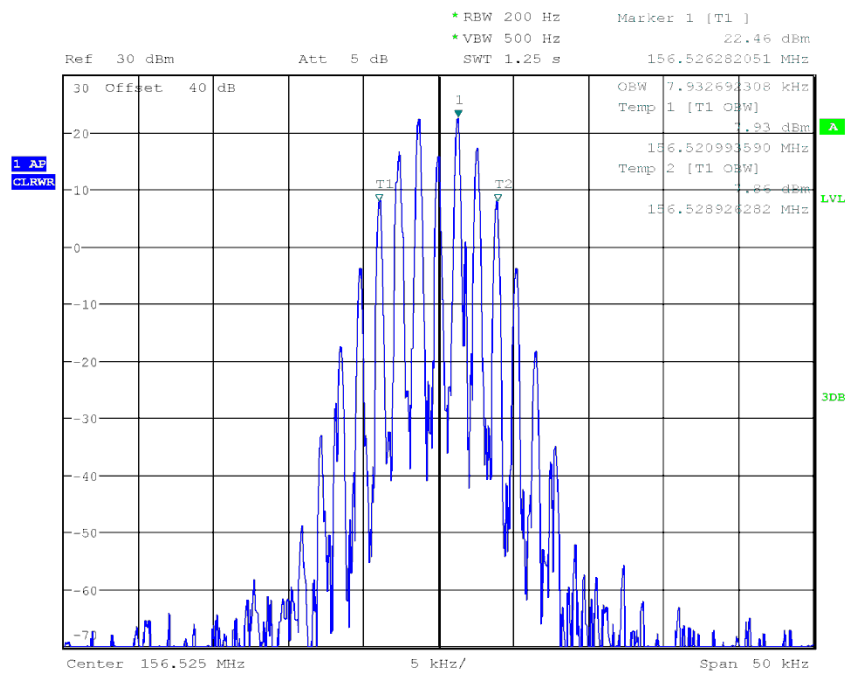



DSC mode, Assigned Frequency:156.525MHz

High-dsc-2100Hz

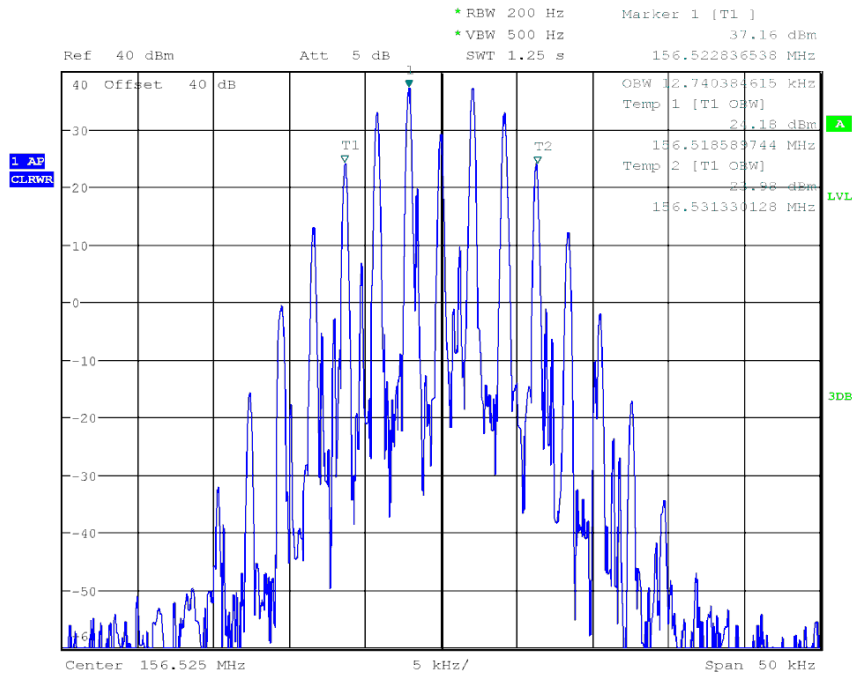

Low-dsc-2100Hz

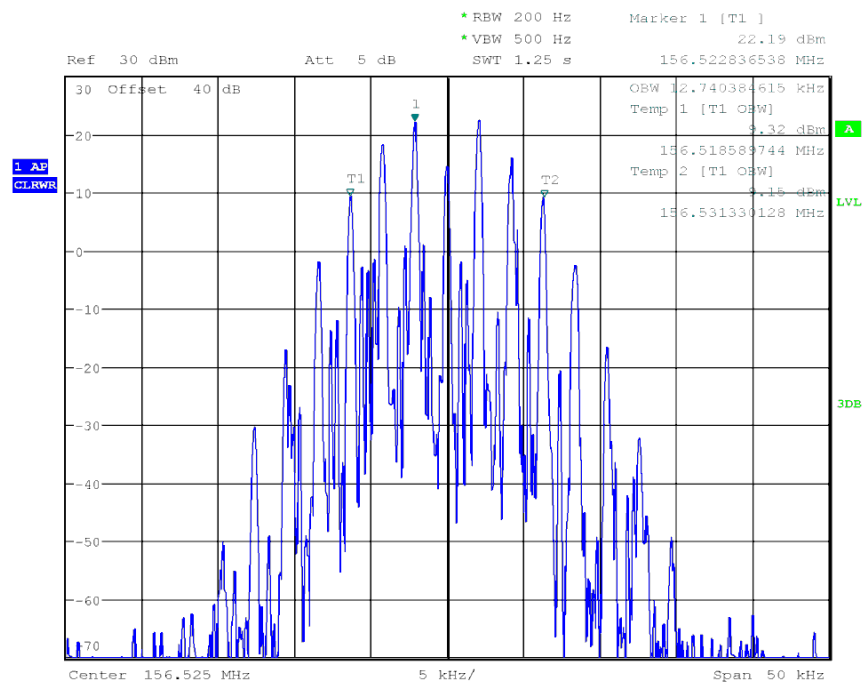

17. Receiver/Harmonic distortion and rated audio-frequency output power

Signal Level (dbuV)	Modulation Frequency (Hz)	AF Loudspeaker		Limit		Verdict
		Pout(W)	Dist.(%)	Output Power(W)	AF Distortion (%)	
Normal condition, Assigned Frequency:156.8MHz						
60	300	3.3	6.6	>2	≤10	Pass
	500	2.9	5.5	>2	≤10	Pass
	1000	2.4	1.5	>2	≤10	Pass

18.Receiver/Audio Frequency Response for receiver

Modulation Frequency (Hz)	Upper Limit (dB)	Lower Limit (dB)	Relative Audio Power			Max Level	Min Level	Verdict
			Fn(dB)	Fn (-1.5KHz)	Fn (+1.5KHz)			
Normal condition, Assigned Frequency:156.8MHz								
300	11.5	7.5	9.23	7.76	7.84	9.23	7.76	Pass
500	7	3	6.25	6.05	6.23	6.25	6.05	Pass
800	2.9	-1.1	2.34	2.38	2.39	2.39	2.34	Pass
1000	1	-3	0.01	0.00	0.00	0.01	0.00	Pass
1500	-1.5	-5.5	-4.03	-3.95	-3.84	-3.84	-4.03	Pass
2000	-5	-9	-7.55	-6.98	-7.03	-6.98	-7.55	Pass
3000	-8.5	-12.5	-12.08	-11.12	-11.23	-11.12	-12.08	Pass

19. Receiver/Maximum useable sensitivity

Test Freq. (MHz)	Temp. (°C)	Power Supplied (V Dc)	Receiver Sensitivity (dBuV)	Sensitivity Limit (dBuV)	Verdict
Normal condition					
156.8	Tnor=25	Vnor=12	-6.8	≤6	Pass
Extreme condition					
156.8	Tmin=-20	Vmin=10.2	-6.8	≤12	Pass
	Tmin =-20	Vmax=13.8	-6.8	≤12	Pass
	Tmax=55	Vmin=10.2	-3.1	≤12	Pass
	Tmax =55	Vmax=13.8	-3.2	≤12	Pass

20. Receiver/Co-channel rejection

Test Freq. (MHz)	Unwanted signal Frequency (MHz)	Rated AF output power (W)@4 ohms	Rejection Ratio (dB)	Upper Limit (dB)	Lower Limit (dB)	Verdict
Normal condition						
156.8	Fn + 3KHz	2	-8.6	0	-10	Pass
	Fn	2	-9.1	0	-10	Pass
	Fn - 3KHz	2	-9.2	0	-10	Pass

21. Receiver/Adjacent channel selectivity

Test Freq. (MHz)	Temperature (°C)	Power Supplied (V Dc)	Ratio of Unwanted to Wanted signal(dB)		Limit (dB)	Verdict
			Fn + 25KHz	Fn - 25KHz		
Normal condition						
156.8	Tnor=25	Vnor=12	73.4	73.6	≥70	Pass
Extreme condition						
156.8	Tmin=-20	Vmin=10.2	72.5	72.7	≥60	Pass
	Tmin =-20	Vmax=13.8	73.2	73.2	≥60	Pass
	Tmax=55	Vmin=10.2	72.8	72.8	≥60	Pass
	Tmax =55	Vmax=13.8	73.5	73.1	≥60	Pass

22. Receiver/Spurious response rejection

Test Freq. (MHz)	Defintion	Frequency of spurious Responses (MHz)	Rated AF output power (W) @ 4 ohms	Rejection ratio (dB)	Rejection ratio Limit (dB)	Verdict
Normal condition(Tnor=25, Vnor=12)						
156.8	1 st IF	21.4	2	78.6	≥70	Pass
	Image	114.0	2	78.6	≥70	Pass
	'Half IF'	146.1	2	78.6	≥70	Pass
	2 nd image	157.7	2	78.6	≥70	Pass
	2 nd LO	249.4	2	78.6	≥70	Pass
	3 rd LO	384.8	2	78.6	≥70	Pass

23. Receiver/Intermodulation response

Test Freq. (MHz)	Temperature (°C)	Power Supplied (V Dc)	Test Condition	Rejection ratio (dB)	Rejection ratio Limit (dB)	Verdict
Normal condition						
156.8	Tnor=25	Vnor=13.6	Upper Side	70.6	≥68	Pass
			Lower Side	70.1	≥68	Pass

24. Receiver/Blocking or desensitisation

Frequencies of the signal		Blocking Level (dBuV)	Block Limit (dBuV)	Verdict	
Wanted signal A (MHz)	Unwanted signal B (MHz)				
Normal condition(Tnor=25, Vnor=12)					
156.8	-10	146.8	94.3	≥90	Pass
	-5	151.8	94.8	≥90	Pass
	-2	154.8	94.5	≥90	Pass
	-1	155.8	93.0	≥90	Pass
	+1	157.8	93.4	≥90	Pass
	+2	158.8	94.6	≥90	Pass
	+5	161.8	94.9	≥90	Pass
	+10	166.8	94.5	≥90	Pass



25. Receiver/Spurious emissions

Assigned Frequency:156.8MHz, 9KHz-150KHz

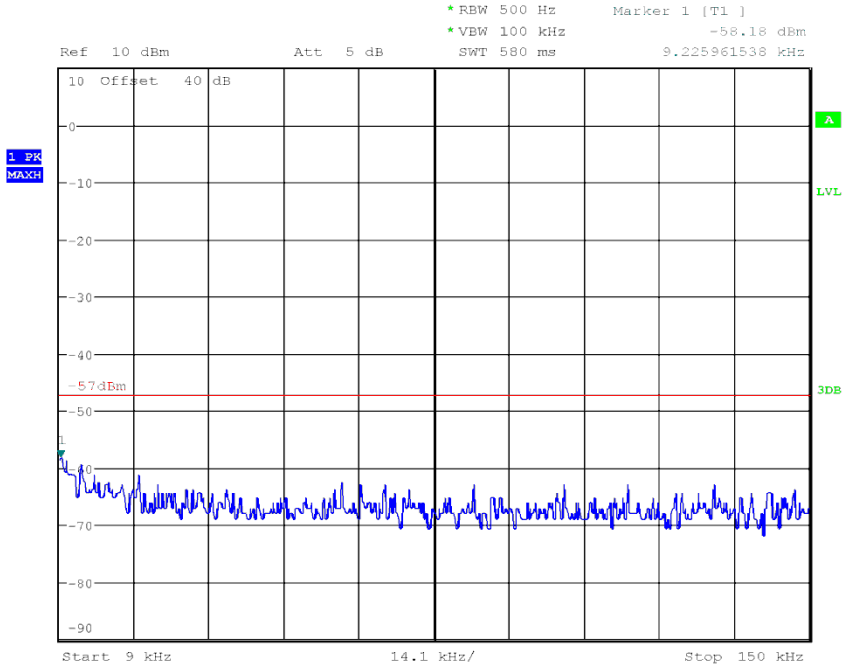

Date: 19.OCT.2018 17:44:36

Assigned Frequency:156.8MHz, 150KHz-30MHz

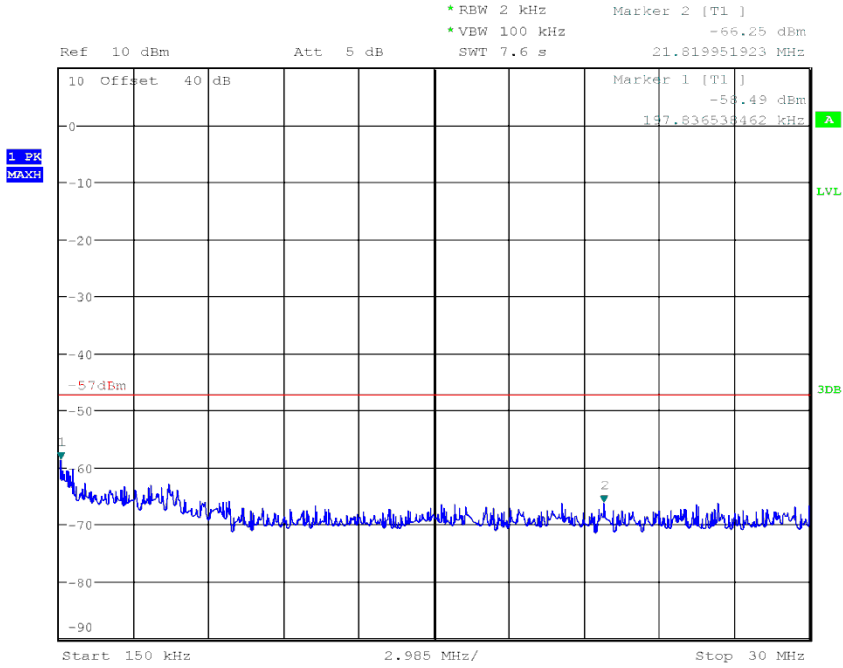

Date: 19.OCT.2018 17:45:28



Assigned Frequency:156.8MHz, 30MHz-1GHz

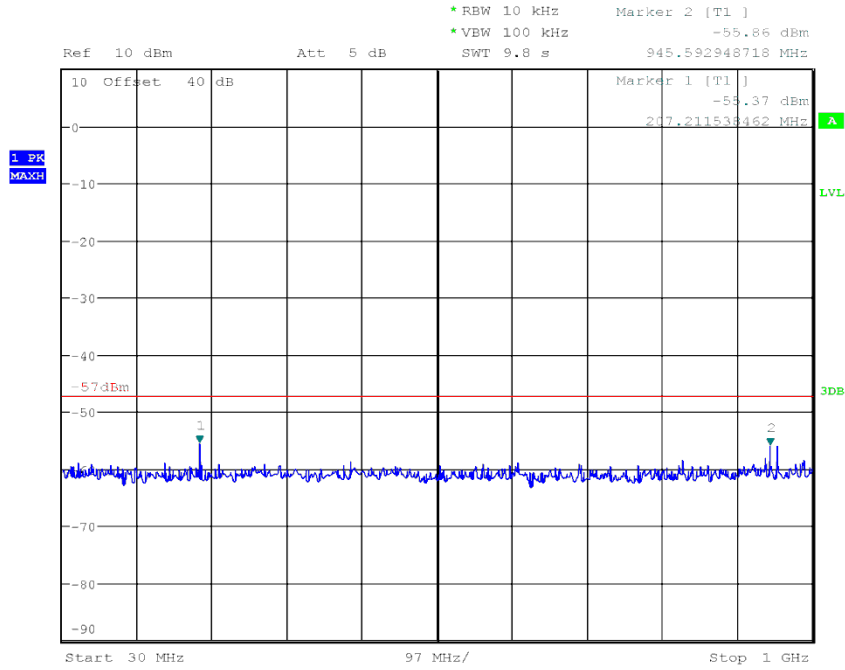

Date: 19.OCT.2018 17:46:53

Assigned Frequency:156.8MHz, 1GHz-2GHz

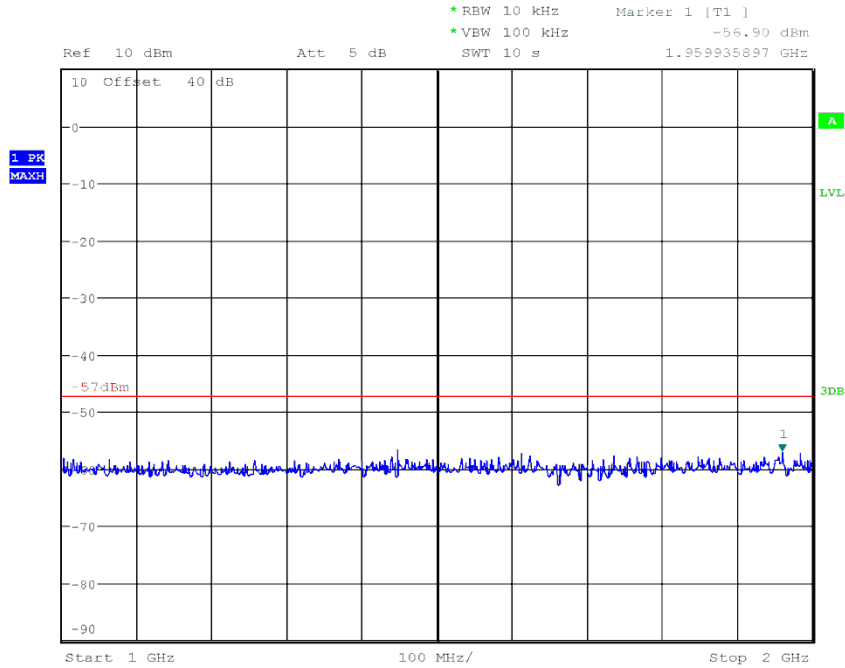

Date: 19.OCT.2018 17:51:04



26.Receiver radiated spurious emissions

Assigned Frequency:156.8MHz, receiver mode				
Frequency MHz	Polarity H/V	Emission Level dBm	Limit dBm	Over Limit dBm
192.794	H	-73.74	-57	-16.74
292.756	H	-71.6	-57	-14.6
368.543	H	-69.78	-57	-12.78
533.684	H	-66.39	-57	-9.39
660.556	H	-63.44	-57	-6.44
784.065	H	-63.17	-57	-6.17
49.883	V	-72.99	-57	-15.99
162.629	V	-73.62	-57	-16.62
246.81	V	-72.68	-57	-15.68
472.243	V	-67.93	-57	-10.93
653.662	V	-64.38	-57	-7.38
767.777	V	-63.21	-57	-6.21

27.Receiver residual noise level

Test Frequency (MHz)	Temperature (°C)	Power Supplied (V Dc)	Receiver residual noise level (dB)	Receiver residual noise Limit (dB)	Verdict
156.8	Tnor=25	Vnor=12	-44.9	≤-40	Pass

28. Receiver/Squelch operation

Relative Output Power(dB)	SINAD(dB)	Input Level (dBuV)	AF Output Power Limit(dB)	SINAD Limit(dB)	Input Level Limit (dBuV)	Verdict
Normal condition, Assigned Frequency:156.8MHz						
-63.5	24	4.8	≤-40	N/A	≤6	Pass

29. Receiver/Squelch hysteresis

Squelch Open(dBuV)	Squelch Closed(dBuV)	Difference (dB)	Upper Limit (dB)	Lower Limit (dB)	Verdict
Normal condition, Assigned Frequency:156.8MHz					
-10.5	-7.2	3.3	6	3	Pass

30. Receiver/Multiple watch characteristic

Temperature (°C)	Power Supplied (V Dc)	Scan Period (s)	Dwell Period (ms)	Dwell Time (s)	Limit			Verdict
					Scan Period (s)	Dwell Period (ms)	Dwell Time (s)	
Normal condition, Assigned Frequency:156.8MHz								
Tnor=25	Vnor=12	1.5	100	1.4	≤2	≤150	0.85 to 2	Pass
Extreme condition, Assigned Frequency:156.8MHz								
Tmin=-20	Vmin=10.2	1.5	100	1.4	≤2	≤150	0.85 to 2	Pass
Tmin =-20	Vmax=13.8	1.5	100	1.4	≤2	≤150		Pass
Tmax=55	Vmin=10.2	1.5	100	1.4	≤2	≤150		Pass
Tmax =55	Vmax=13.8	1.5	100	1.4	≤2	≤150		Pass

31. DSC Receiver/Maximum useable sensitivity

Test Freq. (MHz)	Temp. (°C)	Power Supplied (V Dc)	Carrier Freq. (KHz)	Input Level (dBuV)	BER (%)	BER limit (%)	Verdict
Normal condition							
156.525	Tnor=25	Vnor=12	Fn	0	0.66	≤1	Pass
			Fn+1.5	0	0.45	≤1	Pass
			Fn-1.5	0	0.42	≤1	Pass
Extreme condition							
156.525	Tmin=-20	Vmin=10.2	Fn	6	0.58	≤1	Pass
	Tmin =-20	Vmax=13.8	Fn	6	0.61	≤1	Pass
	Tmax=55	Vmin=10.2	Fn	6	0.54	≤1	Pass
	Tmax =55	Vmax=13.8	Fn	6	0.57	≤1	Pass

32. DSC Receiver/Co-channel rejection

Test Freq. (MHz)	Unwanted signal Frequency (MHz)	Unwanted signal Level* (dBuV)	Wanted signal Level (dBuV)	BER (%)	BER Limit (%)	Verdict
Normal condition						
156.525	F _n + 3KHz	-5	+3	0.48	≤1	Pass
	F _n	-5	+3	0.43	≤1	Pass
	F _n - 3KHz	-5	+3	0.45	≤1	Pass

*:The unwanted signal shall be modulated by 400 Hz with a deviation of ±3 kHz

33. DSC Receiver/Adjacent channel selectivity

Temp. (°C)	Power Supplied (V Dc)	Unwanted signal Frequency (MHz)	Unwanted signal Level* (dBuV)	Wanted signal Level (dBuV)	BER (%)	BER Limit (%)	Verdict
Normal condition, Assigned Frequency:156.525MHz							
T _{nor} =25	V _{nor} =12	F _n + 25KHz	73	3	0.48	≤1	Pass
		F _n	73	3	0.43	≤1	Pass
		F _n - 25KHz	73	3	0.45	≤1	Pass
Extreme condition, Assigned Frequency:156.525MHz							
T _{min} =-20	V _{min} =10.2	F _n + 25KHz	63	6	0.48	≤1	Pass
		F _n	63	6	0.43	≤1	Pass
		F _n - 25KHz	63	6	0.45	≤1	Pass
T _{min} =-20	V _{max} =13.8	F _n + 25KHz	63	6	0.45	≤1	Pass
		F _n	63	6	0.40	≤1	Pass
		F _n - 25KHz	63	6	0.42	≤1	Pass
T _{max} =55	V _{min} =10.2	F _n + 25KHz	63	6	0.59	≤1	Pass
		F _n	63	6	0.65	≤1	Pass
		F _n - 25KHz	63	6	0.62	≤1	Pass
T _{max} =55	V _{max} =13.8	F _n + 25KHz	63	6	0.64	≤1	Pass
		F _n	63	6	0.65	≤1	Pass
		F _n - 25KHz	63	6	0.68	≤1	Pass

*:The unwanted signal shall be modulated by 400 Hz with a deviation of ±3 kHz



34. DSC Receiver/Spurious response and blocking immunity

Test Freq.	Defintion	UnWanted Frequency (MHz)	Wanted signal Level (dBuV)	Unwanted signal Level (dBuV)	BER (%)	BER Limit (%)	Verdict
Normal condition(Tnor=25, Vnor=12)							
156.525	1 st IF (Receiver A)	21.400	3	73	0.74	≤1	Pass
	1 st LO-Freq. - IF	113.725	3	73	0.52	≤1	Pass
	2 x 1 st LO-Freq. - IF	248.850	3	73	0.47	≤1	Pass
	2 x 1 st LO-Freq. + IF	291.650	3	73	0.48	≤1	Pass
	3 x 1 st LO-Freq. - IF	383.975	3	73	0.52	≤1	Pass
	3 x 1 st LO-Freq. + IF	426.775	3	73	0.63	≤1	Pass

Test Freq.	Defintion	UnWanted Frequency (MHz)	Wanted signal Level (dBuV)	Unwanted signal Level (dBuV)	BER (%)	BER Limit (%)	Verdict
Normal condition(Tnor=25, Vnor=12)							
156.525	1 st IF (Receiver B)	38.855	3	73	0.59	≤1	Pass
	1 st LO-Freq. - IF	78.815	3	73	0.64	≤1	Pass
	2 x 1 st LO-Freq. - IF	196.485	3	73	0.65	≤1	Pass
	2 x 1 st LO-Freq. + IF	274.195	3	73	0.56	≤1	Pass
	3 x 1 st LO-Freq. - IF	314.155	3	73	0.65	≤1	Pass
	3 x 1 st LO-Freq. + IF	391.865	3	73	0.55	≤1	Pass

Frequencies of the signal		Wanted signal Level A(dBuV)	Unwanted signal Level B(dBuV)	BER (%)	BER Limit (%)	Verdict	
Wanted signal A* (MHz)	Unwanted signal B (MHz)						
Normal condition(Tnor=25, Vnor=12)							
156.525	-10	146.525	3	93	0.32	≤1	Pass
	-5	151.525	3	93	0.35	≤1	Pass
	-2	154.525	3	93	0.57	≤1	Pass
	-1	155.525	3	93	0.71	≤1	Pass

This document is issued by the Company subject to its General Conditions of Service printed overleaf, available on request or accessible at <http://www.sgs.com/en/Terms-and-Conditions.aspx> and, for electronic format documents, subject to Terms and Conditions for Electronic Documents at <http://www.sgs.com/en/Terms-and-Conditions/Terms-e-Documents.aspx>. Attention is drawn to the limitation of liability, indemnification and jurisdiction issues defined therein. Any holder of this document is advised that information contained hereon reflects the Company's findings at the time of its intervention only and within the limits of Client's instructions, if any. The Company's sole responsibility is to its Client and this document does not exonerate parties to a transaction from exercising all their rights and obligations under the transaction documents. This document cannot be reproduced except in full, without prior written approval of the Company. Any unauthorized alteration, forgery or falsification of the content or appearance of this document is unlawful and offenders may be prosecuted to the fullest extent of the law. Unless otherwise stated the results shown in this test report refer only to the sample(s) tested and such sample(s) are retained for 30 days only.



	+1	157.525	3	93	0.67	≤1	Pass
	+2	158.525	3	93	0.56	≤1	Pass
	+5	161.525	3	93	0.46	≤1	Pass
	+10	166.525	3	93	0.36	≤1	Pass

35. DSC Receiver/Intermodulation response

Frequencies of the signal			Wanted signal Level A(dBuV)	Unwanted signal Level* B(dBuV)	Unwanted signal Level* C(dBuV)	BER (%)	BER Limit (%)	Verdict
Generator A	Generator B	Generator C						
Normal condition(Tnor=25, Vnor=12)								
156.525	156.475	156.425	3	68	68	0.58	≤1	Pass
	156.575	156.625	3	68	68	0.58	≤1	Pass

*: Modulated with 400Hz/3KHz deviation

36. DSC Receiver/Dynamic range

Test Freq. (MHz)	Maximum Input Level (dBuV)	Minimum input Level (dBuV)	BER (%)	BER Limit (%)	Verdict
Normal condition(Tnor=25, Vnor=12)					
156.525	100	0	0.64	≤1	Pass

37. DSC Receiver/Simultaneous reception

Test Freq. (MHz)	Input Freq. (MHz)	Input signal Level (dBuV)	Wanted signal Level (dBuV)	SINAD(dB)		BER (%)	SINAD Limit (dB)	BER Limit (%)	Verdict
				With Wanted signal	Without Wanted signal				
Normal condition(Tnor=25, Vnor=12)									
156.525	156.8	20	0	24	0	0.55	≥20	≤1	Pass



38. DSC Receiver/Spurious emissions

Assigned Frequency:156.525MHz, 9KHz-150KHz

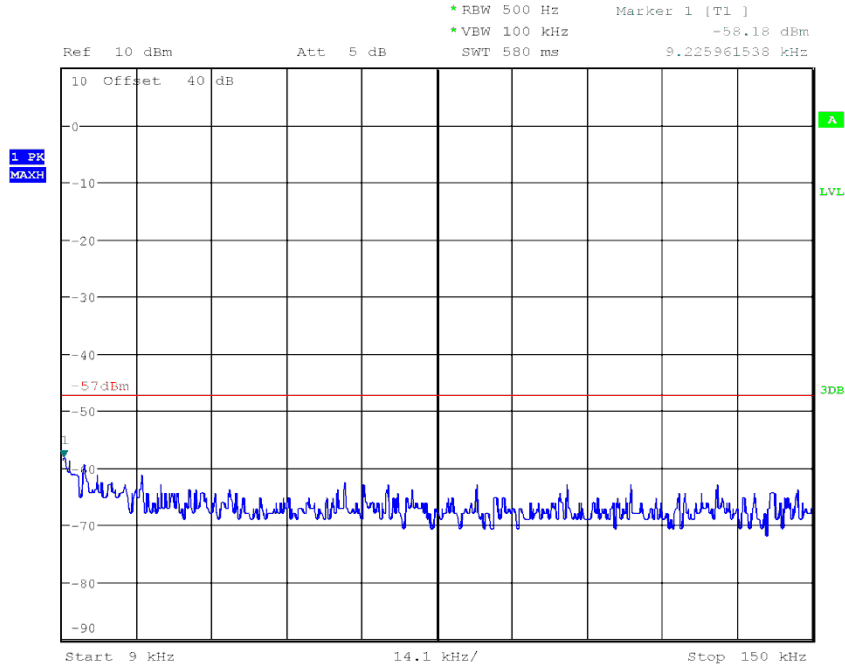

Date: 19.OCT.2018 17:44:36

Assigned Frequency:156.525MHz, 150KHz-30MHz

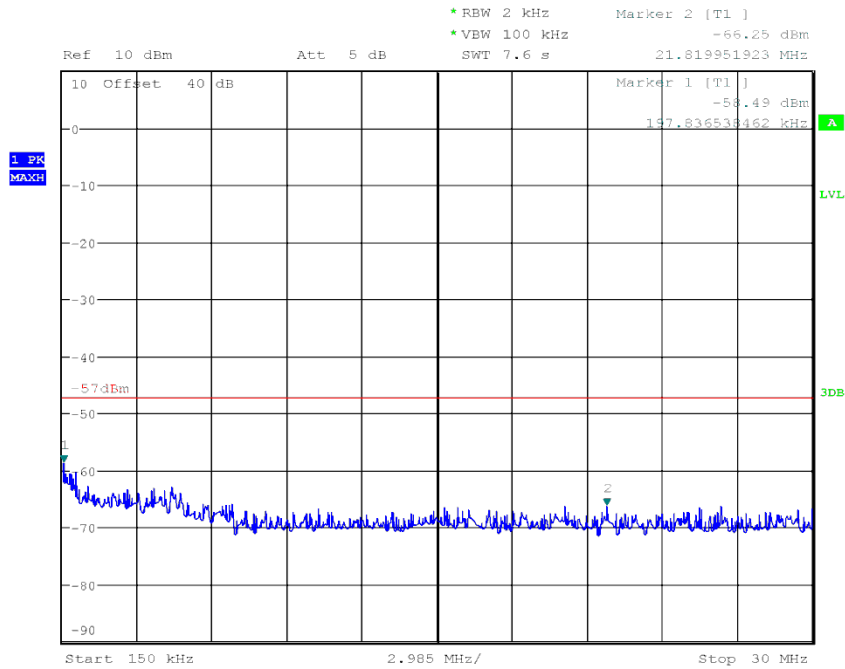

Date: 19.OCT.2018 17:45:28



Assigned Frequency:156.525MHz, 30MHz-1GHz

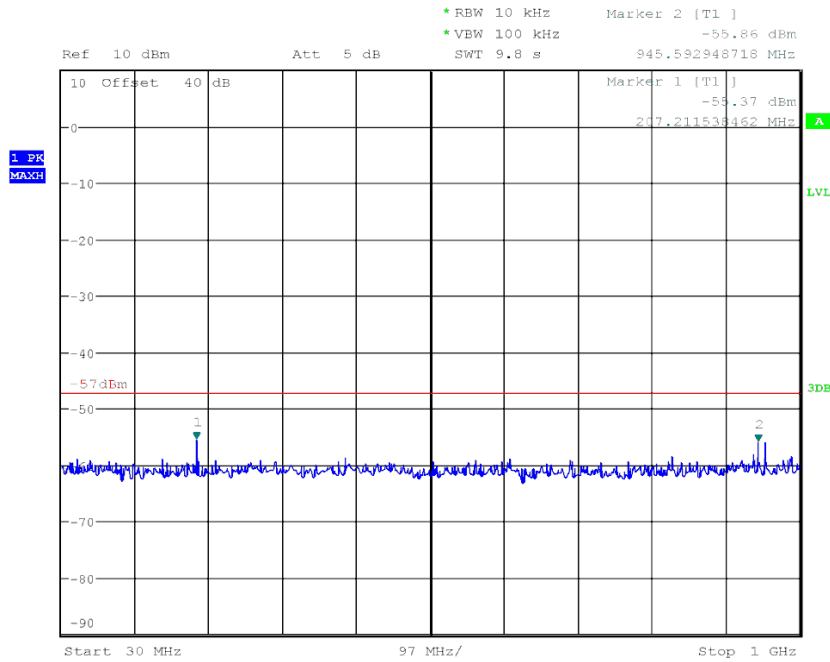

Date: 19.OCT.2018 17:46:53

Assigned Frequency:156.525MHz, 1GHz-2GHz

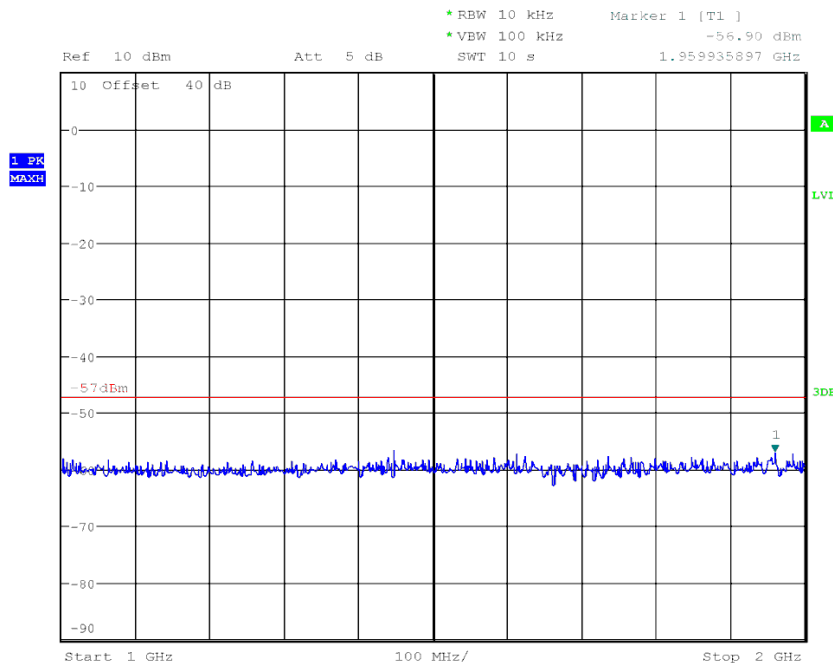

Date: 19.OCT.2018 17:51:04

- End of the Report -