



**SGS-CSTC Standards Technical Services Co., Ltd.  
Shenzhen Branch**

No. 1 Workshop, M-10, Middle section, Science & Technology Park,  
Shenzhen, Guangdong, China 518057

Telephone: +86 (0) 755 2601 2053  
Fax: +86 (0) 755 2671 0594  
Email: ee.shenzhen@sgs.com

Report No.: SZEM180900844702  
Page: 1 of 77

## TEST REPORT

**Application No.:** SZEM1809008447CR  
**Applicant:** Navico Inc.  
**Address of Applicant:** 4500 S. 129th East Avenue, Ste. 200, Tulsa, Oklahoma, 74134 United States  
**Manufacturer:** Navico Auckland Limited  
**Address of Manufacturer:** Arrenway Drive, Rosedale, Auckland, 0632 New Zealand  
**Factory:** Shenzhen Hytera Communications Corporation Limited  
**Address of Factory:** Hytera Technology Park, Baolong Industrial City, Longgang District, Shenzhen, China

**Equipment Under Test (EUT):**  
**EUT Name:** Marine VHF Radio  
**Model No.:** V60, RS40 ♣  
 ♣ Please refer to section 2 of this report which indicates which model was actually tested and which were electrically identical.

**Trade mark:** B&G, SIMRAD  
**FCC ID:** RAYVHFRS40  
**Standards:** 47 CFR Part 80  
**Date of Receipt:** 2018-09-20  
**Date of Test:** 2018-09-26 to 2018-10-19  
**Date of Issue:** 2018-10-29

<b>Test Result:</b>	<b>Pass*</b>
---------------------	--------------

\* In the configuration tested, the EUT complied with the standards specified above.



Keny Xu

EMC Laboratory Manager

The manufacturer should ensure that all products in series production are in conformity with the product sample detailed in this report. If the product in this report is used in any configuration other than that detailed in the report, the manufacturer must ensure the new system complies with all relevant standards. Any mention of SGS International Electrical Approvals or testing done by SGS International Electrical Approvals in connection with, distribution or use of the product described in this report must be approved by SGS International Electrical Approvals in writing.

This document is issued by the Company subject to its General Conditions of Service printed overleaf, available on request or accessible at <http://www.sgs.com/en/Terms-and-Conditions.aspx> and, for electronic format documents, subject to Terms and Conditions for Electronic Documents at <http://www.sgs.com/en/Terms-and-Conditions/Terms-e-Document.aspx>. Attention is drawn to the limitation of liability, indemnification and jurisdiction issues defined therein. Any holder of this document is advised that information contained hereon reflects the Company's findings at the time of its intervention only and within the limits of Client's instructions, if any. The Company's sole responsibility is to its Client and this document does not exonerate parties to a transaction from exercising all their rights and obligations under the transaction documents. This document cannot be reproduced except in full, without prior written approval of the Company. Any unauthorized alteration, forgery or falsification of the content or appearance of this document is unlawful and offenders may be prosecuted to the fullest extent of the law. Unless otherwise stated the results shown in this test report refer only to the sample(s) tested and such sample(s) are retained for 30 days only.



<b>Revision Record</b>				
<b>Version</b>	<b>Chapter</b>	<b>Date</b>	<b>Modifier</b>	<b>Remark</b>
01		2018-10-29		Original

<b>Authorized for issue by:</b>				
				
		<hr/>		
		Edison Li /Project Engineer		
				
		<hr/>		
		Eric Fu /Reviewer		

## 2 Test Summary

Radio Spectrum Technical Requirement				
Item	Standard	Method	Requirement	Result
Antenna Requirement	47 CFR Part 80	N/A	47 CFR Part 80.3(e),	Pass

Item	Standard	Method	Requirement	Result
Bandwidths	47 CFR Part 80	ANSI/TIA-603-E-2016	47 CFR Part 2.1049, 80.205(a)	Pass
Transmitter frequency tolerances	47 CFR Part 80		47 CFR Part 2.1055, 80.209(a)	Pass
Emission Mask	47 CFR Part 80		47 CFR Part 2.1047, 80.211(f)(1)(2)	Pass
Spurious Emissions at antenna Terminals	47 CFR Part 80		47 CFR Part 2.1047, 80.211(f)(3)	Pass
Modulation requirements	47 CFR Part 80		47 CFR Part 2.1047, 80.213	Pass
Transmitter frequency Deviation	47 CFR Part 80		47 CFR Part .1047, 80.213	Pass
Transmitter power	47 CFR Part 80		47 CFR Part 2.1046, 80.215	Pass
Transmitter Carrier Power Reduction	47 CFR Part 80		47 CFR Part 80.215(e)(f)	Pass
Suppression of interference aboard ships	47 CFR Part 80		47 CFR Part 80.217	Pass

**Remark:**

Model No.: V60, RS40

Only the model V60 was tested, since the electrical circuit design, layout, components used, internal wiring and functions were identical for the above models, with only differences are the trade name and model no. for trading purpose.



### 3 Contents

	Page
<b>1 COVER PAGE .....</b>	<b>1</b>
<b>2 TEST SUMMARY .....</b>	<b>3</b>
<b>3 CONTENTS .....</b>	<b>4</b>
<b>4 GENERAL INFORMATION.....</b>	<b>6</b>
4.1 DETAILS OF E.U.T. ....	6
4.2 DESCRIPTION OF SUPPORT UNITS.....	6
4.3 MEASUREMENT UNCERTAINTY.....	6
4.4 TEST LOCATION .....	7
4.5 TEST FACILITY .....	7
4.6 DEVIATION FROM STANDARDS.....	7
4.7 ABNORMALITIES FROM STANDARD CONDITIONS .....	7
<b>5 EQUIPMENT LIST.....</b>	<b>8</b>
<b>6 RADIO SPECTRUM TECHNICAL REQUIREMENT.....</b>	<b>10</b>
6.1 ANTENNA REQUIREMENT .....	10
6.1.1 Test Requirement:.....	10
6.1.2 Conclusion.....	10
<b>7 RADIO SPECTRUM MATTER TEST RESULTS .....</b>	<b>11</b>
7.1 BANDWIDTHS.....	11
7.1.1 E.U.T. Operation.....	13
7.1.2 E.U.T. Operation.....	13
7.1.3 Measurement Data.....	13
7.2 TRANSMITTER FREQUENCY TOLERANCES.....	14
7.2.1 E.U.T. Operation.....	17
7.2.2 E.U.T. Operation.....	17
7.2.3 Measurement Data.....	17
7.3 EMISSIONS MASK.....	18
7.3.1 E.U.T. Operation.....	18
7.3.2 E.U.T. Operation.....	18
7.3.3 Measurement Data.....	18
7.4 SPURIOUS EMISSIONS AT ANTENNA TERMINALS.....	19
7.4.1 E.U.T. Operation.....	19
7.4.2 E.U.T. Operation.....	19
7.4.3 Measurement Data.....	19
7.5 TRANSMITTER UNWANTED EMISSIONS(RADIATED).....	20
7.5.1 E.U.T. Operation.....	20
7.5.2 E.U.T. Operation.....	20
7.5.3 Measurement Data.....	21
7.6 MODULATION REQUIREMENTS.....	22
7.6.1 E.U.T. Operation.....	22
7.6.2 Test Setup Diagram.....	22
7.6.3 Measurement Data.....	22
7.7 TRANSMITTER FREQUENCY DEVIATION.....	23
7.7.1 E.U.T. Operation.....	23



7.7.2	Test Setup Diagram.....	23
7.7.3	Measurement Data.....	23
7.8	TRANSMITTER POWER.....	24
7.8.1	E.U.T. Operation.....	24
7.8.2	Test Setup Diagram.....	24
7.8.3	Measurement Data.....	24
7.9	TRANSMITTER CARRIER POWER REDUCTION.....	25
7.9.1	E.U.T. Operation.....	25
7.9.2	Test Setup Diagram.....	25
7.9.3	Measurement Data.....	25
7.10	SUPPRESSION OF INTERFERENCE ABOARD SHIPS.....	26
7.10.1	E.U.T. Operation.....	26
7.10.2	E.U.T. Operation.....	26
7.10.3	Measurement Data.....	26
<b>8</b>	<b>PHOTOGRAPHS.....</b>	<b>27</b>
8.1	TEST SETUP.....	27
8.2	EUT CONSTRUCTIONAL DETAILS.....	27
<b>9</b>	<b>APPENDIX.....</b>	<b>28</b>
9.1	APPENDIX FCC DATA.....	28-77

## 4 General Information

### 4.1 Details of E.U.T.

Power supply:	12 VDC battery system
Cable:	DC cable: longer than 300cm unshielded
Sample Type:	Mobile device
Transmitter Frequency Range:	156.025MHz-157.425MHz
Receiver Frequency Range:	156.05MHz-163.275MHz
AIS Receiver Frequency Range:	161.975MHz(CH87), 162.025MHz(CH88)
Modulation Type:	FM for Analog
Frequency Spacing:	25KHz
Rated Output Power:	25W/1W
VHF Antenna Connectors:	SO-239(50 ohm, External Antenna)
VHF Antenna Gain:	6dBi

### 4.2 Description of Support Units

Description	Manufacturer	Model No.	Serial No.
DC power	ZHAOXIN	RXN-305D	REF. No.SEA2700
Coaxial Attenuator	Provided by client	TS4	HYT168793

### 4.3 Measurement Uncertainty

No.	Item	Measurement Uncertainty
1	Radio Frequency	$\pm 7.25 \times 10^{-8}$
2	Occupied Bandwidth	$\pm 3\%$
3	RF conducted power	$\pm 0.75\text{dB}$
4	Conducted Spurious emissions	$\pm 0.75\text{dB}$
5	Radiated Spurious emission test	$\pm 4.5\text{dB}$ (30MHz-1GHz)
		$\pm 4.8\text{dB}$ (1GHz-18GHz)
6	Temperature test	$\pm 1^\circ\text{C}$
7	Humidity test	$\pm 3\%$
8	Supply voltages	$\pm 1.5\%$



#### 4.4 Test Location

All tests were performed at:

SGS-CSTC Standards Technical Services Co., Ltd., Shenzhen Branch

No. 1 Workshop, M-10, Middle Section, Science & Technology Park, Shenzhen, Guangdong, China.  
518057.

Tel: +86 755 2601 2053 Fax: +86 755 2671 0594

No tests were sub-contracted.

#### 4.5 Test Facility

The test facility is recognized, certified, or accredited by the following organizations:

- **CNAS (No. CNAS L2929)**

CNAS has accredited SGS-CSTC Standards Technical Services Co., Ltd. Shenzhen Branch EMC Lab to ISO/IEC 17025:2005 General Requirements for the Competence of Testing and Calibration Laboratories (CNAS-CL01 Accreditation Criteria for the Competence of Testing and Calibration Laboratories) for the competence in the field of testing.

- **A2LA (Certificate No. 3816.01)**

SGS-CSTC Standards Technical Services Co., Ltd., Shenzhen EMC Laboratory is accredited by the American Association for Laboratory Accreditation(A2LA). Certificate No. 3816.01.

- **VCCI**

The 3m Fully-anechoic chamber for above 1GHz, 10m Semi-anechoic chamber for below 1GHz, Shielded Room for Mains Port Conducted Interference Measurement and Telecommunication Port Conducted Interference Measurement of SGS-CSTC Standards Technical Services Co., Ltd. have been registered in accordance with the Regulations for Voluntary Control Measures with Registration No.: G-20026, R-14188, C-12383 and T-11153 respectively.

- **FCC –Designation Number: CN1178**

SGS-CSTC Standards Technical Services Co., Ltd., Shenzhen EMC Laboratory has been recognized as an accredited testing laboratory.

Designation Number: CN1178. Test Firm Registration Number: 406779.

- **Innovation, Science and Economic Development Canada**

SGS-CSTC Standards Technical Services Co., Ltd., Shenzhen EMC Laboratory has been recognized by ISED as an accredited testing laboratory.

CAB identifier: CN0006.

IC#: 4620C.

#### 4.6 Deviation from Standards

None

#### 4.7 Abnormalities from Standard Conditions

None



## 5 Equipment List

RF conducted test					
Test Equipment	Manufacturer	Model No.	Inventory No.	Cal Date	Cal Due Date
DC Power Supply	ZhaoXin	PS-3005D	SEM011-05	2017-09-27	2018-09-26
				2018-09-25	2019-09-24
Spectrum Analyzer (20Hz-43GHz)	Rohde & Schwarz	FSU43	SEM004-08	2018-04-13	2019-04-12
Signal Generator (9kHz-40GHz)	KEYSIGHT	N5173B	SEM006-05	2017-09-27	2018-09-26
				2018-09-25	2019-09-24
Measurement Software	JS Tonscend	JS1120-2 BT/WIFI V2.6	N/A	N/A	N/A
Coaxial Cable	SGS	N/A	SEM031-01	2018-07-13	2019-07-12
Attenuator	Weinschel Associates	WA41	SEM021-09	N/A	N/A
Cell Site Test Set	HP	8921A	3633A04615	2018-04-11	2019-04-10
Signal Generator	HP	8656B	3334U13373	2018-04-12	2019-04-11
Signal Generator	R&S	SMA100A	102174	2018-04-12	2019-04-11
Audio Analyzer	Rohde & Schwarz	UPV	SEM008-03	2018-09-25	2019-09-24

Radiated Spurious Emissions					
Equipment	Manufacturer	Model No	Inventory No	Cal Date	Cal Due Date
3m Semi-Anechoic Chamber	AUDIX	N/A	SEM001-02	2017-05-02	2020-05-01
Measurement Software	AUDIX	e3 V8.2014-6-27	N/A	N/A	N/A
Coaxial Cable	SGS	N/A	SEM026-01	2018-07-13	2019-07-12
Spectrum Analyzer	Rohde & Schwarz	FSU43	SEM004-08	2018-04-13	2019-04-14
BiConiLog Antenna (26-3000MHz)	ETS-Lindgren	3142C	SEM003-01	2017-06-27	2020-06-26
Horn Antenna (1-18GHz)	Rohde & Schwarz	HF907	SEM003-07	2018-06-14	2021-06-13
Horn Antenna (15GHz-40GHz)	Schwarzbeck	BBHA 9170	SEM003-15	2017-10-17	2020-10-16
Pre-amplifier (0.1-1300MHz)	HP	8447D	SEM005-02	2017-09-27	2018-09-26
				2018-09-25	2019-09-24
Low Noise Amplifier (100MHz-18GHz)	Black Diamond Series	BDLNA-0118- 352810	SEM005-05	2017-09-27	2018-09-27
				2018-09-25	2019-09-24
Pre-amplifier(18-26GHz)	Rohde & Schwarz	CH14-H052	SEM005-17	2017-12-04	2018-12-03
Pre-amplifier (26-40GHz)	Compliance Directions Systems Inc.	PAP-2640-50	SEM005-08	2018-04-02	2019-04-01

This document is issued by the Company subject to its General Conditions of Service printed overleaf, available on request or accessible at <http://www.sgs.com/en/Terms-and-Conditions.aspx> and, for electronic format documents, subject to Terms and Conditions for Electronic Documents at <http://www.sgs.com/en/Terms-and-Conditions/Terms-e-Document.aspx>. Attention is drawn to the limitation of liability, indemnification and jurisdiction issues defined therein. Any holder of this document is advised that information contained hereon reflects the Company's findings at the time of its intervention only and within the limits of Client's instructions, if any. The Company's sole responsibility is to its Client and this document does not exonerate parties to a transaction from exercising all their rights and obligations under the transaction documents. This document cannot be reproduced except in full, without prior written approval of the Company. Any unauthorized alteration, forgery or falsification of the content or appearance of this document is unlawful and offenders may be prosecuted to the fullest extent of the law. Unless otherwise stated the results shown in this test report refer only to the sample(s) tested and such sample(s) are retained for 30 days only.





**SGS-CSTC Standards Technical Services Co., Ltd.  
Shenzhen Branch**

Report No.: SZEM180900844702  
Page: 9 of 77

DC Power Supply	Zhao Xin	RXN-305D	SEM011-02	2017-09-27	2018-09-26
				2018-09-25	2019-09-24
Active Loop Antenna	ETS-Lindgren	6502	SEM003-08	2017-08-22	2020-08-21
Band filter	N/A	N/A	SEM023-01	N/A	N/A

<b>RE in Chamber</b>					
Test Equipment	Manufacturer	Model No.	Inventory No.	Cal. Date (yyyy-mm-dd)	Cal. Due date (yyyy-mm-dd)
3m Semi-Anechoic Chamber	ETS-LINDGREN	N/A	SEM001-01	2017-08-05	2020-08-04
MXE EMI Receiver (20Hz-8.4GHz)	Agilent Technologies	N9038A	SEM004-05	2017-09-27	2018-09-26
				2018-09-25	2019-09-24
BiConiLog Antenna (26-3000MHz)	ETS-LINDGREN	3142C	SEM003-01	2017-06-27	2020-06-26
Trilog-Broadband Antenna(30M-1GHz)	Schwarzbeck	VULB9168	SEM003-18	2016-06-29	2019-06-28
Pre-amplifier (0.1-1300MHz)	Agilent Technologies	8447D	SEM005-01	2018-04-02	2019-04-01
Measurement Software	AUDIX	e3 V8.2014-6-27	N/A	N/A	N/A
Coaxial Cable	SGS	N/A	SEM025-01	2018-07-13	2019-07-12

<b>General used equipment</b>					
Equipment	Manufacturer	Model No	Inventory No	Cal Date	Cal Due Date
Humidity/ Temperature Indicator	Shanghai Meteorological Industry Factory	ZJ1-2B	SEM002-03	2017-09-29	2018-09-28
				2018-09-27	2019-09-26
Humidity/ Temperature Indicator	Shanghai Meteorological Industry Factory	ZJ1-2B	SEM002-04	2017-09-29	2018-09-28
				2018-09-27	2019-09-26
Humidity/ Temperature Indicator	Mingle	N/A	SEM002-08	2017-09-29	2018-09-28
				2018-09-27	2019-09-26
Barometer	Changchun Meteorological Industry Factory	DYM3	SEM002-01	2018-04-08	2019-04-07



## 6 Radio Spectrum Technical Requirement

### 6.1 Antenna Requirement

#### 6.1.1 Test Requirement:

47 CFR Part Part 80.81

#### 6.1.2 Conclusion

##### 80.81 Requirements:

All telephony emissions of a ship station or a marine utility station on board ship within the frequency band 30-200 MHz must be vertically polarized.

EUT Antenna:

Antenna location: Refer to Internal photos.



## 7 Radio Spectrum Matter Test Results

### 7.1 Bandwidths

Test Requirement: 47 CFR FCC Part2.1049 & FCC Part 80.205(a)  
Test Method: ANSI/TIA-603-E:2016  
Limit:

(a).An emission designator shows the necessary bandwidth for each class of emission of a station except that in ship earth stations it shows the occupied or necessary bandwidth, whichever is greater. The following table gives the class of emission and corresponding emission designator and authorized bandwidth:

emission	Emission designator	Authorized bandwidth (kHz)
A1A	160HA1A	0.4
A1B <sup>1</sup>	160HA1B	0.4
A1D <sup>12</sup>	16K0A1D	20.0
A2A	2K66A2A	2.8
A2B <sup>1</sup>	2K66A2B	2.8
A2D <sup>12</sup>	16K0A2D	20.0
A3E	6K00A3E	8.0
A3N <sup>2</sup>	2K66A3N	2.8
A3X <sup>3</sup>	3K20A3X	25.0
F1B <sup>4</sup>	280HF1B	0.3
F1B <sup>5</sup>	300HF1B	0.5
F1B <sup>6</sup>	16KOF1B	20.0
F1C	2K80F1C	3.0
F1D <sup>12</sup>	16K0F1D	20.0
F2B <sup>6</sup>	16KOF2B	20.0
F2C <sup>7</sup>	16KOF2C	20.0
F2D <sup>12</sup>	16K0F2D	20.0
F3C	2K80F3C	3.0
F3C <sup>7</sup>	16KOF3C	20.0
F3E <sup>8</sup>	16KOF3E	20.0
F3N <sup>9</sup>	20MOF3N	20,000.0
G1D <sup>12</sup>	16K0G1D	20.0
G2D <sup>12</sup>	16K0G2D	20.0
G3D <sup>10</sup>	16KOG3D	20.0



G3E <sup>8</sup>	16KOG3E	20.0
G3N <sup>3 13</sup>	16KOG3N	20.0
H2A	1K40H2A	2.8
H2B <sup>1</sup>	1K40H2B	2.8
H3E <sup>11</sup>	2K80H3E	3.0
H3N	2K66H3N	2.8
J2A	160HJ2A	0.4
J2B <sup>4</sup>	280HJ2B	0.3
J2B <sup>5</sup>	300HJ2B	0.5
J2B	2K80J2B	3.0
J2C	2K80J2C	3.0
J2D <sup>14</sup>	2K80J2D	3.0
J3C	2K80J3C	3.0
J3E <sup>11</sup>	2K80J3E	3.0
J3N	160HJ3N	0.4
NON	NON	0.4
PON	( <sup>12</sup> )	( <sup>12</sup> )
R3E <sup>11</sup>	2K80R3E	3.0

<sup>1</sup>On 500 kHz and 2182 kHz A1B, A2B, H2B and J2B emissions indicate transmission of the auto alarm signals.

<sup>2</sup>Applicable only to transmissions in the 405-525 kHz band for direction finding.

<sup>3</sup>Applicable only to EPIRB's.

<sup>4</sup>Radioprinter transmissions for communications with private coast stations.

<sup>5</sup>NB-DP radiotelegraph and data transmissions for communications with public coast stations.

<sup>6</sup>Applicable only to radioprinter and data in the 156-162 MHz band and radioprinter in the 216-220 MHz band.

<sup>7</sup>Applicable only to facsimile in the 156-162 MHz and 216-220 MHz bands.

<sup>8</sup>Applicable only when maximum frequency deviation is 5 kHz. See also paragraph (b) of this section.

<sup>9</sup>Applicable only to marine hand-held radar.

<sup>10</sup>Applicable only to on-board frequencies for maneuvering or navigation.

<sup>11</sup>Transmitters approved prior to December 31, 1969, for emission H3E, J3E and R3E and an authorized bandwidth of 3.5 kHz may continue to be operated. These transmitters will not be authorized in new installations.

<sup>12</sup>Applicable to radiolocation and associated telecommand ship stations operating on 154.585 MHz, 159.480 MHz, 160.725 MHz, 160.785 MHz, 454.000 MHz, and 459.000 MHz; emergency position indicating radiobeacons operating in the 406.000-406.1000 MHz frequency bank; and data transmissions in the 156-162 MHz band.

<sup>13</sup>[Reserved]

<sup>14</sup>The information is contained in multiple very low level subcarriers.

(b) For land stations the maximum authorized frequency deviation for F3E or G3E emission is as follows:

(1) 5 kHz in the 72.0-73.0 MHz, 75.4-76.0 MHz and 156-162 MHz bands;

(2) 15 kHz for stations which were authorized for operation before December 1, 1961, in the 73.0-74.6 MHz band.

### 7.1.1 E.U.T. Operation

Operating Environment:

Temperature: 25.0 °C      Humidity: 55 % RH      Atmospheric Pressure: 1010 mbar

Test mode: a: TX mode, Keep the EUT in transmitting mode.

### 7.1.2 E.U.T. Operation

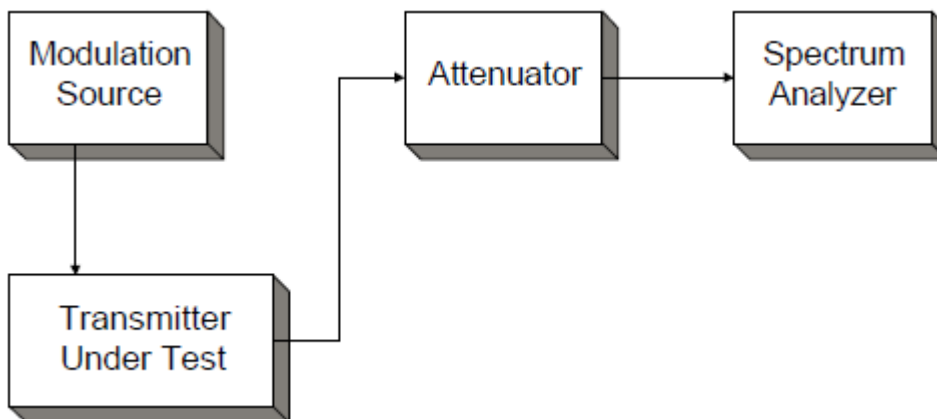

### 7.1.3 Measurement Data

The detailed test data see: Appendix FCC data.



**7.2 Transmitter Frequency Tolerances.**

Test Requirement 47 CFR FCC Part2.1055 & FCC Part 80.209(a)  
Test Method: ANSI/TIA-603-E:2016  
Limit:

(a). The frequency tolerance requirements applicable to transmitters in the maritime services are shown in the following table. Tolerances are given as parts in 106 unless shown in Hz.

<b>Frequency bands and categories of stations</b>	<b>Tolerances<sup>1</sup></b>
(1) Band 100-525 kHz:	
(i) Coast stations:	
For single sideband emissions	20 Hz.
For transmitters with narrow-band direct printing and data emissions	10 Hz <sup>2</sup>
For transmitters with digital selective calling emissions	10 Hz.
For all other emissions	100.
(ii) Ship stations:	
For transmitters with narrow-band direct printing and data emissions	20 Hz.
For transmitters with digital selective calling emissions	10 Hz <sup>2</sup>
For all other transmitters	10 Hz.
(iii) Ship stations for emergency only:	
For all emissions	20 Hz.
(iv) Survival craft stations:	
For all emissions	20 Hz.
(v) Radiodetermination stations:	
For all emissions	100.
(2) Band 1600-4000 kHz:	
(i) Coast stations and Alaska fixed stations:	
For single sideband and facsimile	20 Hz.
For narrow-band direct printing and data emissions	10 Hz. <sup>2</sup>
For transmitters with digital selective calling emissions	10 Hz. <sup>2</sup>
For all other emissions	50 Hz.
(ii) Ship stations:	
For transmitters with narrow-band direct printing and data emissions	10 Hz. <sup>2</sup>
For transmitters with digital selective calling emissions	10 Hz. <sup>3</sup>
For all other transmitters	20 Hz.
(iii) Survival craft stations:	20 Hz.

This document is issued by the Company subject to its General Conditions of Service printed overleaf, available on request or accessible at <http://www.sgs.com/en/Terms-and-Conditions.aspx> and, for electronic format documents, subject to Terms and Conditions for Electronic Documents at <http://www.sgs.com/en/Terms-and-Conditions/Terms-e-Document.aspx>. Attention is drawn to the limitation of liability, indemnification and jurisdiction issues defined therein. Any holder of this document is advised that information contained hereon reflects the Company's findings at the time of its intervention only and within the limits of Client's instructions, if any. The Company's sole responsibility is to its Client and this document does not exonerate parties to a transaction from exercising all their rights and obligations under the transaction documents. This document cannot be reproduced except in full, without prior written approval of the Company. Any unauthorized alteration, forgery or falsification of the content or appearance of this document is unlawful and offenders may be prosecuted to the fullest extent of the law. Unless otherwise stated the results shown in this test report refer only to the sample(s) tested and such sample(s) are retained for 30 days only.



(iv) Radiodetermination stations:	
With power 200W or less	20.
With power above 200W	10.
(3) Band 4000-27500 kHz:	
(i) Coast stations and Alaska fixed stations:	
For single sideband and facsimile emissions	20 Hz.
For narrow-band direct printing and data emissions	10 Hz. <sup>2</sup>
For digital selective calling emissions	10 Hz.
For Morse telegraphy emissions	10.
For all other emissions	15 Hz.
(ii) Ship stations:	
For transmitters with narrow-band direct printing and data emissions	10 Hz. <sup>2</sup>
For transmitters with digital selective calling emissions	10 Hz. <sup>3</sup>
For all other transmitters	20 Hz.
(iii) Survival craft stations:	50 Hz.
(4) Band 72-76 MHz:	
(i) Fixed stations:	
Operating in the 72.0-73.0 and 75.4-76.0 MHz bands	5.
Operating in the 73.74.6 MHz band	50.
(5) Band 156-162 MHz:	
(i) Coast stations:	
For carriers licensed to operate with a carrier power:	
Below 3 watts	10.
3 to 100 watts	5. <sup>7</sup>
(ii) Ship stations	10. <sup>4</sup>
(iii) Survival craft stations operating on 121.500 MHz	50.
(iv) EPIRBs:	
Operating on 121.500 and 243.000 MHz	50.
Operating on 156.750 and 156.800 MHz. <sup>6</sup>	10.
(6) Band 216-220 MHz:	
(i) Coast stations:	
For all emissions	5.
(ii) Ship stations:	
For all emissions	5.
(7) Band 400-466 MHz:	

This document is issued by the Company subject to its General Conditions of Service printed overleaf, available on request or accessible at <http://www.sgs.com/en/Terms-and-Conditions.aspx> and, for electronic format documents, subject to Terms and Conditions for Electronic Documents at <http://www.sgs.com/en/Terms-and-Conditions/Terms-e-Document.aspx>. Attention is drawn to the limitation of liability, indemnification and jurisdiction issues defined therein. Any holder of this document is advised that information contained hereon reflects the Company's findings at the time of its intervention only and within the limits of Client's instructions, if any. The Company's sole responsibility is to its Client and this document does not exonerate parties to a transaction from exercising all their rights and obligations under the transaction documents. This document cannot be reproduced except in full, without prior written approval of the Company. Any unauthorized alteration, forgery or falsification of the content or appearance of this document is unlawful and offenders may be prosecuted to the fullest extent of the law. Unless otherwise stated the results shown in this test report refer only to the sample(s) tested and such sample(s) are retained for 30 days only.



(i) EPIRBs operating on 406-406.1 MHz	5.
(ii) On-board stations	5.
(iii) Radiolocation and telecommand stations.	5.
(8) Band 1626.5-1646.5 MHz:	
(i) Ship earth stations	5.

<sup>1</sup>Transmitters authorized prior to January 2, 1990, with frequency tolerances equal to or better than those required after this date will continue to be authorized in the maritime services provided they retain approval and comply with the applicable standards in this part.

<sup>2</sup>The frequency tolerance for narrow-band direct printing and data transmitters installed before January 2, 1992, is 15 Hz for coast stations and 20 Hz for ship stations. The frequency tolerance for narrow-band direct printing and data transmitters approved or installed after January 1, 1992, is 10 Hz.

<sup>3</sup>[Reserved]

<sup>4</sup>For transmitters in the radiolocation and associated telecommand service operating on 154.584 MHz, 159.480 MHz, 160.725 MHz and 160.785 MHz the frequency tolerance is 15 parts in 10<sup>6</sup>.

<sup>5</sup>[Reserved]

<sup>6</sup>[Reserved]

<sup>7</sup>For transmitters operated at private coast stations with antenna heights less than 6 meters (20 feet) above ground and output power of 25 watts or less the frequency tolerance is 10 parts in 10<sup>6</sup>.

(b) When pulse modulation is used in land and ship radar stations operating in the bands above 2.4 GHz the frequency at which maximum emission occurs must be within the authorized bandwidth and must not be closer than 1.5/T MHz to the upper and lower limits of the authorized bandwidth where "T" is the pulse duration in microseconds. In the band 14.00-14.05 GHz the center frequency must not vary more than 10 MHz from 14.025 GHz.

(c) For stations in the maritime radiodetermination service, other than ship radar stations, the authorized frequency tolerance will be specified on the license when it is not specified in this part.



### 7.2.1 E.U.T. Operation

Operating Environment:

Temperature: 25.0 °C      Humidity: 55 % RH      Atmospheric Pressure: 1010 mbar

Test mode: a: TX mode, Keep the EUT in transmitting mode.

### 7.2.2 E.U.T. Operation

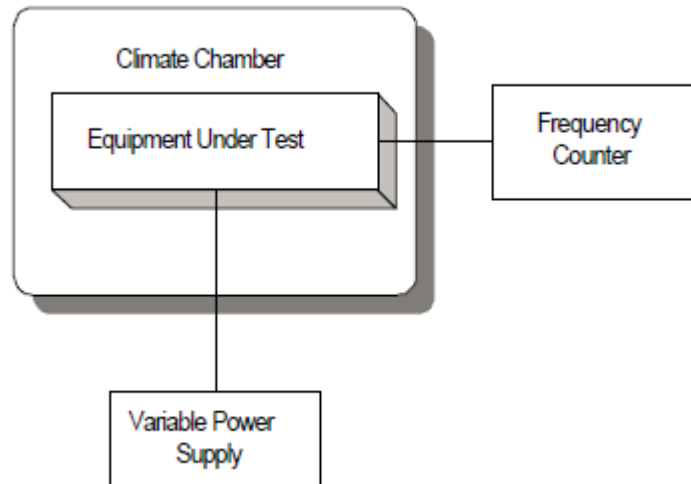

### 7.2.3 Measurement Data

The detailed test data see: Appendix FCC data.

### 7.3 Emissions Mask

Test Requirement: 47 CFR FCC Part2.1047 & FCC Part 80.211(f) (1) (2)  
Test Method: ANSI/TIA-603-E:2016  
Limit:

- (f) The mean power when using emissions other than those in paragraphs (a), (b), (c) and (d) of this section:
- (1) On any frequency removed from the assigned frequency by more than 50 percent up to and including 100 percent of the authorized bandwidth: At least 25 dB;
  - (2) On any frequency removed from the assigned frequency by more than 100 percent up to and including 250 percent of the authorized bandwidth: At least 35 dB;

#### 7.3.1 E.U.T. Operation

Operating Environment:  
Temperature: 25.0 °C      Humidity: 55 % RH      Atmospheric Pressure: 1010 mbar  
Test mode: a: TX mode, Keep the EUT in transmitting mode.

#### 7.3.2 E.U.T. Operation

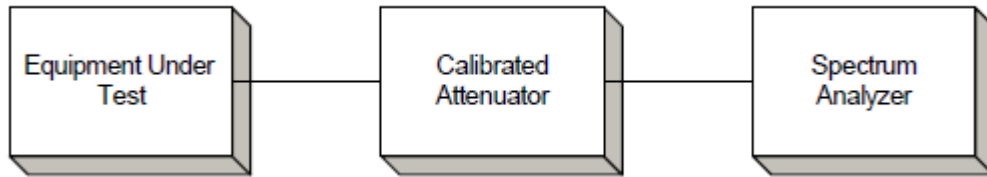

#### 7.3.3 Measurement Data

The detailed test data see: Appendix FCC data.

### 7.4 Spurious Emissions at Antenna Terminals

Test Requirement: 47 CFR FCC Part2.1047 & FCC Part 80.211(f) (3)  
Test Method: ANSI/TIA-603-E:2016  
Limit:

- (f) The mean power when using emissions other than those in paragraphs (a), (b), (c) and (d) of this section:
- (3) On any frequency removed from the assigned frequency by more than 250 percent of the authorized bandwidth: At least 43 plus  $10\log_{10}$  (mean power in watts) dB.

#### 7.4.1 E.U.T. Operation

Operating Environment:  
Temperature: 25.0 °C      Humidity: 55 % RH      Atmospheric Pressure: 1010 mbar  
Test mode: a: TX mode, Keep the EUT in transmitting mode.

#### 7.4.2 E.U.T. Operation

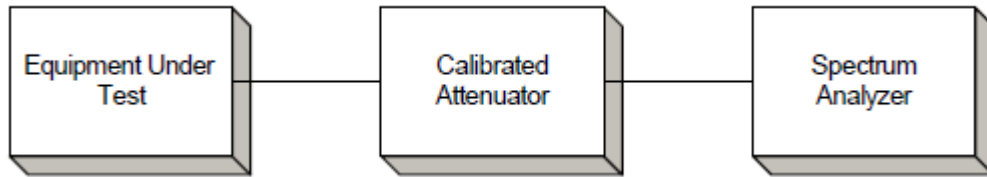

#### 7.4.3 Measurement Data

The detailed test data see: Appendix FCC data.

## 7.5 Transmitter Unwanted Emissions(Radiated)

Test Requirement: 47 CFR FCC Part2.1047 & FCC Part 80.211(f)  
 Test Method: ANSI/TIA-603-E:2016  
 Limit:

- (f) The mean power when using emissions other than those in paragraphs (a), (b), (c) and (d) of this section:
- (1) On any frequency removed from the assigned frequency by more than 50 percent up to and including 100 percent of the authorized bandwidth: At least 25 dB;
  - (2) On any frequency removed from the assigned frequency by more than 100 percent up to and including 250 percent of the authorized bandwidth: At least 35 dB; and
  - (3) On any frequency removed from the assigned frequency by more than 250 percent of the authorized bandwidth: At least 43 plus  $10\log_{10}$  (mean power in watts) dB.

### 7.5.1 E.U.T. Operation

Operating Environment:  
 Temperature: 25.0 °C      Humidity: 55 % RH      Atmospheric Pressure: 1010 mbar  
 Test mode: a: TX mode, Keep the EUT in transmitting mode.

### 7.5.2 E.U.T. Operation

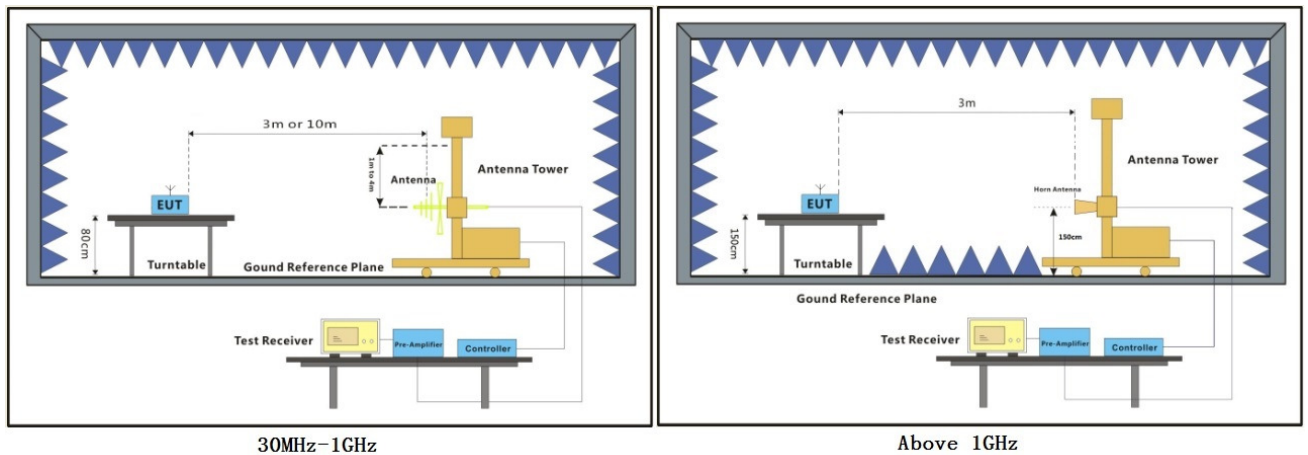

### 7.5.3 Measurement Data

#### Test Procedure:

- (1) On a test site, the EUT shall be placed on a turntable and in the position closest to the normal use as declared by the user.
- (2) The test antenna shall be oriented initially for vertical polarization located 3m from the EUT to correspond to the transmitter.
- (3) The output of the antenna shall be connected to the measuring receiver and either a peak or quasi-peak detector was used for the measurement as indicated on the report. The detector selection is based on how close the emission level was approaching the limit.
- (4) The transmitter shall be switched on; if possible, without the modulation and the measurement receiver shall be tuned to the frequency of the transmitter under test.
- (5) The test antenna shall be raised and lowered through the specified range of height until the measuring receiver detects a maximum signal level.
- (6) The transmitter shall then be rotated through 360° in the horizontal plane, until the maximum signal level is detected by the measuring receiver.
- (7) The test antenna shall be raised and lowered again through the specified range of height until the measuring receiver detects a maximum signal level.
- (8) The maximum signal level detected by the measuring receiver shall be noted.
- (9) The measurement shall be repeated with the test antenna set to horizontal polarization.
- (10) Replace the antenna with a proper Antenna (substitution antenna).
- (11) The substitution antenna shall be oriented for vertical polarization and, if necessary, the length of the substitution antenna shall be adjusted to correspond to the frequency of transmitting.
- (12) The substitution antenna shall be connected to a calibrated signal generator.
- (13) If necessary, the input attenuator setting of the measuring receiver shall be adjusted in order to increase the sensitivity of the measuring receiver.
- (14) The test antenna shall be raised and lowered through the specified range of the height to ensure that the maximum signal is received.
- (15) The input signal to substitution antenna shall be adjusted to the level that produces a level detected by the measuring receiver, that is equal to the level noted while the transmitter radiated power was measured, corrected for the change of input attenuation setting of the measuring receiver.
- (16) The input level to the substitution antenna shall be recorded as power level in dBm, corrected for any change of input attenuator setting of the measuring receiver.
- (17) The measurement shall be repeated with the test antenna and the substitution antenna oriented for horizontal polarization.

The detailed test data see: Appendix FCC data.

## 7.6 Modulation Requirements

Test Requirement: 47 CFR FCC Part2.1047 & FCC Part 80.213(a)  
Test Method: ANSI/TIA-603-E:2016  
Limit:

(a) Transmitters must meet the following modulation requirements:

- (1) When double sideband emission is used the peak modulation must be maintained between 75 and 100 percent;
- (2) When phase or frequency modulation is used in the 156-162 MHz band the peak modulation must be maintained between 75 and 100 percent. A frequency deviation of  $\pm 5$  kHz is defined as 100 percent peak modulation; and
- (3) In single sideband operation the upper sideband must be transmitted. Single sideband transmitters must automatically limit the peak envelope power to their authorized operating power and meet the requirements in §80.207(c).

### 7.6.1 E.U.T. Operation

Operating Environment:  
Temperature: 25.0 °C      Humidity: 54 % RH      Atmospheric Pressure: 1010 mbar  
Test mode: a: TX mode, Keep the EUT in transmitting mode.

### 7.6.2 Test Setup Diagram

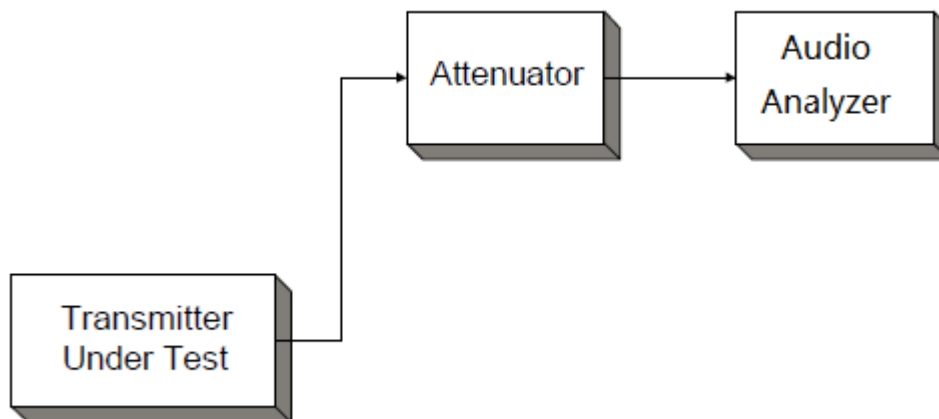

### 7.6.3 Measurement Data

The detailed test data see: Appendix FCC data.

## 7.7 Transmitter Frequency Deviation

Test Requirement: 47 CFR FCC Part 2.1047 & FCC Part 80.213(d)  
 Test Method: ANSI/TIA-603-E:2016  
 Limit:

(d) Ship and coast station transmitters operating in the 156-162 MHz and 216-220 bands must be capable of proper operation with a frequency deviation that does not exceed  $\pm 5$  kHz when using any emission authorized by §80.207.

### 7.7.1 E.U.T. Operation

Operating Environment:  
 Temperature: 25.0 °C      Humidity: 54 % RH      Atmospheric Pressure: 1010 mbar  
 Test mode: a: TX mode, Keep the EUT in transmitting mode.

### 7.7.2 Test Setup Diagram

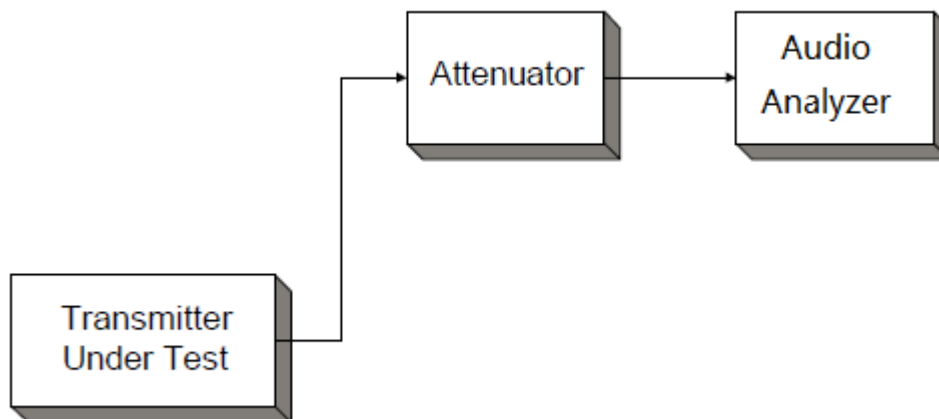

### 7.7.3 Measurement Data

The detailed test data see: Appendix FCC data.

**7.8 Transmitter Power**

Test Requirement: 47 CFR FCC Part2.1046 & FCC Part 80.215  
Test Method: ANSI/TIA-603-E:2016  
Limit:

e) Ship stations frequencies above 27500 kHz. The maximum power must not exceed the values listed below.

(1) Ship stations 156-162 MHz—25W<sup>6</sup>

<sup>6</sup>Reducible to 1 watt or less, except for transmitters limited to public correspondence channels and used in an automated system.

(g) The carrier power of ship station radiotelephone transmitters, except portable transmitters, operating in the 156-162 MHz band must be at least 8 but not more than 25 watts. Transmitters that use 12 volt lead acid storage batteries as a primary power source must be measured with a primary voltage between 12.2 and 13.7 volts DC. Additionally, unless otherwise indicated, equipment in radiotelephone ship stations operating in the 156-162 MHz band must meet the following requirements:

(1) All transmitters and remote control units must be capable of reducing the carrier power to one watt or less;

(2) Except as indicated in (g)(4) of this section, all transmitters manufactured after January 21, 1987, or in use after January 21, 1997, must automatically reduce the carrier power to one watt or less when the transmitter is tuned to 156.375 MHz or 156.650 MHz, and must be provided with a manual override switch which when held by an operator will permit full carrier power operation on 156.375 MHz and 156.650 MHz;

**7.8.1 E.U.T. Operation**

Operating Environment:  
Temperature: 25.0 °C      Humidity: 55 % RH      Atmospheric Pressure: 1010 mbar  
Test mode: a: TX mode, Keep the EUT in transmitting mode.

**7.8.2 Test Setup Diagram**

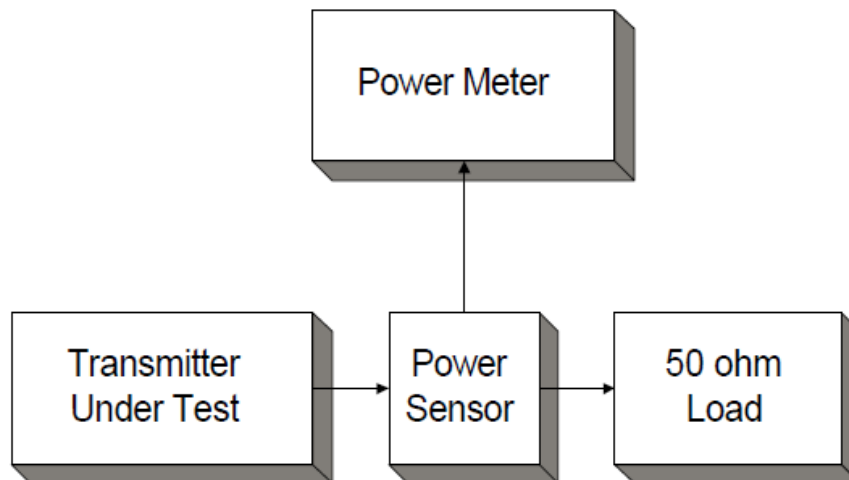

**7.8.3 Measurement Data**

The detailed test data see: Appendix FCC data.



**7.9 Transmitter Carrier Power Reduction**

Test Requirement 47 CFR FCC Part 80.215  
 Test Method: ANSI/TIA-603-E:2016  
 Limit:

e) Ship stations frequencies above 27500 kHz. The maximum power must not exceed the values listed below.

(1) Ship stations 156-162 MHz—25W<sup>6</sup>

<sup>6</sup>Reducible to 1 watt or less, except for transmitters limited to public correspondence channels and used in an automated system.

(g) The carrier power of ship station radiotelephone transmitters, except portable transmitters, operating in the 156-162 MHz band must be at least 8 but not more than 25 watts. Transmitters that use 12 volt lead acid storage batteries as a primary power source must be measured with a primary voltage between 12.2 and 13.7 volts DC. Additionally, unless otherwise indicated, equipment in radiotelephone ship stations operating in the 156-162 MHz band must meet the following requirements:

(1) All transmitters and remote control units must be capable of reducing the carrier power to one watt or less;

(2) Except as indicated in (g)(4) of this section, all transmitters manufactured after January 21, 1987, or in use after January 21, 1997, must automatically reduce the carrier power to one watt or less when the transmitter is tuned to 156.375 MHz or 156.650 MHz, and must be provided with a manual override switch which when held by an operator will permit full carrier power operation on 156.375 MHz and 156.650 MHz;

**7.9.1 E.U.T. Operation**

Operating Environment:  
 Temperature: 25.0 °C Humidity: 55 % RH Atmospheric Pressure: 1010 mbar  
 Test mode: a: TX mode, Keep the EUT in transmitting mode.

**7.9.2 Test Setup Diagram**

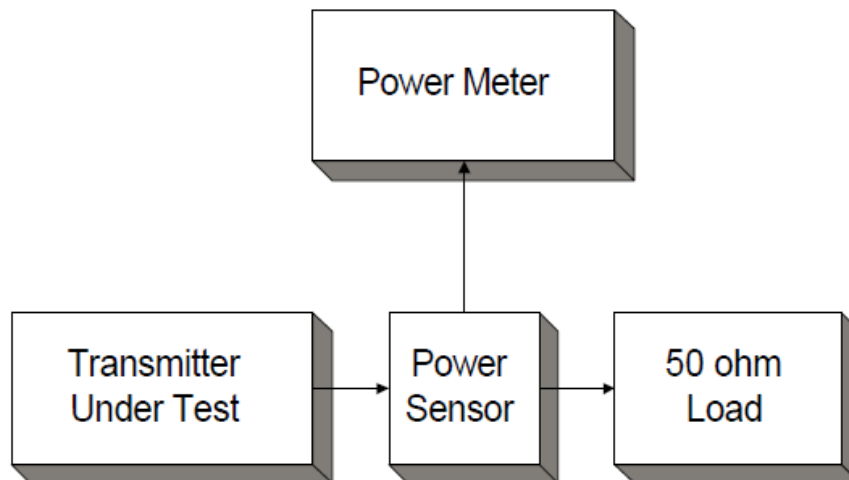

**7.9.3 Measurement Data**

The detailed test data see: Appendix FCC data.

### 7.10 Suppression of interference aboard ships

Test Requirement 47 CFR FCC Part 80.217  
Test Method: ANSI/TIA-603-E:2016  
Limit:

(a) A voluntarily equipped ship station receiver must not cause harmful interference to any receiver required by statute or treaty.

(b) The electromagnetic field from receivers required by statute or treaty must not exceed the following value at a distance over sea water of one nautical mile from the receiver:

Frequency of interfering emissions	Field intensity in microvolts per meter
Below 30 MHz	0.1
30 to 100 MHz	0.3
100 to 300 MHz	1.0
Over 300 MHz	3.0

Or

Deliver not more than the following amounts of power, to an artificial antenna having electrical characteristics equivalent to those of the average receiving antenna(s) use on shipboard:

Frequency of interfering emissions	Power to artificial antenna in microwatts
Below 30 MHz	400(-3.98dBm)
30 to 100 MHz	4,000(6.02dBm)
100 to 300 MHz	40,000(16.02dBm)
Over 300 MHz	400,000(36.02dBm)

#### 7.10.1 E.U.T. Operation

Operating Environment:

Temperature: 25.0 °C Humidity: 55 % RH Atmospheric Pressure: 1010 mbar

Test mode: a: TX mode, Keep the EUT in transmitting mode.

#### 7.10.2 E.U.T. Operation

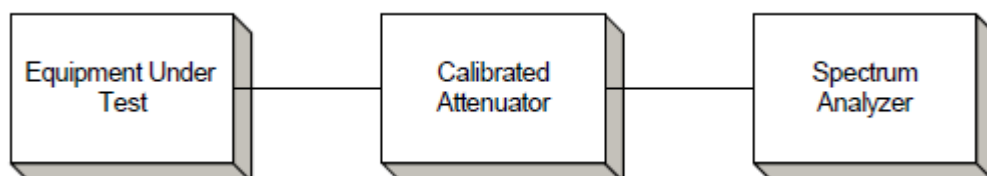

#### 7.10.3 Measurement Data

The detailed test data see: Appendix FCC data.



## **8 Photographs**

### **8.1 Test Setup**

Please refer to setup photos.

### **8.2 EUT Constructional Details**

Please Refer to external and internal photos for details.

## 9 Appendix

### 9.1 Appendix FCC data.

#### 1.Occupied Bandwidth

Test Frequency (MHz)	Modulation Type	Power Level	99% Occupied Bandwidth (kHz)	26dB Bandwidth (kHz)	Limit (kHz)
156.025	FM/G3E	Max	14.90	15.61	N/A
		Low	14.95	15.61	N/A
156.3		Max	15.10	15.53	N/A
		Low	15.10	15.70	N/A
156.8		Max	15.10	15.70	N/A
		Low	14.80	15.70	N/A
156.65		Max	14.80	15.56	N/A
		Low	15.10	15.72	N/A
157.425		Max	15.00	15.60	N/A
		Low	15.00	15.65	N/A
156.525	FM/G2B (dsc-1300Hz)	Max	12.35	14.65	N/A
		Low	8.10	10.70	N/A
	FM/G2B dsc-2100Hz	Max	13.05	17.35	N/A
		Low	13.05	17.40	N/A



99% Occupied Bandwidth

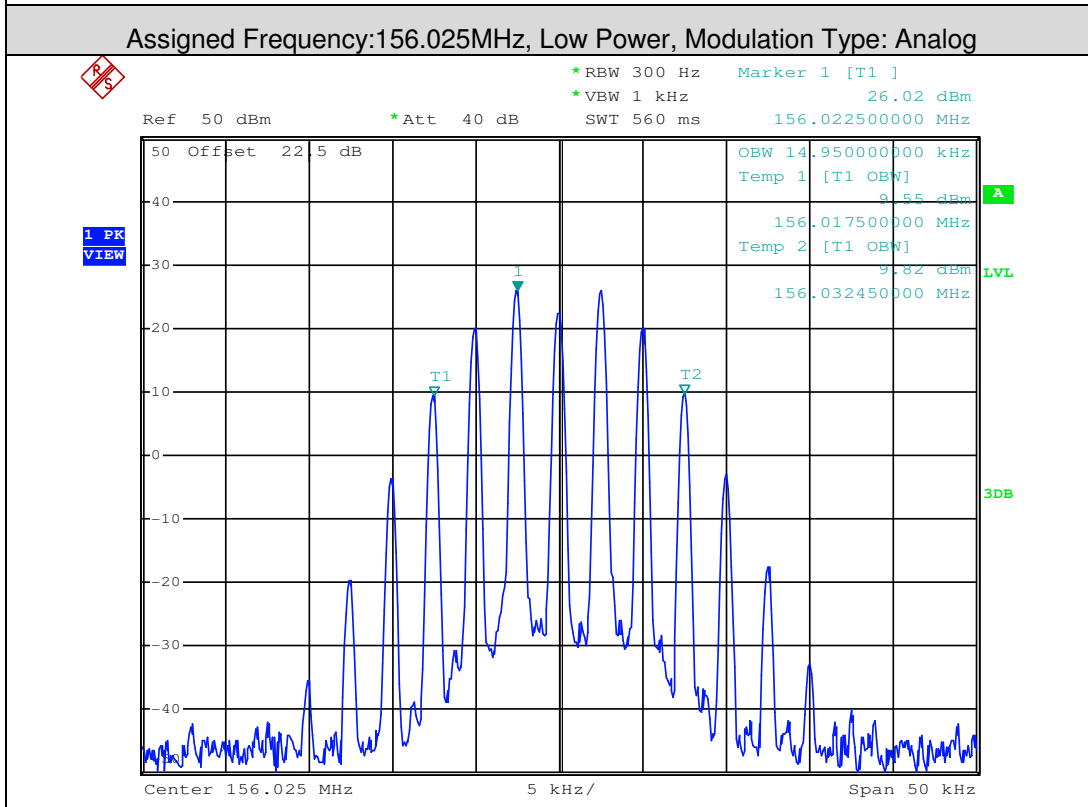
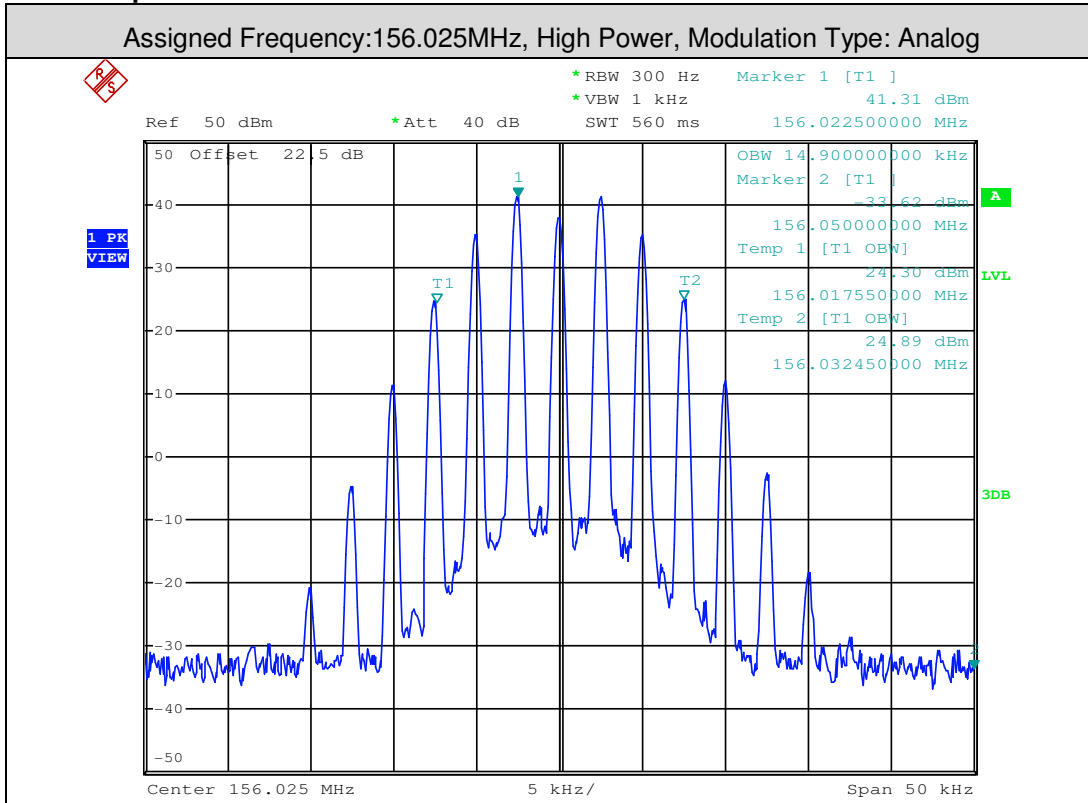

This document is issued by the Company subject to its General Conditions of Service printed overleaf, available on request or accessible at <http://www.sgs.com/en/Terms-and-Conditions.aspx> and, for electronic format documents, subject to Terms and Conditions for Electronic Documents at <http://www.sgs.com/en/Terms-and-Conditions/Terms-e-Document.aspx>. Attention is drawn to the limitation of liability, indemnification and jurisdiction issues defined therein. Any holder of this document is advised that information contained hereon reflects the Company's findings at the time of its intervention only and within the limits of Client's instructions, if any. The Company's sole responsibility is to its Client and this document does not exonerate parties to a transaction from exercising all their rights and obligations under the transaction documents. This document cannot be reproduced except in full, without prior written approval of the Company. Any unauthorized alteration, forgery or falsification of the content or appearance of this document is unlawful and offenders may be prosecuted to the fullest extent of the law. Unless otherwise stated the results shown in this test report refer only to the sample(s) tested and such sample(s) are retained for 30 days only.

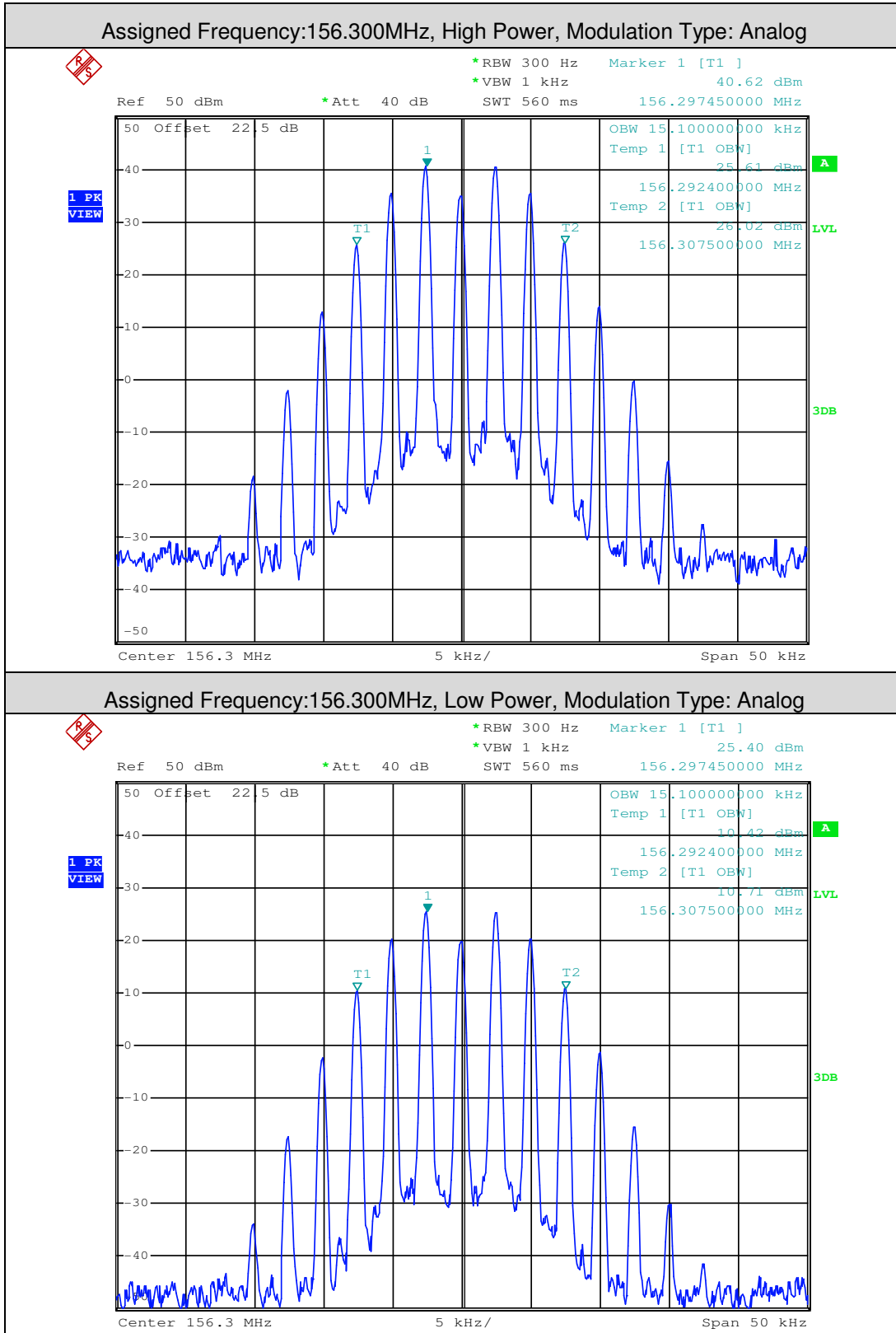

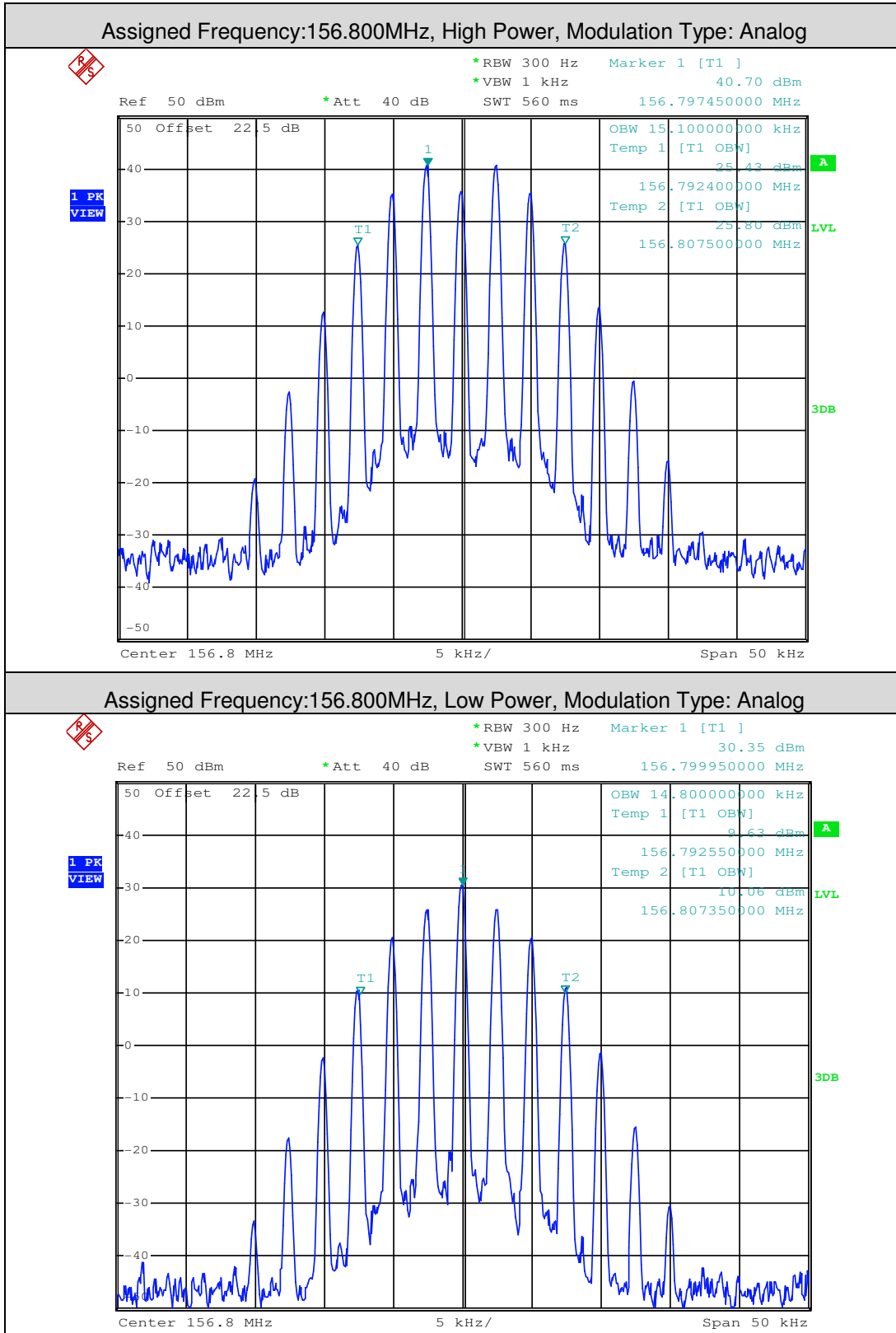

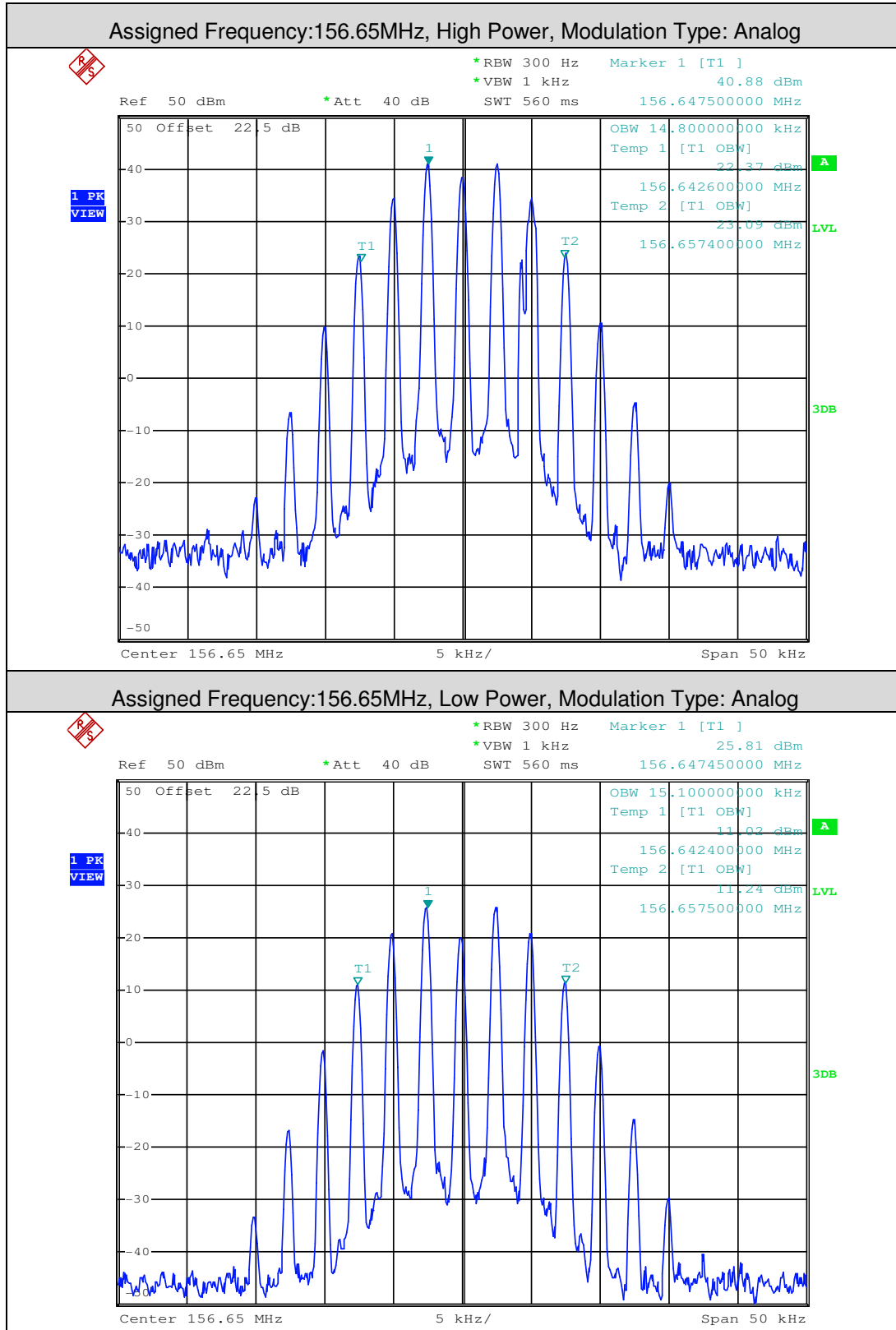



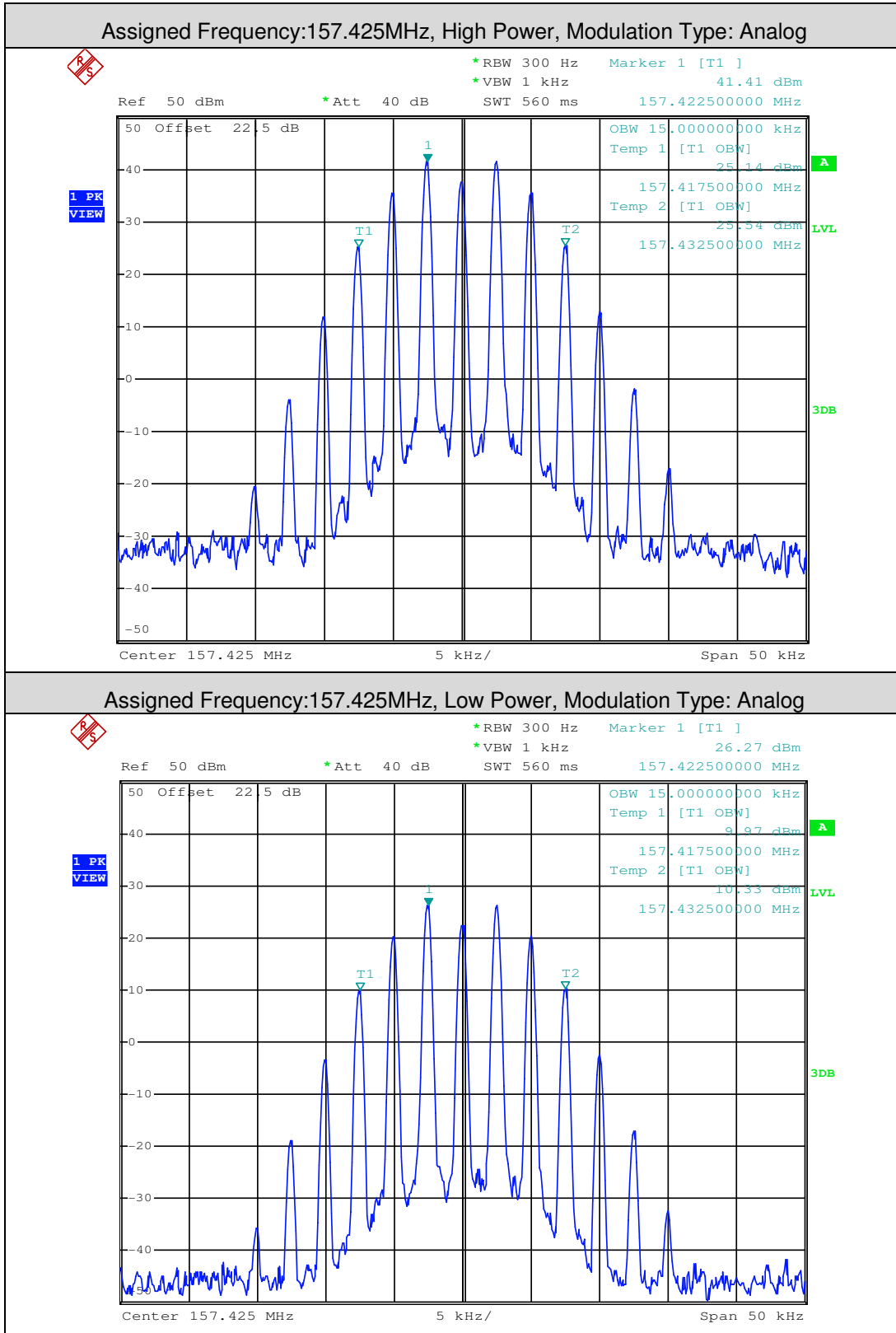

26dB Bandwidth

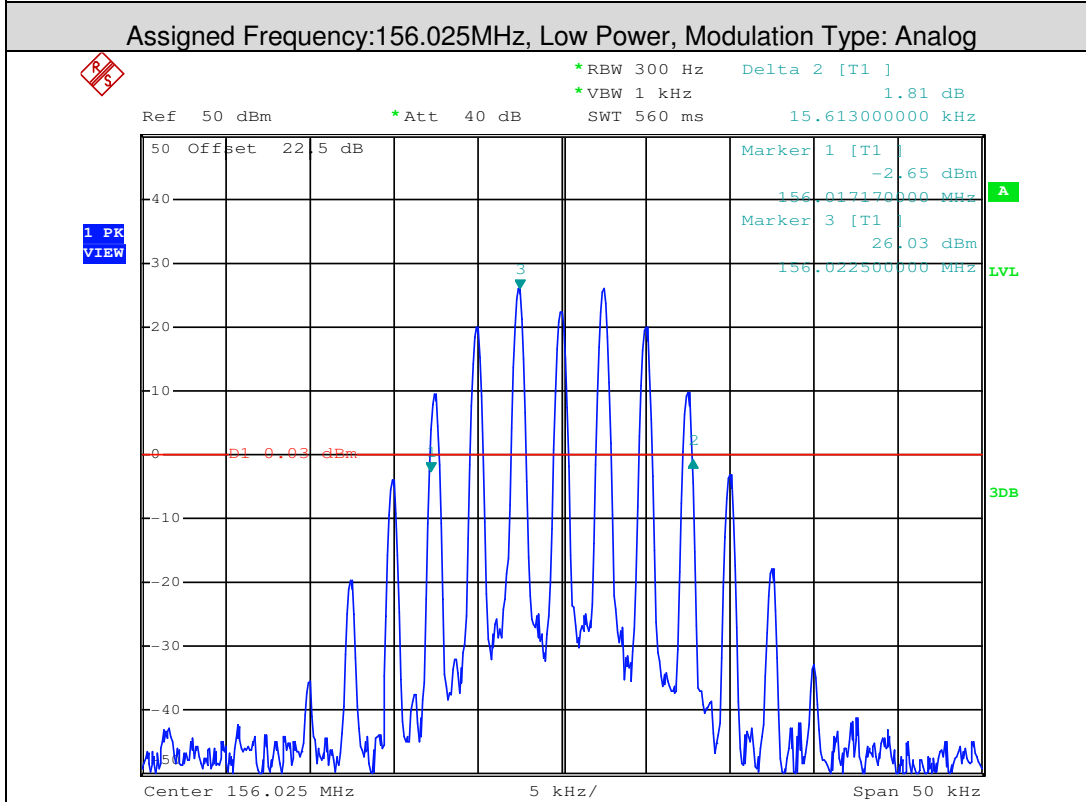
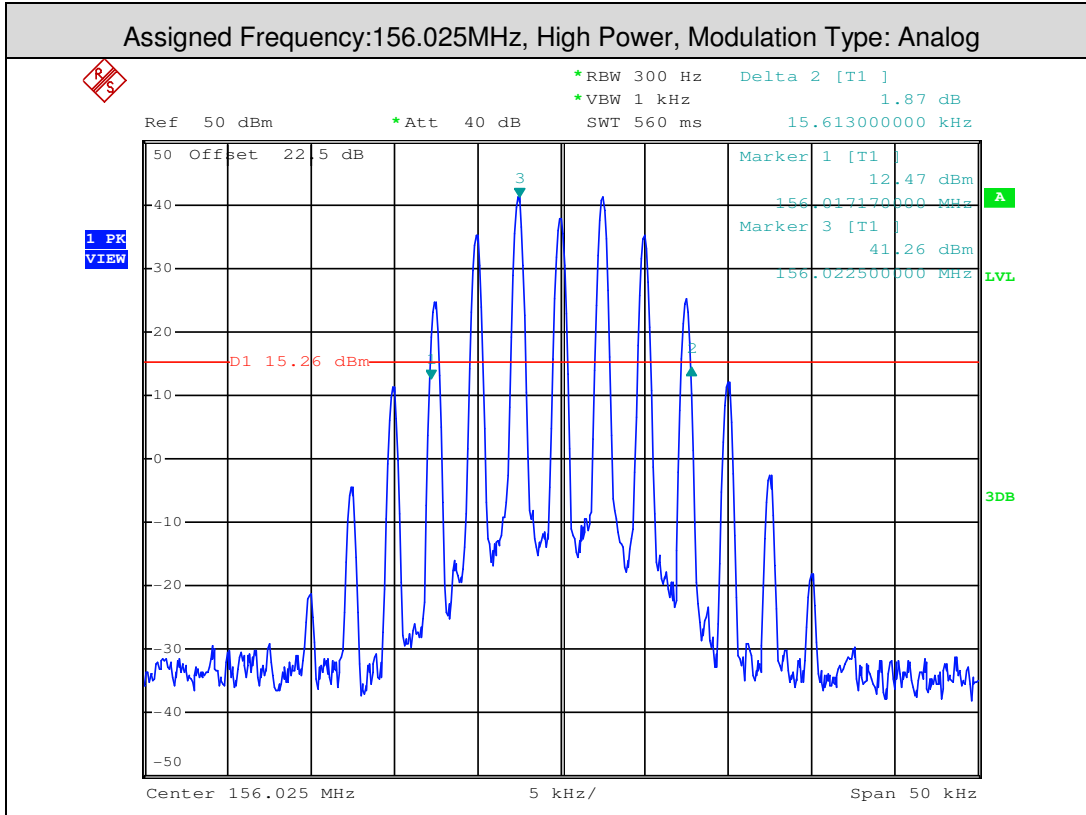

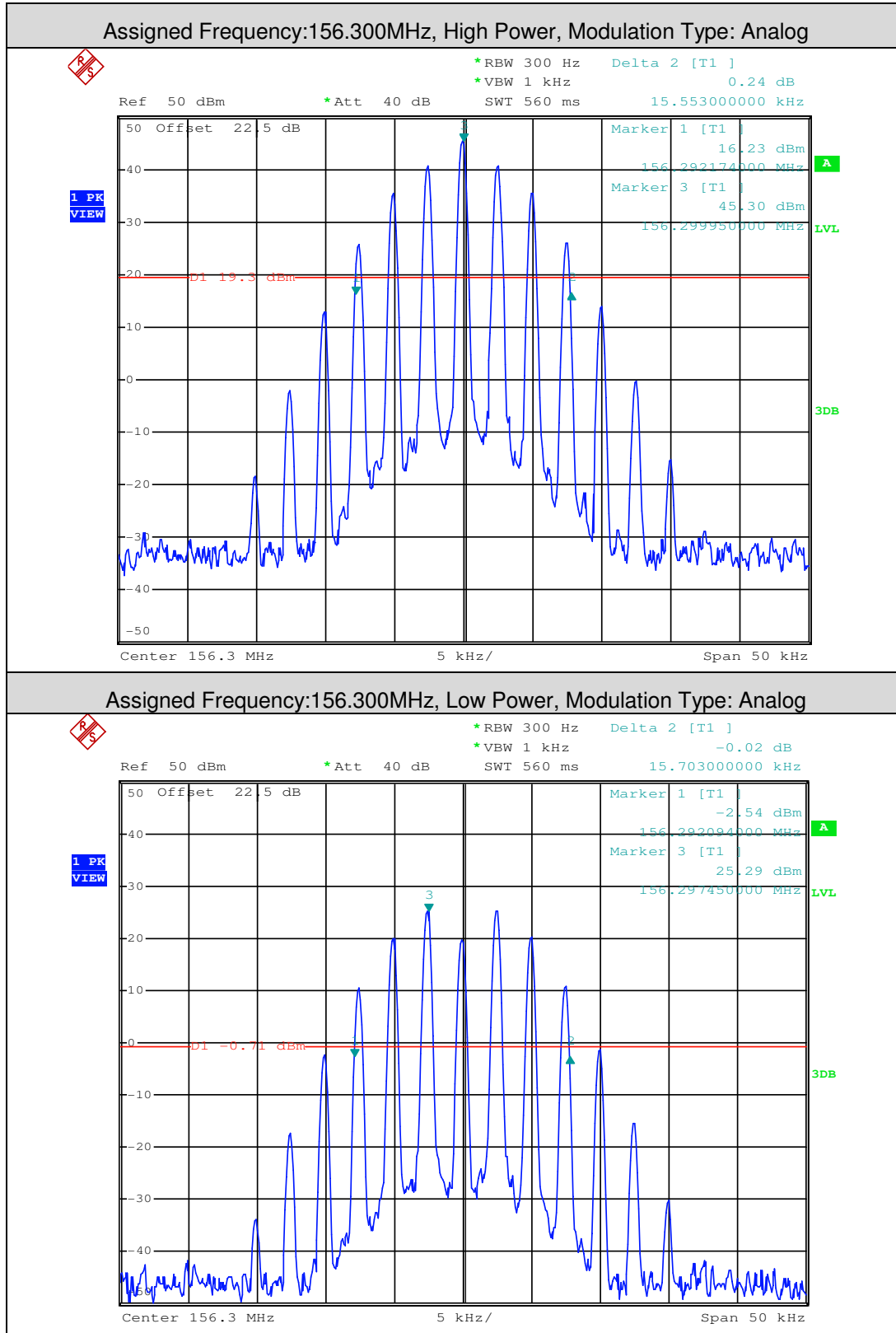

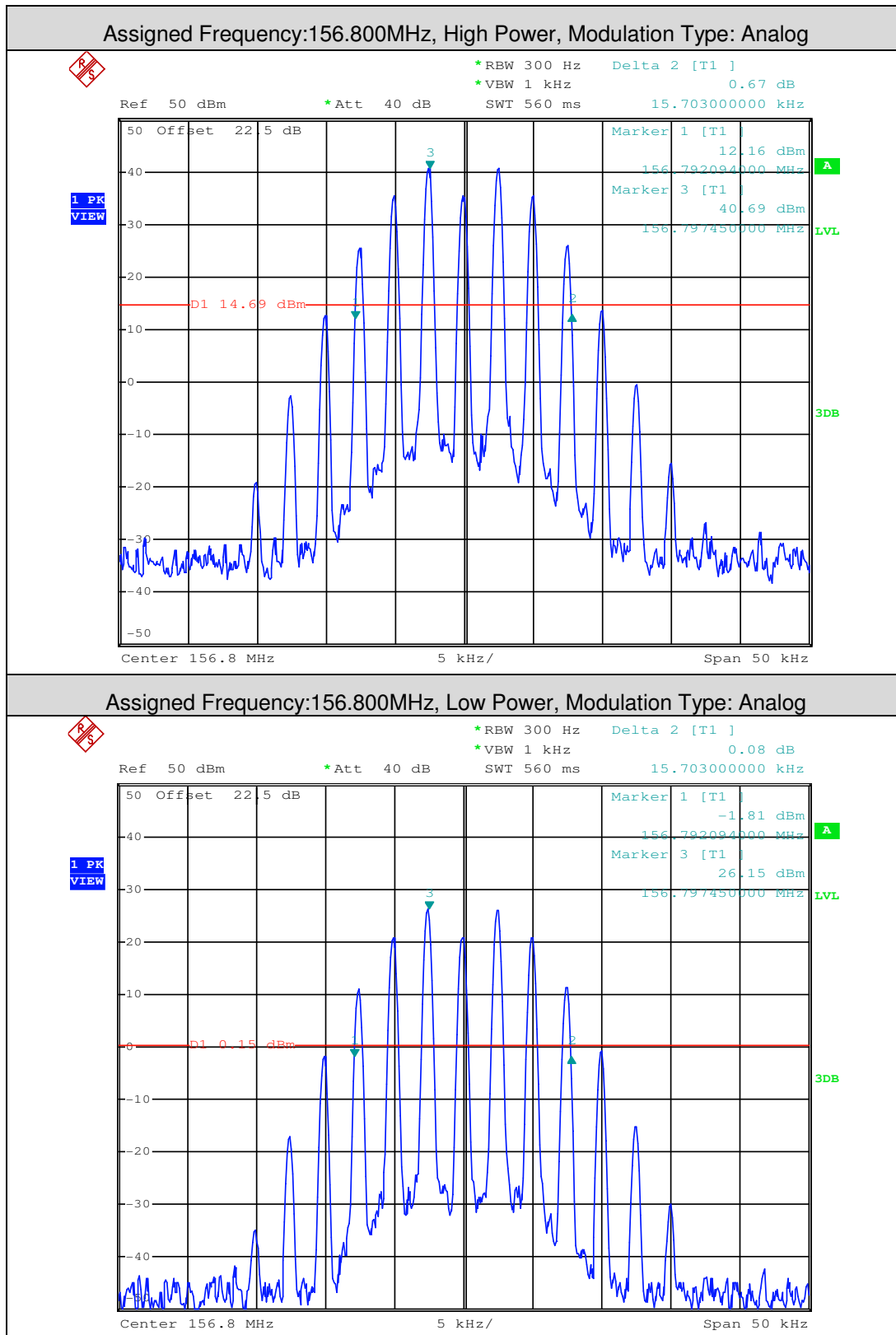

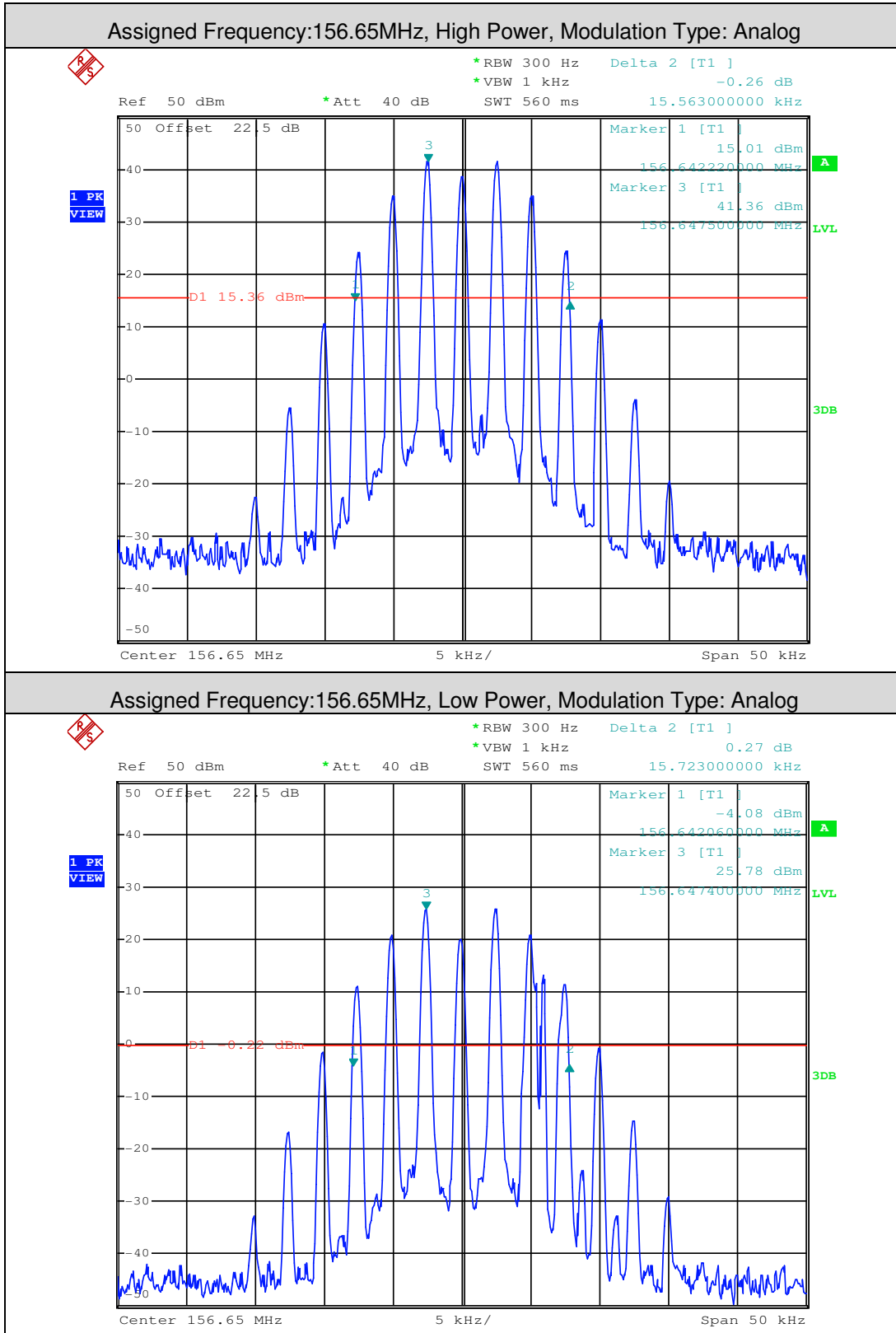

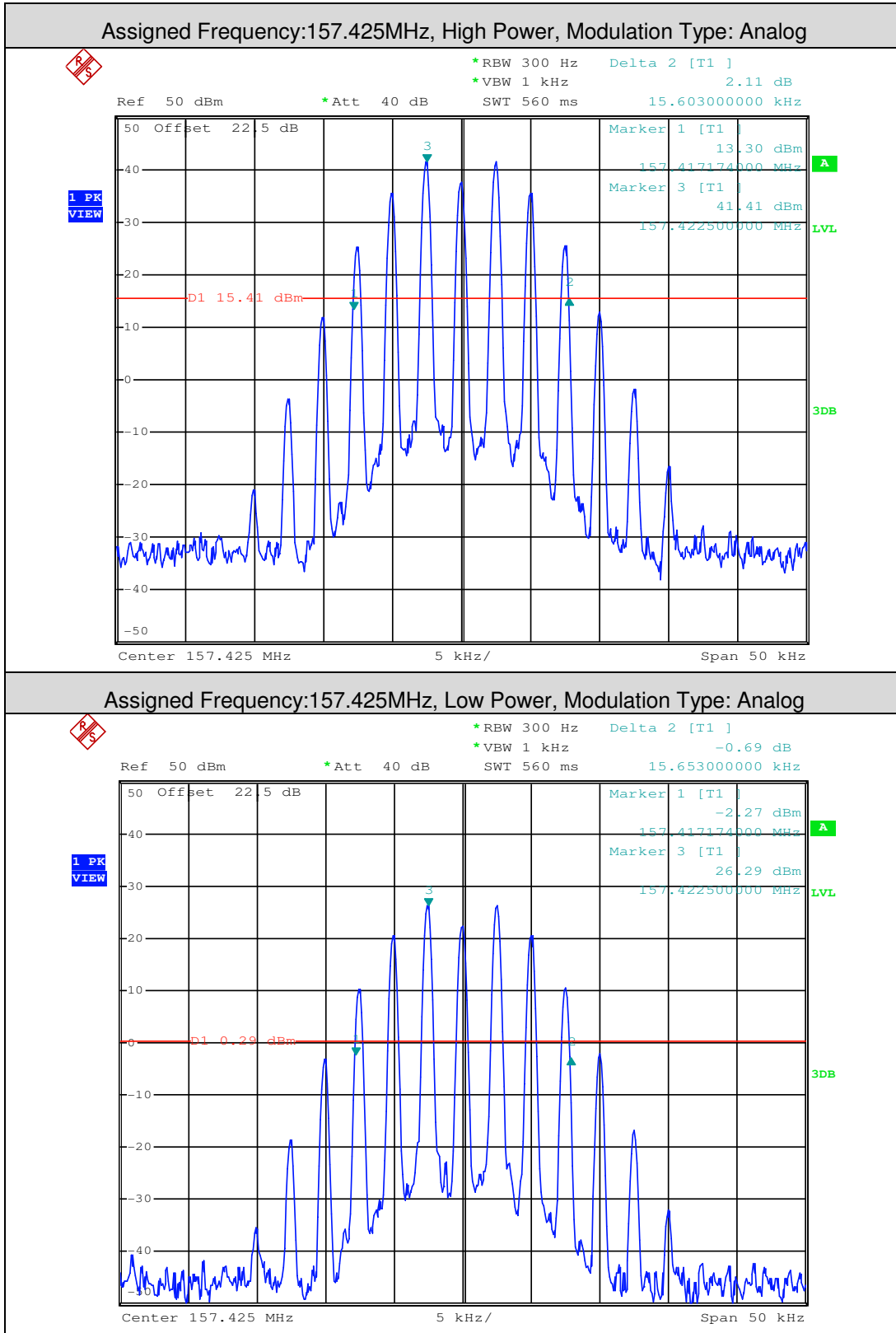

Test data for DSC mode

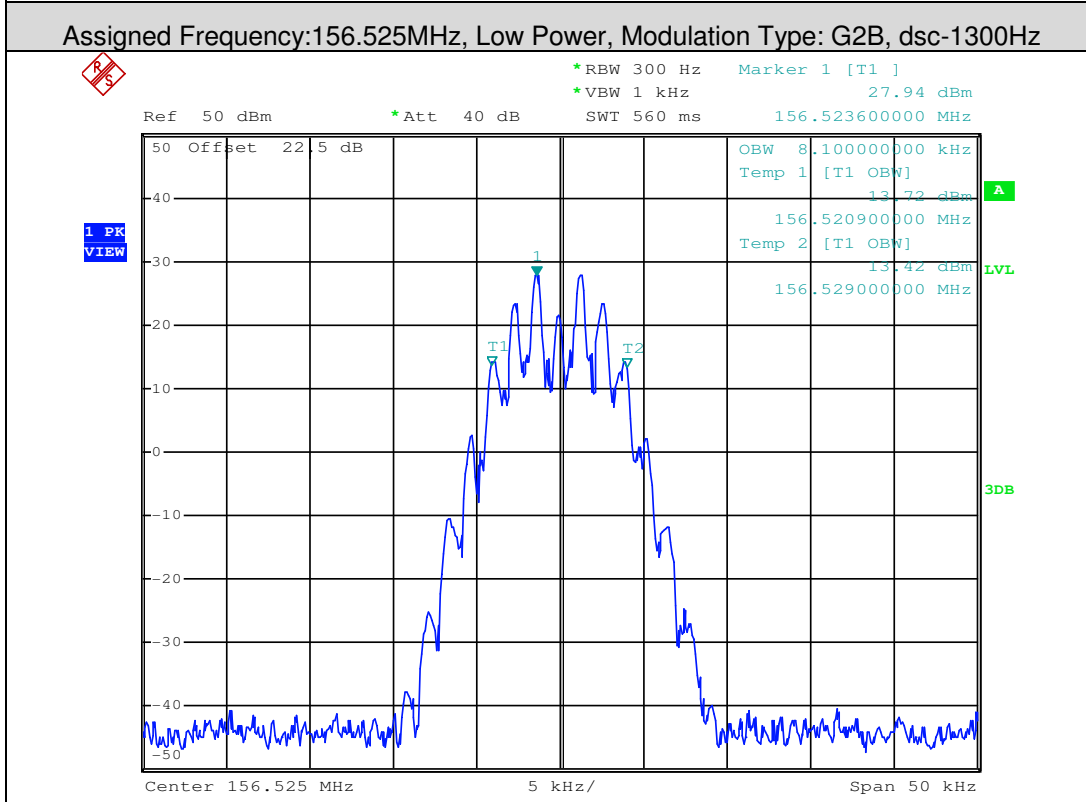
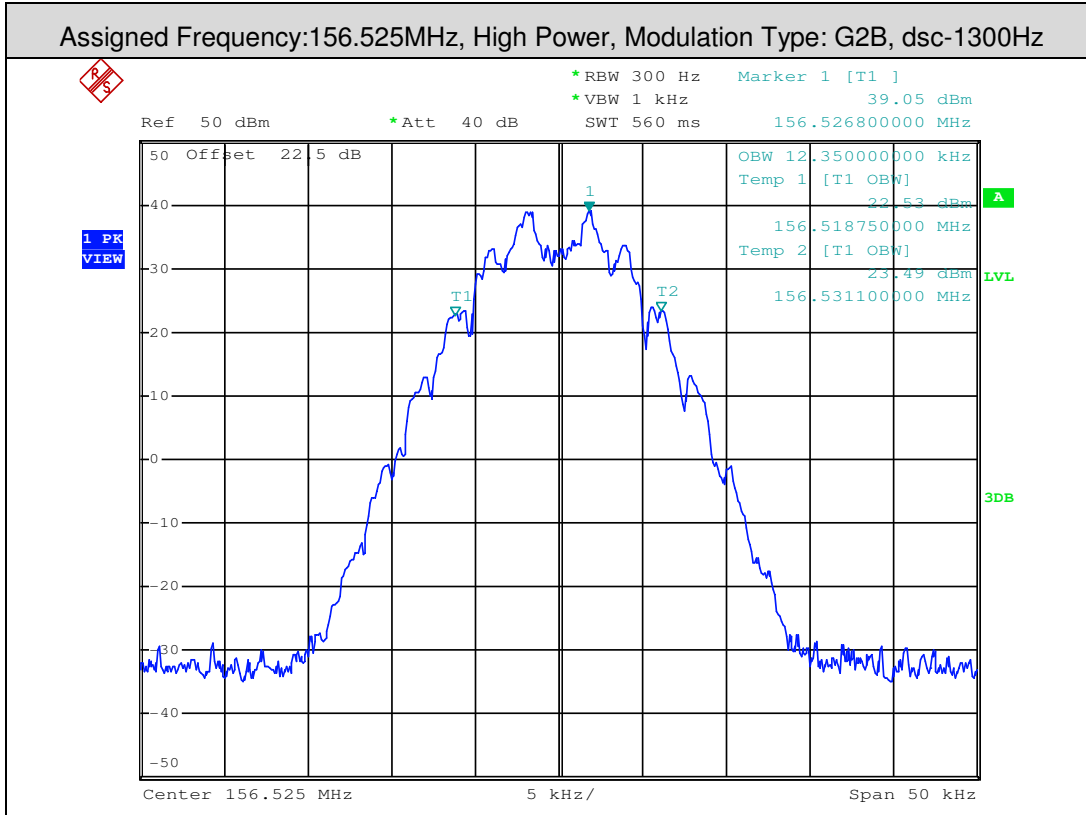



Assigned Frequency:156.525MHz, High Power, Modulation Type: G2B, dsc-2100Hz

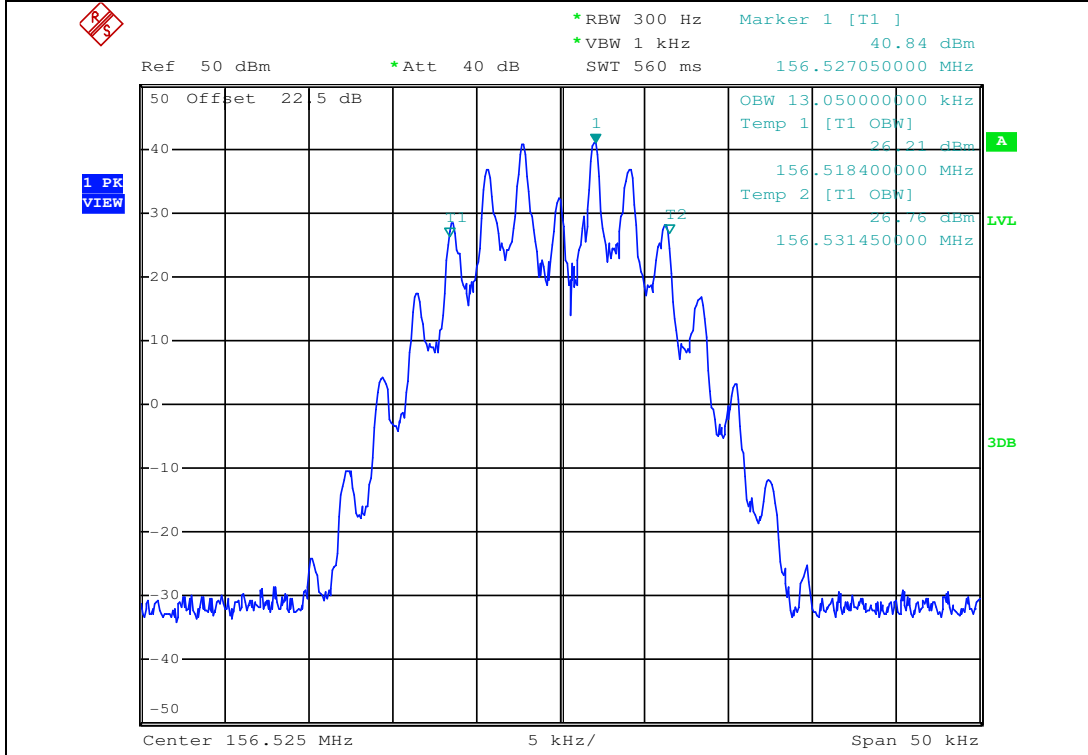

Assigned Frequency:156.525MHz, Low Power, Modulation Type: G2B, dsc-2100Hz

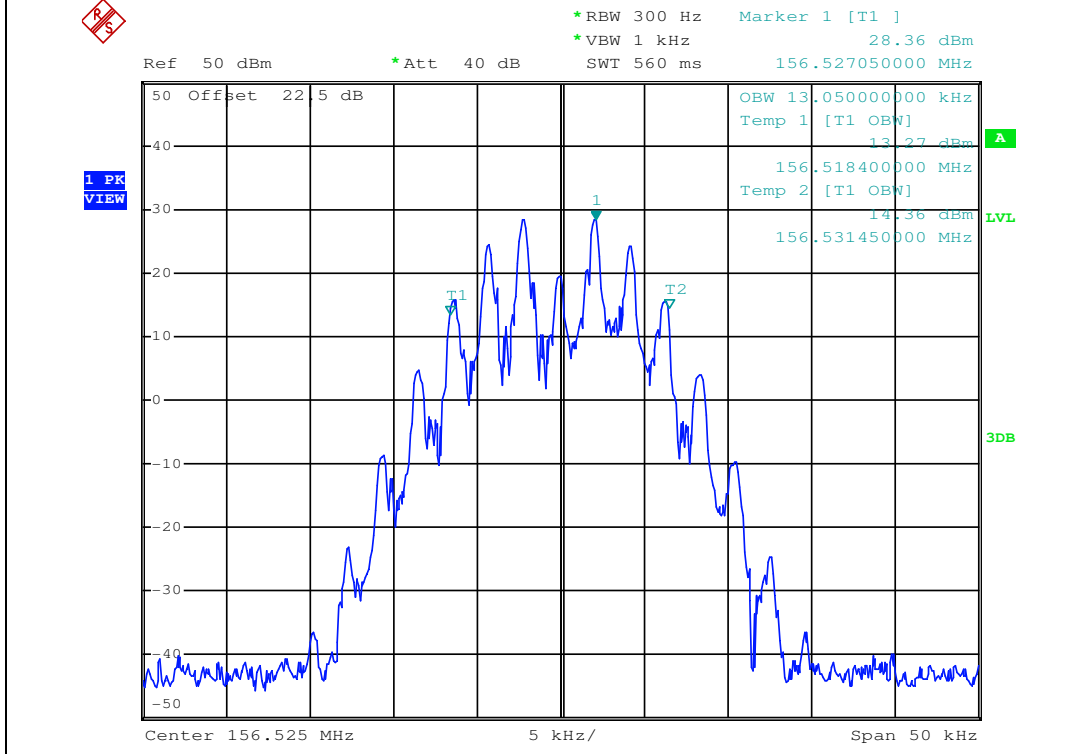

This document is issued by the Company subject to its General Conditions of Service printed overleaf, available on request or accessible at <http://www.sgs.com/en/Terms-and-Conditions.aspx> and, for electronic format documents, subject to Terms and Conditions for Electronic Documents at <http://www.sgs.com/en/Terms-and-Conditions/Terms-e-Document.aspx>. Attention is drawn to the limitation of liability, indemnification and jurisdiction issues defined therein. Any holder of this document is advised that information contained hereon reflects the Company's findings at the time of its intervention only and within the limits of Client's instructions, if any. The Company's sole responsibility is to its Client and this document does not exonerate parties to a transaction from exercising all their rights and obligations under the transaction documents. This document cannot be reproduced except in full, without prior written approval of the Company. Any unauthorized alteration, forgery or falsification of the content or appearance of this document is unlawful and offenders may be prosecuted to the fullest extent of the law. Unless otherwise stated the results shown in this test report refer only to the sample(s) tested and such sample(s) are retained for 30 days only.





**2. Transmitter Frequency Tolerances.**

Unmodulated, Assigned Frequency:156.025MHz					
Voltage(V)	Temperature (°C)	Measured Frequency(MHz)	Frequency Error(ppm)	FCC Limit (ppm)	Result
12	-20	156.025072	0.461	±10	Pass
	-15	156.025081	0.519		
	-10	156.025075	0.481		
	0	156.025068	0.436		
	10	156.025072	0.461		
	20	156.025056	0.359		
	30	156.025082	0.526		
	40	156.025073	0.468		
	50	156.025055	0.353		
	55	156.025017	0.109		
10.2	25	156.025064	0.410		
13.8	25	156.025059	0.378		

Unmodulated, Assigned Frequency:157.425MHz					
Voltage(V)	Temperature (°C)	Measured Frequency(MHz)	Frequency Error(ppm)	FCC Limit (ppm)	Result
12	-20	157.425095	0.603	±10	Pass
	-15	157.425099	0.629		
	-10	157.425084	0.534		
	0	157.425079	0.502		
	10	157.425087	0.553		
	20	157.425059	0.375		
	30	157.425086	0.546		
	40	157.425097	0.616		
	50	157.425076	0.483		
	55	157.425088	0.559		
10.2	25	157.425054	0.343		
13.8	25	157.425059	0.375		

3. Emission Mask

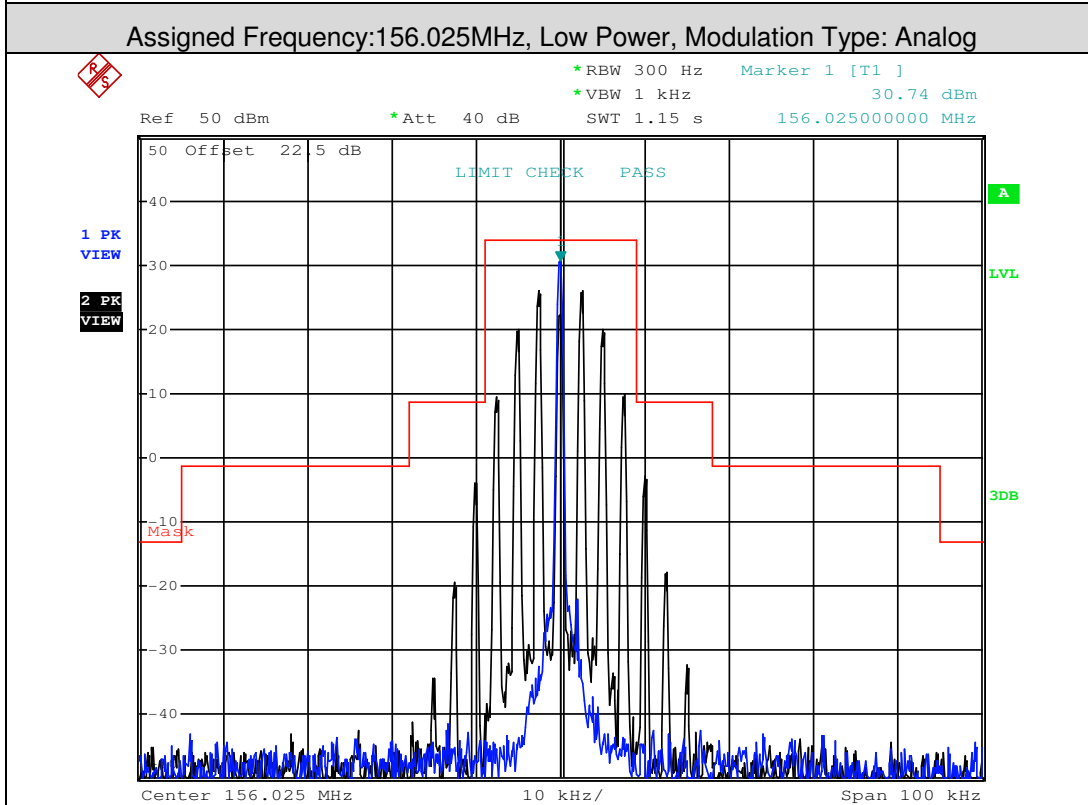
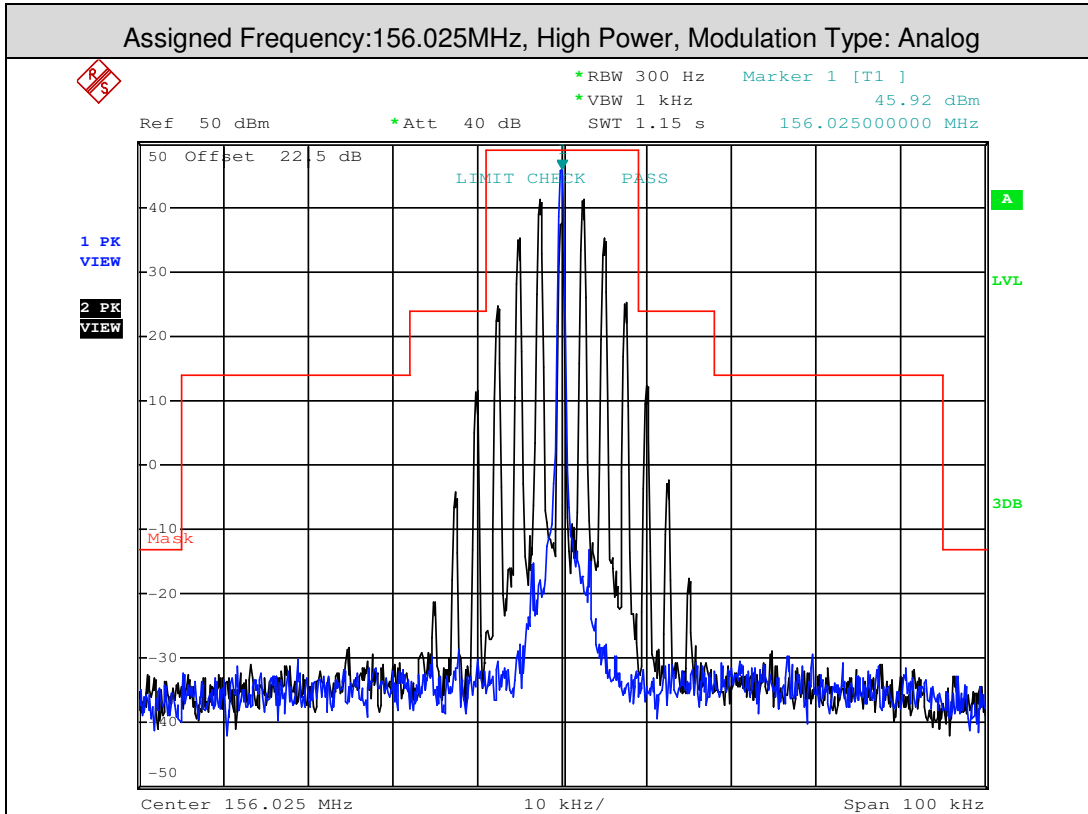

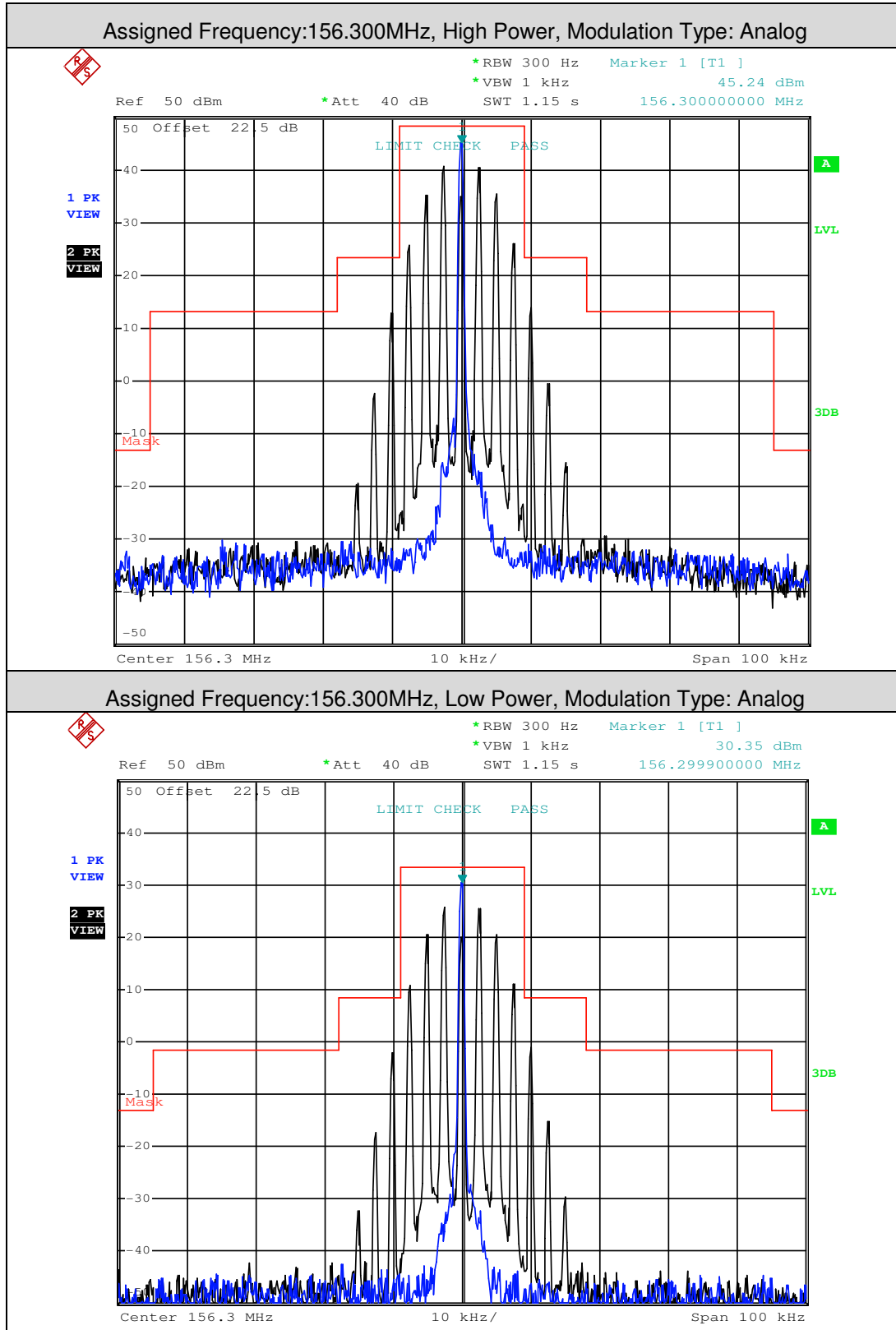

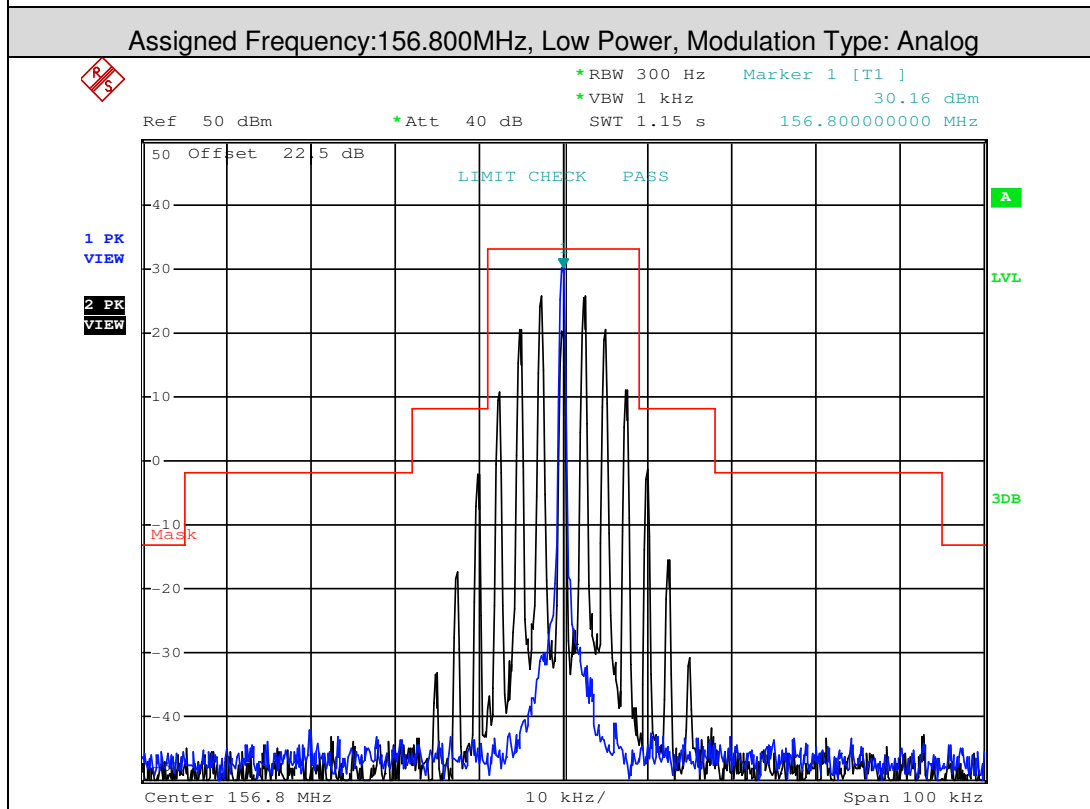
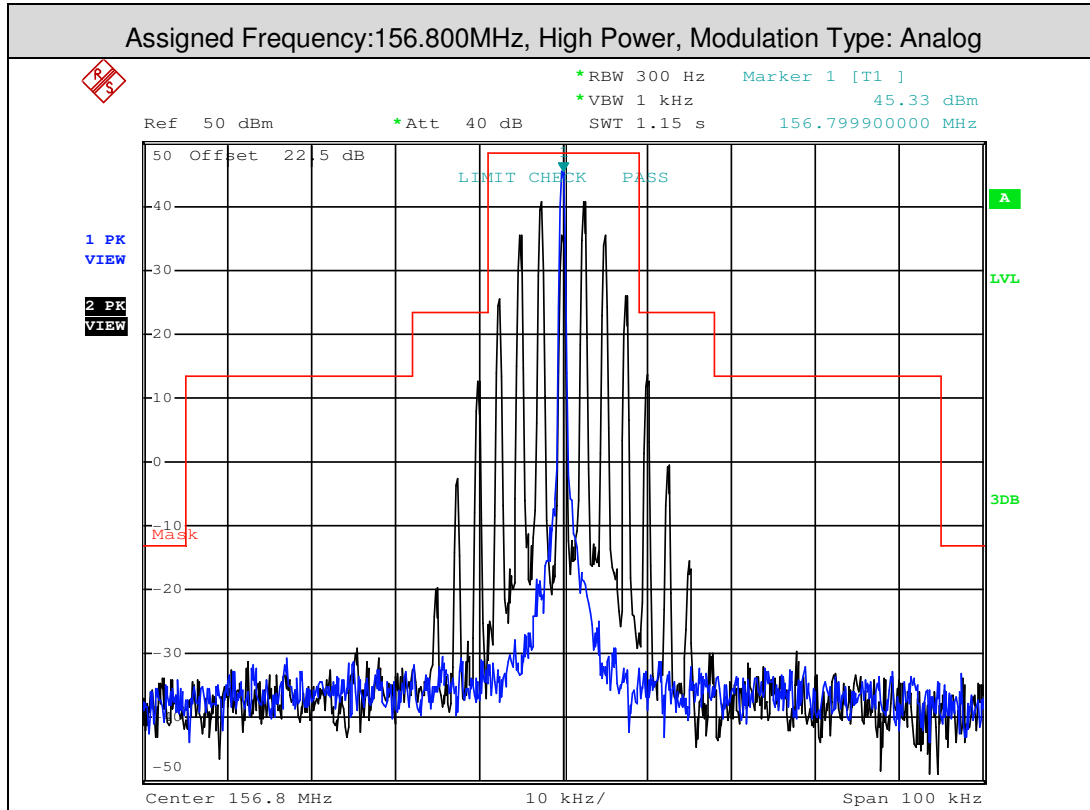

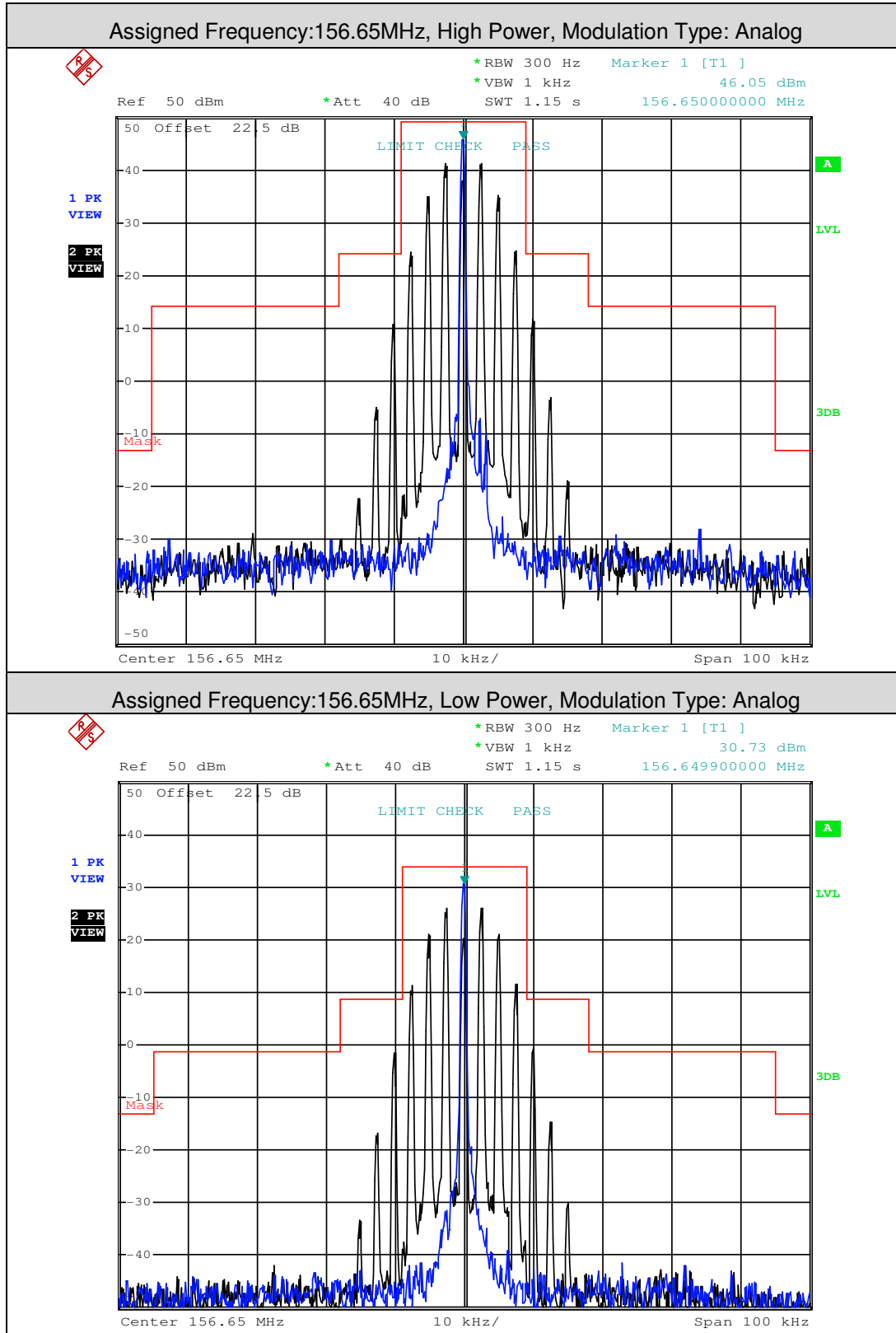

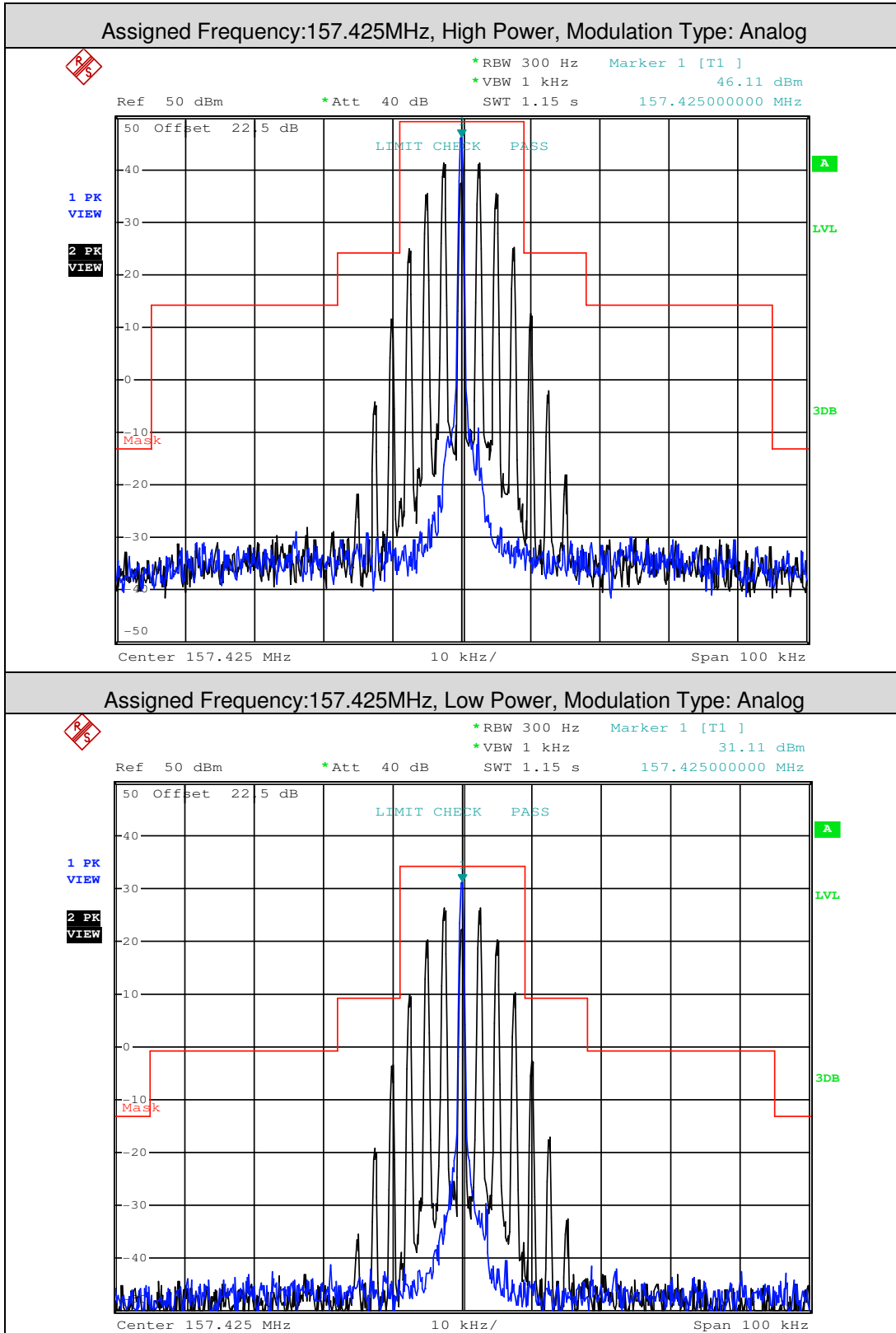

Assigned Frequency:156.525MHz, High Power, Modulation Type: G2B, dsc-1300Hz

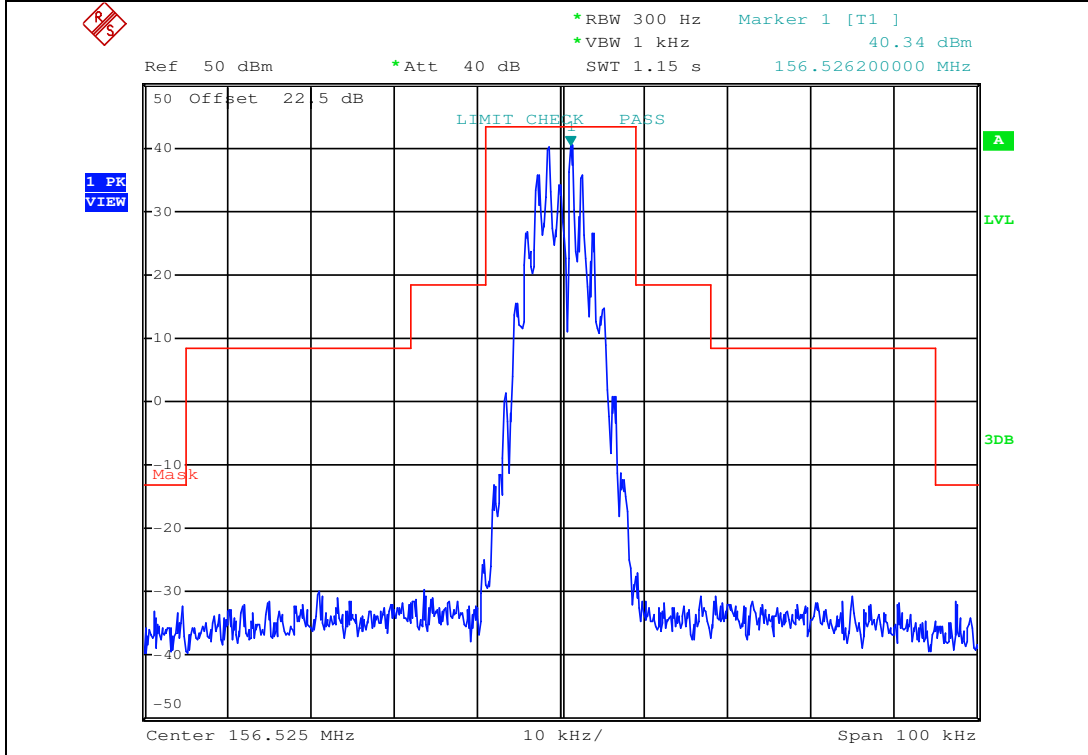

Assigned Frequency:156.525MHz, Low Power, Modulation Type: G2B, dsc-1300Hz

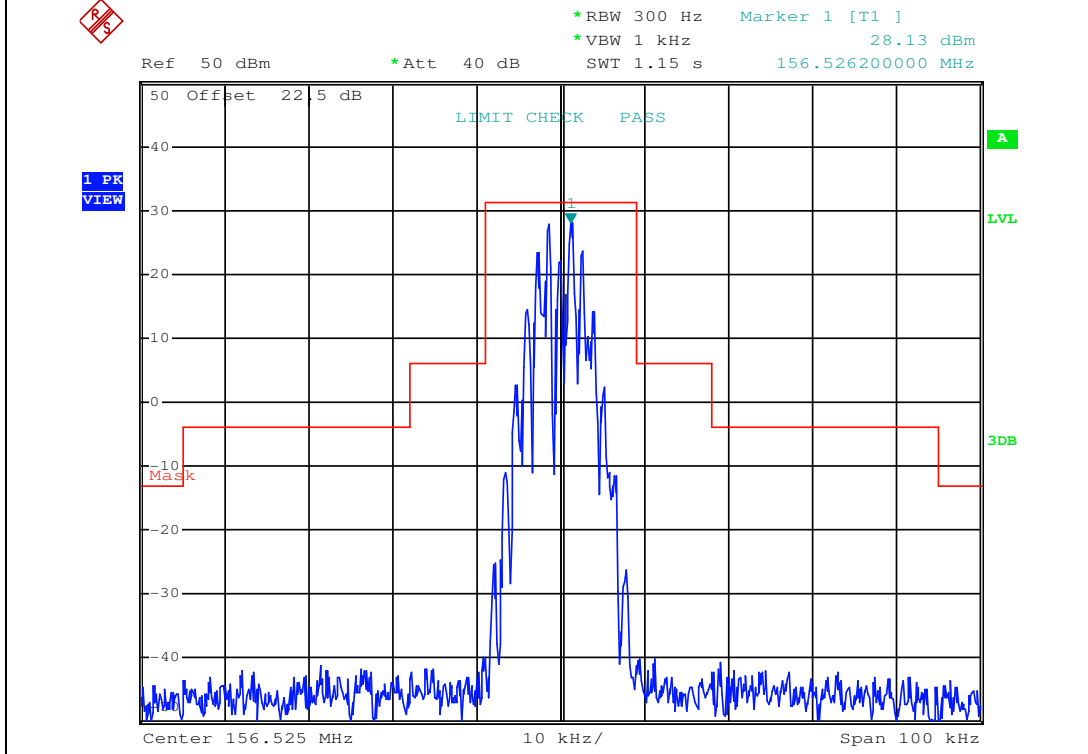

This document is issued by the Company subject to its General Conditions of Service printed overleaf, available on request or accessible at <http://www.sgs.com/en/Terms-and-Conditions.aspx> and, for electronic format documents, subject to Terms and Conditions for Electronic Documents at <http://www.sgs.com/en/Terms-and-Conditions/Terms-e-Document.aspx>. Attention is drawn to the limitation of liability, indemnification and jurisdiction issues defined therein. Any holder of this document is advised that information contained hereon reflects the Company's findings at the time of its intervention only and within the limits of Client's instructions, if any. The Company's sole responsibility is to its Client and this document does not exonerate parties to a transaction from exercising all their rights and obligations under the transaction documents. This document cannot be reproduced except in full, without prior written approval of the Company. Any unauthorized alteration, forgery or falsification of the content or appearance of this document is unlawful and offenders may be prosecuted to the fullest extent of the law. Unless otherwise stated the results shown in this test report refer only to the sample(s) tested and such sample(s) are retained for 30 days only.



Assigned Frequency:156.525MHz, High Power, Modulation Type: G2B, dsc-2100Hz

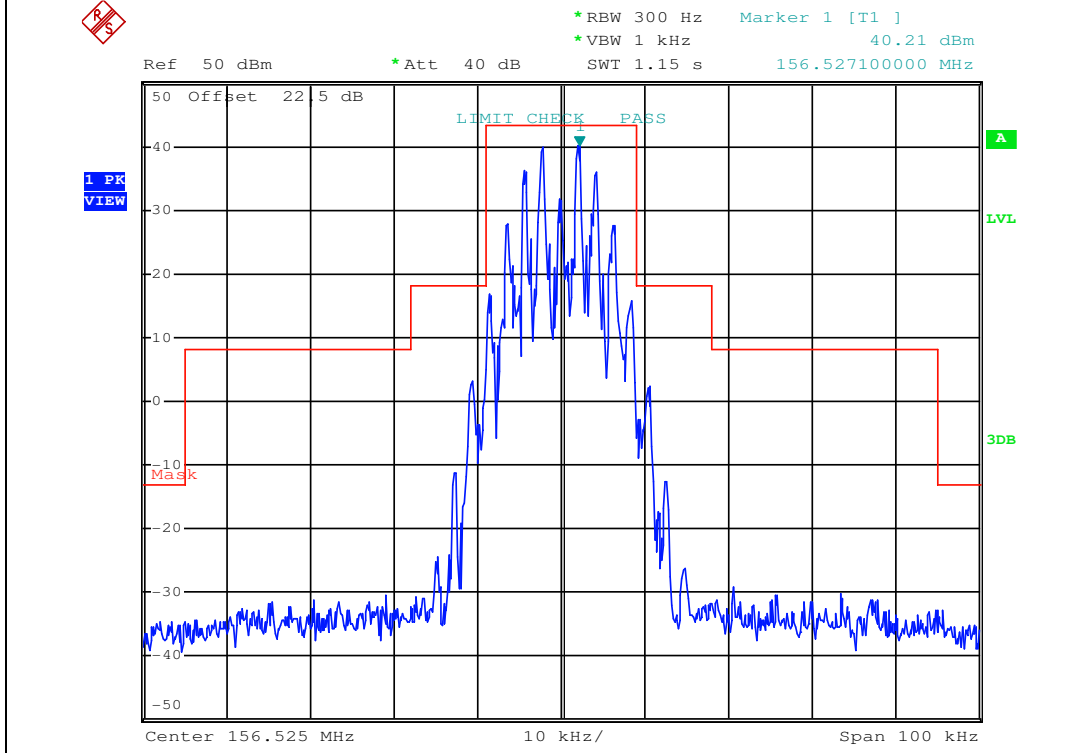

Assigned Frequency:156.525MHz, Low Power, Modulation Type: G2B, dsc-2100Hz

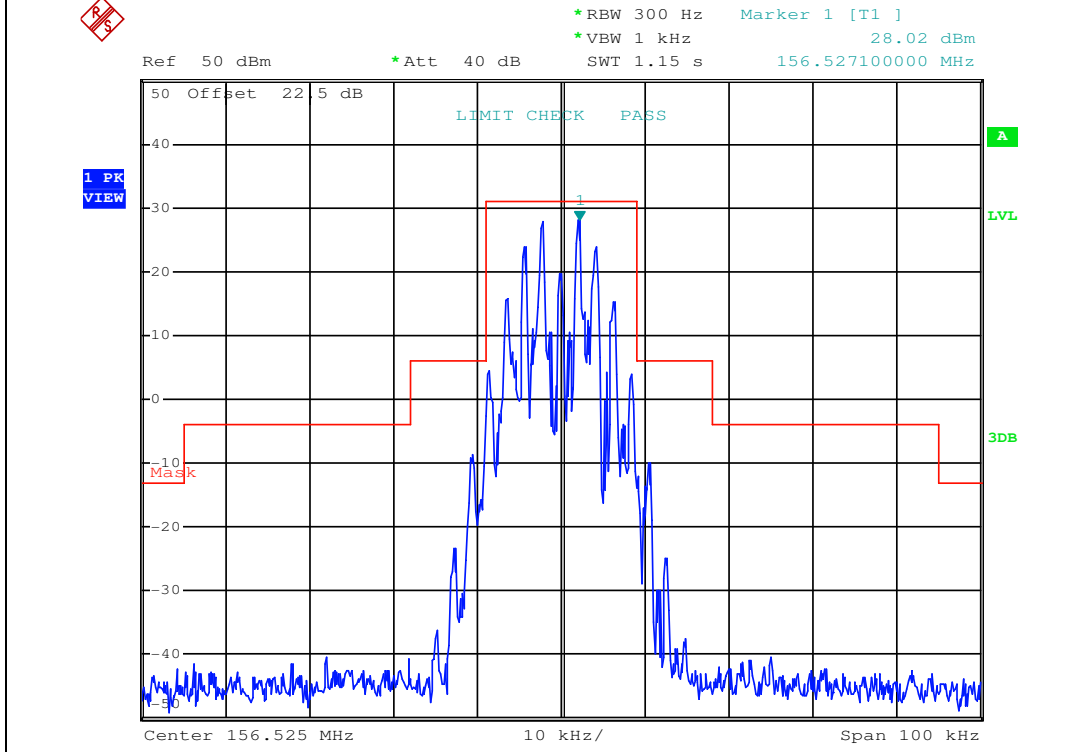

This document is issued by the Company subject to its General Conditions of Service printed overleaf, available on request or accessible at <http://www.sgs.com/en/Terms-and-Conditions.aspx> and, for electronic format documents, subject to Terms and Conditions for Electronic Documents at <http://www.sgs.com/en/Terms-and-Conditions/Terms-e-Document.aspx>. Attention is drawn to the limitation of liability, indemnification and jurisdiction issues defined therein. Any holder of this document is advised that information contained hereon reflects the Company's findings at the time of its intervention only and within the limits of Client's instructions, if any. The Company's sole responsibility is to its Client and this document does not exonerate parties to a transaction from exercising all their rights and obligations under the transaction documents. This document cannot be reproduced except in full, without prior written approval of the Company. Any unauthorized alteration, forgery or falsification of the content or appearance of this document is unlawful and offenders may be prosecuted to the fullest extent of the law. Unless otherwise stated the results shown in this test report refer only to the sample(s) tested and such sample(s) are retained for 30 days only.





4. Conducted Spurious Emission

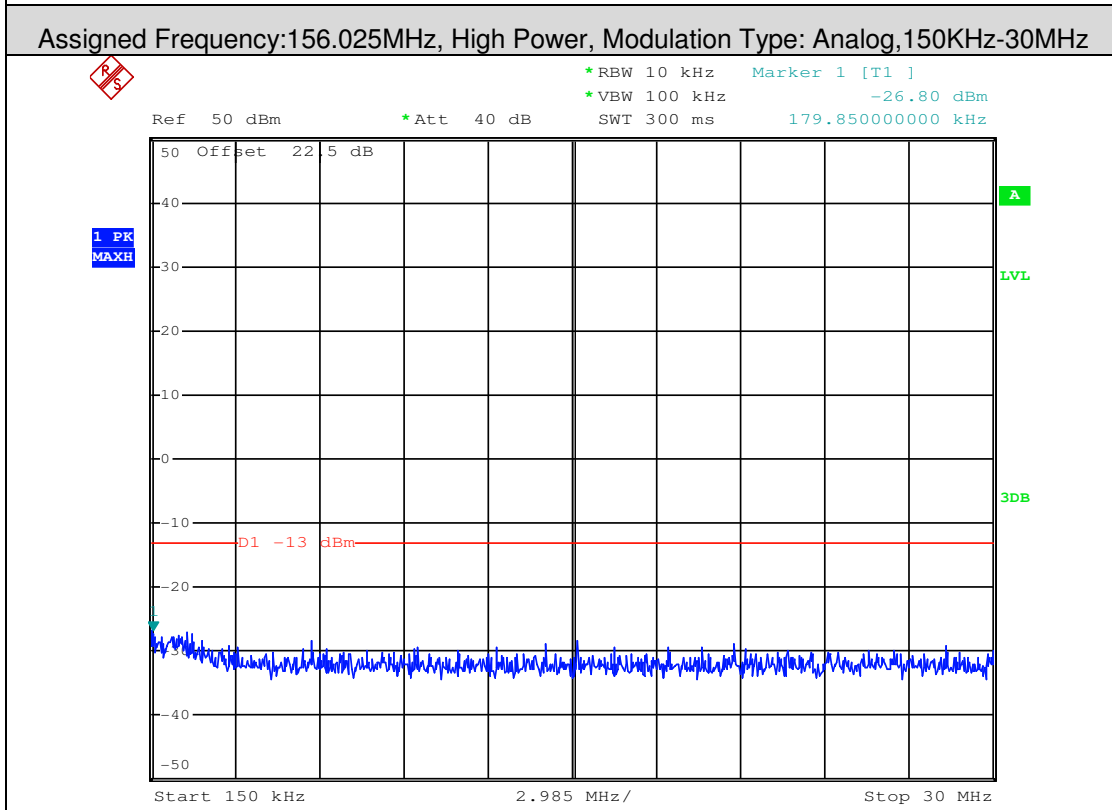
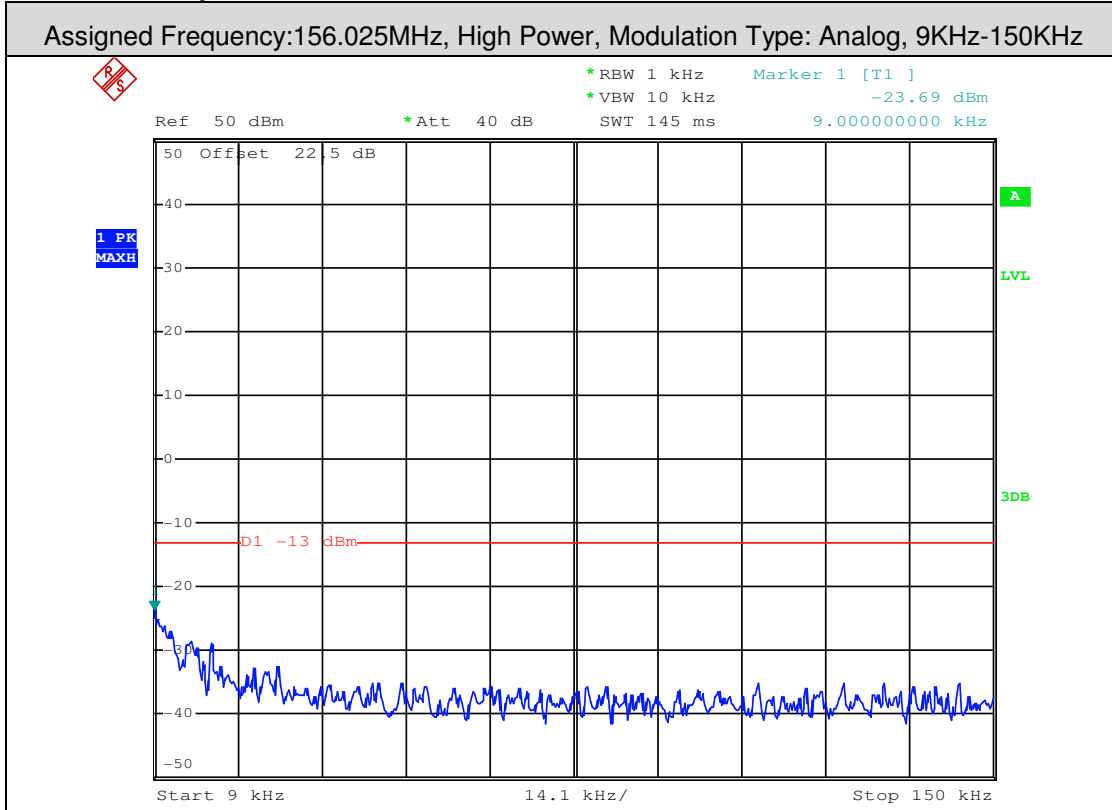

This document is issued by the Company subject to its General Conditions of Service printed overleaf, available on request or accessible at <http://www.sgs.com/en/Terms-and-Conditions.aspx> and, for electronic format documents, subject to Terms and Conditions for Electronic Documents at <http://www.sgs.com/en/Terms-and-Conditions/Terms-e-Document.aspx>. Attention is drawn to the limitation of liability, indemnification and jurisdiction issues defined therein. Any holder of this document is advised that information contained hereon reflects the Company's findings at the time of its intervention only and within the limits of Client's instructions, if any. The Company's sole responsibility is to its Client and this document does not exonerate parties to a transaction from exercising all their rights and obligations under the transaction documents. This document cannot be reproduced except in full, without prior written approval of the Company. Any unauthorized alteration, forgery or falsification of the content or appearance of this document is unlawful and offenders may be prosecuted to the fullest extent of the law. Unless otherwise stated the results shown in this test report refer only to the sample(s) tested and such sample(s) are retained for 30 days only.

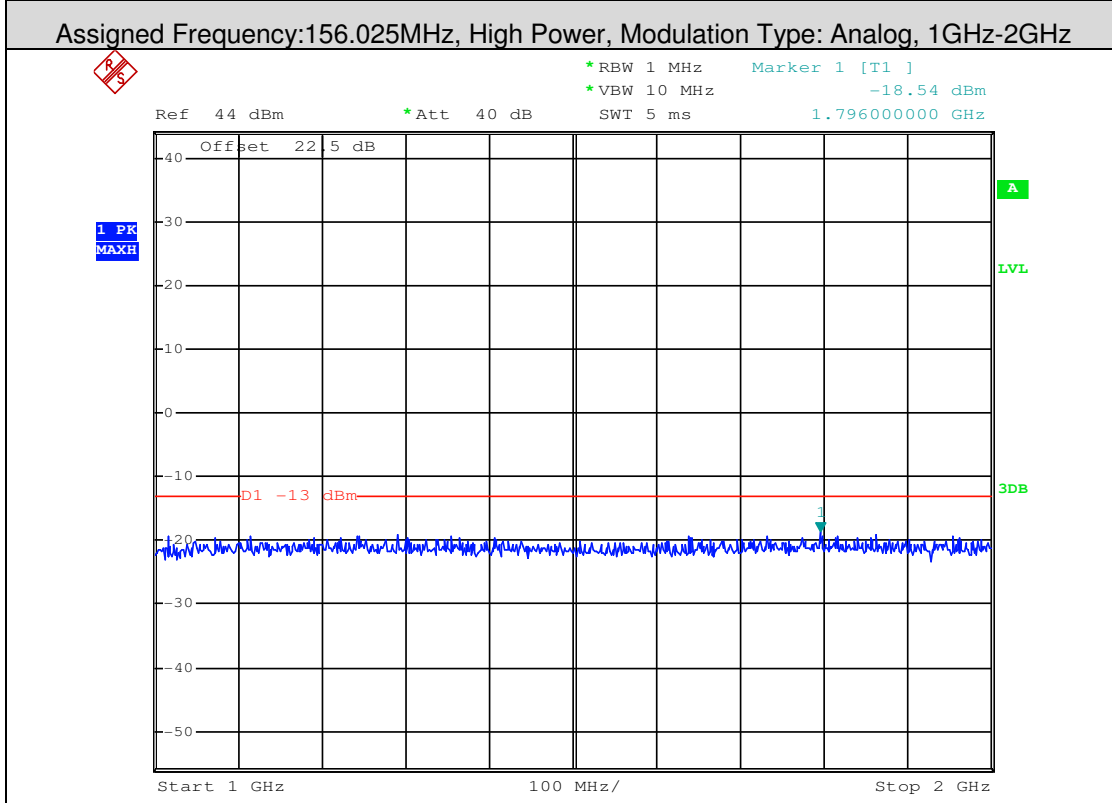
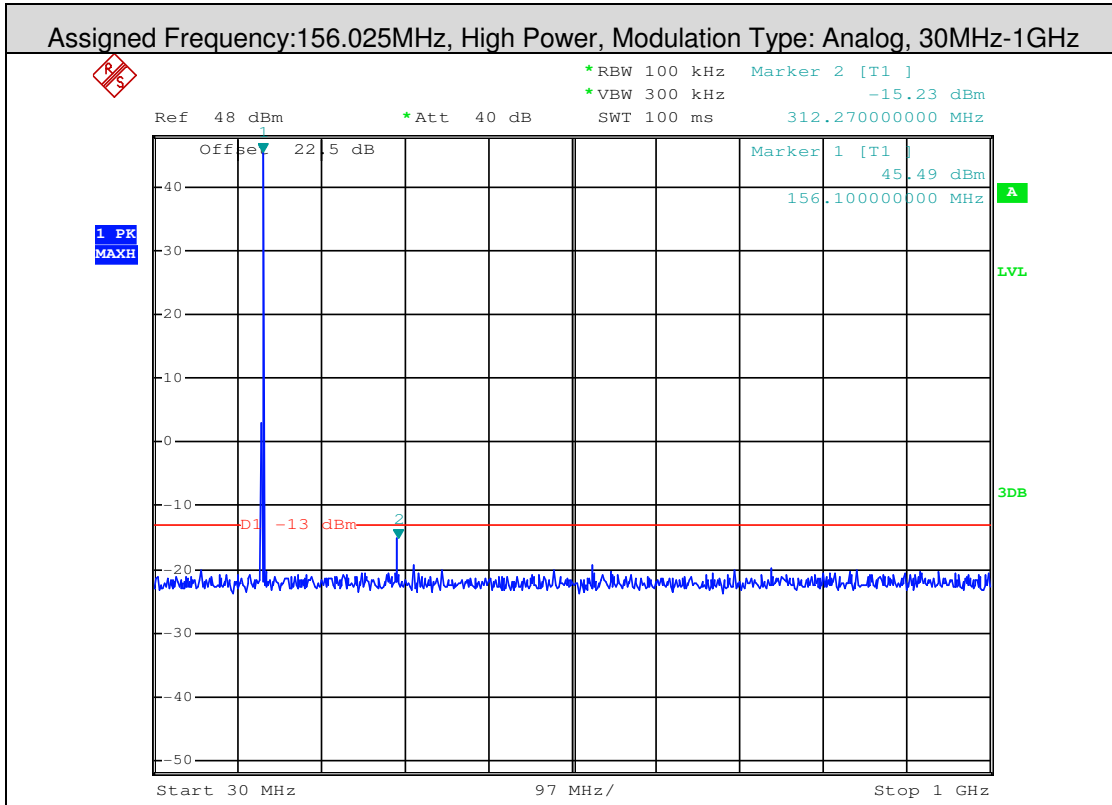

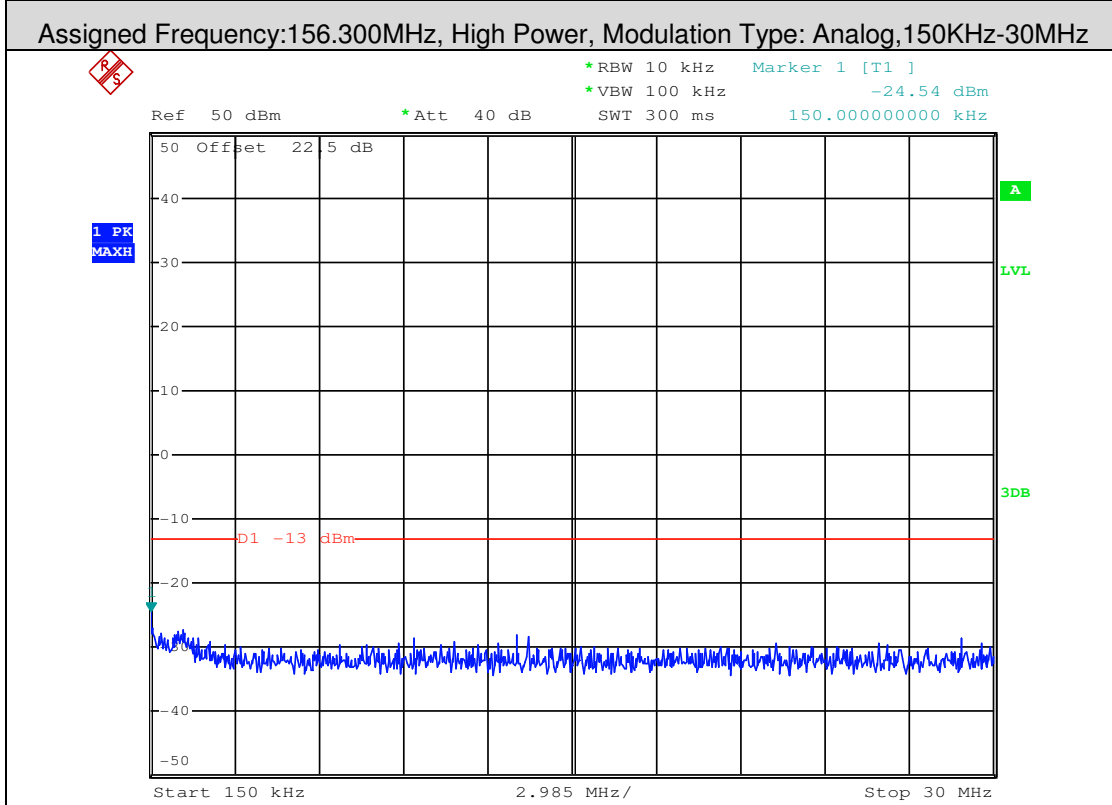
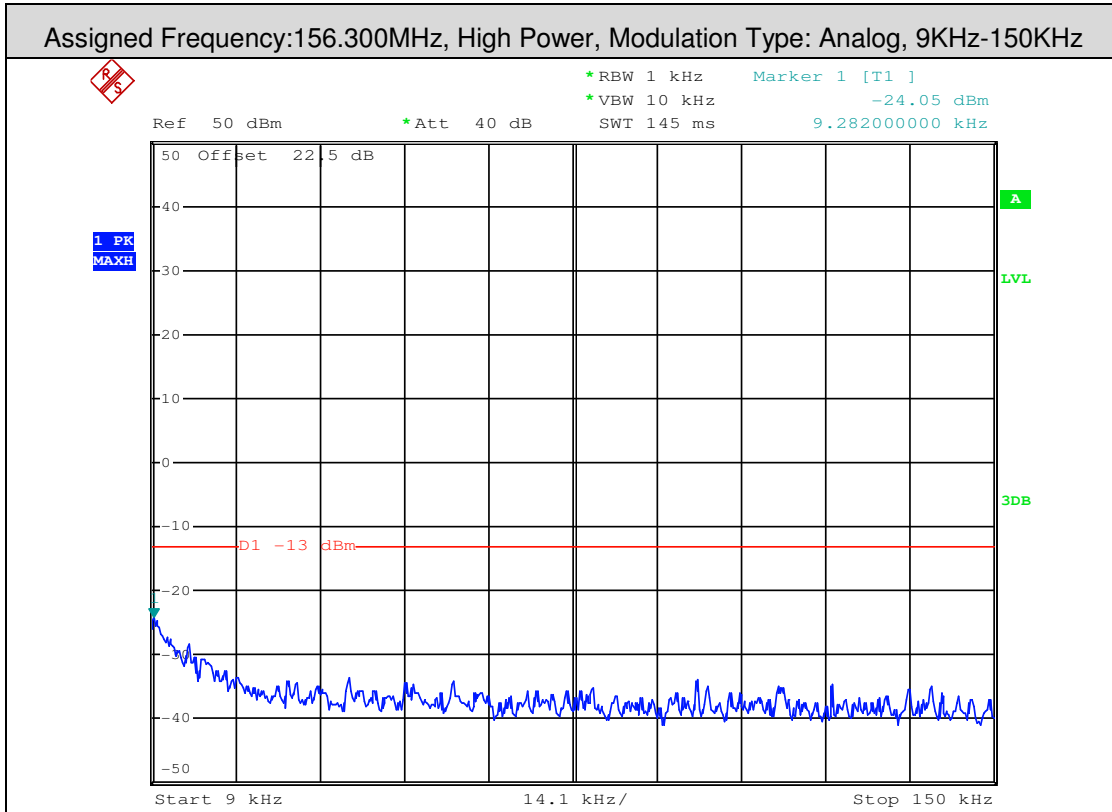

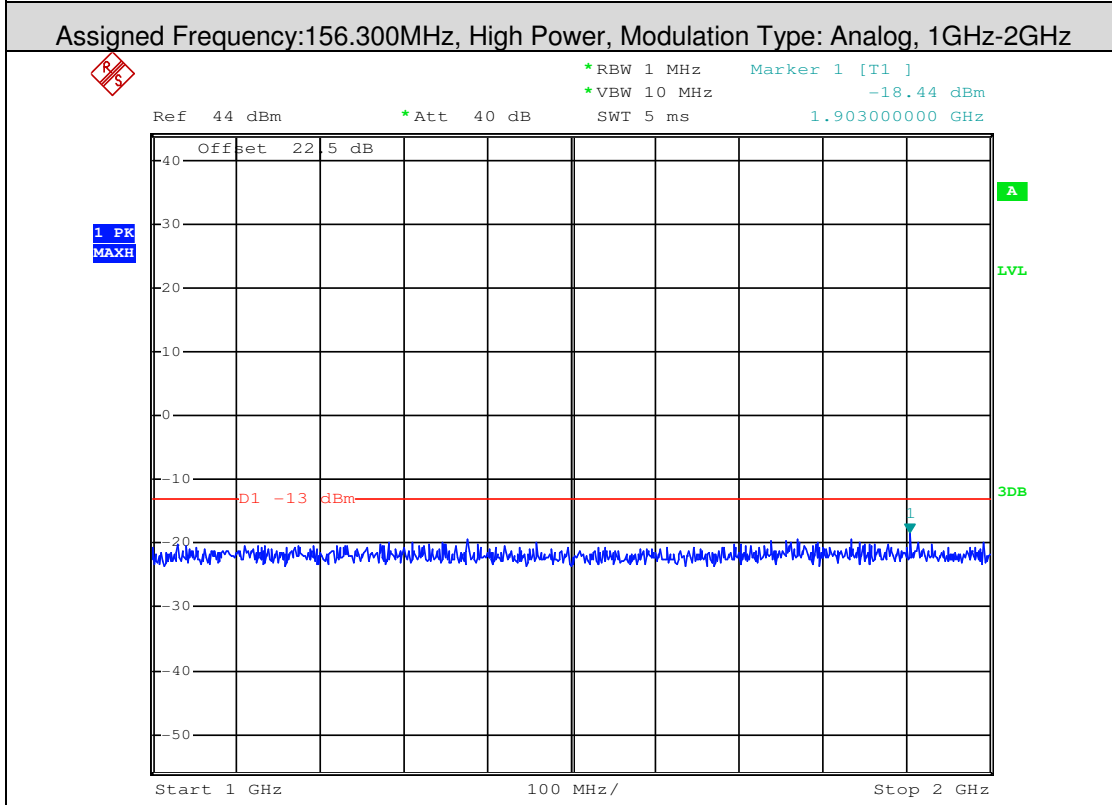
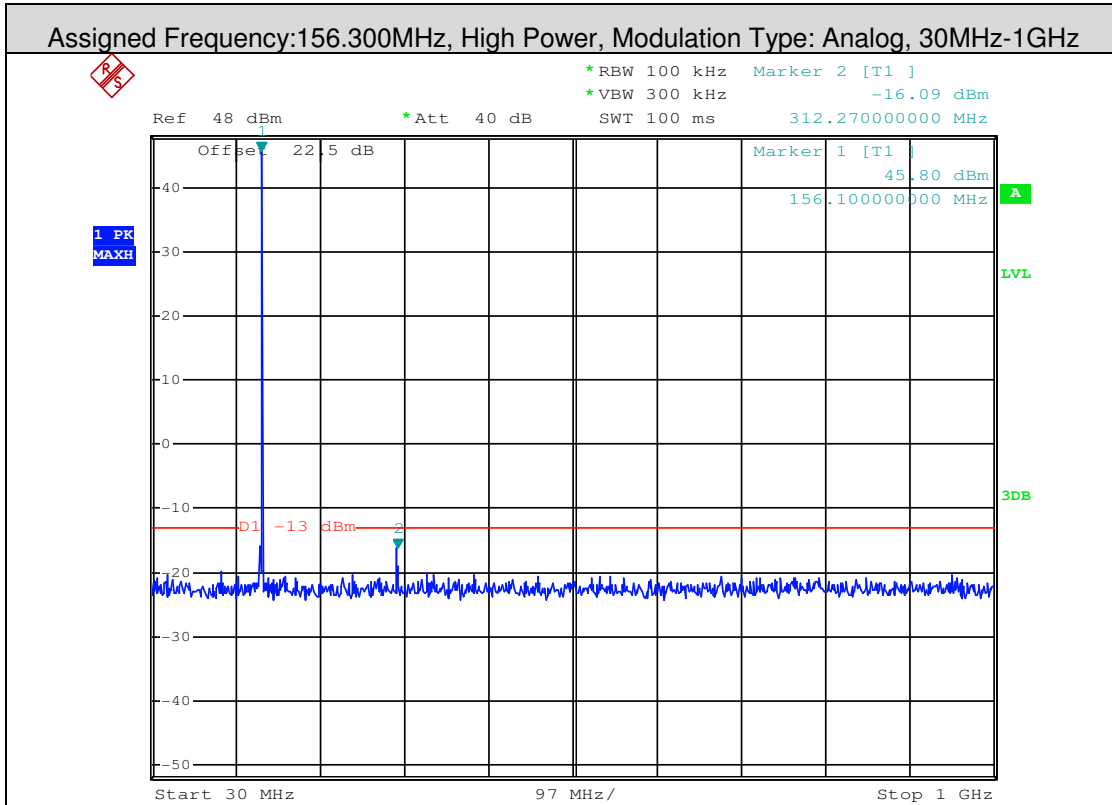

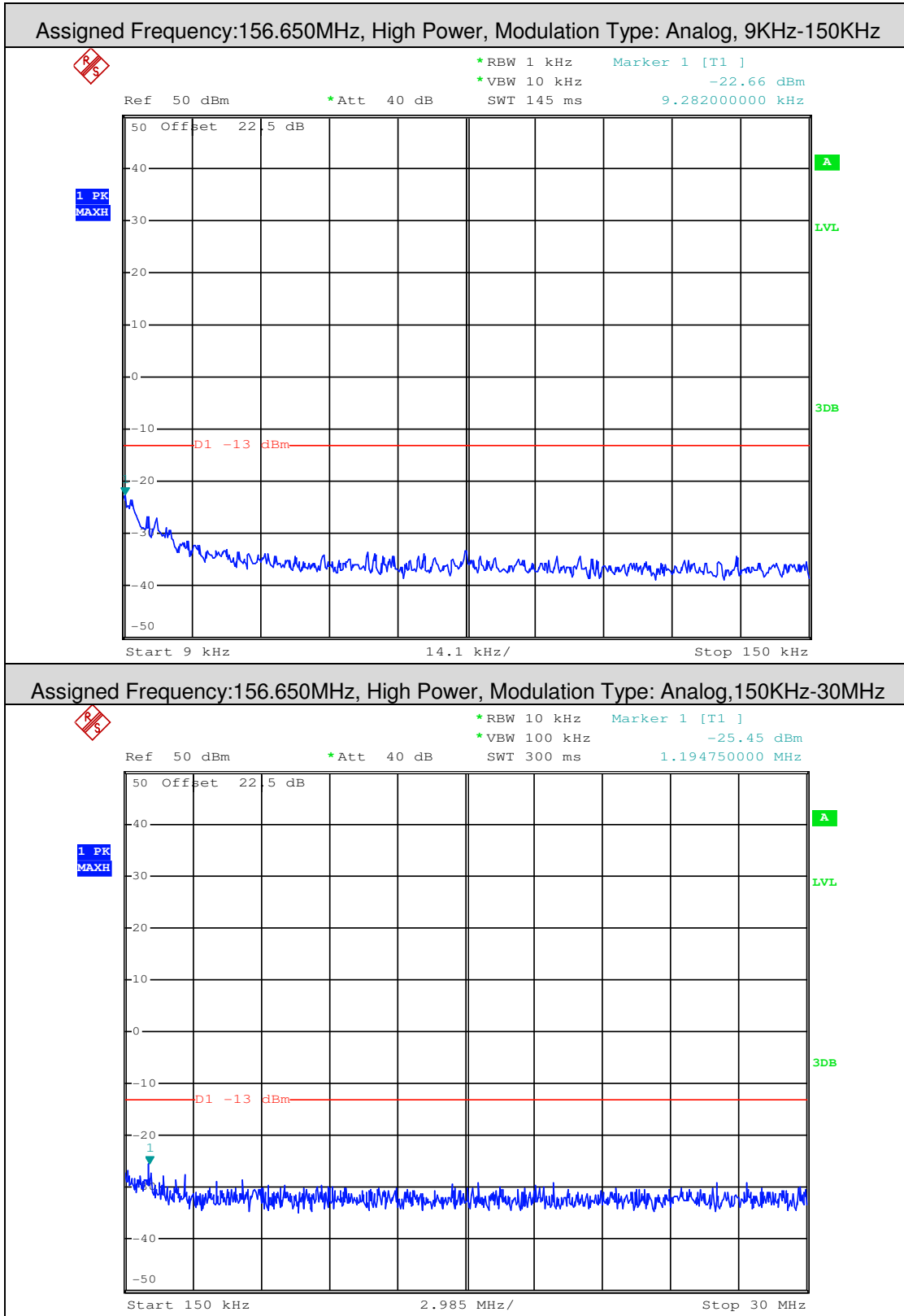

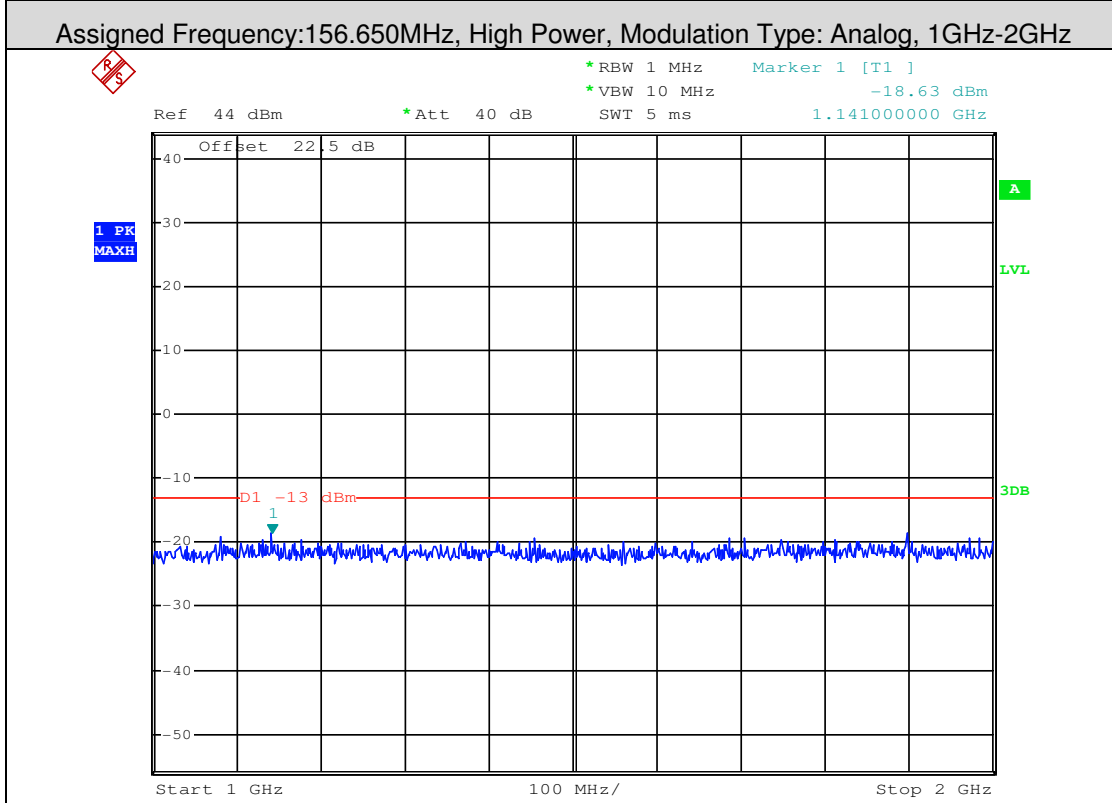
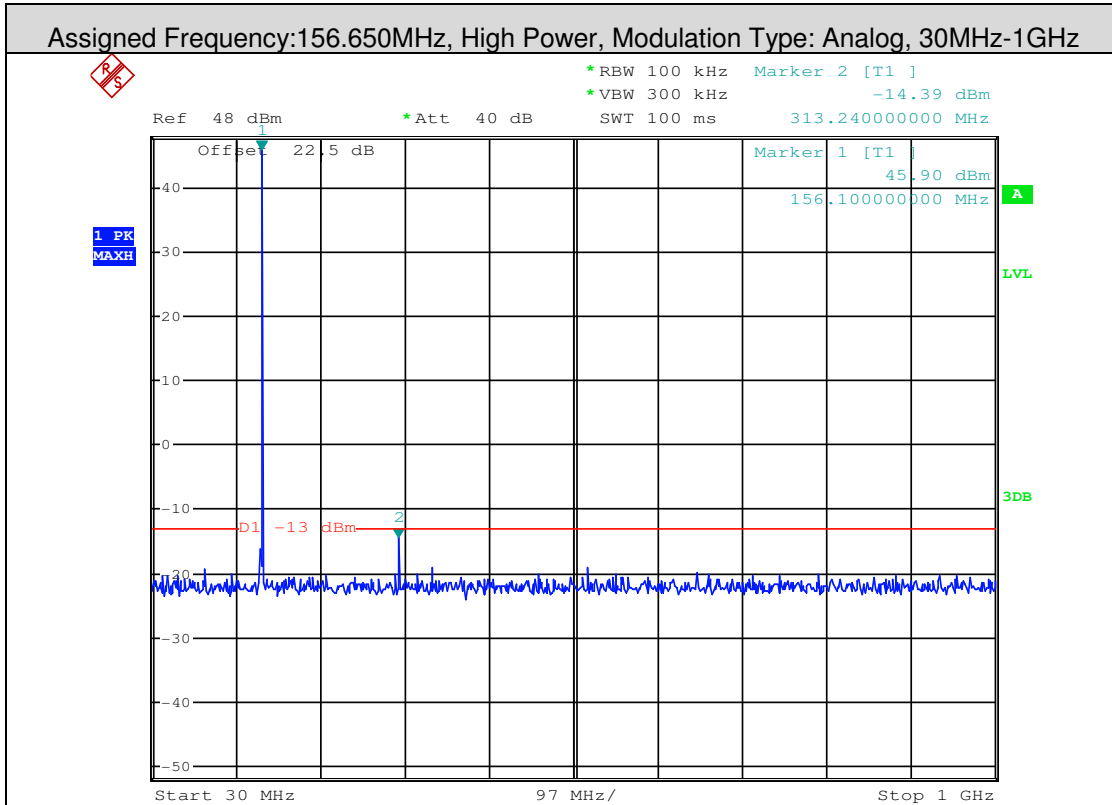



Assigned Frequency:156.800MHz, High Power, Modulation Type: Analog, 9KHz-150KHz

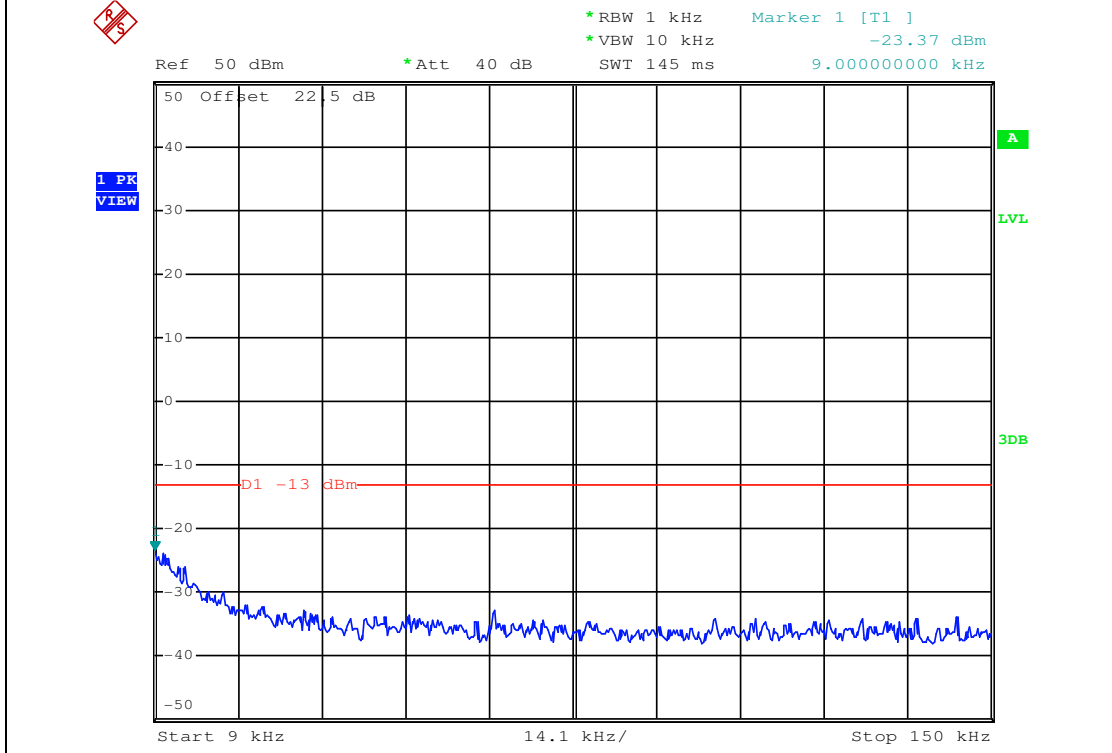

Assigned Frequency:156.800MHz, High Power, Modulation Type: Analog, 150KHz-30MHz

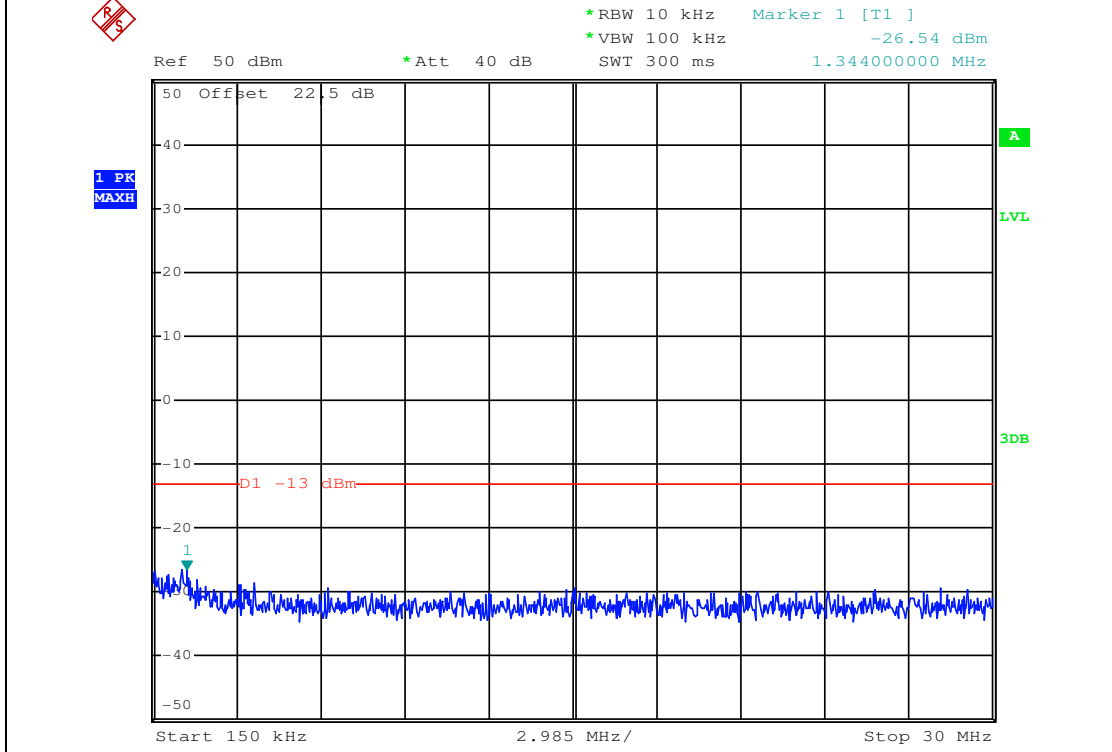

This document is issued by the Company subject to its General Conditions of Service printed overleaf, available on request or accessible at <http://www.sgs.com/en/Terms-and-Conditions.aspx> and, for electronic format documents, subject to Terms and Conditions for Electronic Documents at <http://www.sgs.com/en/Terms-and-Conditions/Terms-e-Document.aspx>. Attention is drawn to the limitation of liability, indemnification and jurisdiction issues defined therein. Any holder of this document is advised that information contained herein reflects the Company's findings at the time of its intervention only and within the limits of Client's instructions, if any. The Company's sole responsibility is to its Client and this document does not exonerate parties to a transaction from exercising all their rights and obligations under the transaction documents. This document cannot be reproduced except in full, without prior written approval of the Company. Any unauthorized alteration, forgery or falsification of the content or appearance of this document is unlawful and offenders may be prosecuted to the fullest extent of the law. Unless otherwise stated the results shown in this test report refer only to the sample(s) tested and such sample(s) are retained for 30 days only.

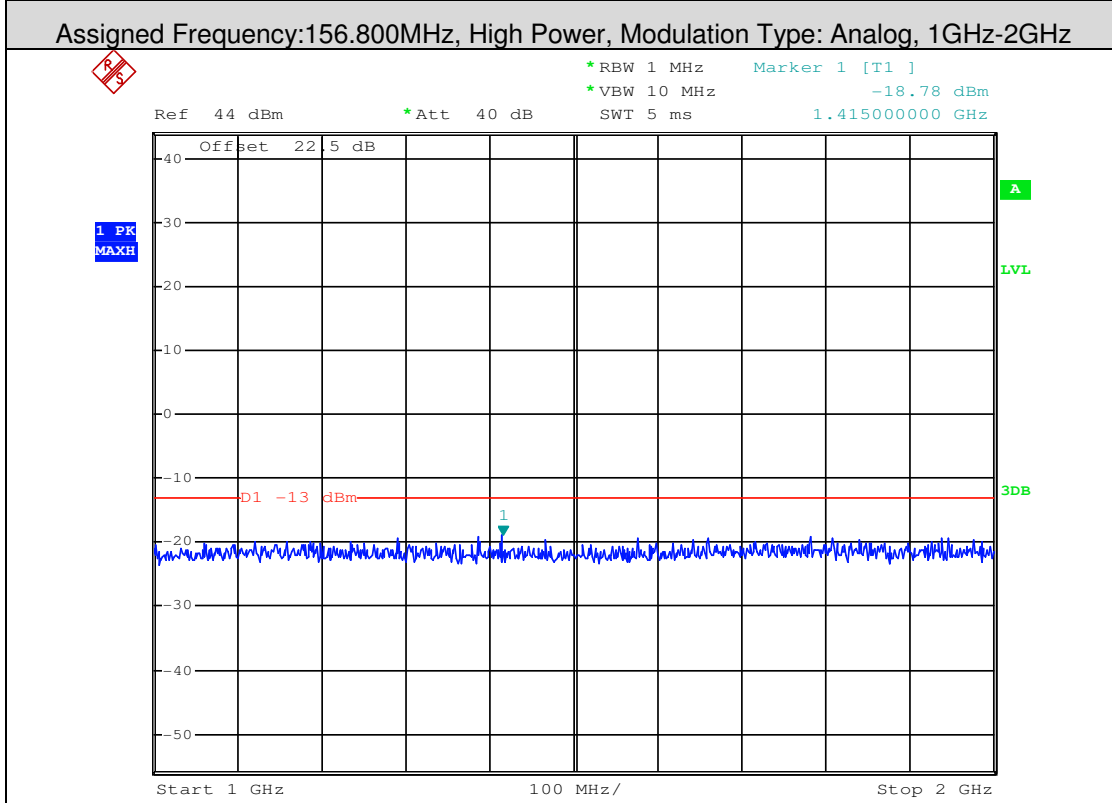
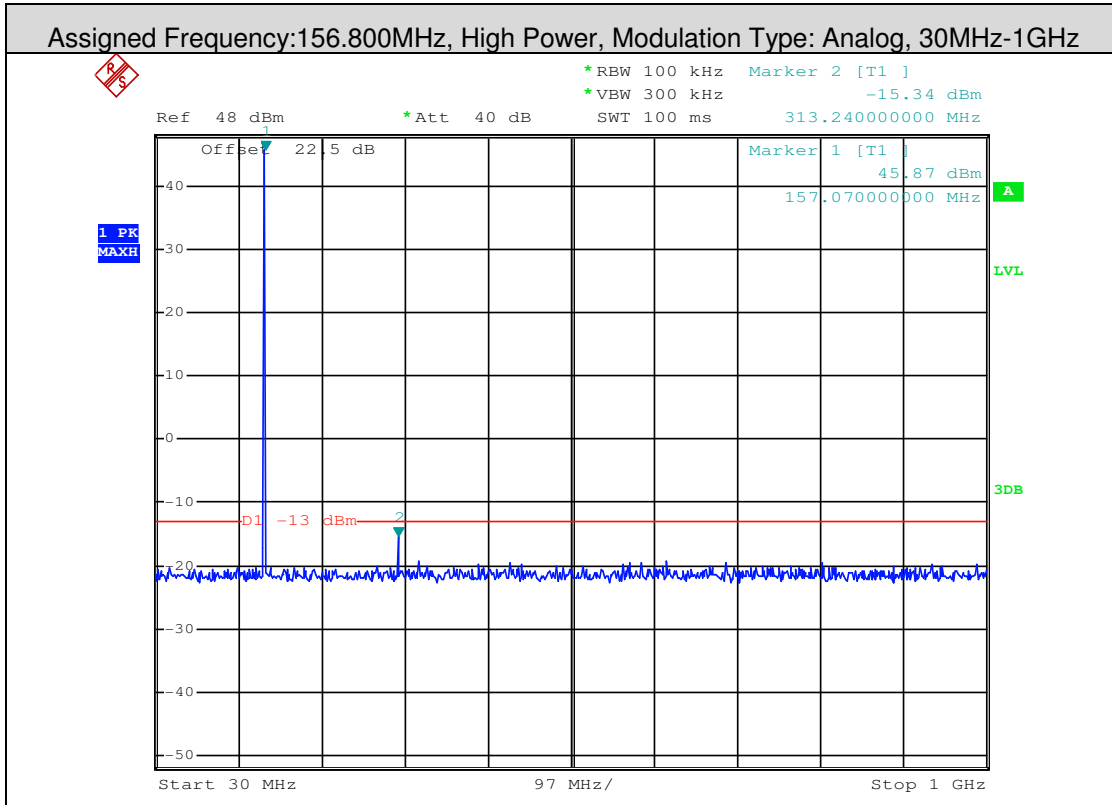





Assigned Frequency:156.525MHz, High Power, Modulation Type: Analog, 9KHz-150KHz

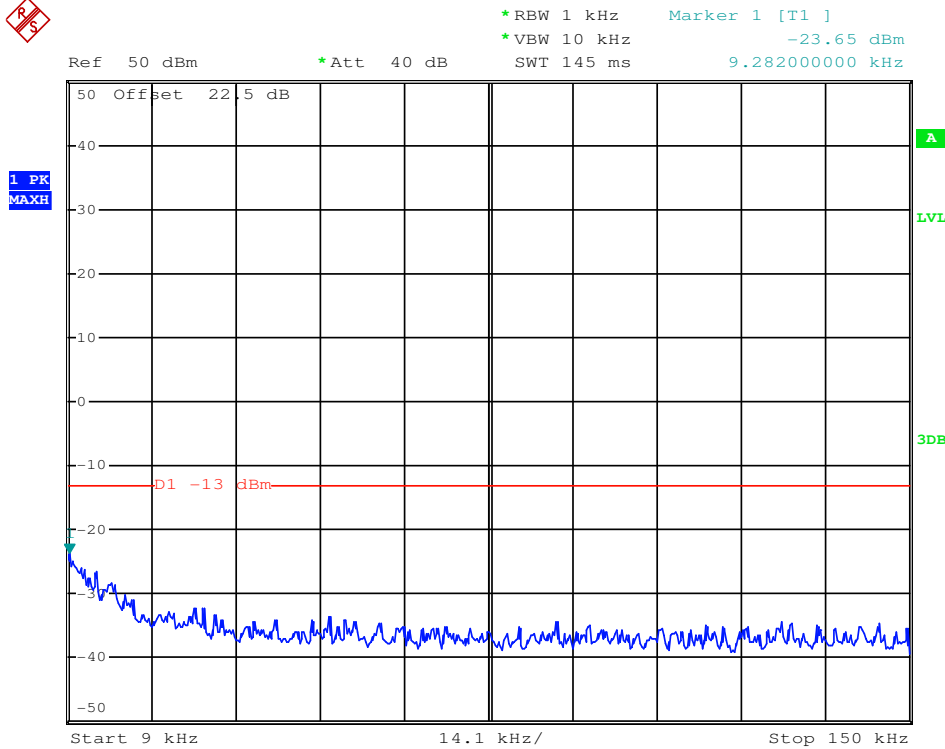

Assigned Frequency:156.525MHz, High Power, Modulation Type: Analog, 150KHz-30MHz

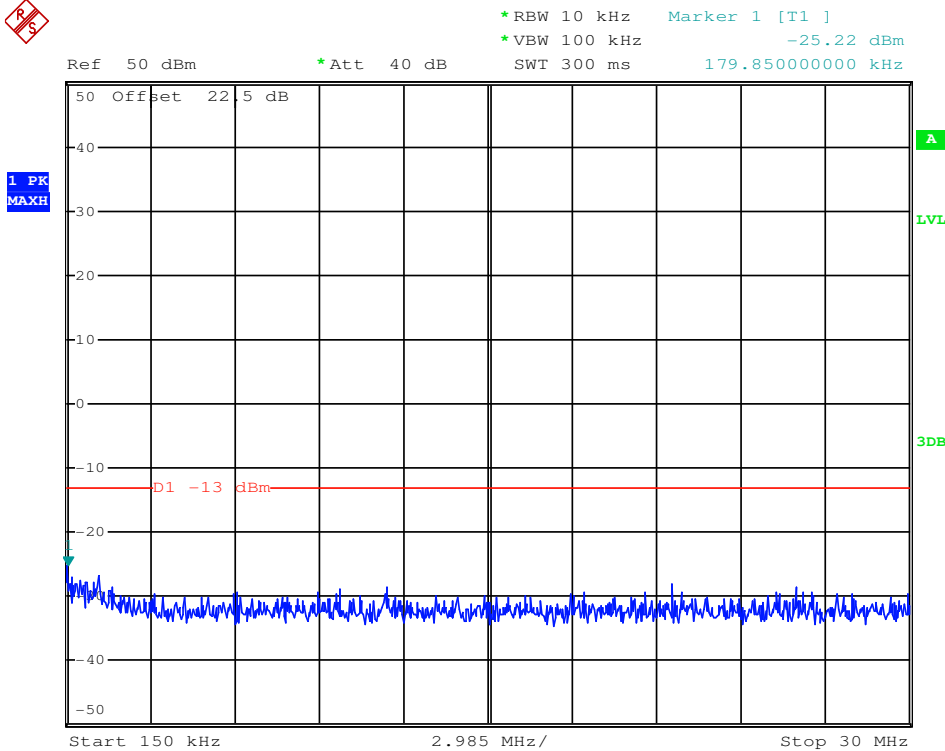

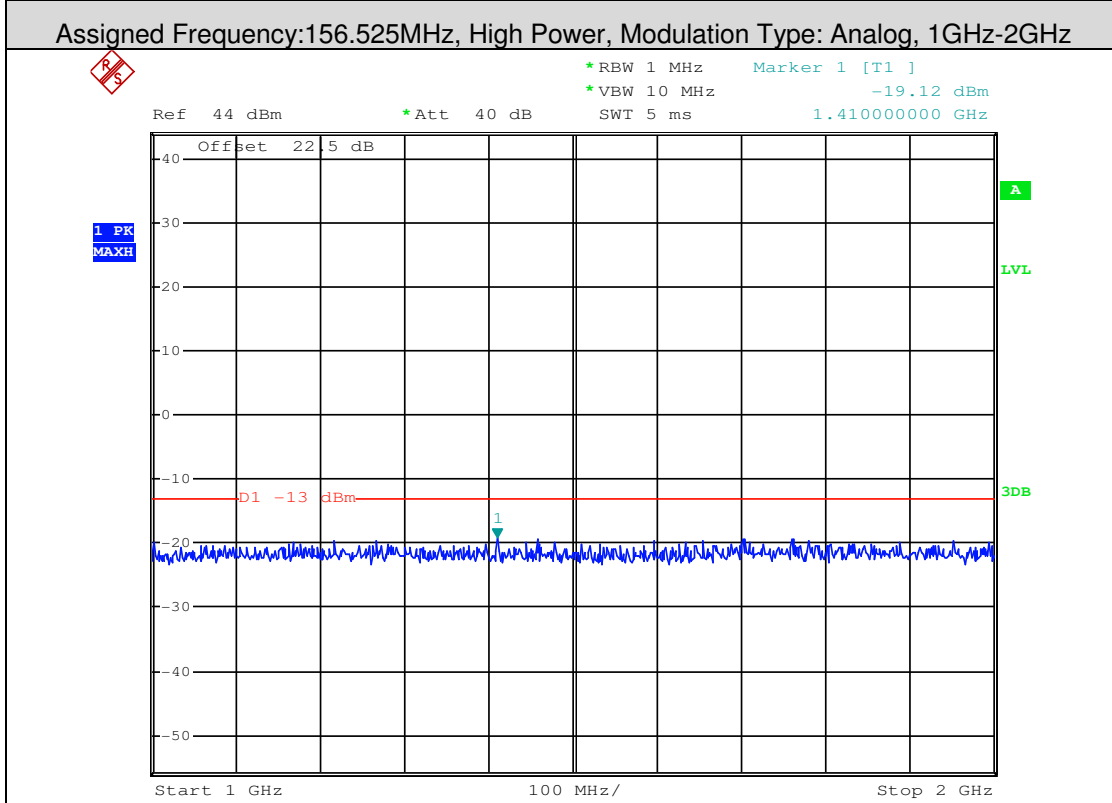
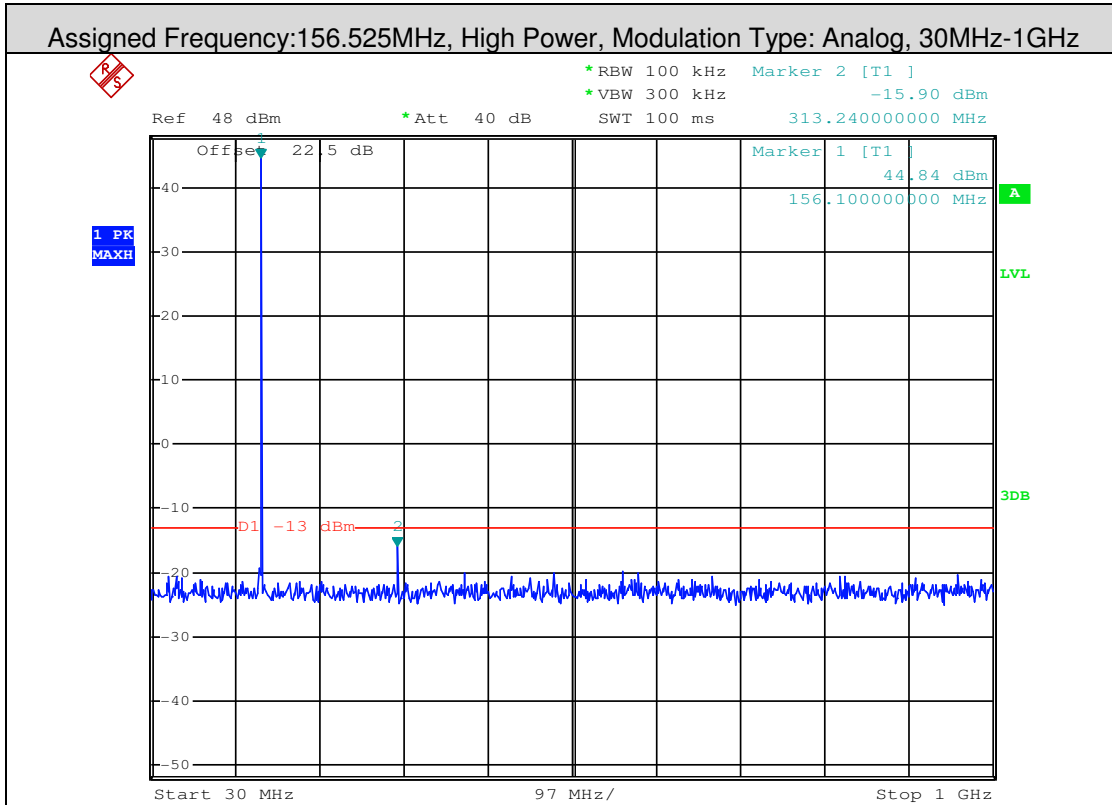



Assigned Frequency:157.425MHz, High Power, Modulation Type: Analog, 9KHz-150KHz

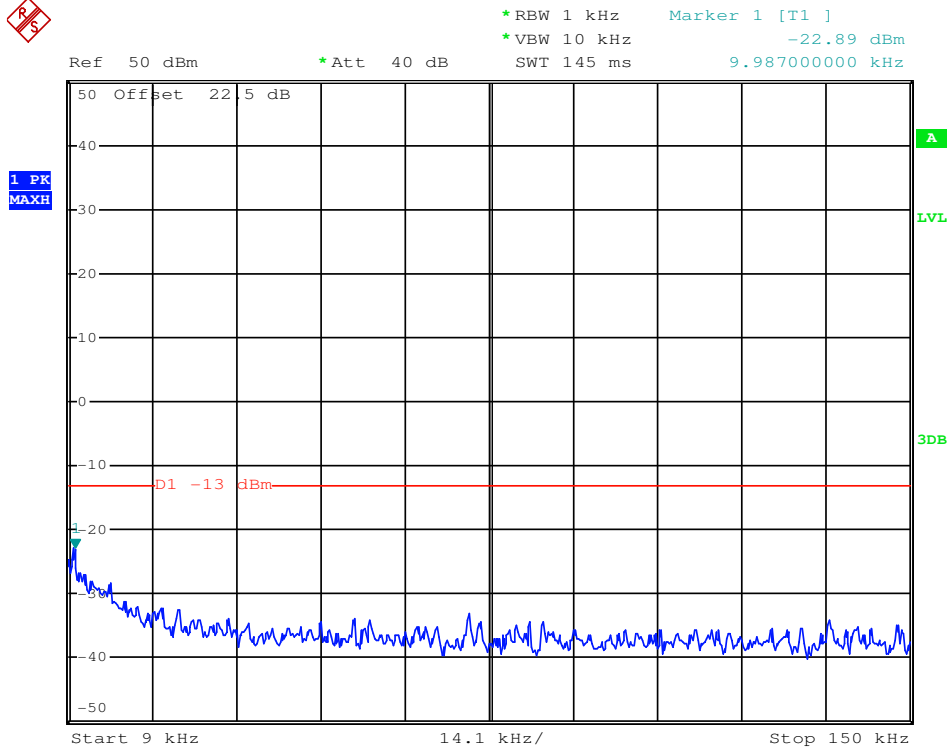

Assigned Frequency:157.425MHz, High Power, Modulation Type: Analog, 150KHz-30MHz

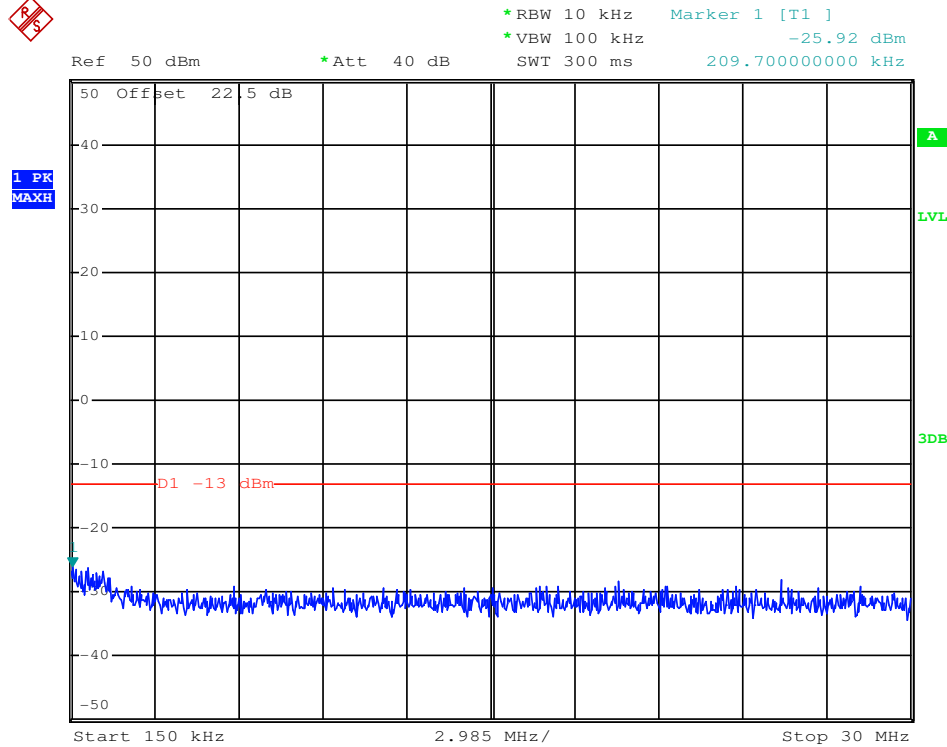

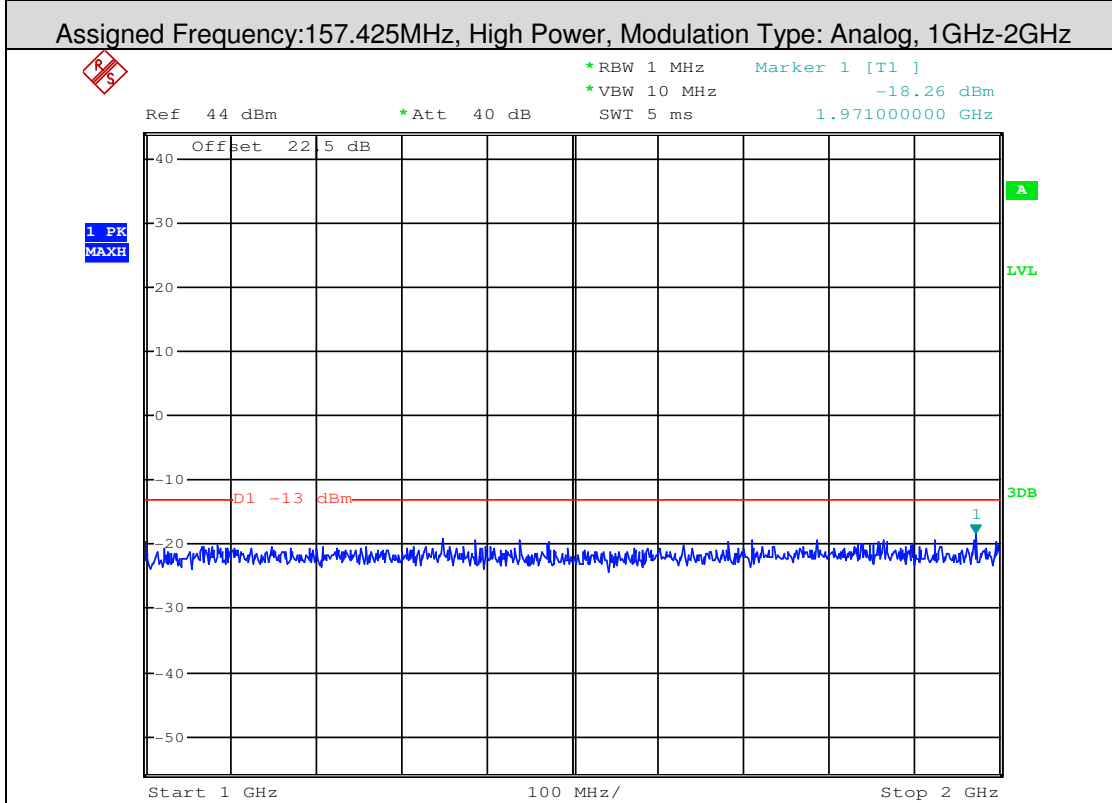
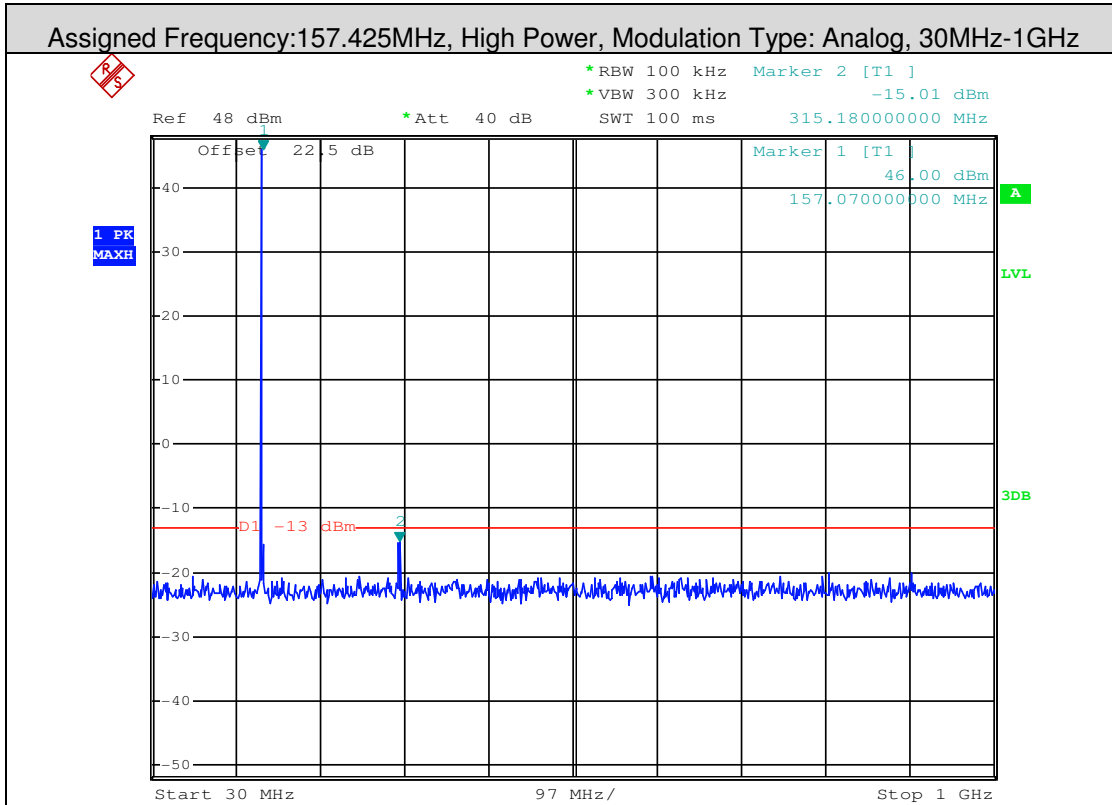



5. Transmitter Unwanted Emission(Radiated)

Assigned Frequency:156.025MHz, Modulation Type: Analog,								
Frequency (MHz)	S.G. Power (dBm)	Cable loss (dB)	Antenna Gain (dBi)	EIRP (dBm)	Limit (dBm)	Over Limit (dB)	Polarization (H/V)	Result
1037.42	-58.25	0.43	1.9	-58.93	-13.00	-45.93	Horizontal	Pass
1589.668	-58.96	0.52	6.0	-55.63	-13.00	-42.63	Horizontal	Pass
2006.452	-60.41	0.53	5.8	-57.29	-13.00	-44.29	Horizontal	Pass
1307.671	-54.48	0.43	1.9	-55.16	-13.00	-42.16	Vertical	Pass
1632.406	-61.43	0.52	6.0	-58.10	-13.00	-45.1	Vertical	Pass
2034.553	-60.99	0.53	5.8	-57.87	-13.00	-44.87	Vertical	Pass

Assigned Frequency:157.425MHz, Modulation Type: Analog,								
Frequency (MHz)	S.G. Power (dBm)	Cable loss (dB)	Antenna Gain (dBi)	EIRP (dBm)	Limit (dBm)	Over Limit (dB)	Polarization (H/V)	Result
1287.882	-55.63	0.43	1.9	-56.31	-13.00	-43.31	Horizontal	Pass
1698.193	-62.68	0.52	6.0	-59.35	-13.00	-46.35	Horizontal	Pass
2049.327	-62.64	0.53	5.8	-59.52	-13.00	-46.52	Horizontal	Pass
1300.44	-55.77	0.43	1.9	-56.45	-13.00	-43.45	Vertical	Pass
1651.755	-62.4	0.52	6.0	-59.07	-13.00	-46.07	Vertical	Pass
2009.242	-62.08	0.53	5.8	-58.96	-13.00	-45.96	Vertical	Pass

**5. Modulation Characteristics**

Test Frequency (MHz)	Modulation Frequency (Hz)	Upper Limit	Lower Limit	Modulation Index(dB) Relative. To 1KHz	Verdict
156.025	300	-9.5	-13.5	-13.0	Pass
	500	-5	-9	-7.1	Pass
	800	-1	-5	-2.7	Pass
	1500	4.5	0.5	3.2	Pass
	1800	6	2	5.5	Pass
	2000	7	3	6.8	Pass
	2500	9	5	8.5	Pass
	3000	10.5	6.5	8.9	Pass
157.425	300	-9.5	-13.5	-13.1	Pass
	500	-5	-9	-7.3	Pass
	800	-1	-5	-2.8	Pass
	1500	4.5	0.5	3.4	Pass
	1800	6	2	5.7	Pass
	2000	7	3	6.2	Pass
	2500	9	5	8.6	Pass
	3000	10.5	6.5	8.9	Pass



Test Frequency (MHz)	Modulation Frequency (Hz)	Input level	Maximum Deviation(KHz)		Limit (KHz)	Verdict
			High Power	Low Power		
156.025	100	20dB 3KHz	0.74	0.74	≤5.0	Pass
	200	20dB 3KHz	2.72	2.72	≤5.0	Pass
	300	20dB 3KHz	3.95	3.95	≤5.0	Pass
	400	20dB 3KHz	3.86	3.86	≤5.0	Pass
	500	20dB 3KHz	3.91	3.91	≤5.0	Pass
	1000	20dB 3KHz	4.27	4.27	≤5.0	Pass
	1500	20dB 3KHz	3.92	3.92	≤5.0	Pass
	2000	20dB 3KHz	3.95	3.95	≤5.0	Pass
	2500	20dB 3KHz	4.36	4.36	≤5.0	Pass
	3000	20dB 3KHz	4.38	4.38	≤5.0	Pass
157.425	100	20dB 3KHz	0.77	0.77	≤5.0	Pass
	200	20dB 3KHz	2.79	2.79	≤5.0	Pass
	300	20dB 3KHz	3.95	3.95	≤5.0	Pass
	400	20dB 3KHz	3.86	3.86	≤5.0	Pass
	500	20dB 3KHz	3.91	3.91	≤5.0	Pass
	1000	20dB 3KHz	4.22	4.22	≤5.0	Pass
	1500	20dB 3KHz	3.92	3.92	≤5.0	Pass
	2000	20dB 3KHz	3.96	3.96	≤5.0	Pass
	2500	20dB 3KHz	4.37	4.37	≤5.0	Pass
	3000	20dB 3KHz	4.38	4.38	≤5.0	Pass

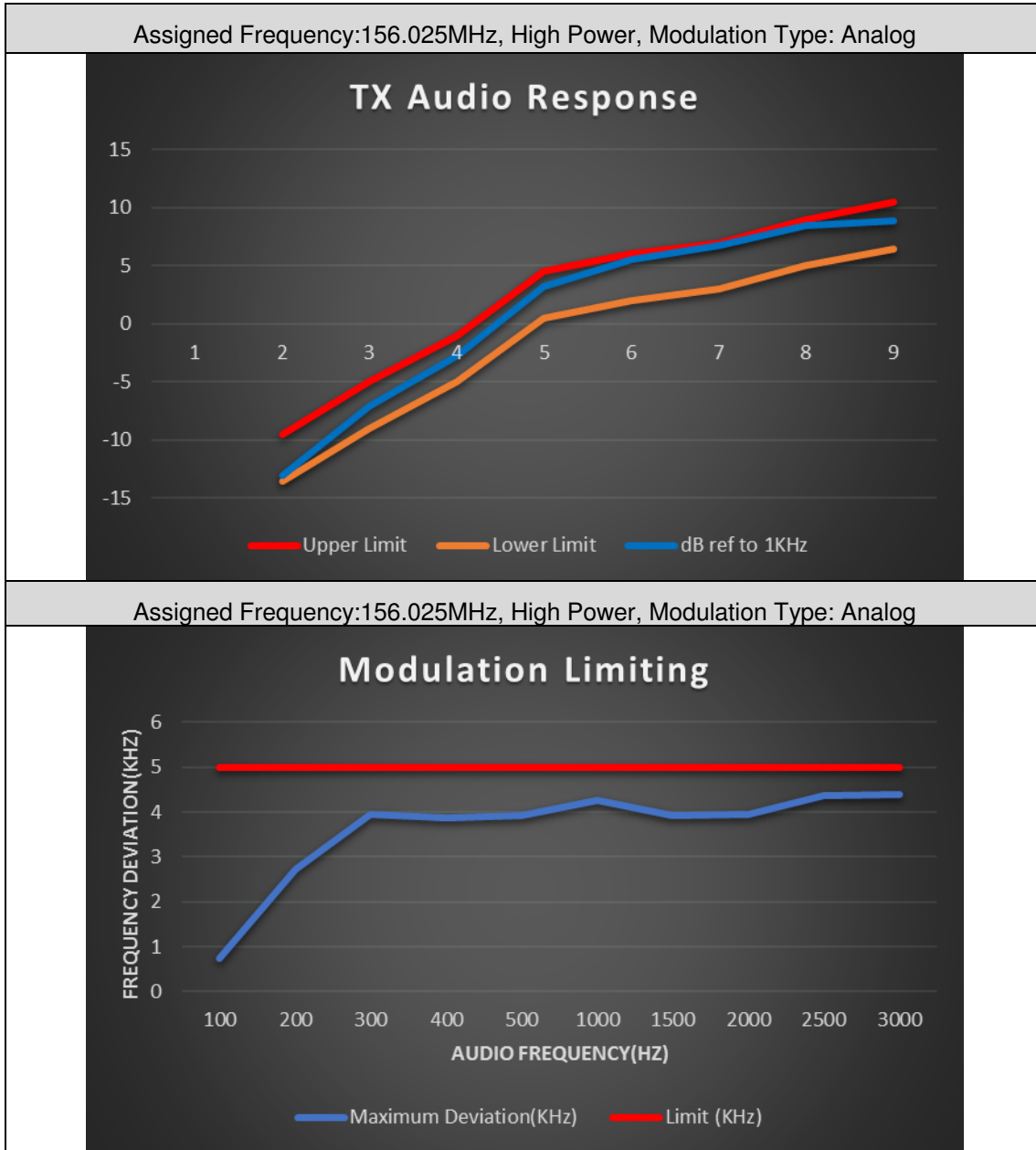



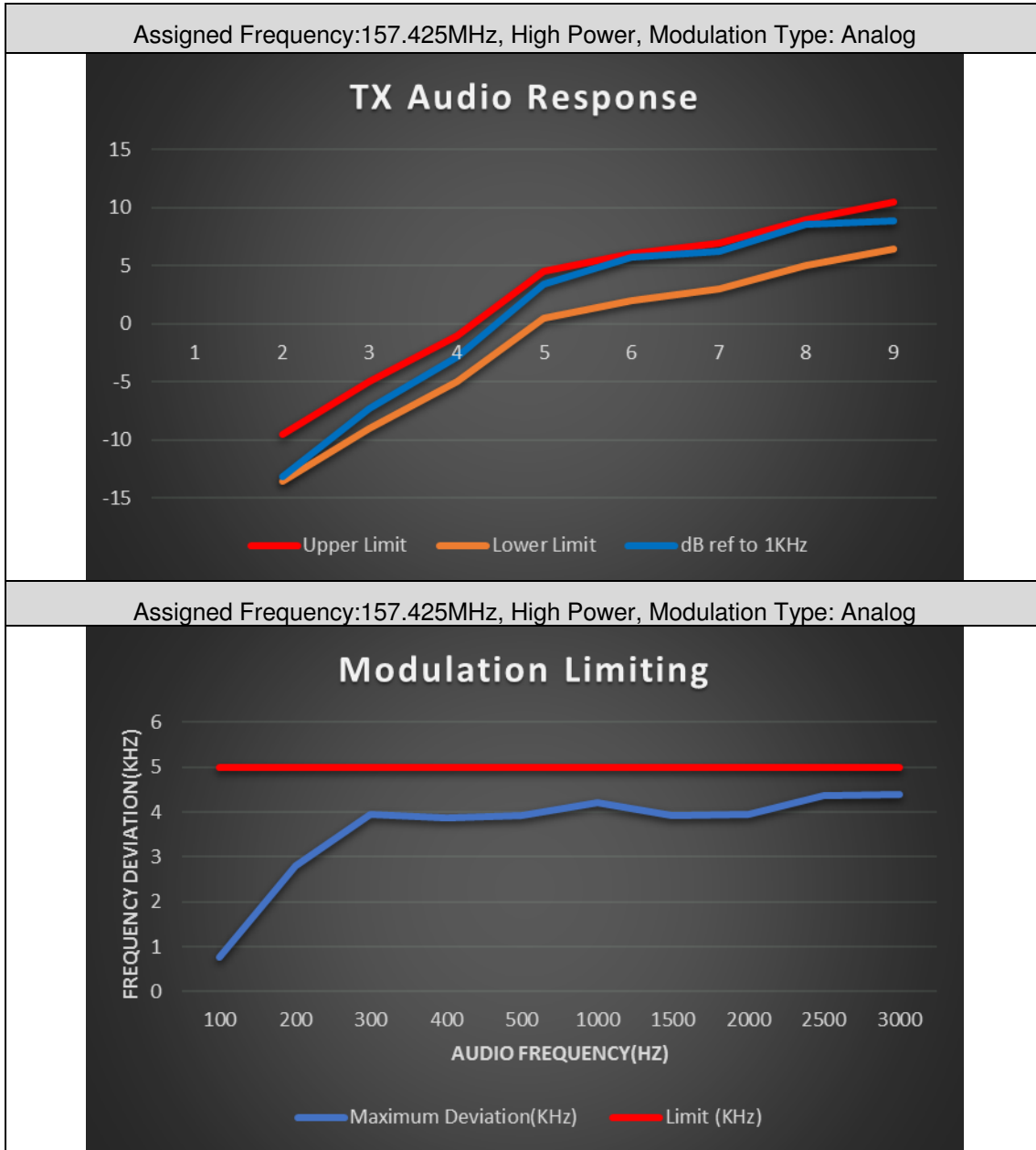

**Low Pass Filter Response**

Assigned Frequency:156.025MHz, High Power, Modulation Type: Analog		
Audio Frequency(KHz)	ResponseAttenuation(dB)	Limit (dB)
1	0	/
3	-15.7	0
4	-24.2	-7.5
5	-29.5	-13.3
6	-43.2	-18.1
7	-42.8	-22.1
8	-48.5	-25.6
9	-52.7	-28.6
10	-55.3	-31.4
15	-59.7	-41.9
20	-68.4	-50.0
30	-69.6	-50.0
40	-74.2	-50.0
50	-78.5	-50.0
60	-79.1	-50.0
70	-84.4	-50.0

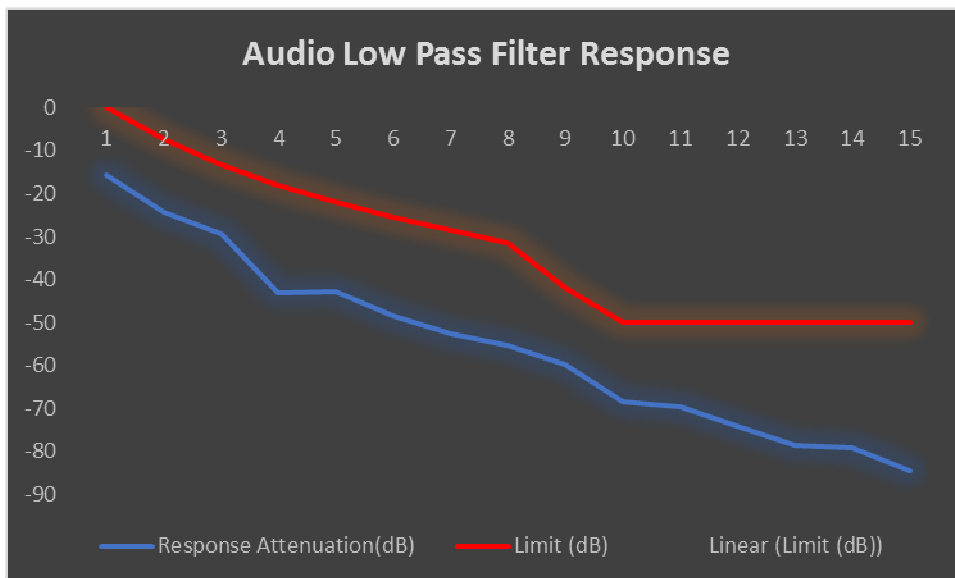



Assigned Frequency:157.425MHz, High Power, Modulation Type: Analog		
Audio Frequency(KHz)	ResponseAttenuation(dB)	Limit (dB)
1	0	/
3	-15.1	0
4	-24.2	-7.5
5	-29.6	-13.3
6	-43.7	-18.1
7	-42.3	-22.1
8	-48.9	-25.6
9	-52.5	-28.6
10	-55.2	-31.4
15	-59.4	-41.9
20	-68.8	-50.0
30	-69.1	-50.0
40	-74.3	-50.0
50	-78.4	-50.0
60	-79.8	-50.0
70	-84.3	-50.0

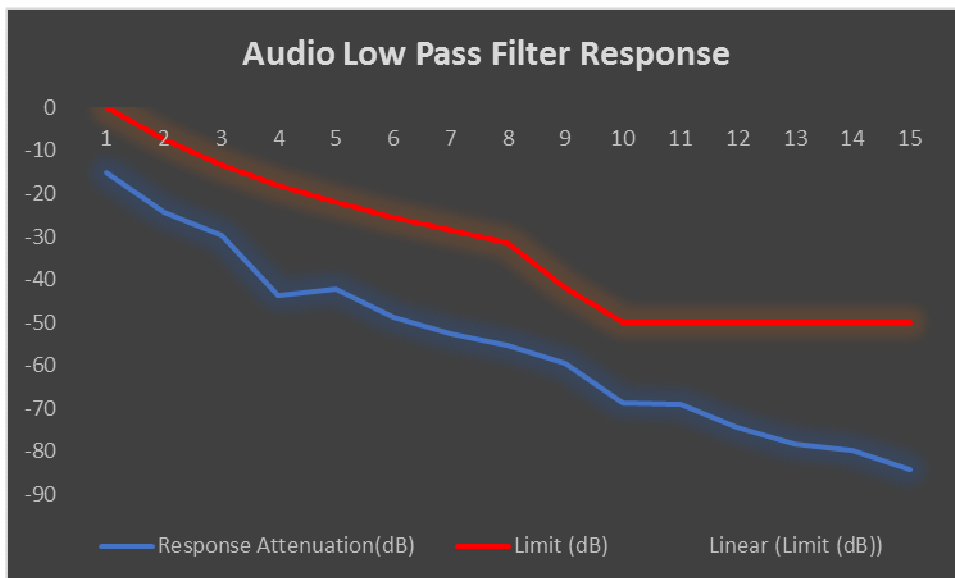

**6. Transmitter Power**

Test Voltage (V Dc)	Test Frequency (MHz)	Power Level	Output Power(dBm)	Output Power(W)	Limit
12	156.025	Max	43.97	24.95	25W
		Low	29.05	0.80	1W
	156.300	Max	43.9	24.55	25W
		Low	29.02	0.80	1W
	156.650	Max	43.91	24.60	25W
		Low	29.18	0.83	1W
	156.800	Max	43.94	24.77	25W
		Low	29.08	0.81	1W
	157.425	Max	43.89	24.49	25W
		Low	29.28	0.85	1W
	156.525	Max	43.87	24.38	25W
		Low	28.39	0.69	1W

Note: the high power is 25W, and low power is 1W that declared by manufacturer.

**7. Transmitter Carrier Power Reduction**

Test Voltage (V Dc)	Test Frequency (MHz)	Power Level	Default Power (W)	Limit	Result
12	156.375	Low	0.85	one watt or less	Pass
	156.650	Low	0.83	one watt or less	Pass
	156.775	Low	0.78	one watt or less	Pass
	156.825	Low	0.81	one watt or less	Pass
	156.850	Low	0.81	one watt or less	Pass
	156.875	Low	0.80	one watt or less	Pass

Note: All transmitters units must be capable of reducing the carrier power to one watt or less;

All transmitters must automatically reduce the carrier power to one watt or less when transmitting on 156.375 MHz or 156.650 MHz, and must be provided with a manual override switch which when held by an operator will permit full carrier power operation on 156.375 MHz and 156.650 MHz;

All transmitters must be capable of tuning to 156.775MHz and 156.825MHz and must automatically reduce the carrier power to one watt or less, with no manual override capability, when the transmitter is tuned to either 156.775MHz or 156.825MHz;

8. Suppression of interference aboard ships

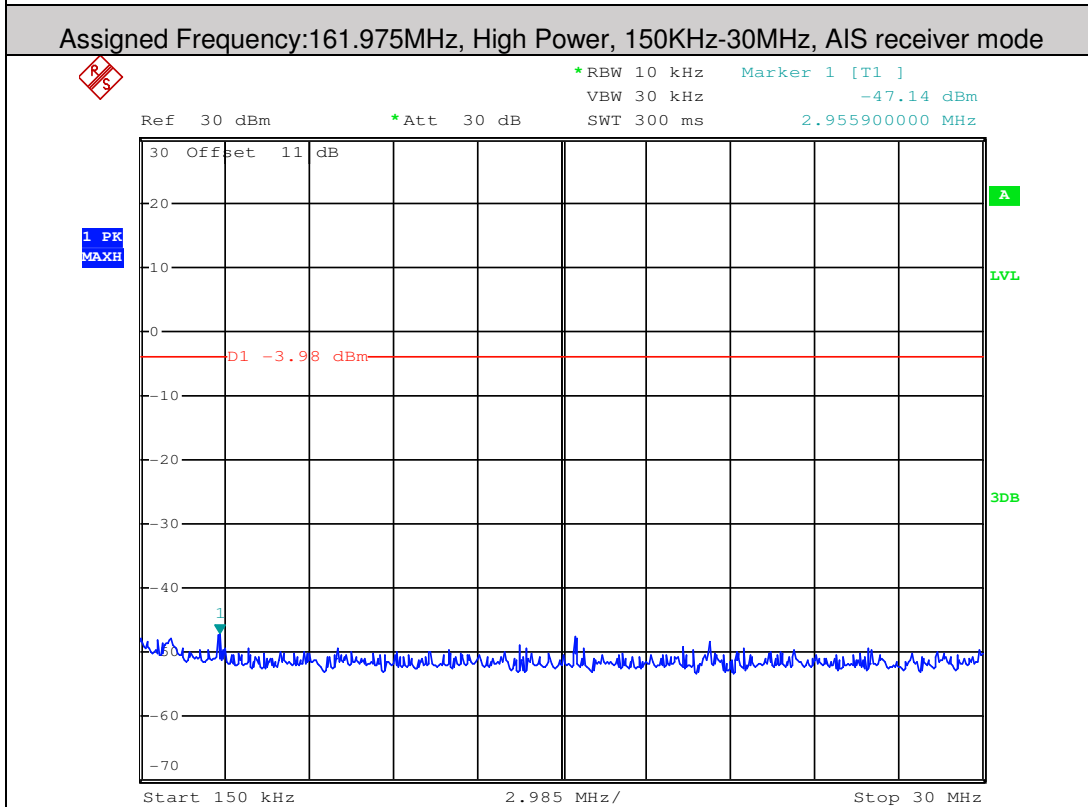
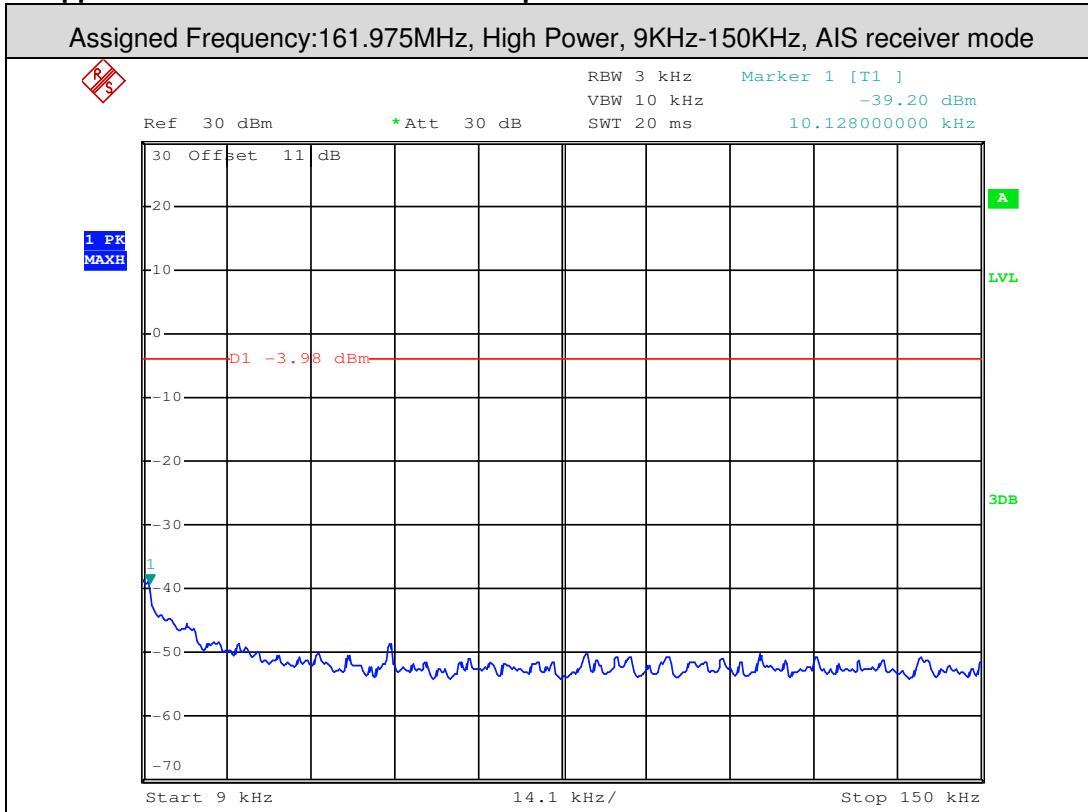

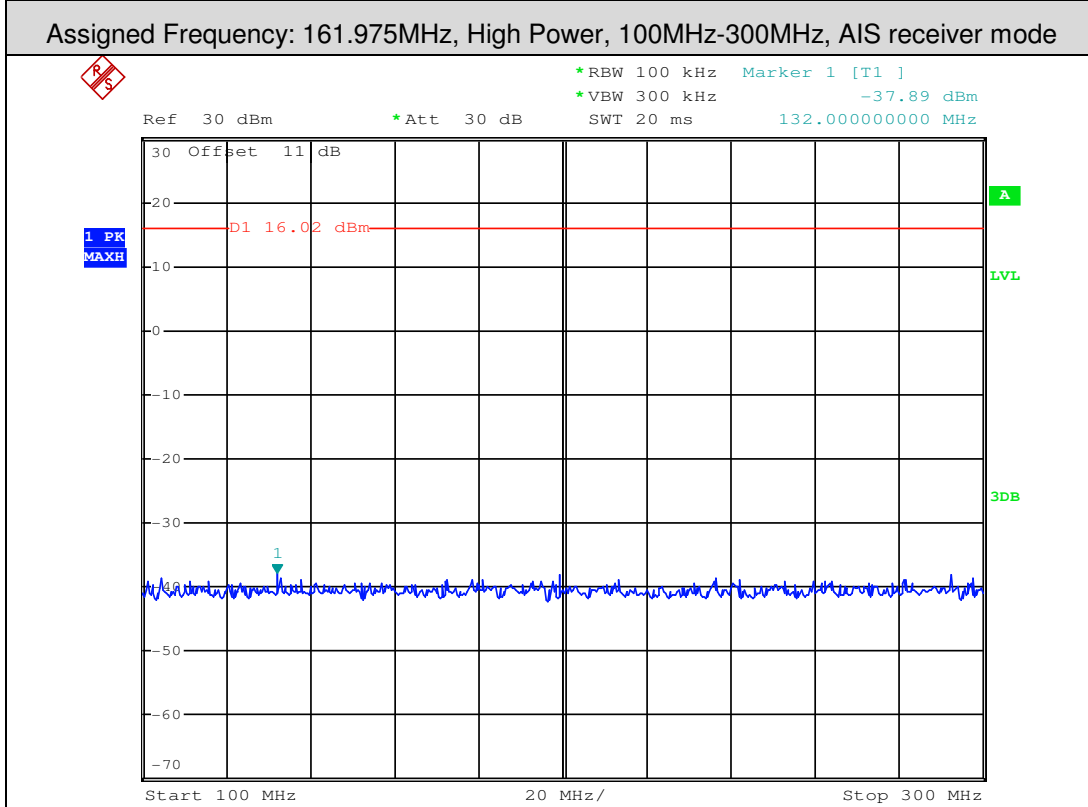
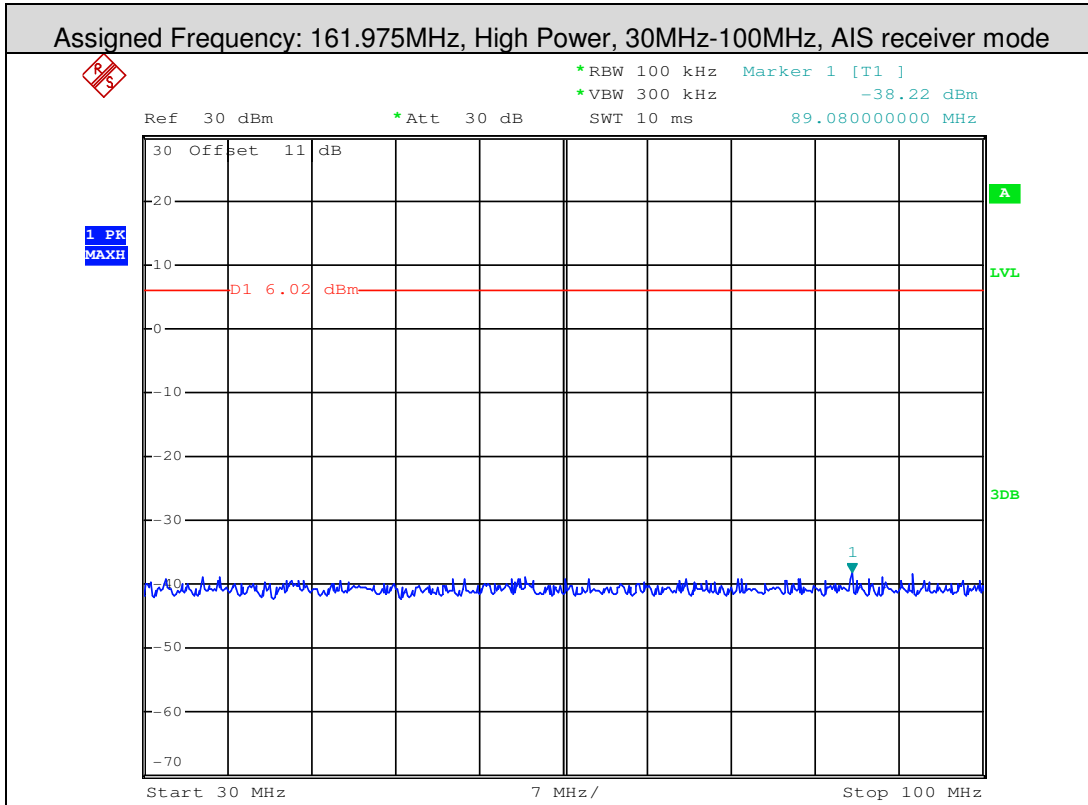

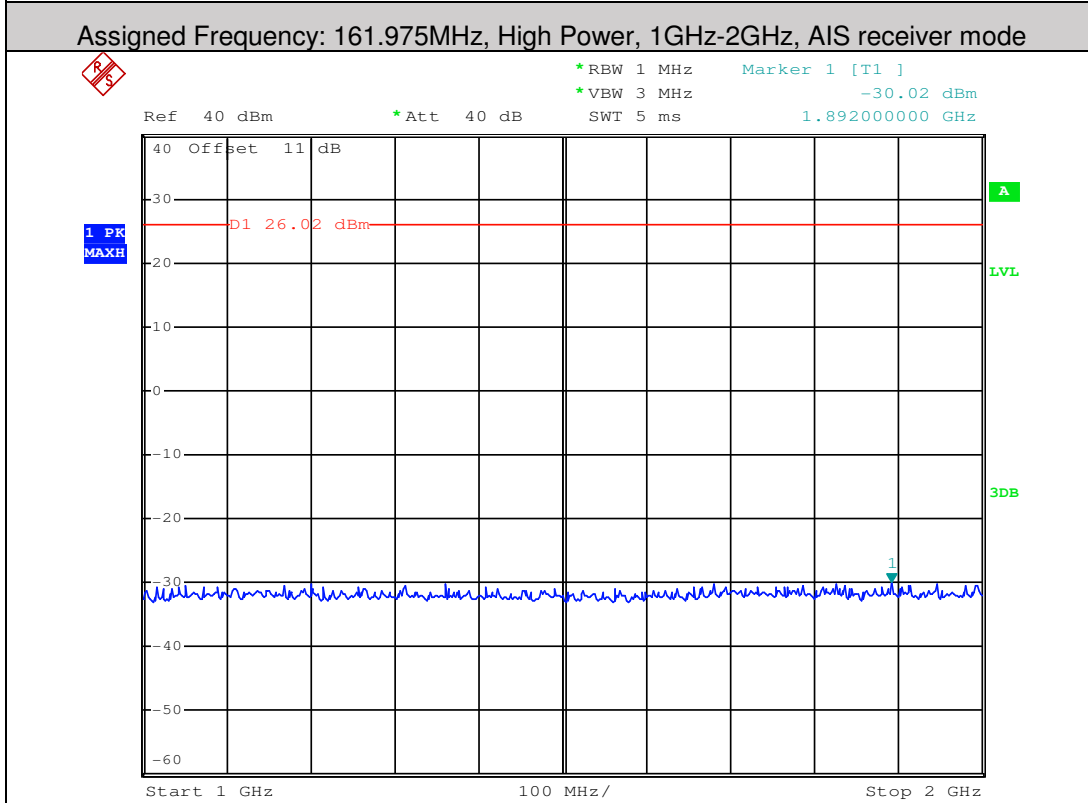
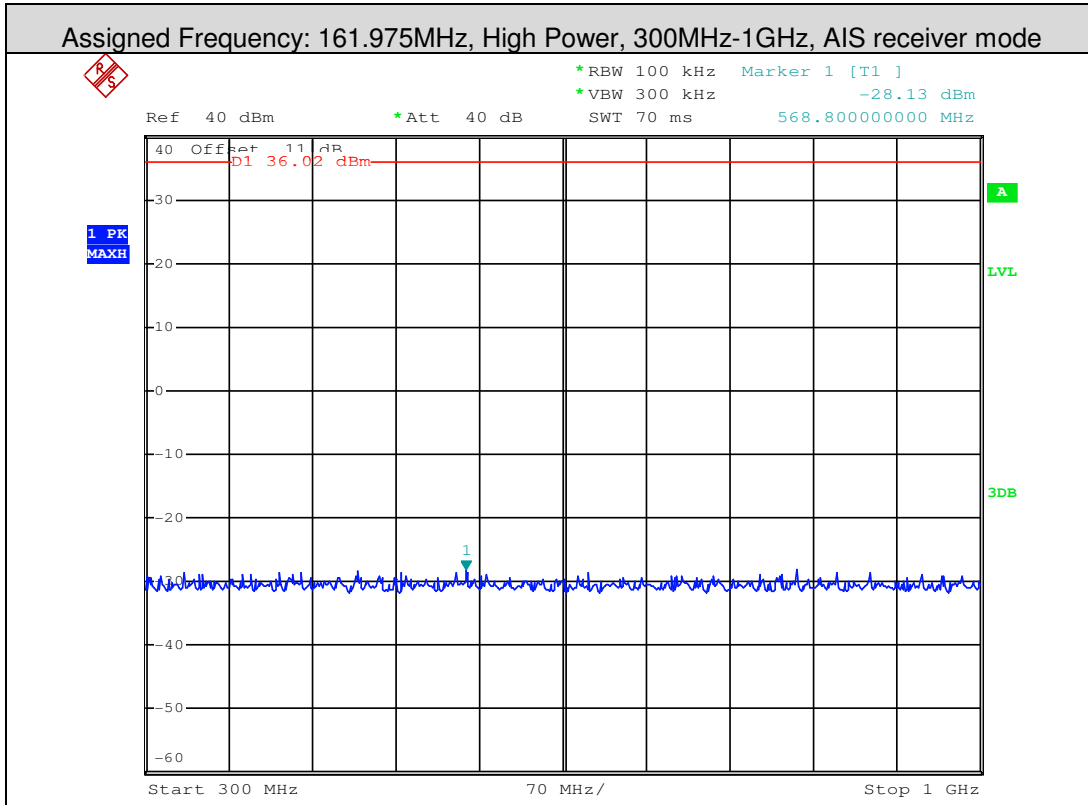

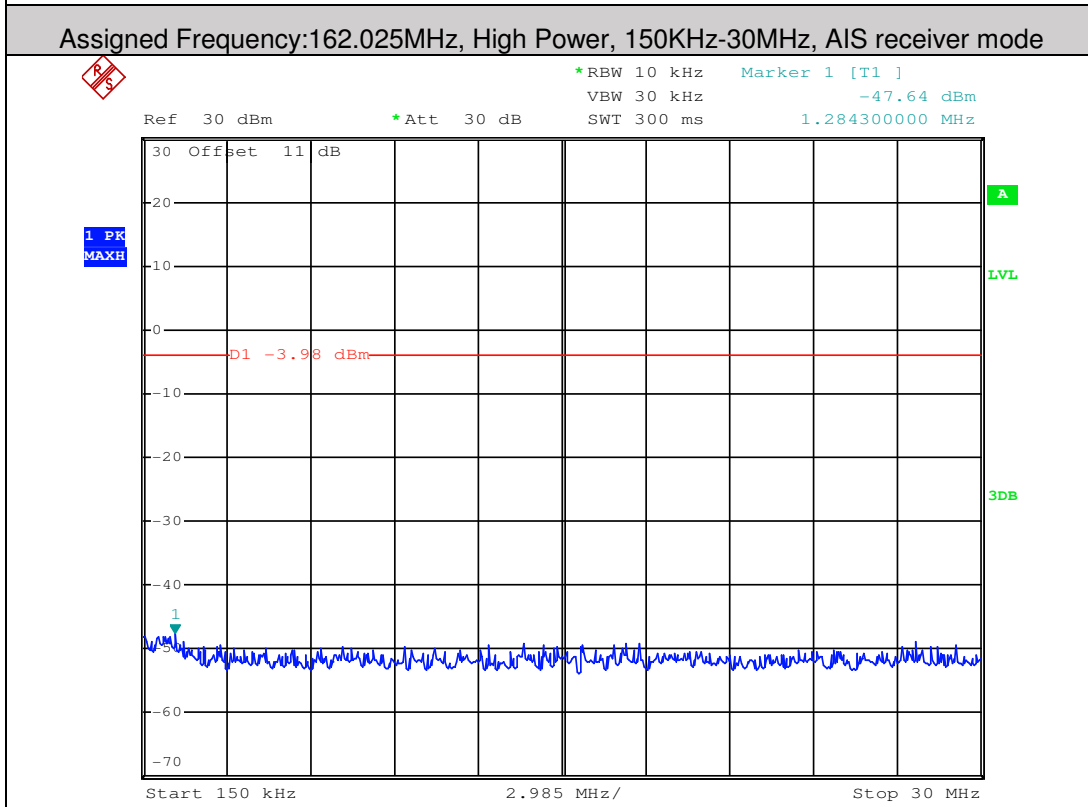
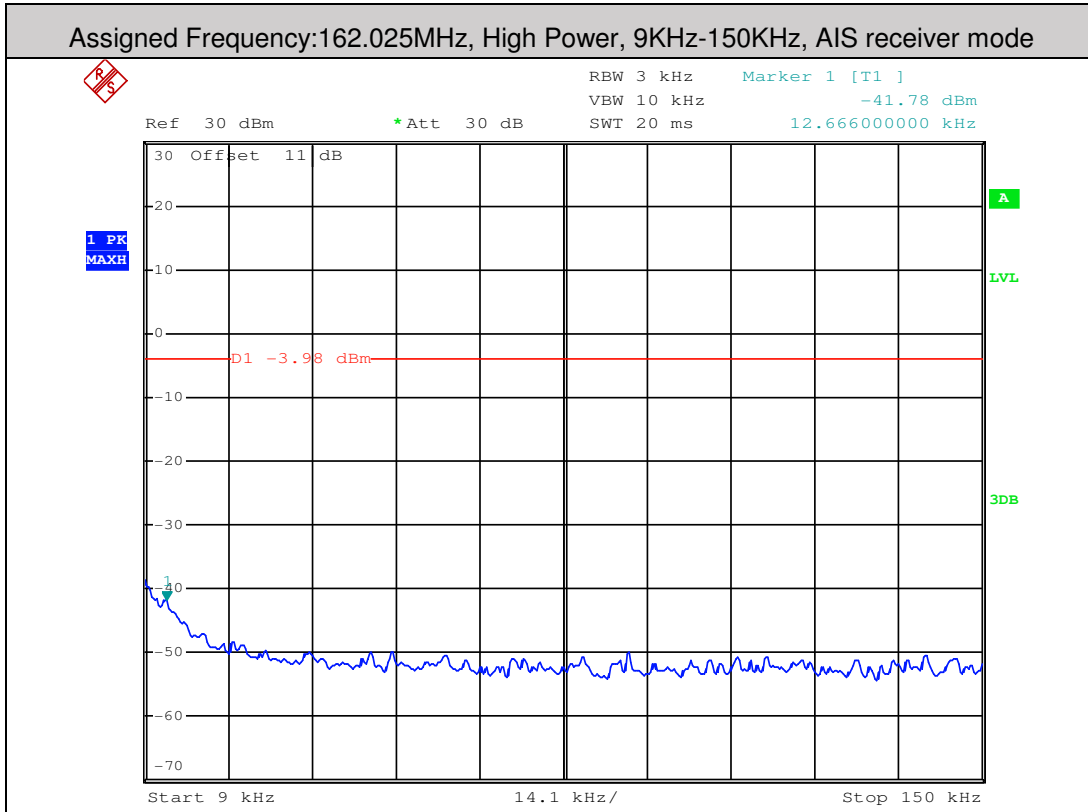



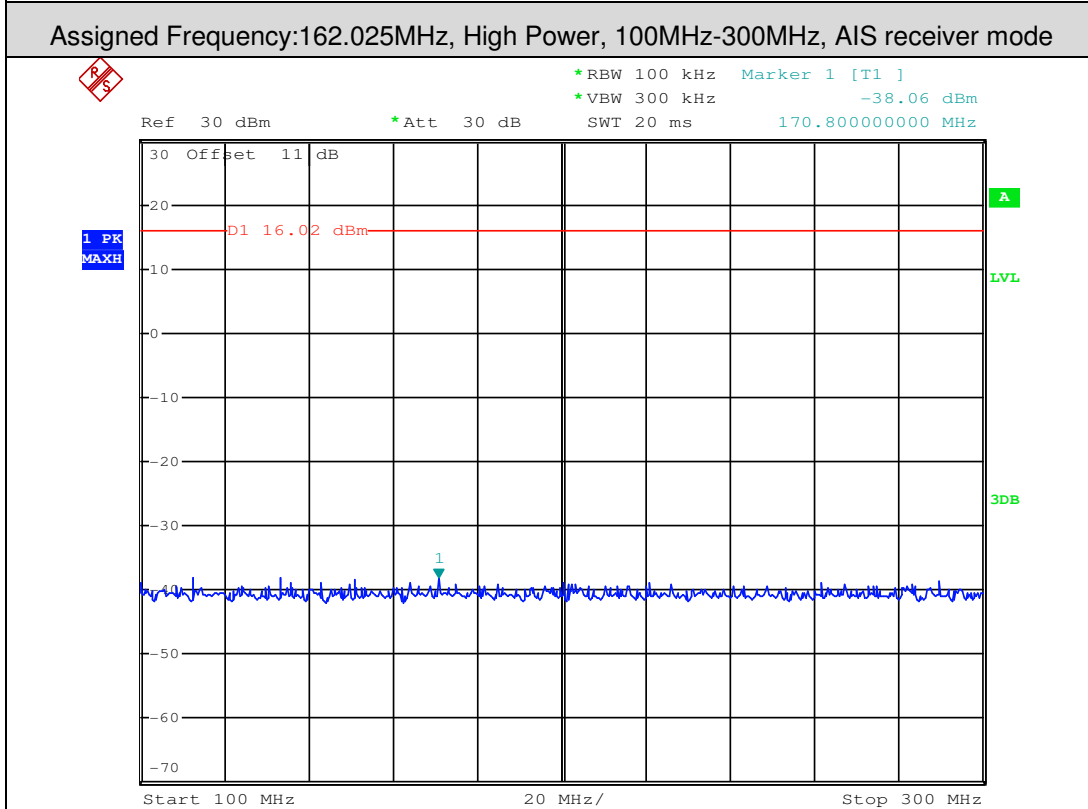
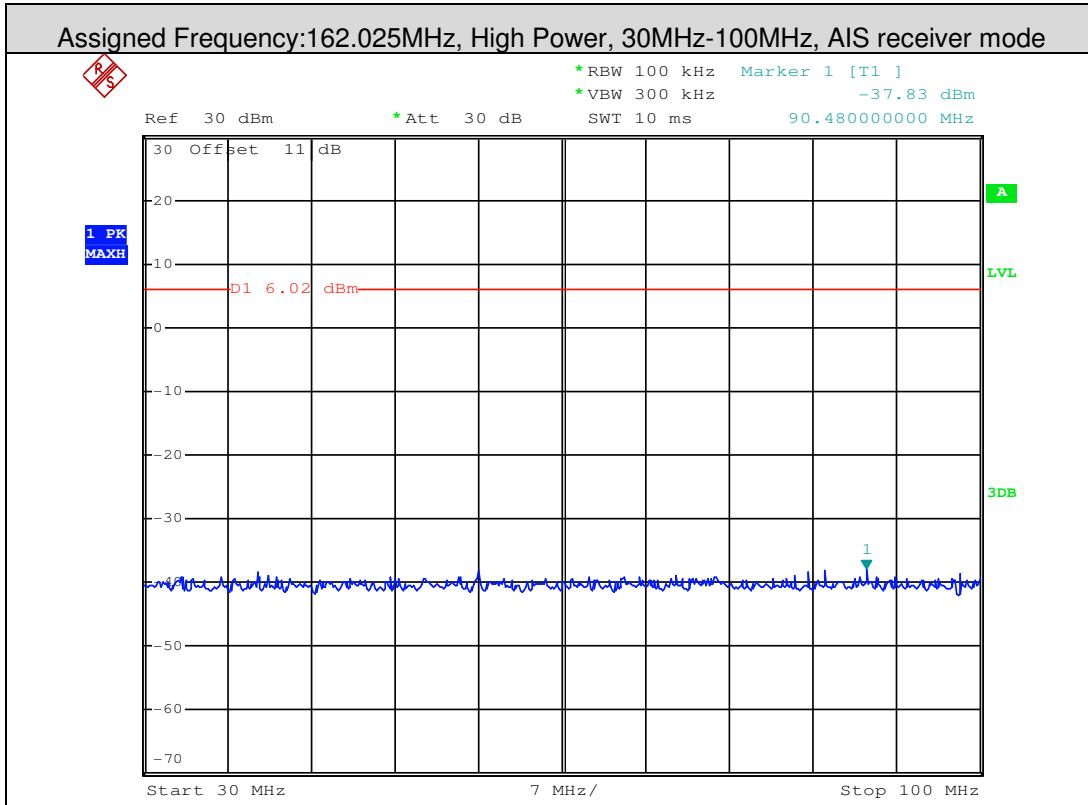

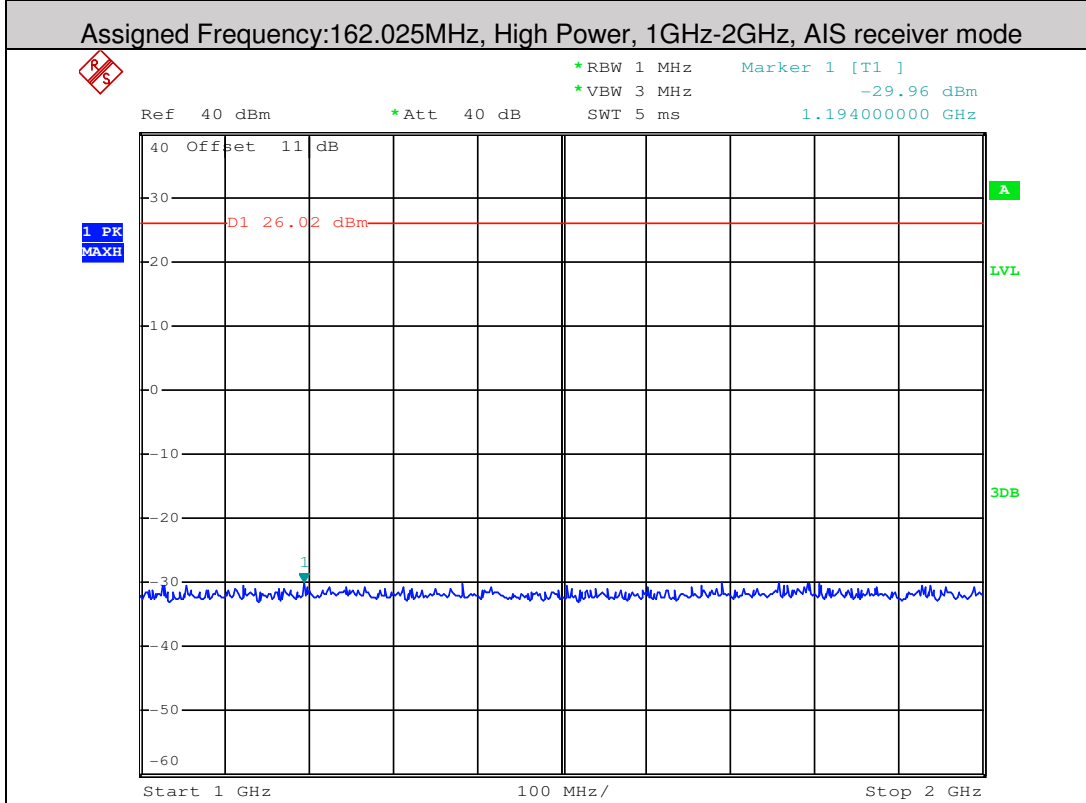
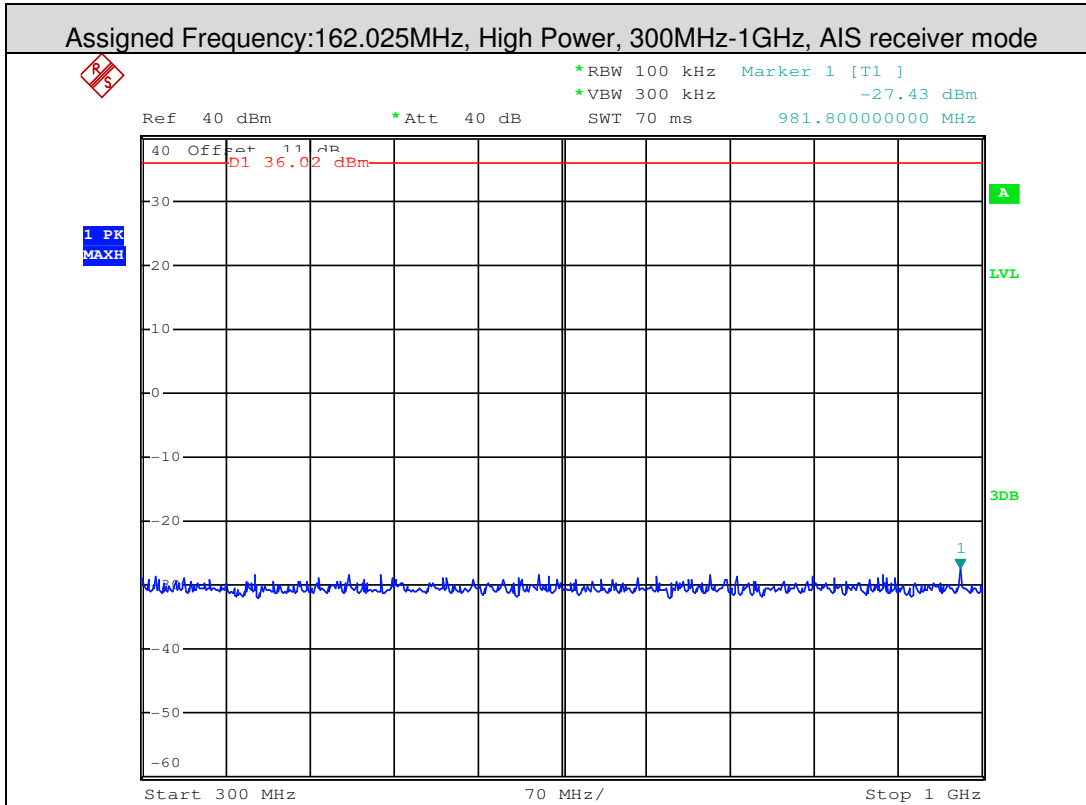

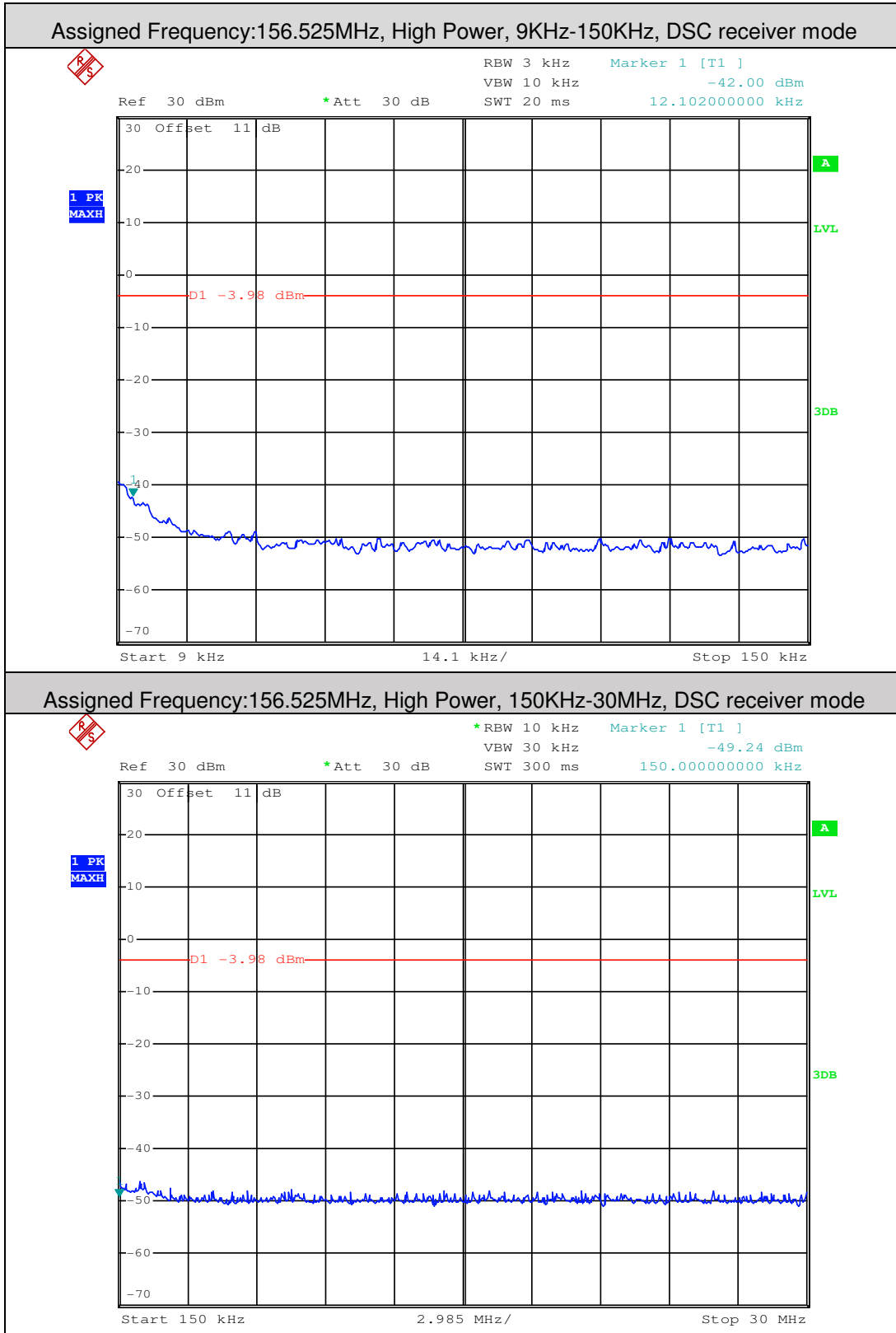

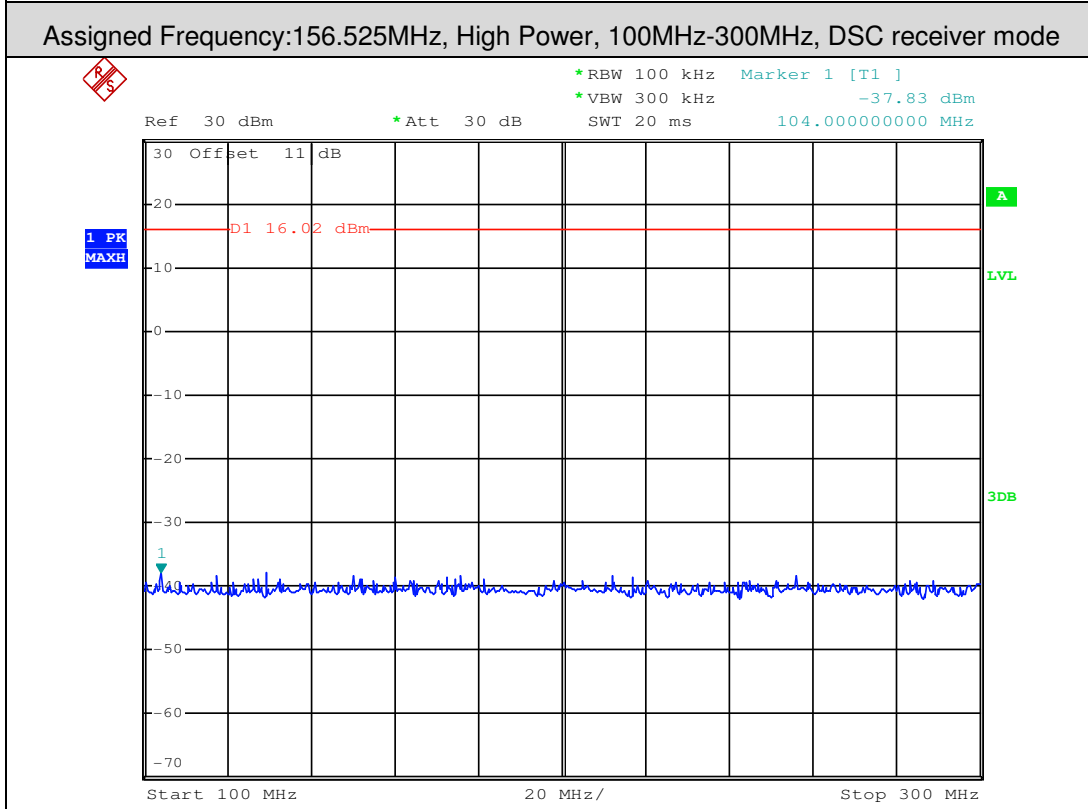
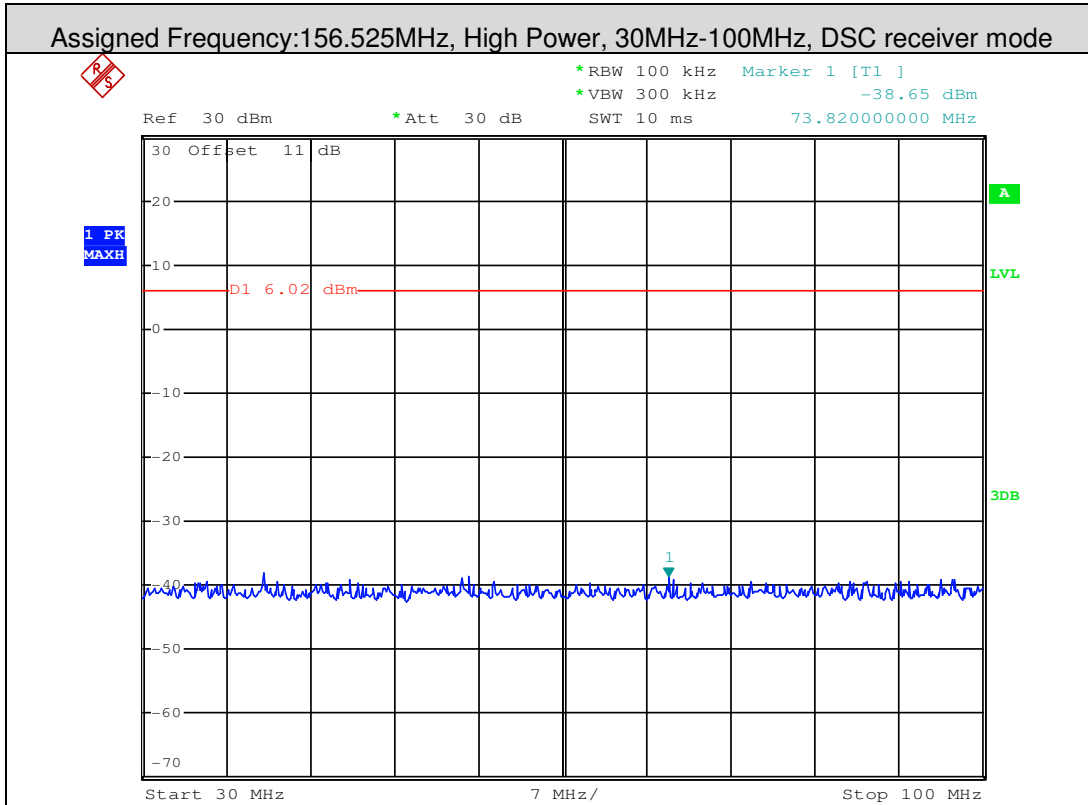

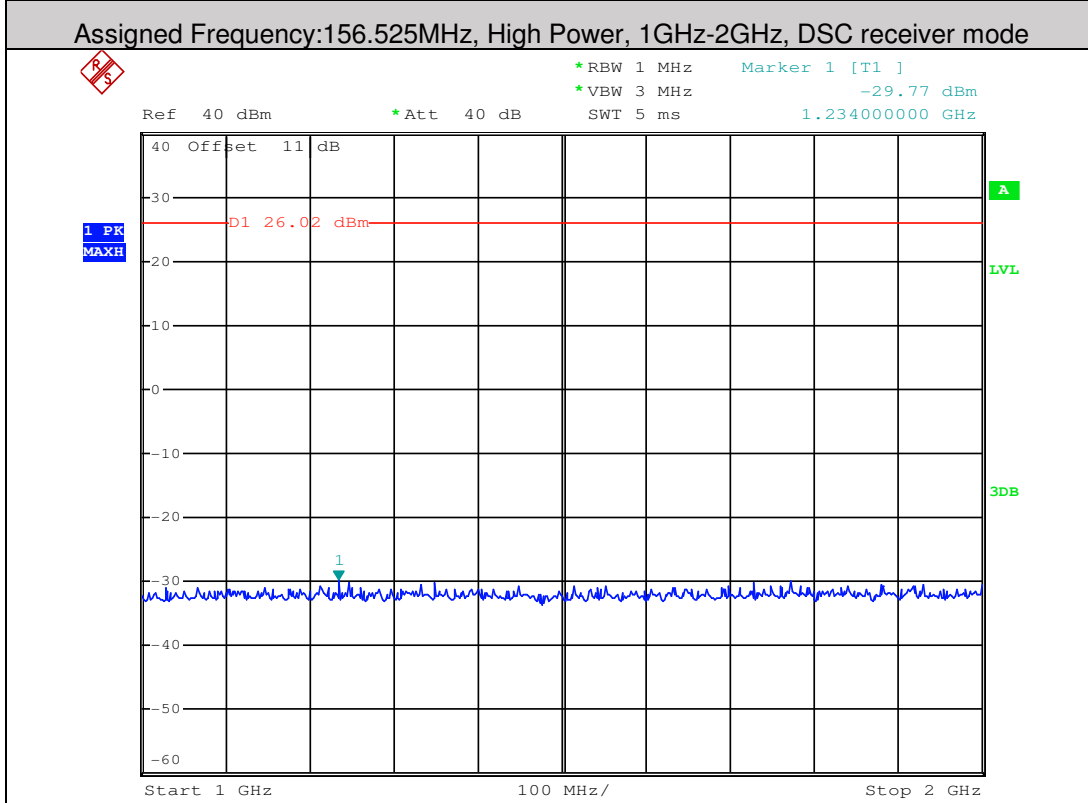
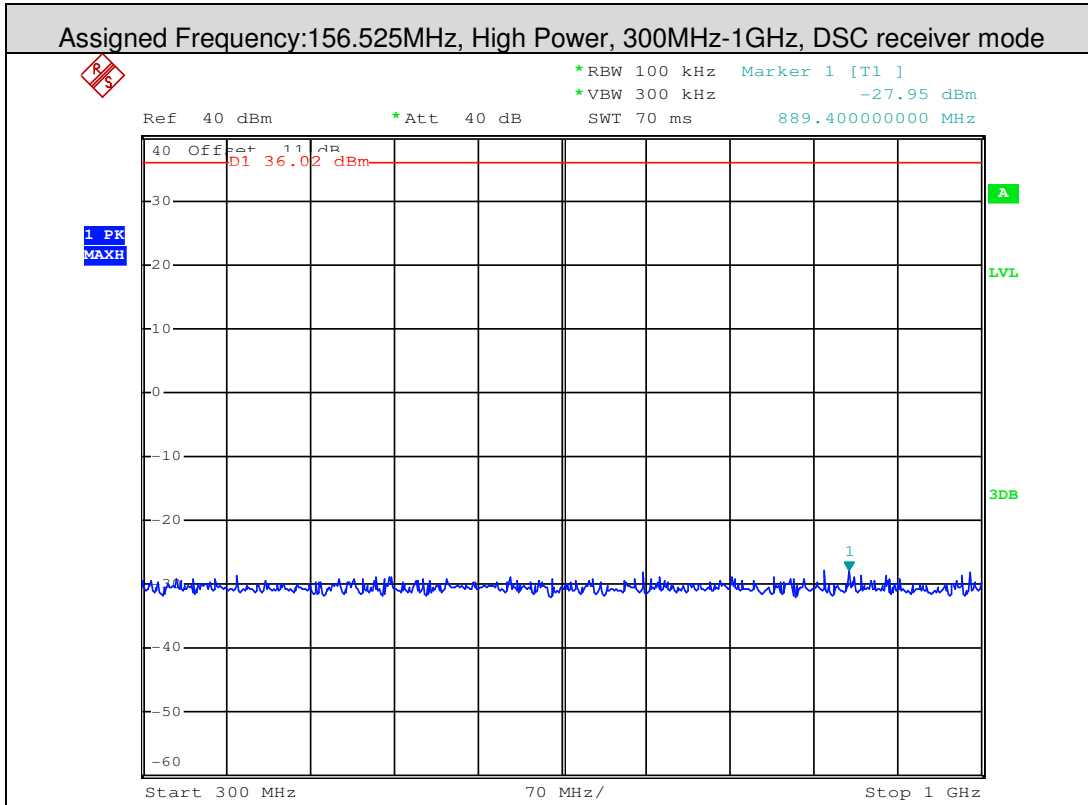

-End of Report-