



## **TEST REPORT**

**Application No.:** SZEM2007006018CR  
**Applicant:** Navico Inc.  
**Address of Applicant:** 4500 S. 129th East Avenue, Ste. 200, Tulsa, Oklahoma, 74134 United States  
**Manufacturer:** Navico Auckland Limited  
**Address of Manufacturer:** Arrenway Drive, Rosedale, Auckland, 0632 New Zealand  
**Factory:** Shenzhen Fastrain Technology Co., Ltd.  
**Address of Factory:** No.3 Baolong 4th Rd., Baolong Industrial Area, Longgang District, Shenzhen, China

**Equipment Under Test (EUT):**  
**EUT Name:** MARINE BLACK BOX DSC/AIS VHF RADIO SYSTEM  
**Model No.:** NRS-2  
**Trade mark:** NAVICO  
**FCC ID:** RAYVHFNRS2  
**Standards:** 47 CFR Part 80  
**Date of Receipt:** 2020-07-03  
**Date of Test:** 2020-07-31 to 2020-09-04  
**Date of Issue:** 2020-09-18

<b>Test Result:</b>	<b>Pass*</b>
---------------------	--------------

\* In the configuration tested, the EUT complied with the standards specified above.

*Keny Xu*

Keny Xu  
 EMC Laboratory Manager



Unless otherwise agreed in writing, this document is issued by the Company subject to its General Conditions of Service printed overleaf, available on request or accessible at <http://www.sgs.com/en/Terms-and-Conditions.aspx> and, for electronic format documents, subject to Terms and Conditions for Electronic Documents at <http://www.sgs.com/en/Terms-and-Conditions/Terms-e-Document.aspx>. Attention is drawn to the limitation of liability, indemnification and jurisdiction issues defined therein. Any holder of this document is advised that information contained hereon reflects the Company's findings at the time of its intervention only and within the limits of Client's instructions, if any. The Company's sole responsibility is to its Client and this document does not exonerate parties to a transaction from exercising all their rights and obligations under the transaction documents. This document cannot be reproduced except in full, without prior written approval of the Company. Any unauthorized alteration, forgery or falsification of the content or appearance of this document is unlawful and offenders may be prosecuted to the fullest extent of the law. Unless otherwise stated the results shown in this test report refer only to the sample(s) tested and such sample(s) are retained for 30 days only.  
**Attention: To check the authenticity of testing /inspection report & certificate, please contact us at telephone: (86-755) 8307 1443, or email: CN.Doccheck@sgs.com**

<i>Revision Record</i>				
<i>Version</i>	<i>Chapter</i>	<i>Date</i>	<i>Modifier</i>	<i>Remark</i>
01		2020-09-18		Original

<b>Authorized for issue by:</b>			
			
		<hr/> <b>Edison Li /Project Engineer</b>	
			
		<hr/> <b>Eric Fu /Reviewer</b>	



Unless otherwise agreed in writing, this document is issued by the Company subject to its General Conditions of Service printed overleaf, available on request or accessible at <http://www.sgs.com/en/Terms-and-Conditions.aspx> and, for electronic format documents, subject to Terms and Conditions for Electronic Documents at <http://www.sgs.com/en/Terms-and-Conditions/Terms-e-Documents.aspx>. Attention is drawn to the limitation of liability, indemnification and jurisdiction issues defined therein. Any holder of this document is advised that information contained hereon reflects the Company's findings at the time of its intervention only and within the limits of Client's instructions, if any. The Company's sole responsibility is to its Client and this document does not exonerate parties to a transaction from exercising all their rights and obligations under the transaction documents. This document cannot be reproduced except in full, without prior written approval of the Company. Any unauthorized alteration, forgery or falsification of the content or appearance of this document is unlawful and offenders may be prosecuted to the fullest extent of the law. Unless otherwise stated the results shown in this test report refer only to the sample(s) tested and such sample(s) are retained for 30 days only.

## 2 Test Summary

Radio Spectrum Technical Requirement				
Item	Standard	Method	Requirement	Result
Antenna Requirement	47 CFR Part 80	N/A	47 CFR Part 80.3(e),	Pass

Item	Standard	Method	Requirement	Result
Bandwidths	47 CFR Part 80	ANSI/TIA-603-E-2016 ANSI C63.26:2015	47 CFR Part 2.1049, 80.205(a)	Pass
Transmitter frequency tolerances	47 CFR Part 80		47 CFR Part 2.1055, 80.209(a)	Pass
Emission Mask	47 CFR Part 80		47 CFR Part 2.1047, 80.211(f)(1)(2)	Pass
Spurious Emissions at antenna Terminals	47 CFR Part 80		47 CFR Part 2.1047, 80.211(f)(3)	Pass
Modulation requirements	47 CFR Part 80		47 CFR Part 2.1047, 80.213	Pass
Transmitter frequency Deviation	47 CFR Part 80		47 CFR Part .1047, 80.213	Pass
Transmitter power	47 CFR Part 80		47 CFR Part 2.1046, 80.215	Pass
Transmitter Carrier Power Reduction	47 CFR Part 80		47 CFR Part 80.215(e)(f)	Pass
Suppression of interference aboard ships	47 CFR Part 80		47 CFR Part 80.217	Pass



Unless otherwise agreed in writing, this document is issued by the Company subject to its General Conditions of Service printed overleaf, available on request or accessible at <http://www.sgs.com/en/Terms-and-Conditions.aspx> and, for electronic format documents, subject to Terms and Conditions for Electronic Documents at <http://www.sgs.com/en/Terms-and-Conditions/Terms-e-Documents.aspx>. Attention is drawn to the limitation of liability, indemnification and jurisdiction issues defined therein. Any holder of this document is advised that information contained hereon reflects the Company's findings at the time of its intervention only and within the limits of Client's instructions, if any. The Company's sole responsibility is to its Client and this document does not exonerate parties to a transaction from exercising all their rights and obligations under the transaction documents. This document cannot be reproduced except in full, without prior written approval of the Company. Any unauthorized alteration, forgery or falsification of the content or appearance of this document is unlawful and offenders may be prosecuted to the fullest extent of the law. Unless otherwise stated the results shown in this test report refer only to the sample(s) tested and such sample(s) are retained for 30 days only.

Attention: To check the authenticity of testing / inspection report & certificate, please contact us at telephone: (86-755) 8307 1443, or email: [CN.Doccheck@sgs.com](mailto:CN.Doccheck@sgs.com)

### 3 Contents

	Page
1 COVER PAGE .....	1
2 TEST SUMMARY .....	3
3 CONTENTS .....	4
4 GENERAL INFORMATION .....	6
4.1 DETAILS OF E.U.T. ....	6
4.2 DESCRIPTION OF SUPPORT UNITS .....	6
4.3 MEASUREMENT UNCERTAINTY .....	7
4.4 TEST LOCATION.....	8
4.5 TEST FACILITY .....	8
4.6 DEVIATION FROM STANDARDS .....	8
4.7 ABNORMALITIES FROM STANDARD CONDITIONS.....	8
5 EQUIPMENT LIST .....	9
6 RADIO SPECTRUM TECHNICAL REQUIREMENT .....	11
6.1 ANTENNA REQUIREMENT .....	11
6.1.1 <i>Test Requirement:</i> .....	11
6.1.2 <i>Conclusion</i> .....	11
7 RADIO SPECTRUM MATTER TEST RESULTS .....	12
7.1 BANDWIDTHS .....	12
7.1.1 <i>E.U.T. Operation</i> .....	14
7.1.2 <i>E.U.T. Operation</i> .....	14
7.1.3 <i>Measurement Data</i> .....	14
7.2 TRANSMITTER FREQUENCY TOLERANCES .....	15
7.2.1 <i>E.U.T. Operation</i> .....	18
7.2.2 <i>E.U.T. Operation</i> .....	18
7.2.3 <i>Measurement Data</i> .....	18
7.3 EMISSIONS MASK .....	19
7.3.1 <i>E.U.T. Operation</i> .....	19
7.3.2 <i>E.U.T. Operation</i> .....	19
7.3.3 <i>Measurement Data</i> .....	19
7.4 SPURIOUS EMISSIONS AT ANTENNA TERMINALS .....	20
7.4.1 <i>E.U.T. Operation</i> .....	20
7.4.2 <i>E.U.T. Operation</i> .....	20
7.4.3 <i>Measurement Data</i> .....	20
7.5 TRANSMITTER UNWANTED EMISSIONS(RADIATED) .....	21
7.5.1 <i>E.U.T. Operation</i> .....	22
7.5.2 <i>E.U.T. Operation</i> .....	22
7.5.3 <i>Measurement Data</i> .....	23
7.6 MODULATION REQUIREMENTS .....	24



Unless otherwise agreed in writing, this document is issued by the Company subject to its General Conditions of Service printed overleaf, available on request or accessible at <http://www.sgs.com/en/Terms-and-Conditions.aspx> and, for electronic format documents, subject to Terms and Conditions for Electronic Documents at <http://www.sgs.com/en/Terms-and-Conditions/Terms-e-Documents.aspx>. Attention is drawn to the limitation of liability, indemnification and jurisdiction issues defined therein. Any holder of this document is advised that information contained hereon reflects the Company's findings at the time of its intervention only and within the limits of Client's instructions, if any. The Company's sole responsibility is to its Client and this document does not exonerate parties to a transaction from exercising all their rights and obligations under the transaction documents. This document cannot be reproduced except in full, without prior written approval of the Company. Any unauthorized alteration, forgery or falsification of the content or appearance of this document is unlawful and offenders may be prosecuted to the fullest extent of the law. Unless otherwise stated the results shown in this test report refer only to the sample(s) tested and such sample(s) are retained for 30 days only.

Attention: To check the authenticity of testing /inspection report & certificate, please contact us at telephone: (86-755) 8307 1443, or email: [CN\\_Doccheck@sgs.com](mailto:CN_Doccheck@sgs.com)  
 No.1 Workshop, M-10, Middle Section, Science & Technology Park, Shenzhen, China 518057 t (86-755) 26012053 f (86-755) 26710594 www.sgs.com.cn  
 中国·深圳·科技园中区M-10栋一号厂房 邮编: 518057 t (86-755) 26012053 f (86-755) 26710594 sgs.china@sgs.com

7.6.1	<i>E.U.T. Operation</i> .....	24
7.6.2	<i>Test Setup Diagram</i> .....	24
7.6.3	<i>Measurement Data</i> .....	24
7.7	TRANSMITTER FREQUENCY DEVIATION.....	25
7.7.1	<i>E.U.T. Operation</i> .....	25
7.7.2	<i>Test Setup Diagram</i> .....	25
7.7.3	<i>Measurement Data</i> .....	25
7.8	TRANSMITTER POWER.....	26
7.8.1	<i>E.U.T. Operation</i> .....	26
7.8.2	<i>Test Setup Diagram</i> .....	26
7.8.3	<i>Measurement Data</i> .....	27
7.9	TRANSMITTER CARRIER POWER REDUCTION.....	28
7.9.1	<i>E.U.T. Operation</i> .....	28
7.9.2	<i>Test Setup Diagram</i> .....	28
7.9.3	<i>Measurement Data</i> .....	29
7.10	SUPPRESSION OF INTERFERENCE ABOARD SHIPS.....	30
7.10.1	<i>E.U.T. Operation</i> .....	30
7.10.2	<i>E.U.T. Operation</i> .....	30
7.10.3	<i>Measurement Data</i> .....	30
<b>8</b>	<b>PHOTOGRAPHS</b> .....	<b>31</b>
8.1	TEST SETUP.....	31
8.2	EUT CONSTRUCTIONAL DETAILS.....	31
<b>9</b>	<b>APPENDIX</b> .....	<b>32</b>
9.1	APPENDIX FCC DATA.....	32-93



Unless otherwise agreed in writing, this document is issued by the Company subject to its General Conditions of Service printed overleaf, available on request or accessible at <http://www.sgs.com/en/Terms-and-Conditions.aspx> and, for electronic format documents, subject to Terms and Conditions for Electronic Documents at <http://www.sgs.com/en/Terms-and-Conditions/Terms-e-Documents.aspx>. Attention is drawn to the limitation of liability, indemnification and jurisdiction issues defined therein. Any holder of this document is advised that information contained hereon reflects the Company's findings at the time of its intervention only and within the limits of Client's instructions, if any. The Company's sole responsibility is to its Client and this document does not exonerate parties to a transaction from exercising all their rights and obligations under the transaction documents. This document cannot be reproduced except in full, without prior written approval of the Company. Any unauthorized alteration, forgery or falsification of the content or appearance of this document is unlawful and offenders may be prosecuted to the fullest extent of the law. Unless otherwise stated the results shown in this test report refer only to the sample(s) tested and such sample(s) are retained for 30 days only.  
 Attention: To check the authenticity of testing / inspection report & certificate, please contact us at telephone: (86-755) 8307 1443, or email: [CN\\_Doccheck@sgs.com](mailto:CN_Doccheck@sgs.com)

## 4 General Information

### 4.1 Details of E.U.T.

Power supply:	12 VDC battery system
Cable:	DC cable: longer than 300cm unshielded
Sample Type:	Mobile device
Internal Source:	More than 108MHz
Transmitter Frequency Range:	VHF:156.025MHz-157.425MHz
AIS Transmitter Frequency Range:	AIS Class B:161.975MHz(CH87), 162.025MHz(CH88)
DSC Transmitter Frequency Range:	156.525MHz(CH70), Meets Global DSC Class D standards.
Modulation Type:	VHF:FM for Analog DSC:FSK AIS:GMSK
Frequency Spacing:	VHF: 25KHz
Emission Type:	16K0G3E for VHF 16K0G2B for DSC 9K05GXW for AIS
Rated Output Power:	25W/1W for VHF/DS; 2W for AIS
VHF/DSC Antenna Connectors:	SO-239(50 ohm, External Antenna)
AIS Antenna Connectors:	SO-239(50 ohm, External Antenna)
VHF/DSC Antenna Gain:	6dBi
AIS Antenna Gain:	6dBi
Type of Equipment:	Ship stations

### 4.2 Description of Support Units

Description	Manufacturer	Model No.	Serial No.
DC power	ZHAOXIN	RXN-305D	REF. No.SEA2700
Coaxial Attenuator	Provided by client	TS4	HYT168793
Wired Handset	SIMRAD	HS100	/
Wired Speaker	/	SP100	/
Wired Handset	B&G	H100	/
Wired Speaker	/	SP100	/



### 4.3 Measurement Uncertainty

No.	Item	Measurement Uncertainty
1	Radio Frequency	$\pm 7.25 \times 10^{-8}$
2	Occupied Bandwidth	$\pm 3\%$
3	RF conducted power	$\pm 0.75\text{dB}$
4	Conducted Spurious emissions	$\pm 0.75\text{dB}$
5	Radiated Spurious emission test	$\pm 4.5\text{dB}$ (30MHz-1GHz)
		$\pm 4.8\text{dB}$ (1GHz-18GHz)
6	Temperature test	$\pm 1^\circ\text{C}$
7	Humidity test	$\pm 3\%$
8	Supply voltages	$\pm 1.5\%$



#### 4.4 Test Location

All tests were performed at:

SGS-CSTC Standards Technical Services Co., Ltd., Shenzhen Branch

No. 1 Workshop, M-10, Middle Section, Science & Technology Park, Shenzhen, Guangdong, China.  
518057.

Tel: +86 755 2601 2053 Fax: +86 755 2671 0594

No tests were sub-contracted.

#### 4.5 Test Facility

The test facility is recognized, certified, or accredited by the following organizations:

• **A2LA (Certificate No. 3816.01)**

SGS-CSTC Standards Technical Services Co., Ltd., Shenzhen EMC Laboratory is accredited by the American Association for Laboratory Accreditation(A2LA). Certificate No. 3816.01.

• **VCCI**

The 3m Fully-anechoic chamber for above 1GHz, 10m Semi-anechoic chamber for below 1GHz, Shielded Room for Mains Port Conducted Interference Measurement and Telecommunication Port Conducted Interference Measurement of SGS-CSTC Standards Technical Services Co., Ltd. have been registered in accordance with the Regulations for Voluntary Control Measures with Registration No.: G-20026, R-14188, C-12383 and T-11153 respectively.

• **FCC –Designation Number: CN1178**

SGS-CSTC Standards Technical Services Co., Ltd., Shenzhen EMC Laboratory has been recognized as an accredited testing laboratory.

Designation Number: CN1178. Test Firm Registration Number: 406779.

• **Innovation, Science and Economic Development Canada**

SGS-CSTC Standards Technical Services Co., Ltd., Shenzhen EMC Laboratory has been recognized by ISED as an accredited testing laboratory.

CAB identifier: CN0006.

IC#: 4620C.

#### 4.6 Deviation from Standards

None

#### 4.7 Abnormalities from Standard Conditions

None



Unless otherwise agreed in writing, this document is issued by the Company subject to its General Conditions of Service printed overleaf, available on request or accessible at <http://www.sgs.com/en/Terms-and-Conditions.aspx> and, for electronic format documents, subject to Terms and Conditions for Electronic Documents at <http://www.sgs.com/en/Terms-and-Conditions/Terms-e-Documents.aspx>. Attention is drawn to the limitation of liability, indemnification and jurisdiction issues defined therein. Any holder of this document is advised that information contained hereon reflects the Company's findings at the time of its intervention only and within the limits of Client's instructions, if any. The Company's sole responsibility is to its Client and this document does not exonerate parties to a transaction from exercising all their rights and obligations under the transaction documents. This document cannot be reproduced except in full, without prior written approval of the Company. Any unauthorized alteration, forgery or falsification of the content or appearance of this document is unlawful and offenders may be prosecuted to the fullest extent of the law. Unless otherwise stated the results shown in this test report refer only to the sample(s) tested and such sample(s) are retained for 30 days only.  
Attention: To check the authenticity of testing / inspection report & certificate, please contact us at telephone: (86-755) 8307 1443, or email: [CN\\_Doccheck@sgs.com](mailto:CN_Doccheck@sgs.com)



## 5 Equipment List

RF Conducted Test					
Equipment	Manufacturer	Model No	Inventory No	Cal Date	Cal Due Date
Shielding Room	SAEMC	MSR733	SEM001-09	2019-06-13	2022-06-12
DC Power Supply	Rohde & Schwarz	NGSM 32/10	SEM011-04	2020-03-24	2021-03-23
Spectrum Analyzer	Rohde & Schwarz	FSU43	SEM004-08	2020-04-01	2021-03-31
Measurement Software	TST	TST PASS V1.0.5	N/A	N/A	N/A
Coaxial Cable	SGS	N/A	SEM031-01	2020-07-10	2021-07-09
Attenuator	Huber+Suhner	6620_SMA-50- 1	SEM021-09	N/A	N/A
Signal Generator	KEYSIGHT	N5173B	SEM006-05	2019-09-24	2020-09-23
Power Meter	Rohde & Schwarz	NRVS	SEM014-02	2019-09-24	2020-09-23
Electric and Magnetic Field Analyzer	Narda	EHP-50F	SEM022-05	2019-11-28	2020-11-27
Power Sensor	KEYSIGHT	U2021XA	SEM009-20	2020-05-21	2021-05-20
Power Meter	Rohde & Schwarz	NRVS	SEM014-02	2020-09-23	2021-09-22

Radiated Spurious Emissions(Below 1GHz)					
Test Equipment	Manufacturer	Model No.	Inventory No.	Cal. Date	Cal. Due date
3m Semi-Anechoic Chamber	ETS-LINDGREN	N/A	SEM001-01	2020-07-19	2023-07-18
MXE EMI receiver(3Hz-3.6GHz)	KEYSIGHT	N9038A	SEM004-15	2019-12-16	2020-12-15
BiConiLog Antenna (26-3000MHz)	ETS-LINDGREN	3142C	SEM003-02	2019-05-24	2022-05-23
Pre-amplifier (0.1-1300MHz)	Agilent Technologies	8447D	SEM005-01	2020-04-01	2021-03-31
Measurement Software	AUDIX	e3 V8.2014-6- 27	N/A	N/A	N/A
Coaxial Cable	SGS	N/A	SEM025-01	2020-07-10	2021-07-09



Unless otherwise agreed in writing, this document is issued by the Company subject to its General Conditions of Service printed overleaf, available on request or accessible at <http://www.sgs.com/en/Terms-and-Conditions.aspx> and, for electronic format documents, subject to Terms and Conditions for Electronic Documents at <http://www.sgs.com/en/Terms-and-Conditions/Terms-e-Documents.aspx>. Attention is drawn to the limitation of liability, indemnification and jurisdiction issues defined therein. Any holder of this document is advised that information contained hereon reflects the Company's findings at the time of its intervention only and within the limits of Client's instructions, if any. The Company's sole responsibility is to its Client and this document does not exonerate parties to a transaction from exercising all their rights and obligations under the transaction documents. This document cannot be reproduced except in full, without prior written approval of the Company. Any unauthorized alteration, forgery or falsification of the content or appearance of this document is unlawful and offenders may be prosecuted to the fullest extent of the law. Unless otherwise stated the results shown in this test report refer only to the sample(s) tested and such sample(s) are retained for 30 days only.

Attention: To check the authenticity of testing / inspection report & certificate, please contact us at telephone: (86-755) 8307 1443, or email: [CN.Doccheck@sgs.com](mailto:CN.Doccheck@sgs.com)

<b>Radiated Spurious Emissions</b>					
<b>Equipment</b>	<b>Manufacturer</b>	<b>Model No</b>	<b>Inventory No</b>	<b>Cal Date</b>	<b>Cal Due Date</b>
3m Semi-Anechoic Chamber	AUDIX	N/A	SEM001-02	2018-03-13	2021-03-12
Measurement Software	AUDIX	e3 V8.2014-6-27	N/A	N/A	N/A
Coaxial Cable	SGS	N/A	SEM026-01	2020-07-10	2021-07-09
EXA Spectrum Analyzer	AgilentTechnologies Inc	N9010A	SEM004-12	2020-04-09	2021-04-08
Horn Antenna	Rohde & Schwarz	HF907	SEM003-07	2018-04-13	2021-04-12
Horn Antenna	Schwarzbeck	BBHA 9170	SEM003-15	2017-10-17	2020-10-16
Pre-Amplifier	Compliance Directions Systems Inc.	PAP-0126	SEM004-11	2019-09-24	2020-09-23
Pre-amplifier	Rohde & Schwarz	CH14-H052	SEM005-17	2020-04-01	2021-03-31
Pre-amplifier	Compliance Directions Systems Inc.	PAP-2640-50	SEM005-08	2020-04-01	2021-03-31
DC Power Supply	Zhao Xin	KXN-6020D	SEM011-08	2019-09-24	2020-09-23
Active Loop Antenna	ETS-Lindgren	6502	SEM003-08	2020-08-14	2023-08-13

<b>General used equipment</b>					
<b>Equipment</b>	<b>Manufacturer</b>	<b>Model No</b>	<b>Inventory No</b>	<b>Cal Date</b>	<b>Cal Due Date</b>
Humidity/ Temperature Indicator	Shanghai Meteorological Industry Factory	ZJ1-2B	SEM002-03	2019-09-26	2020-09-25
Humidity/ Temperature Indicator	Shanghai Meteorological Industry Factory	ZJ1-2B	SEM002-04	2019-09-26	2020-09-25
Humidity/ Temperature Indicator	Mingle	N/A	SEM002-08	2019-09-26	2020-09-25
Barometer	Changchun Meteorological Industry Factory	DYM3	SEM002-01	2020-04-07	2021-04-06



Unless otherwise agreed in writing, this document is issued by the Company subject to its General Conditions of Service printed overleaf, available on request or accessible at <http://www.sgs.com/en/Terms-and-Conditions.aspx> and, for electronic format documents, subject to Terms and Conditions for Electronic Documents at <http://www.sgs.com/en/Terms-and-Conditions/Terms-e-Documents.aspx>. Attention is drawn to the limitation of liability, indemnification and jurisdiction issues defined therein. Any holder of this document is advised that information contained hereon reflects the Company's findings at the time of its intervention only and within the limits of Client's instructions, if any. The Company's sole responsibility is to its Client and this document does not exonerate parties to a transaction from exercising all their rights and obligations under the transaction documents. This document cannot be reproduced except in full, without prior written approval of the Company. Any unauthorized alteration, forgery or falsification of the content or appearance of this document is unlawful and offenders may be prosecuted to the fullest extent of the law. Unless otherwise stated the results shown in this test report refer only to the sample(s) tested and such sample(s) are retained for 30 days only.

**Attention:** To check the authenticity of testing / inspection report & certificate, please contact us at telephone: (86-755) 8307 1443, or email: [CN.Doccheck@sgs.com](mailto:CN.Doccheck@sgs.com)  
No.1 Workshop, M-10, Middle Section, Science & Technology Park, Shenzhen, China 518057 t (86-755) 26012053 f (86-755) 26710594 www.sgs.com.cn  
中国·深圳·科技园中区M-10栋一号厂房 邮编: 518057 t (86-755) 26012053 f (86-755) 26710594 sgs.china@sgs.com

## 6 Radio Spectrum Technical Requirement

### 6.1 Antenna Requirement

#### 6.1.1 Test Requirement:

47 CFR Part Part 80.81

#### 6.1.2 Conclusion

##### 80.81 Requirements:

All telephony emissions of a ship station or a marine utility station on board ship within the frequency band 30-200 MHz must be vertically polarized.

EUT Antenna:

Antenna location: Refer to Internal photos.



## 7 Radio Spectrum Matter Test Results

### 7.1 Bandwidths

Test Requirement: 47 CFR FCC Part2.1049 & FCC Part 80.205(a)

Test Method: ANSI/TIA-603-E:2016

Limit:

(a).An emission designator shows the necessary bandwidth for each class of emission of a station except that in ship earth stations it shows the occupied or necessary bandwidth, whichever is greater. The following table gives the class of emission and corresponding emission designator and authorized bandwidth:

emission	Emission designator	Authorized bandwidth (kHz)
A1A	160HA1A	0.4
A1B <sup>1</sup>	160HA1B	0.4
A1D <sup>12</sup>	16K0A1D	20.0
A2A	2K66A2A	2.8
A2B <sup>1</sup>	2K66A2B	2.8
A2D <sup>12</sup>	16K0A2D	20.0
A3E	6K00A3E	8.0
A3N <sup>2</sup>	2K66A3N	2.8
A3X <sup>3</sup>	3K20A3X	25.0
F1B <sup>4</sup>	280HF1B	0.3
F1B <sup>5</sup>	300HF1B	0.5
F1B <sup>6</sup>	16K0F1B	20.0
F1C	2K80F1C	3.0
F1D <sup>12</sup>	16K0F1D	20.0
F2B <sup>6</sup>	16K0F2B	20.0
F2C <sup>7</sup>	16K0F2C	20.0
F2D <sup>12</sup>	16K0F2D	20.0
F3C	2K80F3C	3.0
F3C <sup>7</sup>	16K0F3C	20.0
F3E <sup>8</sup>	16K0F3E	20.0
F3N <sup>9</sup>	20MOF3N	20,000.0
G1D <sup>12</sup>	16K0G1D	20.0



Unless otherwise agreed in writing, this document is issued by the Company subject to its General Conditions of Service printed overleaf, available on request or accessible at <http://www.sgs.com/en/Terms-and-Conditions.aspx> and, for electronic format documents, subject to Terms and Conditions for Electronic Documents at <http://www.sgs.com/en/Terms-and-Conditions/Terms-e-Documents.aspx>. Attention is drawn to the limitation of liability, indemnification and jurisdiction issues defined therein. Any holder of this document is advised that information contained hereon reflects the Company's findings at the time of its intervention only and within the limits of Client's instructions, if any. The Company's sole responsibility is to its Client and this document does not exonerate parties to a transaction from exercising all their rights and obligations under the transaction documents. This document cannot be reproduced except in full, without prior written approval of the Company. Any unauthorized alteration, forgery or falsification of the content or appearance of this document is unlawful and offenders may be prosecuted to the fullest extent of the law. Unless otherwise stated the results shown in this test report refer only to the sample(s) tested and such sample(s) are retained for 30 days only.

Attention: To check the authenticity of testing / inspection report & certificate, please contact us at telephone: (86-755) 8307 1443, or email: [CN.Doccheck@sgs.com](mailto:CN.Doccheck@sgs.com)

G2D <sup>12</sup>	16K0G2D	20.0
G3D <sup>10</sup>	16KOG3D	20.0
G3E <sup>8</sup>	16KOG3E	20.0
G3N <sup>3 13</sup>	16KOG3N	20.0
H2A	1K40H2A	2.8
H2B <sup>1</sup>	1K40H2B	2.8
H3E <sup>11</sup>	2K80H3E	3.0
H3N	2K66H3N	2.8
J2A	160HJ2A	0.4
J2B <sup>4</sup>	280HJ2B	0.3
J2B <sup>5</sup>	300HJ2B	0.5
J2B	2K80J2B	3.0
J2C	2K80J2C	3.0
J2D <sup>14</sup>	2K80J2D	3.0
J3C	2K80J3C	3.0
J3E <sup>11</sup>	2K80J3E	3.0
J3N	160HJ3N	0.4
NON	NON	0.4
PON	( <sup>12</sup> )	( <sup>12</sup> )
R3E <sup>11</sup>	2K80R3E	3.0

<sup>1</sup>On 500 kHz and 2182 kHz A1B, A2B, H2B and J2B emissions indicate transmission of the auto alarm signals.

<sup>2</sup>Applicable only to transmissions in the 405-525 kHz band for direction finding.

<sup>3</sup>Applicable only to EPIRB's.

<sup>4</sup>Radioprinter transmissions for communications with private coast stations.

<sup>5</sup>NB-DP radiotelegraph and data transmissions for communications with public coast stations.

<sup>6</sup>Applicable only to radioprinter and data in the 156-162 MHz band and radioprinter in the 216-220 MHz band.

<sup>7</sup>Applicable only to facsimile in the 156-162 MHz and 216-220 MHz bands.

<sup>8</sup>Applicable only when maximum frequency deviation is 5 kHz. See also paragraph (b) of this section.

<sup>9</sup>Applicable only to marine hand-held radar.

<sup>10</sup>Applicable only to on-board frequencies for maneuvering or navigation.



Unless otherwise agreed in writing, this document is issued by the Company subject to its General Conditions of Service printed overleaf, available on request or accessible at <http://www.sgs.com/en/Terms-and-Conditions.aspx> and, for electronic format documents, subject to Terms and Conditions for Electronic Documents at <http://www.sgs.com/en/Terms-and-Conditions/Terms-e-Documents.aspx>. Attention is drawn to the limitation of liability, indemnification and jurisdiction issues defined therein. Any holder of this document is advised that information contained hereon reflects the Company's findings at the time of its intervention only and within the limits of Client's instructions, if any. The Company's sole responsibility is to its Client and this document does not exonerate parties to a transaction from exercising all their rights and obligations under the transaction documents. This document cannot be reproduced except in full, without prior written approval of the Company. Any unauthorized alteration, forgery or falsification of the content or appearance of this document is unlawful and offenders may be prosecuted to the fullest extent of the law. Unless otherwise stated the results shown in this test report refer only to the sample(s) tested and such sample(s) are retained for 30 days only.

Attention: To check the authenticity of testing / inspection report & certificate, please contact us at telephone: (86-755) 8307 1443, or email: [CN\\_Doccheck@sgs.com](mailto:CN_Doccheck@sgs.com)  
No.1 Workshop, M-10, Middle Section, Science & Technology Park, Shenzhen, China 518057 t (86-755) 26012053 f (86-755) 26710594 www.sgs.com.cn  
中国·深圳·科技园中区M-10栋一号厂房 邮编: 518057 t (86-755) 26012053 f (86-755) 26710594 sgs.china@sgs.com

<sup>11</sup>Transmitters approved prior to December 31, 1969, for emission H3E, J3E and R3E and an authorized bandwidth of 3.5 kHz may continue to be operated. These transmitters will not be authorized in new installations.

<sup>12</sup>Applicable to radiolocation and associated telecommand ship stations operating on 154.585 MHz, 159.480 MHz, 160.725 MHz, 160.785 MHz, 454.000 MHz, and 459.000 MHz; emergency position indicating radiobeacons operating in the 406.000-406.1000 MHz frequency bank; and data transmissions in the 156-162 MHz band.

<sup>13</sup>[Reserved]

<sup>14</sup>The information is contained in multiple very low level subcarriers.

(b) For land stations the maximum authorized frequency deviation for F3E or G3E emission is as follows:

(1) 5 kHz in the 72.0-73.0 MHz, 75.4-76.0 MHz and 156-162 MHz bands;

(2) 15 kHz for stations which were authorized for operation before December 1, 1961, in the 73.0-74.6 MHz band.

The bandwidth of the AIS station is 25KHz as per FCC Part 80.393.

### 7.1.1 E.U.T. Operation

Operating Environment:

Temperature: 25.1 °C      Humidity: 53.8 % RH      Atmospheric Pressure: 1010 mbar  
 Test mode: c: TX mode, Keep the EUT in transmitting mode.

### 7.1.2 E.U.T. Operation

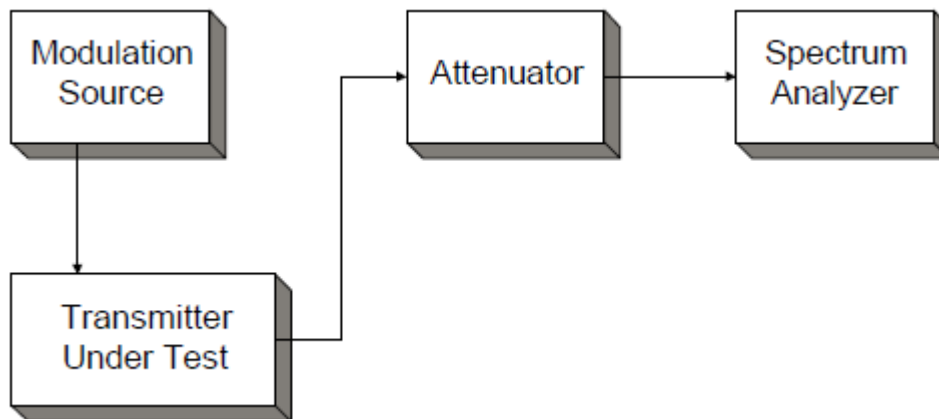

### 7.1.3 Measurement Data

The detailed test data see: Appendix FCC data.



Unless otherwise agreed in writing, this document is issued by the Company subject to its General Conditions of Service printed overleaf, available on request or accessible at <http://www.sgs.com/en/Terms-and-Conditions.aspx> and, for electronic format documents, subject to Terms and Conditions for Electronic Documents at <http://www.sgs.com/en/Terms-and-Conditions/Terms-e-Documents.aspx>. Attention is drawn to the limitation of liability, indemnification and jurisdiction issues defined therein. Any holder of this document is advised that information contained hereon reflects the Company's findings at the time of its intervention only and within the limits of Client's instructions, if any. The Company's sole responsibility is to its Client and this document does not exonerate parties to a transaction from exercising all their rights and obligations under the transaction documents. This document cannot be reproduced except in full, without prior written approval of the Company. Any unauthorized alteration, forgery or falsification of the content or appearance of this document is unlawful and offenders may be prosecuted to the fullest extent of the law. Unless otherwise stated the results shown in this test report refer only to the sample(s) tested and such sample(s) are retained for 30 days only.  
 Attention: To check the authenticity of testing / inspection report & certificate, please contact us at telephone: (86-755) 8307 1443, or email: [CN.Doccheck@sgs.com](mailto:CN.Doccheck@sgs.com)

## 7.2 Transmitter Frequency Tolerances.

Test Requirement 47 CFR FCC Part2.1055 & FCC Part 80.209(a)  
Test Method: ANSI/TIA-603-E:2016  
Limit:

(a). The frequency tolerance requirements applicable to transmitters in the maritime services are shown in the following table. Tolerances are given as parts in 106 unless shown in Hz.

Frequency bands and categories of stations	Tolerances <sup>1</sup>
(1) Band 100-525 kHz:	
(i) Coast stations:	
For single sideband emissions	20 Hz.
For transmitters with narrow-band direct printing and data emissions	10 Hz <sup>2</sup>
For transmitters with digital selective calling emissions	10 Hz.
For all other emissions	100.
(ii) Ship stations:	
For transmitters with narrow-band direct printing and data emissions	20 Hz.
For transmitters with digital selective calling emissions	10 Hz <sup>2</sup>
For all other transmitters	10 Hz.
(iii) Ship stations for emergency only:	
For all emissions	20 Hz.
(iv) Survival craft stations:	
For all emissions	20 Hz.
(v) Radiodetermination stations:	
For all emissions	100.
(2) Band 1600-4000 kHz:	
(i) Coast stations and Alaska fixed stations:	
For single sideband and facsimile	20 Hz.
For narrow-band direct printing and data emissions	10 Hz. <sup>2</sup>
For transmitters with digital selective calling emissions	10 Hz. <sup>2</sup>
For all other emissions	50 Hz.
(ii) Ship stations:	
For transmitters with narrow-band direct printing and data emissions	10 Hz. <sup>2</sup>



Unless otherwise agreed in writing, this document is issued by the Company subject to its General Conditions of Service printed overleaf, available on request or accessible at <http://www.sgs.com/en/Terms-and-Conditions.aspx> and, for electronic format documents, subject to Terms and Conditions for Electronic Documents at <http://www.sgs.com/en/Terms-and-Conditions/Terms-e-Documents.aspx>. Attention is drawn to the limitation of liability, indemnification and jurisdiction issues defined therein. Any holder of this document is advised that information contained hereon reflects the Company's findings at the time of its intervention only and within the limits of Client's instructions, if any. The Company's sole responsibility is to its Client and this document does not exonerate parties to a transaction from exercising all their rights and obligations under the transaction documents. This document cannot be reproduced except in full, without prior written approval of the Company. Any unauthorized alteration, forgery or falsification of the content or appearance of this document is unlawful and offenders may be prosecuted to the fullest extent of the law. Unless otherwise stated the results shown in this test report refer only to the sample(s) tested and such sample(s) are retained for 30 days only.

Attention: To check the authenticity of testing / inspection report & certificate, please contact us at telephone: (86-755) 8307 1443, or email: [CN.Doccheck@sgs.com](mailto:CN.Doccheck@sgs.com)

For transmitters with digital selective calling emissions	10 Hz. <sup>3</sup>
For all other transmitters	20 Hz.
(iii) Survival craft stations:	20 Hz.
(iv) Radiodetermination stations:	
With power 200W or less	20.
With power above 200W	10.
(3) Band 4000-27500 kHz:	
(i) Coast stations and Alaska fixed stations:	
For single sideband and facsimile emissions	20 Hz.
For narrow-band direct printing and data emissions	10 Hz. <sup>2</sup>
For digital selective calling emissions	10 Hz.
For Morse telegraphy emissions	10.
For all other emissions	15 Hz.
(ii) Ship stations:	
For transmitters with narrow-band direct printing and data emissions	10 Hz. <sup>2</sup>
For transmitters with digital selective calling emissions	10 Hz. <sup>3</sup>
For all other transmitters	20 Hz.
(iii) Survival craft stations:	50 Hz.
(4) Band 72-76 MHz:	
(i) Fixed stations:	
Operating in the 72.0-73.0 and 75.4-76.0 MHz bands	5.
Operating in the 73.74.6 MHz band	50.
(5) Band 156-162 MHz:	
(i) Coast stations:	
For carriers licensed to operate with a carrier power:	
Below 3 watts	10.
3 to 100 watts	5. <sup>7</sup>
(ii) Ship stations	10. <sup>4</sup>
(iii) Survival craft stations operating on 121.500 MHz	50.
(iv) EPIRBs:	
Operating on 121.500 and 243.000 MHz	50.
Operating on 156.750 and 156.800 MHz. <sup>6</sup>	10.



Unless otherwise agreed in writing, this document is issued by the Company subject to its General Conditions of Service printed overleaf, available on request or accessible at <http://www.sgs.com/en/Terms-and-Conditions.aspx> and, for electronic format documents, subject to Terms and Conditions for Electronic Documents at <http://www.sgs.com/en/Terms-and-Conditions/Terms-e-Documents.aspx>. Attention is drawn to the limitation of liability, indemnification and jurisdiction issues defined therein. Any holder of this document is advised that information contained hereon reflects the Company's findings at the time of its intervention only and within the limits of Client's instructions, if any. The Company's sole responsibility is to its Client and this document does not exonerate parties to a transaction from exercising all their rights and obligations under the transaction documents. This document cannot be reproduced except in full, without prior written approval of the Company. Any unauthorized alteration, forgery or falsification of the content or appearance of this document is unlawful and offenders may be prosecuted to the fullest extent of the law. Unless otherwise stated the results shown in this test report refer only to the sample(s) tested and such sample(s) are retained for 30 days only.

Attention: To check the authenticity of testing / inspection report & certificate, please contact us at telephone: (86-755) 8307 1443, or email: [CN.Doccheck@sgs.com](mailto:CN.Doccheck@sgs.com)



(6) Band 216-220 MHz:	
(i) Coast stations:	
For all emissions	5.
(ii) Ship stations:	
For all emissions	5.
(7) Band 400-466 MHz:	
(i) EPIRBs operating on 406-406.1 MHz	5.
(ii) On-board stations	5.
(iii) Radiolocation and telecommand stations.	5.
(8) Band 1626.5-1646.5 MHz:	
(i) Ship earth stations	5.

<sup>1</sup>Transmitters authorized prior to January 2, 1990, with frequency tolerances equal to or better than those required after this date will continue to be authorized in the maritime services provided they retain approval and comply with the applicable standards in this part.

<sup>2</sup>The frequency tolerance for narrow-band direct printing and data transmitters installed before January 2, 1992, is 15 Hz for coast stations and 20 Hz for ship stations. The frequency tolerance for narrow-band direct printing and data transmitters approved or installed after January 1, 1992, is 10 Hz.

<sup>3</sup>[Reserved]

<sup>4</sup>For transmitters in the radiolocation and associated telecommand service operating on 154.584 MHz, 159.480 MHz, 160.725 MHz and 160.785 MHz the frequency tolerance is 15 parts in 10<sup>6</sup>.

<sup>5</sup>[Reserved]

<sup>6</sup>[Reserved]

<sup>7</sup>For transmitters operated at private coast stations with antenna heights less than 6 meters (20 feet) above ground and output power of 25 watts or less the frequency tolerance is 10 parts in 10<sup>6</sup>.

(b) When pulse modulation is used in land and ship radar stations operating in the bands above 2.4 GHz the frequency at which maximum emission occurs must be within the authorized bandwidth and must not be closer than 1.5/T MHz to the upper and lower limits of the authorized bandwidth where "T" is the pulse duration in microseconds. In the band 14.00-14.05 GHz the center frequency must not vary more than 10 MHz from 14.025 GHz.

(c) For stations in the maritime radiodetermination service, other than ship radar stations, the authorized frequency tolerance will be specified on the license when it is not specified in this part.



Unless otherwise agreed in writing, this document is issued by the Company subject to its General Conditions of Service printed overleaf, available on request or accessible at <http://www.sgs.com/en/Terms-and-Conditions.aspx> and, for electronic format documents, subject to Terms and Conditions for Electronic Documents at <http://www.sgs.com/en/Terms-and-Conditions/Terms-e-Documents.aspx>. Attention is drawn to the limitation of liability, indemnification and jurisdiction issues defined therein. Any holder of this document is advised that information contained hereon reflects the Company's findings at the time of its intervention only and within the limits of Client's instructions, if any. The Company's sole responsibility is to its Client and this document does not exonerate parties to a transaction from exercising all their rights and obligations under the transaction documents. This document cannot be reproduced except in full, without prior written approval of the Company. Any unauthorized alteration, forgery or falsification of the content or appearance of this document is unlawful and offenders may be prosecuted to the fullest extent of the law. Unless otherwise stated the results shown in this test report refer only to the sample(s) tested and such sample(s) are retained for 30 days only.  
Attention: To check the authenticity of testing / inspection report & certificate, please contact us at telephone: (86-755) 8307 1443, or email: [CN\\_Doccheck@sgs.com](mailto:CN_Doccheck@sgs.com)

**7.2.1 E.U.T. Operation**

Operating Environment:

Temperature: 25.1 °C Humidity: 53.8 % RH Atmospheric Pressure: 1010 mbar  
Test mode: c: TX mode, Keep the EUT in transmitting mode.

**7.2.2 E.U.T. Operation**

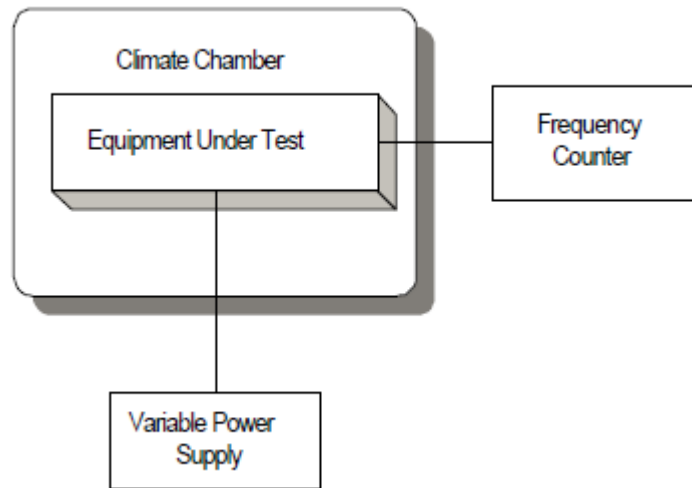

**7.2.3 Measurement Data**

The detailed test data see: Appendix FCC data.



Unless otherwise agreed in writing, this document is issued by the Company subject to its General Conditions of Service printed overleaf, available on request or accessible at <http://www.sgs.com/en/Terms-and-Conditions.aspx> and, for electronic format documents, subject to Terms and Conditions for Electronic Documents at <http://www.sgs.com/en/Terms-and-Conditions/Terms-e-Documents.aspx>. Attention is drawn to the limitation of liability, indemnification and jurisdiction issues defined therein. Any holder of this document is advised that information contained hereon reflects the Company's findings at the time of its intervention only and within the limits of Client's instructions, if any. The Company's sole responsibility is to its Client and this document does not exonerate parties to a transaction from exercising all their rights and obligations under the transaction documents. This document cannot be reproduced except in full, without prior written approval of the Company. Any unauthorized alteration, forgery or falsification of the content or appearance of this document is unlawful and offenders may be prosecuted to the fullest extent of the law. Unless otherwise stated the results shown in this test report refer only to the sample(s) tested and such sample(s) are retained for 30 days only.  
Attention: To check the authenticity of testing / inspection report & certificate, please contact us at telephone: (86-755) 8307 1443, or email: [CN.Doccheck@sgs.com](mailto:CN.Doccheck@sgs.com)

### 7.3 Emissions Mask

Test Requirement: 47 CFR FCC Part2.1047 & FCC Part 80.211(f) (1) (2)  
Test Method: ANSI/TIA-603-E:2016  
Limit:

- (f) The mean power when using emissions other than those in paragraphs (a), (b), (c) and (d) of this section:
  - (1) On any frequency removed from the assigned frequency by more than 50 percent up to and including 100 percent of the authorized bandwidth: At least 25 dB;
  - (2) On any frequency removed from the assigned frequency by more than 100 percent up to and including 250 percent of the authorized bandwidth: At least 35 dB;

Note: As required by FCC part 80.211(f), the limit value of the Emission Mask is calculated based on the measured maximum carrier power minus the corresponding value defined by the standard.

#### 7.3.1 E.U.T. Operation

Operating Environment:  
Temperature: 25.1 °C Humidity: 53.8 % RH Atmospheric Pressure: 1010 mbar  
Test mode: c: TX mode, Keep the EUT in transmitting mode.

#### 7.3.2 E.U.T. Operation

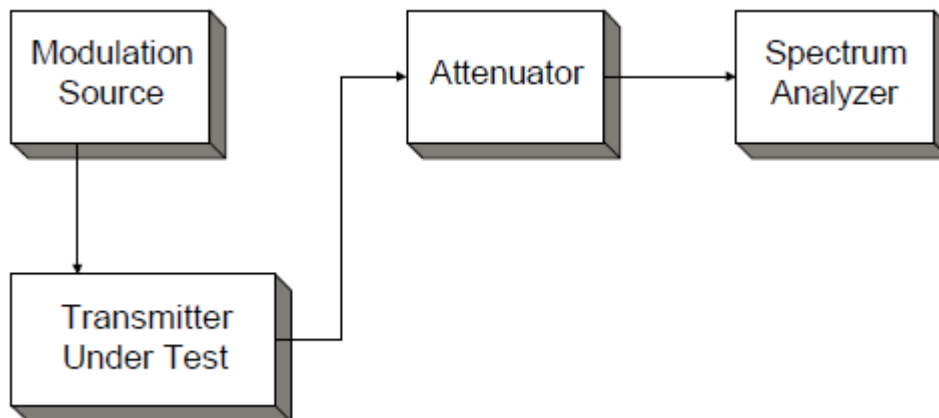

#### 7.3.3 Measurement Data

The detailed test data see: Appendix FCC data.



Unless otherwise agreed in writing, this document is issued by the Company subject to its General Conditions of Service printed overleaf, available on request or accessible at <http://www.sgs.com/en/Terms-and-Conditions.aspx> and, for electronic format documents, subject to Terms and Conditions for Electronic Documents at <http://www.sgs.com/en/Terms-and-Conditions/Terms-e-Documents.aspx>. Attention is drawn to the limitation of liability, indemnification and jurisdiction issues defined therein. Any holder of this document is advised that information contained hereon reflects the Company's findings at the time of its intervention only and within the limits of Client's instructions, if any. The Company's sole responsibility is to its Client and this document does not exonerate parties to a transaction from exercising all their rights and obligations under the transaction documents. This document cannot be reproduced except in full, without prior written approval of the Company. Any unauthorized alteration, forgery or falsification of the content or appearance of this document is unlawful and offenders may be prosecuted to the fullest extent of the law. Unless otherwise stated the results shown in this test report refer only to the sample(s) tested and such sample(s) are retained for 30 days only.  
Attention: To check the authenticity of testing / inspection report & certificate, please contact us at telephone: (86-755) 8307 1443, or email: [CN.Doccheck@sgs.com](mailto:CN.Doccheck@sgs.com)

## 7.4 Spurious Emissions at Antenna Terminals

Test Requirement: 47 CFR FCC Part2.1047 & FCC Part 80.211(f) (3)  
 Test Method: ANSI/TIA-603-E:2016  
 Limit:

- (f) The mean power when using emissions other than those in paragraphs (a), (b), (c) and (d) of this section:  
 (3) On any frequency removed from the assigned frequency by more than 250 percent of the authorized bandwidth: At least 43 plus  $10\log_{10}$  (mean power in watts) dB.

### 7.4.1 E.U.T. Operation

Operating Environment:  
 Temperature: 25.1 °C Humidity: 53.8 % RH Atmospheric Pressure: 1010 mbar  
 Test mode: c: TX mode, Keep the EUT in transmitting mode.

### 7.4.2 E.U.T. Operation

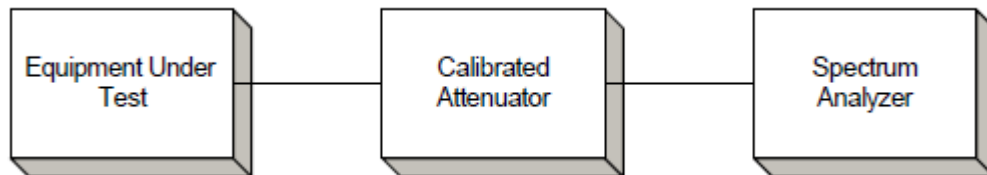

### 7.4.3 Measurement Data

The detailed test data see: Appendix FCC data.



Unless otherwise agreed in writing, this document is issued by the Company subject to its General Conditions of Service printed overleaf, available on request or accessible at <http://www.sgs.com/en/Terms-and-Conditions.aspx> and, for electronic format documents, subject to Terms and Conditions for Electronic Documents at <http://www.sgs.com/en/Terms-and-Conditions/Terms-e-Documents.aspx>. Attention is drawn to the limitation of liability, indemnification and jurisdiction issues defined therein. Any holder of this document is advised that information contained hereon reflects the Company's findings at the time of its intervention only and within the limits of Client's instructions, if any. The Company's sole responsibility is to its Client and this document does not exonerate parties to a transaction from exercising all their rights and obligations under the transaction documents. This document cannot be reproduced except in full, without prior written approval of the Company. Any unauthorized alteration, forgery or falsification of the content or appearance of this document is unlawful and offenders may be prosecuted to the fullest extent of the law. Unless otherwise stated the results shown in this test report refer only to the sample(s) tested and such sample(s) are retained for 30 days only.  
 Attention: To check the authenticity of testing / inspection report & certificate, please contact us at telephone: (86-755) 8307 1443, or email: [CN.Doccheck@sgs.com](mailto:CN.Doccheck@sgs.com)

## 7.5 Transmitter Unwanted Emissions(Radiated)

Test Requirement: 47 CFR FCC Part2.1047 & FCC Part 80.211(f)  
Test Method: ANSI/TIA-603-E:2016  
Limit:

- (f) The mean power when using emissions other than those in paragraphs (a), (b), (c) and (d) of this section:
- (1) On any frequency removed from the assigned frequency by more than 50 percent up to and including 100 percent of the authorized bandwidth: At least 25 dB;
  - (2) On any frequency removed from the assigned frequency by more than 100 percent up to and including 250 percent of the authorized bandwidth: At least 35 dB; and
  - (3) On any frequency removed from the assigned frequency by more than 250 percent of the authorized bandwidth: At least 43 plus  $10\log_{10}$  (mean power in watts) dB.



**7.5.1 E.U.T. Operation**

Operating Environment:

Temperature: 25.1 °C Humidity: 53.8 % RH Atmospheric Pressure: 1010 mbar  
 Test mode: c: TX mode, Keep the EUT in transmitting mode.

**7.5.2 E.U.T. Operation**

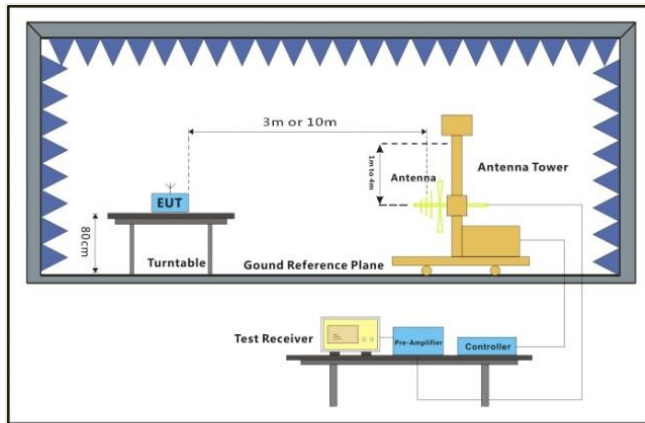

30MHz-1GHz

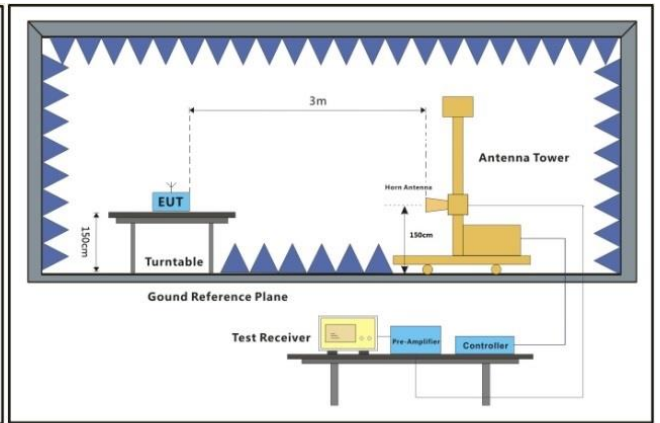

Above 1GHz

Radiation Emission Test Setup

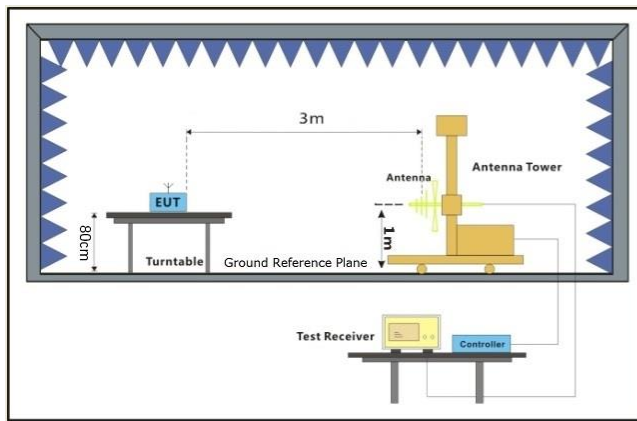

EUT

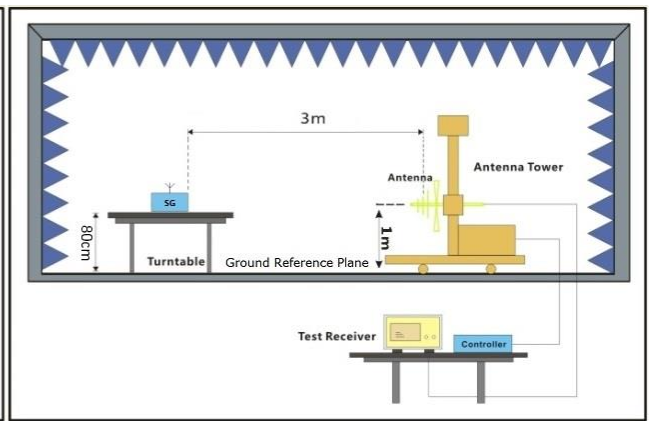

Substiute Antenna+Signal Generator

Substitution Test Setup



### 7.5.3 Measurement Data

#### Test Procedure:

- (1) On a test site, the EUT shall be placed on a turntable and in the position closest to the normal use as declared by the user.
- (2) The test antenna shall be oriented initially for vertical polarization located 3m from the EUT to correspond to the transmitter.
- (3) The output of the antenna shall be connected to the measuring receiver and either a peak or quasi-peak detector was used for the measurement as indicated on the report. The detector selection is based on how close the emission level was approaching the limit.
- (4) The transmitter shall be switched on; if possible, without the modulation and the measurement receiver shall be tuned to the frequency of the transmitter under test.
- (5) The test antenna shall be raised and lowered through the specified range of height until the measuring receiver detects a maximum signal level.
- (6) The transmitter shall then be rotated through 360° in the horizontal plane, until the maximum signal level is detected by the measuring receiver.
- (7) The test antenna shall be raised and lowered again through the specified range of height until the measuring receiver detects a maximum signal level.
- (8) The maximum signal level detected by the measuring receiver shall be noted.
- (9) The measurement shall be repeated with the test antenna set to horizontal polarization.
- (10) Replace the antenna with a proper Antenna (substitution antenna).
- (11) The substitution antenna shall be oriented for vertical polarization and, if necessary, the length of the substitution antenna shall be adjusted to correspond to the frequency of transmitting.
- (12) The substitution antenna shall be connected to a calibrated signal generator.
- (13) If necessary, the input attenuator setting of the measuring receiver shall be adjusted in order to increase the sensitivity of the measuring receiver.
- (14) The test antenna shall be raised and lowered through the specified range of the height to ensure that the maximum signal is received.
- (15) The input signal to substitution antenna shall be adjusted to the level that produces a level detected by the measuring receiver, that is equal to the level noted while the transmitter radiated power was measured, corrected for the change of input attenuation setting of the measuring receiver.
- (16) The input level to the substitution antenna shall be recorded as power level in dBm, corrected for any change of input attenuator setting of the measuring receiver.
- (17) The measurement shall be repeated with the test antenna and the substitution antenna oriented for horizontal polarization.

The detailed test data see: Appendix FCC data.



Unless otherwise agreed in writing, this document is issued by the Company subject to its General Conditions of Service printed overleaf, available on request or accessible at <http://www.sgs.com/en/Terms-and-Conditions.aspx> and, for electronic format documents, subject to Terms and Conditions for Electronic Documents at <http://www.sgs.com/en/Terms-and-Conditions/Terms-e-Documents.aspx>. Attention is drawn to the limitation of liability, indemnification and jurisdiction issues defined therein. Any holder of this document is advised that information contained hereon reflects the Company's findings at the time of its intervention only and within the limits of Client's instructions, if any. The Company's sole responsibility is to its Client and this document does not exonerate parties to a transaction from exercising all their rights and obligations under the transaction documents. This document cannot be reproduced except in full, without prior written approval of the Company. Any unauthorized alteration, forgery or falsification of the content or appearance of this document is unlawful and offenders may be prosecuted to the fullest extent of the law. Unless otherwise stated the results shown in this test report refer only to the sample(s) tested and such sample(s) are retained for 30 days only.  
Attention: To check the authenticity of testing / inspection report & certificate, please contact us at telephone: (86-755) 8307 1443, or email: [CN.Doccheck@sgs.com](mailto:CN.Doccheck@sgs.com)

## 7.6 Modulation Requirements

Test Requirement: 47 CFR FCC Part2.1047 & FCC Part 80.213(a)  
 Test Method: ANSI/TIA-603-E:2016  
 Limit:

(a) Transmitters must meet the following modulation requirements:

- (1) When double sideband emission is used the peak modulation must be maintained between 75 and 100 percent;
- (2) When phase or frequency modulation is used in the 156-162 MHz band the peak modulation must be maintained between 75 and 100 percent. A frequency deviation of  $\pm 5$  kHz is defined as 100 percent peak modulation; and
- (3) In single sideband operation the upper sideband must be transmitted. Single sideband transmitters must automatically limit the peak envelope power to their authorized operating power and meet the requirements in §80.207(c).

### 7.6.1 E.U.T. Operation

Operating Environment:

Temperature: 25.1 °C Humidity: 53.8 % RH Atmospheric Pressure: 1010 mbar  
 Test mode: c: TX mode, Keep the EUT in transmitting mode.

### 7.6.2 Test Setup Diagram

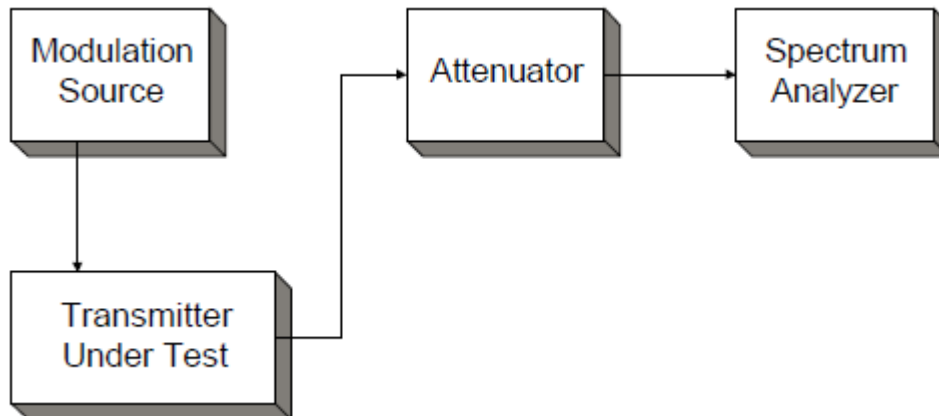

### 7.6.3 Measurement Data

The detailed test data see: Appendix FCC data.



Unless otherwise agreed in writing, this document is issued by the Company subject to its General Conditions of Service printed overleaf, available on request or accessible at <http://www.sgs.com/en/Terms-and-Conditions.aspx> and, for electronic format documents, subject to Terms and Conditions for Electronic Documents at <http://www.sgs.com/en/Terms-and-Conditions/Terms-e-Documents.aspx>. Attention is drawn to the limitation of liability, indemnification and jurisdiction issues defined therein. Any holder of this document is advised that information contained hereon reflects the Company's findings at the time of its intervention only and within the limits of Client's instructions, if any. The Company's sole responsibility is to its Client and this document does not exonerate parties to a transaction from exercising all their rights and obligations under the transaction documents. This document cannot be reproduced except in full, without prior written approval of the Company. Any unauthorized alteration, forgery or falsification of the content or appearance of this document is unlawful and offenders may be prosecuted to the fullest extent of the law. Unless otherwise stated the results shown in this test report refer only to the sample(s) tested and such sample(s) are retained for 30 days only.  
 Attention: To check the authenticity of testing / inspection report & certificate, please contact us at telephone: (86-755) 8307 1443, or email: [CN.Doccheck@sgs.com](mailto:CN.Doccheck@sgs.com)



## 7.7 Transmitter Frequency Deviation

Test Requirement: 47 CFR FCC Part2.1047 & FCC Part 80.213(d)  
 Test Method: ANSI/TIA-603-E:2016  
 Limit:

(d) Ship and coast station transmitters operating in the 156-162 MHz and 216-220 bands must be capable of proper operation with a frequency deviation that does not exceed  $\pm 5$  kHz when using any emission authorized by §80.207.

### 7.7.1 E.U.T. Operation

Operating Environment:

Temperature: 25.1 °C Humidity: 53.8 % RH Atmospheric Pressure: 1010 mbar  
 Test mode: c: TX mode, Keep the EUT in transmitting mode.

### 7.7.2 Test Setup Diagram

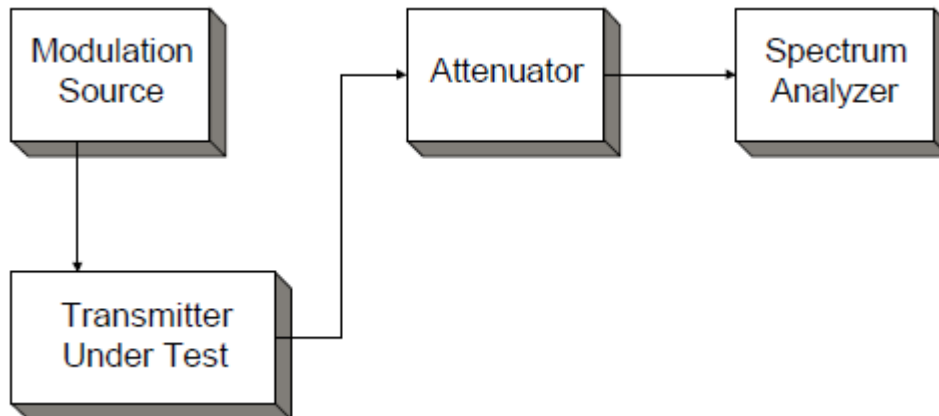

### 7.7.3 Measurement Data

The detailed test data see: Appendix FCC data.



**7.8 Transmitter Power**

Test Requirement: 47 CFR FCC Part2.1046 & FCC Part 80.215  
 Test Method: ANSI/TIA-603-E:2016  
 Limit:

e) Ship stations frequencies above 27500 kHz. The maximum power must not exceed the values listed below.  
 (1) Ship stations 156-162 MHz—25W<sup>6</sup>

<sup>6</sup>Reducible to 1 watt or less, except for transmitters limited to public correspondence channels and used in an automated system.

(g) The carrier power of ship station radiotelephone transmitters, except portable transmitters, operating in the 156-162 MHz band must be at least 8 but not more than 25 watts. Transmitters that use 12 volt lead acid storage batteries as a primary power source must be measured with a primary voltage between 12.2 and 13.7 volts DC. Additionally, unless otherwise indicated, equipment in radiotelephone ship stations operating in the 156-162 MHz band must meet the following requirements:

- (1) All transmitters and remote control units must be capable of reducing the carrier power to one watt or less;
- (2) Except as indicated in (g)(4) of this section, all transmitters manufactured after January 21, 1987, or in use after January 21, 1997, must automatically reduce the carrier power to one watt or less when the transmitter is tuned to 156.375 MHz or 156.650 MHz, and must be provided with a manual override switch which when held by an operator will permit full carrier power operation on 156.375 MHz and 156.650 MHz;

**7.8.1 E.U.T. Operation**

Operating Environment:  
 Temperature: 25.1 °C Humidity: 53.8 % RH Atmospheric Pressure: 1010 mbar  
 Test mode: c: TX mode, Keep the EUT in transmitting mode.

**7.8.2 Test Setup Diagram**

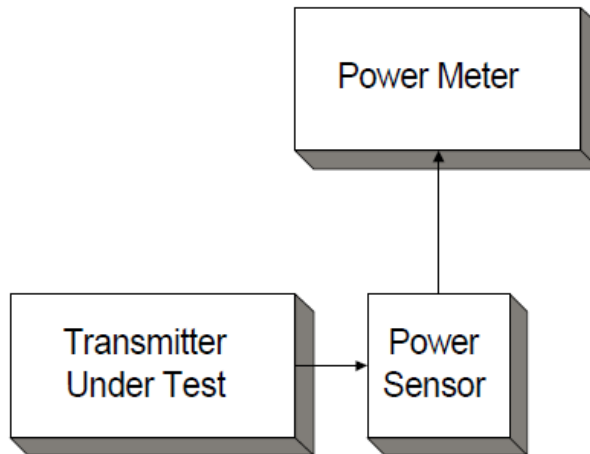

Unless otherwise agreed in writing, this document is issued by the Company subject to its General Conditions of Service printed overleaf, available on request or accessible at <http://www.sgs.com/en/Terms-and-Conditions.aspx> and, for electronic format documents, subject to Terms and Conditions for Electronic Documents at <http://www.sgs.com/en/Terms-and-Conditions/Terms-e-Documents.aspx>. Attention is drawn to the limitation of liability, indemnification and jurisdiction issues defined therein. Any holder of this document is advised that information contained hereon reflects the Company's findings at the time of its intervention only and within the limits of Client's instructions, if any. The Company's sole responsibility is to its Client and this document does not exonerate parties to a transaction from exercising all their rights and obligations under the transaction documents. This document cannot be reproduced except in full, without prior written approval of the Company. Any unauthorized alteration, forgery or falsification of the content or appearance of this document is unlawful and offenders may be prosecuted to the fullest extent of the law. Unless otherwise stated the results shown in this test report refer only to the sample(s) tested and such sample(s) are retained for 30 days only.  
 Attention: To check the authenticity of testing / inspection report & certificate, please contact us at telephone: (86-755) 8307 1443, or email: [CN\\_Doccheck@sgs.com](mailto:CN_Doccheck@sgs.com)



7.8.3 Measurement Data

The detailed test data see: Appendix FCC data.



Unless otherwise agreed in writing, this document is issued by the Company subject to its General Conditions of Service printed overleaf, available on request or accessible at <http://www.sgs.com/en/Terms-and-Conditions.aspx> and, for electronic format documents, subject to Terms and Conditions for Electronic Documents at <http://www.sgs.com/en/Terms-and-Conditions/Terms-e-Documents.aspx>. Attention is drawn to the limitation of liability, indemnification and jurisdiction issues defined therein. Any holder of this document is advised that information contained hereon reflects the Company's findings at the time of its intervention only and within the limits of Client's instructions, if any. The Company's sole responsibility is to its Client and this document does not exonerate parties to a transaction from exercising all their rights and obligations under the transaction documents. This document cannot be reproduced except in full, without prior written approval of the Company. Any unauthorized alteration, forgery or falsification of the content or appearance of this document is unlawful and offenders may be prosecuted to the fullest extent of the law. Unless otherwise stated the results shown in this test report refer only to the sample(s) tested and such sample(s) are retained for 30 days only.  
Attention: To check the authenticity of testing / inspection report & certificate, please contact us at telephone: (86-755) 8307 1443, or email: [CN.Doccheck@sgs.com](mailto:CN.Doccheck@sgs.com)

## 7.9 Transmitter Carrier Power Reduction

Test Requirement 47 CFR FCC Part 80.215  
 Test Method: ANSI/TIA-603-E:2016  
 Limit:

e) Ship stations frequencies above 27500 kHz. The maximum power must not exceed the values listed below.

(1) Ship stations 156-162 MHz—25W6

6Reducible to 1 watt or less, except for transmitters limited to public correspondence channels and used in an automated system.

(g) The carrier power of ship station radiotelephone transmitters, except portable transmitters, operating in the 156-162 MHz band must be at least 8 but not more than 25 watts. Transmitters that use 12 volt lead acid storage batteries as a primary power source must be measured with a primary voltage between 12.2 and 13.7 volts DC. Additionally, unless otherwise indicated, equipment in radiotelephone ship stations operating in the 156-162 MHz band must meet the following requirements:

(1) All transmitters and remote control units must be capable of reducing the carrier power to one watt or less;

(2) Except as indicated in (g)(4) of this section, all transmitters manufactured after January 21, 1987, or in use after January 21, 1997, must automatically reduce the carrier power to one watt or less when the transmitter is tuned to 156.375 MHz or 156.650 MHz, and must be provided with a manual override switch which when held by an operator will permit full carrier power operation on 156.375 MHz and 156.650 MHz;

### 7.9.1 E.U.T. Operation

Operating Environment:

Temperature: 25.1 °C Humidity: 53.8 % RH Atmospheric Pressure: 1010 mbar

Test mode: c: TX mode, Keep the EUT in transmitting mode.

### 7.9.2 Test Setup Diagram

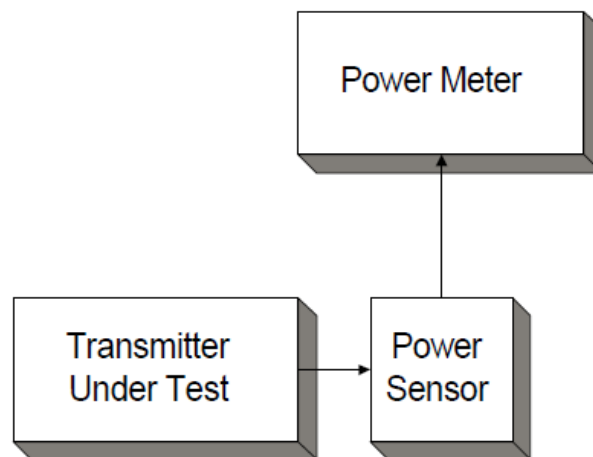

Unless otherwise agreed in writing, this document is issued by the Company subject to its General Conditions of Service printed overleaf, available on request or accessible at <http://www.sgs.com/en/Terms-and-Conditions.aspx> and, for electronic format documents, subject to Terms and Conditions for Electronic Documents at <http://www.sgs.com/en/Terms-and-Conditions/Terms-e-Documents.aspx>. Attention is drawn to the limitation of liability, indemnification and jurisdiction issues defined therein. Any holder of this document is advised that information contained hereon reflects the Company's findings at the time of its intervention only and within the limits of Client's instructions, if any. The Company's sole responsibility is to its Client and this document does not exonerate parties to a transaction from exercising all their rights and obligations under the transaction documents. This document cannot be reproduced except in full, without prior written approval of the Company. Any unauthorized alteration, forgery or falsification of the content or appearance of this document is unlawful and offenders may be prosecuted to the fullest extent of the law. Unless otherwise stated the results shown in this test report refer only to the sample(s) tested and such sample(s) are retained for 30 days only.



7.9.3 Measurement Data

The detailed test data see: Appendix FCC data.



Unless otherwise agreed in writing, this document is issued by the Company subject to its General Conditions of Service printed overleaf, available on request or accessible at <http://www.sgs.com/en/Terms-and-Conditions.aspx> and, for electronic format documents, subject to Terms and Conditions for Electronic Documents at <http://www.sgs.com/en/Terms-and-Conditions/Terms-e-Documents.aspx>. Attention is drawn to the limitation of liability, indemnification and jurisdiction issues defined therein. Any holder of this document is advised that information contained hereon reflects the Company's findings at the time of its intervention only and within the limits of Client's instructions, if any. The Company's sole responsibility is to its Client and this document does not exonerate parties to a transaction from exercising all their rights and obligations under the transaction documents. This document cannot be reproduced except in full, without prior written approval of the Company. Any unauthorized alteration, forgery or falsification of the content or appearance of this document is unlawful and offenders may be prosecuted to the fullest extent of the law. Unless otherwise stated the results shown in this test report refer only to the sample(s) tested and such sample(s) are retained for 30 days only.

Attention: To check the authenticity of testing / inspection report & certificate, please contact us at telephone: (86-755) 8307 1443, or email: [CN.Doccheck@sgs.com](mailto:CN.Doccheck@sgs.com)  
No.1 Workshop, M-10, Middle Section, Science & Technology Park, Shenzhen, China 518057 t (86-755) 26012053 f (86-755) 26710594 www.sgs.com.cn  
中国·深圳·科技园中区M-10栋一号厂房 邮编: 518057 t (86-755) 26012053 f (86-755) 26710594 sgs.china@sgs.com

**7.10 Suppression of interference aboard ships**

Test Requirement 47 CFR FCC Part 80.217  
 Test Method: ANSI/TIA-603-E:2016  
 Limit:

- (a) A voluntarily equipped ship station receiver must not cause harmful interference to any receiver required by statute or treaty.
- (b) The electromagnetic field from receivers required by statute or treaty must not exceed the following value at a distance over sea water of one nautical mile from the receiver:

Frequency of interfering emissions	Field intensity in microvolts per meter
Below 30 MHz	0.1
30 to 100 MHz	0.3
100 to 300 MHz	1.0
Over 300 MHz	3.0

Or Deliver not more than the following amounts of power, to an artificial antenna having electrical characteristics equivalent to those of the average receiving antenna(s) use on shipboard:

Frequency of interfering emissions	Power to artificial antenna in microwatts
Below 30 MHz	400(-3.98dBm)
30 to 100 MHz	4,000(6.02dBm)
100 to 300 MHz	40,000(16.02dBm)
Over 300 MHz	400,000(36.02dBm)

**7.10.1 E.U.T. Operation**

Operating Environment:

Temperature: 25.1 °C Humidity: 53.8 % RH Atmospheric Pressure: 1010 mbar  
 Test mode: c: TX mode, Keep the EUT in transmitting mode.

**7.10.2 E.U.T. Operation**

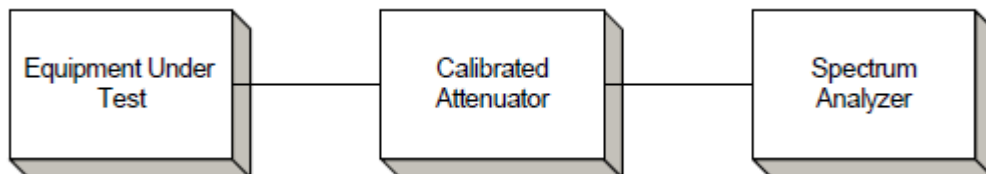

**7.10.3 Measurement Data**

The detailed test data see: Appendix FCC data.



Unless otherwise agreed in writing, this document is issued by the Company subject to its General Conditions of Service printed overleaf, available on request or accessible at <http://www.sgs.com/en/Terms-and-Conditions.aspx> and, for electronic format documents, subject to Terms and Conditions for Electronic Documents at <http://www.sgs.com/en/Terms-and-Conditions/Terms-e-Documents.aspx>. Attention is drawn to the limitation of liability, indemnification and jurisdiction issues defined therein. Any holder of this document is advised that information contained hereon reflects the Company's findings at the time of its intervention only and within the limits of Client's instructions, if any. The Company's sole responsibility is to its Client and this document does not exonerate parties to a transaction from exercising all their rights and obligations under the transaction documents. This document cannot be reproduced except in full, without prior written approval of the Company. Any unauthorized alteration, forgery or falsification of the content or appearance of this document is unlawful and offenders may be prosecuted to the fullest extent of the law. Unless otherwise stated the results shown in this test report refer only to the sample(s) tested and such sample(s) are retained for 30 days only.  
 Attention: To check the authenticity of testing / inspection report & certificate, please contact us at telephone: (86-755) 8307 1443, or email: [CN\\_Doccheck@sgs.com](mailto:CN_Doccheck@sgs.com)

## 8 Photographs

### 8.1 Test Setup

Please refer to setup photos.

### 8.2 EUT Constructional Details

Please Refer to external and internal photos for details.



## 9 Appendix

### 9.1 Appendix FCC data.

#### 1.Occupied Bandwidth

Test Frequency (MHz)	Modulation Type	Power Level	99% Occupied Bandwidth (kHz)	26dB Bandwidth (kHz)	Limit (kHz)
156.025	FM/G3E	Max	15.150	16.302	N/A
		Low	15.300	16.252	N/A
156.3		Max	15.325	16.278	N/A
		Low	15.350	16.252	N/A
156.8		Max	15.400	16.277	N/A
		Low	13.150	16.252	N/A
156.65		Max	15.400	16.277	N/A
		Low	13.175	16.252	N/A
157.425		Max	15.475	16.278	N/A
		Low	15.325	16.252	N/A
162.025	GMSK/GXW	/	8.05	9.602	N/A
156.525	FSK/G2B (dsc-1300Hz)	Max	7.950	9.553	N/A
		Low	8.000	8.504	N/A
	FSK/G2B dsc-2100Hz	Max	12.731	15.154	N/A
		Low	12.750	15.154	N/A





**99% Occupied Bandwidth**

**Assigned Frequency:156.025MHz, High Power, Modulation Type: FM**

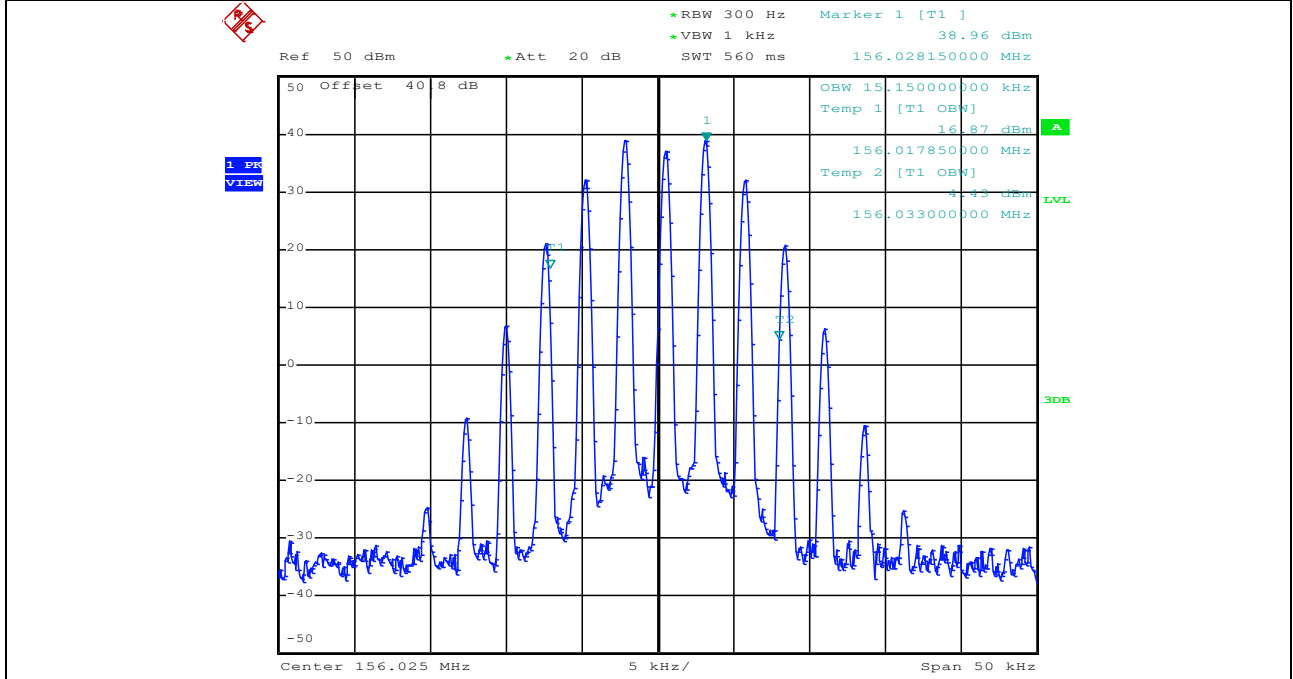

**Assigned Frequency:156.025MHz, Low Power, Modulation Type: FM**

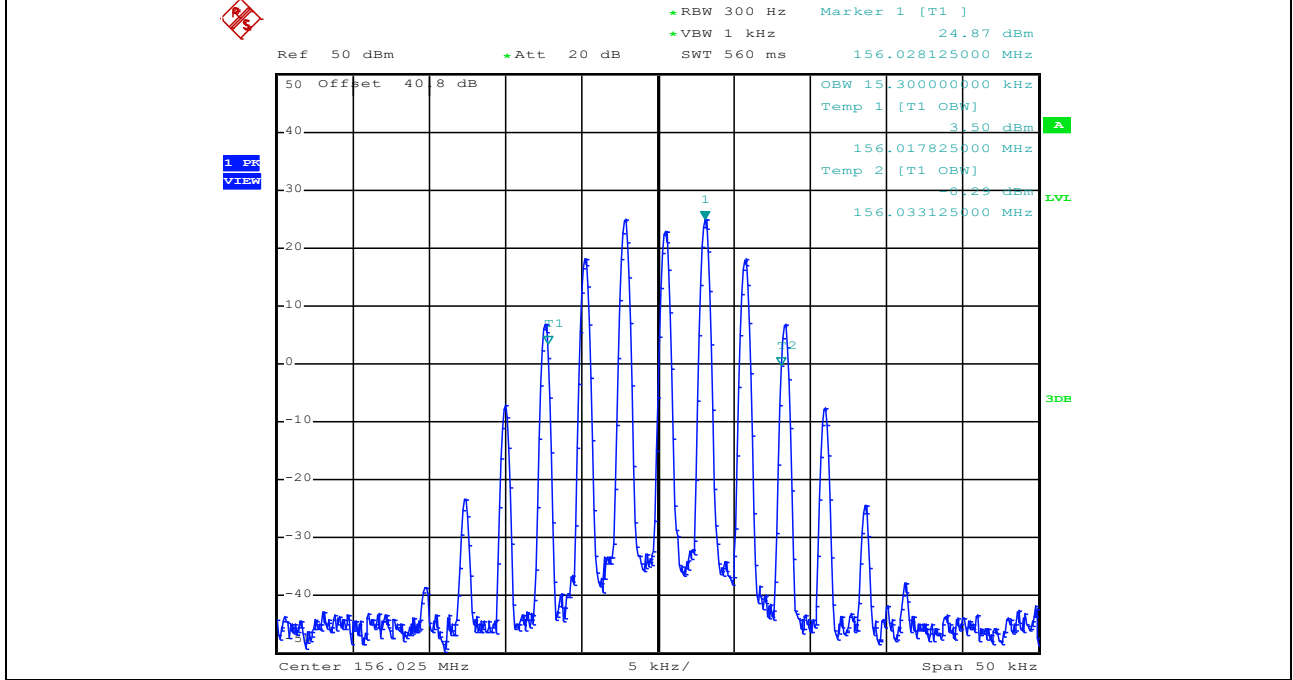

Unless otherwise agreed in writing, this document is issued by the Company subject to its General Conditions of Service printed overleaf, available on request or accessible at <http://www.sgs.com/en/Terms-and-Conditions.aspx> and, for electronic format documents, subject to Terms and Conditions for Electronic Documents at <http://www.sgs.com/en/Terms-and-Conditions/Terms-e-Documents.aspx>. Attention is drawn to the limitation of liability, indemnification and jurisdiction issues defined therein. Any holder of this document is advised that information contained hereon reflects the Company's findings at the time of its intervention only and within the limits of Client's instructions, if any. The Company's sole responsibility is to its Client and this document does not exonerate parties to a transaction from exercising all their rights and obligations under the transaction documents. This document cannot be reproduced except in full, without prior written approval of the Company. Any unauthorized alteration, forgery or falsification of the content or appearance of this document is unlawful and offenders may be prosecuted to the fullest extent of the law. Unless otherwise stated the results shown in this test report refer only to the sample(s) tested and such sample(s) are retained for 30 days only.

Assigned Frequency: 156.300MHz, High Power, Modulation Type: FM

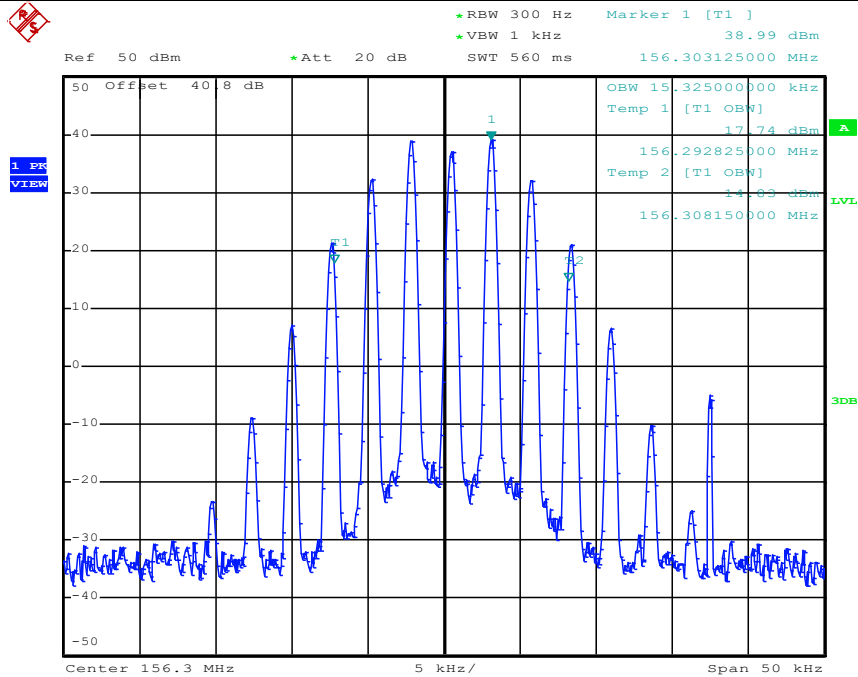

Assigned Frequency: 156.300MHz, Low Power, Modulation Type: FM

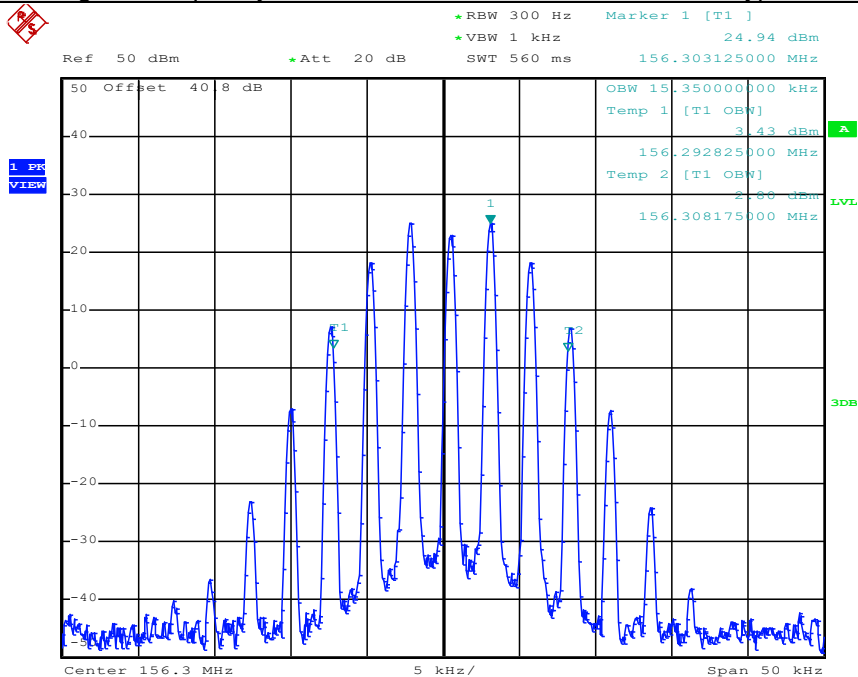

Unless otherwise agreed in writing, this document is issued by the Company subject to its General Conditions of Service printed overleaf, available on request or accessible at <http://www.sgs.com/en/Terms-and-Conditions.aspx> and, for electronic format documents, subject to Terms and Conditions for Electronic Documents at <http://www.sgs.com/en/Terms-and-Conditions/Terms-e-Documents.aspx>. Attention is drawn to the limitation of liability, indemnification and jurisdiction issues defined therein. Any holder of this document is advised that information contained hereon reflects the Company's findings at the time of its intervention only and within the limits of Client's instructions, if any. The Company's sole responsibility is to its Client and this document does not exonerate parties to a transaction from exercising all their rights and obligations under the transaction documents. This document cannot be reproduced except in full, without prior written approval of the Company. Any unauthorized alteration, forgery or falsification of the content or appearance of this document is unlawful and offenders may be prosecuted to the fullest extent of the law. Unless otherwise stated the results shown in this test report refer only to the sample(s) tested and such sample(s) are retained for 30 days only.

**Assigned Frequency: 156.800MHz, High Power, Modulation Type: FM**

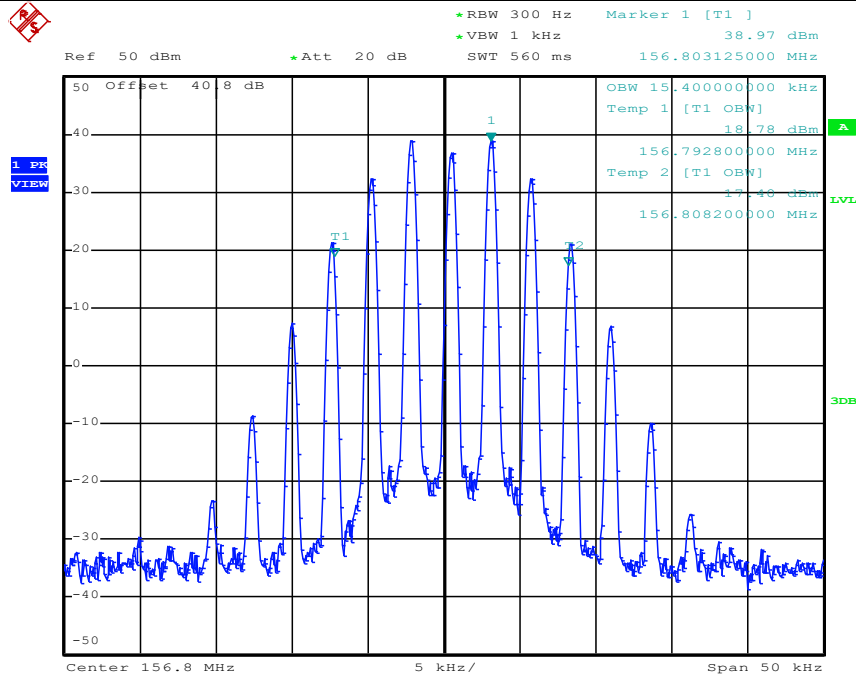

**Assigned Frequency: 156.800MHz, Low Power, Modulation Type: FM**

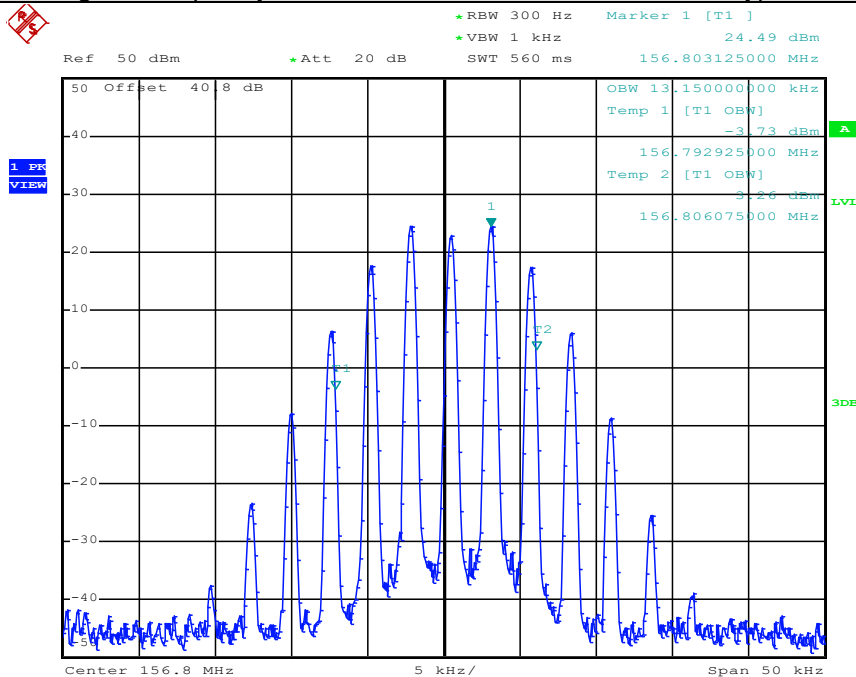

Unless otherwise agreed in writing, this document is issued by the Company subject to its General Conditions of Service printed overleaf, available on request or accessible at <http://www.sgs.com/en/Terms-and-Conditions.aspx> and, for electronic format documents, subject to Terms and Conditions for Electronic Documents at <http://www.sgs.com/en/Terms-and-Conditions/Terms-e-Documents.aspx>. Attention is drawn to the limitation of liability, indemnification and jurisdiction issues defined therein. Any holder of this document is advised that information contained hereon reflects the Company's findings at the time of its intervention only and within the limits of Client's instructions, if any. The Company's sole responsibility is to its Client and this document does not exonerate parties to a transaction from exercising all their rights and obligations under the transaction documents. This document cannot be reproduced except in full, without prior written approval of the Company. Any unauthorized alteration, forgery or falsification of the content or appearance of this document is unlawful and offenders may be prosecuted to the fullest extent of the law. Unless otherwise stated the results shown in this test report refer only to the sample(s) tested and such sample(s) are retained for 30 days only.

### Assigned Frequency: 156.65MHz, High Power, Modulation Type: FM

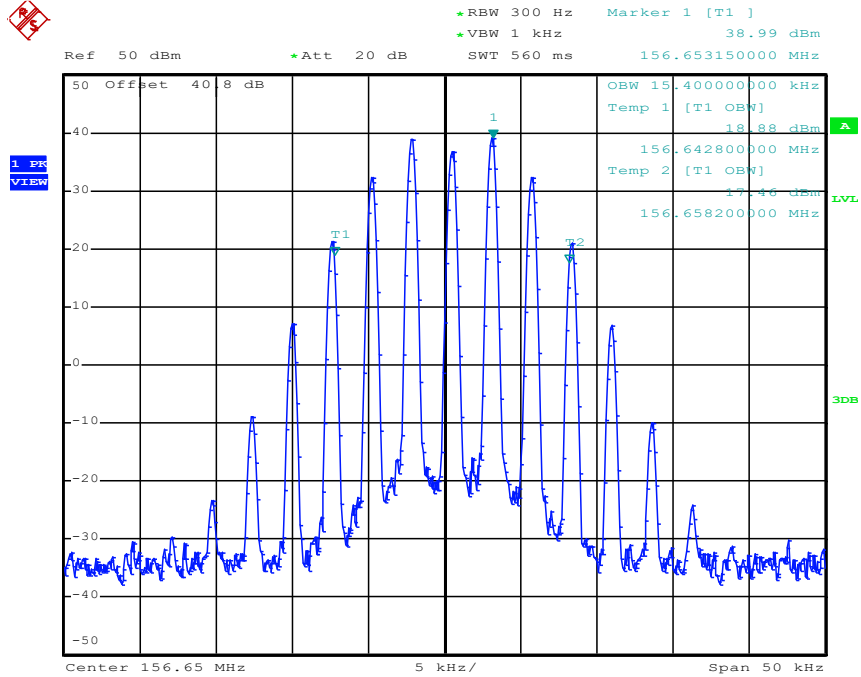

### Assigned Frequency: 156.65MHz, Low Power, Modulation Type: FM

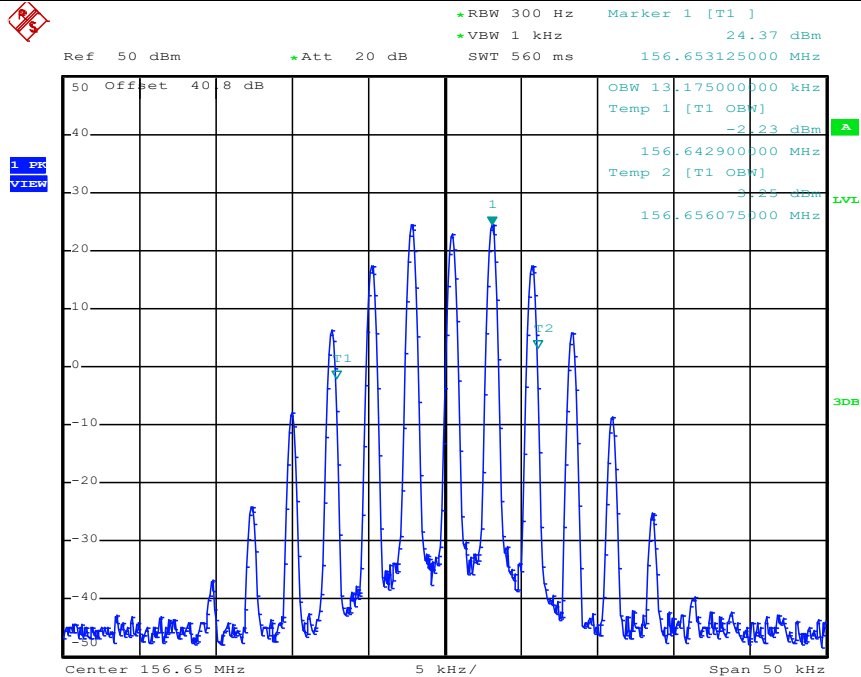

Unless otherwise agreed in writing, this document is issued by the Company subject to its General Conditions of Service printed overleaf, available on request or accessible at <http://www.sgs.com/en/Terms-and-Conditions.aspx> and, for electronic format documents, subject to Terms and Conditions for Electronic Documents at <http://www.sgs.com/en/Terms-and-Conditions/Terms-e-Documents.aspx>. Attention is drawn to the limitation of liability, indemnification and jurisdiction issues defined therein. Any holder of this document is advised that information contained hereon reflects the Company's findings at the time of its intervention only and within the limits of Client's instructions, if any. The Company's sole responsibility is to its Client and this document does not exonerate parties to a transaction from exercising all their rights and obligations under the transaction documents. This document cannot be reproduced except in full, without prior written approval of the Company. Any unauthorized alteration, forgery or falsification of the content or appearance of this document is unlawful and offenders may be prosecuted to the fullest extent of the law. Unless otherwise stated the results shown in this test report refer only to the sample(s) tested and such sample(s) are retained for 30 days only.

Attention: To check the authenticity of testing /inspection report & certificate, please contact us at telephone: (86-755) 8307 1443, or email: [CN.Doccheck@sgs.com](mailto:CN.Doccheck@sgs.com)  
 No.1 Workshop, M-10, Middle Section, Science & Technology Park, Shenzhen, China 518057 t (86-755) 26012053 f (86-755) 26710594 www.sgs.com.cn  
 中国·深圳·科技园中区M-10栋一号厂房 邮编: 518057 t (86-755) 26012053 f (86-755) 26710594 sgs.china@sgs.com

**Assigned Frequency: 157.425MHz, High Power, Modulation Type: FM**

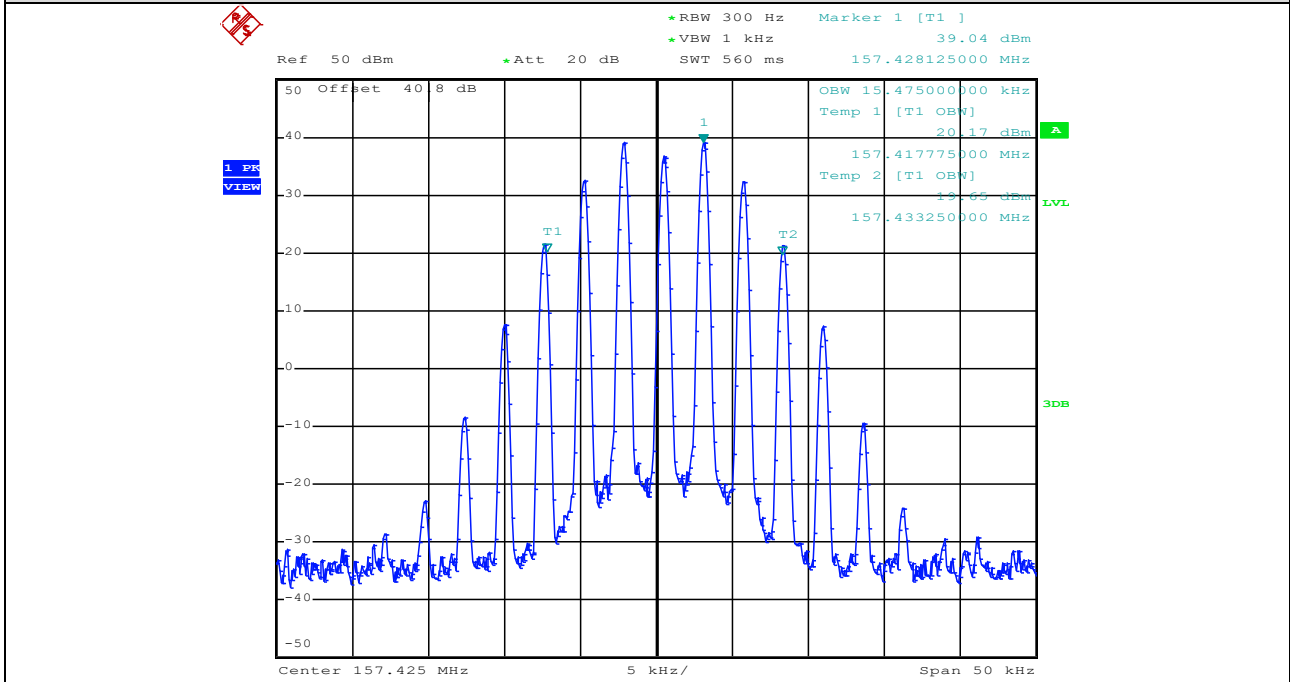

**Assigned Frequency: 157.425MHz, Low Power, Modulation Type: FM**

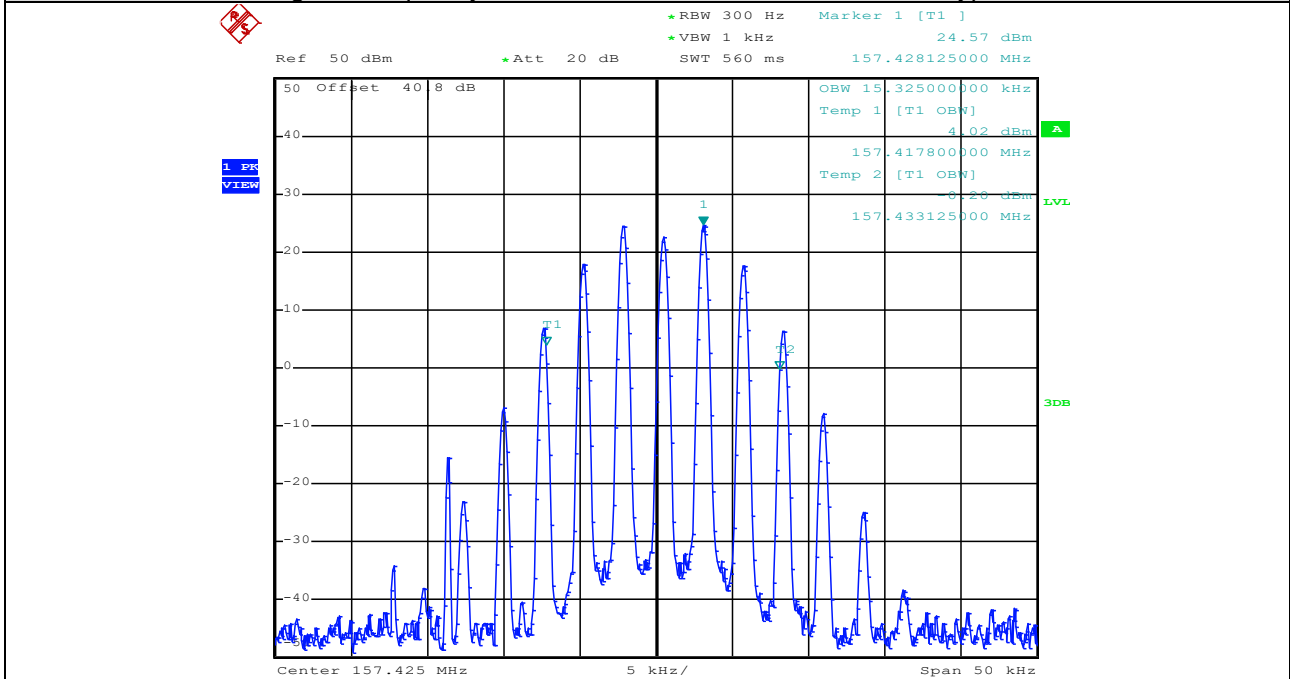

Unless otherwise agreed in writing, this document is issued by the Company subject to its General Conditions of Service printed overleaf, available on request or accessible at <http://www.sgs.com/en/Terms-and-Conditions.aspx> and, for electronic format documents, subject to Terms and Conditions for Electronic Documents at <http://www.sgs.com/en/Terms-and-Conditions/Terms-e-Documents.aspx>. Attention is drawn to the limitation of liability, indemnification and jurisdiction issues defined therein. Any holder of this document is advised that information contained hereon reflects the Company's findings at the time of its intervention only and within the limits of Client's instructions, if any. The Company's sole responsibility is to its Client and this document does not exonerate parties to a transaction from exercising all their rights and obligations under the transaction documents. This document cannot be reproduced except in full, without prior written approval of the Company. Any unauthorized alteration, forgery or falsification of the content or appearance of this document is unlawful and offenders may be prosecuted to the fullest extent of the law. Unless otherwise stated the results shown in this test report refer only to the sample(s) tested and such sample(s) are retained for 30 days only.

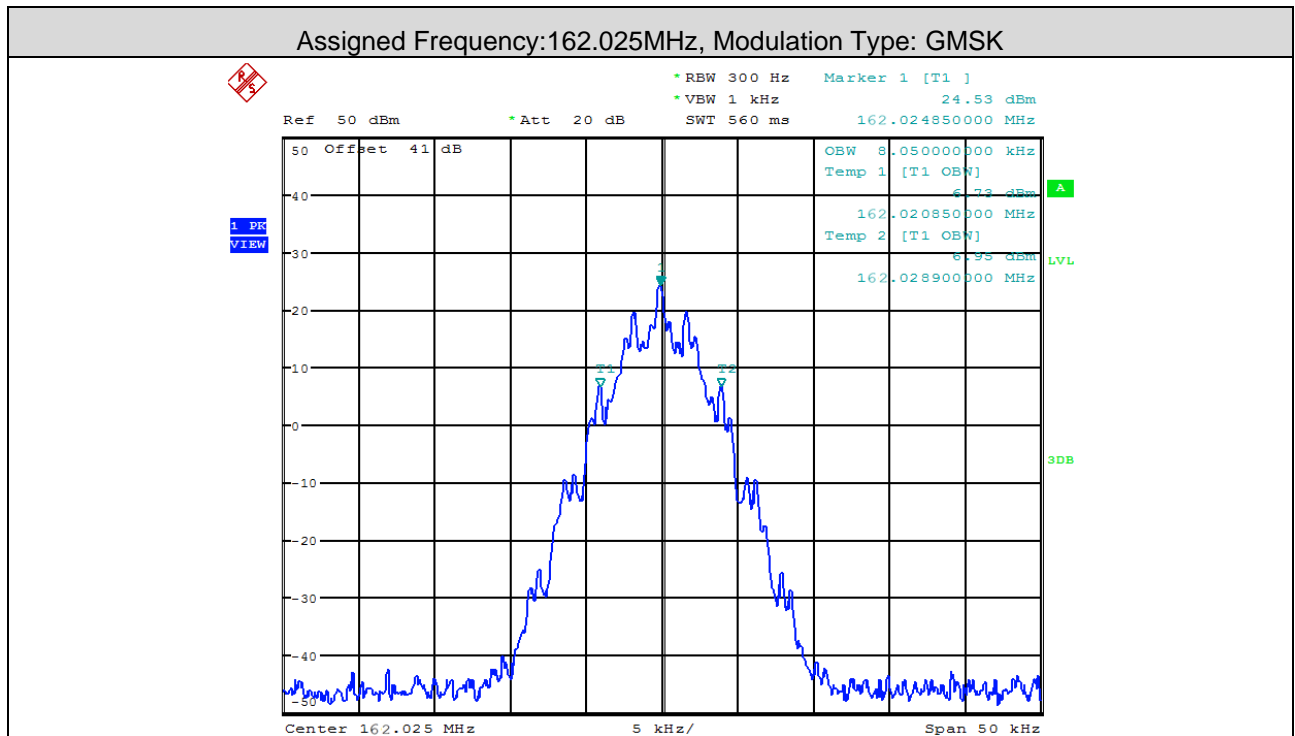

Unless otherwise agreed in writing, this document is issued by the Company subject to its General Conditions of Service printed overleaf, available on request or accessible at <http://www.sgs.com/en/Terms-and-Conditions.aspx> and, for electronic format documents, subject to Terms and Conditions for Electronic Documents at <http://www.sgs.com/en/Terms-and-Conditions/Terms-e-Documents.aspx>. Attention is drawn to the limitation of liability, indemnification and jurisdiction issues defined therein. Any holder of this document is advised that information contained hereon reflects the Company's findings at the time of its intervention only and within the limits of Client's instructions, if any. The Company's sole responsibility is to its Client and this document does not exonerate parties to a transaction from exercising all their rights and obligations under the transaction documents. This document cannot be reproduced except in full, without prior written approval of the Company. Any unauthorized alteration, forgery or falsification of the content or appearance of this document is unlawful and offenders may be prosecuted to the fullest extent of the law. Unless otherwise stated the results shown in this test report refer only to the sample(s) tested and such sample(s) are retained for 30 days only.

**26dB Bandwidth**

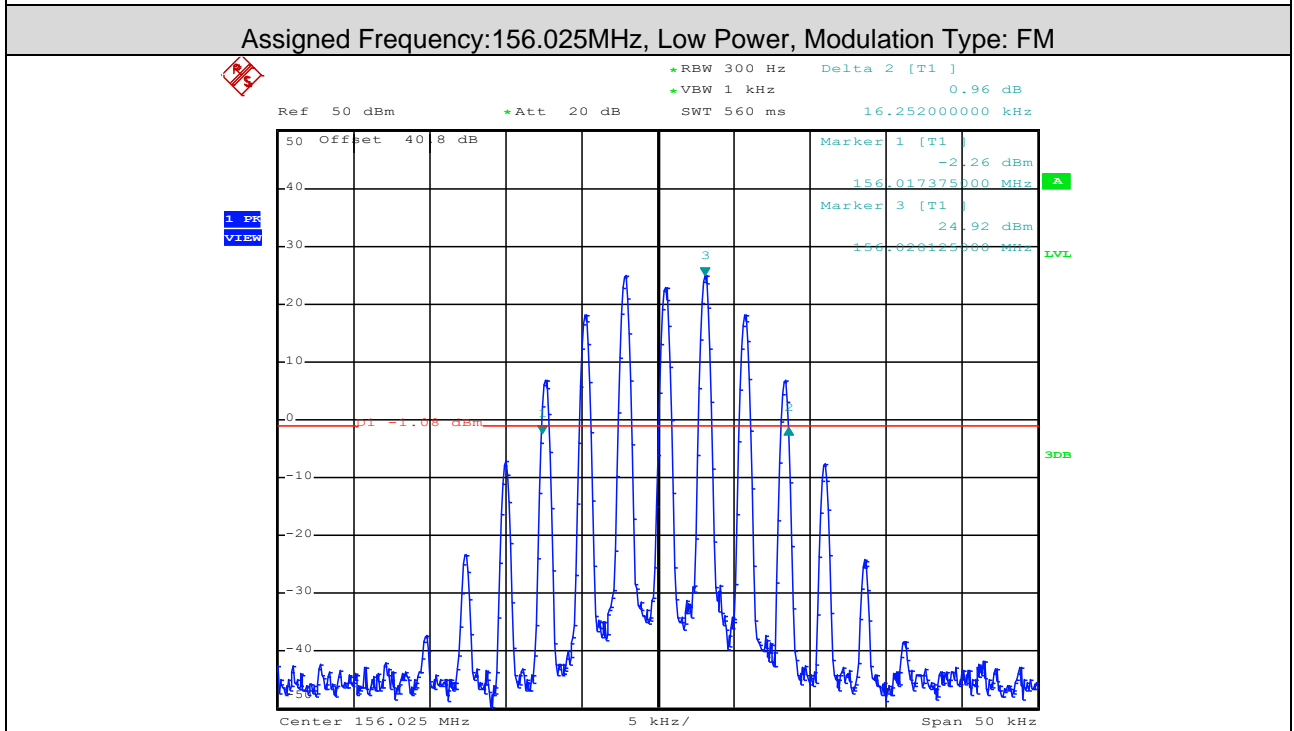
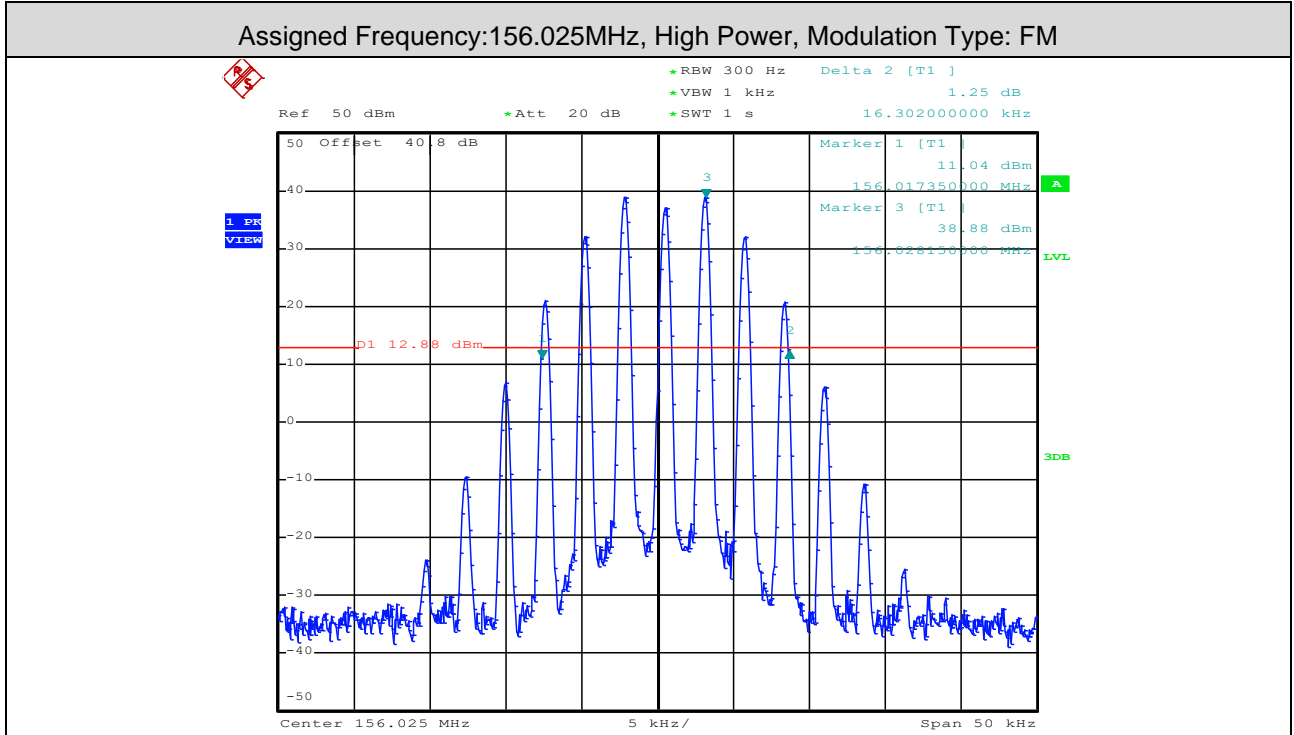

Unless otherwise agreed in writing, this document is issued by the Company subject to its General Conditions of Service printed overleaf, available on request or accessible at <http://www.sgs.com/en/Terms-and-Conditions.aspx> and, for electronic format documents, subject to Terms and Conditions for Electronic Documents at <http://www.sgs.com/en/Terms-and-Conditions/Terms-e-Documents.aspx>. Attention is drawn to the limitation of liability, indemnification and jurisdiction issues defined therein. Any holder of this document is advised that information contained hereon reflects the Company's findings at the time of its intervention only and within the limits of Client's instructions, if any. The Company's sole responsibility is to its Client and this document does not exonerate parties to a transaction from exercising all their rights and obligations under the transaction documents. This document cannot be reproduced except in full, without prior written approval of the Company. Any unauthorized alteration, forgery or falsification of the content or appearance of this document is unlawful and offenders may be prosecuted to the fullest extent of the law. Unless otherwise stated the results shown in this test report refer only to the sample(s) tested and such sample(s) are retained for 30 days only.

### Assigned Frequency: 156.300MHz, High Power, Modulation Type: FM

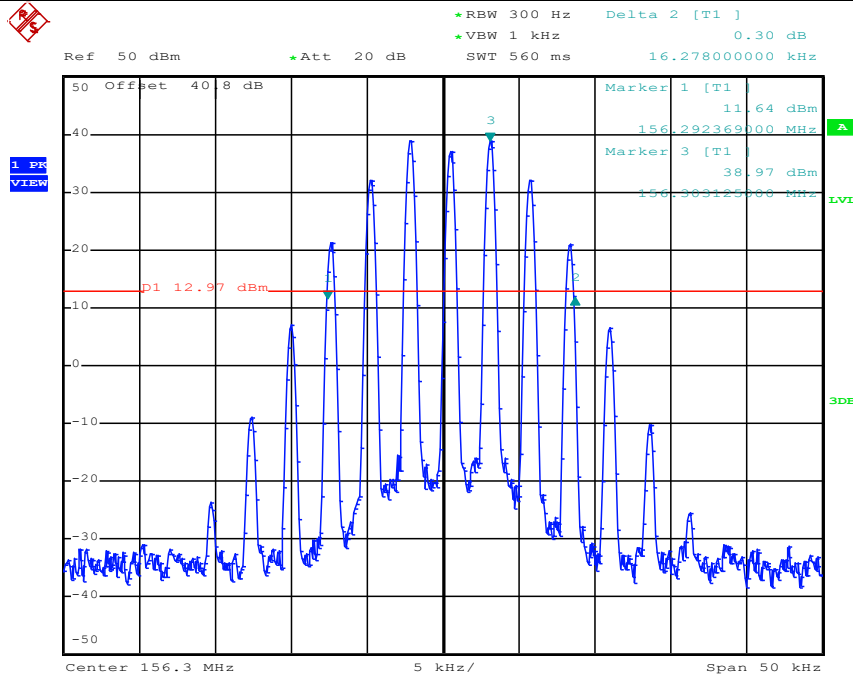

### Assigned Frequency: 156.300MHz, Low Power, Modulation Type: FM

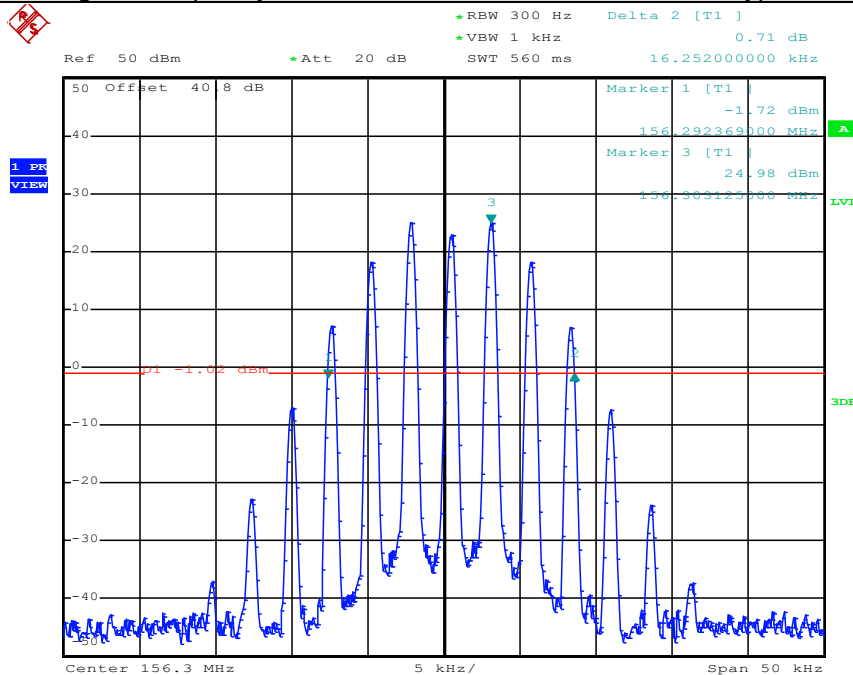



**Assigned Frequency:156.800MHz, High Power, Modulation Type: FM**

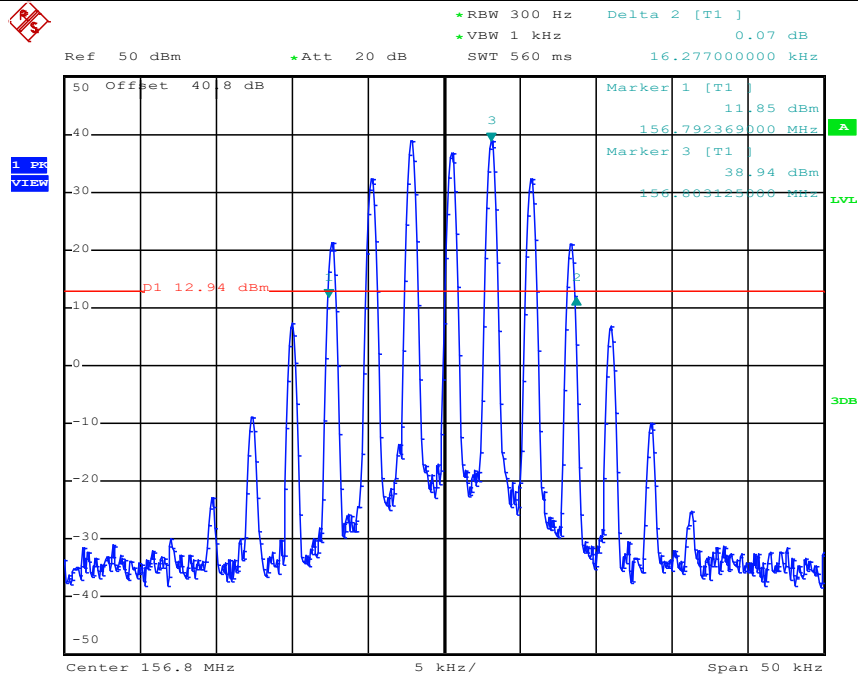

**Assigned Frequency:156.800MHz, Low Power, Modulation Type: FM**

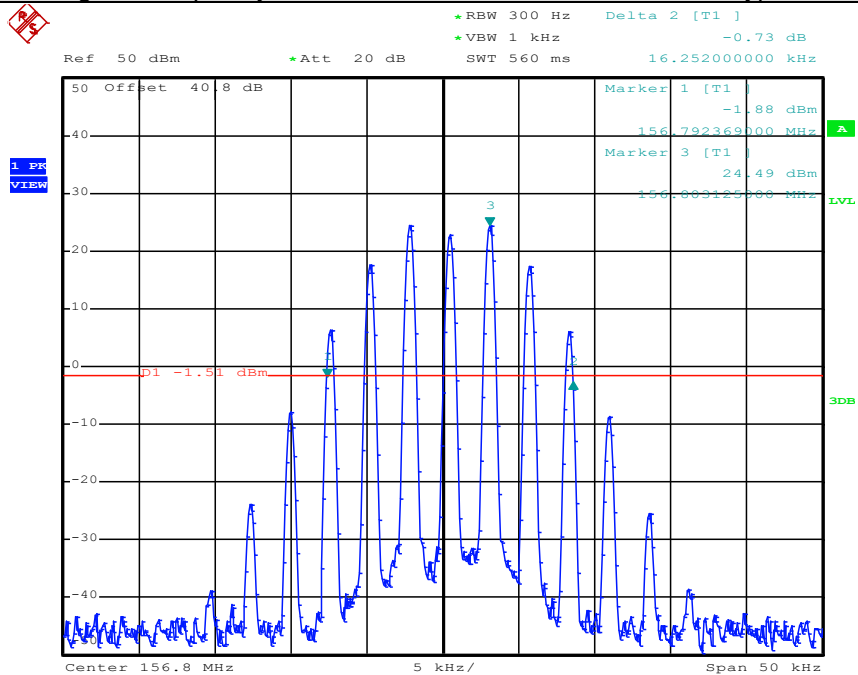

Unless otherwise agreed in writing, this document is issued by the Company subject to its General Conditions of Service printed overleaf, available on request or accessible at <http://www.sgs.com/en/Terms-and-Conditions.aspx> and, for electronic format documents, subject to Terms and Conditions for Electronic Documents at <http://www.sgs.com/en/Terms-and-Conditions/Terms-e-Documents.aspx>. Attention is drawn to the limitation of liability, indemnification and jurisdiction issues defined therein. Any holder of this document is advised that information contained hereon reflects the Company's findings at the time of its intervention only and within the limits of Client's instructions, if any. The Company's sole responsibility is to its Client and this document does not exonerate parties to a transaction from exercising all their rights and obligations under the transaction documents. This document cannot be reproduced except in full, without prior written approval of the Company. Any unauthorized alteration, forgery or falsification of the content or appearance of this document is unlawful and offenders may be prosecuted to the fullest extent of the law. Unless otherwise stated the results shown in this test report refer only to the sample(s) tested and such sample(s) are retained for 30 days only.

Assigned Frequency: 156.65MHz, High Power, Modulation Type: FM

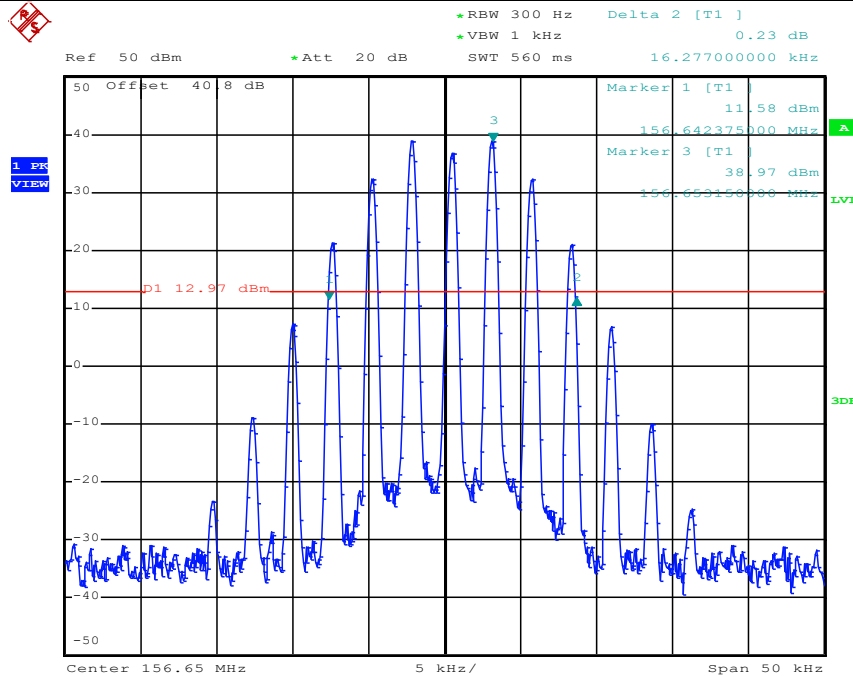

Assigned Frequency: 156.65MHz, Low Power, Modulation Type: FM

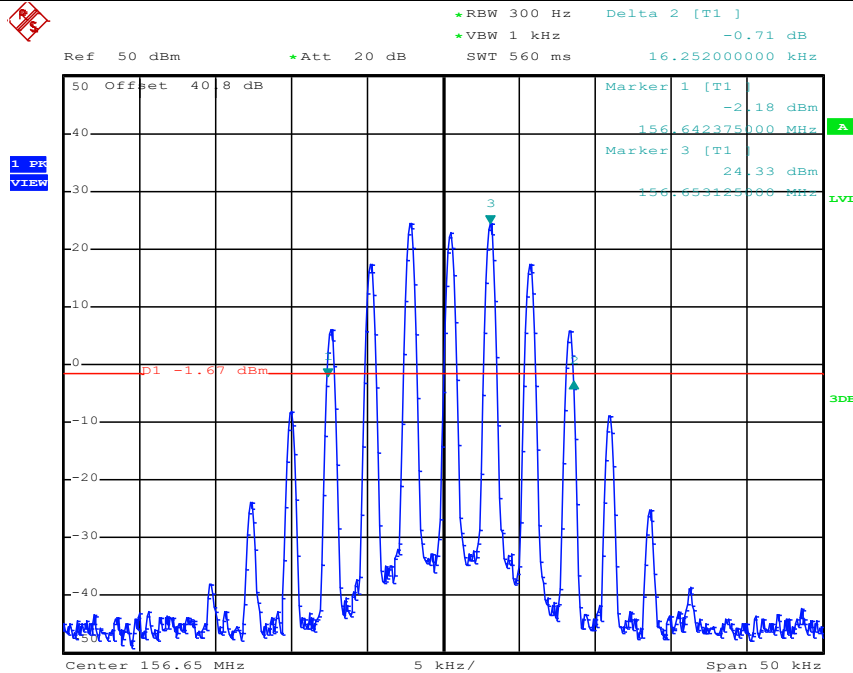

Unless otherwise agreed in writing, this document is issued by the Company subject to its General Conditions of Service printed overleaf, available on request or accessible at <http://www.sgs.com/en/Terms-and-Conditions.aspx> and, for electronic format documents, subject to Terms and Conditions for Electronic Documents at <http://www.sgs.com/en/Terms-and-Conditions/Terms-e-Documents.aspx>. Attention is drawn to the limitation of liability, indemnification and jurisdiction issues defined therein. Any holder of this document is advised that information contained hereon reflects the Company's findings at the time of its intervention only and within the limits of Client's instructions, if any. The Company's sole responsibility is to its Client and this document does not exonerate parties to a transaction from exercising all their rights and obligations under the transaction documents. This document cannot be reproduced except in full, without prior written approval of the Company. Any unauthorized alteration, forgery or falsification of the content or appearance of this document is unlawful and offenders may be prosecuted to the fullest extent of the law. Unless otherwise stated the results shown in this test report refer only to the sample(s) tested and such sample(s) are retained for 30 days only.

Assigned Frequency: 157.425MHz, High Power, Modulation Type: FM

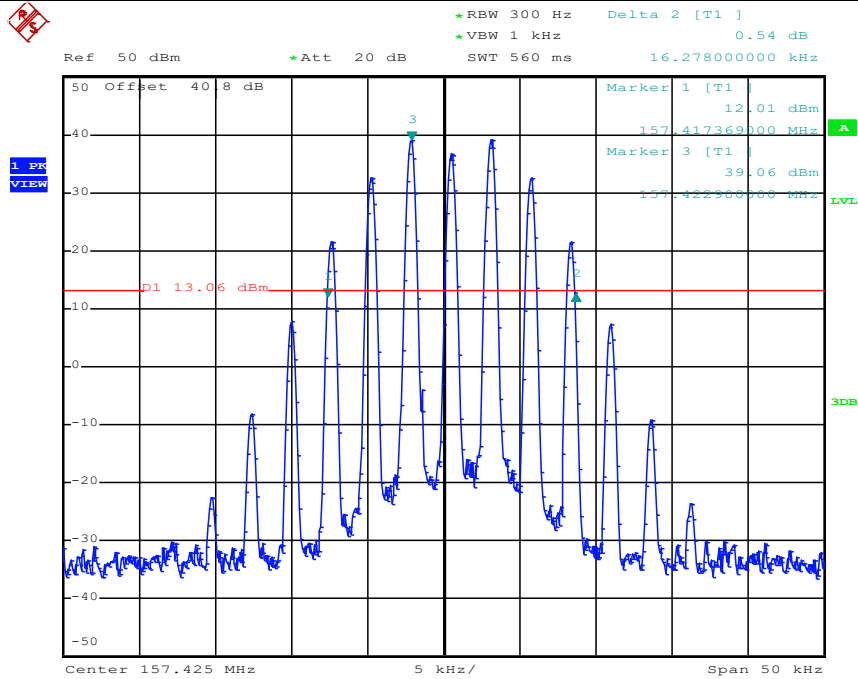

Assigned Frequency: 157.425MHz, Low Power, Modulation Type: FM

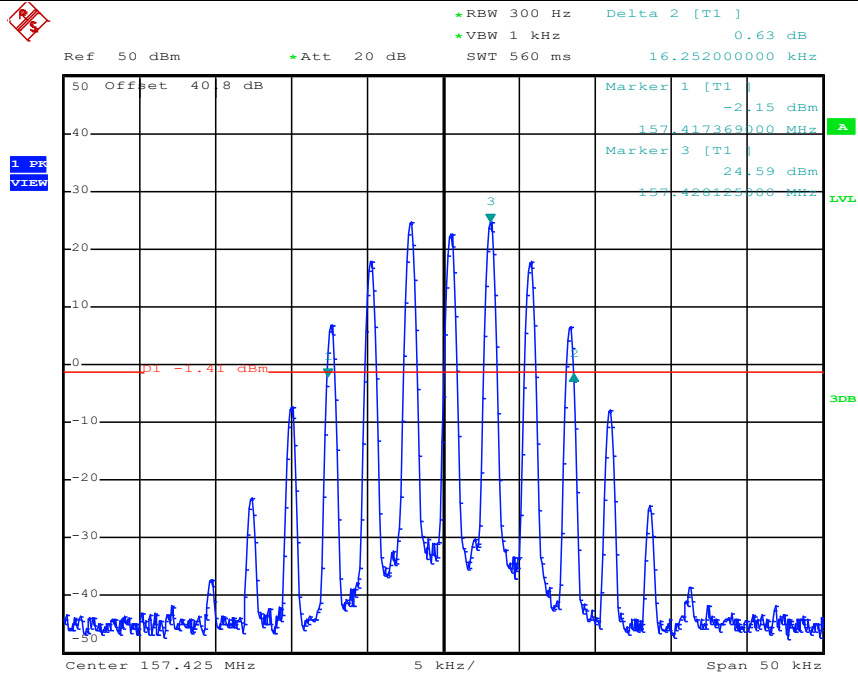

Unless otherwise agreed in writing, this document is issued by the Company subject to its General Conditions of Service printed overleaf, available on request or accessible at <http://www.sgs.com/en/Terms-and-Conditions.aspx> and, for electronic format documents, subject to Terms and Conditions for Electronic Documents at <http://www.sgs.com/en/Terms-and-Conditions/Terms-e-Documents.aspx>. Attention is drawn to the limitation of liability, indemnification and jurisdiction issues defined therein. Any holder of this document is advised that information contained hereon reflects the Company's findings at the time of its intervention only and within the limits of Client's instructions, if any. The Company's sole responsibility is to its Client and this document does not exonerate parties to a transaction from exercising all their rights and obligations under the transaction documents. This document cannot be reproduced except in full, without prior written approval of the Company. Any unauthorized alteration, forgery or falsification of the content or appearance of this document is unlawful and offenders may be prosecuted to the fullest extent of the law. Unless otherwise stated the results shown in this test report refer only to the sample(s) tested and such sample(s) are retained for 30 days only.

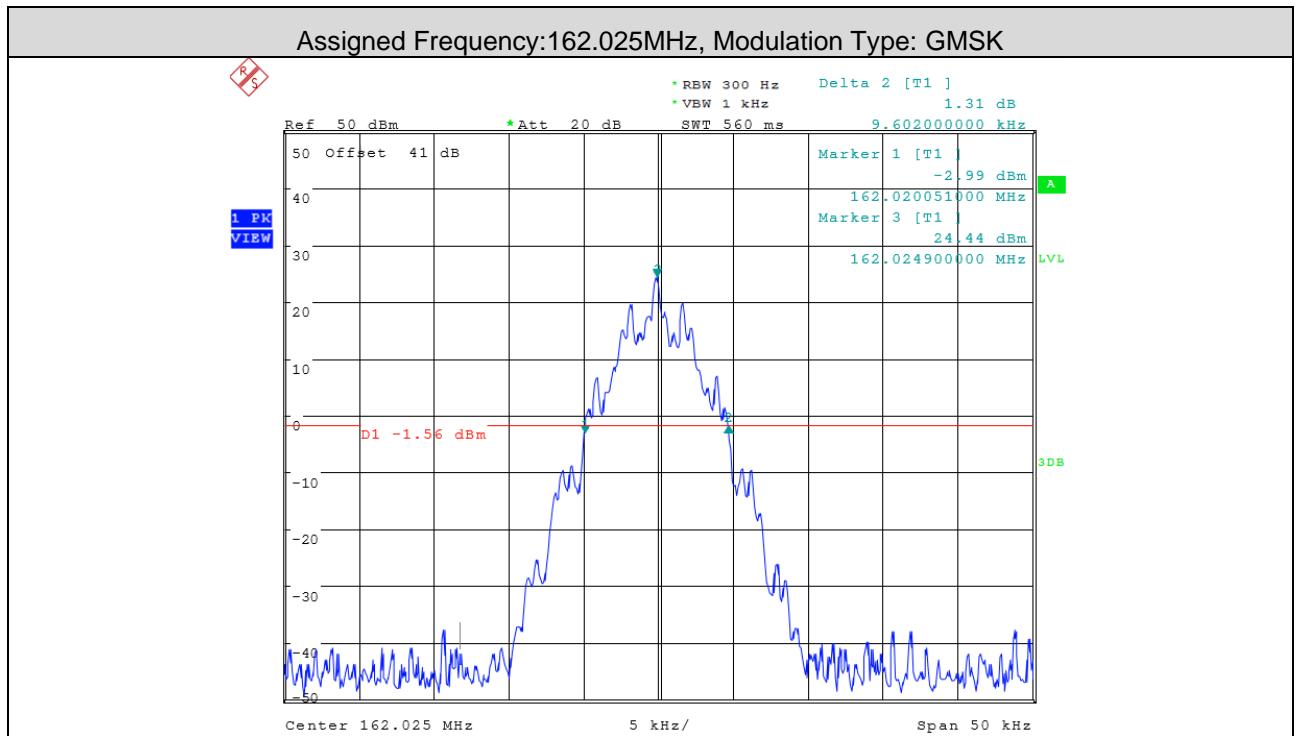

Unless otherwise agreed in writing, this document is issued by the Company subject to its General Conditions of Service printed overleaf, available on request or accessible at <http://www.sgs.com/en/Terms-and-Conditions.aspx> and, for electronic format documents, subject to Terms and Conditions for Electronic Documents at <http://www.sgs.com/en/Terms-and-Conditions/Terms-e-Documents.aspx>. Attention is drawn to the limitation of liability, indemnification and jurisdiction issues defined therein. Any holder of this document is advised that information contained hereon reflects the Company's findings at the time of its intervention only and within the limits of Client's instructions, if any. The Company's sole responsibility is to its Client and this document does not exonerate parties to a transaction from exercising all their rights and obligations under the transaction documents. This document cannot be reproduced except in full, without prior written approval of the Company. Any unauthorized alteration, forgery or falsification of the content or appearance of this document is unlawful and offenders may be prosecuted to the fullest extent of the law. Unless otherwise stated the results shown in this test report refer only to the sample(s) tested and such sample(s) are retained for 30 days only.

Attention: To check the authenticity of testing / inspection report & certificate, please contact us at telephone: (86-755) 8307 1443, or email: [CN.Doccheck@sgs.com](mailto:CN.Doccheck@sgs.com)

**Test data for DSC mode/ 99% Occupied Bandwidth**

Assigned Frequency: 156.525MHz, High Power, Modulation Type: FSK, dsc-1300Hz

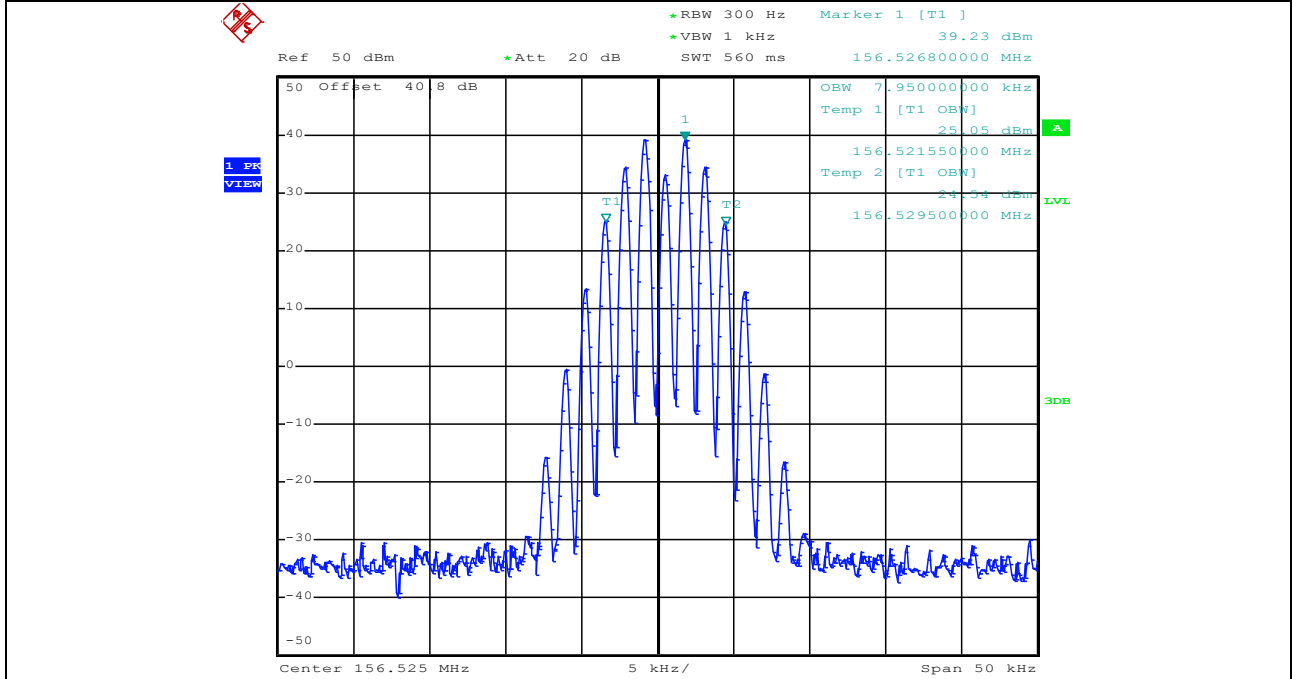

Assigned Frequency: 156.525MHz, Low Power, Modulation Type: FSK, dsc-1300Hz

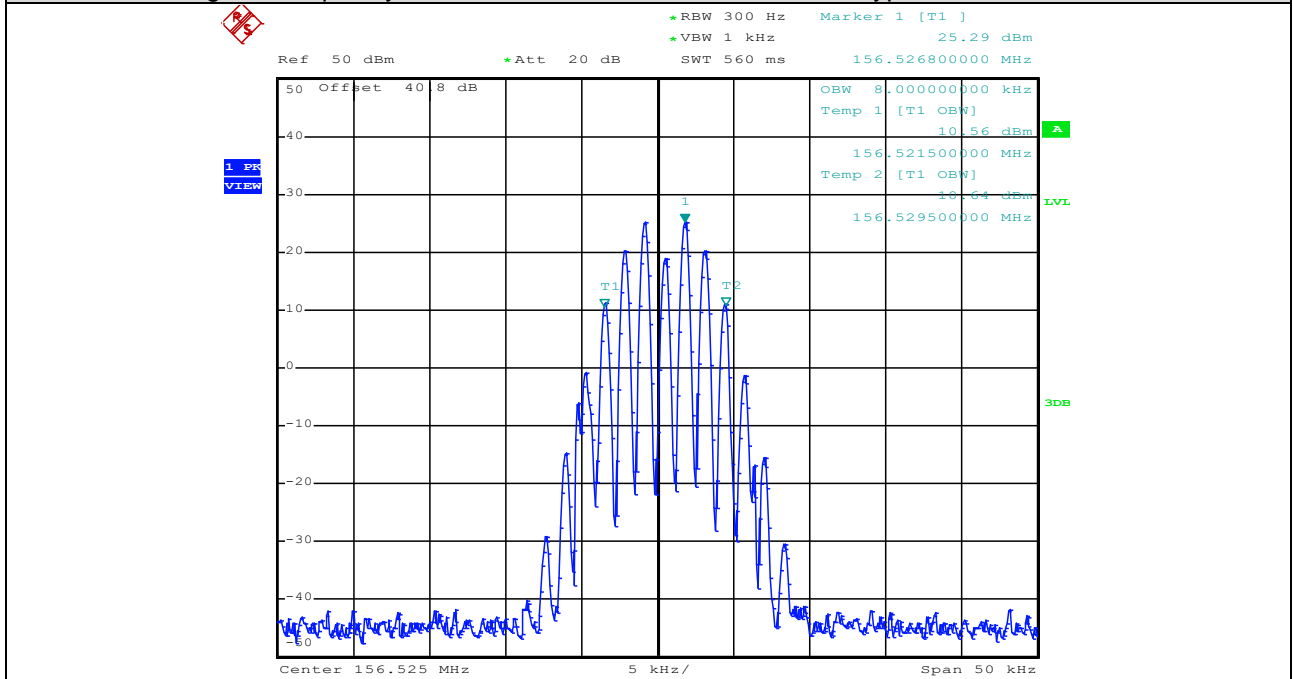

Unless otherwise agreed in writing, this document is issued by the Company subject to its General Conditions of Service printed overleaf, available on request or accessible at <http://www.sgs.com/en/Terms-and-Conditions.aspx> and, for electronic format documents, subject to Terms and Conditions for Electronic Documents at <http://www.sgs.com/en/Terms-and-Conditions/Terms-e-Documents.aspx>. Attention is drawn to the limitation of liability, indemnification and jurisdiction issues defined therein. Any holder of this document is advised that information contained hereon reflects the Company's findings at the time of its intervention only and within the limits of Client's instructions, if any. The Company's sole responsibility is to its Client and this document does not exonerate parties to a transaction from exercising all their rights and obligations under the transaction documents. This document cannot be reproduced except in full, without prior written approval of the Company. Any unauthorized alteration, forgery or falsification of the content or appearance of this document is unlawful and offenders may be prosecuted to the fullest extent of the law. Unless otherwise stated the results shown in this test report refer only to the sample(s) tested and such sample(s) are retained for 30 days only.

Assigned Frequency: 156.525MHz, High Power, Modulation Type: FSK, dsc-2100Hz

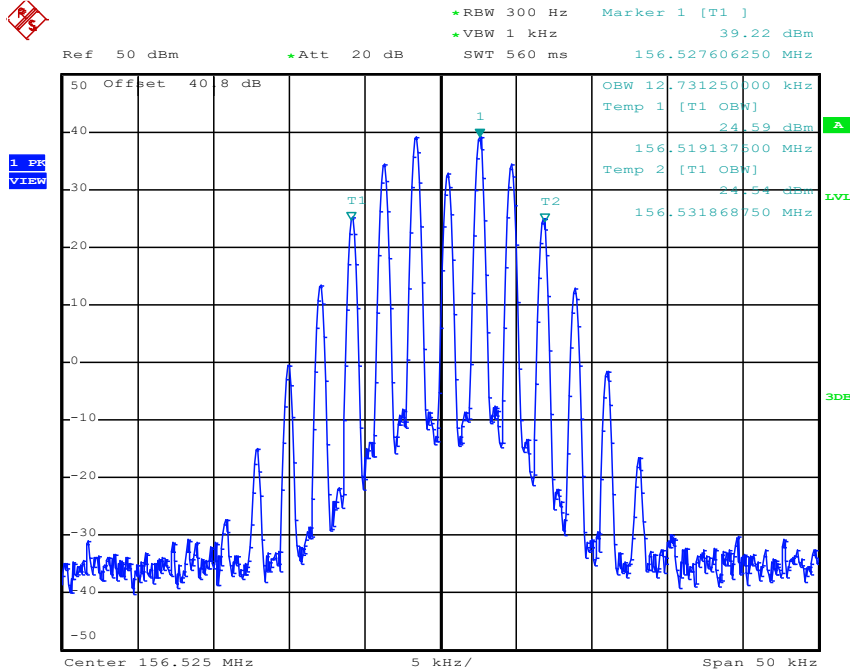

Assigned Frequency: 156.525MHz, Low Power, Modulation Type: FSK, dsc-2100Hz

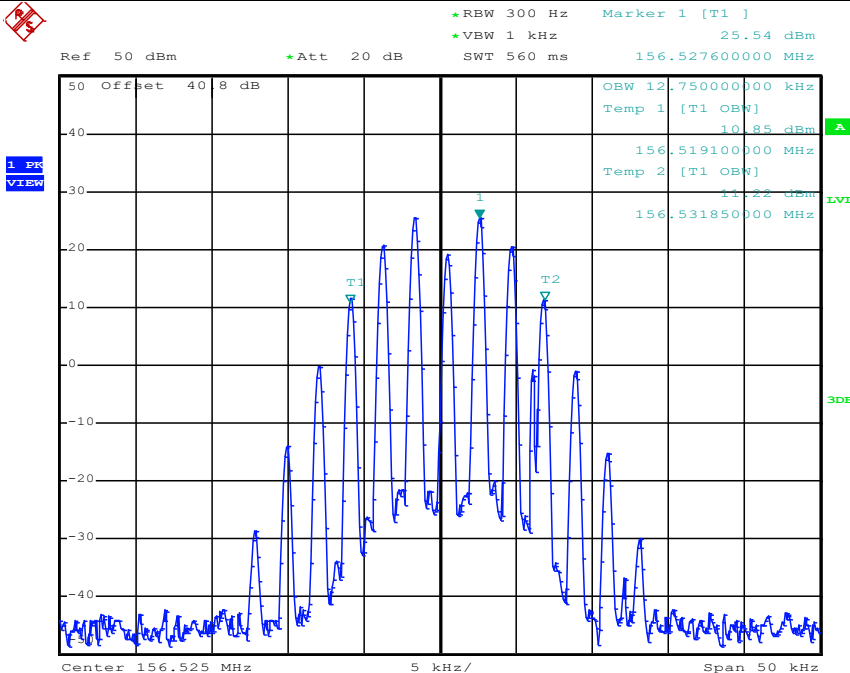

Unless otherwise agreed in writing, this document is issued by the Company subject to its General Conditions of Service printed overleaf, available on request or accessible at <http://www.sgs.com/en/Terms-and-Conditions.aspx> and, for electronic format documents, subject to Terms and Conditions for Electronic Documents at <http://www.sgs.com/en/Terms-and-Conditions/Terms-e-Documents.aspx>. Attention is drawn to the limitation of liability, indemnification and jurisdiction issues defined therein. Any holder of this document is advised that information contained hereon reflects the Company's findings at the time of its intervention only and within the limits of Client's instructions, if any. The Company's sole responsibility is to its Client and this document does not exonerate parties to a transaction from exercising all their rights and obligations under the transaction documents. This document cannot be reproduced except in full, without prior written approval of the Company. Any unauthorized alteration, forgery or falsification of the content or appearance of this document is unlawful and offenders may be prosecuted to the fullest extent of the law. Unless otherwise stated the results shown in this test report refer only to the sample(s) tested and such sample(s) are retained for 30 days only.

Attention: To check the authenticity of testing /inspection report & certificate, please contact us at telephone: (86-755) 8307 1443, or email: [CN.Doccheck@sgs.com](mailto:CN.Doccheck@sgs.com)  
 No.1 Workshop, M-10, Middle Section, Science & Technology Park, Shenzhen, China 518057 t (86-755) 26012053 f (86-755) 26710594 www.sgs.com.cn  
 中国·深圳·科技园中区M-10栋一号厂房 邮编: 518057 t (86-755) 26012053 f (86-755) 26710594 sgs.china@sgs.com

**Test data for DSC mode/ 26dB Bandwidth**

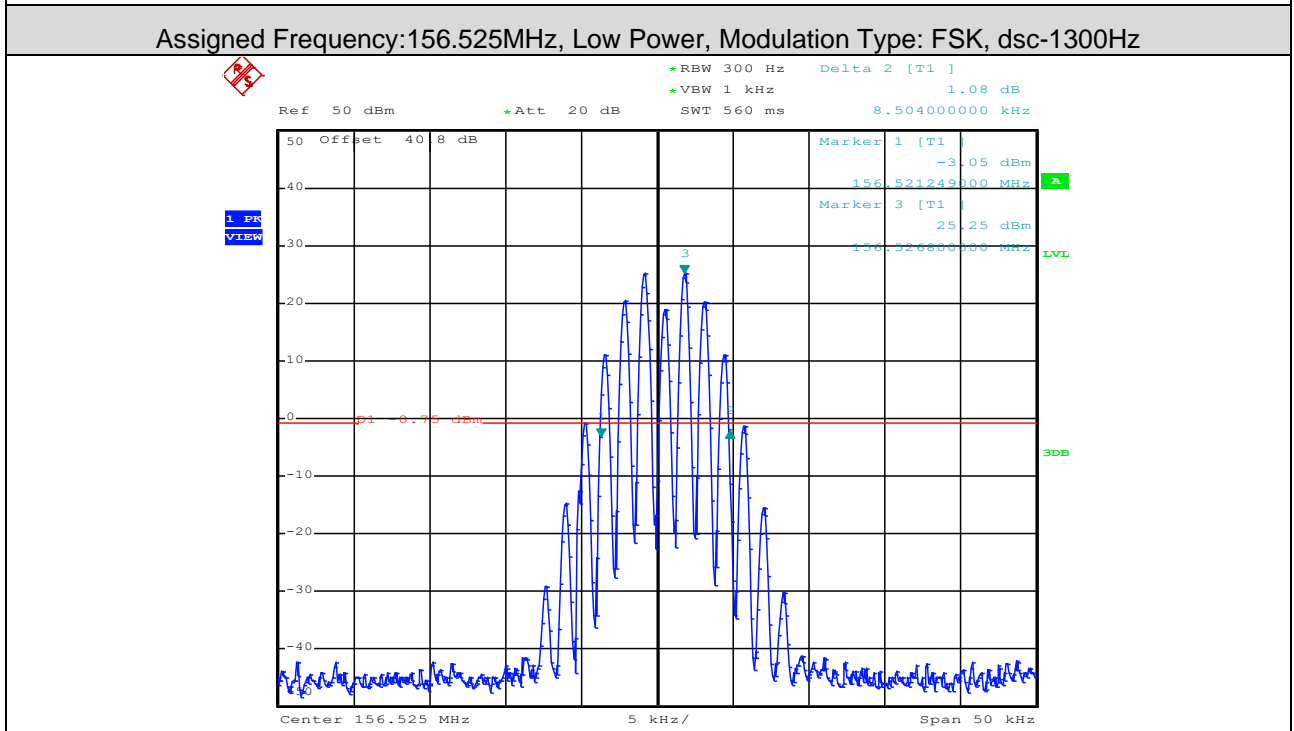
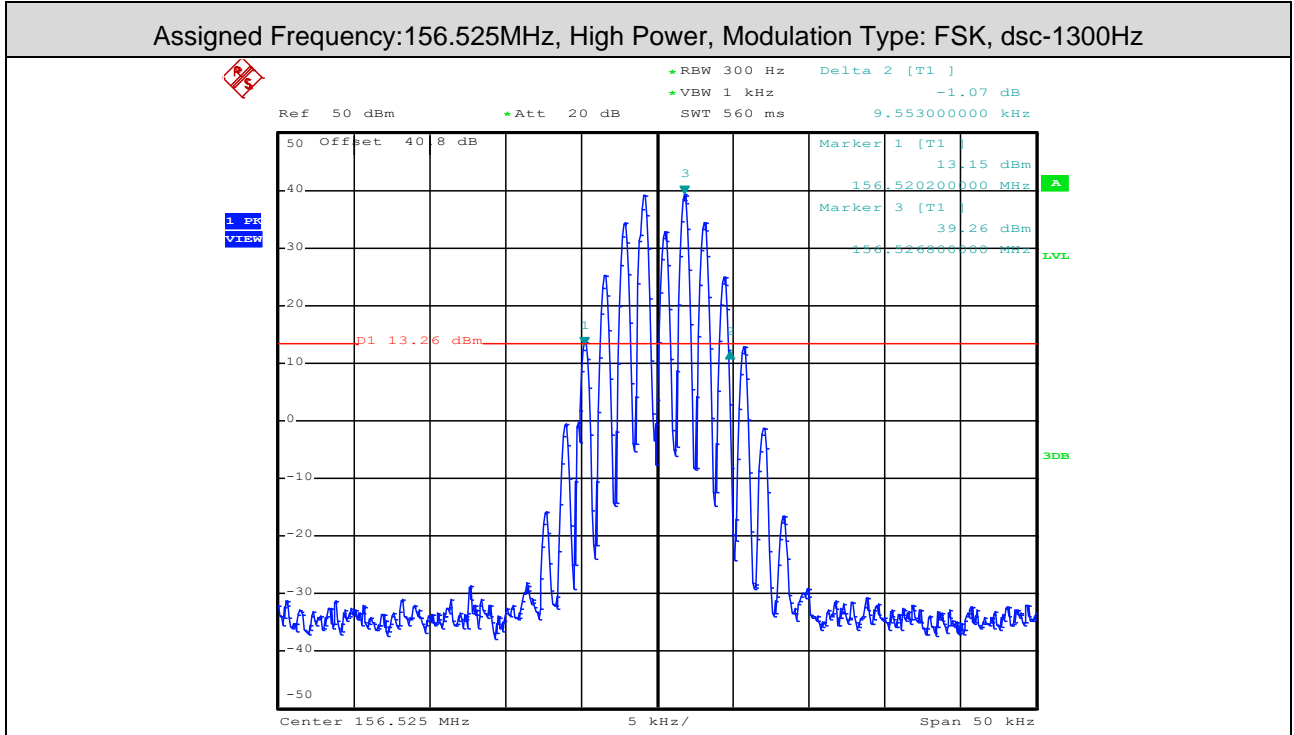

Unless otherwise agreed in writing, this document is issued by the Company subject to its General Conditions of Service printed overleaf, available on request or accessible at <http://www.sgs.com/en/Terms-and-Conditions.aspx> and, for electronic format documents, subject to Terms and Conditions for Electronic Documents at <http://www.sgs.com/en/Terms-and-Conditions/Terms-e-Documents.aspx>. Attention is drawn to the limitation of liability, indemnification and jurisdiction issues defined therein. Any holder of this document is advised that information contained hereon reflects the Company's findings at the time of its intervention only and within the limits of Client's instructions, if any. The Company's sole responsibility is to its Client and this document does not exonerate parties to a transaction from exercising all their rights and obligations under the transaction documents. This document cannot be reproduced except in full, without prior written approval of the Company. Any unauthorized alteration, forgery or falsification of the content or appearance of this document is unlawful and offenders may be prosecuted to the fullest extent of the law. Unless otherwise stated the results shown in this test report refer only to the sample(s) tested and such sample(s) are retained for 30 days only.

Assigned Frequency: 156.525MHz, High Power, Modulation Type: FSK, dsc-2100Hz

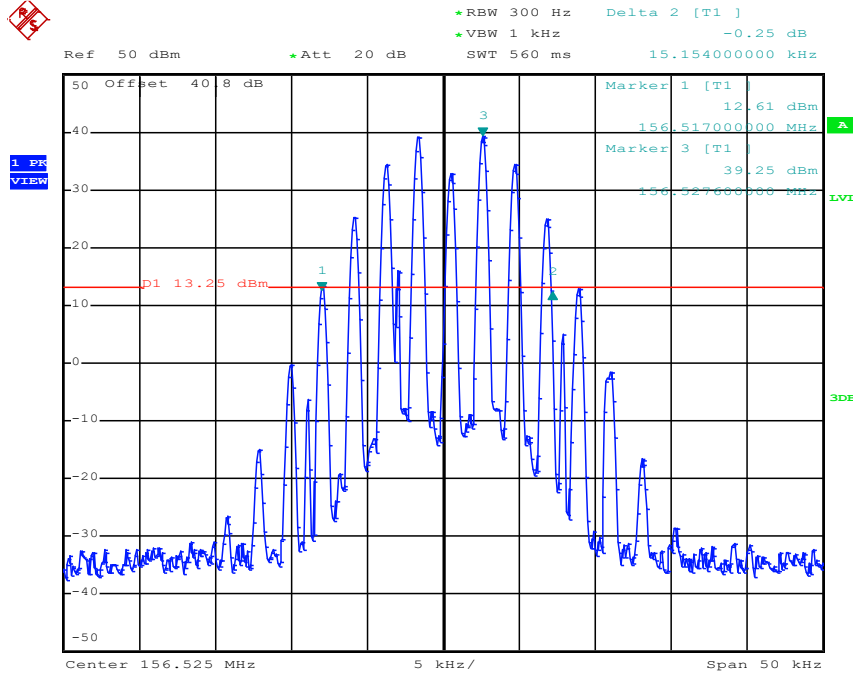

Assigned Frequency: 156.525MHz, Low Power, Modulation Type: FSK, dsc-2100Hz

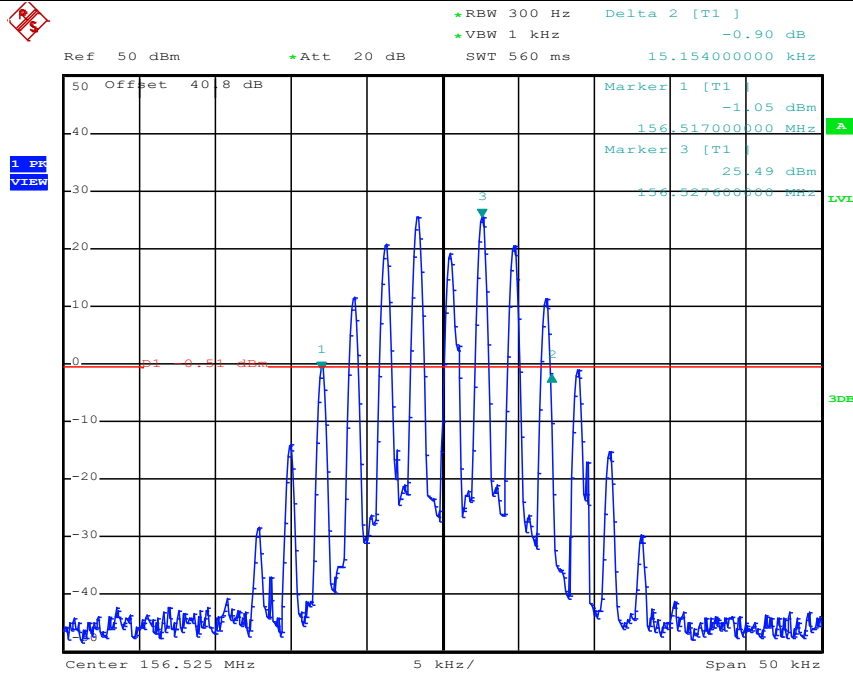

Unless otherwise agreed in writing, this document is issued by the Company subject to its General Conditions of Service printed overleaf, available on request or accessible at <http://www.sgs.com/en/Terms-and-Conditions.aspx> and, for electronic format documents, subject to Terms and Conditions for Electronic Documents at <http://www.sgs.com/en/Terms-and-Conditions/Terms-e-Documents.aspx>. Attention is drawn to the limitation of liability, indemnification and jurisdiction issues defined therein. Any holder of this document is advised that information contained hereon reflects the Company's findings at the time of its intervention only and within the limits of Client's instructions, if any. The Company's sole responsibility is to its Client and this document does not exonerate parties to a transaction from exercising all their rights and obligations under the transaction documents. This document cannot be reproduced except in full, without prior written approval of the Company. Any unauthorized alteration, forgery or falsification of the content or appearance of this document is unlawful and offenders may be prosecuted to the fullest extent of the law. Unless otherwise stated the results shown in this test report refer only to the sample(s) tested and such sample(s) are retained for 30 days only.

Attention: To check the authenticity of testing /inspection report & certificate, please contact us at telephone: (86-755) 8307 1443, or email: [CN.Doccheck@sgs.com](mailto:CN.Doccheck@sgs.com)

No.1 Workshop, M-10, Middle Section, Science & Technology Park, Shenzhen, China 518057 t (86-755) 26012053 f (86-755) 26710594 www.sgs.com.cn  
 中国·深圳·科技园中区M-10栋一号厂房 邮编: 518057 t (86-755) 26012053 f (86-755) 26710594 sgs.china@sgs.com



**2. Transmitter Frequency Tolerances.**

Unmodulated, Assigned Frequency:156.025MHz					
Voltage(V)	Temperature (°C)	Measured Frequency(MHz)	Frequency Error(ppm)	FCC Limit (ppm)	Result
12	-20	156.025014	0.0897	±10	Pass
	-15	156.025005	0.0320		
	-10	156.025021	0.1346		
	0	156.025033	0.2115		
	10	156.025008	0.0513		
	20	156.025022	0.1410		
	30	156.025013	0.0833		
	40	156.025011	0.0705		
	50	156.025035	0.2243		
	55	156.025027	0.1730		
10.2	25	156.025041	0.2628		
13.8	25	156.025025	0.1602		

Unmodulated, Assigned Frequency:162.025MHz					
Voltage(V)	Temperature (°C)	Measured Frequency(MHz)	Frequency Error(ppm)	FCC Limit (ppm)	Result
12	-20	162.025025	0.1543	±10	Pass
	-15	162.025033	0.2037		
	-10	162.025051	0.3148		
	0	162.025026	0.1605		
	10	162.025052	0.3209		
	20	162.025017	0.1049		
	30	162.025024	0.1481		
	40	162.025010	0.0617		
	50	162.025016	0.0988		
	55	162.025023	0.1420		
10.2	25	162.025042	0.2592		
13.8	25	162.025025	0.1543		



Unless otherwise agreed in writing, this document is issued by the Company subject to its General Conditions of Service printed overleaf, available on request or accessible at <http://www.sgs.com/en/Terms-and-Conditions.aspx> and, for electronic format documents, subject to Terms and Conditions for Electronic Documents at <http://www.sgs.com/en/Terms-and-Conditions/Terms-e-Documents.aspx>. Attention is drawn to the limitation of liability, indemnification and jurisdiction issues defined therein. Any holder of this document is advised that information contained hereon reflects the Company's findings at the time of its intervention only and within the limits of Client's instructions, if any. The Company's sole responsibility is to its Client and this document does not exonerate parties to a transaction from exercising all their rights and obligations under the transaction documents. This document cannot be reproduced except in full, without prior written approval of the Company. Any unauthorized alteration, forgery or falsification of the content or appearance of this document is unlawful and offenders may be prosecuted to the fullest extent of the law. Unless otherwise stated the results shown in this test report refer only to the sample(s) tested and such sample(s) are retained for 30 days only.

Unmodulated, Assigned Frequency:156.525MHz					
Voltage(V)	Temperature (°C)	Measured Frequency(MHz)	Frequency Error(ppm)	FCC Limit (ppm)	Result
12	-20	156.525017	0.1086	±10	Pass
	-15	156.525024	0.1533		
	-10	156.525013	0.0831		
	0	156.525008	0.0511		
	10	156.525024	0.1533		
	20	156.525026	0.1661		
	30	156.525042	0.2683		
	40	156.525027	0.1725		
	50	156.525012	0.0767		
	55	156.525011	0.0703		
10.2	25	156.525024	0.1533		
13.8	25	156.525005	0.0319		



Unless otherwise agreed in writing, this document is issued by the Company subject to its General Conditions of Service printed overleaf, available on request or accessible at <http://www.sgs.com/en/Terms-and-Conditions.aspx> and, for electronic format documents, subject to Terms and Conditions for Electronic Documents at <http://www.sgs.com/en/Terms-and-Conditions/Terms-e-Documents.aspx>. Attention is drawn to the limitation of liability, indemnification and jurisdiction issues defined therein. Any holder of this document is advised that information contained hereon reflects the Company's findings at the time of its intervention only and within the limits of Client's instructions, if any. The Company's sole responsibility is to its Client and this document does not exonerate parties to a transaction from exercising all their rights and obligations under the transaction documents. This document cannot be reproduced except in full, without prior written approval of the Company. Any unauthorized alteration, forgery or falsification of the content or appearance of this document is unlawful and offenders may be prosecuted to the fullest extent of the law. Unless otherwise stated the results shown in this test report refer only to the sample(s) tested and such sample(s) are retained for 30 days only.

**3. Emission Mask**

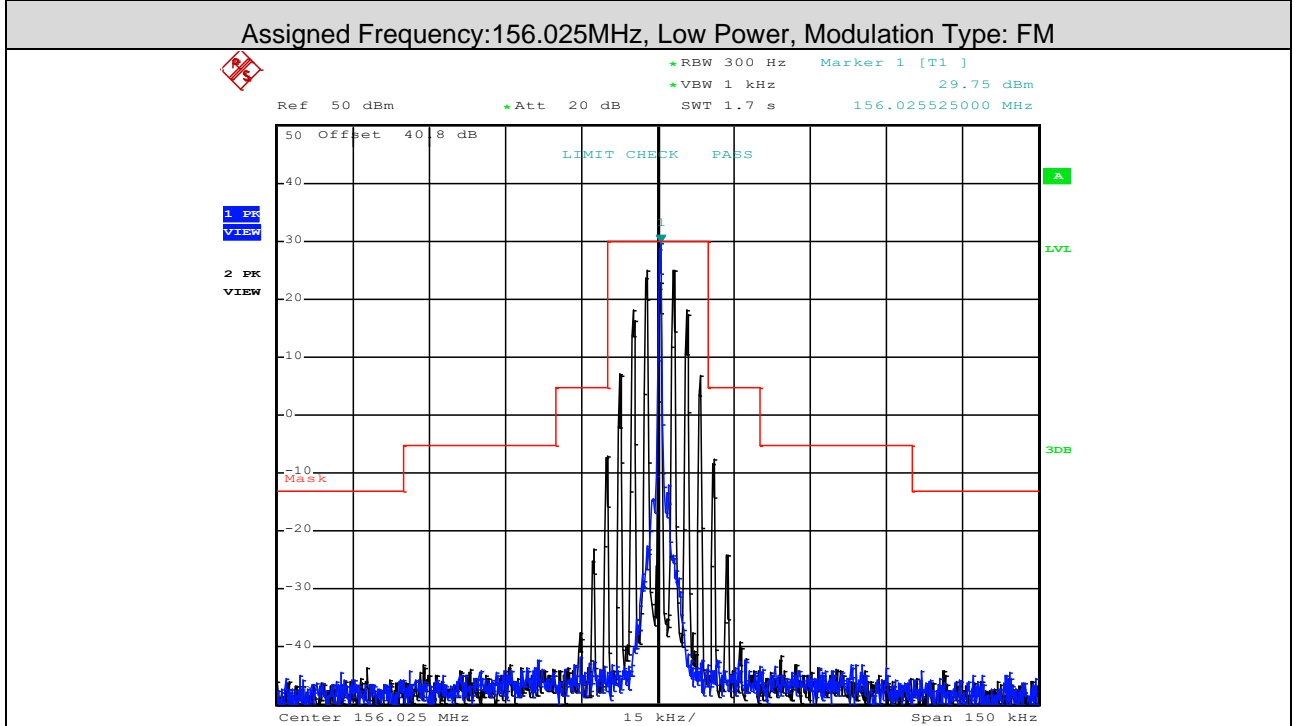
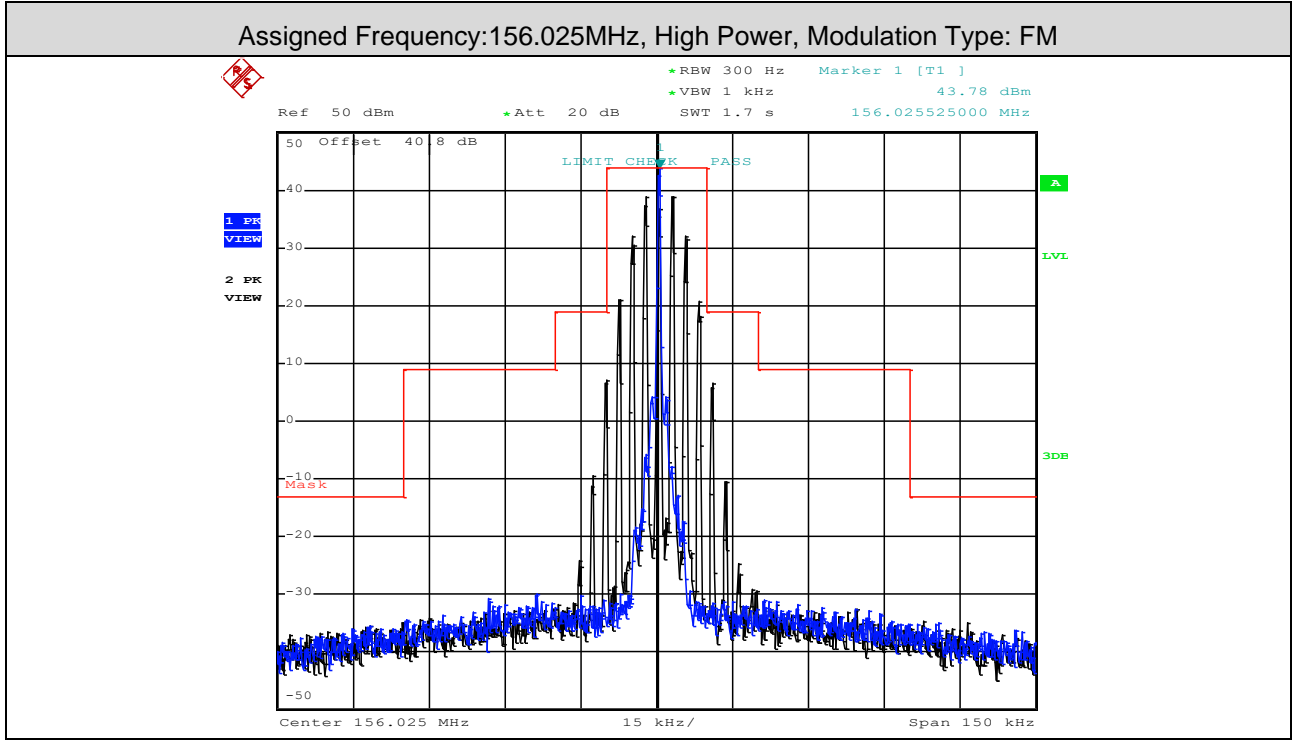

Unless otherwise agreed in writing, this document is issued by the Company subject to its General Conditions of Service printed overleaf, available on request or accessible at <http://www.sgs.com/en/Terms-and-Conditions.aspx> and, for electronic format documents, subject to Terms and Conditions for Electronic Documents at <http://www.sgs.com/en/Terms-and-Conditions/Terms-e-Documents.aspx>. Attention is drawn to the limitation of liability, indemnification and jurisdiction issues defined therein. Any holder of this document is advised that information contained hereon reflects the Company's findings at the time of its intervention only and within the limits of Client's instructions, if any. The Company's sole responsibility is to its Client and this document does not exonerate parties to a transaction from exercising all their rights and obligations under the transaction documents. This document cannot be reproduced except in full, without prior written approval of the Company. Any unauthorized alteration, forgery or falsification of the content or appearance of this document is unlawful and offenders may be prosecuted to the fullest extent of the law. Unless otherwise stated the results shown in this test report refer only to the sample(s) tested and such sample(s) are retained for 30 days only.

Assigned Frequency: 156.300MHz, High Power, Modulation Type: FM

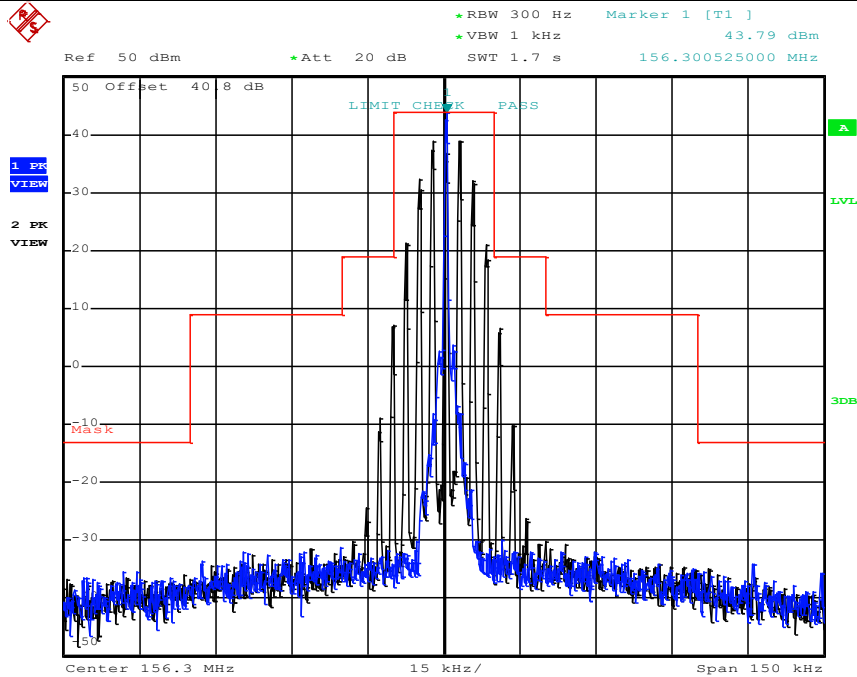

Assigned Frequency: 156.300MHz, Low Power, Modulation Type: FM

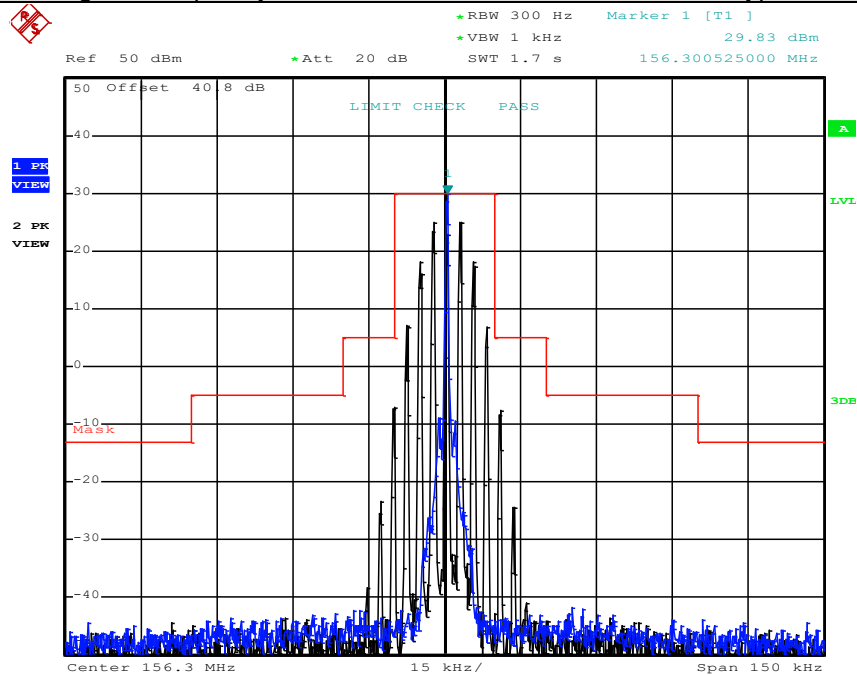

Unless otherwise agreed in writing, this document is issued by the Company subject to its General Conditions of Service printed overleaf, available on request or accessible at <http://www.sgs.com/en/Terms-and-Conditions.aspx> and, for electronic format documents, subject to Terms and Conditions for Electronic Documents at <http://www.sgs.com/en/Terms-and-Conditions/Terms-e-Documents.aspx>. Attention is drawn to the limitation of liability, indemnification and jurisdiction issues defined therein. Any holder of this document is advised that information contained hereon reflects the Company's findings at the time of its intervention only and within the limits of Client's instructions, if any. The Company's sole responsibility is to its Client and this document does not exonerate parties to a transaction from exercising all their rights and obligations under the transaction documents. This document cannot be reproduced except in full, without prior written approval of the Company. Any unauthorized alteration, forgery or falsification of the content or appearance of this document is unlawful and offenders may be prosecuted to the fullest extent of the law. Unless otherwise stated the results shown in this test report refer only to the sample(s) tested and such sample(s) are retained for 30 days only.

Attention: To check the authenticity of testing /inspection report & certificate, please contact us at telephone: (86-755) 8307 1443, or email: [CN.Doccheck@sgs.com](mailto:CN.Doccheck@sgs.com)  
 No.1 Workshop, M-10, Middle Section, Science & Technology Park, Shenzhen, China 518057 t (86-755) 26012053 f (86-755) 26710594 www.sgs.com.cn  
 中国·深圳·科技园中区M-10栋一号厂房 邮编: 518057 t (86-755) 26012053 f (86-755) 26710594 sgs.china@sgs.com

Assigned Frequency: 156.800MHz, High Power, Modulation Type: FM

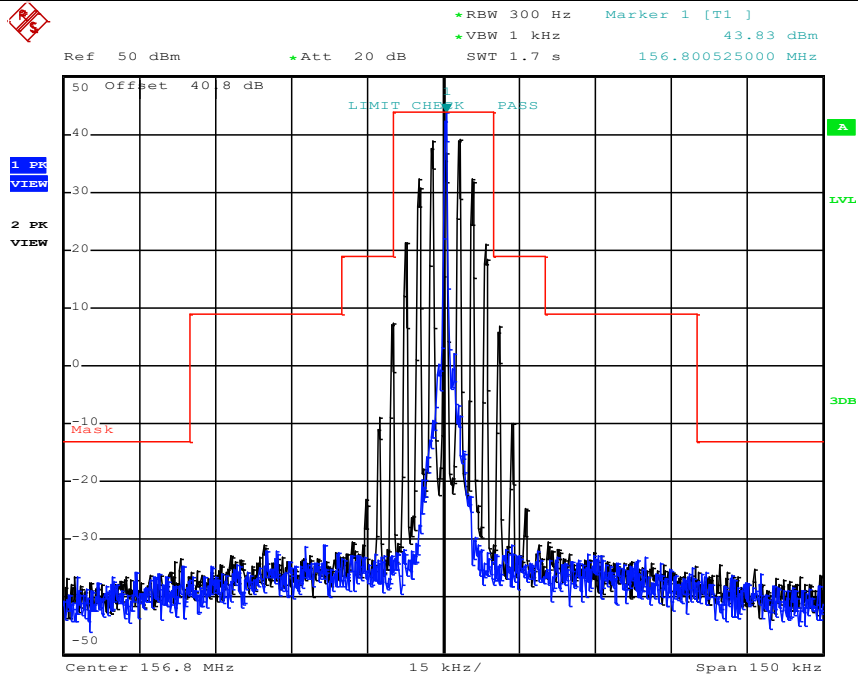

Assigned Frequency: 156.800MHz, Low Power, Modulation Type: FM

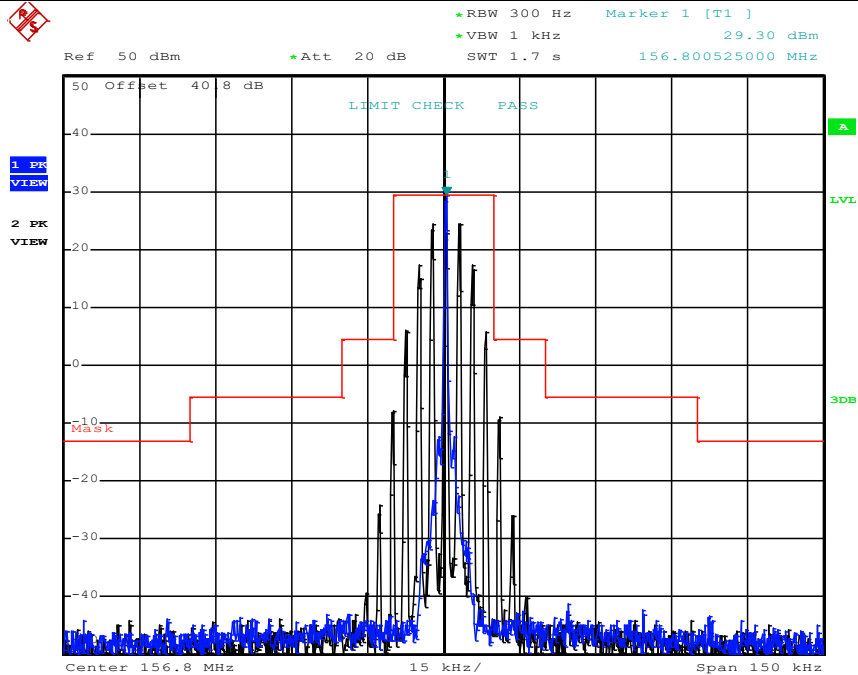

Unless otherwise agreed in writing, this document is issued by the Company subject to its General Conditions of Service printed overleaf, available on request or accessible at <http://www.sgs.com/en/Terms-and-Conditions.aspx> and, for electronic format documents, subject to Terms and Conditions for Electronic Documents at <http://www.sgs.com/en/Terms-and-Conditions/Terms-e-Documents.aspx>. Attention is drawn to the limitation of liability, indemnification and jurisdiction issues defined therein. Any holder of this document is advised that information contained hereon reflects the Company's findings at the time of its intervention only and within the limits of Client's instructions, if any. The Company's sole responsibility is to its Client and this document does not exonerate parties to a transaction from exercising all their rights and obligations under the transaction documents. This document cannot be reproduced except in full, without prior written approval of the Company. Any unauthorized alteration, forgery or falsification of the content or appearance of this document is unlawful and offenders may be prosecuted to the fullest extent of the law. Unless otherwise stated the results shown in this test report refer only to the sample(s) tested and such sample(s) are retained for 30 days only.

Attention: To check the authenticity of testing /inspection report & certificate, please contact us at telephone: (86-755) 8307 1443, or email: [CN.Doccheck@sgs.com](mailto:CN.Doccheck@sgs.com)

No.1 Workshop, M-10, Middle Section, Science & Technology Park, Shenzhen, China 518057 t (86-755) 26012053 f (86-755) 26710594 www.sgs.com.cn  
 中国·深圳·科技园中区M-10栋一号厂房 邮编: 518057 t (86-755) 26012053 f (86-755) 26710594 sgs.china@sgs.com

Assigned Frequency: 156.65MHz, High Power, Modulation Type: FM

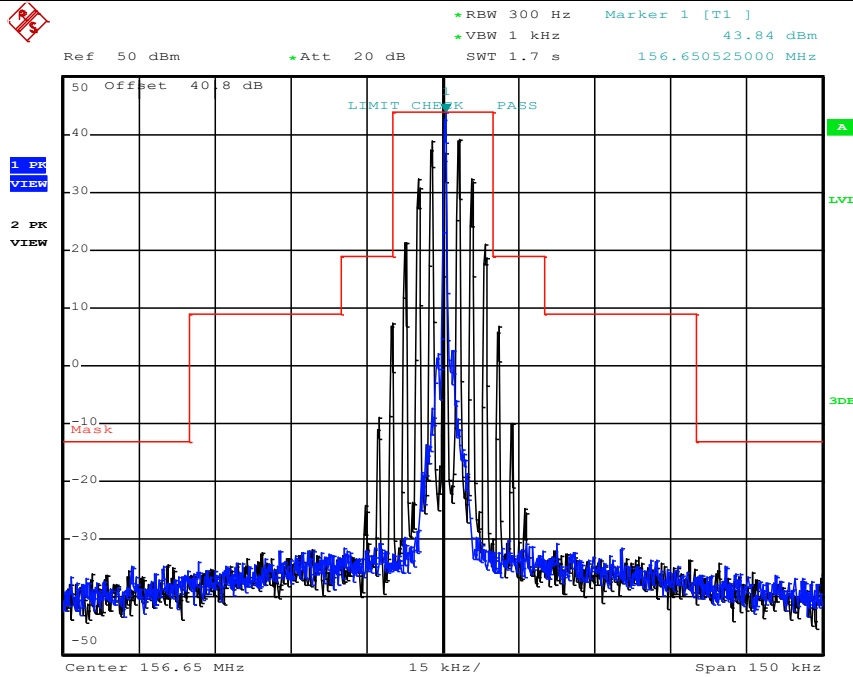

Assigned Frequency: 156.65MHz, Low Power, Modulation Type: FM

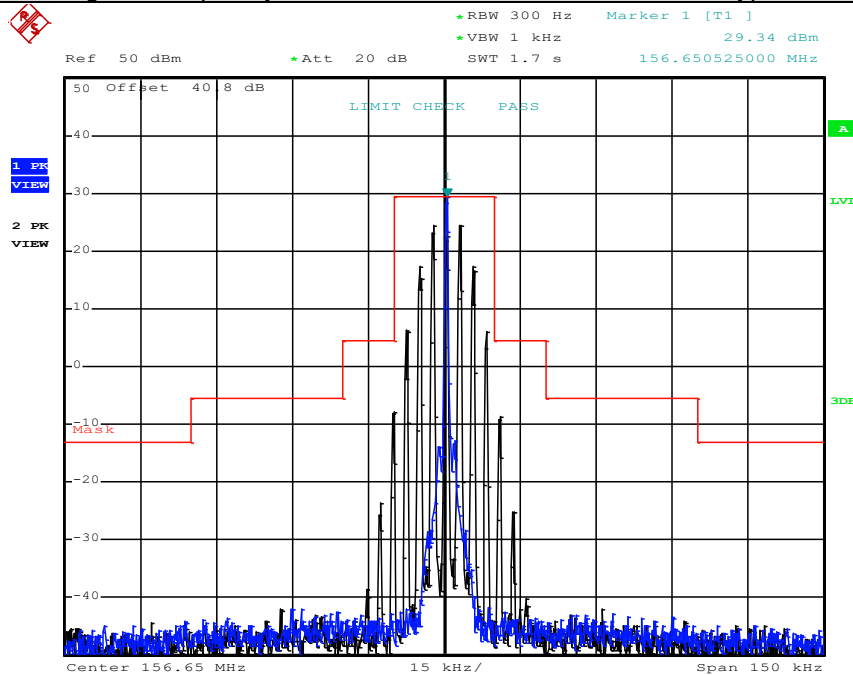

Unless otherwise agreed in writing, this document is issued by the Company subject to its General Conditions of Service printed overleaf, available on request or accessible at <http://www.sgs.com/en/Terms-and-Conditions.aspx> and, for electronic format documents, subject to Terms and Conditions for Electronic Documents at <http://www.sgs.com/en/Terms-and-Conditions/Terms-e-Documents.aspx>. Attention is drawn to the limitation of liability, indemnification and jurisdiction issues defined therein. Any holder of this document is advised that information contained hereon reflects the Company's findings at the time of its intervention only and within the limits of Client's instructions, if any. The Company's sole responsibility is to its Client and this document does not exonerate parties to a transaction from exercising all their rights and obligations under the transaction documents. This document cannot be reproduced except in full, without prior written approval of the Company. Any unauthorized alteration, forgery or falsification of the content or appearance of this document is unlawful and offenders may be prosecuted to the fullest extent of the law. Unless otherwise stated the results shown in this test report refer only to the sample(s) tested and such sample(s) are retained for 30 days only.

Attention: To check the authenticity of testing /inspection report & certificate, please contact us at telephone: (86-755) 8307 1443, or email: [CN.Doccheck@sgs.com](mailto:CN.Doccheck@sgs.com)

No.1 Workshop, M-10, Middle Section, Science & Technology Park, Shenzhen, China 518057 t (86-755) 26012053 f (86-755) 26710594 www.sgs.com.cn  
 中国·深圳·科技园中区M-10栋一号厂房 邮编: 518057 t (86-755) 26012053 f (86-755) 26710594 sgs.china@sgs.com

Assigned Frequency: 157.425MHz, High Power, Modulation Type: FM

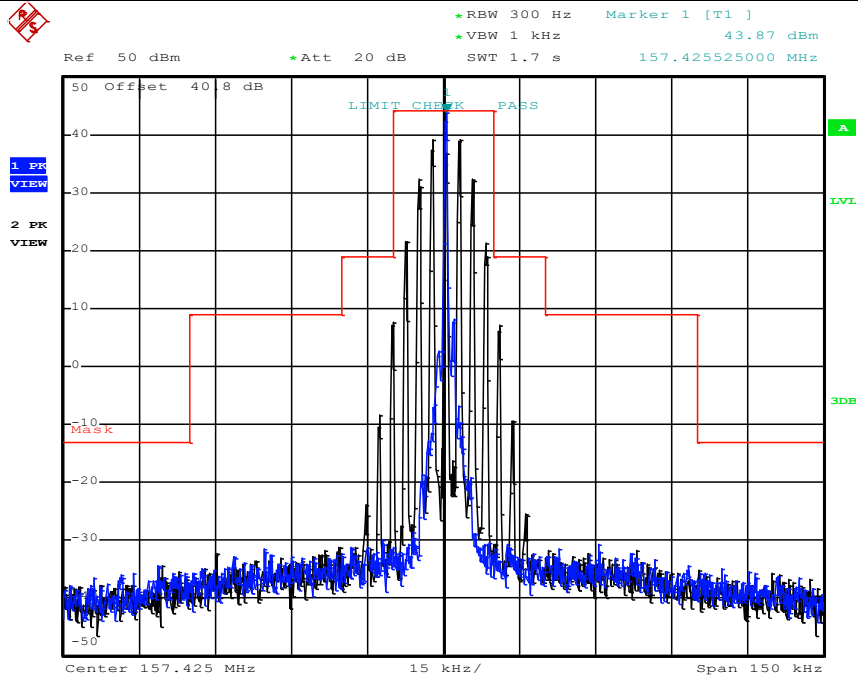

Assigned Frequency: 157.425MHz, Low Power, Modulation Type: FM

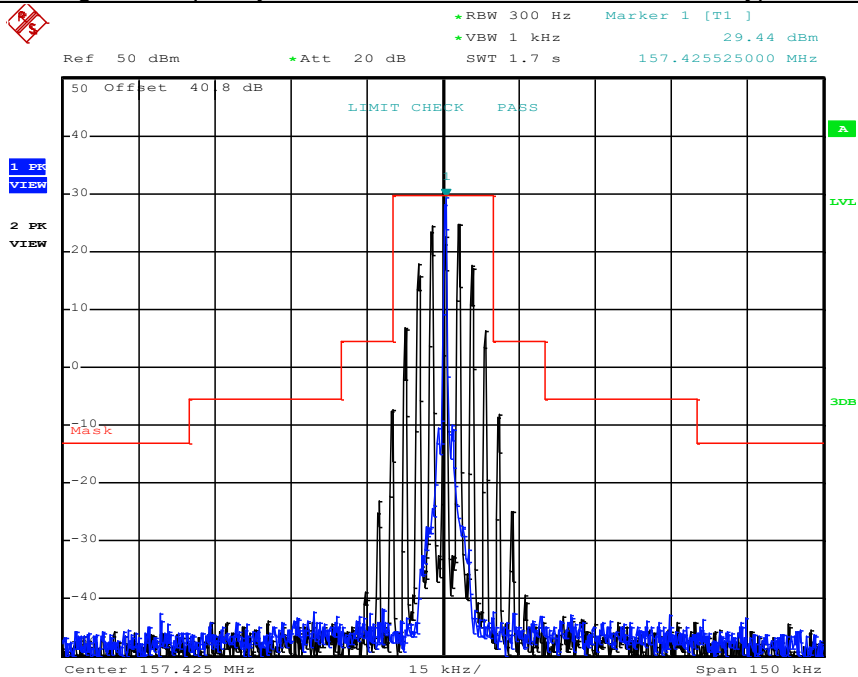

Unless otherwise agreed in writing, this document is issued by the Company subject to its General Conditions of Service printed overleaf, available on request or accessible at <http://www.sgs.com/en/Terms-and-Conditions.aspx> and, for electronic format documents, subject to Terms and Conditions for Electronic Documents at <http://www.sgs.com/en/Terms-and-Conditions/Terms-e-Documents.aspx>. Attention is drawn to the limitation of liability, indemnification and jurisdiction issues defined therein. Any holder of this document is advised that information contained hereon reflects the Company's findings at the time of its intervention only and within the limits of Client's instructions, if any. The Company's sole responsibility is to its Client and this document does not exonerate parties to a transaction from exercising all their rights and obligations under the transaction documents. This document cannot be reproduced except in full, without prior written approval of the Company. Any unauthorized alteration, forgery or falsification of the content or appearance of this document is unlawful and offenders may be prosecuted to the fullest extent of the law. Unless otherwise stated the results shown in this test report refer only to the sample(s) tested and such sample(s) are retained for 30 days only.

Attention: To check the authenticity of testing /inspection report & certificate, please contact us at telephone: (86-755) 8307 1443, or email: [CN.Doccheck@sgs.com](mailto:CN.Doccheck@sgs.com)  
 No.1 Workshop, M-10, Middle Section, Science & Technology Park, Shenzhen, China 518057    t (86-755) 26012053 f (86-755) 26710594    www.sgs.com.cn  
 中国·深圳·科技园中区M-10栋一号厂房    邮编: 518057    t (86-755) 26012053 f (86-755) 26710594    sgs.china@sgs.com

Assigned Frequency: 156.525MHz, High Power, Modulation Type: FSK, dsc-1300Hz

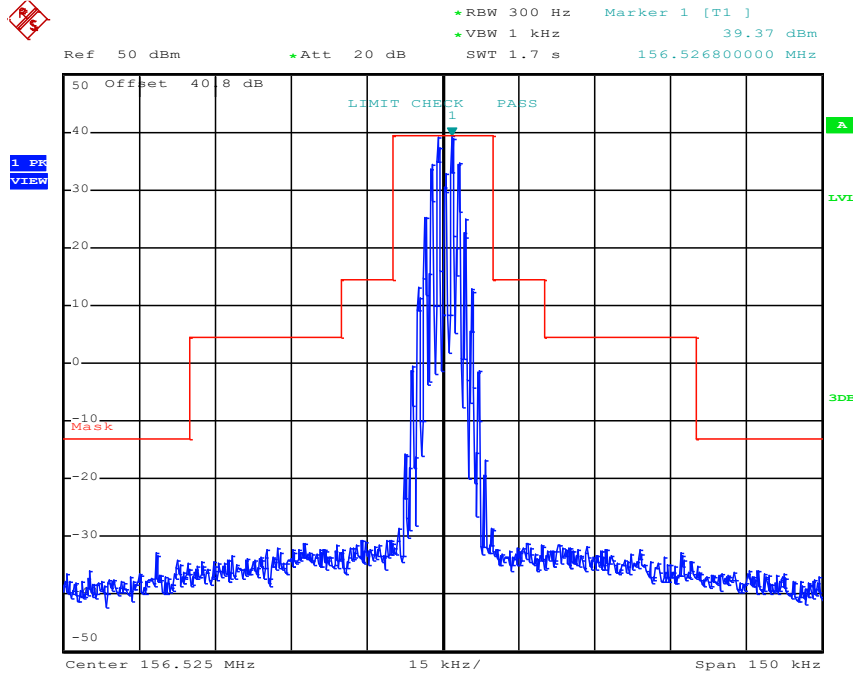

Assigned Frequency: 156.525MHz, Low Power, Modulation Type: FSK, dsc-1300Hz

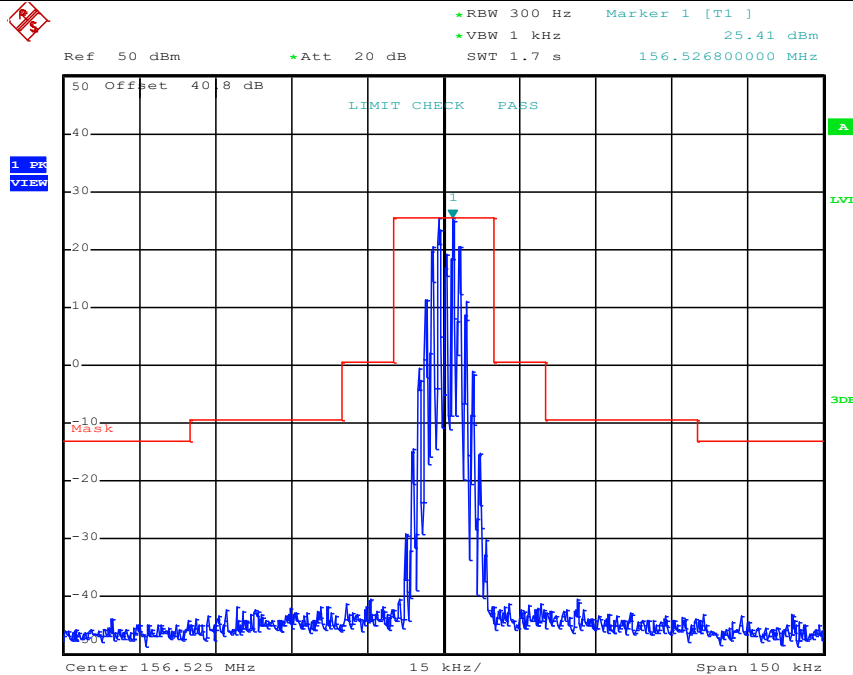

Unless otherwise agreed in writing, this document is issued by the Company subject to its General Conditions of Service printed overleaf, available on request or accessible at <http://www.sgs.com/en/Terms-and-Conditions.aspx> and, for electronic format documents, subject to Terms and Conditions for Electronic Documents at <http://www.sgs.com/en/Terms-and-Conditions/Terms-e-Documents.aspx>. Attention is drawn to the limitation of liability, indemnification and jurisdiction issues defined therein. Any holder of this document is advised that information contained hereon reflects the Company's findings at the time of its intervention only and within the limits of Client's instructions, if any. The Company's sole responsibility is to its Client and this document does not exonerate parties to a transaction from exercising all their rights and obligations under the transaction documents. This document cannot be reproduced except in full, without prior written approval of the Company. Any unauthorized alteration, forgery or falsification of the content or appearance of this document is unlawful and offenders may be prosecuted to the fullest extent of the law. Unless otherwise stated the results shown in this test report refer only to the sample(s) tested and such sample(s) are retained for 30 days only.



Assigned Frequency:156.525MHz, High Power, Modulation Type: FSK, dsc-2100Hz

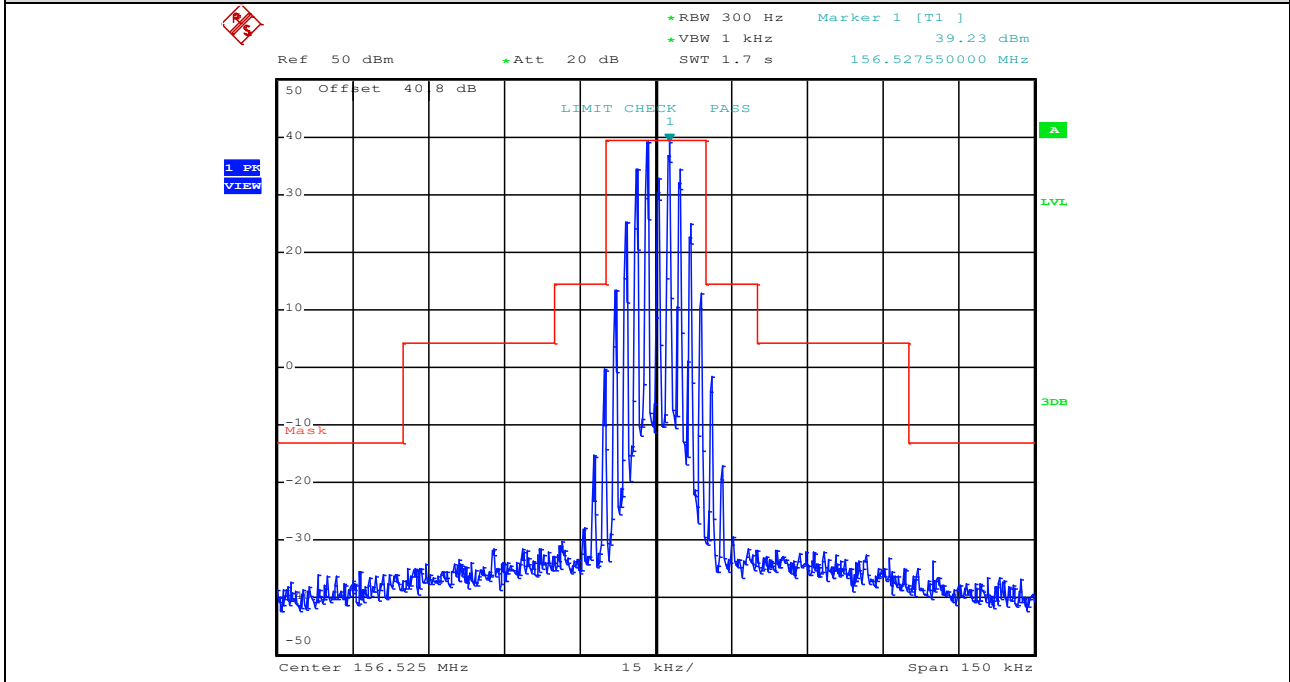

Assigned Frequency:156.525MHz, Low Power, Modulation Type: FSK, dsc-2100Hz

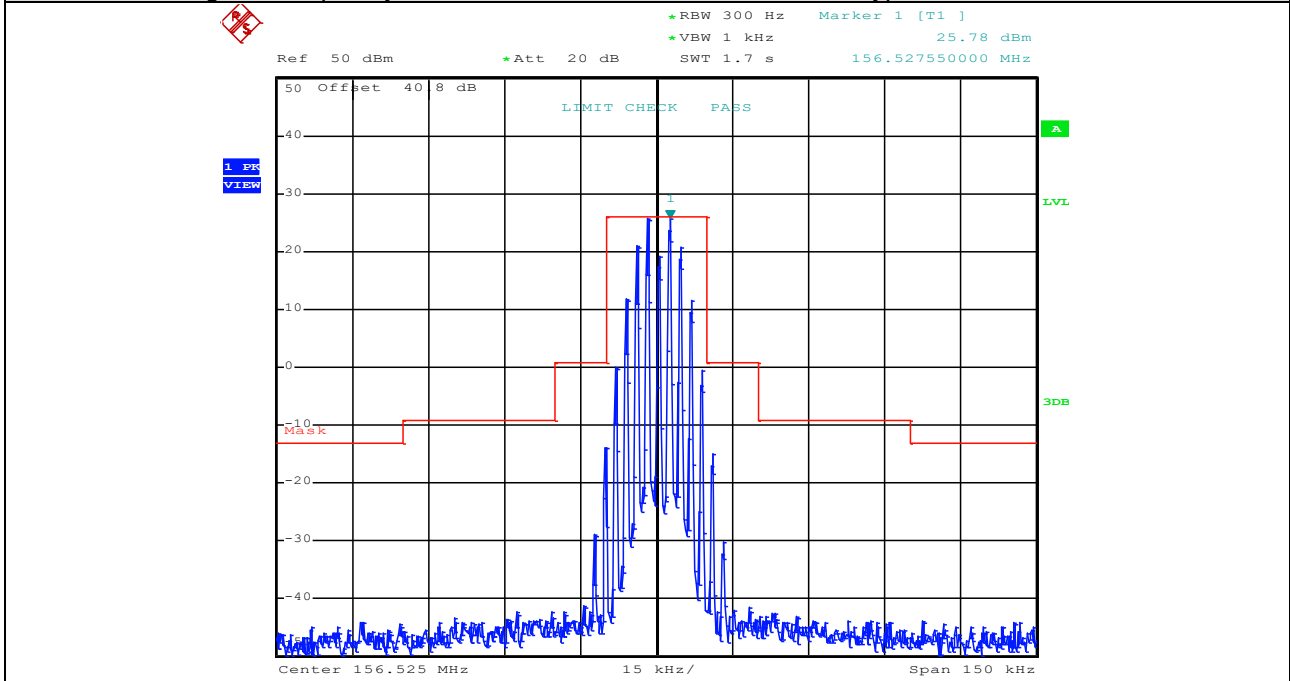

Unless otherwise agreed in writing, this document is issued by the Company subject to its General Conditions of Service printed overleaf, available on request or accessible at <http://www.sgs.com/en/Terms-and-Conditions.aspx> and, for electronic format documents, subject to Terms and Conditions for Electronic Documents at <http://www.sgs.com/en/Terms-and-Conditions/Terms-e-Documents.aspx>. Attention is drawn to the limitation of liability, indemnification and jurisdiction issues defined therein. Any holder of this document is advised that information contained hereon reflects the Company's findings at the time of its intervention only and within the limits of Client's instructions, if any. The Company's sole responsibility is to its Client and this document does not exonerate parties to a transaction from exercising all their rights and obligations under the transaction documents. This document cannot be reproduced except in full, without prior written approval of the Company. Any unauthorized alteration, forgery or falsification of the content or appearance of this document is unlawful and offenders may be prosecuted to the fullest extent of the law. Unless otherwise stated the results shown in this test report refer only to the sample(s) tested and such sample(s) are retained for 30 days only.

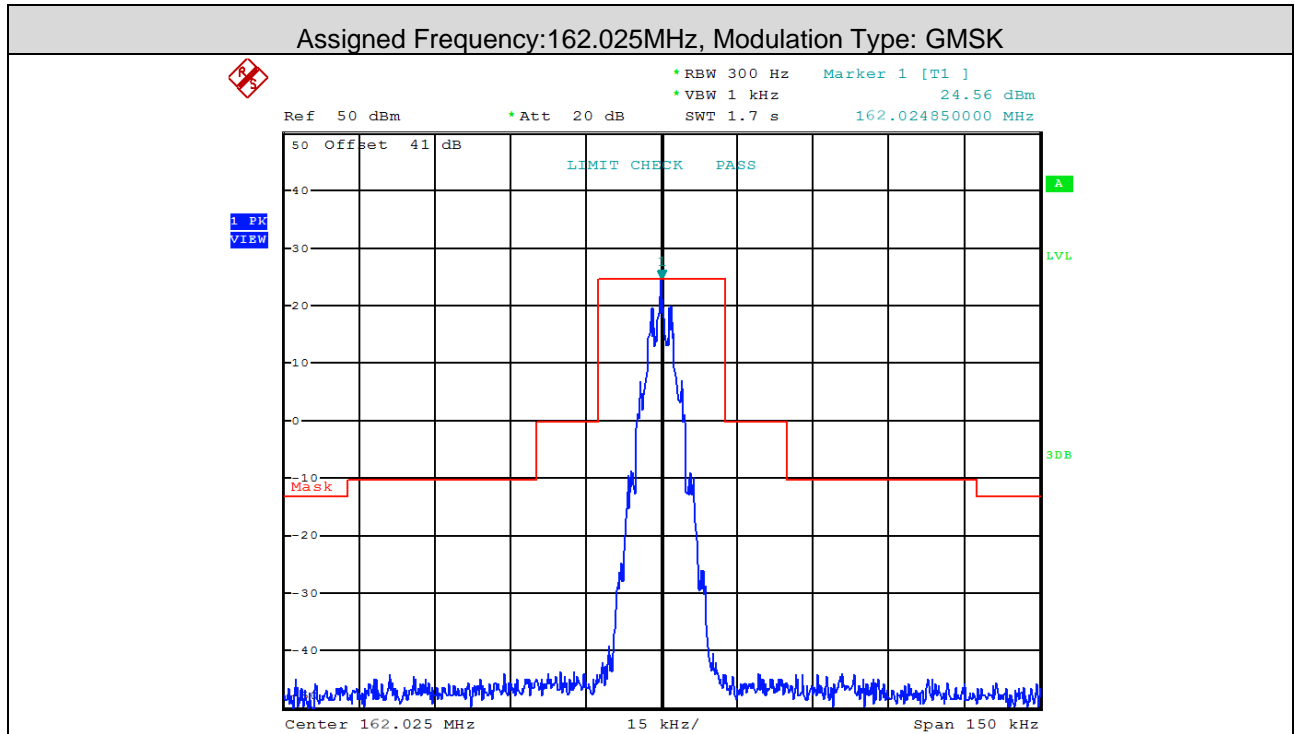

**4. Conducted Spurious Emission**

Assigned Frequency:156.025MHz, High Power, Modulation Type: FM, 9KHz-150KHz

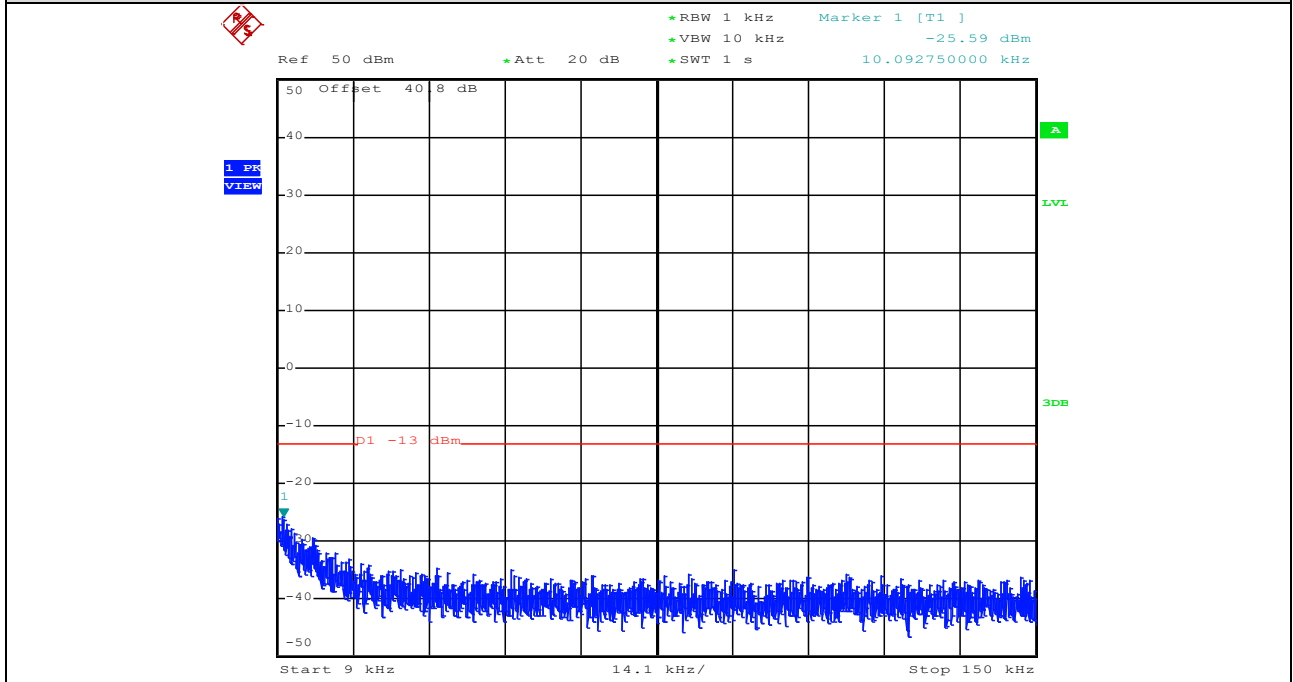

Assigned Frequency:156.025MHz, High Power, Modulation Type: FM,150KHz-30MHz

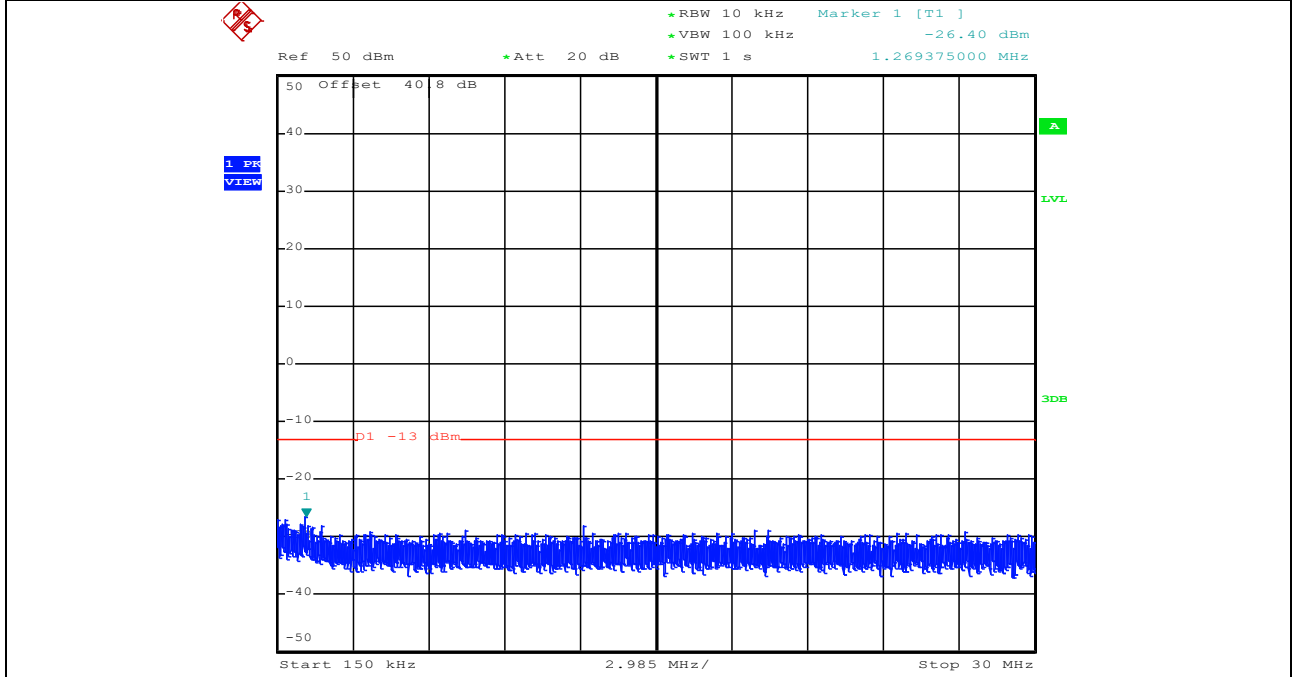

Unless otherwise agreed in writing, this document is issued by the Company subject to its General Conditions of Service printed overleaf, available on request or accessible at <http://www.sgs.com/en/Terms-and-Conditions.aspx> and, for electronic format documents, subject to Terms and Conditions for Electronic Documents at <http://www.sgs.com/en/Terms-and-Conditions/Terms-e-Documents.aspx>. Attention is drawn to the limitation of liability, indemnification and jurisdiction issues defined therein. Any holder of this document is advised that information contained hereon reflects the Company's findings at the time of its intervention only and within the limits of Client's instructions, if any. The Company's sole responsibility is to its Client and this document does not exonerate parties to a transaction from exercising all their rights and obligations under the transaction documents. This document cannot be reproduced except in full, without prior written approval of the Company. Any unauthorized alteration, forgery or falsification of the content or appearance of this document is unlawful and offenders may be prosecuted to the fullest extent of the law. Unless otherwise stated the results shown in this test report refer only to the sample(s) tested and such sample(s) are retained for 30 days only.

**Assigned Frequency: 156.025MHz, High Power, Modulation Type: FM, 30MHz-1GHz**

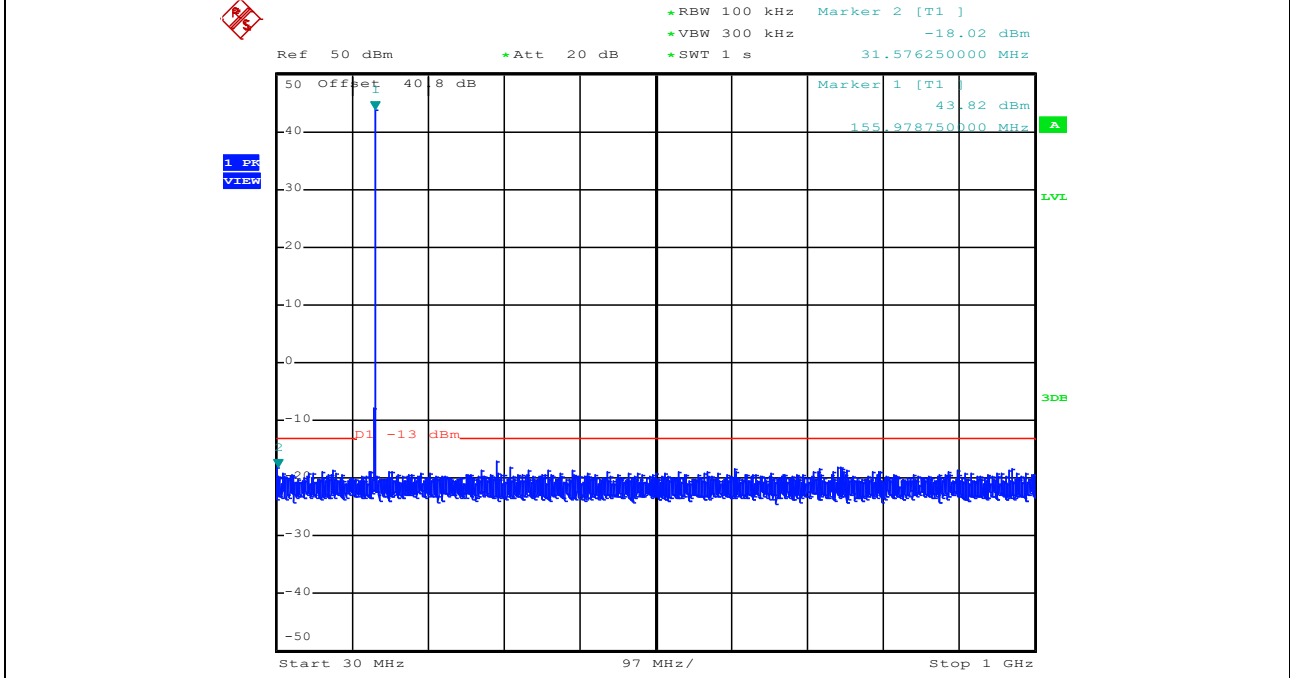

**Assigned Frequency: 156.025MHz, High Power, Modulation Type: FM, 1GHz-2GHz**

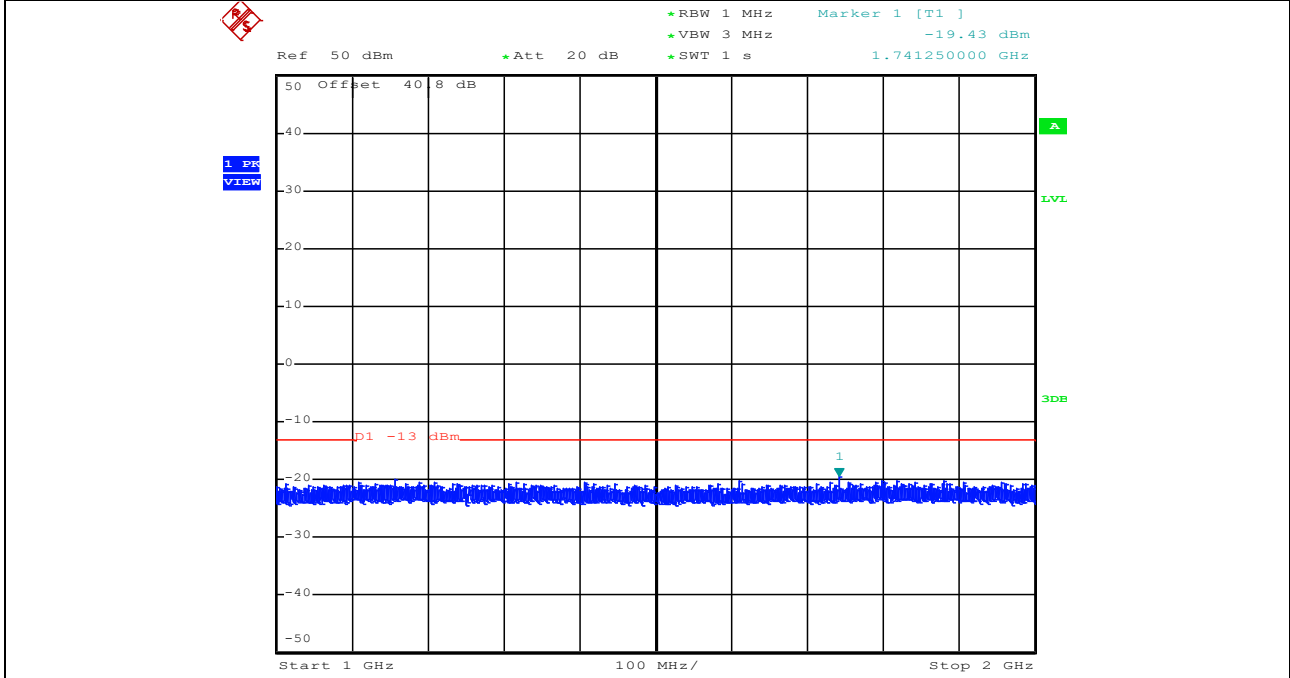

Unless otherwise agreed in writing, this document is issued by the Company subject to its General Conditions of Service printed overleaf, available on request or accessible at <http://www.sgs.com/en/Terms-and-Conditions.aspx> and, for electronic format documents, subject to Terms and Conditions for Electronic Documents at <http://www.sgs.com/en/Terms-and-Conditions/Terms-e-Documents.aspx>. Attention is drawn to the limitation of liability, indemnification and jurisdiction issues defined therein. Any holder of this document is advised that information contained hereon reflects the Company's findings at the time of its intervention only and within the limits of Client's instructions, if any. The Company's sole responsibility is to its Client and this document does not exonerate parties to a transaction from exercising all their rights and obligations under the transaction documents. This document cannot be reproduced except in full, without prior written approval of the Company. Any unauthorized alteration, forgery or falsification of the content or appearance of this document is unlawful and offenders may be prosecuted to the fullest extent of the law. Unless otherwise stated the results shown in this test report refer only to the sample(s) tested and such sample(s) are retained for 30 days only.

**Assigned Frequency:156.300MHz, High Power, Modulation Type: FM, 9KHz-150KHz**

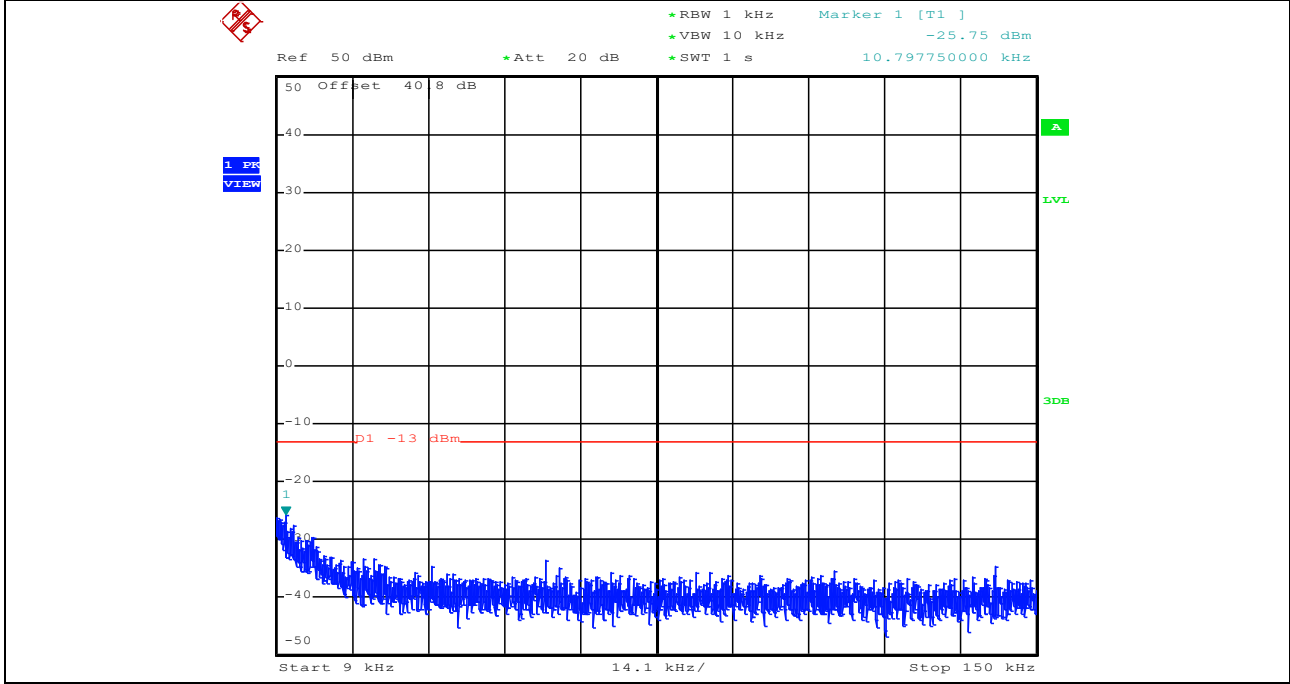

**Assigned Frequency:156.300MHz, High Power, Modulation Type: FM,150KHz-30MHz**

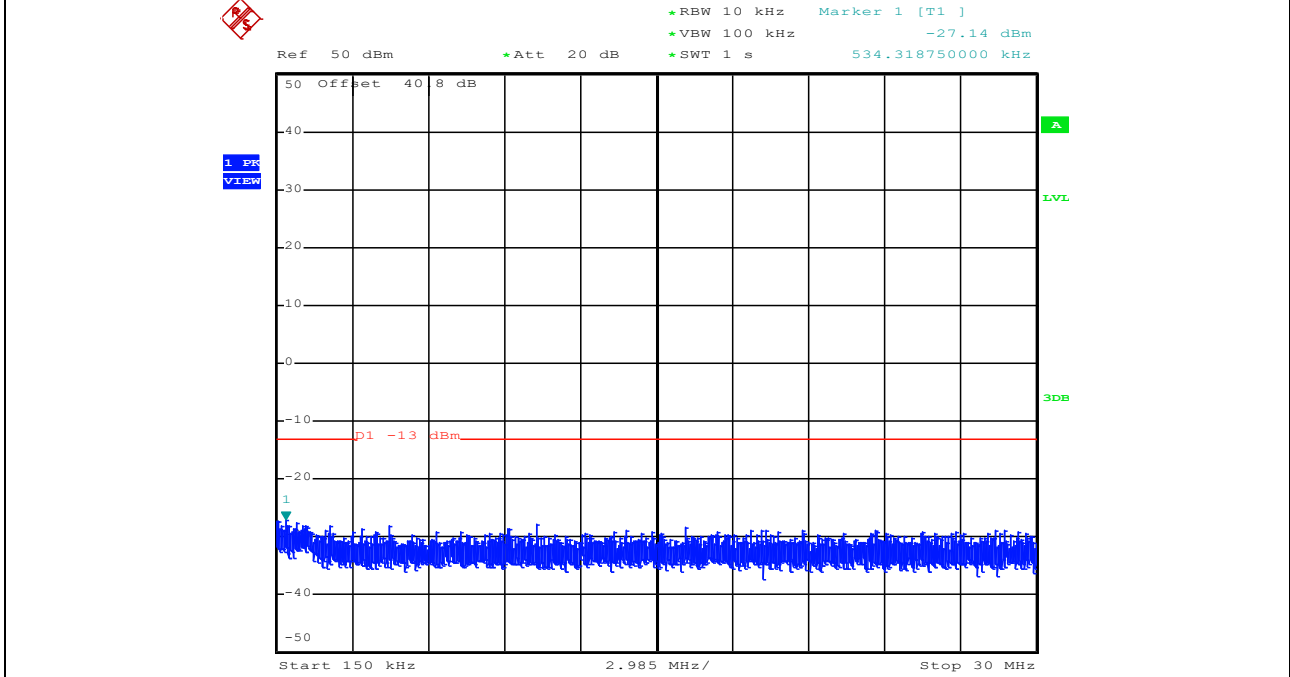

Unless otherwise agreed in writing, this document is issued by the Company subject to its General Conditions of Service printed overleaf, available on request or accessible at <http://www.sgs.com/en/Terms-and-Conditions.aspx> and, for electronic format documents, subject to Terms and Conditions for Electronic Documents at <http://www.sgs.com/en/Terms-and-Conditions/Terms-e-Documents.aspx>. Attention is drawn to the limitation of liability, indemnification and jurisdiction issues defined therein. Any holder of this document is advised that information contained hereon reflects the Company's findings at the time of its intervention only and within the limits of Client's instructions, if any. The Company's sole responsibility is to its Client and this document does not exonerate parties to a transaction from exercising all their rights and obligations under the transaction documents. This document cannot be reproduced except in full, without prior written approval of the Company. Any unauthorized alteration, forgery or falsification of the content or appearance of this document is unlawful and offenders may be prosecuted to the fullest extent of the law. Unless otherwise stated the results shown in this test report refer only to the sample(s) tested and such sample(s) are retained for 30 days only.

**Assigned Frequency: 156.300MHz, High Power, Modulation Type: FM, 30MHz-1GHz**

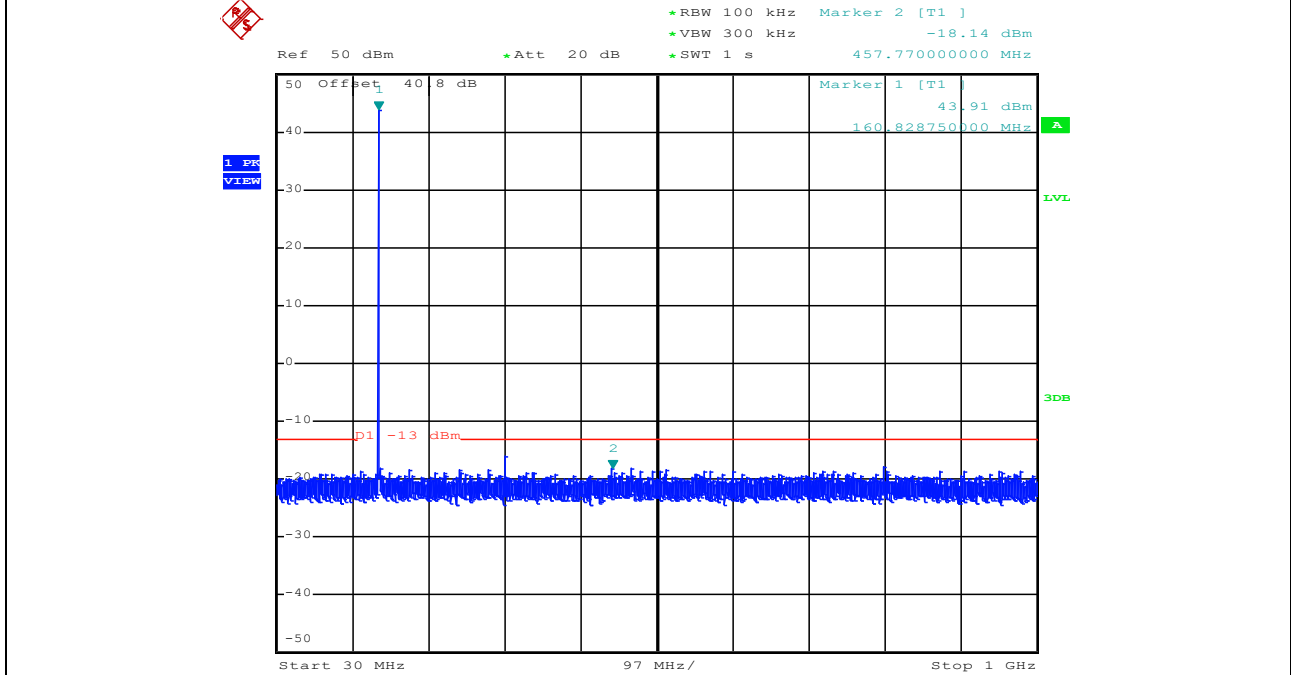

**Assigned Frequency: 156.300MHz, High Power, Modulation Type: FM, 1GHz-2GHz**

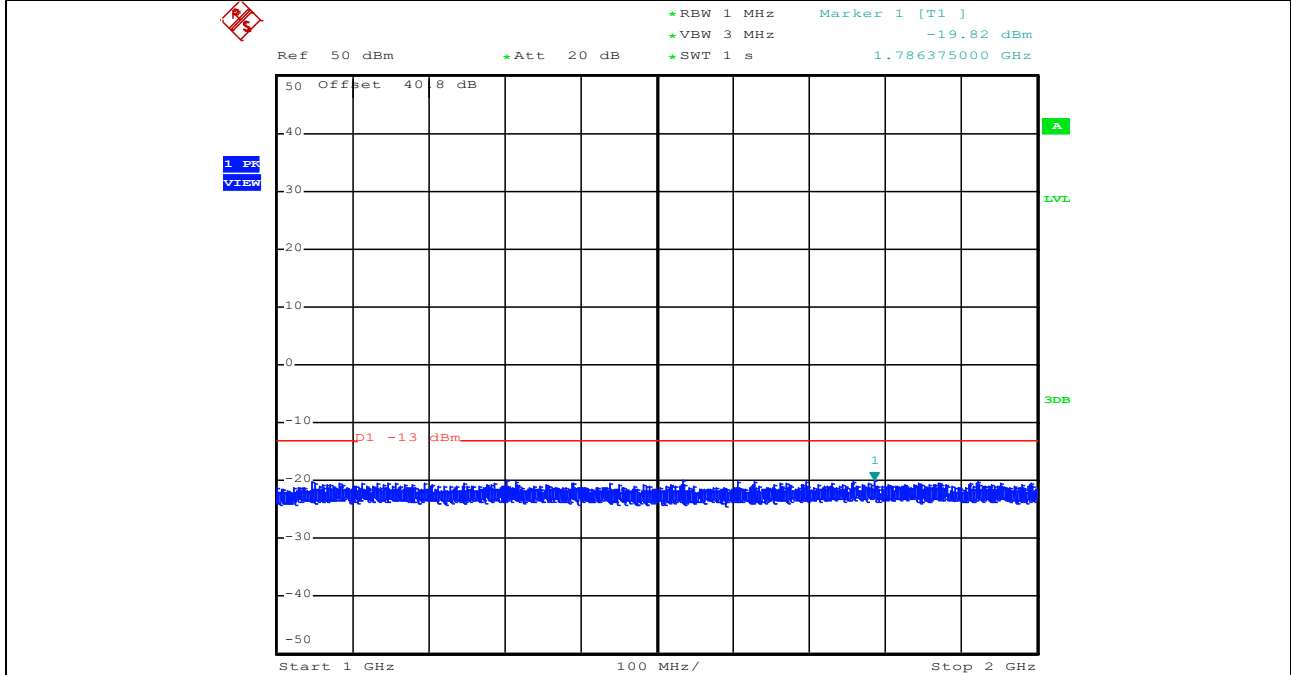

Unless otherwise agreed in writing, this document is issued by the Company subject to its General Conditions of Service printed overleaf, available on request or accessible at <http://www.sgs.com/en/Terms-and-Conditions.aspx> and, for electronic format documents, subject to Terms and Conditions for Electronic Documents at <http://www.sgs.com/en/Terms-and-Conditions/Terms-e-Documents.aspx>. Attention is drawn to the limitation of liability, indemnification and jurisdiction issues defined therein. Any holder of this document is advised that information contained hereon reflects the Company's findings at the time of its intervention only and within the limits of Client's instructions, if any. The Company's sole responsibility is to its Client and this document does not exonerate parties to a transaction from exercising all their rights and obligations under the transaction documents. This document cannot be reproduced except in full, without prior written approval of the Company. Any unauthorized alteration, forgery or falsification of the content or appearance of this document is unlawful and offenders may be prosecuted to the fullest extent of the law. Unless otherwise stated the results shown in this test report refer only to the sample(s) tested and such sample(s) are retained for 30 days only.

Attention: To check the authenticity of testing /inspection report & certificate, please contact us at telephone: (86-755) 8307 1443, or email: [CN.Doccheck@sgs.com](mailto:CN.Doccheck@sgs.com)

No.1 Workshop, M-10, Middle Section, Science & Technology Park, Shenzhen, China 518057 t (86-755) 26012053 f (86-755) 26710594 www.sgs.com.cn  
 中国·深圳·科技园中区M-10栋一号厂房 邮编: 518057 t (86-755) 26012053 f (86-755) 26710594 sgs.china@sgs.com

**Assigned Frequency:156.650MHz, High Power, Modulation Type: FM, 9KHz-150KHz**

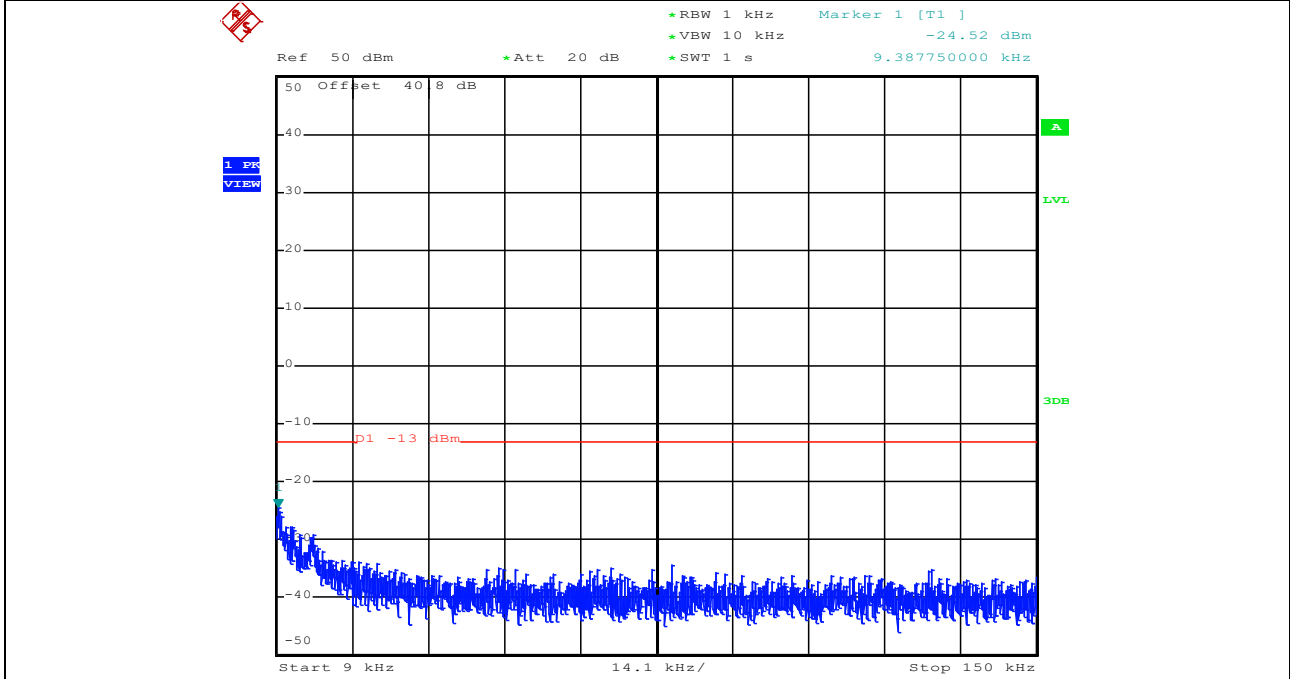

**Assigned Frequency:156.650MHz, High Power, Modulation Type: FM,150KHz-30MHz**

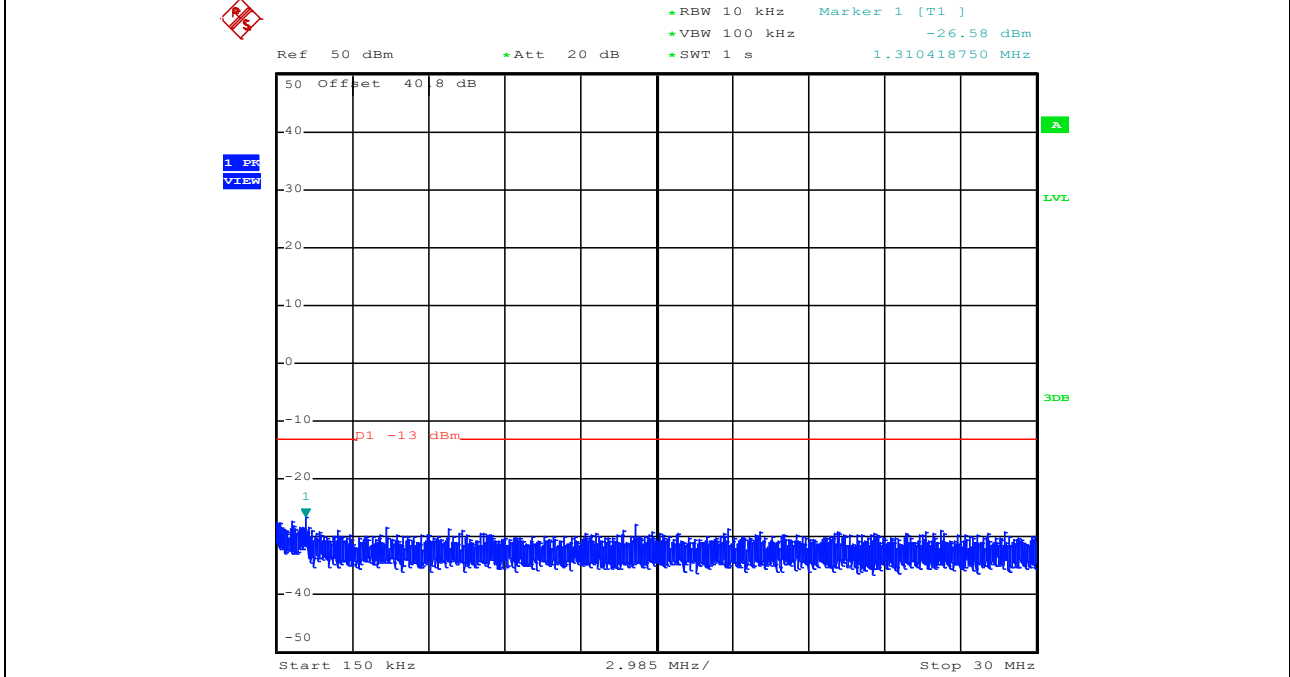

Unless otherwise agreed in writing, this document is issued by the Company subject to its General Conditions of Service printed overleaf, available on request or accessible at <http://www.sgs.com/en/Terms-and-Conditions.aspx> and, for electronic format documents, subject to Terms and Conditions for Electronic Documents at <http://www.sgs.com/en/Terms-and-Conditions/Terms-e-Documents.aspx>. Attention is drawn to the limitation of liability, indemnification and jurisdiction issues defined therein. Any holder of this document is advised that information contained hereon reflects the Company's findings at the time of its intervention only and within the limits of Client's instructions, if any. The Company's sole responsibility is to its Client and this document does not exonerate parties to a transaction from exercising all their rights and obligations under the transaction documents. This document cannot be reproduced except in full, without prior written approval of the Company. Any unauthorized alteration, forgery or falsification of the content or appearance of this document is unlawful and offenders may be prosecuted to the fullest extent of the law. Unless otherwise stated the results shown in this test report refer only to the sample(s) tested and such sample(s) are retained for 30 days only.

**Assigned Frequency:156.650MHz, High Power, Modulation Type: FM, 30MHz-1GHz**

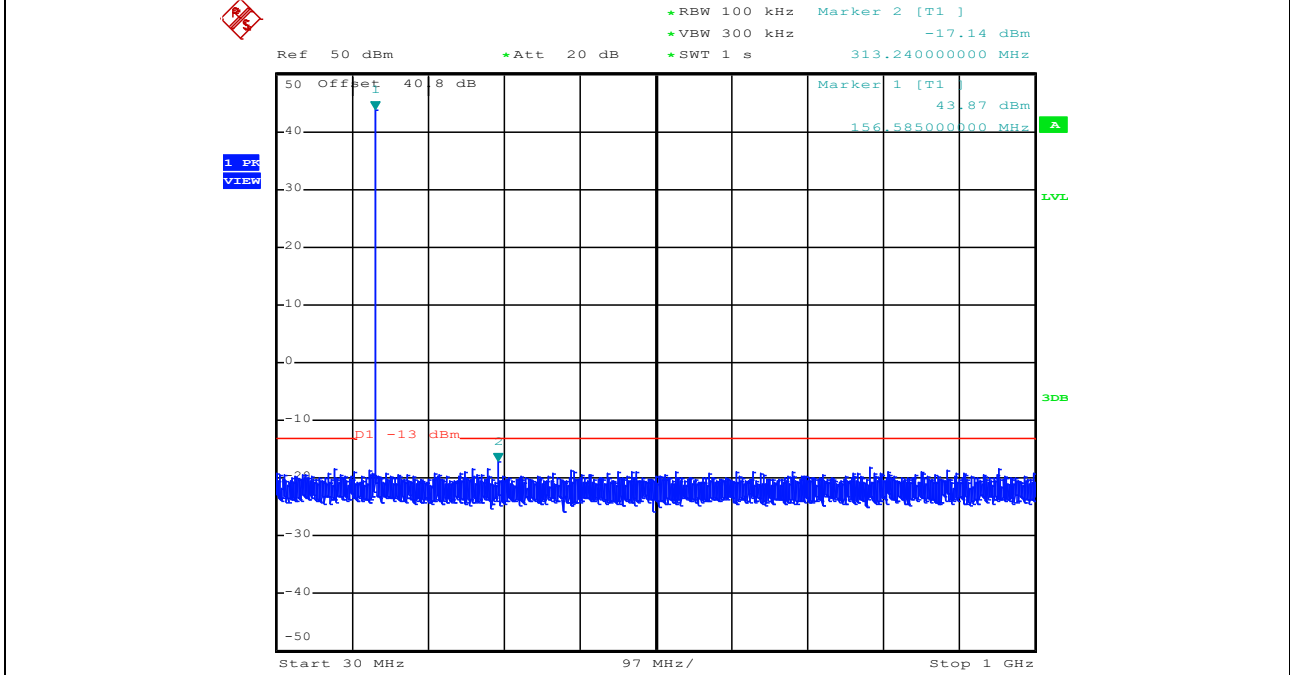

**Assigned Frequency:156.650MHz, High Power, Modulation Type: FM, 1GHz-2GHz**

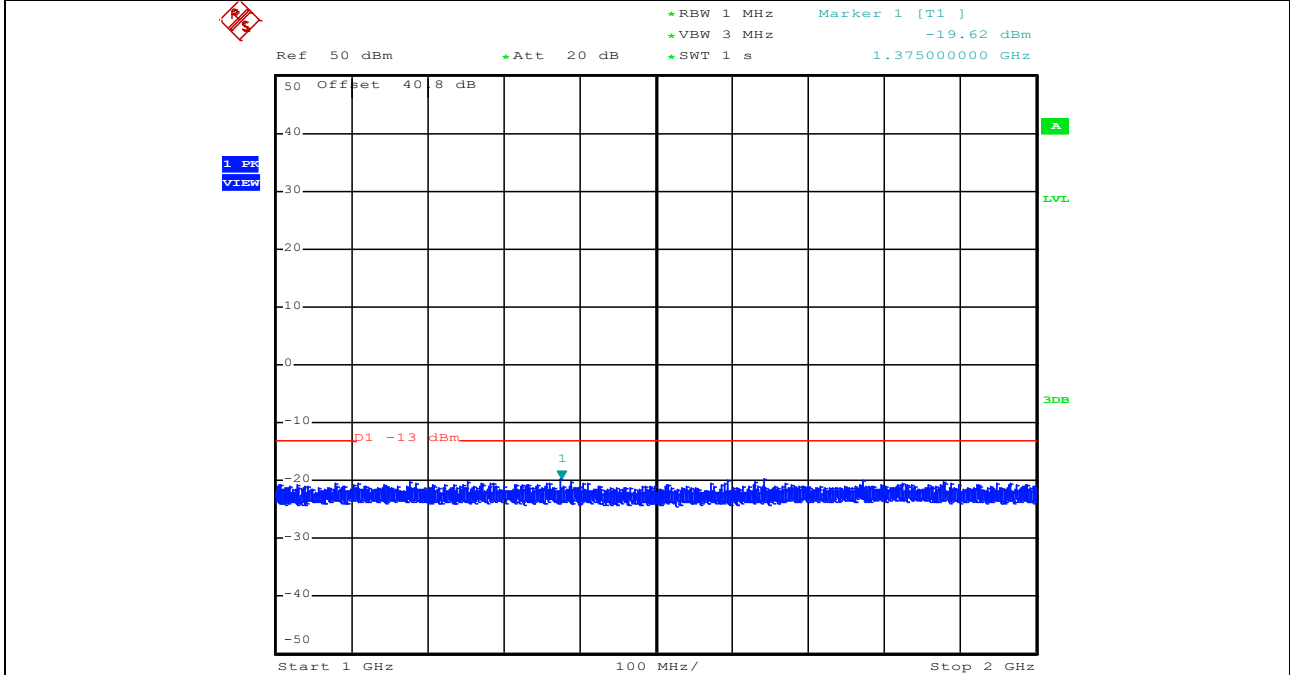

Unless otherwise agreed in writing, this document is issued by the Company subject to its General Conditions of Service printed overleaf, available on request or accessible at <http://www.sgs.com/en/Terms-and-Conditions.aspx> and, for electronic format documents, subject to Terms and Conditions for Electronic Documents at <http://www.sgs.com/en/Terms-and-Conditions/Terms-e-Documents.aspx>. Attention is drawn to the limitation of liability, indemnification and jurisdiction issues defined therein. Any holder of this document is advised that information contained hereon reflects the Company's findings at the time of its intervention only and within the limits of Client's instructions, if any. The Company's sole responsibility is to its Client and this document does not exonerate parties to a transaction from exercising all their rights and obligations under the transaction documents. This document cannot be reproduced except in full, without prior written approval of the Company. Any unauthorized alteration, forgery or falsification of the content or appearance of this document is unlawful and offenders may be prosecuted to the fullest extent of the law. Unless otherwise stated the results shown in this test report refer only to the sample(s) tested and such sample(s) are retained for 30 days only.

Attention: To check the authenticity of testing /inspection report & certificate, please contact us at telephone: (86-755) 8307 1443, or email: [CN.Doccheck@sgs.com](mailto:CN.Doccheck@sgs.com)



Assigned Frequency: 156.800MHz, High Power, Modulation Type: FM, 9KHz-150KHz

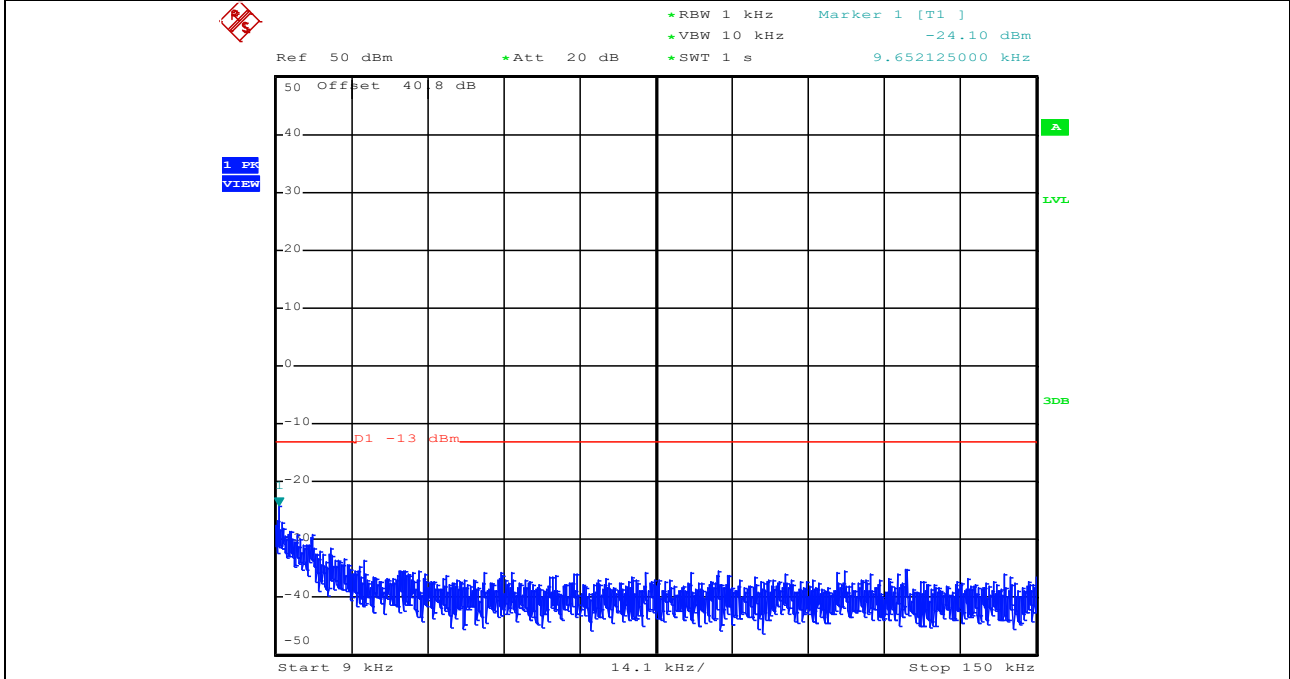

Assigned Frequency: 156.800MHz, High Power, Modulation Type: FM, 150KHz-30MHz

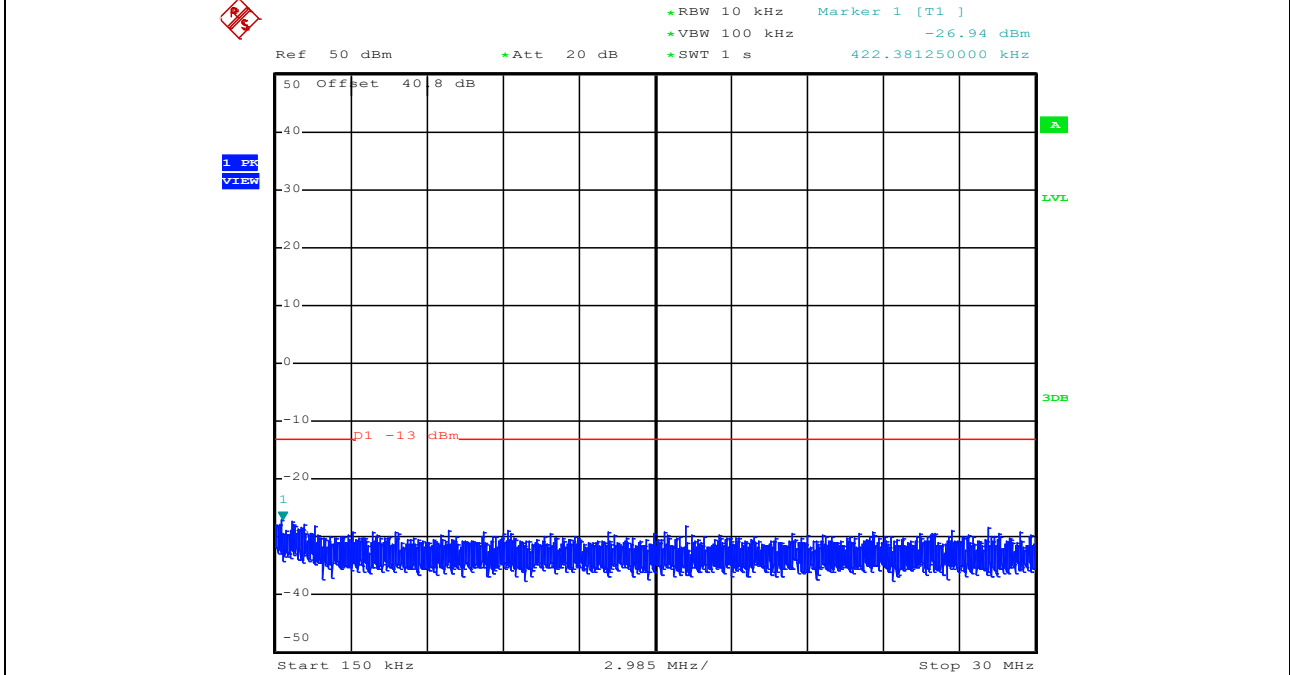

**Assigned Frequency: 156.800MHz, High Power, Modulation Type: FM, 30MHz-1GHz**

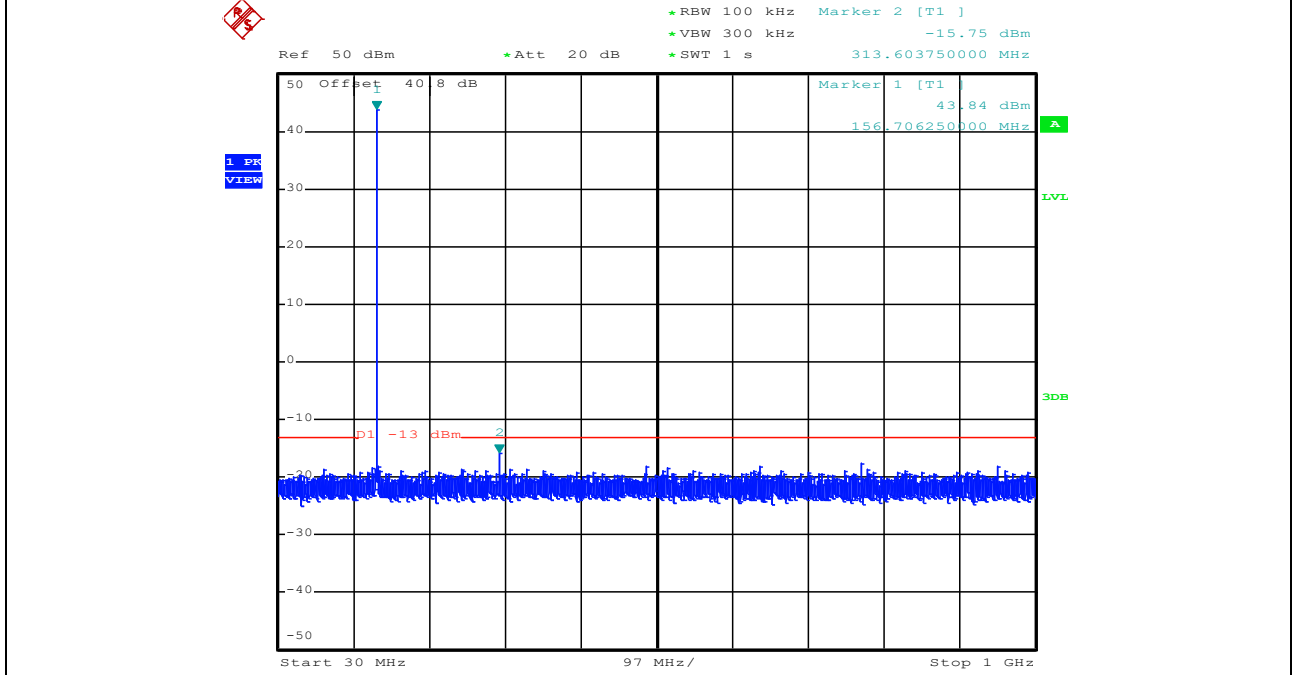

**Assigned Frequency: 156.800MHz, High Power, Modulation Type: FM, 1GHz-2GHz**

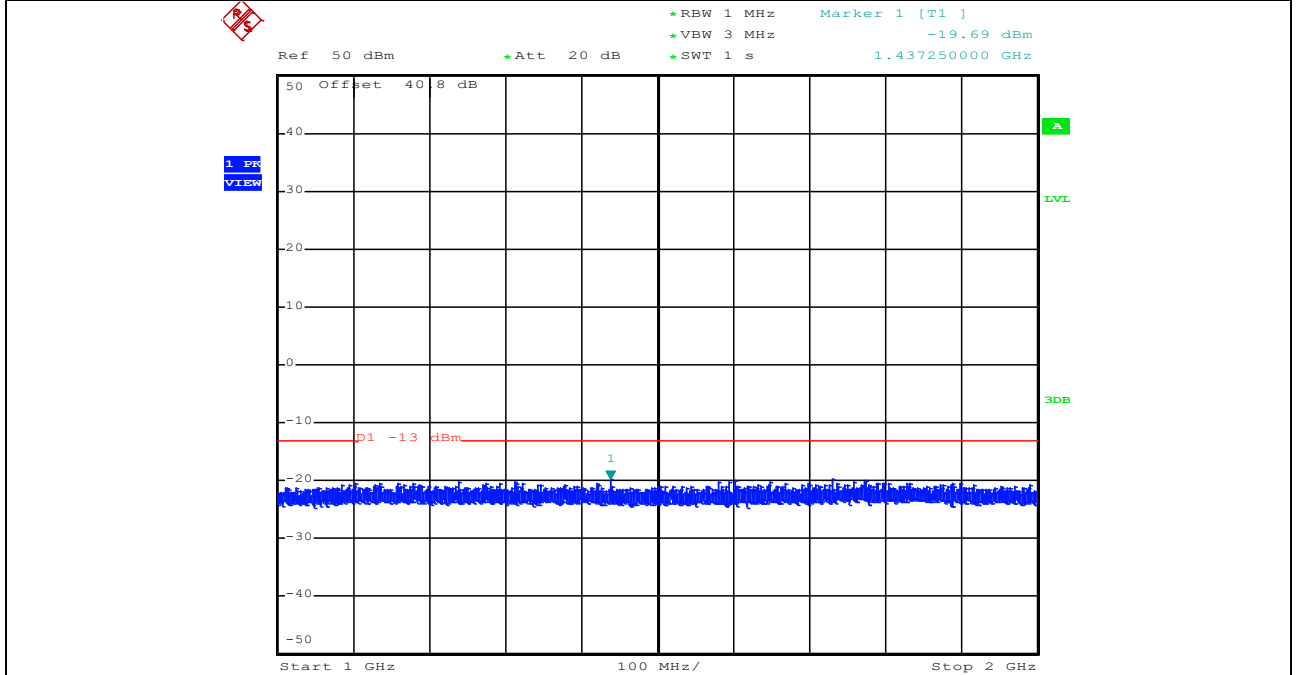

Unless otherwise agreed in writing, this document is issued by the Company subject to its General Conditions of Service printed overleaf, available on request or accessible at <http://www.sgs.com/en/Terms-and-Conditions.aspx> and, for electronic format documents, subject to Terms and Conditions for Electronic Documents at <http://www.sgs.com/en/Terms-and-Conditions/Terms-e-Documents.aspx>. Attention is drawn to the limitation of liability, indemnification and jurisdiction issues defined therein. Any holder of this document is advised that information contained hereon reflects the Company's findings at the time of its intervention only and within the limits of Client's instructions, if any. The Company's sole responsibility is to its Client and this document does not exonerate parties to a transaction from exercising all their rights and obligations under the transaction documents. This document cannot be reproduced except in full, without prior written approval of the Company. Any unauthorized alteration, forgery or falsification of the content or appearance of this document is unlawful and offenders may be prosecuted to the fullest extent of the law. Unless otherwise stated the results shown in this test report refer only to the sample(s) tested and such sample(s) are retained for 30 days only.

Attention: To check the authenticity of testing /inspection report & certificate, please contact us at telephone: (86-755) 8307 1443, or email: [CN.Doccheck@sgs.com](mailto:CN.Doccheck@sgs.com)

Assigned Frequency:156.525MHz, High Power, Modulation Type: FSK, 9KHz-150KHz

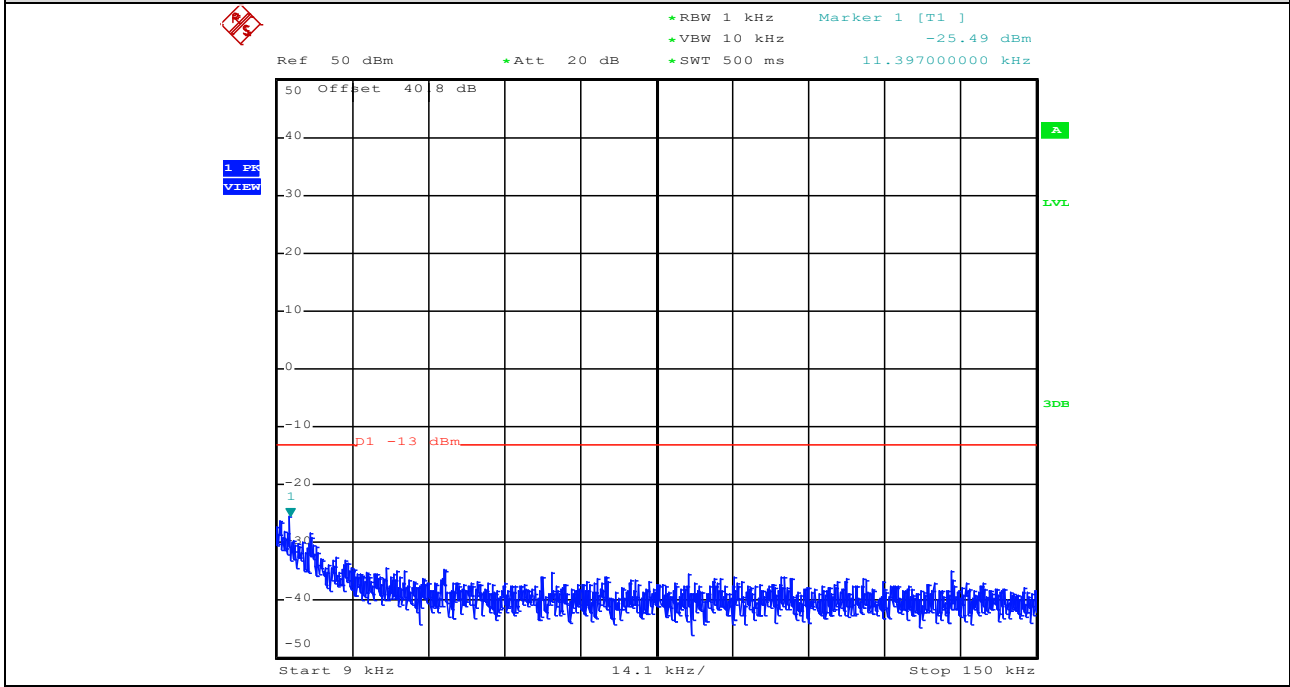

Assigned Frequency:156.525MHz, High Power, Modulation Type: FSK,150KHz-30MHz

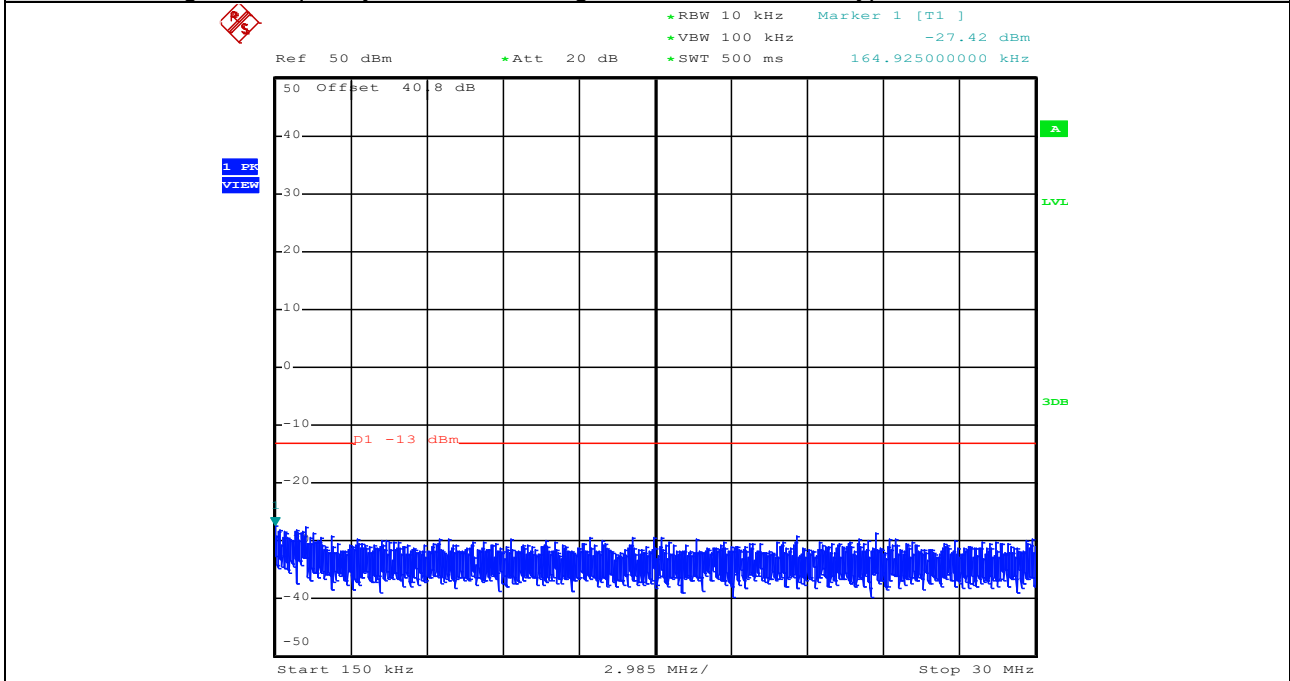

Unless otherwise agreed in writing, this document is issued by the Company subject to its General Conditions of Service printed overleaf, available on request or accessible at <http://www.sgs.com/en/Terms-and-Conditions.aspx> and, for electronic format documents, subject to Terms and Conditions for Electronic Documents at <http://www.sgs.com/en/Terms-and-Conditions/Terms-e-Documents.aspx>. Attention is drawn to the limitation of liability, indemnification and jurisdiction issues defined therein. Any holder of this document is advised that information contained hereon reflects the Company's findings at the time of its intervention only and within the limits of Client's instructions, if any. The Company's sole responsibility is to its Client and this document does not exonerate parties to a transaction from exercising all their rights and obligations under the transaction documents. This document cannot be reproduced except in full, without prior written approval of the Company. Any unauthorized alteration, forgery or falsification of the content or appearance of this document is unlawful and offenders may be prosecuted to the fullest extent of the law. Unless otherwise stated the results shown in this test report refer only to the sample(s) tested and such sample(s) are retained for 30 days only.

Attention: To check the authenticity of testing /inspection report & certificate, please contact us at telephone: (86-755) 8307 1443, or email: [CN.Doccheck@sgs.com](mailto:CN.Doccheck@sgs.com)  
 No.1 Workshop, M-10, Middle Section, Science & Technology Park, Shenzhen, China 518057 t (86-755) 26012053 f (86-755) 26710594 www.sgs.com.cn  
 中国·深圳·科技园中区M-10栋一号厂房 邮编: 518057 t (86-755) 26012053 f (86-755) 26710594 sgs.china@sgs.com

**Assigned Frequency: 156.525MHz, High Power, Modulation Type: FSK, 30MHz-1GHz**

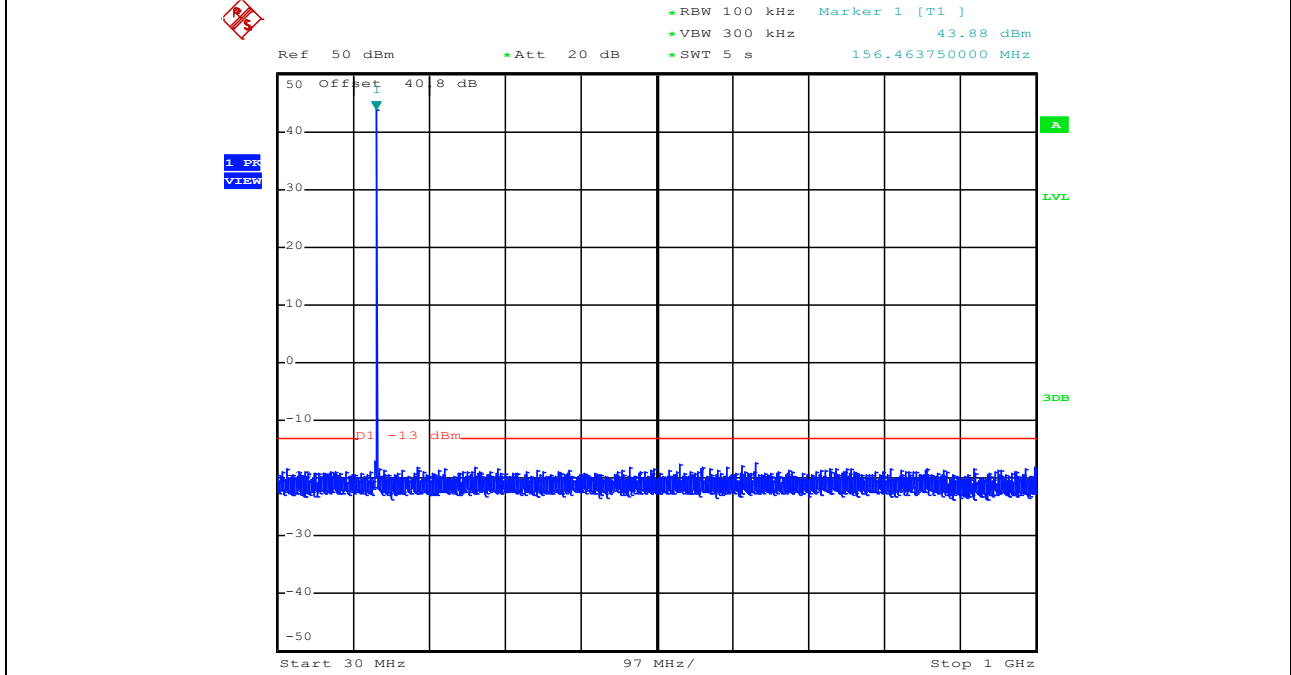

**Assigned Frequency: 156.525MHz, High Power, Modulation Type: FSK, 1GHz-2GHz**

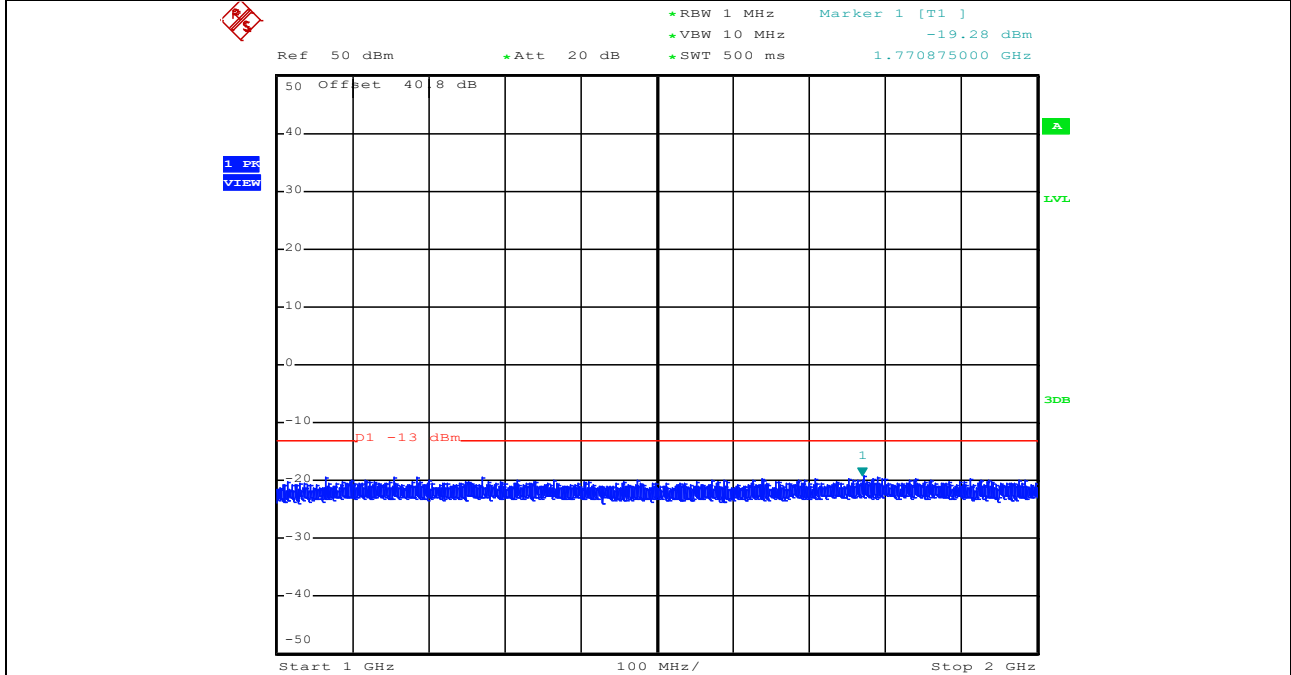

Unless otherwise agreed in writing, this document is issued by the Company subject to its General Conditions of Service printed overleaf, available on request or accessible at <http://www.sgs.com/en/Terms-and-Conditions.aspx> and, for electronic format documents, subject to Terms and Conditions for Electronic Documents at <http://www.sgs.com/en/Terms-and-Conditions/Terms-e-Documents.aspx>. Attention is drawn to the limitation of liability, indemnification and jurisdiction issues defined therein. Any holder of this document is advised that information contained hereon reflects the Company's findings at the time of its intervention only and within the limits of Client's instructions, if any. The Company's sole responsibility is to its Client and this document does not exonerate parties to a transaction from exercising all their rights and obligations under the transaction documents. This document cannot be reproduced except in full, without prior written approval of the Company. Any unauthorized alteration, forgery or falsification of the content or appearance of this document is unlawful and offenders may be prosecuted to the fullest extent of the law. Unless otherwise stated the results shown in this test report refer only to the sample(s) tested and such sample(s) are retained for 30 days only.

**Assigned Frequency:157.425MHz, High Power, Modulation Type: FM, 9KHz-150KHz**

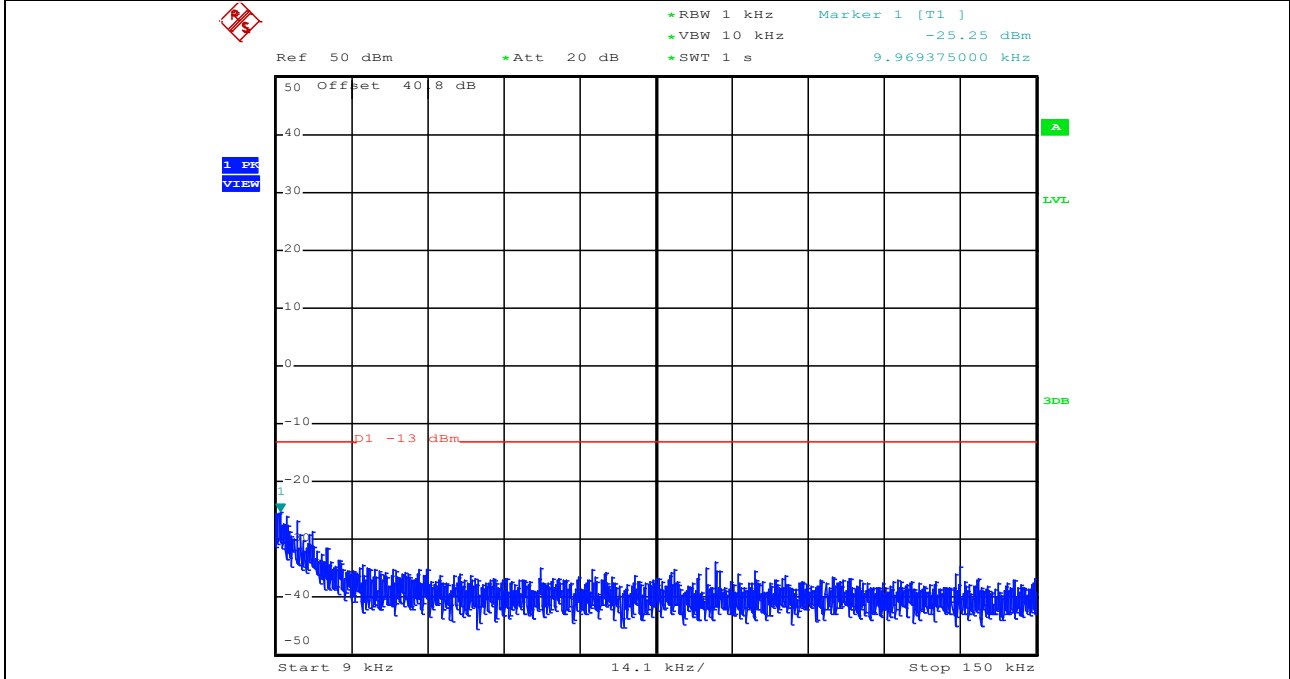

**Assigned Frequency:157.425MHz, High Power, Modulation Type: FM, 150KHz-30MHz**

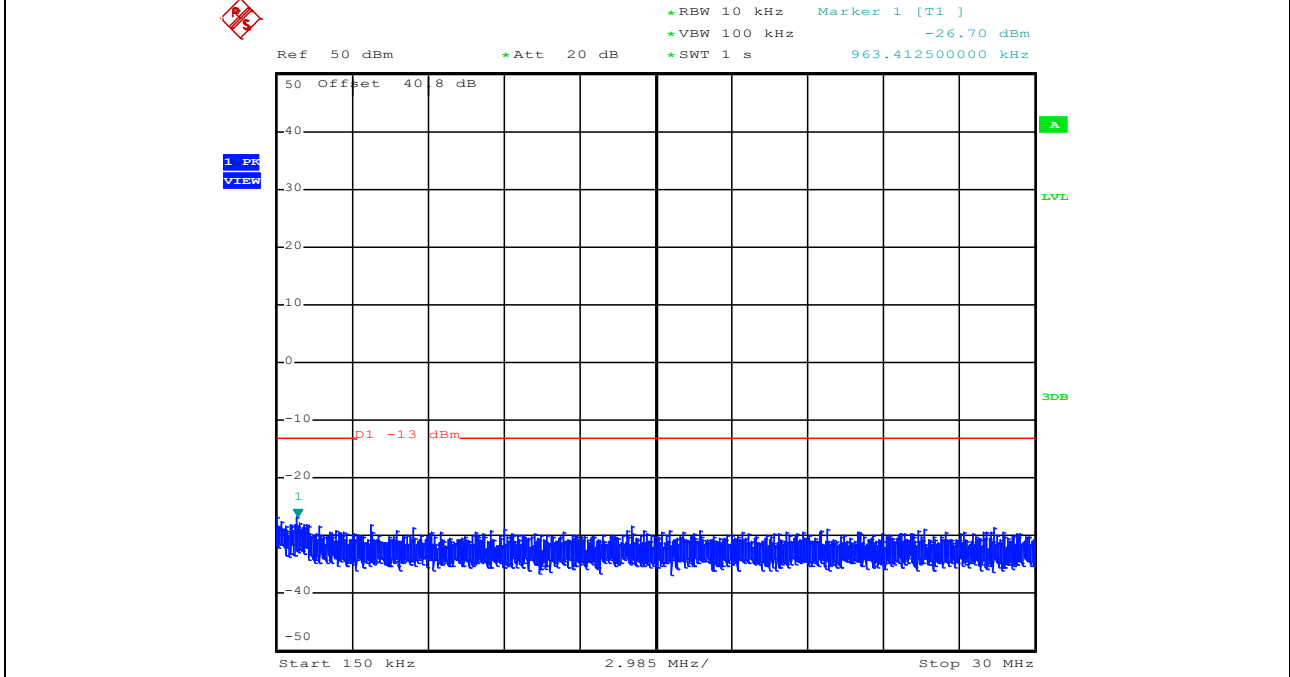

Unless otherwise agreed in writing, this document is issued by the Company subject to its General Conditions of Service printed overleaf, available on request or accessible at <http://www.sgs.com/en/Terms-and-Conditions.aspx> and, for electronic format documents, subject to Terms and Conditions for Electronic Documents at <http://www.sgs.com/en/Terms-and-Conditions/Terms-e-Documents.aspx>. Attention is drawn to the limitation of liability, indemnification and jurisdiction issues defined therein. Any holder of this document is advised that information contained hereon reflects the Company's findings at the time of its intervention only and within the limits of Client's instructions, if any. The Company's sole responsibility is to its Client and this document does not exonerate parties to a transaction from exercising all their rights and obligations under the transaction documents. This document cannot be reproduced except in full, without prior written approval of the Company. Any unauthorized alteration, forgery or falsification of the content or appearance of this document is unlawful and offenders may be prosecuted to the fullest extent of the law. Unless otherwise stated the results shown in this test report refer only to the sample(s) tested and such sample(s) are retained for 30 days only.

**Attention:** To check the authenticity of testing /inspection report & certificate, please contact us at telephone: (86-755) 8307 1443, or email: [CN.Doccheck@sgs.com](mailto:CN.Doccheck@sgs.com)  
 No.1 Workshop, M-10, Middle Section, Science & Technology Park, Shenzhen, China 518057 t (86-755) 26012053 f (86-755) 26710594 www.sgs.com  
 中国·深圳·科技园中区M-10栋一号厂房 邮编: 518057 t (86-755) 26012053 f (86-755) 26710594 sgs.china@sgs.com

**Assigned Frequency:157.425MHz, High Power, Modulation Type: FM, 30MHz-1GHz**

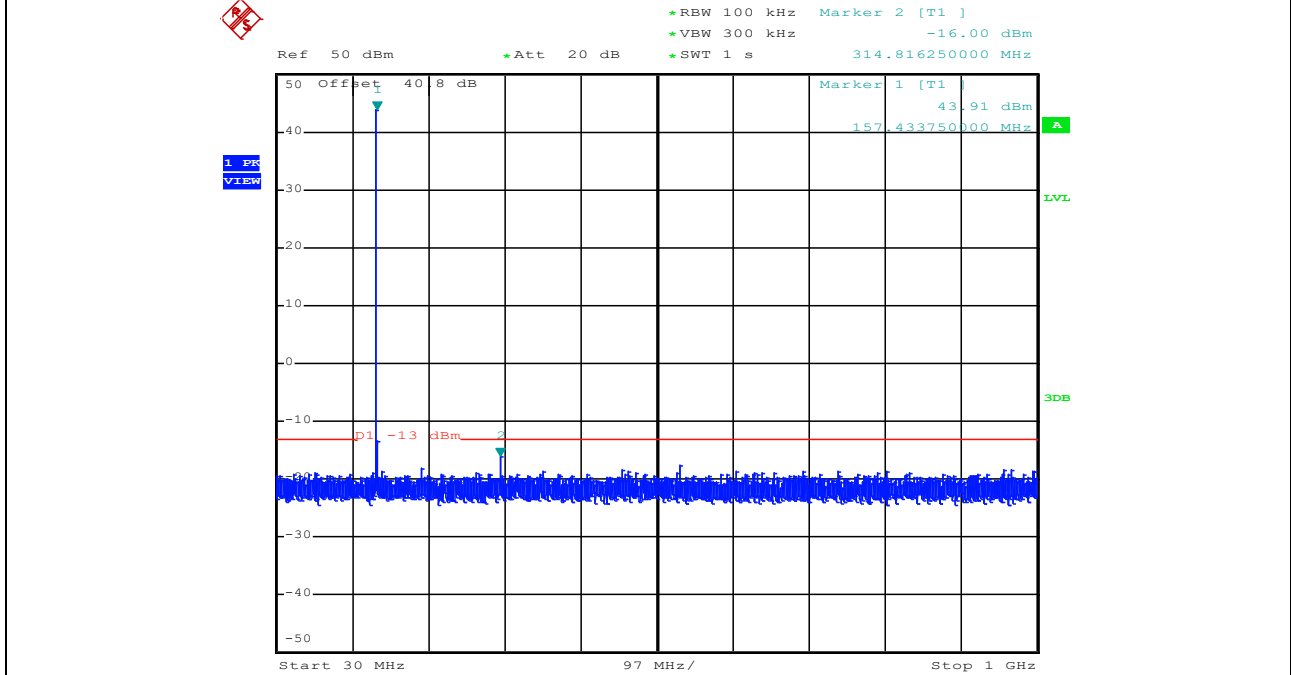

**Assigned Frequency:157.425MHz, High Power, Modulation Type: FM, 1GHz-2GHz**

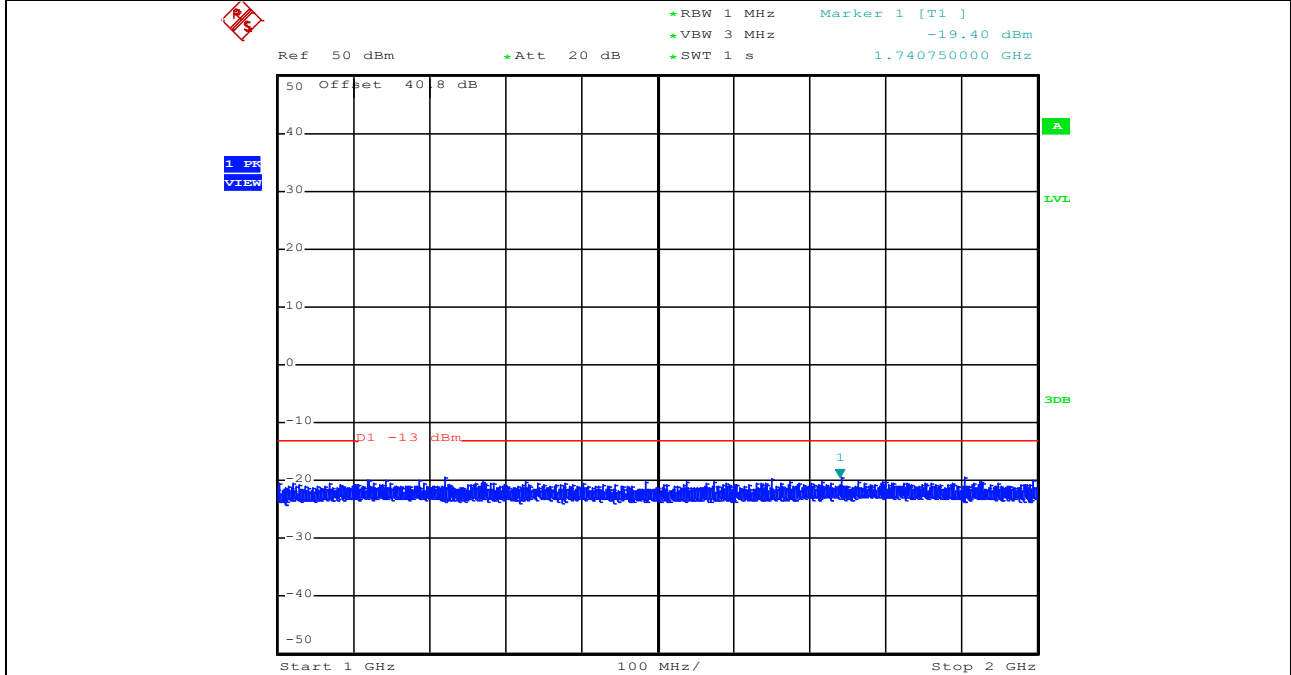

Unless otherwise agreed in writing, this document is issued by the Company subject to its General Conditions of Service printed overleaf, available on request or accessible at <http://www.sgs.com/en/Terms-and-Conditions.aspx> and, for electronic format documents, subject to Terms and Conditions for Electronic Documents at <http://www.sgs.com/en/Terms-and-Conditions/Terms-e-Documents.aspx>. Attention is drawn to the limitation of liability, indemnification and jurisdiction issues defined therein. Any holder of this document is advised that information contained hereon reflects the Company's findings at the time of its intervention only and within the limits of Client's instructions, if any. The Company's sole responsibility is to its Client and this document does not exonerate parties to a transaction from exercising all their rights and obligations under the transaction documents. This document cannot be reproduced except in full, without prior written approval of the Company. Any unauthorized alteration, forgery or falsification of the content or appearance of this document is unlawful and offenders may be prosecuted to the fullest extent of the law. Unless otherwise stated the results shown in this test report refer only to the sample(s) tested and such sample(s) are retained for 30 days only.

Attention: To check the authenticity of testing /inspection report & certificate, please contact us at telephone: (86-755) 8307 1443, or email: [CN.Doccheck@sgs.com](mailto:CN.Doccheck@sgs.com)

No.1 Workshop, M-10, Middle Section, Science & Technology Park, Shenzhen, China 518057 t (86-755) 26012053 f (86-755) 26710594 www.sgs.com.cn  
 中国·深圳·科技园中区M-10栋一号厂房 邮编: 518057 t (86-755) 26012053 f (86-755) 26710594 sgs.china@sgs.com

Assigned Frequency:162.025MHz, Modulation Type: GMSK, 9KHz-150KHz

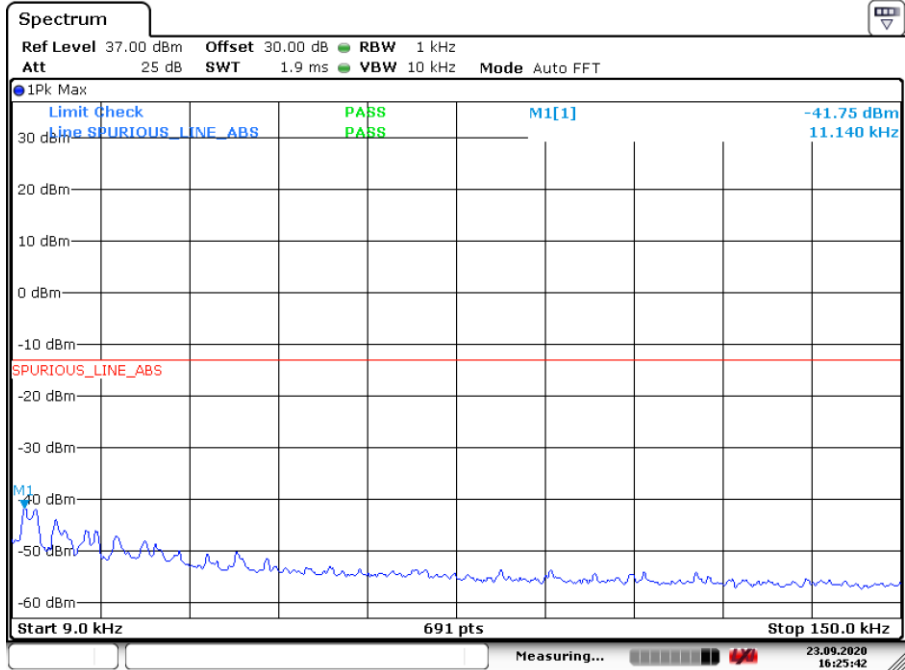

Assigned Frequency:162.025MHz, Modulation Type: GMSK, 150KHz-30MHz

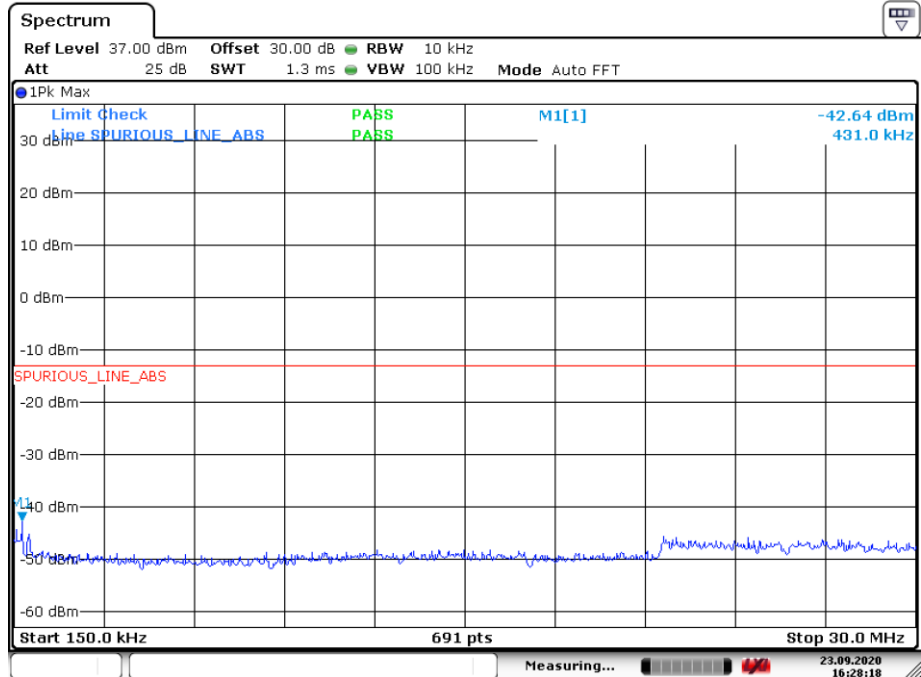

Unless otherwise agreed in writing, this document is issued by the Company subject to its General Conditions of Service printed overleaf, available on request or accessible at <http://www.sgs.com/en/Terms-and-Conditions.aspx> and, for electronic format documents, subject to Terms and Conditions for Electronic Documents at <http://www.sgs.com/en/Terms-and-Conditions/Terms-e-Documents.aspx>. Attention is drawn to the limitation of liability, indemnification and jurisdiction issues defined therein. Any holder of this document is advised that information contained hereon reflects the Company's findings at the time of its intervention only and within the limits of Client's instructions, if any. The Company's sole responsibility is to its Client and this document does not exonerate parties to a transaction from exercising all their rights and obligations under the transaction documents. This document cannot be reproduced except in full, without prior written approval of the Company. Any unauthorized alteration, forgery or falsification of the content or appearance of this document is unlawful and offenders may be prosecuted to the fullest extent of the law. Unless otherwise stated the results shown in this test report refer only to the sample(s) tested and such sample(s) are retained for 30 days only.

Assigned Frequency: 162.025MHz, Modulation Type: GMSK, 30MHz-1GHz

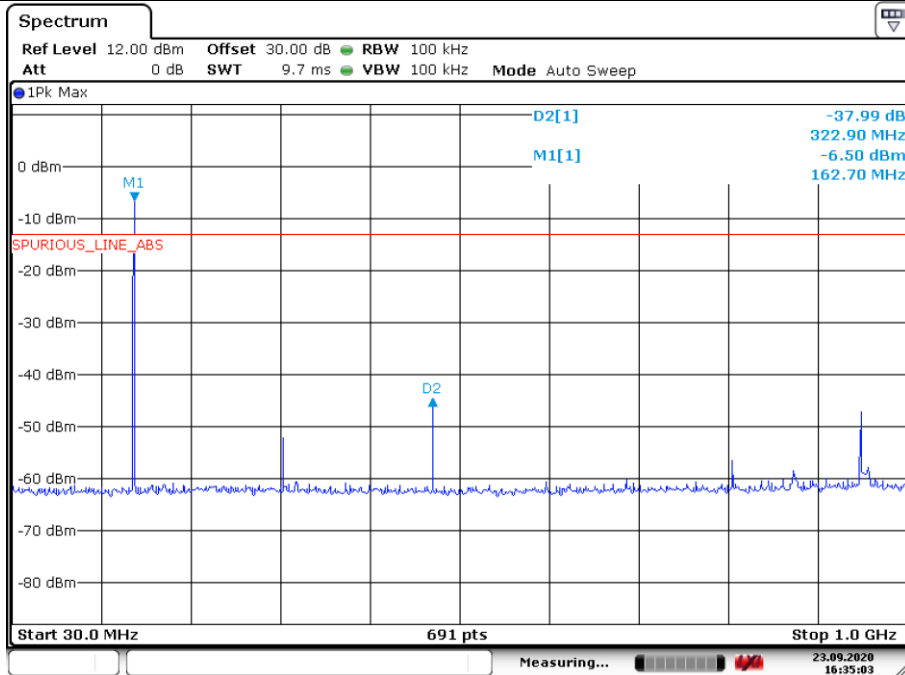

Assigned Frequency: 162.025MHz, Modulation Type: GMSK, 1GHz-2GHz

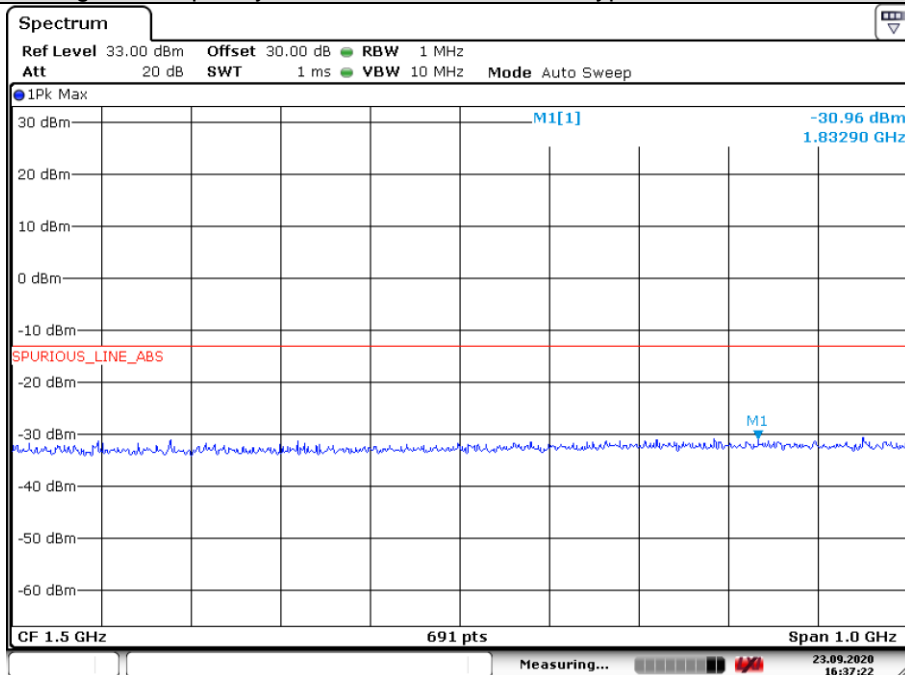

Unless otherwise agreed in writing, this document is issued by the Company subject to its General Conditions of Service printed overleaf, available on request or accessible at <http://www.sgs.com/en/Terms-and-Conditions.aspx> and, for electronic format documents, subject to Terms and Conditions for Electronic Documents at <http://www.sgs.com/en/Terms-and-Conditions/Terms-e-Documents.aspx>. Attention is drawn to the limitation of liability, indemnification and jurisdiction issues defined therein. Any holder of this document is advised that information contained hereon reflects the Company's findings at the time of its intervention only and within the limits of Client's instructions, if any. The Company's sole responsibility is to its Client and this document does not exonerate parties to a transaction from exercising all their rights and obligations under the transaction documents. This document cannot be reproduced except in full, without prior written approval of the Company. Any unauthorized alteration, forgery or falsification of the content or appearance of this document is unlawful and offenders may be prosecuted to the fullest extent of the law. Unless otherwise stated the results shown in this test report refer only to the sample(s) tested and such sample(s) are retained for 30 days only.



**5. Transmitter Unwanted Emission(Radiated)**

Assigned Frequency:156.025MHz, Modulation Type: FM								
Frequency (MHz)	S.G. Power (dBm)	Cable loss (dB)	Antenna Gain(dBi)	EIRP (dBm)	Limit (dBm)	Over Limit(dB)	Polarization (H/V)	Result
1248.20	-53.95	0.43	1.9	-52.48	-13.00	-39.48	Horizontal	Pass
1404.23	-52.64	0.43	1.9	-51.17	-13.00	-38.17	Horizontal	Pass
1560.25	-56.7	0.52	6	-51.22	-13.00	-38.22	Horizontal	Pass
1248.20	-51.51	0.43	1.9	-50.04	-13.00	-37.04	Vertical	Pass
1404.23	-46.91	0.43	1.9	-45.44	-13.00	-32.44	Vertical	Pass
1560.25	-53.02	0.52	6	-47.54	-13.00	-34.54	Vertical	Pass

Assigned Frequency:162.025MHz, Modulation Type: GMSK								
Frequency (MHz)	S.G. Power (dBm)	Cable loss (dB)	Antenna Gain(dBi)	EIRP (dBm)	Limit (dBm)	Over Limit(dB)	Polarization (H/V)	Result
1296.20	-53.22	0.43	1.9	-51.75	-13	-38.75	Horizontal	Pass
1458.23	-52.01	0.43	1.9	-50.54	-13	-37.54	Horizontal	Pass
1620.25	-56.25	0.52	6	-50.77	-13	-37.77	Horizontal	Pass
1296.20	-51.59	0.43	1.9	-50.12	-13	-37.12	Vertical	Pass
1458.23	-45.22	0.43	1.9	-43.75	-13	-30.75	Vertical	Pass
1620.25	-49.99	0.52	6	-44.51	-13	-31.51	Vertical	Pass

Assigned Frequency:156.525MHz, Modulation Type: FSK								
Frequency (MHz)	S.G. Power (dBm)	Cable loss (dB)	Antenna Gain(dBi)	EIRP (dBm)	Limit (dBm)	Over Limit(dB)	Polarization (H/V)	Result
1252.20	-52.51	0.43	1.9	-51.04	-13	-38.04	Horizontal	Pass
1408.73	-51.91	0.43	1.9	-50.44	-13	-37.44	Horizontal	Pass
1565.25	-55.26	0.52	6	-49.78	-13	-36.78	Horizontal	Pass
1252.20	-49.91	0.43	1.9	-48.44	-13	-35.44	Vertical	Pass
1408.73	-47.06	0.43	1.9	-45.59	-13	-32.59	Vertical	Pass
1565.25	-50.36	0.52	6	-44.88	-13	-31.88	Vertical	Pass

Note: All modes and modulation have been tested and we found the three frequencies shown above has the worst test result. Only record the worst test result.



Unless otherwise agreed in writing, this document is issued by the Company subject to its General Conditions of Service printed overleaf, available on request or accessible at <http://www.sgs.com/en/Terms-and-Conditions.aspx> and, for electronic format documents, subject to Terms and Conditions for Electronic Documents at <http://www.sgs.com/en/Terms-and-Conditions/Terms-e-Documents.aspx>. Attention is drawn to the limitation of liability, indemnification and jurisdiction issues defined therein. Any holder of this document is advised that information contained hereon reflects the Company's findings at the time of its intervention only and within the limits of Client's instructions, if any. The Company's sole responsibility is to its Client and this document does not exonerate parties to a transaction from exercising all their rights and obligations under the transaction documents. This document cannot be reproduced except in full, without prior written approval of the Company. Any unauthorized alteration, forgery or falsification of the content or appearance of this document is unlawful and offenders may be prosecuted to the fullest extent of the law. Unless otherwise stated the results shown in this test report refer only to the sample(s) tested and such sample(s) are retained for 30 days only.

Attention: To check the authenticity of testing / inspection report & certificate, please contact us at telephone: (86-755) 8307 1443, or email: [CN.Doccheck@sgs.com](mailto:CN.Doccheck@sgs.com)  
 No.1 Workshop, M-10, Middle Section, Science & Technology Park, Shenzhen, China 518057 t (86-755) 26012053 f (86-755) 26710594 www.sgs.com.cn  
 中国·深圳·科技园中区M-10栋一号厂房 邮编: 518057 t (86-755) 26012053 f (86-755) 26710594 sgs.china@sgs.com

**6. Modulation Characteristics**

Test Frequency (MHz)	Modulation Frequency (Hz)	Upper Limit	Lower Limit	Modulation Index(dB) Relative. To 1KHz	Verdict
156.025	300	-9.5	-13.5	-13.1	Pass
	500	-5	-9	-8.2	Pass
	800	-0.9	-4.9	-2.1	Pass
	1000	1	-3	0	Pass
	1500	4.5	0.5	+2.8	Pass
	1800	6.1	2.1	+4.7	Pass
	2000	7	3	+6.2	Pass
	2500	9	5	+7.8	Pass
	3000	10.5	6.5	+9.2	Pass
156.525	300	-9.5	-13.5	-13	Pass
	500	-5	-9	-8.1	Pass
	800	-0.9	-4.9	-1.9	Pass
	1000	1	-3	0	Pass
	1500	4.5	0.5	+2.6	Pass
	1800	6.1	2.1	+4.7	Pass
	2000	7	3	+6	Pass
	2500	9	5	+7.5	Pass
	3000	10.5	6.5	+9	Pass



Unless otherwise agreed in writing, this document is issued by the Company subject to its General Conditions of Service printed overleaf, available on request or accessible at <http://www.sgs.com/en/Terms-and-Conditions.aspx> and, for electronic format documents, subject to Terms and Conditions for Electronic Documents at <http://www.sgs.com/en/Terms-and-Conditions/Terms-e-Documents.aspx>. Attention is drawn to the limitation of liability, indemnification and jurisdiction issues defined therein. Any holder of this document is advised that information contained hereon reflects the Company's findings at the time of its intervention only and within the limits of Client's instructions, if any. The Company's sole responsibility is to its Client and this document does not exonerate parties to a transaction from exercising all their rights and obligations under the transaction documents. This document cannot be reproduced except in full, without prior written approval of the Company. Any unauthorized alteration, forgery or falsification of the content or appearance of this document is unlawful and offenders may be prosecuted to the fullest extent of the law. Unless otherwise stated the results shown in this test report refer only to the sample(s) tested and such sample(s) are retained for 30 days only.

Test Frequency (MHz)	Modulation Frequency (Hz)	Input level	Maximum Deviation(KHz)		Limit (KHz)	Verdict
			High Power	Low Power		
156.025	100	20dB 3KHz	1.2	1.2	≤5.0	Pass
	200	20dB 3KHz	3.3	3.1	≤5.0	Pass
	300	20dB 3KHz	4.2	4.2	≤5.0	Pass
	400	20dB 3KHz	4.0	4.0	≤5.0	Pass
	500	20dB 3KHz	4.3	4.3	≤5.0	Pass
	1000	20dB 3KHz	4.1	4.1	≤5.0	Pass
	1500	20dB 3KHz	3.85	3.85	≤5.0	Pass
	2000	20dB 3KHz	4.1	4.1	≤5.0	Pass
	2500	20dB 3KHz	4.5	4.5	≤5.0	Pass
	3000	20dB 3KHz	4.3	4.2	≤5.0	Pass
156.525	100	20dB 3KHz	1.2	1.3	≤5.0	Pass
	200	20dB 3KHz	3.2	3.2	≤5.0	Pass
	300	20dB 3KHz	4.25	4.2	≤5.0	Pass
	400	20dB 3KHz	4	4.1	≤5.0	Pass
	500	20dB 3KHz	4.3	4.26	≤5.0	Pass
	1000	20dB 3KHz	4.15	4.15	≤5.0	Pass
	1500	20dB 3KHz	3.9	3.9	≤5.0	Pass
	2000	20dB 3KHz	4.15	4.1	≤5.0	Pass
	2500	20dB 3KHz	4.45	4.4	≤5.0	Pass
	3000	20dB 3KHz	4.2	4.3	≤5.0	Pass



Unless otherwise agreed in writing, this document is issued by the Company subject to its General Conditions of Service printed overleaf, available on request or accessible at <http://www.sgs.com/en/Terms-and-Conditions.aspx> and, for electronic format documents, subject to Terms and Conditions for Electronic Documents at <http://www.sgs.com/en/Terms-and-Conditions/Terms-e-Documents.aspx>. Attention is drawn to the limitation of liability, indemnification and jurisdiction issues defined therein. Any holder of this document is advised that information contained hereon reflects the Company's findings at the time of its intervention only and within the limits of Client's instructions, if any. The Company's sole responsibility is to its Client and this document does not exonerate parties to a transaction from exercising all their rights and obligations under the transaction documents. This document cannot be reproduced except in full, without prior written approval of the Company. Any unauthorized alteration, forgery or falsification of the content or appearance of this document is unlawful and offenders may be prosecuted to the fullest extent of the law. Unless otherwise stated the results shown in this test report refer only to the sample(s) tested and such sample(s) are retained for 30 days only.

Assigned Frequency: 156.025MHz, High Power, Modulation Type: FM

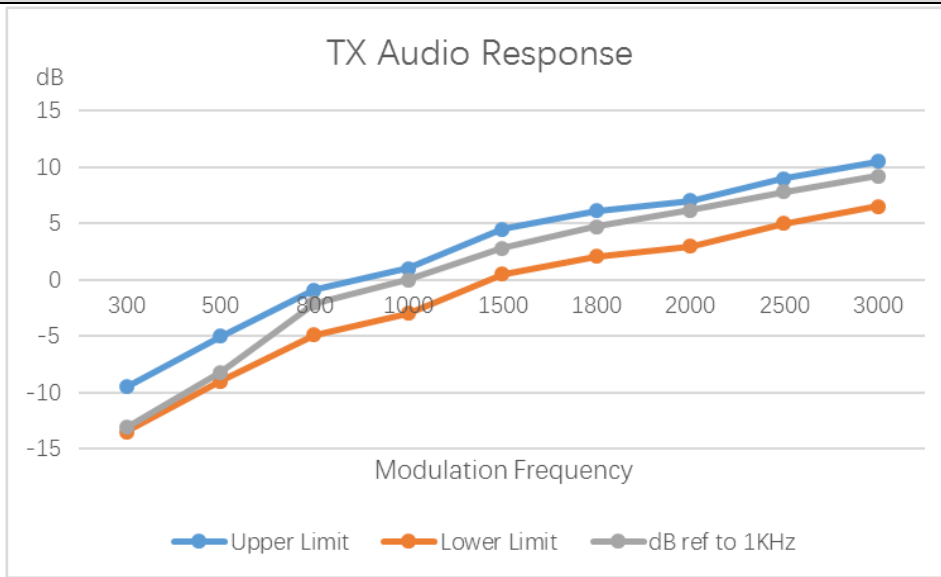

Assigned Frequency: 156.025MHz, High Power, Modulation Type: FM

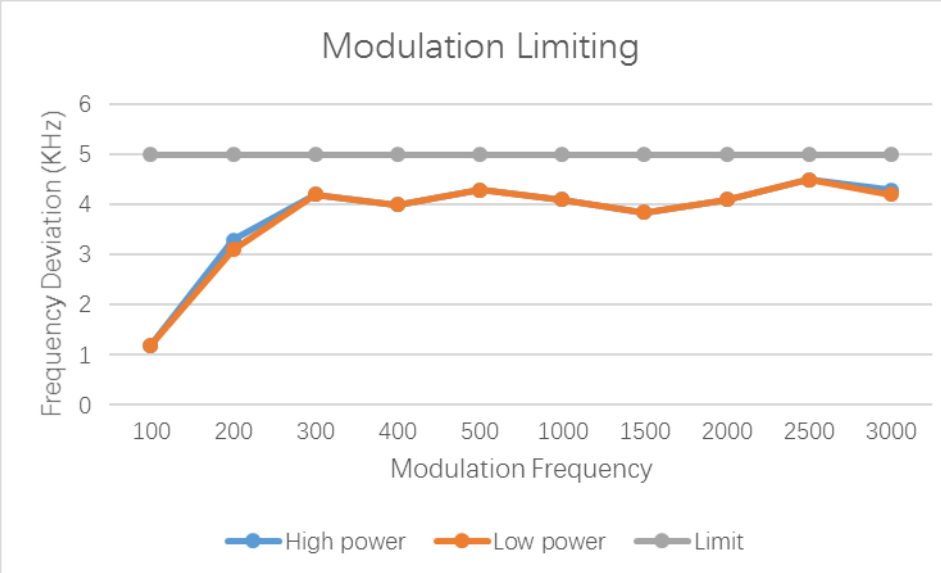

Unless otherwise agreed in writing, this document is issued by the Company subject to its General Conditions of Service printed overleaf, available on request or accessible at <http://www.sgs.com/en/Terms-and-Conditions.aspx> and, for electronic format documents, subject to Terms and Conditions for Electronic Documents at <http://www.sgs.com/en/Terms-and-Conditions/Terms-e-Documents.aspx>. Attention is drawn to the limitation of liability, indemnification and jurisdiction issues defined therein. Any holder of this document is advised that information contained hereon reflects the Company's findings at the time of its intervention only and within the limits of Client's instructions, if any. The Company's sole responsibility is to its Client and this document does not exonerate parties to a transaction from exercising all their rights and obligations under the transaction documents. This document cannot be reproduced except in full, without prior written approval of the Company. Any unauthorized alteration, forgery or falsification of the content or appearance of this document is unlawful and offenders may be prosecuted to the fullest extent of the law. Unless otherwise stated the results shown in this test report refer only to the sample(s) tested and such sample(s) are retained for 30 days only.

Attention: To check the authenticity of testing / inspection report & certificate, please contact us at telephone: (86-755) 8307 1443, or email: [CN.Doccheck@sgs.com](mailto:CN.Doccheck@sgs.com)

Assigned Frequency:156.525MHz, Modulation Type: FSK

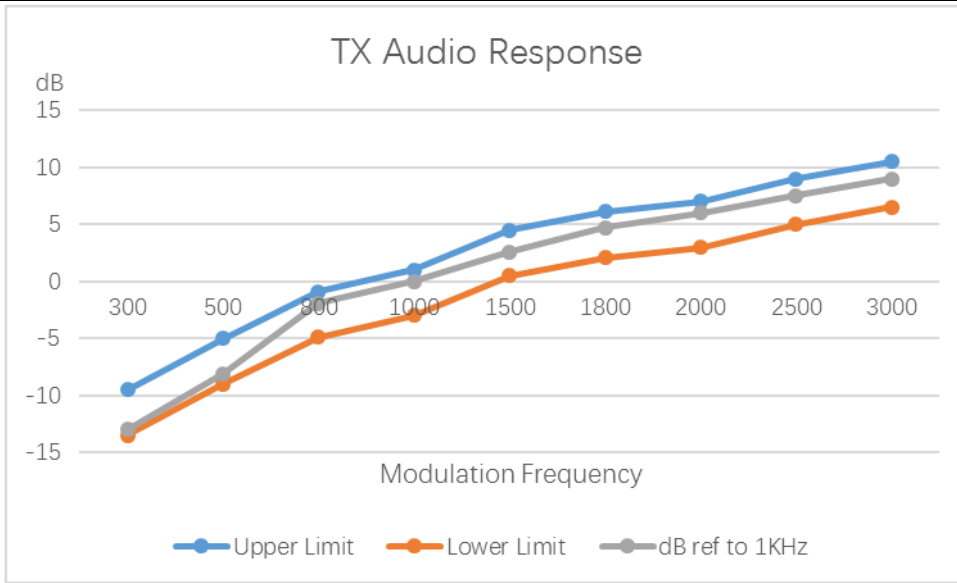

Assigned Frequency:156.525MHz, Modulation Type: FSK

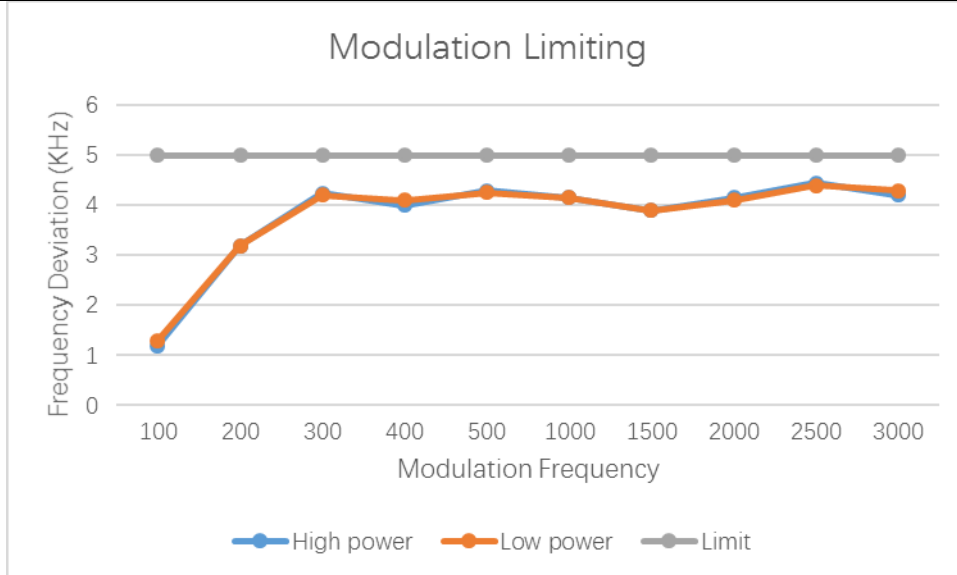

Unless otherwise agreed in writing, this document is issued by the Company subject to its General Conditions of Service printed overleaf, available on request or accessible at <http://www.sgs.com/en/Terms-and-Conditions.aspx> and, for electronic format documents, subject to Terms and Conditions for Electronic Documents at <http://www.sgs.com/en/Terms-and-Conditions/Terms-e-Documents.aspx>. Attention is drawn to the limitation of liability, indemnification and jurisdiction issues defined therein. Any holder of this document is advised that information contained hereon reflects the Company's findings at the time of its intervention only and within the limits of Client's instructions, if any. The Company's sole responsibility is to its Client and this document does not exonerate parties to a transaction from exercising all their rights and obligations under the transaction documents. This document cannot be reproduced except in full, without prior written approval of the Company. Any unauthorized alteration, forgery or falsification of the content or appearance of this document is unlawful and offenders may be prosecuted to the fullest extent of the law. Unless otherwise stated the results shown in this test report refer only to the sample(s) tested and such sample(s) are retained for 30 days only.

**Low Pass Filter Response**

Assigned Frequency:156.025MHz, High Power, Modulation Type: FM		
Audio Frequency(KHz)	ResponseAttenuation(dB)	Limit (dB)
1	0	/
3	-14.5	0
4	-23.2	-7.5
5	-28.6	-13.3
6	-41	-18.1
7	-41.9	-22.1
8	-47	-25.6
9	-53.4	-28.6
10	-56.5	-31.4
15	-60	-41.9
20	-69.5	-50.0
30	-71	-50.0
40	-75.2	-50.0
50	-79.5	-50.0
60	-80.2	-50.0
70	-85	-50.0

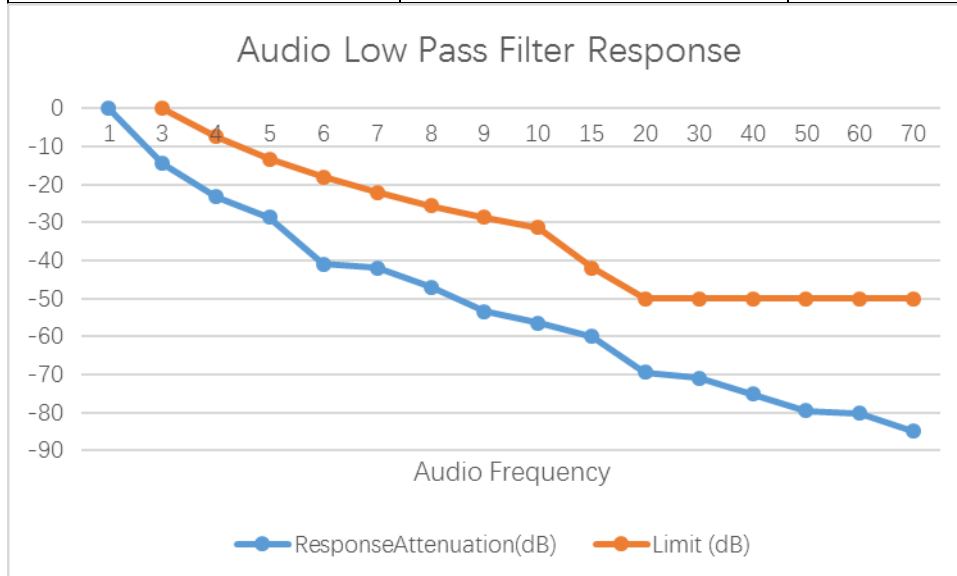

Unless otherwise agreed in writing, this document is issued by the Company subject to its General Conditions of Service printed overleaf, available on request or accessible at <http://www.sgs.com/en/Terms-and-Conditions.aspx> and, for electronic format documents, subject to Terms and Conditions for Electronic Documents at <http://www.sgs.com/en/Terms-and-Conditions/Terms-e-Documents.aspx>. Attention is drawn to the limitation of liability, indemnification and jurisdiction issues defined therein. Any holder of this document is advised that information contained hereon reflects the Company's findings at the time of its intervention only and within the limits of Client's instructions, if any. The Company's sole responsibility is to its Client and this document does not exonerate parties to a transaction from exercising all their rights and obligations under the transaction documents. This document cannot be reproduced except in full, without prior written approval of the Company. Any unauthorized alteration, forgery or falsification of the content or appearance of this document is unlawful and offenders may be prosecuted to the fullest extent of the law. Unless otherwise stated the results shown in this test report refer only to the sample(s) tested and such sample(s) are retained for 30 days only.

Assigned Frequency:156.525MHz, High Power, Modulation Type: FSK		
Audio Frequency(KHz)	ResponseAttenuation(dB)	Limit (dB)
1	0	/
3	-14.3	0
4	-23	-7.5
5	-28.4	-13.3
6	-41.3	-18.1
7	-42	-22.1
8	-46.8	-25.6
9	-53.2	-28.6
10	-56.4	-31.4
15	-60.2	-41.9
20	-70	-50.0
30	-71.5	-50.0
40	-75.4	-50.0
50	-79.1	-50.0
60	-80.3	-50.0
70	-85.2	-50.0

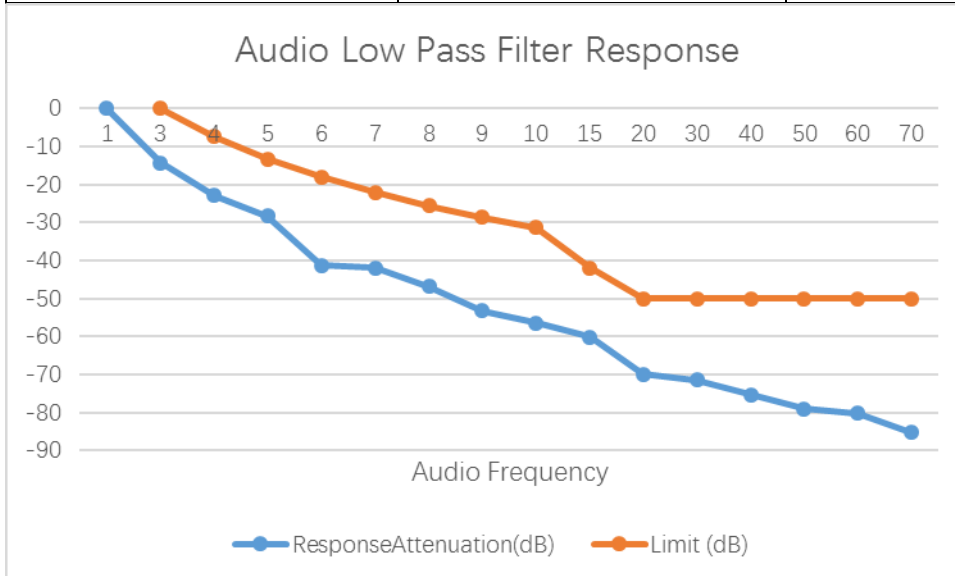

Unless otherwise agreed in writing, this document is issued by the Company subject to its General Conditions of Service printed overleaf, available on request or accessible at <http://www.sgs.com/en/Terms-and-Conditions.aspx> and, for electronic format documents, subject to Terms and Conditions for Electronic Documents at <http://www.sgs.com/en/Terms-and-Conditions/Terms-e-Documents.aspx>. Attention is drawn to the limitation of liability, indemnification and jurisdiction issues defined therein. Any holder of this document is advised that information contained hereon reflects the Company's findings at the time of its intervention only and within the limits of Client's instructions, if any. The Company's sole responsibility is to its Client and this document does not exonerate parties to a transaction from exercising all their rights and obligations under the transaction documents. This document cannot be reproduced except in full, without prior written approval of the Company. Any unauthorized alteration, forgery or falsification of the content or appearance of this document is unlawful and offenders may be prosecuted to the fullest extent of the law. Unless otherwise stated the results shown in this test report refer only to the sample(s) tested and such sample(s) are retained for 30 days only.

**7. Transmitter Power**

Test Voltage (V Dc)	Test Frequency (MHz)	Power Level	Output Power(dBm)	Output Power(W)	Limit	
12	156.025	Max	43.95	24.83	25W	
		Low	29.16	0.82	1W	
	156.300	Max	43.92	24.66	25W	
		Low	28.98	0.79	1W	
	156.650	Max	43.89	24.49	25W	
		Low	28.87	0.77	1W	
	156.800	Max	43.92	24.66	25W	
		Low	28.97	0.79	1W	
	157.425	Max	43.88	24.43	25W	
		Low	28.99	0.79	1W	
	156.525	Max	43.76	23.77	25W	
		Low	28.85	0.77	1W	
	162.025	/		32.76	1.89	See Note
				ERP:36.61	ERP:4.58	See Note

Note:

- 1). The high power is 25W, the low power is 1W for VHF/DSC, and the nominal power of AIS is 2W that declared by manufacturer.
- 2). The transmitter output power not exceeding 25 watts and an ERP not exceeding 18 watts.
- 3).  $ERP = EIRP - 2.15$ ,  $EIRP = \text{Conducted Power} + \text{Antenna Gain(dBi)}$ .



Unless otherwise agreed in writing, this document is issued by the Company subject to its General Conditions of Service printed overleaf, available on request or accessible at <http://www.sgs.com/en/Terms-and-Conditions.aspx> and, for electronic format documents, subject to Terms and Conditions for Electronic Documents at <http://www.sgs.com/en/Terms-and-Conditions/Terms-e-Documents.aspx>. Attention is drawn to the limitation of liability, indemnification and jurisdiction issues defined therein. Any holder of this document is advised that information contained hereon reflects the Company's findings at the time of its intervention only and within the limits of Client's instructions, if any. The Company's sole responsibility is to its Client and this document does not exonerate parties to a transaction from exercising all their rights and obligations under the transaction documents. This document cannot be reproduced except in full, without prior written approval of the Company. Any unauthorized alteration, forgery or falsification of the content or appearance of this document is unlawful and offenders may be prosecuted to the fullest extent of the law. Unless otherwise stated the results shown in this test report refer only to the sample(s) tested and such sample(s) are retained for 30 days only.  
Attention: To check the authenticity of testing / inspection report & certificate, please contact us at telephone: (86-755) 8307 1443, or email: [CN.Doccheck@sgs.com](mailto:CN.Doccheck@sgs.com)



**8. Transmitter Carrier Power Reduction**

Test Voltage (V Dc)	Test Frequency (MHz)	Power Level	Default Power (W)	Limit	Result
12	156.025	Low	0.84	one watt or less	Pass
	156.300	Low	0.78	one watt or less	Pass
	156.650	Low	0.75	one watt or less	Pass
	156.800	Low	0.82	one watt or less	Pass
	157.425	Low	0.81	one watt or less	Pass
	156.525	Low	0.84	one watt or less	Pass
	162.025	Low	0.85	one watt or less	Pass
	156.025	Low	0.84	one watt or less	Pass

Note:

- 1).All transmitters units must be capable of reducing the carrier power to one watt or less;
- 2).All transmitters must automatically reduce the carrier power to one watt or less when transmitting on 156.375 MHz or 156.650 MHz, and must be provided with a manual override switch which when held by an operator will permit full carrier power operation on 156.375 MHz and 156.650 MHz;
- 3).All transmitters must be capable of tuning to 156.775MHz and 156.825MHz and must automatically reduce the carrier power to one watt or less, with no manual override capability, when the transmitter is tuned to either 156.775MHz or 156.825MHz;



Unless otherwise agreed in writing, this document is issued by the Company subject to its General Conditions of Service printed overleaf, available on request or accessible at <http://www.sgs.com/en/Terms-and-Conditions.aspx> and, for electronic format documents, subject to Terms and Conditions for Electronic Documents at <http://www.sgs.com/en/Terms-and-Conditions/Terms-e-Documents.aspx>. Attention is drawn to the limitation of liability, indemnification and jurisdiction issues defined therein. Any holder of this document is advised that information contained hereon reflects the Company's findings at the time of its intervention only and within the limits of Client's instructions, if any. The Company's sole responsibility is to its Client and this document does not exonerate parties to a transaction from exercising all their rights and obligations under the transaction documents. This document cannot be reproduced except in full, without prior written approval of the Company. Any unauthorized alteration, forgery or falsification of the content or appearance of this document is unlawful and offenders may be prosecuted to the fullest extent of the law. Unless otherwise stated the results shown in this test report refer only to the sample(s) tested and such sample(s) are retained for 30 days only.  
**Attention: To check the authenticity of testing / inspection report & certificate, please contact us at telephone: (86-755) 8307 1443, or email: CN\_Doccheck@sgs.com**

**9. Suppression of interference aboard ships**

Assigned Frequency: 161.975MHz, 9KHz-150KHz, AIS receiver mode

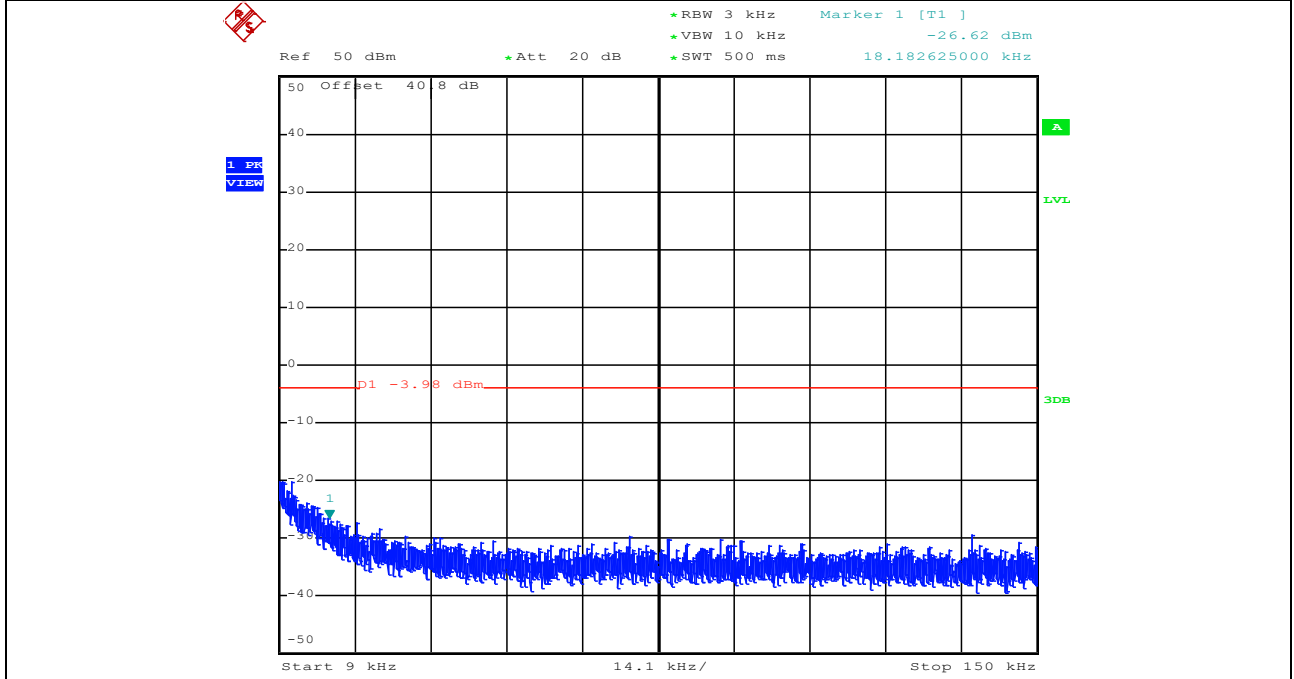

Assigned Frequency: 161.975MHz, 150KHz-30MHz, AIS receiver mode

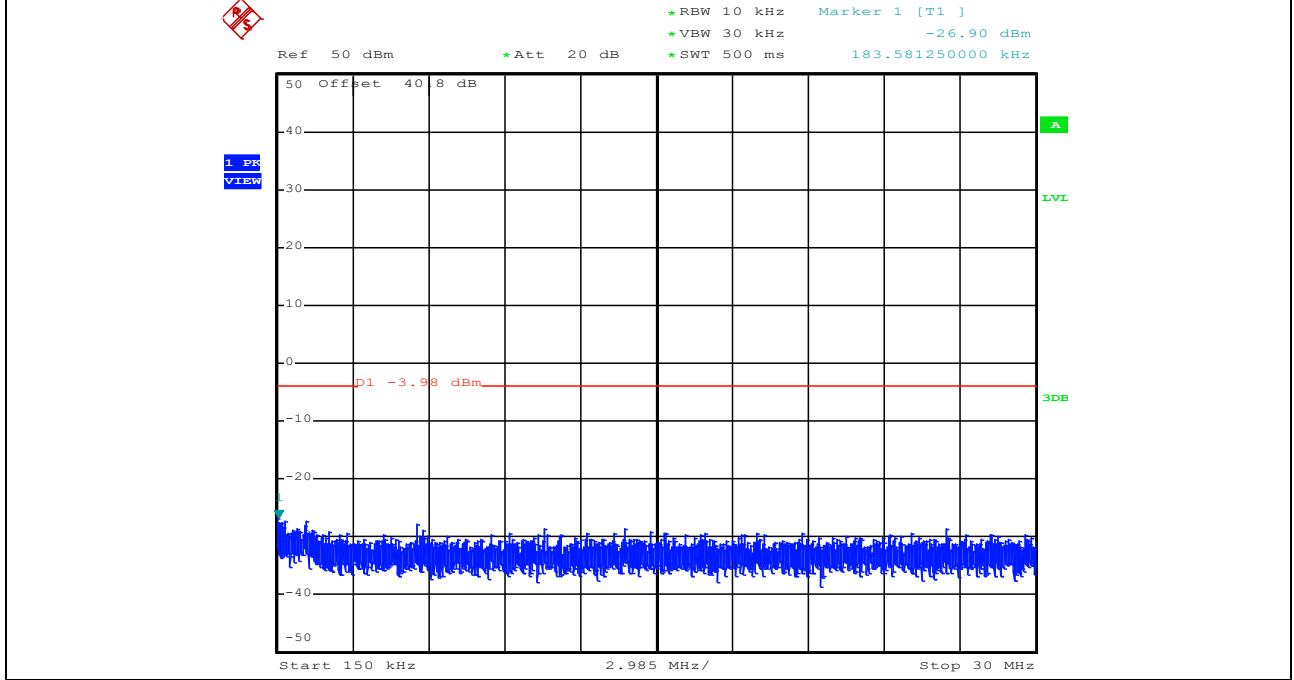

Unless otherwise agreed in writing, this document is issued by the Company subject to its General Conditions of Service printed overleaf, available on request or accessible at <http://www.sgs.com/en/Terms-and-Conditions.aspx> and, for electronic format documents, subject to Terms and Conditions for Electronic Documents at <http://www.sgs.com/en/Terms-and-Conditions/Terms-e-Documents.aspx>. Attention is drawn to the limitation of liability, indemnification and jurisdiction issues defined therein. Any holder of this document is advised that information contained hereon reflects the Company's findings at the time of its intervention only and within the limits of Client's instructions, if any. The Company's sole responsibility is to its Client and this document does not exonerate parties to a transaction from exercising all their rights and obligations under the transaction documents. This document cannot be reproduced except in full, without prior written approval of the Company. Any unauthorized alteration, forgery or falsification of the content or appearance of this document is unlawful and offenders may be prosecuted to the fullest extent of the law. Unless otherwise stated the results shown in this test report refer only to the sample(s) tested and such sample(s) are retained for 30 days only.

Attention: To check the authenticity of testing /inspection report & certificate, please contact us at telephone: (86-755) 8307 1443, or email: [CN.Doccheck@sgs.com](mailto:CN.Doccheck@sgs.com)

No.1 Workshop, M-10, Middle Section, Science & Technology Park, Shenzhen, China 518057 t (86-755) 26012053 f (86-755) 26710594 www.sgs.com.cn  
 中国·深圳·科技园中区M-10栋一号厂房 邮编: 518057 t (86-755) 26012053 f (86-755) 26710594 sgs.china@sgs.com

**Assigned Frequency: 161.975MHz, 30MHz-100MHz, AIS receiver mode**

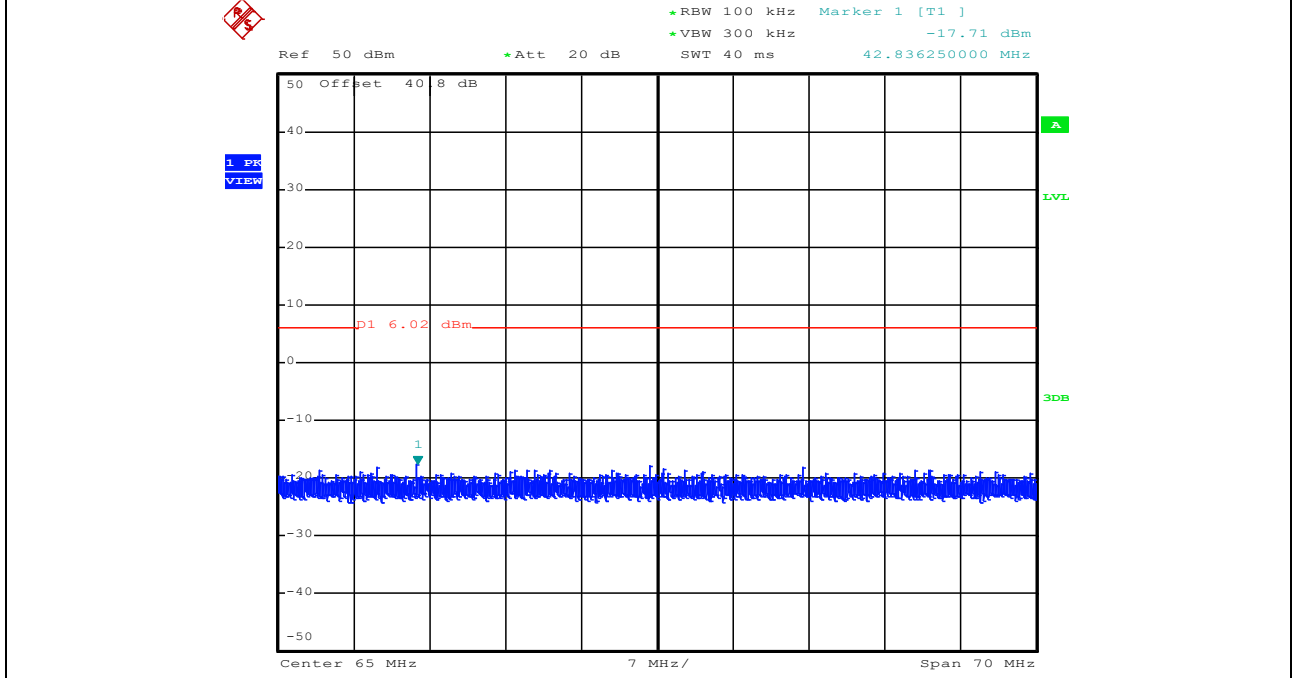

**Assigned Frequency: 161.975MHz, 100MHz-300MHz, AIS receiver mode**

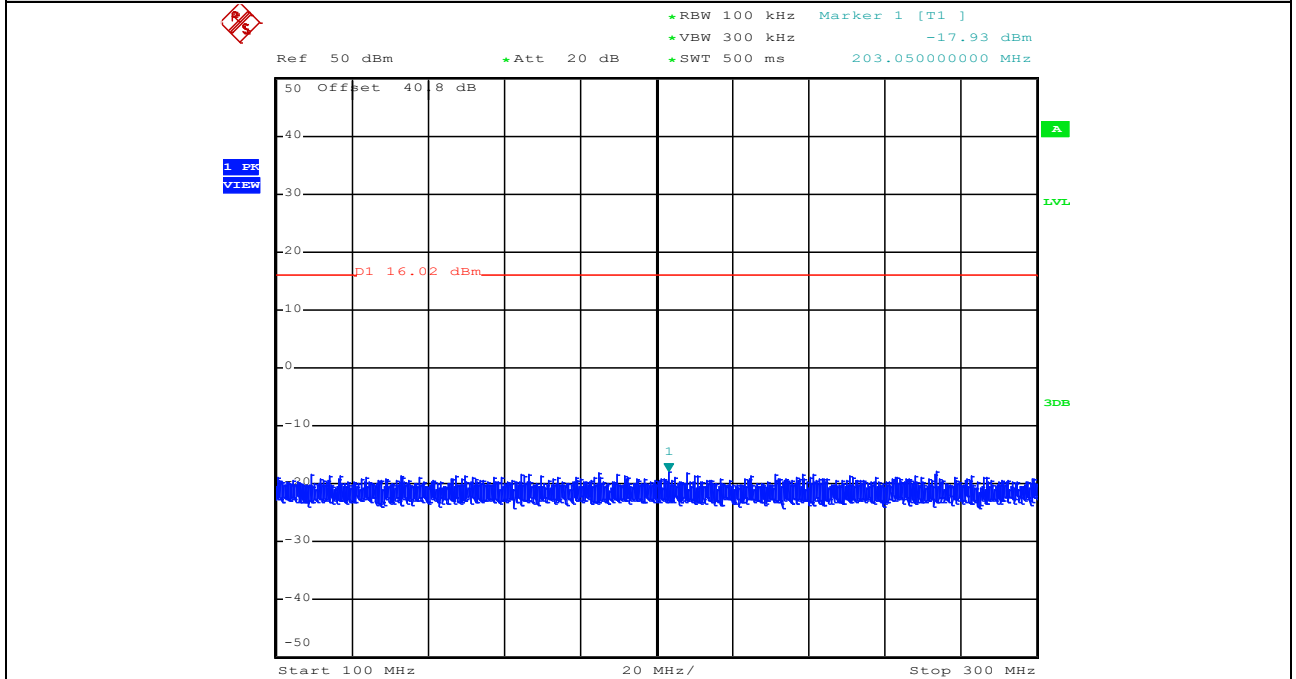

Unless otherwise agreed in writing, this document is issued by the Company subject to its General Conditions of Service printed overleaf, available on request or accessible at <http://www.sgs.com/en/Terms-and-Conditions.aspx> and, for electronic format documents, subject to Terms and Conditions for Electronic Documents at <http://www.sgs.com/en/Terms-and-Conditions/Terms-e-Documents.aspx>. Attention is drawn to the limitation of liability, indemnification and jurisdiction issues defined therein. Any holder of this document is advised that information contained hereon reflects the Company's findings at the time of its intervention only and within the limits of Client's instructions, if any. The Company's sole responsibility is to its Client and this document does not exonerate parties to a transaction from exercising all their rights and obligations under the transaction documents. This document cannot be reproduced except in full, without prior written approval of the Company. Any unauthorized alteration, forgery or falsification of the content or appearance of this document is unlawful and offenders may be prosecuted to the fullest extent of the law. Unless otherwise stated the results shown in this test report refer only to the sample(s) tested and such sample(s) are retained for 30 days only.

Attention: To check the authenticity of testing /inspection report & certificate, please contact us at telephone: (86-755) 8307 1443, or email: [CN.Doccheck@sgs.com](mailto:CN.Doccheck@sgs.com)

No.1 Workshop, M-10, Middle Section, Science & Technology Park, Shenzhen, China 518057    t (86-755) 26012053 f (86-755) 26710594    www.sgs.com.cn  
 中国·深圳·科技园中区M-10栋一号厂房    邮编: 518057    t (86-755) 26012053 f (86-755) 26710594    sgs.china@sgs.com

**Assigned Frequency: 161.975MHz, 300MHz-1GHz, AIS receiver mode**

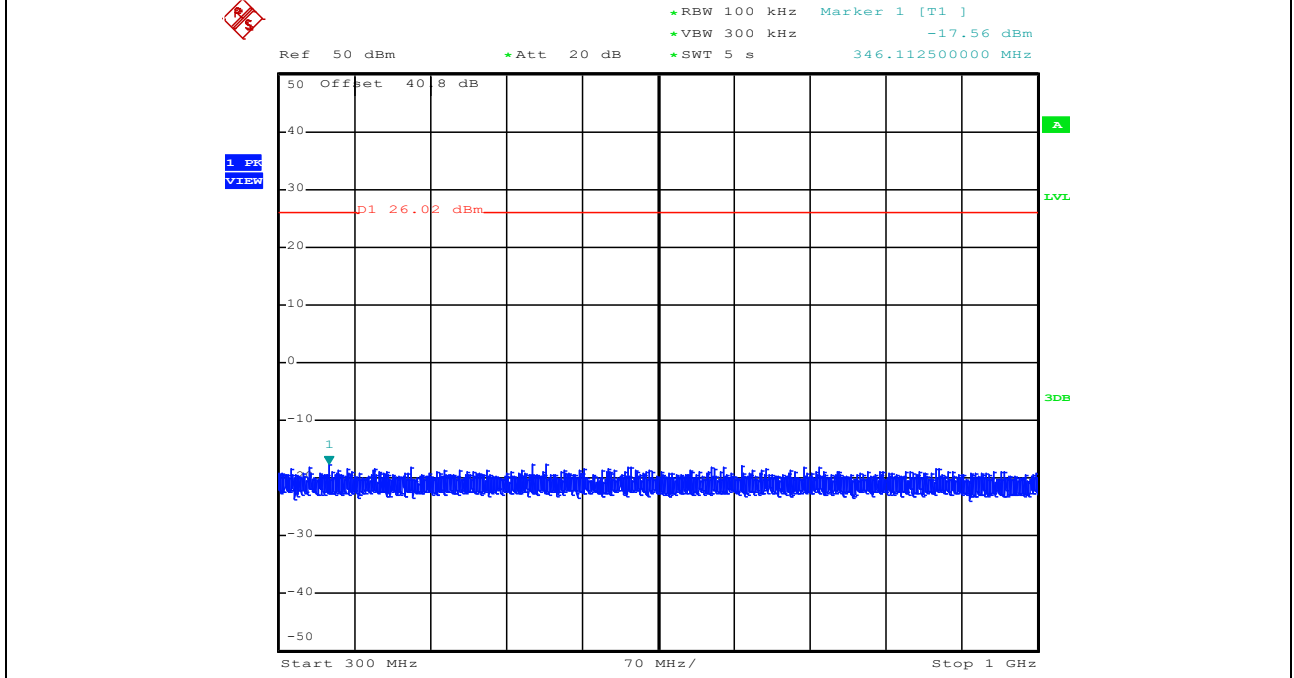

**Assigned Frequency: 161.975MHz, 1GHz-2GHz, AIS receiver mode**

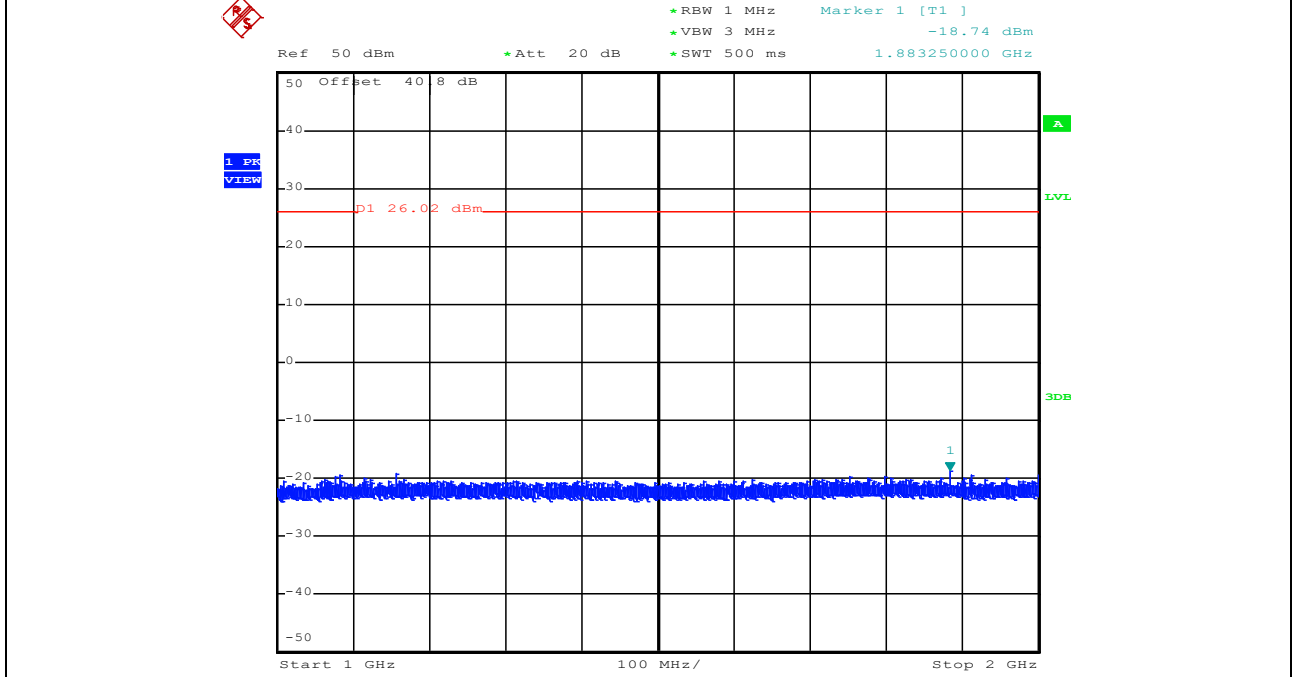

Unless otherwise agreed in writing, this document is issued by the Company subject to its General Conditions of Service printed overleaf, available on request or accessible at <http://www.sgs.com/en/Terms-and-Conditions.aspx> and, for electronic format documents, subject to Terms and Conditions for Electronic Documents at <http://www.sgs.com/en/Terms-and-Conditions/Terms-e-Documents.aspx>. Attention is drawn to the limitation of liability, indemnification and jurisdiction issues defined therein. Any holder of this document is advised that information contained hereon reflects the Company's findings at the time of its intervention only and within the limits of Client's instructions, if any. The Company's sole responsibility is to its Client and this document does not exonerate parties to a transaction from exercising all their rights and obligations under the transaction documents. This document cannot be reproduced except in full, without prior written approval of the Company. Any unauthorized alteration, forgery or falsification of the content or appearance of this document is unlawful and offenders may be prosecuted to the fullest extent of the law. Unless otherwise stated the results shown in this test report refer only to the sample(s) tested and such sample(s) are retained for 30 days only.

Attention: To check the authenticity of testing /inspection report & certificate, please contact us at telephone: (86-755) 8307 1443, or email: [CN.Doccheck@sgs.com](mailto:CN.Doccheck@sgs.com)

No.1 Workshop, M-10, Middle Section, Science & Technology Park, Shenzhen, China 518057    t (86-755) 26012053 f (86-755) 26710594    www.sgs.com.cn  
 中国·深圳·科技园中区M-10栋一号厂房    邮编: 518057    t (86-755) 26012053 f (86-755) 26710594    sgs.china@sgs.com

Assigned Frequency: 162.025MHz, 9KHz-150KHz, AIS receiver mode

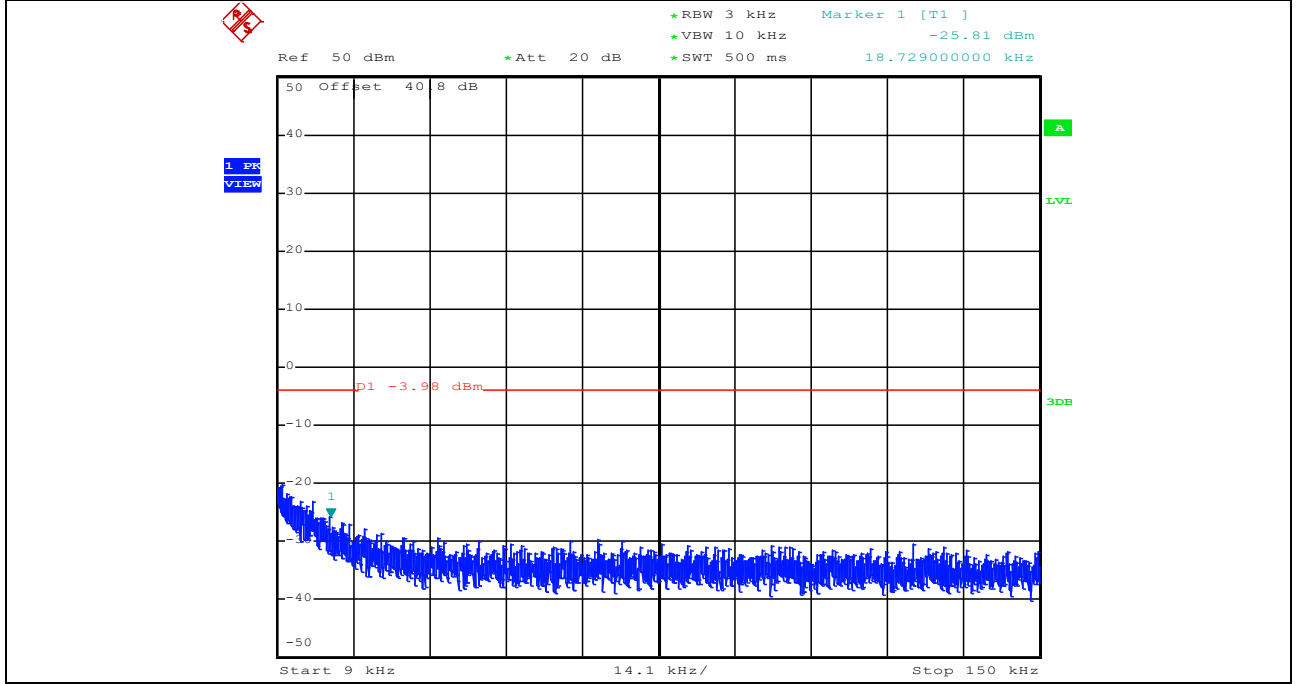

Assigned Frequency: 162.025MHz, 150KHz-30MHz, AIS receiver mode

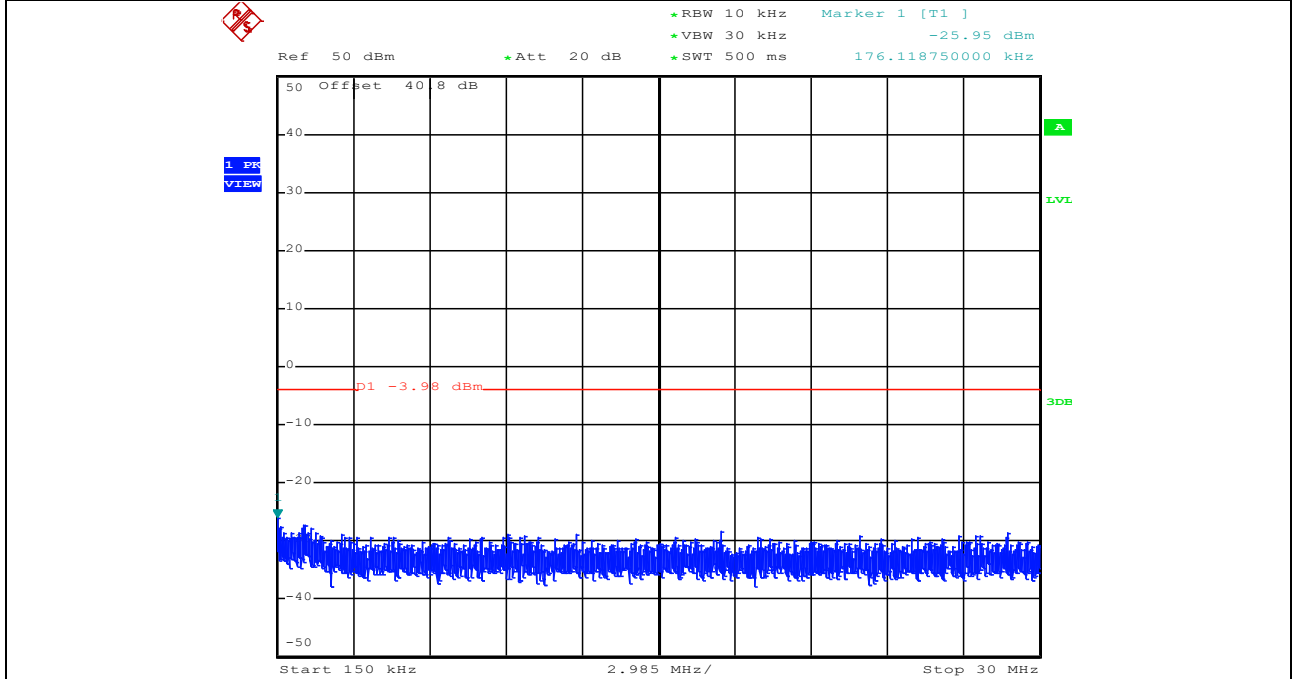

Unless otherwise agreed in writing, this document is issued by the Company subject to its General Conditions of Service printed overleaf, available on request or accessible at <http://www.sgs.com/en/Terms-and-Conditions.aspx> and, for electronic format documents, subject to Terms and Conditions for Electronic Documents at <http://www.sgs.com/en/Terms-and-Conditions/Terms-e-Documents.aspx>. Attention is drawn to the limitation of liability, indemnification and jurisdiction issues defined therein. Any holder of this document is advised that information contained hereon reflects the Company's findings at the time of its intervention only and within the limits of Client's instructions, if any. The Company's sole responsibility is to its Client and this document does not exonerate parties to a transaction from exercising all their rights and obligations under the transaction documents. This document cannot be reproduced except in full, without prior written approval of the Company. Any unauthorized alteration, forgery or falsification of the content or appearance of this document is unlawful and offenders may be prosecuted to the fullest extent of the law. Unless otherwise stated the results shown in this test report refer only to the sample(s) tested and such sample(s) are retained for 30 days only.

**Assigned Frequency:162.025MHz, 30MHz-100MHz, AIS receiver mode**

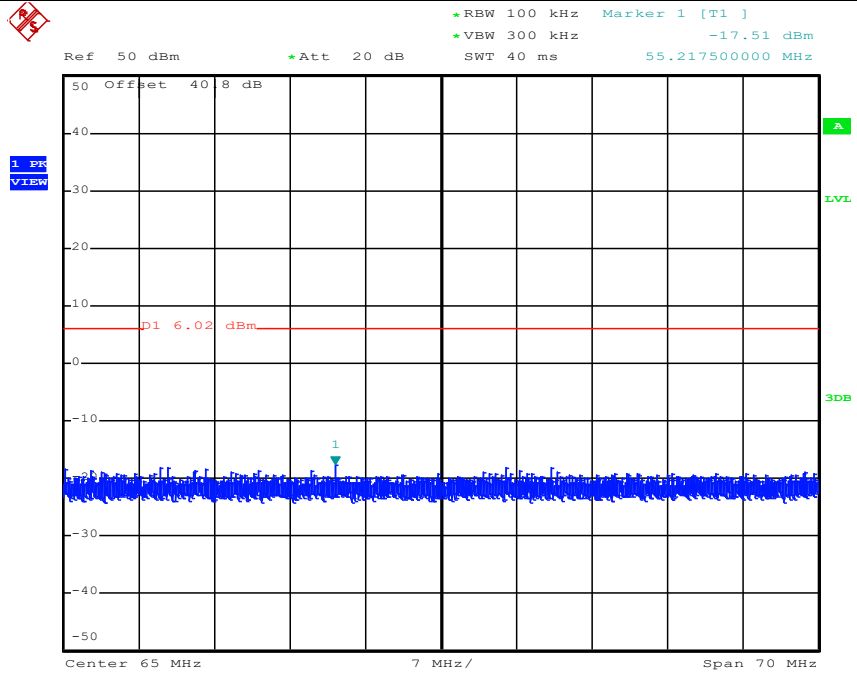

**Assigned Frequency:162.025MHz, 100MHz-300MHz, AIS receiver mode**

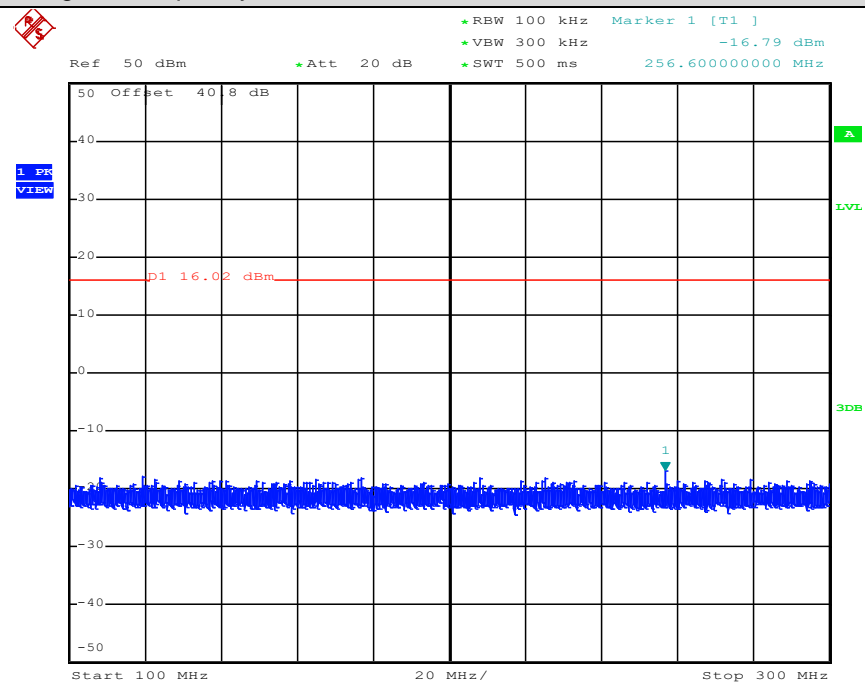

Unless otherwise agreed in writing, this document is issued by the Company subject to its General Conditions of Service printed overleaf, available on request or accessible at <http://www.sgs.com/en/Terms-and-Conditions.aspx> and, for electronic format documents, subject to Terms and Conditions for Electronic Documents at <http://www.sgs.com/en/Terms-and-Conditions/Terms-e-Documents.aspx>. Attention is drawn to the limitation of liability, indemnification and jurisdiction issues defined therein. Any holder of this document is advised that information contained hereon reflects the Company's findings at the time of its intervention only and within the limits of Client's instructions, if any. The Company's sole responsibility is to its Client and this document does not exonerate parties to a transaction from exercising all their rights and obligations under the transaction documents. This document cannot be reproduced except in full, without prior written approval of the Company. Any unauthorized alteration, forgery or falsification of the content or appearance of this document is unlawful and offenders may be prosecuted to the fullest extent of the law. Unless otherwise stated the results shown in this test report refer only to the sample(s) tested and such sample(s) are retained for 30 days only.

Attention: To check the authenticity of testing /inspection report & certificate, please contact us at telephone: (86-755) 8307 1443, or email: [CN.Doccheck@sgs.com](mailto:CN.Doccheck@sgs.com)

No.1 Workshop, M-10, Middle Section, Science & Technology Park, Shenzhen, China 518057    t (86-755) 26012053 f (86-755) 26710594    www.sgs.com  
 中国·深圳·科技园中区M-10栋一号厂房    邮编: 518057    t (86-755) 26012053 f (86-755) 26710594    sgs.china@sgs.com

**Assigned Frequency:162.025MHz, 300MHz-1GHz, AIS receiver mode**

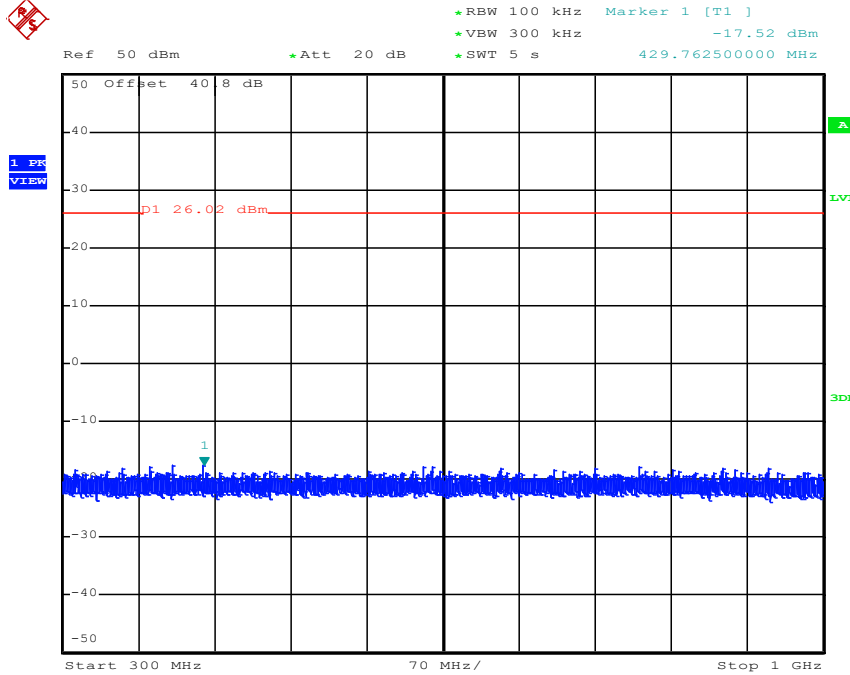

**Assigned Frequency:162.025MHz, 1GHz-2GHz, AIS receiver mode**

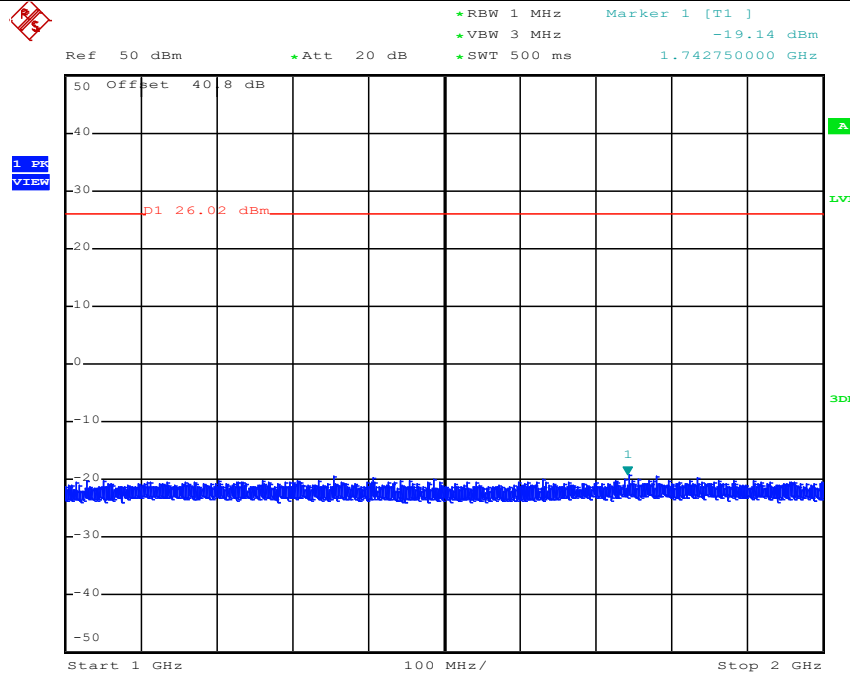

Unless otherwise agreed in writing, this document is issued by the Company subject to its General Conditions of Service printed overleaf, available on request or accessible at <http://www.sgs.com/en/Terms-and-Conditions.aspx> and, for electronic format documents, subject to Terms and Conditions for Electronic Documents at <http://www.sgs.com/en/Terms-and-Conditions/Terms-e-Documents.aspx>. Attention is drawn to the limitation of liability, indemnification and jurisdiction issues defined therein. Any holder of this document is advised that information contained hereon reflects the Company's findings at the time of its intervention only and within the limits of Client's instructions, if any. The Company's sole responsibility is to its Client and this document does not exonerate parties to a transaction from exercising all their rights and obligations under the transaction documents. This document cannot be reproduced except in full, without prior written approval of the Company. Any unauthorized alteration, forgery or falsification of the content or appearance of this document is unlawful and offenders may be prosecuted to the fullest extent of the law. Unless otherwise stated the results shown in this test report refer only to the sample(s) tested and such sample(s) are retained for 30 days only.

Attention: To check the authenticity of testing /inspection report & certificate, please contact us at telephone: (86-755) 8307 1443, or email: [CN.Doccheck@sgs.com](mailto:CN.Doccheck@sgs.com)  
 No.1 Workshop, M-10, Middle Section, Science & Technology Park, Shenzhen, China 518057 t (86-755) 26012053 f (86-755) 26710594 www.sgs.com.cn  
 中国·深圳·科技园中区M-10栋一号厂房 邮编: 518057 t (86-755) 26012053 f (86-755) 26710594 sgs.china@sgs.com

**Assigned Frequency: 156.525MHz, 9KHz-150KHz, DSC receiver mode**

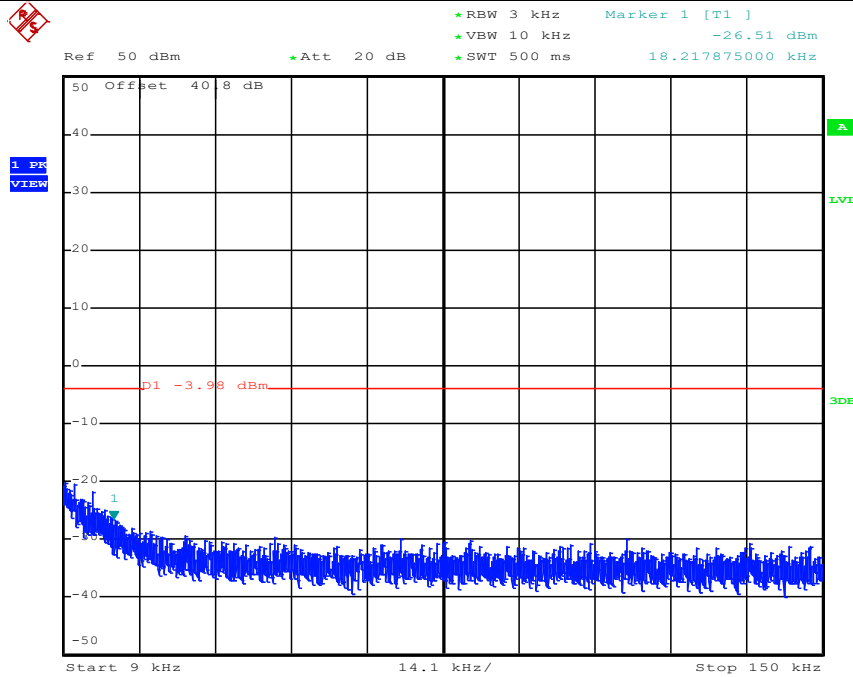

**Assigned Frequency: 156.525MHz, 150KHz-30MHz, DSC receiver mode**

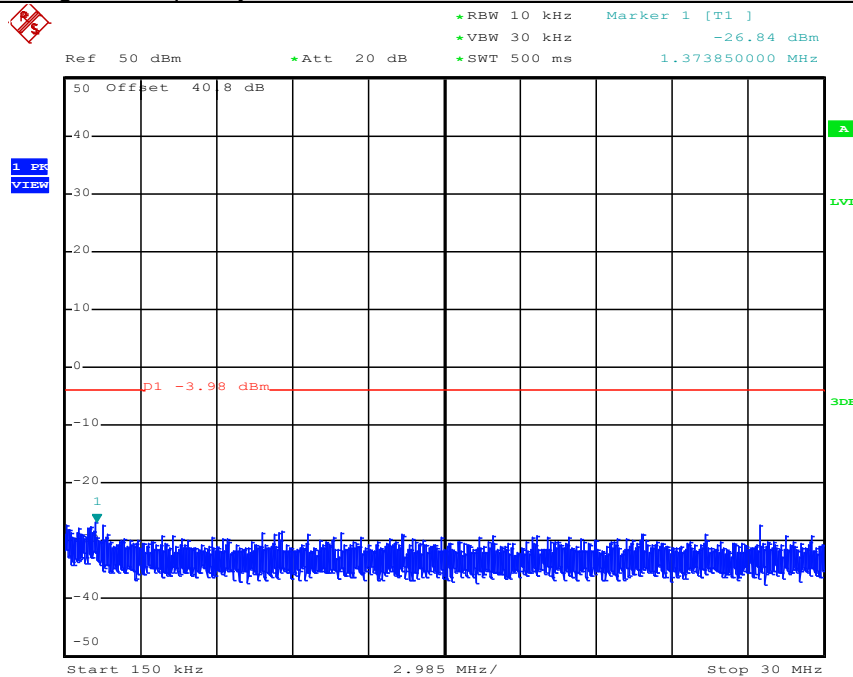

Unless otherwise agreed in writing, this document is issued by the Company subject to its General Conditions of Service printed overleaf, available on request or accessible at <http://www.sgs.com/en/Terms-and-Conditions.aspx> and, for electronic format documents, subject to Terms and Conditions for Electronic Documents at <http://www.sgs.com/en/Terms-and-Conditions/Terms-e-Documents.aspx>. Attention is drawn to the limitation of liability, indemnification and jurisdiction issues defined therein. Any holder of this document is advised that information contained hereon reflects the Company's findings at the time of its intervention only and within the limits of Client's instructions, if any. The Company's sole responsibility is to its Client and this document does not exonerate parties to a transaction from exercising all their rights and obligations under the transaction documents. This document cannot be reproduced except in full, without prior written approval of the Company. Any unauthorized alteration, forgery or falsification of the content or appearance of this document is unlawful and offenders may be prosecuted to the fullest extent of the law. Unless otherwise stated the results shown in this test report refer only to the sample(s) tested and such sample(s) are retained for 30 days only.



**Assigned Frequency:156.525MHz, 30MHz-100MHz, DSC receiver mode**

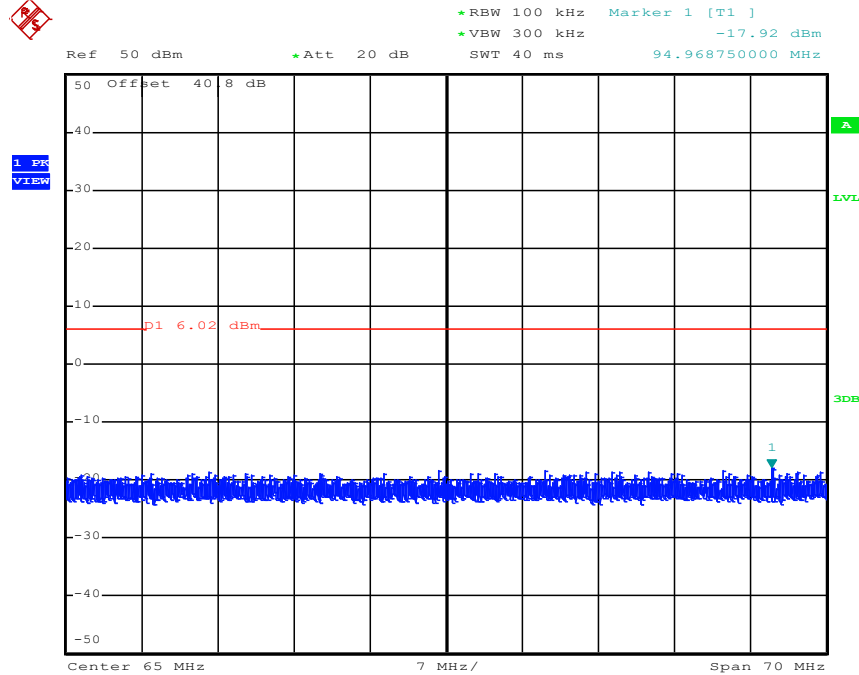

**Assigned Frequency:156.525MHz, 100MHz-300MHz, DSC receiver mode**

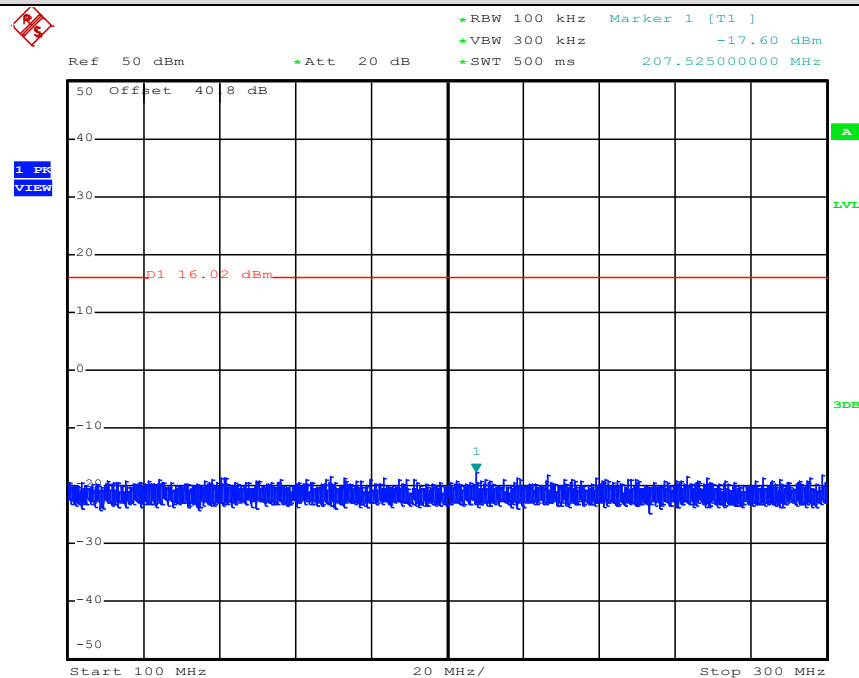

Unless otherwise agreed in writing, this document is issued by the Company subject to its General Conditions of Service printed overleaf, available on request or accessible at <http://www.sgs.com/en/Terms-and-Conditions.aspx> and, for electronic format documents, subject to Terms and Conditions for Electronic Documents at <http://www.sgs.com/en/Terms-and-Conditions/Terms-e-Documents.aspx>. Attention is drawn to the limitation of liability, indemnification and jurisdiction issues defined therein. Any holder of this document is advised that information contained hereon reflects the Company's findings at the time of its intervention only and within the limits of Client's instructions, if any. The Company's sole responsibility is to its Client and this document does not exonerate parties to a transaction from exercising all their rights and obligations under the transaction documents. This document cannot be reproduced except in full, without prior written approval of the Company. Any unauthorized alteration, forgery or falsification of the content or appearance of this document is unlawful and offenders may be prosecuted to the fullest extent of the law. Unless otherwise stated the results shown in this test report refer only to the sample(s) tested and such sample(s) are retained for 30 days only.

Attention: To check the authenticity of testing /inspection report & certificate, please contact us at telephone: (86-755) 8307 1443, or email: [CN.Doccheck@sgs.com](mailto:CN.Doccheck@sgs.com)  
 No.1 Workshop, M-10, Middle Section, Science & Technology Park, Shenzhen, China 518057 t (86-755) 26012053 f (86-755) 26710594 www.sgs.com.cn  
 中国·深圳·科技园中区M-10栋一号厂房 邮编: 518057 t (86-755) 26012053 f (86-755) 26710594 sgs.china@sgs.com

**Assigned Frequency:156.525MHz, 300MHz-1GHz, DSC receiver mode**

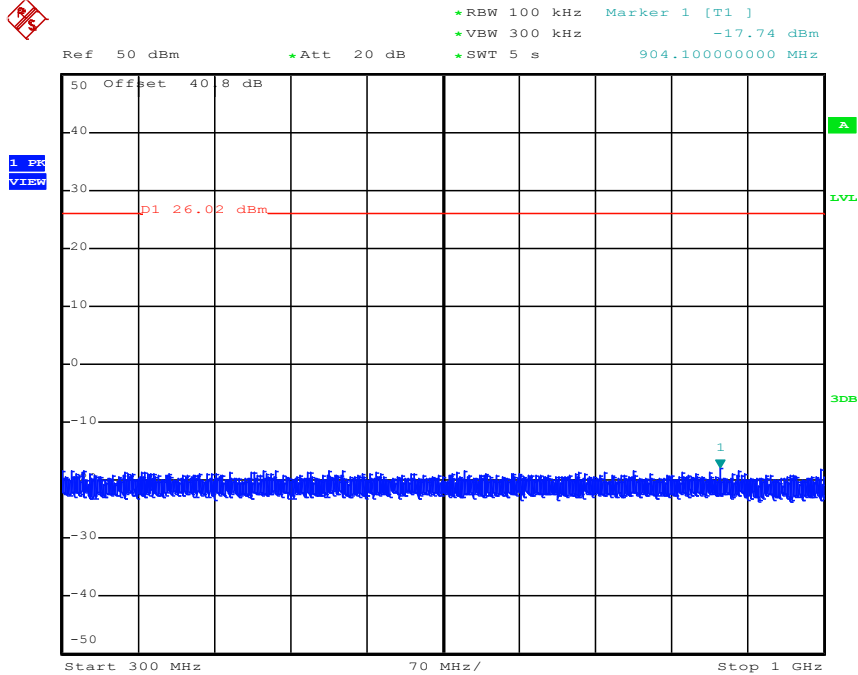

**Assigned Frequency:156.525MHz, 1GHz-2GHz, DSC receiver mode**

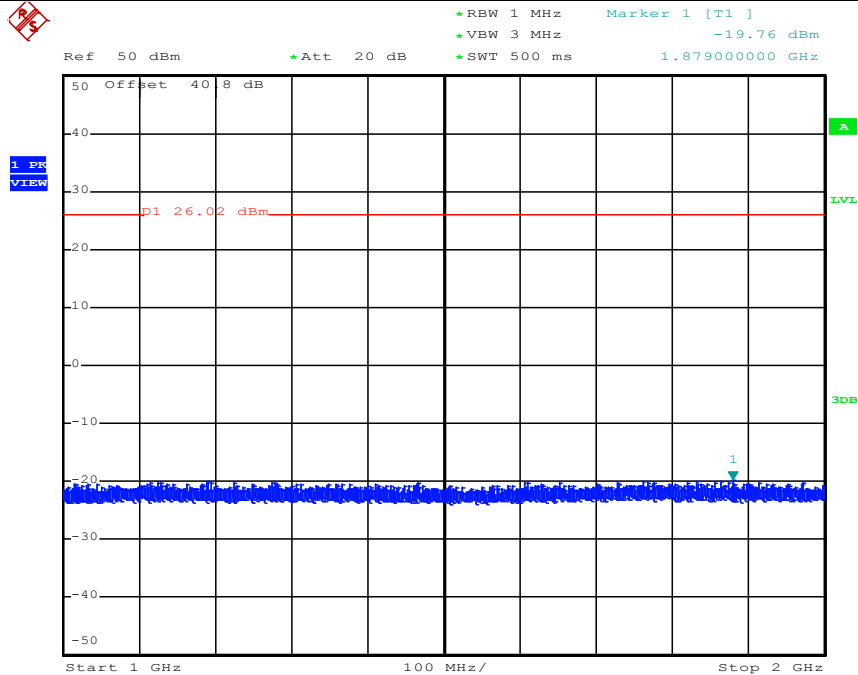

Unless otherwise agreed in writing, this document is issued by the Company subject to its General Conditions of Service printed overleaf, available on request or accessible at <http://www.sgs.com/en/Terms-and-Conditions.aspx> and, for electronic format documents, subject to Terms and Conditions for Electronic Documents at <http://www.sgs.com/en/Terms-and-Conditions/Terms-e-Documents.aspx>. Attention is drawn to the limitation of liability, indemnification and jurisdiction issues defined therein. Any holder of this document is advised that information contained hereon reflects the Company's findings at the time of its intervention only and within the limits of Client's instructions, if any. The Company's sole responsibility is to its Client and this document does not exonerate parties to a transaction from exercising all their rights and obligations under the transaction documents. This document cannot be reproduced except in full, without prior written approval of the Company. Any unauthorized alteration, forgery or falsification of the content or appearance of this document is unlawful and offenders may be prosecuted to the fullest extent of the law. Unless otherwise stated the results shown in this test report refer only to the sample(s) tested and such sample(s) are retained for 30 days only.

Assigned Frequency: 156.025MHz, 9KHz-150KHz, VHF receiver mode

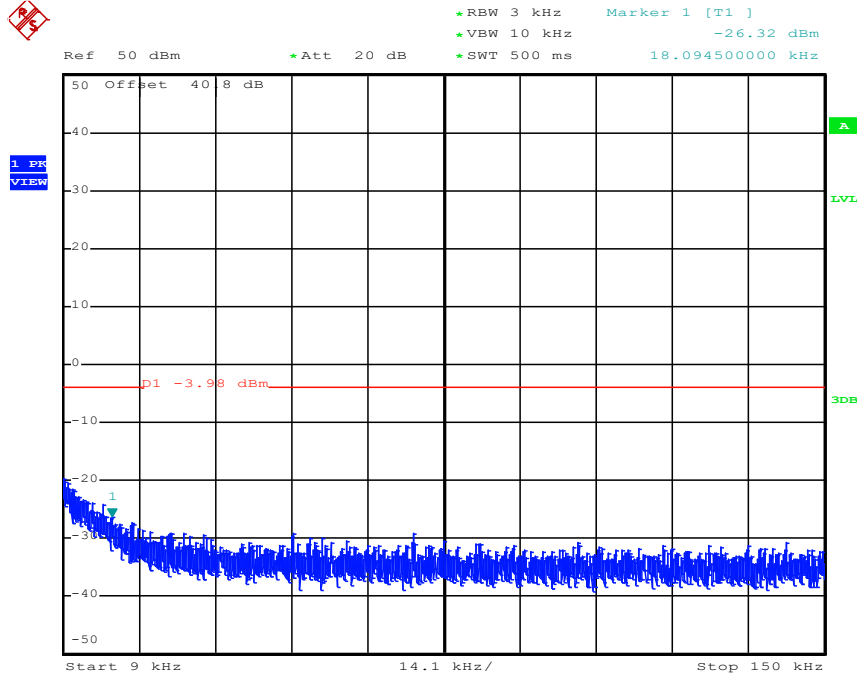

Assigned Frequency: 156.025MHz, 150KHz-30MHz, VHF receiver mode

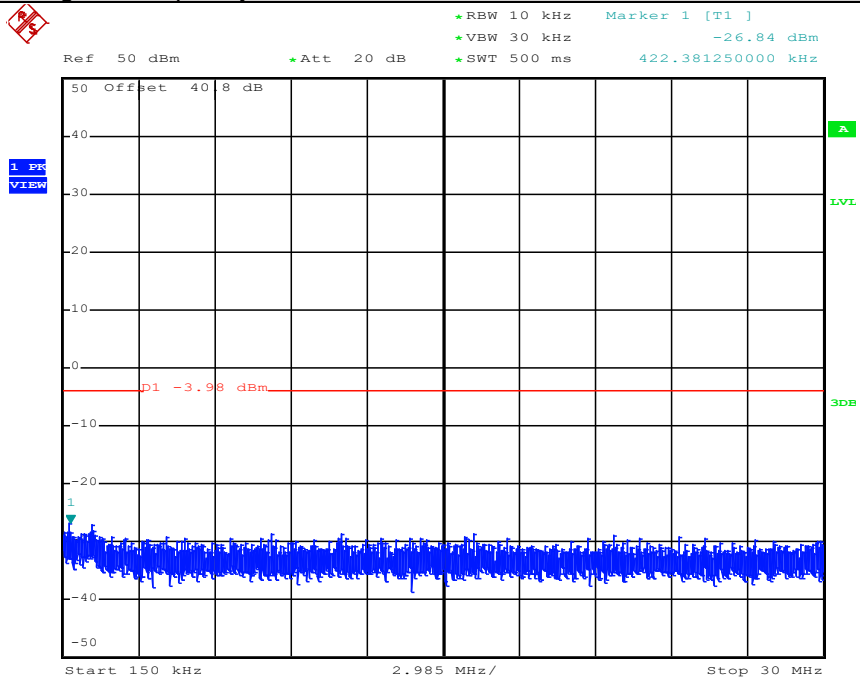

Unless otherwise agreed in writing, this document is issued by the Company subject to its General Conditions of Service printed overleaf, available on request or accessible at <http://www.sgs.com/en/Terms-and-Conditions.aspx> and, for electronic format documents, subject to Terms and Conditions for Electronic Documents at <http://www.sgs.com/en/Terms-and-Conditions/Terms-e-Documents.aspx>. Attention is drawn to the limitation of liability, indemnification and jurisdiction issues defined therein. Any holder of this document is advised that information contained hereon reflects the Company's findings at the time of its intervention only and within the limits of Client's instructions, if any. The Company's sole responsibility is to its Client and this document does not exonerate parties to a transaction from exercising all their rights and obligations under the transaction documents. This document cannot be reproduced except in full, without prior written approval of the Company. Any unauthorized alteration, forgery or falsification of the content or appearance of this document is unlawful and offenders may be prosecuted to the fullest extent of the law. Unless otherwise stated the results shown in this test report refer only to the sample(s) tested and such sample(s) are retained for 30 days only.

Attention: To check the authenticity of testing /inspection report & certificate, please contact us at telephone: (86-755) 8307 1443, or email: [CN.Doccheck@sgs.com](mailto:CN.Doccheck@sgs.com)  
 No.1 Workshop, M-10, Middle Section, Science & Technology Park, Shenzhen, China 518057 t (86-755) 26012053 f (86-755) 26710594 www.sgs.com.cn  
 中国·深圳·科技园中区M-10栋一号厂房 邮编: 518057 t (86-755) 26012053 f (86-755) 26710594 sgs.china@sgs.com

Assigned Frequency: 156.025MHz, 30MHz-100MHz, VHF receiver mode

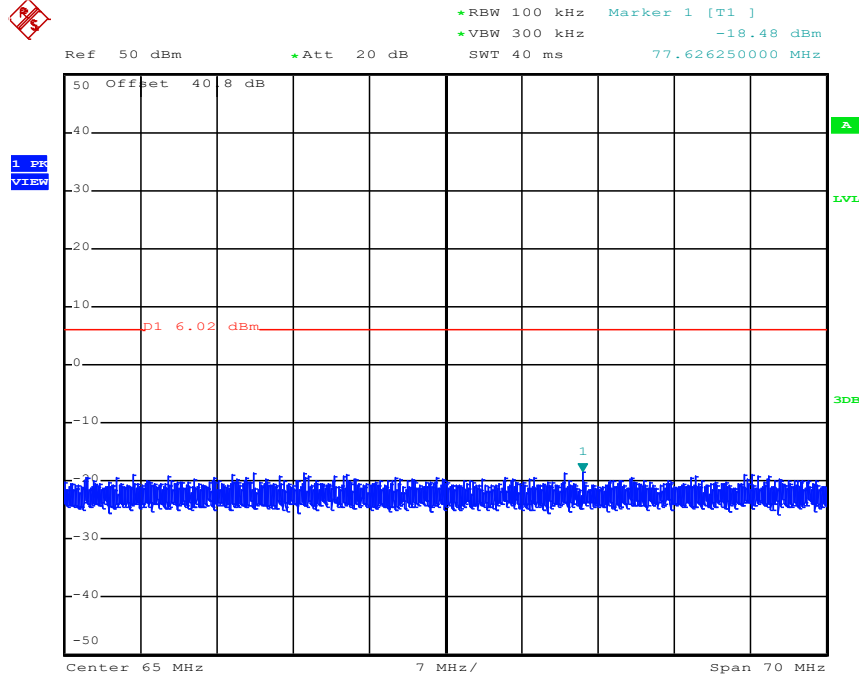

Assigned Frequency: 156.025MHz, 100MHz-300MHz, VHF receiver mode

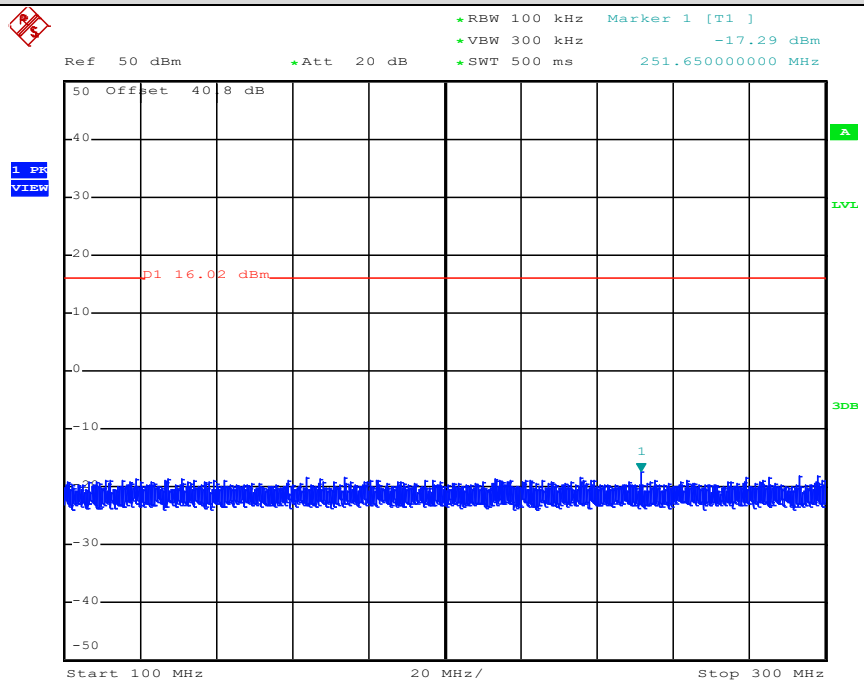

Unless otherwise agreed in writing, this document is issued by the Company subject to its General Conditions of Service printed overleaf, available on request or accessible at <http://www.sgs.com/en/Terms-and-Conditions.aspx> and, for electronic format documents, subject to Terms and Conditions for Electronic Documents at <http://www.sgs.com/en/Terms-and-Conditions/Terms-e-Documents.aspx>. Attention is drawn to the limitation of liability, indemnification and jurisdiction issues defined therein. Any holder of this document is advised that information contained hereon reflects the Company's findings at the time of its intervention only and within the limits of Client's instructions, if any. The Company's sole responsibility is to its Client and this document does not exonerate parties to a transaction from exercising all their rights and obligations under the transaction documents. This document cannot be reproduced except in full, without prior written approval of the Company. Any unauthorized alteration, forgery or falsification of the content or appearance of this document is unlawful and offenders may be prosecuted to the fullest extent of the law. Unless otherwise stated the results shown in this test report refer only to the sample(s) tested and such sample(s) are retained for 30 days only.

Attention: To check the authenticity of testing /inspection report & certificate, please contact us at telephone: (86-755) 8307 1443, or email: [CN.Doccheck@sgs.com](mailto:CN.Doccheck@sgs.com)

No.1 Workshop, M-10, Middle Section, Science & Technology Park, Shenzhen, China 518057    t (86-755) 26012053 f (86-755) 26710594    www.sgs.com.cn  
 Shenzhen Branch    中国·深圳·科技园中区M-10栋一号厂房    邮编: 518057    t (86-755) 26012053 f (86-755) 26710594    sgs.china@sgs.com

**Assigned Frequency: 156.025MHz, 300MHz-1GHz, VHF receiver mode**

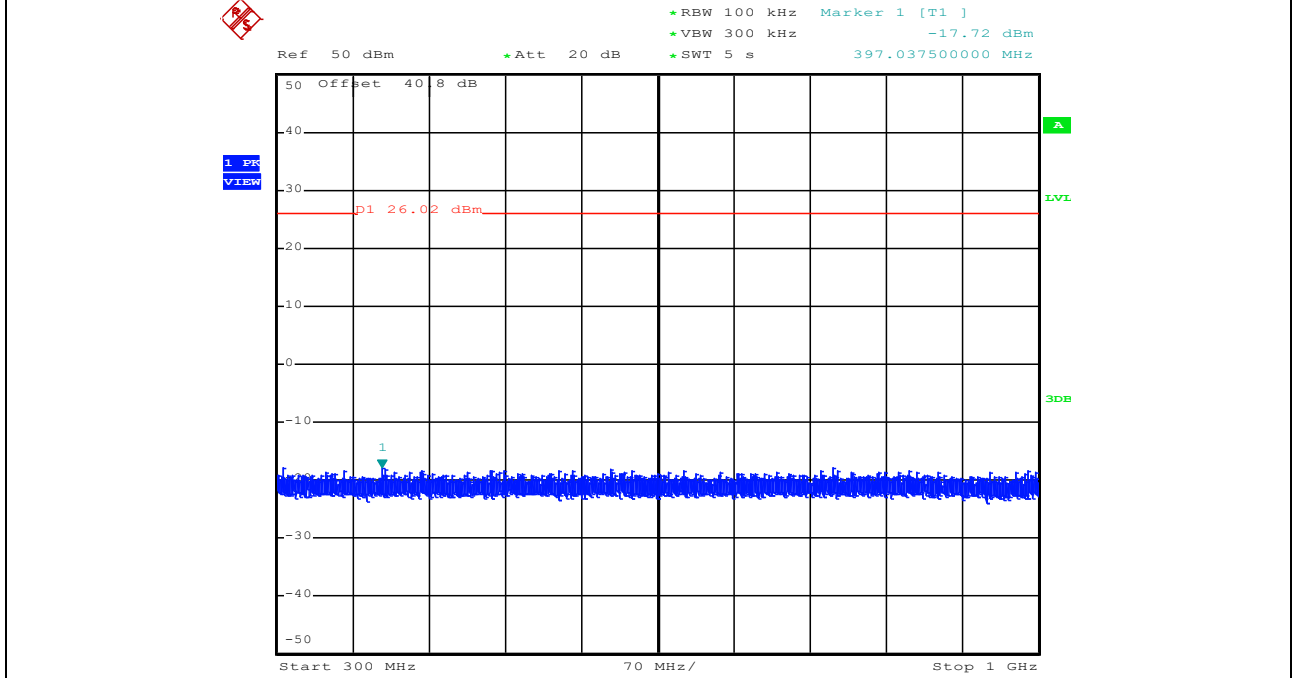

**Assigned Frequency: 156.025MHz, 1GHz-2GHz, VHF receiver mode**

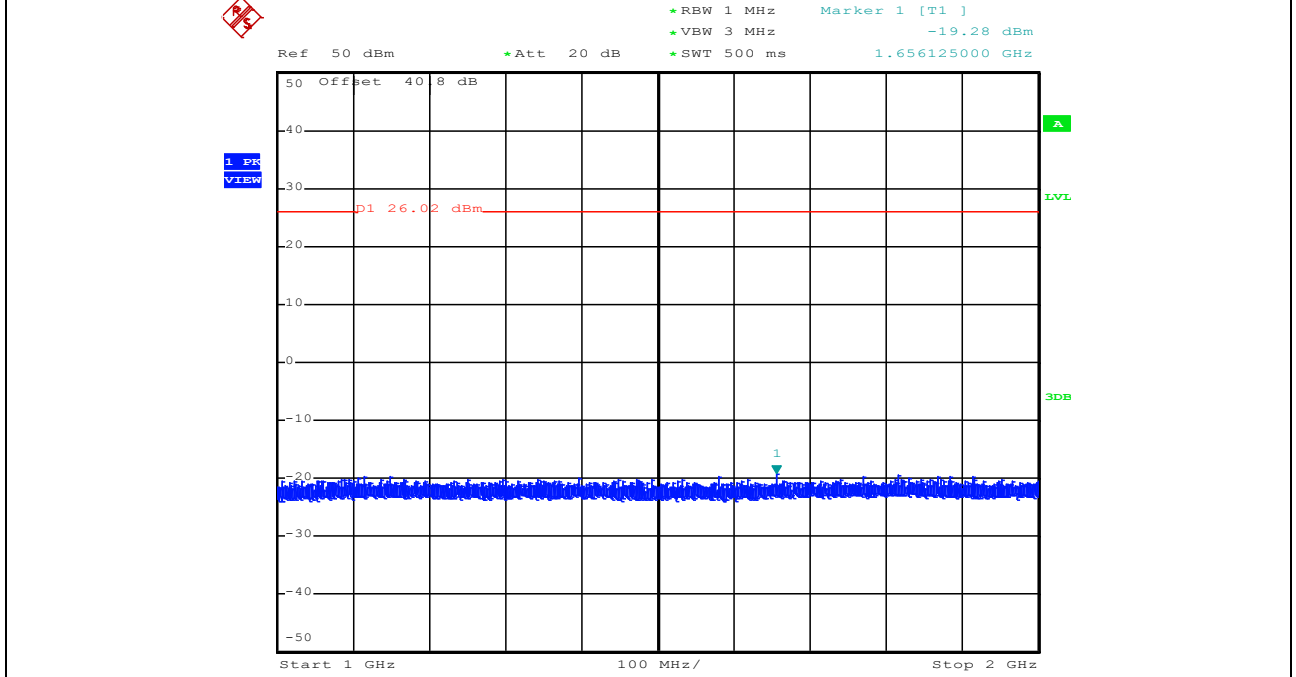

-End of Report-



Unless otherwise agreed in writing, this document is issued by the Company subject to its General Conditions of Service printed overleaf, available on request or accessible at <http://www.sgs.com/en/Terms-and-Conditions.aspx> and, for electronic format documents, subject to Terms and Conditions for Electronic Documents at <http://www.sgs.com/en/Terms-and-Conditions/Terms-e-Documents.aspx>. Attention is drawn to the limitation of liability, indemnification and jurisdiction issues defined therein. Any holder of this document is advised that information contained hereon reflects the Company's findings at the time of its intervention only and within the limits of Client's instructions, if any. The Company's sole responsibility is to its Client and this document does not exonerate parties to a transaction from exercising all their rights and obligations under the transaction documents. This document cannot be reproduced except in full, without prior written approval of the Company. Any unauthorized alteration, forgery or falsification of the content or appearance of this document is unlawful and offenders may be prosecuted to the fullest extent of the law. Unless otherwise stated the results shown in this test report refer only to the sample(s) tested and such sample(s) are retained for 30 days only.

Attention: To check the authenticity of testing / inspection report & certificate, please contact us at telephone: (86-755) 8307 1443, or email: [CN.Doccheck@sgs.com](mailto:CN.Doccheck@sgs.com)  
 No.1 Workshop, M-10, Middle Section, Science & Technology Park, Shenzhen, China 518057 t (86-755) 26012053 f (86-755) 26710594 www.sgs.com.cn  
 中国·深圳·科技园中区M-10栋一号厂房 邮编: 518057 t (86-755) 26012053 f (86-755) 26710594 sgs.china@sgs.com