



Test Report - FCC PART 80 (Radar)

Applicant: Navico Inc.

Approved for Release By:

Signature: Bruno Clavier

Name & Title: Bruno Clavier, General Manager

Date of Signature 6/8/2022

This test report shall not be reproduced except in full without the written and signed permission of Timco Engineering Inc. (IIA). This test report relates only to the items tested as identified and is not valid for any subsequent changes or modifications made to the equipment under test.

Table of Contents

1.	CUSTOMER INFORMATION.....	4
1.1	PART 80 TEST RESULT SUMMARY	4
2.	LOCATION OF TESTING	5
2.1	TEST LABORATORY	5
2.2	TESTING WAS PERFORMED, REVIEWED BY	5
3.	TEST SAMPLE(S) (EUT/DUT).....	6
3.1	DESCRIPTION OF THE EUT.....	6
3.2	CONFIGURATION OF EUT	7
3.3	TEST SETUP OF EUT.....	7
4.	TEST METHODS & APPLICABLE REGULATORY LIMITS.....	8
4.1	TEST METHODS/STANDARDS/GUIDANCE:	8
4.2	APPLIED LIMITS AND REGULATORY LIMITS:.....	8
5.	MEASUREMENT UNCERTAINTY.....	8
6.	ENVIRONMENTAL CONDITIONS	8
6.1	TEMPERATURE & HUMIDITY.....	8
7.	LIST OF TEST EQUIPMENT AND TEST FACILITY.....	9
7.1	LIST OF TEST EQUIPMENT	9
8.	TEST RESULTS	10
8.1	POWER AT THE FINAL AMPLIFIER.....	11
8.2	RF OUTPUT POWER	12
8.3	BANDWIDTH & EMISSION	13
8.3.1	<i>Bandwidth Plot, 99%, 9390 MHz, 64 nm.....</i>	<i>15</i>
8.3.2	<i>Bandwidth Plot, 99%, 9390 MHz, 0.125 nm.....</i>	<i>16</i>
8.3.3	<i>Bandwidth Plot, 99%, 9390 MHz, 1.5 nm.....</i>	<i>17</i>
8.3.4	<i>Bandwidth Plot, 99%, 9390 MHz, 6 nm.....</i>	<i>18</i>
8.3.5	<i>Bandwidth Plot, 99%, 9434 MHz, 0.5 nm.....</i>	<i>19</i>
8.3.6	<i>Bandwidth Plot, 99%, 9434 MHz, 2 nm.....</i>	<i>20</i>
8.3.7	<i>Bandwidth Plot, 99%, 9452 MHz, 0.75 nm.....</i>	<i>21</i>
8.3.8	<i>Bandwidth Plot, 99%, 9476 MHz, 4 nm.....</i>	<i>22</i>
8.3.9	<i>Bandwidth Plot, 99%, 9496 MHz, 12 nm.....</i>	<i>23</i>
8.4	EMISSION LIMITATIONS, IN-BAND.....	24
8.4.1	<i>Emission Mask, 9390 MHz, 64 nm.....</i>	<i>25</i>
8.4.2	<i>Emission Mask, 9390 MHz, 0.125 nm.....</i>	<i>26</i>
8.4.3	<i>Emission Mask, 9390 MHz, 1.5 nm.....</i>	<i>27</i>
8.4.4	<i>Emission Mask, 9390 MHz, 6 nm.....</i>	<i>28</i>
8.4.5	<i>Emission Mask, 9434 MHz, 0.5 nm.....</i>	<i>29</i>
8.4.6	<i>Emission Mask, 9434 MHz, 2 nm.....</i>	<i>30</i>



8.4.7	<i>Emission Mask, 9452 MHz, 0.75 nm</i>	31
8.4.8	<i>Emission Mask, 9476 MHz, 4 nm</i>	32
8.4.9	<i>Emission Mask, 9496 MHz, 12 nm</i>	33
8.5	EMISSION LIMITATIONS, OUT-OF-BAND	34
8.5.1	<i>Conducted Emissions, Below 1 GHz, 9390 MHz, 64 nm</i>	35
8.5.2	<i>Conducted Emissions, Above 1 GHz, 9390 MHz, 64 nm</i>	36
8.5.3	<i>Conducted Emissions, Above 9 GHz, 9390 MHz, 64 nm</i>	37
8.5.4	<i>Conducted Emissions, Below 1GHz, 9496 MHz, 12 nm</i>	38
8.5.5	<i>Conducted Emissions, Above 1 GHz, 9496 MHz, 12 nm</i>	39
8.5.6	<i>Conducted Emissions, Above 9 GHz, 9496 MHz, 12 nm</i>	40
8.6	RADIATED EMISSIONS	41
8.6.1	<i>Radiated Emissions, 9390 MHz</i>	42
8.6.2	<i>Radiated Emissions, 9496 MHz</i>	43
8.7	MODULATION CHARACTERISTICS	44
8.7.1	<i>Audio Frequency Response</i>	44
8.7.2	<i>Low Pass Filter Response</i>	44
8.7.3	<i>Modulation Limiting</i>	44
8.8	FREQUENCY STABILITY	45
8.8.1	<i>Frequency Stability Data</i>	46
8.8.2	<i>Frequency Stability Plot</i>	47
8.9	TRANSIENT FREQUENCY BEHAVIOR	48
8.10	ADJACENT CHANNEL POWER LIMITS	49
9.	ANNEX-A - PHOTOGRAPHS OF THE EUT	50
10.	ANNEX-B – TEST SETUP PHOTOGRAPHS	50
11.	HISTORY OF TEST REPORT CHANGES	50

1. Customer Information

Applicant: Navico Inc.
Address: 4500 S. 129th East Avenue
 Suite 200
 Tulsa, Ok.,74134-5885, United States

1.1 Part 80 Test Result Summary

The following test procedure and guidance were used for measuring FCC PART 80 (STATIONS IN THE MARITIME SERVICES) known as Licensed Maritime Radiotelephone; ANSI C63.26-2015. Full test results are available in this report.

Applicable Clauses from Part 2		
FCC Clauses	Description of the requirements	Result: (Pass, Fail, N/A)
2.202	Bandwidth & Emission	Pass
2.1033 (c)(8)	Power at the Final Amplifier	Reported
2.1046 (a)	RF Output Power	Pass
2.1047	Modulation characteristics	n/a
2.1049	Occupied Bandwidth	Pass
2.1051	Spurious emissions at antenna terminals	Pass
2.1053	Field strength of spurious radiation	Pass
2.1055	Frequency stability	Pass

Applicable Clauses from Part 80		
FCC Clauses	Description of the requirements	Result: (Pass, Fail, N/A)
80.205 (a), (d)	Bandwidths & Emission designator	Reported
80.209 (c)	Transmitter Frequency Tolerance	Pass
80.211 (f)	Emission Limitations, In-band	Pass
80.211 (f)	Emission Limitations, Out-of-band	Pass
80.213 (g)	Modulation Requirements	n/a
80.215 (a) (3), (n) (3)	Transmitter Power	Pass

No additions to the test methods were needed. There were no deviations, or exclusions from the test methods. No test results are from external providers or from the customer. The test results relate only to the items tested. Timco does not offer opinions and interpretations, only a pass/fail statement.

2. Location of Testing

2.1 Test Laboratory

Timco Engineering Inc. is a subsidiary of Industrial Inspection & Analysis, Inc. ("IIA").
Testing was performed at Timco's permanent laboratory located at 849 NW State Road 45, Newberry, Florida 32669

FCC test firm # 578780
FCC Designation # US1070
FCC site registration is under A2LA certificate # 0955.01
ISED Canada test site registration # 2056A
EU Notified Body # 1177
For all designations see A2LA scope # 0955.01

2.2 Testing was performed, reviewed by

Dates of Testing: 10/29/2021 – 11/18/2021

Signature:

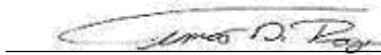

Sr. EMC Engineer
EMC-003838-NE



Name & Title:

Tim Royer, EMC Engineer

Date of Signature

6/8/2022

Signature:



Name & Title:

Kristoffer Costa, EMC Technician

Date of Signature

6/8/2022

3. Test Sample(s) (EUT/DUT)

The test sample was received: 10/29/2021

3.1 Description of the EUT

A description as well as unambiguous identification of the EUT(s) tested. Where more than one sample is required for technical reasons (such as the use of connected units for the purpose of conducted output power testing where the product units will have integral antennas), each specific test shall identify which unit was tested.

Identification	
FCC ID:	RAYHALO2000
Brief Description	SIMRAD HALO 2000 SERIES Pulse Compression Radar
Model(s) #	HALO 2000 SERIES
Firmware version	8.1.99.91
Software version	8.1.99.91
Serial Number	2106950004

Technical Characteristics	
Technology	Pulse Compression Radar
Frequency Range	9.3 GHz-9.5 GHz
RF O/P Power (Max.)	50W
Modulation	Pulse/ FM Chirp
Bandwidth & Emission Class	PON
Antenna Connector	WR90
Voltage Rating (AC or Batt.)	12V DC

Antenna Characteristics			
Antenna	Frequency Range	Mode / BW	Antenna Gain
1	9.39-9.50GHz	3 ft	26 dBi
	9.39-9.50GHz	4 ft	27.2 dBi
	9.39-9.50GHz	6 ft	29 dBi

3.2 Configuration of EUT

Test Modes				
Mode (#)	Mode (Type)	Test Frequencies (MHz)	BW (nominal) (MHz)	Emission Designator
1	Transmit	9390 9408 9452 9476 9496	100.16	PON

* Standard operating mode was considered worst case as compared to Bird Mode.

Operating conditions during Testing:

The device was operated without the provided antenna(s).

No other modifications of the device under test (including firmware, specific software settings, and input/output signal levels to the EUT) were made.

Peripherals used during Testing:

A laptop was used to program the EUT.

3.3 Test Setup of EUT

Equipment, antenna, and cable arrangement. The setup of the equipment and cable or wire placement on the test site that produces the highest radiated and the highest ac power line conducted emissions shall be shown clearly and described. Information on the orientation of portable equipment during testing shall be included. Drawings or photographs may be used for this purpose.

Test Setups are included in the test report.

4. Test methods & Applicable Regulatory Limits

4.1 Test methods/Standards/Guidance:

Test procedures and guidance for measuring Licensed Part 80 Licensed device:

- 1) ANSI C63.26-2015
- 2) ITU-R M.1177-3 (per 80.273 (a) (6))

4.2 Applied Limits and Regulatory Limits:

- 1) FCC CFR 47 Part 80

5. Measurement Uncertainty

Parameter	Uncertainty (dB)
Conducted Emissions	± 3.14 dB
Radiated Emissions (9kHz – 30 MHz)	± 3.08 dB
Radiated Emissions (30 – 200 MHz)	± 2.16 dB
Radiated Emissions (200 – 1000 MHz)	± 2.15 dB
Radiated Emissions (1 GHz – 18 GHz)	± 2.14 dB
Radiated Emissions (18 GHz – 40 GHz)	± 2.31 dB
Note: The uncertainties provided in this table represent an expanded uncertainty expressed at approximately the 95% confidence level using a coverage factor of K=2.	

6. Environmental Conditions

6.1 Temperature & Humidity

Measurements performed at the test site did not exceed the following:

Parameter	Measurement
Temperature	23 C +/- 5%
Humidity	55% +/- 5%
Barometric Pressure	30.05 in Hg
Note: Specific environmental conditions that are applicable to a specific test are available in the test result section.	

7. List of Test Equipment and Test Facility

The test equipment used identified by type, manufacturer, serial number, or other identification and the date on which the next calibration or service check is due.

Description of the firmware or software used to operate EUT for testing purposes.

A complete list of all test equipment used shall be included with the test report. The manufacturer's model and serial numbers, and date of last calibration, and calibration interval shall be included. Measurement cable loss, measuring instrument bandwidth and detector function, video bandwidth, if appropriate, and antenna factors shall also be included where applicable.

7.1 List of Test Equipment

Test Equipment						
Type	Device	Manufacturer	Model	SN#	Current Cal	Cal Due
Antenna, NSA	Log-Periodic 1243	Eaton	96005	1243	5/4/21	5/3/2024
Antenna	Double-Ridged Horn/ETS Horn 1	ETS-Lindgren	3117	00035923	2/25/20	2/24/2023
CHAMBER	CHAMBER	Panashield	3M	N/A	3/12/19	3/11/2022
Pre-amp	Pre-amp	RF-LAMBDA	RLNA00M45GA	NA	2/27/19	2/26/2022
Receiver	EMI Test Receiver R&S ESU 40	Rohde & Schwarz	ESU 40	100320	5/27/21	5/26/2024
Function Generator	Function Generator	Standford	DS340	25200	1/13/21	1/13/2024
Thermometer	Type K J Thermometer	Martel	303	080504494	1/18/20	1/17/2023
Signal Generator	Signal Generator HP 8648C	HP	8648C	3847A04696	3/31/21	3/30/2024
Antenna	Biconical 1057	Eaton	94455-1	1057	10/16/20	10/16/2023

Software			
Software	Author	Version	Validation on
ESU Firmware	Rohde & Schwarz	4.43 SP3; BIOS v5.1-24-3	2018
RSCCommander	Rohde & Schwarz	1.6.4	2014
ScopeExplorer	LeCroy	v2.25.0.0	2009
Field Strength	Timco	v4.10.7.0	2016

8. Test Results

The results of the test are usually indicated in the form of tables, spectrum analyzer plots, charts, sample calculations, as appropriate for each test procedure.

A description and/or a block diagram of the test setup is usually provided.

The measurement results, along with the appropriate limits for comparison, may be presented in tabular or graphical form. In addition, any variation in the measurement environment may be reported if applicable (e.g., a significant change of temperature that could affect the cable loss and amplifier response).

Units of measurement

Unless noted otherwise in the referenced standard, the measurements of ac power-line conducted emissions and conducted power output will be reported in units of dB μ V. Unless noted otherwise in the referenced standard, the measurements of radiated emissions will be reported in units of decibels, referenced to one microvolt per meter (dB μ V/m) for electric fields, or to one ampere per meter (dBA/m) for magnetic fields, at the distance specified in the appropriate standards or requirements. The measurements of antenna-conducted power for receivers may be reported in units of dB μ V if the impedance of the measuring instrument is also reported. Otherwise, antenna-conducted power will be reported in units of decibels referenced to one milliwatt (dBm). All formulas for data conversions and conversion factors, if used, will be included in this measurement report.

Example:

Freq (MHz)	Meter Reading	+ ACF	+CL	= FS
33	20 dB μ V	+ 10.36 dB/m	+0.40 dB	=30.36 dB μ V/m @ 3m

EIRP = Pcond (dBm) + dBi

8.1 Power at the Final Amplifier

Limits from FCC Part 2.1033 (c)(8).

No method of measurement is specified. The result has been calculated based on all available information.

Test Results		
EUT Operating Voltage (V)	EUT Current (A)	Power at the Final Amplifier
12	4.17	50W

8.2 RF Output Power

Limits from FCC Parts 2.1046(a), 80.215 (a) (3), (n) (3), 87.131 footnote 4, and 90.205 (r); and test procedure from ANSI C63.26-2015.

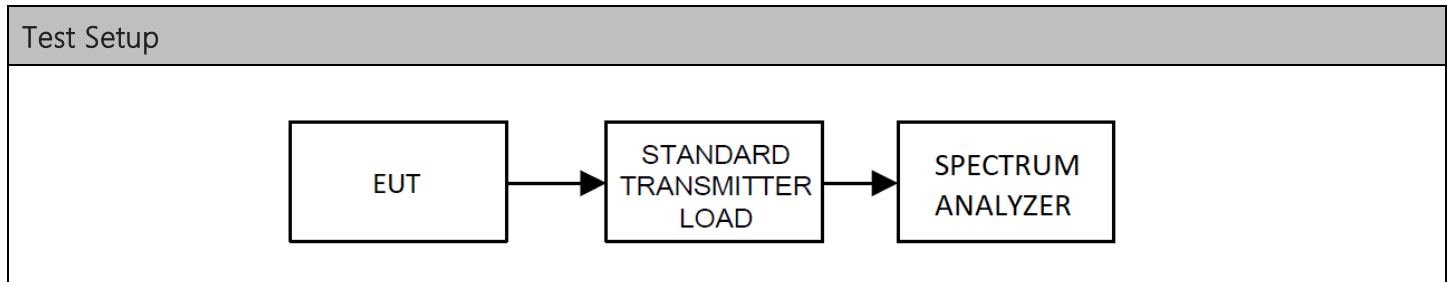

Mode	Center Freq (MHz)	Duty Cycle (%)	Mesured Output (dBm)	Loss (dBm)	Mean Power (dBm)	Mean Power (W)	Peak Power (W)
64 nm	9390.00	6.84%	-9.180	42.600	33.420	2.198	32.132
0.125 nm	9390.00	0.01%	-35.120	42.600	7.480	0.006	55.976
1.5 nm	9390.00	2.41%	-12.400	42.600	30.200	1.047	43.449
6 nm	9390.00	9.69%	-6.900	42.600	35.700	3.715	38.342
0.5 nm	9434.00	0.49%	-17.300	42.600	25.300	0.339	69.152
2nm	9434.00	6.25%	-9.700	42.600	32.900	1.950	31.198
0.75 nm	9452.00	2.41%	-12.200	42.600	30.400	1.096	45.497
4nm	9476.00	9.69%	-7.140	42.600	35.460	3.516	36.281
12 nm	9496.00	9.81%	-7.300	42.600	35.300	3.388	34.541

Note: The mean power was calculated based on formula:

$$P_a = P_m * DC$$

8.3 Bandwidth & Emission

Limits from FCC Parts 2.1049, 80.205 (a) and test procedure from ANSI C63.26-2015.

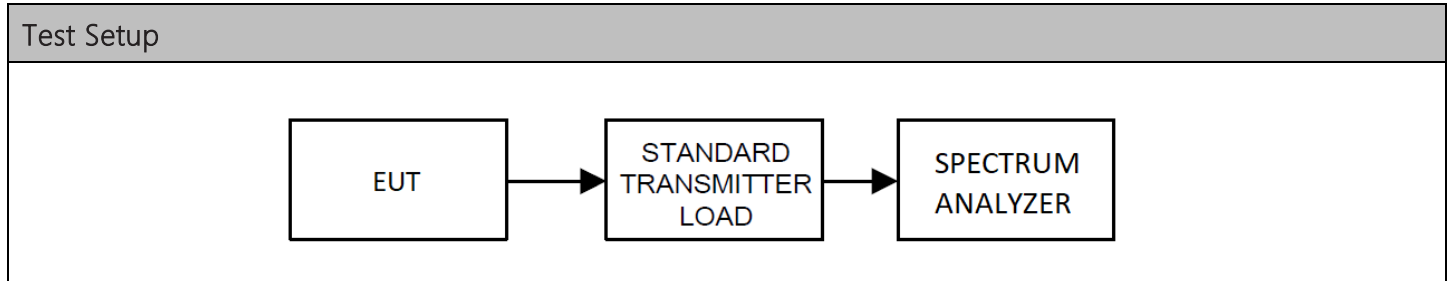

Test Results, Authorized Bandwidth		
Rule Part	Operating Range	Authorized Bandwidth
Part 80	9.3 – 9.5 GHz	200 MHz

Test Results, Occupied Bandwidth		
Tuned Frequency (MHz)	Occupied Bandwidth (MHz)	Bandwidth Type
9390, 64 nm	100.16	99%
9390, 0.125 nm	67.30	99%
9390, 1.5 nm	68.75	99%
9390, 6 nm	88.46	99%
9434, 0.5 nm	35.81	99%
9434, 2 nm	67.30	99%
9452, 0.75 nm	68.75	99%
9476, 4 nm	88.94	99%
9496, 12 nm	96.15	99%

8.3.1 Bandwidth Plot, 99%, 9390 MHz, 64 nm

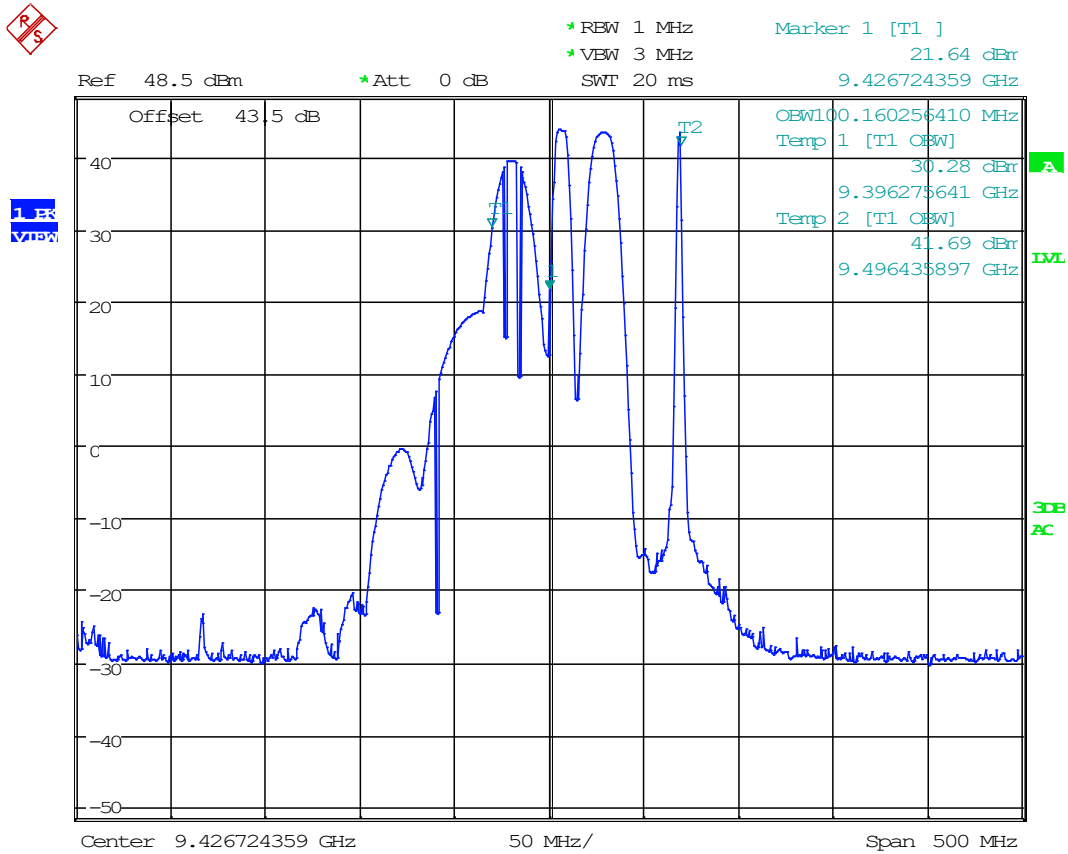

Date: 14.DEC.2021 12:11:32

8.3.2 Bandwidth Plot, 99%, 9390 MHz, 0.125 nm

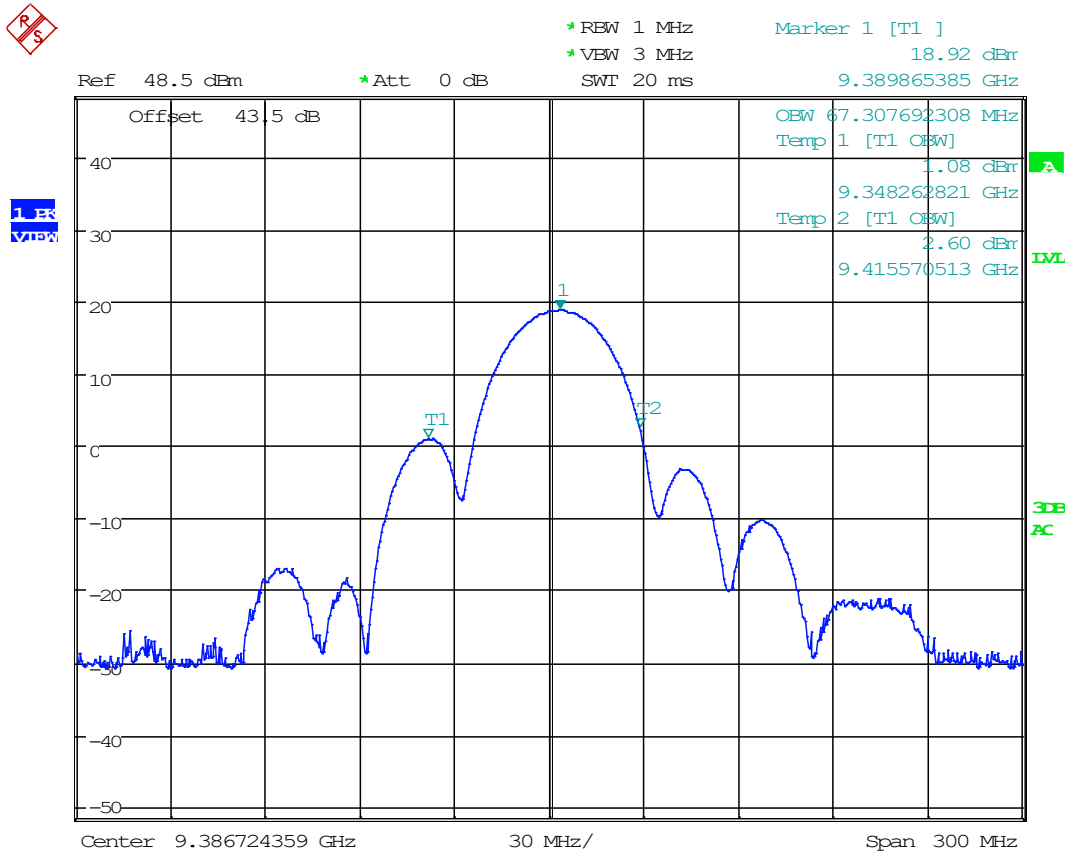

Date: 14.DEC.2021 12:15:17

8.3.3 Bandwidth Plot, 99%, 9390 MHz, 1.5 nm

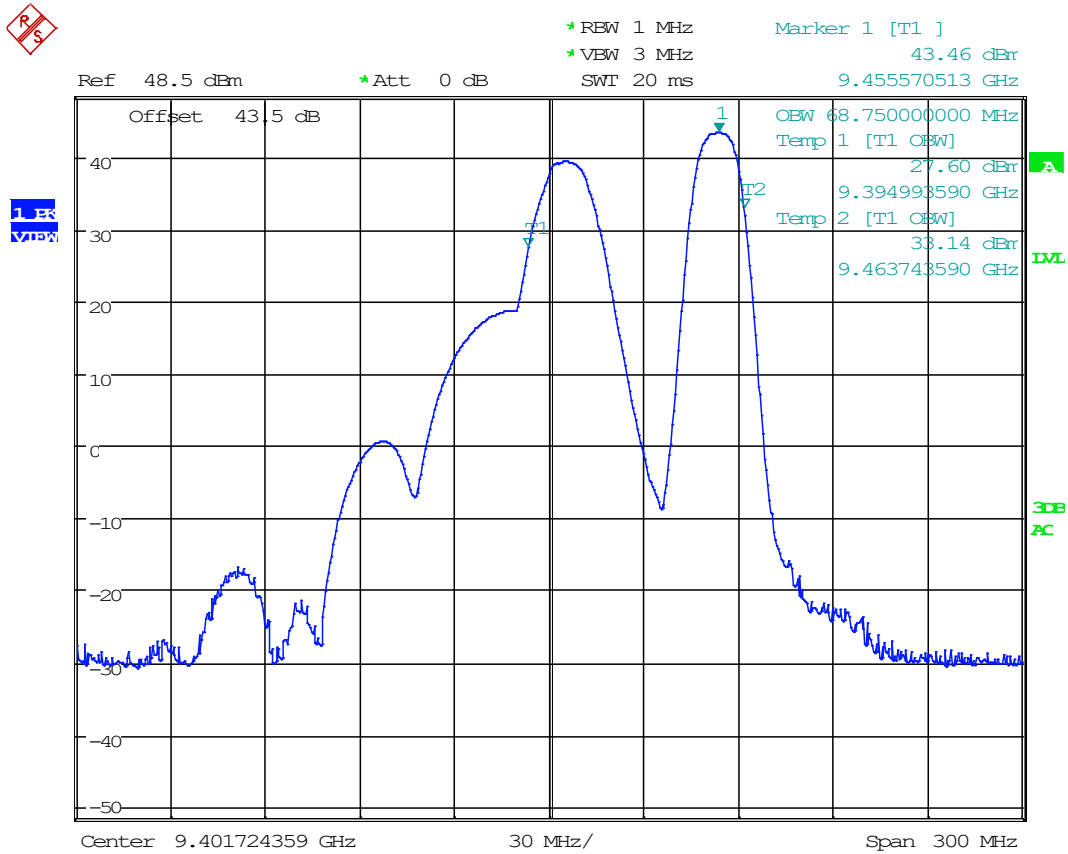

Date: 14.DEC.2021 12:17:05

8.3.4 Bandwidth Plot, 99%, 9390 MHz, 6 nm

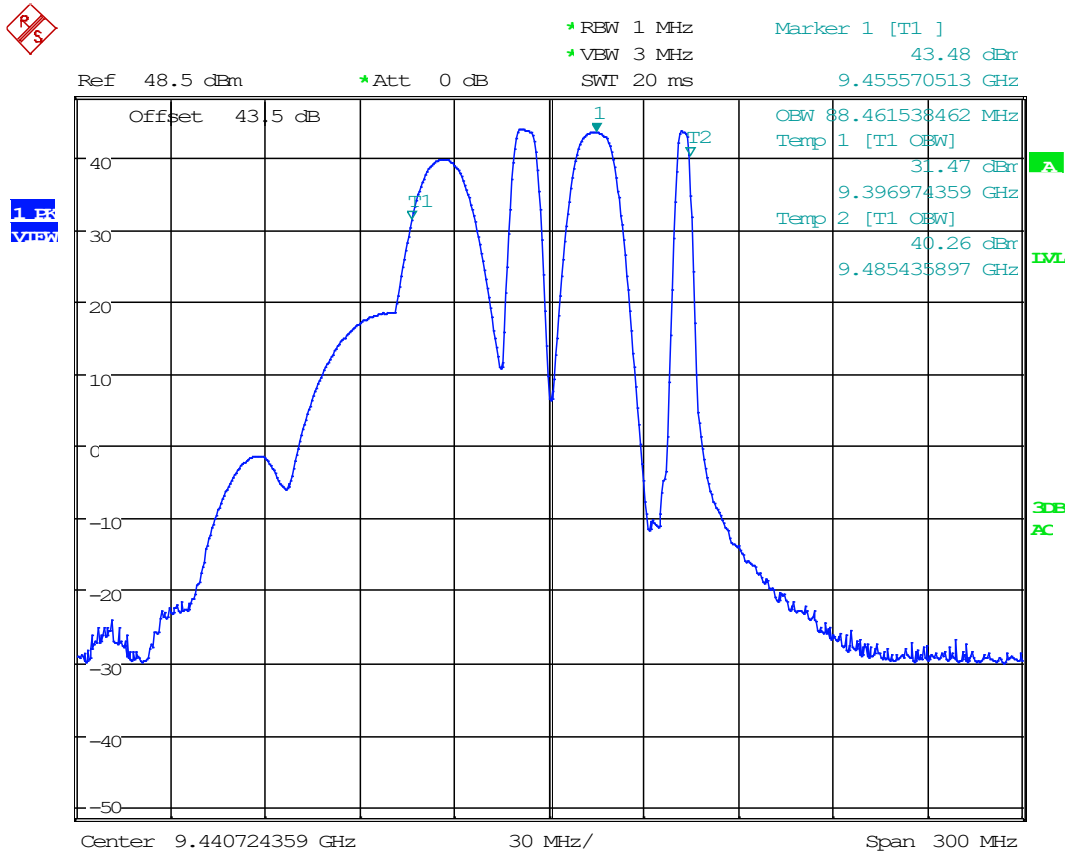

Date: 14.DEC.2021 12:17:53

8.3.5 Bandwidth Plot, 99%, 9434 MHz, 0.5 nm

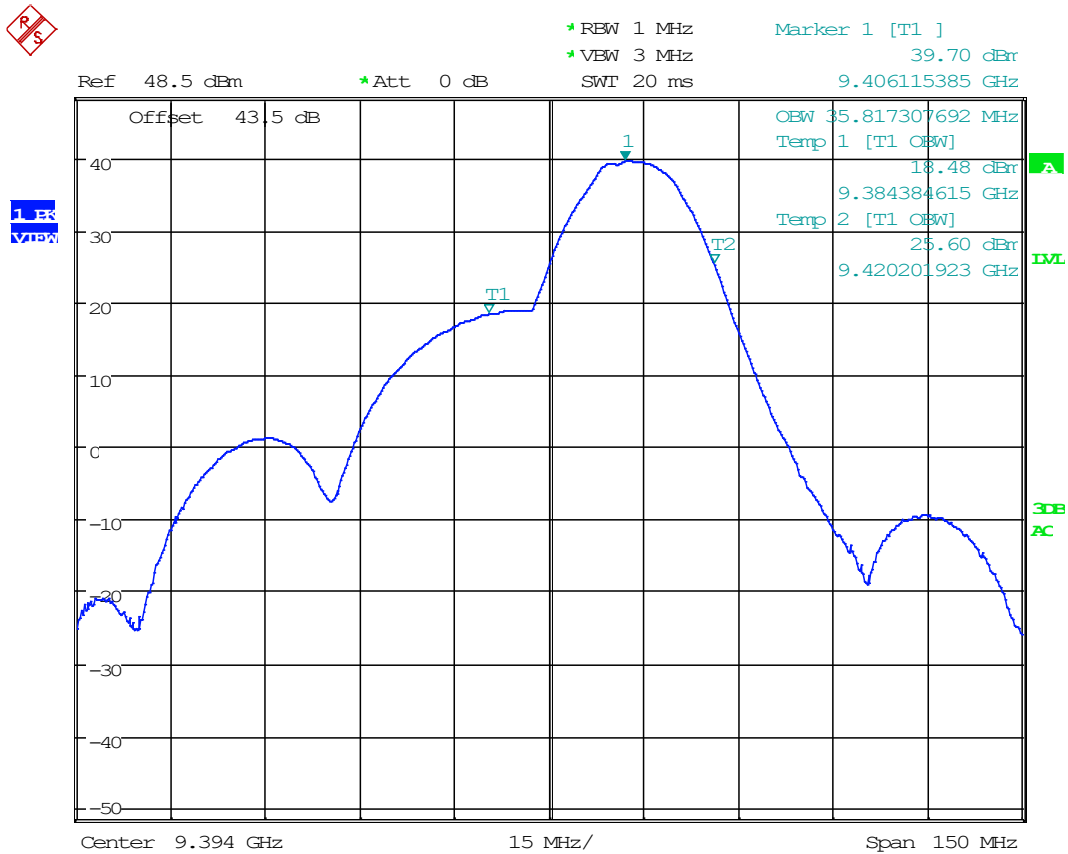

Date: 14.DEC.2021 12:20:29

8.3.6 Bandwidth Plot, 99%, 9434 MHz, 2 nm

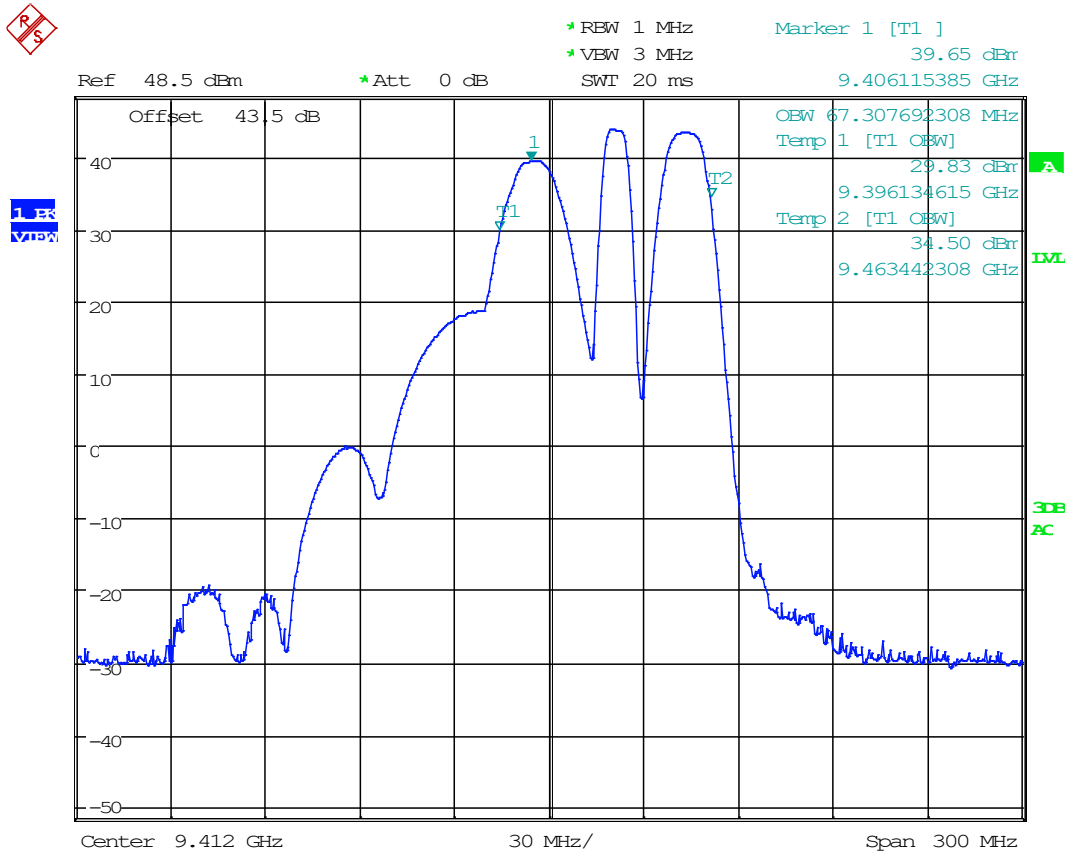

Date: 14.DEC.2021 12:21:31

8.3.7 Bandwidth Plot, 99%, 9452 MHz, 0.75 nm

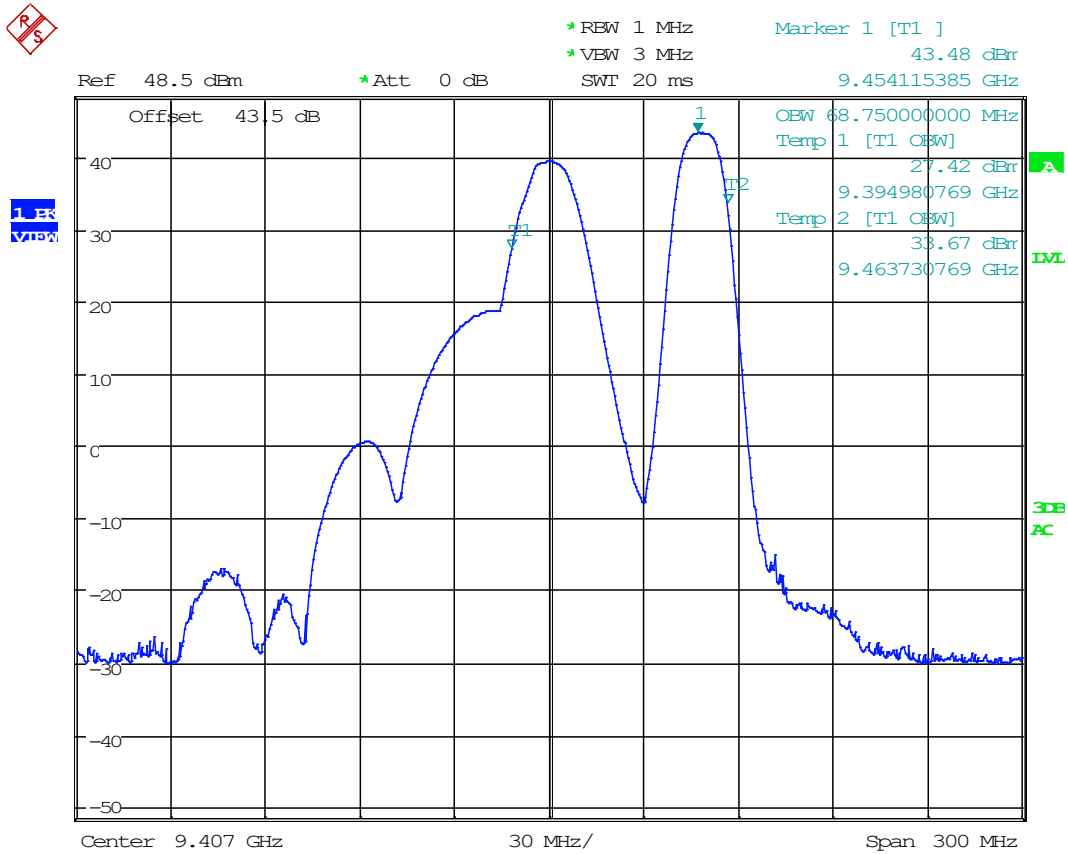

Date: 14.DEC.2021 12:23:27

8.3.8 Bandwidth Plot, 99%, 9476 MHz, 4 nm

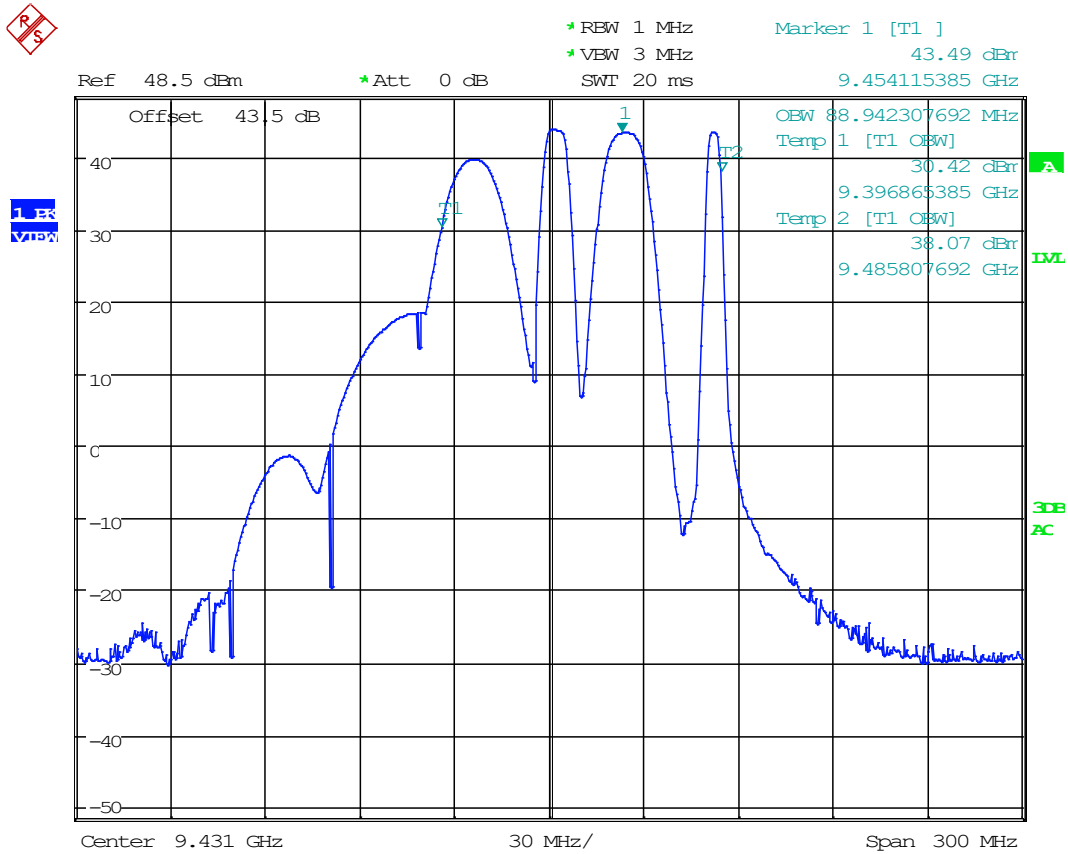

Date: 14.DEC.2021 12:24:20

8.3.9 Bandwidth Plot, 99%, 9496 MHz, 12 nm

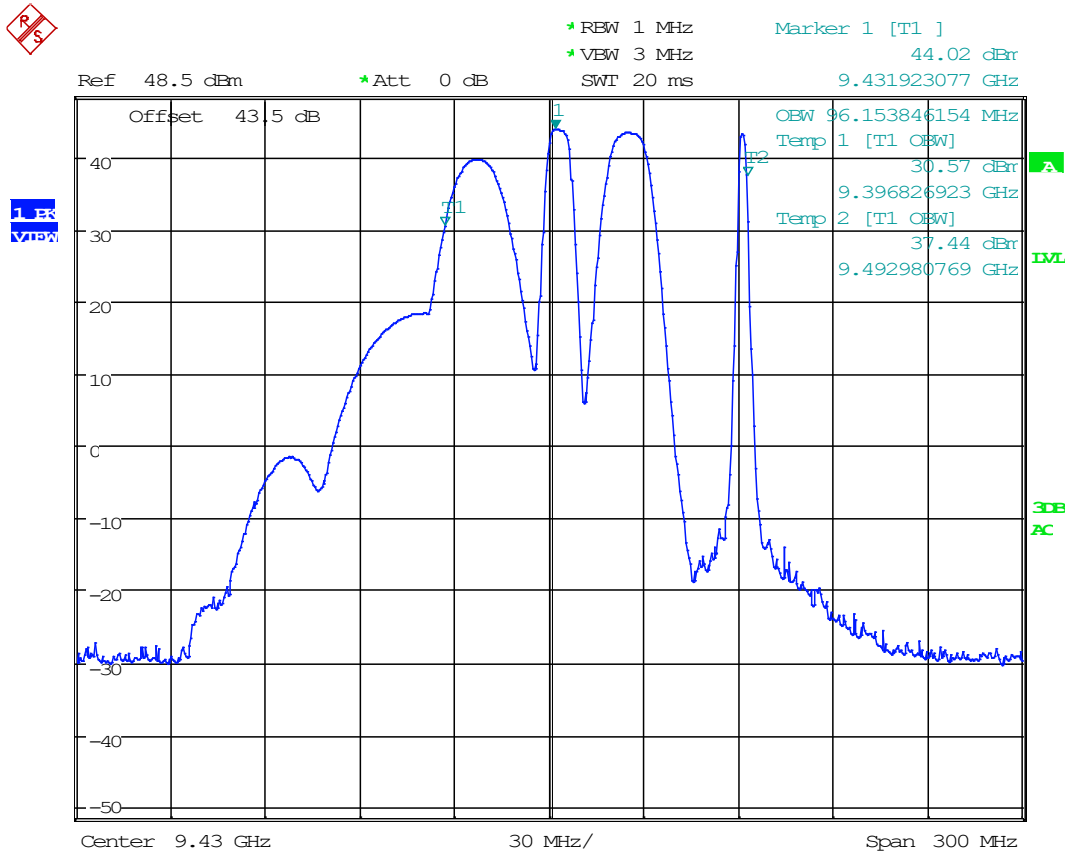

Date: 14.DEC.2021 12:27:30

8.4 Emission Limitations, In-Band

Limits from FCC Parts 80.211 (f) and test procedure from ANSI C63.26-2015.

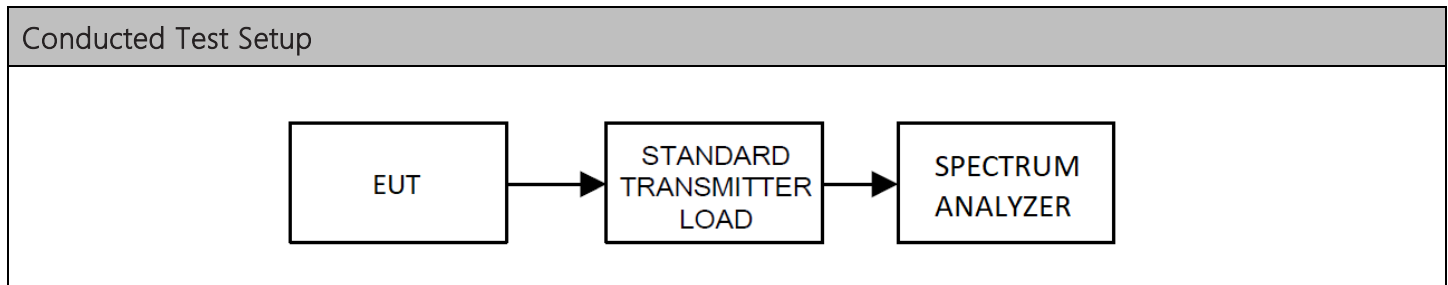

8.4.2 Emission Mask, 9390 MHz, 0.125 nm

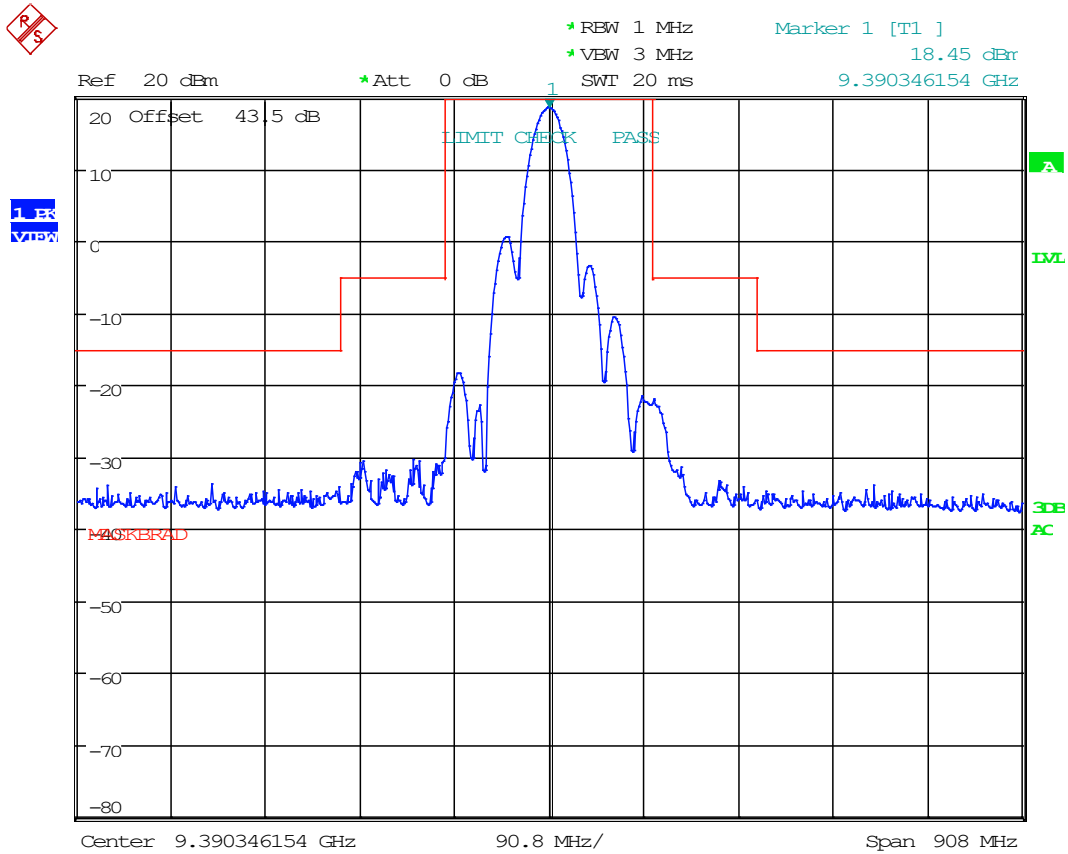

Date: 14.DEC.2021 12:09:13

8.4.3 Emission Mask, 9390 MHz, 1.5 nm

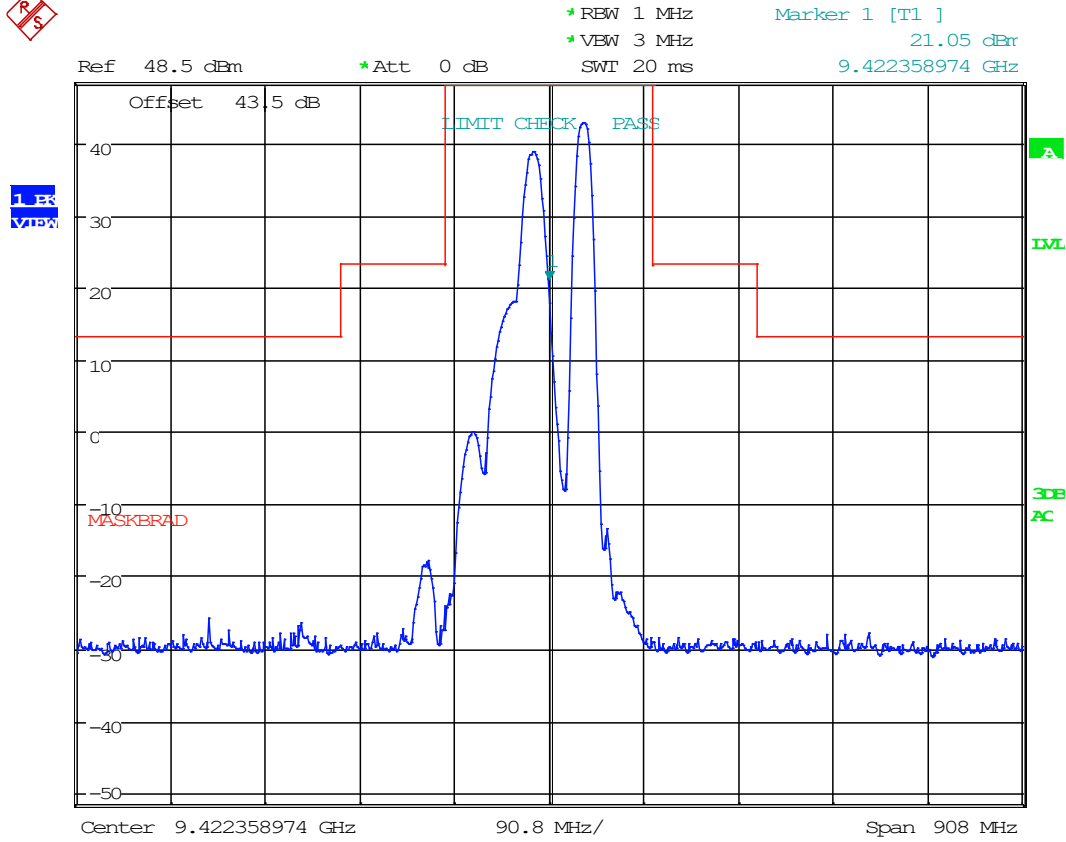

Date: 14.DEC.2021 12:08:33

8.4.4 Emission Mask, 9390 MHz, 6 nm

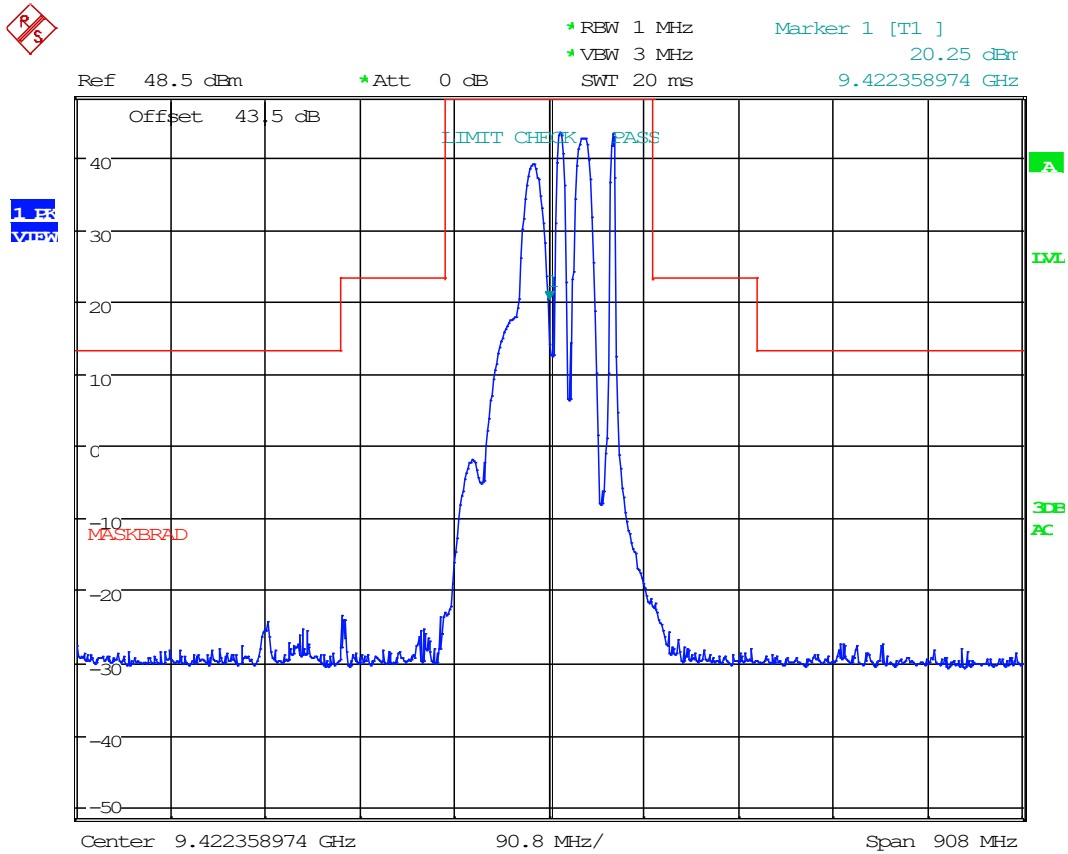

Date: 14.DEC.2021 12:08:00

8.4.5 Emission Mask, 9434 MHz, 0.5 nm

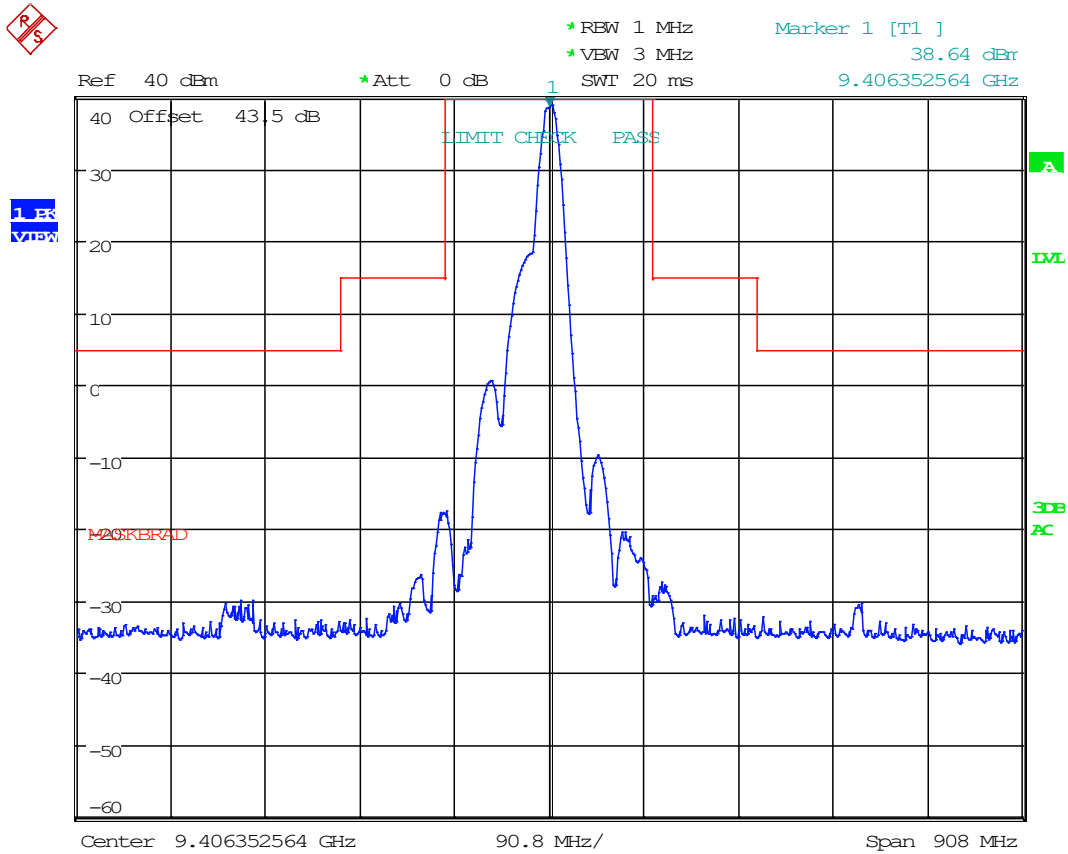

Date: 14.DEC.2021 12:07:10

8.4.6 Emission Mask, 9434 MHz, 2 nm

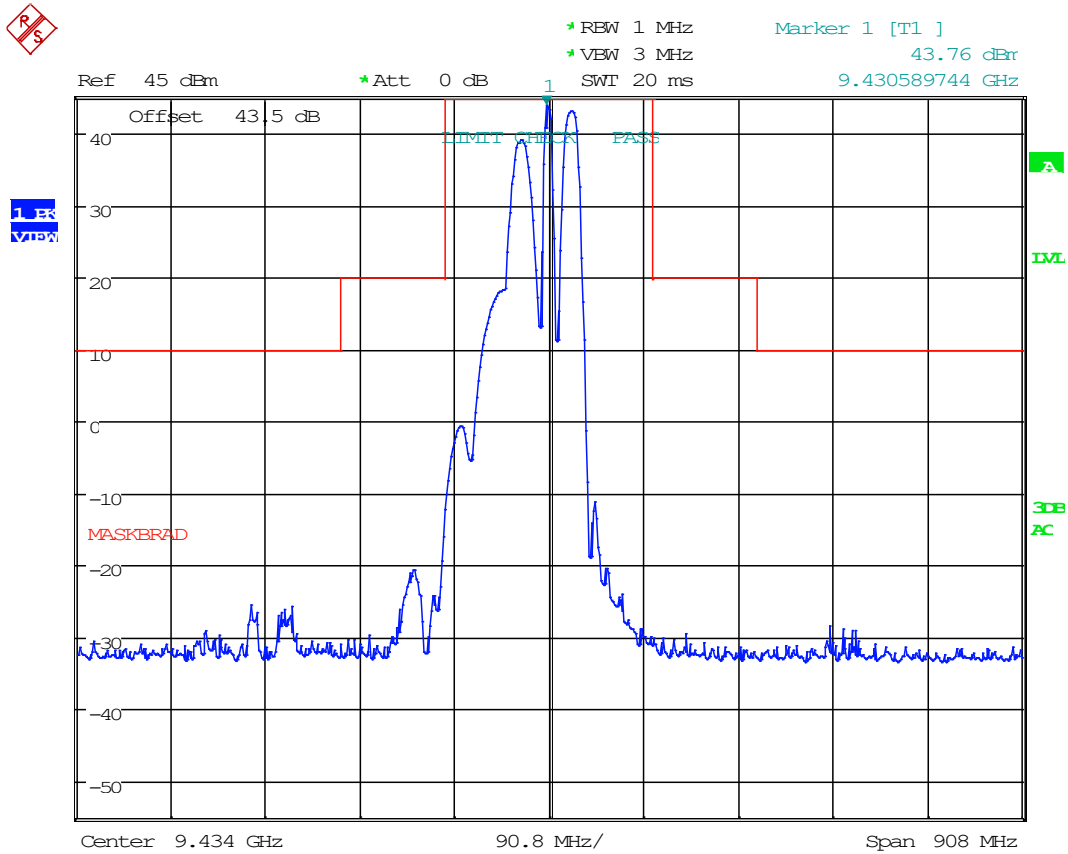

Date: 14.DEC.2021 12:06:30

8.4.8 Emission Mask, 9476 MHz, 4 nm

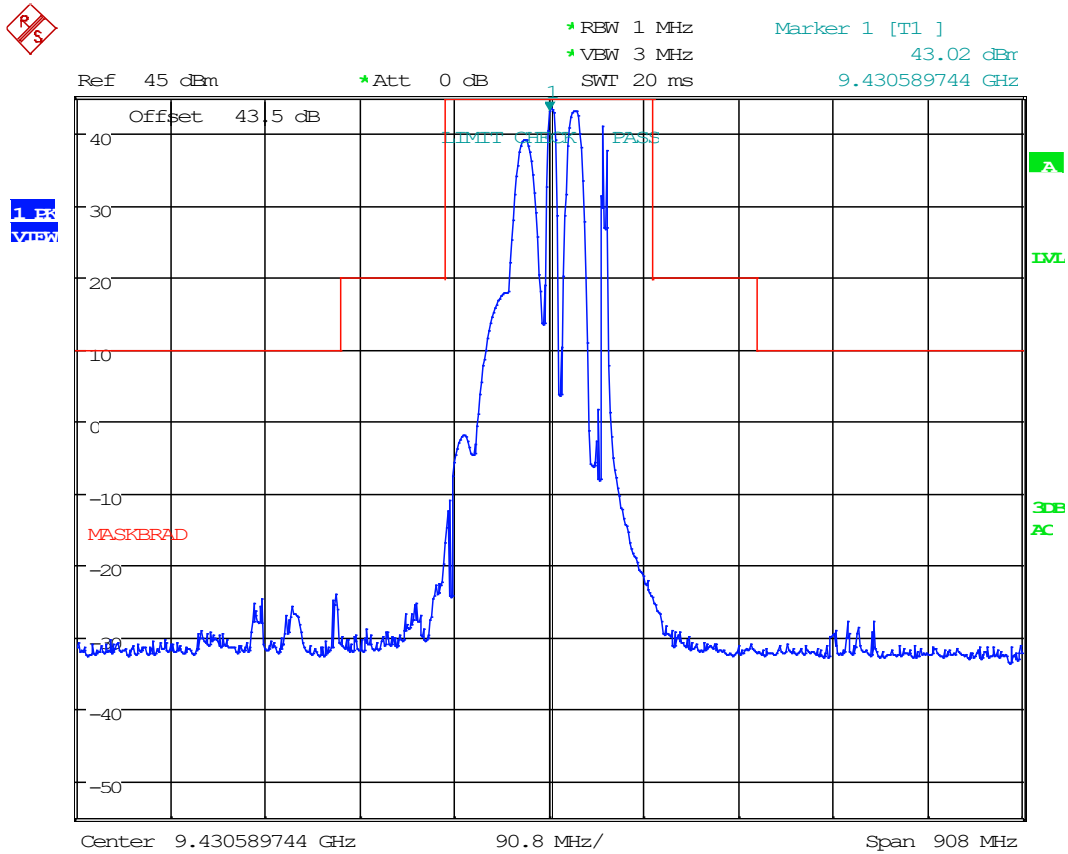

Date: 14.DEC.2021 12:05:07

8.4.9 Emission Mask, 9496 MHz, 12 nm

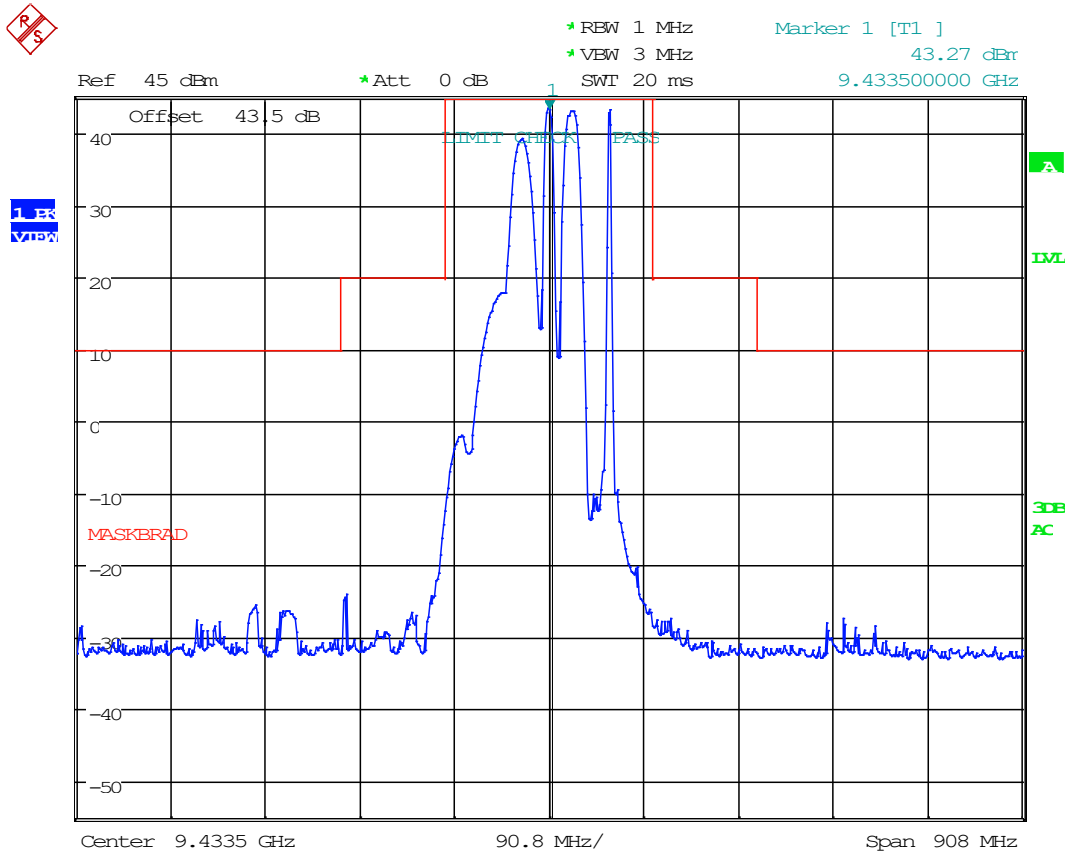

Date: 14.DEC.2021 12:04:00

8.5 Emission Limitations, Out-of-Band

Limits from FCC Parts 2.1051, 80.211 (f) and test procedure from ANSI C63.26-2015.

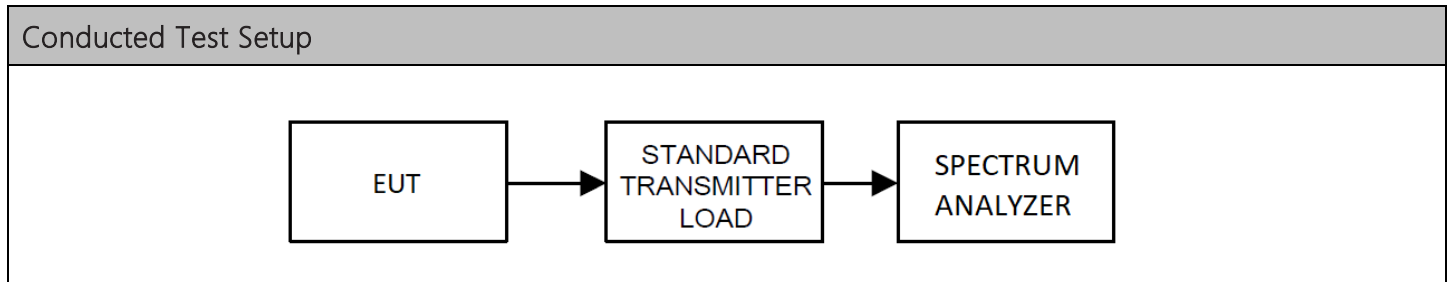

8.5.1 Conducted Emissions, Below 1 GHz, 9390 MHz, 64 nm

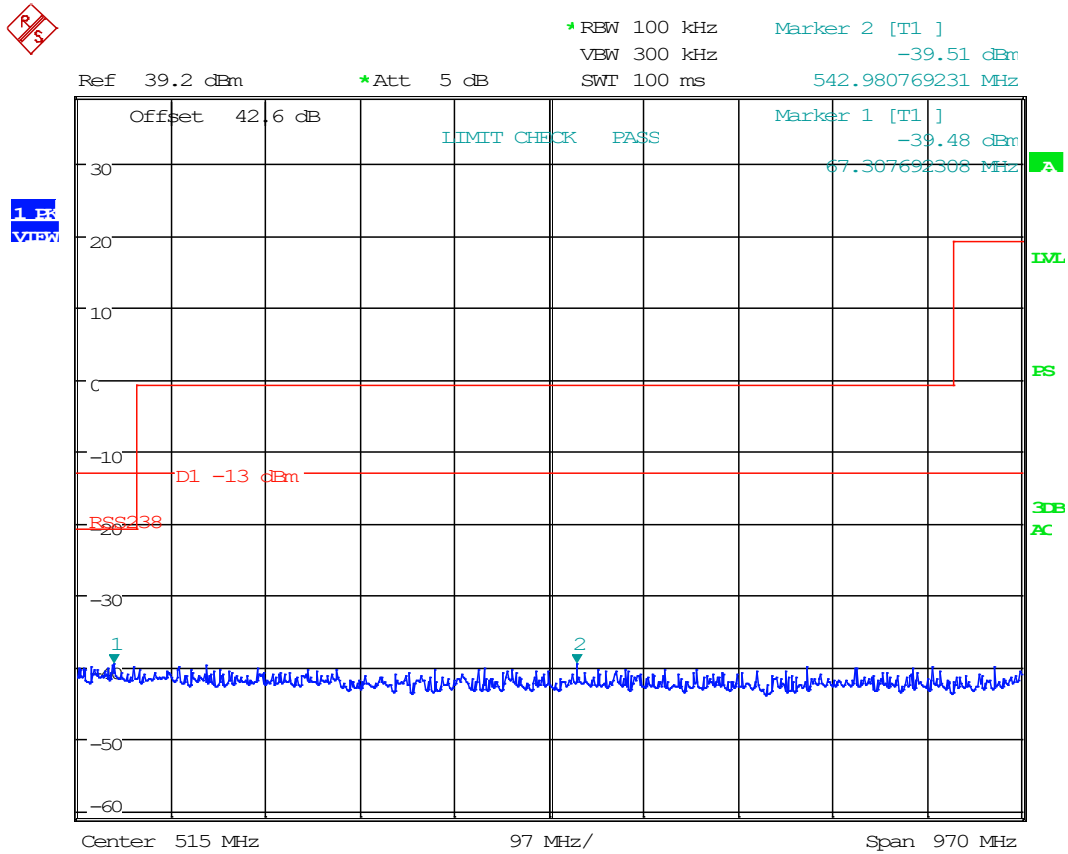

Date: 15.NOV.2021 10:24:07

8.5.2 Conducted Emissions, Above 1 GHz, 9390 MHz, 64 nm

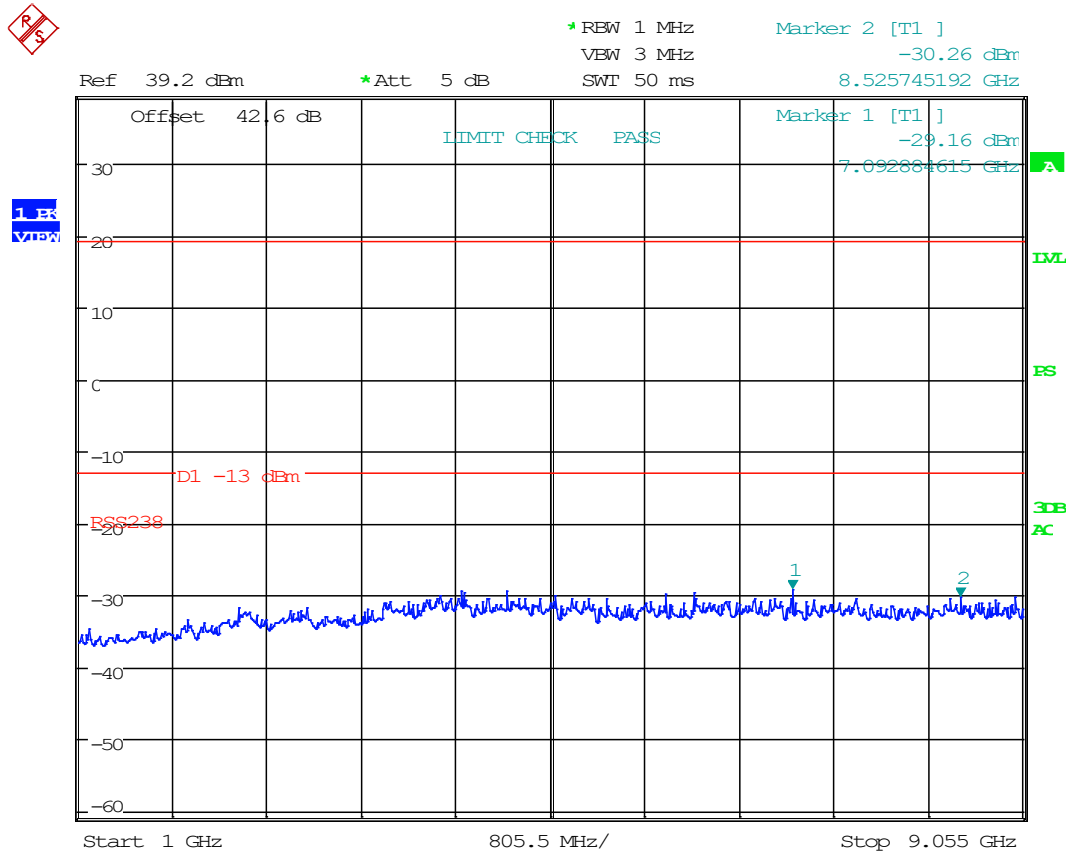

Date: 15.NOV.2021 10:40:27

8.5.3 Conducted Emissions, Above 9 GHz, 9390 MHz, 64 nm

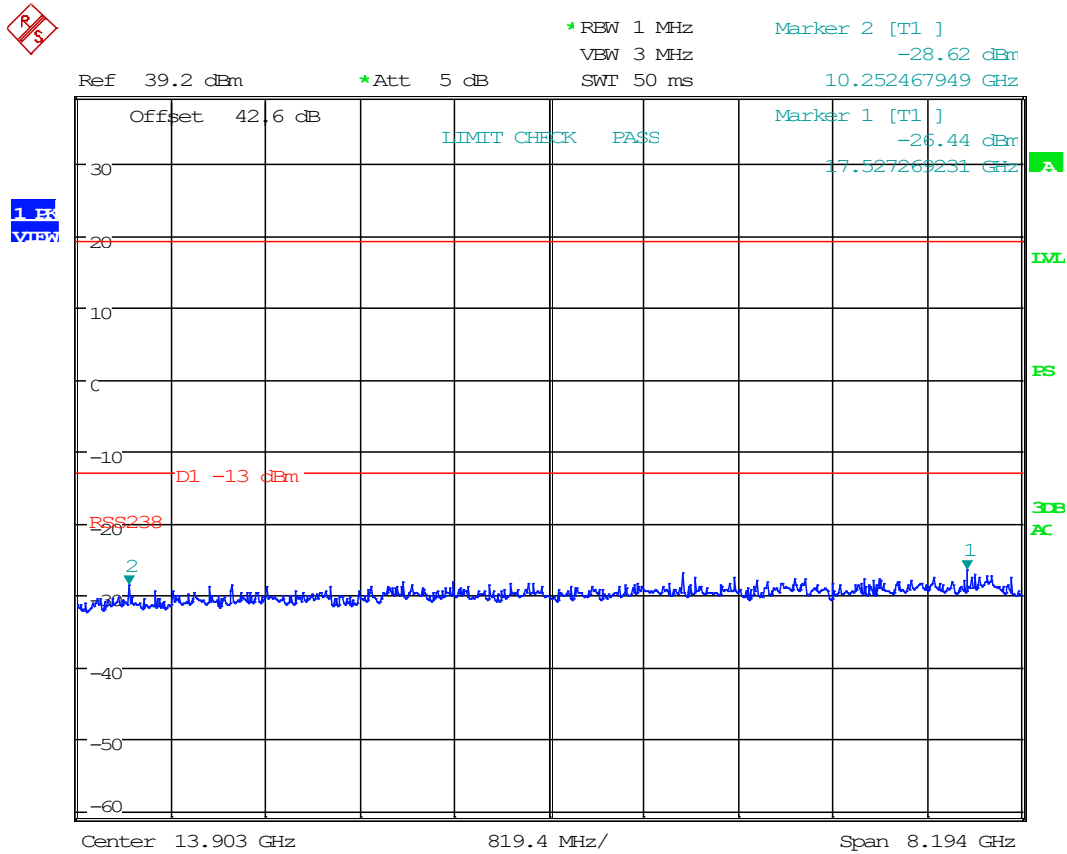

Date: 15.NOV.2021 10:38:59

8.5.4 Conducted Emissions, Below 1GHz, 9496 MHz, 12 nm

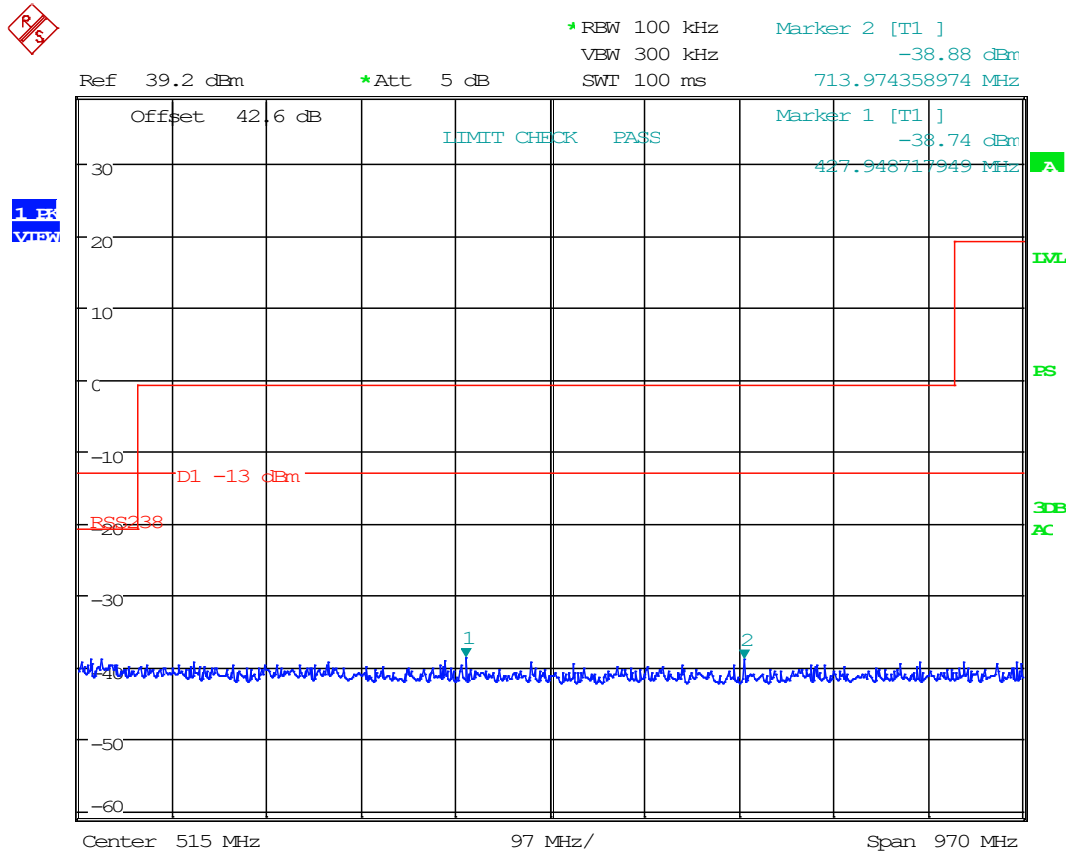

Date: 15.NOV.2021 10:13:30

8.5.5 Conducted Emissions, Above 1 GHz, 9496 MHz, 12 nm

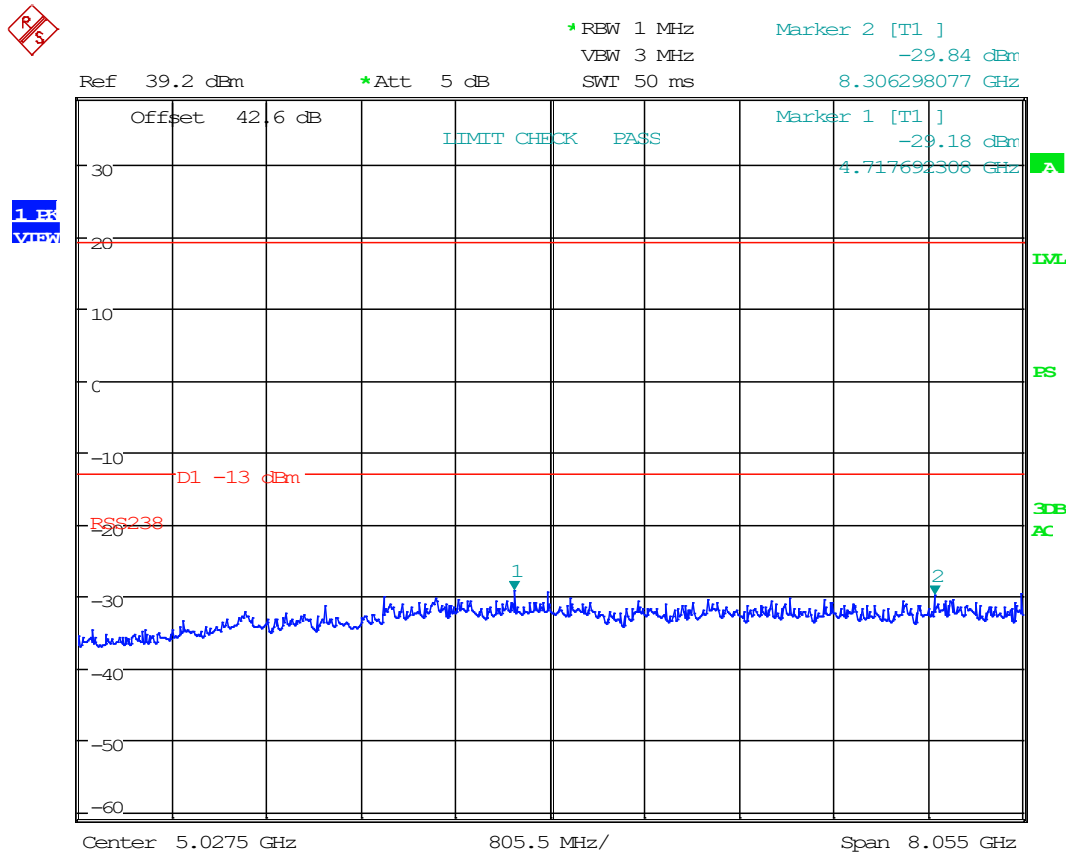

Date: 15.NOV.2021 10:41:18

8.5.6 Conducted Emissions, Above 9 GHz, 9496 MHz, 12 nm

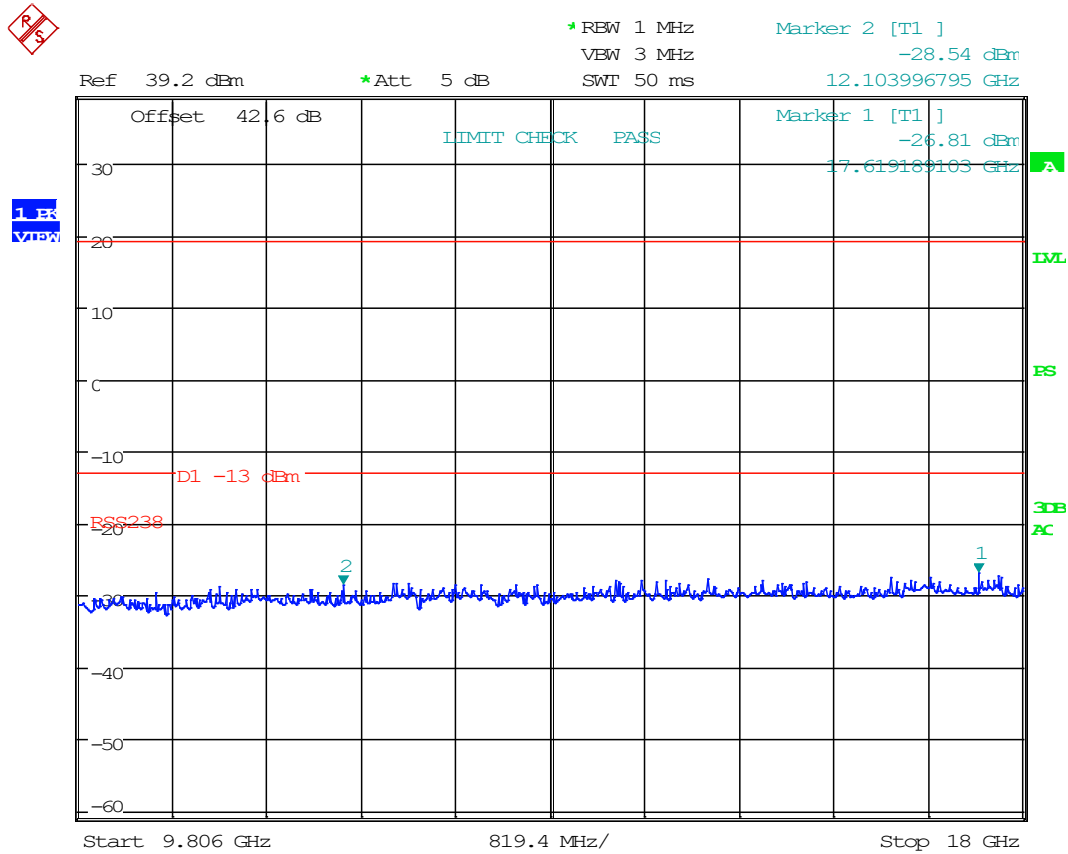

Date: 15.NOV.2021 10:37:56

8.6 Radiated Emissions

Limits from FCC Parts 2.1053, 80.211 (f) and test procedure from ANSI C63.26-2015.

Radiated Test Setup, 30 – 1000 MHz

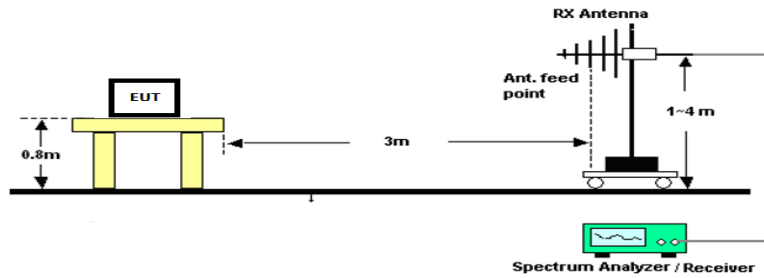

Radiated Test Setup, Above 1000 MHz

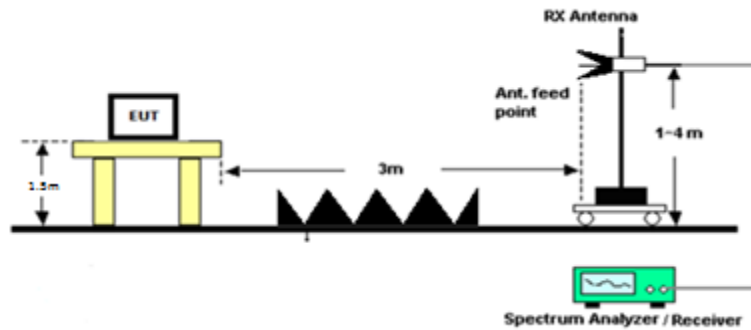



8.6.1 Radiated Emissions, 9390 MHz

Tuned Frequency (MHz)	Emission Frequency (MHz)	Detector	Meter Reading (dBuV)	Antenna Polarity	Coax Loss (dB)	Antenna Correction Factor (dB/m)	Distance (m)	Field Strength (dBµV/m)	ERP (dBm)	Spurious Limit (dBm)	Margin (dB)
9390.00	18780.00	PK	4.93	H	15.49	44.74	3.00	65.17	-32.21	-13.00	19.21
9390.00	18780.00	PK	4.16	V	15.49	44.74	3.00	64.40	-32.98	-13.00	19.98
9390.00	28170.00	PK	8.92	H	18.84	46.84	3.00	74.60	-22.78	-13.00	9.78
9390.00	28170.00	PK	9.40	V	18.84	46.84	3.00	75.08	-22.30	-13.00	9.30
9390.00	37560.00	PK	10.90	H	22.20	45.76	3.00	78.86	-18.52	-13.00	5.52
9390.00	37560.00	PK	10.30	V	22.20	45.76	3.00	78.26	-19.12	-13.00	6.12

8.6.2 Radiated Emissions, 9496 MHz

Tuned Frequency (MHz)	Emission Frequency (MHz)	Detector	Meter Reading (dBuV)	Antenna Polarity	Coax Loss (dB)	Antenna Correction Factor (dB/m)	Distance (m)	Field Strength (dBµV/m)	ERP (dBm)	Spurious Limit (dBm)	Margin (dB)
9496.00	18992.00	PK	4.32	H	15.53	44.74	3.00	64.59	-32.78	-13.00	19.78
9496.00	18992.00	PK	4.34	V	15.53	44.74	3.00	64.61	-32.76	-13.00	19.76
9496.00	28488.00	PK	7.84	H	19.20	46.73	3.00	73.77	-23.61	-13.00	10.61
9496.00	28488.00	PK	7.10	V	19.20	46.73	3.00	73.03	-24.35	-13.00	11.35
9496.00	37984.00	PK	10.24	H	23.07	45.74	3.00	79.05	-18.33	-13.00	5.33
9496.00	37984.00	PK	10.86	V	23.07	45.74	3.00	79.67	-17.71	-13.00	4.71

8.7 Modulation Characteristics

Limits from FCC Parts 2.1047 and 80.213 (g) and test procedure from ANSI C63.26-2015

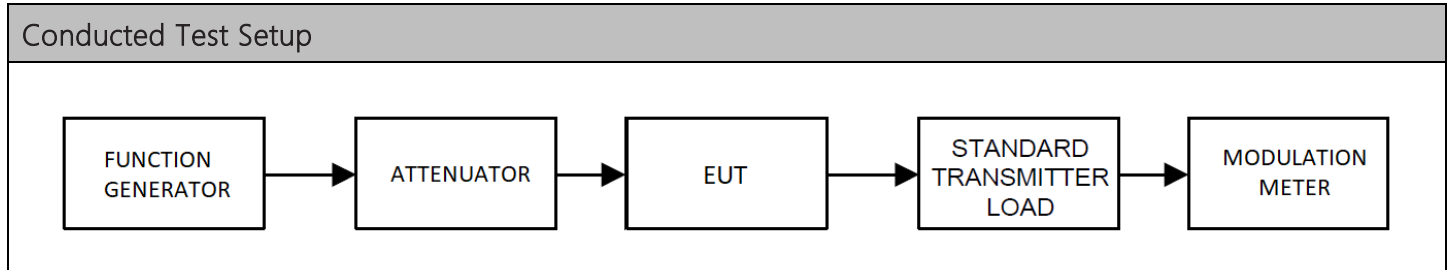

FCC 80.213(g) – Device is allowed any modulation type.

8.7.1 Audio Frequency Response

N/A. Device does not carry Audio.

8.7.2 Low Pass Filter Response

N/A. Device does not carry Audio.

8.7.3 Modulation Limiting

N/A. Device does not need to limit modulation.

8.8 Frequency Stability

Limits from FCC Parts 2.1055, 80.209 (c) and test procedure from ANSI C63.26-2015.

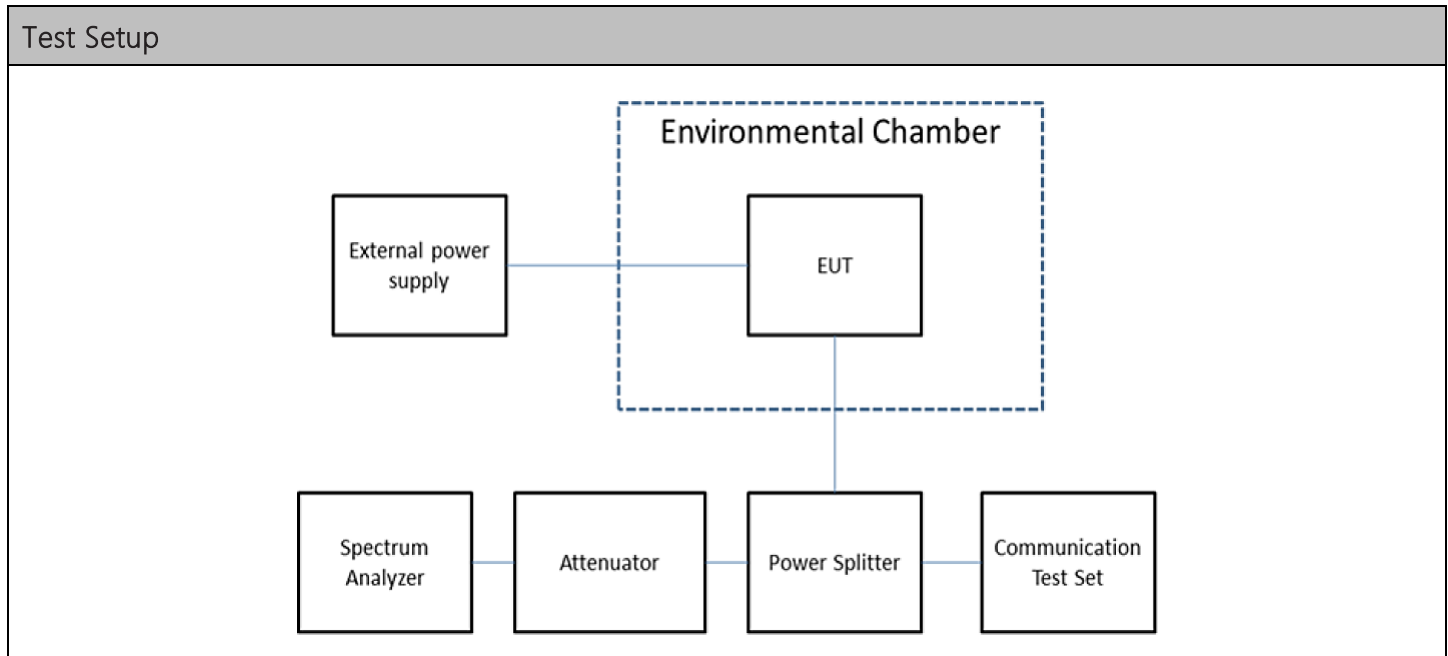

Test Results, Mode 1		
Tuned Frequency (MHz)	Max Deviation (kHz)	Limit (ppm)
9434	32.472	1250

Note: This EUT is designed to operate within FCC Parts 80 and in accordance with ISED RSS-238.

Note: The frequency determining element is the same component for both low and high ranges. The Frequency Stability testing was not repeated for both bands.

Note: The operational range of the EUT is -10 degrees C to +45 degrees C. Operation outside this range is not possible, due to the EUT's built-in limitation. The EUT has been tested to show compliance within this temperature range.

Note: The EUT's built-in power supply is designed to run stable and eliminated voltage differences from AC Mains. Input voltage variation was found to have no effect on the result.

8.8.1 Frequency Stability Data

Limit	1250.0	ppm	
Limit, as ppb	1250000	ppb (Parts per Billion)	
Limit, as %	0.12500	%	
Strictest Combined Limit, as Hz	11791823.513	Hz	
Combined Lower Limit	9421.666986	MHz	
Combined Upper Limit	9445.250634	MHz	
Rated Supply Voltage	12.0	<input type="radio"/> AC <input checked="" type="radio"/> DC	
Temperature / Voltage Variation			
Temperature (°C)	Supplied Voltage (V)	Frequency (MHz)	Deviation (kHz)
-30	12.0	9433.447987	10.823
-20	12.0	9433.437162	21.648
-10	12.0	9433.426339	32.471
0	12.0	9433.437162	21.648
+10	12.0	9433.436984	21.826
+20 (reference)	12.0	9433.458810	0.000
+20	10.2	9433.458810	0.000
+20	13.8	9433.447986	10.824
+30	12.0	9433.426338	32.472
+40	12.0	9433.426338	32.472
+50	12.0	9433.437162	21.648

8.8.2 Frequency Stability Plot

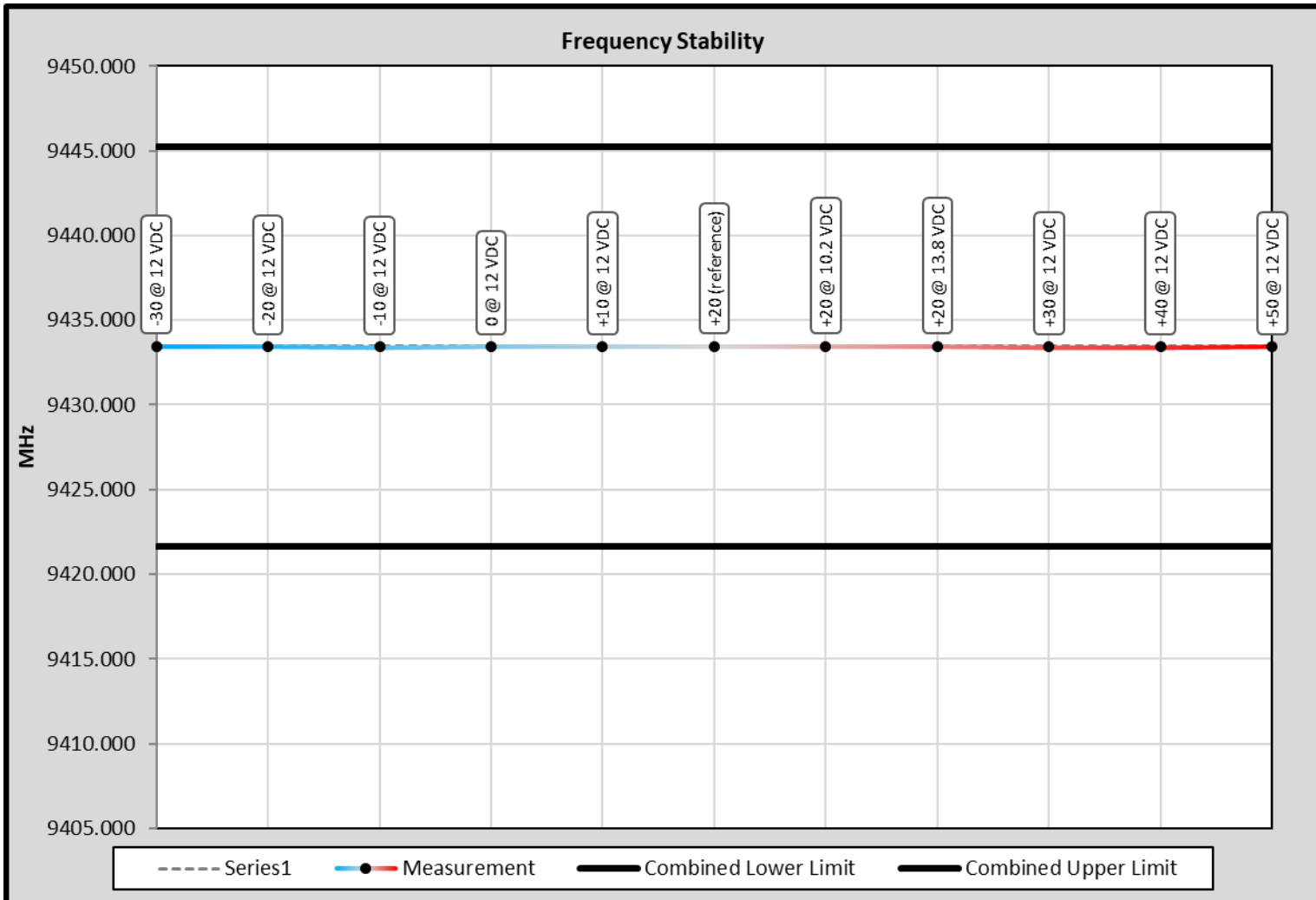

8.9 Transient Frequency Behavior

Limits from FCC Part 90.214; and test procedure from ANSI C63.26-2015.

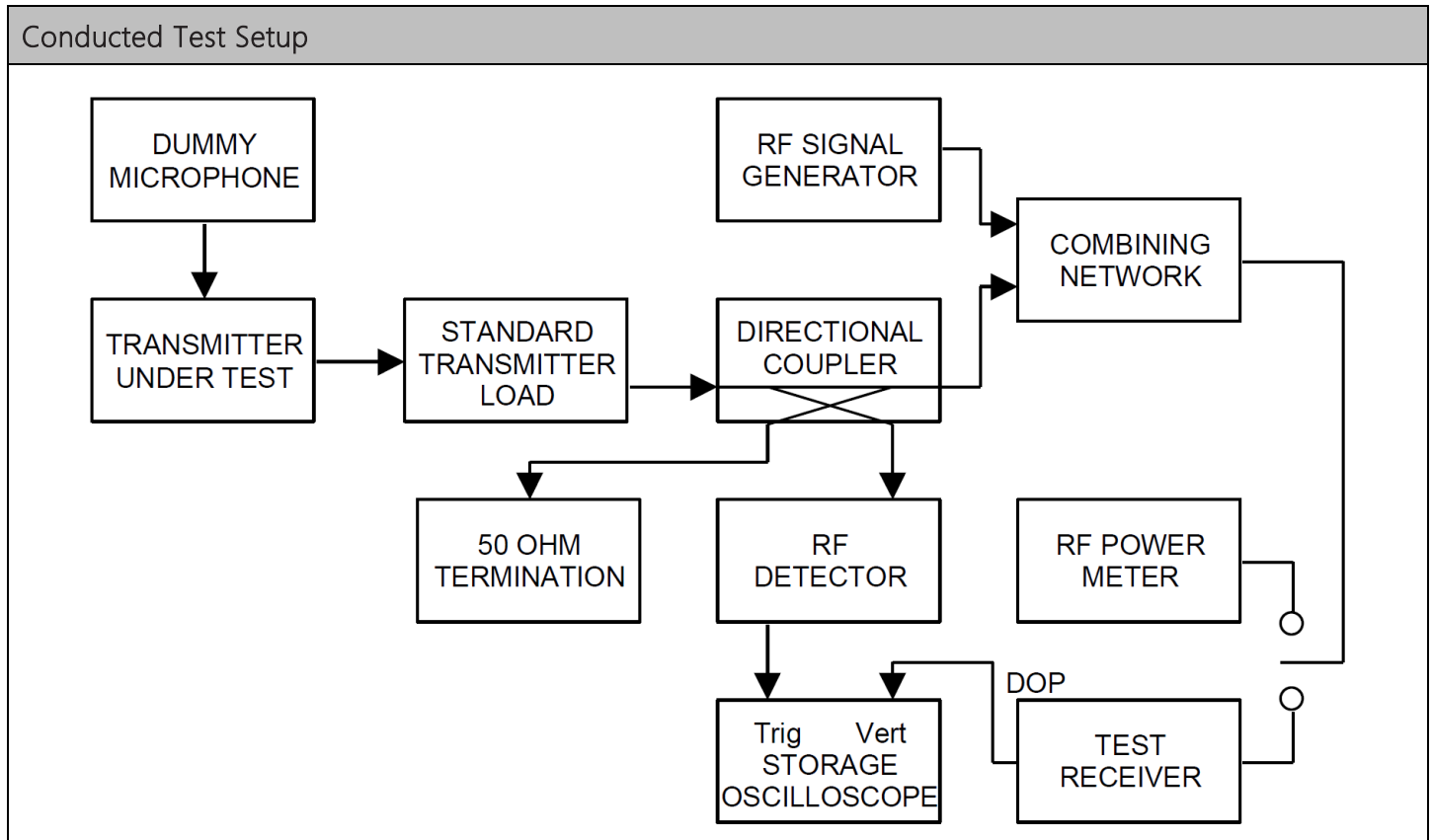

N/A. Device does not operate in a band requiring TFR measurement.

8.10 Adjacent channel power limits

Limits from FCC Part 90.221, and test procedure from ANSI C63.26-2015.

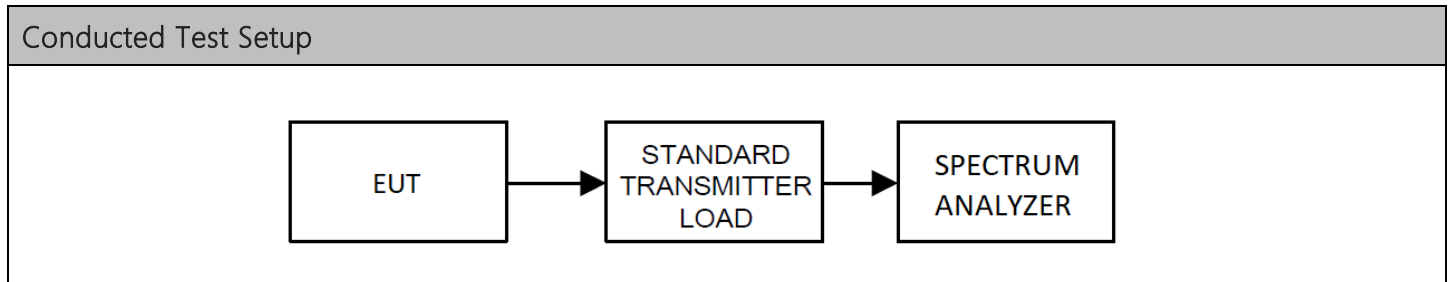

N/A. Device does not operate in a band requiring ACP measurement.

9. ANNEX-A - Photographs of the EUT

Photographs of the EUT and any manufacturer supplied accessories to be used with the EUT are in separate supplementary documents labelled EXTERNAL PHOTOS and INTERNAL PHOTOS.

10. ANNEX-B – Test Setup Photographs

Test setup photographs are located in a separate supplementary ANNEX-B document.

11. History of Test Report Changes

Test Report #	Revision #	Description	Date of Issue
TR_5479-21_FCC_PT80_	1	Initial release	2/4/2022
	2	Updated page 6	3/30/2022
	3	Updated page 6 – added FVIN	6/08/2022

END OF TEST REPORT