



FCC RADIO TEST REPORT

FCC ID : RAXXCI55AX
Equipment : TITAN II
Brand Name : Verizon
Model Name : ARC-XCI55AX
Applicant : Arcadyan Technology Corporation
No.8, Sec.2, Guangfu Rd.,Hsinchu,
30071 Taiwan
Manufacturer : Arcadyan Technology Corporation
No.8, Sec.2, Guangfu Rd.,Hsinchu,
30071 Taiwan
Standard : FCC 47 CFR Part 2, 22(H), 24(E), 27

The product was received on Nov. 30, 2021 and testing was performed from Jan. 04, 2022 to Feb. 08, 2022. We, Sporton International Inc. EMC & Wireless Communications Laboratory, would like to declare that the tested sample has been evaluated in accordance with the test procedures given in ANSI / TIA-603-E and has been in compliance with the applicable technical standards.

The test results in this report apply exclusively to the tested model / sample. Without written approval of Sporton International Inc. EMC & Wireless Communications Laboratory, the test report shall not be reproduced except in full.

Louis Wu

Approved by: Louis Wu

Sporton International Inc. EMC & Wireless Communications Laboratory
No. 52, Huaya 1st Rd., Guishan Dist., Taoyuan City 333, Taiwan (R.O.C.)



Table of Contents

History of this test report.....	3
Summary of Test Result.....	4
1 General Description	5
1.1 Product Feature of Equipment Under Test.....	5
1.2 Modification of EUT	5
1.3 Testing Location	6
1.4 Applicable Standards.....	6
2 Test Configuration of Equipment Under Test	7
2.1 Test Mode.....	7
2.2 Connection Diagram of Test System.....	9
2.3 Support Unit used in test configuration and system	9
2.4 Measurement Results Explanation Example.....	9
2.5 Frequency List of Low/Middle/High Channels	10
3 Conducted Test Items.....	11
3.1 Measuring Instruments	11
3.2 Conducted Output Power and ERP/EIRP	12
3.3 Peak-to-Average Ratio	13
3.4 Occupied Bandwidth.....	14
3.5 Conducted Band Edge	15
3.6 Conducted Spurious Emission	16
3.7 Frequency Stability	17
4 Radiated Test Items	18
4.1 Measuring Instruments	18
4.2 Radiated Spurious Emission Measurement	20
5 List of Measuring Equipment.....	21
6 Uncertainty of Evaluation.....	23
Appendix A. Test Results of Conducted Test	
Appendix B. Test Results of Radiated Test	
Appendix C. Test Setup Photographs	



History of this test report

Report No.	Version	Description	Issued Date
FG1O1524B	01	Initial issue of report	Feb. 14, 2022
FG1O1524B	02	Revise Antenna information	Mar. 04, 2022



Summary of Test Result

Report Clause	Ref Std. Clause	Test Items	Result (PASS/FAIL)	Remark
3.2	§2.1046	Conducted Output Power	Reporting only	-
	§22.913 (a)(5)	Effective Radiated Power (n5)	Pass	
	§24.232 (c)	Equivalent Isotropic Radiated Power (n2)		
	§27.50 (d)(4)	Equivalent Isotropic Radiated Power (n66)		
3.3	§24.232 (d) §27.50 (d)(5)	Peak-to-Average Ratio	Pass	-
3.4	§2.1049	Occupied Bandwidth	Reporting only	-
3.5	§2.1051 §22.917 (a) §24.238 (a) §27.53 (h)	Conducted Band Edge Measurement (n2) (n5) (n66)	Pass	-
3.6	§2.1051 §22.917 (a) §24.238 (a) §27.53 (h)	Conducted Spurious Emission (n2) (n5) (n66)	Pass	-
3.7	§2.1055 §22.355 §24.235 §27.54	Frequency Stability Temperature & Voltage	Pass	-
4.2	§2.1053 §22.917 (a) §24.238 (a) §27.53 (h)	Radiated Spurious Emission (n2) (n5) (n66)	Pass	Under limit 20.09 dB at 2483.000 MHz

Declaration of Conformity:

- The test results (PASS/FAIL) with all measurement uncertainty excluded are presented in accordance with the regulation limits or requirements declared by manufacturers. It's means measurement values may risk exceeding the limit of regulation standards, if measurement uncertainty is include in test results.
- The measurement uncertainty please refer to this report "Uncertainty of Evaluation".

Comments and Explanations:

The product specifications of the EUT presented in the report are declared by the manufacturer who shall take full responsibility for the authenticity.

Reviewed by: Yun Huang

Report Producer: Celery Wei



1 General Description

1.1 Product Feature of Equipment Under Test

LTE/5G NR, and GNSS

Product Feature	
Antenna Type	WWAN <Ant. 0>: Monopole Antenna <Ant. 1>: Dipole Antenna <Ant. 2>: Dipole Antenna <Ant. 3>: Monopole Antenna <Ant. 4>: Monopole Antenna <Ant. 5>: Dipole Antenna <Ant. 6>: Dipole Antenna GPS / Glonass / BDS / Galileo: Dipole Antenna
Antenna Gain	5G NR n2: <Ant. 2>: 3.3 dBi <Ant. 4>: 2.3 dBi 5G NR n5: <Ant. 0>: 0.6 dBi 5G NR n66 <Ant. 0>: 4.1 dBi <Ant. 4>: 2.7 dBi

Remark: The EUT's information above was declared by manufacturer. Please refer to Comments and Explanations in report summary.

1.2 Modification of EUT

No modifications are made to the EUT during all test items.



1.3 Testing Location

Test Site	Sporton International Inc. EMC & Wireless Communications Laboratory
Test Site Location	No.52, Huaya 1st Rd., Guishan Dist., Taoyuan City 333, Taiwan (R.O.C.) TEL: +886-3-327-3456 FAX: +886-3-328-4978
Test Site No.	Sporton Site No.
	TH03-HY
Test Engineer	Luffy Lin
Temperature (°C)	23.5~24.5
Relative Humidity (%)	51~55

Test Site	Sporton International Inc. Wensan Laboratory
Test Site Location	No.58, Aly. 75, Ln. 564, Wenhua 3rd, Rd., Guishan Dist., Taoyuan City 333010, Taiwan (R.O.C.) TEL: +886-3-327-0868 FAX: +886-3-327-0855
Test Site No.	Sporton Site No.
	03CH16-HY (TAF Code: 3786)
Test Engineer	Andy Yang, Karl Hou and Wilson Wu
Temperature (°C)	20~25
Relative Humidity (%)	50~60
Remark	The Radiated Spurious Emission test item subcontracted to Sporton International Inc. Wensan Laboratory.

Note: The test site complies with ANSI C63.4 2014 requirement.

FCC Designation No.: TW1190 and TW3786

ISED Registration No.: 4086B and 4086H

1.4 Applicable Standards

According to the specifications of the manufacturer, the EUT must comply with the requirements of the following standards:

- ♦ ANSI C63.26-2015
- ♦ ANSI / TIA-603-E
- ♦ FCC 47 CFR Part 2, 22(H), 24(E), 27
- ♦ FCC KDB 971168 D01 Power Meas. License Digital Systems v03r01
- ♦ FCC KDB 412172 D01 Determining ERP and EIRP v01r01
- ♦ FCC KDB 414788 D01 Radiated Test Site v01r01.

Remark:

1. All test items were verified and recorded according to the standards and without any deviation during the test.
2. The TAF code is not including all the FCC KDB listed without accreditation.



2 Test Configuration of Equipment Under Test

2.1 Test Mode

Antenna port conducted and radiated test items listed below are performed according to KDB 971168 D01 Power Meas. License Digital Systems v03r01 with maximum output power.

For radiated measurement, the measured emission level of the EUT was maximized by rotating the EUT on a turntable, adjusting the orientation of the EUT and EUT antenna in three orthogonal axis (X: flat, Y: portrait, Z: landscape), and adjusting the measurement antenna orientation, following C63.26 exploratory test procedures and find X Plane for <Ant. 0 + Ant. 2>: EN-DC 5A-n2A, EN-DC 5A-n66A; <Ant. 4 + Ant.2>: EN-DC 66A-n2A, EN-DC 2A-n66A; Y Plane for <Ant. 0>: 5G NR n5; <Ant. 4>: 5G NR n66; <Ant. 2 + Ant.0>: EN-DC 2A-n5A; Z Plane for <Ant. 4>: 5G NR n2; <Ant. 5 + Ant.0>: EN-DC 48A-n5A as worst plane.

Test Items	NR Band	Bandwidth (MHz)							Modulation					RB #			Test Channel		
		5	10	15	20	30	40	50	PI/2 BPSK	QPSK	16QAM	64QAM	256QAM	1	Half	Full	L	M	H
Max. Output Power	n2	v	v	v	v	-	-	-	v	v	v	v	v	v	v	v	v	v	v
	n5	v	v	v	v	-	-	-	v	v	v	v	v	v	v	v	v	v	v
	n66	v	v	v	v	-	v	-	v	v	v	v	v	v	v	v	v	v	v
Peak-to-Ave rage Ratio	n2				v	-	-	-	v	v	v	v	v			v		v	
	n5				v	-	-	-	v	v	v	v	v			v		v	
	n66				v	-		-	v	v	v	v	v			v		v	
26dB and 99% Bandwidth	n2	v	v	v	v	-	-	-	v	v	v	v	v			v		v	
	n5	v	v	v	v	-	-	-	v	v	v	v	v			v		v	
	n66	v	v	v	v	-	v	-	v	v	v	v	v			v		v	
Conducted Band Edge	n2	v	v	v	v	-	-	-	v	v	v	v	v	v		v	v		v
	n5	v	v	v	v	-	-	-	v	v	v	v	v	v		v	v		v
	n66	v	v	v	v	-		-	v	v	v	v	v	v		v	v		v
Conducted Spurious Emission	n2	v				-	-	-		v				v			v	v	v
	n5	v				-	-	-		v				v			v	v	v
	n66	v				-		-		v				v			v	v	v
Frequency Stability	n2				v	-	-	-	v							v		v	
	n5				v	-	-	-	v							v		v	
	n66				v	-		-	v							v		v	
E.R.P / E.I.R.P	n2	v	v	v	v	-	-	-	v	v	v	v	v	Max. Power					
	n5	v	v	v	v	-	-	-	v	v	v	v	v						
	n66	v	v	v	v	-	v	-	v	v	v	v	v						



Test Items	NR Band	Bandwidth (MHz)							Modulation					RB #			Test Channel		
		5	10	15	20	30	40	50	PI/2 BPSK	QPSK	16QAM	64QAM	256QAM	1	Half	Full	L	M	H
Radiated Spurious Emission	n2	Worst Case															v	v	v
	n5	Worst Case															v	v	v
	n66	Worst Case															v	v	v
Remark	<ol style="list-style-type: none"> The mark "v " means that this configuration is chosen for testing The mark "- " means that this bandwidth is not supported. The device is investigated from 30MHz to 10 times of fundamental signal for radiated spurious emission test under different RB size/offset and modulations in exploratory test. Subsequently, only the worst case emissions are reported. For radiated measurement, pre-scanned in two modes, DFT-s OFDM and CP OFDM. The worst cases (DFT-s OFDM) were recorded in this report, the worst modes of FR1 and LTE for simultaneous transmission were verified and compliant. Test combination are EN-DC 5A-n2A, EN-DC 5A-n66A, EN-DC 66A-n2A, EN-DC 2A-n66A, EN-DC 2A-n5A, EN-DC 48A-n5A. 																		

2.2 Connection Diagram of Test System

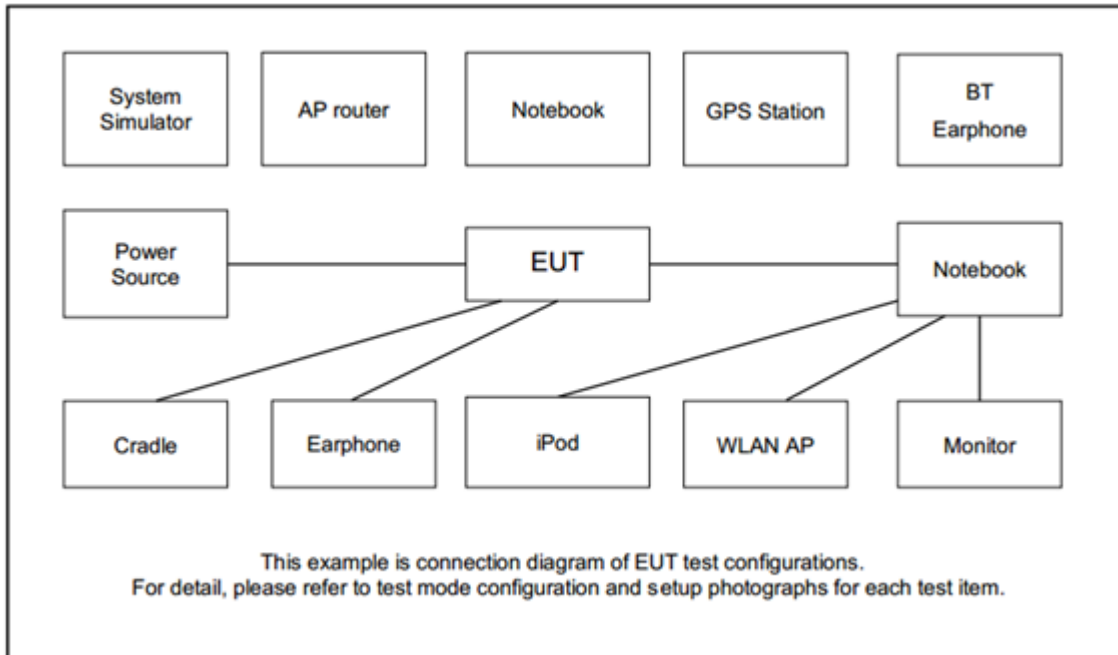

2.3 Support Unit used in test configuration and system

Item	Equipment	Brand Name	Model No.	FCC ID	Data Cable	Power Cord
1.	System Simulator	Anritsu	8821C	N/A	N/A	Unshielded, 1.8 m
2.	System Simulator	R&S	8000A	N/A	N/A	Unshielded, 1.8 m

2.4 Measurement Results Explanation Example

For all conducted test items:

The offset level is set in the spectrum analyzer to compensate the RF cable loss and attenuator factor between EUT conducted output port and spectrum analyzer. With the offset compensation, the spectrum analyzer reading level is exactly the EUT RF output level.

The spectrum analyzer offset is derived from RF cable loss and attenuator factor.

Offset = RF cable loss + attenuator factor.

Following shows an offset computation example with cable loss 4.2 dB and 10dB attenuator.

Example :

$$\begin{aligned} \text{Offset(dB)} &= \text{RF cable loss(dB)} + \text{attenuator factor(dB)} \\ &= 4.2 + 10 = 14.2 \text{ (dB)} \end{aligned}$$



2.5 Frequency List of Low/Middle/High Channels

5G NR Band n2 Channel and Frequency List				
BW [MHz]	Channel/Frequency(MHz)	Lowest	Middle	Highest
20	Channel	372000	376000	380000
	Frequency	1860	1880	1900
15	Channel	371500	376000	380500
	Frequency	1857.5	1880	1902.5
10	Channel	371000	376000	381000
	Frequency	1855	1880	1905
5	Channel	370500	376000	381500
	Frequency	1852.5	1880	1907.5

5G NR Band n5 Channel and Frequency List				
BW [MHz]	Channel/Frequency(MHz)	Lowest	Middle	Highest
20	Channel	166800	167300	167800
	Frequency	834	836.5	839
15	Channel	166300	167300	168300
	Frequency	831.5	836.5	841.5
10	Channel	165800	167300	168800
	Frequency	829	836.5	844
5	Channel	165300	167300	169300
	Frequency	826.5	836.5	846.5

5G NR Band n66 Channel and Frequency List				
BW [MHz]	Channel/Frequency(MHz)	Lowest	Middle	Highest
40	Channel	346000	349000	352000
	Frequency	1730	1745	1760
20	Channel	344000	349000	354000
	Frequency	1720	1745	1770
15	Channel	343500	349000	354500
	Frequency	1717.5	1745	1772.5
10	Channel	343000	349000	355000
	Frequency	1715	1745	1775
5	Channel	342500	349000	355500
	Frequency	1712.5	1745	1777.5

3 Conducted Test Items

3.1 Measuring Instruments

See list of measuring instruments of this test report.

3.1.1 Test Setup

3.1.2 Conducted Output Power

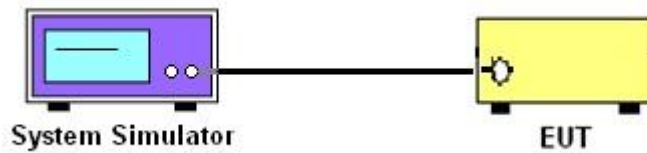

3.1.3 Peak-to-Average Ratio, Occupied Bandwidth ,Conducted Band-Edge and Conducted Spurious Emission

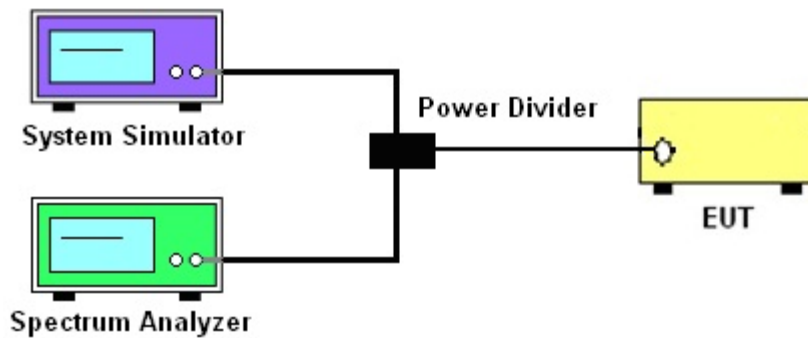

3.1.4 Frequency Stability

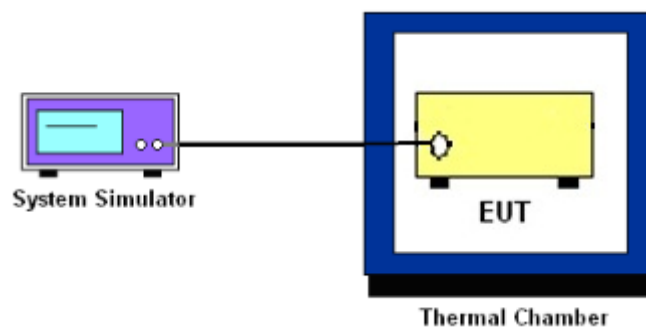

3.1.5 Test Result of Conducted Test

Please refer to Appendix A.



3.2 Conducted Output Power and ERP/EIRP

3.2.1 Description of the Conducted Output Power Measurement and ERP/EIRP Measurement

A system simulator was used to establish communication with the EUT. Its parameters were set to force the EUT transmitting at maximum output power. The measured power in the radio frequency on the transmitter output terminals shall be reported.

The ERP of mobile transmitters must not exceed 7 Watts for 5G NR n5

The EIRP of mobile transmitters must not exceed 2 Watts for 5G NR n2

The EIRP of mobile transmitters must not exceed 1 Watts for 5G NR n66

According to KDB 412172 D01 Power Approach,

$EIRP = P_T + G_T - L_C$, $ERP = EIRP - 2.15$, where

P_T = transmitter output power in dBm

G_T = gain of the transmitting antenna in dBi

L_C = signal attenuation in the connecting cable between the transmitter and antenna in dB

3.2.2 Test Procedures

1. The transmitter output port was connected to the system simulator.
2. Set EUT at maximum power through the system simulator.
3. Select lowest, middle, and highest channels for each band and different modulation.
4. Measure and record the power level from the system simulator.



3.3 Peak-to-Average Ratio

3.3.1 Description of the PAR Measurement

Power Complementary Cumulative Distribution Function (CCDF) curves provide a means for characterizing the power peaks of a digitally modulated signal on a statistical basis. A CCDF curve depicts the probability of the peak signal amplitude exceeding the average power level. Most contemporary measurement instrumentation include the capability to produce CCDF curves for an input signal provided that the instrument's resolution bandwidth can be set wide enough to accommodate the entire input signal bandwidth. In measuring transmissions in this band using an average power technique, the peak-to-average ratio (PAR) of the transmission may not exceed 13 dB.

3.3.2 Test Procedures

The testing follows ANSI C63.26-2015 Section 5.2.6

1. The EUT was connected to spectrum and system simulator via a power divider.
2. Set the CCDF (Complementary Cumulative Distribution Function) option in spectrum analyzer.
3. The highest RF powers were measured and recorded the maximum PAPR level associated with a probability of 0.1 %.
4. Record the deviation as Peak to Average Ratio.



3.4 Occupied Bandwidth

3.4.1 Description of Occupied Bandwidth Measurement

The occupied bandwidth is the width of a frequency band such that, below the lower and above the upper frequency limits, the mean powers emitted are each equal to a specified percentage 0.5% of the total mean transmitted power.

The 26 dB emission bandwidth is defined as the frequency range between two points, one above and one below the carrier frequency, at which the spectral density of the emission is attenuated 26 dB below the maximum in-band spectral density of the modulated signal. Spectral density (power per unit bandwidth) is to be measured with a detector of resolution bandwidth equal to approximately 1.0% of the emission bandwidth.

3.4.2 Test Procedures

The testing follows ANSI C63.26-2015 Section 5.4.3 (26dB) and Section 5.4.4 (99OB)

1. The EUT was connected to spectrum analyzer and system simulator via a power divider.
2. The spectrum analyzer center frequency is set to the nominal EUT channel center frequency. The span range for the spectrum analyzer shall be between two and five times the anticipated OBW.
3. The nominal resolution bandwidth (RBW) shall be in the range of 1 to 5 % of the anticipated OBW, and the VBW shall be at least 3 times the RBW.
4. Set the detection mode to peak, and the trace mode to max hold.
5. Determine the reference value: Set the EUT to transmit a modulated signal. Allow the trace to stabilize. Set the spectrum analyzer marker to the highest level of the displayed trace.
(this is the reference value)
6. Determine the “-26 dB down amplitude” as equal to (Reference Value – X).
7. Place two markers, one at the lowest and the other at the highest frequency of the envelope of the spectral display such that each marker is at or slightly below the “-X dB down amplitude” determined in step 6. If a marker is below this “-X dB down amplitude” value it shall be placed as close as possible to this value. The OBW is the positive frequency difference between the two markers.
8. Use the 99 % power bandwidth function of the spectrum analyzer and report the measured bandwidth.



3.5 Conducted Band Edge

3.5.1 Description of Conducted Band Edge Measurement

22.917(a)

For operations in the 824 – 849 MHz band, the FCC limit is $43 + 10\log_{10}(P[\text{Watts}])$ dB below the transmitter power $P(\text{Watts})$ in a 100kHz bandwidth. However, in the 1MHz bands immediately outside and adjacent to the licensee's frequency block, a resolution bandwidth of at least one percent of the emission bandwidth of the fundamental emission of the transmitter may be employed.

24.238 (a)

For operations in the 1850-1910 and 1930-1990 MHz band, the FCC limit is $43 + 10\log_{10}(P[\text{Watts}])$ dB below the transmitter power $P(\text{Watts})$ in a 1MHz bandwidth. However, in the 1 MHz bands immediately outside and adjacent to the frequency block a resolution bandwidth of at least one percent of the emission bandwidth of the fundamental emission of the transmitter may be employed.

27.53 (h)

For operations in the 1710 – 1755 MHz band, 1755-1780 MHz, the FCC limit is $43 + 10\log_{10}(P[\text{Watts}])$ dB below the transmitter power $P(\text{Watts})$ in a 1 MHz bandwidth. However, in the 1MHz bands immediately outside and adjacent to the licensee's frequency block, a resolution bandwidth of at least one percent of the emission bandwidth of the fundamental emission of the transmitter may be employed.

3.5.2 Test Procedures

The testing follows FCC KDB 971168 D01 v03r01 Section 6.1.

1. The EUT was connected to spectrum analyzer and system simulator via a power divider.
2. The band edges of low and high channels for the highest RF powers were measured.
3. Set RBW \geq 1% EBW in the 1MHz band immediately outside and adjacent to the band edge.
4. Beyond the 1 MHz band from the band edge, RBW=1MHz was used.
5. Set spectrum analyzer with RMS detector.
6. The RF fundamental frequency should be excluded against the limit line in the operating frequency band.
7. Checked that all the results comply with the emission limit line.

The limit line is derived from $43 + 10\log(P)\text{dB}$ below the transmitter power $P(\text{Watts})$



3.6 Conducted Spurious Emission

3.6.1 Description of Conducted Spurious Emission Measurement

The power of any emission outside of the authorized operating frequency ranges must be lower than the transmitter power (P) by a factor of at least $43 + 10 \log (P)$ dB.

It is measured by means of a calibrated spectrum analyzer and scanned from 30 MHz up to a frequency including its 10th harmonic.

3.6.2 Test Procedures

The testing follows FCC KDB 971168 D01 v03r01 Section 6.1.

1. The EUT was connected to spectrum analyzer and system simulator via a power divider.
2. The RF output of EUT was connected to the spectrum analyzer by RF cable and attenuator. The path loss was compensated to the results for each measurement.
3. The middle channel for the highest RF power within the transmitting frequency was measured.
4. The conducted spurious emission for the whole frequency range was taken.
5. Make the measurement with the spectrum analyzer's RBW = 1MHz, VBW = 3MHz.
6. Set spectrum analyzer with RMS detector.
7. Taking the record of maximum spurious emission.
8. The RF fundamental frequency should be excluded against the limit line in the operating frequency band.
9. The limit line is derived from $43 + 10\log(P)$ dB below the transmitter power P(Watts)



3.7 Frequency Stability

3.7.1 Description of Frequency Stability Measurement

22.355

The frequency stability shall be measured by variation of ambient temperature and variation of primary supply voltage to ensure that the fundamental emission stays within the authorized frequency block. The frequency stability of the transmitter shall be maintained within $\pm 0.00025\%$ ($\pm 2.5\text{ppm}$) of the center frequency.

24.235 & 27.54

The frequency stability shall be sufficient to ensure that the fundamental emission stays within the authorized frequency block.

3.7.2 Test Procedures for Temperature Variation

The testing follows FCC KDB 971168 D01 v03r01 Section 9.0.

1. The EUT was set up in the thermal chamber and connected with the system simulator.
2. With power OFF, the temperature was decreased to -30°C and the EUT was stabilized before testing. Power was applied and the maximum change in frequency was recorded within one minute.
3. With power OFF, the temperature was raised in 10°C step up to 50°C . The EUT was stabilized at each step for at least half an hour. Power was applied and the maximum frequency change was recorded within one minute.

3.7.3 Test Procedures for Voltage Variation

The testing follows FCC KDB 971168 D01 v03r01 Section 9.0.

1. The EUT was placed in a temperature chamber at $20\pm 5^{\circ}\text{C}$ and connected with the system simulator.
2. The power supply voltage to the EUT was varied from 85% to 115% of the nominal value measured at the input to the EUT.
3. The variation in frequency was measured for the worst case.

4 Radiated Test Items

4.1 Measuring Instruments

See list of measuring instruments of this test report.

4.1.1 Test Setup

For radiated test below 30MHz

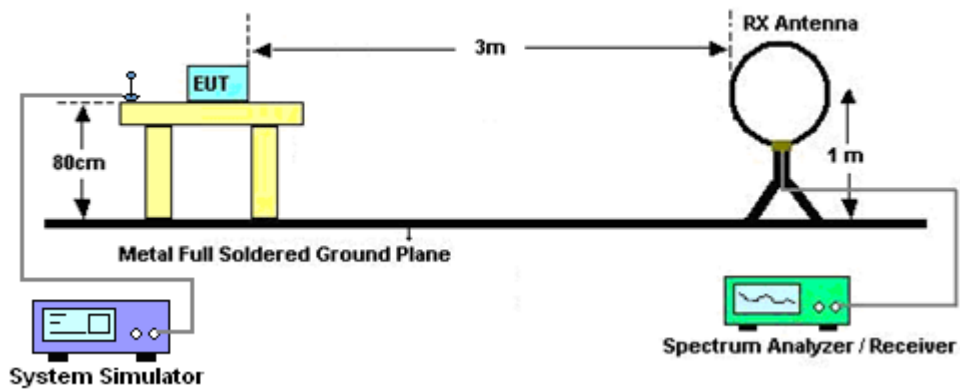

For radiated test from 30MHz to 1GHz

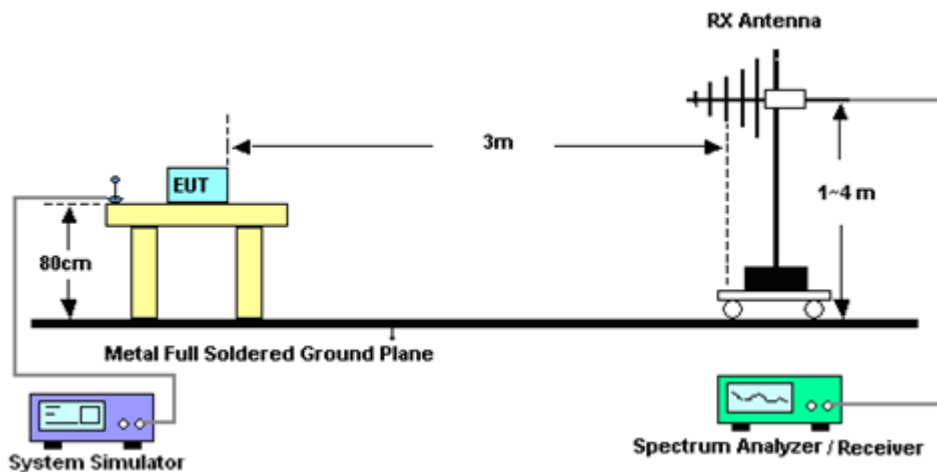

For radiated test from 1GHz to 18GHz

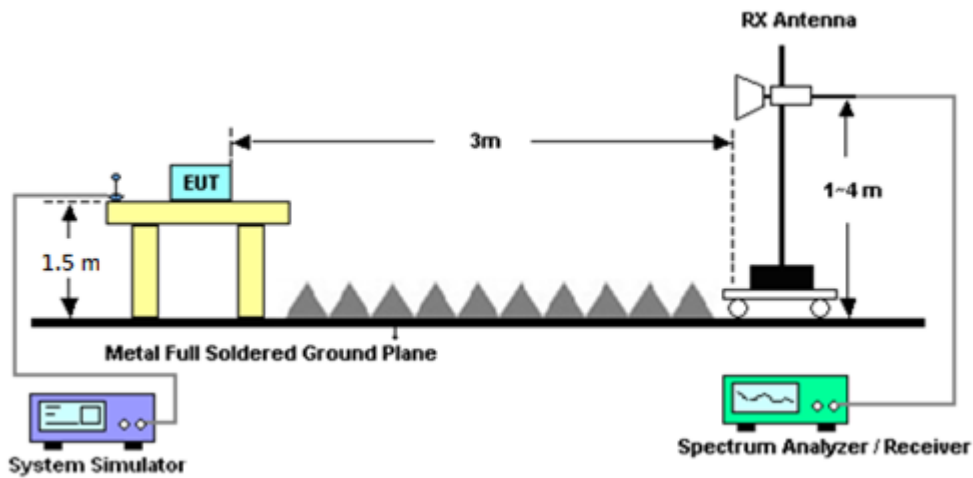

For radiated test above 18GHz

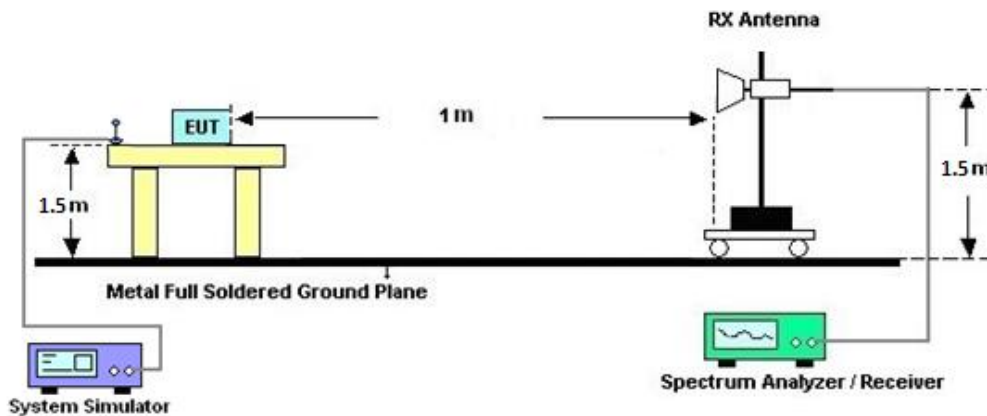

4.1.2 Test Result of Radiated Test

Please refer to Appendix B.

Note:

The low frequency, which started from 9 kHz to 30MHz, was pre-scanned and the result which was 20dB lower than the limit line was not reported.

There is adequate comparison measurement of both open-field test site and alternative test site - semi-Anechoic chamber according to 414788 D01 Radiated Test Site v01r01, and the result came out very similar.



4.2 Radiated Spurious Emission Measurement

4.2.1 Description of Radiated Spurious Emission Measurement

The radiated spurious emission was measured by substitution method according to ANSI / TIA-603-E. The power of any emission outside of the authorized operating frequency ranges must be attenuated below the transmitter power (P) by a factor of at least $43 + 10 \log (P)$ dB. The spectrum is scanned from 30 MHz up to a frequency including its 10th harmonic.

4.2.2 Test Procedures

The testing follows FCC KDB 971168 D01 v03r01 Section 7 and ANSI / TIA-603-E Section 2.2.12.

1. The EUT was placed on a turntable with 0.8 meter for frequency below 1GHz and 1.5 meter for frequency above 1GHz respectively above ground.
2. The EUT was set 3 meters from the receiving antenna, which was mounted on the antenna tower.
3. The table was rotated 360 degrees to determine the position of the highest spurious emission.
4. The height of the receiving antenna is varied between one meter and four meters to search the maximum spurious emission for both horizontal and vertical polarizations.
5. Make the measurement with the spectrum analyzer's RBW = 1MHz, VBW = 3MHz, taking the record of maximum spurious emission.
6. A horn antenna was substituted in place of the EUT and was driven by a signal generator.
7. Tune the output power of signal generator to the same emission level with EUT maximum spurious emission.
8. Taking the record of output power at antenna port.
9. Repeat step 7 to step 8 for another polarization.
10. The RF fundamental frequency should be excluded against the limit line in the operating frequency band.

The limit line is derived from $43 + 10\log(P)$ dB below the transmitter power P(Watts)

$EIRP \text{ (dBm)} = S.G. \text{ Power} - Tx \text{ Cable Loss} + Tx \text{ Antenna Gain}$

$ERP \text{ (dBm)} = EIRP - 2.15$



5 List of Measuring Equipment

Instrument	Brand Name	Model No.	Serial No.	Characteristics	Calibration Date	Test Date	Due Date	Remark
Loop Antenna	Rohde & Schwarz	HFH2-Z2	100488	9 kHz~30 MHz	Sep. 07, 2021	Jan. 15, 2022~ Jan. 22, 2022	Sep. 06, 2022	Radiation (03CH16-HY)
SHF-EHF Horn Antenna	SCHWARZBECK	BBHA9170	00991	18GHz~40GHz	May 12, 2021	Jan. 15, 2022~ Jan. 22, 2022	May 11, 2022	Radiation (03CH16-HY)
SHF-EHF Horn Antenna	SCHWARZBECK	BBHA9170	00993	18GHz~40GHz	Nov. 30, 2021	Jan. 15, 2022~ Jan. 22, 2022	Nov. 29, 2022	Radiation (03CH16-HY)
Spectrum Analyzer	Keysight	N9010A	MY54200486	10Hz~44GHz	Oct. 15, 2021	Jan. 15, 2022~ Jan. 22, 2022	Oct. 14, 2022	Radiation (03CH16-HY)
Preamplifier	EMEC	EM18G40G	060801	18GHz~40GHz	Jun. 22, 2021	Jan. 15, 2022~ Jan. 22, 2022	Jun. 21, 2022	Radiation (03CH16-HY)
Signal Generator	Agilent	MG3694C	163401	0.1Hz~40GHz	Jan. 31, 2021	Jan. 15, 2022~ Jan. 22, 2022	Jan. 30, 2022	Radiation (03CH16-HY)
Bilog Antenna	TESEQ	CBL 6111D & 00800N1D01N -06	41912 & 05	30MHz to 1GHz	Feb. 08, 2021	Jan. 15, 2022~ Jan. 22, 2022	Feb. 07, 2022	Radiation (03CH16-HY)
Bilog Antenna	TESEQ	CBL 6111D & 00802N1D01N -06	47020 & 06	30MHz to 1GHz	Oct. 09, 2021	Jan. 15, 2022~ Jan. 22, 2022	Oct. 08, 2022	Radiation (03CH16-HY)
Horn Antenna	SCHWARZBECK	BBHA 9120 D	9120D-1522	1G~18GHz	Oct. 12, 2021	Jan. 15, 2022~ Jan. 22, 2022	Oct. 11, 2022	Radiation (03CH16-HY)
Horn Antenna	SCHWARZBECK	BBHA 9120 D	9120D-1212	1G~18GHz	May 18, 2021	Jan. 15, 2022~ Jan. 22, 2022	May 18, 2022	Radiation (03CH16-HY)
Amplifier	SONOMA	310N	371607	9kHz~1G	Jul. 05, 2021	Jan. 15, 2022~ Jan. 22, 2022	Jul. 04, 2022	Radiation (03CH16-HY)
Amplifier	EMCI	EMC051845S E	980729	1-18GHz	Jul. 09, 2021	Jan. 15, 2022~ Jan. 22, 2022	Jul. 08, 2022	Radiation (03CH16-HY)
Preamplifier	Keysight	83017A	MY53270264	1GHz~26.5GHz	Dec. 09, 2021	Jan. 15, 2022~ Jan. 22, 2022	Dec. 08, 2022	Radiation (03CH16-HY)
EMI Test Receiver	Keysight	N9038A	MY59053012	3Hz~26.5GHz	Nov. 18, 2021	Jan. 15, 2022~ Jan. 22, 2022	Nov. 17, 2022	Radiation (03CH16-HY)
RF Cable	HUBER + SUHNER	SUCOFLEX 104	MY11680/4P E	NA	Aug. 28, 2021	Jan. 15, 2022~ Jan. 22, 2022	Aug. 27, 2022	Radiation (03CH16-HY)
RF Cable	HUBER + SUHNER	SUCOFLEX 104	MY11688/4P E	NA	Aug. 28, 2021	Jan. 15, 2022~ Jan. 22, 2022	Aug. 27, 2022	Radiation (03CH16-HY)
RF Cable	HUBER + SUHNER	SUCOFLEX 102	EC-A5-300-5 757	NA	Aug. 28, 2021	Jan. 15, 2022~ Jan. 22, 2022	Aug. 27, 2022	Radiation (03CH16-HY)
Software	Audix	E3 6.2009-8-24	RK-001136	N/A	N/A	Jan. 15, 2022~ Jan. 22, 2022	N/A	Radiation (03CH16-HY)
Controller	ChainTek	3000-1	N/A	Control Turn table & Ant Mast	N/A	Jan. 15, 2022~ Jan. 22, 2022	N/A	Radiation (03CH16-HY)
Antenna Mast	ChainTek	MBS-520-1	N/A	1m~4m	N/A	Jan. 15, 2022~ Jan. 22, 2022	N/A	Radiation (03CH16-HY)
Turn Table	ChainTek	T-200-S-1	N/A	0~360 Degree	N/A	Jan. 15, 2022~ Jan. 22, 2022	N/A	Radiation (03CH16-HY)



Instrument	Brand Name	Model No.	Serial No.	Characteristics	Calibration Date	Test Date	Due Date	Remark
AC Power Source	AC POWER	AFC-500W	F104070011	50Hz~60Hz	Sep. 14, 2021	Jan. 04, 2022~ Feb. 08, 2022	Sep. 13, 2022	Conducted (TH03-HY)
Signal Analyzer	Rohde & Schwarz	FSV3044	101048	10Hz~44GHz	Apr. 20, 2021	Jan. 04, 2022~ Feb. 08, 2022	Apr. 19, 2022	Conducted (TH03-HY)
Temperature Chamber	ESPEC	LHU-113	1012005860	-20℃ ~85℃	May 15, 2021	Jan. 04, 2022~ Feb. 08, 2022	May 14, 2022	Conducted (TH03-HY)
Base Station (Measure)	Anritsu	MT8821C	6261849015	LTE	Oct. 06, 2021	Jan. 04, 2022~ Feb. 08, 2022	Oct. 05, 2022	Conducted (TH03-HY)
Base Station (Measure)	Anritsu	MT8000A	6262134933	FR1	Apr. 27, 2021	Jan. 04, 2022~ Feb. 08, 2022	Apr. 26, 2022	Conducted (TH03-HY)



6 Uncertainty of Evaluation

Uncertainty of Radiated Emission Measurement (30 MHz ~ 1000 MHz)

Measuring Uncertainty for a Level of Confidence of 95% ($U = 2Uc(y)$)	2.86 dB
---	---------

Uncertainty of Radiated Emission Measurement (1 GHz ~ 18 GHz)

Measuring Uncertainty for a Level of Confidence of 95% ($U = 2Uc(y)$)	3.68 dB
---	---------

Uncertainty of Radiated Emission Measurement (18 GHz ~ 40 GHz)

Measuring Uncertainty for a Level of Confidence of 95% ($U = 2Uc(y)$)	4.00 dB
---	---------



Appendix A. Test Results of Conducted Test

Conducted Output Power(Average power) and ERP/EIRP

<Ant. 0>

<SCS 15K>

NR n5 Maximum Average Power [dBm] (GT - LC = 0.6 dB)								
BW [MHz]	RB Size	RB Offset	Mod	Lowest	Middle	Highest	ERP (dBm)	ERP(W)
5	1	1	PI/2 BPSK	23.15	23.78	23.61	22.23	0.1671
5	1	23		23.59	23.76	23.67		
5	12	6		23.68	23.74	23.65		
5	1	0		23.16	23.18	23.09		
5	1	24		23.11	23.24	23.18		
5	25	0		23.08	23.19	23.08		
5	1	1	QPSK	23.61	23.65	23.54		
5	1	23		23.48	23.66	23.59		
5	12	6		23.71	23.74	23.72		
5	1	0		22.52	22.58	22.49		
5	1	24		22.49	22.62	22.58		
5	25	0		22.59	22.69	22.56		
5	1	1	16-QAM	22.71	22.40	22.24	21.16	0.1306
5	1	1	64-QAM	21.33	21.42	21.33		
5	1	1	256-QAM	19.35	19.44	19.18		
Limit	ERP < 7W			Result			Pass	

NR n5 Maximum Average Power [dBm] (GT - LC = 0.6 dB)								
BW [MHz]	RB Size	RB Offset	Mod	Lowest	Middle	Highest	ERP (dBm)	ERP(W)
10	1	1	PI/2 BPSK	23.69	23.54	23.74	22.23	0.1671
10	1	50		23.76	23.78	23.72		
10	25	12		23.65	23.72	23.65		
10	1	0		23.12	23.12	23.21		
10	1	51		23.24	23.26	23.24		
10	50	0		23.05	23.24	23.02		
10	1	1	QPSK	23.62	23.65	23.61		
10	1	50		23.65	23.69	23.64		
10	25	12		23.71	23.75	23.65		
10	1	0		22.54	22.49	22.52		
10	1	51		22.65	22.64	22.65		
10	50	0		22.62	22.69	22.53		
10	1	1	16-QAM	22.45	22.65	22.64	21.10	0.1288
10	1	1	64-QAM	21.33	21.54	21.54		
10	1	1	256-QAM	19.21	19.35	19.24		
Limit	ERP < 7W			Result			Pass	



NR n5 Maximum Average Power [dBm] (GT - LC = 0.6 dB)								
BW [MHz]	RB Size	RB Offset	Mod	Lowest	Middle	Highest	ERP (dBm)	ERP(W)
15	1	1	PI/2 BPSK	23.69	23.63	23.22	22.21	0.1663
15	1	77		23.76	23.74	23.74		
15	36	18		23.68	23.71	23.65		
15	1	0		23.15	23.04	23.18		
15	1	78		23.24	23.16	23.21		
15	75	0		23.21	23.23	23.14		
15	1	1	QPSK	23.65	23.54	23.67		
15	1	77		23.65	23.67	23.65		
15	36	18		23.68	23.71	23.65		
15	1	0		22.54	22.47	22.54		
15	1	78		22.64	22.58	22.65		
15	75	0		22.68	22.74	22.63		
15	1	1	16-QAM	22.64	22.35	22.35	21.09	0.1285
15	1	1	64-QAM	21.51	21.54	21.36		
15	1	1	256-QAM	19.32	19.13	19.22		
Limit	ERP < 7W			Result			Pass	

NR n5 Maximum Average Power [dBm] (GT - LC = 0.6 dB)								
BW [MHz]	RB Size	RB Offset	Mod	Lowest	Middle	Highest	ERP (dBm)	ERP(W)
20	1	1	PI/2 BPSK	23.74	23.82	23.65	22.27	0.1687
20	1	104		23.72	23.81	23.75		
20	50	25		23.71	23.74	23.54		
20	1	0		23.25	23.17	23.15		
20	1	105		23.25	23.28	23.25		
20	100	0		23.21	23.38	23.21		
20	1	1	QPSK	23.74	23.62	23.65		
20	1	104		23.74	23.74	23.72		
20	50	25		23.72	23.75	23.65		
20	1	0		22.62	22.57	22.59		
20	1	105		22.65	22.74	22.74		
20	100	0		22.83	22.92	22.71		
20	1	1	16-QAM	22.45	22.38	22.71	21.16	0.1306
20	1	1	64-QAM	21.42	21.45	21.50		
20	1	1	256-QAM	19.42	19.32	19.24		
Limit	ERP < 7W			Result			Pass	



<SCS 30K>

NR n5 Maximum Average Power [dBm] (GT - LC = 0.6 dB)								
BW [MHz]	RB Size	RB Offset	Mod	Lowest	Middle	Highest	ERP (dBm)	ERP(W)
10	1	1	PI/2 BPSK	23.35	23.42	23.37	21.97	0.1574
10	1	22		23.38	23.52	23.46		
10	12	6		23.29	23.46	23.44		
10	1	0		22.82	22.80	22.93		
10	1	23		22.88	22.91	22.96		
10	24	0		22.73	22.95	22.75		
10	1	1	QPSK	23.34	23.38	23.22	20.70	0.1175
10	1	22		23.35	23.33	23.37		
10	12	6		23.28	23.43	23.38		
10	1	0		22.26	22.39	22.25		
10	1	23		22.28	22.34	22.37		
10	24	0		22.34	22.45	22.32		
10	1	1	16-QAM	22.25	22.07	22.14	20.70	0.1175
10	1	1	64-QAM	20.78	20.76	20.72		
10	1	1	256-QAM	18.65	18.66	18.64		
Limit	ERP < 7W			Result			Pass	



NR n5 Maximum Average Power [dBm] (GT - LC = 0.6 dB)								
BW [MHz]	RB Size	RB Offset	Mod	Lowest	Middle	Highest	ERP (dBm)	ERP(W)
15	1	1	PI/2 BPSK	23.35	23.25	23.44	21.97	0.1574
15	1	36		23.46	23.44	23.52		
15	18	9		23.35	23.49	23.39		
15	1	0		22.82	22.76	22.93		
15	1	37		22.92	22.89	23.05		
15	36	0		22.84	22.94	22.75		
15	1	1	QPSK	23.32	23.34	23.26		
15	1	36		23.28	23.37	23.40		
15	18	9		23.35	23.48	23.45		
15	1	0		22.25	22.31	22.25		
15	1	37		22.34	22.41	22.38		
15	36	0		22.42	22.35	22.35		
15	1	1	16-QAM	22.08	22.32	22.34	20.79	0.1199
15	1	1	64-QAM	20.72	20.83	20.85		
15	1	1	256-QAM	18.55	18.62	18.55		
Limit	ERP < 7W			Result			Pass	

NR n5 Maximum Average Power [dBm] (GT - LC = 0.6 dB)								
BW [MHz]	RB Size	RB Offset	Mod	Lowest	Middle	Highest	ERP (dBm)	ERP(W)
20	1	1	PI/2 BPSK	23.29	23.31	23.25	21.99	0.1581
20	1	49		23.44	23.42	23.54		
20	25	12		23.38	23.52	23.45		
20	1	0		22.82	22.79	22.75		
20	1	50		22.90	22.92	23.01		
20	50	0		23.01	23.08	22.85		
20	1	1	QPSK	23.31	23.26	23.35		
20	1	49		23.35	23.42	23.38		
20	25	12		23.35	23.45	23.42		
20	1	0		22.36	22.32	22.29		
20	1	50		22.38	22.40	22.45		
20	50	0		22.45	22.52	22.36		
20	1	1	16-QAM	22.22	22.32	22.04	20.77	0.1194
20	1	1	64-QAM	20.75	20.81	20.84		
20	1	1	256-QAM	18.65	18.66	18.66		
Limit	ERP < 7W			Result			Pass	



<Ant. 2>
<SCS 15K>

NR n2 Maximum Average Power [dBm] (GT - LC = 3.3 dB)								
BW [MHz]	RB Size	RB Offset	Mod	Lowest	Middle	Highest	EIRP (dBm)	EIRP(W)
5	1	1	PI/2 BPSK	22.75	23.08	22.98	26.38	0.4345
5	1	23		22.69	22.89	22.96		
5	12	6		22.89	22.93	23.02		
5	1	0		22.33	22.46	22.54		
5	1	24		22.31	22.43	22.54		
5	25	0		22.35	22.43	22.58		
5	1	1	QPSK	22.79	22.88	23.02		
5	1	23		22.75	22.84	23.02		
5	12	6		22.91	22.92	23.04		
5	1	0		21.81	21.95	22.01		
5	1	24		21.83	21.95	22.02		
5	25	0		21.85	21.95	22.01		
5	1	1	16-QAM	21.95	22.08	22.16	25.46	0.3516
5	1	1	64-QAM	20.48	20.62	20.74		
5	1	1	256-QAM	18.66	18.74	18.85		
Limit	EIRP < 2W			Result			Pass	

NR n2 Maximum Average Power [dBm] (GT - LC = 3.3 dB)								
BW [MHz]	RB Size	RB Offset	Mod	Lowest	Middle	Highest	EIRP (dBm)	EIRP(W)
10	1	1	PI/2 BPSK	22.81	22.86	22.95	26.38	0.4345
10	1	50		22.86	22.92	23.02		
10	25	12		22.88	22.98	23.05		
10	1	0		22.35	22.34	22.51		
10	1	51		22.41	22.47	22.65		
10	50	0		22.41	22.48	22.62		
10	1	1	QPSK	22.91	22.88	23.02		
10	1	50		22.88	22.95	23.08		
10	25	12		22.91	22.97	23.07		
10	1	0		21.91	21.95	21.99		
10	1	51		21.93	21.99	22.15		
10	50	0		21.87	21.98	22.09		
10	1	1	16-QAM	22.07	22.04	22.15	25.45	0.3508
10	1	1	64-QAM	20.54	20.61	20.74		
10	1	1	256-QAM	18.78	18.76	18.86		
Limit	EIRP < 2W			Result			Pass	



NR n2 Maximum Average Power [dBm] (GT - LC = 3.3 dB)										
BW [MHz]	RB Size	RB Offset	Mod	Lowest	Middle	Highest	EIRP (dBm)	EIRP(W)		
15	1	1	PI/2 BPSK	22.81	22.87	22.84	26.31	0.4276		
15	1	77		22.85	22.88	22.97				
15	36	18		22.89	22.94	22.99				
15	1	0		22.36	22.44	22.33				
15	1	78		22.41	22.42	22.52				
15	75	0		22.34	22.47	22.60				
15	1	1	QPSK	22.90	22.92	22.91			26.31	0.4276
15	1	77		22.94	22.91	22.98				
15	36	18		22.81	22.97	23.01				
15	1	0		21.88	21.90	21.92				
15	1	78		21.94	21.98	22.04				
15	75	0		21.86	21.95	22.09				
15	1	1	16-QAM	22.01	22.06	22.01	25.36	0.3436		
15	1	1	64-QAM	20.51	20.58	20.57				
15	1	1	256-QAM	18.75	18.74	18.65				
Limit	EIRP < 2W			Result			Pass			

NR n2 Maximum Average Power [dBm] (GT - LC = 3.3 dB)										
BW [MHz]	RB Size	RB Offset	Mod	Lowest	Middle	Highest	EIRP (dBm)	EIRP(W)		
20	1	1	PI/2 BPSK	23.01	23.09	22.87	26.39	0.4355		
20	1	104		22.86	22.98	23.04				
20	50	25		22.80	22.94	22.98				
20	1	0		22.41	22.46	22.38				
20	1	105		22.49	22.55	22.65				
20	100	0		22.21	22.46	22.52				
20	1	1	QPSK	22.85	22.94	23.05			26.39	0.4355
20	1	104		23.01	23.04	23.08				
20	50	25		22.84	23.01	22.97				
20	1	0		21.96	22.03	22.11				
20	1	105		21.96	22.11	22.21				
20	100	0		21.76	22.01	22.16				
20	1	1	16-QAM	21.83	22.15	21.84	25.45	0.3508		
20	1	1	64-QAM	20.26	20.67	20.35				
20	1	1	256-QAM	18.61	18.84	18.62				
Limit	EIRP < 2W			Result			Pass			



NR n66 Maximum Average Power [dBm] (GT - LC = 4.1 dB)										
BW [MHz]	RB Size	RB Offset	Mod	Lowest	Middle	Highest	EIRP (dBm)	EIRP(W)		
5	1	1	PI/2 BPSK	22.64	22.65	22.75	27.05	0.507		
5	1	23		22.65	22.63	22.67				
5	12	6		22.75	22.85	22.80				
5	1	0		22.25	22.32	22.29				
5	1	24		22.25	22.24	22.38				
5	25	0		22.38	22.41	22.45				
5	1	1	QPSK	22.82	22.95	22.68			26.75	0.4732
5	1	23		22.95	22.92	22.74				
5	12	6		22.74	22.78	22.92				
5	1	0		21.95	21.95	22.01				
5	1	24		21.86	21.96	21.98				
5	25	0		21.92	21.92	21.98				
5	1	1	16-QAM	22.65	21.74	21.82	26.75	0.4732		
5	1	1	64-QAM	20.19	20.25	20.24				
5	1	1	256-QAM	18.48	18.54	18.57				
Limit	EIRP < 1W			Result			Pass			

NR n66 Maximum Average Power [dBm] (GT - LC = 4.1 dB)										
BW [MHz]	RB Size	RB Offset	Mod	Lowest	Middle	Highest	EIRP (dBm)	EIRP(W)		
10	1	1	PI/2 BPSK	22.68	22.67	22.74	27.11	0.514		
10	1	50		20.74	22.75	22.87				
10	25	12		22.85	22.82	22.95				
10	1	0		22.31	22.24	22.31				
10	1	51		22.34	22.32	22.41				
10	50	0		22.40	22.34	22.51				
10	1	1	QPSK	22.95	22.96	22.98			25.95	0.3936
10	1	50		22.98	22.95	23.01				
10	25	12		22.85	22.87	22.91				
10	1	0		21.95	22.25	22.04				
10	1	51		22.02	22.36	22.06				
10	50	0		21.95	21.95	22.04				
10	1	1	16-QAM	21.85	21.77	21.82	25.95	0.3936		
10	1	1	64-QAM	20.24	20.26	20.15				
10	1	1	256-QAM	18.54	18.54	18.65				
Limit	EIRP < 1W			Result			Pass			



NR n66 Maximum Average Power [dBm] (GT - LC = 4.1 dB)								
BW [MHz]	RB Size	RB Offset	Mod	Lowest	Middle	Highest	EIRP (dBm)	EIRP(W)
15	1	1	PI/2 BPSK	22.67	22.73	22.68	27.08	0.5105
15	1	77		22.78	22.69	22.75		
15	36	18		22.84	22.83	22.85		
15	1	0		22.26	22.25	22.26		
15	1	78		22.38	22.28	22.35		
15	75	0		22.41	22.44	22.38		
15	1	1	QPSK	22.92	22.98	22.95		
15	1	77		22.98	22.94	22.95		
15	36	18		22.89	22.85	22.81		
15	1	0		22.01	21.96	21.92		
15	1	78		22.01	21.97	22.04		
15	75	0		21.94	21.96	21.95		
15	1	1	16-QAM	21.95	21.89	21.85	26.05	0.4027
15	1	1	64-QAM	20.21	20.32	20.25		
15	1	1	256-QAM	18.59	18.65	18.52		
Limit	EIRP < 1W			Result			Pass	

NR n66 Maximum Average Power [dBm] (GT - LC = 4.1 dB)								
BW [MHz]	RB Size	RB Offset	Mod	Lowest	Middle	Highest	EIRP (dBm)	EIRP(W)
20	1	1	PI/2 BPSK	23.05	22.85	22.76	27.15	0.5188
20	1	104		22.84	22.83	22.91		
20	50	25		22.86	22.85	22.81		
20	1	0		22.36	22.51	22.45		
20	1	105		22.49	22.45	22.51		
20	100	0		22.45	22.42	22.35		
20	1	1	QPSK	23.01	23.02	22.96		
20	1	104		22.98	23.01	23.01		
20	50	25		22.87	22.86	22.84		
20	1	0		22.08	22.15	21.98		
20	1	105		22.04	22.13	22.16		
20	100	0		21.95	21.92	21.91		
20	1	1	16-QAM	21.88	21.99	21.85	26.09	0.4064
20	1	1	64-QAM	20.32	20.41	20.27		
20	1	1	256-QAM	18.65	18.77	18.58		
Limit	EIRP < 1W			Result			Pass	



NR n66 Maximum Average Power [dBm] (GT - LC = 4.1 dB)								
BW [MHz]	RB Size	RB Offset	Mod	Lowest	Middle	Highest	EIRP (dBm)	EIRP(W)
40	1	1	PI/2 BPSK	22.85	22.72	22.71	27.12	0.5152
40	1	214		22.68	22.76	22.82		
40	108	54		22.88	22.76	22.85		
40	1	0		22.42	22.27	22.35		
40	1	215		22.32	22.32	22.47		
40	216	0		22.84	22.26	22.38		
40	1	1	QPSK	23.01	22.94	23.02	27.12	0.5152
40	1	214		22.97	22.81	23.01		
40	108	54		22.89	22.81	22.83		
40	1	0		22.06	21.98	22.03		
40	1	215		22.01	22.38	22.09		
40	216	0		21.92	21.72	21.87		
40	1	1	16-QAM	21.83	21.78	21.78	25.93	0.3917
40	1	1	64-QAM	20.29	20.25	20.35		
40	1	1	256-QAM	18.66	18.52	18.65		
Limit	EIRP < 1W			Result			Pass	



<SCS 30K>

NR n2 Maximum Average Power [dBm] (GT - LC = 3.3 dB)								
BW [MHz]	RB Size	RB Offset	Mod	Lowest	Middle	Highest	EIRP (dBm)	EIRP(W)
10	1	1	PI/2 BPSK	22.36	22.82	22.92	26.31	0.4276
10	1	22		22.73	22.84	22.94		
10	12	6		22.95	22.95	23.01		
10	1	0		22.32	22.35	22.46		
10	1	23		22.26	22.35	22.15		
10	24	0		22.39	22.48	22.54		
10	1	1	QPSK	22.95	22.84	22.98	25.15	0.3273
10	1	22		22.84	22.85	23.01		
10	12	6		22.69	22.95	22.98		
10	1	0		21.87	21.85	22.01		
10	1	23		21.85	21.84	21.98		
10	24	0		21.85	21.92	22.01		
10	1	1	16-QAM	21.74	21.75	21.85	25.15	0.3273
10	1	1	64-QAM	20.42	20.35	20.51		
10	1	1	256-QAM	18.27	18.25	18.36		
Limit	EIRP < 2W			Result			Pass	



NR n2 Maximum Average Power [dBm] (GT - LC = 3.3 dB)								
BW [MHz]	RB Size	RB Offset	Mod	Lowest	Middle	Highest	EIRP (dBm)	EIRP(W)
15	1	1	PI/2 BPSK	22.79	22.81	22.76	26.27	0.4236
15	1	36		22.75	22.76	22.87		
15	18	9		22.85	22.92	22.96		
15	1	0		22.35	22.40	22.35		
15	1	37		22.31	22.33	22.43		
15	36	0		22.33	22.41	22.35		
15	1	1	QPSK	22.84	22.85	22.90		
15	1	36		22.81	22.82	22.95		
15	18	9		22.87	22.97	22.91		
15	1	0		21.86	21.88	21.89		
15	1	37		21.83	21.85	21.91		
15	36	0		21.85	21.94	21.99		
15	1	1	16-QAM	21.76	21.77	21.80	25.10	0.3236
15	1	1	64-QAM	20.32	20.35	20.34		
15	1	1	256-QAM	18.32	18.21	18.20		
Limit	EIRP < 2W			Result			Pass	

NR n2 Maximum Average Power [dBm] (GT - LC = 3.3 dB)								
BW [MHz]	RB Size	RB Offset	Mod	Lowest	Middle	Highest	EIRP (dBm)	EIRP(W)
20	1	1	PI/2 BPSK	22.78	22.82	23.03	26.33	0.4295
20	1	49		22.80	22.77	22.81		
20	25	12		22.79	22.94	22.82		
20	1	0		22.33	22.36	22.35		
20	1	50		22.35	22.31	22.34		
20	50	0		22.26	22.41	22.28		
20	1	1	QPSK	22.83	22.85	22.82		
20	1	49		22.85	22.87	22.85		
20	25	12		22.83	22.92	22.81		
20	1	0		21.86	21.87	21.84		
20	1	50		21.85	21.88	21.87		
20	50	0		21.74	21.95	21.78		
20	1	1	16-QAM	21.75	21.79	21.77	25.09	0.3228
20	1	1	64-QAM	20.06	20.38	20.32		
20	1	1	256-QAM	18.25	18.32	18.31		
Limit	EIRP < 2W			Result			Pass	



NR n66 Maximum Average Power [dBm] (GT - LC = 4.1 dB)								
BW [MHz]	RB Size	RB Offset	Mod	Lowest	Middle	Highest	EIRP (dBm)	EIRP(W)
10	1	1	PI/2 BPSK	22.74	22.76	22.78	27.02	0.5035
10	1	22		22.71	22.59	22.79		
10	12	6		22.85	22.84	22.92		
10	1	0		22.32	22.35	22.36		
10	1	23		22.32	22.19	22.45		
10	24	0		22.41	22.38	22.42		
10	1	1	QPSK	22.81	22.78	22.85		
10	1	22		22.74	22.79	22.81		
10	12	6		22.81	22.85	22.85		
10	1	0		21.85	21.93	21.95		
10	1	23		21.85	21.79	21.98		
10	24	0		21.93	21.95	21.98		
10	1	1	16-QAM	21.84	21.81	21.79	25.94	0.3926
10	1	1	64-QAM	20.32	20.21	20.18		
10	1	1	256-QAM	18.16	18.15	18.19		
Limit	EIRP < 1W			Result			Pass	

NR n66 Maximum Average Power [dBm] (GT - LC = 4.1 dB)								
BW [MHz]	RB Size	RB Offset	Mod	Lowest	Middle	Highest	EIRP (dBm)	EIRP(W)
15	1	1	PI/2 BPSK	22.75	22.78	22.69	27.00	0.5012
15	1	36		22.67	22.65	22.68		
15	18	9		22.81	22.75	22.79		
15	1	0		22.32	22.35	22.38		
15	1	37		22.39	22.24	22.26		
15	36	0		22.42	22.44	22.49		
15	1	1	QPSK	22.74	22.86	22.82		
15	1	36		22.79	22.74	22.77		
15	18	9		22.86	22.85	22.90		
15	1	0		21.95	21.96	21.98		
15	1	37		21.96	21.84	21.79		
15	36	0		21.95	21.95	21.86		
15	1	1	16-QAM	21.79	21.86	21.93	26.03	0.4009
15	1	1	64-QAM	20.16	20.32	20.26		
15	1	1	256-QAM	18.25	18.28	18.25		
Limit	EIRP < 1W			Result			Pass	



NR n66 Maximum Average Power [dBm] (GT - LC = 4.1 dB)								
BW [MHz]	RB Size	RB Offset	Mod	Lowest	Middle	Highest	EIRP (dBm)	EIRP(W)
20	1	1	PI/2 BPSK	22.74	22.96	22.75	27.06	0.5082
20	1	49		22.76	22.71	22.76		
20	25	12		22.85	22.84	22.82		
20	1	0		22.35	22.54	22.37		
20	1	50		22.33	22.32	22.35		
20	50	0		22.35	22.35	22.36		
20	1	1	QPSK	22.75	22.85	22.75		
20	1	49		22.79	22.75	22.76		
20	25	12		22.95	22.92	22.89		
20	1	0		21.85	21.95	21.86		
20	1	50		21.82	21.84	21.83		
20	50	0		21.92	21.85	21.87		
20	1	1	16-QAM	21.75	21.84	21.75	25.94	0.3926
20	1	1	64-QAM	20.25	20.35	20.21		
20	1	1	256-QAM	18.25	18.34	18.18		
Limit	EIRP < 1W			Result			Pass	

NR n66 Maximum Average Power [dBm] (GT - LC = 4.1 dB)								
BW [MHz]	RB Size	RB Offset	Mod	Lowest	Middle	Highest	EIRP (dBm)	EIRP(W)
40	1	1	PI/2 BPSK	22.85	22.89	22.74	27.03	0.5047
40	1	104		22.71	22.83	22.85		
40	50	25		22.82	22.86	22.78		
40	1	0		22.39	22.43	22.32		
40	1	105		22.28	22.41	22.40		
40	100	0		22.38	22.28	22.38		
40	1	1	QPSK	22.82	22.85	22.84		
40	1	104		22.74	22.85	22.93		
40	50	25		22.86	22.85	22.85		
40	1	0		21.87	21.94	21.92		
40	1	105		21.85	21.95	21.93		
40	100	0		21.95	21.82	21.82		
40	1	1	16-QAM	21.89	21.84	21.98	26.08	0.4055
40	1	1	64-QAM	20.19	20.32	20.25		
40	1	1	256-QAM	18.25	18.32	18.25		
Limit	EIRP < 1W			Result			Pass	



<Ant. 4>
<SCS 15K>

NR n2 Maximum Average Power [dBm] (GT - LC = 2.3 dB)								
BW [MHz]	RB Size	RB Offset	Mod	Lowest	Middle	Highest	EIRP (dBm)	EIRP(W)
5	1	1	PI/2 BPSK	22.99	23.21	23.28	25.65	0.3673
5	1	23		23.08	23.20	23.31		
5	12	6		23.14	23.19	23.35		
5	1	0		22.50	22.65	22.82		
5	1	24		22.63	22.67	22.83		
5	25	0		22.63	22.74	22.88		
5	1	1	QPSK	23.01	23.13	23.27		
5	1	23		23.03	23.15	23.21		
5	12	6		23.14	23.20	23.33		
5	1	0		21.88	22.13	22.25		
5	1	24		22.07	22.15	22.27		
5	25	0		22.09	22.23	22.31		
5	1	1	16-QAM	22.01	21.88	21.95	24.31	0.2698
5	1	1	64-QAM	20.87	20.83	20.98		
5	1	1	256-QAM	18.91	19.15	19.05		
Limit	EIRP < 2W			Result			Pass	

NR n2 Maximum Average Power [dBm] (GT - LC = 2.3 dB)								
BW [MHz]	RB Size	RB Offset	Mod	Lowest	Middle	Highest	EIRP (dBm)	EIRP(W)
10	1	1	PI/2 BPSK	23.02	23.08	23.31	25.69	0.3707
10	1	50		23.25	23.22	23.39		
10	25	12		23.22	23.24	23.35		
10	1	0		22.54	22.65	22.81		
10	1	51		22.71	22.79	22.92		
10	50	0		22.77	22.76	22.88		
10	1	1	QPSK	22.96	23.03	23.26		
10	1	50		23.21	23.19	23.34		
10	25	12		23.27	23.24	23.35		
10	1	0		21.97	21.99	22.21		
10	1	51		22.16	22.18	22.30		
10	50	0		22.30	22.26	22.41		
10	1	1	16-QAM	21.87	22.09	21.92	24.39	0.2748
10	1	1	64-QAM	20.79	20.96	20.93		
10	1	1	256-QAM	19.05	19.07	19.23		
Limit	EIRP < 2W			Result			Pass	



NR n2 Maximum Average Power [dBm] (GT - LC = 2.3 dB)								
BW [MHz]	RB Size	RB Offset	Mod	Lowest	Middle	Highest	EIRP (dBm)	EIRP(W)
15	1	1	PI/2 BPSK	22.95	23.12	23.31	25.65	0.3673
15	1	77		22.29	23.31	23.30		
15	36	18		23.32	23.26	23.35		
15	1	0		22.51	22.58	22.78		
15	1	78		22.77	22.74	22.85		
15	75	0		22.79	22.85	22.77		
15	1	1	QPSK	23.04	23.06	23.18		
15	1	77		23.21	23.21	23.29		
15	36	18		23.23	23.24	23.32		
15	1	0		21.96	21.96	22.19		
15	1	78		22.18	22.24	22.22		
15	75	0		22.32	22.33	22.26		
15	1	1	16-QAM	21.74	21.85	21.98	24.28	0.2679
15	1	1	64-QAM	20.78	20.75	20.85		
15	1	1	256-QAM	18.85	18.85	19.25		
Limit	EIRP < 2W			Result			Pass	

NR n2 Maximum Average Power [dBm] (GT - LC = 2.3 dB)								
BW [MHz]	RB Size	RB Offset	Mod	Lowest	Middle	Highest	EIRP (dBm)	EIRP(W)
20	1	1	PI/2 BPSK	23.15	23.47	23.45	25.77	0.3776
20	1	104		23.28	23.46	23.41		
20	50	25		23.21	23.24	23.25		
20	1	0		22.65	22.75	22.85		
20	1	105		22.79	23.01	22.95		
20	100	0		22.95	22.94	22.58		
20	1	1	QPSK	23.07	23.18	23.32		
20	1	104		23.24	23.34	23.41		
20	50	25		23.16	23.26	23.32		
20	1	0		22.01	22.18	22.32		
20	1	105		22.19	22.38	22.42		
20	100	0		23.35	22.57	22.10		
20	1	1	16-QAM	21.74	21.91	22.07	24.37	0.2735
20	1	1	64-QAM	20.81	20.87	20.95		
20	1	1	256-QAM	19.05	19.03	19.35		
Limit	EIRP < 2W			Result			Pass	



NR n66 Maximum Average Power [dBm] (GT - LC = 2.7 dB)								
BW [MHz]	RB Size	RB Offset	Mod	Lowest	Middle	Highest	EIRP (dBm)	EIRP(W)
5	1	1	PI/2 BPSK	23.10	23.18	23.04	26.03	0.4009
5	1	23		23.11	23.18	23.15		
5	12	6		23.16	23.32	23.25		
5	1	0		22.62	22.74	22.66		
5	1	24		22.64	22.72	22.65		
5	25	0		22.58	22.71	22.69		
5	1	1	QPSK	23.08	23.28	23.15		
5	1	23		23.13	23.22	23.15		
5	12	6		23.17	23.33	23.25		
5	1	0		22.01	22.19	22.17		
5	1	24		22.06	22.14	22.18		
5	25	0		22.16	22.28	22.21		
5	1	1	16-QAM	21.98	22.24	22.23	24.94	0.3119
5	1	1	64-QAM	20.47	20.77	20.65		
5	1	1	256-QAM	18.65	18.68	18.56		
Limit	EIRP < 1W			Result			Pass	

NR n66 Maximum Average Power [dBm] (GT - LC = 2.7 dB)								
BW [MHz]	RB Size	RB Offset	Mod	Lowest	Middle	Highest	EIRP (dBm)	EIRP(W)
10	1	1	PI/2 BPSK	23.21	23.25	23.17	25.99	0.3972
10	1	50		23.27	23.28	23.23		
10	25	12		23.24	22.31	23.26		
10	1	0		22.64	22.72	22.68		
10	1	51		22.82	22.74	22.75		
10	50	0		22.62	22.77	22.74		
10	1	1	QPSK	23.21	23.29	23.17		
10	1	50		23.29	23.28	23.28		
10	25	12		23.26	23.27	23.23		
10	1	0		22.09	22.16	22.06		
10	1	51		22.19	22.30	22.14		
10	50	0		22.18	22.33	22.26		
10	1	1	16-QAM	22.02	22.08	22.28	24.98	0.3148
10	1	1	64-QAM	20.54	20.62	20.74		
10	1	1	256-QAM	18.66	18.75	18.65		
Limit	EIRP < 1W			Result			Pass	



NR n66 Maximum Average Power [dBm] (GT - LC = 2.7 dB)										
BW [MHz]	RB Size	RB Offset	Mod	Lowest	Middle	Highest	EIRP (dBm)	EIRP(W)		
15	1	1	PI/2 BPSK	23.10	23.24	23.04	26.03	0.4009		
15	1	77		23.33	23.26	23.21				
15	36	18		23.28	23.25	23.16				
15	1	0		22.64	22.74	22.58				
15	1	78		22.79	22.78	22.67				
15	75	0		22.75	22.74	22.67				
15	1	1	QPSK	23.21	23.24	23.12			24.95	0.3126
15	1	77		23.25	23.25	23.14				
15	36	18		23.28	23.32	23.17				
15	1	0		22.04	22.18	22.01				
15	1	78		22.18	22.30	22.21				
15	75	0		22.25	22.33	22.17				
15	1	1	16-QAM	22.25	22.13	22.17	24.95	0.3126		
15	1	1	64-QAM	20.71	20.58	20.67				
15	1	1	256-QAM	18.65	18.75	18.52				
Limit	EIRP < 1W			Result			Pass			

NR n66 Maximum Average Power [dBm] (GT - LC = 2.7 dB)										
BW [MHz]	RB Size	RB Offset	Mod	Lowest	Middle	Highest	EIRP (dBm)	EIRP(W)		
20	1	1	PI/2 BPSK	23.41	23.27	23.20	26.11	0.4083		
20	1	104		23.40	23.31	23.27				
20	50	25		23.19	23.27	23.17				
20	1	0		22.74	22.81	22.76				
20	1	105		22.92	22.82	22.79				
20	100	0		22.74	22.81	22.66				
20	1	1	QPSK	23.24	23.34	23.21			25.02	0.3177
20	1	104		23.39	23.25	23.21				
20	50	25		23.20	23.30	23.19				
20	1	0		22.11	22.21	22.11				
20	1	105		22.31	22.34	22.31				
20	100	0		22.28	22.34	22.11				
20	1	1	16-QAM	22.32	22.18	22.02	25.02	0.3177		
20	1	1	64-QAM	20.82	20.66	20.55				
20	1	1	256-QAM	18.76	18.83	18.72				
Limit	EIRP < 1W			Result			Pass			



NR n66 Maximum Average Power [dBm] (GT - LC = 2.7 dB)								
BW [MHz]	RB Size	RB Offset	Mod	Lowest	Middle	Highest	EIRP (dBm)	EIRP(W)
40	1	1	PI/2 BPSK	23.22	23.30	23.24	26.02	0.3999
40	1	214		23.25	23.31	23.25		
40	108	54		23.28	23.23	23.28		
40	1	0		22.74	22.82	22.81		
40	1	215		22.76	22.83	22.84		
40	216	0		22.64	22.73	22.68		
40	1	1	QPSK	23.17	23.22	23.21	25.06	0.3206
40	1	214		23.28	23.32	23.27		
40	108	54		23.24	23.25	23.20		
40	1	0		22.15	22.24	22.21		
40	1	215		22.29	22.35	22.19		
40	216	0		22.15	22.30	22.18		
40	1	1	16-QAM	22.08	22.14	22.36	25.06	0.3206
40	1	1	64-QAM	20.58	20.62	20.84		
40	1	1	256-QAM	18.74	18.78	18.74		
Limit	EIRP < 1W			Result			Pass	



<SCS 30K>

NR n2 Maximum Average Power [dBm] (GT - LC = 2.3 dB)								
BW [MHz]	RB Size	RB Offset	Mod	Lowest	Middle	Highest	EIRP (dBm)	EIRP(W)
10	1	1	PI/2 BPSK	23.14	23.02	23.30	25.62	0.3648
10	1	22		23.19	23.20	23.27		
10	12	6		23.25	23.22	23.32		
10	1	0		22.62	22.57	22.85		
10	1	23		22.66	22.70	22.75		
10	24	0		22.74	22.69	22.83		
10	1	1	QPSK	23.06	23.01	23.25		
10	1	22		23.11	23.13	23.16		
10	12	6		23.25	23.18	23.30		
10	1	0		22.08	22.02	22.27		
10	1	23		22.11	22.03	22.23		
10	24	0		22.26	22.14	22.32		
10	1	1	16-QAM	22.49	22.26	22.63	24.93	0.3112
10	1	1	64-QAM	20.53	20.34	20.62		
10	1	1	256-QAM	18.92	18.74	19.01		
Limit	EIRP < 2W			Result			Pass	

NR n2 Maximum Average Power [dBm] (GT - LC = 2.3 dB)								
BW [MHz]	RB Size	RB Offset	Mod	Lowest	Middle	Highest	EIRP (dBm)	EIRP(W)
15	1	1	PI/2 BPSK	23.23	23.14	23.40	25.71	0.3724
15	1	36		23.27	23.36	23.29		
15	18	9		23.32	23.32	23.41		
15	1	0		22.76	22.58	22.90		
15	1	37		22.79	22.88	22.75		
15	36	0		22.84	22.89	22.79		
15	1	1	QPSK	23.26	23.09	23.29		
15	1	36		23.15	23.28	23.22		
15	18	9		23.32	23.28	23.38		
15	1	0		22.24	22.10	22.26		
15	1	37		22.21	22.23	22.24		
15	36	0		22.36	22.36	22.28		
15	1	1	16-QAM	22.56	22.40	22.51	24.86	0.3062
15	1	1	64-QAM	20.52	20.47	20.63		
15	1	1	256-QAM	18.91	18.83	19.05		
Limit	EIRP < 2W			Result			Pass	



NR n2 Maximum Average Power [dBm] (GT - LC = 2.3 dB)										
BW [MHz]	RB Size	RB Offset	Mod	Lowest	Middle	Highest	EIRP (dBm)	EIRP(W)		
20	1	1	PI/2 BPSK	23.23	23.18	23.42	25.72	0.3733		
20	1	49		23.18	23.36	23.29				
20	25	12		23.26	23.28	23.35				
20	1	0		22.75	22.67	22.98				
20	1	50		22.68	22.89	22.81				
20	50	0		22.94	22.85	22.62				
20	1	1	QPSK	23.16	23.11	23.41			25.52	0.3565
20	1	49		23.14	23.30	23.23				
20	25	12		23.25	23.18	23.37				
20	1	0		22.22	22.10	22.29				
20	1	50		22.07	22.28	22.25				
20	50	0		22.38	22.48	22.12				
20	1	1	16-QAM	23.22	22.17	22.53	25.52	0.3565		
20	1	1	64-QAM	20.37	20.27	20.70				
20	1	1	256-QAM	18.82	18.67	19.11				
Limit	EIRP < 2W			Result			Pass			

NR n66 Maximum Average Power [dBm] (GT - LC = 2.7 dB)										
BW [MHz]	RB Size	RB Offset	Mod	Lowest	Middle	Highest	EIRP (dBm)	EIRP(W)		
10	1	1	PI/2 BPSK	23.23	23.29	23.25	26.04	0.4018		
10	1	22		23.25	23.26	23.25				
10	12	6		23.32	23.34	23.23				
10	1	0		22.76	22.84	22.73				
10	1	23		22.78	22.76	22.75				
10	24	0		22.78	22.79	22.75				
10	1	1	QPSK	23.28	23.34	23.22			25.03	0.3184
10	1	22		23.31	22.28	23.25				
10	12	6		23.34	23.33	23.25				
10	1	0		22.22	22.28	22.25				
10	1	23		22.23	22.22	22.21				
10	24	0		22.31	22.33	22.34				
10	1	1	16-QAM	21.98	22.33	22.16	25.03	0.3184		
10	1	1	64-QAM	20.61	20.75	20.81				
10	1	1	256-QAM	18.47	18.54	18.55				
Limit	EIRP < 1W			Result			Pass			



NR n66 Maximum Average Power [dBm] (GT - LC = 2.7 dB)								
BW [MHz]	RB Size	RB Offset	Mod	Lowest	Middle	Highest	EIRP (dBm)	EIRP(W)
15	1	1	PI/2 BPSK	23.25	23.31	23.13	26.05	0.4027
15	1	36		23.25	23.22	23.11		
15	18	9		23.34	23.35	23.12		
15	1	0		22.75	22.85	22.64		
15	1	37		22.75	22.78	22.62		
15	36	0		22.81	22.79	22.66		
15	1	1	QPSK	23.17	23.32	23.12		
15	1	36		23.28	23.34	23.14		
15	18	9		23.32	23.33	23.18		
15	1	0		22.23	22.29	22.09		
15	1	37		22.26	22.25	22.14		
15	36	0		22.35	22.35	22.13		
15	1	1	16-QAM	22.25	22.08	21.92	24.95	0.3126
15	1	1	64-QAM	20.61	20.73	20.53		
15	1	1	256-QAM	18.45	18.58	18.46		
Limit	EIRP < 1W			Result			Pass	

NR n66 Maximum Average Power [dBm] (GT - LC = 2.7 dB)								
BW [MHz]	RB Size	RB Offset	Mod	Lowest	Middle	Highest	EIRP (dBm)	EIRP(W)
20	1	1	PI/2 BPSK	23.25	23.36	23.18	26.06	0.4036
20	1	49		23.32	23.25	23.14		
20	25	12		23.25	23.25	23.18		
20	1	0		22.73	22.84	22.67		
20	1	50		22.82	22.75	22.66		
20	50	0		22.78	22.76	22.58		
20	1	1	QPSK	23.27	23.25	23.08		
20	1	49		23.25	23.18	23.14		
20	25	12		23.27	23.25	23.16		
20	1	0		22.18	22.24	22.14		
20	1	50		22.25	22.22	22.12		
20	50	0		22.28	22.32	22.09		
20	1	1	16-QAM	21.95	22.34	22.09	25.04	0.3192
20	1	1	64-QAM	20.62	20.73	20.64		
20	1	1	256-QAM	18.44	18.43	18.49		
Limit	EIRP < 1W			Result			Pass	



NR n66 Maximum Average Power [dBm] (GT - LC = 2.7 dB)								
BW [MHz]	RB Size	RB Offset	Mod	Lowest	Middle	Highest	EIRP (dBm)	EIRP(W)
40	1	1	PI/2 BPSK	23.34	23.25	23.28	26.04	0.4018
40	1	104		23.25	23.26	23.26		
40	50	25		23.28	23.23	23.28		
40	1	0		22.82	22.80	22.81		
40	1	105		22.78	22.79	22.82		
40	100	0		22.69	22.66	22.72		
40	1	1	QPSK	23.21	23.29	23.25	26.04	0.4018
40	1	104		23.22	23.24	23.25		
40	50	25		23.28	23.22	23.24		
40	1	0		22.25	22.24	22.25		
40	1	105		22.22	22.33	22.28		
40	100	0		22.18	22.18	22.19		
40	1	1	16-QAM	22.18	22.04	22.05	24.88	0.3076
40	1	1	64-QAM	20.74	20.66	20.65		
40	1	1	256-QAM	18.63	18.55	18.58		
Limit	EIRP < 1W			Result			Pass	



FR1 n2

Peak-to-Average Ratio

Mode	FR1 n2 / 20MHz / DFT-S OFDM				
Mod.	PI/2 BPSK	QPSK	16QAM	64QAM	Limit: 13dB
RB Size	Full RB	Full RB	Full RB	Full RB	Result
Middle CH	5.80	4.90	6.54	6.66	PASS
Mode	FR1 n2 / 20MHz / DFT-S OFDM				
Mod.	256QAM				Limit: 13dB
RB Size	Full RB				Result
Middle CH	6.80				PASS



FR1 n2 / 20MHz / DFT-S OFDM / Middle Channel / Full RB

PI/2 BPSK

QPSK

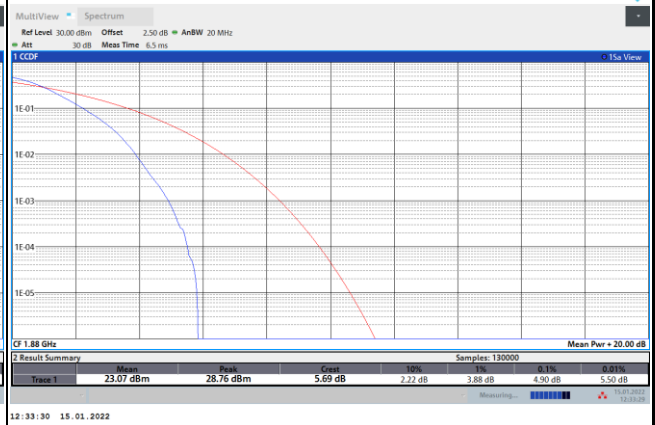
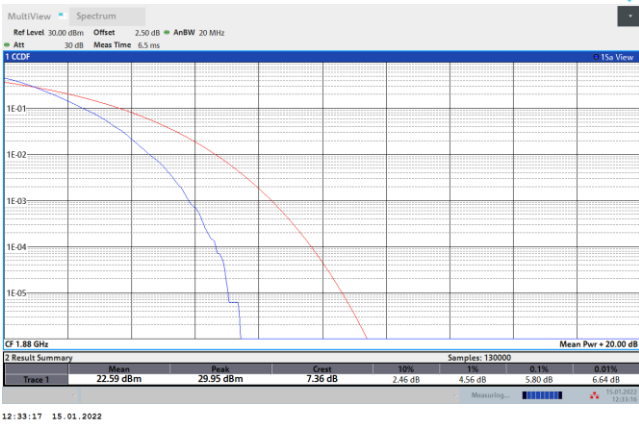

16QAM

64QAM

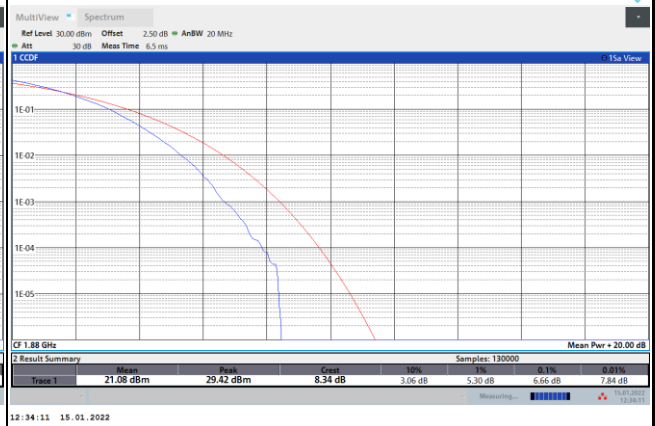
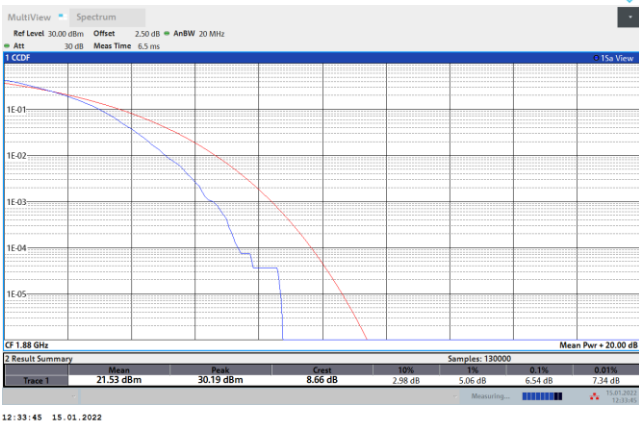

256QAM

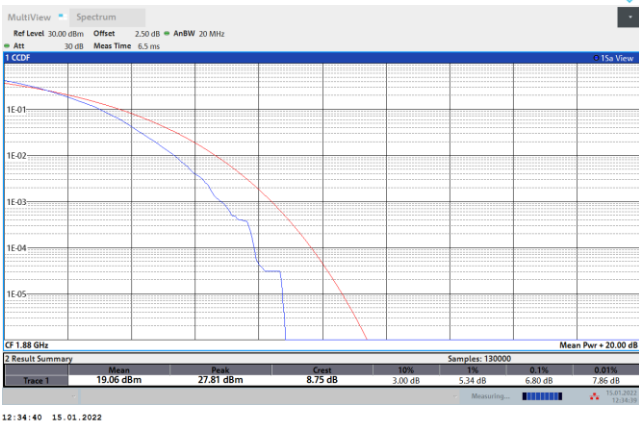



26dB Bandwidth

Mode	FR1 n2 : 26dB BW(MHz) / DFT-S OFDM							
BW	5MHz		10MHz		15MHz		20MHz	
Mod.	PI/2 BPSK		PI/2 BPSK		PI/2 BPSK		PI/2 BPSK	
Middle CH	4.92		9.49		14.30		18.78	

Mode	FR1 n2 : 26dB BW(MHz) / CP OFDM							
BW	5MHz		10MHz		15MHz		20MHz	
Mod.	QPSK	16QAM	QPSK	16QAM	QPSK	16QAM	QPSK	16QAM
Middle CH	4.88	4.82	9.83	9.75	15.02	14.98	20.10	19.78
Mod.	64QAM	256QAM	64QAM	256QAM	64QAM	256QAM	64QAM	256QAM
Middle CH	4.88	4.93	9.69	9.77	14.87	14.89	19.78	19.90



FR1 n2 / 5MHz / DFT-S OFDM / Middle Channel / Full RB

PI/2 BPSK

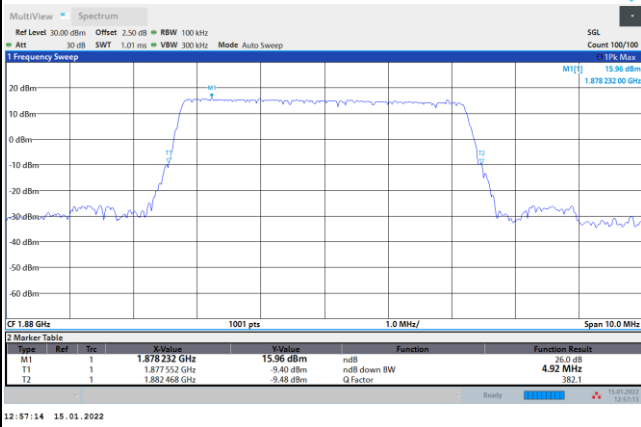

FR1 n2 / 5MHz / CP OFDM / Middle Channel / Full RB

QPSK

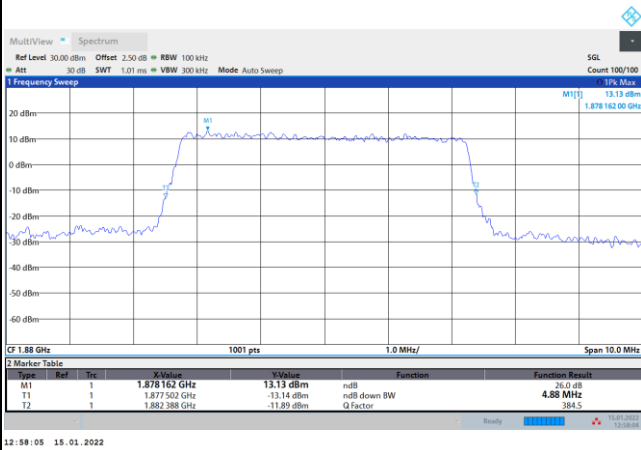

16QAM

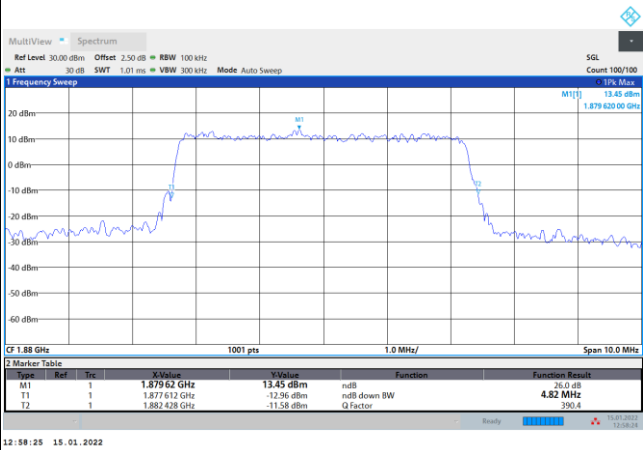

64QAM

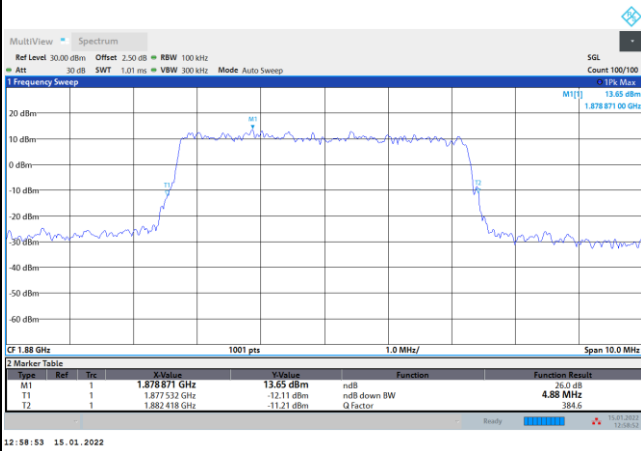

256QAM

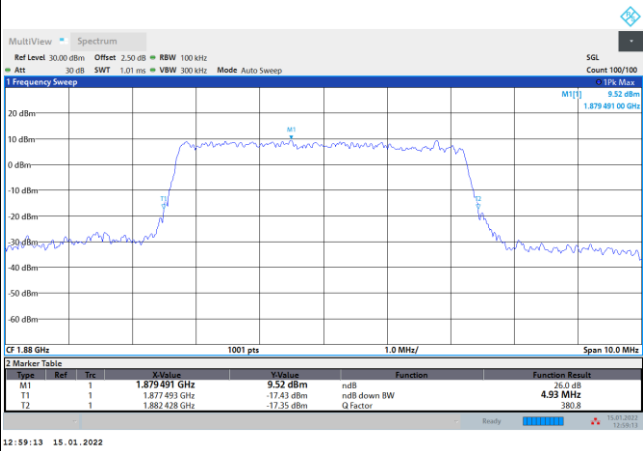



FR1 n2 / 10MHz / DFT-S OFDM / Middle Channel / Full RB

PI/2 BPSK

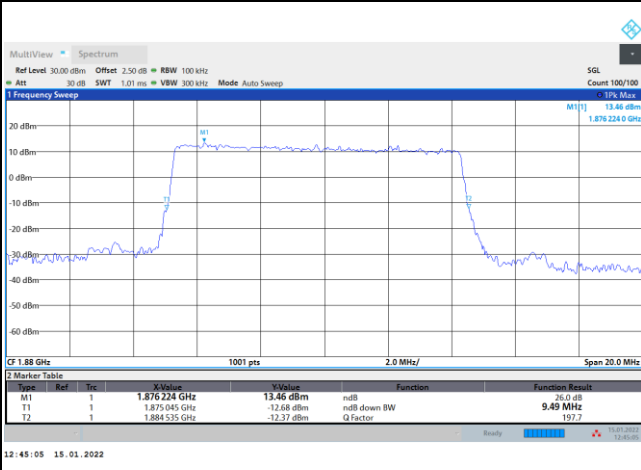

FR1 n2 / 10MHz / CP OFDM / Middle Channel / Full RB

QPSK

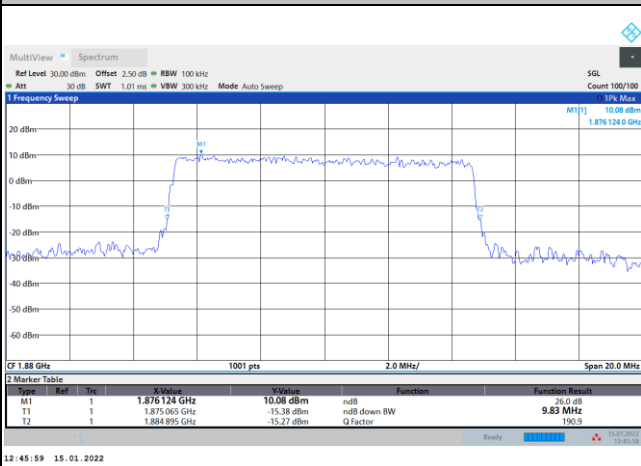

16QAM

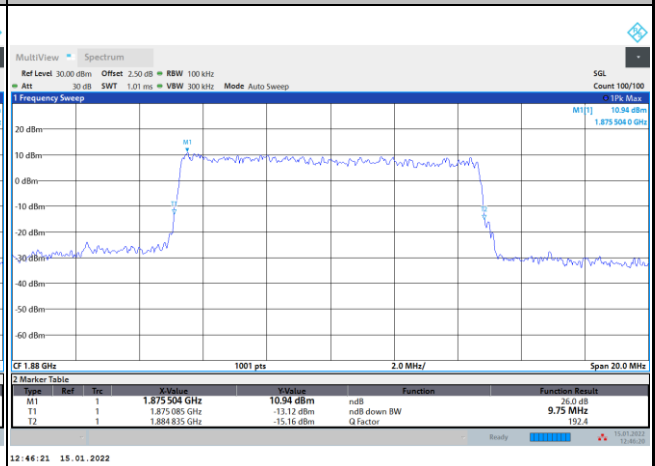

64QAM

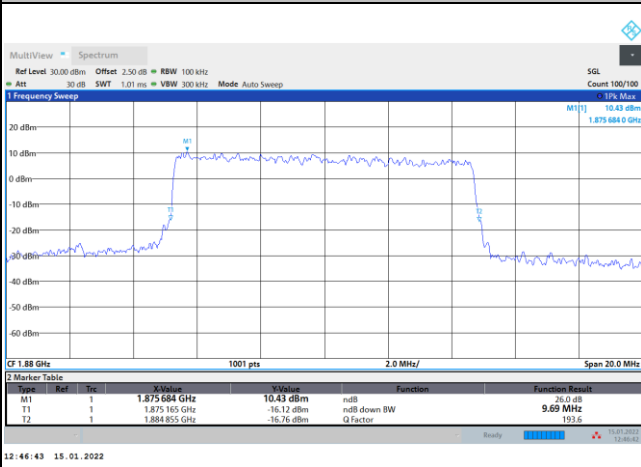

256QAM

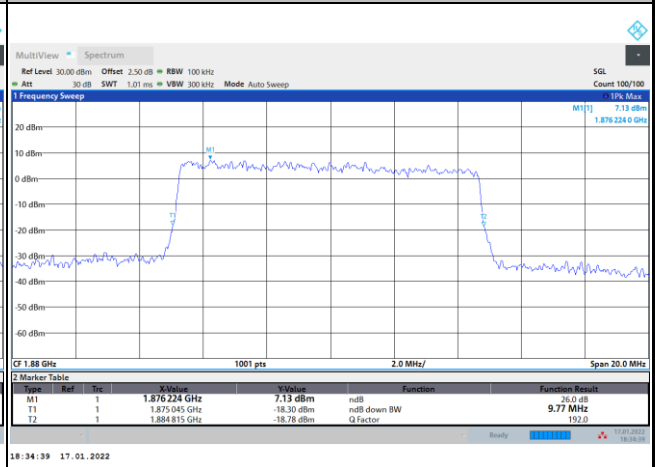



FR1 n2 / 15MHz / DFT-S OFDM / Middle Channel / Full RB

PI/2 BPSK

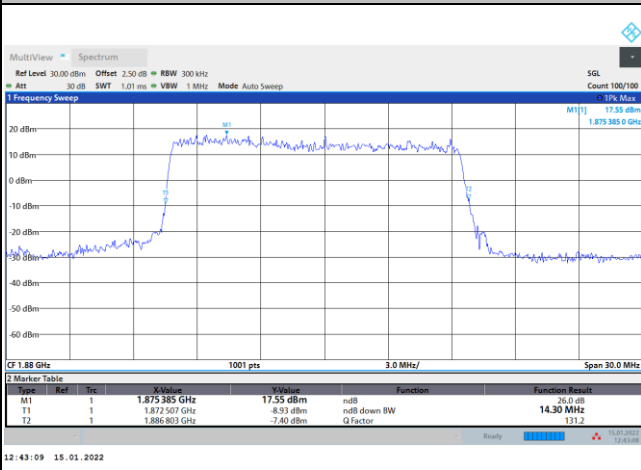

FR1 n2 / 15MHz / CP OFDM / Middle Channel / Full RB

QPSK

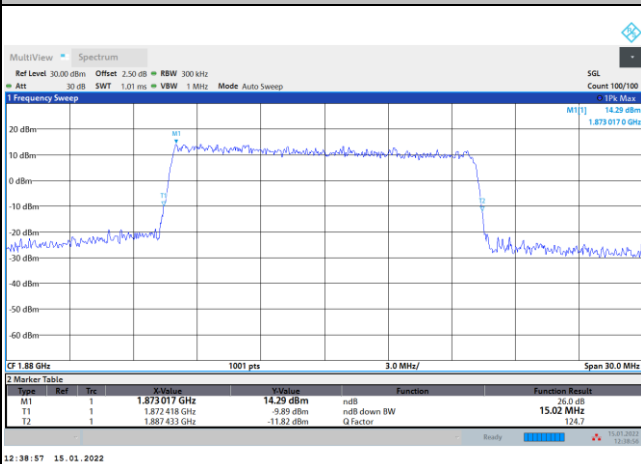

16QAM

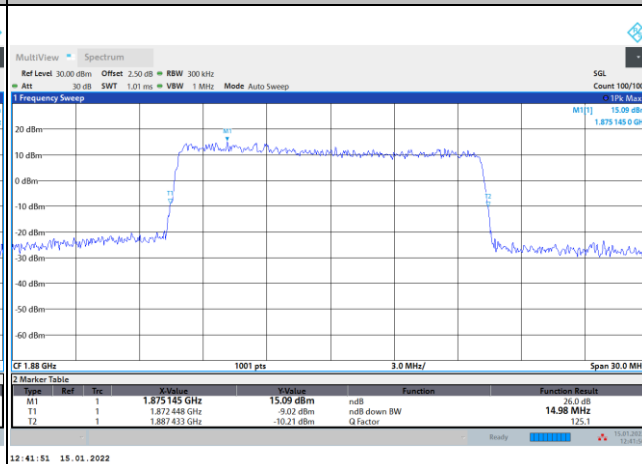

64QAM

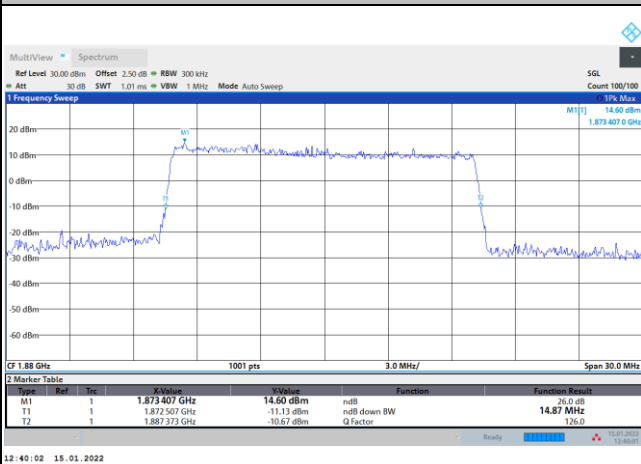

256QAM

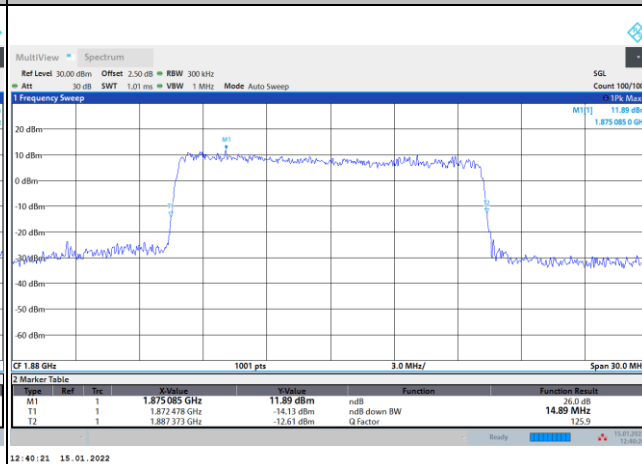



FR1 n2 / 20MHz / DFT-S OFDM / Middle Channel / Full RB

PI/2 BPSK

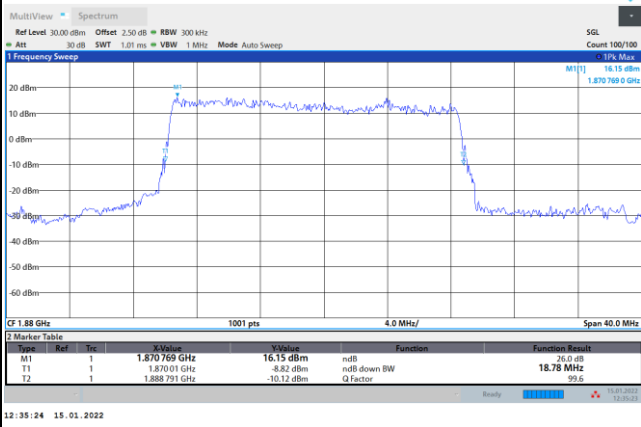

FR1 n2 / 20MHz / CP OFDM / Middle Channel / Full RB

QPSK

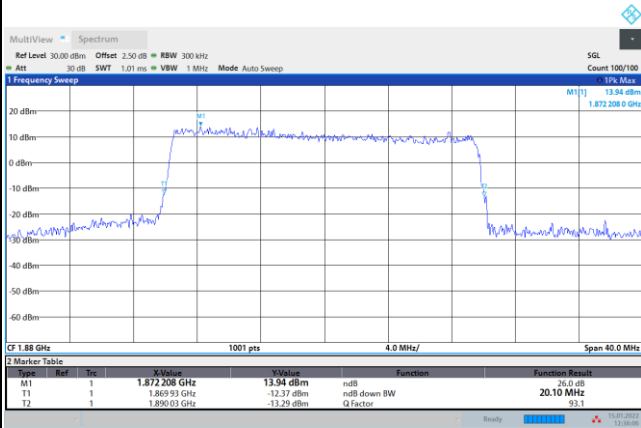

16QAM

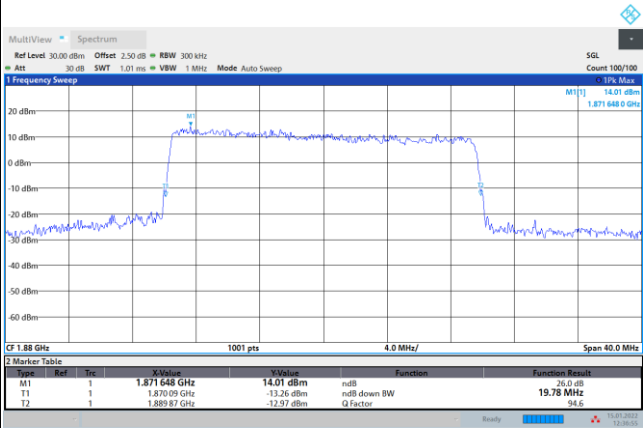

64QAM

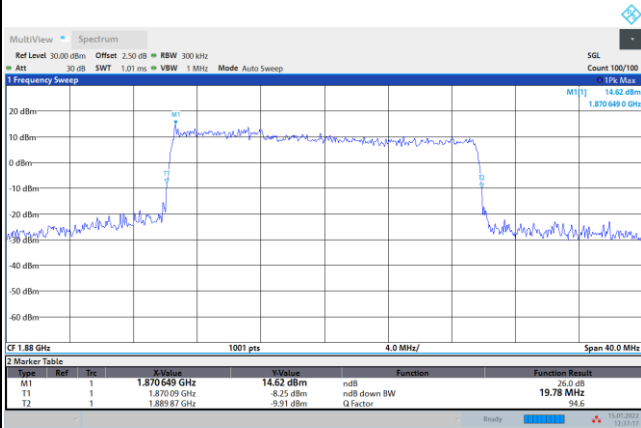

256QAM

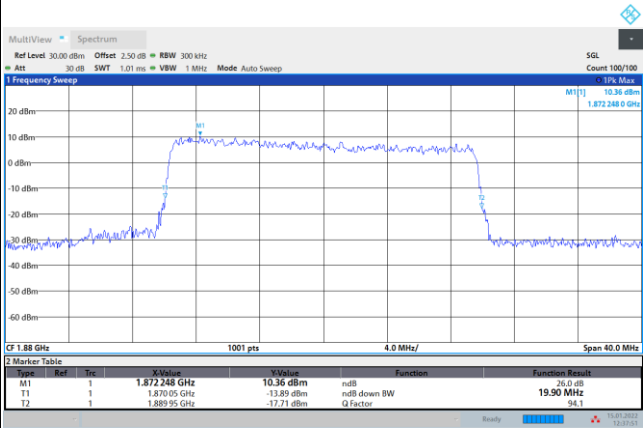



Occupied Bandwidth

Mode	FR1 n2 : 99%OBW(MHz) / DFT-S OFDM							
BW	5MHz		10MHz		15MHz		20MHz	
Mod.	PI/2 BPSK		PI/2 BPSK		PI/2 BPSK		PI/2 BPSK	
Middle CH	4.45		8.90		13.48		17.94	

Mode	FR1 n2 : 99%OBW (MHz) / CP OFDM							
BW	5MHz		10MHz		15MHz		20MHz	
Mod.	QPSK	16QAM	QPSK	16QAM	QPSK	16QAM	QPSK	16QAM
Middle CH	4.48	4.49	9.29	9.28	14.16	14.13	18.97	18.94
Mod.	64QAM	256QAM	64QAM	256QAM	64QAM	256QAM	64QAM	256QAM
Middle CH	4.48	4.49	9.31	9.27	14.16	14.14	18.96	18.96



FR1 n2 / 5MHz / DFT-S OFDM / Middle Channel / Full RB

PI/2 BPSK

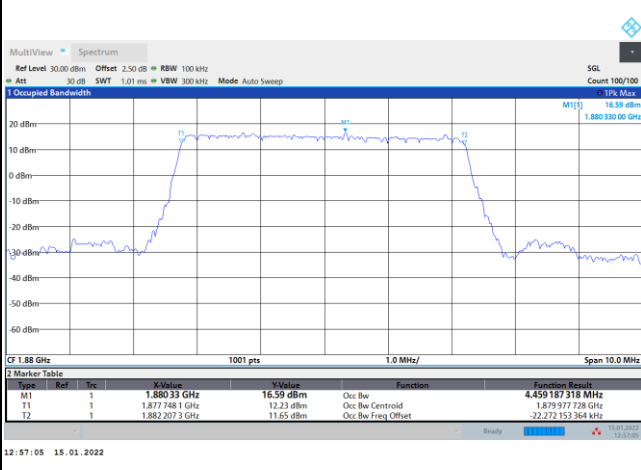

FR1 n2 / 5MHz / CP OFDM / Middle Channel / Full RB

QPSK

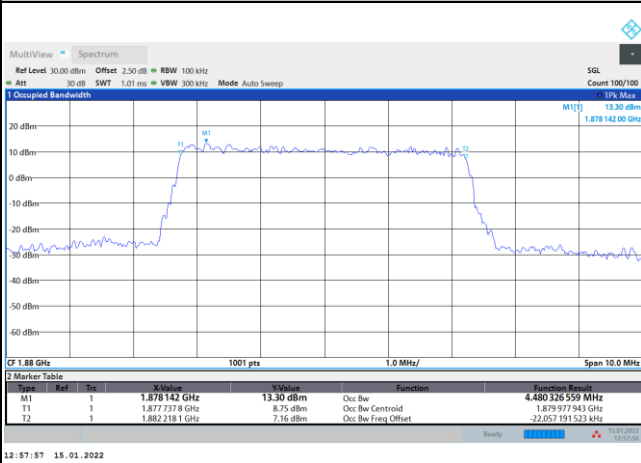

16QAM

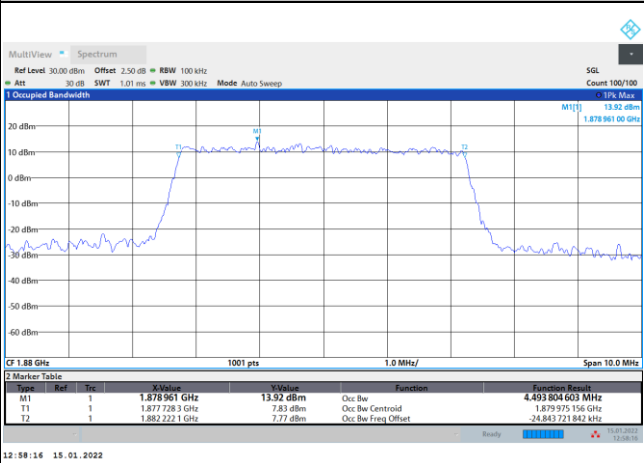

64QAM

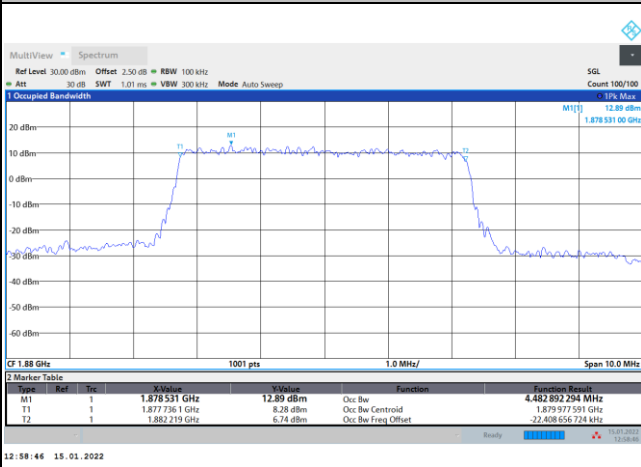

256QAM

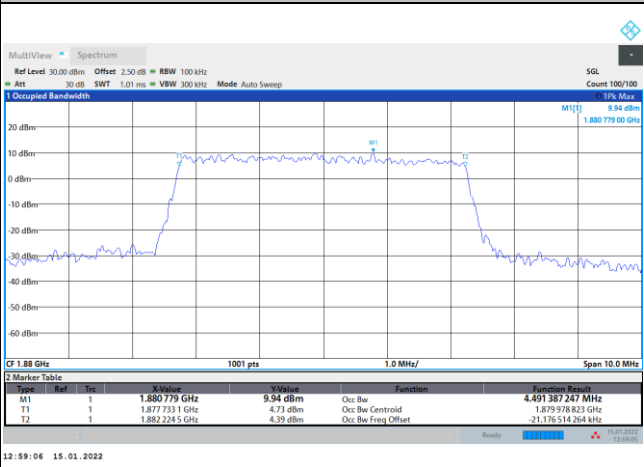



FR1 n2 / 10MHz / DFT-S OFDM / Middle Channel / Full RB

PI/2 BPSK

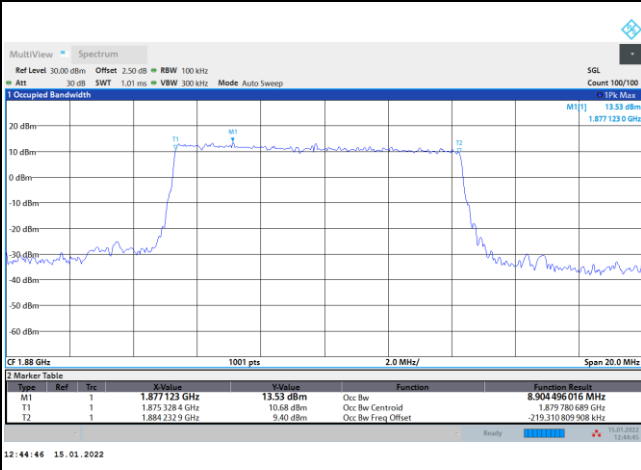

FR1 n2 / 10MHz / CP OFDM / Middle Channel / Full RB

QPSK

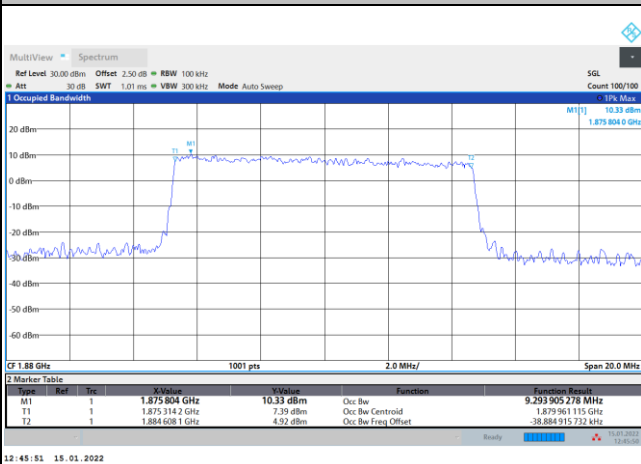

16QAM

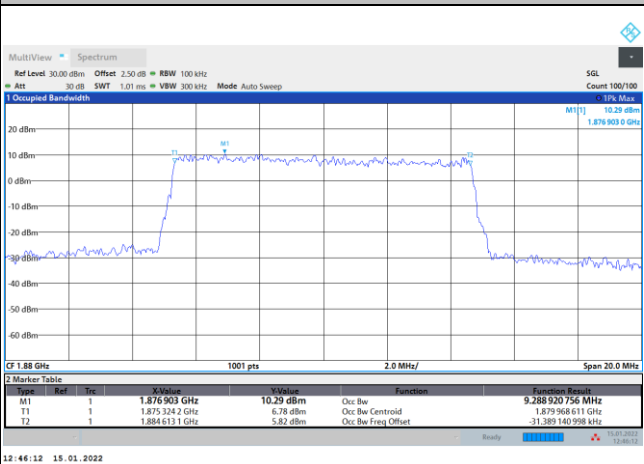

64QAM

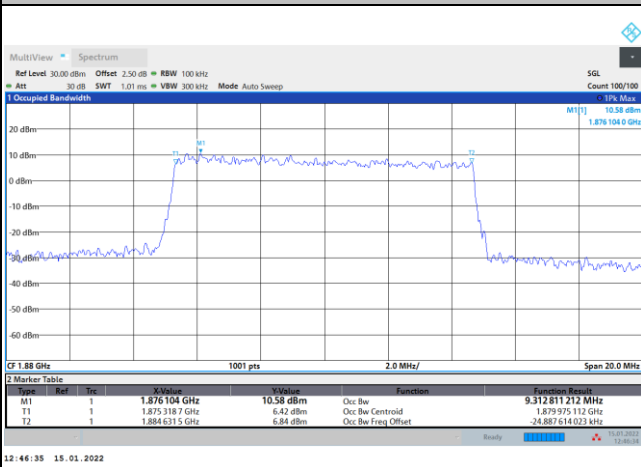

256QAM

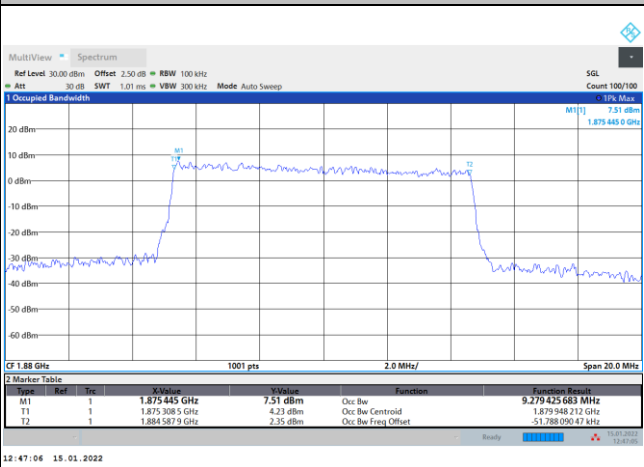



FR1 n2 / 15MHz / DFT-S OFDM / Middle Channel / Full RB

PI/2 BPSK

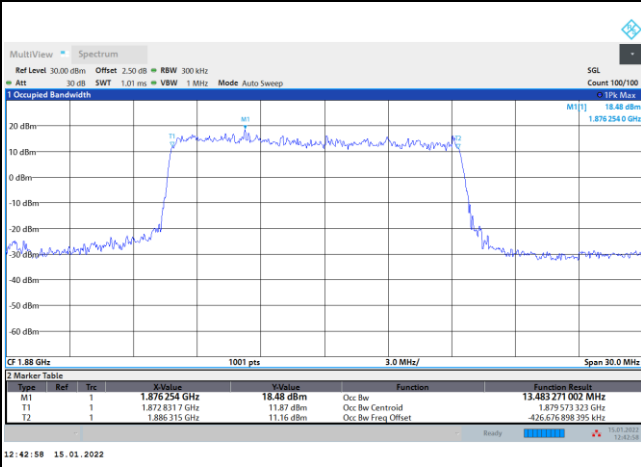

FR1 n2 / 15MHz / CP OFDM / Middle Channel / Full RB

QPSK

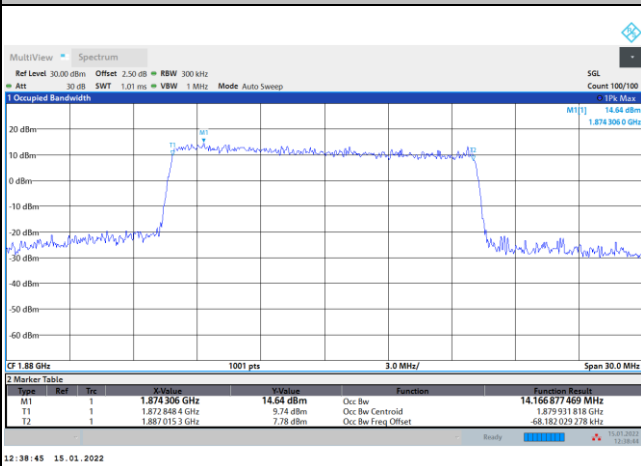

16QAM

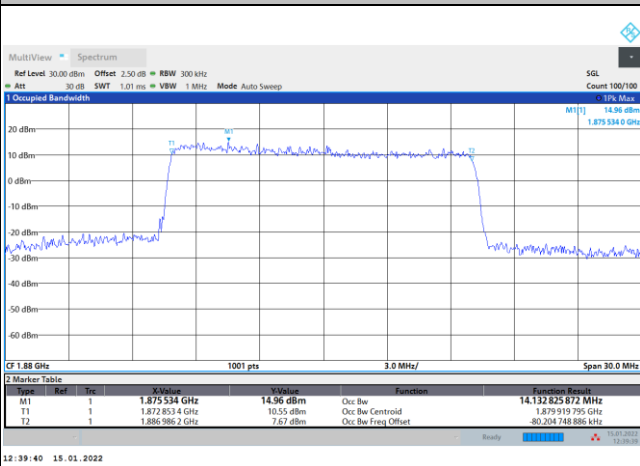

64QAM

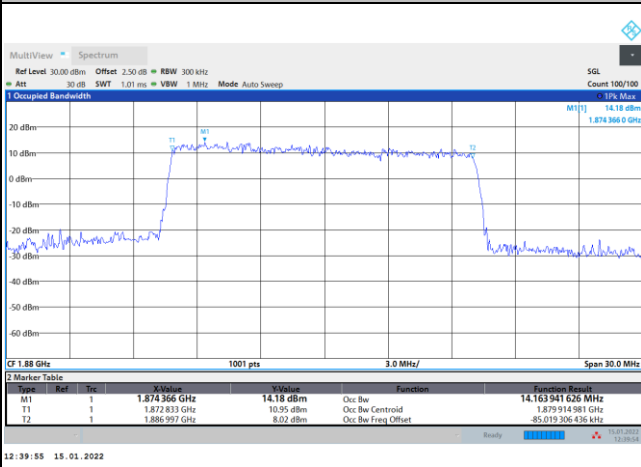

256QAM

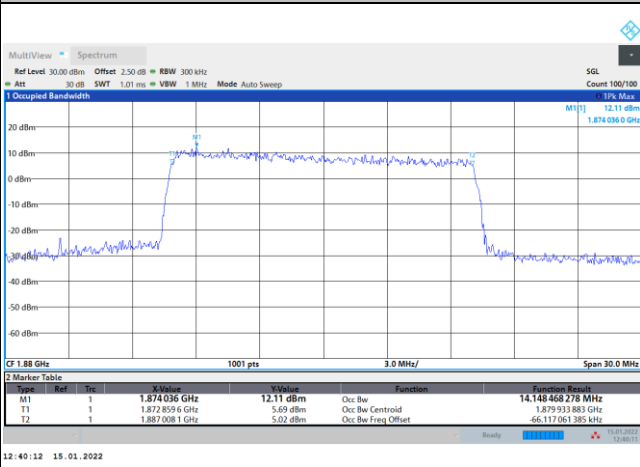



FR1 n2 / 20MHz / DFT-S OFDM / Middle Channel / Full RB

PI/2 BPSK

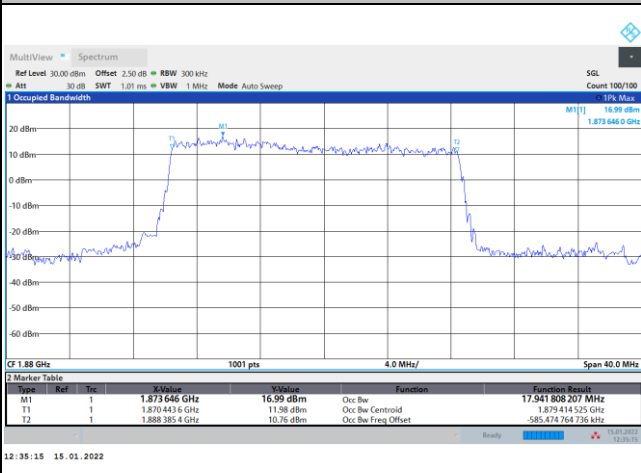

FR1 n2 / 20MHz / CP OFDM / Middle Channel / Full RB

QPSK

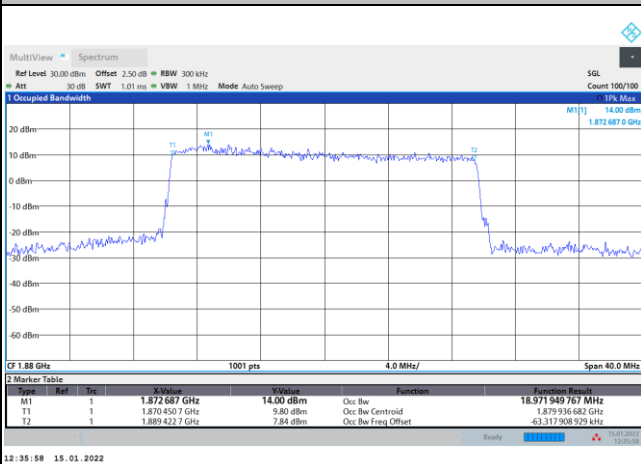

16QAM

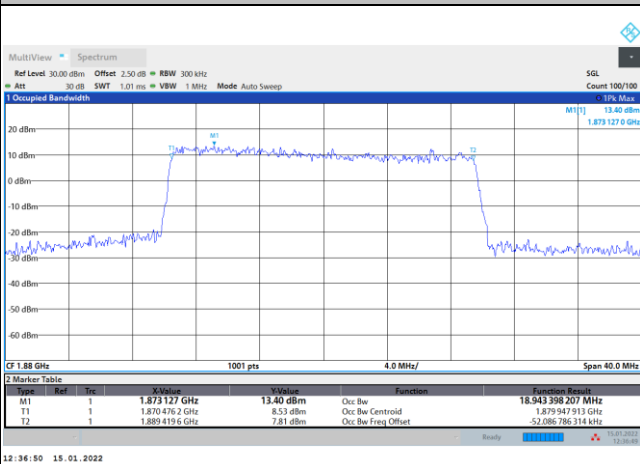

64QAM

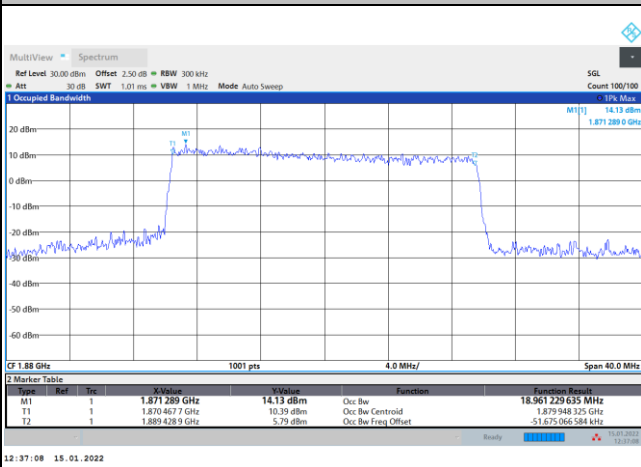

256QAM

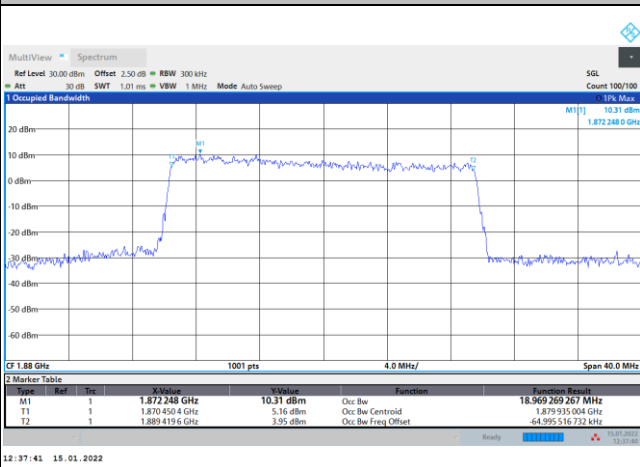



Conducted Band Edge

FR1 n2 / 5MHz / DFT-S OFDM / PI/2 BPSK

Lowest Band Edge / 1RB0

Highest Band Edge / 1RBmax

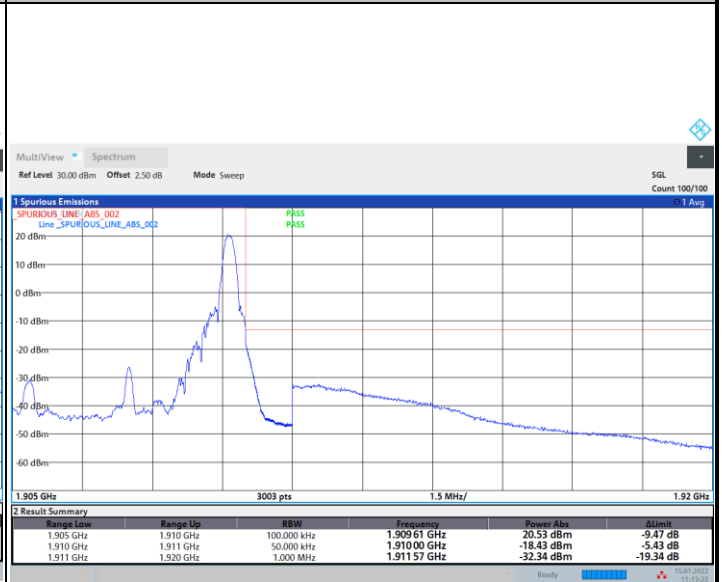
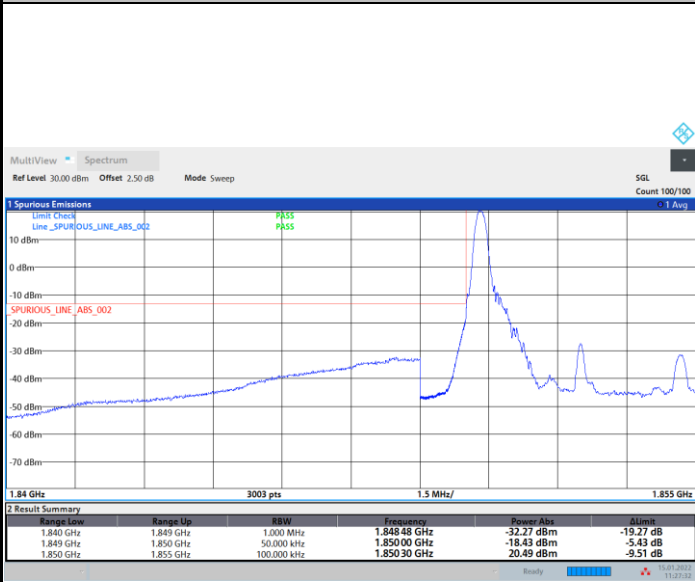

Lowest Band Edge / Full RB

Highest Band Edge / Full RB

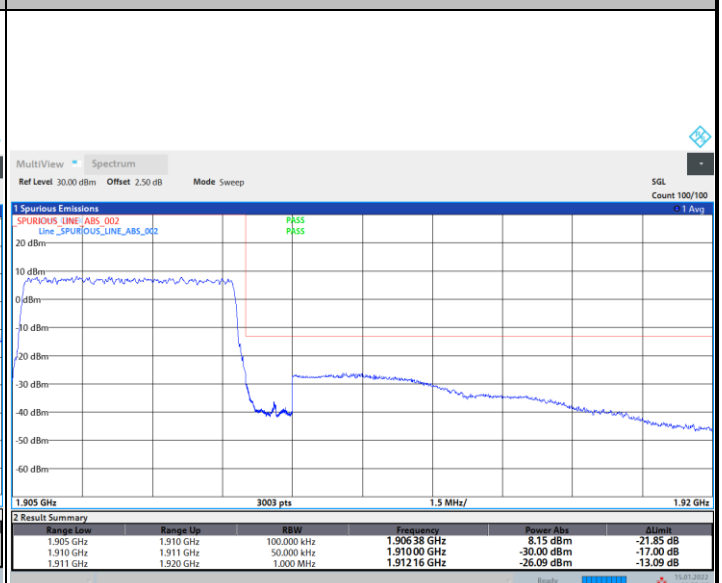
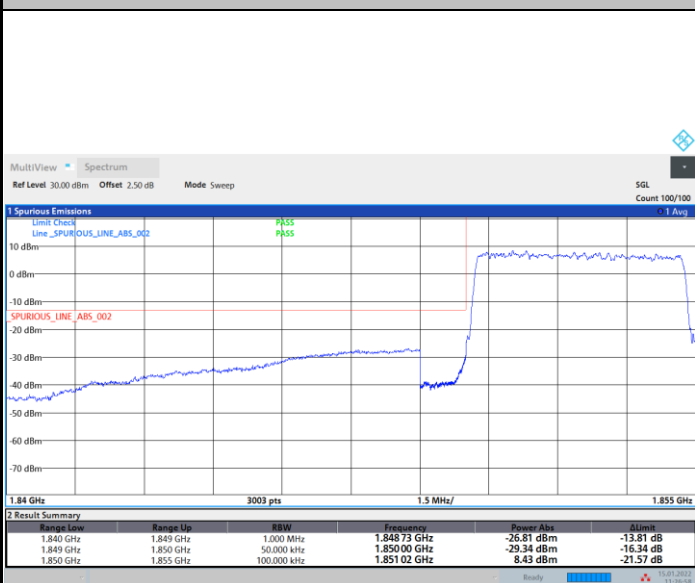



FR1 n2 / 5MHz / DFT-S OFDM / QPSK

Lowest Band Edge / 1RB0

Highest Band Edge / 1RBmax

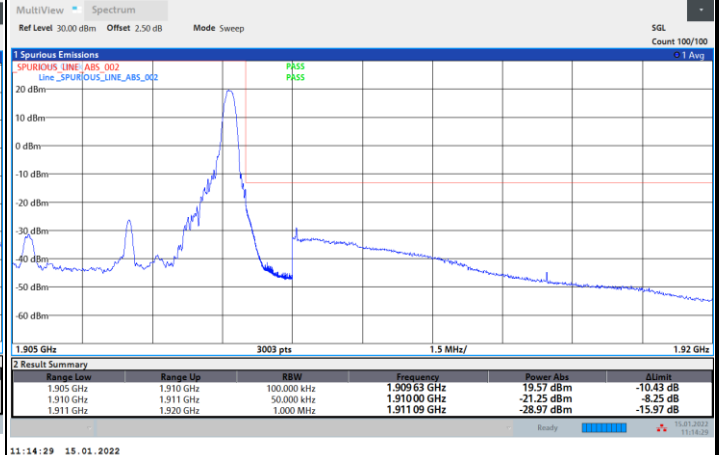
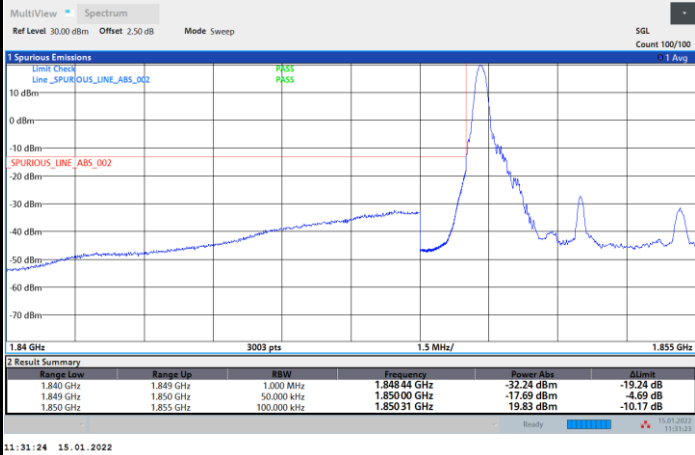

Lowest Band Edge / Full RB

Highest Band Edge / Full RB

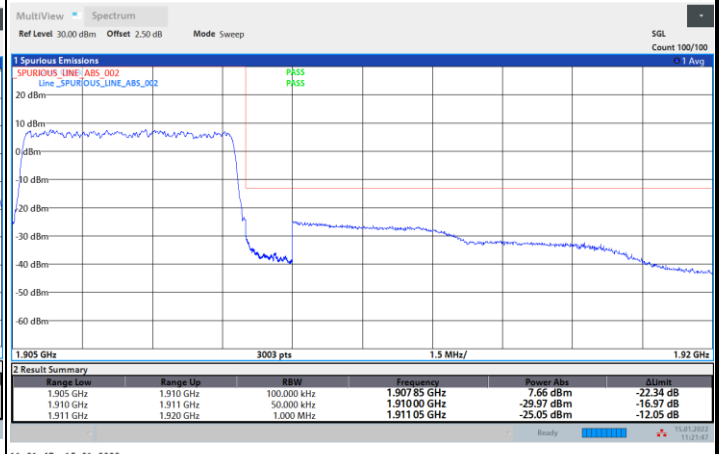
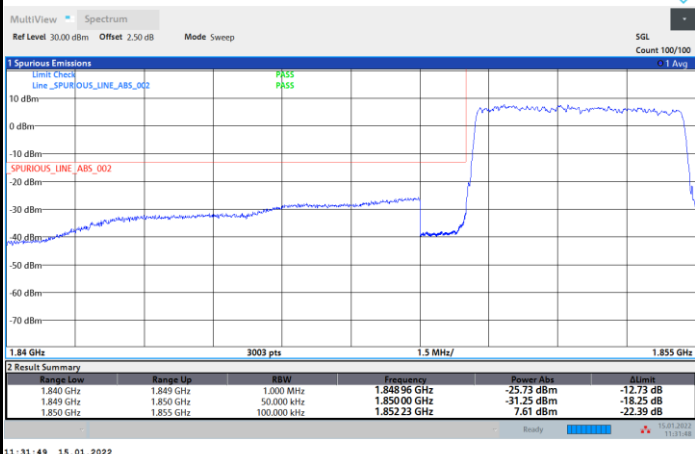



FR1 n2 / 5MHz / DFT-S OFDM / 16QAM

Lowest Band Edge / 1RB0

Highest Band Edge / 1RBmax

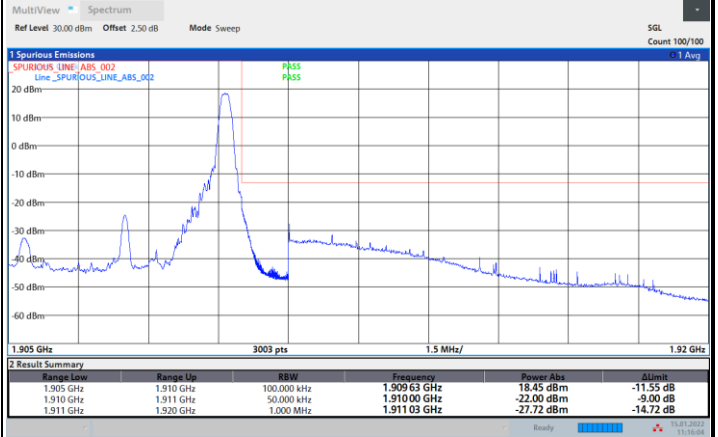
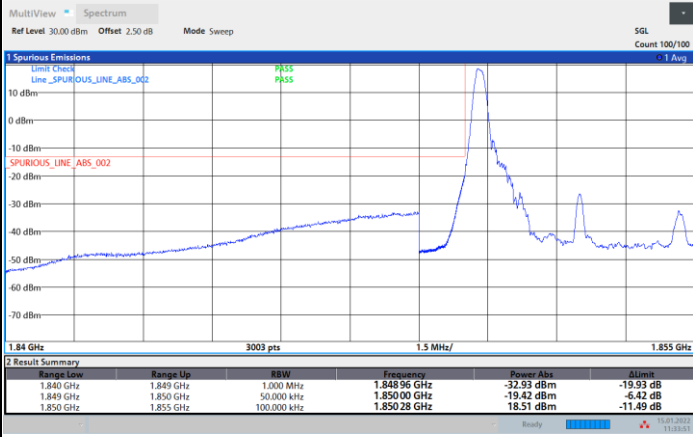

11:33:52 15. 01. 2022

11:16:04 15. 01. 2022

Lowest Band Edge / Full RB

Highest Band Edge / Full RB

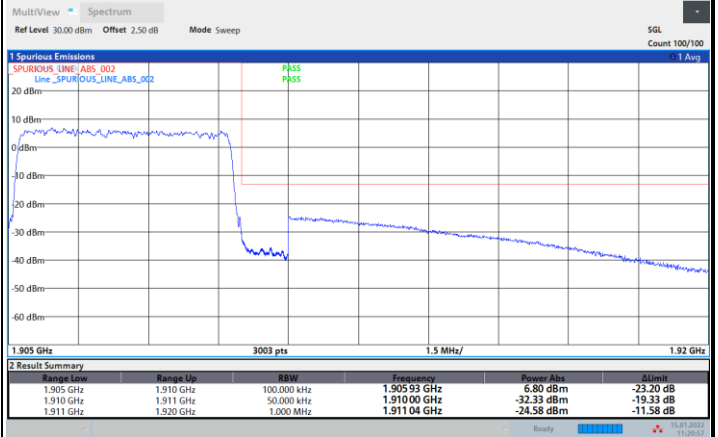
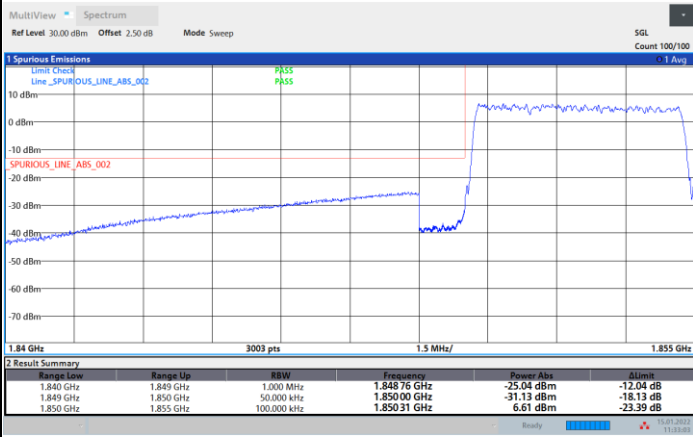

11:33:04 15. 01. 2022

11:20:57 15. 01. 2022



FR1 n2 / 5MHz / DFT-S OFDM / 64QAM

Lowest Band Edge / 1RB0

Highest Band Edge / 1RBmax

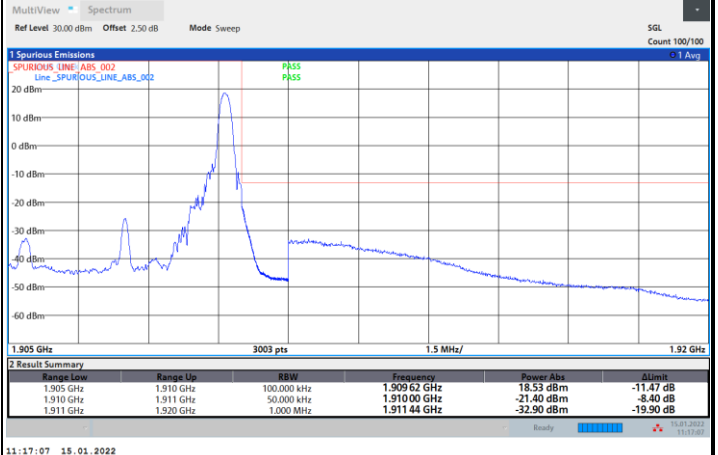
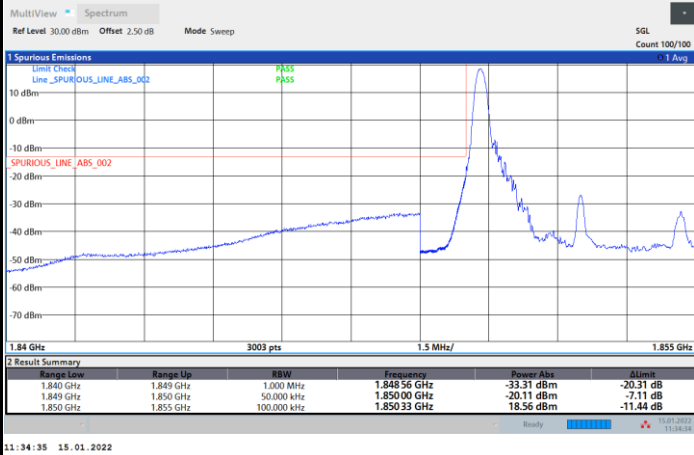

Lowest Band Edge / Full RB

Highest Band Edge / Full RB

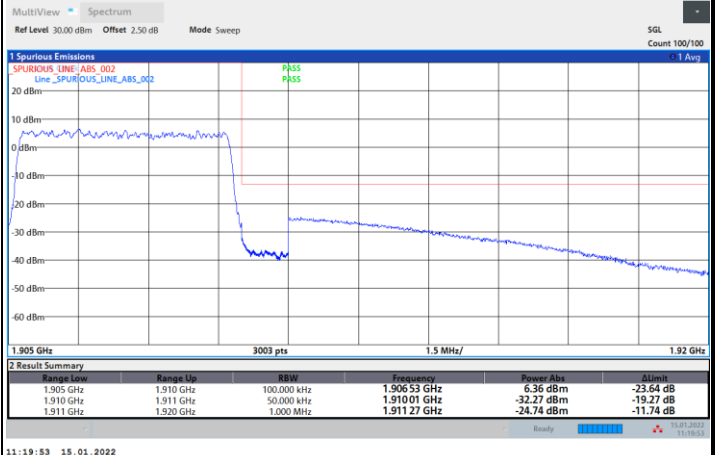
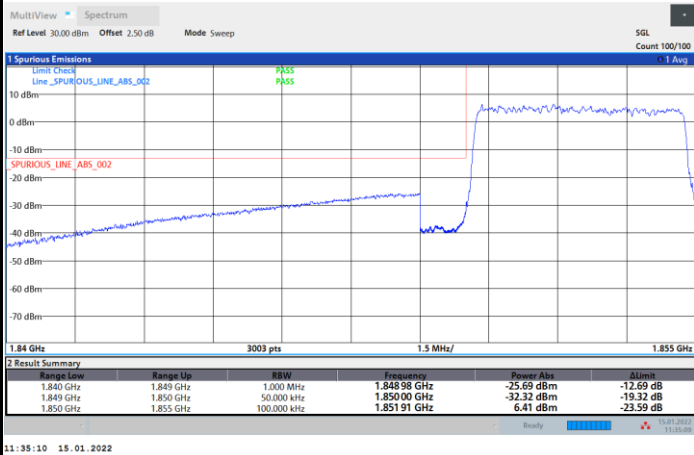



FR1 n2 / 5MHz / DFT-S OFDM / 256QAM

Lowest Band Edge / 1RB0

Highest Band Edge / 1RBmax

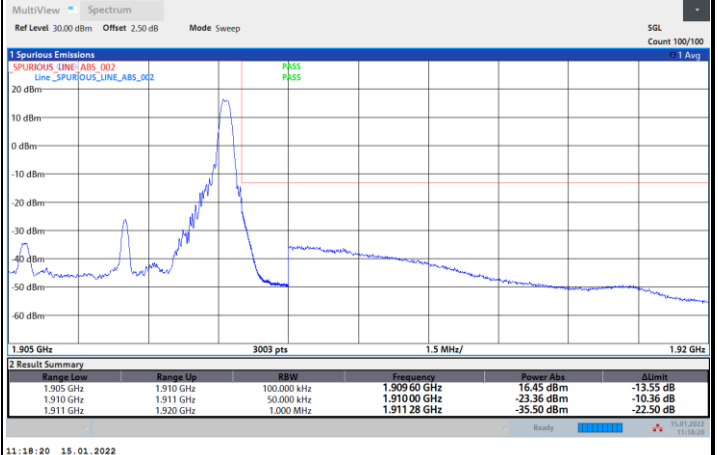

Lowest Band Edge / Full RB

Highest Band Edge / Full RB

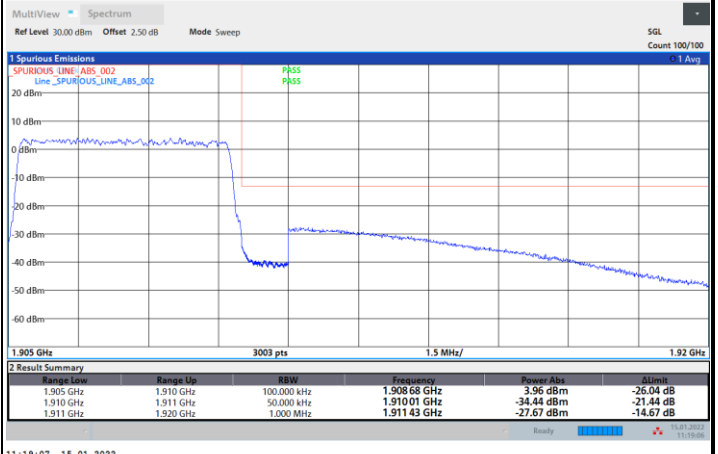
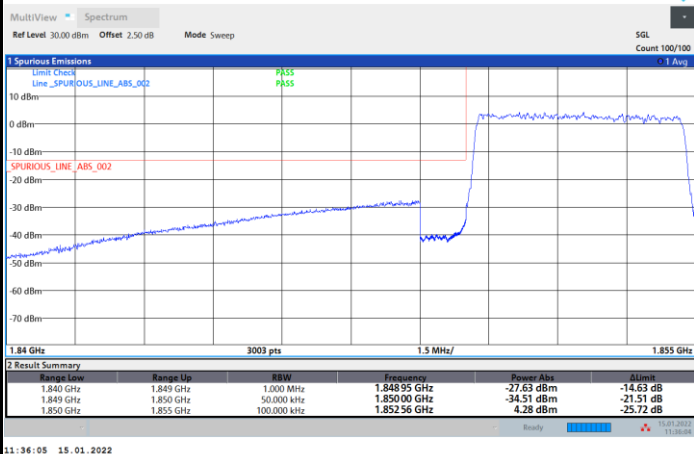



FR1 n2 / 5MHz / CP OFDM / QPSK / Full RB

Lowest Band Edge

Highest Band Edge

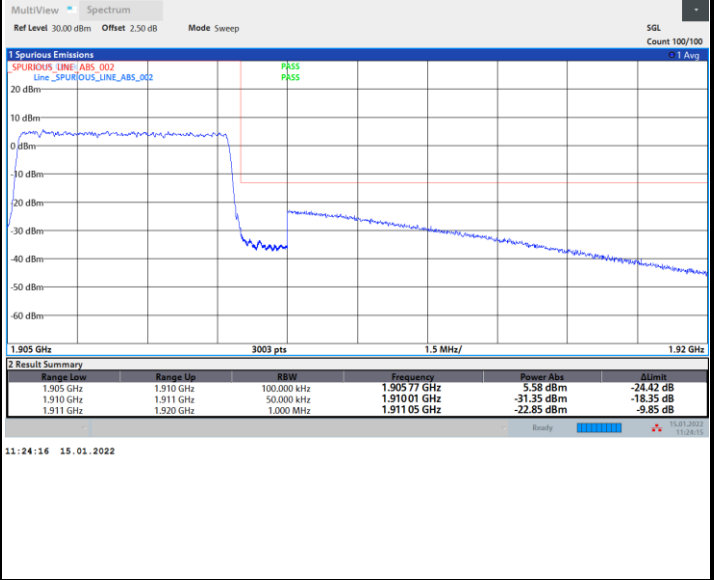
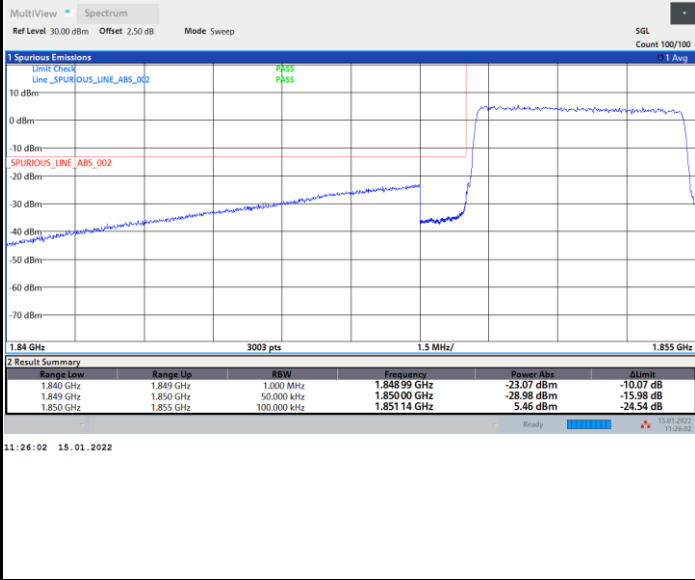

FR1 n2 / 10MHz / DFT-s-OFDM / PI/2 BPSK / Full RB

Lowest Band Edge

Highest Band Edge

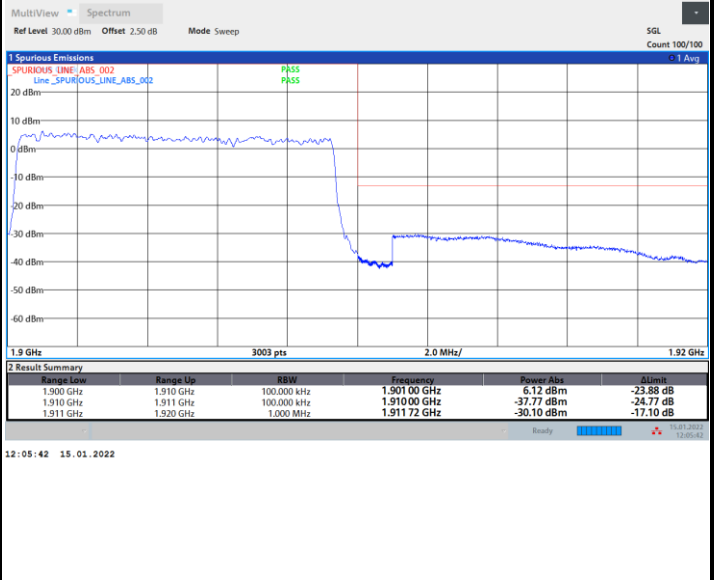



FR1 n2 / 10MHz / DFT-s-OFDM / QPSK / Full RB

Lowest Band Edge

Highest Band Edge

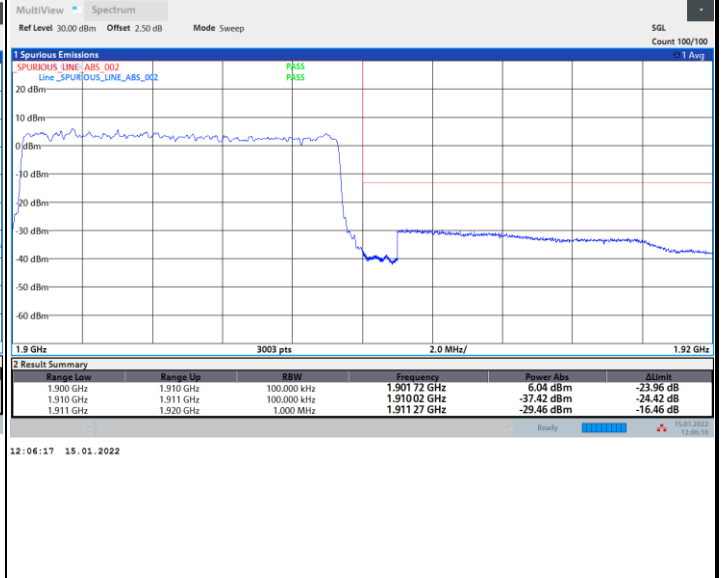
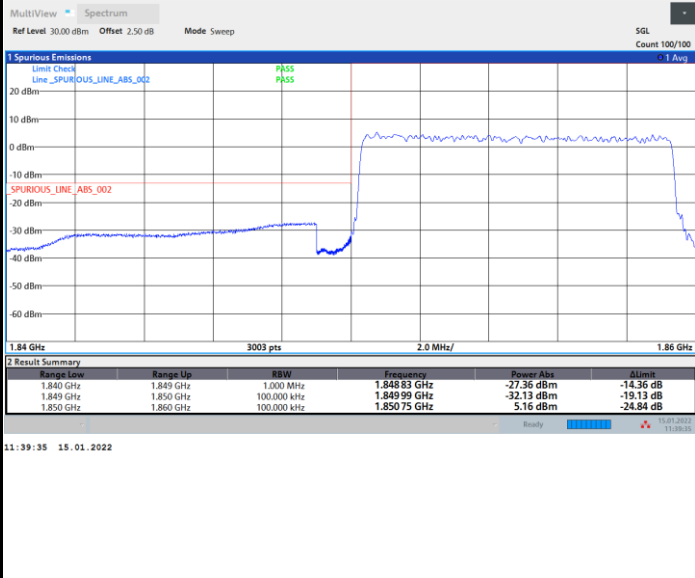

FR1 n2 / 10MHz / DFT-s-OFDM / 16QAM / Full RB

Lowest Band Edge

Highest Band Edge

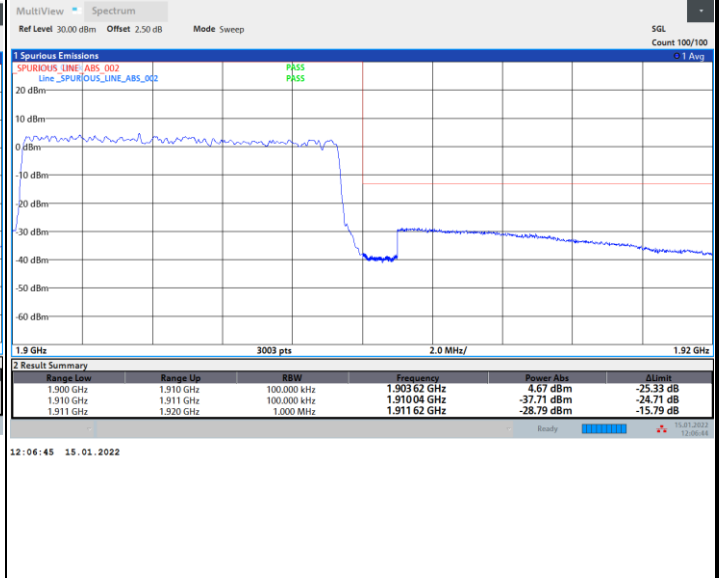
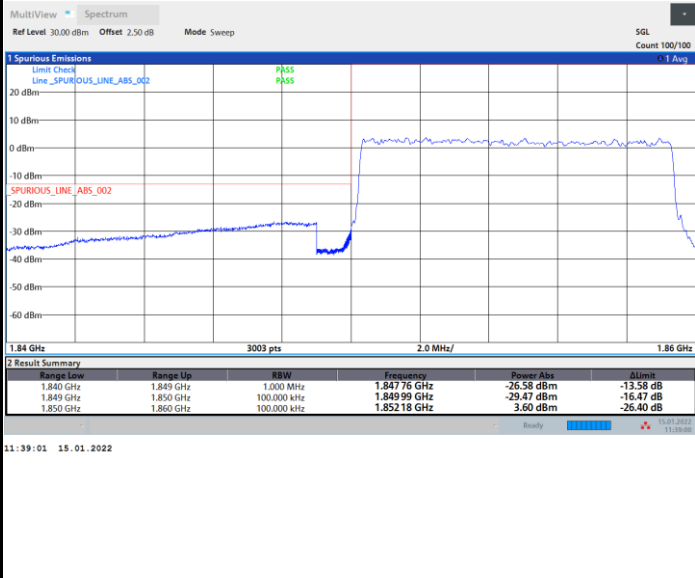



FR1 n2 / 10MHz / DFT-s-OFDM / 64QAM / Full RB

Lowest Band Edge

Highest Band Edge

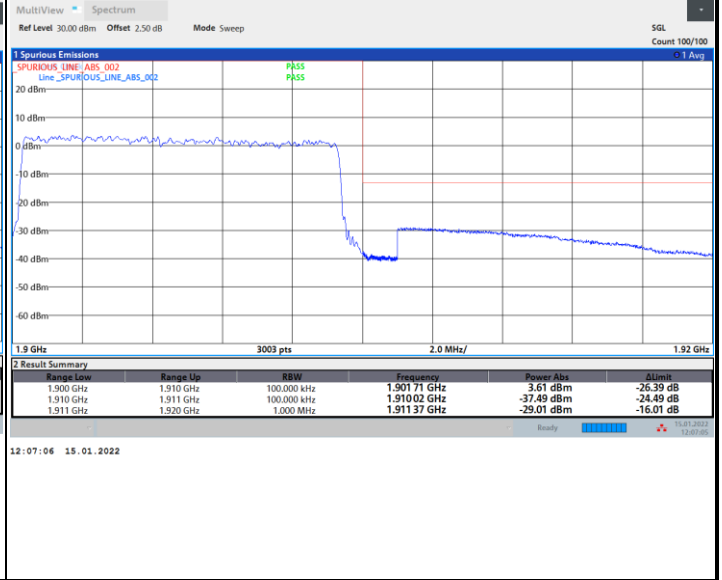
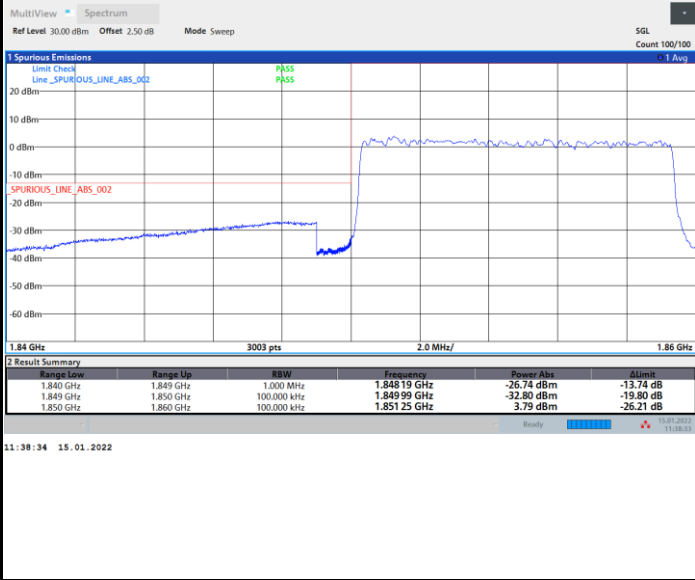

FR1 n2 / 10MHz / DFT-s-OFDM / 256QAM / Full RB

Lowest Band Edge

Highest Band Edge

