

DFS Test Report

Report No.: RFBCMA-WTW-P21050301A-2

FCC ID: RAXWR3200

Test Model: WR3200

Received Date: 2021/6/22

Test Date: 2022/1/4 ~ 2022/1/11

Issued Date: 2022/3/18

Applicant: Arcadyan Technology Corporation

Address: No.8, Sec.2, Guangfu Rd., Hsinchu City 30071, Taiwan, R.O.C.

Issued By: Bureau Veritas Consumer Products Services (H.K.) Ltd., Taoyuan Branch
Hsin Chu Laboratory

Lab Address: E-2, No.1, Li Hsin 1st Road, Hsinchu Science Park, Hsinchu City 300,
Taiwan

Test Location: E-2, No.1, Li Hsin 1st Road, Hsinchu Science Park, Hsinchu City 300,
Taiwan

**FCC Registration /
Designation Number:** 723255 / TW2022



This report is for your exclusive use. Any copying or replication of this report to or for any other person or entity, or use of our name or trademark, is permitted only with our prior written permission. This report sets forth our findings solely with respect to the test samples identified herein. The results set forth in this report are not indicative or representative of the quality or characteristics of the lot from which a test sample was taken or any similar or identical product unless specifically and expressly noted. Our report includes all of the tests requested by you and the results thereof based upon the information that you provided to us. You have 60 days from date of issuance of this report to notify us of any material error or omission caused by our negligence, provided, however, that such notice shall be in writing and shall specifically address the issue you wish to raise. A failure to raise such issue within the prescribed time shall constitute your unqualified acceptance of the completeness of this report, the tests conducted and the correctness of the report contents. Unless specific mention, the uncertainty of measurement has been explicitly taken into account to declare the compliance or non-compliance to the specification. The report must not be used by the client to claim product certification, approval, or endorsement by TAF or any government agencies.

Table of Contents

Release Control Record	3
1 Certificate of Conformity	4
2 EUT Information	5
2.1 Operating Frequency Bands and Mode of EUT	5
2.2 EUT Software and Firmware Version	5
2.3 Description of Available Antennas to the EUT	6
2.4 EUT Maximum and Minimum Conducted Power	7
2.5 EUT Maximum and Minimum EIRP Power	7
2.6 Transmit Power Control (TPC)	8
2.7 Statement of Manufacturer	8
3. U-NII DFS Rule Requirements	9
3.1 Working Modes and Required Test Items	9
3.2 Test Limits and Radar Signal Parameters	10
4. Test & Support Equipment List	13
4.1 Test Instruments	13
4.2 Description of Support Units	13
5. Test Procedure	14
5.1 DFS Measurement System	14
5.2 Calibration of DFS Detection Threshold Level	15
5.3 Deviation from Test Standard	15
5.4 Radiated Test Setup Configuration	16
6. Test Results	17
6.1 Summary of Test Results	17
6.2 Test Results	18
6.2.1 Test Mode: Device Operating In Master Mode	18
6.2.2 U-NII Detection Bandwidth	23
6.2.3 Channel Availability Check Time	29
6.2.4 Channel Closing Transmission and Channel Move Time	31
6.2.5 Non- Occupancy Period	58
7. Information of the Testing Laboratories	60
8. APPENDIX-A	61



Release Control Record

Issue No.	Description	Date Issued
RFBCMA-WTW-P21050301A-2	Original release.	2022/3/18

1 Certificate of Conformity

Product: Standalone Router

Brand: Hughes

Test Model: WR3200

Sample Status: Engineering sample

Applicant: Arcadyan Technology Corporation

Test Date: 2022/1/4 ~ 2022/1/11

Standards: FCC Part 15, Subpart E (Section 15.407)

References Test Guidance: KDB 905462 D02 UNII DFS Compliance Procedures New Rules v02

The above equipment has been tested by **Bureau Veritas Consumer Products Services (H.K.) Ltd., Taoyuan Branch**, and found compliance with the requirement of the above standards. The test record, data evaluation & Equipment Under Test (EUT) configurations represented herein are true and accurate accounts of the measurements of the sample's EMC characteristics under the conditions specified in this report.

Prepared by : Vivian Huang , **Date:** 2022/3/18
Vivian Huang / Specialist

Approved by : Clark Lin , **Date:** 2022/3/18
Clark Lin / Technical Manager

2 EUT Information

2.1 Operating Frequency Bands and Mode of EUT

Table 1: Operating Frequency Bands and Mode of EUT

Operational Mode	Operating Frequency Range	
	5250~5350MHz	5470~5725MHz
Master	✓	✓

2.2 EUT Software and Firmware Version

Table 2: The EUT Software/Firmware Version

No.	Product	Model No.	Software/Firmware Version
1	Standalone Router	WR3200	1.00.26rc1

2.3 Description of Available Antennas to the EUT

Table 3: Antenna List

Antenna Set	RF Chain No.	Model	Antenna Net Gain (dBi)	Frequency Range (GHz)	Antenna Type	Connector Type	Cable Length (mm)
1	0	WG622221-HS	1.9	2.4~2.4835	Dipole	i-pex(MHF)	60
	1	WG622221-HS	2.1	2.4~2.4835	Dipole	i-pex(MHF)	70
	0	WG622221-HS	2.5	5.15~5.85	Dipole	i-pex(MHF)	40
	1	WG622221-HS	3	5.15~5.85	Dipole	i-pex(MHF)	41

*The above Antenna information is declared by manufacturer and for more detailed features description, please refer to the manufacturer's specifications, the laboratory shall not be held responsible.

2.4 EUT Maximum and Minimum Conducted Power

Table 4: The Measured Conducted Output Power

CDD Mode

Frequency Band (MHz)	MAX. Power		MIN. Power	
	Output Power (mW)	Output Power (dBm)	Output Power (mW)	Output Power (dBm)
5250~5350	226.199	23.54	56.754	17.54
5470~5725	229.421	23.61	57.677	17.61

Beamforming Mode

Frequency Band (MHz)	MAX. Power		MIN. Power	
	Output Power (mW)	Output Power (dBm)	Output Power (mW)	Output Power (dBm)
5250~5350	226.199	23.54	56.754	17.54
5470~5725	228.423	23.59	57.412	17.59

2.5 EUT Maximum and Minimum EIRP Power

Table 5: The EIRP Output Power List

CDD Mode

Frequency Band (MHz)	MAX. EIRP Power		MIN. EIRP Power	
	Output Power (mW)	Output Power (dBm)	Output Power (mW)	Output Power (dBm)
5250~5350	450.817	26.54	113.240	20.54
5470~5725	458.142	26.61	115.080	20.61

Beamforming Mode

Frequency Band (MHz)	MAX. EIRP Power		MIN. EIRP Power	
	Output Power (mW)	Output Power (dBm)	Output Power (mW)	Output Power (dBm)
5250~5350	851.138	29.3	213.796	23.3
5470~5725	860.994	29.35	216.272	23.35

2.6 Transmit Power Control (TPC)

U-NII devices operating in the 5.25-5.35 GHz band and the 5.47-5.725 GHz band shall employ a TPC mechanism. The U-NII device is required to have the capability to operate at least 6 dB below the mean EIRP value of 30 dBm. A TPC mechanism is not required for systems with an e.i.r.p. of less than 500 mW.

Applicable	EIRP	FCC 15.407 (h)(1)
√	>500mW	The TPC mechanism is required for system with an EIRP of above 500mW
	<500mW	The TPC mechanism is not required for system with an EIRP of less 500mW

The UUT can adjust a transmitter's output power based on the signal level present at the receiver. TPC is auto controlled by software.

2.7 Statement of Manufacturer

Manufacturer statement confirming that information regarding the parameters of the detected Radar Waveforms is not available to the end user.

3. U-NII DFS Rule Requirements

3.1 Working Modes and Required Test Items

The manufacturer shall state whether the UUT is capable of operating as a Master and/or a Client. If the UUT is capable of operating in more than one operating mode then each operating mode shall be tested separately. See tables 6 and 7 for the applicability of DFS requirements for each of the operational modes.

Table 6: Applicability of DFS Requirements Prior to Use a Channel

Requirement	Operational Mode		
	Master	Client without radar detection	Client with radar detection
Non-Occupancy Period	✓	✓ note	✓
DFS Detection Threshold	✓	Not required	✓
Channel Availability Check Time	✓	Not required	Not required
U-NII Detection Bandwidth	✓	Not required	✓

Note: Per KDB 905462 D03 UNII Clients Without Radar Detection New Rules v01r02 section (b)(5/6), If the client moves with the master, the device is considered compliant if nothing appears in the client non-occupancy period test. For devices that shut down (rather than moving channels), no beacons should appear. An analyzer plot that contains a single 30-minute sweep on the original channel.

Table 7: Applicability of DFS Requirements during Normal Operation.

Requirement	Operational Mode	
	Master or Client with radar detection	Client without radar detection
DFS Detection Threshold	✓	Not required
Channel Closing Transmission Time	✓	✓
Channel Move Time	✓	✓
U-NII Detection Bandwidth	✓	Not required

Additional requirements for devices with multiple bandwidth modes	Master or Client with radar detection	Client without radar detection
U-NII Detection Bandwidth and Statistical Performance Check	All BW modes must be tested	Not required
Channel Move Time and Channel Closing Transmission Time	Test using widest BW mode available	Test using the widest BW mode available for the link
All other tests	Any single BW mode	Not required

Note: Frequencies selected for statistical performance check (Section 7.8.4) should include several frequencies within the radar detection bandwidth and frequencies near the edge of the radar detection bandwidth. For 802.11 devices it is suggested to select frequencies in each of the bonded 20 MHz channels and the channel center frequency.

3.2 Test Limits and Radar Signal Parameters

Detection Threshold Values

Table 8: DFS Detection Thresholds for Master Devices and Client Devices with Radar Detection

Maximum Transmit Power	Value (See Notes 1, 2, and 3)
EIRP \geq 200 milliwatt	-64 dBm
EIRP < 200 milliwatt and power spectral density < 10 dBm/MHz	-62 dBm
EIRP < 200 milliwatt that do not meet the power spectral density requirement	-64 dBm

Note 1: This is the level at the input of the receiver assuming a 0 dBi receive antenna.

Note 2: Throughout these test procedures an additional 1 dB has been added to the amplitude of the test transmission waveforms to account for variations in measurement equipment. This will ensure that the test signal is at or above the detection threshold level to trigger a DFS response.

Note 3: EIRP is based on the highest antenna gain. For MIMO devices refer to KDB Publication 662911 D01.

Table 9: DFS Response Requirement Values

Parameter	Value
Non-occupancy period	Minimum 30 minutes
Channel Availability Check Time	60 seconds
Channel Move Time	10 seconds See Note 1.
Channel Closing Transmission Time	200 milliseconds + an aggregate of 60 milliseconds over remaining 10 second period. See Notes 1 and 2.
U-NII Detection Bandwidth	Minimum 100% of the U-NII 99% transmission power bandwidth. See Note 3

Note 1: Channel Move Time and the Channel Closing Transmission Time should be performed with Radar Type 0. The measurement timing begins at the end of the Radar Type 0 burst.

Note 2: The Channel Closing Transmission Time is comprised of 200 milliseconds starting at the beginning of the Channel Move Time plus any additional intermittent control signals required to facilitate a Channel move (an aggregate of 60 milliseconds) during the remainder of the 10 second period. The aggregate duration of control signals will not count quiet periods in between transmissions.

Note 3: During the U-NII Detection Bandwidth detection test, radar type 0 should be used. For each frequency step the minimum percentage of detection is 90 percent. Measurements are performed with no data traffic.

Parameters of DFS Test Signals

Step intervals of 0.1 microsecond for Pulse Width, 1 microsecond for PRI, 1 MHz for chirp width and 1 for the number of pulses will be utilized for the random determination of specific test waveforms.

Table 10: Short Pulse Radar Test Waveforms

Radar Type	Pulse Width (μsec)	PRI (μsec)	Number of Pulses	Minimum Percentage of Successful Detection	Minimum Number of Trials
0	1	1428	18	See Note 1	See Note 1
1	1	Test A 15 unique PRI values randomly selected from the list of 23 PRI values	Roundup $\left\{ \left(\frac{1}{360} \right) \cdot \left(\frac{19 \cdot 10^6}{\text{PRI}_{\mu\text{sec}}} \right) \right\}$	60%	30
		15 unique PRI values randomly selected within the range of 518~3066 μ sec with a minimum of 1 μ sec, excluding PRI values selected in Test A			
2	1-5	150-230	23-29	60%	30
3	6-10	200-500	16-18	60%	30
4	11-20	200-500	12-16	60%	30
Aggregate (Radar Types 1-4)				80%	120
Note 1: Short Pulse Radar Type 0 should be used for the detection bandwidth test, channel move time, and channel closing time tests.					

Table 11: Long Pulse Radar Test Waveform

Radar Type	Pulse Width (μsec)	Chirp Width (MHz)	PRI (μsec)	Number of Pulses Per Burst	Number of Bursts	Minimum Percentage of Successful Detection	Minimum Number of Trials
5	50-100	5-20	1000-2000	1-3	8-20	80%	30

Three subsets of trials will be performed with a minimum of ten trials per subset. The subset of trials differ in where the Long Pulse Type 5 Signal is tuned in frequency.

- a) the Channel center frequency
- b) tuned frequencies such that 90% of the Long Pulse Type 5 frequency modulation is within the low edge of the UUT Occupied Bandwidth
- c) tuned frequencies such that 90% of the Long Pulse Type 5 frequency modulation is within the high edge of the UUT Occupied Bandwidth

It include 10 trails for every subset, the formula as below,

For subset case 1: the center frequency of the signal generator will remain fixed at the center of the UUT Channel.

For subset case 2: to retain 90% frequency overlap between the radar signal and the UUT Occupied Bandwidth, the center frequency of the signal generator will vary for each of the ten trials in subset case 2. The center frequency of the signal generator for each trial is calculated by:

$$FL+(0.4*Chirp\ Width\ [in\ MHz])$$

For subset case 3: to retain 90% frequency overlap between the radar signal and the UUT Occupied Bandwidth, the center frequency of the signal generator will vary for each of the ten trials in subset case 3. The center frequency of the signal generator for each trial is calculated by:

$$FH-(0.4*Chirp\ Width\ [in\ MHz])$$

Table 12: Frequency Hopping Radar Test Waveform

Radar Type	Pulse Width (μsec)	PRI (μsec)	Pulses per Hop	Hopping Rate (kHz)	Hopping Sequence Length (msec)	Minimum Percentage of Successful Detection	Minimum Number of Trials
6	1	333	9	0.333	300	70%	30

4. Test & Support Equipment List

4.1 Test Instruments

Table 13: Test Instruments List

DESCRIPTION & MANUFACTURER	MODEL NO.	SERIAL NO.	CALIBRATE D DATE	CALIBRATED UNTIL
Test Receiver ESR7 R&S	ESR7	102026	2021/4/16	2022/4/15
MXG X-Series RF Vector Signal Generator Keysight	N5182B	MY53052700	2021/7/13	2022/7/12
Horn Antenna FT-RF	HA-07M18G-NF	0000220091110	2021/11/14	2022/11/13
DFS Control Box	BV-DFS-CB	002	2021/11/30	2022/11/29

- Note:**
1. The test was performed in DFS-2 room.
 2. The calibration interval of the above test instruments is 12 months and the calibrations are traceable to NML/ROC and NIST/USA.
 3. Tested Date: 2022/1/4 ~ 2022/1/11

4.2 Description of Support Units

Table 14: Support Unit Information

No.	Product	Brand	Model No.	FCC ID	Spec
1	Intel® Wi-Fi 6 AX200	Intel	AX200NGW	PD9AX200NG	

NOTE: This device was functioned as a Master Slave device during the DFS test.

Table 15: Software/Firmware Information

No.	Product	Model No.	Software/Firmware Version
1	Intel® Wi-Fi 6 AX200	AX200NGW	21.80.2.1

5. Test Procedure

5.1 DFS Measurement System

A complete DFS Measurement System consists of two subsystems: (1) the Radar Signal Generating system and (2) the Traffic Monitoring system. The control PC is necessary for generating the Radar waveforms in Table 10, 11 and 12. The traffic monitoring subsystem is specified to the type of unit under test (UUT).

Radiated Setup Configuration of DFS Measurement System

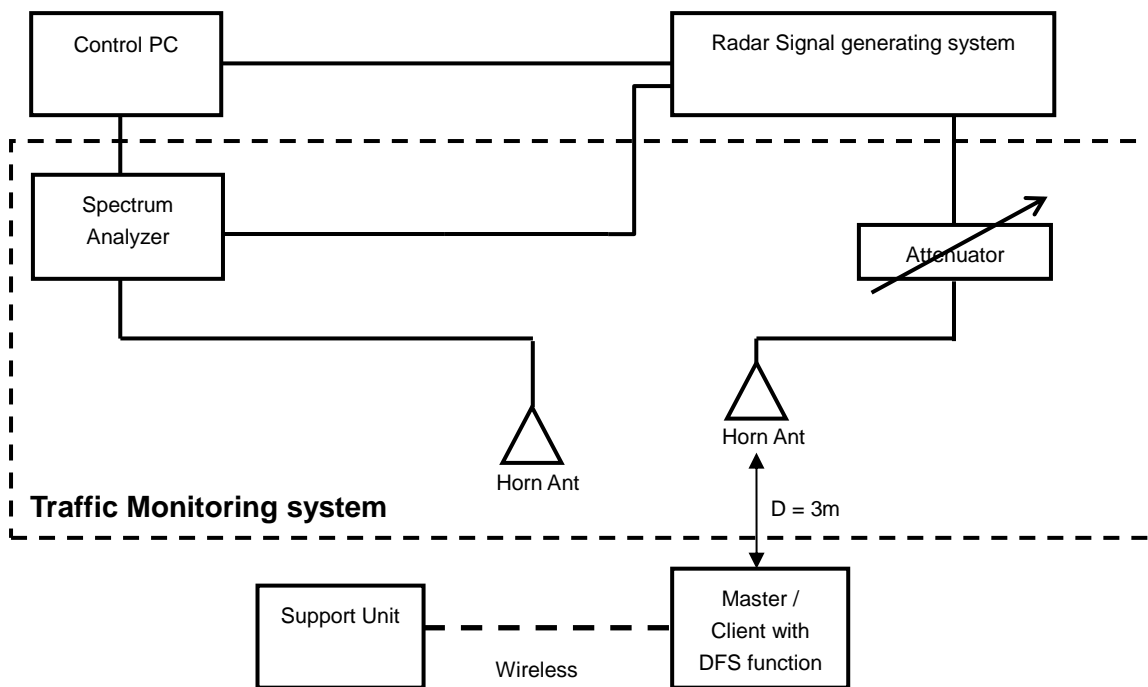

Channel Loading

System testing will be performed with channel-loading using means appropriate to the data types that are used by the unlicensed device. The following requirements apply:

a)	The data file must be of a type that is typical for the device (i.e., MPEG-2, MPEG-4, WAV, MP3, MP4, AVI, etc.) and must generally be transmitting in a streaming mode.	
b)	Software to ping the client is permitted to simulate data transfer but must have random ping intervals.	
c)	Timing plots are required with calculations demonstrating a minimum channel loading of approximately 17% or greater.	✓
d)	Unicast or Multicast protocols are preferable but other protocols may be used. The appropriate protocol used must be described in the test procedures.	

5.2 Calibration of DFS Detection Threshold Level

The measured channel is chosen from the operating channels of the UUT within the 5250-5350MHz or 5470-5725MHz and using the all bandwidth mode available for the link. The radar signal was the same as transmitted channels, and injected into the antenna of AP (master) or Client Device with Radar Detection, measured the channel closing transmission time and channel move time.

Radiated setup configuration of Calibration of DFS Detection Threshold Level

The radar signal generate system is generating waveform pattern of radar types. The amplitude of the radar signal generator system is adjusted to yield a level of -64 dBm as measured on the spectrum analyzer. The interference detection threshold level is lower than -64 dBm hence it provides margin to the limit.

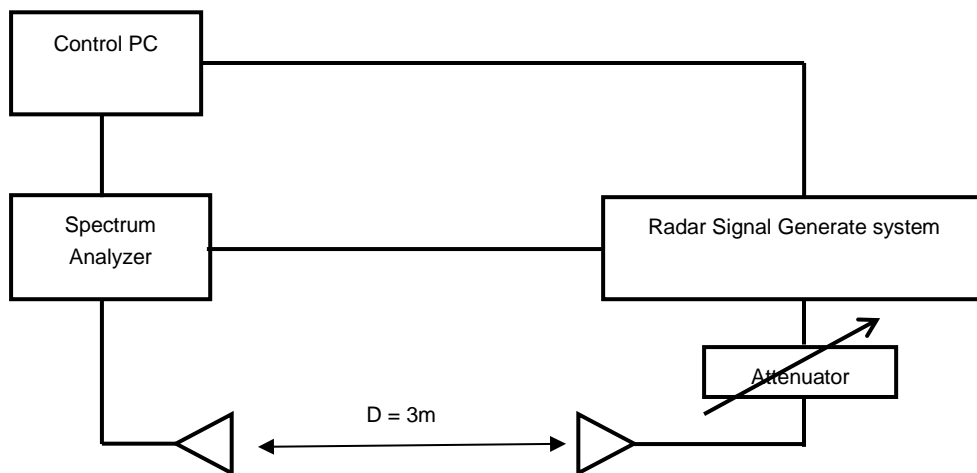

5.3 Deviation from Test Standard

No deviation.

5.4 Radiated Test Setup Configuration

Master mode

The EUT is a U-NII Device operating in Master mode. The radar test signals are injected into the Master Device.

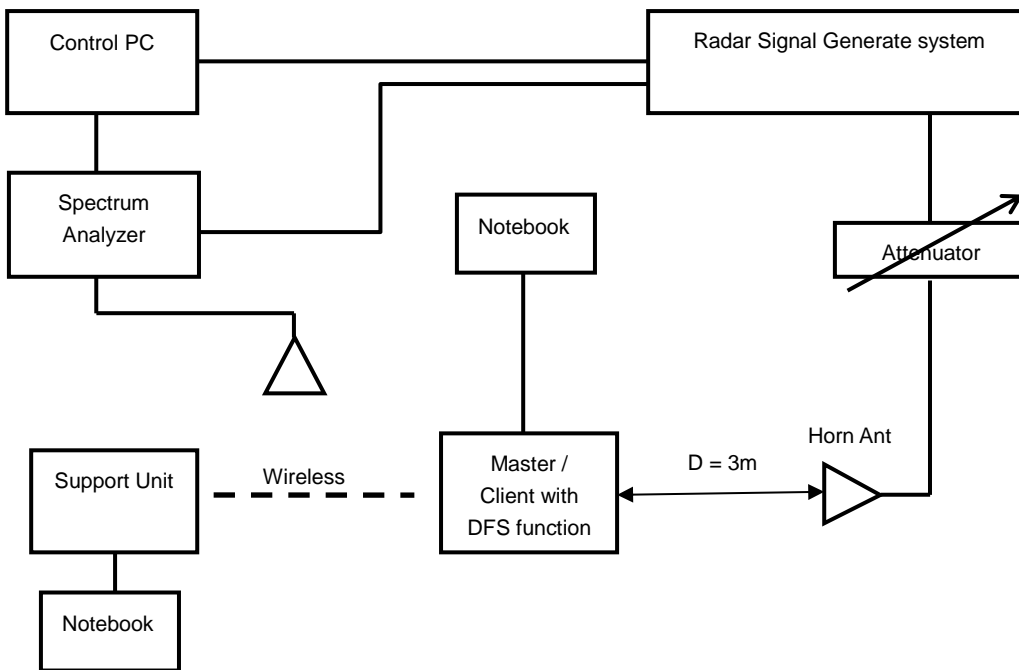

Note: The UUT main beam of the antenna is directly toward the radar emitter during testing.

6. Test Results

6.1 Summary of Test Results

Clause	Test Parameter	Remarks	Pass/Fail
15.407	DFS Detection Threshold	Applicable	Pass
15.407	Channel Availability Check Time	Applicable	Pass
15.407	Channel Move Time	Applicable	Pass
15.407	Channel Closing Transmission Time	Applicable	Pass
15.407	Non- Occupancy Period	Applicable	Pass
15.407	U-NII Detection Bandwidth and Statistical Performance Check	Applicable	Pass

Note: This device does not support "802.11ax Channel Puncturing" function.

6.2 Test Results

6.2.1 Test Mode: Device Operating In Master Mode

The radar test waveforms are injected into the Master.
This test was investigated for different bandwidth (20MHz · 40MHz · 80MHz).
The following plots was done on 80MHz as a representative

DFS Detection Threshold

For detection threshold level of -64dBm, the tested level is lower than required level for 1dB, hence it provides margin to the limit.

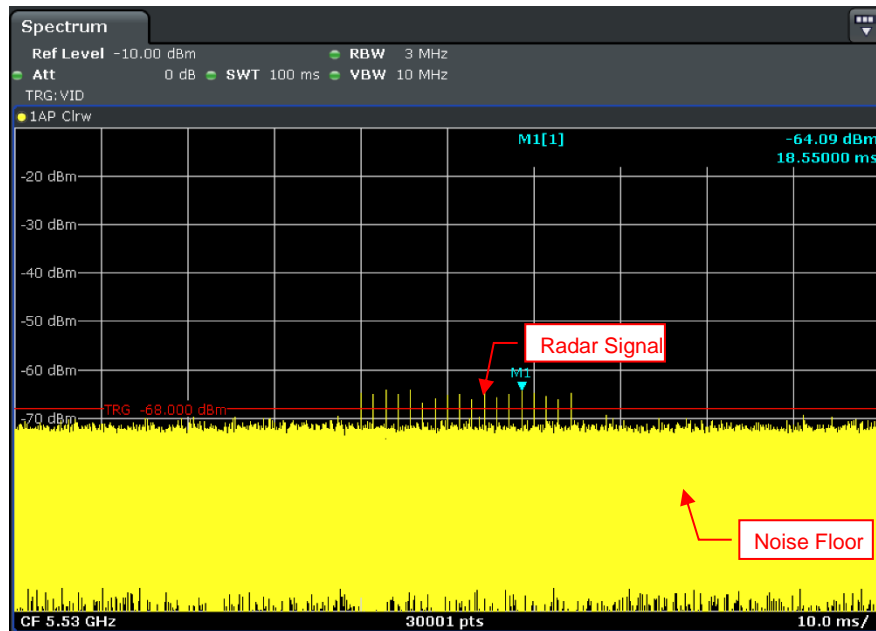

Radar Signal 0

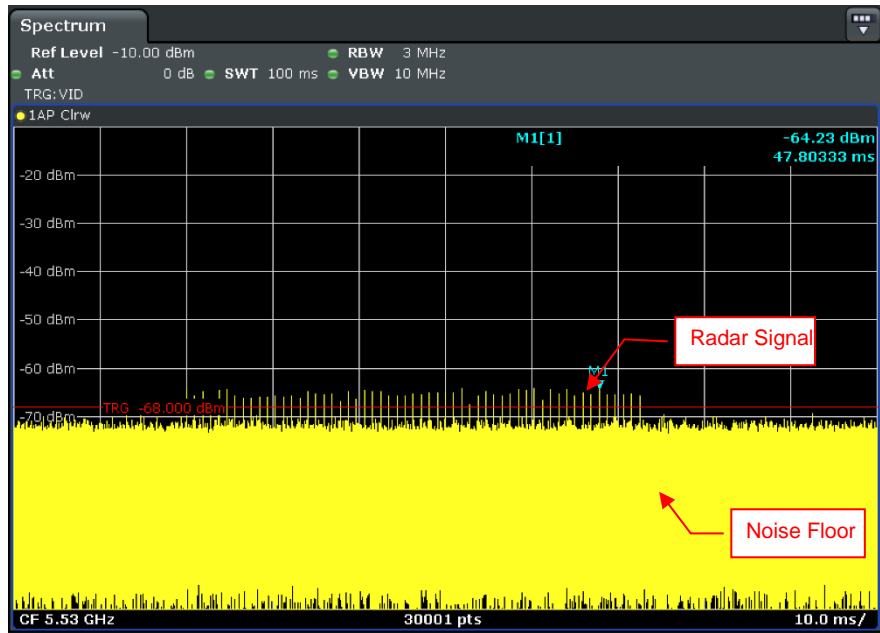

Radar Signal 1 (Test A)

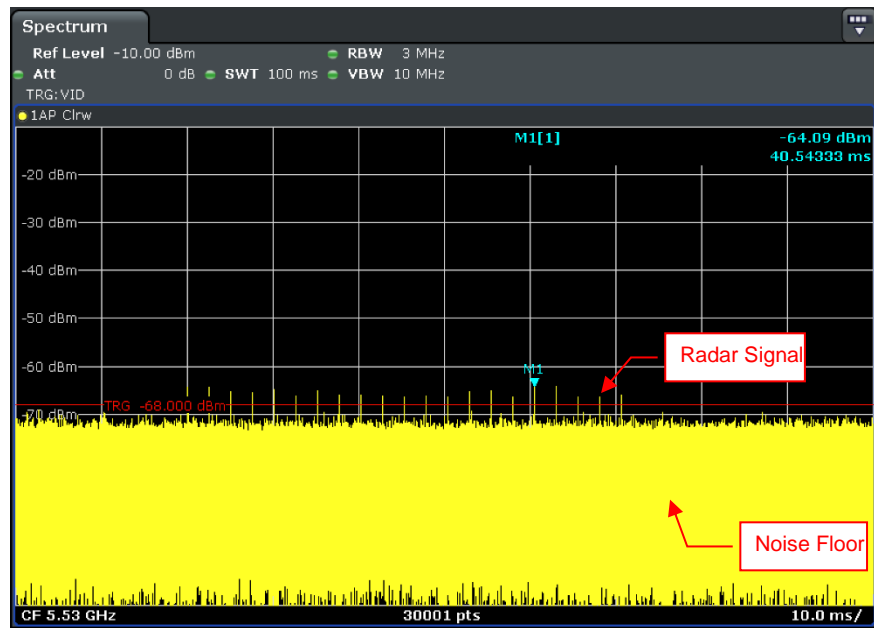

Radar Signal 1 (Test B)

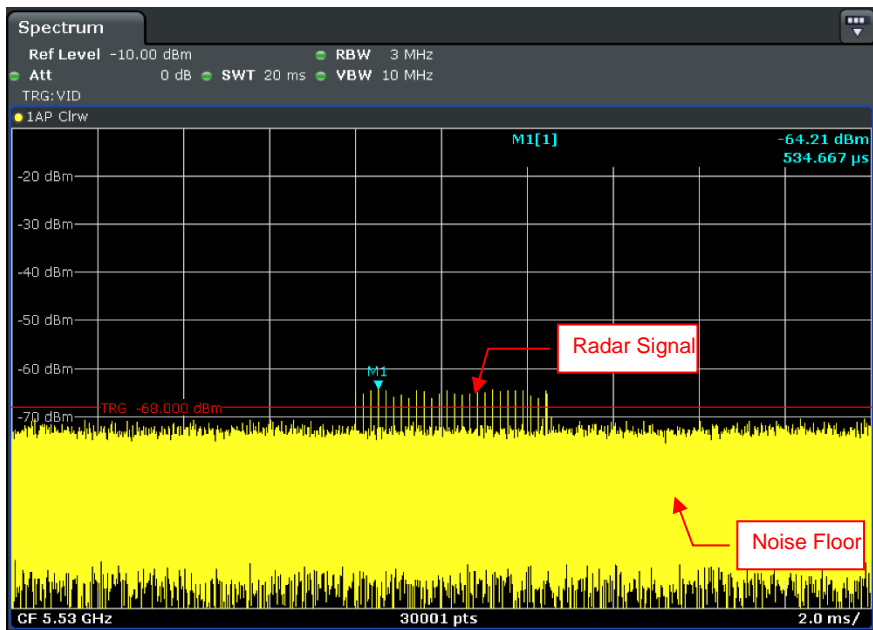

Radar Signal 2

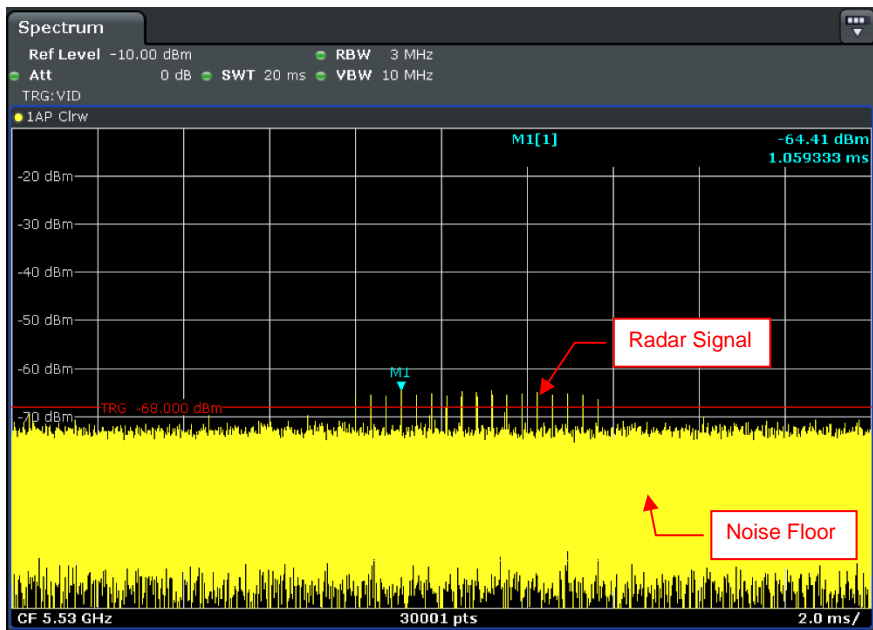

Radar Signal 3

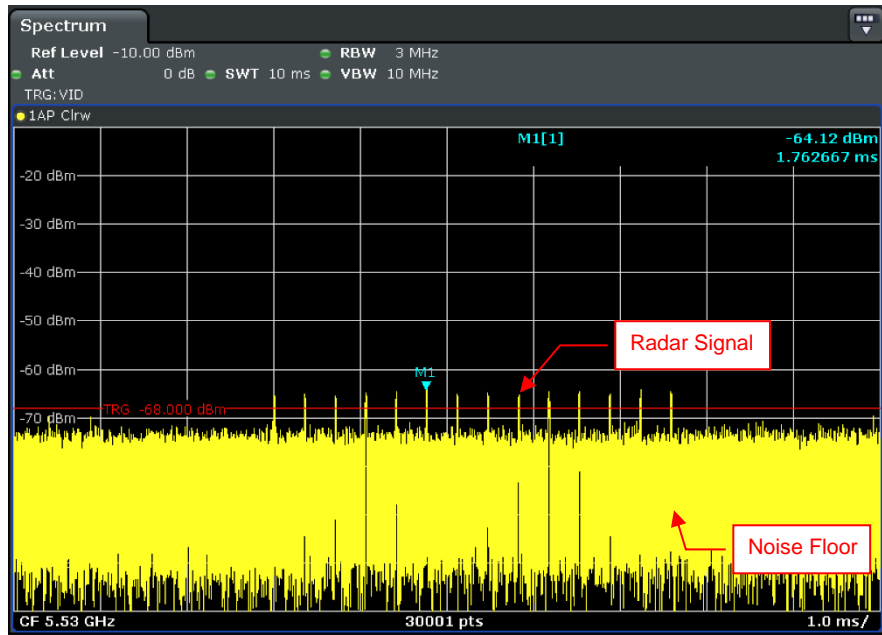

Single Burst of Radar Signal 4

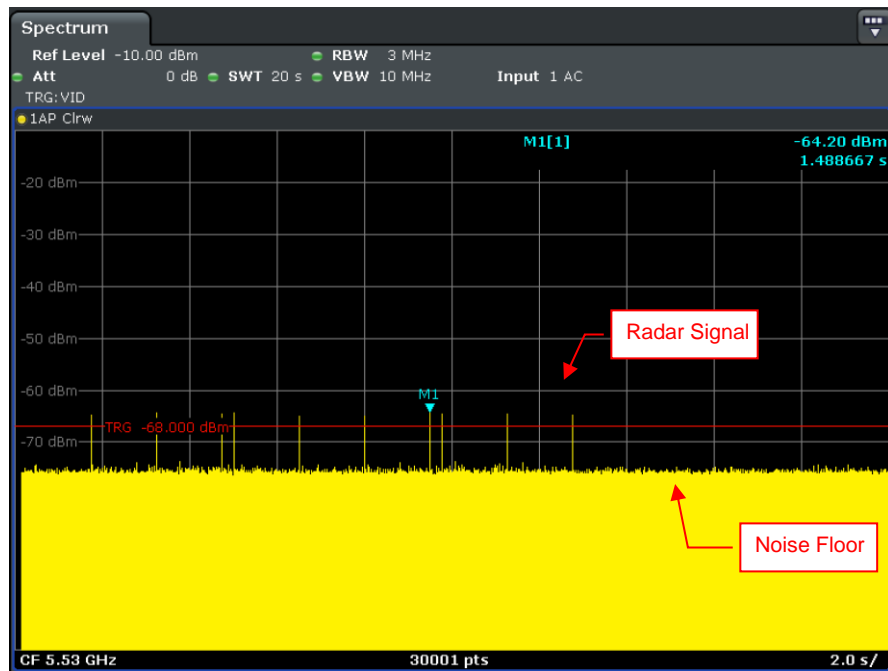

Radar Signal 5

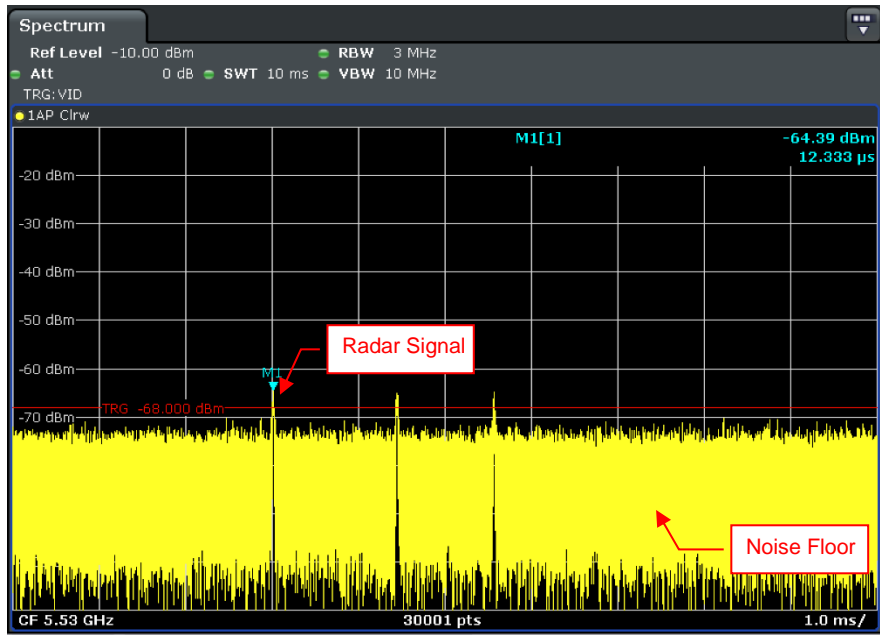

Single Burst of Radar Signal 5

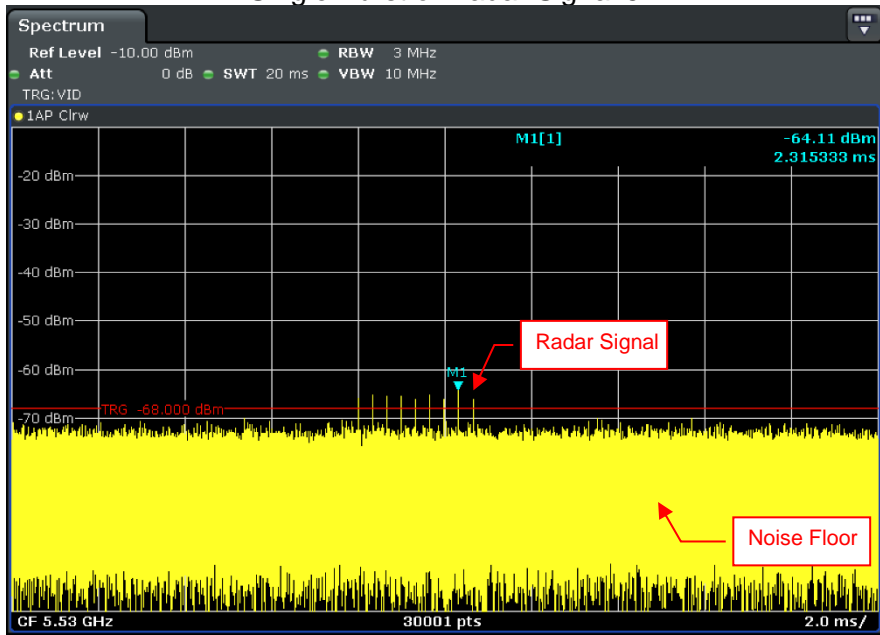

Radar Signal 6

6.2.2 U-NII Detection Bandwidth

802.11ax (HE20)

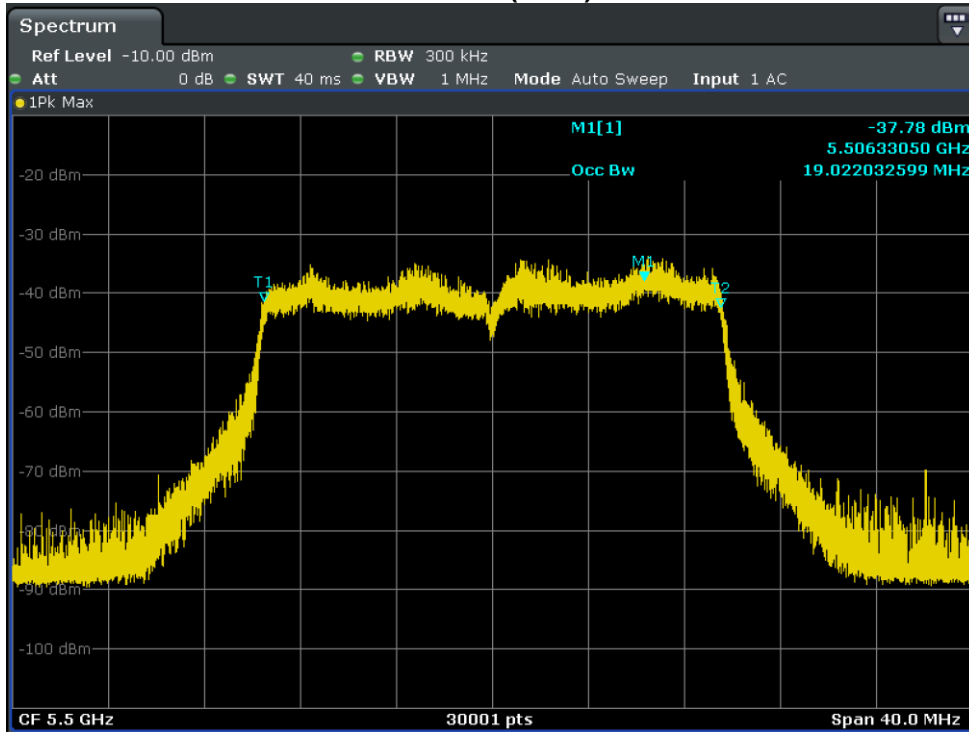

U-NII 99% Channel bandwidth

802.11ax (HE40)

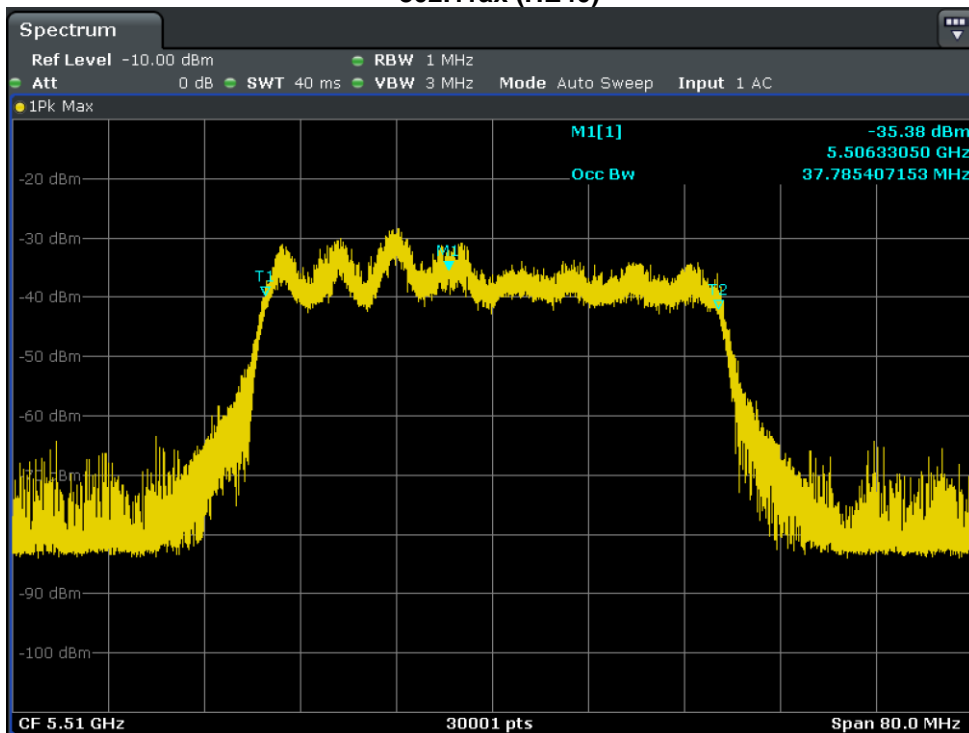

U-NII 99% Channel bandwidth



802.11ax (HE80)

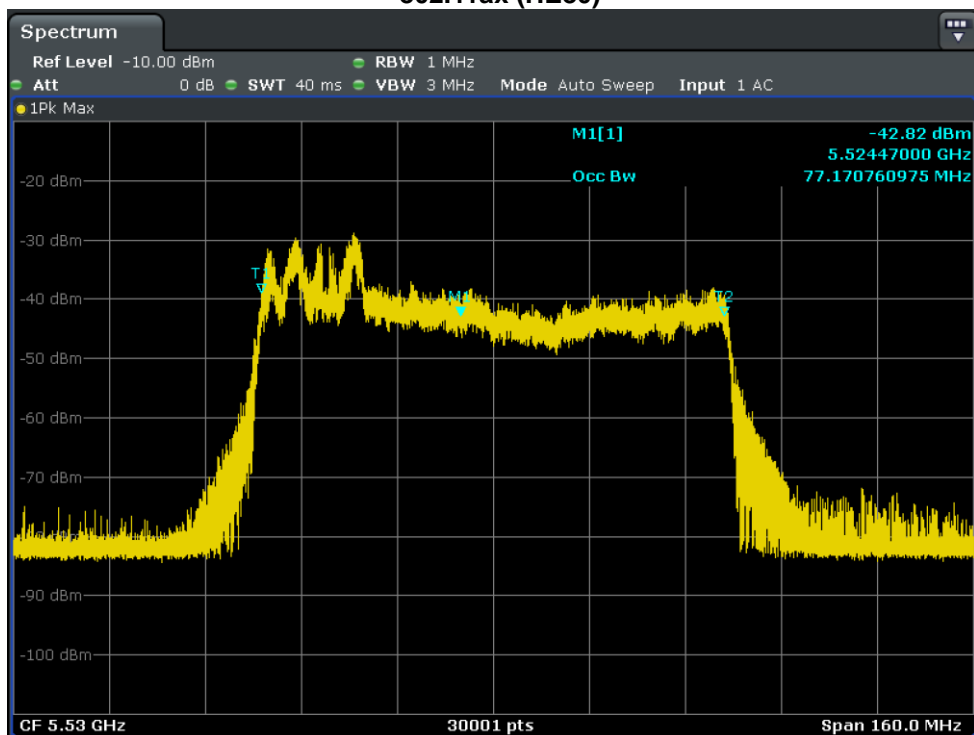

U-NII 99% Channel bandwidth



Detection Bandwidth Test - **802.11ax (HE20)**
Radar Type 0
EUT Frequency: 5500MHz
EUT 99% Power bandwidth:19.022MHz
Detection bandwidth limit (100% of EUT 99% Power bandwidth): 19.022MHz
Detection bandwidth (5510(FH) – 5490(FL)) : 20MHz
Test Result : PASS

Radar Frequency (MHz)	Trial Number / Detection										Detection Rate (%)
	1	2	3	4	5	6	7	8	9	10	
5490(FL)	Yes	No	Yes	Yes	Yes	Yes	Yes	Yes	Yes	Yes	90
5491	Yes	No	Yes	Yes	Yes	Yes	Yes	Yes	Yes	Yes	90
5492	No	Yes	Yes	Yes	Yes	Yes	Yes	Yes	Yes	Yes	90
5493	Yes	Yes	Yes	Yes	Yes	Yes	Yes	Yes	Yes	Yes	100
5494	Yes	Yes	Yes	Yes	Yes	Yes	Yes	Yes	Yes	Yes	100
5495	Yes	Yes	Yes	Yes	Yes	Yes	Yes	Yes	Yes	Yes	100
5496	Yes	Yes	Yes	Yes	Yes	Yes	Yes	Yes	Yes	Yes	100
5497	Yes	Yes	Yes	Yes	Yes	Yes	Yes	Yes	Yes	Yes	100
5498	Yes	Yes	Yes	Yes	Yes	Yes	Yes	Yes	Yes	Yes	100
5499	Yes	Yes	Yes	Yes	Yes	Yes	Yes	Yes	Yes	Yes	100
5500	Yes	Yes	Yes	No	Yes	Yes	Yes	Yes	Yes	Yes	90
5501	Yes	Yes	Yes	Yes	Yes	Yes	Yes	Yes	Yes	Yes	100
5502	Yes	Yes	Yes	Yes	Yes	Yes	Yes	Yes	Yes	Yes	100
5503	Yes	Yes	Yes	Yes	Yes	Yes	Yes	Yes	Yes	Yes	100
5504	Yes	Yes	Yes	Yes	Yes	Yes	Yes	Yes	Yes	Yes	100
5505	Yes	Yes	Yes	Yes	Yes	Yes	Yes	Yes	Yes	Yes	100
5506	Yes	Yes	Yes	Yes	Yes	Yes	Yes	Yes	Yes	Yes	100
5507	Yes	Yes	No	Yes	Yes	Yes	Yes	Yes	Yes	Yes	90
5508	Yes	Yes	Yes	Yes	Yes	Yes	Yes	Yes	Yes	Yes	100
5509	Yes	Yes	Yes	Yes	Yes	Yes	Yes	No	Yes	Yes	90
5510(FH)	Yes	Yes	Yes	Yes	Yes	Yes	Yes	No	Yes	Yes	90



Detection Bandwidth Test - **802.11ax (HE40)**
 Radar Type 0
 EUT Frequency: 5510MHz
 EUT 99% Power bandwidth: 37.785MHz
 Detection bandwidth limit (100% of EUT 99% Power bandwidth): 37.785MHz
 Detection bandwidth (5529(FH) – 5491(FL)) : 38MHz
 Test Result : PASS

Radar Frequency (MHz)	Trial Number / Detection										Detection Rate (%)
	1	2	3	4	5	6	7	8	9	10	
5491(FL)	Yes	Yes	Yes	Yes	Yes	Yes	Yes	Yes	Yes	Yes	100
5492	Yes	No	Yes	Yes	Yes	Yes	Yes	Yes	Yes	Yes	90
5493	No	Yes	Yes	Yes	Yes	Yes	Yes	Yes	Yes	Yes	90
5494	Yes	Yes	Yes	Yes	Yes	Yes	Yes	Yes	Yes	Yes	100
5495	Yes	Yes	Yes	Yes	Yes	Yes	Yes	Yes	Yes	Yes	100
5496	Yes	Yes	Yes	Yes	Yes	Yes	Yes	Yes	Yes	Yes	100
5497	Yes	Yes	Yes	Yes	Yes	Yes	Yes	Yes	Yes	Yes	100
5498	Yes	Yes	Yes	Yes	Yes	Yes	Yes	Yes	Yes	Yes	100
5499	Yes	Yes	Yes	Yes	Yes	Yes	Yes	Yes	Yes	Yes	100
5500	Yes	Yes	Yes	Yes	Yes	Yes	Yes	Yes	No	Yes	90
5501	Yes	Yes	Yes	Yes	Yes	Yes	Yes	Yes	Yes	Yes	100
5502	Yes	Yes	Yes	Yes	Yes	Yes	Yes	Yes	Yes	Yes	100
5503	Yes	Yes	Yes	Yes	Yes	Yes	Yes	Yes	Yes	Yes	100
5504	Yes	Yes	Yes	Yes	Yes	Yes	Yes	Yes	Yes	Yes	100
5505	Yes	Yes	Yes	Yes	Yes	Yes	Yes	Yes	Yes	Yes	100
5506	Yes	Yes	Yes	Yes	Yes	Yes	Yes	Yes	Yes	Yes	100
5507	Yes	Yes	Yes	Yes	Yes	Yes	Yes	Yes	Yes	Yes	100
5508	Yes	Yes	Yes	Yes	Yes	Yes	Yes	Yes	Yes	Yes	100
5509	Yes	Yes	Yes	Yes	Yes	Yes	Yes	Yes	Yes	Yes	100
5510	Yes	No	Yes	Yes	Yes	Yes	Yes	Yes	Yes	Yes	90
5511	Yes	Yes	Yes	Yes	Yes	Yes	Yes	Yes	Yes	Yes	100
5512	Yes	Yes	Yes	Yes	Yes	Yes	Yes	Yes	Yes	Yes	100
5513	Yes	Yes	Yes	Yes	Yes	Yes	Yes	Yes	Yes	Yes	100
5514	Yes	Yes	Yes	Yes	Yes	Yes	Yes	Yes	Yes	Yes	100
5515	Yes	Yes	Yes	Yes	Yes	Yes	Yes	Yes	Yes	Yes	100
5516	Yes	Yes	Yes	Yes	Yes	Yes	Yes	Yes	Yes	Yes	100
5517	Yes	Yes	Yes	Yes	Yes	Yes	Yes	Yes	Yes	Yes	100
5518	Yes	Yes	Yes	Yes	Yes	Yes	Yes	Yes	Yes	Yes	100
5519	Yes	Yes	Yes	Yes	Yes	Yes	Yes	Yes	Yes	Yes	100
5520	Yes	Yes	Yes	Yes	Yes	Yes	Yes	Yes	Yes	Yes	100
5521	Yes	Yes	Yes	Yes	Yes	Yes	Yes	Yes	Yes	Yes	100
5522	Yes	Yes	Yes	Yes	Yes	Yes	Yes	Yes	Yes	Yes	100
5523	Yes	Yes	Yes	Yes	Yes	Yes	Yes	Yes	Yes	Yes	100
5524	Yes	Yes	Yes	Yes	Yes	Yes	Yes	Yes	Yes	Yes	100
5525	Yes	Yes	Yes	Yes	Yes	Yes	Yes	Yes	Yes	Yes	100
5526	Yes	Yes	Yes	Yes	Yes	Yes	Yes	Yes	Yes	Yes	100
5527	Yes	Yes	Yes	Yes	Yes	Yes	Yes	Yes	Yes	Yes	100
5528	Yes	Yes	No	Yes	Yes	Yes	Yes	Yes	Yes	Yes	90
5529(FH)	Yes	Yes	Yes	Yes	Yes	No	Yes	Yes	Yes	Yes	90



Detection Bandwidth Test - **802.11ax (HE80)**
 Radar Type 0
 EUT Frequency: 5530MHz
 EUT 99% Power bandwidth: 77.17MHz
 Detection bandwidth limit (100% of EUT 99% Power bandwidth):77.17MHz
 Detection bandwidth (5569(FH) – 5491(FL)) : 78MHz
 Test Result : PASS

Radar Frequency (MHz)	Trial Number / Detection										Detection Rate (%)
	1	2	3	4	5	6	7	8	9	10	
5491(FL)	Yes	Yes	Yes	Yes	Yes	Yes	Yes	Yes	Yes	Yes	90
5493	Yes	Yes	Yes	Yes	Yes	Yes	Yes	Yes	Yes	Yes	90
5493	Yes	Yes	Yes	Yes	Yes	Yes	Yes	Yes	Yes	Yes	100
5494	Yes	Yes	Yes	Yes	Yes	Yes	Yes	Yes	Yes	Yes	90
5495	Yes	Yes	Yes	Yes	Yes	Yes	Yes	Yes	Yes	Yes	100
5496	Yes	Yes	Yes	Yes	Yes	Yes	Yes	Yes	Yes	Yes	100
5497	Yes	Yes	Yes	Yes	Yes	Yes	Yes	Yes	Yes	Yes	100
5498	Yes	Yes	Yes	Yes	Yes	Yes	Yes	Yes	Yes	Yes	100
5499	Yes	Yes	Yes	Yes	Yes	Yes	Yes	Yes	Yes	Yes	100
5500	Yes	Yes	Yes	Yes	Yes	Yes	Yes	Yes	Yes	Yes	100
5501	Yes	Yes	Yes	Yes	Yes	Yes	Yes	Yes	Yes	Yes	90
5502	Yes	Yes	Yes	Yes	Yes	Yes	Yes	Yes	Yes	Yes	100
5503	Yes	Yes	Yes	Yes	Yes	Yes	Yes	Yes	Yes	Yes	100
5504	Yes	Yes	Yes	Yes	Yes	Yes	Yes	Yes	Yes	Yes	100
5505	Yes	Yes	Yes	Yes	Yes	Yes	Yes	Yes	Yes	Yes	100
5506	Yes	Yes	Yes	Yes	Yes	Yes	Yes	Yes	Yes	Yes	100
5507	Yes	Yes	Yes	Yes	Yes	Yes	Yes	Yes	Yes	Yes	100
5508	Yes	Yes	Yes	Yes	Yes	Yes	Yes	Yes	Yes	Yes	100
5509	Yes	Yes	Yes	Yes	Yes	Yes	Yes	Yes	Yes	Yes	100
5510	Yes	Yes	Yes	Yes	Yes	Yes	Yes	Yes	Yes	Yes	100
5511	Yes	Yes	Yes	Yes	Yes	Yes	Yes	Yes	Yes	Yes	90
5512	Yes	Yes	Yes	Yes	Yes	Yes	Yes	Yes	Yes	Yes	90
5513	Yes	Yes	Yes	Yes	Yes	Yes	Yes	Yes	Yes	Yes	100
5514	Yes	Yes	Yes	Yes	Yes	Yes	Yes	Yes	Yes	Yes	100
5515	Yes	Yes	Yes	Yes	Yes	Yes	Yes	Yes	Yes	Yes	100
5516	Yes	Yes	Yes	Yes	Yes	Yes	Yes	Yes	Yes	Yes	100
5517	Yes	Yes	Yes	Yes	Yes	Yes	Yes	Yes	Yes	Yes	100
5518	Yes	Yes	Yes	Yes	Yes	Yes	Yes	Yes	Yes	Yes	100
5519	Yes	Yes	Yes	Yes	Yes	Yes	Yes	Yes	Yes	Yes	100
5520	Yes	Yes	Yes	Yes	Yes	Yes	Yes	Yes	Yes	Yes	100
5521	Yes	Yes	Yes	Yes	Yes	Yes	Yes	Yes	Yes	Yes	100
5522	Yes	Yes	Yes	Yes	Yes	Yes	Yes	Yes	Yes	Yes	100
5523	Yes	Yes	Yes	Yes	Yes	Yes	Yes	Yes	Yes	Yes	100
5524	Yes	Yes	Yes	Yes	Yes	Yes	Yes	Yes	Yes	Yes	100
5525	Yes	Yes	Yes	Yes	Yes	Yes	Yes	Yes	Yes	Yes	100
5526	Yes	Yes	Yes	Yes	Yes	Yes	Yes	Yes	Yes	Yes	100
5527	Yes	Yes	Yes	Yes	Yes	Yes	Yes	Yes	Yes	Yes	90
5528	Yes	Yes	Yes	Yes	Yes	Yes	Yes	Yes	Yes	Yes	100
5529	Yes	Yes	Yes	Yes	Yes	Yes	Yes	Yes	Yes	Yes	90
5530	Yes	Yes	Yes	Yes	Yes	Yes	Yes	Yes	Yes	Yes	100
5531	Yes	Yes	Yes	Yes	Yes	Yes	Yes	Yes	Yes	Yes	100
5532	Yes	Yes	Yes	Yes	Yes	Yes	Yes	Yes	Yes	Yes	100
5533	Yes	Yes	Yes	Yes	Yes	Yes	Yes	Yes	Yes	Yes	100
5534	Yes	Yes	Yes	Yes	Yes	Yes	Yes	Yes	Yes	Yes	100
5535	Yes	Yes	Yes	Yes	Yes	Yes	Yes	Yes	Yes	Yes	100



5536	Yes	Yes	Yes	Yes	Yes	Yes	Yes	Yes	Yes	Yes	100
5537	Yes	Yes	Yes	Yes	Yes	Yes	Yes	Yes	Yes	Yes	100
5538	Yes	Yes	Yes	Yes	Yes	Yes	Yes	Yes	Yes	Yes	100
5539	Yes	Yes	Yes	Yes	Yes	Yes	Yes	Yes	Yes	Yes	100
5540	Yes	Yes	Yes	Yes	Yes	Yes	Yes	Yes	Yes	Yes	100
5541	Yes	Yes	Yes	Yes	Yes	Yes	Yes	Yes	Yes	Yes	100
5542	Yes	Yes	Yes	Yes	Yes	Yes	Yes	Yes	Yes	Yes	90
5543	Yes	Yes	Yes	Yes	Yes	Yes	Yes	Yes	Yes	Yes	100
5544	Yes	Yes	Yes	Yes	Yes	Yes	Yes	Yes	Yes	Yes	100
5545	Yes	Yes	Yes	Yes	Yes	Yes	Yes	Yes	Yes	Yes	100
5546	Yes	Yes	Yes	Yes	Yes	Yes	Yes	Yes	Yes	Yes	100
5547	Yes	Yes	Yes	Yes	Yes	Yes	Yes	Yes	Yes	Yes	100
5548	Yes	Yes	Yes	Yes	Yes	Yes	Yes	Yes	Yes	Yes	100
5549	Yes	Yes	Yes	Yes	Yes	Yes	Yes	Yes	Yes	Yes	100
5550	Yes	Yes	Yes	Yes	Yes	Yes	Yes	Yes	Yes	Yes	100
5551	Yes	Yes	Yes	Yes	Yes	Yes	Yes	Yes	Yes	Yes	100
5552	Yes	Yes	Yes	Yes	Yes	Yes	Yes	Yes	Yes	Yes	100
5553	Yes	Yes	Yes	Yes	Yes	Yes	Yes	Yes	Yes	Yes	90
5554	Yes	Yes	Yes	Yes	Yes	Yes	Yes	Yes	Yes	Yes	100
5555	Yes	Yes	Yes	Yes	Yes	Yes	Yes	Yes	Yes	Yes	100
5556	Yes	Yes	Yes	Yes	Yes	Yes	Yes	Yes	Yes	Yes	100
5557	Yes	Yes	Yes	Yes	Yes	Yes	Yes	Yes	Yes	Yes	100
5558	Yes	Yes	Yes	Yes	Yes	Yes	Yes	Yes	Yes	Yes	100
5559	Yes	Yes	Yes	Yes	Yes	Yes	Yes	Yes	Yes	Yes	100
5560	Yes	Yes	Yes	Yes	Yes	Yes	Yes	Yes	Yes	Yes	90
5561	Yes	Yes	Yes	Yes	Yes	Yes	Yes	Yes	Yes	Yes	100
5562	Yes	Yes	Yes	Yes	Yes	Yes	Yes	Yes	Yes	Yes	100
5563	Yes	Yes	Yes	Yes	Yes	Yes	Yes	Yes	Yes	Yes	100
5564	Yes	Yes	Yes	Yes	Yes	Yes	Yes	Yes	Yes	Yes	100
5565	Yes	Yes	Yes	Yes	Yes	Yes	Yes	Yes	Yes	Yes	90
5566	Yes	Yes	Yes	Yes	Yes	Yes	Yes	Yes	Yes	Yes	100
5567	Yes	Yes	Yes	Yes	Yes	Yes	Yes	Yes	Yes	Yes	100
5568	Yes	Yes	Yes	Yes	Yes	Yes	Yes	Yes	Yes	Yes	90
5569(FH)	Yes	Yes	Yes	Yes	Yes	Yes	Yes	Yes	Yes	Yes	100

6.2.3 Channel Availability Check Time

If the EUT successfully detected the radar burst, it should be observed as the EUT has no transmissions occurred until the EUT starts transmitting on another channel.

Timing of Radar Signal	Observation	
	EUT	Spectrum Analyzer
Within 1 to 6 second	Detected	No transmissions
Within 54 to 60 second	Detected	No transmissions

Initial Channel Availability Check Time

Channel Availability Check

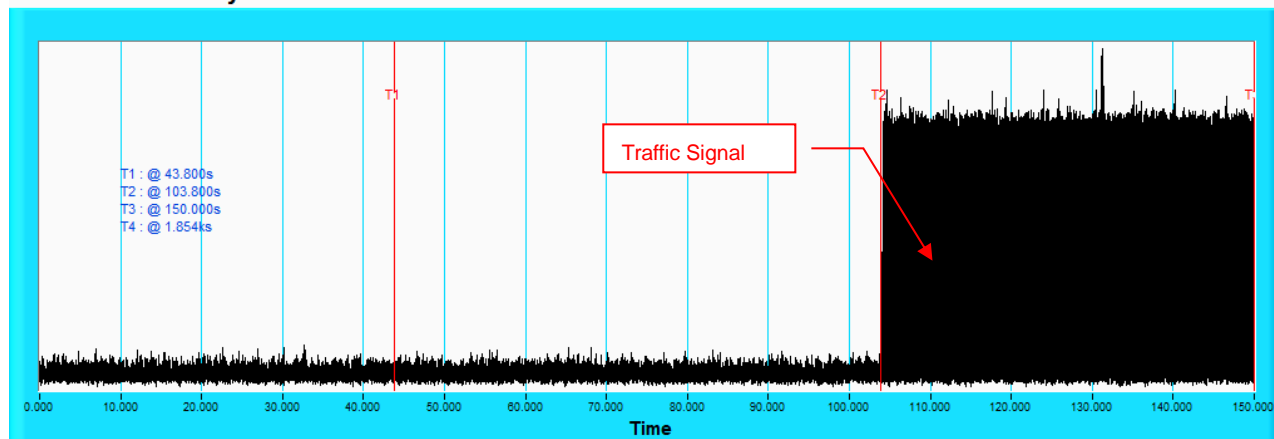

NOTE: T1 denotes the end of power-up time period is 43.8th second. T2 denotes the end of Channel Availability Check time is 103.8th second. Channel Availability Check time is equal to (T2 – T1) 60 seconds.

Radar Burst at the Beginning of the Channel Availability Check Time

Channel Availability Check

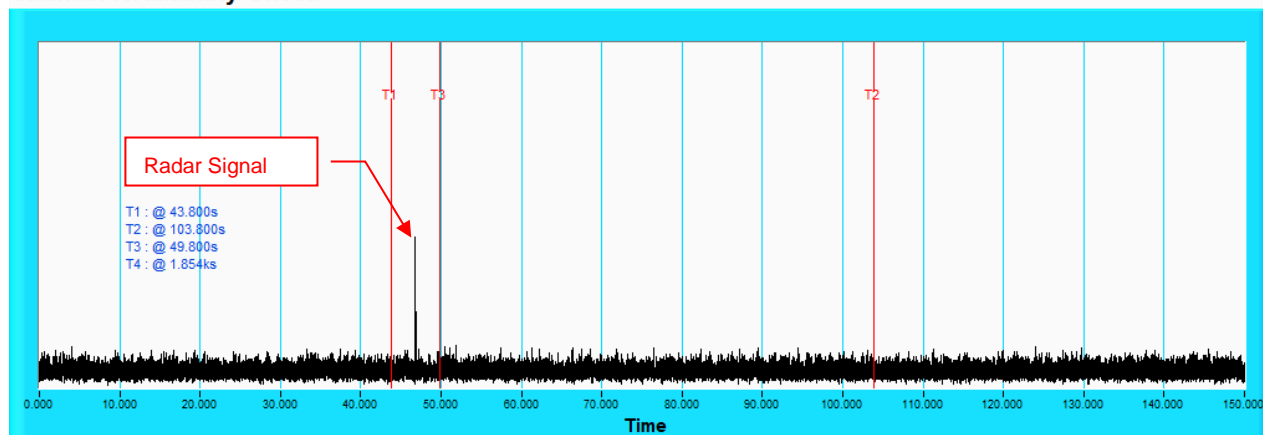

NOTE: T1 denotes the end of power up time period is 43.8th second. T3 denotes 49.8th second and the radar burst was commenced within a 6 second window starting from the end of power-up sequence. T2 denotes the 103.8th second.

Radar Burst at the End of the Channel Availability Check Time

Channel Availability Check

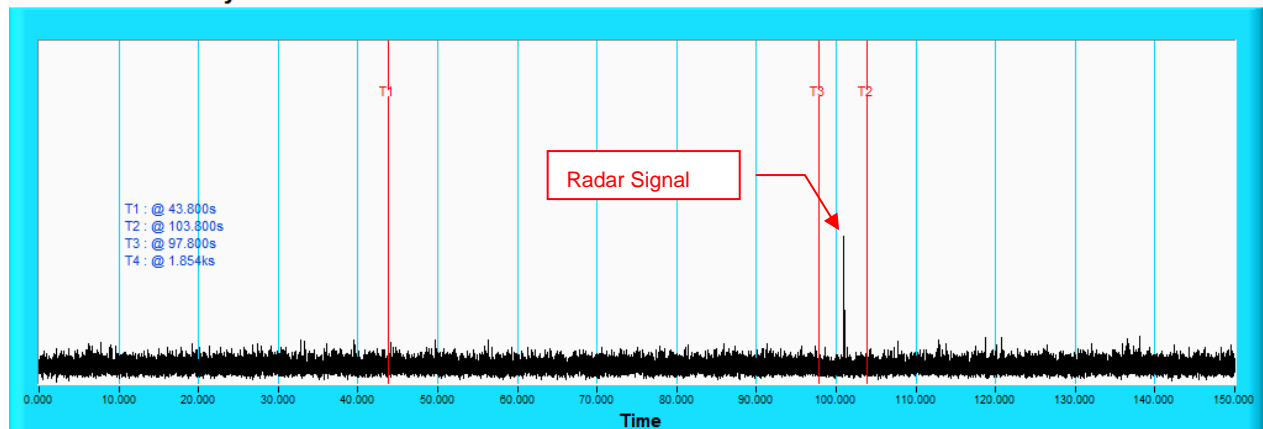

NOTE: T1 denotes the end of power up time period is 43.8th second. T3 denotes 97.8th second and the radar burst was commenced within 54th second to 60th second window starting from the end of power-up sequence. T2 denotes the 103.8th second.



6.2.4 Channel Closing Transmission and Channel Move Time

Wireless Traffic Loading

802.11ax (HE20)

Duty Cycle

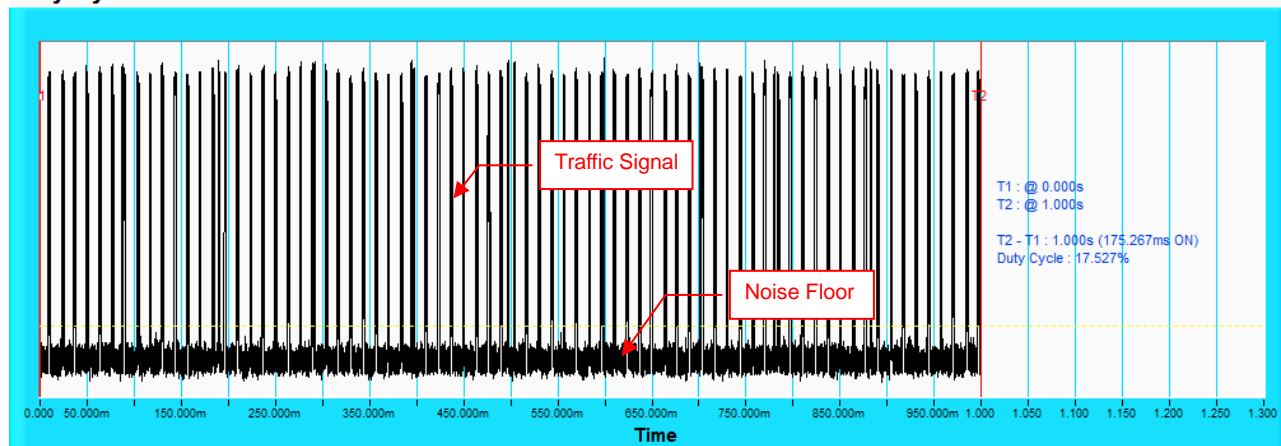

802.11ax (HE40)

Duty Cycle

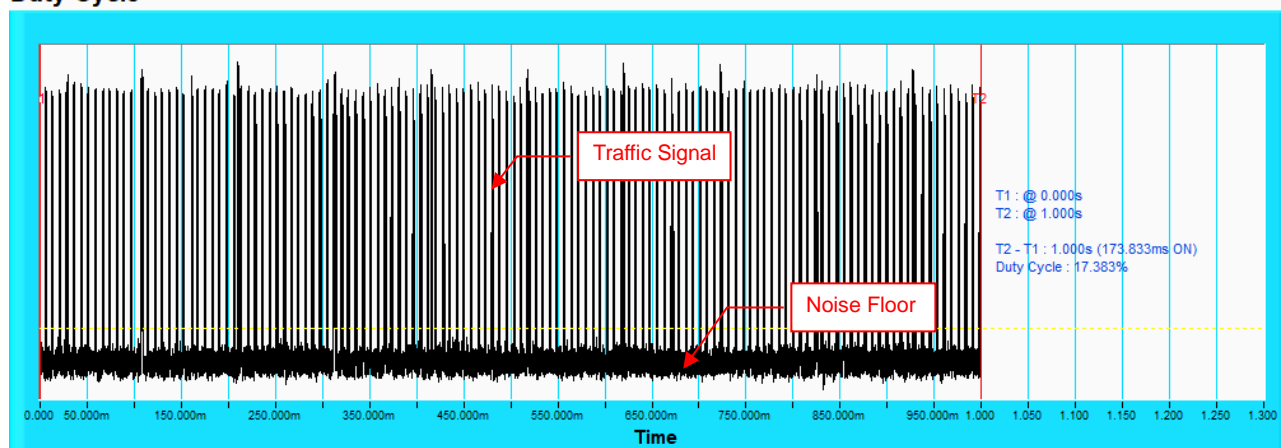

802.11ax (HE80)

Duty Cycle

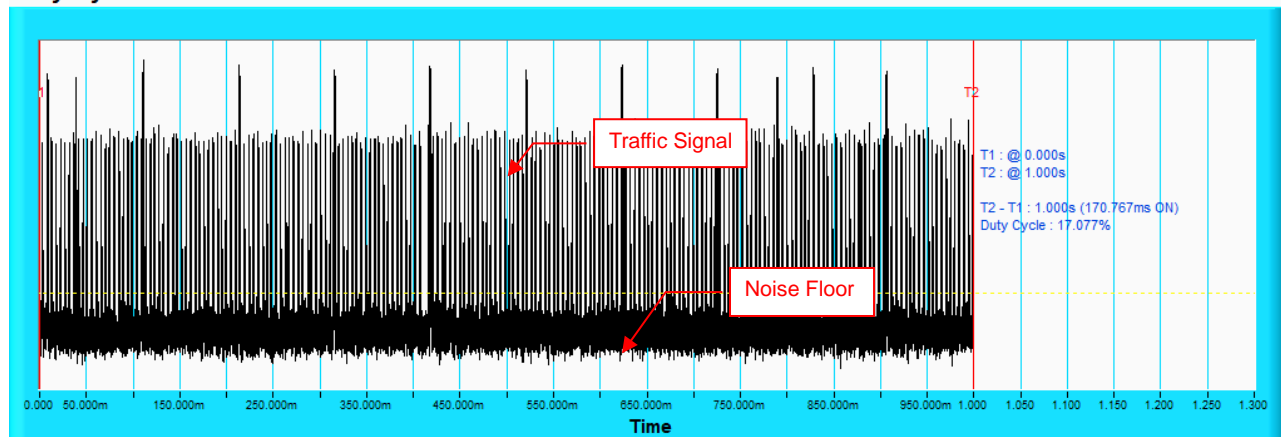

802.11ax (HE20)

Table 1: Short Pulse Radar Test Waveforms

Radar Type	Pulse Width (μsec)	PRI (μsec)	Number of Pulses	Number of Trials(Times)	Percentage of Successful Detection (%)
1	Test A 15 unique PRI values randomly selected from the list of 23 PRI values	Roundup $\left\{ \left(\frac{1}{360} \right) \cdot \left(\frac{19 \cdot 10^6}{\text{PRI}_{\mu\text{sec}}} \right) \right\}$	18	30	90
	15 unique PRI values randomly selected within the range of 518~3066 μsec with a minimum of 1 μsec, excluding PRI values selected in Test A				
2	1-5	150-230	23-29	30	80
3	6-10	200-500	16-18	30	93.3
4	11-20	200-500	12-16	30	83.3
Aggregate (Radar Types 1-4)				120	86.6

Table 2: Long Pulse Radar Test Waveform

Radar Type	Pulse Width (μsec)	Chirp Width (MHz)	PRI (μsec)	Number of Pulses per Burst	Number of Bursts	Number of Trials(Times)	Percentage of Successful Detection (%)
5	50-100	5-20	1000-2000	1-3	8-20	30	86.6

Table 3: Frequency Hopping Radar Test Waveform

Radar Type	Pulse Width (μsec)	PRI (μsec)	Pulses per Hop	Hopping Rate (kHz)	Hopping Sequence Length (msec)	Number of Trials(Times)	Percentage of Successful Detection (%)
6	1	333	9	0.333	300	30	90

802.11ax (HE40)
Table 1: Short Pulse Radar Test Waveforms

Radar Type	Pulse Width (μsec)	PRI (μsec)	Number of Pulses	Number of Trials(Times)	Percentage of Successful Detection (%)
1	Test A 15 unique PRI values randomly selected from the list of 23 PRI values	Roundup $\left\{ \left(\frac{1}{360} \right) \cdot \left(\frac{19 \cdot 10^6}{\text{PRI}_{\mu\text{sec}}} \right) \right\}$	18	30	93.3
	15 unique PRI values randomly selected within the range of 518~3066 μsec with a minimum of 1 μsec, excluding PRI values selected in Test A				
2	1-5	150-230	23-29	30	90
3	6-10	200-500	16-18	30	93.3
4	11-20	200-500	12-16	30	80
Aggregate (Radar Types 1-4)				120	89.1

Table 2: Long Pulse Radar Test Waveform

Radar Type	Pulse Width (μsec)	Chirp Width (MHz)	PRI (μsec)	Number of Pulses per Burst	Number of Bursts	Number of Trials(Times)	Percentage of Successful Detection (%)
5	50-100	5-20	1000-2000	1-3	8-20	30	83.3

Table 3: Frequency Hopping Radar Test Waveform

Radar Type	Pulse Width (μsec)	PRI (μsec)	Pulses per Hop	Hopping Rate (kHz)	Hopping Sequence Length (msec)	Number of Trials(Times)	Percentage of Successful Detection (%)
6	1	333	9	0.333	300	30	93.3

802.11ax (HE80)
Table 1: Short Pulse Radar Test Waveforms

Radar Type	Pulse Width (μsec)	PRI (μsec)	Number of Pulses	Number of Trials(Times)	Percentage of Successful Detection (%)
1	Test A 15 unique PRI values randomly selected from the list of 23 PRI values	Roundup $\left\{ \left(\frac{1}{360} \right) \cdot \left(\frac{19 \cdot 10^6}{\text{PRI}_{\mu\text{sec}}} \right) \right\}$	18	30	86.6
	15 unique PRI values randomly selected within the range of 518~3066 μsec with a minimum of 1 μsec, excluding PRI values selected in Test A				
2	1-5	150-230	23-29	30	90
3	6-10	200-500	16-18	30	83.3
4	11-20	200-500	12-16	30	93.3
Aggregate (Radar Types 1-4)				120	88.3

Table 2: Long Pulse Radar Test Waveform

Radar Type	Pulse Width (μsec)	Chirp Width (MHz)	PRI (μsec)	Number of Pulses per Burst	Number of Bursts	Number of Trials(Times)	Percentage of Successful Detection (%)
5	50-100	5-20	1000-2000	1-3	8-20	30	90

Table 3: Frequency Hopping Radar Test Waveform

Radar Type	Pulse Width (μsec)	PRI (μsec)	Pulses per Hop	Hopping Rate (kHz)	Hopping Sequence Length (msec)	Number of Trials(Times)	Percentage of Successful Detection (%)
6	1	333	9	0.333	300	30	93.3

802.11ax (HE80)

Radar signal 0

Channel Closing Transmission Time & Channel Move Time

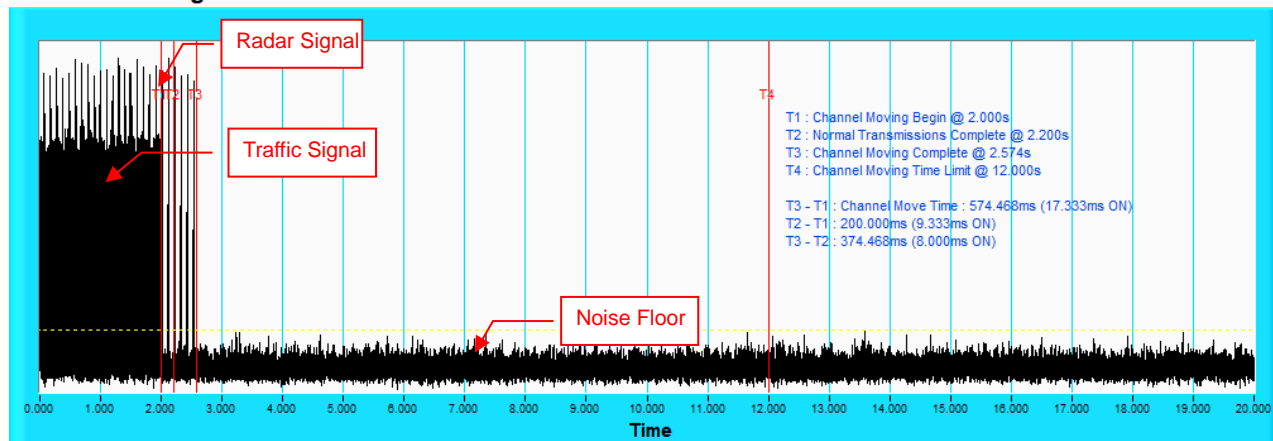

NOTE: T1 denotes the start of Channel Move Time upon the end of the last Radar burst. T2 denotes the data transmission time of 200ms from T1. T3 denotes the end of Channel Move Time. T4 denotes the 10 second from T1 to observe the aggregate duration of transmissions.

Channel Closing Transmission Time & Channel Move Time

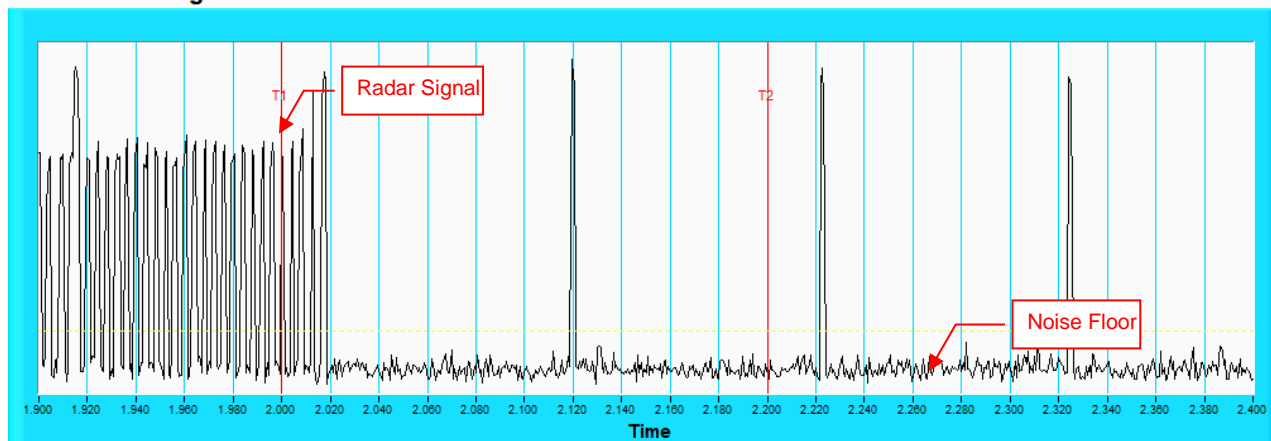

NOTE: Zoom in of the first 500ms after radar signal applied.

Radar signal 1 Channel Closing Transmission Time & Channel Move Time

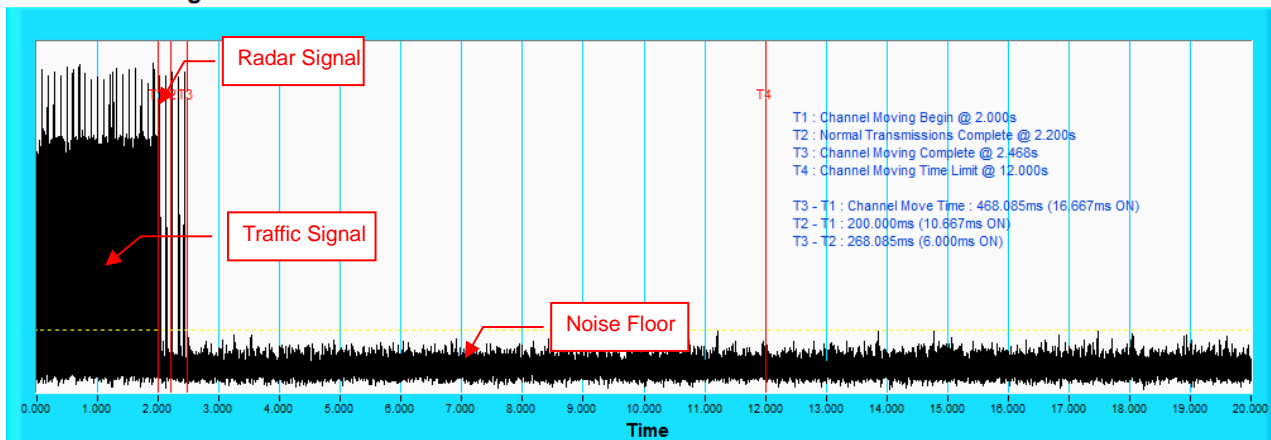

NOTE: T1 denotes the start of Channel Move Time upon the end of the last Radar burst. T2 denotes the data transmission time of 200ms from T1. T3 denotes the end of Channel Move Time. T4 denotes the 10 second from T1 to observe the aggregate duration of transmissions.

Channel Closing Transmission Time & Channel Move Time

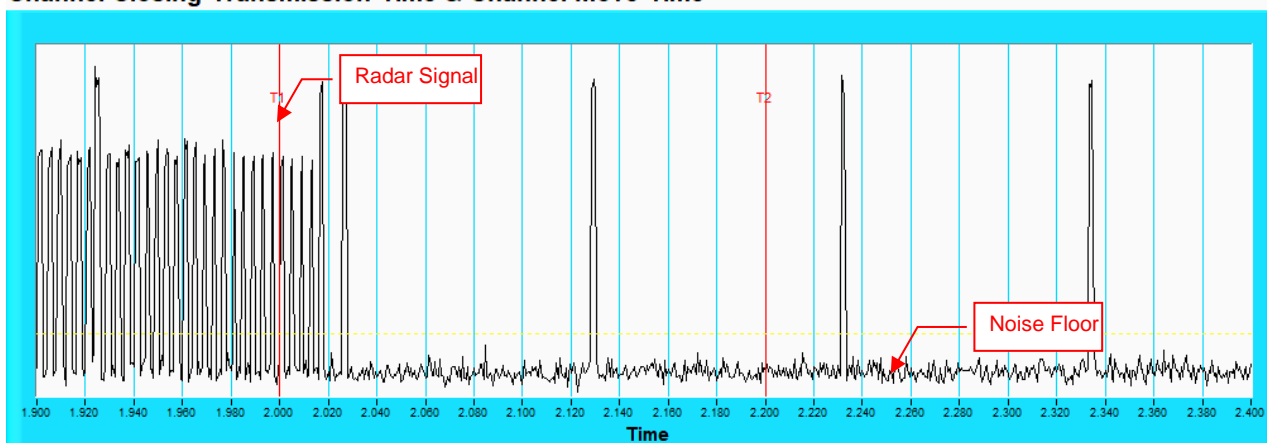

NOTE: Zoom in of the first 500ms after radar signal applied.

Radar signal 2 Channel Closing Transmission Time & Channel Move Time

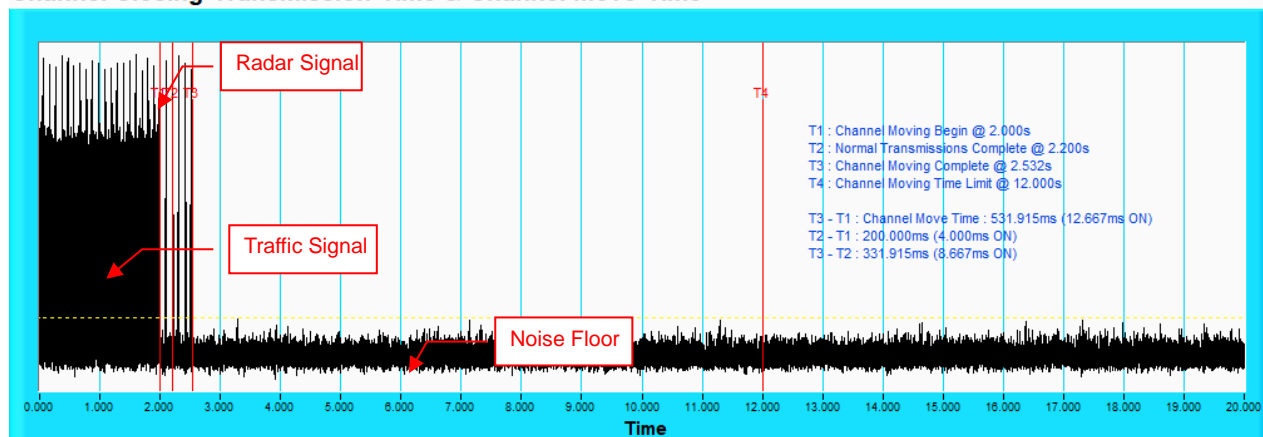

NOTE: T1 denotes the start of Channel Move Time upon the end of the last Radar burst. T2 denotes the data transmission time of 200ms from T1. T3 denotes the end of Channel Move Time. T4 denotes the 10 second from T1 to observe the aggregate duration of transmissions.

Channel Closing Transmission Time & Channel Move Time

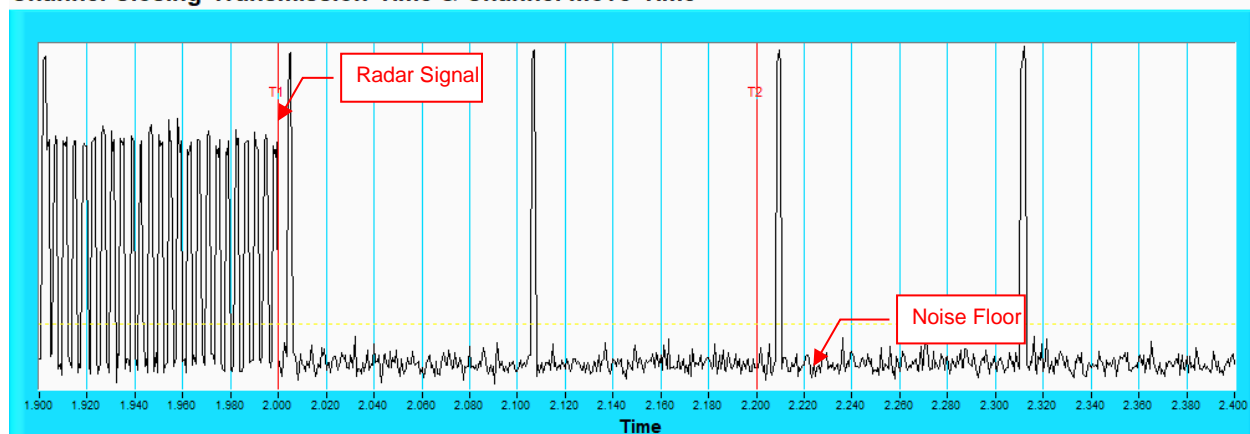

NOTE: Zoom in of the first 500ms after radar signal applied.

Radar signal 3 Channel Closing Transmission Time & Channel Move Time

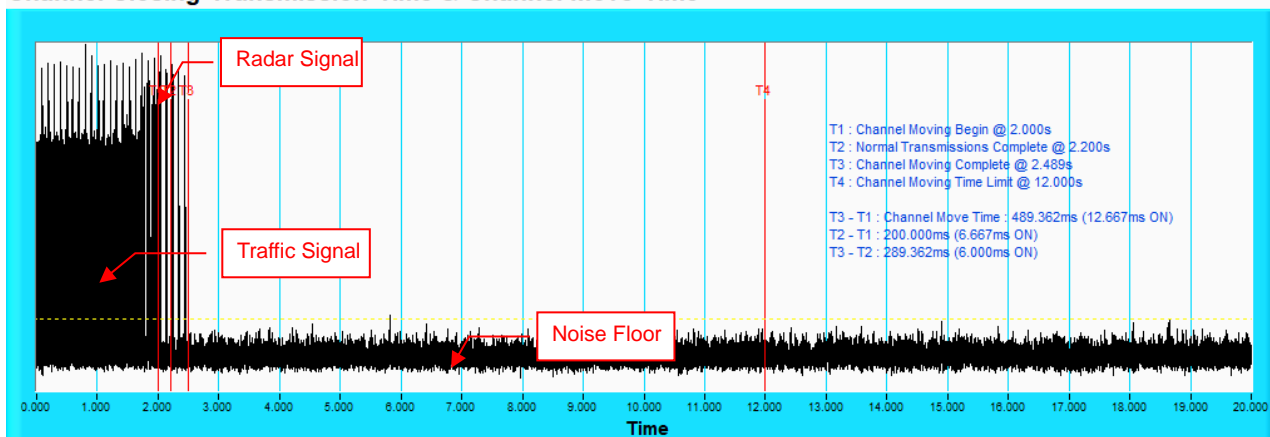

NOTE: T1 denotes the start of Channel Move Time upon the end of the last Radar burst. T2 denotes the data transmission time of 200ms from T1. T3 denotes the end of Channel Move Time. T4 denotes the 10 second from T1 to observe the aggregate duration of transmissions.

Channel Closing Transmission Time & Channel Move Time

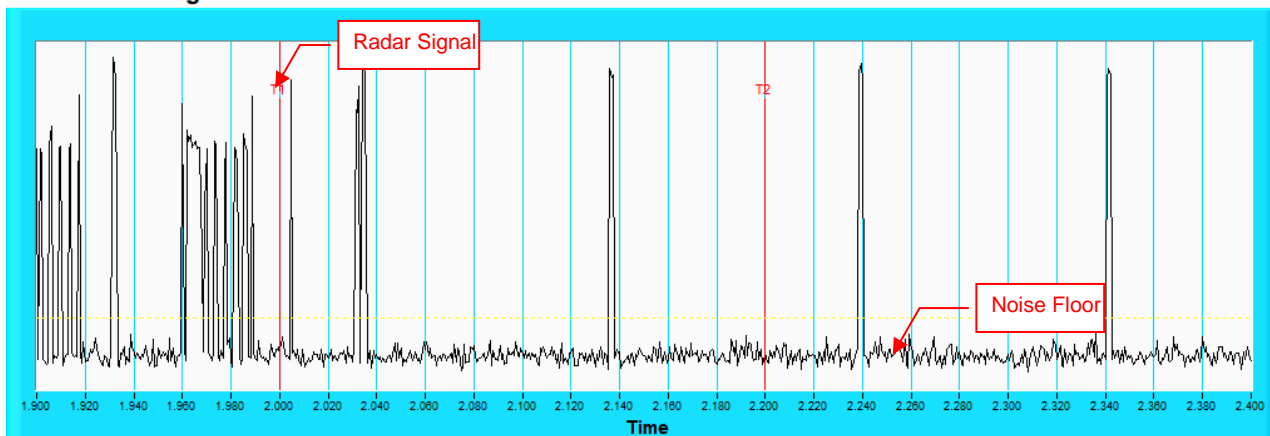

NOTE: Zoom in of the first 500ms after radar signal applied.

Radar signal 4 Channel Closing Transmission Time & Channel Move Time

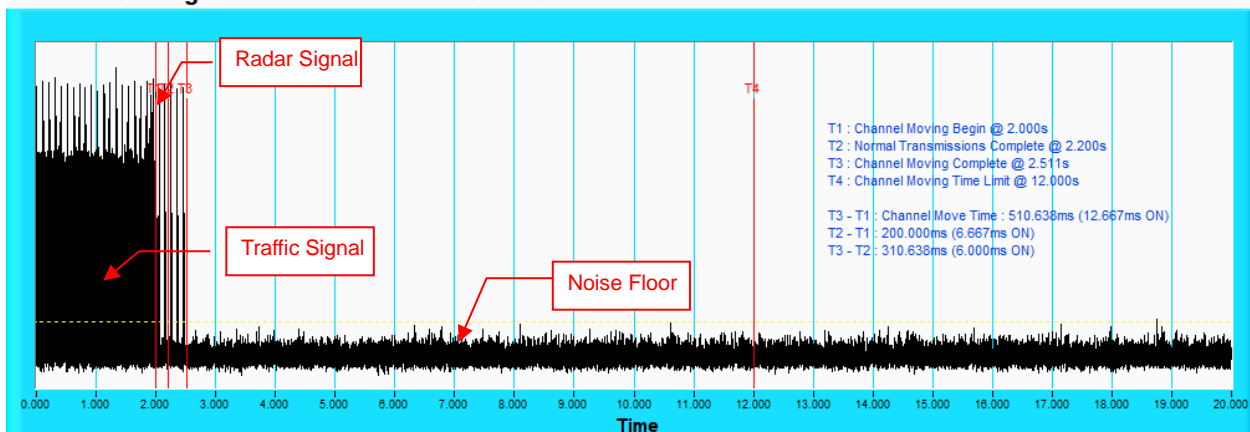

NOTE: T1 denotes the start of Channel Move Time upon the end of the last Radar burst. T2 denotes the data transmission time of 200ms from T1. T3 denotes the end of Channel Move Time. T4 denotes the 10 second from T1 to observe the aggregate duration of transmissions.

Channel Closing Transmission Time & Channel Move Time

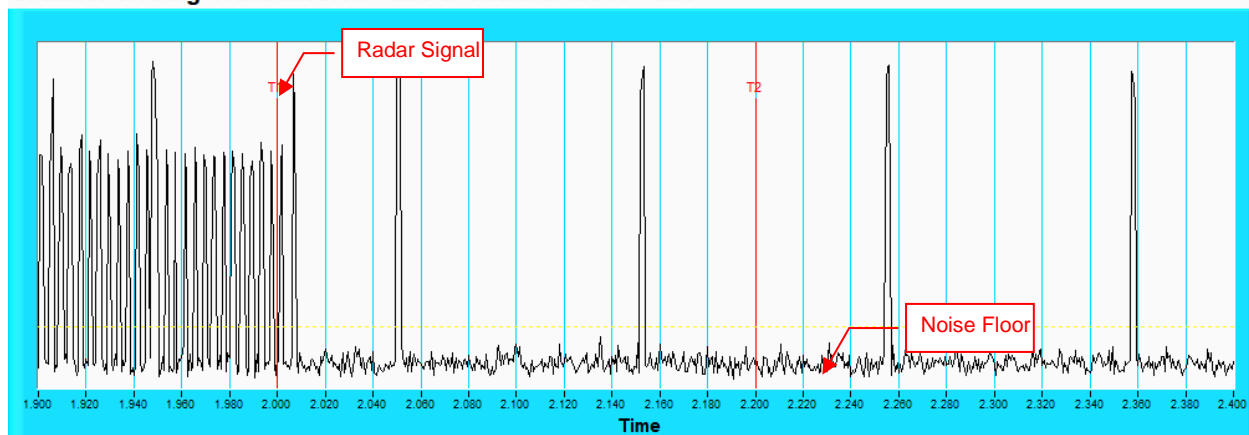

NOTE: Zoom in of the first 500ms after radar signal applied.



802.11ax (HE20)

Type 1 Radar Statistical Performances

Trial #	Test Frequency (MHz)	Pulse Repetition Frequency Number (1 to 23)	Pulse Repetition Frequency (pps)	Pulses per Burst	Pulse Repetition Interval (µsec)	Detection
1	5500	5	1672	89	598	Yes
2	5495	23	326.2	18	3066	Yes
3	5507	15	1253	67	798	Yes
4	5494	17	1193	63	838	Yes
5	5493	9	1475	78	678	Yes
6	5493	7	1567	83	638	Yes
7	5502	4	1730	92	578	Yes
8	5499	16	1223	65	818	Yes
9	5492	8	1520	81	658	No
10	5505	22	1066	57	938	Yes
11	5508	6	1618	86	618	Yes
12	5506	18	1166	62	858	Yes
13	5503	14	1285	68	778	No
14	5500	10	1433	76	698	No
15	5494	2	1859	99	538	Yes
16	5506	-	416.1	22	2403	Yes
17	5506	-	492.9	27	2029	Yes
18	5506	-	368.2	20	2716	Yes
19	5491	-	386.2	21	2589	Yes
20	5492	-	394.5	21	2535	Yes
21	5492	-	360.1	20	2777	Yes
22	5498	-	494.1	27	2024	Yes
23	5505	-	897.7	48	1114	Yes
24	5501	-	962.5	51	1039	Yes
25	5492	-	380.2	21	2630	Yes
26	5509	-	452.7	24	2209	Yes
27	5499	-	391.8	21	2552	Yes
28	5509	-	1083	58	923	Yes
29	5500	-	329.7	18	3033	Yes
30	5506	-	502	27	1992	Yes

Detection Rate : 90%

Note. " - " : 15 unique PRI values randomly selected within the range of 518-3066 µsec, with a minimum increment of 1µsec, excluding PRI values selected in Test A

802.11ax (HE20)

Type 2 Radar Statistical Performances					
Trial #	Test Frequency (MHz)	Pulses per Burst	Pulse Width(us)	PRI(us)	Detection
1	5500	24	2	224	No
2	5498	29	4.5	219	Yes
3	5493	26	3.2	167	Yes
4	5494	27	3.7	216	Yes
5	5499	23	1.1	179	Yes
6	5492	26	3.1	181	Yes
7	5499	27	3.7	188	Yes
8	5497	26	2.9	155	Yes
9	5494	29	4.8	214	Yes
10	5504	23	1.5	195	Yes
11	5503	29	4.9	201	Yes
12	5500	24	1.8	197	Yes
13	5498	23	1.5	158	Yes
14	5493	29	4.9	222	No
15	5509	28	4.2	185	Yes
16	5501	23	1	173	Yes
17	5500	29	4.8	190	Yes
18	5500	29	4.5	200	Yes
19	5494	25	2.3	165	Yes
20	5494	27	3.4	177	Yes
21	5499	23	1	183	Yes
22	5494	28	4	156	No
23	5506	23	1.1	213	Yes
24	5503	25	2.7	229	Yes
25	5492	23	1.2	206	No
26	5496	29	4.9	203	Yes
27	5504	26	3.3	163	Yes
28	5495	26	3.2	182	No
29	5491	24	1.7	166	No
30	5500	25	2.6	210	Yes
Detection Rate : 80%					

802.11ax (HE20)

Type 3 Radar Statistical Performances

Trial #	Test Frequency (MHz)	Pulses per Burst	Pulse Width(us)	PRI(us)	Detection
1	5500	16	7	239	Yes
2	5497	18	9.5	335	Yes
3	5507	17	8.2	411	Yes
4	5496	18	8.7	224	Yes
5	5506	16	6.1	428	Yes
6	5496	17	8.1	332	Yes
7	5499	17	8.7	491	Yes
8	5506	17	7.9	348	Yes
9	5502	18	9.8	206	Yes
10	5493	16	6.5	204	Yes
11	5494	18	9.9	438	Yes
12	5500	16	6.8	484	Yes
13	5505	16	6.5	344	Yes
14	5502	18	9.9	465	Yes
15	5493	18	9.2	444	Yes
16	5503	16	6	357	Yes
17	5503	18	9.8	423	Yes
18	5504	18	9.5	225	Yes
19	5504	16	7.3	217	No
20	5494	17	8.4	242	No
21	5492	16	6	483	Yes
22	5502	18	9	470	Yes
23	5497	16	6.1	308	Yes
24	5500	17	7.7	498	Yes
25	5506	16	6.2	477	Yes
26	5506	18	9.9	375	Yes
27	5495	17	8.3	285	Yes
28	5497	17	8.2	433	Yes
29	5496	16	6.7	490	Yes
30	5491	17	7.6	202	Yes
Detection Rate : 93.3%					

802.11ax (HE20)

Type 4 Radar Statistical Performances					
Trial #	Test Frequency (MHz)	Pulses per Burst	Pulse Width(us)	PRI(us)	Detection
1	5500	13	13.4	239	Yes
2	5506	16	18.8	335	No
3	5500	14	15.9	411	Yes
4	5504	15	17.1	224	Yes
5	5496	12	11.3	428	Yes
6	5504	14	15.8	332	Yes
7	5493	15	17	491	Yes
8	5494	14	15.3	348	Yes
9	5505	16	19.6	206	No
10	5501	12	12.1	204	Yes
11	5504	16	19.8	438	Yes
12	5492	13	12.8	484	Yes
13	5506	12	12.1	344	Yes
14	5505	16	19.6	465	No
15	5502	15	18.1	444	Yes
16	5495	12	11.1	357	Yes
17	5501	16	19.6	423	Yes
18	5502	16	18.9	225	Yes
19	5504	13	13.9	217	No
20	5501	15	16.5	242	Yes
21	5500	12	11	483	Yes
22	5495	15	17.6	470	Yes
23	5500	12	11.4	308	No
24	5509	14	14.7	498	Yes
25	5506	12	11.4	477	Yes
26	5501	16	19.7	375	Yes
27	5504	14	16.1	285	Yes
28	5507	14	16	433	Yes
29	5504	12	12.6	490	Yes
30	5505	14	14.7	202	Yes
Detection Rate : 83.3%					

802.11ax (HE20)

Type 5 Radar Statistical Performances				
Trial #	Minimum Chirp Width(MHz)	Chirp Center Frequency(MHz)	Test Signal Name	Detection
1	7	5500	LP_Signal_01	Yes
2	15	5500	LP_Signal_02	No
3	16	5500	LP_Signal_03	Yes
4	18	5500	LP_Signal_04	Yes
5	8	5500	LP_Signal_05	Yes
6	5	5500	LP_Signal_06	Yes
7	18	5500	LP_Signal_07	Yes
8	12	5500	LP_Signal_08	No
9	12	5500	LP_Signal_09	Yes
10	15	5500	LP_Signal_10	Yes
11	5	5492	LP_Signal_11	Yes
12	6	5492	LP_Signal_12	Yes
13	11	5494	LP_Signal_13	Yes
14	18	5497	LP_Signal_14	Yes
15	20	5498	LP_Signal_15	Yes
16	13	5495	LP_Signal_16	Yes
17	9	5494	LP_Signal_17	Yes
18	11	5494	LP_Signal_18	Yes
19	8	5493	LP_Signal_19	Yes
20	5	5492	LP_Signal_20	No
21	12	5505	LP_Signal_21	Yes
22	17	5503	LP_Signal_22	Yes
23	10	5506	LP_Signal_23	Yes
24	5	5508	LP_Signal_24	No
25	15	5504	LP_Signal_25	Yes
26	11	5506	LP_Signal_26	Yes
27	7	5507	LP_Signal_27	Yes
28	6	5508	LP_Signal_28	Yes
29	6	5508	LP_Signal_29	Yes
30	8	5507	LP_Signal_30	Yes
Detection Rate : 86.6%				

Note: The Long Pulse Radar pattern shown in Appendix A.1

802.11ax (HE20)

Type 6 Radar Statistical Performances					
Trial #	Pulses per Burst	Pulse Width(us)	PRF(us)	Hopping Frequency Sequence Name	Detection
1	9	1	333.3	HOP_FREQ_SEQ_01	Yes
2	9	1	333.3	HOP_FREQ_SEQ_02	Yes
3	9	1	333.3	HOP_FREQ_SEQ_03	Yes
4	9	1	333.3	HOP_FREQ_SEQ_04	Yes
5	9	1	333.3	HOP_FREQ_SEQ_05	Yes
6	9	1	333.3	HOP_FREQ_SEQ_06	Yes
7	9	1	333.3	HOP_FREQ_SEQ_07	Yes
8	9	1	333.3	HOP_FREQ_SEQ_08	Yes
9	9	1	333.3	HOP_FREQ_SEQ_09	Yes
10	9	1	333.3	HOP_FREQ_SEQ_10	No
11	9	1	333.3	HOP_FREQ_SEQ_11	Yes
12	9	1	333.3	HOP_FREQ_SEQ_12	Yes
13	9	1	333.3	HOP_FREQ_SEQ_13	Yes
14	9	1	333.3	HOP_FREQ_SEQ_14	Yes
15	9	1	333.3	HOP_FREQ_SEQ_15	Yes
16	9	1	333.3	HOP_FREQ_SEQ_16	Yes
17	9	1	333.3	HOP_FREQ_SEQ_17	Yes
18	9	1	333.3	HOP_FREQ_SEQ_18	Yes
19	9	1	333.3	HOP_FREQ_SEQ_19	Yes
20	9	1	333.3	HOP_FREQ_SEQ_20	Yes
21	9	1	333.3	HOP_FREQ_SEQ_21	Yes
22	9	1	333.3	HOP_FREQ_SEQ_22	Yes
23	9	1	333.3	HOP_FREQ_SEQ_23	Yes
24	9	1	333.3	HOP_FREQ_SEQ_24	Yes
25	9	1	333.3	HOP_FREQ_SEQ_25	Yes
26	9	1	333.3	HOP_FREQ_SEQ_26	No
27	9	1	333.3	HOP_FREQ_SEQ_27	No
28	9	1	333.3	HOP_FREQ_SEQ_28	Yes
29	9	1	333.3	HOP_FREQ_SEQ_29	Yes
30	9	1	333.3	HOP_FREQ_SEQ_30	Yes
Detection Rate : 90%					

Note: The Frequency Hopping Radar pattern shown in Appendix A.2



802.11ax (HE40)

Type 1 Radar Statistical Performances

Trial #	Test Frequency (MHz)	Pulse Repetition Frequency Number (1 to 23)	Pulse Repetition Frequency (pps)	Pulses per Burst	Pulse Repetition Interval (µsec)	Detection
1	5510	5	1672	89	598	Yes
2	5520	23	326.2	18	3066	Yes
3	5500	15	1253	67	798	Yes
4	5506	17	1193	63	838	Yes
5	5510	9	1475	78	678	Yes
6	5509	7	1567	83	638	No
7	5515	4	1730	92	578	Yes
8	5498	16	1223	65	818	Yes
9	5509	8	1520	81	658	Yes
10	5496	22	1066	57	938	Yes
11	5500	6	1618	86	618	Yes
12	5521	18	1166	62	858	Yes
13	5513	14	1285	68	778	Yes
14	5523	10	1433	76	698	Yes
15	5520	2	1859	99	538	Yes
16	5506	-	416.1	22	2403	Yes
17	5516	-	492.9	27	2029	Yes
18	5525	-	368.2	20	2716	Yes
19	5516	-	386.2	21	2589	Yes
20	5521	-	394.5	21	2535	Yes
21	5527	-	360.1	20	2777	Yes
22	5501	-	494.1	27	2024	Yes
23	5528	-	897.7	48	1114	Yes
24	5502	-	962.5	51	1039	Yes
25	5528	-	380.2	21	2630	Yes
26	5507	-	452.7	24	2209	Yes
27	5518	-	391.8	21	2552	Yes
28	5508	-	1083	58	923	Yes
29	5518	-	329.7	18	3033	Yes
30	5510	-	502	27	1992	No

Detection Rate : 93.3%

Note. " - " : 15 unique PRI values randomly selected within the range of 518-3066 µsec, with a minimum increment of 1µsec, excluding PRI values selected in Test A

802.11ax (HE40)

Type 2 Radar Statistical Performances					
Trial #	Test Frequency (MHz)	Pulses per Burst	Pulse Width(us)	PRI(us)	Detection
1	5510	24	2	224	No
2	5520	29	4.5	219	Yes
3	5500	26	3.2	167	Yes
4	5508	27	3.7	216	No
5	5527	23	1.1	179	Yes
6	5507	26	3.1	181	Yes
7	5527	27	3.7	188	Yes
8	5500	26	2.9	155	Yes
9	5502	29	4.8	214	Yes
10	5496	23	1.5	195	Yes
11	5497	29	4.9	201	Yes
12	5499	24	1.8	197	No
13	5525	23	1.5	158	Yes
14	5515	29	4.9	222	Yes
15	5493	28	4.2	185	Yes
16	5505	23	1	173	Yes
17	5497	29	4.8	190	Yes
18	5525	29	4.5	200	Yes
19	5522	25	2.3	165	Yes
20	5504	27	3.4	177	Yes
21	5526	23	1	183	Yes
22	5515	28	4	156	Yes
23	5499	23	1.1	213	Yes
24	5510	25	2.7	229	Yes
25	5501	23	1.2	206	Yes
26	5514	29	4.9	203	Yes
27	5512	26	3.3	163	Yes
28	5528	26	3.2	182	Yes
29	5528	24	1.7	166	Yes
30	5496	25	2.6	210	Yes
Detection Rate : 90%					

802.11ax (HE40)

Type 3 Radar Statistical Performances

Trial #	Test Frequency (MHz)	Pulses per Burst	Pulse Width(us)	PRI(us)	Detection
1	5510	16	7	239	Yes
2	5520	18	9.5	335	No
3	5500	17	8.2	411	Yes
4	5494	18	8.7	224	Yes
5	5510	16	6.1	428	No
6	5497	17	8.1	332	Yes
7	5507	17	8.7	491	Yes
8	5512	17	7.9	348	Yes
9	5513	18	9.8	206	Yes
10	5498	16	6.5	204	Yes
11	5501	18	9.9	438	Yes
12	5528	16	6.8	484	Yes
13	5525	16	6.5	344	Yes
14	5494	18	9.9	465	Yes
15	5502	18	9.2	444	Yes
16	5514	16	6	357	Yes
17	5506	18	9.8	423	Yes
18	5529	18	9.5	225	Yes
19	5495	16	7.3	217	Yes
20	5506	17	8.4	242	Yes
21	5516	16	6	483	Yes
22	5503	18	9	470	Yes
23	5497	16	6.1	308	Yes
24	5511	17	7.7	498	Yes
25	5502	16	6.2	477	Yes
26	5510	18	9.9	375	Yes
27	5510	17	8.3	285	Yes
28	5508	17	8.2	433	Yes
29	5519	16	6.7	490	Yes
30	5523	17	7.6	202	Yes
Detection Rate : 93.3%					

802.11ax (HE40)

Type 4 Radar Statistical Performances					
Trial #	Test Frequency (MHz)	Pulses per Burst	Pulse Width(us)	PRI(us)	Detection
1	5510	13	13.4	239	Yes
2	5520	16	18.8	335	Yes
3	5500	14	15.9	411	Yes
4	5511	15	17.1	224	No
5	5496	12	11.3	428	Yes
6	5525	14	15.8	332	Yes
7	5513	15	17	491	Yes
8	5496	14	15.3	348	Yes
9	5512	16	19.6	206	Yes
10	5523	12	12.1	204	Yes
11	5512	16	19.8	438	No
12	5524	13	12.8	484	Yes
13	5505	12	12.1	344	Yes
14	5518	16	19.6	465	Yes
15	5510	15	18.1	444	Yes
16	5516	12	11.1	357	No
17	5508	16	19.6	423	Yes
18	5519	16	18.9	225	Yes
19	5506	13	13.9	217	Yes
20	5506	15	16.5	242	Yes
21	5509	12	11	483	Yes
22	5510	15	17.6	470	Yes
23	5500	12	11.4	308	No
24	5494	14	14.7	498	Yes
25	5514	12	11.4	477	Yes
26	5521	16	19.7	375	Yes
27	5518	14	16.1	285	No
28	5497	14	16	433	Yes
29	5507	12	12.6	490	No
30	5507	14	14.7	202	Yes
Detection Rate : 80%					

802.11ax (HE40)

Type 5 Radar Statistical Performances				
Trial #	Minimum Chirp Width(MHz)	Chirp Center Frequency(MHz)	Test Signal Name	Detection
1	16	5510	LP_Signal_01	Yes
2	20	5510	LP_Signal_02	Yes
3	12	5510	LP_Signal_03	Yes
4	5	5510	LP_Signal_04	Yes
5	15	5510	LP_Signal_05	Yes
6	19	5510	LP_Signal_06	No
7	10	5510	LP_Signal_07	Yes
8	20	5510	LP_Signal_08	Yes
9	14	5510	LP_Signal_09	Yes
10	5	5510	LP_Signal_10	Yes
11	17	5498	LP_Signal_11	No
12	18	5498	LP_Signal_12	Yes
13	6	5493	LP_Signal_13	Yes
14	11	5495	LP_Signal_14	Yes
15	15	5497	LP_Signal_15	Yes
16	7	5494	LP_Signal_16	Yes
17	16	5497	LP_Signal_17	Yes
18	5	5493	LP_Signal_18	Yes
19	8	5494	LP_Signal_19	Yes
20	12	5496	LP_Signal_20	Yes
21	14	5523	LP_Signal_21	Yes
22	5	5527	LP_Signal_22	Yes
23	13	5524	LP_Signal_23	No
24	10	5525	LP_Signal_24	Yes
25	17	5522	LP_Signal_25	No
26	5	5527	LP_Signal_26	No
27	20	5521	LP_Signal_27	Yes
28	16	5523	LP_Signal_28	Yes
29	10	5525	LP_Signal_29	Yes
30	20	5521	LP_Signal_30	Yes
Detection Rate : 83.3%				

Note: The Long Pulse Radar pattern shown in Appendix A.1

802.11ax (HE40)

Type 6 Radar Statistical Performances					
Trial #	Pulses per Burst	Pulse Width(us)	PRI(us)	Hopping Frequency Sequence Name	Detection
1	9	1	333.3	HOP_FREQ_SEQ_01	Yes
2	9	1	333.3	HOP_FREQ_SEQ_02	Yes
3	9	1	333.3	HOP_FREQ_SEQ_03	Yes
4	9	1	333.3	HOP_FREQ_SEQ_04	Yes
5	9	1	333.3	HOP_FREQ_SEQ_05	No
6	9	1	333.3	HOP_FREQ_SEQ_06	Yes
7	9	1	333.3	HOP_FREQ_SEQ_07	Yes
8	9	1	333.3	HOP_FREQ_SEQ_08	Yes
9	9	1	333.3	HOP_FREQ_SEQ_09	Yes
10	9	1	333.3	HOP_FREQ_SEQ_10	Yes
11	9	1	333.3	HOP_FREQ_SEQ_11	Yes
12	9	1	333.3	HOP_FREQ_SEQ_12	Yes
13	9	1	333.3	HOP_FREQ_SEQ_13	Yes
14	9	1	333.3	HOP_FREQ_SEQ_14	Yes
15	9	1	333.3	HOP_FREQ_SEQ_15	Yes
16	9	1	333.3	HOP_FREQ_SEQ_16	Yes
17	9	1	333.3	HOP_FREQ_SEQ_17	Yes
18	9	1	333.3	HOP_FREQ_SEQ_18	Yes
19	9	1	333.3	HOP_FREQ_SEQ_19	Yes
20	9	1	333.3	HOP_FREQ_SEQ_20	Yes
21	9	1	333.3	HOP_FREQ_SEQ_21	Yes
22	9	1	333.3	HOP_FREQ_SEQ_22	Yes
23	9	1	333.3	HOP_FREQ_SEQ_23	Yes
24	9	1	333.3	HOP_FREQ_SEQ_24	No
25	9	1	333.3	HOP_FREQ_SEQ_25	Yes
26	9	1	333.3	HOP_FREQ_SEQ_26	Yes
27	9	1	333.3	HOP_FREQ_SEQ_27	Yes
28	9	1	333.3	HOP_FREQ_SEQ_28	Yes
29	9	1	333.3	HOP_FREQ_SEQ_29	Yes
30	9	1	333.3	HOP_FREQ_SEQ_30	Yes

Detection Rate : 93.3%

Note: The Frequency Hopping Radar pattern shown in Appendix A.2



802.11ax (HE80)

Type 1 Radar Statistical Performances

Trial #	Test Frequency (MHz)	Pulse Repetition Frequency Number (1 to 23)	Pulse Repetition Frequency (pps)	Pulses per Burst	Pulse Repetition Interval (µsec)	Detection
1	5530	5	1672	89	598	No
2	5540	23	326.2	18	3066	Yes
3	5560	15	1253	67	798	Yes
4	5520	17	1193	63	838	Yes
5	5500	9	1475	78	678	Yes
6	5547	7	1567	83	638	Yes
7	5504	4	1730	92	578	No
8	5508	16	1223	65	818	Yes
9	5502	8	1520	81	658	Yes
10	5507	22	1066	57	938	Yes
11	5564	6	1618	86	618	Yes
12	5544	18	1166	62	858	Yes
13	5492	14	1285	68	778	Yes
14	5531	10	1433	76	698	Yes
15	5541	2	1859	99	538	Yes
16	5494	-	416.1	22	2403	Yes
17	5547	-	492.9	27	2029	No
18	5548	-	368.2	20	2716	Yes
19	5527	-	386.2	21	2589	Yes
20	5536	-	394.5	21	2535	Yes
21	5548	-	360.1	20	2777	Yes
22	5558	-	494.1	27	2024	Yes
23	5548	-	897.7	48	1114	Yes
24	5551	-	962.5	51	1039	Yes
25	5515	-	380.2	21	2630	Yes
26	5525	-	452.7	24	2209	Yes
27	5517	-	391.8	21	2552	Yes
28	5529	-	1083	58	923	No
29	5550	-	329.7	18	3033	Yes
30	5503	-	502	27	1992	Yes

Detection Rate : 86.6%

Note. “ - “ : 15 unique PRI values randomly selected within the range of 518-3066 µsec, with a minimum increment of 1µsec, excluding PRI values selected in Test A

802.11ax (HE80)

Type 2 Radar Statistical Performances					
Trial #	Test Frequency (MHz)	Pulses per Burst	Pulse Width(us)	PRI(us)	Detection
1	5530	24	2	224	Yes
2	5540	29	4.5	219	Yes
3	5560	26	3.2	167	Yes
4	5520	27	3.7	216	Yes
5	5500	23	1.1	179	Yes
6	5498	26	3.1	181	No
7	5557	27	3.7	188	Yes
8	5532	26	2.9	155	Yes
9	5568	29	4.8	214	No
10	5514	23	1.5	195	Yes
11	5548	29	4.9	201	Yes
12	5495	24	1.8	197	Yes
13	5527	23	1.5	158	Yes
14	5492	29	4.9	222	Yes
15	5549	28	4.2	185	Yes
16	5500	23	1	173	Yes
17	5527	29	4.8	190	Yes
18	5525	29	4.5	200	Yes
19	5525	25	2.3	165	Yes
20	5567	27	3.4	177	No
21	5533	23	1	183	Yes
22	5563	28	4	156	Yes
23	5524	23	1.1	213	Yes
24	5560	25	2.7	229	Yes
25	5533	23	1.2	206	Yes
26	5500	29	4.9	203	Yes
27	5528	26	3.3	163	Yes
28	5537	26	3.2	182	Yes
29	5541	24	1.7	166	Yes
30	5528	25	2.6	210	Yes
Detection Rate : 90%					

802.11ax (HE80)

Type 3 Radar Statistical Performances

Trial #	Test Frequency (MHz)	Pulses per Burst	Pulse Width(us)	PRI(us)	Detection
1	5530	16	7	239	Yes
2	5540	18	9.5	335	Yes
3	5560	17	8.2	411	Yes
4	5520	18	8.7	224	Yes
5	5500	16	6.1	428	Yes
6	5497	17	8.1	332	Yes
7	5549	17	8.7	491	No
8	5511	17	7.9	348	Yes
9	5496	18	9.8	206	Yes
10	5523	16	6.5	204	Yes
11	5538	18	9.9	438	No
12	5522	16	6.8	484	Yes
13	5535	16	6.5	344	Yes
14	5494	18	9.9	465	Yes
15	5551	18	9.2	444	Yes
16	5559	16	6	357	Yes
17	5541	18	9.8	423	Yes
18	5545	18	9.5	225	Yes
19	5511	16	7.3	217	Yes
20	5520	17	8.4	242	No
21	5515	16	6	483	Yes
22	5554	18	9	470	Yes
23	5534	16	6.1	308	No
24	5526	17	7.7	498	No
25	5515	16	6.2	477	Yes
26	5568	18	9.9	375	Yes
27	5498	17	8.3	285	Yes
28	5556	17	8.2	433	Yes
29	5546	16	6.7	490	Yes
30	5542	17	7.6	202	Yes
Detection Rate : 83.3%					

802.11ax (HE80)

Type 4 Radar Statistical Performances					
Trial #	Test Frequency (MHz)	Pulses per Burst	Pulse Width(us)	PRI(us)	Detection
1	5530	13	13.4	239	Yes
2	5540	16	18.8	335	Yes
3	5560	14	15.9	411	Yes
4	5520	15	17.1	224	No
5	5500	12	11.3	428	Yes
6	5527	14	15.8	332	Yes
7	5533	15	17	491	Yes
8	5520	14	15.3	348	Yes
9	5555	16	19.6	206	Yes
10	5514	12	12.1	204	Yes
11	5541	16	19.8	438	No
12	5530	13	12.8	484	Yes
13	5522	12	12.1	344	Yes
14	5502	16	19.6	465	Yes
15	5501	15	18.1	444	Yes
16	5567	12	11.1	357	Yes
17	5544	16	19.6	423	Yes
18	5541	16	18.9	225	Yes
19	5516	13	13.9	217	Yes
20	5541	15	16.5	242	Yes
21	5549	12	11	483	Yes
22	5540	15	17.6	470	Yes
23	5539	12	11.4	308	Yes
24	5515	14	14.7	498	Yes
25	5533	12	11.4	477	Yes
26	5516	16	19.7	375	Yes
27	5552	14	16.1	285	Yes
28	5541	14	16	433	Yes
29	5525	12	12.6	490	Yes
30	5509	14	14.7	202	Yes
Detection Rate : 93.3%					

802.11ax (HE80)

Type 5 Radar Statistical Performances				
Trial #	Minimum Chirp Width(MHz)	Chirp Center Frequency(MHz)	Test Signal Name	Detection
1	8	5530	LP_Signal_01	Yes
2	9	5530	LP_Signal_02	Yes
3	7	5530	LP_Signal_03	Yes
4	9	5530	LP_Signal_04	Yes
5	7	5530	LP_Signal_05	Yes
6	17	5530	LP_Signal_06	Yes
7	17	5530	LP_Signal_07	No
8	12	5530	LP_Signal_08	Yes
9	16	5530	LP_Signal_09	Yes
10	11	5530	LP_Signal_10	Yes
11	12	5496	LP_Signal_11	Yes
12	15	5497	LP_Signal_12	Yes
13	17	5498	LP_Signal_13	Yes
14	19	5499	LP_Signal_14	Yes
15	11	5495	LP_Signal_15	Yes
16	17	5498	LP_Signal_16	No
17	6	5493	LP_Signal_17	Yes
18	15	5497	LP_Signal_18	Yes
19	9	5495	LP_Signal_19	No
20	18	5498	LP_Signal_20	Yes
21	16	5563	LP_Signal_21	Yes
22	8	5566	LP_Signal_22	Yes
23	16	5563	LP_Signal_23	Yes
24	16	5563	LP_Signal_24	Yes
25	18	5562	LP_Signal_25	Yes
26	15	5563	LP_Signal_26	Yes
27	18	5562	LP_Signal_27	Yes
28	10	5565	LP_Signal_28	Yes
29	14	5563	LP_Signal_29	Yes
30	17	5562	LP_Signal_30	Yes
				Detection Rate : 90%

Note: The Long Pulse Radar pattern shown in Appendix A.1

802.11ax (HE80)

Type 6 Radar Statistical Performances					
Trial #	Pulses per Burst	Pulse Width(us)	PRI(us)	Hopping Frequency Sequence Name	Detection
1	9	1	333.3	HOP_FREQ_SEQ_01	Yes
2	9	1	333.3	HOP_FREQ_SEQ_02	Yes
3	9	1	333.3	HOP_FREQ_SEQ_03	Yes
4	9	1	333.3	HOP_FREQ_SEQ_04	Yes
5	9	1	333.3	HOP_FREQ_SEQ_05	Yes
6	9	1	333.3	HOP_FREQ_SEQ_06	Yes
7	9	1	333.3	HOP_FREQ_SEQ_07	Yes
8	9	1	333.3	HOP_FREQ_SEQ_08	No
9	9	1	333.3	HOP_FREQ_SEQ_09	Yes
10	9	1	333.3	HOP_FREQ_SEQ_10	Yes
11	9	1	333.3	HOP_FREQ_SEQ_11	Yes
12	9	1	333.3	HOP_FREQ_SEQ_12	Yes
13	9	1	333.3	HOP_FREQ_SEQ_13	Yes
14	9	1	333.3	HOP_FREQ_SEQ_14	Yes
15	9	1	333.3	HOP_FREQ_SEQ_15	Yes
16	9	1	333.3	HOP_FREQ_SEQ_16	Yes
17	9	1	333.3	HOP_FREQ_SEQ_17	Yes
18	9	1	333.3	HOP_FREQ_SEQ_18	Yes
19	9	1	333.3	HOP_FREQ_SEQ_19	Yes
20	9	1	333.3	HOP_FREQ_SEQ_20	Yes
21	9	1	333.3	HOP_FREQ_SEQ_21	Yes
22	9	1	333.3	HOP_FREQ_SEQ_22	Yes
23	9	1	333.3	HOP_FREQ_SEQ_23	Yes
24	9	1	333.3	HOP_FREQ_SEQ_24	Yes
25	9	1	333.3	HOP_FREQ_SEQ_25	Yes
26	9	1	333.3	HOP_FREQ_SEQ_26	Yes
27	9	1	333.3	HOP_FREQ_SEQ_27	Yes
28	9	1	333.3	HOP_FREQ_SEQ_28	Yes
29	9	1	333.3	HOP_FREQ_SEQ_29	Yes
30	9	1	333.3	HOP_FREQ_SEQ_30	No
Detection Rate : 93.3%					

Note: The Frequency Hopping Radar pattern shown in Appendix A.2

6.2.5 Non- Occupancy Period

1) Test results demonstrating an associated client link is established with the master on a test frequency.

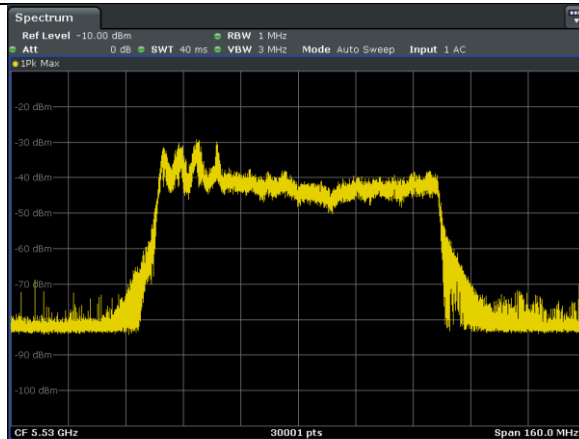

EUT (master) links with Client on 5530MHz

2) The master and DFS-certified client device are associated, and system testing will be performed with channel-loading for a non-occupancy period test.

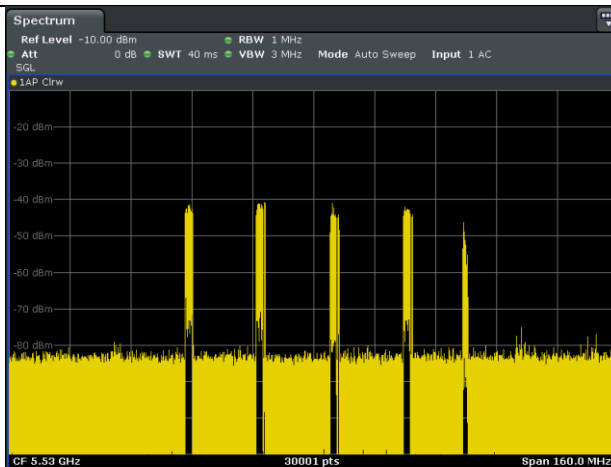

Client performed with channel-loading via master.

3). The device transmits one type of radar as specified in the DFS Order.

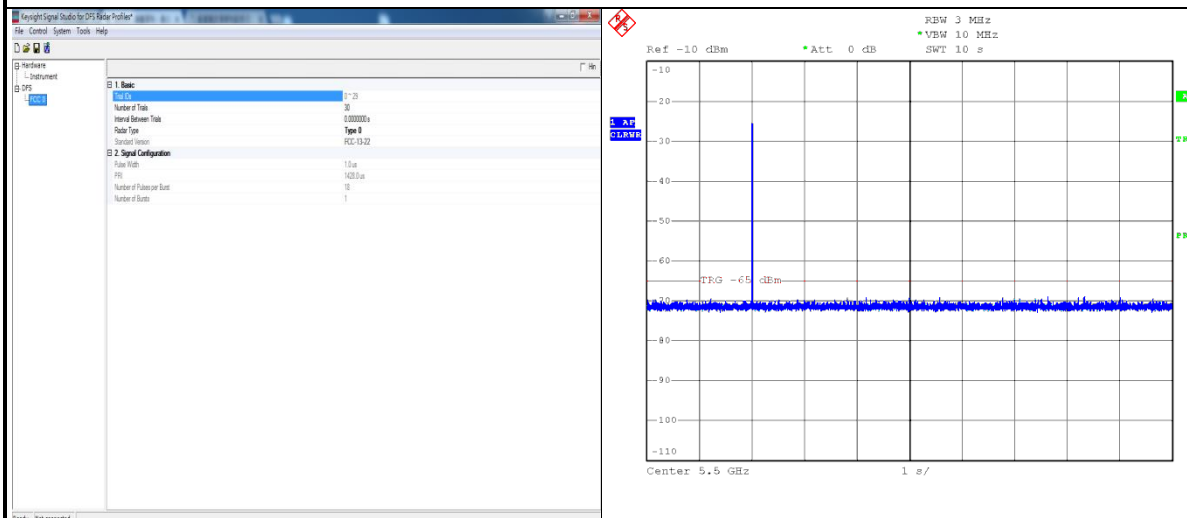

Radar 0 is used to test during DFS testing.

4) The test frequency has been monitored to ensure no transmission of any type has occurred for 30 minutes;

Note: If the client moves with the master, the device is considered compliant if nothing appears in the client non-occupancy period test. For devices that shut down (rather than moving channels), no beacons should appear;

5) An analyzer plot that contains a single 30-minute sweep on the original test frequency.

Non - Occupancy Period

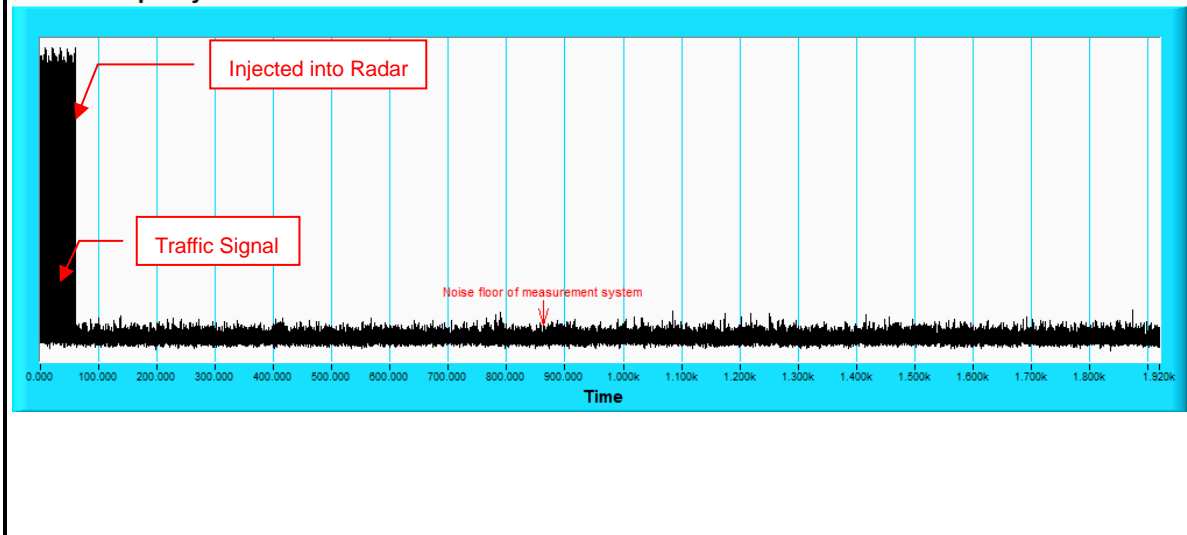

7. Information of the Testing Laboratories

We, Bureau Veritas Consumer Products Services (H.K.) Ltd., Taoyuan Branch, were founded in 1988 to provide our best service in EMC, Radio, Telecom and Safety consultation. Our laboratories are accredited and approved according to ISO/IEC 17025.

If you have any comments, please feel free to contact us at the following:

Lin Kou EMC/RF Lab:

Tel: 886-2-26052180

Fax: 886-2-26051924

Hsin Chu EMC/RF/Telecom Lab:

Tel: 886-3-6668565

Fax: 886-3-6668323

Hwa Ya EMC/RF/Safety Lab:

Tel: 886-3-3183232

Fax: 886-3-3270892

Email: service.adt@tw.bureauveritas.com

Web Site: www.bureauveritas-adt.com

The address and road map of all our labs can be found in our web site also.

8. APPENDIX-A

RADAR TEST SIGNAL

A.1 The Long Pulse Radar Pattern

BW20

Long Pulse Radar Test Signal

Test Signal Name: LP_Signal_01

Number of Bursts in Trial: 10

Burst	Pulses per Burst	Chrip (MHz)	Pulse Width(us)	PRI-1 (us)	PRI-2 (us)	PRI-3 (us)
1	1	7	58.7	1765	-	-
2	3	7	84.3	1452	1398	1571
3	3	7	87.4	1358	1377	1111
4	3	7	91.4	1554	1036	1662
5	1	7	61.8	1828	-	-
6	1	7	51.8	1621	-	-
7	3	7	93.4	1063	1317	1923
8	2	7	73.8	1804	1156	-
9	2	7	72.6	1935	1079	-
10	2	7	82.5	1049	1478	-
11	-	-	-	-	-	-
12	-	-	-	-	-	-
13	-	-	-	-	-	-
14	-	-	-	-	-	-
15	-	-	-	-	-	-
16	-	-	-	-	-	-
17	-	-	-	-	-	-
18	-	-	-	-	-	-
19	-	-	-	-	-	-
20	-	-	-	-	-	-

Long Pulse Radar Test Signal

Test Signal Name: LP_Signal_02

Number of Bursts in Trial: 16

Burst	Pulses per Burst	Chrip (MHz)	Pulse Width(us)	PRI-1 (us)	PRI-2 (us)	PRI-3 (us)
1	1	15	51.3	1713	-	-
2	1	15	54	1485	-	-
3	2	15	69.1	1043	1750	-
4	3	15	93.8	1665	1844	1155
5	3	15	99.1	1505	1825	1538
6	2	15	76	1866	1508	-
7	1	15	63.5	1889	-	-
8	2	15	69.8	1024	1578	-
9	1	15	60.9	1067	-	-
10	1	15	52.9	1162	-	-
11	2	15	73.7	1211	1581	-
12	3	15	87.8	1516	1753	1473
13	2	15	68.6	1029	1730	-
14	1	15	50.9	1930	-	-
15	2	15	83	1675	1303	-
16	2	15	69.5	1296	1410	-
17						
18						
19						
20						



Long Pulse Radar Test Signal

Test Signal Name: LP_Signal_03

Number of Bursts in Trial: 17

Burst	Pulses per Burst	Chrip (MHz)	Pulse Width(us)	PRI-1 (us)	PRI-2 (us)	PRI-3 (us)
1	1	16	56.4	1603	-	-
2	1	16	53.9	1545	-	-
3	1	16	53.5	1943	-	-
4	1	16	59.4	1206	-	-
5	2	16	78.5	1305	1969	-
6	3	16	86.1	1355	1823	1948
7	2	16	67	1788	1958	-
8	2	16	74.5	1213	1124	-
9	2	16	81.3	1215	1366	-
10	2	16	81.5	1429	1293	-
11	2	16	79.9	1345	1990	-
12	1	16	50.5	1996	-	-
13	3	16	88.4	1871	1121	1723
14	1	16	65.7	1964	-	-
15	3	16	93	1962	1265	1267
16	1	16	63.6	1020	-	-
17	2	16	78.1	1737	1422	-
18						
19						
20						

Long Pulse Radar Test Signal

Test Signal Name: LP_Signal_04

Number of Bursts in Trial: 18

Burst	Pulses per Burst	Chrip (MHz)	Pulse Width(us)	PRI-1 (us)	PRI-2 (us)	PRI-3 (us)
1	2	18	76.8	1105	1462	-
2	2	18	72.6	1668	1188	-
3	2	18	70.4	1321	1820	-
4	1	18	57	1683	-	-
5	3	18	88.6	1721	1611	1967
6	1	18	55	1594	-	-
7	3	18	93.3	1624	1678	1625
8	3	18	86.7	1720	1540	1349
9	3	18	86.7	1816	1617	1754
10	1	18	57.7	1382	-	-
11	2	18	78.1	1561	1416	-
12	1	18	59.9	1734	-	-
13	2	18	71	1677	1220	-
14	1	18	65.7	1497	-	-
15	3	18	86.4	1957	1088	1054
16	1	18	58.3	1104	-	-
17	3	18	92.3	1589	1800	1189
18	3	18	95.4	1147	1801	1748
19						
20						



Long Pulse Radar Test Signal

Test Signal Name: LP_Signal_05

Number of Bursts in Trial: 11

Burst	Pulses per Burst	Chrip (MHz)	Pulse Width(us)	PRI-1 (us)	PRI-2 (us)	PRI-3 (us)
1	3	8	89.4	1574	1736	1023
2	2	8	70.2	1655	1500	-
3	1	8	63.2	1445	-	-
4	1	8	53.9	1098	-	-
5	1	8	65.2	1918	-	-
6	3	8	87.1	1453	1658	1236
7	3	8	94.6	1896	1154	1456
8	1	8	62.4	1646	-	-
9	2	8	67.6	1600	1439	-
10	3	8	96.2	1629	1909	1879
11	1	8	62.9	1793	-	-
12						
13						
14						
15						
16						
17						
18						
19						
20						



Long Pulse Radar Test Signal

Test Signal Name: LP_Signal_06

Number of Bursts in Trial: 8

Burst	Pulses per Burst	Chrip (MHz)	Pulse Width(us)	PRI-1 (us)	PRI-2 (us)	PRI-3 (us)
1	2	5	81.4	1413	1565	-
2	3	5	95.3	1774	1131	1995
3	1	5	60	1160	-	-
4	1	5	60.1	1922	-	-
5	1	5	59.6	1069	-	-
6	3	5	91.8	1259	1810	1477
7	2	5	78.4	1763	1487	-
8	1	5	62.6	1122	-	-
9						
10						
11						
12						
13						
14						
15						
16						
17						
18						
19						
20						



Long Pulse Radar Test Signal

Test Signal Name: LP_Signal_07

Number of Bursts in Trial: 19

Burst	Pulses per Burst	Chrip (MHz)	Pulse Width(us)	PRI-1 (us)	PRI-2 (us)	PRI-3 (us)
1	1	18	62.4	1000	-	-
2	2	18	67.9	1925	1039	-
3	3	18	99	1890	1228	1326
4	1	18	60.3	1210	-	-
5	2	18	72.7	1688	1548	-
6	3	18	91.9	1988	1503	1201
7	2	18	78.3	1309	1198	-
8	3	18	88.9	1080	1399	1115
9	1	18	64.5	1087	-	-
10	1	18	60.3	1133	-	-
11	1	18	65.8	1579	-	-
12	3	18	93.5	1619	1682	1758
13	3	18	92.2	1533	1842	1979
14	3	18	96.2	1672	1744	1971
15	2	18	70.3	1414	1692	-
16	1	18	53.5	1706	-	-
17	3	18	93.4	1870	1242	1395
18	1	18	64.9	1438	-	-
19	2	18	72.9	1239	1817	-
20						

Long Pulse Radar Test Signal

Test Signal Name: LP_Signal_08

Number of Bursts in Trial: 14

Burst	Pulses per Burst	Chrip (MHz)	Pulse Width(us)	PRI-1 (us)	PRI-2 (us)	PRI-3 (us)
1	1	12	57.3	1698	-	-
2	2	12	83.3	1700	1427	-
3	1	12	62.5	1952	-	-
4	2	12	76.1	1612	1397	-
5	3	12	87.5	1139	1901	1400
6	3	12	97.1	1352	1798	1636
7	2	12	73.8	1496	1536	-
8	1	12	55.2	1357	-	-
9	1	12	62.5	1811	-	-
10	2	12	68.1	1251	1843	-
11	3	12	99.9	1819	1057	1017
12	1	12	61.3	1342	-	-
13	2	12	73.9	1725	1872	-
14	1	12	58	1747	-	-
15						
16						
17						
18						
19						
20						

Long Pulse Radar Test Signal

Test Signal Name: LP_Signal_09

Number of Bursts in Trial: 13

Burst	Pulses per Burst	Chrip (MHz)	Pulse Width(us)	PRI-1 (us)	PRI-2 (us)	PRI-3 (us)
1	3	12	95.8	1465	1975	1904
2	2	12	79.9	1764	1174	-
3	2	12	77.4	1235	1584	-
4	3	12	90.4	1114	1974	1027
5	1	12	59.9	1126	-	-
6	3	12	90.5	1275	1985	1845
7	1	12	62	1062	-	-
8	3	12	87	1463	1587	1887
9	3	12	98.3	1586	1187	1651
10	2	12	80.1	1277	1881	-
11	1	12	52.1	1330	-	-
12	1	12	51.7	1333	-	-
13	1	12	52.7	1867	-	-
14						
15						
16						
17						
18						
19						
20						

Long Pulse Radar Test Signal

Test Signal Name: LP_Signal_10

Number of Bursts in Trial: 16

Burst	Pulses per Burst	Chrip (MHz)	Pulse Width(us)	PRI-1 (us)	PRI-2 (us)	PRI-3 (us)
1	2	15	70.7	1934	1731	-
2	3	15	85.3	1179	1751	1711
3	2	15	75	1034	1261	-
4	1	15	56.4	1954	-	-
5	2	15	66.7	1243	1090	-
6	3	15	94.8	1224	1970	1214
7	2	15	68.8	1701	1280	-
8	2	15	71	1563	1537	-
9	2	15	79.4	1525	1389	-
10	3	15	100	1717	1498	1740
11	3	15	91.9	1295	1037	1829
12	1	15	61.5	1949	-	-
13	1	15	63.2	1596	-	-
14	3	15	99	1254	1919	1073
15	3	15	86.6	1606	1849	1202
16	1	15	65.8	1635	-	-
17						
18						
19						
20						



Long Pulse Radar Test Signal

Test Signal Name: LP_Signal_11

Number of Bursts in Trial: 8

Burst	Pulses per Burst	Chrip (MHz)	Pulse Width(us)	PRI-1 (us)	PRI-2 (us)	PRI-3 (us)
1	2	5	70.7	1897	1749	-
2	1	5	64.6	1965	-	-
3	3	5	99	1012	1045	1772
4	3	5	91.9	1583	1466	1549
5	3	5	85.5	1420	1780	1459
6	3	5	96.5	1530	1924	1835
7	1	5	66.2	1550	-	-
8	3	5	92.9	1929	1335	1883
9						
10						
11						
12						
13						
14						
15						
16						
17						
18						
19						
20						



Long Pulse Radar Test Signal

Test Signal Name: LP_Signal_12

Number of Bursts in Trial: 9

Burst	Pulses per Burst	Chrip (MHz)	Pulse Width(us)	PRI-1 (us)	PRI-2 (us)	PRI-3 (us)
1	1	6	63.1	1642	-	-
2	3	6	83.5	1005	1981	1250
3	2	6	74.5	1914	1474	-
4	1	6	60.9	1430	-	-
5	2	6	70.4	1680	1542	-
6	3	6	85.1	1048	1127	1393
7	2	6	82.4	1605	1282	-
8	2	6	74	1108	1691	-
9	3	6	85.7	1486	1976	1212
10						
11						
12						
13						
14						
15						
16						
17						
18						
19						
20						



Long Pulse Radar Test Signal

Test Signal Name: LP_Signal_13

Number of Bursts in Trial: 12

Burst	Pulses per Burst	Chrip (MHz)	Pulse Width(us)	PRI-1 (us)	PRI-2 (us)	PRI-3 (us)
1	3	11	94.4	1385	1336	1376
2	1	11	53	1805	-	-
3	2	11	70	1248	1558	-
4	3	11	87.6	1403	1170	1315
5	1	11	61.7	1042	-	-
6	2	11	83.2	1100	1535	-
7	1	11	66.6	1038	-	-
8	1	11	55.1	1423	-	-
9	3	11	87	1789	1306	1643
10	1	11	66.4	1409	-	-
11	2	11	80	1319	1094	-
12	3	11	85.6	1891	1291	1529
13						
14						
15						
16						
17						
18						
19						
20						



Long Pulse Radar Test Signal

Test Signal Name: LP_Signal_14

Number of Bursts in Trial: 19

Burst	Pulses per Burst	Chrip (MHz)	Pulse Width(us)	PRI-1 (us)	PRI-2 (us)	PRI-3 (us)
1	2	18	78.9	1613	1263	-
2	3	18	96.7	1627	1432	1986
3	3	18	91.5	1472	1759	1784
4	2	18	75.4	1274	1795	-
5	2	18	71.1	1968	1444	-
6	2	18	77.5	1588	1441	-
7	1	18	65.4	1710	-	-
8	1	18	53.1	1419	-	-
9	1	18	59.9	1518	-	-
10	2	18	67.3	1195	1168	-
11	2	18	74.2	1386	1216	-
12	2	18	69	1557	1132	-
13	2	18	82.1	1987	1186	-
14	3	18	93.3	1365	1032	1728
15	2	18	83.3	1103	1568	-
16	2	18	70.3	1699	1281	-
17	1	18	57.9	1285	-	-
18	1	18	50.6	1850	-	-
19	3	18	94.3	1479	1218	1733
20						



Long Pulse Radar Test Signal

Test Signal Name: LP_Signal_15

Number of Bursts in Trial: 20

Burst	Pulses per Burst	Chrip (MHz)	Pulse Width(us)	PRI-1 (us)	PRI-2 (us)	PRI-3 (us)
1	2	20	67.5	1434	1117	-
2	2	20	67.8	1567	1773	-
3	2	20	75.9	1846	1362	-
4	2	20	68.9	1237	1818	-
5	3	20	96	1339	1796	1852
6	1	20	66.6	1289	-	-
7	2	20	78.3	1862	1856	-
8	1	20	58.9	1412	-	-
9	2	20	81.5	1113	1591	-
10	2	20	82.4	1059	1861	-
11	3	20	86.8	1797	1163	1320
12	3	20	98.5	1268	1300	1868
13	2	20	80.1	1086	1482	-
14	3	20	86.3	1860	1407	1998
15	1	20	57.2	1241	-	-
16	3	20	84.3	1808	1873	1628
17	3	20	86.8	1258	1302	1978
18	2	20	83	1690	1378	-
19	3	20	85.6	1327	1956	1311
20	3	20	99.4	1112	1815	1262

Long Pulse Radar Test Signal

Test Signal Name: LP_Signal_16

Number of Bursts in Trial: 14

Burst	Pulses per Burst	Chrip (MHz)	Pulse Width(us)	PRI-1 (us)	PRI-2 (us)	PRI-3 (us)
1	1	13	57.5	1379	-	-
2	2	13	67	1551	1620	-
3	2	13	70.9	1939	1083	-
4	2	13	75.7	1332	1476	-
5	2	13	77.1	1840	1010	-
6	2	13	78.8	1371	1618	-
7	1	13	51	1494	-	-
8	1	13	55.4	1794	-	-
9	2	13	68.5	1590	1266	-
10	3	13	100	1484	1314	1428
11	3	13	96.4	1363	1361	1292
12	3	13	97.2	1694	1480	1446
13	3	13	86.4	1447	1227	1102
14	2	13	72.1	1184	1638	-
15						
16						
17						
18						
19						
20						

Long Pulse Radar Test Signal

Test Signal Name: LP_Signal_17

Number of Bursts in Trial: 11

Burst	Pulses per Burst	Chrip (MHz)	Pulse Width(us)	PRI-1 (us)	PRI-2 (us)	PRI-3 (us)
1	1	9	62.4	1329	-	-
2	2	9	67.8	1364	1937	-
3	1	9	53	1790	-	-
4	2	9	77.8	1546	1906	-
5	3	9	95.6	1145	1743	1499
6	1	9	58.8	1199	-	-
7	3	9	92.8	1424	1408	1381
8	2	9	68.5	1340	1972	-
9	3	9	84	1607	1663	1270
10	2	9	70.8	1468	1760	-
11	2	9	73.1	1869	1515	-
12						
13						
14						
15						
16						
17						
18						
19						
20						



Long Pulse Radar Test Signal

Test Signal Name: LP_Signal_18

Number of Bursts in Trial: 13

Burst	Pulses per Burst	Chrip (MHz)	Pulse Width(us)	PRI-1 (us)	PRI-2 (us)	PRI-3 (us)
1	2	11	68.8	1504	1973	-
2	3	11	94.2	1920	1299	1467
3	2	11	82.7	1003	1351	-
4	2	11	74.8	1597	1457	-
5	1	11	58.9	1874	-	-
6	3	11	96.5	1838	1708	1328
7	3	11	87.3	1405	1271	1687
8	2	11	72.4	1200	1433	-
9	1	11	51.3	1475	-	-
10	3	11	86.8	1159	1652	1942
11	1	11	50.4	1056	-	-
12	3	11	97	1884	1876	1415
13	1	11	50.1	1519	-	-
14						
15						
16						
17						
18						
19						
20						



Long Pulse Radar Test Signal

Test Signal Name: LP_Signal_19

Number of Bursts in Trial: 10

Burst	Pulses per Burst	Chrip (MHz)	Pulse Width(us)	PRI-1 (us)	PRI-2 (us)	PRI-3 (us)
1	3	8	91.9	1301	1337	1645
2	2	8	67.2	1983	1040	-
3	1	8	65.5	1671	-	-
4	2	8	72.8	1489	1016	-
5	3	8	90.5	1552	1180	1064
6	2	8	81.6	1807	1853	-
7	3	8	86	1312	1905	1278
8	3	8	89.6	1152	1068	1832
9	1	8	62.1	1119	-	-
10	1	8	58	1234	-	-
11						
12						
13						
14						
15						
16						
17						
18						
19						
20						



Long Pulse Radar Test Signal

Test Signal Name: LP_Signal_20

Number of Bursts in Trial: 8

Burst	Pulses per Burst	Chrip (MHz)	Pulse Width(us)	PRI-1 (us)	PRI-2 (us)	PRI-3 (us)
1	2	5	73.8	1071	1915	-
2	3	5	89.5	1294	1450	1025
3	2	5	81.2	1144	1146	-
4	1	5	59	1041	-	-
5	3	5	87.5	1096	1941	1018
6	2	5	76.7	1667	1947	-
7	1	5	56.5	1573	-	-
8	3	5	89	1033	1391	1304
9						
10						
11						
12						
13						
14						
15						
16						
17						
18						
19						
20						



Long Pulse Radar Test Signal

Test Signal Name: LP_Signal_21

Number of Bursts in Trial: 14

Burst	Pulses per Burst	Chrip (MHz)	Pulse Width(us)	PRI-1 (us)	PRI-2 (us)	PRI-3 (us)
1	2	12	83.1	1762	1058	-
2	1	12	50	1739	-	-
3	1	12	52.6	1055	-	-
4	1	12	58.2	1704	-	-
5	3	12	84.6	1226	1177	1886
6	2	12	68.3	1269	1851	-
7	2	12	80.6	1814	1074	-
8	1	12	59.5	1009	-	-
9	1	12	53.4	1417	-	-
10	1	12	59.1	1431	-	-
11	2	12	74.8	1002	1394	-
12	3	12	85	1670	1755	1158
13	3	12	85.3	1307	1560	1078
14	1	12	61.9	1197	-	-
15						
16						
17						
18						
19						
20						



Long Pulse Radar Test Signal

Test Signal Name: LP_Signal_22

Number of Bursts in Trial: 17

Burst	Pulses per Burst	Chrip (MHz)	Pulse Width(us)	PRI-1 (us)	PRI-2 (us)	PRI-3 (us)
1	2	17	70.8	1022	1015	-
2	1	17	52.9	1483	-	-
3	3	17	86	1524	1308	1287
4	2	17	78.4	1821	1406	-
5	3	17	93.3	1991	1966	1290
6	2	17	70	1858	1471	-
7	2	17	78.1	1507	1705	-
8	1	17	52.4	1060	-	-
9	3	17	84.8	1859	1839	1993
10	3	17	83.5	1150	1492	1443
11	1	17	56.7	1208	-	-
12	3	17	86.2	1674	1125	1053
13	1	17	58.8	1436	-	-
14	3	17	85.4	1686	1509	1577
15	2	17	77.7	1297	1298	-
16	3	17	87.4	1649	1894	1075
17	3	17	99.8	1185	1167	1616
18						
19						
20						



Long Pulse Radar Test Signal

Test Signal Name: LP_Signal_23

Number of Bursts in Trial: 12

Burst	Pulses per Burst	Chrip (MHz)	Pulse Width(us)	PRI-1 (us)	PRI-2 (us)	PRI-3 (us)
1	3	10	95.7	1353	1813	1028
2	3	10	94.9	1735	1994	1084
3	3	10	97.9	1354	1792	1418
4	2	10	67.4	1348	1008	-
5	3	10	96.9	1916	1425	1283
6	3	10	97.6	1384	1050	1569
7	3	10	83.6	1231	1219	1194
8	2	10	82.6	1128	1346	-
9	3	10	97.2	1142	1769	1173
10	3	10	92.3	1181	1164	1458
11	2	10	80.9	1222	1756	-
12	2	10	78.1	1190	1999	-
13						
14						
15						
16						
17						
18						
19						
20						



Long Pulse Radar Test Signal

Test Signal Name: LP_Signal_24

Number of Bursts in Trial: 8

Burst	Pulses per Burst	Chrip (MHz)	Pulse Width(us)	PRI-1 (us)	PRI-2 (us)	PRI-3 (us)
1	2	5	76.9	1564	1767	-
2	1	5	64.7	1437	-	-
3	2	5	77.1	1046	1944	-
4	2	5	72.7	1440	1374	-
5	1	5	61.9	1035	-	-
6	2	5	68.6	1205	1892	-
7	2	5	78.3	1047	1273	-
8	2	5	73.1	1426	1863	-
9						
10						
11						
12						
13						
14						
15						
16						
17						
18						
19						
20						



Long Pulse Radar Test Signal

Test Signal Name: LP_Signal_25

Number of Bursts in Trial: 16

Burst	Pulses per Burst	Chrip (MHz)	Pulse Width(us)	PRI-1 (us)	PRI-2 (us)	PRI-3 (us)
1	1	15	59.1	1718	-	-
2	3	15	83.5	1070	1129	1318
3	3	15	86.5	1176	1253	1442
4	1	15	60.8	1209	-	-
5	2	15	80.7	2000	1360	-
6	1	15	65.2	1101	-	-
7	2	15	69.1	1511	1030	-
8	1	15	51.5	1161	-	-
9	3	15	98.5	1061	1951	1812
10	1	15	59.5	1325	-	-
11	3	15	95.3	1284	1650	1169
12	2	15	81.8	1460	1077	-
13	1	15	66	1149	-	-
14	1	15	59.3	1373	-	-
15	2	15	79.2	1836	1534	-
16	3	15	90.2	1455	1738	1490
17						
18						
19						
20						



Long Pulse Radar Test Signal

Test Signal Name: LP_Signal_26

Number of Bursts in Trial: 13

Burst	Pulses per Burst	Chrip (MHz)	Pulse Width(us)	PRI-1 (us)	PRI-2 (us)	PRI-3 (us)
1	3	11	87.5	1343	1331	1313
2	3	11	94.6	1448	1543	1803
3	2	11	73.9	1722	1514	-
4	1	11	55.4	1506	-	-
5	1	11	52.3	1960	-	-
6	3	11	95.8	1240	1380	1252
7	3	11	96.1	1372	1411	1908
8	2	11	77.8	1885	1593	-
9	3	11	97.2	1021	1614	1633
10	2	11	74.3	1582	1097	-
11	1	11	57.9	1031	-	-
12	2	11	68.8	1927	1936	-
13	2	11	79.6	1857	1470	-
14						
15						
16						
17						
18						
19						
20						

Long Pulse Radar Test Signal

Test Signal Name: LP_Signal_27

Number of Bursts in Trial: 9

Burst	Pulses per Burst	Chrip (MHz)	Pulse Width(us)	PRI-1 (us)	PRI-2 (us)	PRI-3 (us)
1	1	7	63.4	1595	-	-
2	3	7	97	1451	1660	1562
3	2	7	66.7	1116	1544	-
4	3	7	99.5	1553	1526	1768
5	1	7	64.3	1107	-	-
6	3	7	90.7	1992	1626	1899
7	1	7	62.1	1630	-	-
8	1	7	58.3	1676	-	-
9	3	7	87	1726	1696	1464
10						
11						
12						
13						
14						
15						
16						
17						
18						
19						
20						



Long Pulse Radar Test Signal

Test Signal Name: LP_Signal_28

Number of Bursts in Trial: 9

Burst	Pulses per Burst	Chrip (MHz)	Pulse Width(us)	PRI-1 (us)	PRI-2 (us)	PRI-3 (us)
1	3	6	86.8	1673	1383	1653
2	2	6	81.7	1841	1911	-
3	2	6	78.4	1900	1229	-
4	2	6	82.1	1527	1072	-
5	3	6	84.1	1893	1742	1491
6	3	6	87.7	1247	1341	1955
7	3	6	97	1559	1685	1572
8	3	6	99.1	1641	1727	1848
9	1	6	62	1245	-	-
10						
11						
12						
13						
14						
15						
16						
17						
18						
19						
20						



Long Pulse Radar Test Signal

Test Signal Name: LP_Signal_29

Number of Bursts in Trial: 8

Burst	Pulses per Burst	Chrip (MHz)	Pulse Width(us)	PRI-1 (us)	PRI-2 (us)	PRI-3 (us)
1	2	6	67.5	1193	1182	-
2	3	6	85.6	1221	1741	1338
3	3	6	86.9	1580	1775	1809
4	3	6	85.3	1082	1854	1095
5	2	6	67.3	1898	1977	-
6	3	6	94.8	1791	1350	1230
7	2	6	72.9	1681	1323	-
8	2	6	70.7	1709	1123	-
9						
10						
11						
12						
13						
14						
15						
16						
17						
18						
19						



Long Pulse Radar Test Signal

Test Signal Name: LP_Signal_30

Number of Bursts in Trial: 10

Burst	Pulses per Burst	Chrip (MHz)	Pulse Width(us)	PRI-1 (us)	PRI-2 (us)	PRI-3 (us)
1	1	8	63.3	1044	-	-
2	3	8	87.4	1945	1602	1203
3	1	8	58.7	1556	-	-
4	1	8	63.6	1598	-	-
5	1	8	56.3	1110	-	-
6	1	8	57.2	1878	-	-
7	1	8	50.3	1659	-	-
8	2	8	71.9	1143	1724	-
9	3	8	85.1	1404	1715	1449
10	1	8	62.5	1276	-	-
11						
12						
13						
14						
15						
16						
17						
18						
19						
20						



BW40

Long Pulse Radar Test Signal

Test Signal Name: LP_Signal_01

Number of Bursts in Trial: 17

Burst	Pulses per Burst	Chirp (MHz)	Pulse Width(us)	PRI-1 (us)	PRI-2 (us)	PRI-3 (us)
1	3	16	84.9	1262	1427	1286
2	3	16	99	1621	1355	1756
3	2	16	72.3	1743	1187	-
4	1	16	52	1329	-	-
5	3	16	84.4	1749	1671	1675
6	3	16	95.6	1031	1729	1449
7	1	16	65.7	1019	-	-
8	3	16	98.9	1561	1536	1257
9	2	16	78.8	1490	1250	-
10	1	16	50.8	1396	-	-
11	3	16	88.2	1559	1172	1325
12	3	16	93.2	1473	1752	1232
13	1	16	53.4	1439	-	-
14	2	16	69.7	1259	1643	-
15	3	16	84.1	1488	1179	1692
16	1	16	57.2	1496	-	-
17	3	16	84.5	1773	1557	1939
18	-	-	-	-	-	-
19	-	-	-	-	-	-
20	-	-	-	-	-	-

Long Pulse Radar Test Signal

Test Signal Name: LP_Signal_02

Number of Bursts in Trial: 20

Burst	Pulses per Burst	Chirp (MHz)	Pulse Width(us)	PRI-1 (us)	PRI-2 (us)	PRI-3 (us)
1	1	20	50.7	1209	-	-
2	1	20	62.3	1169	-	-
3	2	20	72.3	1802	1733	-
4	2	20	80.4	1248	1569	-
5	1	20	50	1358	-	-
6	2	20	77.1	1778	1192	-
7	2	20	68.4	1710	1283	-
8	3	20	87.9	1901	1871	1868
9	1	20	51.6	1870	-	-
10	3	20	99.5	1114	1549	1884
11	3	20	85	1764	1750	1296
12	2	20	67.3	1281	1105	-
13	3	20	99.7	1290	1955	1501
14	3	20	97	1852	1301	1574
15	3	20	99.3	1450	1918	1564
16	3	20	87.1	1698	1758	1368
17	2	20	75.8	1976	1040	-
18	3	20	98.8	1363	1578	1936
19	3	20	83.7	1360	1842	1310
20	2	20	71.3	1826	1628	-

Long Pulse Radar Test Signal

Test Signal Name: LP_Signal_03

Number of Bursts in Trial: 13

Burst	Pulses per Burst	Chirp (MHz)	Pulse Width(us)	PRI-1 (us)	PRI-2 (us)	PRI-3 (us)
1	3	12	84.6	1659	1008	1055
2	3	12	97	1205	1407	1305
3	3	12	94.1	1690	1507	1448
4	2	12	81.3	1382	1506	-
5	2	12	77.5	1239	1830	-
6	1	12	56.7	1706	-	-
7	2	12	82.5	1475	1984	-
8	3	12	99	1580	1421	1203
9	1	12	64.4	1044	-	-
10	2	12	74.1	1516	1724	-
11	3	12	89.3	1387	1720	1060
12	1	12	59.9	1923	-	-
13	3	12	99.9	1600	1797	1466
14	-	-	-	-	-	-
15	-	-	-	-	-	-
16	-	-	-	-	-	-
17	-	-	-	-	-	-
18	-	-	-	-	-	-
19	-	-	-	-	-	-
20	-	-	-	-	-	-

Long Pulse Radar Test Signal

Test Signal Name: LP_Signal_04

Number of Bursts in Trial: 8

Burst	Pulses per Burst	Chirp (MHz)	Pulse Width(us)	PRI-1 (us)	PRI-2 (us)	PRI-3 (us)
1	3	5	92.5	1844	1249	1048
2	1	5	59.1	1349	-	-
3	3	5	94.1	1167	1398	1228
4	3	5	88.3	1057	1376	1115
5	2	5	70	1741	1803	-
6	3	5	84.9	1535	1125	1461
7	2	5	71.9	1631	1142	-
8	1	5	53.9	1876	-	-
9	-	-	-	-	-	-
10	-	-	-	-	-	-
11	-	-	-	-	-	-
12	-	-	-	-	-	-
13	-	-	-	-	-	-
14	-	-	-	-	-	-
15	-	-	-	-	-	-
16	-	-	-	-	-	-
17	-	-	-	-	-	-
18	-	-	-	-	-	-
19	-	-	-	-	-	-
20	-	-	-	-	-	-

Long Pulse Radar Test Signal

Test Signal Name: LP_Signal_05

Number of Bursts in Trial: 16

Burst	Pulses per Burst	Chirp (MHz)	Pulse Width(us)	PRI-1 (us)	PRI-2 (us)	PRI-3 (us)
1	1	15	64.1	1322	-	-
2	2	15	82.7	1241	1217	-
3	3	15	96.1	1541	1924	1938
4	2	15	80.8	1920	1972	-
5	2	15	81.5	1447	1780	-
6	2	15	79.1	1784	1711	-
7	1	15	53.8	1022	-	-
8	3	15	88.9	1914	1457	1680
9	1	15	56	1635	-	-
10	2	15	77.7	1413	1023	-
11	2	15	71	1977	1502	-
12	1	15	50.4	1670	-	-
13	3	15	86	1654	1174	1854
14	3	15	99.9	1595	1292	1338
15	1	15	53.8	1908	-	-
16	2	15	68.2	1845	1258	-
17	-	-	-	-	-	-
18	-	-	-	-	-	-
19	-	-	-	-	-	-
20	-	-	-	-	-	-



Long Pulse Radar Test Signal

Test Signal Name: LP_Signal_06

Number of Bursts in Trial: 19

Burst	Pulses per Burst	Chirp (MHz)	Pulse Width(us)	PRI-1 (us)	PRI-2 (us)	PRI-3 (us)
1	3	19	91	1856	1285	1509
2	1	19	52.8	1484	-	-
3	3	19	93.3	1612	1725	1594
4	3	19	94.6	1406	1719	1783
5	2	19	69.5	1998	1102	-
6	2	19	73.5	1119	1152	-
7	2	19	77.6	1822	1140	-
8	1	19	60.1	1380	-	-
9	2	19	75	1066	1630	-
10	2	19	67.5	1848	1699	-
11	1	19	57.2	1056	-	-
12	3	19	87.8	1432	1656	1385
13	1	19	55.1	1425	-	-
14	3	19	98.8	1424	1182	1545
15	1	19	55.7	1892	-	-
16	1	19	63.9	1951	-	-
17	1	19	61.7	1076	-	-
18	2	19	67.4	1078	1927	-
19	2	19	70.5	1071	1489	-
20	-	-	-	-	-	-



Long Pulse Radar Test Signal

Test Signal Name: LP_Signal_07

Number of Bursts in Trial: 12

Burst	Pulses per Burst	Chirp (MHz)	Pulse Width(us)	PRI-1 (us)	PRI-2 (us)	PRI-3 (us)
1	1	10	64.2	1789	-	-
2	3	10	98	1946	1691	1034
3	1	10	50.5	1738	-	-
4	3	10	96	1622	1300	1722
5	2	10	77.6	1667	1883	-
6	2	10	78.6	1017	1237	-
7	1	10	60	1148	-	-
8	1	10	58.3	1603	-	-
9	3	10	96.4	1287	1417	1498
10	2	10	68.3	1790	1922	-
11	1	10	59.5	1829	-	-
12	1	10	63.8	1435	-	-
13	-	-	-	-	-	-
14	-	-	-	-	-	-
15	-	-	-	-	-	-
16	-	-	-	-	-	-
17	-	-	-	-	-	-
18	-	-	-	-	-	-
19	-	-	-	-	-	-
20	-	-	-	-	-	-



Long Pulse Radar Test Signal

Test Signal Name: LP_Signal_08

Number of Bursts in Trial: 20

Burst	Pulses per Burst	Chirp (MHz)	Pulse Width(us)	PRI-1 (us)	PRI-2 (us)	PRI-3 (us)
1	3	20	92.7	1932	1124	1726
2	1	20	55.3	1894	-	-
3	2	20	75.9	1302	1732	-
4	3	20	97.4	1763	1705	1777
5	2	20	67.1	1210	1269	-
6	3	20	91.6	1218	1604	1942
7	2	20	77.4	1161	1715	-
8	3	20	84.4	1880	1838	1126
9	3	20	90.7	1714	1181	1647
10	1	20	55.1	1793	-	-
11	3	20	86	1799	1141	1682
12	1	20	55.7	1761	-	-
13	1	20	64	1213	-	-
14	2	20	71.9	1511	1912	-
15	1	20	66	1012	-	-
16	3	20	83.8	1730	2000	1992
17	1	20	57.2	1157	-	-
18	2	20	71.9	1431	1242	-
19	1	20	57	1298	-	-
20	3	20	88.7	1191	1587	1801

Long Pulse Radar Test Signal

Test Signal Name: LP_Signal_09

Number of Bursts in Trial: 15

Burst	Pulses per Burst	Chirp (MHz)	Pulse Width(us)	PRI-1 (us)	PRI-2 (us)	PRI-3 (us)
1	2	14	68.6	1523	1815	-
2	2	14	79.4	1558	1810	-
3	3	14	89.6	1629	1207	1599
4	2	14	70.2	1665	1798	-
5	3	14	90.4	1247	1186	1316
6	1	14	56.8	1433	-	-
7	1	14	65.7	1390	-	-
8	1	14	65.9	1230	-	-
9	1	14	59.4	1459	-	-
10	1	14	65.1	1694	-	-
11	2	14	81.2	1930	1327	-
12	3	14	91.8	1416	1978	1660
13	1	14	65.5	1886	-	-
14	1	14	53.6	1313	-	-
15	1	14	64.5	1245	-	-
16	-	-	-	-	-	-
17	-	-	-	-	-	-
18	-	-	-	-	-	-
19	-	-	-	-	-	-
20	-	-	-	-	-	-

Long Pulse Radar Test Signal

Test Signal Name: LP_Signal_10

Number of Bursts in Trial: 8

Burst	Pulses per Burst	Chirp (MHz)	Pulse Width(us)	PRI-1 (us)	PRI-2 (us)	PRI-3 (us)
1	2	5	82.5	1529	1581	-
2	2	5	79.3	1377	1615	-
3	1	5	51.4	1264	-	-
4	3	5	88.7	1165	1957	1500
5	2	5	72.4	1469	1483	-
6	3	5	84.4	1537	1661	1118
7	2	5	83	1531	1824	-
8	2	5	79.9	1064	1374	-
9	-	-	-	-	-	-
10	-	-	-	-	-	-
11	-	-	-	-	-	-
12	-	-	-	-	-	-
13	-	-	-	-	-	-
14	-	-	-	-	-	-
15	-	-	-	-	-	-
16	-	-	-	-	-	-
17	-	-	-	-	-	-
18	-	-	-	-	-	-
19	-	-	-	-	-	-
20	-	-	-	-	-	-



Long Pulse Radar Test Signal

Test Signal Name: LP_Signal_11

Number of Bursts in Trial: 17

Burst	Pulses per Burst	Chirp (MHz)	Pulse Width(us)	PRI-1 (us)	PRI-2 (us)	PRI-3 (us)
1	1	17	59.1	1173	-	-
2	1	17	62	1808	-	-
3	3	17	94.8	1519	1294	1412
4	2	17	82	1028	1794	-
5	1	17	55.7	1318	-	-
6	1	17	62.5	1757	-	-
7	2	17	76.3	1846	1180	-
8	1	17	51.1	1252	-	-
9	2	17	74.4	1960	1551	-
10	1	17	61.3	1442	-	-
11	2	17	70.8	1423	1465	-
12	3	17	95.3	1460	1676	1384
13	1	17	63.2	1289	-	-
14	1	17	65.8	1226	-	-
15	1	17	55.6	1504	-	-
16	1	17	56.9	1916	-	-
17	1	17	60.3	1400	-	-
18	-	-	-	-	-	-
19	-	-	-	-	-	-
20	-	-	-	-	-	-

Long Pulse Radar Test Signal

Test Signal Name: LP_Signal_12

Number of Bursts in Trial: 19

Burst	Pulses per Burst	Chirp (MHz)	Pulse Width(us)	PRI-1 (us)	PRI-2 (us)	PRI-3 (us)
1	2	18	75.9	1762	1769	-
2	1	18	61.4	1070	-	-
3	2	18	74.9	1026	1759	-
4	2	18	75.5	1562	1929	-
5	2	18	74	1422	1639	-
6	3	18	94.2	1565	1042	1468
7	3	18	90.2	1700	1366	1405
8	1	18	60.3	1194	-	-
9	1	18	57.3	1087	-	-
10	3	18	83.6	1129	1899	1092
11	1	18	54.4	1975	-	-
12	1	18	55.8	1196	-	-
13	2	18	83.3	1547	1550	-
14	3	18	84.7	1463	1774	1492
15	1	18	54.2	1734	-	-
16	3	18	85.6	1669	1045	1919
17	3	18	99.5	1156	1533	1888
18	2	18	80.4	1821	1806	-
19	1	18	58.2	1397	-	-
20	-	-	-	-	-	-



Long Pulse Radar Test Signal

Test Signal Name: LP_Signal_13

Number of Bursts in Trial: 8

Burst	Pulses per Burst	Chirp (MHz)	Pulse Width(us)	PRI-1 (us)	PRI-2 (us)	PRI-3 (us)
1	3	6	95.6	1623	1206	1662
2	2	6	74.8	1610	1284	-
3	1	6	60	1943	-	-
4	1	6	53.3	1234	-	-
5	2	6	83.2	1589	1986	-
6	1	6	64	1877	-	-
7	1	6	56.7	1342	-	-
8	2	6	80.5	1099	1703	-
9	-	-	-	-	-	-
10	-	-	-	-	-	-
11	-	-	-	-	-	-
12	-	-	-	-	-	-
13	-	-	-	-	-	-
14	-	-	-	-	-	-
15	-	-	-	-	-	-
16	-	-	-	-	-	-
17	-	-	-	-	-	-
18	-	-	-	-	-	-
19	-	-	-	-	-	-
20	-	-	-	-	-	-

Long Pulse Radar Test Signal

Test Signal Name: LP_Signal_14

Number of Bursts in Trial: 13

Burst	Pulses per Burst	Chirp (MHz)	Pulse Width(us)	PRI-1 (us)	PRI-2 (us)	PRI-3 (us)
1	3	11	94.8	1530	1219	1952
2	1	11	58.3	1613	-	-
3	1	11	51.3	1038	-	-
4	1	11	66.6	1809	-	-
5	2	11	73.6	1701	1059	-
6	3	11	94.5	1645	1999	1568
7	2	11	78.3	1135	1160	-
8	3	11	96.6	1813	1950	1063
9	2	11	73	1401	1585	-
10	1	11	58	1039	-	-
11	1	11	54.3	1853	-	-
12	3	11	85.2	1037	1444	1855
13	2	11	67.9	1532	1304	-
14	-	-	-	-	-	-
15	-	-	-	-	-	-
16	-	-	-	-	-	-
17	-	-	-	-	-	-
18	-	-	-	-	-	-
19	-	-	-	-	-	-
20	-	-	-	-	-	-

Long Pulse Radar Test Signal

Test Signal Name: LP_Signal_15

Number of Bursts in Trial: 16

Burst	Pulses per Burst	Chirp (MHz)	Pulse Width(us)	PRI-1 (us)	PRI-2 (us)	PRI-3 (us)
1	1	15	54.6	1608	-	-
2	2	15	71.7	1189	1478	-
3	3	15	98.4	1370	1681	1471
4	2	15	78.9	1260	1753	-
5	2	15	71.8	1050	1476	-
6	3	15	95.3	1620	1058	1399
7	3	15	91.2	1369	1605	1577
8	2	15	76.6	1346	1236	-
9	1	15	66.5	1837	-	-
10	1	15	59.7	1805	-	-
11	1	15	63.7	1089	-	-
12	3	15	85.5	1270	1188	1085
13	3	15	97.5	1267	1312	1481
14	1	15	61.3	1091	-	-
15	3	15	85.5	1965	1046	1588
16	1	15	65.8	1967	-	-
17	-	-	-	-	-	-
18	-	-	-	-	-	-
19	-	-	-	-	-	-
20	-	-	-	-	-	-

Long Pulse Radar Test Signal

Test Signal Name: LP_Signal_16

Number of Bursts in Trial: 9

Burst	Pulses per Burst	Chirp (MHz)	Pulse Width(us)	PRI-1 (us)	PRI-2 (us)	PRI-3 (us)
1	1	7	58	1859	-	-
2	3	7	91.8	1274	1211	1088
3	1	7	61.5	1745	-	-
4	2	7	67.2	1079	1731	-
5	1	7	63.6	1222	-	-
6	3	7	95.5	1514	1833	1445
7	1	7	51.9	1727	-	-
8	1	7	56	1307	-	-
9	2	7	67	1878	1573	-
10	-	-	-	-	-	-
11	-	-	-	-	-	-
12	-	-	-	-	-	-
13	-	-	-	-	-	-
14	-	-	-	-	-	-
15	-	-	-	-	-	-
16	-	-	-	-	-	-
17	-	-	-	-	-	-
18	-	-	-	-	-	-
19	-	-	-	-	-	-
20	-	-	-	-	-	-

Long Pulse Radar Test Signal

Test Signal Name: LP_Signal_17

Number of Bursts in Trial: 16

Burst	Pulses per Burst	Chirp (MHz)	Pulse Width(us)	PRI-1 (us)	PRI-2 (us)	PRI-3 (us)
1	2	16	80.8	1272	1371	-
2	1	16	61.3	1609	-	-
3	1	16	54.9	1410	-	-
4	3	16	88.2	1007	1928	1616
5	2	16	81.3	1437	1796	-
6	2	16	77.6	1517	1303	-
7	3	16	95.2	1953	1275	1001
8	3	16	95.3	1137	1204	1067
9	3	16	90.3	1073	1834	1051
10	3	16	91	1345	1652	1261
11	1	16	53.1	1032	-	-
12	1	16	61.6	1097	-	-
13	2	16	74.4	1666	1792	-
14	1	16	61.4	1828	-	-
15	2	16	68.7	1317	1276	-
16	1	16	65.6	1708	-	-
17	-	-	-	-	-	-
18	-	-	-	-	-	-
19	-	-	-	-	-	-
20	-	-	-	-	-	-



Long Pulse Radar Test Signal

Test Signal Name: LP_Signal_18

Number of Bursts in Trial: 8

Burst	Pulses per Burst	Chirp (MHz)	Pulse Width(us)	PRI-1 (us)	PRI-2 (us)	PRI-3 (us)
1	1	5	53.9	1153	-	-
2	2	5	78.2	1776	1543	-
3	3	5	98.7	1324	1906	1840
4	3	5	87.6	1229	1689	1786
5	2	5	81.2	1353	1381	-
6	2	5	76.2	1288	1931	-
7	2	5	83.2	1403	1770	-
8	3	5	92.9	1897	1090	1900
9	-	-	-	-	-	-
10	-	-	-	-	-	-
11	-	-	-	-	-	-
12	-	-	-	-	-	-
13	-	-	-	-	-	-
14	-	-	-	-	-	-
15	-	-	-	-	-	-
16	-	-	-	-	-	-
17	-	-	-	-	-	-
18	-	-	-	-	-	-
19	-	-	-	-	-	-
20	-	-	-	-	-	-



Long Pulse Radar Test Signal

Test Signal Name: LP_Signal_19

Number of Bursts in Trial: 11

Burst	Pulses per Burst	Chirp (MHz)	Pulse Width(us)	PRI-1 (us)	PRI-2 (us)	PRI-3 (us)
1	2	8	80.7	1602	1103	-
2	1	8	64.9	1065	-	-
3	1	8	66.3	1190	-	-
4	3	8	92.9	1987	1548	1479
5	2	8	67.9	1839	1053	-
6	1	8	54.3	1277	-	-
7	1	8	59.1	1015	-	-
8	2	8	69.7	1200	1414	-
9	3	8	92.4	1043	1176	1093
10	1	8	61.9	1351	-	-
11	3	8	91	1485	1458	1265
12	-	-	-	-	-	-
13	-	-	-	-	-	-
14	-	-	-	-	-	-
15	-	-	-	-	-	-
16	-	-	-	-	-	-
17	-	-	-	-	-	-
18	-	-	-	-	-	-
19	-	-	-	-	-	-
20	-	-	-	-	-	-



Long Pulse Radar Test Signal

Test Signal Name: LP_Signal_20

Number of Bursts in Trial: 13

Burst	Pulses per Burst	Chirp (MHz)	Pulse Width(us)	PRI-1 (us)	PRI-2 (us)	PRI-3 (us)
1	3	12	84	1123	1357	1636
2	3	12	86.2	1482	1997	1831
3	3	12	88.5	1291	1934	1847
4	3	12	85.3	1688	1438	1981
5	2	12	82.1	1653	1199	-
6	2	12	68.6	1082	1958	-
7	3	12	90.2	1638	1825	1898
8	1	12	57.1	1650	-	-
9	2	12	70.3	1982	1154	-
10	2	12	82.3	1419	1467	-
11	1	12	54.2	1113	-	-
12	3	12	83.6	1221	1772	1556
13	2	12	80.4	1539	1224	-
14	-	-	-	-	-	-
15	-	-	-	-	-	-
16	-	-	-	-	-	-
17	-	-	-	-	-	-
18	-	-	-	-	-	-
19	-	-	-	-	-	-
20	-	-	-	-	-	-

Long Pulse Radar Test Signal

Test Signal Name: LP_Signal_21

Number of Bursts in Trial: 15

Burst	Pulses per Burst	Chirp (MHz)	Pulse Width(us)	PRI-1 (us)	PRI-2 (us)	PRI-3 (us)
1	3	14	92.9	1395	1974	1862
2	1	14	51.6	1464	-	-
3	1	14	59.7	1223	-	-
4	2	14	67.2	1145	1913	-
5	1	14	53.2	1096	-	-
6	2	14	68.4	1084	1487	-
7	3	14	85.9	1672	1455	1971
8	1	14	54.6	1970	-	-
9	2	14	78.2	1572	1315	-
10	1	14	62.1	1903	-	-
11	1	14	57.4	1359	-	-
12	1	14	66.3	1679	-	-
13	1	14	61.2	1524	-	-
14	1	14	52.3	1873	-	-
15	2	14	77.3	1996	1238	-
16	-	-	-	-	-	-
17	-	-	-	-	-	-
18	-	-	-	-	-	-
19	-	-	-	-	-	-
20	-	-	-	-	-	-

Long Pulse Radar Test Signal

Test Signal Name: LP_Signal_22

Number of Bursts in Trial: 8

Burst	Pulses per Burst	Chirp (MHz)	Pulse Width(us)	PRI-1 (us)	PRI-2 (us)	PRI-3 (us)
1	3	5	86	1812	1256	1143
2	2	5	81.8	1004	1696	-
3	3	5	83.5	1593	1816	1768
4	2	5	69.3	1686	1860	-
5	1	5	62.5	1138	-	-
6	2	5	70.4	1651	1905	-
7	3	5	84.7	1225	1775	1677
8	2	5	79.5	1728	1634	-
9	-	-	-	-	-	-
10	-	-	-	-	-	-
11	-	-	-	-	-	-
12	-	-	-	-	-	-
13	-	-	-	-	-	-
14	-	-	-	-	-	-
15	-	-	-	-	-	-
16	-	-	-	-	-	-
17	-	-	-	-	-	-
18	-	-	-	-	-	-
19	-	-	-	-	-	-
20	-	-	-	-	-	-



Long Pulse Radar Test Signal

Test Signal Name: LP_Signal_23

Number of Bursts in Trial: 15

Burst	Pulses per Burst	Chirp (MHz)	Pulse Width(us)	PRI-1 (us)	PRI-2 (us)	PRI-3 (us)
1	1	13	65.4	1584	-	-
2	3	13	93	1411	1979	1081
3	1	13	66.5	1003	-	-
4	2	13	68.9	1782	1120	-
5	3	13	91	1695	1214	1712
6	2	13	69	1781	1915	-
7	1	13	62.8	1146	-	-
8	1	13	60.5	1704	-	-
9	2	13	76.5	1520	1889	-
10	2	13	81.4	1499	1940	-
11	3	13	85.9	1171	1687	1350
12	3	13	100	1863	1454	1227
13	1	13	66.3	1542	-	-
14	3	13	94.6	1344	1961	1379
15	3	13	92	1627	1819	1544
16	-	-	-	-	-	-
17	-	-	-	-	-	-
18	-	-	-	-	-	-
19	-	-	-	-	-	-
20	-	-	-	-	-	-

Long Pulse Radar Test Signal

Test Signal Name: LP_Signal_24

Number of Bursts in Trial: 12

Burst	Pulses per Burst	Chirp (MHz)	Pulse Width(us)	PRI-1 (us)	PRI-2 (us)	PRI-3 (us)
1	1	10	66.4	1268	-	-
2	2	10	73.9	1029	1601	-
3	2	10	76.1	1052	1155	-
4	3	10	86.4	1879	1074	1619
5	1	10	55.7	1841	-	-
6	2	10	74	1452	1451	-
7	2	10	81	1546	1959	-
8	2	10	68.9	1243	1220	-
9	2	10	70.9	1195	1969	-
10	1	10	66.3	1429	-	-
11	1	10	62.9	1033	-	-
12	2	10	71.2	1440	1648	-
13	-	-	-	-	-	-
14	-	-	-	-	-	-
15	-	-	-	-	-	-
16	-	-	-	-	-	-
17	-	-	-	-	-	-
18	-	-	-	-	-	-
19	-	-	-	-	-	-
20	-	-	-	-	-	-

Long Pulse Radar Test Signal

Test Signal Name: LP_Signal_25

Number of Bursts in Trial: 17

Burst	Pulses per Burst	Chirp (MHz)	Pulse Width(us)	PRI-1 (us)	PRI-2 (us)	PRI-3 (us)
1	3	17	88.5	1598	1334	1525
2	3	17	98.9	1100	1570	1735
3	3	17	84.9	1215	1495	1107
4	2	17	71	1011	1571	-
5	1	17	59.9	1966	-	-
6	1	17	58.1	1614	-	-
7	2	17	72.1	1326	1980	-
8	3	17	94.3	1418	1266	1094
9	2	17	74.3	1331	1887	-
10	3	17	86.7	1491	1163	1618
11	3	17	99.6	1673	1273	2000
12	3	17	95	1178	1836	1663
13	3	17	85.6	1989	1526	1538
14	1	17	65.4	1693	-	-
15	1	17	51.5	1811	-	-
16	2	17	81	1893	1020	-
17	3	17	84.9	1881	1902	1077
18	-	-	-	-	-	-
19	-	-	-	-	-	-
20	-	-	-	-	-	-



Long Pulse Radar Test Signal

Test Signal Name: LP_Signal_26

Number of Bursts in Trial: 8

Burst	Pulses per Burst	Chirp (MHz)	Pulse Width(us)	PRI-1 (us)	PRI-2 (us)	PRI-3 (us)
1	2	5	75.3	1443	1954	-
2	1	5	52.3	1948	-	-
3	1	5	60.9	1061	-	-
4	3	5	91.4	1937	1144	1626
5	3	5	89.9	1006	1655	1787
6	2	5	67	1904	1320	-
7	3	5	95.4	1864	1579	1742
8	3	5	86.5	1201	1340	1098
9	-	-	-	-	-	-
10	-	-	-	-	-	-
11	-	-	-	-	-	-
12	-	-	-	-	-	-
13	-	-	-	-	-	-
14	-	-	-	-	-	-
15	-	-	-	-	-	-
16	-	-	-	-	-	-
17	-	-	-	-	-	-
18	-	-	-	-	-	-
19	-	-	-	-	-	-
20	-	-	-	-	-	-

Long Pulse Radar Test Signal

Test Signal Name: LP_Signal_27

Number of Bursts in Trial: 20

Burst	Pulses per Burst	Chirp (MHz)	Pulse Width(us)	PRI-1 (us)	PRI-2 (us)	PRI-3 (us)
1	3	20	84.1	1968	1208	1649
2	2	20	79	1607	1597	-
3	1	20	55.4	1299	-	-
4	3	20	84.5	1617	1624	1567
5	2	20	74	1147	1678	-
6	3	20	95.7	1684	1910	1133
7	1	20	52.6	1857	-	-
8	2	20	78	1112	1534	-
9	3	20	97.9	1388	1183	1872
10	2	20	74.3	1723	1462	-
11	1	20	61.7	1364	-	-
12	3	20	91.6	1212	1505	1009
13	1	20	60.3	1027	-	-
14	2	20	76	1434	1632	-
15	3	20	91.8	1590	1582	1000
16	3	20	94.2	1072	1964	1823
17	1	20	50.3	1047	-	-
18	2	20	67.6	1658	1925	-
19	2	20	79.8	1865	1323	-
20	2	20	74.3	1280	1891	-

Long Pulse Radar Test Signal

Test Signal Name: LP_Signal_28

Number of Bursts in Trial: 17

Burst	Pulses per Burst	Chirp (MHz)	Pulse Width(us)	PRI-1 (us)	PRI-2 (us)	PRI-3 (us)
1	2	16	81.1	1850	1321	-
2	1	16	50.7	1477	-	-
3	3	16	90.4	1935	1408	1426
4	2	16	72.5	1674	1005	-
5	3	16	100	1641	1814	1991
6	3	16	84	1586	1746	1394
7	3	16	95.6	1110	1717	1339
8	1	16	63.9	1583	-	-
9	1	16	51.9	1278	-	-
10	2	16	79.8	1555	1013	-
11	3	16	98.7	1348	1709	1985
12	2	16	81.9	1592	1518	-
13	3	16	89.5	1933	1168	1356
14	3	16	84.6	1995	1820	1069
15	2	16	75.9	1713	1095	-
16	2	16	79.2	1767	1697	-
17	2	16	66.7	1736	1111	-
18	-	-	-	-	-	-
19	-	-	-	-	-	-
20	-	-	-	-	-	-

Long Pulse Radar Test Signal

Test Signal Name: LP_Signal_29

Number of Bursts in Trial: 12

Burst	Pulses per Burst	Chirp (MHz)	Pulse Width(us)	PRI-1 (us)	PRI-2 (us)	PRI-3 (us)
1	1	10	59.7	1739	-	-
2	1	10	50.2	1164	-	-
3	3	10	91	1306	1086	1337
4	3	10	97	1375	1436	1240
5	2	10	66.9	1010	1795	-
6	3	10	87.8	1553	1159	1702
7	3	10	91.1	1874	1127	1642
8	3	10	89.8	1136	1075	1521
9	3	10	89.5	1341	1895	1293
10	2	10	74.6	1041	1515	-
11	3	10	99.4	1508	1907	1779
12	1	10	60.5	1765	-	-
13	-	-	-	-	-	-
14	-	-	-	-	-	-
15	-	-	-	-	-	-
16	-	-	-	-	-	-
17	-	-	-	-	-	-
18	-	-	-	-	-	-
19	-	-	-	-	-	-



Long Pulse Radar Test Signal

Test Signal Name: LP_Signal_30

Number of Bursts in Trial: 20

Burst	Pulses per Burst	Chirp (MHz)	Pulse Width(us)	PRI-1 (us)	PRI-2 (us)	PRI-3 (us)
1	2	20	66.7	1827	1233	-
2	3	20	91.1	1151	1202	1282
3	2	20	72.3	1198	1197	-
4	3	20	87.3	1389	1817	1166
5	2	20	71	1843	1540	-
6	1	20	55.3	1314	-	-
7	2	20	83.3	1474	1361	-
8	3	20	88.6	1744	1818	1295
9	2	20	83	1994	1513	-
10	3	20	84.6	1807	1956	1921
11	3	20	90	1866	1409	1945
12	1	20	50.1	1668	-	-
13	3	20	88.7	1365	1235	1441
14	2	20	76	1512	1909	-
15	2	20	68	1560	1150	-
16	2	20	75.7	1721	1858	-
17	2	20	79.9	1373	1591	-
18	1	20	52	1497	-	-
19	2	20	75.8	1035	1386	-
20	1	20	50	1014	-	-



BW80

Long Pulse Radar Test Signal

Test Signal Name: LP_Signal_01

Number of Bursts in Trial: 10

Burst	Pulses per Burst	Chrip (MHz)	Pulse Width(us)	PRI-1 (us)	PRI-2 (us)	PRI-3 (us)
1	1	8	61	1508	-	-
2	1	8	63.6	1149	-	-
3	1	8	57.3	1174	-	-
4	1	8	62.7	1924	-	-
5	1	8	56.9	1099	-	-
6	3	8	89.3	1882	1626	1569
7	3	8	88.2	1622	1087	1261
8	2	8	74	1476	1252	-
9	3	8	85	1392	1977	1489
10	2	8	69.3	1713	1390	-
11						
12						
13						
14						
15						
16						
17						
18						
19						
20						

Long Pulse Radar Test Signal

Test Signal Name: LP_Signal_02

Number of Bursts in Trial: 11

Burst	Pulses per Burst	Chrip (MHz)	Pulse Width(us)	PRI-1 (us)	PRI-2 (us)	PRI-3 (us)
1	2	9	75	1435	1931	-
2	2	9	82.2	1022	1332	-
3	3	9	87.9	1633	1301	1902
4	3	9	95.8	1534	1407	1056
5	2	9	69.1	1373	1496	-
6	3	9	88.5	1729	1167	1215
7	1	9	55.5	1471	-	-
8	2	9	81.8	1105	1414	-
9	1	9	63.6	1477	-	-
10	3	9	91.7	1699	1306	1956
11	3	9	87	1759	1086	1966
12						
13						
14						
15						
16						
17						
18						
19						
20						



Long Pulse Radar Test Signal

Test Signal Name: LP_Signal_03

Number of Bursts in Trial: 9

Burst	Pulses per Burst	Chrip (MHz)	Pulse Width(us)	PRI-1 (us)	PRI-2 (us)	PRI-3 (us)
1	1	7	62.2	1023	-	-
2	3	7	85.5	1408	1788	1881
3	3	7	85.9	1081	1109	1008
4	3	7	92.8	1300	1770	1859
5	3	7	83.8	1429	1771	1126
6	3	7	92.5	1275	1820	1728
7	1	7	65.9	1570	-	-
8	2	7	81.2	1449	1379	-
9	3	7	90	1360	1094	1783
10						
11						
12						
13						
14						
15						
16						
17						
18						
19						
20						

Long Pulse Radar Test Signal

Test Signal Name: LP_Signal_04

Number of Bursts in Trial: 11

Burst	Pulses per Burst	Chrip (MHz)	Pulse Width(us)	PRI-1 (us)	PRI-2 (us)	PRI-3 (us)
1	1	9	65.4	1287	-	-
2	1	9	62.4	1816	-	-
3	1	9	57.2	1012	-	-
4	2	9	77	1267	1084	-
5	1	9	66.2	1734	-	-
6	3	9	85.8	1172	1189	1621
7	1	9	62.7	1863	-	-
8	2	9	68.7	1127	1494	-
9	1	9	55.5	2000	-	-
10	2	9	72.5	1528	1264	-
11	2	9	69.7	1741	1682	-
12						
13						
14						
15						
16						
17						
18						
19						
20						



Long Pulse Radar Test Signal

Test Signal Name: LP_Signal_05

Number of Bursts in Trial: 9

Burst	Pulses per Burst	Chrip (MHz)	Pulse Width(us)	PRI-1 (us)	PRI-2 (us)	PRI-3 (us)
1	3	7	91.4	1652	1611	1190
2	3	7	85.3	1645	1604	1677
3	3	7	88.2	1481	1442	1892
4	2	7	75.3	1840	1665	-
5	1	7	58.4	1080	-	-
6	3	7	91.1	1400	1005	1594
7	3	7	90.1	1520	1350	1743
8	1	7	64.8	1216	-	-
9	1	7	56.4	1289	-	-
10						
11						
12						
13						
14						
15						
16						
17						
18						
19						
20						



Long Pulse Radar Test Signal

Test Signal Name: LP_Signal_06

Number of Bursts in Trial: 18

Burst	Pulses per Burst	Chrip (MHz)	Pulse Width(us)	PRI-1 (us)	PRI-2 (us)	PRI-3 (us)
1	3	17	98.3	1687	1598	1810
2	2	17	81.7	1161	1034	-
3	2	17	80.4	1072	1200	-
4	3	17	98.5	1595	1185	1640
5	2	17	80	1933	1697	-
6	3	17	98.8	1846	1358	1171
7	2	17	78.1	1663	1845	-
8	2	17	71.4	1253	1985	-
9	2	17	69.9	1552	1198	-
10	2	17	73.1	1996	1187	-
11	3	17	96.8	1710	2000	1466
12	2	17	72.2	1616	1177	-
13	3	17	92.8	1374	1737	1605
14	3	17	95.1	1643	1669	1849
15	1	17	53.8	1707	-	-
16	1	17	62.6	1638	-	-
17	2	17	75	1750	1349	-
18	1	17	60.8	1942	-	-
19						
20						

Long Pulse Radar Test Signal

Test Signal Name: LP_Signal_07

Number of Bursts in Trial: 17

Burst	Pulses per Burst	Chrip (MHz)	Pulse Width(us)	PRI-1 (us)	PRI-2 (us)	PRI-3 (us)
1	2	17	79.5	1151	1873	-
2	2	17	83.3	1036	1704	-
3	2	17	75.8	1299	1027	-
4	3	17	86.8	1965	1954	1078
5	2	17	76.2	1013	1887	-
6	3	17	91.2	1271	1895	1720
7	2	17	71.9	1334	1237	-
8	3	17	95.6	1689	1058	1202
9	2	17	77	1974	1389	-
10	3	17	97.4	1847	1719	1664
11	1	17	60.6	1599	-	-
12	3	17	84.4	1953	1361	1480
13	3	17	92.7	1580	1475	1548
14	1	17	52.3	1347	-	-
15	1	17	51.1	1774	-	-
16	2	17	74.7	1653	1844	-
17	3	17	91.7	1521	1964	1436
18						
19						
20						

Long Pulse Radar Test Signal

Test Signal Name: LP_Signal_08

Number of Bursts in Trial: 14

Burst	Pulses per Burst	Chrip (MHz)	Pulse Width(us)	PRI-1 (us)	PRI-2 (us)	PRI-3 (us)
1	3	12	83.8	1307	1557	1911
2	2	12	82	1915	1884	-
3	1	12	58.7	1195	-	-
4	3	12	97.1	1317	1568	1454
5	2	12	67.5	1193	1499	-
6	1	12	57.7	1543	-	-
7	3	12	91.4	1343	1245	1315
8	3	12	98.9	1779	1044	1046
9	2	12	82.4	1125	1756	-
10	2	12	75.7	1959	1917	-
11	3	12	97.6	1660	1501	1453
12	3	12	98.7	1427	1411	1782
13	3	12	90.3	1452	1324	1701
14	3	12	84.3	1448	1900	1516
15						
16						
17						
18						
19						
20						

Long Pulse Radar Test Signal

Test Signal Name: LP_Signal_09

Number of Bursts in Trial: 17

Burst	Pulses per Burst	Chrip (MHz)	Pulse Width(us)	PRI-1 (us)	PRI-2 (us)	PRI-3 (us)
1	1	16	62.7	1909	-	-
2	3	16	83.5	1363	1613	1206
3	2	16	80.3	1438	1514	-
4	1	16	60.5	1395	-	-
5	2	16	81.6	1803	1205	-
6	2	16	80.7	1362	1251	-
7	1	16	61.5	1224	-	-
8	1	16	55.4	1703	-	-
9	3	16	89.3	1108	1866	1394
10	2	16	76.6	1043	1666	-
11	3	16	84.4	1183	1019	1321
12	2	16	71.7	1869	1331	-
13	2	16	80.8	1148	1727	-
14	1	16	60.8	1493	-	-
15	3	16	85.6	1865	1738	1642
16	2	16	80.4	1297	1890	-
17	3	16	94.5	1500	1242	1310
18						
19						
20						

Long Pulse Radar Test Signal

Test Signal Name: LP_Signal_10

Number of Bursts in Trial: 13

Burst	Pulses per Burst	Chrip (MHz)	Pulse Width(us)	PRI-1 (us)	PRI-2 (us)	PRI-3 (us)
1	2	11	71.1	1812	1555	-
2	2	11	68	1225	1592	-
3	1	11	53.3	1450	-	-
4	2	11	70.1	1627	1197	-
5	2	11	80.6	1545	1905	-
6	1	11	66.2	1768	-	-
7	1	11	63.8	1304	-	-
8	1	11	62	1433	-	-
9	2	11	75.6	1531	1107	-
10	3	11	84.5	1366	1670	1563
11	3	11	88	1425	1342	1879
12	3	11	93.9	1864	1180	1066
13	1	11	65.5	1620	-	-
14						
15						
16						
17						
18						
19						
20						

Long Pulse Radar Test Signal

Test Signal Name: LP_Signal_11

Number of Bursts in Trial: 14

Burst	Pulses per Burst	Chrip (MHz)	Pulse Width(us)	PRI-1 (us)	PRI-2 (us)	PRI-3 (us)
1	2	12	74.4	1619	1405	-
2	3	12	97	1277	1145	1992
3	3	12	86.7	1134	1074	1843
4	1	12	63	1814	-	-
5	3	12	97.9	1744	1117	1549
6	1	12	50.8	1212	-	-
7	1	12	62.4	1910	-	-
8	3	12	91.8	1135	1824	1155
9	2	12	69.6	1249	1130	-
10	3	12	94.1	1885	1968	1588
11	2	12	80.2	1447	1384	-
12	2	12	78.3	1927	1539	-
13	3	12	92.8	1851	1491	1809
14	2	12	82.1	1128	1226	-
15						
16						
17						
18						
19						
20						



Long Pulse Radar Test Signal

Test Signal Name: LP_Signal_12

Number of Bursts in Trial: 16

Burst	Pulses per Burst	Chrip (MHz)	Pulse Width(us)	PRI-1 (us)	PRI-2 (us)	PRI-3 (us)
1	1	15	62.6	1376	-	-
2	3	15	95.8	1415	1488	1975
3	2	15	76.9	1063	1772	-
4	2	15	80.6	1661	1711	-
5	1	15	63.3	1270	-	-
6	1	15	52	1455	-	-
7	2	15	81.2	1377	1589	-
8	2	15	76.4	1564	1629	-
9	2	15	80.6	1822	1510	-
10	3	15	87	1723	1787	1146
11	1	15	64.2	1925	-	-
12	2	15	82.1	1674	1995	-
13	2	15	67.2	1529	1538	-
14	1	15	66.4	1355	-	-
15	3	15	98.6	1637	1867	1519
16	1	15	55.9	1830	-	-
17						
18						
19						
20						

Long Pulse Radar Test Signal

Test Signal Name: LP_Signal_13

Number of Bursts in Trial: 17

Burst	Pulses per Burst	Chrip (MHz)	Pulse Width(us)	PRI-1 (us)	PRI-2 (us)	PRI-3 (us)
1	3	17	96.2	1346	1827	1861
2	2	17	73.5	1141	1685	-
3	1	17	61.6	1541	-	-
4	2	17	73.7	1222	1004	-
5	1	17	52.1	1749	-	-
6	3	17	87.4	1231	1671	1124
7	3	17	85.1	1998	1991	1780
8	2	17	67.7	1755	1351	-
9	1	17	62.9	1116	-	-
10	3	17	84.7	1614	1007	1250
11	2	17	68	1196	1850	-
12	1	17	52.6	1051	-	-
13	1	17	51.4	1364	-	-
14	2	17	74	1733	1957	-
15	2	17	73.2	1244	1630	-
16	3	17	91.9	1213	1035	1880
17	3	17	87.9	1133	1111	1667
18						
19						
20						

Long Pulse Radar Test Signal

Test Signal Name: LP_Signal_14

Number of Bursts in Trial: 19

Burst	Pulses per Burst	Chrip (MHz)	Pulse Width(us)	PRI-1 (us)	PRI-2 (us)	PRI-3 (us)
1	3	19	84.1	1359	1095	1769
2	1	19	51.2	1967	-	-
3	1	19	66.2	1987	-	-
4	3	19	98.7	1947	1837	1490
5	1	19	53.9	1860	-	-
6	2	19	74.7	1526	1504	-
7	3	19	91.8	1893	1989	1944
8	3	19	84.3	1785	1877	1218
9	3	19	98	1527	1383	1055
10	1	19	66.4	1852	-	-
11	3	19	99.8	1020	1639	1891
12	3	19	98.9	1556	1441	1356
13	1	19	65.7	1015	-	-
14	3	19	83.7	1648	1090	1296
15	3	19	96	1898	1952	1571
16	3	19	93.3	1963	1762	1422
17	1	19	63.6	1576	-	-
18	3	19	97.9	1140	1804	1440
19	1	19	56.6	1016	-	-
20						

Long Pulse Radar Test Signal

Test Signal Name: LP_Signal_15

Number of Bursts in Trial: 12

Burst	Pulses per Burst	Chrip (MHz)	Pulse Width(us)	PRI-1 (us)	PRI-2 (us)	PRI-3 (us)
1	1	11	66.6	1265	-	-
2	2	11	69	1178	1853	-
3	2	11	80	1106	1969	-
4	2	11	75.2	1886	1104	-
5	1	11	60.7	1908	-	-
6	1	11	59.2	1834	-	-
7	2	11	67.6	1322	1958	-
8	2	11	78.6	1607	1833	-
9	3	11	84.1	1823	1721	1431
10	2	11	78.6	1751	1445	-
11	2	11	75	1609	1795	-
12	1	11	56.5	1577	-	-
13						
14						
15						
16						
17						
18						
19						
20						

Long Pulse Radar Test Signal

Test Signal Name: LP_Signal_16

Number of Bursts in Trial: 18

Burst	Pulses per Burst	Chrip (MHz)	Pulse Width(us)	PRI-1 (us)	PRI-2 (us)	PRI-3 (us)
1	1	17	63.7	1294	-	-
2	2	17	72.3	1632	1413	-
3	3	17	94.3	1165	1451	1045
4	2	17	83.1	1097	1936	-
5	1	17	65.2	1247	-	-
6	2	17	82.4	1562	1811	-
7	1	17	57.3	1067	-	-
8	3	17	92.3	1186	1610	1458
9	3	17	98.8	1428	1482	1945
10	2	17	69.8	1484	1182	-
11	3	17	89.5	1175	1600	1385
12	1	17	54.1	1139	-	-
13	2	17	71	1524	1815	-
14	3	17	85.4	1344	1011	1625
15	2	17	68.8	1298	1581	-
16	3	17	97.2	1654	1434	1410
17	1	17	51	1093	-	-
18	2	17	72	1112	1474	-
19						
20						

Long Pulse Radar Test Signal

Test Signal Name: LP_Signal_17

Number of Bursts in Trial: 9

Burst	Pulses per Burst	Chrip (MHz)	Pulse Width(us)	PRI-1 (us)	PRI-2 (us)	PRI-3 (us)
1	1	6	59.4	1238	-	-
2	3	6	87.9	1662	1048	1725
3	2	6	76.2	1028	1257	-
4	1	6	66.5	1464	-	-
5	2	6	75.2	1918	1462	-
6	2	6	68.8	1578	1951	-
7	1	6	54.1	1986	-	-
8	2	6	76	1432	1790	-
9	1	6	55.5	1353	-	-
10						
11						
12						
13						
14						
15						
16						
17						
18						
19						
20						

Long Pulse Radar Test Signal

Test Signal Name: LP_Signal_18

Number of Bursts in Trial: 16

Burst	Pulses per Burst	Chrip (MHz)	Pulse Width(us)	PRI-1 (us)	PRI-2 (us)	PRI-3 (us)
1	3	15	89.5	1658	1765	1387
2	3	15	86.3	1209	1617	1705
3	3	15	96.2	1523	1032	1650
4	1	15	57.7	1070	-	-
5	1	15	55.7	1156	-	-
6	2	15	73	1525	1495	-
7	1	15	59.8	1731	-	-
8	3	15	86	1050	1188	1345
9	2	15	76.5	1380	1288	-
10	2	15	71.4	1089	1311	-
11	1	15	50.5	1984	-	-
12	2	15	80.7	1096	1021	-
13	1	15	60.8	1615	-	-
14	1	15	56.2	1706	-	-
15	1	15	55.5	1848	-	-
16	1	15	57.9	1684	-	-
17						
18						
19						
20						



Long Pulse Radar Test Signal

Test Signal Name: LP_Signal_19

Number of Bursts in Trial: 11

Burst	Pulses per Burst	Chrip (MHz)	Pulse Width(us)	PRI-1 (us)	PRI-2 (us)	PRI-3 (us)
1	3	9	96.8	1941	1870	1430
2	2	9	79.6	1517	1584	-
3	2	9	75.8	1817	1181	-
4	1	9	54.1	1305	-	-
5	2	9	75.4	1553	1129	-
6	3	9	90.4	1904	1978	1724
7	2	9	70.5	1208	1176	-
8	2	9	77.6	1894	1921	-
9	1	9	62	1460	-	-
10	2	9	69.1	1354	1443	-
11	3	9	87.1	1807	1040	1439
12						
13						
14						
15						
16						
17						
18						
19						
20						

Long Pulse Radar Test Signal

Test Signal Name: LP_Signal_20

Number of Bursts in Trial: 18

Burst	Pulses per Burst	Chrip (MHz)	Pulse Width(us)	PRI-1 (us)	PRI-2 (us)	PRI-3 (us)
1	2	18	80.4	1230	1672	-
2	3	18	97.3	1325	1715	1009
3	3	18	97.1	1388	1137	1502
4	2	18	75.4	1136	1688	-
5	2	18	79	1014	1049	-
6	3	18	89.3	1279	1401	1047
7	2	18	76.8	1602	1203	-
8	2	18	67.9	1585	1115	-
9	1	18	56	1132	-	-
10	1	18	52.6	1290	-	-
11	1	18	62	1386	-	-
12	3	18	83.7	1284	1276	1680
13	2	18	81.2	1550	1446	-
14	1	18	61.1	1341	-	-
15	3	18	99.4	1497	1485	1767
16	3	18	92.3	1919	1403	1981
17	2	18	75.7	1634	1509	-
18	1	18	50.4	1166	-	-
19						
20						

Long Pulse Radar Test Signal

Test Signal Name: LP_Signal_21

Number of Bursts in Trial: 17

Burst	Pulses per Burst	Chrip (MHz)	Pulse Width(us)	PRI-1 (us)	PRI-2 (us)	PRI-3 (us)
1	3	16	91.3	1747	1138	1467
2	3	16	98.6	1872	1255	1854
3	2	16	81.6	1031	1735	-
4	2	16	70.6	1513	1718	-
5	1	16	58.5	1612	-	-
6	2	16	78.5	1419	1835	-
7	3	16	89.3	1260	1939	1838
8	2	16	78.3	1683	1593	-
9	2	16	71.8	1053	1314	-
10	2	16	80.2	1030	1832	-
11	3	16	99.2	1566	1536	1572
12	1	16	65.8	1858	-	-
13	2	16	68.5	1201	1702	-
14	3	16	95.8	1686	1234	1668
15	3	16	86.6	1378	1098	1337
16	3	16	85.9	1318	1800	1673
17	2	16	79.5	1406	1391	-
18						
19						
20						

Long Pulse Radar Test Signal

Test Signal Name: LP_Signal_22

Number of Bursts in Trial: 11

Burst	Pulses per Burst	Chrip (MHz)	Pulse Width(us)	PRI-1 (us)	PRI-2 (us)	PRI-3 (us)
1	3	8	88.8	1152	1076	1263
2	2	8	79.4	1657	1623	-
3	3	8	96	1808	1316	1147
4	2	8	71.6	1930	1042	-
5	3	8	91.5	1748	1248	1223
6	3	8	84.1	1159	1295	1544
7	3	8	88.4	1716	1560	1950
8	3	8	99.6	1901	1121	1303
9	1	8	55.3	1157	-	-
10	3	8	84.7	1340	1268	1586
11	3	8	95.9	1194	1693	1144
12						
13						
14						
15						
16						
17						
18						
19						
20						

Long Pulse Radar Test Signal

Test Signal Name: LP_Signal_23

Number of Bursts in Trial: 17

Burst	Pulses per Burst	Chrip (MHz)	Pulse Width(us)	PRI-1 (us)	PRI-2 (us)	PRI-3 (us)
1	3	16	94.7	1062	1628	1922
2	3	16	93.1	1082	1948	1365
3	2	16	76.1	1114	1937	-
4	3	16	98.1	1913	1828	1712
5	3	16	94.8	1871	1457	1402
6	2	16	77.2	1855	1730	-
7	2	16	70.8	1191	1164	-
8	2	16	70.5	1786	1052	-
9	1	16	55.5	1960	-	-
10	1	16	59.8	1259	-	-
11	3	16	88.7	1091	1971	1404
12	2	16	68.6	1101	1239	-
13	3	16	86.2	1659	1463	1876
14	1	16	50.6	1940	-	-
15	2	16	67.4	1281	1676	-
16	3	16	96.7	1150	1928	1179
17	2	16	68.8	1367	1926	-
18						
19						
20						

Long Pulse Radar Test Signal

Test Signal Name: LP_Signal_24

Number of Bursts in Trial: 17

Burst	Pulses per Burst	Chrip (MHz)	Pulse Width(us)	PRI-1 (us)	PRI-2 (us)	PRI-3 (us)
1	3	16	90.2	1935	1079	1478
2	3	16	84.2	1757	1982	1606
3	1	16	66.3	1162	-	-
4	3	16	97.2	1976	1479	1302
5	3	16	95.3	1118	1818	1829
6	2	16	81.7	1426	1122	-
7	1	16	60.5	1309	-	-
8	1	16	62.8	1059	-	-
9	2	16	79.7	1077	1029	-
10	2	16	78.9	1970	1483	-
11	3	16	99.8	1472	1262	1313
12	1	16	64.5	1006	-	-
13	3	16	93.2	1717	1778	1169
14	2	16	71	1003	1899	-
15	1	16	53.2	1826	-	-
16	3	16	93.8	1819	1217	1232
17	3	16	93.5	1839	1221	1437
18						
19						
20						

Long Pulse Radar Test Signal

Test Signal Name: LP_Signal_25

Number of Bursts in Trial: 19

Burst	Pulses per Burst	Chrip (MHz)	Pulse Width(us)	PRI-1 (us)	PRI-2 (us)	PRI-3 (us)
1	3	18	83.6	1590	1646	1773
2	2	18	78.8	1532	1417	-
3	1	18	54.1	1739	-	-
4	1	18	51	1219	-	-
5	2	18	71.1	1857	1796	-
6	3	18	91.4	1883	1025	1603
7	2	18	74.9	1068	1983	-
8	1	18	66	1745	-	-
9	2	18	80.4	1211	1761	-
10	2	18	69.7	1558	1393	-
11	1	18	50.1	1997	-	-
12	1	18	60.8	1207	-	-
13	1	18	59.8	1017	-	-
14	2	18	70.9	1170	1754	-
15	2	18	74.1	1100	1369	-
16	3	18	87.4	1308	1327	1214
17	2	18	69.6	1060	1143	-
18	1	18	59.3	1547	-	-
19	2	18	71.1	1018	1912	-
20						

Long Pulse Radar Test Signal

Test Signal Name: LP_Signal_26

Number of Bursts in Trial: 16

Burst	Pulses per Burst	Chrip (MHz)	Pulse Width(us)	PRI-1 (us)	PRI-2 (us)	PRI-3 (us)
1	2	15	68.3	1085	1505	-
2	3	15	98.8	1700	1371	1522
3	3	15	99.5	1897	1103	1348
4	1	15	61.4	1120	-	-
5	1	15	65.5	1235	-	-
6	3	15	85.2	1789	1740	1649
7	1	15	65	1168	-	-
8	3	15	98.3	1291	1962	1326
9	2	15	71	1797	1540	-
10	1	15	56	1368	-	-
11	1	15	62.3	1282	-	-
12	3	15	88.8	1794	1409	1591
13	3	15	85.4	1791	1906	1518
14	2	15	74.9	1999	1473	-
15	3	15	92.8	1333	1554	1932
16	2	15	67	1511	1889	-
17						
18						
19						
20						

Long Pulse Radar Test Signal

Test Signal Name: LP_Signal_27

Number of Bursts in Trial: 19

Burst	Pulses per Burst	Chrip (MHz)	Pulse Width(us)	PRI-1 (us)	PRI-2 (us)	PRI-3 (us)
1	3	18	88.7	1601	1038	1083
2	3	18	92.6	1565	1537	1692
3	2	18	67.7	1696	1920	-
4	2	18	69.1	1227	1929	-
5	3	18	92.8	1412	1352	1631
6	3	18	91.4	1836	1608	1596
7	2	18	81.1	1486	1862	-
8	1	18	64.8	1533	-	-
9	1	18	61.9	1714	-	-
10	1	18	60.3	1293	-	-
11	1	18	52	1980	-	-
12	2	18	69.9	1233	1792	-
13	1	18	57.9	1173	-	-
14	2	18	75.6	1559	1057	-
15	2	18	77.2	1375	1801	-
16	2	18	73.6	1990	1142	-
17	1	18	61.7	1037	-	-
18	2	18	82.1	1736	1573	-
19	2	18	75.4	1372	1766	-
20						

Long Pulse Radar Test Signal

Test Signal Name: LP_Signal_28

Number of Bursts in Trial: 12

Burst	Pulses per Burst	Chrip (MHz)	Pulse Width(us)	PRI-1 (us)	PRI-2 (us)	PRI-3 (us)
1	3	10	94.7	1329	1955	1420
2	3	10	84.2	1184	1507	1266
3	2	10	67.3	1163	1784	-
4	3	10	88.6	1597	1973	1708
5	1	10	65.9	1236	-	-
6	1	10	56	1694	-	-
7	3	10	93.1	1821	1903	1283
8	1	10	53.9	1075	-	-
9	1	10	60	1856	-	-
10	2	10	68	1258	1328	-
11	2	10	80.9	1624	1695	-
12	1	10	64.8	1644	-	-
13						
14						
15						
16						
17						
18						
19						
20						

Long Pulse Radar Test Signal

Test Signal Name: LP_Signal_29

Number of Bursts in Trial: 16

Burst	Pulses per Burst	Chrip (MHz)	Pulse Width(us)	PRI-1 (us)	PRI-2 (us)	PRI-3 (us)
1	3	14	85.9	1370	1000	1154
2	2	14	67.1	1256	1753	-
3	1	14	53.8	1776	-	-
4	3	14	85.5	1655	1961	1399
5	3	14	94.8	1583	1102	1726
6	1	14	51.9	1357	-	-
7	3	14	90.2	1806	1979	1220
8	2	14	78.4	1923	1542	-
9	2	14	77	1061	1498	-
10	2	14	67.6	1071	1681	-
11	3	14	84.6	1416	1988	1764
12	3	14	99.5	1825	1722	1875
13	1	14	55.1	1470	-	-
14	2	14	83.1	1054	1946	-
15	3	14	95.2	1746	1618	1424
16	3	14	90.4	1709	1065	1069
17						
18						
19						

Long Pulse Radar Test Signal

Test Signal Name: LP_Signal_30

Number of Bursts in Trial: 18

Burst	Pulses per Burst	Chrip (MHz)	Pulse Width(us)	PRI-1 (us)	PRI-2 (us)	PRI-3 (us)
1	3	17	95.4	1574	1546	1798
2	2	17	78.8	1243	1775	-
3	3	17	88.8	1246	1842	1423
4	2	17	77	1199	1949	-
5	1	17	53.2	1073	-	-
6	3	17	99.5	1943	1229	1320
7	3	17	98.1	1907	1092	1119
8	2	17	82.9	1272	1254	-
9	2	17	71.3	1396	1192	-
10	1	17	54	1273	-	-
11	1	17	51.7	1278	-	-
12	1	17	63.1	1001	-	-
13	3	17	99.8	1690	1158	1656
14	3	17	87.5	1010	1330	1292
15	2	17	71	1934	1635	-
16	3	17	96.9	1285	1972	1228
17	2	17	81.1	1459	1503	-
18	3	17	95.6	1878	1418	1752
19						
20						



A.2 The Frequency Hopping Radar pattern

Hopping Frequency Sequence Name: HOP_FREQ_SEQ_01

Frequency (MHz)	0	1	2	3	4
0	5691	5382	5438	5668	5419
5	5471	5385	5437	5502	5347
10	5363	5555	5607	5409	5421
15	5649	5404	5284	5310	5305
20	5554	5508	5370	5441	5531
25	5488	5496	5582	5522	5602
30	5317	5307	5299	5281	5325
35	5390	5504	5563	5577	5714
40	5435	5613	5679	5513	5642
45	5587	5417	5336	5505	5681
50	5648	5594	5391	5256	5530
55	5262	5722	5387	5278	5614
60	5580	5705	5470	5296	5595
65	5655	5378	5443	5606	5625
70	5446	5413	5466	5717	5275
75	5711	5626	5339	5410	5424
80	5566	5301	5448	5641	5293
85	5573	5393	5367	5535	5515
90	5350	5633	5459	5467	5297
95	5279	5386	5715	5624	5403

Hopping Frequency Sequence Name: HOP_FREQ_SEQ_02

Frequency (MHz)	0	1	2	3	4
0	5471	5621	5374	5354	5261
5	5513	5310	5512	5568	5651
10	5672	5344	5648	5507	5442
15	5262	5434	5290	5355	5497
20	5562	5577	5408	5530	5504
25	5279	5699	5308	5556	5266
30	5681	5264	5514	5523	5432
35	5595	5359	5255	5628	5274
40	5696	5520	5278	5639	5516
45	5397	5419	5563	5259	5438
50	5470	5567	5307	5619	5463
55	5666	5575	5707	5502	5433
60	5551	5635	5338	5427	5481
65	5324	5644	5555	5661	5350
70	5691	5538	5703	5613	5687
75	5585	5686	5547	5553	5461
80	5422	5457	5636	5588	5367
85	5377	5478	5445	5545	5684
90	5610	5287	5462	5285	5323
95	5597	5258	5420	5467	5698



Hopping Frequency Sequence Name: HOP_FREQ_SEQ_03

Frequency (MHz)	0	1	2	3	4
0	5251	5385	5310	5515	5481
5	5555	5332	5587	5256	5383
10	5603	5705	5311	5702	5463
15	5350	5561	5393	5400	5689
20	5570	5268	5349	5522	5477
25	5642	5685	5427	5412	5590
30	5308	5696	5632	5682	5343
35	5571	5686	5252	5505	5542
40	5304	5458	5421	5636	5348
45	5280	5502	5524	5312	5325
50	5346	5358	5708	5286	5513
55	5288	5661	5692	5488	5283
60	5356	5404	5270	5370	5504
65	5697	5717	5397	5707	5616
70	5351	5663	5544	5655	5650
75	5613	5625	5330	5678	5321
80	5307	5316	5538	5637	5413
85	5638	5485	5627	5291	5357
90	5382	5437	5562	5451	5596
95	5473	5366	5395	5509	5464

Hopping Frequency Sequence Name: HOP_FREQ_SEQ_04

Frequency (MHz)	0	1	2	3	4
0	5506	5624	5721	5579	5323
5	5694	5257	5662	5419	5590
10	5437	5494	5352	5422	5484
15	5438	5688	5496	5348	5406
20	5578	5337	5290	5611	5547
25	5433	5537	5533	5516	5350
30	5556	5372	5456	5541	5710
35	5302	5523	5658	5553	5524
40	5387	5396	5661	5633	5277
45	5260	5585	5582	5365	5697
50	5444	5409	5584	5457	5379
55	5615	5407	5546	5520	5490
60	5703	5663	5705	5691	5668
65	5550	5636	5320	5512	5675
70	5304	5716	5639	5503	5527
75	5295	5659	5606	5485	5681
80	5459	5384	5648	5501	5378
85	5689	5631	5305	5317	5297
90	5294	5264	5454	5617	5435
95	5452	5469	5690	5507	5562



Hopping Frequency Sequence Name: HOP_FREQ_SEQ_05

Frequency (MHz)	0	1	2	3	4
0	5664	5388	5657	5265	5543
5	5261	5279	5262	5582	5419
10	5368	5283	5393	5617	5505
15	5526	5340	5599	5598	5489
20	5503	5328	5603	5520	5321
25	5486	5620	5658	5445	5513
30	5587	5705	5361	5277	5490
35	5319	5336	5467	5363	5567
40	5334	5426	5630	5584	5715
45	5668	5640	5418	5477	5476
50	5460	5508	5407	5304	5569
55	5597	5268	5367	5649	5655
60	5648	5495	5531	5259	5394
65	5499	5672	5530	5307	5478
70	5473	5719	5524	5615	5462
75	5496	5415	5327	5694	5377
80	5447	5301	5320	5572	5561
85	5449	5721	5643	5404	5482
90	5303	5488	5471	5392	5413
95	5602	5299	5454	5351	5675

Hopping Frequency Sequence Name: HOP_FREQ_SEQ_06

Frequency (MHz)	0	1	2	3	4
0	5444	5627	5593	5426	5385
5	5303	5679	5337	5648	5626
10	5299	5547	5434	5526	5517
15	5467	5702	5438	5412	5497
20	5572	5269	5692	5493	5587
25	5338	5464	5346	5531	5431
30	5470	5327	5382	5656	5416
35	5581	5590	5586	5381	5677
40	5650	5272	5666	5724	5513
45	5695	5276	5601	5374	5267
50	5352	5321	5511	5597	5608
55	5723	5280	5523	5312	5562
60	5345	5690	5454	5680	5448
65	5611	5362	5674	5281	5545
70	5344	5373	5591	5421	5465
75	5568	5514	5329	5496	5541
80	5510	5298	5515	5551	5414
85	5524	5641	5686	5652	5701
90	5647	5406	5265	5500	5585
95	5252	5387	5313	5675	5697



Hopping Frequency Sequence Name: HOP_FREQ_SEQ_07

Frequency (MHz)	0	1	2	3	4
0	5699	5391	5529	5587	5605
5	5442	5701	5412	5336	5358
10	5608	5475	5435	5547	5497
15	5708	5483	5604	5505	5263
20	5685	5684	5466	5665	5667
25	5450	5251	5573	5320	5427
30	5445	5631	5379	5555	5672
35	5264	5392	5516	5258	5334
40	5721	5675	5359	5659	5629
45	5703	5562	5686	5431	5570
50	5468	5477	5502	5381	5309
55	5432	5510	5635	5256	5280
60	5626	5418	5397	5647	5572
65	5469	5559	5714	5255	5347
70	5600	5470	5380	5337	5558
75	5549	5291	5439	5277	5670
80	5673	5710	5454	5584	5261
85	5554	5648	5425	5521	5299
90	5288	5609	5602	5307	5484
95	5285	5303	5317	5723	5444

Hopping Frequency Sequence Name: HOP_FREQ_SEQ_08

Frequency (MHz)	0	1	2	3	4
0	5479	5630	5465	5273	5447
5	5484	5626	5487	5499	5662
10	5539	5697	5516	5568	5693
15	5624	5336	5431	5321	5416
20	5429	5723	5298	5439	5363
25	5614	5395	5554	5285	5712
30	5684	5384	5660	5308	5674
35	5694	5288	5279	5417	5306
40	5452	5438	5623	5574	5718
45	5274	5655	5442	5717	5480
50	5419	5579	5673	5613	5397
55	5254	5514	5656	5692	5578
60	5658	5561	5675	5580	5563
65	5678	5669	5716	5346	5683
70	5404	5361	5265	5311	5449
75	5446	5339	5659	5530	5543
80	5533	5297	5258	5670	5430
85	5454	5547	5453	5519	5602
90	5719	5502	5418	5711	5548
95	5619	5362	5468	5649	5406

Hopping Frequency Sequence Name: HOP_FREQ_SEQ_09

Frequency (MHz)	0	1	2	3	4
0	5637	5394	5401	5434	5667
5	5526	5648	5562	5662	5470
10	5486	5557	5350	5589	5306
15	5276	5439	5476	5513	5424
20	5498	5664	5290	5412	5629
25	5466	5501	5658	5319	5279
30	5670	5341	5400	5397	5261
35	5379	5550	5570	5695	5291
40	5521	5464	5339	5715	5678
45	5538	5525	5300	5533	5358
50	5374	5552	5361	5369	5385
55	5310	5593	5365	5395	5504
60	5615	5442	5295	5622	5614
65	5631	5543	5383	5324	5450
70	5298	5422	5653	5323	5705
75	5511	5320	5314	5461	5321
80	5625	5357	5512	5607	5645
85	5387	5349	5539	5270	5430
90	5255	5636	5417	5549	5556
95	5628	5509	5352	5410	5672

Hopping Frequency Sequence Name: HOP_FREQ_SEQ_10

Frequency (MHz)	0	1	2	3	4
0	5417	5633	5337	5595	5509
5	5568	5670	5637	5253	5601
10	5304	5275	5598	5545	5610
15	5297	5403	5542	5521	5705
20	5432	5664	5605	5379	5385
25	5517	5415	5704	5287	5353
30	5321	5559	5298	5615	5709
35	5692	5400	5470	5443	5345
40	5609	5604	5402	5482	5712
45	5510	5518	5608	5261	5586
50	5571	5550	5715	5575	5278
55	5305	5460	5339	5500	5691
60	5600	5722	5530	5567	5702
65	5330	5561	5643	5719	5658
70	5446	5426	5346	5552	5310
75	5453	5622	5398	5257	5373
80	5492	5475	5570	5625	5481
85	5442	5260	5354	5265	5352
90	5607	5597	5262	5357	5527
95	5690	5364	5472	5533	5454



Hopping Frequency Sequence Name: HOP_FREQ_SEQ_11

Frequency (MHz)	0	1	2	3	4
0	5672	5397	5273	5659	5254
5	5707	5595	5712	5416	5430
10	5710	5539	5261	5265	5631
15	5385	5530	5645	5469	5422
20	5343	5258	5643	5371	5358
25	5308	5267	5432	5488	5387
30	5460	5448	5255	5483	5415
35	5658	5714	5498	5620	5444
40	5687	5340	5722	5331	5439
45	5691	5319	5639	5458	5585
50	5251	5291	5664	5576	5627
55	5648	5293	5690	5510	5571
60	5376	5695	5512	5534	5253
65	5507	5466	5668	5597	5656
70	5318	5624	5296	5553	5374
75	5494	5419	5473	5252	5685
80	5351	5692	5544	5661	5637
85	5260	5630	5457	5370	5557
90	5522	5533	5716	5572	5292
95	5527	5517	5352	5489	5618

Hopping Frequency Sequence Name: HOP_FREQ_SEQ_12

Frequency (MHz)	0	1	2	3	4
0	5452	5636	5684	5345	5571
5	5274	5617	5312	5579	5637
10	5544	5328	5302	5363	5652
15	5473	5560	5651	5514	5614
20	5351	5424	5584	5460	5331
25	5671	5594	5635	5592	5421
30	5502	5434	5687	5710	5581
35	5510	5534	5380	5392	5278
40	5487	5368	5478	5299	5377
45	5692	5723	5364	5427	5342
50	5399	5361	5722	5405	5707
55	5445	5505	5385	5457	5463
60	5554	5550	5667	5633	5488
65	5588	5318	5379	5556	5698
70	5253	5650	5586	5562	5454
75	5504	5320	5607	5381	5561
80	5357	5638	5610	5593	5552
85	5660	5612	5618	5280	5539
90	5275	5485	5309	5582	5598
95	5347	5371	5721	5568	5358



Hopping Frequency Sequence Name: HOP_FREQ_SEQ_13

Frequency (MHz)	0	1	2	3	4
0	5707	5400	5620	5506	5316
5	5542	5387	5267	5369	5475
10	5689	5343	5558	5673	5561
15	5687	5279	5559	5331	5359
20	5493	5525	5452	5304	5462
25	5543	5363	5696	5358	5544
30	5323	5644	5688	5409	5433
35	5720	5365	5306	5426	5448
40	5694	5691	5252	5325	5675
45	5458	5382	5338	5648	5610
50	5715	5603	5393	5464	5697
55	5418	5549	5579	5595	5526
60	5416	5634	5550	5499	5295
65	5380	5496	5490	5566	5669
70	5698	5480	5608	5390	5656
75	5547	5704	5609	5335	5706
80	5532	5281	5333	5388	5545
85	5670	5552	5541	5556	5269
90	5528	5663	5391	5575	5377
95	5714	5594	5326	5637	5582

Hopping Frequency Sequence Name: HOP_FREQ_SEQ_14

Frequency (MHz)	0	1	2	3	4
0	5390	5639	5556	5667	5633
5	5358	5564	5462	5333	5576
10	5406	5478	5384	5278	5694
15	5552	5339	5382	5604	5620
20	5270	5659	5466	5541	5277
25	5350	5395	5469	5325	5392
30	5586	5687	5601	5428	5561
35	5253	5456	5674	5579	5459
40	5533	5558	5629	5322	5438
45	5465	5396	5701	5400	5591
50	5304	5444	5553	5520	5362
55	5262	5310	5345	5387	5288
60	5715	5602	5303	5442	5691
65	5515	5608	5530	5275	5411
70	5559	5351	5680	5568	5276
75	5513	5443	5644	5709	5355
80	5555	5272	5391	5616	5461
85	5493	5617	5298	5542	5551
90	5721	5596	5703	5343	5692
95	5566	5618	5707	5452	5313



Hopping Frequency Sequence Name: HOP_FREQ_SEQ_15

Frequency (MHz)	0	1	2	3	4
0	5645	5500	5492	5353	5378
5	5497	5489	5537	5496	5405
10	5715	5267	5425	5473	5640
15	5466	5485	5552	5337	5278
20	5253	5504	5533	5250	5616
25	5344	5672	5526	5426	5673
30	5558	5546	5335	5548	5523
35	5547	5470	5257	5373	5372
40	5263	5567	5635	5319	5436
45	5321	5454	5279	5287	5467
50	5480	5495	5642	5721	5684
55	5450	5487	5542	5358	5320
60	5389	5434	5604	5514	5464
65	5644	5265	5545	5689	5631
70	5284	5720	5656	5527	5273
75	5374	5419	5494	5688	5553
80	5301	5418	5564	5444	5708
85	5579	5556	5361	5668	5412
90	5593	5707	5654	5658	5381
95	5457	5272	5647	5516	5686

Hopping Frequency Sequence Name: HOP_FREQ_SEQ_16

Frequency (MHz)	0	1	2	3	4
0	5425	5264	5428	5514	5695
5	5539	5511	5612	5659	5646
10	5531	5466	5668	5261	5253
15	5496	5588	5597	5529	5286
20	5419	5445	5622	5698	5504
25	5671	5400	5630	5460	5292
30	5562	5515	5487	5271	5565
35	5260	5266	5507	5287	5686
40	5346	5505	5316	5365	5301
45	5631	5415	5332	5552	5721
50	5656	5546	5256	5544	5628
55	5638	5441	5593	5361	5707
60	5449	5570	5334	5527	5431
65	5715	5413	5583	5572	5437
70	5492	5325	5420	5472	5632
75	5486	5620	5494	5465	5475
80	5566	5681	5481	5549	5284
85	5347	5647	5639	5273	5326
90	5660	5397	5692	5263	5349
95	5474	5327	5414	5568	5658



Hopping Frequency Sequence Name: HOP_FREQ_SEQ_17

Frequency (MHz)	0	1	2	3	4
0	5680	5503	5364	5675	5440
5	5581	5436	5687	5347	5344
10	5577	5320	5507	5291	5282
15	5341	5623	5594	5642	5721
20	5672	5585	5386	5614	5671
25	5392	5523	5603	5259	5494
30	5334	5548	5472	5501	5261
35	5566	5704	5351	5634	5660
40	5298	5622	5429	5346	5640
45	5410	5294	5281	5714	5473
50	5385	5439	5597	5357	5442
55	5367	5475	5254	5395	5308
60	5655	5678	5578	5260	5376
65	5670	5353	5377	5441	5362
70	5619	5307	5707	5295	5397
75	5406	5387	5321	5608	5445
80	5589	5456	5717	5676	5462
85	5629	5544	5449	5479	5489
90	5602	5368	5669	5673	5336
95	5611	5465	5666	5361	5491

Hopping Frequency Sequence Name: HOP_FREQ_SEQ_18

Frequency (MHz)	0	1	2	3	4
0	5363	5267	5300	5361	5282
5	5623	5458	5287	5510	5648
10	5411	5681	5645	5486	5303
15	5332	5275	5697	5687	5438
20	5680	5654	5424	5703	5644
25	5658	5472	5331	5528	5473
30	5437	5429	5716	5413	5289
35	5368	5442	5430	5338	5461
40	5512	5284	5308	5407	5601
45	5261	5322	5531	5704	5436
50	5665	5419	5349	5498	5474
55	5649	5707	5425	5321	5502
60	5323	5264	5311	5655	5614
65	5599	5573	5566	5392	5390
70	5487	5404	5259	5494	5718
75	5318	5446	5674	5250	5662
80	5560	5634	5627	5584	5334
85	5630	5672	5663	5405	5470
90	5508	5696	5685	5389	5525
95	5596	5292	5465	5720	5520



Hopping Frequency Sequence Name: HOP_FREQ_SEQ_19

Frequency (MHz)	0	1	2	3	4
0	5618	5506	5711	5425	5502
5	5287	5383	5362	5576	5380
10	5342	5470	5686	5681	5324
15	5420	5402	5325	5635	5630
20	5688	5345	5365	5695	5617
25	5546	5437	5564	5562	5515
30	5326	5386	5359	5662	5584
35	5410	5533	5701	5588	5601
40	5300	5692	5697	5548	5404
45	5530	5716	5405	5492	5394
50	5591	5349	5612	5699	5620
55	5391	5266	5303	5671	5361
60	5687	5334	5577	5366	5465
65	5260	5594	5279	5638	5378
70	5393	5494	5463	5363	5430
75	5282	5322	5418	5271	5499
80	5385	5292	5443	5491	5250
85	5270	5625	5277	5678	5357
90	5532	5320	5579	5622	5680
95	5408	5723	5417	5605	5639

Hopping Frequency Sequence Name: HOP_FREQ_SEQ_20

Frequency (MHz)	0	1	2	3	4
0	5398	5270	5647	5586	5344
5	5329	5405	5437	5264	5587
10	5273	5259	5252	5401	5345
15	5508	5529	5428	5680	5347
20	5599	5414	5306	5309	5590
25	5337	5640	5668	5596	5557
30	5312	5343	5574	5339	5307
35	5549	5624	5594	5266	5612
40	5614	5300	5635	5313	5362
45	5696	5488	5550	5447	5381
50	5603	5275	5709	5689	5685
55	5257	5403	5490	5494	5393
60	5377	5686	5641	5288	5684
65	5630	5656	5664	5710	5461
70	5493	5721	5439	5700	5302
75	5402	5368	5399	5426	5434
80	5280	5355	5440	5628	5372
85	5370	5632	5605	5352	5485
90	5634	5547	5591	5639	5578
95	5387	5595	5543	5629	5282



Hopping Frequency Sequence Name: HOP_FREQ_SEQ_21

Frequency (MHz)	0	1	2	3	4
0	5653	5509	5583	5272	5564
5	5371	5330	5512	5427	5416
10	5582	5523	5293	5499	5366
15	5596	5559	5531	5250	5539
20	5607	5580	5344	5301	5563
25	5700	5600	5368	5297	5630
30	5696	5676	5300	5314	5588
35	5602	5688	5715	5390	5419
40	5526	5550	5383	5573	5456
45	5398	5291	5571	5608	5500
50	5268	5479	5489	5326	5420
55	5532	5686	5593	5309	5465
60	5522	5542	5253	5570	5704
65	5258	5633	5666	5391	5556
70	5360	5404	5447	5496	5415
75	5659	5271	5511	5380	5678
80	5536	5713	5515	5437	5406
85	5648	5335	5586	5378	5650
90	5312	5668	5429	5656	5270
95	5476	5269	5698	5266	5277

Hopping Frequency Sequence Name: HOP_FREQ_SEQ_22

Frequency (MHz)	0	1	2	3	4
0	5433	5273	5519	5406	5413
5	5352	5587	5590	5623	5513
10	5312	5334	5694	5387	5686
15	5537	5673	5353	5615	5649
20	5285	5390	5536	5491	5452
25	5571	5401	5664	5263	5565
30	5257	5529	5265	5422	5428
35	5661	5669	5440	5389	5466
40	5511	5696	5492	5695	5559
45	5654	5569	5553	5533	5355
50	5665	5377	5509	5335	5476
55	5719	5640	5308	5506	5436
60	5651	5707	5402	5627	5301
65	5582	5605	5698	5351	5638
70	5596	5419	5391	5618	5715
75	5642	5557	5458	5455	5317
80	5578	5434	5601	5531	5368
85	5708	5659	5678	5637	5626
90	5370	5340	5318	5689	5657
95	5254	5374	5723	5326	5464



Hopping Frequency Sequence Name: HOP_FREQ_SEQ_23

Frequency (MHz)	0	1	2	3	4
0	5591	5512	5455	5594	5626
5	5552	5277	5662	5656	5355
10	5347	5673	5375	5414	5408
15	5675	5338	5640	5718	5545
20	5526	5340	5701	5382	5509
25	5379	5401	5299	5602	5698
30	5305	5551	5689	5647	5514
35	5620	5394	5519	5457	5451
40	5703	5646	5449	5461	5489
45	5527	5539	5359	5627	5606
50	5420	5706	5366	5428	5598
55	5536	5323	5335	5325	5407
60	5397	5618	5709	5453	5722
65	5513	5531	5641	5433	5441
70	5645	5516	5599	5268	5367
75	5577	5587	5287	5700	5439
80	5707	5667	5573	5469	5334
85	5321	5434	5685	5671	5376
90	5643	5399	5568	5505	5324
95	5639	5571	5346	5312	5712

Hopping Frequency Sequence Name: HOP_FREQ_SEQ_24

Frequency (MHz)	0	1	2	3	4
0	5371	5276	5391	5280	5468
5	5594	5299	5262	5344	5659
10	5278	5462	5416	5609	5429
15	5288	5465	5268	5534	5409
20	5264	5471	5482	5267	5253
25	5405	5706	5257	5444	5440
30	5646	5387	5666	5533	5610
35	5350	5500	5365	5542	5254
40	5290	5701	5486	5456	5519
45	5442	5685	5485	5479	5687
50	5359	5523	5548	5591	5619
55	5281	5434	5562	5563	5541
60	5376	5668	5714	5480	5580
65	5265	5513	5622	5717	5502
70	5699	5592	5721	5536	5556
75	5310	5368	5420	5484	5680
80	5354	5633	5704	5331	5613
85	5337	5624	5256	5568	5511
90	5642	5550	5388	5670	5427
95	5576	5453	5455	5329	5292



Hopping Frequency Sequence Name: HOP_FREQ_SEQ_25

Frequency (MHz)	0	1	2	3	4
0	5626	5515	5327	5441	5688
5	5636	5699	5337	5507	5391
10	5684	5251	5457	5329	5450
15	5376	5592	5371	5333	5454
20	5542	5575	5680	5463	5455
25	5533	5677	5608	5335	5291
30	5486	5426	5603	5602	5440
35	5638	5672	5701	5621	5275
40	5279	5381	5703	5369	5483
45	5288	5499	5525	5646	5615
50	5572	5361	5718	5530	5301
55	5657	5589	5711	5405	5306
60	5438	5252	5563	5605	5373
65	5537	5429	5616	5475	5425
70	5411	5488	5702	5344	5697
75	5495	5428	5430	5414	5401
80	5261	5315	5610	5322	5389
85	5328	5466	5694	5663	5476
90	5596	5323	5586	5360	5433
95	5713	5564	5346	5347	5303

Hopping Frequency Sequence Name: HOP_FREQ_SEQ_26

Frequency (MHz)	0	1	2	3	4
0	5406	5279	5263	5505	5530
5	5678	5721	5412	5670	5598
10	5518	5515	5595	5427	5471
15	5367	5622	5474	5281	5646
20	5453	5644	5621	5552	5428
25	5421	5529	5336	5439	5325
30	5528	5315	5560	5342	5592
35	5458	5317	5417	5290	5517
40	5641	5609	5480	5692	5479
45	5608	5704	5668	5362	5712
50	5419	5581	5487	5533	5424
55	5359	5496	5635	5698	5550
60	5302	5503	5657	5378	5652
65	5307	5675	5703	5483	5705
70	5673	5454	5397	5557	5382
75	5416	5425	5391	5486	5452
80	5715	5308	5380	5344	5647
85	5571	5525	5547	5576	5363
90	5402	5287	5538	5445	5500
95	5590	5476	5252	5446	5432



Hopping Frequency Sequence Name: HOP_FREQ_SEQ_27

Frequency (MHz)	0	1	2	3	4
0	5564	5518	5674	5666	5275
5	5342	5646	5487	5261	5427
10	5449	5304	5636	5622	5492
15	5455	5274	5480	5326	5363
20	5461	5335	5659	5544	5401
25	5687	5381	5539	5640	5359
30	5570	5679	5517	5460	5366
35	5656	5378	5505	5310	5581
40	5631	5600	5579	5374	5574
45	5621	5459	5691	5287	5721
50	5724	5491	5595	5632	5576
55	5681	5380	5612	5313	5686
60	5454	5669	5582	5495	5609
65	5426	5603	5561	5327	5591
70	5470	5506	5652	5557	5330
75	5649	5413	5269	5670	5668
80	5438	5647	5553	5515	5322
85	5723	5618	5722	5717	5475
90	5309	5601	5344	5604	5690
95	5445	5685	5457	5368	5436

Hopping Frequency Sequence Name: HOP_FREQ_SEQ_28

Frequency (MHz)	0	1	2	3	4
0	5344	5282	5610	5352	5592
5	5384	5668	5562	5424	5634
10	5380	5665	5677	5342	5513
15	5543	5401	5583	5371	5555
20	5469	5501	5600	5633	5374
25	5575	5330	5267	5269	5393
30	5709	5474	5675	5518	5476
35	5517	5596	5581	5356	5593
40	5470	5683	5614	5571	5453
45	5299	5723	5514	5367	5296
50	5504	5324	5325	5273	5378
55	5272	5537	5441	5252	5549
60	5287	5276	5627	5349	5362
65	5309	5724	5333	5366	5625
70	5372	5713	5315	5271	5445
75	5548	5428	5717	5697	5443
80	5618	5564	5680	5667	5652
85	5615	5262	5494	5512	5334
90	5306	5421	5305	5522	5620
95	5413	5619	5284	5552	5714



Hopping Frequency Sequence Name: HOP_FREQ_SEQ_29

Frequency (MHz)	0	1	2	3	4
0	5599	5521	5546	5513	5337
5	5426	5593	5637	5587	5366
10	5689	5454	5718	5537	5534
15	5631	5528	5686	5416	5272
20	5380	5570	5541	5625	5347
25	5657	5373	5427	5276	5554
30	5431	5415	5292	5296	5656
35	5687	5377	5509	5604	5309
40	5291	5455	5282	5568	5382
45	5322	5306	5352	5401	5472
50	5259	5279	5327	5646	5696
55	5591	5470	5514	5507	5437
60	5482	5273	5553	5592	5585
65	5700	5566	5559	5632	5490
70	5321	5529	5433	5601	5331
75	5338	5317	5325	5697	5658
80	5684	5406	5263	5694	5260
85	5503	5265	5384	5617	5606
90	5365	5622	5545	5552	5522
95	5511	5567	5336	5707	5663

Hopping Frequency Sequence Name: HOP_FREQ_SEQ_30

Frequency (MHz)	0	1	2	3	4
0	5379	5382	5482	5674	5654
5	5565	5615	5712	5275	5573
10	5620	5718	5284	5257	5555
15	5622	5655	5314	5364	5561
20	5388	5261	5714	5320	5254
25	5606	5576	5477	5461	5318
30	5443	5630	5444	5494	5698
35	5303	5648	5662	5518	5720
40	5471	5393	5522	5689	5302
45	5465	5405	5666	5594	5310
50	5625	5590	5604	5650	5684
55	5289	5485	5636	5602	5427
60	5580	5476	5538	5311	5271
65	5391	5524	5293	5490	5515
70	5436	5442	5480	5290	5554
75	5458	5460	5306	5474	5671
80	5570	5326	5691	5455	5424
85	5345	5703	5479	5657	5613
90	5710	5560	5586	5404	5440
95	5528	5417	5605	5642	5675

--- END ---