



# FCC Test Report

**Equipment** : Wireless LAN Network Module  
**Brand Name** : Arcadyan  
**Model No.** : WN9711BTAAC-YA  
**FCC ID** : RAXWN9711  
**Standard** : 47 CFR FCC Part 15.247  
**Operating Band** : 2400 MHz – 2483.5 MHz  
**Applicant** : Arcadyan Technology Corporation  
No.8, Sec.2, Guangfu Rd.,Hsinchu, 30071 Taiwan  
**Manufacturer** : Arcadyan Technology Corporation  
No.8, Sec.2, Guangfu Rd.,Hsinchu, 30071 Taiwan

The product sample received on Jun. 05, 2017 and completely tested on Dec. 13, 2017. We, SPORTON, would like to declare that the tested sample has been evaluated in accordance with the procedures given inanes and shown compliance with the applicable technical standards.

The test results in this report apply exclusively to the tested model / sample. Without written approval of SPORTON INTERNATIONALINC., the test report shall not be reproduced except in full.

  
Cliff Chang  
SPORTON INTERNATIONAL INC.





# Table of Contents

**1 GENERAL DESCRIPTION .....5**

1.1 Information.....5

1.2 Testing Applied Standards .....9

1.3 Testing Location Information .....9

1.4 Measurement Uncertainty .....9

**2 TEST CONFIGURATION OF EUT .....10**

2.1 The Worst Case Measurement Configuration.....10

2.2 EUT Operation during Test .....11

2.3 Accessories .....12

2.4 Support Equipment.....12

2.5 Test Setup Diagram .....13

**3 TRANSMITTER TEST RESULT .....16**

3.1 AC Power-line Conducted Emissions .....16

3.2 Emissions in Restricted Frequency Bands.....17

**4 TEST EQUIPMENT AND CALIBRATION DATA .....20**

**APPENDIX A. PHOTOGRAPHS OF EUT**

**APPENDIX B. TEST RESULTS OF AC POWER-LINE CONDUCTED EMISSIONS**

**APPENDIX C. TEST RESULTS OF EMISSIONS IN RESTRICTED FREQUENCY BANDS**

**APPENDIX D. TEST RESULTS OF RADIATED EMISSION CO-LOCATION**

**APPENDIX E. TEST PHOTOS**



### Summary of Test Result

Conformance Test Specifications				
Report Clause	Ref. Std. Clause	Description	Limit	Result
1.1.2	15.203	Antenna Requirement	FCC 15.203	Complied
3.1	15.207	AC Power-line Conducted Emissions	FCC 15.207	Complied
3.2	15.247(d)	Emissions in Restricted Frequency Bands	Restricted Bands: FCC 15.209	Complied



### Revision History

Report No.	Version	Description	Issued Date
FR770523-01AC	Rev. 01	Initial issue of report	Dec. 22, 2017



# 1 General Description

## 1.1 Information

### 1.1.1 RF General Information

Frequency Range (MHz)	Bluetooth Version	Ch. Frequency (MHz)	Channel Number
2400-2483.5	BR / EDR	2402-2480	0-78 [79]

Band	Mode	BWch (MHz)	Nant
2.4-2.4835GHz	BT-BR(1Mbps)	1	1TX
2.4-2.4835GHz	BT-EDR(2Mbps)	1	1TX
2.4-2.4835GHz	BT-EDR(3Mbps)	1	1TX

Note:

- ♦ Bluetooth BR uses a GFSK (1Mbps).
- ♦ Bluetooth EDR uses a combination of  $\pi/4$ -DQPSK (2Mbps) and 8DPSK (3Mbps).
- ♦ Bluetooth BR/EDR uses as a system using FHSS modulation.
- ♦ BWch is the nominal channel bandwidth.
- ♦ Nss-Min is the minimum number of spatial streams.
- ♦ Nant is the number of outputs. e.g., 2(2, 3) means have 2 outputs for port 2 and port 3. 2 means have 2 outputs for port 1 and port 2.



1.1.2 Antenna Information

Set	Ant.	Brand	Model Name	Antenna Type	Connector	Gain (dBi)	
						2.4GHz	5GHz
1	1	ACON	AEMEE-10000	Dipole Antenna	Reversed-SMA	3.24	4.54
	2	ACON	AEMEE-10000	Dipole Antenna	Reversed-SMA	3.24	4.54
Set	Ant.	Brand	Model Name	Antenna Type	Connector	Gain (dBi)	
						2.4GHz	5GHz
2	3	ACON	AEP6P-100009	PIFA Antenna	I-PEX	3.15	3.15
	4	ACON	AEP6P-100010	PIFA Antenna	I-PEX	2.30	3.15

Dipole Cable	Brand	Model Name	Cable Length (mm)	Cable Loss (dB)		True Gain (dBi)	
				2.4GHz / BT	5GHz	2.4GHz / BT	5GHz
1	ACON	AEC8P-1000000 (Gray)	30	0.08	0.12	3.16	4.42
		AEC8P-1000001 (Black)					
2	ACON	AEC8P-1000002 (Gray)	50	0.13	0.19	3.11	4.35
		AEC8P-1000003 (Black)					
3	ACON	AEC8P-1000004 (Gray)	70	0.19	0.27	3.05	4.27
		AEC8P-1000005 (Black)					
4	ACON	AEC8P-1000006 (Gray)	90	0.24	0.35	3.00	4.19
		AEC8P-1000007 (Black)					
5	ACON	AEC8P-1000008 (Gray)	120	0.32	0.46	2.92	4.08
		AEC8P-1000009 (Black)					
6	ACON	AEC8P-1000010 (Gray)	160	0.43	0.62	2.81	3.92
		AEC8P-1000011 (Black)					
7	ACON	AEC8P-1000012 (Gray)	200	0.54	0.77	2.70	3.77
		AEC8P-1000013 (Black)					
8	ACON	AEC8P-1000014 (Gray)	240	0.64	0.93	2.60	3.61
		AEC8P-1000015 (Black)					
9	ACON	AEC8P-1000016 (Gray)	280	0.75	1.08	2.49	3.46
		AEC8P-1000017 (Black)					
10	ACON	AEC8P-1000018 (Gray)	320	0.86	1.24	2.38	3.30
		AEC8P-1000019 (Black)					
11	ACON	AEC8P-1000020 (Gray)	360	0.96	1.39	2.28	3.15
		AEC8P-1000021 (Black)					
12	ACON	AEC8P-1000022 (Gray)	400	1.07	1.54	2.17	3.00
		AEC8P-1000023 (Black)					



Dipole Cable	Brand	Model Name	Cable Length (mm)	Cable Loss (dB)		True Gain (dBi)	
				2.4GHz / BT	5GHz	2.4GHz / BT	5GHz
13	ACON	AEC8P-1000024 (Gray) AEC8P-1000025 (Black)	450	1.21	1.74	2.03	2.80
14	ACON	AEC8P-1000026 (Gray) AEC8P-1000027 (Black)	500	1.34	1.93	1.90	2.61
PIFA Cable	Brand	Model Name	Cable Length (mm)	True Gain (dBi)			
				2.4GHz / BT		5GHz	
15	ACON	AEP6P-100009 (Black)	300	3.15		3.15	
		AEP6P-100010 (Gray)	400	2.30		3.15	

Note: The EUT has two radios, Radio 1 supports WLAN 2.4GHz, WLAN 5GHz and Bluetooth function, Radio 2 supports WLAN 5GHz function only.

The EUT has two sets of antenna and there are two antennas for each set.

Dipole Antenna collocate with 14 set cable selling, only the higher gain antenna “cable 1” was tested and recorded in the report.

PIFA Antenna collocate with 1 set cable selling.

**For Radio 1 (WLAN 2.4GHz, WLAN 5GHz and Bluetooth):**

**For IEEE 802.11a/b/g/n/ac mode (1TX/1RX):**

Dipole Antenna: Only Ant. 1 (Port 1) can be used as transmitting/receiving antenna.

PIFA Antenna: Only Ant. 3 (Port 1) can be used as transmitting/receiving antenna.

**For Radio 2 (WLAN 5GHz):**

**For IEEE 802.11a/n/ac mode (1TX/1RX):**

Dipole Antenna: Only Ant. 2 (Port 1) can be used as transmitting/receiving antenna.

PIFA Antenna: Only Ant. 4 (Port 1) can be used as transmitting/receiving antenna.

**1.1.3 Mode Test Duty Cycle**

Mode	DC	DCF(dB)	T(s)	VBW(Hz) ≥ 1/T
BT-BR(1Mbps)	0.785	1.051	2.888m	1k
BT-EDR(2Mbps)	0.382	4.179	1.53m	1k
BT-EDR(3Mbps)	0.312	5.058	1.073m	1k

**1.1.4 EUT Operational Condition**

<b>EUT Power Type</b>	From host system
-----------------------	------------------



1.1.5 Table for Class II Change

This product is an extension of original one reported under Sporton project number: FR770523AC

Below is the table for the change of the product with respect to the original one.

Modifications	Performance Checking
<ol style="list-style-type: none"> <li>1. Adding a CPU shielding frame.</li> <li>2. Adding a CPU shielding cover.</li> <li>3. Adding a Thermal pad on CPU.</li> </ol>	<p>For Dipole Antenna necessary to evaluated as below:</p> <ol style="list-style-type: none"> <li>1. Emissions in Restricted Frequency Bands Below 1GHz.</li> <li>2. Emissions in Restricted Frequency Bands Above 1GHz for 2402 MHz only, and it is max power channel of original test report. (The test results are based on original output power to re-test.).</li> </ol> <p>For PIFA Antenna necessary to evaluated as below:</p> <ol style="list-style-type: none"> <li>1. AC Power-line Conducted Emissions.</li> <li>2. Emissions in Restricted Frequency Bands.</li> <li>3. Simultaneous Transmission Analysis - Radiated Emission Co-location.</li> </ol>
<ol style="list-style-type: none"> <li>4. Adding one set PIFA antennas.</li> </ol>	<ol style="list-style-type: none"> <li>1. AC Power-line Conducted Emissions.</li> <li>2. Emissions in Restricted Frequency Bands.</li> <li>3. Simultaneous Transmission Analysis - Radiated Emission Co-location.</li> </ol>
<ol style="list-style-type: none"> <li>5. Adding master mode in band 2~band 3 (5250~5350 MHz, 5470~5725 MHz).</li> </ol>	<p>It doesn't need to verify RF test.</p>

Note: For Emissions in Restricted Frequency Bands Below 1GHz test result of Dipole antenna was based on original report.



## 1.2 Testing Applied Standards

According to the specifications of the manufacturer, the EUT must comply with the requirements of the following standards:

- ◆ 47 CFR FCC Part 15
- ◆ FCC Public Notice DA 00-705
- ◆ FCC KDB 412172 D01 v01r01

## 1.3 Testing Location Information

Testing Location		
<input type="checkbox"/>	HWA YA	ADD : No. 52, Hwa Ya 1st Rd., Kwei-Shan Hsiang, Tao Yuan Hsien, Taiwan, R.O.C. TEL : 886-3-327-3456 FAX : 886-3-318-0055
<input checked="" type="checkbox"/>	JHUBEI	ADD : No.8, Lane 724, Bo-ai St., Jhubei City, HsinChu County 302, Taiwan, R.O.C. TEL : 886-3-656-9065 FAX : 886-3-656-9085

Test Condition	Test Site No.	Test Engineer	Test Environment	Test Date
Radiated	03CH01-CB (below 1GHz)	Joy Tseng	23°C / 55%	Jul. 28, 2017, Nov. 23, 2017
Radiated	03CH01-CB (above1GHz)	Joy Tseng	23°C / 55%	Nov. 28, 2017~Dec. 13, 2017
AC Conduction	CO01-CB	Tony Chang	22°C / 52%	Nov. 27, 2017

Test site Designation No. TW0006 with FCC.

Test site registered number IC 4086D with Industry Canada.

## 1.4 Measurement Uncertainty

ISO/IEC 17025 requires that an estimate of the measurement uncertainties associated with the emissions test results be included in the report. The measurement uncertainties given below are based on a 95% confidence level (based on a coverage factor (k=2))

Test Items	Uncertainty	Remark
Conducted Emission (150kHz ~ 30MHz)	3.2 dB	Confidence levels of 95%
Radiated Emission (30MHz ~ 1,000MHz)	3.6 dB	Confidence levels of 95%
Radiated Emission (1GHz ~ 18GHz)	3.7 dB	Confidence levels of 95%
Radiated Emission (18GHz ~ 40GHz)	3.5 dB	Confidence levels of 95%

## 2 Test Configuration of EUT

### 2.1 The Worst Case Measurement Configuration

The Worst Case Mode for Following Conformance Tests	
<b>Tests Item</b>	AC power-line conducted emissions
<b>Condition</b>	AC power-line conducted measurement for line and neutral
<b>Operating Mode</b>	Normal Link
According to the original test report, Slave mode - Radio 1 (2.4GHz + Bluetooth) + Radio 2 (5GHz) has been evaluated to be the worst case. So the measurement will follow this same test configuration.	
1	Slave mode - Radio 1 (2.4GHz + Bluetooth) + Radio 2 (5GHz) with PIFA antenna

The Worst Case Mode for Following Conformance Tests	
<b>Tests Item</b>	Emissions in Restricted Frequency Bands
<b>Test Condition</b>	Radiated measurement If EUT consist of multiple antenna assembly (multiple antenna are used in EUT regardless of spatial multiplexing MIMO configuration), the radiated test should be performed with highest antenna gain of each antenna type.
<b>Operating Mode &lt; 1GHz</b>	Normal Link
According to the original test report, EUT in Z axis AP Mode - Radio 1 (2.4GHz+Bluetooth)+ Radio 2 (5GHz) has been evaluated to be the worst case. So the measurement will follow this same test configuration.	
1	EUT in Z axis Slave Mode - Radio 1 (2.4GHz+Bluetooth)+ Radio 2 (5GHz) with Dipole antenna
2	EUT in Z axis AP Mode - Radio 1 (2.4GHz+Bluetooth)+ Radio 2 (5GHz) with PIFA antenna
<b>Operating Mode &gt; 1GHz</b>	CTX
The EUT was performed at X axis, Y axis and Z axis position for Emissions in Restricted Frequency Bands above 1GHz test, and the worst case was found at Z axis. So the measurement will follow this same test configuration.	
1	EUT in Z axis with Dipole antenna
2	EUT in Z axis with PIFA antenna



The Worst Case Mode for Following Conformance Tests	
<b>Tests Item</b>	Simultaneous Transmission Analysis - Radiated Emission Co-location
<b>Test Condition</b>	Radiated measurement
<b>Operating Mode</b>	Normal Link
1	EUT X axis - Radio 1 (2.4GHz + Bluetooth) + Radio 2 (5GHz) with PIFA antenna
2	EUT Y axis - Radio 1 (2.4GHz + Bluetooth) + Radio 2 (5GHz) with PIFA antenna
3	EUT Z axis - Radio 1 (2.4GHz + Bluetooth) + Radio 2 (5GHz) with PIFA antenna
4	EUT X axis - Radio 1 (5GHz + Bluetooth) + Radio 2 (5GHz) with PIFA antenna
5	EUT Y axis - Radio 1 (5GHz + Bluetooth) + Radio 2 (5GHz) with PIFA antenna
6	EUT Z axis - Radio 1 (5GHz + Bluetooth) + Radio 2 (5GHz) with PIFA antenna
For operating mode 2 and mode 5 are the worst case and it was record in this test report.	
Refer to Appendix D for Radiated Emission Co-location.	

The Worst Case Mode for Following Conformance Tests	
<b>Tests Item</b>	Simultaneous Transmission Analysis - Co-location RF Exposure Evaluation
<b>Operating Mode</b>	
1	Radio 1 (2.4GHz + Bluetooth) + Radio 2 (5GHz)
2	Radio 1 (5GHz + Bluetooth) + Radio 2 (5GHz)
Refer to Sporton Test Report No.: FA770523-01 for Co-location RF Exposure Evaluation.	

## 2.2 EUT Operation during Test

For CTX Mode:

The EUT was programmed to be in continuously transmitting mode.

For Normal Link:

During the test, the EUT operation to normal function.



### 2.3 Accessories

N/A

### 2.4 Support Equipment

For Test Site No: CO01-CB

Support Equipment				
No.	Equipment	Brand Name	Model Name	FCC ID
1	NB	DELL	E6430	DoC
2	Bluetooth Speaker	MARUS	MSK06C-RD	DoC
3	AP Router	ASUS	DSL-AC68U	DoC
4	AP Router	Planex	GW-AP54SGX	KA220030603014-1
5	Fixture	Arcadyan	WN9711BTAAC Test jig	N/A

For Test Site No: 03CH01-CB (below 1GHz)

Support Equipment				
No.	Equipment	Brand Name	Model Name	FCC ID
1	NB	DELL	E4300	DoC
2	NB*2	Apple	Mac Book	DoC
3	Bluetooth Speaker	MARUS	MSK06C-RD	DoC
4	Fixture	Arcadyan	WN9711BTAAC Test jig	N/A

For Test Site No: 03CH01-CB (above 1GHz)

Support Equipment				
No.	Equipment	Brand Name	Model Name	FCC ID
1	NB	DELL	E4300	DoC
2	Fixture	Arcadyan	WN9711BTAAC Test jig	N/A

## 2.5 Test Setup Diagram

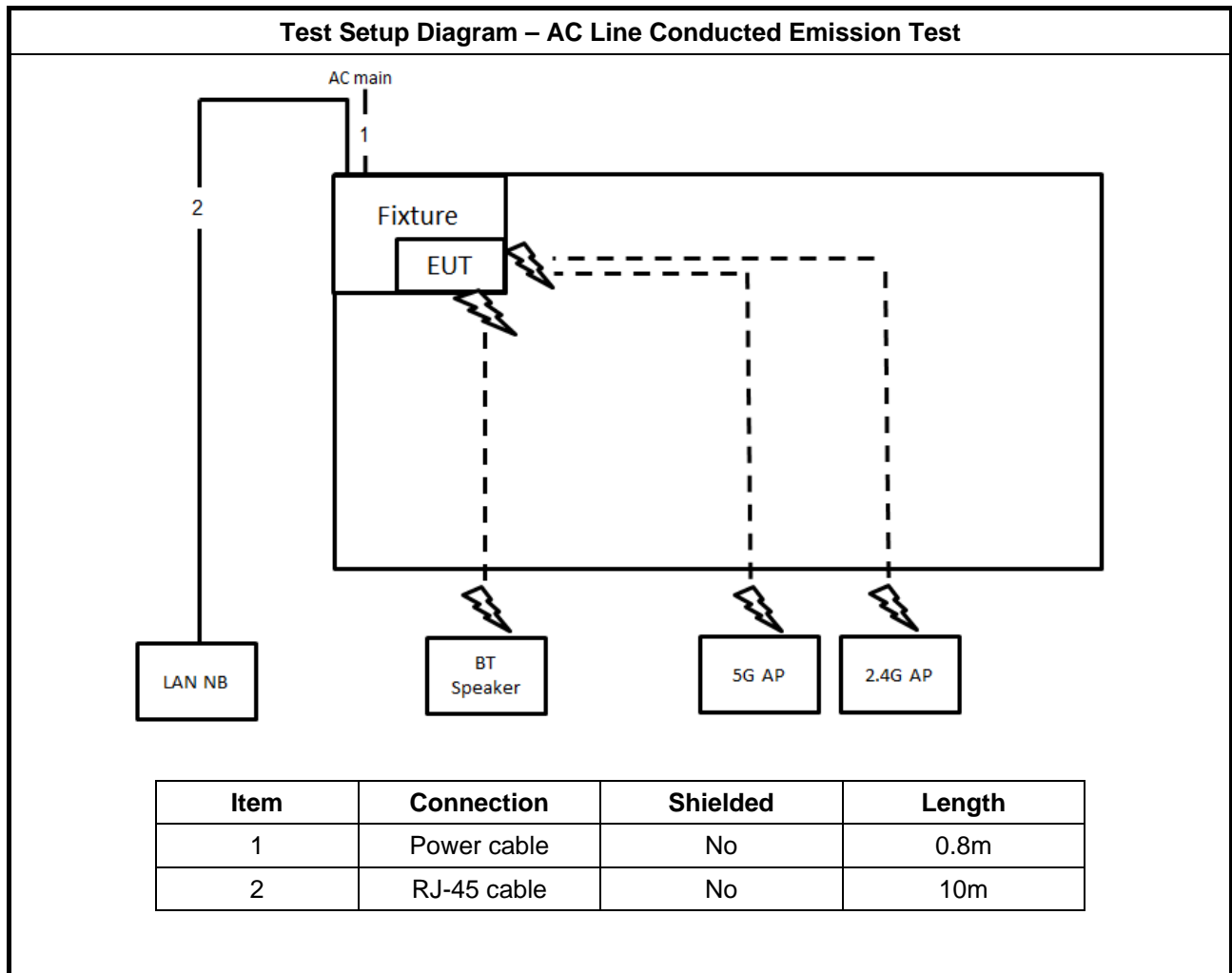

Test Setup Diagram - Radiated Test < 1GHz

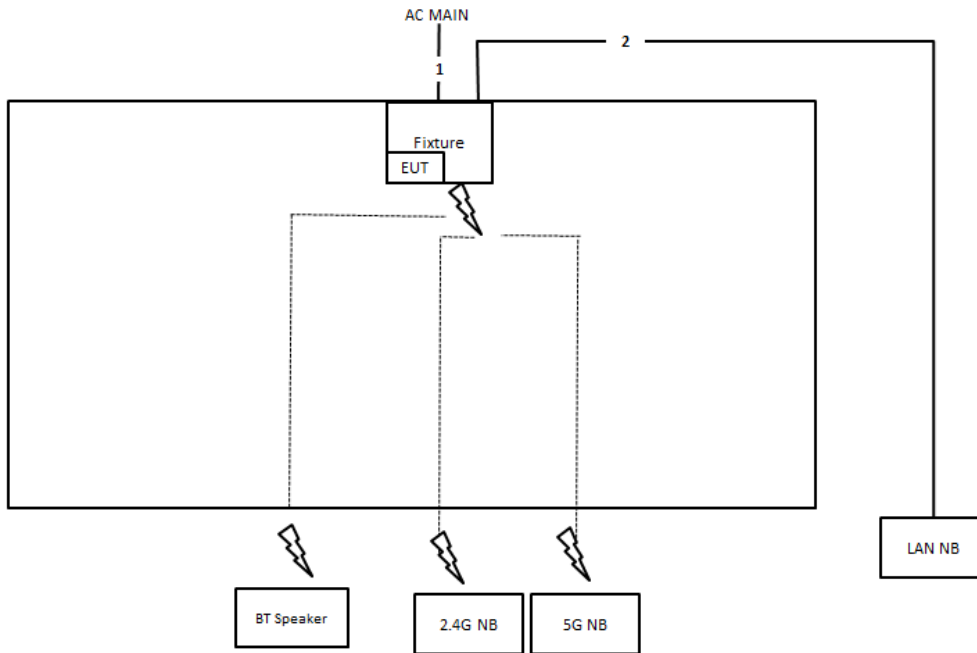

Item	Connection	Shielded	Length
1	Power cable	No	1.5m
2	RJ-45 cable	No	10m

Test Setup Diagram - Radiated Test > 1GHz

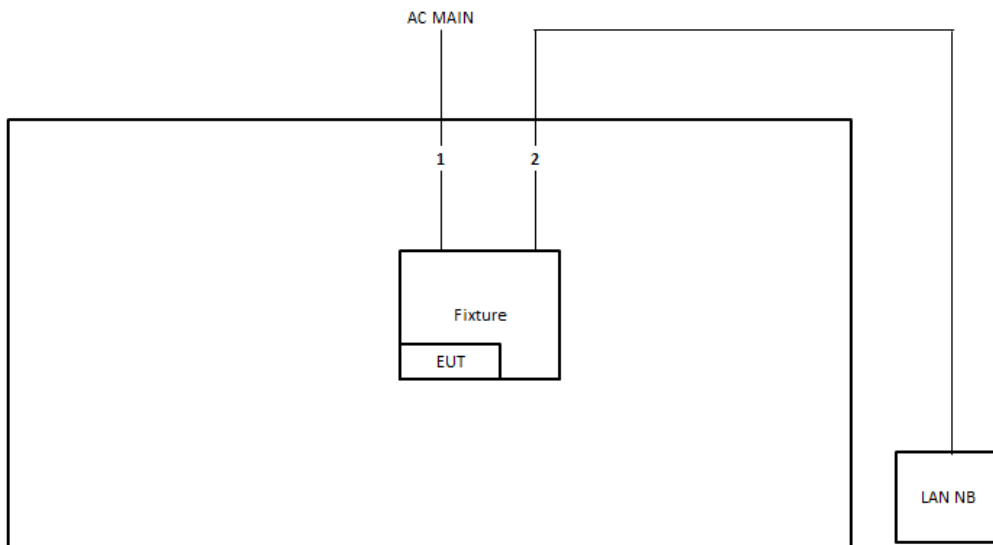

Item	Connection	Shielded	Length
1	Power cable	No	1.5m
2	RJ-45 cable	No	10m

### 3 Transmitter Test Result

#### 3.1 AC Power-line Conducted Emissions

##### 3.1.1 AC Power-line Conducted Emissions Limit

AC Power-line Conducted Emissions Limit		
Frequency Emission (MHz)	Quasi-Peak	Average
0.15-0.5	66 - 56 *	56 - 46 *
0.5-5	56	46
5-30	60	50

Note 1: \* Decreases with the logarithm of the frequency.

##### 3.1.2 Measuring Instruments

Refer a test equipment and calibration data table in this test report.

##### 3.1.3 Test Procedures

Test Method
<ul style="list-style-type: none"> <li>Refer as ANSI C63.10-2013, clause 6.2 for AC power-line conducted emissions.</li> </ul>

##### 3.1.4 Test Setup

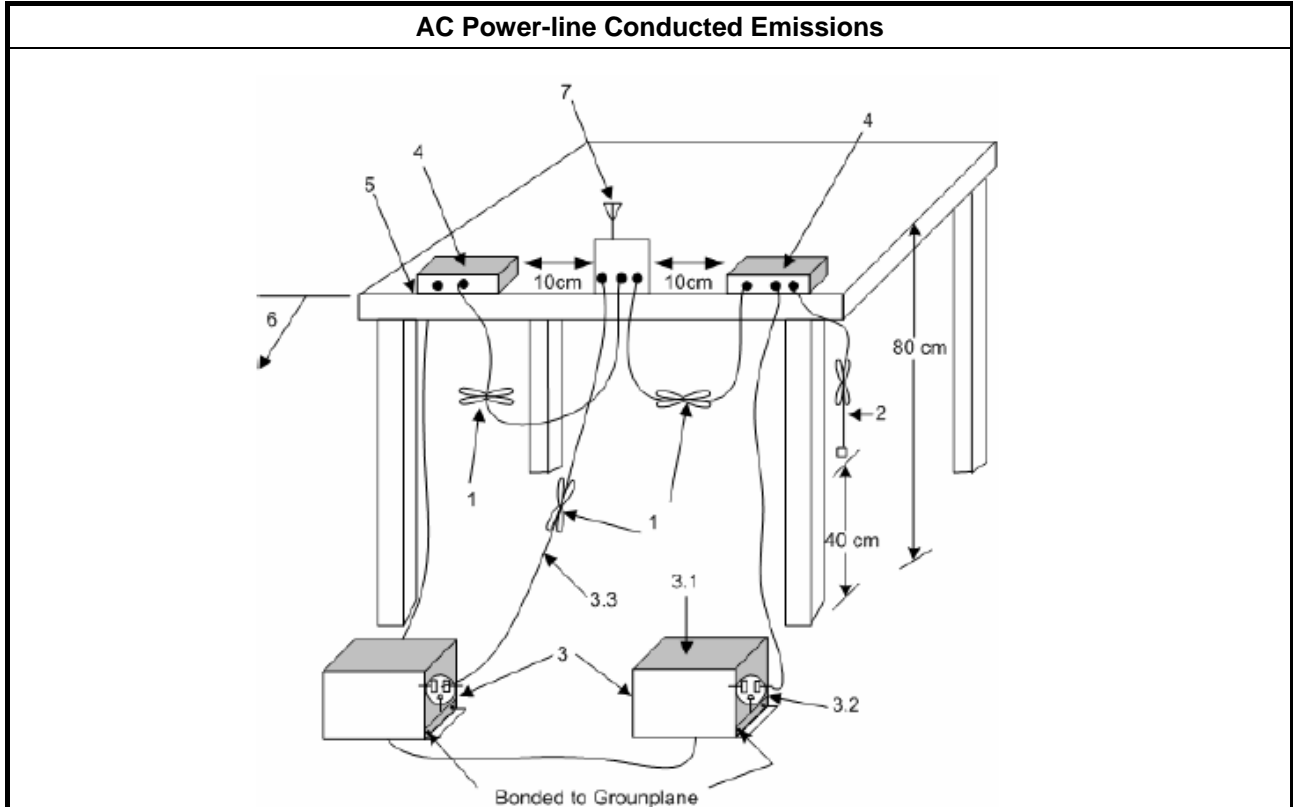

##### 3.1.5 Test Result of AC Power-line Conducted Emissions

Refer as Appendix B



### 3.2 Emissions in Restricted Frequency Bands

#### 3.2.1 Emissions in Restricted Frequency Bands Limit

Restricted Band Emissions Limit			
Frequency Range (MHz)	Field Strength (uV/m)	Field Strength (dBuV/m)	Measure Distance (m)
0.009~0.490	2400/F(kHz)	48.5 - 13.8	300
0.490~1.705	24000/F(kHz)	33.8 - 23	30
1.705~30.0	30	29	30
30~88	100	40	3
88~216	150	43.5	3
216~960	200	46	3
Above 960	500	54	3

Note 1: Test distance for frequencies at or above 30 MHz, measurements may be performed at a distance other than the limit distance provided they are not performed in the near field and the emissions to be measured can be detected by the measurement equipment. When performing measurements at a distance other than that specified, the results shall be extrapolated to the specified distance using an extrapolation factor of 20 dB/decade (inverse of linear distance for field-strength measurements, inverse of linear distance-squared for power-density measurements).

Note 2: Test distance for frequencies at below 30 MHz, measurements may be performed at a distance closer than the EUT limit distance; however, an attempt should be made to avoid making measurements in the near field. When performing measurements below 30 MHz at a closer distance than the limit distance, the results shall be extrapolated to the specified distance by either making measurements at a minimum of two or more distances on at least one radial to determine the proper extrapolation factor or by using the square of an inverse linear distance extrapolation factor (40 dB / decade). The test report shall specify the extrapolation method used to determine compliance of the EUT.

#### 3.2.2 Measuring Instruments

Refer a test equipment and calibration data table in this test report.

#### 3.2.3 Test Procedures

Test Method	
	<ul style="list-style-type: none"> <li>▪ The average emission levels shall be measured in [hopping duty factor].</li> </ul>
	<ul style="list-style-type: none"> <li>▪ Refer as ANSI C63.10; clause 6.9.2.2 band-edge testing shall be performed at the lowest frequency channel and highest frequency channel within the allowed operating band.</li> </ul>
	<ul style="list-style-type: none"> <li>▪ For the transmitter unwanted emissions shall be measured using following options below:               <ul style="list-style-type: none"> <li>▪ Refer as ANSI C63.10, clause 4.1.4.2.1 QP value.</li> <li>▪ Refer as ANSI C63.10, clause 4.1.4.2.2 measurement procedure peak.</li> <li>▪ Refer as ANSI C63.10, clause 4.1.4.2.4 average value of hopping pulsed emissions.</li> </ul> </li> </ul>

### 3.2.4 Test Setup

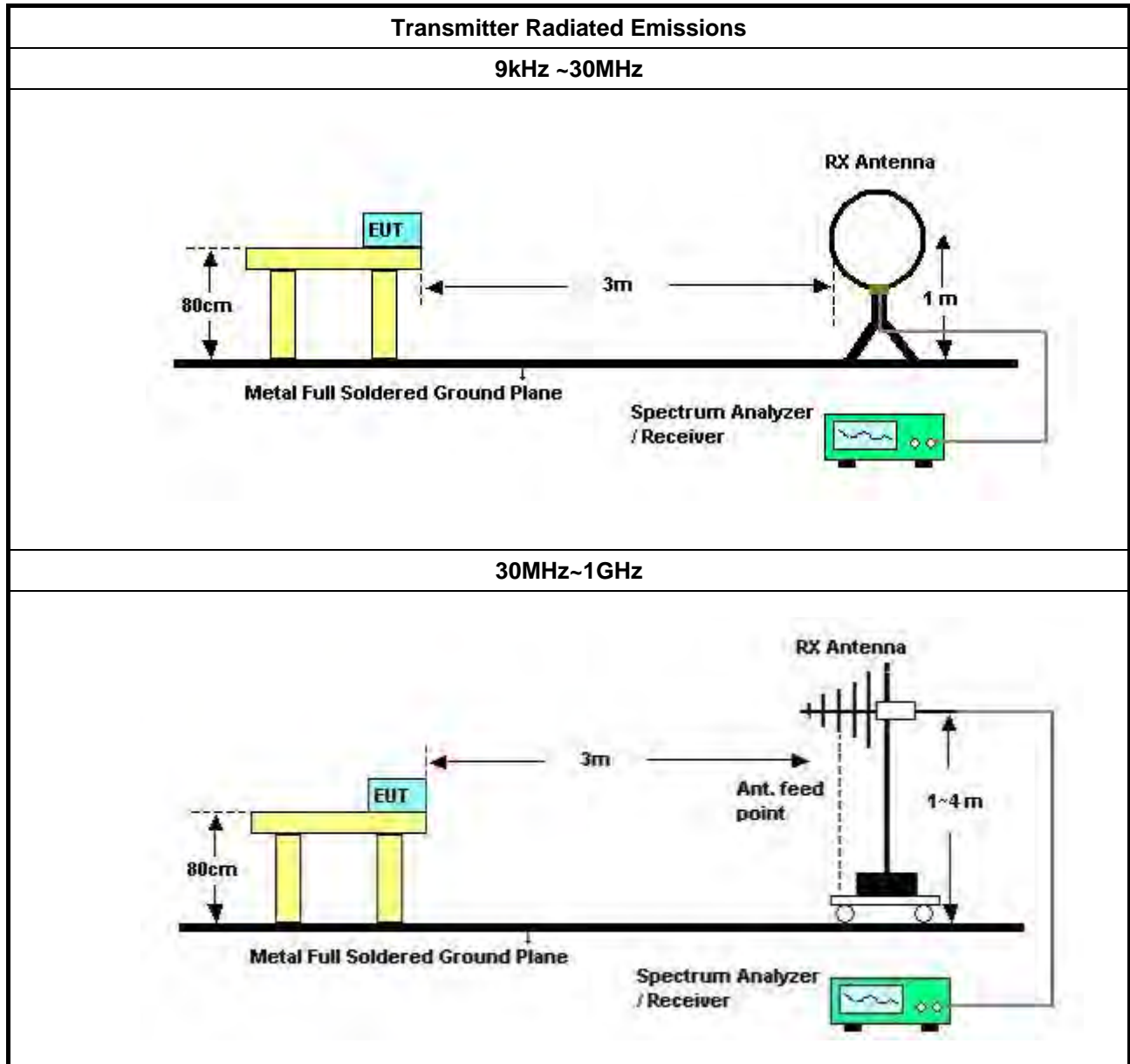

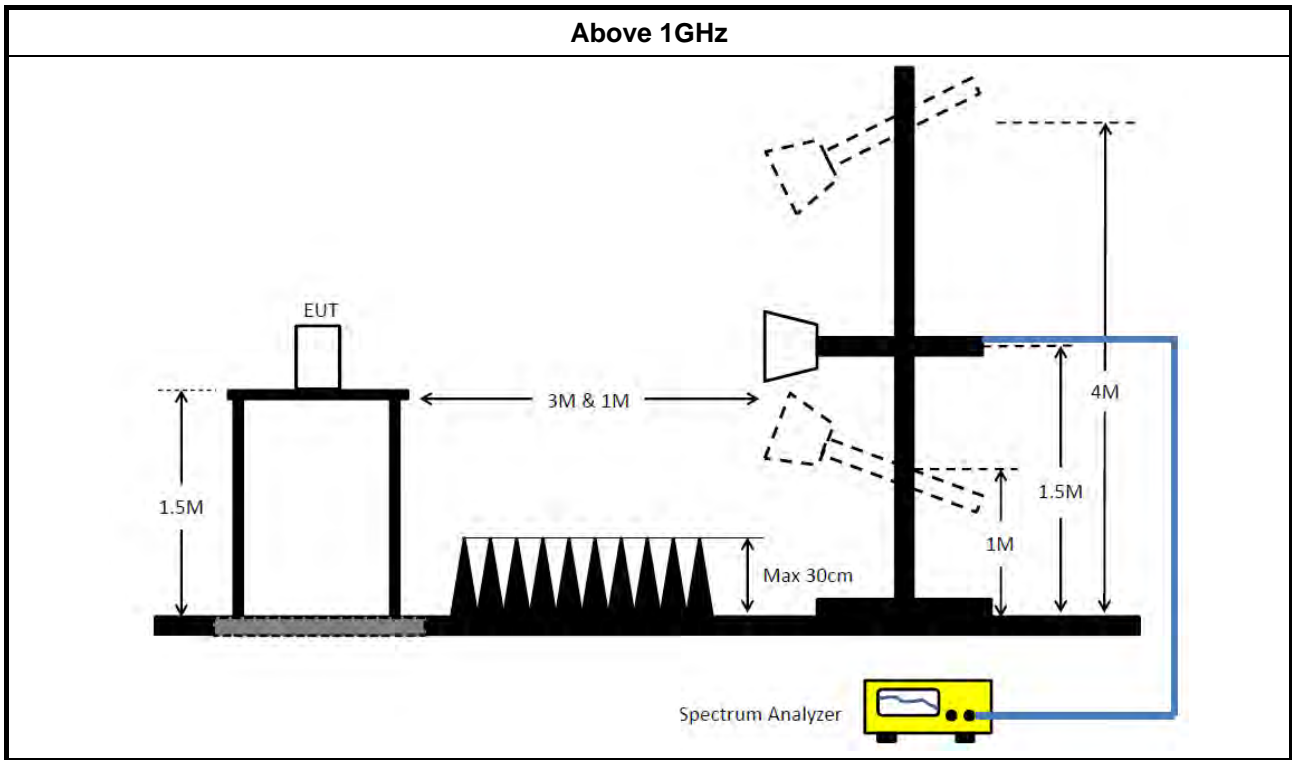

### 3.2.5 Transmitter Radiated Unwanted Emissions (Below 30MHz)

All amplitude of spurious emissions that are attenuated by more than 20 dB below the permissible value has no need to be reported.

### 3.2.6 Transmitter Radiated Unwanted Emissions

Refer as Appendix C



## 4 Test Equipment and Calibration Data

Instrument	Manufacturer	Model No.	Serial No.	Characteristics	Calibration Date	Calibration Due Date	Remark
EMI Receiver	Agilent	N9038A	My52260123	9kHz ~ 8.45GHz	Jan. 23, 2017	Jan. 22, 2018	Conduction (CO01-CB)
LISN	F.C.C.	FCC-LISN-50-16-2	04083	150kHz ~ 100MHz	Dec. 14, 2016	Dec. 13, 2017	Conduction (CO01-CB)
LISN	Schwarzbeck	NSLK 8127	8127647	9kHz ~ 30MHz	Dec. 21, 2016	Dec. 20, 2017	Conduction (CO01-CB)
COND Cable	Woken	Cable	01	150kHz ~ 30MHz	May 23, 2017	May 22, 2018	Conduction (CO01-CB)
Software	Audix	E3	6.120210n	-	N.C.R.	N.C.R.	Conduction (CO01-CB)
BILOG ANTENNA with 6dB Attenuator	TESEQ & EMC	CBL6112D & N-6-06	37880 & AT-N0609	20MHz ~ 2GHz	Aug. 30, 2016	Aug. 29, 2017	Radiation (03CH01-CB)
BILOG ANTENNA with 6dB Attenuator	TESEQ & EMC	CBL6112D & N-6-06	37880 & AT-N0609	20MHz ~ 2GHz	Aug. 30, 2017	Aug. 29, 2018	Radiation (03CH01-CB)
Horn Antenna	EMCO	3115	00075790	750MHz ~ 18GHz	Nov. 20, 2017	Nov. 19, 2018	Radiation (03CH01-CB)
Horn Antenna	Schwarzbeck	BBHA 9170	BBHA9170252	15GHz ~ 40GHz	Jul. 05, 2017	Jul. 04, 2018	Radiation (03CH01-CB)
Pre-Amplifier	EMCI	EMC330N	980332	20MHz ~ 3GHz	May 02, 2017	May 01, 2018	Radiation (03CH01-CB)
Pre-Amplifier	Agilent	8449B	3008A02310	1GHz ~ 26.5GHz	Jan. 16, 2017	Jan. 15, 2018	Radiation (03CH01-CB)
Pre-Amplifier	MITEQ	TTA1840-35-H G	1864479	18GHz ~ 40GHz	Jul. 10, 2017	Jul. 09, 2018	Radiation (03CH01-CB)
Spectrum Analyzer	R&S	FSP40	100056	9kHz ~ 40GHz	Nov. 22, 2016	Nov. 21, 2017	Radiation (03CH01-CB)
Spectrum Analyzer	R&S	FSP40	100056	9kHz ~ 40GHz	Nov. 23, 2017	Nov. 22, 2018	Radiation (03CH01-CB)
EMI Test	R&S	ESCS	100355	9kHz ~ 2.75GHz	May 06, 2017	May 05, 2018	Radiation (03CH01-CB)
RF Cable-low	Woken	Low Cable-16+17	N/A	30 MHz ~ 1 GHz	Oct. 24, 2016	Oct. 23, 2017	Radiation (03CH01-CB)
RF Cable-low	Woken	Low Cable-16+17	N/A	30 MHz ~ 1 GHz	Oct. 11, 2017	Oct. 10, 2018	Radiation (03CH01-CB)
RF Cable-high	Woken	High Cable-16	N/A	1 GHz ~ 18 GHz	Oct. 11, 2017	Oct. 10, 2018	Radiation (03CH01-CB)
RF Cable-high	Woken	High Cable-16+17	N/A	1 GHz ~ 18 GHz	Oct. 11, 2017	Oct. 10, 2018	Radiation (03CH01-CB)



<b>Instrument</b>	<b>Manufacturer</b>	<b>Model No.</b>	<b>Serial No.</b>	<b>Characteristics</b>	<b>Calibration Date</b>	<b>Calibration Due Date</b>	<b>Remark</b>
RF Cable-high	Woken	High Cable-40G#1	N/A	18GHz ~ 40 GHz	Oct. 11, 2017	Oct. 10, 2018	Radiation (03CH01-CB)
RF Cable-high	Woken	High Cable-40G#2	N/A	18GHz ~ 40 GHz	Oct. 11, 2017	Oct. 10, 2018	Radiation (03CH01-CB)
Loop Antenna	Teseq	HLA 6120	24155	9kHz - 30 MHz	Mar. 16, 2016*	Mar. 15, 2018*	Radiation (03CH01-CB)

Note: Calibration Interval of instruments listed above is one year.

“\*\*” Calibration Interval of instruments listed above is two years.

N.C.R. means Non-Calibration required.



# AC Power-line Conducted Emissions Result

Appendix B

AC Power-line Conducted Emissions Result																																																																																																																																																									
Operating Mode	1	Power Phase	Neutral																																																																																																																																																						
Operating Function	Normal Link																																																																																																																																																								
<div style="display: flex; justify-content: space-between; align-items: flex-start;"> <div style="text-align: center;"> </div> <div style="text-align: right;"> <p>Date: 2017-11-27 Time: 15:25:47</p> </div> </div>																																																																																																																																																									
<table border="1" style="width: 100%; border-collapse: collapse; margin-top: 10px;"> <thead> <tr> <th></th> <th>Freq</th> <th>Level</th> <th>Over</th> <th>Limit</th> <th>Read</th> <th>LISN</th> <th>Cable</th> <th>Remark</th> <th>Pol/Phase</th> </tr> <tr> <th></th> <th>MHz</th> <th>dBuV</th> <th>Limit</th> <th>Line</th> <th>Level</th> <th>Factor</th> <th>Loss</th> <th></th> <th></th> </tr> <tr> <th></th> <th></th> <th></th> <th>dB</th> <th>dBuV</th> <th>dBuV</th> <th>dB</th> <th>dB</th> <th></th> <th></th> </tr> </thead> <tbody> <tr> <td>1</td> <td>0.1677</td> <td>35.07</td> <td>-20.01</td> <td>55.08</td> <td>24.82</td> <td>10.10</td> <td>0.15</td> <td>Average</td> <td>NEUTRAL</td> </tr> <tr> <td>2</td> <td>0.1677</td> <td>45.16</td> <td>-19.92</td> <td>65.08</td> <td>34.91</td> <td>10.10</td> <td>0.15</td> <td>QP</td> <td>NEUTRAL</td> </tr> <tr style="border: 2px solid black;"> <td>3</td> <td>0.3410</td> <td>39.91</td> <td>-9.27</td> <td>49.18</td> <td>29.68</td> <td>10.19</td> <td>0.04</td> <td>Average</td> <td>NEUTRAL</td> </tr> <tr> <td>4</td> <td>0.3410</td> <td>49.13</td> <td>-10.05</td> <td>59.18</td> <td>38.90</td> <td>10.19</td> <td>0.04</td> <td>QP</td> <td>NEUTRAL</td> </tr> <tr> <td>5</td> <td>0.5101</td> <td>30.74</td> <td>-15.26</td> <td>46.00</td> <td>20.46</td> <td>10.22</td> <td>0.06</td> <td>Average</td> <td>NEUTRAL</td> </tr> <tr> <td>6</td> <td>0.5101</td> <td>40.87</td> <td>-15.13</td> <td>56.00</td> <td>30.59</td> <td>10.22</td> <td>0.06</td> <td>QP</td> <td>NEUTRAL</td> </tr> <tr> <td>7</td> <td>0.8528</td> <td>30.66</td> <td>-15.34</td> <td>46.00</td> <td>20.40</td> <td>10.10</td> <td>0.16</td> <td>Average</td> <td>NEUTRAL</td> </tr> <tr> <td>8</td> <td>0.8528</td> <td>39.92</td> <td>-16.08</td> <td>56.00</td> <td>29.66</td> <td>10.10</td> <td>0.16</td> <td>QP</td> <td>NEUTRAL</td> </tr> <tr> <td>9</td> <td>4.7464</td> <td>22.24</td> <td>-23.76</td> <td>46.00</td> <td>12.14</td> <td>9.99</td> <td>0.11</td> <td>Average</td> <td>NEUTRAL</td> </tr> <tr> <td>10</td> <td>4.7464</td> <td>29.32</td> <td>-26.68</td> <td>56.00</td> <td>19.22</td> <td>9.99</td> <td>0.11</td> <td>QP</td> <td>NEUTRAL</td> </tr> <tr> <td>11</td> <td>20.9243</td> <td>21.80</td> <td>-28.20</td> <td>50.00</td> <td>11.23</td> <td>10.36</td> <td>0.21</td> <td>Average</td> <td>NEUTRAL</td> </tr> <tr> <td>12</td> <td>20.9243</td> <td>28.66</td> <td>-31.34</td> <td>60.00</td> <td>18.09</td> <td>10.36</td> <td>0.21</td> <td>QP</td> <td>NEUTRAL</td> </tr> </tbody> </table>					Freq	Level	Over	Limit	Read	LISN	Cable	Remark	Pol/Phase		MHz	dBuV	Limit	Line	Level	Factor	Loss						dB	dBuV	dBuV	dB	dB			1	0.1677	35.07	-20.01	55.08	24.82	10.10	0.15	Average	NEUTRAL	2	0.1677	45.16	-19.92	65.08	34.91	10.10	0.15	QP	NEUTRAL	3	0.3410	39.91	-9.27	49.18	29.68	10.19	0.04	Average	NEUTRAL	4	0.3410	49.13	-10.05	59.18	38.90	10.19	0.04	QP	NEUTRAL	5	0.5101	30.74	-15.26	46.00	20.46	10.22	0.06	Average	NEUTRAL	6	0.5101	40.87	-15.13	56.00	30.59	10.22	0.06	QP	NEUTRAL	7	0.8528	30.66	-15.34	46.00	20.40	10.10	0.16	Average	NEUTRAL	8	0.8528	39.92	-16.08	56.00	29.66	10.10	0.16	QP	NEUTRAL	9	4.7464	22.24	-23.76	46.00	12.14	9.99	0.11	Average	NEUTRAL	10	4.7464	29.32	-26.68	56.00	19.22	9.99	0.11	QP	NEUTRAL	11	20.9243	21.80	-28.20	50.00	11.23	10.36	0.21	Average	NEUTRAL	12	20.9243	28.66	-31.34	60.00	18.09	10.36	0.21	QP	NEUTRAL
	Freq	Level	Over	Limit	Read	LISN	Cable	Remark	Pol/Phase																																																																																																																																																
	MHz	dBuV	Limit	Line	Level	Factor	Loss																																																																																																																																																		
			dB	dBuV	dBuV	dB	dB																																																																																																																																																		
1	0.1677	35.07	-20.01	55.08	24.82	10.10	0.15	Average	NEUTRAL																																																																																																																																																
2	0.1677	45.16	-19.92	65.08	34.91	10.10	0.15	QP	NEUTRAL																																																																																																																																																
3	0.3410	39.91	-9.27	49.18	29.68	10.19	0.04	Average	NEUTRAL																																																																																																																																																
4	0.3410	49.13	-10.05	59.18	38.90	10.19	0.04	QP	NEUTRAL																																																																																																																																																
5	0.5101	30.74	-15.26	46.00	20.46	10.22	0.06	Average	NEUTRAL																																																																																																																																																
6	0.5101	40.87	-15.13	56.00	30.59	10.22	0.06	QP	NEUTRAL																																																																																																																																																
7	0.8528	30.66	-15.34	46.00	20.40	10.10	0.16	Average	NEUTRAL																																																																																																																																																
8	0.8528	39.92	-16.08	56.00	29.66	10.10	0.16	QP	NEUTRAL																																																																																																																																																
9	4.7464	22.24	-23.76	46.00	12.14	9.99	0.11	Average	NEUTRAL																																																																																																																																																
10	4.7464	29.32	-26.68	56.00	19.22	9.99	0.11	QP	NEUTRAL																																																																																																																																																
11	20.9243	21.80	-28.20	50.00	11.23	10.36	0.21	Average	NEUTRAL																																																																																																																																																
12	20.9243	28.66	-31.34	60.00	18.09	10.36	0.21	QP	NEUTRAL																																																																																																																																																
<p>Note 1: "&gt;20dB" means emission levels that exceed the level of 20 dB below the applicable limit.            Note 2: "N/F" means Nothing Found emissions (No emissions were detected.)</p>																																																																																																																																																									



# AC Power-line Conducted Emissions Result

Appendix B

AC Power-line Conducted Emissions Result																																																																																																																																																									
Operating Mode	1	Power Phase	Line																																																																																																																																																						
Operating Function	Normal Link																																																																																																																																																								
<p>The graph displays the AC power-line conducted emissions. The y-axis represents Level in dBuV (0 to 80), and the x-axis represents Frequency in MHz (0.1502 to 30). Two red lines indicate the CISPR limits: CISPR_B_QP (upper) and CISPR_B_AV (lower). The blue line shows the measured emission levels, with several peaks marked by vertical lines and numbered 1 through 12.</p>																																																																																																																																																									
<table border="1"> <thead> <tr> <th></th> <th>Freq</th> <th>Level</th> <th>Over</th> <th>Limit</th> <th>Read</th> <th>LISN</th> <th>Cable</th> <th>Remark</th> <th>Pol/Phase</th> </tr> <tr> <th></th> <th>MHz</th> <th>dBuV</th> <th>Limit</th> <th>Line</th> <th>Level</th> <th>Factor</th> <th>Loss</th> <th></th> <th></th> </tr> <tr> <th></th> <th></th> <th></th> <th>dB</th> <th>dBuV</th> <th>dBuV</th> <th>dB</th> <th>dB</th> <th></th> <th></th> </tr> </thead> <tbody> <tr><td>1</td><td>0.1650</td><td>34.85</td><td>-20.36</td><td>55.21</td><td>24.70</td><td>10.00</td><td>0.15</td><td>Average</td><td>LINE</td></tr> <tr><td>2</td><td>0.1650</td><td>44.87</td><td>-20.34</td><td>65.21</td><td>34.72</td><td>10.00</td><td>0.15</td><td>QP</td><td>LINE</td></tr> <tr><td>3</td><td>0.3428</td><td>39.70</td><td>-9.43</td><td>49.13</td><td>29.72</td><td>9.94</td><td>0.04</td><td>Average</td><td>LINE</td></tr> <tr><td>4</td><td>0.3428</td><td>49.03</td><td>-10.10</td><td>59.13</td><td>39.05</td><td>9.94</td><td>0.04</td><td>QP</td><td>LINE</td></tr> <tr><td>5</td><td>0.5101</td><td>30.52</td><td>-15.48</td><td>46.00</td><td>20.51</td><td>9.95</td><td>0.06</td><td>Average</td><td>LINE</td></tr> <tr><td>6</td><td>0.5101</td><td>40.63</td><td>-15.37</td><td>56.00</td><td>30.62</td><td>9.95</td><td>0.06</td><td>QP</td><td>LINE</td></tr> <tr><td>7</td><td>0.8528</td><td>30.94</td><td>-15.06</td><td>46.00</td><td>20.82</td><td>9.96</td><td>0.16</td><td>Average</td><td>LINE</td></tr> <tr><td>8</td><td>0.8528</td><td>40.49</td><td>-15.51</td><td>56.00</td><td>30.37</td><td>9.96</td><td>0.16</td><td>QP</td><td>LINE</td></tr> <tr><td>9</td><td>2.7068</td><td>23.22</td><td>-22.78</td><td>46.00</td><td>13.10</td><td>9.96</td><td>0.16</td><td>Average</td><td>LINE</td></tr> <tr><td>10</td><td>2.7068</td><td>30.52</td><td>-25.48</td><td>56.00</td><td>20.40</td><td>9.96</td><td>0.16</td><td>QP</td><td>LINE</td></tr> <tr><td>11</td><td>19.8445</td><td>21.68</td><td>-28.32</td><td>50.00</td><td>11.14</td><td>10.34</td><td>0.20</td><td>Average</td><td>LINE</td></tr> <tr><td>12</td><td>19.8445</td><td>28.51</td><td>-31.49</td><td>60.00</td><td>17.97</td><td>10.34</td><td>0.20</td><td>QP</td><td>LINE</td></tr> </tbody> </table>					Freq	Level	Over	Limit	Read	LISN	Cable	Remark	Pol/Phase		MHz	dBuV	Limit	Line	Level	Factor	Loss						dB	dBuV	dBuV	dB	dB			1	0.1650	34.85	-20.36	55.21	24.70	10.00	0.15	Average	LINE	2	0.1650	44.87	-20.34	65.21	34.72	10.00	0.15	QP	LINE	3	0.3428	39.70	-9.43	49.13	29.72	9.94	0.04	Average	LINE	4	0.3428	49.03	-10.10	59.13	39.05	9.94	0.04	QP	LINE	5	0.5101	30.52	-15.48	46.00	20.51	9.95	0.06	Average	LINE	6	0.5101	40.63	-15.37	56.00	30.62	9.95	0.06	QP	LINE	7	0.8528	30.94	-15.06	46.00	20.82	9.96	0.16	Average	LINE	8	0.8528	40.49	-15.51	56.00	30.37	9.96	0.16	QP	LINE	9	2.7068	23.22	-22.78	46.00	13.10	9.96	0.16	Average	LINE	10	2.7068	30.52	-25.48	56.00	20.40	9.96	0.16	QP	LINE	11	19.8445	21.68	-28.32	50.00	11.14	10.34	0.20	Average	LINE	12	19.8445	28.51	-31.49	60.00	17.97	10.34	0.20	QP	LINE
	Freq	Level	Over	Limit	Read	LISN	Cable	Remark	Pol/Phase																																																																																																																																																
	MHz	dBuV	Limit	Line	Level	Factor	Loss																																																																																																																																																		
			dB	dBuV	dBuV	dB	dB																																																																																																																																																		
1	0.1650	34.85	-20.36	55.21	24.70	10.00	0.15	Average	LINE																																																																																																																																																
2	0.1650	44.87	-20.34	65.21	34.72	10.00	0.15	QP	LINE																																																																																																																																																
3	0.3428	39.70	-9.43	49.13	29.72	9.94	0.04	Average	LINE																																																																																																																																																
4	0.3428	49.03	-10.10	59.13	39.05	9.94	0.04	QP	LINE																																																																																																																																																
5	0.5101	30.52	-15.48	46.00	20.51	9.95	0.06	Average	LINE																																																																																																																																																
6	0.5101	40.63	-15.37	56.00	30.62	9.95	0.06	QP	LINE																																																																																																																																																
7	0.8528	30.94	-15.06	46.00	20.82	9.96	0.16	Average	LINE																																																																																																																																																
8	0.8528	40.49	-15.51	56.00	30.37	9.96	0.16	QP	LINE																																																																																																																																																
9	2.7068	23.22	-22.78	46.00	13.10	9.96	0.16	Average	LINE																																																																																																																																																
10	2.7068	30.52	-25.48	56.00	20.40	9.96	0.16	QP	LINE																																																																																																																																																
11	19.8445	21.68	-28.32	50.00	11.14	10.34	0.20	Average	LINE																																																																																																																																																
12	19.8445	28.51	-31.49	60.00	17.97	10.34	0.20	QP	LINE																																																																																																																																																
<p>Note 1: "&gt;20dB" means emission levels that exceed the level of 20 dB below the applicable limit.            Note 2: "N/F" means Nothing Found emissions (No emissions were detected.)</p>																																																																																																																																																									



# RSE below 1GHz Result

RSE below 1GHz Result																																																																																																									
Operating Mode	1	Polarization	Horizontal																																																																																																						
Operating Function	Normal Link																																																																																																								
<div style="display: flex; justify-content: space-between; align-items: flex-start;"> <div style="text-align: center;"> <p style="font-size: small;">Date: 2017-11-23 Time: 17:21:03</p> </div> </div>																																																																																																									
<table border="1" style="width: 100%; border-collapse: collapse; font-size: x-small;"> <thead> <tr> <th></th> <th>Freq</th> <th>Level</th> <th>Limit</th> <th>Over</th> <th>Read</th> <th>CableAntenna</th> <th>Preamp</th> <th>A/Pos</th> <th>T/Pos</th> <th>Remark</th> <th>Pol/Phase</th> </tr> <tr> <th></th> <th>MHz</th> <th>dBuV/m</th> <th>dBuV/m</th> <th>dB</th> <th>dBuV</th> <th>dB</th> <th>dB/m</th> <th>dB</th> <th>cm</th> <th>deg</th> <th></th> </tr> </thead> <tbody> <tr> <td>1</td> <td>56.19</td> <td>30.07</td> <td>40.00</td> <td>-9.93</td> <td>47.72</td> <td>1.29</td> <td>13.47</td> <td>32.41</td> <td>150</td> <td>79</td> <td>Peak</td> <td>HORIZONTAL</td> </tr> <tr> <td>2</td> <td>74.62</td> <td>28.70</td> <td>40.00</td> <td>-11.30</td> <td>47.28</td> <td>0.84</td> <td>12.98</td> <td>32.40</td> <td>200</td> <td>336</td> <td>Peak</td> <td>HORIZONTAL</td> </tr> <tr> <td>3</td> <td>125.06</td> <td>28.99</td> <td>43.50</td> <td>-14.51</td> <td>41.60</td> <td>1.15</td> <td>18.60</td> <td>32.36</td> <td>150</td> <td>358</td> <td>Peak</td> <td>HORIZONTAL</td> </tr> <tr> <td>4</td> <td>153.19</td> <td>29.69</td> <td>43.50</td> <td>-13.81</td> <td>44.21</td> <td>1.05</td> <td>16.77</td> <td>32.34</td> <td>100</td> <td>2</td> <td>Peak</td> <td>HORIZONTAL</td> </tr> <tr> <td>5</td> <td>800.18</td> <td>37.09</td> <td>46.00</td> <td>-8.91</td> <td>39.10</td> <td>3.51</td> <td>26.60</td> <td>32.12</td> <td>100</td> <td>187</td> <td>Peak</td> <td>HORIZONTAL</td> </tr> <tr> <td>6</td> <td>903.00</td> <td>38.24</td> <td>46.00</td> <td>-7.76</td> <td>37.57</td> <td>4.72</td> <td>27.53</td> <td>31.58</td> <td>150</td> <td>302</td> <td>Peak</td> <td>HORIZONTAL</td> </tr> </tbody> </table>					Freq	Level	Limit	Over	Read	CableAntenna	Preamp	A/Pos	T/Pos	Remark	Pol/Phase		MHz	dBuV/m	dBuV/m	dB	dBuV	dB	dB/m	dB	cm	deg		1	56.19	30.07	40.00	-9.93	47.72	1.29	13.47	32.41	150	79	Peak	HORIZONTAL	2	74.62	28.70	40.00	-11.30	47.28	0.84	12.98	32.40	200	336	Peak	HORIZONTAL	3	125.06	28.99	43.50	-14.51	41.60	1.15	18.60	32.36	150	358	Peak	HORIZONTAL	4	153.19	29.69	43.50	-13.81	44.21	1.05	16.77	32.34	100	2	Peak	HORIZONTAL	5	800.18	37.09	46.00	-8.91	39.10	3.51	26.60	32.12	100	187	Peak	HORIZONTAL	6	903.00	38.24	46.00	-7.76	37.57	4.72	27.53	31.58	150	302	Peak	HORIZONTAL
	Freq	Level	Limit	Over	Read	CableAntenna	Preamp	A/Pos	T/Pos	Remark	Pol/Phase																																																																																														
	MHz	dBuV/m	dBuV/m	dB	dBuV	dB	dB/m	dB	cm	deg																																																																																															
1	56.19	30.07	40.00	-9.93	47.72	1.29	13.47	32.41	150	79	Peak	HORIZONTAL																																																																																													
2	74.62	28.70	40.00	-11.30	47.28	0.84	12.98	32.40	200	336	Peak	HORIZONTAL																																																																																													
3	125.06	28.99	43.50	-14.51	41.60	1.15	18.60	32.36	150	358	Peak	HORIZONTAL																																																																																													
4	153.19	29.69	43.50	-13.81	44.21	1.05	16.77	32.34	100	2	Peak	HORIZONTAL																																																																																													
5	800.18	37.09	46.00	-8.91	39.10	3.51	26.60	32.12	100	187	Peak	HORIZONTAL																																																																																													
6	903.00	38.24	46.00	-7.76	37.57	4.72	27.53	31.58	150	302	Peak	HORIZONTAL																																																																																													
<p>Note 1: "&gt;20dB" means emission levels that exceed the level of 20 dB below the applicable limit.            Note 2: "N/F" means Nothing Found emissions (No emissions were detected.)</p>																																																																																																									





# RSE below 1GHz Result

Appendix C.1

RSE below 1GHz Result																																																																																																			
Operating Mode	1	Polarization	Vertical																																																																																																
Operating Function	Normal Link																																																																																																		
<div style="display: flex; justify-content: space-between; align-items: flex-start;"> <div style="text-align: center;"> <p>The graph displays the measured RSE level in dBuV/m against frequency in MHz from 30 to 1000. A red stepped line represents the FCC CLASS-B limit. The blue trace shows the measured signal, which remains below the limit line. Six specific peaks are marked with red vertical lines and numbered 1 through 6.</p> </div> <div style="text-align: right;"> <p>Date: 2017-11-23 Time: 17:23:54</p> </div> </div>																																																																																																			
<table border="1" style="width: 100%; border-collapse: collapse; font-size: small;"> <thead> <tr> <th></th> <th>Freq</th> <th>Level</th> <th>Limit</th> <th>Over</th> <th>Read</th> <th>CableAntenna</th> <th>Preamp</th> <th>A/Pos</th> <th>T/Pos</th> <th>Remark</th> <th>Pol/Phase</th> </tr> <tr> <th></th> <th>MHz</th> <th>dBuV/m</th> <th>dBuV/m</th> <th>dB</th> <th>dBuV</th> <th>dB</th> <th>dB/m</th> <th>dB</th> <th>cm</th> <th>deg</th> <th></th> </tr> </thead> <tbody> <tr> <td>1</td> <td>40.67</td> <td>36.09</td> <td>40.00</td> <td>-3.91</td> <td>47.94</td> <td>1.19</td> <td>19.39</td> <td>32.43</td> <td>100</td> <td>22 Peak</td> <td>VERTICAL</td> </tr> <tr> <td>2</td> <td>56.19</td> <td>36.82</td> <td>40.00</td> <td>-3.18</td> <td>54.47</td> <td>1.29</td> <td>13.47</td> <td>32.41</td> <td>100</td> <td>116 Peak</td> <td>VERTICAL</td> </tr> <tr> <td>3</td> <td>62.98</td> <td>36.45</td> <td>40.00</td> <td>-3.55</td> <td>55.00</td> <td>1.19</td> <td>12.67</td> <td>32.41</td> <td>100</td> <td>116 QP</td> <td>VERTICAL</td> </tr> <tr> <td>4</td> <td>75.59</td> <td>35.95</td> <td>40.00</td> <td>-4.05</td> <td>54.44</td> <td>0.85</td> <td>13.06</td> <td>32.40</td> <td>100</td> <td>317 Peak</td> <td>VERTICAL</td> </tr> <tr> <td>5</td> <td>143.49</td> <td>30.52</td> <td>43.50</td> <td>-12.98</td> <td>44.30</td> <td>1.14</td> <td>17.42</td> <td>32.34</td> <td>100</td> <td>335 Peak</td> <td>VERTICAL</td> </tr> <tr> <td>6</td> <td>903.00</td> <td>39.93</td> <td>46.00</td> <td>-6.07</td> <td>39.26</td> <td>4.72</td> <td>27.53</td> <td>31.58</td> <td>300</td> <td>220 Peak</td> <td>VERTICAL</td> </tr> </tbody> </table>					Freq	Level	Limit	Over	Read	CableAntenna	Preamp	A/Pos	T/Pos	Remark	Pol/Phase		MHz	dBuV/m	dBuV/m	dB	dBuV	dB	dB/m	dB	cm	deg		1	40.67	36.09	40.00	-3.91	47.94	1.19	19.39	32.43	100	22 Peak	VERTICAL	2	56.19	36.82	40.00	-3.18	54.47	1.29	13.47	32.41	100	116 Peak	VERTICAL	3	62.98	36.45	40.00	-3.55	55.00	1.19	12.67	32.41	100	116 QP	VERTICAL	4	75.59	35.95	40.00	-4.05	54.44	0.85	13.06	32.40	100	317 Peak	VERTICAL	5	143.49	30.52	43.50	-12.98	44.30	1.14	17.42	32.34	100	335 Peak	VERTICAL	6	903.00	39.93	46.00	-6.07	39.26	4.72	27.53	31.58	300	220 Peak	VERTICAL
	Freq	Level	Limit	Over	Read	CableAntenna	Preamp	A/Pos	T/Pos	Remark	Pol/Phase																																																																																								
	MHz	dBuV/m	dBuV/m	dB	dBuV	dB	dB/m	dB	cm	deg																																																																																									
1	40.67	36.09	40.00	-3.91	47.94	1.19	19.39	32.43	100	22 Peak	VERTICAL																																																																																								
2	56.19	36.82	40.00	-3.18	54.47	1.29	13.47	32.41	100	116 Peak	VERTICAL																																																																																								
3	62.98	36.45	40.00	-3.55	55.00	1.19	12.67	32.41	100	116 QP	VERTICAL																																																																																								
4	75.59	35.95	40.00	-4.05	54.44	0.85	13.06	32.40	100	317 Peak	VERTICAL																																																																																								
5	143.49	30.52	43.50	-12.98	44.30	1.14	17.42	32.34	100	335 Peak	VERTICAL																																																																																								
6	903.00	39.93	46.00	-6.07	39.26	4.72	27.53	31.58	300	220 Peak	VERTICAL																																																																																								
<p>Note 1: "&gt;20dB" means emission levels that exceed the level of 20 dB below the applicable limit.            Note 2: "N/F" means Nothing Found emissions (No emissions were detected.)</p>																																																																																																			



## RSE below 1GHz Result

Appendix C.1

RSE below 1GHz Result																																																																																															
Operating Mode	2	Polarization	Horizontal																																																																																												
Operating Function	Normal Link																																																																																														
<p>The graph displays the RSE below 1GHz result. The y-axis represents Level (dBuV/m) from 0 to 100, and the x-axis represents Frequency (MHz) from 30 to 1000. A red line indicates the FCC CLASS-B limit, which is 54 dBuV/m from 30 to 100 MHz, 43.5 dBuV/m from 100 to 200 MHz, and 46 dBuV/m from 200 to 1000 MHz. The blue line shows the measured emission levels, with six peaks labeled 1 through 6. Peak 1 is at 54.25 MHz, peak 2 at 71.71 MHz, peak 3 at 125.06 MHz, peak 4 at 150.28 MHz, peak 5 at 638.19 MHz, and peak 6 at 800.18 MHz.</p>																																																																																															
	<table border="1"> <thead> <tr> <th>Peak</th> <th>Freq (MHz)</th> <th>Level (dBuV/m)</th> <th>Limit Line (dBuV/m)</th> <th>Over Limit (dB)</th> <th>Read Level (dBuV)</th> <th>CableAntenna Loss (dB)</th> <th>Preamp Factor (dB/m)</th> <th>A/Pos (dB)</th> <th>T/Pos (cm)</th> <th>Remark</th> <th>Pol/Phase</th> </tr> </thead> <tbody> <tr> <td>1</td> <td>54.25</td> <td>30.56</td> <td>40.00</td> <td>-9.44</td> <td>47.79</td> <td>1.32</td> <td>13.87</td> <td>32.42</td> <td>100</td> <td>299 Peak</td> <td>HORIZONTAL</td> </tr> <tr> <td>2</td> <td>71.71</td> <td>28.41</td> <td>40.00</td> <td>-11.59</td> <td>47.17</td> <td>0.89</td> <td>12.75</td> <td>32.40</td> <td>200</td> <td>301 Peak</td> <td>HORIZONTAL</td> </tr> <tr> <td>3</td> <td>125.06</td> <td>29.93</td> <td>43.50</td> <td>-13.57</td> <td>42.54</td> <td>1.15</td> <td>18.60</td> <td>32.36</td> <td>150</td> <td>204 Peak</td> <td>HORIZONTAL</td> </tr> <tr> <td>4</td> <td>150.28</td> <td>32.12</td> <td>43.50</td> <td>-11.38</td> <td>46.50</td> <td>1.08</td> <td>16.88</td> <td>32.34</td> <td>150</td> <td>54 Peak</td> <td>HORIZONTAL</td> </tr> <tr> <td>5</td> <td>638.19</td> <td>32.08</td> <td>46.00</td> <td>-13.92</td> <td>35.95</td> <td>3.22</td> <td>25.29</td> <td>32.38</td> <td>100</td> <td>282 Peak</td> <td>HORIZONTAL</td> </tr> <tr> <td>6</td> <td>800.18</td> <td>40.27</td> <td>46.00</td> <td>-5.73</td> <td>42.28</td> <td>3.51</td> <td>26.60</td> <td>32.12</td> <td>100</td> <td>183 Peak</td> <td>HORIZONTAL</td> </tr> </tbody> </table>	Peak	Freq (MHz)	Level (dBuV/m)	Limit Line (dBuV/m)	Over Limit (dB)	Read Level (dBuV)	CableAntenna Loss (dB)	Preamp Factor (dB/m)	A/Pos (dB)	T/Pos (cm)	Remark	Pol/Phase	1	54.25	30.56	40.00	-9.44	47.79	1.32	13.87	32.42	100	299 Peak	HORIZONTAL	2	71.71	28.41	40.00	-11.59	47.17	0.89	12.75	32.40	200	301 Peak	HORIZONTAL	3	125.06	29.93	43.50	-13.57	42.54	1.15	18.60	32.36	150	204 Peak	HORIZONTAL	4	150.28	32.12	43.50	-11.38	46.50	1.08	16.88	32.34	150	54 Peak	HORIZONTAL	5	638.19	32.08	46.00	-13.92	35.95	3.22	25.29	32.38	100	282 Peak	HORIZONTAL	6	800.18	40.27	46.00	-5.73	42.28	3.51	26.60	32.12	100	183 Peak	HORIZONTAL										
Peak	Freq (MHz)	Level (dBuV/m)	Limit Line (dBuV/m)	Over Limit (dB)	Read Level (dBuV)	CableAntenna Loss (dB)	Preamp Factor (dB/m)	A/Pos (dB)	T/Pos (cm)	Remark	Pol/Phase																																																																																				
1	54.25	30.56	40.00	-9.44	47.79	1.32	13.87	32.42	100	299 Peak	HORIZONTAL																																																																																				
2	71.71	28.41	40.00	-11.59	47.17	0.89	12.75	32.40	200	301 Peak	HORIZONTAL																																																																																				
3	125.06	29.93	43.50	-13.57	42.54	1.15	18.60	32.36	150	204 Peak	HORIZONTAL																																																																																				
4	150.28	32.12	43.50	-11.38	46.50	1.08	16.88	32.34	150	54 Peak	HORIZONTAL																																																																																				
5	638.19	32.08	46.00	-13.92	35.95	3.22	25.29	32.38	100	282 Peak	HORIZONTAL																																																																																				
6	800.18	40.27	46.00	-5.73	42.28	3.51	26.60	32.12	100	183 Peak	HORIZONTAL																																																																																				
<p>Note 1: "&gt;20dB" means emission levels that exceed the level of 20 dB below the applicable limit.            Note 2: "N/F" means Nothing Found emissions (No emissions were detected.)</p>																																																																																															

## RSE below 1GHz Result

<b>Operating Mode</b>	2	<b>Polarization</b>	Vertical
<b>Operating Function</b>	Normal Link		

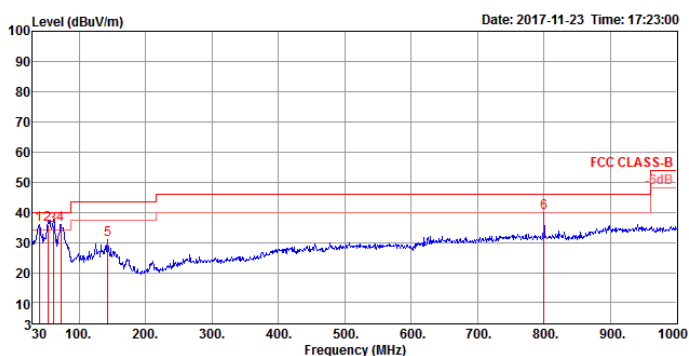

	Freq	Level	Limit	Over	Read	CableAntenna	Preamp	A/Pos	T/Pos	Remark	Pol/Phase
	MHz	dBuV/m	dBuV/m	dB	dBuV	dB	dB/m	dB	cm	deg	
1	39.70	36.01	40.00	-3.99	47.34	1.15	19.95	32.43	100	224 Peak	VERTICAL
2	53.28	36.00	40.00	-4.00	53.00	1.35	14.07	32.42	100	0 QP	VERTICAL
3	61.04	35.51	40.00	-4.49	54.00	1.23	12.69	32.41	100	282 QP	VERTICAL
4	72.68	35.91	40.00	-4.09	54.62	0.88	12.81	32.40	100	242 Peak	VERTICAL
5	143.49	30.89	43.50	-12.61	44.67	1.14	17.42	32.34	100	291 Peak	VERTICAL
6	800.18	39.92	46.00	-6.08	41.93	3.51	26.60	32.12	100	72 Peak	VERTICAL

Note 1: ">20dB" means emission levels that exceed the level of 20 dB below the applicable limit.

Note 2: "N/F" means Nothing Found emissions (No emissions were detected.)



**For Dipole Antenna  
Summary**

Mode	Result	Type	Freq (Hz)	Level (dBuV/m)	Limit (dBuV/m)	Margin (dB)	Factor (dB)	Dist (m)	Pol. (H/V)	Azimuth (°)	Height (m)	Comments
BT-BR(3Mbps)	-	-	-	-	-	-	-	-	-	-	-	-
2.4-2.4835GHz	Pass	AV	2.3846G	42.36	54.00	-11.64	29.92	3	H	350	2.72	-

### BT-EDR(3Mbps)

### 2402MHz\_TX

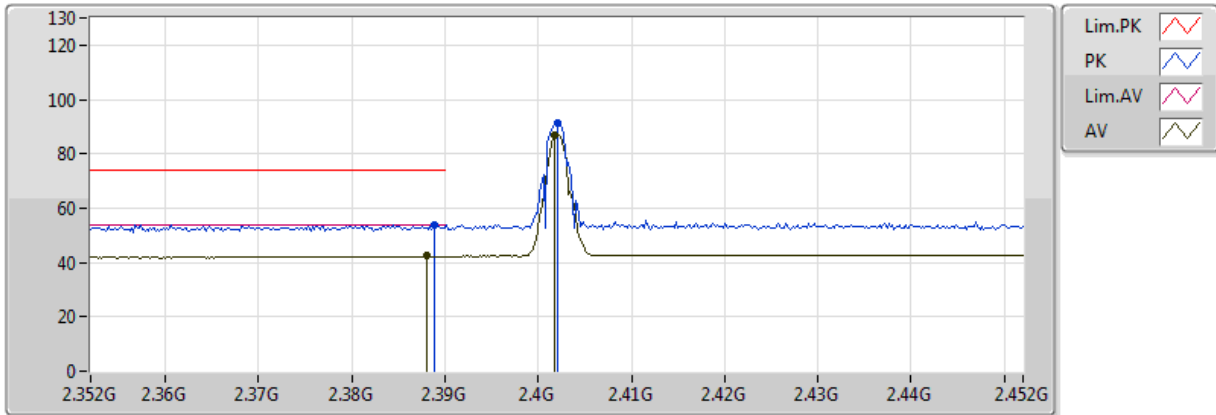

20171212  
EUT\_Z\_1TX  
Setting 00  
05-E-3  
FSP

Type	Freq(Hz)	Level(dBuV/m)	Limit(dBuV/m)	Margin(dB)	Factor(dB)	Dist(m)	Pol.(H/V)	Azimuth(°)	Height(m)	Comments
AV	2.388G	42.32	54.00	-11.68	29.93	3	V	87	2.22	-
AV	2.4018G	87.03	Inf	-Inf	29.95	3	V	87	2.22	-
PK	2.3888G	53.86	74.00	-20.14	29.93	3	V	87	2.22	-
PK	2.402G	91.58	Inf	-Inf	29.95	3	V	87	2.22	-

### BT-EDR(3Mbps)

### 2402MHz\_TX

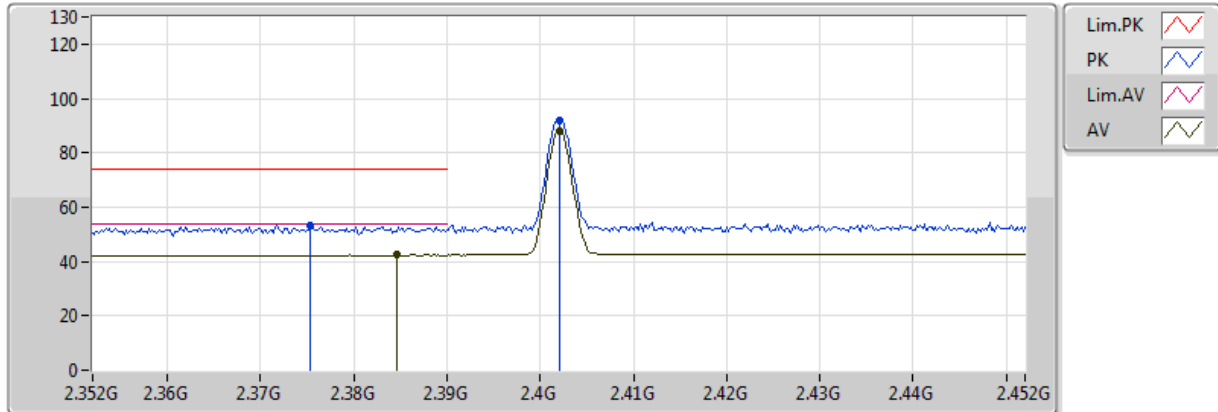

20171212  
EUT\_Z\_1TX  
Setting 00  
05-E-3  
FSP

Type	Freq(Hz)	Level(dBuV/m)	Limit(dBuV/m)	Margin(dB)	Factor(dB)	Dist(m)	Pol.(H/V)	Azimuth(°)	Height(m)	Comments
AV	2.3846G	42.36	54.00	-11.64	29.92	3	H	350	2.72	-
AV	2.402G	87.88	Inf	-Inf	29.95	3	H	350	2.72	-
PK	2.3754G	53.40	74.00	-20.60	29.92	3	H	350	2.72	-
PK	2.402G	92.01	Inf	-Inf	29.95	3	H	350	2.72	-

### BT-EDR(3Mbps)

### 2402MHz\_TX

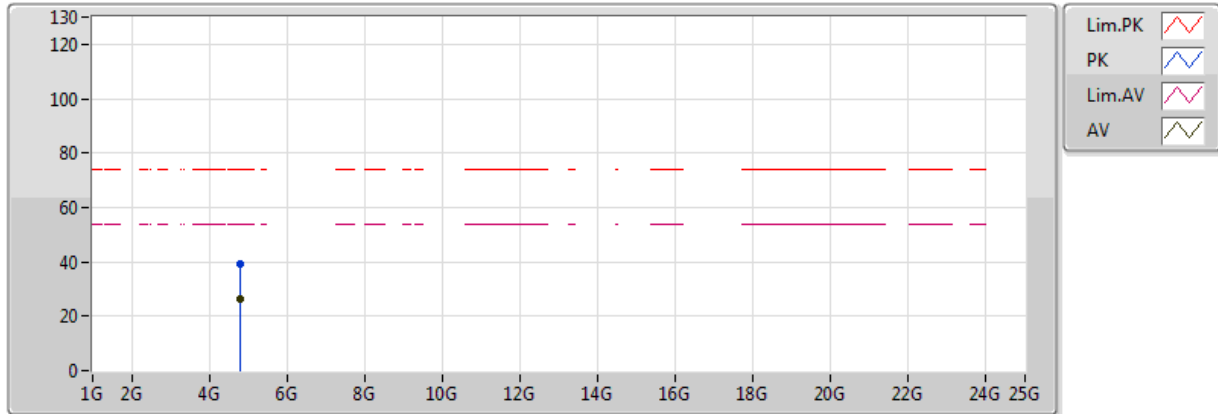

20171128  
EUT\_Z\_1TX  
Setting 00  
02-C-5  
FSU

Type	Freq(Hz)	Level(dBuV/m)	Limit(dBuV/m)	Margin(dB)	Factor(dB)	Dist(m)	Pol.(H/V)	Azimuth(°)	Height(m)	Comments
AV	4.80416G	26.23	54.00	-27.77	9.15	3	V	221	2.07	-
PK	4.8014G	39.36	74.00	-34.64	9.14	3	V	221	2.07	-

### BT-EDR(3Mbps)

### 2402MHz\_TX

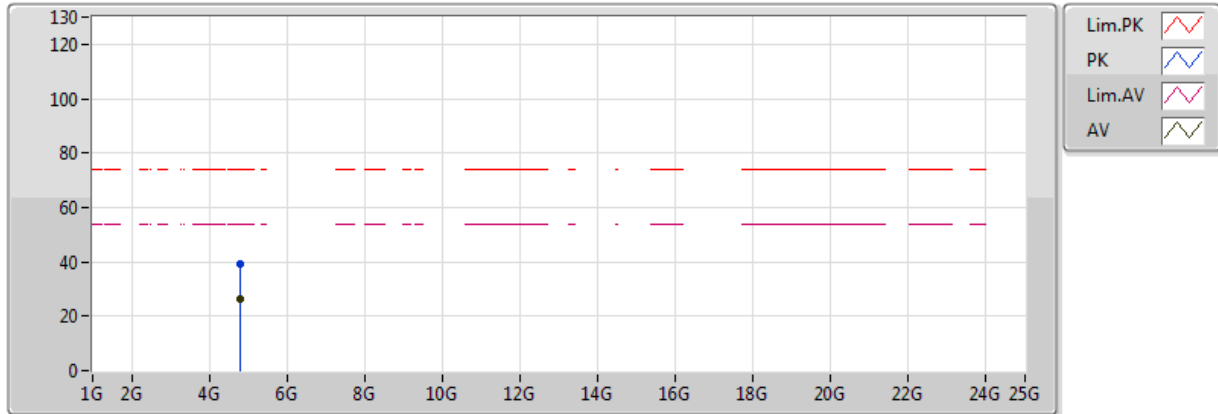

20171128  
EUT\_Z\_1TX  
Setting 00  
02-C-5  
FSU

Type	Freq(Hz)	Level(dBuV/m)	Limit(dBuV/m)	Margin(dB)	Factor(dB)	Dist(m)	Pol.(H/V)	Azimuth(°)	Height(m)	Comments
AV	4.80828G	26.25	54.00	-27.75	9.16	3	H	108	1.16	-
PK	4.80564G	39.24	74.00	-34.76	9.15	3	H	108	1.16	-





For PIFA Antenna  
Summary

Mode	Result	Type	Freq (Hz)	Level (dBuV/m)	Limit (dBuV/m)	Margin (dB)	Factor (dB)	Dist (m)	Pol. (H/V)	Azimuth (°)	Height (m)	Comments
BT-BR(1Mbps)	-	-	-	-	-	-	-	-	-	-	-	-
2.4-2.4835GHz	Pass	AV	2.4962G	48.01	54.00	-5.99	32.49	3	V	13	2.32	-

### BT-BR(1Mbps)

### 2402MHz\_TX

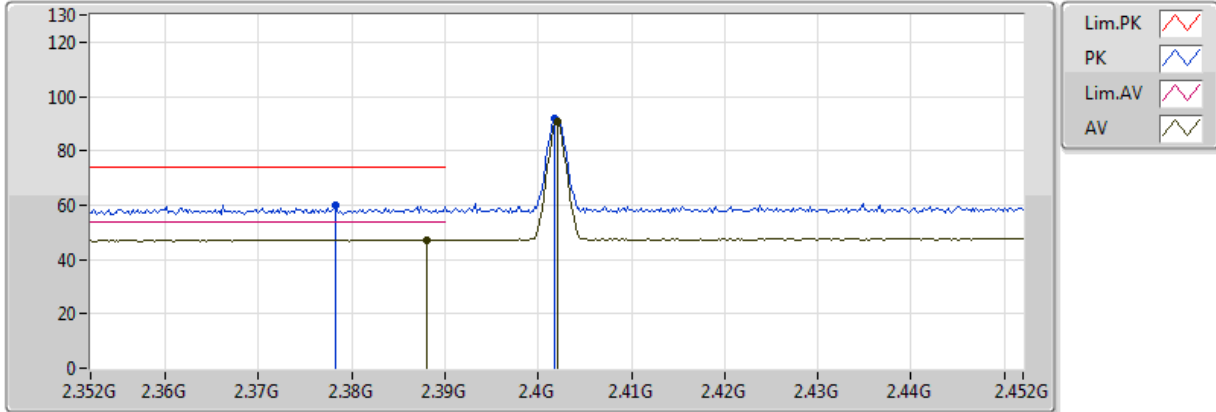

20171128  
EUT\_Z\_1TX  
Setting 00  
02-C-5  
FSU

Type	Freq(Hz)	Level(dBuV/m)	Limit(dBuV/m)	Margin(dB)	Factor(dB)	Dist(m)	Pol.(H/V)	Azimuth(°)	Height(m)	Comments
AV	2.388G	47.32	54.00	-6.68	32.13	3	V	99	1.50	-
AV	2.402G	90.82	Inf	-Inf	32.18	3	V	99	1.50	-
PK	2.3782G	59.84	74.00	-14.16	32.10	3	V	99	1.50	-
PK	2.4018G	91.76	Inf	-Inf	32.18	3	V	99	1.50	-

### BT-BR(1Mbps)

### 2402MHz\_TX

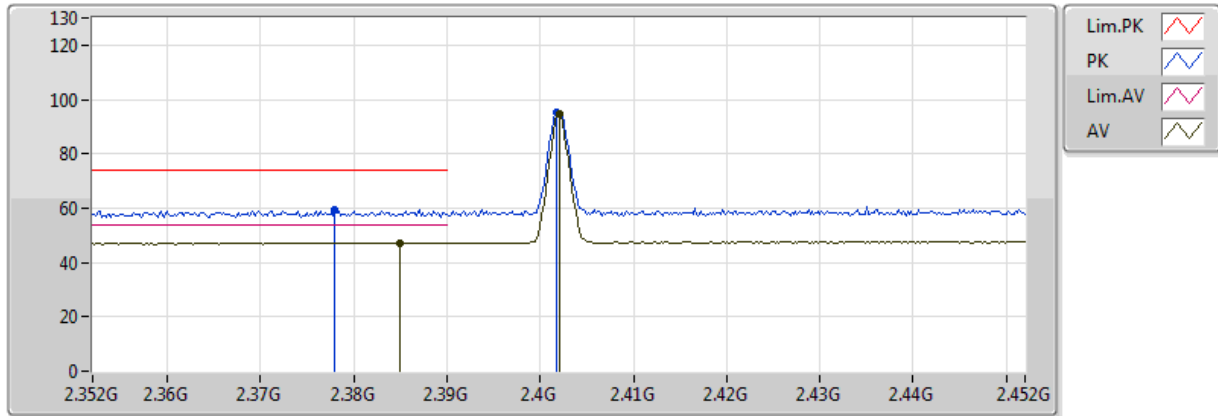

20171128  
EUT\_Z\_1TX  
Setting 00  
02-C-5  
FSU

Type	Freq(Hz)	Level(dBuV/m)	Limit(dBuV/m)	Margin(dB)	Factor(dB)	Dist(m)	Pol.(H/V)	Azimuth(°)	Height(m)	Comments
AV	2.385G	47.28	54.00	-6.72	32.12	3	H	137	2.62	-
AV	2.402G	94.44	Inf	-Inf	32.18	3	H	137	2.62	-
PK	2.378G	59.36	74.00	-14.64	32.10	3	H	137	2.62	-
PK	2.4018G	95.40	Inf	-Inf	32.18	3	H	137	2.62	-



### BT-BR(1Mbps)

### 2402MHz\_TX

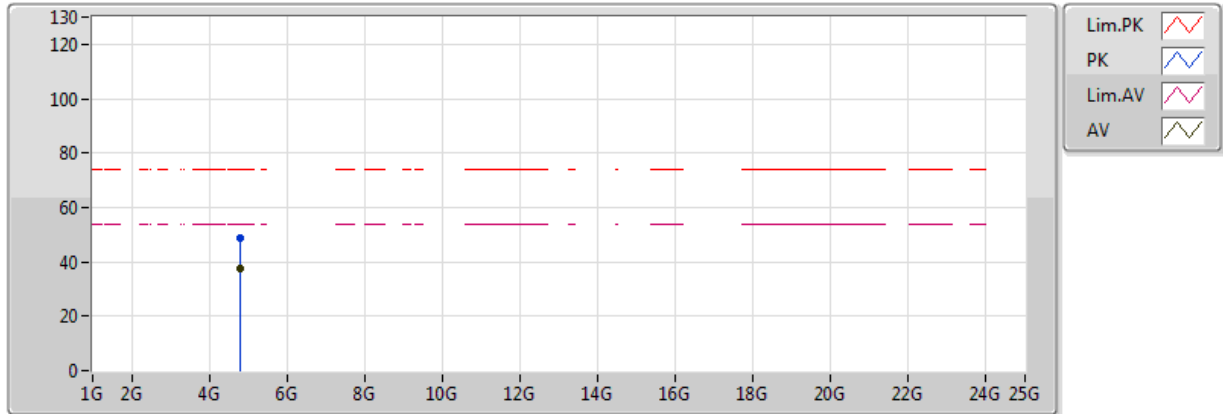

20171128  
 EUT\_Z\_1TX  
 Setting 00  
 02-C-5  
 FSU

Type	Freq(Hz)	Level(dBuV/m)	Limit(dBuV/m)	Margin(dB)	Factor(dB)	Dist(m)	Pol.(H/V)	Azimuth(°)	Height(m)	Comments
AV	4.80384G	37.67	54.00	-16.33	9.15	3	V	22	2.06	-
PK	4.80432G	48.88	74.00	-25.12	9.15	3	V	22	2.06	-

### BT-BR(1Mbps)

### 2402MHz\_TX

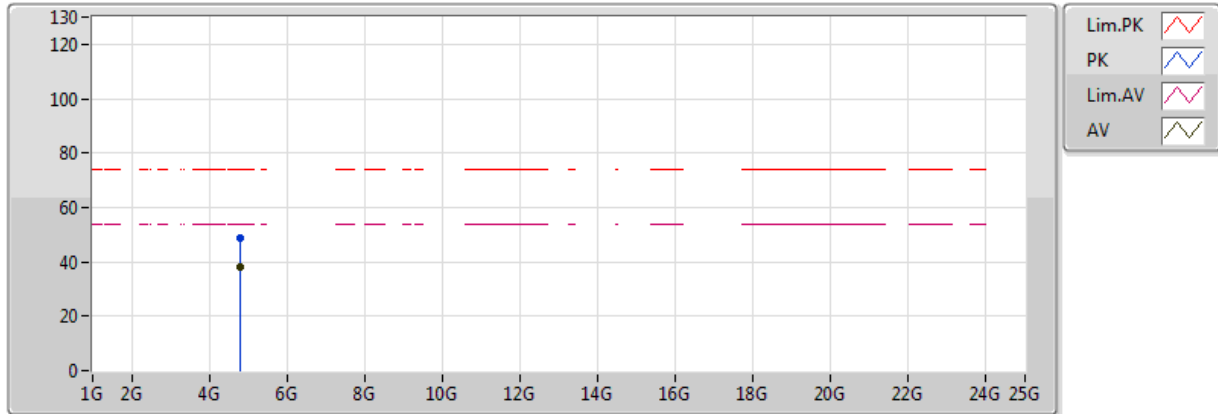

20171128  
EUT\_Z\_1TX  
Setting 00  
02-C-5  
FSU

Type	Freq(Hz)	Level(dBuV/m)	Limit(dBuV/m)	Margin(dB)	Factor(dB)	Dist(m)	Pol.(H/V)	Azimuth(°)	Height(m)	Comments
AV	4.80388G	38.13	54.00	-15.87	9.15	3	H	154	2.04	-
PK	4.80334G	48.81	74.00	-25.19	9.15	3	H	154	2.04	-

### BT-BR(1Mbps)

### 2440MHz\_TX

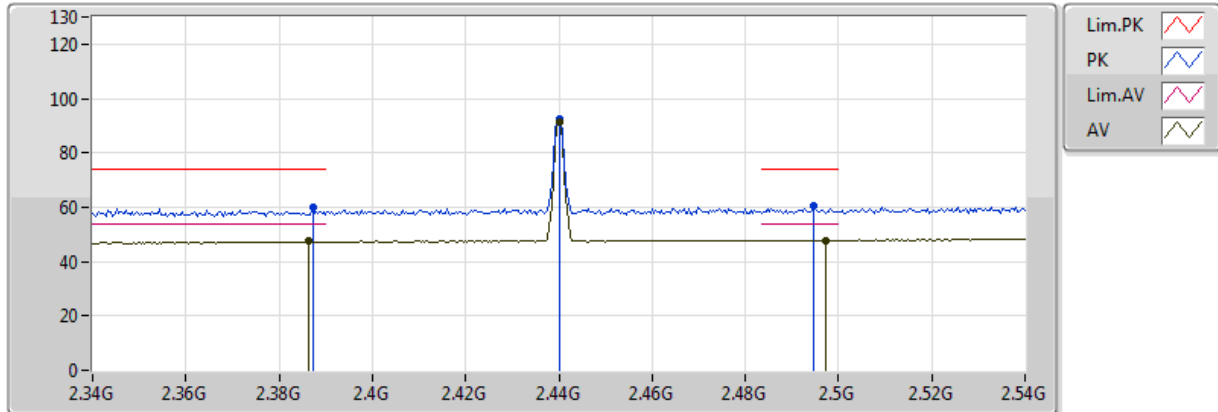

20171128  
EUT\_Z\_1TX  
Setting 00  
02-C-5  
FSU

Type	Freq(Hz)	Level(dBuV/m)	Limit(dBuV/m)	Margin(dB)	Factor(dB)	Dist(m)	Pol.(H/V)	Azimuth(°)	Height(m)	Comments
AV	2.3864G	47.37	54.00	-6.63	32.13	3	V	164	1.48	-
AV	2.44G	91.59	Inf	-Inf	32.30	3	V	164	1.48	-
AV	2.4972G	47.84	54.00	-6.16	32.49	3	V	164	1.48	-
PK	2.3872G	59.71	74.00	-14.29	32.13	3	V	164	1.48	-
PK	2.44G	92.69	Inf	-Inf	32.30	3	V	164	1.48	-
PK	2.4948G	60.29	74.00	-13.71	32.48	3	V	164	1.48	-

### BT-BR(1Mbps)

### 2440MHz\_TX

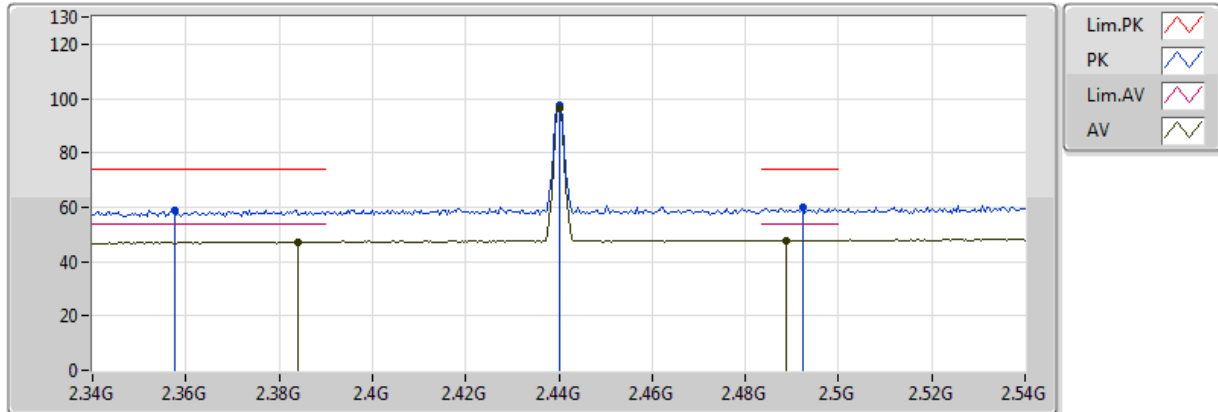

20171128  
EUT\_Z\_1TX  
Setting 00  
02-C-5  
FSU

Type	Freq(Hz)	Level(dBuV/m)	Limit(dBuV/m)	Margin(dB)	Factor(dB)	Dist(m)	Pol.(H/V)	Azimuth(°)	Height(m)	Comments
AV	2.384G	47.27	54.00	-6.73	32.12	3	H	118	2.79	-
AV	2.44G	96.36	Inf	-Inf	32.30	3	H	118	2.79	-
AV	2.4888G	47.81	54.00	-6.19	32.46	3	H	118	2.79	-
PK	2.3576G	59.08	74.00	-14.92	32.04	3	H	118	2.79	-
PK	2.44G	97.38	Inf	-Inf	32.30	3	H	118	2.79	-
PK	2.4924G	59.73	74.00	-14.27	32.47	3	H	118	2.79	-



### BT-BR(1Mbps)

### 2440MHz\_TX

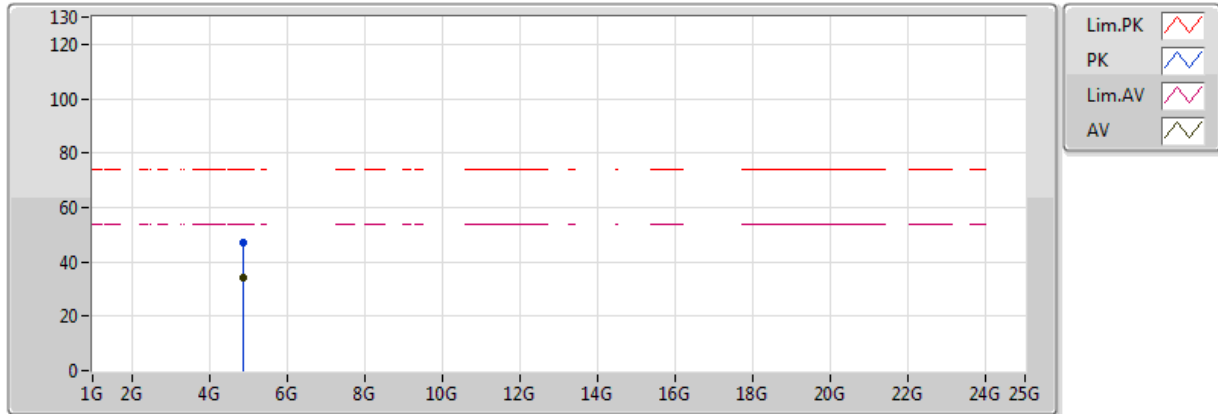

20171128  
EUT\_Z\_1TX  
Setting 00  
02-C-5  
FSU

Type	Freq(Hz)	Level(dBuV/m)	Limit(dBuV/m)	Margin(dB)	Factor(dB)	Dist(m)	Pol.(H/V)	Azimuth(°)	Height(m)	Comments
AV	4.87996G	34.40	54.00	-19.60	9.30	3	V	1	2.01	-
PK	4.87972G	47.30	74.00	-26.70	9.30	3	V	1	2.01	-



### BT-BR(1Mbps)

### 2440MHz\_TX

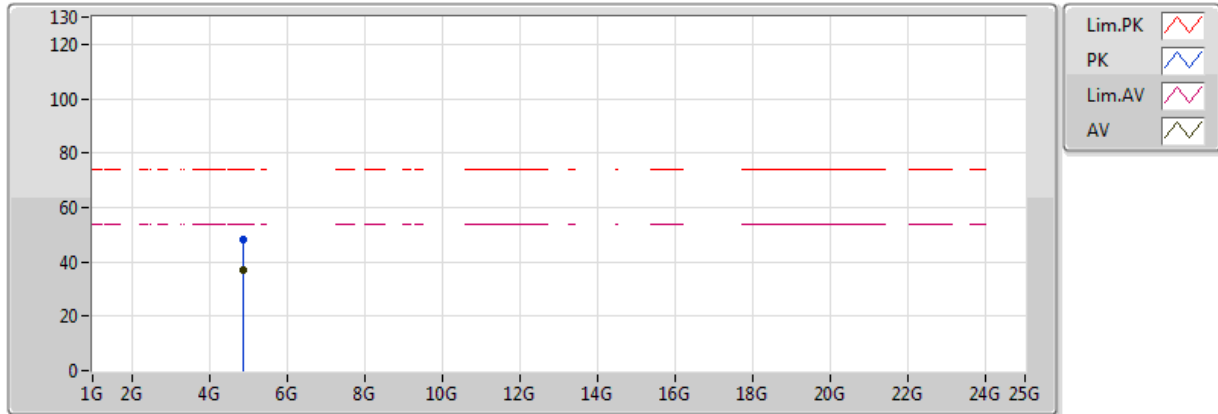

20171128  
EUT\_Z\_1TX  
Setting 00  
02-C-5  
FSU

Type	Freq(Hz)	Level(dBuV/m)	Limit(dBuV/m)	Margin(dB)	Factor(dB)	Dist(m)	Pol.(H/V)	Azimuth(°)	Height(m)	Comments
AV	4.8799G	36.86	54.00	-17.14	9.30	3	H	151	2.11	-
PK	4.87972G	48.01	74.00	-25.99	9.30	3	H	151	2.11	-

### BT-BR(1Mbps)

### 2480MHz\_TX

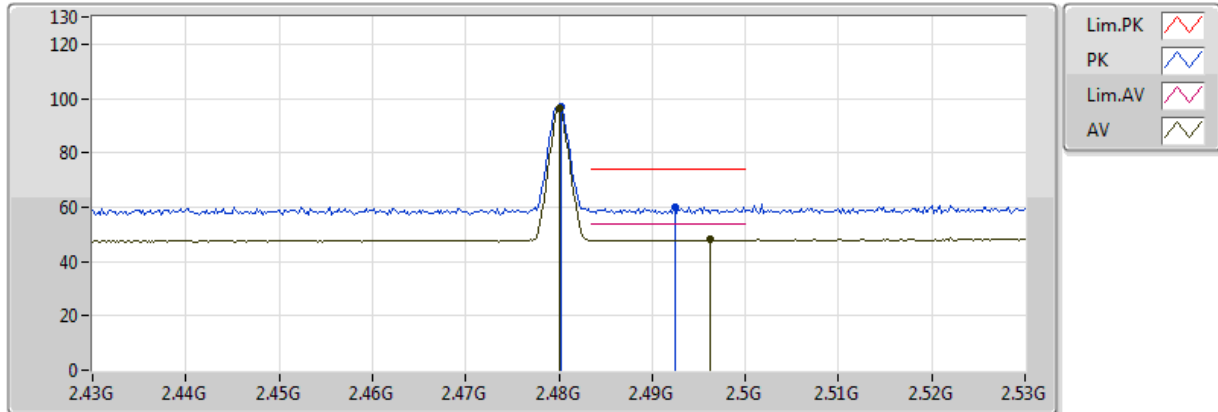

20171128  
EUT\_Z\_1TX  
Setting 00  
02-C-5  
FSU

Type	Freq(Hz)	Level(dBuV/m)	Limit(dBuV/m)	Margin(dB)	Factor(dB)	Dist(m)	Pol.(H/V)	Azimuth(°)	Height(m)	Comments
AV	2.48G	96.11	Inf	-Inf	32.43	3	V	13	2.32	-
AV	2.4962G	48.01	54.00	-5.99	32.49	3	V	13	2.32	-
PK	2.4802G	97.02	Inf	-Inf	32.43	3	V	13	2.32	-
PK	2.4924G	60.02	74.00	-13.98	32.47	3	V	13	2.32	-

### BT-BR(1Mbps)

### 2480MHz\_TX

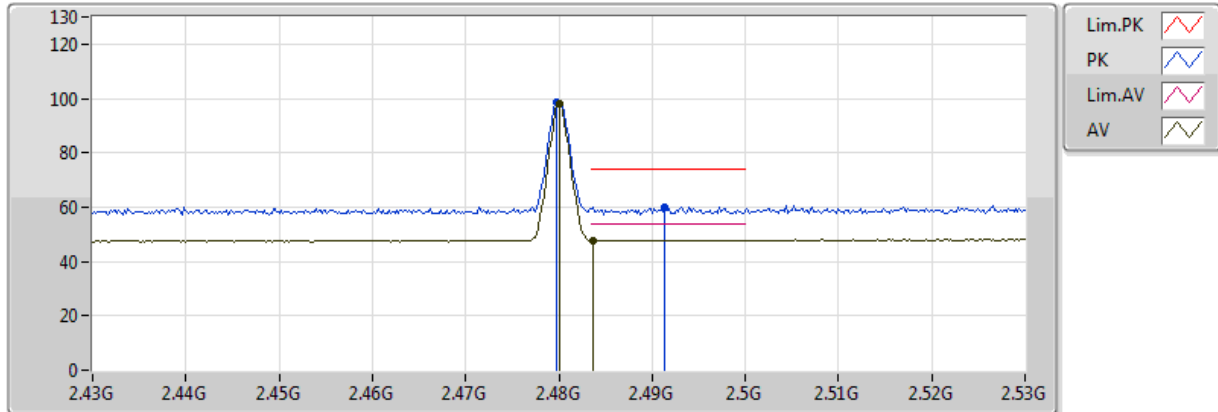

20171128  
EUT\_Z\_1TX  
Setting 00  
02-C-5  
FSU

Type	Freq(Hz)	Level(dBuV/m)	Limit(dBuV/m)	Margin(dB)	Factor(dB)	Dist(m)	Pol.(H/V)	Azimuth(°)	Height(m)	Comments
AV	2.48G	97.95	Inf	-Inf	32.43	3	H	197	1.50	-
AV	2.4836G	47.86	54.00	-6.14	32.45	3	H	197	1.50	-
PK	2.4798G	98.89	Inf	-Inf	32.43	3	H	197	1.50	-
PK	2.4914G	60.19	74.00	-13.81	32.47	3	H	197	1.50	-

### BT-BR(1Mbps)

### 2480MHz\_TX

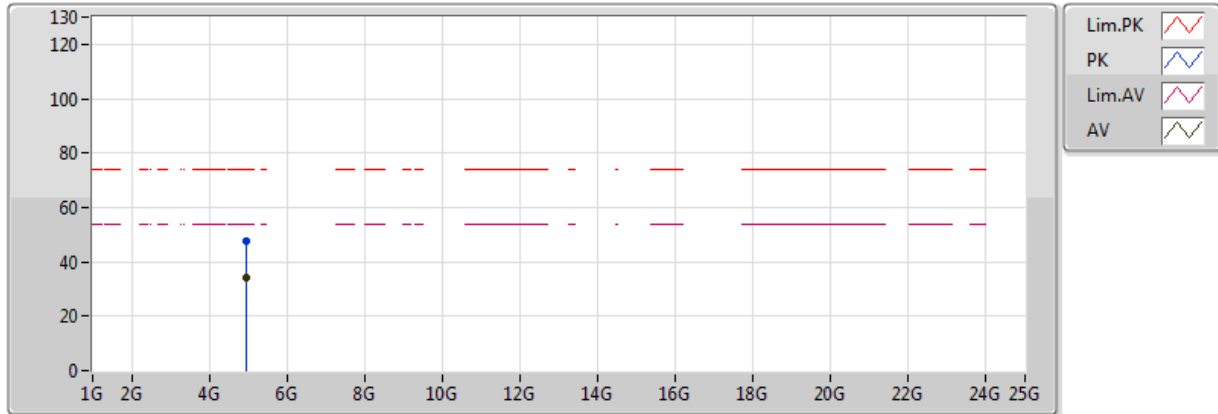

20171128  
 EUT\_Z\_1TX  
 Setting 00  
 02-C-5  
 FSU

Type	Freq(Hz)	Level(dBuV/m)	Limit(dBuV/m)	Margin(dB)	Factor(dB)	Dist(m)	Pol.(H/V)	Azimuth(°)	Height(m)	Comments
AV	4.95714G	34.11	54.00	-19.89	9.44	3	V	244	1.50	-
PK	4.96036G	47.85	74.00	-26.15	9.45	3	V	244	1.50	-

### BT-BR(1Mbps)

### 2480MHz\_TX

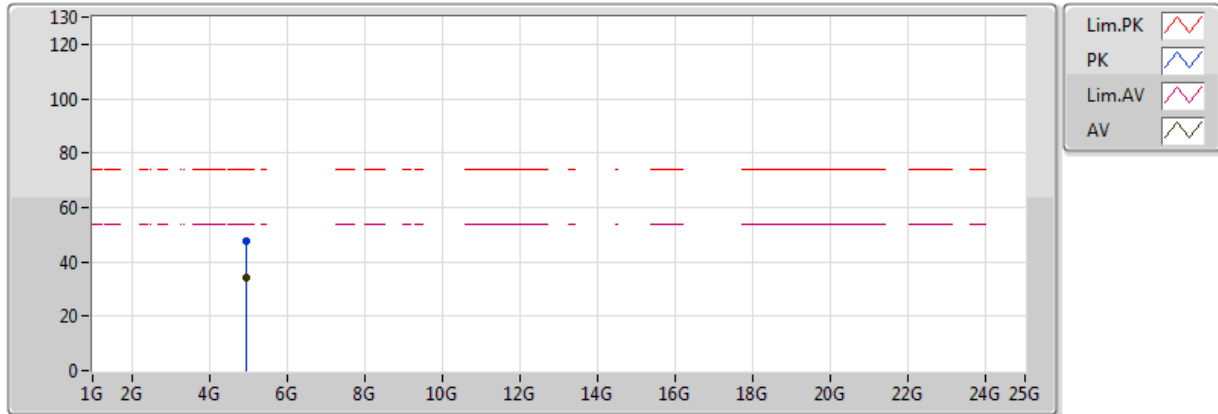

20171128  
EUT\_Z\_1TX  
Setting 00  
02-C-5  
FSU

Type	Freq(Hz)	Level(dBuV/m)	Limit(dBuV/m)	Margin(dB)	Factor(dB)	Dist(m)	Pol.(H/V)	Azimuth(°)	Height(m)	Comments
AV	4.95884G	34.11	54.00	-19.89	9.45	3	H	280	1.50	-
PK	4.95768G	47.58	74.00	-26.42	9.44	3	H	280	1.50	-

### BT-EDR(3Mbps)

### 2402MHz\_TX

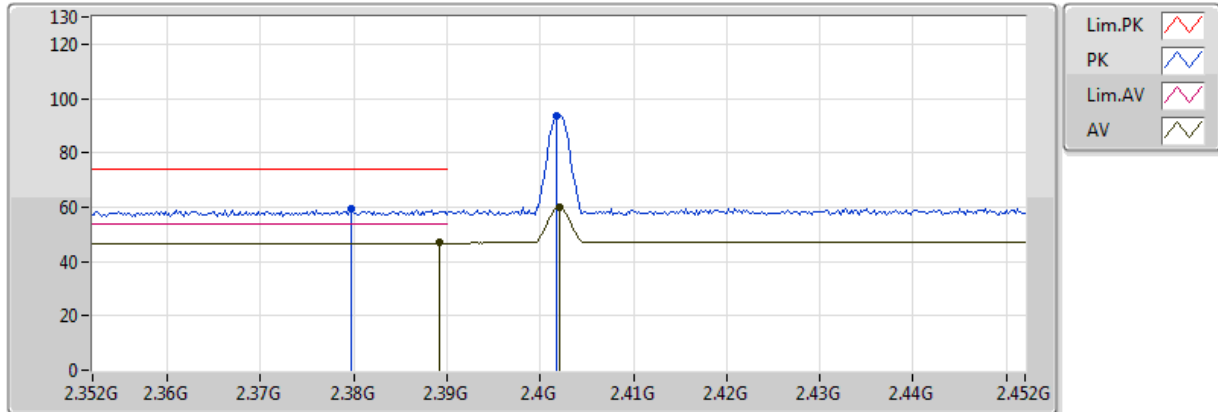

20171128  
EUT\_Z\_1TX  
Setting 00  
02-C-5  
FSU

Type	Freq(Hz)	Level(dBuV/m)	Limit(dBuV/m)	Margin(dB)	Factor(dB)	Dist(m)	Pol.(H/V)	Azimuth(°)	Height(m)	Comments
AV	2.3892G	46.81	54.00	-7.19	32.14	3	V	103	1.53	-
AV	2.402G	59.78	Inf	-Inf	32.18	3	V	103	1.53	-
PK	2.3798G	59.28	74.00	-14.72	32.11	3	V	103	1.53	-
PK	2.4018G	93.63	Inf	-Inf	32.18	3	V	103	1.53	-

### BT-EDR(3Mbps)

### 2402MHz\_TX

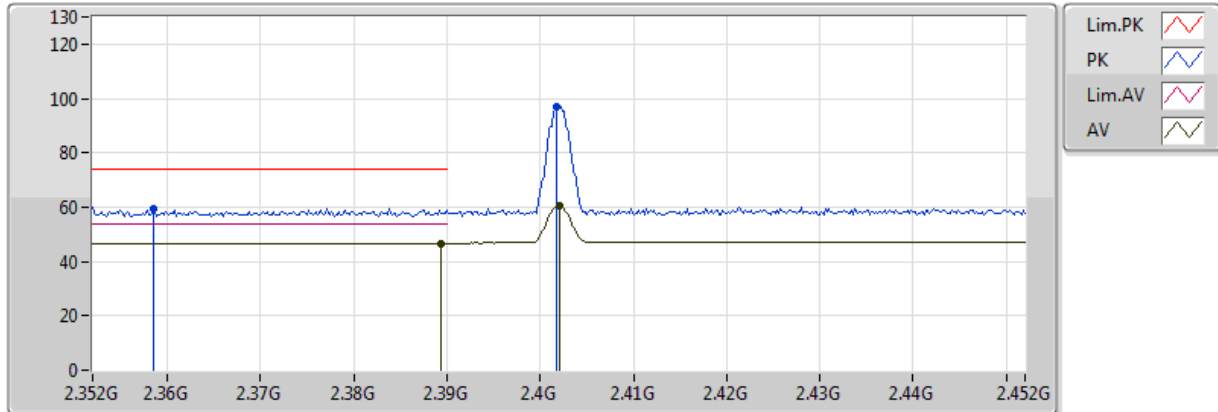

20171128  
EUT\_Z\_1TX  
Setting 00  
02-C-5  
FSU

Type	Freq(Hz)	Level(dBuV/m)	Limit(dBuV/m)	Margin(dB)	Factor(dB)	Dist(m)	Pol.(H/V)	Azimuth(°)	Height(m)	Comments
AV	2.3894G	46.77	54.00	-7.23	32.14	3	H	6	2.62	-
AV	2.402G	60.52	Inf	-Inf	32.18	3	H	6	2.62	-
PK	2.3586G	59.22	74.00	-14.78	32.05	3	H	6	2.62	-
PK	2.4018G	97.04	Inf	-Inf	32.18	3	H	6	2.62	-

### BT-EDR(3Mbps)

### 2402MHz\_TX

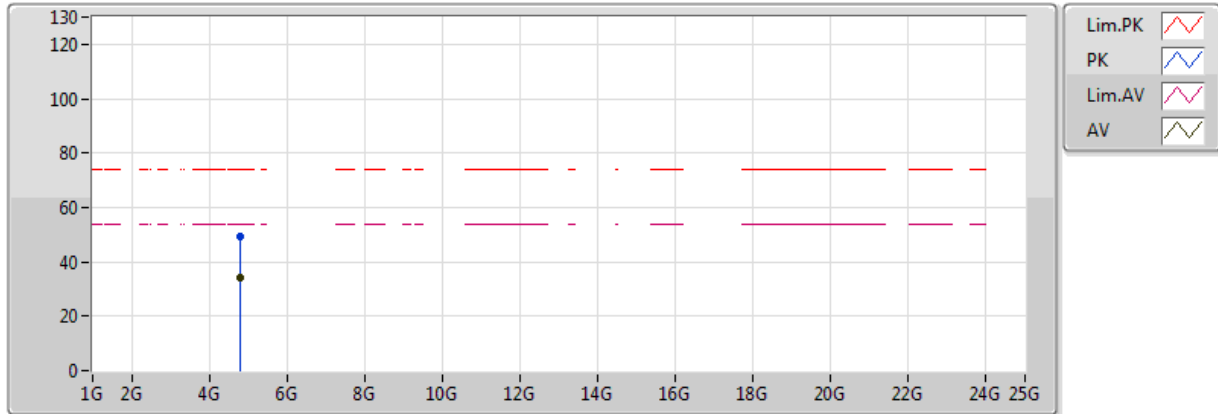

20171128  
EUT\_Z\_1TX  
Setting 00  
02-C-5  
FSU

Type	Freq(Hz)	Level(dBuV/m)	Limit(dBuV/m)	Margin(dB)	Factor(dB)	Dist(m)	Pol.(H/V)	Azimuth(°)	Height(m)	Comments
AV	4.80398G	34.19	54.00	-19.81	9.15	3	V	44	2.06	-
PK	4.80436G	49.06	74.00	-24.94	9.15	3	V	44	2.06	-





### BT-EDR(3Mbps)

### 2402MHz\_TX

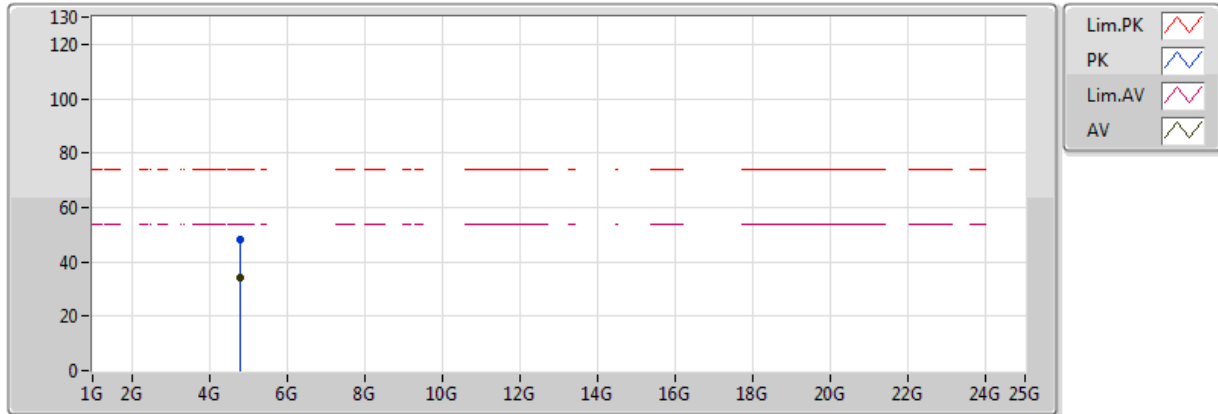

20171128  
EUT\_Z\_1TX  
Setting 00  
02-C-5  
FSU

Type	Freq(Hz)	Level(dBuV/m)	Limit(dBuV/m)	Margin(dB)	Factor(dB)	Dist(m)	Pol.(H/V)	Azimuth(°)	Height(m)	Comments
AV	4.80404G	34.04	54.00	-19.96	9.15	3	H	185	2.02	-
PK	4.80448G	48.38	74.00	-25.62	9.15	3	H	185	2.02	-

### BT-EDR(3Mbps)

### 2440MHz\_TX

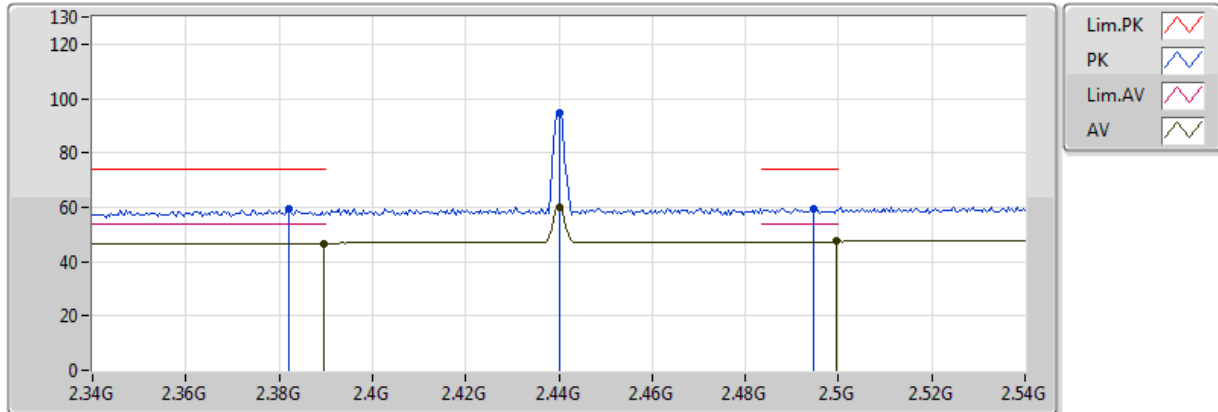

20171128  
EUT\_Z\_1TX  
Setting 00  
02-C-5  
FSU

Type	Freq(Hz)	Level(dBuV/m)	Limit(dBuV/m)	Margin(dB)	Factor(dB)	Dist(m)	Pol.(H/V)	Azimuth(°)	Height(m)	Comments
AV	2.3896G	46.76	54.00	-7.24	32.14	3	V	202	1.83	-
AV	2.44G	60.17	Inf	-Inf	32.30	3	V	202	1.83	-
AV	2.4996G	47.36	54.00	-6.64	32.50	3	V	202	1.83	-
PK	2.382G	59.13	74.00	-14.87	32.12	3	V	202	1.83	-
PK	2.44G	94.57	Inf	-Inf	32.30	3	V	202	1.83	-
PK	2.4948G	59.30	74.00	-14.70	32.48	3	V	202	1.83	-

### BT-EDR(3Mbps)

### 2440MHz\_TX

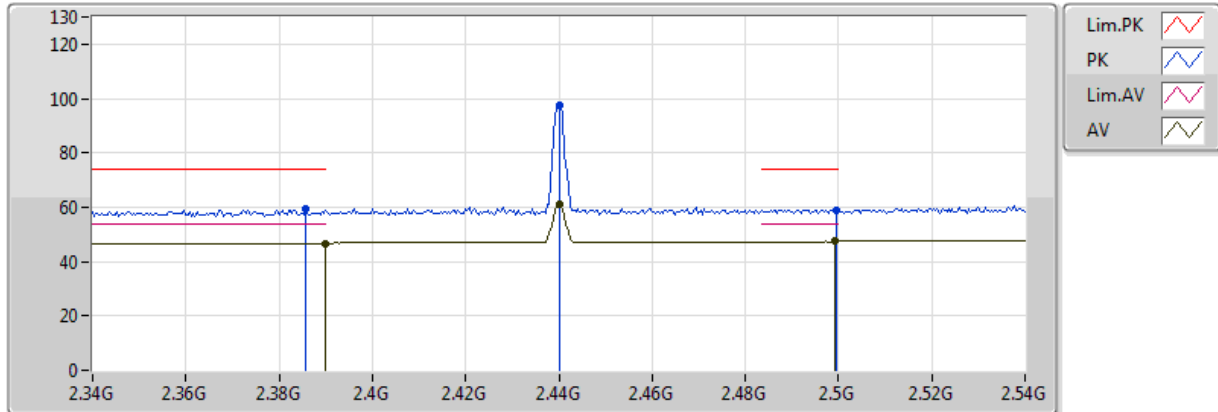

20171128  
EUT\_Z\_1TX  
Setting 00  
02-C-5  
FSU

Type	Freq(Hz)	Level(dBuV/m)	Limit(dBuV/m)	Margin(dB)	Factor(dB)	Dist(m)	Pol.(H/V)	Azimuth(°)	Height(m)	Comments
AV	2.39G	46.78	54.00	-7.22	32.14	3	H	19	2.10	-
AV	2.44G	61.02	Inf	-Inf	32.30	3	H	19	2.10	-
AV	2.4992G	47.37	54.00	-6.63	32.50	3	H	19	2.10	-
PK	2.3856G	59.43	74.00	-14.57	32.13	3	H	19	2.10	-
PK	2.44G	97.36	Inf	-Inf	32.30	3	H	19	2.10	-
PK	2.4996G	59.09	74.00	-14.91	32.50	3	H	19	2.10	-

### BT-EDR(3Mbps)

### 2440MHz\_TX

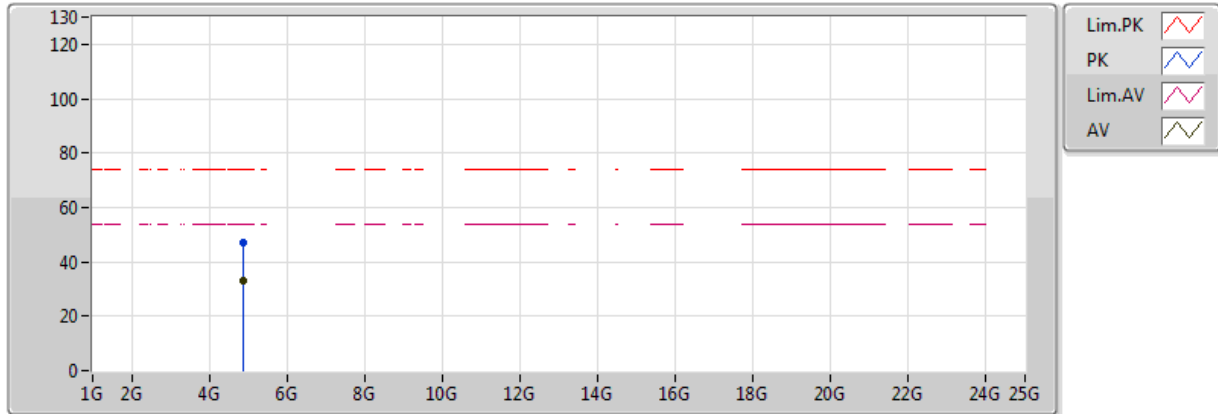

20171128  
EUT\_Z\_1TX  
Setting 00  
02-C-5  
FSU

Type	Freq(Hz)	Level(dBuV/m)	Limit(dBuV/m)	Margin(dB)	Factor(dB)	Dist(m)	Pol.(H/V)	Azimuth(°)	Height(m)	Comments
AV	4.87978G	33.18	54.00	-20.82	9.30	3	V	123	2.13	-
PK	4.8795G	47.25	74.00	-26.75	9.30	3	V	123	2.13	-

### BT-EDR(3Mbps)

### 2440MHz\_TX

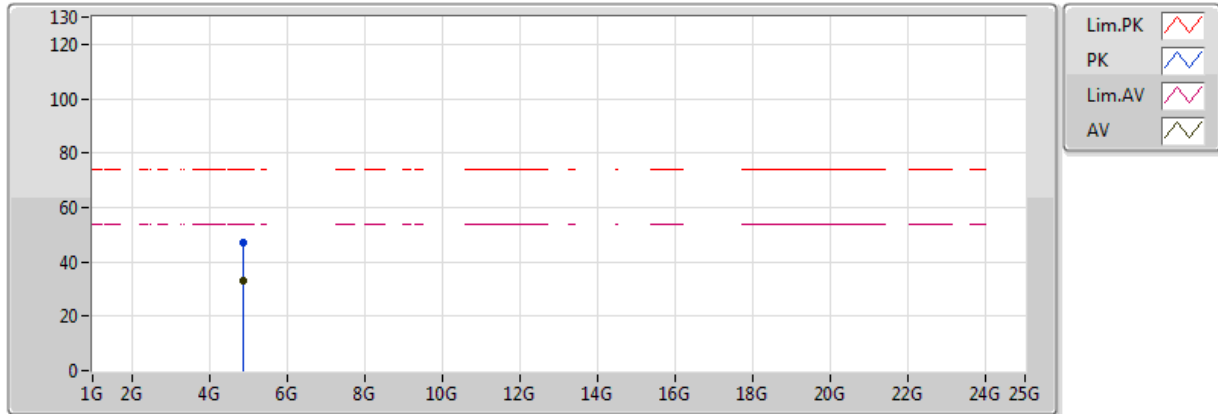

20171128  
EUT\_Z\_1TX  
Setting 00  
02-C-5  
FSU

Type	Freq(Hz)	Level(dBuV/m)	Limit(dBuV/m)	Margin(dB)	Factor(dB)	Dist(m)	Pol.(H/V)	Azimuth(°)	Height(m)	Comments
AV	4.88012G	33.30	54.00	-20.70	9.30	3	H	176	2.23	-
PK	4.88026G	47.06	74.00	-26.94	9.30	3	H	176	2.23	-

### BT-EDR(3Mbps)

### 2480MHz\_TX

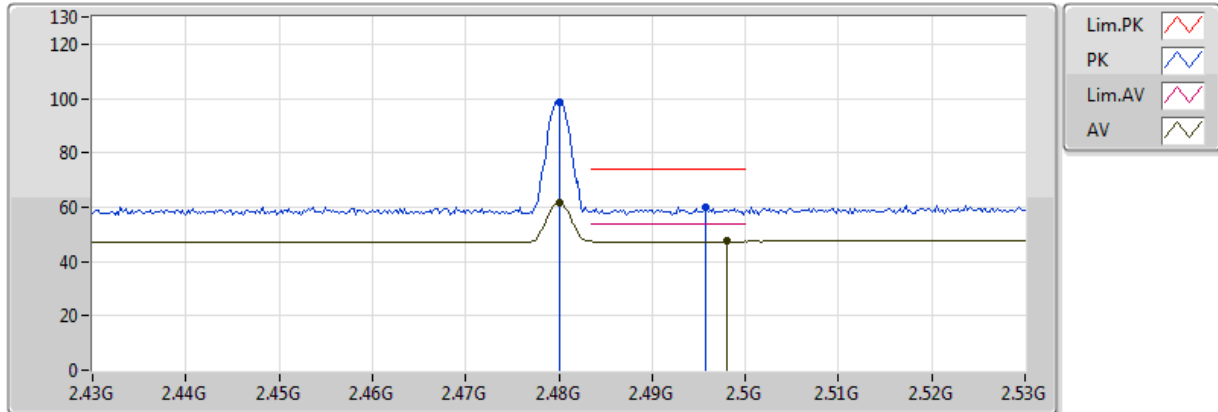

20171128  
EUT\_Z\_1TX  
Setting 00  
02-C-5  
FSU

Type	Freq(Hz)	Level(dBuV/m)	Limit(dBuV/m)	Margin(dB)	Factor(dB)	Dist(m)	Pol.(H/V)	Azimuth(°)	Height(m)	Comments
AV	2.48G	61.58	Inf	-Inf	32.43	3	V	140	1.77	-
AV	2.498G	47.36	54.00	-6.64	32.49	3	V	140	1.77	-
PK	2.48G	98.90	Inf	-Inf	32.43	3	V	140	1.77	-
PK	2.4958G	59.95	74.00	-14.05	32.49	3	V	140	1.77	-

### BT-EDR(3Mbps)

### 2480MHz\_TX

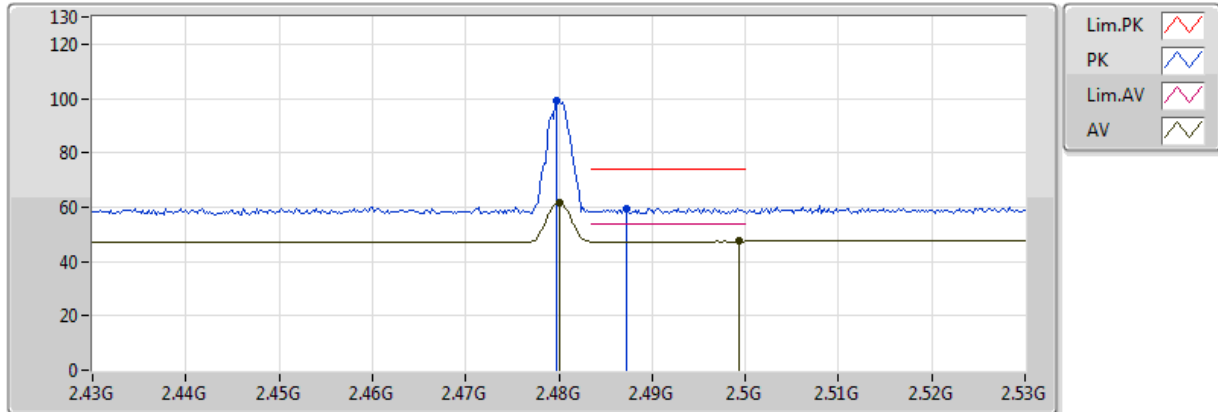

20171128  
EUT\_Z\_1TX  
Setting 00  
02-C-5  
FSU

Type	Freq(Hz)	Level(dBuV/m)	Limit(dBuV/m)	Margin(dB)	Factor(dB)	Dist(m)	Pol.(H/V)	Azimuth(°)	Height(m)	Comments
AV	2.48G	61.74	Inf	-Inf	32.43	3	H	178	1.50	-
AV	2.4994G	47.39	54.00	-6.61	32.50	3	H	178	1.50	-
PK	2.4798G	99.24	Inf	-Inf	32.43	3	H	178	1.50	-
PK	2.4872G	59.51	74.00	-14.49	32.46	3	H	178	1.50	-

### BT-EDR(3Mbps)

### 2480MHz\_TX

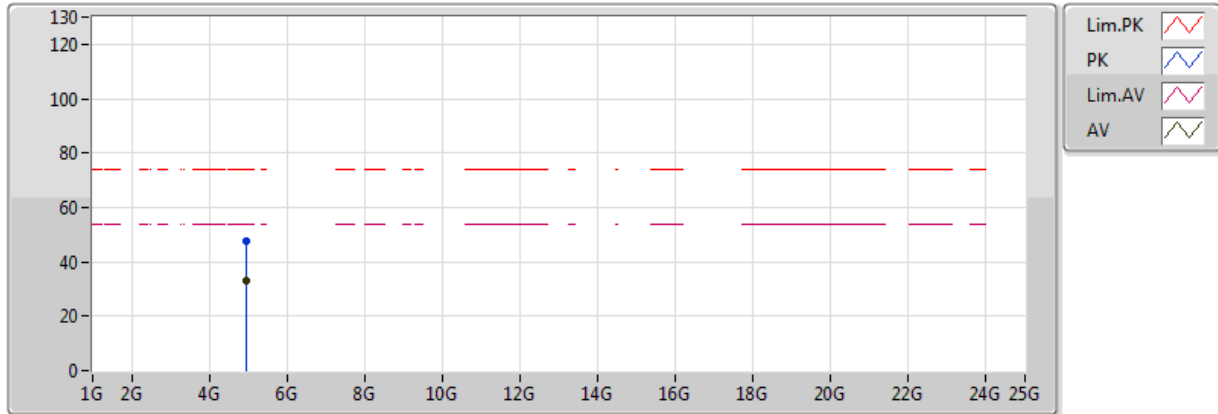

20171128  
EUT\_Z\_1TX  
Setting 00  
02-C-5  
FSU

Type	Freq(Hz)	Level(dBuV/m)	Limit(dBuV/m)	Margin(dB)	Factor(dB)	Dist(m)	Pol.(H/V)	Azimuth(°)	Height(m)	Comments
AV	4.95622G	33.24	54.00	-20.76	9.44	3	V	43	1.50	-
PK	4.96104G	47.76	74.00	-26.24	9.45	3	V	43	1.50	-



### BT-EDR(3Mbps)

### 2480MHz\_TX

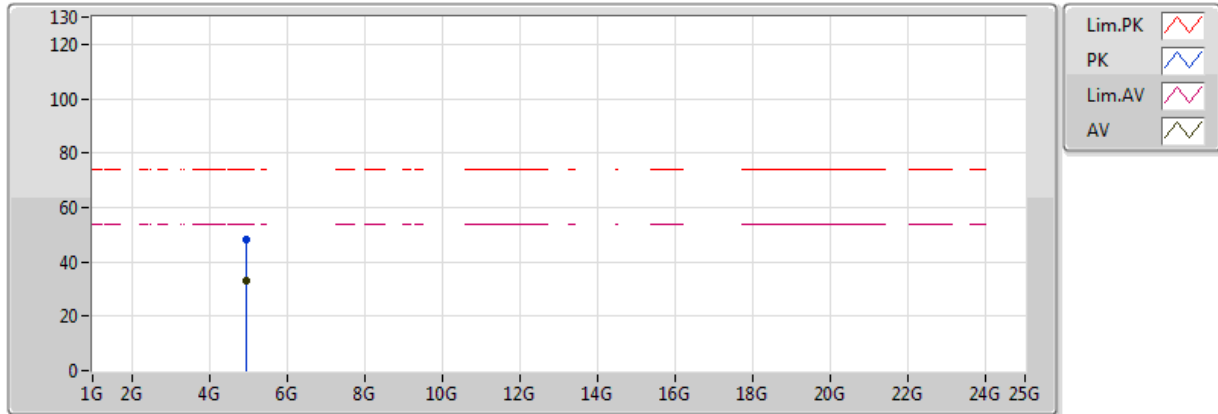

20171128  
EUT\_Z\_1TX  
Setting 00  
02-C-5  
FSU

Type	Freq(Hz)	Level(dBuV/m)	Limit(dBuV/m)	Margin(dB)	Factor(dB)	Dist(m)	Pol.(H/V)	Azimuth(°)	Height(m)	Comments
AV	4.95504G	33.27	54.00	-20.73	9.44	3	H	24	2.24	-
PK	4.96238G	48.13	74.00	-25.87	9.45	3	H	24	2.24	-

