



Ecom Sertech Corp.

Rm. 258, Bldg. 17, NO.195, Sec. 4 Chung Hsing Rd., ChuTung Chen, Hsinchu, Taiwan 310, R.O.C
TEL:886-3-5918012 FAX: 886-3-5825720

FCC ID : RAXWN4501CARC

Report No. : ER03-12-021FRF

Page 1 of 60



TEST REPORT

Product Name : OfficeConnect Wireless 11g USB Adapter

Model Number : 3CRWE254G72

Applicant : Arcadyan Technology Corporation

Address : 4F, No. 9, Park Avenue II, Science-based Industrial Park,
Hsinchu 300, Taiwan, R.O.C.

Received Date : Dec. 09, 2003

Tested Date : Oct. 01~14, 2003

Notes :

1. This report will be invalid if duplicated or photocopied in part.
2. This report refers only to the specimen(s) submitted to testing, and be invalid as seperately used.
3. This report is invalid without examination stamp and signature of this institute.
4. The tested specimen(s) will be preserved for thirty days from the data issued.
5. The report must not be used to claim product certification, approval, or endorsement by NVLAP, NIST, or any agency of the federal government.
6. **This report is transferred from ER03-10-003.**





Ecom Sertech Corp.

Rm. 258, Bldg. 17, NO.195, Sec. 4 Chung Hsing Rd., ChuTung Chen, Hsinchu, Taiwan 310, R.O.C
TEL:886-3-5918012 FAX: 886-3-5825720

FCC ID : RAXWN4501CARC

Report No. : ER03-12-021FRF

Page 2 of 60

Test Report Certification

Product Name : OfficeConnect Wireless 11g USB Adapter

Model Number : 3CRWE254G72

Applicant : Arcadyan Technology Corporation

Measurement Standard :

47 CFR Part 15, Subpart B and Subpart C (Section 15.247),
ANSI C63.4-2001

Tested By : K. P. Pang, **Date** : Dec. 09, 2003
(K. P. Pang)

Reviewed By : Roger Sheng, **Date** : Dec. 09, 2003
(Roger Sheng)

Approved By : Chieh-De Tsai, **Date** : Dec. 09, 2003
(Chieh-De Tsai, Manager)



WE HEREBY CERTIFY THAT: The measurements shown in the attachment were made in accordance with the procedures indicated, and the energy emitted by the equipment was found to be within the limits applicable. We assume full responsibility for the accuracy and completeness of these measurements and vouch for the qualifications of all persons taking them.



TABLE OF CONTENTS

TITLE	PAGE NO.
1. GENERAL INFORMATION	5
1.1 General Statement.....	5
1.2 General Description of EUT & Power.....	5
1.3 Description of Peripherals.....	6
1.4 EUT & Peripherals Setup Diagram.....	7
1.5 EUT Operating Condition.....	7
1.6 Description of Test Site	8
1.7 Summary of Test Results.....	8
2. CONDUCTED POWERLINE TEST	9
2.1 Test Equipments	9
2.2 Test Setup	9
2.3 Conducted Power Line Emission Limit.....	10
2.4 Test Procedure	10
2.5 Uncertainty of Conducted Emission	10
2.6 Conducted RF Voltage Measurement.....	11-12
2.7 Photos of Conduction Test.....	13
3. RADIATED EMISSION TEST	14
3.1 Test Equipments	14
3.2 Test Setup	14
3.3 Radiation Limit.....	15
3.4 Test Procedures.....	16
3.5 Uncertainty of Radiated Emission	16
3.6 Radiated RF Noise Measurement	17-42
3.7 Photos of Open Site	43-44
4. 6dB BANDWIDTH MEASUREMENT	45
4.1 Test Equipments	45
4.2 Test Setup	45
4.3 Limits of 6dB Bandwidth Measurement.....	45
4.4 Test Procedure	45
4.5 Uncertainty of Conducted Emission	45
4.6 Test Results.....	46
4.7 Photo of 6db Bandwidth Measurement.....	47-48
5. MAXIMUM PEAK OUTPUT POWER	49
5.1 Test Equipments	49
5.2 Test Setup	49
5.3 Limits of Maximum Peak Output Power	49
5.4 Test Procedure	50
5.5 Uncertainty of Conducted Emission	50
5.6 Test Results.....	50
6. POWER SPECTRAL DENSITY MEASUREMENT.....	51
6.1 Test Equipments	51
6.2 Test Setup	51
6.3 Limits of Power Spectral Density Measurement	51
6.4 Test Procedure	52
6.5 Uncertainty of Conducted Emission	52
6.6 Test Results.....	52
6.7 Photo of Power Spectral Density Measurement	53-54



Ecom Sertech Corp.

Rm. 258, Bldg. 17, NO.195, Sec. 4 Chung Hsing Rd., ChuTung Chen, Hsinchu, Taiwan 310, R.O.C
TEL:886-3-5918012 FAX : 886-3-5825720

FCC ID : RAXWN4501CARC

Report No. : ER03-12-021FRF

Page 4 of 60

TABLE OF CONTENTS

TITLE	PAGE NO.
7. OUT OF BAND MEASUREMENT	55
7.1 Test Equipments	55
7.2 Test Setup	55
7.3 Limits of Out of Band Emissions Measurement	55
7.4 Test Procedure	56
7.5 Uncertainty of Conducted Emission	56
7.6 Test Results	56-57
7.7 Photo of Out of Band Measurement	58-59
8. ANTENNA REQUIREMENT	60
8.1 Standard Applicable	60
8.2 Antenna Connected Construction	60



1. GENERAL INFORMATION

1.1 General Statement

MEASUREMENT DEVIATION : Comply with standard in full

TRACEABILITY : This test result is traceable to national or international std.

1.2 General Description of EUT & Power

MANUFACTURER : Arcadyan Technology Corporation

SAMPLE NAME : OfficeConnect Wireless 11g USB Adapter

MODEL NAME : 3CRWE254G72

FREQUENCY RANGE : 2412 MHz to 2462MHz

RF RATED POWER : 19dBm (For 802.11b mode), 18dBm (For 802.11g)

CHANNEL NUMBER : 11

AIR DATA RATE : 54Mbps (802.11g Mode), 11Mbps(802.11b Mode)

TYPE OF MODULATION : Orthogonal Frequency Division Multiplex or Direct Sequence
Spread Spectrum

FREQUENCY SELECTION : BY SOFTWARE

EUT Description : 2.4GHz (Orthogonal Frequency Division Multiplex or Direct
Sequence Spread Spectrum) Data Transceiver for
OfficeConnect Wireless 11g USB Adapter

ANTENNA TYPE : Chip Antenna on PCB , Antenna Gain : -2.9dBi.

POWER SOURCE : 5.0VDC (From PC)



1.3 Description of Peripherals

(1) Notebook PC

MANUFACTURER : DELL CORP.
MODEL NUMBER : PP01L
SERIAL NUMBER : CN-09C748-48155-1AP-6081
FCC : DOC
POWER CORD : Unshielded, Detachable, 1.8m

(2) PRINTER

MANUFACTURER : HP CORP.
MODEL NUMBER : C6431D
SERIAL NUMBER : CN19T6S011
FCC ID : DOC
POWER SOURCE : 100-240VAC,50/60Hz,0.7A
SIGNAL CABLE : Shielded , Undetachable , 1.8m

(3) MODEM

MANUFACTURER : ZYXEL communication Corp.
MODEL NUMBER : Omni 56K
SERIAL NUMBER : S1Z4107729
FCC ID : 1880MN156K
POWER SOURCE : 9VAC(From Power Adapter)
SIGNAL CABLE : Shielded , Undetachable , 1.8m

(4) Notebook PC

MANUFACTURER : DELL CORP.
MODEL NUMBER : PP01L
SERIAL NUMBER : CN-09C748-48155-1AP-6630
FCC : DOC
POWER CORD : Unshielded, Detachable, 1.8m

1.4 EUT & Peripherals Setup Diagram

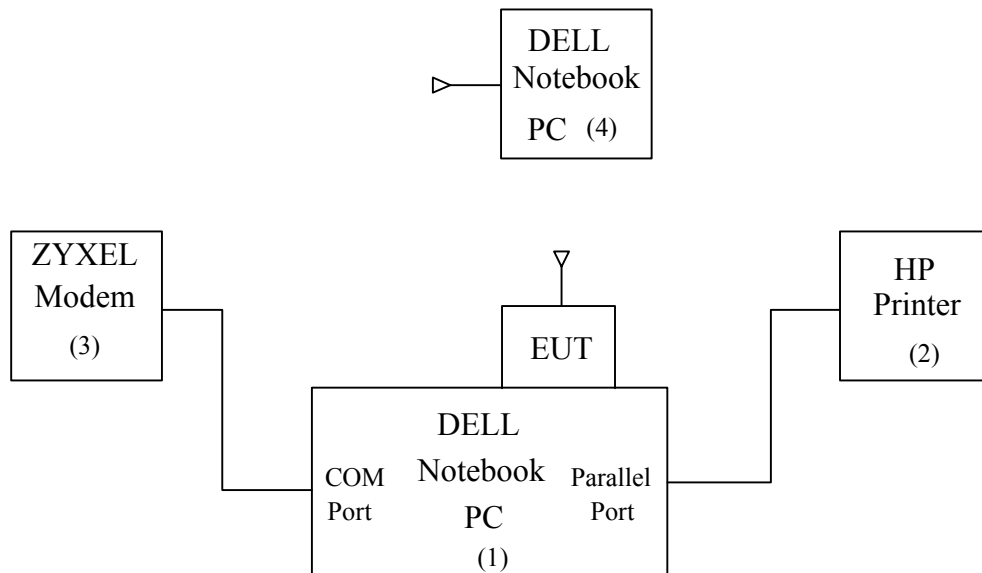

1.5 EUT Operating Condition

1. Set up all computers like the setup diagram.
2. Notebook PC (1) ping 192.168.1.90 -t -l 5000 to Notebook PC (4).
3. Notebook PC (4) ping 192.168.1.80 -t -l 5000 to Notebook PC (1).
4. All of the function are under run.
5. Start test.



Ecom Sertech Corp.

Rm. 258, Bldg. 17, NO.195, Sec. 4 Chung Hsing Rd., ChuTung Chen, Hsinchu, Taiwan 310, R.O.C
TEL:886-3-5918012 FAX : 886-3-5825720

FCC ID : RAXWN4501CARC

Report No. : ER03-12-021FRF

Page 8 of 60

1.6 Description of Test Site

SITE DESCRIPTION : FCC Certificate NO. : 90585
 BSMI Certificate NO. : SL2-IN-E-0002
 NVLAP Lab code : 200118-0
 CNLA Certificate NO. : CNLA-ZL97018
 VCCI Certificate NO. : R-1229, C-1250

NAME OF SITE : Ecom Sertech Corp. Hsinchu
 (Spin-off from ITRI / ERSO on Apr. 01, 2003)
 SITE LOCATION : Rm.258, Bldg.17, NO.195 , Sec. 4, Chung Hsing Rd.,
 Chu-Tung Chen. Hsin-Chu, Taiwan 310 R.O.C.

1.7 Summary of Test Results

The EUT has been tested according to the following specifications :

APPLIED STANDARD : 47 CFR Part 15, Subpart B and Subpart C			
Standard Section	Test Type and Limit	Result	REMARK
15.107 15.207	AC Power Conducted Emission Limit : 15.107	PASS	Meet the requirement of limit
15.247(a)(2)	Spectrum Bandwidth of a Orthogonal Frequency Division Multiplex System Limit : 6dB bandwidth > 500KHz	PASS	Meet the requirement of limit
15.247(b)	Maximum Peak Output Power Limit : max. 30dBm	PASS	Meet the requirement of limit
15.109 15.205 15.209	Transmitter Radiated Emissions Limit : Table 15.209	PASS	Meet the requirement of limit
15.247(d)	Power Spectral Density Limit : max. 8dBm	PASS	Meet the requirement of limit
15.247(c)	Out of Band Emission and Restricted Band Radiation Limit:20dB less than peak value of fundamental frequency Restricted band Limit:Table 15.209	PASS	Meet the requirement of limit



2. CONDUCTED POWERLINE TEST

2.1 Test Equipments

The following test equipments are used during the conducted powerline tests :

Manufacturer or Type	Model No	Serial No.	Date of Calibration	Calibration Period	Remark
SPECTRUM ANALYZER & DISPLAY	HP 8568A	2235A02320	APR. 01, 2003	1 Year	PRETEST
QUASI-PEAK ADAPTER	HP 85650 A	2341A00672	APR. 01, 2003	1 Year	PRETEST
ISOLATION TRANSFORMER	SOLAR 7032-1	N/A	N/A	N/A	FINAL
L.I.S.N.	EMCO 3850/2	9311-1025 9401-1028	JAN. 08, 2003 For Characteristic impedance MAY 18, 2003 For Insertion loss	1 Year	FINAL
TEST RECEIVER	R/S ESHS30	838550/003	JUN. 07, 2003	1 Year	FINAL
SHIELDED ROOM	KEENE 5983	NO.1	N/A	N/A	FINAL
PULSE LIMIT	R/S EHS3Z2	357.8810.52	JUL. 10, 2003	1 Year	FINAL
N TYPE COAXIAL CABLE	-----	-----	JUL. 10, 2003	1 Year	FINAL
50Ω TERMINATOR	-----	-----	JUL. 10, 2003	1 Year	FINAL

2.2 Test Setup

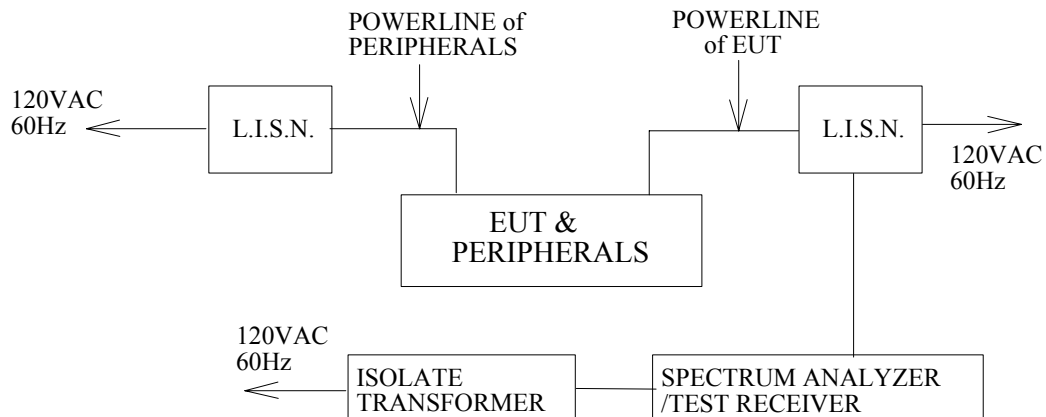



2.3 Conducted Power Line Emission Limit

For unintentional device, according to § 15.107(a) Line Conducted Emission Limits is as following :

Frequency (MHz)	Maximum RF Line Voltage (Db μ v)			
	CLASS A		CLASS B	
	Q.P.	Ave.	Q.P.	Ave.
0.15 - 0.50	79	66	66-56	56-46
0.50 - 5.00	73	60	56	46
5.00 - 30.0	73	60	60	50

For intentional device, according to § 15.207(a) Line Conducted Emission Limit is same as above table.

2.4 Test Procedure

The test procedure is performed in a 12ft×12ft×8ft(L×W×H) shielded room. the EUT along with its peripherals were placed on a 1.0m(W)× 1.5m(L) and 0.8m in height wooden table and the EUT was adjusted to maintain a 0.4 meter space from a vertical reference plane. The EUT was connected to power mains through a line impedance stabilization network (LISN) which provides 50 ohm coupling impedance for measuring instrument and the chasis ground was bounded to the horizontal ground plane of shielded room. All peripherals were connected to the second LISN and the chasis ground also bounded to the horizontal ground plane of shielded room. The excess power cable between the EUT and the LISN was bundled. The power cables of peripherals were unbundled. All connecting cables of EUT and peripherals were moved to find the maximum emission.

2.5 Uncertainty of Conducted Emission

The uncertainty of conducted emission is ± 1.36 dB.



2.6 Conducted RF Voltage Measurement

The frequency spectrum from 0.15 MHz to 30 MHz was investigated. All emissions not reported below are more than 20 dB below the prescribed limits.

Temperature : 26 °C

Humidity : 65 % RH

Frequency (MHz)	Loss(dB)		Measurement				L1 Emission (dBμV)		L2 Emission (dBμV)		Limits (dBμV)	
			L1(dBμV)		L2(dBμV)		Q.P.	A.V.	Q.P.	A.V.	Q.P.	A.V.
	L1	L2	Q.P.	A.V.	Q.P.	A.V.						
0.150	0.1	0.2	*	*	*	*	*	*	*	*	66.00	56.00
0.162	0.1	0.2	*	*	34.00	*	*	*	34.20	*	65.36	55.36
0.264	0.1	0.2	39.30	35.80	*	*	39.40	35.90	*	*	61.30	51.30
0.330	0.1	0.2	36.50	30.60	*	*	36.60	30.70	*	*	59.45	49.45
0.399	0.1	0.2	*	*	34.60	32.60	*	*	34.80	32.80	57.87	47.87
0.530	0.1	0.2	34.60	31.20	33.50	30.30	34.70	31.30	33.70	30.50	56.00	46.00
1.990	0.1	0.2	*	*	27.60	*	*	*	27.80	*	56.00	46.00
2.110	0.1	0.2	27.30	*	*	*	27.40	*	*	*	56.00	46.00
2.540	0.2	0.2	*	*	20.80	*	*	*	21.00	*	56.00	46.00
2.840	0.2	0.2	28.70	*	*	*	28.90	*	*	*	56.00	46.00
4.260	0.2	0.2	*	*	19.90	*	*	*	20.10	*	56.00	46.00
4.630	0.2	0.2	22.60	*	*	*	22.80	*	*	*	56.00	46.00
11.700	0.5	0.5	30.50	*	*	*	31.00	*	*	*	60.00	50.00
14.506	0.6	0.6	*	*	27.40	20.40	*	*	28.00	21.00	60.00	50.00
15.850	0.7	0.7	28.20	*	*	*	28.90	*	*	*	60.00	50.00
16.050	0.7	0.7	*	*	26.60	*	*	*	27.30	*	60.00	50.00
30.000	1.4	1.8	*	*	*	*	*	*	*	*	60.00	50.00

REMARKS : 1. * Undetectable or the Q.P. value is lower than the limits of Ave.

2. Mode : 802.11b mode.

3. The EUT can be operated in transmitting, stand-by and receiving mode.

After preliminary scan, EUT in transmitting mode has highest emission.

The EUT was set in transmitting mode at final test to get the worst case test results.



Ecom Sertech Corp.

Rm. 258, Bldg. 17, NO.195, Sec. 4 Chung Hsing Rd., ChuTung Chen, Hsinchu, Taiwan 310, R.O.C
 TEL:886-3-5918012 FAX : 886-3-5825720

FCC ID : RAXWN4501CARC

Report No. : ER03-12-021FRF

Page 12 of 60

The frequency spectrum from 0.15 MHz to 30 MHz was investigated. All emissions not reported below are more than 20 dB below the prescribed limits.

Temperature : 26 °C

Humidity : 65 % RH

Frequency (MHz)	Loss(dB)		Measurement				L1 Emission (dBµV)		L2 Emission (dBµV)		Limits (dBµV)	
			L1(dBµV)		L2(dBµV)		Q.P.	A.V.	Q.P.	A.V.	Q.P.	A.V.
	L1	L2	Q.P.	A.V.	Q.P.	A.V.						
0.150	0.1	0.2	*	*	*	*	*	*	*	*	66.00	56.00
0.159	0.1	0.2	*	*	35.10	*	*	*	35.30	*	65.52	55.52
0.192	0.1	0.2	34.20	*	*	*	34.30	*	*	*	63.95	53.95
0.399	0.1	0.2	36.80	*	34.70	*	36.90	*	34.90	*	57.87	47.87
0.530	0.1	0.2	34.40	*	33.30	*	34.50	*	33.50	*	56.00	46.00
1.990	0.1	0.2	26.00	*	27.10	*	26.10	*	27.30	*	56.00	46.00
2.800	0.2	0.2	23.90	*	24.50	*	24.10	*	24.70	*	56.00	46.00
4.660	0.2	0.2	*	*	21.70	*	*	*	21.90	*	56.00	46.00
4.930	0.2	0.2	21.70	*	*	*	21.90	*	*	*	56.00	46.00
13.150	0.5	0.5	*	*	31.70	*	*	*	32.20	*	60.00	50.00
14.750	0.6	0.6	30.60	*	*	*	31.20	*	*	*	60.00	50.00
17.050	0.7	0.7	*	*	25.70	*	*	*	26.40	*	60.00	50.00
17.450	0.8	0.8	24.50	*	*	*	25.30	*	*	*	60.00	50.00
30.000	1.4	1.8	*	*	*	*	*	*	*	*	60.00	50.00

- REMARKS : 1. * Undetectable or the Q.P. value is lower than the limits of Ave.
 2. Mode : 802.11g mode.
 3. The EUT can be operated in transmitting, stand-by and receiving mode.
 After preliminary scan, EUT in transmitting mode has highest emission.
 The EUT was set in transmitting mode at final test to get the worst case test results.

2.7 Photos of Conduction Test



3. RADIATED EMISSION TEST

3.1 Test Equipments

The following test equipments are utilized in making the measurements contained in this report.

Manufacturer or Type	Model No	Serial No	Date of Calibration	Calibration Period	Remark
CHASE BI-LOG ANTENNA	CBL6112B	2421	MAY 07, 2003	1 Year	FINAL
OPEN SITE	-----	No.2	JAN. 10, 2003	1 Year	FINAL
N TYPE COAXIAL CABLE	CHA9525	4	JUL. 13, 2003	1 Year	FINAL
Horn Antenna	AH-118	10089	FEB. 25, 2003	1 Year	FINAL
HP Pre-amplifier	8449B	3008A01471	OCT. 11, 2003	1 Year	FINAL
HP High pass filter	84300/80038	011	cal. on use	1 Year	FINAL
Horn Antenna	AH-840	03077	FEB. 25, 2003	1 Year	FINAL

3.2 Test Setup

The diagram below shows the test setup that is utilized to make the measurements for emission from 30 to 1GHz.

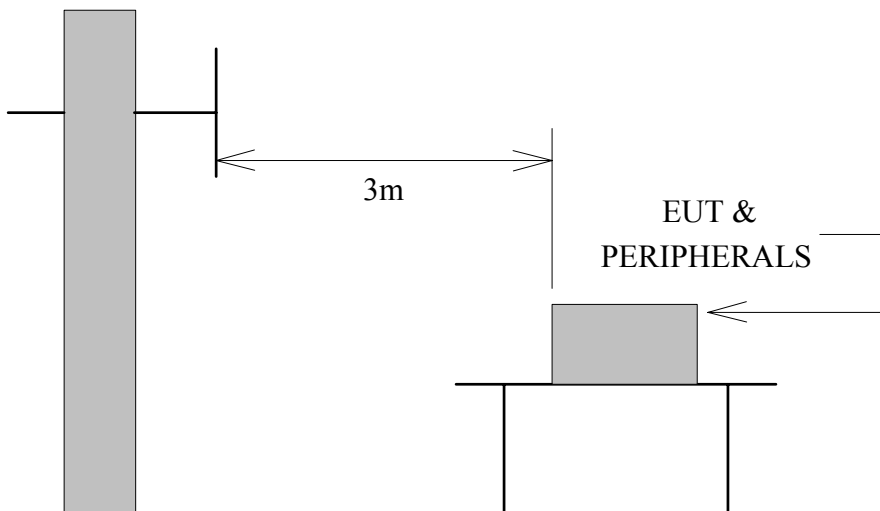

Antenna Elevation Variable

The diagram below shows the test setup that is utilized to make the measurements for emission above 1GHz.

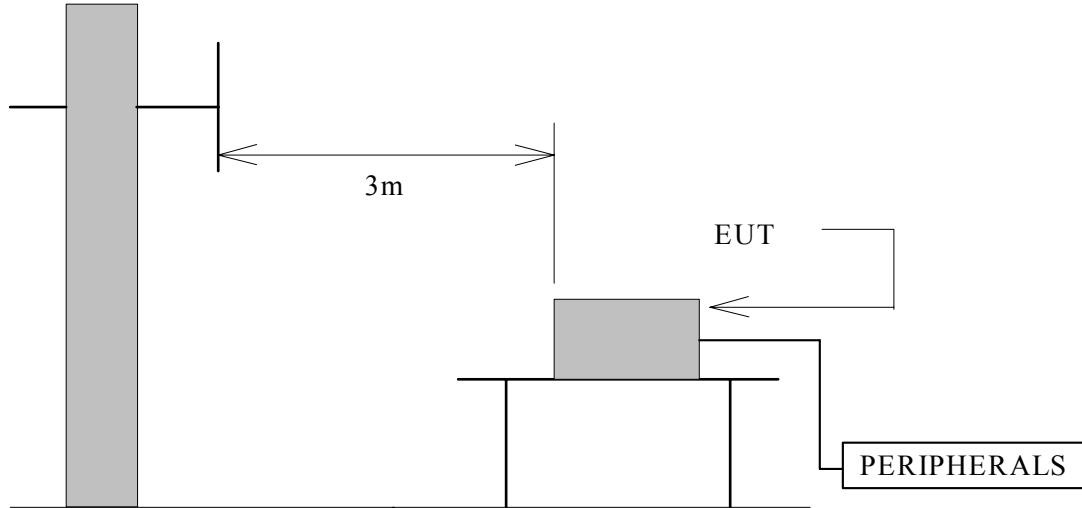

Antenna Elevation Variable

3.3 Radiation Limit

For unintentional device, according to § 15.109(a), except for Class A digital devices, the field strength of radiated emissions from unintentional radiators at a distance of 3 meters shall not exceed the following values :

Frequency (MHz)	Distance (Meters)	Radiated (dB μ V/M)	Radiated (μ V/M)
30-88	3	40.0	100
88-216	3	43.5	150
216-960	3	46.0	200
Above 960	3	54.0	500

For intentional device, according to § 15.209(a), the general requirement of field strength of radiated emissions from intentional radiators at a distance of 3 meters shall not exceed the above table.



3.4 Test Procedures

- a. The EUT was placed on the top of a rotating table 0.8 meters above the ground at a 10 meter open area test site. The table was rotated 360 degrees to determine the position of the highest radiation.
- b. The EUT was set 3 meters away from the interference-receiving antenna, which was mounted on the top of a variable-height antenna tower.
- c. The antenna is a broadband antenna, and its height is varied from one meter to four meters above the ground to determine the maximum value of the field strength. Both horizontal and vertical polarization of the antenna are set to make the measurement.
- d. For each suspected emission, the EUT was arranged to its worst case and then the antenna was tuned to heights from 1 meter to 4 meters and the table was turned from 0 degrees to 360 degrees to find the maximum reading.
- e. The test-receiver system was set to Peak Detect Function and Specified Bandwidth with Maximum Hold Mode.
- f. If the emission level of the EUT in peak mode was 10 dB lower than the limit specified, then testing could be stopped and the peak values of the EUT would be reported. Otherwise the emissions that did not have 10 dB margin would be re-tested one by one using peak, quasi-peak or average method as specified and then reported in a data sheet.

NOTE :

1. The resolution bandwidth and video bandwidth of test receiver/spectrum analyzer is 120 KHz for Peak detection (PK) and Quasi-peak detection (QP) at frequency below 1GHz.
2. The resolution bandwidth and video bandwidth of test receiver/spectrum analyzer is 1 MHz for Peak detection and frequency above 1GHz.
3. The resolution bandwidth of test receiver/spectrum analyzer is 1 MHz and the video bandwidth is 10 Hz for Average detection (AV) at frequency above 1GHz.

3.5 Uncertainty of Radiated Emission

The uncertainty of radiated emission is ± 2.72 dB.



3.6 Radiated RF Noise Measurement

Test Requirement: 15.109, 15.209

The frequency spectrum from 30 MHz to 1000 MHz was investigated. All emissions not reported below are more than 20 dB below the prescribed limits.

All readings are quasi-peak values.

Temperature : 25.7 °C

Humidity : 63 % RH

Frequency (MHz)	Antenna Factor (dB)	Cable Loss (dB)	Meter Reading at 3m(dB μ V/M)		Limits at 3m (dB μ V/M)	Emission Level at 3m(dB μ V/M)	
			Horizontal	Vertical		Horizontal	Vertical
30.00	21.39	0.90	*	*	40.00	*	*
240.01	12.55	3.12	11.80	8.10	46.00	27.47	23.77
270.01	13.25	3.36	11.70	8.50	46.00	28.31	25.11
300.02	13.50	3.60	9.60	8.40	46.00	26.70	25.50
330.02	14.62	3.78	13.10	12.70	46.00	31.50	31.10
390.02	16.87	4.14	12.20	11.40	46.00	33.21	32.41
479.98	18.10	4.76	10.00	9.40	46.00	32.86	32.26
990.06	21.53	6.96	5.80	6.60	54.00	34.29	35.09
1000.00	21.58	7.00	*	*	54.00	*	*

REMARKS : 1. * Undetectable

2. Emission level (dB μ V/M) =Antenna Factor (dB/m) + Cable loss (dB) + Meter Reading (dB μ V).

3. According to technical experiences, all spurious emission at channel 1,6,11 are almost the same below 1GHz,so that the channel 1 was chosen as representative in final test.

4. Mode : Wireless 802.11b Transmitting test.



Ecom Sertech Corp.

Rm. 258, Bldg. 17, NO.195, Sec. 4 Chung Hsing Rd.,ChuTung Chen, Hsinchu, Taiwan 310, R.O.C
TEL:886-3-5918012 FAX : 886-3-5825720

FCC ID : RAXWN4501CARC

Report No. : ER03-12-021FRF

Page 18 of 60

Test Requirement: 15.109, 15.209

The frequency spectrum from 30 MHz to 1000 MHz was investigated. All emissions not reported below are more than 20 dB below the prescribed limits.

All readings are quasi-peak values.

Temperature : 25.7 °C

Humidity : 63 % RH

Frequency (MHz)	Antenna Factor (dB)	Cable Loss (dB)	Meter Reading at 3m(dB μ V/M)		Limits at 3m (dB μ V/M)	Emission Level at 3m(dB μ V/M)	
			Horizontal	Vertical		Horizontal	Vertical
30.00	21.39	0.90	*	*	40.00	*	*
240.01	12.55	3.12	11.10	10.40	46.00	26.77	26.07
270.01	13.25	3.36	10.30	8.00	46.00	26.91	24.61
300.02	13.50	3.60	11.50	8.70	46.00	28.60	25.80
330.02	14.62	3.78	11.70	11.00	46.00	30.10	29.40
390.02	16.87	4.14	12.90	10.90	46.00	33.91	31.91
479.98	18.10	4.76	12.40	10.80	46.00	35.26	33.66
990.06	21.53	6.96	5.70	7.50	54.00	34.19	35.99
1000.00	21.58	7.00	*	*	54.00	*	*

REMARKS : 1. *Undetectable

2. Emission level (dBμV/M) =Antenna Factor (dB/m) + Cable loss (dB)
+ Meter Reading (dBμV).

3. According to technical experiences, all spurious emission at channel 1,6,11 are almost the same below 1GHz,so that the channel 1 was chosen as representative in finial test.

4. Mode : Wireless 802.11g Transmitting test.



Ecom Sertech Corp.

Rm. 258, Bldg. 17, NO.195, Sec. 4 Chung Hsing Rd., ChuTung Chen, Hsinchu, Taiwan 310, R.O.C
 TEL:886-3-5918012 FAX : 886-3-5825720

FCC ID : RAXWN4501CARC

Report No. : ER03-12-021FRF

Page 19 of 60

Test Requirement: 15.109 ,15.209

The frequency spectrum above 1 GHz was investigated. All emissions not reported below are more than 40 dB below the prescribed limits. Readings are both peak and average values.

Company	Arcadyan Technology Corporation	Test Date :	2003/10/3
Product Name	OfficeConnect Wireless 11g USB Adapter	Test By:	K. P. Pang
Model Name	3CRWE254G72	TEMP&Humidity :	27.9°C , 43%

CH1 RX				Measurement Distance at 1m				Horizontal polarity			
Freq.	Reading	AF	Cable	Pre-amp	Dist	Filter	Level	Limit	Margin	Mark	Height
(MHz)	(dBuV)	(dBuV)	(dB)	(dB)	dB	dB	(dBuV/m)	(dBuV/m)	(dB)	(P/Q/A)	(Meter)
4824.18	57.29	34.44	2.82	35.16	9.50	0.00	49.89	74	-24.11	P	1.0
4824.18	55.61	34.44	2.82	35.16	9.50	0.00	48.21	54	-5.79	A	1.0
7236.08	44.70	39.81	4.79	35.65	9.50	0.00	44.15	74	-29.85	P	1.0
7236.08	33.58	39.81	4.79	35.65	9.50	0.00	33.03	54	-20.97	A	1.0
9648.37	50.54	38.54	5.90	36.44	9.50	0.00	49.04	74	-24.96	P	1.0
9648.37	45.71	38.54	5.90	36.44	9.50	0.00	44.21	54	-9.79	A	1.0

1. AF: Antenna Factor, Cable: Cable Loss, Pre-Amp: Preamplifier gain, Filter: High Pass Filter Insertion Loss (3.5GHz)
2. Analyzer setting P(Peak): RBW=1MHz, VBW=1MHz, A(Average): RBW=1MHz,VBW=10Hz
3. Dist : correction to extra plate reading to 3m specification distance 1m measurement distance = -9.5dB
4. The result basic equation calculation as follow :

$$\text{Level} = \text{Reading} + \text{AF} + \text{Cable} - \text{Preamp} + \text{Filter} - \text{Dist}, \text{Margin} = \text{Level} - \text{Limit}$$
5. The test limit is 3M limit.
6. The other emission levels were very low against the limit.
7. For 802.11b mode at 11Mbps.



Ecom Sertech Corp.

Rm. 258, Bldg. 17, NO.195, Sec. 4 Chung Hsing Rd., ChuTung Chen, Hsinchu, Taiwan 310, R.O.C
 TEL:886-3-5918012 FAX : 886-3-5825720

FCC ID : RAXWN4501CARC

Report No. : ER03-12-021FRF

Page 20 of 60

Test Requirement: 15.109 ,15.209

The frequency spectrum above 1 GHz was investigated. All emissions not reported below are more than 40 dB below the prescribed limits. Readings are both peak and average values.

Company	Arcadyan Technology Corporation	Test Date :	2003/10/3
Product Name	OfficeConnect Wireless 11g USB Adapter	Test By:	K. P. Pang
Model Name	3CRWE254G72	TEMP&Humidity :	27.9°C , 43%

CH1 RX				Measurement Distance at 1m					Vertical polarity		
Freq.	Reading	AF	Cable	Pre-amp	Dist	Filter	Level	Limit	Margin	Mark	Height
(MHz)	(dBuV)	(dBuV)	(dB)	(dB)	dB	dB	(dBuV/m)	(dBuV/m)	(dB)	(P/Q/A)	(Meter)
4824.11	54.98	34.44	2.82	35.16	9.50	0.00	47.58	74	-26.42	P	1.0
4824.11	52.36	34.44	2.82	35.16	9.50	0.00	44.96	54	-9.04	A	1.0
7237.55	44.28	39.80	4.80	35.65	9.50	0.00	43.73	74	-30.27	P	1.0
7237.55	33.43	39.80	4.80	35.65	9.50	0.00	32.88	54	-21.12	A	1.0
9648.35	48.01	38.54	5.90	36.44	9.50	0.00	46.51	74	-27.49	P	1.0
9648.35	40.93	38.54	5.90	36.44	9.50	0.00	39.43	54	-14.57	A	1.0

1. AF: Antenna Factor, Cable: Cable Loss, Pre-Amp: Preamplifier gain, Filter: High Pass Filter Insertion Loss (3.5GHz)
2. Analyzer setting P(Peak): RBW=1MHz, VBW=1MHz, A(Average): RBW=1MHz,VBW=10Hz
3. Dist : correction to extra plate reading to 3m specification distance 1m measurement distance = -9.5dB
4. The result basic equation calculation as follow :

$$\text{Level} = \text{Reading} + \text{AF} + \text{Cable} - \text{Preamp} + \text{Filter} - \text{Dist}, \text{Margin} = \text{Level} - \text{Limit}$$
5. The test limit is 3M limit.
6. The other emission levels were very low against the limit.
7. For 802.11b mode at 11Mbps.



Ecom Sertech Corp.

Rm. 258, Bldg. 17, NO.195, Sec. 4 Chung Hsing Rd., ChuTung Chen, Hsinchu, Taiwan 310, R.O.C
 TEL:886-3-5918012 FAX : 886-3-5825720

FCC ID : RAXWN4501CARC

Report No. : ER03-12-021FRF

Page 21 of 60

Test Requirement: 15.109 ,15.209

The frequency spectrum above 1 GHz was investigated. All emissions not reported below are more than 40 dB below the prescribed limits. Readings are both peak and average values.

Company	Arcadyan Technology Corporation	Test Date :	2003/10/3
Product Name	OfficeConnect Wireless 11g USB Adapter	Test By:	K. P. Pang
Model Name	3CRWE254G72	TEMP&Humidity :	27.9°C , 43%

CH6 RX				Measurement Distance at 1m				Horizontal polarity			
Freq.	Reading	AF	Cable	Pre-amp	Dist	Filter	Level	Limit	Margin	Mark	Height
(MHz)	(dBuV)	(dBuV)	(dB)	(dB)	dB	dB	(dBuV/m)	(dBuV/m)	(dB)	(P/Q/A)	(Meter)
4874.18	55.49	34.77	2.73	35.20	9.50	0.00	48.29	74	-25.71	P	1.0
4874.18	53.21	34.77	2.73	35.20	9.50	0.00	46.01	54	-7.99	A	1.0
7310.63	44.56	39.78	4.82	35.64	9.50	0.00	44.02	74	-29.98	P	1.0
7310.63	33.71	39.78	4.82	35.64	9.50	0.00	33.17	54	-20.83	A	1.0
9748.23	51.22	38.53	5.90	36.60	9.50	0.00	49.55	74	-24.45	P	1.0
9748.23	45.17	38.53	5.90	36.60	9.50	0.00	43.50	54	-10.50	A	1.0

1. AF: Antenna Factor, Cable: Cable Loss, Pre-Amp: Preamplifier gain, Filter: High Pass Filter Insertion Loss (3.5GHz)
2. Analyzer setting P(Peak): RBW=1MHz, VBW=1MHz, A(Average): RBW=1MHz,VBW=10Hz
3. Dist : correction to extra plate reading to 3m specification distance 1m measurement distance = -9.5dB
4. The result basic equation calculation as follow :

$$\text{Level} = \text{Reading} + \text{AF} + \text{Cable} - \text{Preamp} + \text{Filter} - \text{Dist}, \text{Margin} = \text{Level} - \text{Limit}$$
5. The test limit is 3M limit.
6. The other emission levels were very low against the limit.
7. For 802.11b mode at 11Mbps.



Ecom Sertech Corp.

Rm. 258, Bldg. 17, NO.195, Sec. 4 Chung Hsing Rd., ChuTung Chen, Hsinchu, Taiwan 310, R.O.C
 TEL:886-3-5918012 FAX : 886-3-5825720

FCC ID : RAXWN4501CARC

Report No. : ER03-12-021FRF

Page 22 of 60

Test Requirement: 15.109 ,15.209

The frequency spectrum above 1 GHz was investigated. All emissions not reported below are more than 40 dB below the prescribed limits. Readings are both peak and average values.

Company	Arcadyan Technology Corporation	Test Date :	2003/10/3
Product Name	OfficeConnect Wireless 11g USB Adapter	Test By:	K. P. Pang
Model Name	3CRWE254G72	TEMP&Humidity :	27.9°C , 43%

CH6 RX				Measurement Distance at 1m					Vertical polarity		
Freq.	Reading	AF	Cable	Pre-amp	Dist	Filter	Level	Limit	Margin	Mark	Height
(MHz)	(dBuV)	(dBuV)	(dB)	(dB)	dB	dB	(dBuV/m)	(dBuV/m)	(dB)	(P/Q/A)	(Meter)
4873.16	54.11	34.76	2.73	35.20	9.50	0.00	46.90	74	-27.10	P	1.0
4873.16	51.56	34.76	2.73	35.20	9.50	0.00	44.35	54	-9.65	A	1.0
7311.55	45.18	39.78	4.82	35.64	9.50	0.00	44.64	74	-29.36	P	1.0
7311.55	33.54	39.78	4.82	35.64	9.50	0.00	33.00	54	-21.00	A	1.0
9747.61	49.00	38.53	5.90	36.60	9.50	0.00	47.33	74	-26.67	P	1.0
9747.61	42.06	38.53	5.90	36.60	9.50	0.00	40.39	54	-13.61	A	1.0

1. AF: Antenna Factor, Cable: Cable Loss, Pre-Amp: Preamplifier gain, Filter: High Pass Filter Insertion Loss (3.5GHz)
2. Analyzer setting P(Peak): RBW=1MHz, VBW=1MHz, A(Average): RBW=1MHz,VBW=10Hz
3. Dist : correction to extra plate reading to 3m specification distance 1m measurement distance = -9.5dB
4. The result basic equation calculation as follow :

$$\text{Level} = \text{Reading} + \text{AF} + \text{Cable} - \text{Preamp} + \text{Filter} - \text{Dist}, \text{Margin} = \text{Level} - \text{Limit}$$
5. The test limit is 3M limit.
6. The other emission levels were very low against the limit.
7. For 802.11b mode at 11Mbps.



Ecom Sertech Corp.

Rm. 258, Bldg. 17, NO.195, Sec. 4 Chung Hsing Rd., ChuTung Chen, Hsinchu, Taiwan 310, R.O.C
 TEL:886-3-5918012 FAX : 886-3-5825720

FCC ID : RAXWN4501CARC

Report No. : ER03-12-021FRF

Page 23 of 60

Test Requirement: 15.109 ,15.209

The frequency spectrum above 1 GHz was investigated. All emissions not reported below are more than 40 dB below the prescribed limits. Readings are both peak and average values.

Company	Arcadyan Technology Corporation	Test Date :	2003/10/3
Product Name	OfficeConnect Wireless 11g USB Adapter	Test By:	K. P. Pang
Model Name	3CRWE254G72	TEMP&Humidity :	27.9°C , 43%

CH11 RX				Measurement Distance at 1m				Horizontal polarity			
Freq.	Reading	AF	Cable	Pre-amp	Dist	Filter	Level	Limit	Margin	Mark	Height
(MHz)	(dBuV)	(dBuV)	(dB)	(dB)	dB	dB	(dBuV/m)	(dBuV/m)	(dB)	(P/Q/A)	(Meter)
4924.19	56.91	35.10	2.64	35.24	9.50	0.00	49.91	74	-24.09	P	1.0
4924.19	55.08	35.10	2.64	35.24	9.50	0.00	48.08	54	-5.92	A	1.0
7385.91	45.15	39.75	4.85	35.62	9.50	0.00	44.63	74	-29.37	P	1.0
7385.91	33.01	39.75	4.85	35.62	9.50	0.00	32.49	54	-21.51	A	1.0
9848.35	50.98	38.52	5.90	36.76	9.50	0.00	49.14	74	-24.86	P	1.0
9848.35	46.22	38.52	5.90	36.76	9.50	0.00	44.38	54	-9.62	A	1.0

1. AF: Antenna Factor, Cable: Cable Loss, Pre-Amp: Preamplifier gain, Filter: High Pass Filter Insertion Loss (3.5GHz)
2. Analyzer setting P(Peak): RBW=1MHz, VBW=1MHz, A(Average): RBW=1MHz,VBW=10Hz
3. Dist : correction to extra plate reading to 3m specification distance 1m measurement distance = -9.5dB
4. The result basic equation calculation as follow :

$$\text{Level} = \text{Reading} + \text{AF} + \text{Cable} - \text{Preamp} + \text{Filter} - \text{Dist}, \text{Margin} = \text{Level} - \text{Limit}$$
5. The test limit is 3M limit.
6. The other emission levels were very low against the limit.
7. For 802.11b mode at 11Mbps.



Ecom Sertech Corp.

Rm. 258, Bldg. 17, NO.195, Sec. 4 Chung Hsing Rd., ChuTung Chen, Hsinchu, Taiwan 310, R.O.C
 TEL: 886-3-5918012 FAX: 886-3-5825720

FCC ID : RAXWN4501CARC

Report No. : ER03-12-021FRF

Page 24 of 60

Test Requirement: 15.109 ,15.209

The frequency spectrum above 1 GHz was investigated. All emissions not reported below are more than 40 dB below the prescribed limits. Readings are both peak and average values.

Company	Arcadyan Technology Corporation	Test Date :	2003/10/3
Product Name	OfficeConnect Wireless 11g USB Adapter	Test By:	K. P. Pang
Model Name	3CRWE254G72	TEMP&Humidity :	27.9°C , 43%

CH11 RX				Measurement Distance at 1m					Vertical polarity		
Freq.	Reading	AF	Cable	Pre-amp	Dist	Filter	Level	Limit	Margin	Mark	Height
(MHz)	(dBuV)	(dBuV)	(dB)	(dB)	dB	dB	(dBuV/m)	(dBuV/m)	(dB)	(P/Q/A)	(Meter)
4924.13	53.69	35.10	2.64	35.24	9.50	0.00	46.69	74	-27.31	P	1.0
4924.13	50.97	35.10	2.64	35.24	9.50	0.00	43.97	54	-10.03	A	1.0
7386.01	44.26	39.75	4.85	35.62	9.50	0.00	43.74	74	-30.26	P	1.0
7386.01	33.32	39.75	4.85	35.62	9.50	0.00	32.80	54	-21.20	A	1.0
9848.22	50.10	38.52	5.90	36.76	9.50	0.00	48.26	74	-25.74	P	1.0
9848.22	43.67	38.52	5.90	36.76	9.50	0.00	41.83	54	-12.17	A	1.0

1. AF: Antenna Factor, Cable: Cable Loss, Pre-Amp: Preamplifier gain, Filter: High Pass Filter Insertion Loss (3.5GHz)

2. Analyzer setting P(Peak): RBW=1MHz, VBW=1MHz, A(Average): RBW=1MHz, VBW=10Hz

3. Dist : correction to extra plate reading to 3m specification distance 1m measurement distance = -9.5dB

4. The result basic equation calculation as follow :

$$\text{Level} = \text{Reading} + \text{AF} + \text{Cable} - \text{Preamp} + \text{Filter} - \text{Dist}, \text{Margin} = \text{Level} - \text{Limit}$$

5. The test limit is 3M limit.

6. The other emission levels were very low against the limit.

7. For 802.11b mode at 11Mbps.



Ecom Sertech Corp.

Rm. 258, Bldg. 17, NO.195, Sec. 4 Chung Hsing Rd., ChuTung Chen, Hsinchu, Taiwan 310, R.O.C
TEL:886-3-5918012 FAX : 886-3-5825720

FCC ID : RAXWN4501CARC

Report No. : ER03-12-021FRF

Page 25 of 60

Test Requirement: 15.109 ,15.209

The frequency spectrum above 1 GHz was investigated. All emissions not reported below are more than 40 dB below the prescribed limits. Readings are both peak and average values.

Company	Arcadyan Technology Corporation	Test Date :	2003/10/3
Product Name	OfficeConnect Wireless 11g USB Adapter	Test By:	K. P. Pang
Model Name	3CRWE254G72	TEMP&Humidity :	27.4°C , 58%

CH1 RX				Measurement Distance at 1m				Horizontal polarity			
Freq.	Reading	AF	Cable	Pre-amp	Dist	Filter	Level	Limit	Margin	Mark	Height
(MHz)	(dBuV)	(dBuV)	(dB)	(dB)	dB	dB	(dBuV/m)	(dBuV/m)	(dB)	(P/Q/A)	(Meter)
4824.15	54.79	34.44	2.82	35.16	9.50	0.00	47.39	74	-26.61	P	1.0
4824.15	52.74	34.44	2.82	35.16	9.50	0.00	45.34	54	-8.66	A	1.0
7236.18	43.95	39.81	4.79	35.65	9.50	0.00	43.40	74	-30.60	P	1.0
7236.18	33.39	39.81	4.79	35.65	9.50	0.00	32.84	54	-21.16	A	1.0
9648.16	49.73	38.54	5.90	36.44	9.50	0.00	48.23	74	-25.77	P	1.0
9648.16	44.27	38.54	5.90	36.44	9.50	0.00	42.77	54	-11.23	A	1.0

1. AF: Antenna Factor, Cable: Cable Loss, Pre-Amp: Preamplifier gain, Filter: High Pass Filter Insertion Loss (3.5GHz)
2. Analyzer setting P(Peak): RBW=1MHz, VBW=1MHz, A(Average): RBW=1MHz,VBW=10Hz
3. Dist : correction to extra plate reading to 3m specification distance 1m measurement distance = -9.5dB
4. The result basic equation calculation as follow :
Level = Reading + AF + Cable - Preamp + Filter - Dist, Margin = Level - Limit
5. The test limit is 3M limit.
6. The other emission levels were very low against the limit.
7. For 802.11g mode at 6Mbps.



Ecom Sertech Corp.

Rm. 258, Bldg. 17, NO.195, Sec. 4 Chung Hsing Rd., ChuTung Chen, Hsinchu, Taiwan 310, R.O.C
TEL:886-3-5918012 FAX : 886-3-5825720

FCC ID : RAXWN4501CARC

Report No. : ER03-12-021FRF

Page 26 of 60

Test Requirement: 15.109 ,15.209

The frequency spectrum above 1 GHz was investigated. All emissions not reported below are more than 40 dB below the prescribed limits. Readings are both peak and average values.

Company	Arcadyan Technology Corporation	Test Date :	2003/10/3
Product Name	OfficeConnect Wireless 11g USB Adapter	Test By:	K. P. Pang
Model Name	3CRWE254G72	TEMP&Humidity :	27.4°C , 58%

CH1 RX				Measurement Distance at 1m					Vertical polarity		
Freq.	Reading	AF	Cable	Pre-amp	Dist	Filter	Level	Limit	Margin	Mark	Height
(MHz)	(dBuV)	(dBuV)	(dB)	(dB)	dB	dB	(dBuV/m)	(dBuV/m)	(dB)	(P/Q/A)	(Meter)
4824.12	54.40	34.44	2.82	35.16	9.50	0.00	47.00	74	-27.00	P	1.0
4824.12	52.02	34.44	2.82	35.16	9.50	0.00	44.62	54	-9.38	A	1.0
7236.03	44.63	39.81	4.79	35.65	9.50	0.00	44.08	74	-29.92	P	1.0
7236.03	33.54	39.81	4.79	35.65	9.50	0.00	32.99	54	-21.01	A	1.0
9648.38	47.80	38.54	5.90	36.44	9.50	0.00	46.30	74	-27.70	P	1.0
9648.38	38.82	38.54	5.90	36.44	9.50	0.00	37.32	54	-16.68	A	1.0

1. AF: Antenna Factor, Cable: Cable Loss, Pre-Amp: Preamplifier gain, Filter: High Pass Filter Insertion Loss (3.5GHz)
2. Analyzer setting P(Peak): RBW=1MHz, VBW=1MHz, A(Average): RBW=1MHz,VBW=10Hz
3. Dist : correction to extra plate reading to 3m specification distance 1m measurement distance = -9.5dB
4. The result basic equation calculation as follow :
Level = Reading + AF + Cable - Preamp + Filter - Dist, Margin = Level - Limit
5. The test limit is 3M limit.
6. The other emission levels were very low against the limit.
7. For 802.11g mode at 6Mbps.



Ecom Sertech Corp.

Rm. 258, Bldg. 17, NO.195, Sec. 4 Chung Hsing Rd., ChuTung Chen, Hsinchu, Taiwan 310, R.O.C
 TEL:886-3-5918012 FAX : 886-3-5825720

FCC ID : RAXWN4501CARC

Report No. : ER03-12-021FRF

Page 27 of 60

Test Requirement: 15.109 ,15.209

The frequency spectrum above 1 GHz was investigated. All emissions not reported below are more than 40 dB below the prescribed limits. Readings are both peak and average values.

Company	Arcadyan Technology Corporation	Test Date :	2003/10/3
Product Name	OfficeConnect Wireless 11g USB Adapter	Test By:	K. P. Pang
Model Name	3CRWE254G72	TEMP&Humidity :	27.4°C , 58%

CH6 RX				Measurement Distance at 1m				Horizontal polarity			
Freq.	Reading	AF	Cable	Pre-amp	Dist	Filter	Level	Limit	Margin	Mark	Height
(MHz)	(dBuV)	(dBuV)	(dB)	(dB)	dB	dB	(dBuV/m)	(dBuV/m)	(dB)	(P/Q/A)	(Meter)
4874.25	54.62	34.77	2.73	35.20	9.50	0.00	47.42	74	-26.58	P	1.0
4874.25	51.95	34.77	2.73	35.20	9.50	0.00	44.75	54	-9.25	A	1.0
7310.95	45.27	39.78	4.82	35.64	9.50	0.00	44.73	74	-29.27	P	1.0
7310.95	33.86	39.78	4.82	35.64	9.50	0.00	33.32	54	-20.68	A	1.0
9748.18	50.91	38.53	5.90	36.60	9.50	0.00	49.24	74	-24.76	P	1.0
9748.18	44.52	38.53	5.90	36.60	9.50	0.00	42.85	54	-11.15	A	1.0

1. AF: Antenna Factor, Cable: Cable Loss, Pre-Amp: Preamplifier gain, Filter: High Pass Filter Insertion Loss (3.5GHz)
2. Analyzer setting P(Peak): RBW=1MHz, VBW=1MHz, A(Average): RBW=1MHz,VBW=10Hz
3. Dist : correction to extra plate reading to 3m specification distance 1m measurement distance = -9.5dB
4. The result basic equation calculation as follow :

$$\text{Level} = \text{Reading} + \text{AF} + \text{Cable} - \text{Preamp} + \text{Filter} - \text{Dist}, \text{Margin} = \text{Level} - \text{Limit}$$
5. The test limit is 3M limit.
6. The other emission levels were very low against the limit.
7. For 802.11g mode at 6Mbps.



Ecom Sertech Corp.

Rm. 258, Bldg. 17, NO.195, Sec. 4 Chung Hsing Rd., ChuTung Chen, Hsinchu, Taiwan 310, R.O.C
 TEL:886-3-5918012 FAX : 886-3-5825720

FCC ID : RAXWN4501CARC

Report No. : ER03-12-021FRF

Page 28 of 60

Test Requirement: 15.109 ,15.209

The frequency spectrum above 1 GHz was investigated. All emissions not reported below are more than 40 dB below the prescribed limits. Readings are both peak and average values.

Company	Arcadyan Technology Corporation	Test Date :	2003/10/3
Product Name	OfficeConnect Wireless 11g USB Adapter	Test By:	K. P. Pang
Model Name	3CRWE254G72	TEMP&Humidity :	27.4°C , 58%

CH6 RX				Measurement Distance at 1m					Vertical polarity		
Freq.	Reading	AF	Cable	Pre-amp	Dist	Filter	Level	Limit	Margin	Mark	Height
(MHz)	(dBuV)	(dBuV)	(dB)	(dB)	dB	dB	(dBuV/m)	(dBuV/m)	(dB)	(P/Q/A)	(Meter)
4874.02	53.45	34.77	2.73	35.20	9.50	0.00	46.25	74	-27.75	P	1.0
4874.02	50.59	34.77	2.73	35.20	9.50	0.00	43.39	54	-10.61	A	1.0
7310.93	43.91	39.78	4.82	35.64	9.50	0.00	43.37	74	-30.63	P	1.0
7310.93	32.94	39.78	4.82	35.64	9.50	0.00	32.40	54	-21.60	A	1.0
9748.29	48.81	38.53	5.90	36.60	9.50	0.00	47.14	74	-26.86	P	1.0
9748.29	40.85	38.53	5.90	36.60	9.50	0.00	39.18	54	-14.82	A	1.0

1. AF: Antenna Factor, Cable: Cable Loss, Pre-Amp: Preamplifier gain, Filter: High Pass Filter Insertion Loss (3.5GHz)
2. Analyzer setting P(Peak): RBW=1MHz, VBW=1MHz, A(Average): RBW=1MHz,VBW=10Hz
3. Dist : correction to extra plate reading to 3m specification distance 1m measurement distance = -9.5dB
4. The result basic equation calculation as follow :

$$\text{Level} = \text{Reading} + \text{AF} + \text{Cable} - \text{Preamp} + \text{Filter} - \text{Dist}, \text{Margin} = \text{Level} - \text{Limit}$$
5. The test limit is 3M limit.
6. The other emission levels were very low against the limit.
7. For 802.11g mode at 6Mbps.



Ecom Sertech Corp.

Rm. 258, Bldg. 17, NO.195, Sec. 4 Chung Hsing Rd., ChuTung Chen, Hsinchu, Taiwan 310, R.O.C
TEL:886-3-5918012 FAX : 886-3-5825720

FCC ID : RAXWN4501CARC

Report No. : ER03-12-021FRF

Page 29 of 60

Test Requirement: 15.109 ,15.209

The frequency spectrum above 1 GHz was investigated. All emissions not reported below are more than 40 dB below the prescribed limits. Readings are both peak and average values.

Company	Arcadyan Technology Corporation	Test Date :	2003/10/3
Product Name	OfficeConnect Wireless 11g USB Adapter	Test By:	K. P. Pang
Model Name	3CRWE254G72	TEMP&Humidity :	27.4°C , 58%

CH11 RX				Measurement Distance at 1m				Horizontal polarity			
Freq.	Reading	AF	Cable	Pre-amp	Dist	Filter	Level	Limit	Margin	Mark	Height
(MHz)	(dBuV)	(dBuV)	(dB)	(dB)	dB	dB	(dBuV/m)	(dBuV/m)	(dB)	(P/Q/A)	(Meter)
4924.26	55.99	35.10	2.64	35.24	9.50	0.00	48.99	74	-25.01	P	1.0
4924.26	53.78	35.10	2.64	35.24	9.50	0.00	46.78	54	-7.22	A	1.0
7385.91	43.49	39.75	4.85	35.62	9.50	0.00	42.97	74	-31.03	P	1.0
7385.91	33.65	39.75	4.85	35.62	9.50	0.00	33.13	54	-20.87	A	1.0
9848.24	51.10	38.52	5.90	36.76	9.50	0.00	49.26	74	-24.74	P	1.0
9848.24	45.52	38.52	5.90	36.76	9.50	0.00	43.68	54	-10.32	A	1.0

1. AF: Antenna Factor, Cable: Cable Loss, Pre-Amp: Preamplifier gain, Filter: High Pass Filter Insertion Loss (3.5GHz)
2. Analyzer setting P(Peak): RBW=1MHz, VBW=1MHz, A(Average): RBW=1MHz,VBW=10Hz
3. Dist : correction to extra plate reading to 3m specification distance 1m measurement distance = -9.5dB
4. The result basic equation calculation as follow :
Level = Reading + AF + Cable - Preamp + Filter - Dist, Margin = Level - Limit
5. The test limit is 3M limit.
6. The other emission levels were very low against the limit.
7. For 802.11g mode at 6Mbps.



Ecom Sertech Corp.

Rm. 258, Bldg. 17, NO.195, Sec. 4 Chung Hsing Rd., ChuTung Chen, Hsinchu, Taiwan 310, R.O.C
TEL:886-3-5918012 FAX : 886-3-5825720

FCC ID : RAXWN4501CARC

Report No. : ER03-12-021FRF

Page 30 of 60

Test Requirement: 15.109 ,15.209

The frequency spectrum above 1 GHz was investigated. All emissions not reported below are more than 40 dB below the prescribed limits. Readings are both peak and average values.

Company	Arcadyan Technology Corporation	Test Date :	2003/10/3
Product Name	OfficeConnect Wireless 11g USB Adapter	Test By:	K. P. Pang
Model Name	3CRWE254G72	TEMP&Humidity :	27.4°C , 58%

CH11 RX				Measurement Distance at 1m					Vertical polarity		
Freq.	Reading	AF	Cable	Pre-amp	Dist	Filter	Level	Limit	Margin	Mark	Height
(MHz)	(dBuV)	(dBuV)	(dB)	(dB)	dB	dB	(dBuV/m)	(dBuV/m)	(dB)	(P/Q/A)	(Meter)
4924.23	53.75	35.10	2.64	35.24	9.50	0.00	46.75	74	-27.25	P	1.0
4924.23	50.83	35.10	2.64	35.24	9.50	0.00	43.83	54	-10.17	A	1.0
7386.05	43.20	39.75	4.85	35.62	9.50	0.00	42.68	74	-31.32	P	1.0
7386.05	32.03	39.75	4.85	35.62	9.50	0.00	31.51	54	-22.49	A	1.0
9848.43	49.23	38.52	5.90	36.76	9.50	0.00	47.39	74	-26.61	P	1.0
9848.43	41.91	38.52	5.90	36.76	9.50	0.00	40.07	54	-13.93	A	1.0

1. AF: Antenna Factor, Cable: Cable Loss, Pre-Amp: Preamplifier gain, Filter: High Pass Filter Insertion Loss (3.5GHz)

2. Analyzer setting P(Peak): RBW=1MHz, VBW=1MHz, A(Average): RBW=1MHz,VBW=10Hz

3. Dist : correction to extra plate reading to 3m specification distance 1m measurement distance = -9.5dB

4. The result basic equation calculation as follow :

$$\text{Level} = \text{Reading} + \text{AF} + \text{Cable} - \text{Preamp} + \text{Filter} - \text{Dist}, \text{Margin} = \text{Level} - \text{Limit}$$

5. The test limit is 3M limit.

6. The other emission levels were very low against the limit.

7. For 802.11g mode at 6Mbps.



Ecom Sertech Corp.

Rm. 258, Bldg. 17, NO.195, Sec. 4 Chung Hsing Rd., ChuTung Chen, Hsinchu, Taiwan 310, R.O.C
 TEL:886-3-5918012 FAX : 886-3-5825720

FCC ID : RAXWN4501CARC

Report No. : ER03-12-021FRF

Page 31 of 60

Test Requirement: 15.205

The frequency spectrum above 1 GHz was investigated. All emissions not reported below are more than 40 dB below the prescribed limits. Readings are both peak and average values.

Company	Arcadyan Technology Corporation	Test Date :	2003/10/3
Product Name	OfficeConnect Wireless 11g USB Adapter	Test By:	K. P. Pang
Model Name	3CRWE254G72	TEMP&Humidity :	27.9°C , 43%

CH1 TX				Measurement Distance at 1m				Horizontal polarity			
Freq.	Reading	AF	Closs	Pre-amp	Dist	Filter	Level	Limit	Margin	Mark	Height
(MHz)	(dBuV)	(dBuV)	(dB)	(dB)	dB	dB	(dBuV/m)	(dBuV/m)	(dB)	(P/Q/A)	(Meter)
* 2389.89	29.53	31.81	3.84	0.00	9.50	0.00	55.68	74	-18.32	P	1.00
* 2389.89	17.19	31.81	3.84	0.00	9.50	0.00	43.34	54	-10.66	A	1.00
2413.35	75.25	31.79	3.66	0.00	9.50	0.00	101.20	Fundamental Frequency		P	1.00
2413.35	68.05	31.79	3.66	0.00	9.50	0.00	94.00			A	1.00
* 4824.16	47.15	34.44	2.82	35.16	9.50	2.00	41.75	74	-32.25	P	1.00
* 4824.16	40.84	34.44	2.82	35.16	9.50	2.00	35.44	54	-18.56	A	1.00
7236.49	44.80	39.81	4.79	35.65	9.50	2.00	46.25	74	-27.75	P	1.00
7236.49	34.02	39.81	4.79	35.65	9.50	2.00	35.47	54	-18.53	A	1.00
9648.24	52.60	38.54	5.90	36.44	9.50	0.61	51.71	74	-22.29	P	1.00
9648.24	49.18	38.54	5.90	36.44	9.50	0.61	48.29	54	-5.71	A	1.00
* 12066.75	-----	-----	-----	-----	9.50	0.80	-----	-----	-----	-----	1.00
* 14480.10	-----	-----	-----	-----	9.50	0.68	-----	-----	-----	-----	1.00
16893.45	-----	-----	-----	-----	9.50	0.66	-----	-----	-----	-----	1.00
* 19306.80	-----	-----	-----	-----	9.50	2.51	-----	-----	-----	-----	1.00
21720.15	-----	-----	-----	-----	9.50	0.70	-----	-----	-----	-----	1.00
24133.50	-----	-----	-----	-----	9.50	2.11	-----	-----	-----	-----	1.00

- Note :
- The measurement was searched to 10th harmonic, Remark “---” means that the emissions level is too low to be measured.
 - AF: Antenna Factor, Cable: Cable Loss, Pre-Amp: Preamplifier gain, Filter: High Pass Filter Insertion Loss (3.5GHz)
 - Analyzer setting P(Peak): RBW=1MHz, VBW=1MHz, A(Average): RBW=1MHz, VBW=10Hz
 - Remark “*” means that Restricted band.
 - Dist : correction to extra plate reading to 3m specification distance 1m measurement distance = -9.5dB
 - The result basic equation calculation is as follow:
 $Level = Reading + AF + Cable - Preamp + Filter - Dist, Margin = Level - Limit$
 - The other emission levels were very low against the limit
 - The test limit distance is 3M limit.
 - For 802.11b mode at 11Mbps.



Ecom Sertech Corp.

Rm. 258, Bldg. 17, NO.195, Sec. 4 Chung Hsing Rd.,ChuTung Chen, Hsinchu, Taiwan 310, R.O.C
 TEL:886-3-5918012 FAX : 886-3-5825720

FCC ID : RAXWN4501CARC

Report No. : ER03-12-021FRF

Page 32 of 60

Test Requirement: 15.205

The frequency spectrum above 1 GHz was investigated. All emissions not reported below are more than 40 dB below the prescribed limits. Readings are both peak and average values.

Company	Arcadyan Technology Corporation	Test Date :	2003/10/3
Product Name	OfficeConnect Wireless 11g USB Adapter	Test By:	K. P. Pang
Model Name	3CRWE254G72	TEMP&Humidity :	27.9°C , 43%

CH1 TX				Measurement Distance at 1m				Vertical polarity			
Freq.	Reading	AF	Closs	Pre-amp	Dist	Filter	Level	Limit	Margin	Mark	Height
(MHz)	(dBuV)	(dBuV)	(dB)	(dB)	dB	dB	(dBuV/m)	(dBuV/m)	(dB)	(P/Q/A)	(Meter)
* 2389.89	30.51	31.81	3.84	0.00	9.50	0.00	56.66	74	-17.34	P	1.00
* 2389.89	17.16	31.81	3.84	0.00	9.50	0.00	43.31	54	-10.69	A	1.00
2413.40	78.22	31.79	3.66	0.00	9.50	0.00	104.16	Fundamental Frequency		P	1.00
2413.40	71.15	31.79	3.66	0.00	9.50	0.00	97.09			A	1.00
* 4824.15	44.93	34.44	2.82	35.16	9.50	2.00	39.53	74	-34.47	P	1.00
* 4824.15	37.02	34.44	2.82	35.16	9.50	2.00	31.62	54	-22.38	A	1.00
7235.99	44.51	39.81	4.79	35.65	9.50	2.00	45.96	74	-28.04	P	1.00
7235.99	33.14	39.81	4.79	35.65	9.50	2.00	34.59	54	-19.41	A	1.00
9648.27	47.55	38.54	5.90	36.44	9.50	0.61	46.66	74	-27.34	P	1.00
9648.27	40.01	38.54	5.90	36.44	9.50	0.61	39.12	54	-14.88	A	1.00
* 12067.00	-----	-----	-----	-----	9.50	0.80	-----	-----	-----	-----	1.00
* 14480.40	-----	-----	-----	-----	9.50	0.68	-----	-----	-----	-----	1.00
16893.80	-----	-----	-----	-----	9.50	0.66	-----	-----	-----	-----	1.00
* 19307.20	-----	-----	-----	-----	9.50	2.51	-----	-----	-----	-----	1.00
21720.60	-----	-----	-----	-----	9.50	0.70	-----	-----	-----	-----	1.00
24134.00	-----	-----	-----	-----	9.50	2.11	-----	-----	-----	-----	1.00

Note :

- The measurement was searched to 10th harmonic, Remark “---” means that the emissions level is too low to be measured.
- AF: Antenna Factor, Cable: Cable Loss, Pre-Amp: Preamplifier gain, Filter: High Pass Filter Insertion Loss (3.5GHz)
- Analyzer setting P(Peak): RBW=1MHz, VBW=1MHz, A(Average): RBW=1MHz, VBW=10Hz
- Remark “*” means that Restricted band.
- Dist : correction to extra plate reading to 3m specification distance 1m measurement distance = -9.5dB
- The result basic equation calculation is as follow:
 $Level = Reading + AF + Cable - Preamp + Filter - Dist$, $Margin = Level - Limit$
- The other emission levels were very low against the limit
- The test limit distance is 3M limit.
- For 802.11b mode at 11Mbps.



Ecom Sertech Corp.

Rm. 258, Bldg. 17, NO.195, Sec. 4 Chung Hsing Rd., ChuTung Chen, Hsinchu, Taiwan 310, R.O.C
 TEL:886-3-5918012 FAX: 886-3-5825720

FCC ID : RAXWN4501CARC

Report No. : ER03-12-021FRF

Page 33 of 60

Test Requirement: 15.205

The frequency spectrum above 1 GHz was investigated. All emissions not reported below are more than 40 dB below the prescribed limits. Readings are both peak and average values.

Company	Arcadyan Technology Corporation	Test Date :	2003/10/3
Product Name	OfficeConnect Wireless 11g USB Adapter	Test By:	K. P. Pang
Model Name	3CRWE254G72	TEMP&Humidity :	27.9°C , 43%

CH6 TX				Measurement Distance at 1m				Horizontal polarity			
Freq.	Reading	AF	Closs	Pre-amp	Dist	Filter	Level	Limit	Margin	Mark	Height
(MHz)	(dBuV)	(dBuV)	(dB)	(dB)	dB	dB	(dBuV/m)	(dBuV/m)	(dB)	(P/Q/A)	(Meter)
2438.40	75.67	31.76	3.47	0.00	9.50	0.00	101.40	Fundamental Frequency		P	1.00
2438.40	68.45	31.76	3.47	0.00	9.50	0.00	94.18			A	1.00
* 4874.20	48.19	34.77	2.73	35.20	9.50	1.80	42.79	74	-31.21	P	1.00
* 4874.20	41.89	34.77	2.73	35.20	9.50	1.80	36.49	54	-17.51	A	1.00
* 7311.60	44.29	39.78	4.82	35.64	9.50	2.00	45.75	74	-28.25	P	1.00
* 7311.60	32.83	39.78	4.82	35.64	9.50	2.00	34.29	54	-19.71	A	1.00
9748.29	53.26	38.53	5.90	36.60	9.50	0.55	52.14	74	-21.86	P	1.00
9748.29	48.90	38.53	5.90	36.60	9.50	0.55	47.78	54	-6.22	A	1.00
* 12192.00	-----	-----	-----	-----	9.50	0.80	-----	-----	-----	-----	1.00
14630.40	-----	-----	-----	-----	9.50	0.60	-----	-----	-----	-----	1.00
17068.80	-----	-----	-----	-----	9.50	0.76	-----	-----	-----	-----	1.00
* 19507.20	-----	-----	-----	-----	9.50	2.75	-----	-----	-----	-----	1.00
21945.60	-----	-----	-----	-----	9.50	0.70	-----	-----	-----	-----	1.00
24384.00	-----	-----	-----	-----	9.50	1.76	-----	-----	-----	-----	1.00

Note :

- The measurement was searched to 10th harmonic, Remark “---” means that the emissions level is too low to be measured.
- AF: Antenna Factor, Cable: Cable Loss, Pre-Amp: Preamplifier gain, Filter: High Pass Filter Insertion Loss (3.5GHz)
- Analyzer setting P(Peak): RBW=1MHz, VBW=1MHz, A(Average): RBW=1MHz, VBW=10Hz
- Remark “*” means that Restricted band.
- Dist : correction to extra plate reading to 3m specification distance 1m measurement distance = -9.5dB
- The result basic equation calculation is as follow:
 $Level = Reading + AF + Cable - Preamp + Filter - Dist$, $Margin = Level - Limit$
- The other emission levels were very low against the limit
- The test limit distance is 3M limit.
- For 802.11b mode at 11Mbps.



Ecom Sertech Corp.

Rm. 258, Bldg. 17, NO.195, Sec. 4 Chung Hsing Rd., ChuTung Chen, Hsinchu, Taiwan 310, R.O.C
 TEL:886-3-5918012 FAX: 886-3-5825720

FCC ID : RAXWN4501CARC

Report No. : ER03-12-021FRF

Page 34 of 60

Test Requirement: 15.205

The frequency spectrum above 1 GHz was investigated. All emissions not reported below are more than 40 dB below the prescribed limits. Readings are both peak and average values.

Company	Arcadyan Technology Corporation	Test Date :	2003/10/3
Product Name	OfficeConnect Wireless 11g USB Adapter	Test By:	K. P. Pang
Model Name	3CRWE254G72	TEMP&Humidity :	27.9°C , 43%

CH6 TX				Measurement Distance at 1m				Vertical polarity			
Freq.	Reading	AF	Closs	Pre-amp	Dist	Filter	Level	Limit	Margin	Mark	Height
(MHz)	(dBuV)	(dBuV)	(dB)	(dB)	dB	dB	(dBuV/m)	(dBuV/m)	(dB)	(P/Q/A)	(Meter)
2438.35	75.91	31.76	3.47	0.00	9.50	0.00	101.64	Fundamental Frequency		P	1.00
2438.35	68.74	31.76	3.47	0.00	9.50	0.00	94.47			A	1.00
* 4874.21	45.94	34.77	2.73	35.20	9.50	1.80	40.54	74	-33.46	P	1.00
* 4874.21	38.71	34.77	2.73	35.20	9.50	1.80	33.31	54	-20.69	A	1.00
* 7310.99	44.63	39.78	4.82	35.64	9.50	2.00	46.09	74	-27.91	P	1.00
* 7310.99	33.83	39.78	4.82	35.64	9.50	2.00	35.29	54	-18.71	A	1.00
9748.28	47.97	38.53	5.90	36.60	9.50	0.55	46.85	74	-27.15	P	1.00
9748.28	41.05	38.53	5.90	36.60	9.50	0.55	39.93	54	-14.07	A	1.00
* 12191.75	-----	-----	-----	-----	9.50	0.80	-----	-----	-----	-----	1.00
14630.10	-----	-----	-----	-----	9.50	0.60	-----	-----	-----	-----	1.00
17068.45	-----	-----	-----	-----	9.50	0.75	-----	-----	-----	-----	1.00
* 19506.80	-----	-----	-----	-----	9.50	2.74	-----	-----	-----	-----	1.00
21945.15	-----	-----	-----	-----	9.50	0.70	-----	-----	-----	-----	1.00
24383.50	-----	-----	-----	-----	9.50	1.76	-----	-----	-----	-----	1.00

Note :

- The measurement was searched to 10th harmonic, Remark “---” means that the emissions level is too low to be measured.
- AF: Antenna Factor, Cable: Cable Loss, Pre-Amp: Preamplifier gain, Filter: High Pass Filter Insertion Loss (3.5GHz)
- Analyzer setting P(Peak): RBW=1MHz, VBW=1MHz, A(Average): RBW=1MHz, VBW=10Hz
- Remark “*” means that Restricted band.
- Dist : correction to extra plate reading to 3m specification distance 1m measurement distance = -9.5dB
- The result basic equation calculation is as follow:
 $Level = Reading + AF + Cable - Preamp + Filter - Dist$, $Margin = Level - Limit$
- The other emission levels were very low against the limit
- The test limit distance is 3M limit.
- For 802.11b mode at 11Mbps.



Ecom Sertech Corp.

Rm. 258, Bldg. 17, NO.195, Sec. 4 Chung Hsing Rd., ChuTung Chen, Hsinchu, Taiwan 310, R.O.C
 TEL:886-3-5918012 FAX : 886-3-5825720

FCC ID : RAXWN4501CARC

Report No. : ER03-12-021FRF

Page 35 of 60

Test Requirement: 15.205

The frequency spectrum above 1 GHz was investigated. All emissions not reported below are more than 40 dB below the prescribed limits. Readings are both peak and average values.

Company	Arcadyan Technology Corporation	Test Date :	2003/10/3
Product Name	OfficeConnect Wireless 11g USB Adapter	Test By:	K. P. Pang
Model Name	3CRWE254G72	TEMP&Humidity :	27.9°C , 43%

CH11 TX				Measurement Distance at 1m				Horizontal polarity			
Freq.	Reading	AF	Closs	Pre-amp	Dist	Filter	Level	Limit	Margin	Mark	Height
(MHz)	(dBuV)	(dBuV)	(dB)	(dB)	dB	dB	(dBuV/m)	(dBuV/m)	(dB)	(P/Q/A)	(Meter)
2463.45	74.21	31.74	3.28	0.00	9.50	0.00	99.72	Fundamental Frequency		P	1.00
2463.45	67.09	31.74	3.28	0.00	9.50	0.00	92.60			A	1.00
* 2483.65	30.05	31.72	3.12	0.00	9.50	0.00	55.39	74	-18.61	P	1.00
* 2483.65	17.66	31.72	3.12	0.00	9.50	0.00	43.00	54	-11.00	A	1.00
* 4924.23	47.30	35.10	2.64	35.24	9.50	1.60	41.90	74	-32.10	P	1.00
* 4924.23	39.12	35.10	2.64	35.24	9.50	1.60	33.72	54	-20.28	A	1.00
* 7386.01	45.67	39.75	4.85	35.62	9.50	2.00	47.15	74	-26.85	P	1.00
* 7386.01	33.73	39.75	4.85	35.62	9.50	2.00	35.21	54	-18.79	A	1.00
9848.22	52.08	38.52	5.90	36.76	9.50	0.49	50.73	74	-23.27	P	1.00
9848.22	47.34	38.52	5.90	36.76	9.50	0.49	45.99	54	-8.01	A	1.00
* 12317.25	-----	-----	-----	-----	9.50	0.80	-----	-----	-----	-----	1.00
14780.70	-----	-----	-----	-----	9.50	0.48	-----	-----	-----	-----	1.00
17244.15	-----	-----	-----	-----	9.50	0.90	-----	-----	-----	-----	1.00
* 19707.60	-----	-----	-----	-----	9.50	4.05	-----	-----	-----	-----	1.00
* 22171.05	-----	-----	-----	-----	9.50	0.70	-----	-----	-----	-----	1.00
24634.50	-----	-----	-----	-----	9.50	1.57	-----	-----	-----	-----	1.00

Note :

- The measurement was searched to 10th harmonic, Remark “---” means that the emissions level is too low to be measured.
- AF: Antenna Factor, Cable: Cable Loss, Pre-Amp: Preamplifier gain, Filter: High Pass Filter Insertion Loss (3.5GHz)
- Analyzer setting P(Peak): RBW=1MHz, VBW=1MHz, A(Average): RBW=1MHz, VBW=10Hz
- Remark “*” means that Restricted band.
- Dist : correction to extra plate reading to 3m specification distance 1m measurement distance = -9.5dB
- The result basic equation calculation is as follow:
 $Level = Reading + AF + Cable - Preamp + Filter - Dist, Margin = Level - Limit$
- The other emission levels were very low against the limit
- The test limit distance is 3M limit.
- For 802.11b mode at 11Mbps.



Ecom Sertech Corp.

Rm. 258, Bldg. 17, NO.195, Sec. 4 Chung Hsing Rd., ChuTung Chen, Hsinchu, Taiwan 310, R.O.C
 TEL:886-3-5918012 FAX: 886-3-5825720

FCC ID : RAXWN4501CARC

Report No. : ER03-12-021FRF

Page 36 of 60

Test Requirement: 15.205

The frequency spectrum above 1 GHz was investigated. All emissions not reported below are more than 40 dB below the prescribed limits. Readings are both peak and average values.

Company	Arcadyan Technology Corporation	Test Date :	2003/10/3
Product Name	OfficeConnect Wireless 11g USB Adapter	Test By:	K. P. Pang
Model Name	3CRWE254G72	TEMP&Humidity :	27.9°C , 43%

CH11 TX				Measurement Distance at 1m				Vertical polarity			
Freq.	Reading	AF	Closs	Pre-amp	Dist	Filter	Level	Limit	Margin	Mark	Height
(MHz)	(dBuV)	(dBuV)	(dB)	(dB)	dB	dB	(dBuV/m)	(dBuV/m)	(dB)	(P/Q/A)	(Meter)
2463.40	72.38	31.74	3.28	0.00	9.50	0.00	97.89	Fundamental Frequency		P	1.00
2463.40	65.30	31.74	3.28	0.00	9.50	0.00	90.81			A	1.00
* 2483.65	30.26	31.72	3.12	0.00	9.50	0.00	55.60	74	-18.40	P	1.00
* 2483.65	17.06	31.72	3.12	0.00	9.50	0.00	42.40	54	-11.60	A	1.00
* 4924.26	44.93	35.10	2.64	35.24	9.50	1.60	39.53	74	-34.47	P	1.00
* 4924.26	35.43	35.10	2.64	35.24	9.50	1.60	30.03	54	-23.97	A	1.00
* 7386.04	44.88	39.75	4.85	35.62	9.50	2.00	46.36	74	-27.64	P	1.00
* 7386.04	33.68	39.75	4.85	35.62	9.50	2.00	35.16	54	-18.84	A	1.00
9848.31	49.17	38.52	5.90	36.76	9.50	0.49	47.82	74	-26.18	P	1.00
9848.31	42.64	38.52	5.90	36.76	9.50	0.49	41.29	54	-12.71	A	1.00
* 12317.00	-----	-----	-----	-----	9.50	0.80	-----	-----	-----	-----	1.00
14780.40	-----	-----	-----	-----	9.50	0.48	-----	-----	-----	-----	1.00
17243.80	-----	-----	-----	-----	9.50	0.90	-----	-----	-----	-----	1.00
* 19707.20	-----	-----	-----	-----	9.50	4.05	-----	-----	-----	-----	1.00
* 22170.60	-----	-----	-----	-----	9.50	0.70	-----	-----	-----	-----	1.00
24634.00	-----	-----	-----	-----	9.50	1.57	-----	-----	-----	-----	1.00

Note :

- The measurement was searched to 10th harmonic, Remark “---” means that the emissions level is too low to be measured.
- AF: Antenna Factor, Cable: Cable Loss, Pre-Amp: Preamplifier gain, Filter: High Pass Filter Insertion Loss (3.5GHz)
- Analyzer setting P(Peak): RBW=1MHz, VBW=1MHz, A(Average): RBW=1MHz, VBW=10Hz
- Remark “*” means that Restricted band.
- Dist : correction to extra plate reading to 3m specification distance 1m measurement distance = -9.5dB
- The result basic equation calculation is as follow:
 $Level = Reading + AF + Cable - Preamp + Filter - Dist, Margin = Level - Limit$
- The other emission levels were very low against the limit
- The test limit distance is 3M limit.
- For 802.11b mode at 11Mbps.



Ecom Sertech Corp.

Rm. 258, Bldg. 17, NO.195, Sec. 4 Chung Hsing Rd., ChuTung Chen, Hsinchu, Taiwan 310, R.O.C
 TEL:886-3-5918012 FAX : 886-3-5825720

FCC ID : RAXWN4501CARC

Report No. : ER03-12-021FRF

Page 37 of 60

Test Requirement: 15.205

The frequency spectrum above 1 GHz was investigated. All emissions not reported below are more than 40 dB below the prescribed limits. Readings are both peak and average values.

Company	Arcadyan Technology Corporation	Test Date :	2003/10/3
Product Name	OfficeConnect Wireless 11g USB Adapter	Test By:	K. P. Pang
Model Name	3CRWE254G72	TEMP&Humidity :	27.9°C , 43%

CH1 TX				Measurement Distance at 1m				Horizontal polarity			
Freq.	Reading	AF	Closs	Pre-amp	Dist	Filter	Level	Limit	Margin	Mark	Height
(MHz)	(dBuV)	(dBuV)	(dB)	(dB)	dB	dB	(dBuV/m)	(dBuV/m)	(dB)	(P/Q/A)	(Meter)
* 2389.86	43.52	31.81	3.84	0.00	9.50	0.00	69.67	74	-4.33	P	1.00
* 2389.86	25.57	31.81	3.84	0.00	9.50	0.00	51.72	54	-2.28	A	1.00
2414.20	73.83	31.79	3.65	0.00	9.50	0.00	99.77	Fundamental Frequency		P	1.00
2414.20	65.46	31.79	3.65	0.00	9.50	0.00	91.40			A	1.00
* 4824.22	46.79	34.44	2.82	35.16	9.50	2.00	41.39	74	-32.61	P	1.00
* 4824.22	40.12	34.44	2.82	35.16	9.50	2.00	34.72	54	-19.28	A	1.00
7235.99	45.36	39.81	4.79	35.65	9.50	2.00	46.81	74	-27.19	P	1.00
7235.99	34.32	39.81	4.79	35.65	9.50	2.00	35.77	54	-18.23	A	1.00
9648.24	54.02	38.54	5.90	36.44	9.50	0.61	53.13	74	-20.87	P	1.00
9648.24	49.87	38.54	5.90	36.44	9.50	0.61	48.98	54	-5.02	A	1.00
* 12071.00	-----	-----	-----	-----	9.50	0.80	-----	-----	-----	-----	1.00
* 14485.20	-----	-----	-----	-----	9.50	0.68	-----	-----	-----	-----	1.00
16899.40	-----	-----	-----	-----	9.50	0.66	-----	-----	-----	-----	1.00
* 19313.60	-----	-----	-----	-----	9.50	2.51	-----	-----	-----	-----	1.00
21727.80	-----	-----	-----	-----	9.50	0.70	-----	-----	-----	-----	1.00
24142.00	-----	-----	-----	-----	9.50	2.10	-----	-----	-----	-----	1.00

Note :

- The measurement was searched to 10th harmonic, Remark “---” means that the emissions level is too low to be measured.
- AF: Antenna Factor, Cable: Cable Loss, Pre-Amp: Preamplifier gain, Filter: High Pass Filter Insertion Loss (3.5GHz)
- Analyzer setting P(Peak): RBW=1MHz, VBW=1MHz, A(Average): RBW=1MHz, VBW=10Hz
- Remark “*” means that Restricted band.
- Dist : correction to extra plate reading to 3m specification distance 1m measurement distance = -9.5dB
- The result basic equation calculation is as follow:
 $Level = Reading + AF + Cable - Preamp + Filter - Dist$, $Margin = Level - Limit$
- The other emission levels were very low against the limit
- The test limit distance is 3M limit.
- For 802.11g mode at 6Mbps.
- The test data marked in gray background means the EUT emission data is located in the margin uncertainty range of emission limits.



Ecom Sertech Corp.

Rm. 258, Bldg. 17, NO.195, Sec. 4 Chung Hsing Rd., ChuTung Chen, Hsinchu, Taiwan 310, R.O.C
 TEL:886-3-5918012 FAX : 886-3-5825720

FCC ID : RAXWN4501CARC

Report No. : ER03-12-021FRF

Page 38 of 60

Test Requirement: 15.205

The frequency spectrum above 1 GHz was investigated. All emissions not reported below are more than 40 dB below the prescribed limits. Readings are both peak and average values.

Company	Arcadyan Technology Corporation	Test Date :	2003/10/3
Product Name	OfficeConnect Wireless 11g USB Adapter	Test By:	K. P. Pang
Model Name	3CRWE254G72	TEMP&Humidity :	27.9°C , 43%

CH1 TX				Measurement Distance at 1m				Vertical polarity			
Freq.	Reading	AF	Closs	Pre-amp	Dist	Filter	Level	Limit	Margin	Mark	Height
(MHz)	(dBuV)	(dBuV)	(dB)	(dB)	dB	dB	(dBuV/m)	(dBuV/m)	(dB)	(P/Q/A)	(Meter)
* 2389.95	43.63	31.81	3.84	0.00	9.50	0.00	69.78	74	-4.22	P	1.00
* 2389.95	25.73	31.81	3.84	0.00	9.50	0.00	51.88	54	-2.12	A	1.00
2410.54	73.03	31.79	3.68	0.00	9.50	0.00	99.00	Fundamental Frequency		P	1.00
2410.54	64.78	31.79	3.68	0.00	9.50	0.00	90.75			A	1.00
* 4824.27	46.29	34.44	2.82	35.16	9.50	2.00	40.89	74	-33.11	P	1.00
* 4824.27	36.84	34.44	2.82	35.16	9.50	2.00	31.44	54	-22.56	A	1.00
7236.04	45.24	39.81	4.79	35.65	9.50	2.00	46.69	74	-27.31	P	1.00
7236.04	34.33	39.81	4.79	35.65	9.50	2.00	35.78	54	-18.22	A	1.00
9648.21	48.25	38.54	5.90	36.44	9.50	0.61	47.36	74	-26.64	P	1.00
9648.21	41.36	38.54	5.90	36.44	9.50	0.61	40.47	54	-13.53	A	1.00
* 12052.70	-----	-----	-----	-----	9.50	0.80	-----	-----	-----	-----	1.00
14463.24	-----	-----	-----	-----	9.50	0.66	-----	-----	-----	-----	1.00
16873.78	-----	-----	-----	-----	9.50	0.65	-----	-----	-----	-----	1.00
* 19284.32	-----	-----	-----	-----	9.50	2.48	-----	-----	-----	-----	1.00
21694.86	-----	-----	-----	-----	9.50	0.70	-----	-----	-----	-----	1.00
24105.40	-----	-----	-----	-----	9.50	2.15	-----	-----	-----	-----	1.00

Note :

- The measurement was searched to 10th harmonic, Remark “---” means that the emissions level is too low to be measured.
- AF: Antenna Factor, Cable: Cable Loss, Pre-Amp: Preamplifier gain, Filter: High Pass Filter Insertion Loss (3.5GHz)
- Analyzer setting P(Peak): RBW=1MHz, VBW=1MHz, A(Average): RBW=1MHz, VBW=10Hz
- Remark “*” means that Restricted band.
- Dist : correction to extra plate reading to 3m specification distance 1m measurement distance = -9.5dB
- The result basic equation calculation is as follow:
 $Level = Reading + AF + Cable - Preamp + Filter - Dist$, $Margin = Level - Limit$
- The other emission levels were very low against the limit
- The test limit distance is 3M limit.
- For 802.11g mode at 6Mbps.
- The test data marked in gray background means the EUT emission data is located in the margin uncertainty range of emission limits.



Ecom Sertech Corp.

Rm. 258, Bldg. 17, NO.195, Sec. 4 Chung Hsing Rd., ChuTung Chen, Hsinchu, Taiwan 310, R.O.C
 TEL:886-3-5918012 FAX: 886-3-5825720

FCC ID : RAXWN4501CARC

Report No. : ER03-12-021FRF

Page 39 of 60

Test Requirement: 15.205

The frequency spectrum above 1 GHz was investigated. All emissions not reported below are more than 40 dB below the prescribed limits. Readings are both peak and average values.

Company	Arcadyan Technology Corporation	Test Date :	2003/10/3
Product Name	OfficeConnect Wireless 11g USB Adapter	Test By:	K. P. Pang
Model Name	3CRWE254G72	TEMP&Humidity :	27.9°C , 43%

CH6 TX				Measurement Distance at 1m				Horizontal polarity			
Freq.	Reading	AF	Closs	Pre-amp	Dist	Filter	Level	Limit	Margin	Mark	Height
(MHz)	(dBuV)	(dBuV)	(dB)	(dB)	dB	dB	(dBuV/m)	(dBuV/m)	(dB)	(P/Q/A)	(Meter)
2444.16	72.78	31.76	3.42	0.00	9.50	0.00	98.46	Fundamental Frequency		P	1.00
2444.16	64.34	31.76	3.42	0.00	9.50	0.00	90.02			A	1.00
* 4874.25	47.57	34.77	2.73	35.20	9.50	1.80	42.17	74	-31.83	P	1.00
* 4874.25	39.91	34.77	2.73	35.20	9.50	1.80	34.51	54	-19.49	A	1.00
* 7311.77	43.16	39.78	4.82	35.64	9.50	2.00	44.62	74	-29.38	P	1.00
* 7311.77	32.76	39.78	4.82	35.64	9.50	2.00	34.22	54	-19.78	A	1.00
9748.31	52.71	38.53	5.90	36.60	9.50	0.55	51.59	74	-22.41	P	1.00
9748.31	48.13	38.53	5.90	36.60	9.50	0.55	47.01	54	-6.99	A	1.00
* 12220.80	-----	-----	-----	-----	9.50	0.80	-----	-----	-----	-----	1.00
14664.96	-----	-----	-----	-----	9.50	0.57	-----	-----	-----	-----	1.00
17109.12	-----	-----	-----	-----	9.50	0.79	-----	-----	-----	-----	1.00
* 19553.28	-----	-----	-----	-----	9.50	3.05	-----	-----	-----	-----	1.00
21997.44	-----	-----	-----	-----	9.50	0.70	-----	-----	-----	-----	1.00
24441.60	-----	-----	-----	-----	9.50	1.68	-----	-----	-----	-----	1.00

- Note :
- The measurement was searched to 10th harmonic, Remark “---” means that the emissions level is too low to be measured.
 - AF: Antenna Factor, Cable: Cable Loss, Pre-Amp: Preamplifier gain, Filter: High Pass Filter Insertion Loss (3.5GHz)
 - Analyzer setting P(Peak): RBW=1MHz, VBW=1MHz, A(Average): RBW=1MHz, VBW=10Hz
 - Remark “*” means that Restricted band.
 - Dist : correction to extra plate reading to 3m specification distance 1m measurement distance = -9.5dB
 - The result basic equation calculation is as follow:
 $Level = Reading + AF + Cable - Preamp + Filter - Dist$, $Margin = Level - Limit$
 - The other emission levels were very low against the limit
 - The test limit distance is 3M limit.
 - For 802.11g mode at 6Mbps.



Ecom Sertech Corp.

Rm. 258, Bldg. 17, NO.195, Sec. 4 Chung Hsing Rd., ChuTung Chen, Hsinchu, Taiwan 310, R.O.C
 TEL:886-3-5918012 FAX : 886-3-5825720

FCC ID : RAXWN4501CARC

Report No. : ER03-12-021FRF

Page 40 of 60

Test Requirement: 15.205

The frequency spectrum above 1 GHz was investigated. All emissions not reported below are more than 40 dB below the prescribed limits. Readings are both peak and average values.

Company	Arcadyan Technology Corporation	Test Date :	2003/10/3
Product Name	OfficeConnect Wireless 11g USB Adapter	Test By:	K. P. Pang
Model Name	3CRWE254G72	TEMP&Humidity :	27.9°C , 43%

CH6 TX				Measurement Distance at 1m				Vertical polarity			
Freq.	Reading	AF	Closs	Pre-amp	Dist	Filter	Level	Limit	Margin	Mark	Height
(MHz)	(dBuV)	(dBuV)	(dB)	(dB)	dB	dB	(dBuV/m)	(dBuV/m)	(dB)	(P/Q/A)	(Meter)
2439.45	70.41	31.76	3.46	0.00	9.50	0.00	96.13	Fundamental Frequency		P	1.00
2439.45	62.05	31.76	3.46	0.00	9.50	0.00	87.77			A	1.00
* 4874.01	46.73	34.77	2.73	35.20	9.50	1.80	41.33	74	-32.67	P	1.00
* 4874.01	38.91	34.77	2.73	35.20	9.50	1.80	33.51	54	-20.49	A	1.00
* 7311.04	45.04	39.78	4.82	35.64	9.50	2.00	46.50	74	-27.50	P	1.00
* 7311.04	34.35	39.78	4.82	35.64	9.50	2.00	35.81	54	-18.19	A	1.00
9748.31	48.44	38.53	5.90	36.60	9.50	0.55	47.32	74	-26.68	P	1.00
9748.31	41.32	38.53	5.90	36.60	9.50	0.55	40.20	54	-13.80	A	1.00
* 12197.25	-----	-----	-----	-----	9.50	0.80	-----	-----	-----	-----	1.00
14636.70	-----	-----	-----	-----	9.50	0.59	-----	-----	-----	-----	1.00
17076.15	-----	-----	-----	-----	9.50	0.76	-----	-----	-----	-----	1.00
* 19515.60	-----	-----	-----	-----	9.50	2.80	-----	-----	-----	-----	1.00
21955.05	-----	-----	-----	-----	9.50	0.70	-----	-----	-----	-----	1.00
24394.50	-----	-----	-----	-----	9.50	1.75	-----	-----	-----	-----	1.00

Note :

- The measurement was searched to 10th harmonic, Remark “---” means that the emissions level is too low to be measured.
- AF: Antenna Factor, Cable: Cable Loss, Pre-Amp: Preamplifier gain, Filter: High Pass Filter Insertion Loss (3.5GHz)
- Analyzer setting P(Peak): RBW=1MHz, VBW=1MHz, A(Average): RBW=1MHz, VBW=10Hz
- Remark “*” means that Restricted band.
- Dist : correction to extra plate reading to 3m specification distance 1m measurement distance = -9.5dB
- The result basic equation calculation is as follow:
 $Level = Reading + AF + Cable - Preamp + Filter - Dist$, $Margin = Level - Limit$
- The other emission levels were very low against the limit
- The test limit distance is 3M limit.
- For 802.11g mode at 6Mbps.



Ecom Sertech Corp.

Rm. 258, Bldg. 17, NO.195, Sec. 4 Chung Hsing Rd., ChuTung Chen, Hsinchu, Taiwan 310, R.O.C
 TEL:886-3-5918012 FAX : 886-3-5825720

FCC ID : RAXWN4501CARC

Report No. : ER03-12-021FRF

Page 41 of 60

Test Requirement: 15.205

The frequency spectrum above 1 GHz was investigated. All emissions not reported below are more than 40 dB below the prescribed limits. Readings are both peak and average values.

Company	Arcadyan Technology Corporation	Test Date :	2003/10/3
Product Name	OfficeConnect Wireless 11g USB Adapter	Test By:	K. P. Pang
Model Name	3CRWE254G72	TEMP&Humidity :	27.9°C , 43%

CH11 TX				Measurement Distance at 1m				Horizontal polarity			
Freq.	Reading	AF	Closs	Pre-amp	Dist	Filter	Level	Limit	Margin	Mark	Height
(MHz)	(dBuV)	(dBuV)	(dB)	(dB)	dB	dB	(dBuV/m)	(dBuV/m)	(dB)	(P/Q/A)	(Meter)
2464.45	73.24	31.74	3.27	0.00	9.50	0.00	98.75	Fundamental Frequency		P	1.00
2464.45	65.00	31.74	3.27	0.00	9.50	0.00	90.51			A	1.00
* 2483.65	42.49	31.72	3.12	0.00	9.50	0.00	67.83	74	-6.17	P	1.00
* 2483.65	26.58	31.72	3.12	0.00	9.50	0.00	51.92	54	-2.08	A	1.00
* 4924.28	46.12	35.10	2.64	35.24	9.50	1.60	40.72	74	-33.28	P	1.00
* 4924.28	38.46	35.10	2.64	35.24	9.50	1.60	33.06	54	-20.94	A	1.00
* 7385.93	44.39	39.75	4.85	35.62	9.50	2.00	45.87	74	-28.13	P	1.00
* 7385.93	33.78	39.75	4.85	35.62	9.50	2.00	35.26	54	-18.74	A	1.00
9848.28	52.30	38.52	5.90	36.76	9.50	0.49	50.95	74	-23.05	P	1.00
9848.28	47.48	38.52	5.90	36.76	9.50	0.49	46.13	54	-7.87	A	1.00
* 12322.25	-----	-----	-----	-----	9.50	0.80	-----	-----	-----	-----	1.00
14786.70	-----	-----	-----	-----	9.50	0.47	-----	-----	-----	-----	1.00
17251.15	-----	-----	-----	-----	9.50	0.90	-----	-----	-----	-----	1.00
* 19715.60	-----	-----	-----	-----	9.50	4.10	-----	-----	-----	-----	1.00
* 22180.05	-----	-----	-----	-----	9.50	0.70	-----	-----	-----	-----	1.00
24644.50	-----	-----	-----	-----	9.50	1.57	-----	-----	-----	-----	1.00

Note :

- The measurement was searched to 10th harmonic, Remark “---” means that the emissions level is too low to be measured.
- AF: Antenna Factor, Cable: Cable Loss, Pre-Amp: Preamplifier gain, Filter: High Pass Filter Insertion Loss (3.5GHz)
- Analyzer setting P(Peak): RBW=1MHz, VBW=1MHz, A(Average): RBW=1MHz, VBW=10Hz
- Remark “*” means that Restricted band.
- Dist : correction to extra plate reading to 3m specification distance 1m measurement distance = -9.5dB
- The result basic equation calculation is as follow:
 $Level = Reading + AF + Cable - Preamp + Filter - Dist, Margin = Level - Limit$
- The other emission levels were very low against the limit
- The test limit distance is 3M limit.
- For 802.11g mode at 6Mbps.
- The test data marked in gray background means the EUT emission data is located in the margin uncertainty range of emission limits.



Ecom Sertech Corp.

Rm. 258, Bldg. 17, NO.195, Sec. 4 Chung Hsing Rd., ChuTung Chen, Hsinchu, Taiwan 310, R.O.C
 TEL:886-3-5918012 FAX : 886-3-5825720

FCC ID : RAXWN4501CARC

Report No. : ER03-12-021FRF

Page 42 of 60

Test Requirement: 15.205

The frequency spectrum above 1 GHz was investigated. All emissions not reported below are more than 40 dB below the prescribed limits. Readings are both peak and average values.

Company	Arcadyan Technology Corporation	Test Date :	2003/10/3
Product Name	OfficeConnect Wireless 11g USB Adapter	Test By:	K. P. Pang
Model Name	3CRWE254G72	TEMP&Humidity :	27.9°C , 43%

CH11 TX				Measurement Distance at 1m				Vertical polarity			
Freq.	Reading	AF	Closs	Pre-amp	Dist	Filter	Level	Limit	Margin	Mark	Height
(MHz)	(dBuV)	(dBuV)	(dB)	(dB)	dB	dB	(dBuV/m)	(dBuV/m)	(dB)	(P/Q/A)	(Meter)
2463.10	69.76	31.74	3.28	0.00	9.50	0.00	95.28	Fundamental Frequency		P	1.00
2463.10	61.54	31.74	3.28	0.00	9.50	0.00	87.06			A	1.00
* 2483.65	39.30	31.72	3.12	0.00	9.50	0.00	64.64	74	-9.36	P	1.00
* 2483.65	23.78	31.72	3.12	0.00	9.50	0.00	49.12	54	-4.88	A	1.00
* 4924.18	48.20	35.10	2.64	35.24	9.50	1.60	42.80	74	-31.20	P	1.00
* 4924.18	40.10	35.10	2.64	35.24	9.50	1.60	34.70	54	-19.30	A	1.00
* 7385.21	44.56	39.75	4.85	35.62	9.50	2.00	46.04	74	-27.96	P	1.00
* 7385.21	33.10	39.75	4.85	35.62	9.50	2.00	34.58	54	-19.42	A	1.00
9848.38	49.59	38.52	5.90	36.76	9.50	0.49	48.24	74	-25.76	P	1.00
9848.38	41.41	38.52	5.90	36.76	9.50	0.49	40.06	54	-13.94	A	1.00
* 12315.50	-----	-----	-----	-----	9.50	0.80	-----	-----	-----	-----	1.00
14778.60	-----	-----	-----	-----	9.50	0.48	-----	-----	-----	-----	1.00
17241.70	-----	-----	-----	-----	9.50	0.89	-----	-----	-----	-----	1.00
* 19704.80	-----	-----	-----	-----	9.50	4.03	-----	-----	-----	-----	1.00
* 22167.90	-----	-----	-----	-----	9.50	0.70	-----	-----	-----	-----	1.00
24631.00	-----	-----	-----	-----	9.50	1.57	-----	-----	-----	-----	1.00

Note :

- The measurement was searched to 10th harmonic, Remark “---” means that the emissions level is too low to be measured.
- AF: Antenna Factor, Cable: Cable Loss, Pre-Amp: Preamplifier gain, Filter: High Pass Filter Insertion Loss (3.5GHz)
- Analyzer setting P(Peak): RBW=1MHz, VBW=1MHz, A(Average): RBW=1MHz, VBW=10Hz
- Remark “*” means that Restricted band.
- Dist : correction to extra plate reading to 3m specification distance 1m measurement distance = -9.5dB
- The result basic equation calculation is as follow:
 $Level = Reading + AF + Cable - Preamp + Filter - Dist, Margin = Level - Limit$
- The other emission levels were very low against the limit
- The test limit distance is 3M limit.
- For 802.11g mode at 6Mbps.

3.7 Photos of Open Site





Ecom Sertech Corp.

Rm. 258, Bldg. 17, NO.195, Sec. 4 Chung Hsing Rd., ChuTung Chen, Hsinchu, Taiwan 310, R.O.C
TEL:886-3-5918012 FAX : 886-3-5825720

FCC ID : RAXWN4501CARC

Report No. : ER03-12-021FRF

Page 44 of 60



4. 6dB BANDWIDTH MEASUREMENT

4.1 Test Equipments

Description & Manufacturer	Model No.	Serial No.	Date Of Calibration
ROHDE & SCHWARZ SPECTRUM ANALYZER	FSEK30	835253/002	JUN. 17, 2003
HP ATTENUATOR	8496B	3247A18505	Cal. on use
HP PLOTTER	7750A	725A 852141	N/A

Note :

1. The measurement uncertainty is less than +/- 2.6dB, which is calculated as per the NAMAS document NIS81.
2. The calibration interval of the above test instruments is 12 months and the calibrations are traceable to NML/ROC and NIST/USA.

4.2 Test Setup

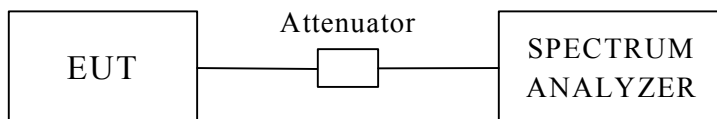

4.3 Limits of 6dB Bandwidth Measurement

The minimum of 6dB Bandwidth Measurement is >500KHz

4.4 Test Procedure

The transmitter output was connected to the spectrum analyzer through an attenuator. The bandwidth of the fundamental frequency was measured by spectrum analyzer with 100 KHz RBW and 100 KHz VBW. The 6dB bandwidth is defined as the total spectrum the power of which is higher than peak power minus 6dB.

4.5 Uncertainty of Conducted Emission

The uncertainty of conducted emission is ± 200KHz.



4.6 Test Results

Input Power (System)	5.0VDC(Form PC)	Environmental Conditions	33.4°C, 43%RH,
Tested By	K. P. Pang		

Channel	Channel Frequency (MHz)	6dB Bandwidth (MHz)	Minimum Limit (MHz)	Pass / Fail
1	2412	11.14	0.5	PASS
6	2437	10.26	0.5	PASS
11	2462	10.66	0.5	PASS

Note: For 802.11b Mode

Channel	Channel Frequency (MHz)	6dB Bandwidth (MHz)	Minimum Limit (MHz)	Pass / Fail
1	2412	16.47	0.5	PASS
6	2437	16.47	0.5	PASS
11	2462	16.47	0.5	PASS

Note: For 802.11g Mode



4.7 Photo of 6db Bandwidth Measurement

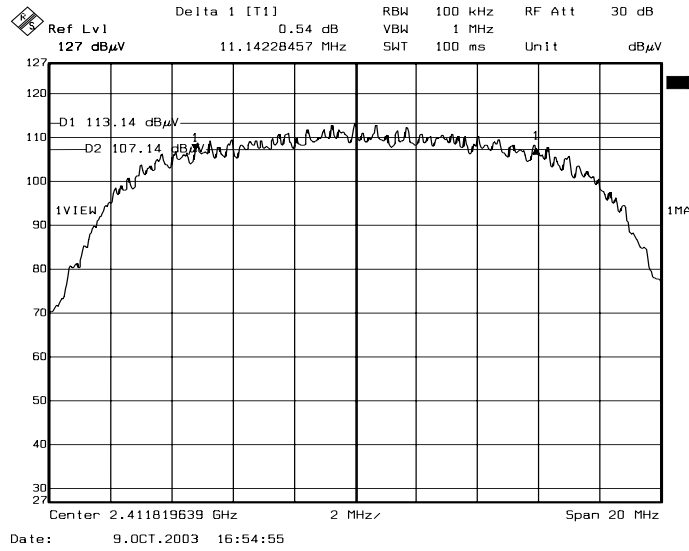

Channel 1

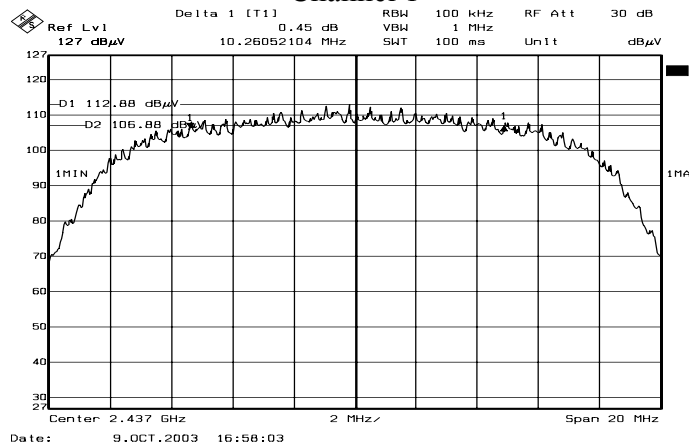

Channel 6

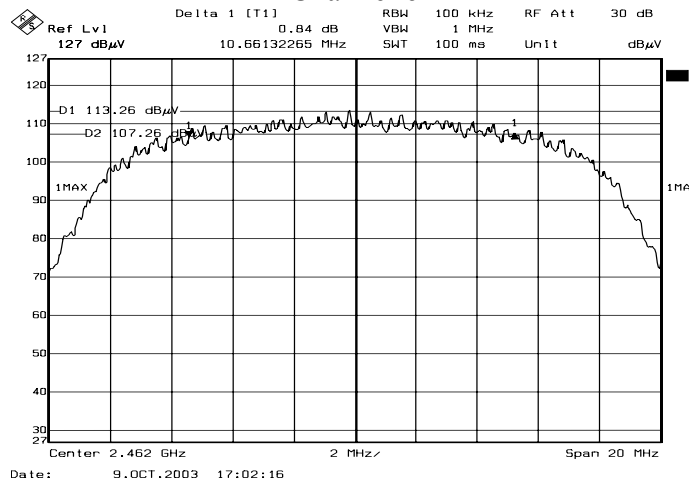

Channel 11

Note: For 802.11b Mode



Ecom Sertech Corp.

Rm. 258, Bldg. 17, NO.195, Sec. 4 Chung Hsing Rd., ChuTung Chen, Hsinchu, Taiwan 310, R.O.C
TEL:886-3-5918012 FAX: 886-3-5825720

FCC ID : RAXWN4501CARC

Report No. : ER03-12-021FRF

Page 48 of 60

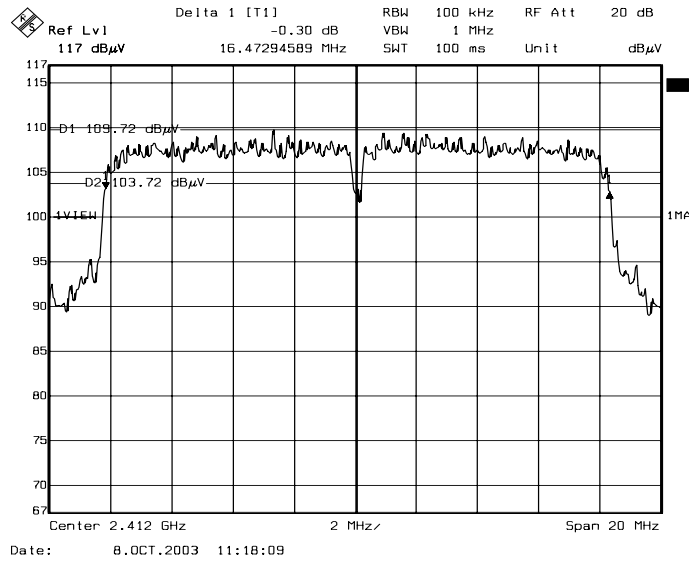

Channel 1

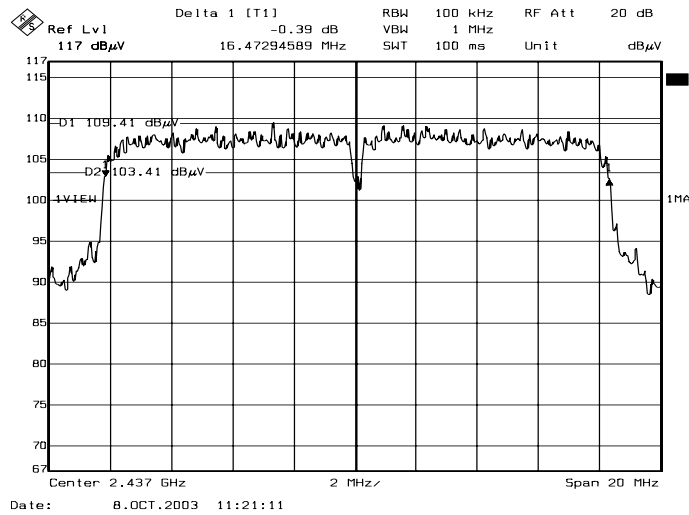

Channel 6

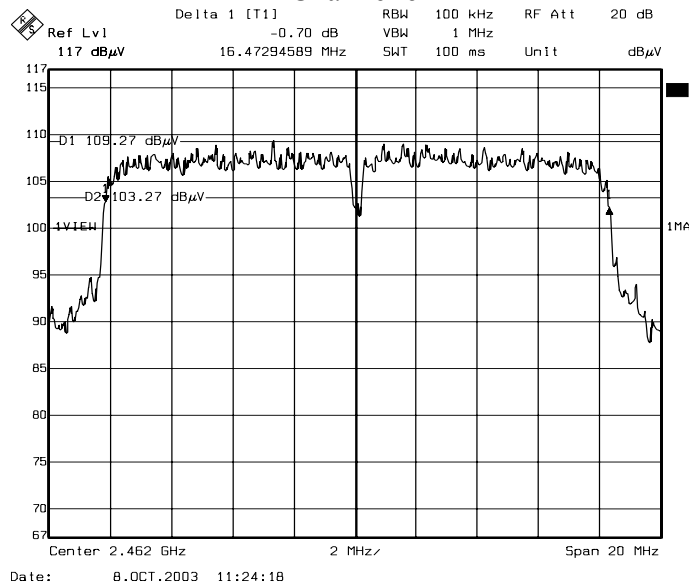

Channel 11

Note: For 802.11g Mode

5. MAXIMUM PEAK OUTPUT POWER

5.1 Test Equipments

Description & Manufacturer	Model No.	Serial No.	Date Of Calibration
ROHDE & SCHWARZ SPECTRUM ANALYZER	FSEK30	835253/002	JUN. 17, 2003
HP ATTENUATOR	8496B	3247A18505	Cal. on use
HP PLOTTER	7750A	725A 852141	N/A

Note :

1. The measurement uncertainty is less than +/- 2.6dB, which is calculated as per the NAMAS document NIS81.
2. The calibration interval of the above test instruments is 12 months and the calibrations are traceable to NML/ROC and NIST/USA.

5.2 Test Setup

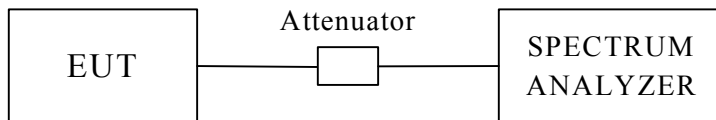

5.3 Limits of Maximum Peak Output Power

The Maximum Peak Output Power Measurement is 30dBm.



5.4 Test Procedure

The RF power output was measured with a Power meter connected to the RF Antenna connector (conducted measurement) while EUT was operating in transmit mode at the appropriate center frequency.

5.5 Uncertainty of Conducted Emission

The uncertainty of conducted emission is ± 1.82 dB.

5.6 Test Results

Input Power (System)	5.0VDC(Form PC)	Environmental Conditions	33.4°C, 43%RH,
Tested By	K. P. Pang		

Channel	Channel Frequency (MHz)	Peak Power Output (dBm)	Peak Power Limit (dBm)	Pass / Fail
1	2412	19.13	30	PASS
6	2437	19.10	30	PASS
11	2462	19.04	30	PASS

- Note :
1. For 802.11b Mode
 2. At final test to get the worst-case emission at 11Mbps.
 3. The result basic equation calculation as follow :

$$\text{Peak Power Output} = \text{Peak Power Reading} + \text{Cable loss} + \text{Attenuator}$$

Channel	Channel Frequency (MHz)	Peak Power Output (dBm)	Peak Power Limit (dBm)	Pass / Fail
1	2412	18.16	30	PASS
6	2437	18.14	30	PASS
11	2462	18.07	30	PASS

- Note :
1. For 802.11g Mode
 2. At final test to get the worst-case emission at 6Mbps.
 3. The result basic equation calculation as follow :

$$\text{Peak Power Output} = \text{Peak Power Reading} + \text{Cable loss} + \text{Attenuator}$$



6. POWER SPECTRAL DENSITY MEASUREMENT

6.1 Test Equipments

Description & Manufacturer	Model No.	Serial No.	Date Of Calibration
ROHDE & SCHWARZ SPECTRUM ANALYZER	FSEK30	835253/002	JUN. 17, 2003
HP ATTENUATOR	8496B	3247A18505	Cal. on use
HP PLOTTER	7750A	725A 852141	N/A

Note :

1. The measurement uncertainty is less than +/- 2.6dB, which is calculated as per the NAMAS document NIS81.
2. The calibration interval of the above test instruments is 12 months and the calibrations are traceable to NML/ROC and NIST/USA.

6.2 Test Setup

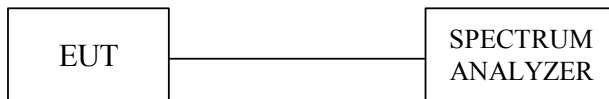

6.3 Limits of Power Spectral Density Measurement

The Maximum Power Spectral Density Measurement is 8dBm.



6.4 Test Procedure

The transmitter output was connected to the spectrum analyzer through an attenuator, the bandwidth of the fundamental frequency was measured with the spectrum analyzer using 3KHz RBW and 30KHz VBW, set sweep time=span / 3KHz.

The power spectral density was measured and recorded.

The sweep time is allowed to be longer than span / 3KHz for a full response of the mixer in the spectrum analyzer.

6.5 Uncertainty of Conducted Emission

The uncertainty of conducted emission is ± 1.82dB.

6.6 Test Results

Input Power (System)	5.0VDC(Form PC)	Environmental Conditions	33.4°C , 43%RH,
Tested By	K. P. Pang		

Channel	Channel Frequency (MHz)	Final RF Power Level in 3KHz BW (dBm)	Maximum Limit (dBm)	Pass / Fail
1	2412	-8.64	8	PASS
6	2437	-8.63	8	PASS
11	2462	-8.70	8	PASS

Note: 1. For 11Mbps (802.11b mode) at final test to get the worst-case emission at 11Mbps.

Channel	Channel Frequency (MHz)	Final RF Power Level in 3KHz BW (dBm)	Maximum Limit (dBm)	Pass / Fail
1	2412	-12.79	8	PASS
6	2437	-12.91	8	PASS
11	2462	-13.39	8	PASS

Note: 1. For 54Mbps (802.11g mode) at final test to get the worst-case emission at 6Mbps.



6.7 Photo of Power Spectral Density Measurement

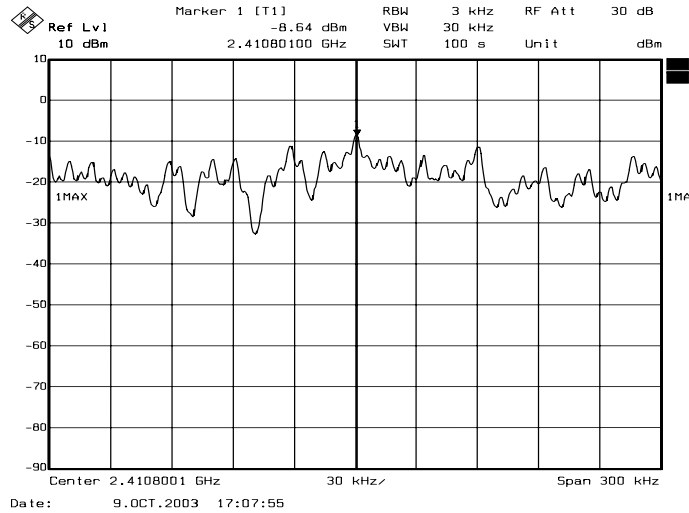

Channel 1

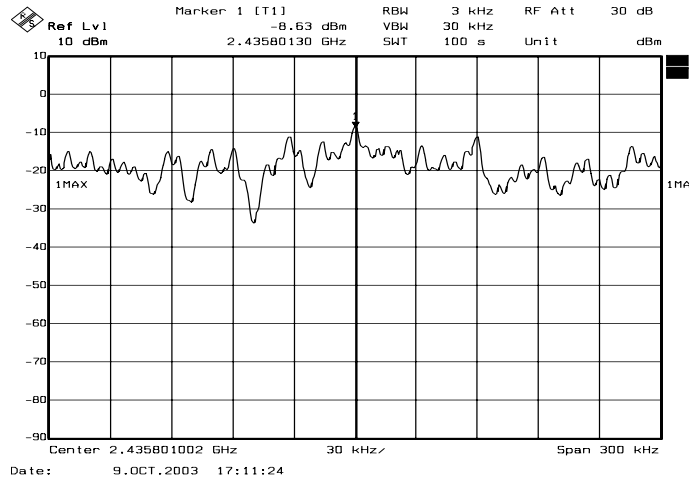

Channel 6

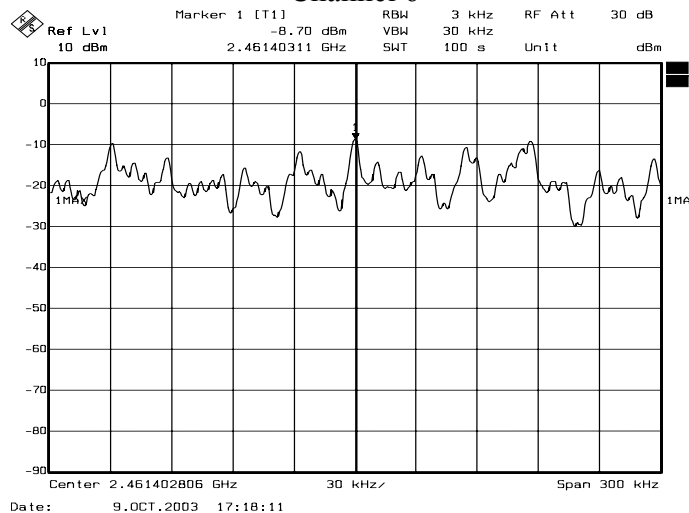

Channel 11

Note: For 802.11b Mode



Ecom Sertech Corp.

Rm. 258, Bldg. 17, NO.195, Sec. 4 Chung Hsing Rd., ChuTung Chen, Hsinchu, Taiwan 310, R.O.C
TEL: 886-3-5918012 FAX: 886-3-5825720

FCC ID : RAXWN4501CARC

Report No. : ER03-12-021FRF

Page 54 of 60

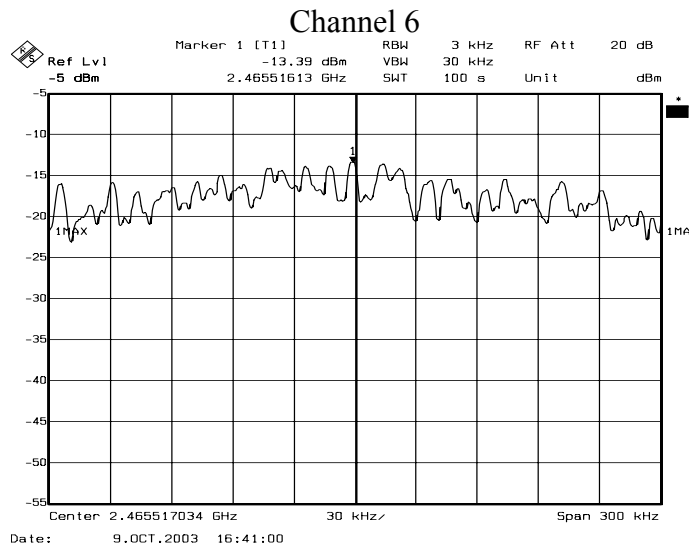
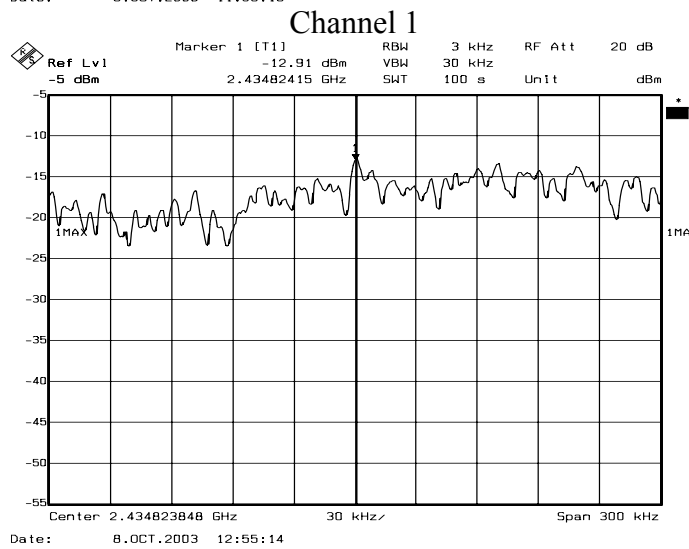
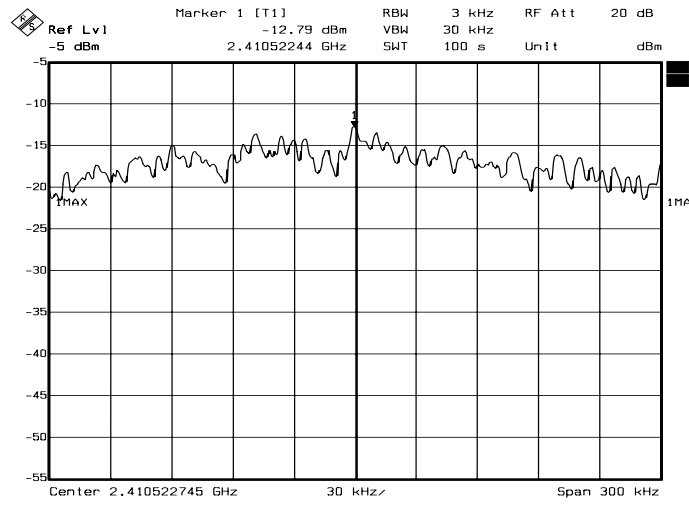

Channel 11

Note: For 802.11g Mode

7. OUT OF BAND MEASUREMENT

7.1 Test Equipments

Description & Manufacturer	Model No.	Serial No.	Date Of Calibration
ROHDE & SCHWARZ SPECTRUM ANALYZER	FSEK30	835253/002	JUN. 17, 2003
HP ATTENUATOR	8496B	3247A18505	Cal. on use
HP PLOTTER	7750A	725A 852141	N/A

Note :

1. The measurement uncertainty is less than +/- 2.6dB, which is calculated as per the NAMAS document NIS81.
2. The calibration interval of the above test instruments is 12 months and the calibrations are traceable to NML/ROC and NIST/USA.

7.2 Test Setup

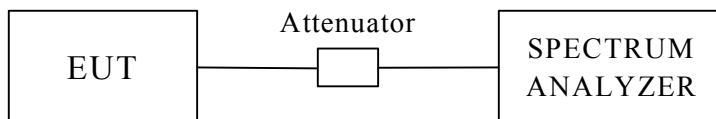

7.3 Limits of Out of Band Emissions Measurement

1. Below -20dB of the highest emission level of operating band (in 100KHz Resolution Bandwidth).
2. Fall in the restricted bands listed in section 15.205. The maximum permitted average field strength is listed in section 15.209.



7.4 Test Procedure

The transmitter output was connected to the spectrum analyzer via a low lose cable. Set both RBW and VBW of spectrum analyzer to 100KHz with suitable frequency span including 100KHz bandwidth from band edge. The band edges was measured and recorded.

7.5 Uncertainty of Conducted Emission

The uncertainty of conducted emission is $\pm 1.82\text{dB}$.

7.6 Test Results

A. Conducted

Refer to 7.7 photo of out band Emission measurement

B. Radiated

For 802.11b Mode

Refer to the section 3.6, the measured radiated band edge emissions are listed below :

Input Power (System)	5.0VDC(Form PC)	Environmental Conditions	33.4°C, 43%RH
Tested By	K. P. Pang		

Band edge Frequency (MHz)	Measured radiated band edge field strength (dBuV/m)		Horizontal radiated band edge field strength limit (dBuV/m)		Test result
	Horizontal	Vertical	Horizontal	Vertical	
2399.97	66.46 (PK)	69.42 (PK)	81.20 (PK)	84.16 (PK)	PASS
	59.26 (AV)	62.35 (AV)	79.72 (AV)	77.89 (AV)	
2483.65	45.92 (PK)	44.09 (PK)	74.00 (PK)	74.00 (PK)	PASS
	38.80 (AV)	37.01 (AV)	54.00 (AV)	54.00 (AV)	



Ecom Sertech Corp.

Rm. 258, Bldg. 17, NO.195, Sec. 4 Chung Hsing Rd., ChuTung Chen, Hsinchu, Taiwan 310, R.O.C
TEL:886-3-5918012 FAX : 886-3-5825720

FCC ID : RAXWN4501CARC

Report No. : ER03-12-021FRF

Page 57 of 60

For 802.11g Mode

Refer to the section 3.6, the measured radiated band edge emissions are listed below :

Input Power (System)	5.0VDC(Form PC)	Environmental Conditions	33.4°C, 43%RH
Tested By	K. P. Pang		

Band edge Frequency (MHz)	Measured radiated band edge field strength (dBuV/m)		Horizontal radiated band edge field strength limit (dBuV/m)		Test result
	Horizontal	Vertical	Horizontal	Vertical	
2399.97	77.31 (PK) 68.94 (AV)	76.54 (PK) 68.29 (AV)	79.77 (PK) 78.75 (AV)	79.00 (PK) 75.28 (AV)	PASS
2483.65	62.14 (PK) 53.90 (AV)	58.67 (PK) 50.45 (AV)	74.00 (PK) 54.00 (AV)	74.00 (PK) 54.00 (AV)	PASS



Ecom Sertech Corp.

Rm. 258, Bldg. 17, NO.195, Sec. 4 Chung Hsing Rd., ChuTung Chen, Hsinchu, Taiwan 310, R.O.C
TEL:886-3-5918012 FAX: 886-3-5825720

FCC ID : RAXWN4501CARC

Report No. : ER03-12-021FRF

Page 58 of 60

7.7 Photo of Out of Band Measurement

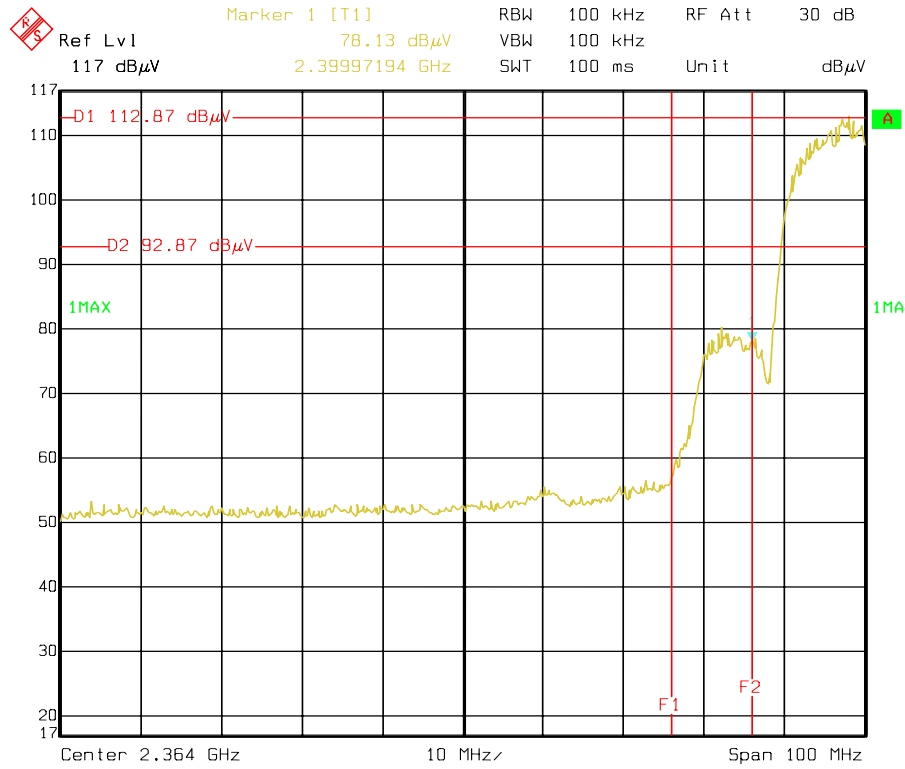

Date: 14.OCT.2003 15:38:31

FRONT

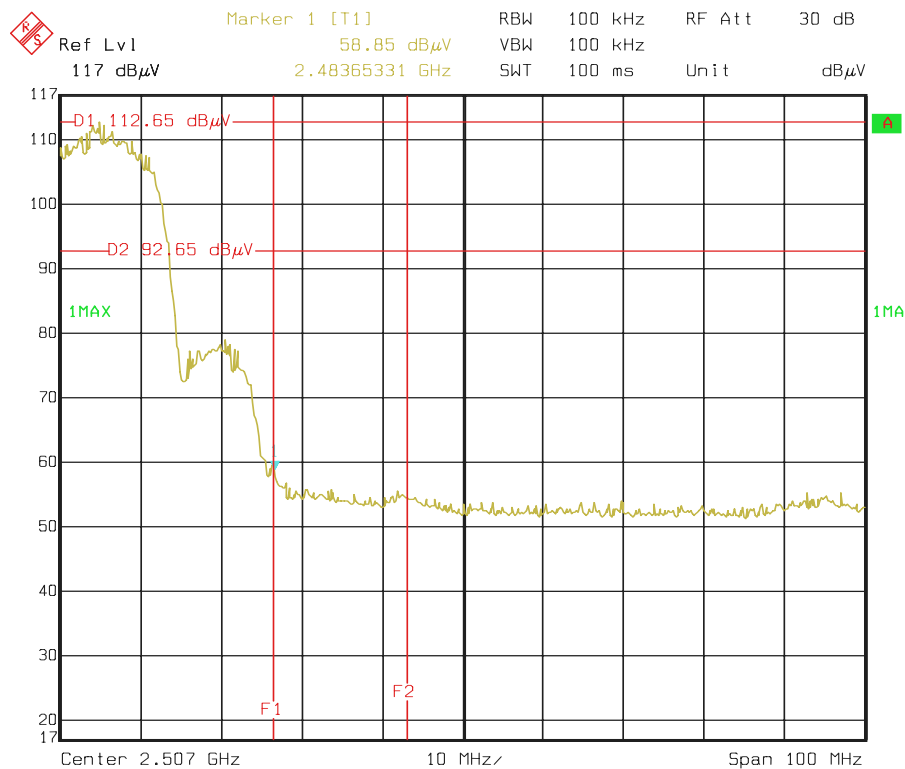

Date: 14.OCT.2003 15:33:39

BACK

Note: For 802.11b Mode



Ecom Sertech Corp.

Rm. 258, Bldg. 17, NO.195, Sec. 4 Chung Hsing Rd., ChuTung Chen, Hsinchu, Taiwan 310, R.O.C
TEL:886-3-5918012 FAX: 886-3-5825720

FCC ID : RAXWN4501CARC

Report No. : ER03-12-021FRF

Page 59 of 60

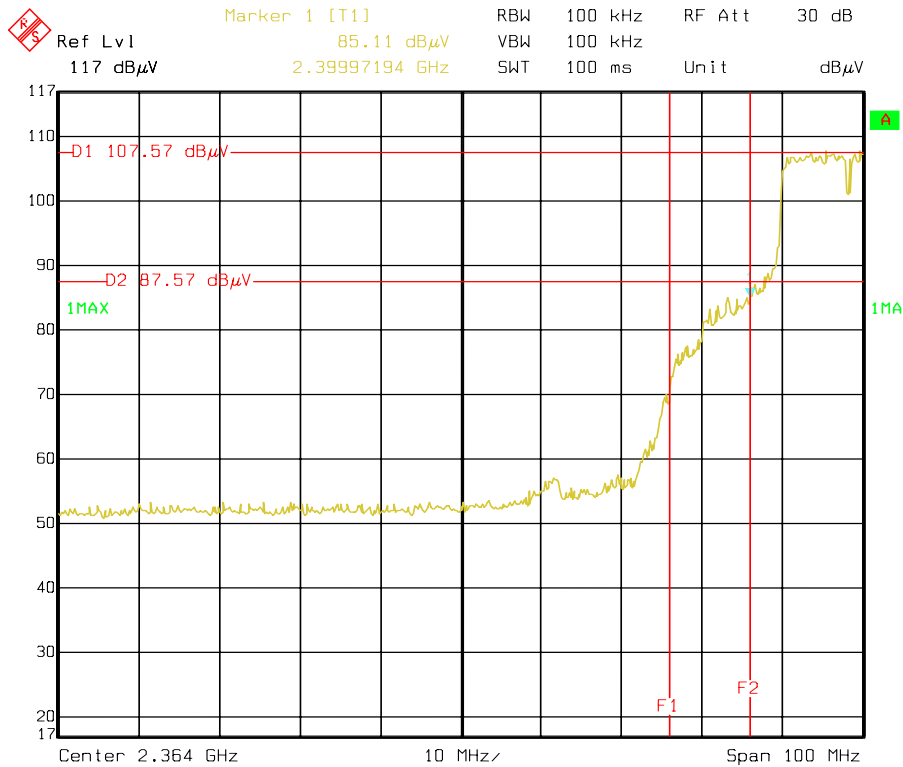

Date: 14.OCT.2003 15:25:11

FRONT

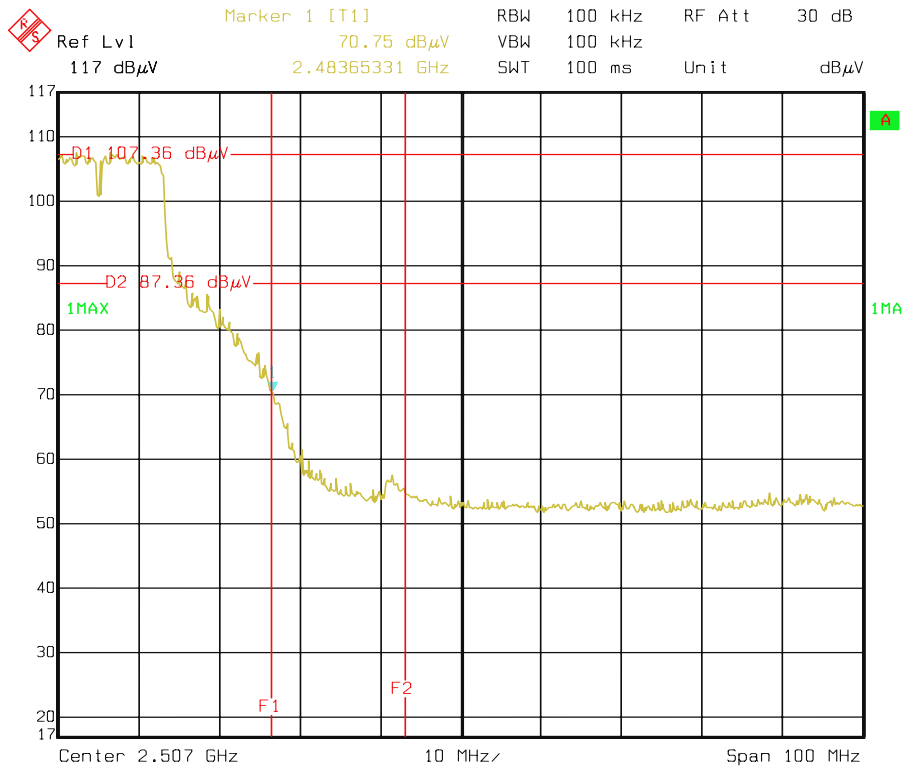

Date: 14.OCT.2003 15:28:56

BACK

Note: For 802.11g Mode



8. ANTENNA REQUIREMENT

8.1 Standard Applicable

For intentional device, according to FCC 47 CFR Section 15.203, an intentional radiator shall be designed to ensure that no antenna other than that furnished by the responsible party shall be used with the device.

And according to FCC 47 CFR Section 15.247 (b), if transmitting antennas of directional gain greater than 6dBi are used, the power shall be reduced by the amount in dB that the directional gain of the antenna exceeds 6dBi.

8.2 Antenna Connected Construction

The antenna used in this product is chip on PCB. And the maximum Gain of the antenna is only -2.9dBi.