



FCC TEST REPORT

REPORT NO.: RF930503H04

MODEL NO.: WL-527, 3CRWE554G72TU, 3CRWE554G72T

RECEIVED: May 04, 2004

TESTED: May 06 to 28, 2004

APPLICANT: Arcadyan Technology Corporation

ADDRESS: 4F, No. 9, Park Avenue II, Science-based
Industrial Park, Hsinchu 300, Taiwan, R.O.C.

ISSUED BY: Advance Data Technology Corporation

LAB LOCATION: No. 81-1, Lu Liao Keng, 9 Ling, Wu Lung Tsuen,
Chiung Lin Hsiang, Hsin Chu Hsien,
Taiwan, R.O.C.

This test report consists of 61 pages in total. It may be duplicated completely for legal use with the approval of the applicant. It should not be reproduced, except in full, without the written approval of our laboratory. The client should not use it to claim product endorsement by CNLA, or any government agencies. The test results in the report only apply to the tested sample.



0536
ILAC MRA



Table of Contents

| | | |
|-------|---|----|
| 1 | CERTIFICATION | 4 |
| 2 | SUMMARY OF TEST RESULTS | 5 |
| 3 | GENERAL INFORMATION | 6 |
| 3.1 | GENERAL DESCRIPTION OF EUT | 6 |
| 3.2 | DESCRIPTION OF TEST MODES | 8 |
| 3.3 | GENERAL DESCRIPTION OF APPLIED STANDARDS | 8 |
| 3.4 | DESCRIPTION OF SUPPORT UNITS | 9 |
| 3.5 | CONFIGURATION OF SYSTEM UNDER TEST | 10 |
| 4 | TEST TYPES AND RESULTS | 11 |
| 4.1 | CONDUCTED EMISSION MEASUREMENT | 11 |
| 4.1.1 | LIMITS OF CONDUCTED EMISSION MEASUREMENT | 11 |
| 4.1.2 | TEST INSTRUMENTS | 11 |
| 4.1.3 | TEST SETUP | 12 |
| 4.1.4 | EUT OPERATING CONDITIONS | 13 |
| 4.1.5 | TEST RESULTS | 14 |
| 4.2 | Radiated Emission Measurement | 16 |
| 4.2.1 | LIMITS OF RADIATED EMISSION MEASUREMENT | 16 |
| 4.2.2 | TEST INSTRUMENTS | 17 |
| 4.2.3 | TEST PROCEDURES | 18 |
| 4.2.4 | TEST SETUP | 19 |
| 4.2.5 | EUT OPERATING CONDITIONS | 19 |
| 4.2.6 | TEST RESULTS | 20 |
| 4.2.7 | TEST RESULTS - DSSS | 21 |
| 4.2.8 | TEST RESULTS -OFDM | 24 |
| 4.3 | 6dB BANDWIDTH MEASUREMENT | 27 |
| 4.3.1 | LIMITS OF 6dB BANDWIDTH MEASUREMENT | 27 |
| 4.3.2 | TEST INSTRUMENTS | 27 |
| 4.3.3 | TEST PROCEDURE | 28 |
| 4.3.4 | TEST SETUP | 28 |
| 4.3.5 | EUT OPERATING CONDITIONS | 28 |
| 4.3.6 | TEST RESULTS-DSSS | 29 |
| 4.3.7 | TEST RESULTS-OFDM | 33 |
| 4.4 | MAXIMUM PEAK OUTPUT POWER | 37 |
| 4.4.1 | LIMITS OF MAXIMUM PEAK OUTPUT POWER MEASUREMENT | 37 |
| 4.4.2 | TEST INSTRUMENTS | 37 |



| | | |
|-------|---|----|
| 4.4.3 | TEST PROCEDURES..... | 38 |
| 4.4.4 | TEST SETUP..... | 38 |
| 4.4.5 | EUT OPERATING CONDITIONS..... | 38 |
| 4.4.6 | TEST RESULTS- DSSS..... | 39 |
| 4.4.7 | TEST RESULTS- OFDM..... | 40 |
| 4.5 | POWER SPECTRAL DENSITY MEASUREMENT..... | 41 |
| 4.5.1 | LIMITS OF POWER SPECTRAL DENSITY MEASUREMENT..... | 41 |
| 4.5.2 | TEST INSTRUMENTS..... | 41 |
| 4.5.3 | TEST PROCEDURE..... | 42 |
| 4.5.4 | TEST SETUP..... | 42 |
| 4.5.5 | EUT OPERATING CONDITIONS..... | 42 |
| 4.5.6 | TEST RESULTS-DSSS..... | 43 |
| 4.5.7 | TEST RESULTS-OFDM..... | 47 |
| 4.6 | BAND EDGES MEASUREMENT..... | 51 |
| 4.6.1 | LIMITS OF BAND EDGES MEASUREMENT..... | 51 |
| 4.6.2 | TEST INSTRUMENTS..... | 51 |
| 4.6.3 | TEST PROCEDURE..... | 51 |
| 4.6.4 | EUT OPERATING CONDITION..... | 51 |
| 4.6.5 | TEST RESULTS - DSSS..... | 52 |
| 4.6.6 | TEST RESULTS-OFDM..... | 55 |
| 4.7 | ANTENNA REQUIREMENT..... | 58 |
| 4.7.1 | STANDARD APPLICABLE..... | 58 |
| 4.7.2 | ANTENNA CONNECTED CONSTRUCTION..... | 58 |
| 5 | PHOTOGRAPHS OF THE TEST CONFIGURATION..... | 59 |
| 6 | INFORMATION ON THE TESTING LABORATORIES..... | 61 |



1 CERTIFICATION

PRODUCT : OfficeConnect Wireless 11g Cable/DSL Router
BRAND NAME : 3Com
MODEL NO. : WL-527, 3CRWE554G72TU, 3CRWE554G72T
TESTED: May 06 to 28, 2004
APPLICANT : Arcadyan Technology Corporation
TEST ITEM: ENGINEERING SAMPLE
STANDARDS : 47 CFR Part 15, Subpart C (Section 15.247),
ANSI C63.4-1992

The above equipment (Model: WL-527) has been tested by **Advance Data Technology Corporation**, and found compliance with the requirement of the above standards. The test record, data evaluation & Equipment Under Test (EUT) configurations represented herein are true and accurate accounts of the measurements of the sample's EMC characteristics under the conditions specified in this report.

PREPARED BY: Carol Liao, **DATE:** Jun. 04, 2004
(Carol Liao)

APPROVED BY: Eric Lin, **DATE:** Jun. 04, 2004
(Eric Lin, Manager)



2 SUMMARY OF TEST RESULTS

The EUT has been tested according to the following specifications:

| APPLIED STANDARD: 47 CFR Part 15, Subpart C | | | |
|--|---|---------------|---|
| Standard Section | Test Type and Limit | Result | REMARK |
| 15.207 | AC Power Conducted Emission Limit: 48dBuV | PASS | Meet the requirement of limit Minimum passing margin is -7.37 dBuV at 0.177 MHz |
| 15.247(a)(2) | Spectrum Bandwidth of a Direct Sequence Spread Spectrum System Limit: min. 500kHz | PASS | Meet the requirement of limit |
| 15.247(b) | Maximum Peak Output Power Limit: max. 30dBm | PASS | Meet the requirement of limit |
| 15.247(c) | Transmitter Radiated Emissions Limit: Table 15.209 | PASS | Meet the requirement of limit Minimum passing margin is -1.00 dBuV at 2483.50MHz |
| 15.247(d) | Power Spectral Density Limit: max. 8dBm | PASS | Meet the requirement of limit |
| 15.247(c) | Band Edge Measurement Limit: 20 dB less than the peak value of fundamental frequency | PASS | Meet the requirement of limit |



3 GENERAL INFORMATION

3.1 GENERAL DESCRIPTION OF EUT

| | |
|---------------------------|---|
| PRODUCT | OfficeConnect Wireless 11g Cable/DSL Router |
| MODEL NO. | WL-527, 3CRWE554G72TU, 3CRWE554G72T |
| POWER SUPPLY | 12Vdc from Power Adapter |
| MODULATION TYPE | CCK, OFDM |
| RADIO TECHNOLOGY | DSSS, OFDM |
| TRANSFER RATE | 1/2/5.5/6/9/11/12/18/24/36/48/54Mbps |
| FREQUENCY RANGE | 2412MHz ~ 2462MHz |
| NUMBER OF CHANNEL | 11 |
| OUTPUT POWER | 19.83dBm |
| ANTENNA TYPE | Dipole Antenna |
| DATA CABLE | NA |
| I/O PORTS | RJ 45 Port x 5 (WAN x1, LAN x 4) |
| ASSOCIATED DEVICES | NA |

NOTE:

1. The EUT has three model names which are identical to each other in all aspects except for the followings:

| Brand | Model Name |
|-------|---------------|
| 3Com | WL-527 |
| | 3CRWE554G72TU |
| | 3CRWE554G72T |

From the above models, model: **WL-527** was selected as representative model for the test and its data was recorded in this report.



2. The EUT was powered by the following adapter:

| | |
|-----------------------|--|
| Brand: | DVE |
| Model No.: | DSA-0151A-12 A |
| Input power : | 100-120Vac 50/60Hz 0.4A |
| Output power : | +12Vdc 1.25A cable:1.9m with one core |

3. The EUT operates in the 2.4GHz frequency spectrum with throughput of up to 54Mbps.
4. The EUT complies with IEEE 802.11g draft standards, and backwards compatible with IEEE 802.11b products.
5. The above EUT information was declared by the manufacturer and for more detailed features description, please refer to the manufacturer's specifications or User's Manual.



3.2 DESCRIPTION OF TEST MODES

Eleven channels are provided in this EUT.

| Channel | Frequency | Channel | Frequency |
|---------|-----------|---------|-----------|
| 1 | 2412 MHz | 7 | 2442 MHz |
| 2 | 2417 MHz | 8 | 2447 MHz |
| 3 | 2422 MHz | 9 | 2452 MHz |
| 4 | 2427 MHz | 10 | 2457 MHz |
| 5 | 2432 MHz | 11 | 2462 MHz |
| 6 | 2437 MHz | | |

NOTE:

1. Below 1 GHz, the channel 1, 6, and 11 were pre-tested in chamber. The channel 11, worst case one, was chosen for final test.
2. Above 1 GHz, the channel 1, 6, and 11 were tested individually.
3. Transfer rate, 11Mbps with CCK technique and 6Mbps with OFDM technique, the worst case, were chosen for final test.

3.3 GENERAL DESCRIPTION OF APPLIED STANDARDS

The EUT is an OfficeConnect Wireless 11g Cable/DSL Router . According to the specifications of the manufacturer, it must comply with the requirements of the following standards:

47 CFR Part 15, Subpart C. (15.247)

ANSI C63.4 : 1992

All tests have been performed and recorded as per the above standards.

NOTE: The EUT is also considered as a kind of computer peripheral, because the connection to computer is necessary for typical use. It has been verified to comply with the requirements of 47 CFR Part 15, Subpart B, Class B (DoC). The test report has been issued separately.



3.4 DESCRIPTION OF SUPPORT UNITS

The EUT has been tested as an independent unit together with other necessary accessories or support units. The following support units or accessories were used to form a representative test configuration during the tests.

| No. | Product | Brand | Model No. | Serial No. | FCC ID |
|-----|-------------------|-------|-----------|--------------------------|------------------|
| 1 | Personal Computer | DELL | 4600 | 00043-517-542-487 | FCC DoC |
| 2 | Color monitor | ADI | CM100 | 026058T10200628 A | FCC DoC |
| 3 | PRINTER | HP | C2642A | MY79F1C3MZ | B94C2642X |
| 4 | MODEM | ACEEX | 1414 | 0206026776 | IFAXDM1414 |
| 5 | keyboard | BTC | KB-5200T | N23305028 | E5XKB5122WTH0110 |
| 6 | PS/2 MOUSE | BTC | M851 | G00347024432 | NA |
| 7 | NOTEBOOK | DELL | PP01L | TW-09C748-12800-1A3-1999 | FCC DoC |

| No. | Signal cable description |
|-----|--|
| 1 | NA |
| 2 | 1.8 m braid shielded wire, terminated with VGA connector via metallic frame, w/o core. |
| 3 | 1.8 m foil shielded wire, terminal by frame, PS2 Connector, w/o Core. |
| 4 | 1.0 m braid shielded wire, terminated with DB25 and DB9 connector via metallic frame, w/o core |
| 5 | 1.8 m foil shielded wire, terminal by frame, PS2 Connector, w/o Core. |
| 6 | 1.8 m foil shielded wire, terminal by frame, PS2 Connector, w/o Core. |
| 7 | NA |

Note: 1. All power cords of the above support units are unshielded (1.8m).

3.5 CONFIGURATION OF SYSTEM UNDER TEST

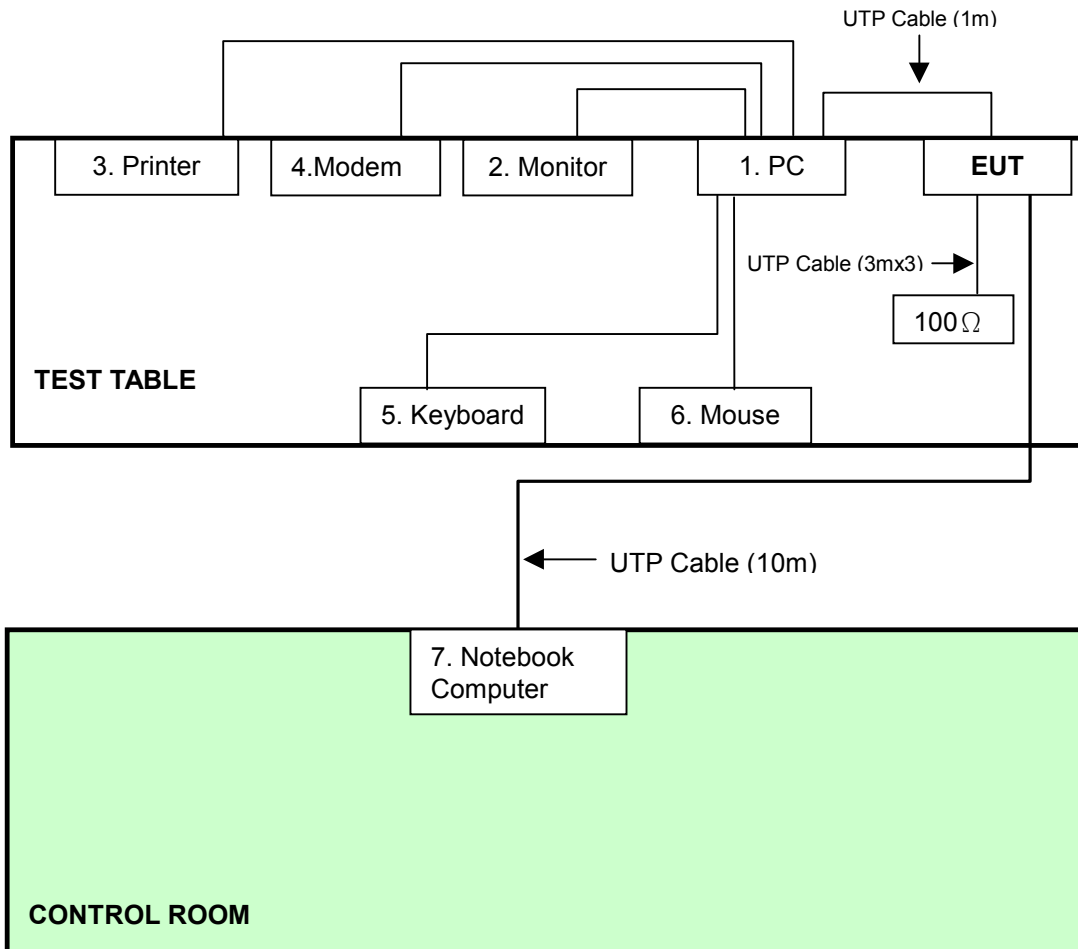

- NOTE:**
1. Support unit 7 was kept in the control room during the test.
 2. Please refer to the photos of test configuration in Item 5 also.



4 TEST TYPES AND RESULTS

4.1 CONDUCTED EMISSION MEASUREMENT

4.1.1 LIMITS OF CONDUCTED EMISSION MEASUREMENT

| FREQUENCY OF EMISSION (MHz) | CONDUCTED LIMIT (dB μ V) | |
|-----------------------------|------------------------------|----------|
| | Quasi-peak | Average |
| 0.15-0.5 | 66 to 56 | 56 to 46 |
| 0.5-5 | 56 | 46 |
| 5-30 | 60 | 50 |

NOTE:

1. The lower limit shall apply at the transition frequencies.
2. All emanations from a class B digital device or system, including any network of conductors and apparatus connected thereto, shall not exceed the level of field strengths specified above.

4.1.2 TEST INSTRUMENTS

| DESCRIPTION & MANUFACTURER | MODEL NO. | SERIAL NO. | CALIBRATED UNTIL |
|-----------------------------------|-----------|-------------|------------------|
| ROHDE & SCHWARZ Test Receiver | ESCS 30 | 847124/029 | Dec. 04, 2004 |
| ROHDE & SCHWARZ LISN (for EUT) | ESHS-Z5 | 848773/004 | Nov. 04, 2004 |
| KYORITSU LISN (for peripheral) | KNW-407 | 8/1395/12 | Jul. 27, 2004 |
| RF Cable (JETBAO) | RG233/U | Cable_CA_01 | Jul. 03, 2004 |
| Terminator(for KYORITSU) | 50 | 3 | May 10, 2005 |
| Software | Cond-V2e | NA | NA |

- NOTE:**
1. The calibration interval of the above test instruments is 12 months and the calibrations are traceable to NML/ROC and NIST/USA.
 2. The test was performed in ADT Shielded Room No. A.
 3. The VCCI Con A Registration No. is C-817.

3. TEST PROCEDURES

- The EUT/HOST was placed 0.4 meters from the conducting wall of the shielded room with EUT/HOST being connected to the power mains through a line impedance stabilization network (LISN). Other support units were connected to the power mains through another LISN. The two LISNs provide 50 ohm/ 50uH of coupling impedance for the measuring instrument.
- Both lines of the power mains connected to the EUT/HOST were checked for maximum conducted interference.
- The frequency range from 150 kHz to 30 MHz was searched. Emission levels over 10dB under the prescribed limits could not be reported

4.1.3 TEST SETUP

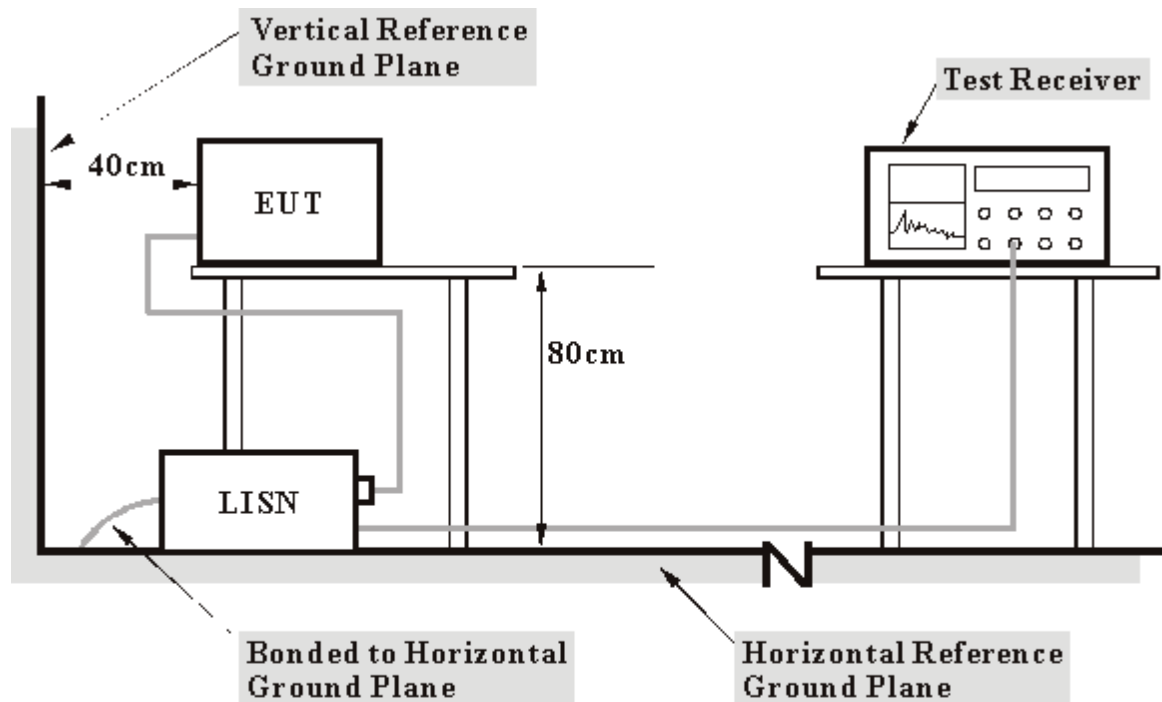

- Note:**
- Support units were connected to second LISN.
 - Both of LISNs (AMN) 80 cm from EUT and at the least 80 cm from other units and other metal planes support units.

For the actual test configuration, please refer to the related item – Photographs of the Test Configuration.



4.1.4 EUT OPERATING CONDITIONS

- a. Placed the EUT on the testing table.
- b. The support units (1-6) act as a Server PC system to communicate with EUT via UTP cable.
- c. Prepared other computer systems (support unit 7) to act as a communication partner and placed them outside of testing area.
- d. The communication partner run the Ping test program "CTx Rx 2.1.0" to enable EUT under transmission/receiving condition continuously via one TEL line and wireless transmission.
- e. PC sends "H" messages to modem.
- f. PC sends "H" messages to printer, and the printer prints them on paper.



4.1.5 TEST RESULTS

| | | | |
|---------------------------------|--|----------------------|-----------|
| EUT | OfficeConnect Wireless 11g Cable/DSL Router | MODEL | WL-527 |
| MODE | Channel 11 | 6dB BANDWIDTH | 9 kHz |
| INPUT POWER (SYSTEM) | 120Vac, 60 Hz | PHASE | Line (L) |
| ENVIRONMENTAL CONDITIONS | 27 deg. C, 57%RH, 973 hPa | TESTED BY | Tony Chen |

| No | Freq. [MHz] | Corr. Factor (dB) | Reading Value [dB (uV)] | | Emission Level [dB (uV)] | | Limit [dB (uV)] | | Margin (dB) | |
|----------|----------------|-------------------------|----------------------------|--------------|-----------------------------|--------------|--------------------|--------------|----------------|--------------|
| | | | Q.P. | AV. | Q.P. | AV. | Q.P. | AV. | Q.P. | AV. |
| 1 | 0.158 | 0.22 | 53.15 | - | 53.37 | - | 65.58 | 55.58 | -12.21 | - |
| 2 | 0.177 | 0.25 | 55.25 | 46.98 | 55.50 | 47.23 | 64.61 | 54.61 | -9.10 | -7.37 |
| 3 | 0.365 | 0.22 | 37.52 | - | 37.74 | - | 58.62 | 48.62 | -20.88 | - |
| 4 | 0.455 | 0.21 | 37.45 | - | 37.66 | - | 56.79 | 46.79 | -19.13 | - |
| 5 | 0.654 | 0.24 | 36.07 | - | 36.31 | - | 56.00 | 46.00 | -19.69 | - |
| 6 | 0.724 | 0.25 | 38.61 | - | 38.86 | - | 56.00 | 46.00 | -17.14 | - |
| 7 | 0.982 | 0.30 | 38.07 | - | 38.37 | - | 56.00 | 46.00 | -17.63 | - |

- NOTES:** (1) "": Undetectable
 (2) Q.P. and AV. are abbreviations of quasi-peak and average.
 (3) "-": The Quasi-peak reading value also meets an average limit, thus measurement with the average detector is unnecessary.
 (4) The emission levels of other frequencies were very low against the limit.
 (5) Correction Factor = Insertion loss + Cable loss
 (6) Margin value = Emission level - Limit value

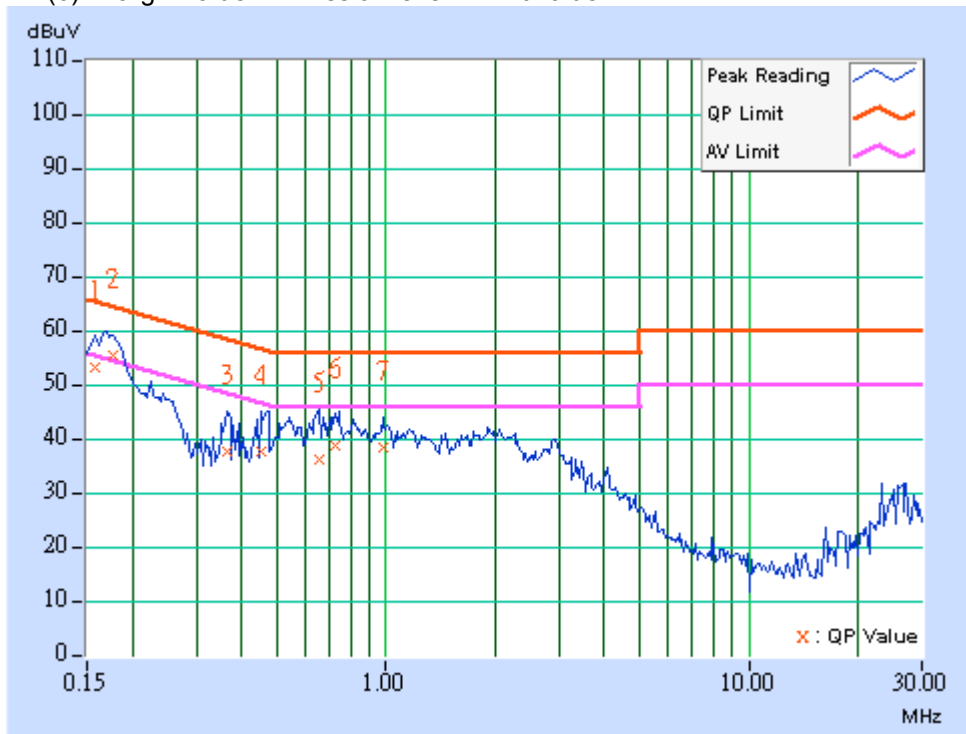



| | | | |
|---------------------------------|--|----------------------|-------------|
| EUT | OfficeConnect Wireless 11g Cable/DSL Router | MODEL | WL-527 |
| MODE | Channel 11 | 6dB BANDWIDTH | 9 kHz |
| INPUT POWER (SYSTEM) | 120Vac, 60 Hz | PHASE | Neutral (N) |
| ENVIRONMENTAL CONDITIONS | 27 deg. C, 57%RH, 973 hPa | TESTED BY | Tony Chen |

| No | Freq. [MHz] | Corr. Factor (dB) | Reading Value [dB (uV)] | | Emission Level [dB (uV)] | | Limit [dB (uV)] | | Margin (dB) | |
|----|----------------|-------------------------|----------------------------|-------|-----------------------------|-------|--------------------|-------|----------------|-------|
| | | | Q.P. | AV. | Q.P. | AV. | Q.P. | AV. | Q.P. | AV. |
| 1 | 0.170 | 0.24 | 56.26 | 46.57 | 56.50 | 46.81 | 64.98 | 54.98 | -8.48 | -8.17 |
| 2 | 0.193 | 0.29 | 51.45 | - | 51.74 | - | 63.91 | 53.91 | -12.17 | - |
| 3 | 0.373 | 0.21 | 38.19 | - | 38.40 | - | 58.44 | 48.44 | -20.04 | - |
| 4 | 0.478 | 0.21 | 37.48 | - | 37.69 | - | 56.37 | 46.37 | -18.68 | - |
| 5 | 0.552 | 0.23 | 41.50 | - | 41.73 | - | 56.00 | 46.00 | -14.27 | - |
| 6 | 0.728 | 0.25 | 40.90 | - | 41.15 | - | 56.00 | 46.00 | -14.85 | - |
| 7 | 0.830 | 0.27 | 40.61 | - | 40.88 | - | 56.00 | 46.00 | -15.12 | - |
| 8 | 0.978 | 0.30 | 40.34 | - | 40.64 | - | 56.00 | 46.00 | -15.36 | - |

- NOTES:** (1) "***": Undetectable
 (2) Q.P. and AV. are abbreviations of quasi-peak and average.
 (3) "-": The Quasi-peak reading value also meets an average limit, thus measurement with the average detector is unnecessary.
 (4) The emission levels of other frequencies were very low against the limit.
 (5) Correction Factor = Insertion loss + Cable loss
 (6) Margin value = Emission level - Limit value

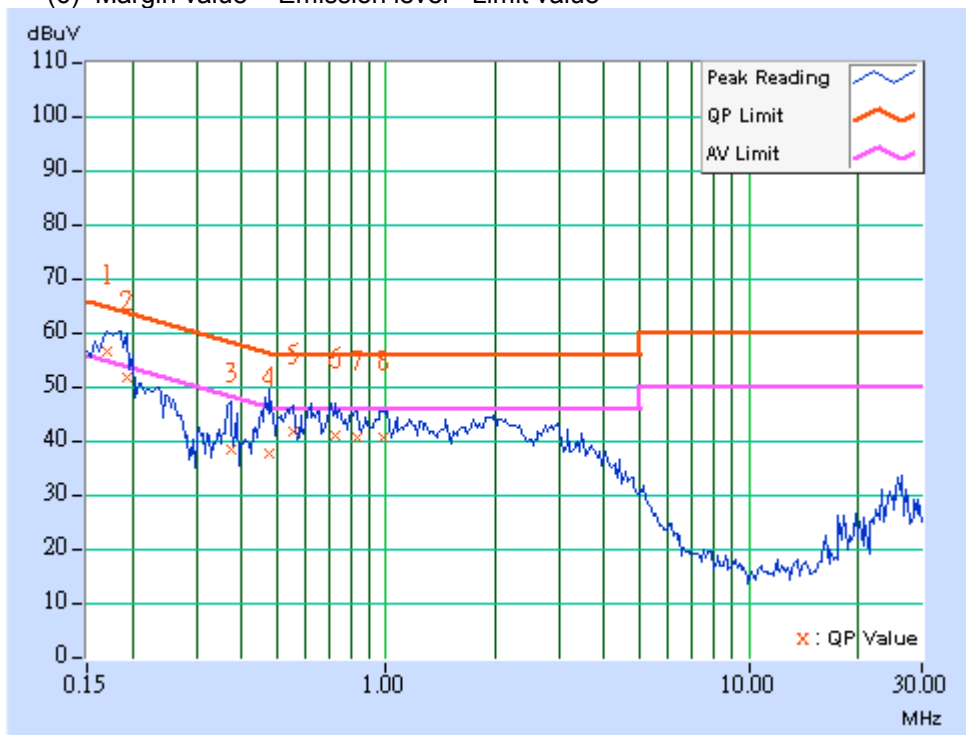



4.2 RADIATED EMISSION MEASUREMENT

4.2.1 LIMITS OF RADIATED EMISSION MEASUREMENT

Field strength limits are at the distance of 3 meters, emissions radiated outside of the specified bands, shall be according to the general radiated limits in 15.209 as following:

| Frequencies (MHz) | Field strength (microvolts/meter) | Measurement distance (meters) |
|----------------------|--------------------------------------|----------------------------------|
| 0.009-0.490 | 2400/F(kHz) | 300 |
| 0.490-1.705 | 24000/F(kHz) | 30 |
| 1.705-30.0 | 30 | 30 |
| 30-88 | 100 | 3 |
| 88-216 | 150 | 3 |
| 216-960 | 200 | 3 |
| Above 960 | 500 | 3 |

NOTE:

1. The lower limit shall apply at the transition frequencies.
2. Emission level (dBuV/m) = 20 log Emission level (uV/m).
3. As shown in 15.35(b), for frequencies above 1000MHz, the field strength limits are based on average detector, however, the peak field strength of any emission shall not exceed the maximum permitted average limits, specified above by more than 20dB under any condition of modulation.



4.2.2 TEST INSTRUMENTS

| DESCRIPTION & MANUFACTURER | MODEL NO. | SERIAL NO. | CALIBRATED UNTIL |
|---------------------------------------|-----------|-------------------------|------------------|
| HP Spectrum Analyzer | 8594ER | 3829U04676 | Aug. 30, 2004 |
| ADVANTEST Spectrum Analyzer | R3271A | 85060311 | Jun. 16, 2004 |
| CHASE RF Pre_Amplifier | CPA9232 | 1057 | May. 10, 2005 |
| HP Pre_Amplifier | 8449B | 3008A01922 | Oct. 13, 2004 |
| ROHDE & SCHWARZ Test Receiver | ESVS 10 | 849231 /019 | Sep. 30, 2004 |
| CHASE Broadband Antenna | CBL6111c | 2730 | Jul 30, 2004 |
| Schwarzbeck Horn_Antenna | 3115 | 5619 | Jul. 17, 2004 |
| Schwarzbeck Horn_Antenna | BBHA 9170 | BBHA9170192 | Feb. 16, 2005 |
| SCHWARZBECK Tunable Dipole Antenna | UHAP | 897 | Mar. 07, 2005 |
| SCHWARZBECK Tunable Dipole Antenna | VHAP | 880 | Mar. 07, 2005 |
| RF Switches (ARNITSU) | CS-201 | 1565157 | Dec. 01, 2004 |
| RF CABLE (Chaintek) 1GHz-20GHz | SF102 | 22054-2 | Feb. 10. 2005 |
| RF Cable(RICHTEC) | 9913-30M | STCCAB-30M- 1GHz-021 | Dec. 01, 2004 |
| Software | AS60P8 | NA | NA |
| CHANCE MOST Antenna Tower | AT-100 | 0203 | NA |
| CHANCE MOST Turn Table | TT-100 | 0203 | NA |

Note: 1. The calibration interval of the above test instruments is 12 months (36 months for Tunable Dipole Antenna) and the calibrations are traceable to NML/ROC and NIST/USA.

2. * = These equipment are used for the final measurement.
3. The horn antenna and HP preamplifier (model: 8449B) are used only for the measurement of emission frequency above 1GHz if tested.
4. The test was performed in ADT Open Site No. C.
5. The FCC Site Registration No. is 656396.
6. The VCCI Site Registration No. is R-1626.
7. The CANADA Site Registration No. is IC 4824-3.



4.2.3 TEST PROCEDURES

- a. The EUT was placed on the top of a rotating table 0.8 meters above the ground at a 10 meter open area test site. The table was rotated 360 degrees to determine the position of the highest radiation.
- b. The EUT was set 3 meters away from the interference-receiving antenna, which was mounted on the top of a variable-height antenna tower.
- c. The antenna is a broadband antenna, and its height is varied from one meter to four meters above the ground to determine the maximum value of the field strength. Both horizontal and vertical polarizations of the antenna are set to make the measurement.
- d. For each suspected emission, the EUT was arranged to its worst case and then the antenna was tuned to heights from 1 meter to 4 meters and the rotatable table was turned from 0 degrees to 360 degrees to find the maximum reading.
- e. The test-receiver system was set to Peak Detect Function and Specified Bandwidth with Maximum Hold Mode.
- f. If the emission level of the EUT in peak mode was 10 dB lower than the limit specified, then testing could be stopped and the peak values of the EUT would be reported. Otherwise the emissions that did not have 10 dB margin would be re-tested one by one using peak, quasi-peak or average method as specified and then reported in a data sheet.

NOTE:

1. The resolution bandwidth and video bandwidth of test receiver/spectrum analyzer is 120kHz for Peak detection (PK) and Quasi-peak detection (QP) at frequency below 1GHz.
2. The resolution bandwidth and video bandwidth of test receiver/spectrum analyzer is 1 MHz for Peak detection at frequency above 1GHz.
3. The resolution bandwidth of test receiver/spectrum analyzer is 1 MHz and the video bandwidth is 300 Hz for Average detection (AV) at frequency above 1GHz.

4.2.4 TEST SETUP

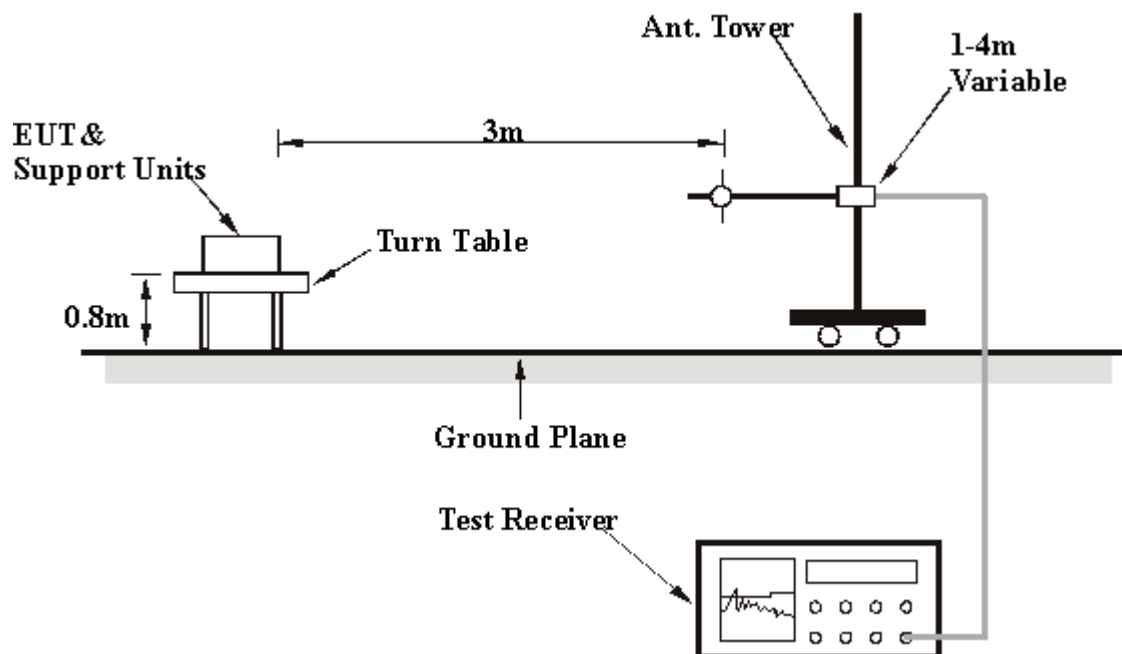

For the actual test configuration, please refer to the related item – Photographs of the Test Configuration.

4.2.5 EUT OPERATING CONDITIONS

Same as 4.1.5.

4.2.6 TEST RESULTS

| | | | |
|---------------------------------|--|--|-----------------------|
| EUT | OfficeConnect Wireless 11g Cable/DSL Router | MODEL | WL-527 |
| MODE | Channel 11 | FREQUENCY RANGE | 30-1000 MHz |
| INPUT POWER (SYSTEM) | 120Vac, 60 Hz | DETECTOR FUNCTION & BANDWIDTH | Quasi-Peak, 120kHz |
| ENVIRONMENTAL CONDITIONS | 24 deg. C, 69%RH, 973 hPa | TESTED BY | Larry Peng |

ANTENNA POLARITY & TEST DISTANCE: HORIZONTAL AT 3 M

| No. | Freq. (MHz) | Emission Level (dBuV/m) | Limit (dBuV/m) | Margin (dB) | Antenna Height (m) | Table Angle (Degree) | Raw Value (dBuV) | Correction Factor (dB/m) |
|-----|-------------|-------------------------|----------------|-------------|--------------------|----------------------|------------------|--------------------------|
| 1 | 125.00 | 30.30 QP | 43.50 | -13.20 | 2.21 H | 247 | 18.20 | 12.10 |
| 2 | 195.75 | 30.30 QP | 43.50 | -13.20 | 1.73 H | 43 | 18.70 | 11.60 |
| 3 | 249.99 | 37.30 QP | 46.00 | -8.70 | 1.65 H | 0 | 24.10 | 13.20 |
| 4 | 375.02 | 44.30 QP | 46.00 | -1.70 | 1.22 H | 47 | 26.90 | 17.40 |
| 5 | 392.00 | 32.40 QP | 46.00 | -13.60 | 1.48 H | 55 | 14.50 | 17.90 |
| 6 | 479.99 | 31.30 QP | 46.00 | -14.70 | 1.58 H | 6 | 11.00 | 20.30 |
| 7 | 499.99 | 31.80 QP | 46.00 | -14.20 | 1.48 H | 35 | 10.90 | 20.90 |
| 8 | 520.00 | 36.40 QP | 46.00 | -9.60 | 2.17 H | 8 | 15.10 | 21.30 |
| 9 | 599.99 | 35.10 QP | 46.00 | -10.90 | 1.62 H | 198 | 12.20 | 23.00 |
| 10 | 749.99 | 33.40 QP | 46.00 | -12.60 | 1.69 H | 99 | 8.00 | 25.30 |
| 11 | 760.00 | 38.10 QP | 46.00 | -7.90 | 1.18 H | 305 | 12.60 | 25.50 |

ANTENNA POLARITY & TEST DISTANCE: VERTICAL AT 3 M

| No. | Freq. (MHz) | Emission Level (dBuV/m) | Limit (dBuV/m) | Margin (dB) | Antenna Height (m) | Table Angle (Degree) | Raw Value (dBuV) | Correction Factor (dB/m) |
|-----|-------------|-------------------------|----------------|-------------|--------------------|----------------------|------------------|--------------------------|
| 1 | 125.01 | 37.30 QP | 43.50 | -6.20 | 1.00 V | 358 | 25.10 | 12.10 |
| 2 | 200.00 | 29.80 QP | 43.50 | -13.70 | 1.00 V | 0 | 18.60 | 11.20 |
| 3 | 250.01 | 34.10 QP | 46.00 | -11.90 | 1.00 V | 275 | 20.90 | 13.20 |
| 4 | 360.00 | 33.50 QP | 46.00 | -12.50 | 1.39 V | 300 | 16.50 | 16.90 |
| 5 | 375.02 | 42.80 QP | 46.00 | -3.20 | 1.00 V | 120 | 25.50 | 17.40 |
| 6 | 399.99 | 29.00 QP | 46.00 | -17.00 | 1.00 V | 241 | 10.90 | 18.10 |
| 7 | 520.00 | 36.30 QP | 46.00 | -9.70 | 1.19 V | 250 | 15.00 | 21.30 |
| 8 | 600.00 | 37.50 QP | 46.00 | -8.50 | 1.11 V | 202 | 14.50 | 23.00 |
| 9 | 680.00 | 35.80 QP | 46.00 | -10.20 | 1.71 V | 3 | 11.50 | 24.30 |
| 10 | 760.00 | 38.40 QP | 46.00 | -7.60 | 1.46 V | 237 | 12.90 | 25.50 |

- REMARKS:**
1. Emission level(dBuV/m)=Raw Value(dBuV) + Correction Factor(dB)
 2. Correction Factor(dB/m) = Antenna Factor (dB/m) + Cable Factor (dB)
 3. The other emission levels were very low against the limit.
 4. Margin value = Emission level – Limit value.



4.2.7 TEST RESULTS - DSSS

| | | | |
|---------------------------------|--|--|------------------------------------|
| EUT | OfficeConnect Wireless 11g Cable/DSL Router | MODEL | WL-527 |
| MODE | Channel 1 | FREQUENCY RANGE | 1000~25000MHz |
| INPUT POWER (SYSTEM) | 120Vac, 60 Hz | DETECTOR FUNCTION & BANDWIDTH | Peak (PK) Average (AV) 1 MHz |
| ENVIRONMENTAL CONDITIONS | 30 deg. C, 55%RH, 973 hPa | TESTED BY | Tony Chen |

ANTENNA POLARITY & TEST DISTANCE: HORIZONTAL AT 3 M

| No. | Freq. (MHz) | Emission Level (dBuV/m) | Limit (dBuV/m) | Margin (dB) | Antenna Height (m) | Table Angle (Degree) | Raw Value (dBuV) | Correction Factor (dB/m) |
|-----|-------------|-------------------------|----------------|-------------|--------------------|----------------------|------------------|--------------------------|
| 1 | 2385.00 | 40.30 PK | 74.00 | -33.70 | 1.13 H | 342 | 9.90 | 30.40 |
| 2 | 2390.00 | 48.70 PK | 74.00 | -25.30 | 1.24 H | 258 | 18.30 | 30.40 |
| 3 | *2412.00 | 98.90 PK | | | 1.53 H | 138 | 68.30 | 30.50 |
| 3 | *2412.00 | 93.40 AV | | | 1.53 H | 138 | 62.80 | 30.50 |
| 4 | 4824.00 | 49.50 PK | 74.00 | -24.50 | 1.74 H | 220 | 13.20 | 36.20 |
| 5 | 9648.00 | 51.10 PK | 78.90 | -27.80 | 1.52 H | 270 | 6.10 | 44.90 |
| 5 | 9648.00 | 42.80 AV | 73.40 | -30.60 | 1.52 H | 270 | -2.10 | 44.90 |

ANTENNA POLARITY & TEST DISTANCE: VERTICAL AT 3 M

| No. | Freq. (MHz) | Emission Level (dBuV/m) | Limit (dBuV/m) | Margin (dB) | Antenna Height (m) | Table Angle (Degree) | Raw Value (dBuV) | Correction Factor (dB/m) |
|-----|-------------|-------------------------|----------------|-------------|--------------------|----------------------|------------------|--------------------------|
| 1 | 2385.00 | 50.70 PK | 74.00 | -23.30 | 1.48 V | 360 | 20.30 | 30.40 |
| 2 | 2390.00 | 59.70 PK | 74.00 | -14.30 | 1.24 V | 214 | 29.30 | 30.40 |
| 2 | 2390.00 | 50.50 AV | 54.00 | -3.50 | 1.24 V | 214 | 20.10 | 30.40 |
| 3 | *2412.00 | 111.70 PK | | | 1.69 V | 122 | 81.20 | 30.50 |
| 3 | *2412.00 | 104.70 AV | | | 1.69 V | 122 | 74.20 | 30.50 |
| 4 | 4824.00 | 53.20 PK | 74.00 | -20.80 | 1.10 V | 16 | 17.00 | 36.20 |
| 4 | 4824.00 | 51.40 AV | 54.00 | -2.60 | 1.10 V | 16 | 15.20 | 36.20 |
| 5 | 9648.00 | 57.30 PK | 91.70 | -34.40 | 1.96 V | 282 | 12.40 | 44.90 |
| 5 | 9648.00 | 54.90 AV | 84.70 | -29.80 | 1.96 V | 282 | 10.00 | 44.90 |

- REMARKS:**
1. Emission level(dBuV/m)=Raw Value(dBuV) + Correction Factor(dB)
 2. Correction Factor(dB/m) = Antenna Factor (dB/m) + Cable Factor (dB)
 3. The other emission levels were very low against the limit.
 4. Margin value = Emission level – Limit value.
 5. The limit value is defined as per 15.247
 6. " * " : Fundamental frequency



| | | | |
|---------------------------------|--|--|------------------------------------|
| EUT | OfficeConnect Wireless 11g Cable/DSL Router | MODEL | WL-527 |
| MODE | Channel 6 | FREQUENCY RANGE | 1000~25000MHz |
| INPUT POWER (SYSTEM) | 120Vac, 60 Hz | DETECTOR FUNCTION & BANDWIDTH | Peak (PK) Average (AV) 1 MHz |
| ENVIRONMENTAL CONDITIONS | 30 deg. C, 55%RH, 973 hPa | TESTED BY | Tony Chen |

ANTENNA POLARITY & TEST DISTANCE: HORIZONTAL AT 3 M

| No. | Freq. (MHz) | Emission Level (dBuV/m) | Limit (dBuV/m) | Margin (dB) | Antenna Height (m) | Table Angle (Degree) | Raw Value (dBuV) | Correction Factor (dB/m) |
|-----|-------------|-------------------------|----------------|-------------|--------------------|----------------------|------------------|--------------------------|
| 1 | *2437.00 | 99.90 PK | | | 1.47 H | 320 | 69.20 | 30.70 |
| 1 | *2437.00 | 93.90 AV | | | 1.47 H | 320 | 63.20 | 30.70 |
| 2 | 4874.00 | 50.60 PK | 74.00 | -23.40 | 1.90 H | 250 | 14.10 | 36.50 |
| 3 | 7311.00 | 46.50 PK | 74.00 | -27.50 | 1.28 H | 360 | 4.70 | 41.80 |
| 4 | 9748.00 | 52.40 PK | 79.90 | -27.50 | 1.85 H | 146 | 7.80 | 44.60 |
| 4 | 9748.00 | 46.20 AV | 73.90 | -27.70 | 1.85 H | 146 | 1.60 | 44.60 |

ANTENNA POLARITY & TEST DISTANCE: VERTICAL AT 3 M

| No. | Freq. (MHz) | Emission Level (dBuV/m) | Limit (dBuV/m) | Margin (dB) | Antenna Height (m) | Table Angle (Degree) | Raw Value (dBuV) | Correction Factor (dB/m) |
|-----|-------------|-------------------------|----------------|-------------|--------------------|----------------------|------------------|--------------------------|
| 1 | *2437.00 | 114.10 PK | | | 1.23 V | 55 | 83.40 | 30.70 |
| 1 | *2437.00 | 107.50 AV | | | 1.23 V | 55 | 76.80 | 30.70 |
| 2 | 4874.00 | 54.70 PK | 74.00 | -19.30 | 1.60 V | 288 | 18.20 | 36.50 |
| 2 | 4874.00 | 52.80 AV | 54.00 | -1.20 | 1.60 V | 288 | 16.30 | 36.50 |
| 3 | 7311.00 | 46.30 PK | 74.00 | -27.70 | 1.27 V | 324 | 4.60 | 41.80 |
| 4 | 9748.00 | 56.00 PK | 94.10 | -38.10 | 1.38 V | 293 | 11.30 | 44.60 |
| 4 | 9748.00 | 53.90 AV | 87.50 | -33.60 | 1.38 V | 293 | 9.30 | 44.60 |

- REMARKS:**
1. Emission level(dBuV/m)=Raw Value(dBuV) + Correction Factor(dB)
 2. Correction Factor(dB/m) = Antenna Factor (dB/m) + Cable Factor (dB)
 3. The other emission levels were very low against the limit.
 4. Margin value = Emission level – Limit value.
 5. The limit value is defined as per 15.247
 6. “ * “ : Fundamental frequency



| | | | |
|---------------------------------|--|--|------------------------------------|
| EUT | OfficeConnect Wireless 11g Cable/DSL Router | MODEL | WL-527 |
| MODE | Channel 11 | FREQUENCY RANGE | 1000~25000MHz |
| INPUT POWER (SYSTEM) | 120Vac, 60 Hz | DETECTOR FUNCTION & BANDWIDTH | Peak (PK) Average (AV) 1 MHz |
| ENVIRONMENTAL CONDITIONS | 30 deg. C, 55%RH, 973 hPa | TESTED BY | Tony Chen |

ANTENNA POLARITY & TEST DISTANCE: HORIZONTAL AT 3 M

| No. | Freq. (MHz) | Emission Level (dBuV/m) | Limit (dBuV/m) | Margin (dB) | Antenna Height (m) | Table Angle (Degree) | Raw Value (dBuV) | Correction Factor (dB/m) |
|-----|-------------|-------------------------|----------------|-------------|--------------------|----------------------|------------------|--------------------------|
| 1 | *2462.00 | 101.90 PK | | | 1.11 H | 68 | 71.00 | 30.80 |
| 1 | *2462.00 | 95.50 AV | | | 1.11 H | 68 | 64.70 | 30.80 |
| 2 | 2483.50 | 50.30 PK | 74.00 | -23.70 | 1.20 H | 302 | 19.30 | 31.00 |
| 3 | 4924.00 | 51.80 PK | 74.00 | -22.20 | 1.80 H | 250 | 15.20 | 36.70 |
| 3 | 4924.00 | 49.70 AV | 54.00 | -4.30 | 1.80 H | 250 | 13.00 | 36.70 |
| 4 | 7386.00 | 46.30 PK | 74.00 | -27.70 | 1.28 H | 338 | 4.50 | 41.80 |
| 5 | 9848.00 | 52.70 PK | 81.90 | -29.20 | 1.49 H | 83 | 8.30 | 44.40 |
| 5 | 9848.00 | 46.30 AV | 75.50 | -29.20 | 1.49 H | 83 | 2.00 | 44.40 |

ANTENNA POLARITY & TEST DISTANCE: VERTICAL AT 3 M

| No. | Freq. (MHz) | Emission Level (dBuV/m) | Limit (dBuV/m) | Margin (dB) | Antenna Height (m) | Table Angle (Degree) | Raw Value (dBuV) | Correction Factor (dB/m) |
|-----|-------------|-------------------------|----------------|-------------|--------------------|----------------------|------------------|--------------------------|
| 1 | *2462.00 | 113.10 PK | | | 1.18 V | 2 | 82.20 | 30.80 |
| 1 | *2462.00 | 106.20 AV | | | 1.18 V | 2 | 75.40 | 30.80 |
| 2 | 2483.50 | 61.30 PK | 74.00 | -12.70 | 1.25 V | 32 | 30.30 | 31.00 |
| 2 | 2483.50 | 52.40 AV | 54.00 | -1.60 | 1.25 V | 32 | 21.40 | 31.00 |
| 3 | 4924.00 | 54.30 PK | 74.00 | -19.70 | 1.47 V | 195 | 17.60 | 36.70 |
| 3 | 4924.00 | 51.80 AV | 54.00 | -2.20 | 1.47 V | 195 | 15.10 | 36.70 |
| 4 | 7386.00 | 46.10 PK | 74.00 | -27.90 | 1.29 V | 310 | 4.30 | 41.80 |
| 5 | 9848.00 | 59.00 PK | 93.10 | -34.10 | 2.00 V | 281 | 14.70 | 44.40 |
| 5 | 9848.00 | 56.60 AV | 86.20 | -29.60 | 2.00 V | 281 | 12.30 | 44.40 |

- REMARKS:**
1. Emission level(dBuV/m)=Raw Value(dBuV) + Correction Factor(dB)
 2. Correction Factor(dB/m) = Antenna Factor (dB/m) + Cable Factor (dB)
 3. The other emission levels were very low against the limit.
 4. Margin value = Emission level – Limit value.
 5. The limit value is defined as per 15.247
 6. “ * “ : Fundamental frequency

4.2.8 TEST RESULTS -OFDM

| | | | |
|---------------------------------|--|--|------------------------------------|
| EUT | OfficeConnect Wireless 11g Cable/DSL Router | MODEL | WL-527 |
| MODE | Channel 1 | FREQUENCY RANGE | 1000~25000MHz |
| INPUT POWER (SYSTEM) | 120Vac, 60 Hz | DETECTOR FUNCTION & BANDWIDTH | Peak (PK) Average (AV) 1 MHz |
| ENVIRONMENTAL CONDITIONS | 30 deg. C, 55%RH, 973 hPa | TESTED BY | Tony Chen |

ANTENNA POLARITY & TEST DISTANCE: HORIZONTAL AT 3 M

| No. | Freq. (MHz) | Emission Level (dBuV/m) | Limit (dBuV/m) | Margin (dB) | Antenna Height (m) | Table Angle (Degree) | Raw Value (dBuV) | Correction Factor (dB/m) |
|-----|-------------|-------------------------|----------------|-------------|--------------------|----------------------|------------------|--------------------------|
| 1 | 2375.00 | 38.90 PK | 74.00 | -35.10 | 1.42 H | 34 | 8.60 | 30.40 |
| 2 | 2390.00 | 49.70 PK | 74.00 | -24.30 | 1.42 H | 231 | 19.30 | 30.40 |
| 3 | *2412.00 | 95.30 PK | | | 1.12 H | 67 | 64.70 | 30.50 |
| 3 | *2412.00 | 87.30 AV | | | 1.12 H | 67 | 56.80 | 30.50 |
| 4 | 4824.00 | 48.10 PK | 74.00 | -25.90 | 1.18 H | 254 | 11.90 | 36.20 |
| 5 | 9648.00 | 51.80 PK | 75.30 | -23.50 | 1.91 H | 144 | 6.90 | 44.90 |
| 5 | 9648.00 | 45.20 AV | 67.30 | -22.10 | 1.91 H | 144 | 0.30 | 44.90 |

ANTENNA POLARITY & TEST DISTANCE: VERTICAL AT 3 M

| No. | Freq. (MHz) | Emission Level (dBuV/m) | Limit (dBuV/m) | Margin (dB) | Antenna Height (m) | Table Angle (Degree) | Raw Value (dBuV) | Correction Factor (dB/m) |
|-----|-------------|-------------------------|----------------|-------------|--------------------|----------------------|------------------|--------------------------|
| 1 | 1187.00 | 37.50 PK | 74.00 | -36.50 | 1.15 V | 111 | 10.60 | 26.80 |
| 2 | 2375.00 | 49.00 PK | 74.00 | -25.00 | 1.75 V | 119 | 18.60 | 30.40 |
| 3 | 2390.00 | 61.40 PK | 74.00 | -12.60 | 1.24 V | 221 | 31.00 | 30.40 |
| 3 | 2390.00 | 52.40 AV | 54.00 | -1.60 | 1.24 V | 221 | 22.00 | 30.40 |
| 4 | *2412.00 | 107.20 PK | | | 1.25 V | 331 | 76.60 | 30.50 |
| 4 | *2412.00 | 99.10 AV | | | 1.25 V | 331 | 68.60 | 30.50 |
| 5 | 4824.00 | 52.60 PK | 74.00 | -21.40 | 1.47 V | 290 | 16.30 | 36.20 |
| 5 | 4824.00 | 51.50 AV | 54.00 | -2.50 | 1.47 V | 290 | 15.30 | 36.20 |
| 6 | 9648.00 | 59.20 PK | 87.20 | -28.00 | 1.56 V | 288 | 14.30 | 44.90 |
| 6 | 9648.00 | 57.50 AV | 79.10 | -21.60 | 1.56 V | 288 | 12.60 | 44.90 |

- REMARKS:**
1. Emission level(dBuV/m)=Raw Value(dBuV) + Correction Factor(dB)
 2. Correction Factor(dB/m) = Antenna Factor (dB/m) + Cable Factor (dB)
 3. The other emission levels were very low against the limit.
 4. Margin value = Emission level – Limit value.
 5. The limit value is defined as per 15.247
 6. “ * “ : Fundamental frequency



| | | | |
|---------------------------------|---|--|------------------------------------|
| EUT | OfficeConnect Wireless 11g Cable/DSL Router | MODEL | WL-527 |
| MODE | Channel 6 | FREQUENCY RANGE | 1000~25000MHz |
| INPUT POWER (SYSTEM) | 120Vac, 60 Hz | DETECTOR FUNCTION & BANDWIDTH | Peak (PK) Average (AV) 1 MHz |
| ENVIRONMENTAL CONDITIONS | 30 deg. C, 55%RH, 973 hPa | TESTED BY | Tony Chen |

ANTENNA POLARITY & TEST DISTANCE: HORIZONTAL AT 3 M

| No. | Freq. (MHz) | Emission Level (dBuV/m) | Limit (dBuV/m) | Margin (dB) | Antenna Height (m) | Table Angle (Degree) | Raw Value (dBuV) | Correction Factor (dB/m) |
|-----|-------------|-------------------------|----------------|-------------|--------------------|----------------------|------------------|--------------------------|
| 1 | *2437.00 | 97.00 PK | | | 1.10 H | 68 | 66.30 | 30.70 |
| 1 | *2437.00 | 89.70 AV | | | 1.10 H | 68 | 59.00 | 30.70 |
| 2 | 4874.00 | 47.40 PK | 74.00 | -26.60 | 1.20 H | 326 | 10.90 | 36.50 |
| 3 | 7311.00 | 44.80 PK | 74.00 | -29.20 | 1.19 H | 324 | 3.00 | 41.80 |
| 4 | 9748.00 | 52.90 PK | 77.00 | -24.10 | 1.97 H | 184 | 8.20 | 44.60 |
| 4 | 9748.00 | 46.30 AV | 69.70 | -23.40 | 1.97 H | 184 | 1.60 | 44.60 |

ANTENNA POLARITY & TEST DISTANCE: VERTICAL AT 3 M

| No. | Freq. (MHz) | Emission Level (dBuV/m) | Limit (dBuV/m) | Margin (dB) | Antenna Height (m) | Table Angle (Degree) | Raw Value (dBuV) | Correction Factor (dB/m) |
|-----|-------------|-------------------------|----------------|-------------|--------------------|----------------------|------------------|--------------------------|
| 1 | *2437.00 | 110.00 PK | | | 1.40 V | 39 | 79.30 | 30.70 |
| 1 | *2437.00 | 101.60 AV | | | 1.40 V | 39 | 70.90 | 30.70 |
| 2 | 4874.00 | 53.90 PK | 74.00 | -20.10 | 1.48 V | 285 | 17.40 | 36.50 |
| 2 | 4874.00 | 52.00 AV | 54.00 | -2.00 | 1.48 V | 285 | 15.60 | 36.50 |
| 3 | 7311.00 | 45.10 PK | 74.00 | -28.90 | 1.26 V | 207 | 3.30 | 41.80 |
| 4 | 9748.00 | 58.10 PK | 90.00 | -31.90 | 1.85 V | 283 | 13.40 | 44.60 |
| 4 | 9748.00 | 55.60 AV | 81.60 | -26.00 | 1.85 V | 283 | 11.00 | 44.60 |

- REMARKS:**
1. Emission level(dBuV/m)=Raw Value(dBuV) + Correction Factor(dB)
 2. Correction Factor(dB/m) = Antenna Factor (dB/m) + Cable Factor (dB)
 3. The other emission levels were very low against the limit.
 4. Margin value = Emission level – Limit value.
 5. The limit value is defined as per 15.247
 6. “ * “ : Fundamental frequency



| | | | |
|---------------------------------|--|--|------------------------------------|
| EUT | OfficeConnect Wireless 11g Cable/DSL Router | MODEL | WL-527 |
| MODE | Channel 11 | FREQUENCY RANGE | 1000~25000MHz |
| INPUT POWER (SYSTEM) | 120Vac, 60 Hz | DETECTOR FUNCTION & BANDWIDTH | Peak (PK) Average (AV) 1 MHz |
| ENVIRONMENTAL CONDITIONS | 30 deg. C, 55%RH, 973 hPa | TESTED BY | Tony Chen |

ANTENNA POLARITY & TEST DISTANCE: HORIZONTAL AT 3 M

| No. | Freq. (MHz) | Emission Level (dBuV/m) | Limit (dBuV/m) | Margin (dB) | Antenna Height (m) | Table Angle (Degree) | Raw Value (dBuV) | Correction Factor (dB/m) |
|-----|-------------|-------------------------|----------------|-------------|--------------------|----------------------|------------------|--------------------------|
| 1 | *2462.00 | 96.90 PK | | | 1.51 H | 41 | 66.00 | 30.80 |
| 1 | *2462.00 | 88.90 AV | | | 1.51 H | 41 | 58.10 | 30.80 |
| 2 | 2483.50 | 50.40 PK | 74.00 | -23.60 | 1.23 H | 245 | 19.40 | 31.00 |
| 3 | 2498.00 | 39.60 PK | 74.00 | -34.40 | 1.14 H | 283 | 8.90 | 30.70 |
| 4 | 4924.00 | 50.10 PK | 76.90 | -26.80 | 1.63 H | 278 | 13.40 | 36.70 |
| 5 | 9848.00 | 50.90 PK | 68.90 | -18.00 | 1.71 H | 219 | 6.60 | 44.40 |

ANTENNA POLARITY & TEST DISTANCE: VERTICAL AT 3 M

| No. | Freq. (MHz) | Emission Level (dBuV/m) | Limit (dBuV/m) | Margin (dB) | Antenna Height (m) | Table Angle (Degree) | Raw Value (dBuV) | Correction Factor (dB/m) |
|----------|----------------|-------------------------|----------------|--------------|--------------------|----------------------|------------------|--------------------------|
| 1 | *2462.00 | 108.60 PK | | | 1.13 V | 43 | 77.80 | 30.80 |
| 1 | *2462.00 | 100.30 AV | | | 1.13 V | 43 | 69.50 | 30.80 |
| 2 | 2483.50 | 62.40 PK | 74.00 | -11.60 | 1.24 V | 241 | 31.40 | 31.00 |
| 2 | 2483.50 | 53.00 AV | 54.00 | -1.00 | 1.24 V | 241 | 22.10 | 31.00 |
| 3 | 2498.00 | 48.80 PK | 74.00 | -25.20 | 1.25 V | 339 | 18.00 | 30.70 |
| 4 | 4924.00 | 54.00 PK | 74.00 | -20.00 | 1.48 V | 191 | 17.30 | 36.70 |
| 4 | 4924.00 | 52.40 AV | 54.00 | -1.60 | 1.48 V | 191 | 15.70 | 36.70 |
| 5 | 9848.00 | 52.10 PK | 88.60 | -36.50 | 1.08 V | 274 | 7.80 | 44.40 |
| 5 | 9848.00 | 49.20 AV | 80.30 | -31.10 | 1.08 V | 274 | 4.80 | 44.40 |

- REMARKS:**
1. Emission level(dBuV/m)=Raw Value(dBuV) + Correction Factor(dB)
 2. Correction Factor(dB/m) = Antenna Factor (dB/m) + Cable Factor (dB)
 3. The other emission levels were very low against the limit.
 4. Margin value = Emission level – Limit value.
 5. The limit value is defined as per 15.247
 6. " * " : Fundamental frequency



4.3 6dB BANDWIDTH MEASUREMENT

4.3.1 LIMITS OF 6dB BANDWIDTH MEASUREMENT

The minimum of 6dB Bandwidth Measurement is 0.5 MHz.

4.3.2 TEST INSTRUMENTS

| Description & Manufacturer | Model No. | Serial No. | Calibrated Until |
|----------------------------|-----------|------------|------------------|
| R&S SPECTRUM ANALYZER | FSP40 | 100036 | Nov. 27, 2004 |

NOTE:

- 1.The measurement uncertainty is less than +/- 2.6dB, which is calculated as per the NAMAS document NIS81.
- 2.The calibration interval of the above test instruments is 12 months and the calibrations are traceable to NML/ROC and NIST/USA.

4.3.3 TEST PROCEDURE

The transmitter output was connected to the spectrum analyzer through an attenuator. The bandwidth of the fundamental frequency was measured by spectrum analyzer with 100 kHz RBW and 100 kHz VBW. The 6 dB bandwidth is defined as the total spectrum the power of which is higher than peak power minus 6 dB.

4.3.4 TEST SETUP



For the actual test configuration, please refer to the related Item – Photographs of the Test Configuration.

4.3.5 EUT OPERATING CONDITIONS

The software provided by client to enable the EUT under transmission condition continuously at lowest, middle and highest channel frequencies individually.



4.3.6 TEST RESULTS-DSSS

| | | | |
|-----------------------------|---|---------------------------------|---------------------------|
| EUT | OfficeConnect Wireless 11g Cable/DSL Router | | |
| MODEL | WL-527 | ENVIRONMENTAL CONDITIONS | 27 deg. C, 63%RH, 973 hPa |
| INPUT POWER (SYSTEM) | 120Vac, 60 Hz | TESTED BY | Tony Chen |

| CHANNEL | CHANNEL FREQUENCY (MHz) | 6 dB BANDWIDTH (MHz) | MINIMUM LIMIT (MHz) | PASS/FAIL |
|----------------|--------------------------------|-----------------------------|----------------------------|------------------|
| 1 | 2412 | 11.50 | 0.5 | PASS |
| 6 | 2437 | 11.50 | 0.5 | PASS |
| 11 | 2462 | 11.55 | 0.5 | PASS |



CH1

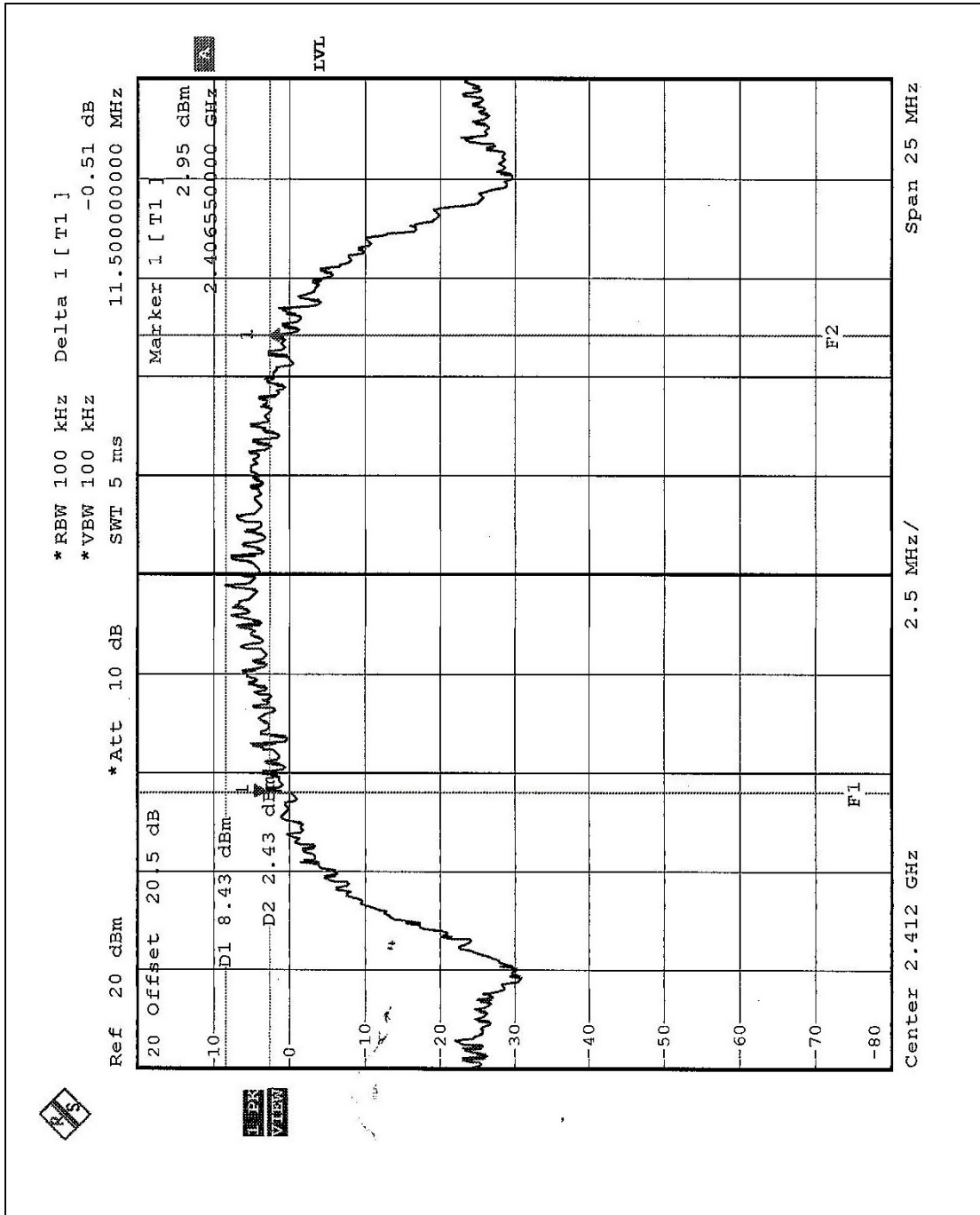



CH6

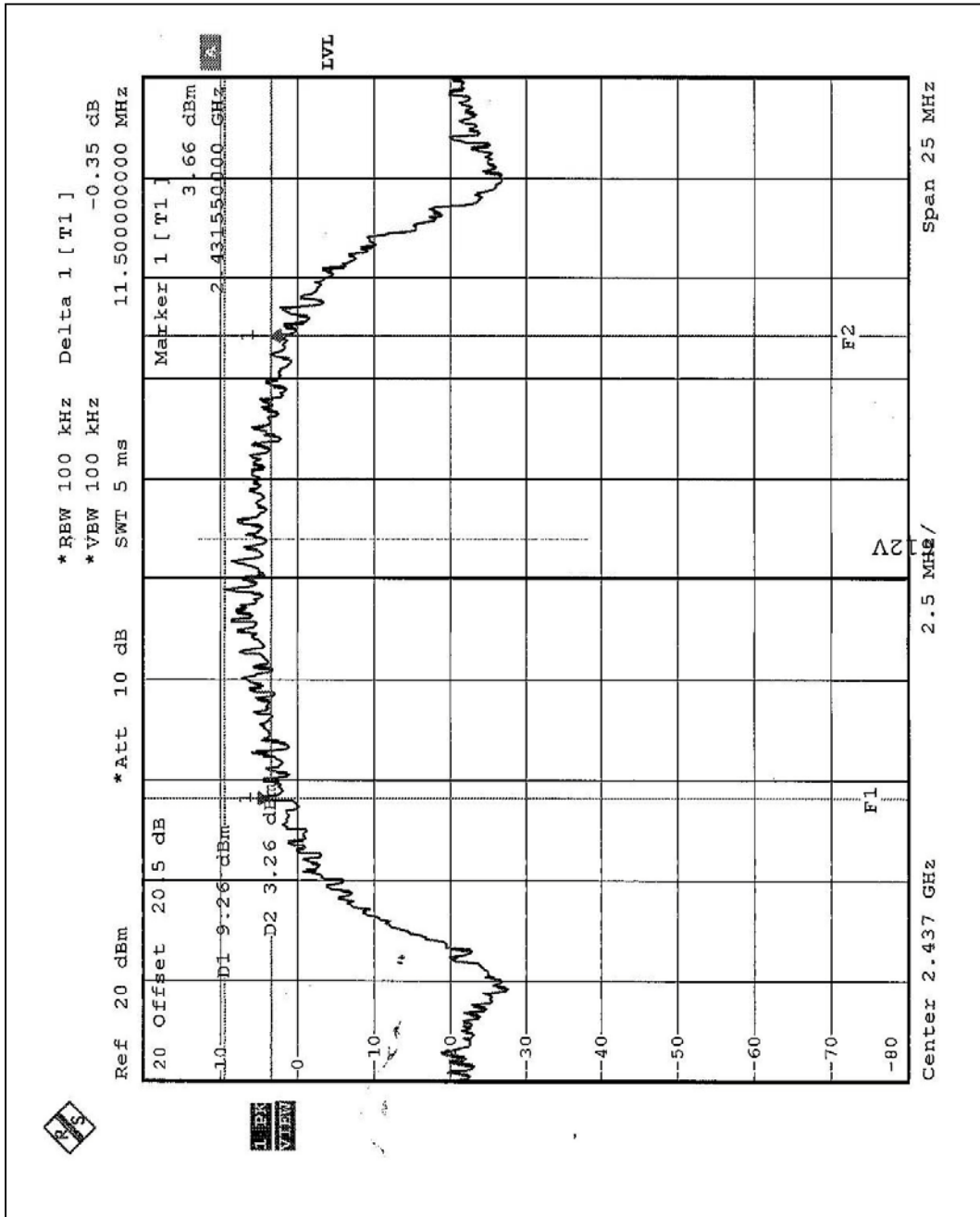



CH11

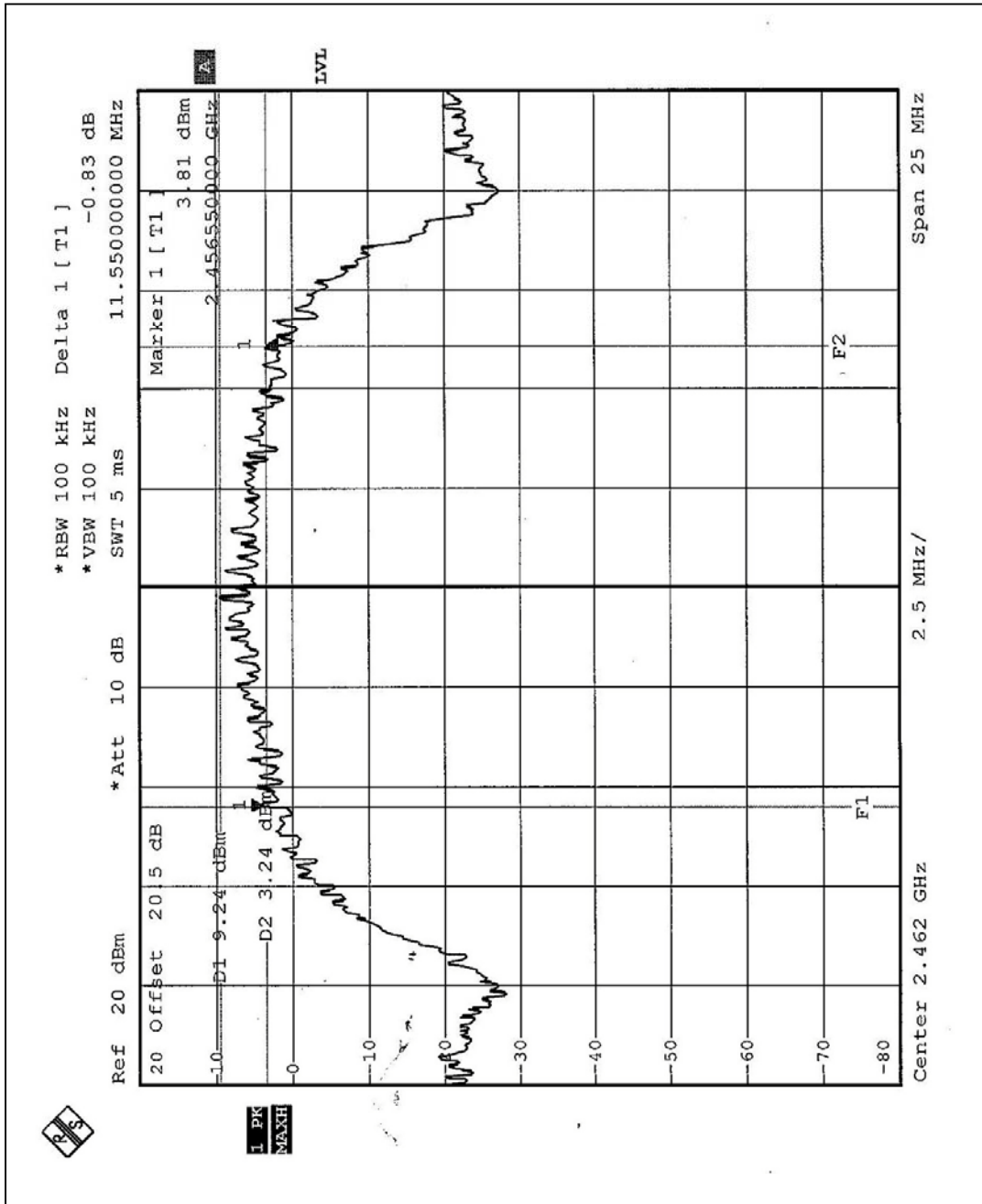



4.3.7 TEST RESULTS-OFDM

| | | | |
|-----------------------------|---|---------------------------------|---------------------------|
| EUT | OfficeConnect Wireless 11g Cable/DSL Router | | |
| MODEL | WL-527 | ENVIRONMENTAL CONDITIONS | 27 deg. C, 63%RH, 973 hPa |
| INPUT POWER (SYSTEM) | 120Vac, 60 Hz | TESTED BY | Tony Chen |

| CHANNEL | CHANNEL FREQUENCY (MHz) | 6 dB BANDWIDTH (MHz) | MINIMUM LIMIT (MHz) | PASS/FAIL |
|----------------|--------------------------------|-----------------------------|----------------------------|------------------|
| 1 | 2412 | 16.45 | 0.5 | PASS |
| 6 | 2437 | 16.40 | 0.5 | PASS |
| 11 | 2462 | 16.45 | 0.5 | PASS |



CH1

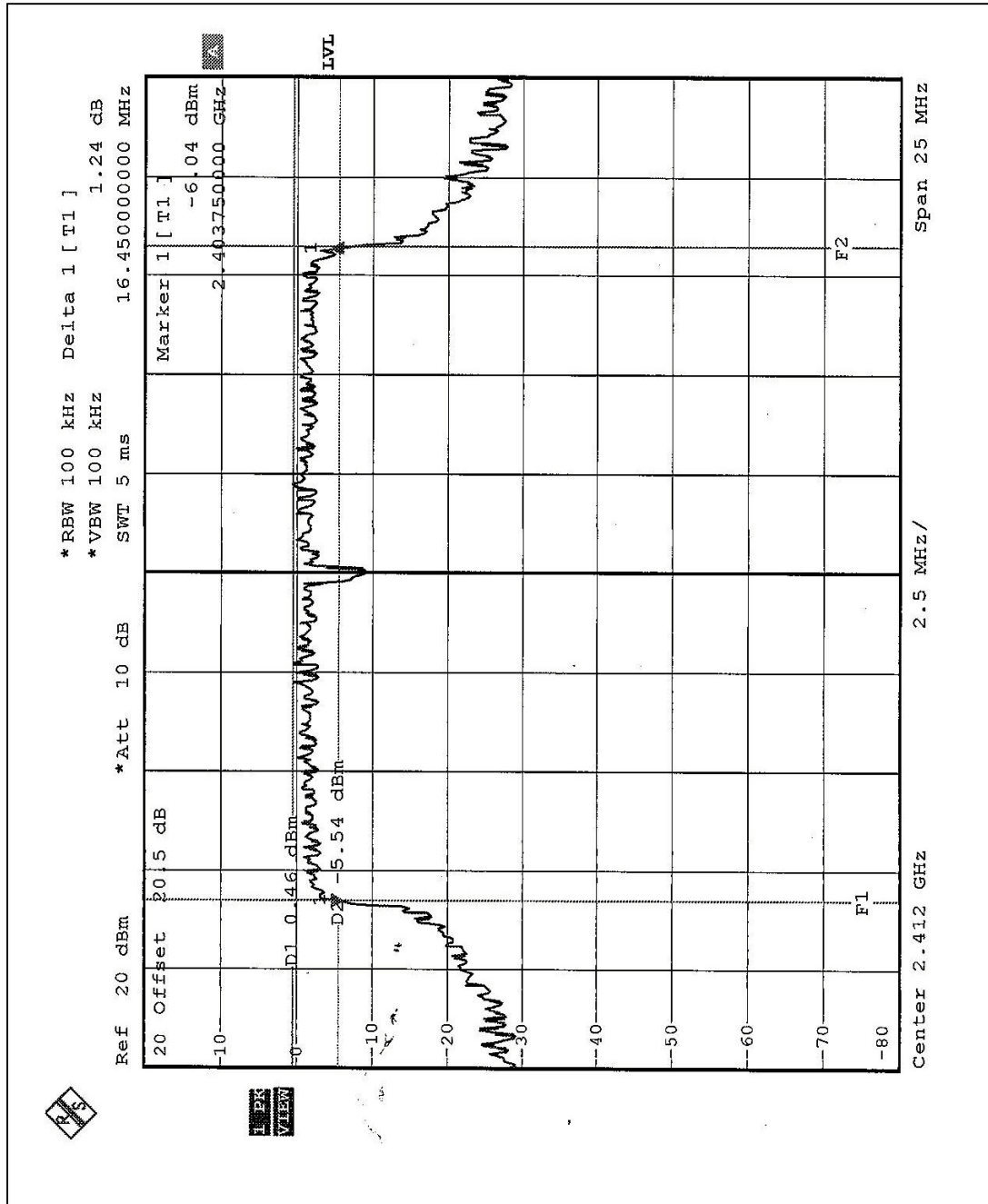



CH6

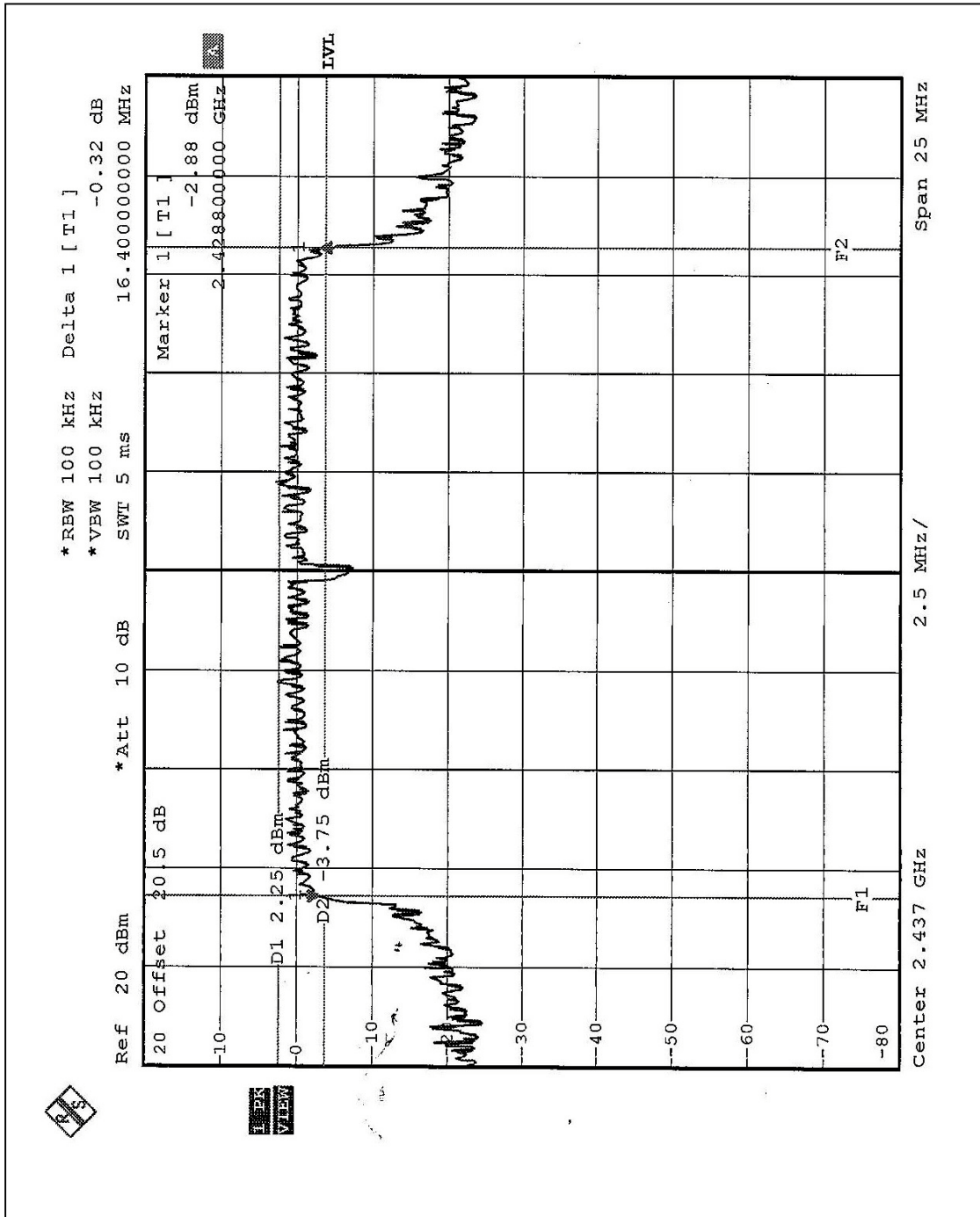



CH11

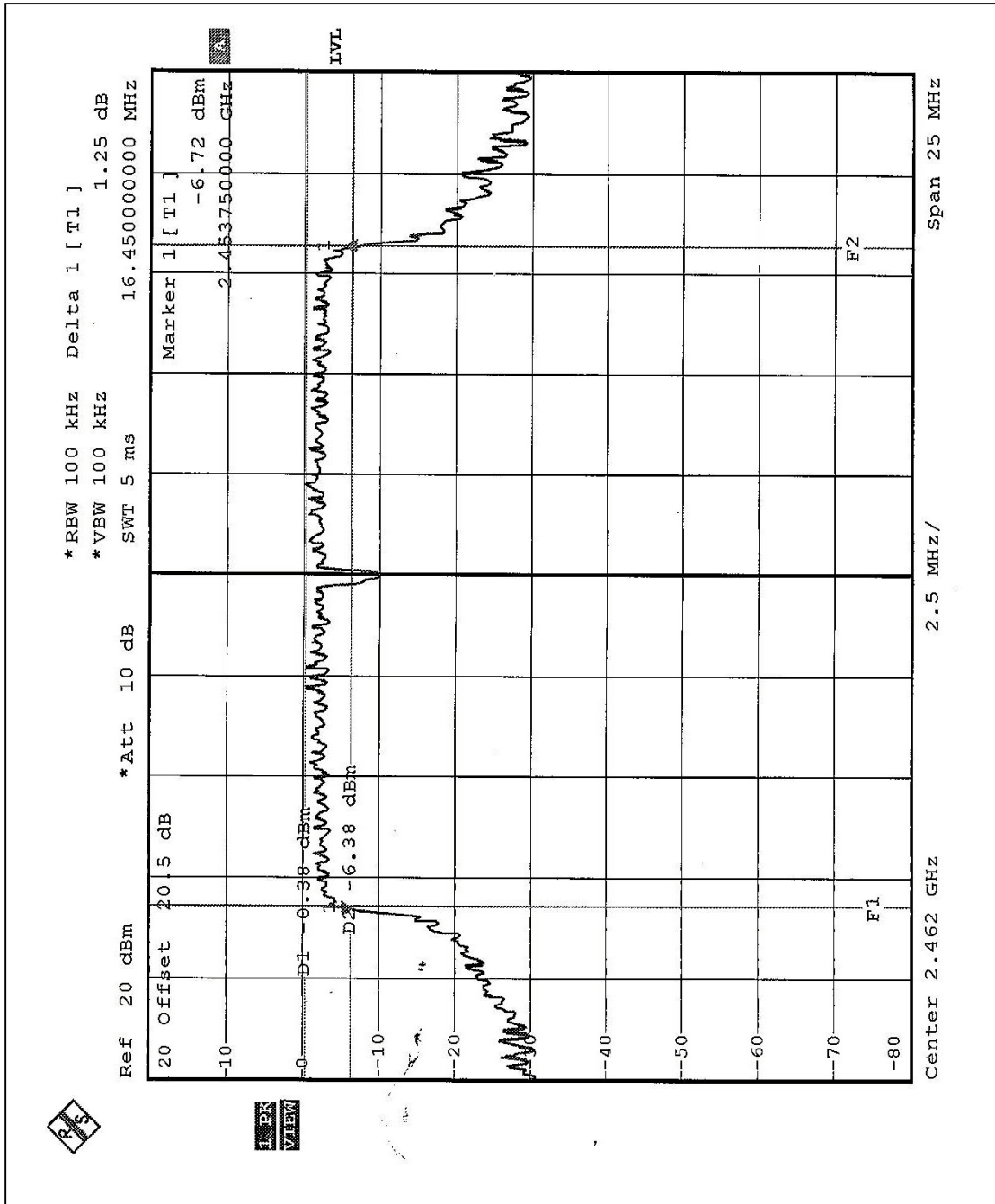



4.4 MAXIMUM PEAK OUTPUT POWER

4.4.1 LIMITS OF MAXIMUM PEAK OUTPUT POWER MEASUREMENT

The Maximum Peak Output Power Measurement is 30dBm.

4.4.2 TEST INSTRUMENTS

| Description & Manufacturer | Model No. | Serial No. | Calibrated Until |
|----------------------------|-----------|------------|------------------|
| R&S SPECTRUM ANALYZER | FSP40 | 100036 | Nov. 27, 2004 |
| Agilent SIGNAL GENERATOR | E8257C | MY43320668 | Jan. 1, 2005 |
| TEKTRONIX OSCILLOSCOPE | TDS 220 | B027241 | Jun. 30, 2005 |
| NARDA DETECTOR | 4503A | FSCM99899 | NA |

NOTE:

The calibration interval of the above test instruments is 12 months and the calibrations are traceable to NML/ROC and NIST/USA.



4.4.3 TEST PROCEDURES

1. A detector was used on the output port of the EUT. An oscilloscope was used to read the peak response of the detector.
2. Replaced the EUT by the signal generator. The center frequency of the S.G was adjusted to the center frequency of the measured channel.
3. Adjusted the power to have the same peak reading on oscilloscope. Record the power level.

4.4.4 TEST SETUP

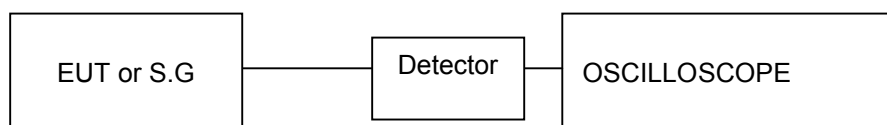

4.4.5 EUT OPERATING CONDITIONS

Same as Item 4.3.5



4.4.6 TEST RESULTS- DSSS

| | | | |
|-----------------------------|---|---------------------------------|---------------------------|
| EUT | OfficeConnect Wireless 11g Cable/DSL Router | | |
| MODEL | WL-527 | ENVIRONMENTAL CONDITIONS | 27 deg. C, 63%RH, 973 hPa |
| INPUT POWER (SYSTEM) | 120Vac, 60 Hz | TESTED BY | Tony Chen |

| CHANNEL | CHANNEL FREQUENCY (MHz) | PEAK POWER OUTPUT (dBm) | PEAK POWER LIMIT (dBm) | PASS/FAIL |
|----------------|--------------------------------|--------------------------------|-------------------------------|------------------|
| 1 | 2412 | 18.92 | 30 | PASS |
| 6 | 2437 | 19.83 | 30 | PASS |
| 11 | 2462 | 19.50 | 30 | PASS |



4.4.7 TEST RESULTS- OFDM

| | | | |
|-----------------------------|---|---------------------------------|---------------------------|
| EUT | OfficeConnect Wireless 11g Cable/DSL Router | | |
| MODEL | WL-527 | ENVIRONMENTAL CONDITIONS | 27 deg. C, 63%RH, 973 hPa |
| INPUT POWER (SYSTEM) | 120Vac, 60 Hz | TESTED BY | Tony Chen |

| CHANNEL | CHANNEL FREQUENCY (MHz) | PEAK POWER OUTPUT (dBm) | PEAK POWER LIMIT (dBm) | PASS/FAIL |
|----------------|--------------------------------|--------------------------------|-------------------------------|------------------|
| 1 | 2412 | 17.50 | 30 | PASS |
| 6 | 2437 | 19.43 | 30 | PASS |
| 11 | 2462 | 18.01 | 30 | PASS |



4.5 POWER SPECTRAL DENSITY MEASUREMENT

4.5.1 LIMITS OF POWER SPECTRAL DENSITY MEASUREMENT

The Maximum of Power Spectral Density Measurement is 8dBm.

4.5.2 TEST INSTRUMENTS

| Description & Manufacturer | Model No. | Serial No. | Calibrated Until |
|----------------------------|-----------|------------|------------------|
| R&S SPECTRUM ANALYZER | FSP40 | 100036 | Nov. 27, 2004 |

NOTE:

- 1.The measurement uncertainty is less than +/- 2.6dB, which is calculated as per the NAMAS document NIS81.
- 2.The calibration interval of the above test instruments is 12 months and the calibrations are traceable to NML/ROC and NIST/USA.

4.5.3 TEST PROCEDURE

The transmitter output was connected to the spectrum analyzer through an attenuator, the bandwidth of the fundamental frequency was measured with the spectrum analyzer using 3 kHz RBW and 30 kHz VBW, set sweep time=span/3kHz. The power spectral density was measured and recorded. The sweep time is allowed to be longer than span/3KHz for a full response of the mixer in the spectrum analyzer.

4.5.4 TEST SETUP

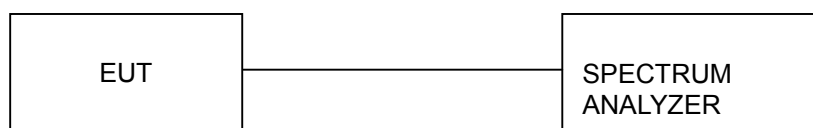

4.5.5 EUT OPERATING CONDITIONS

Same as 4.3.5



4.5.6 TEST RESULTS-DSSS

| | | | |
|-----------------------------|---|---------------------------------|---------------------------|
| EUT | OfficeConnect Wireless 11g Cable/DSL Router | | |
| MODEL | WL-527 | ENVIRONMENTAL CONDITIONS | 27 deg. C, 63%RH, 973 hPa |
| INPUT POWER (SYSTEM) | 120Vac, 60 Hz | TESTED BY | Tony Chen |

| CHANNEL NUMBER | CHANNEL FREQUENCY (MHz) | RF POWER LEVEL IN 3 KHz BW (dBm) | MAXIMUM LIMIT (dBm) | PASS/FAIL |
|-----------------------|--------------------------------|---|----------------------------|------------------|
| 1 | 2412 | -5.27 | 8 | PASS |
| 6 | 2437 | -4.55 | 8 | PASS |
| 11 | 2462 | -4.83 | 8 | PASS |



CH1

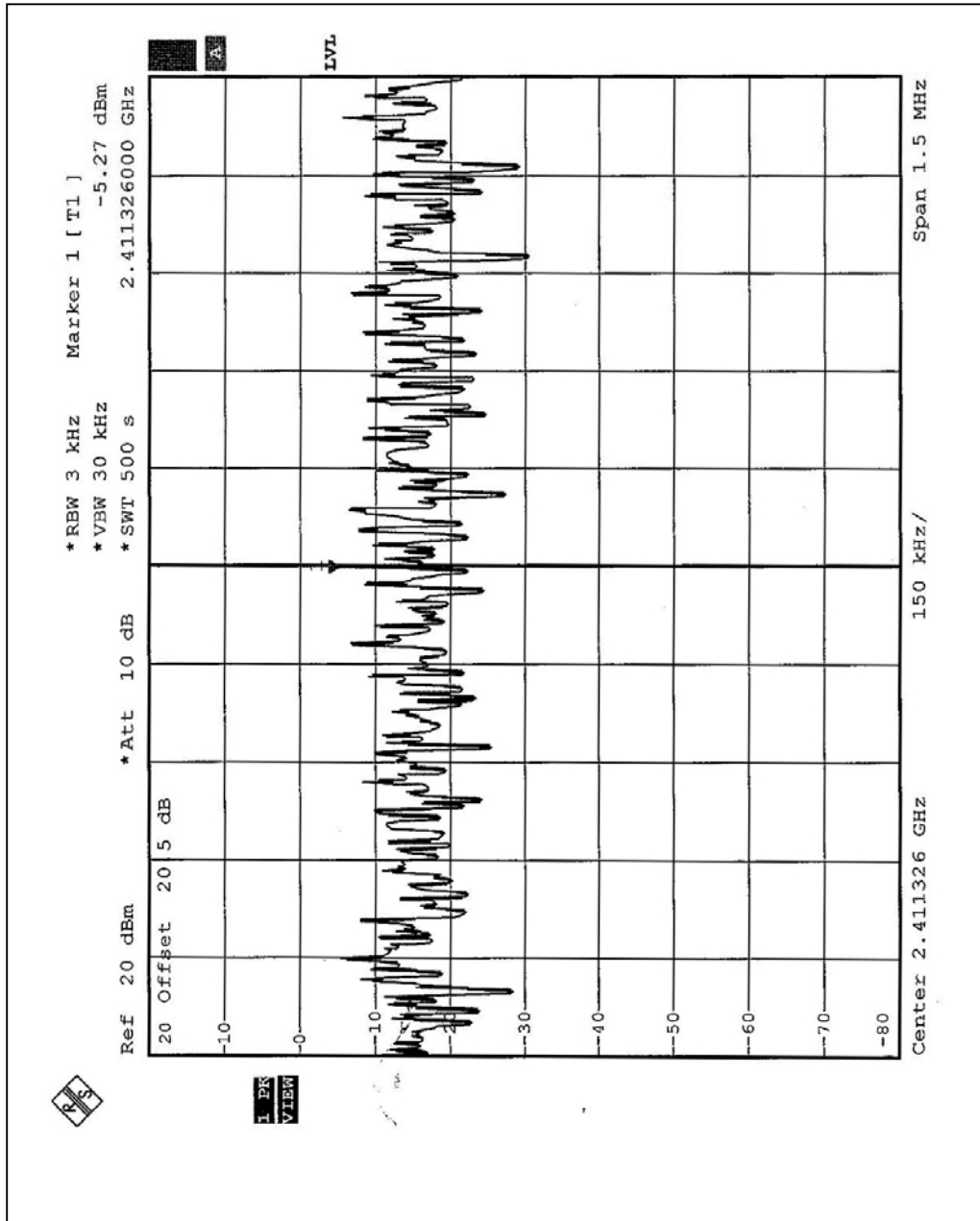



CH6

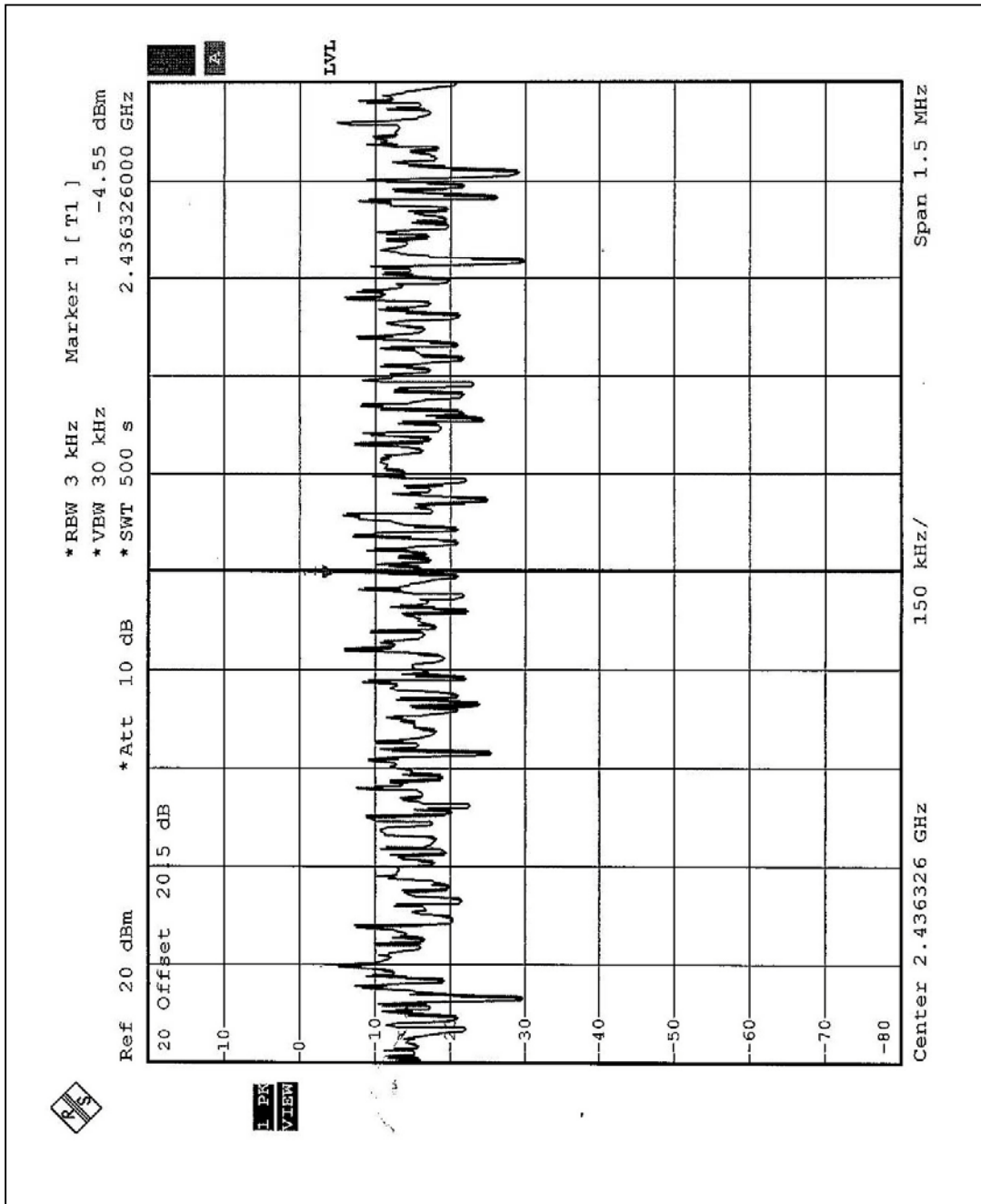



CH11

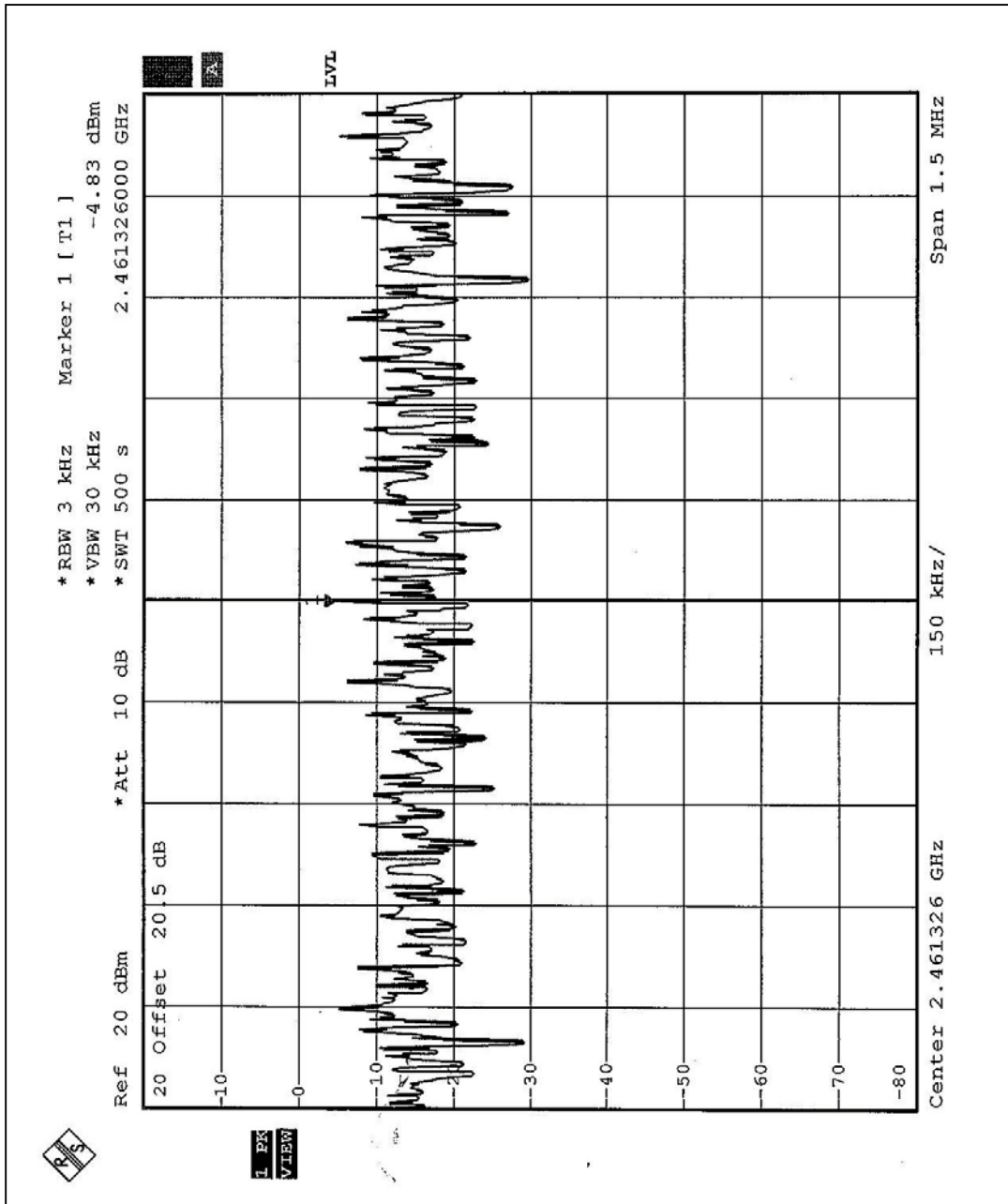



4.5.7 TEST RESULTS-OFDM

| | | | |
|-----------------------------|---|---------------------------------|---------------------------|
| EUT | OfficeConnect Wireless 11g Cable/DSL Router | | |
| MODEL | WL-527 | ENVIRONMENTAL CONDITIONS | 27 deg. C, 63%RH, 973 hPa |
| INPUT POWER (SYSTEM) | 120Vac, 60 Hz | TESTED BY | Tony Chen |

| CHANNEL NUMBER | CHANNEL FREQUENCY (MHz) | RF POWER LEVEL IN 3 KHz BW (dBm) | MAXIMUM LIMIT (dBm) | PASS/FAIL |
|-----------------------|--------------------------------|---|----------------------------|------------------|
| 1 | 2412 | -13.38 | 8 | PASS |
| 6 | 2437 | -11.33 | 8 | PASS |
| 11 | 2462 | -13.05 | 8 | PASS |



CH1

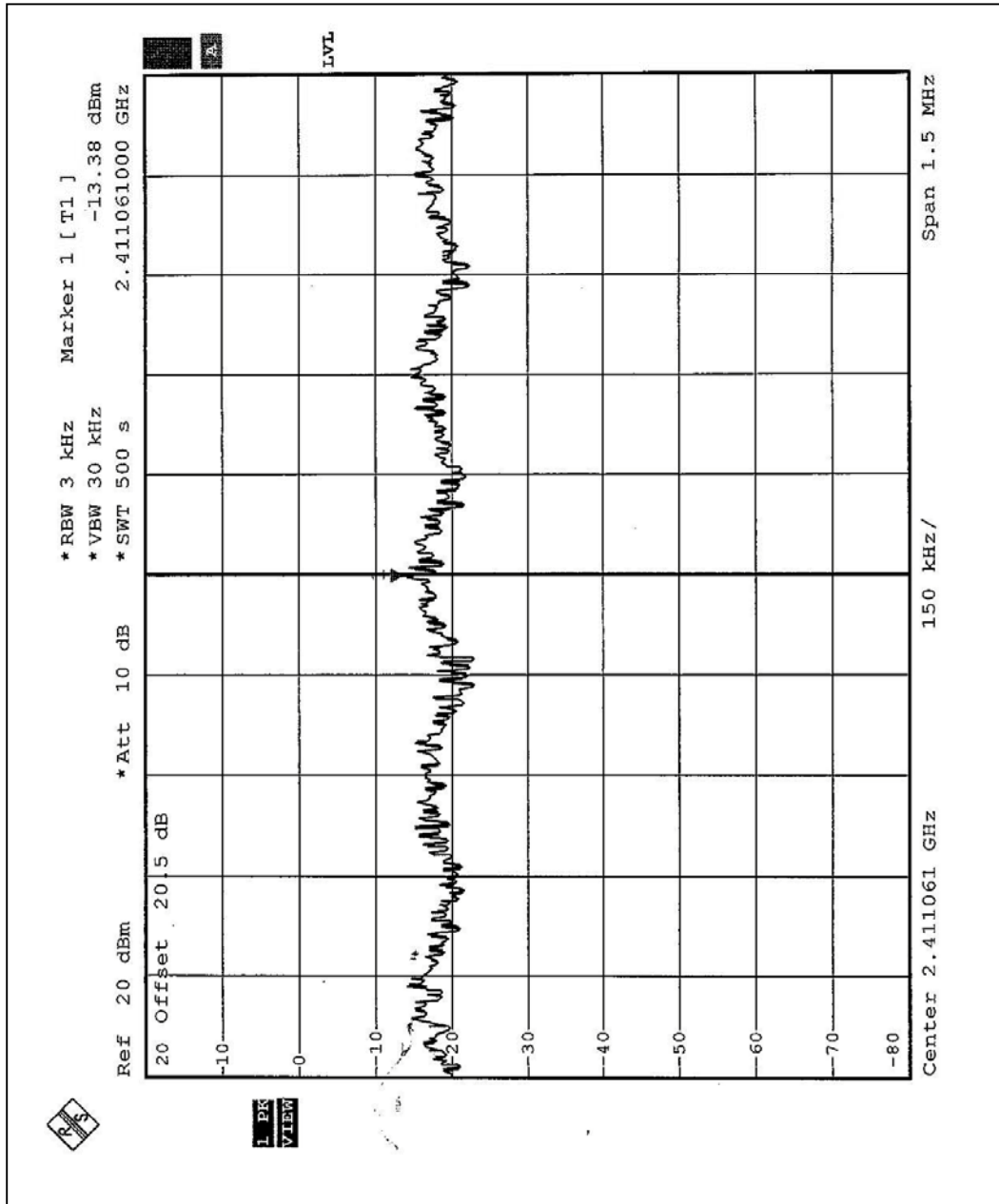



CH6

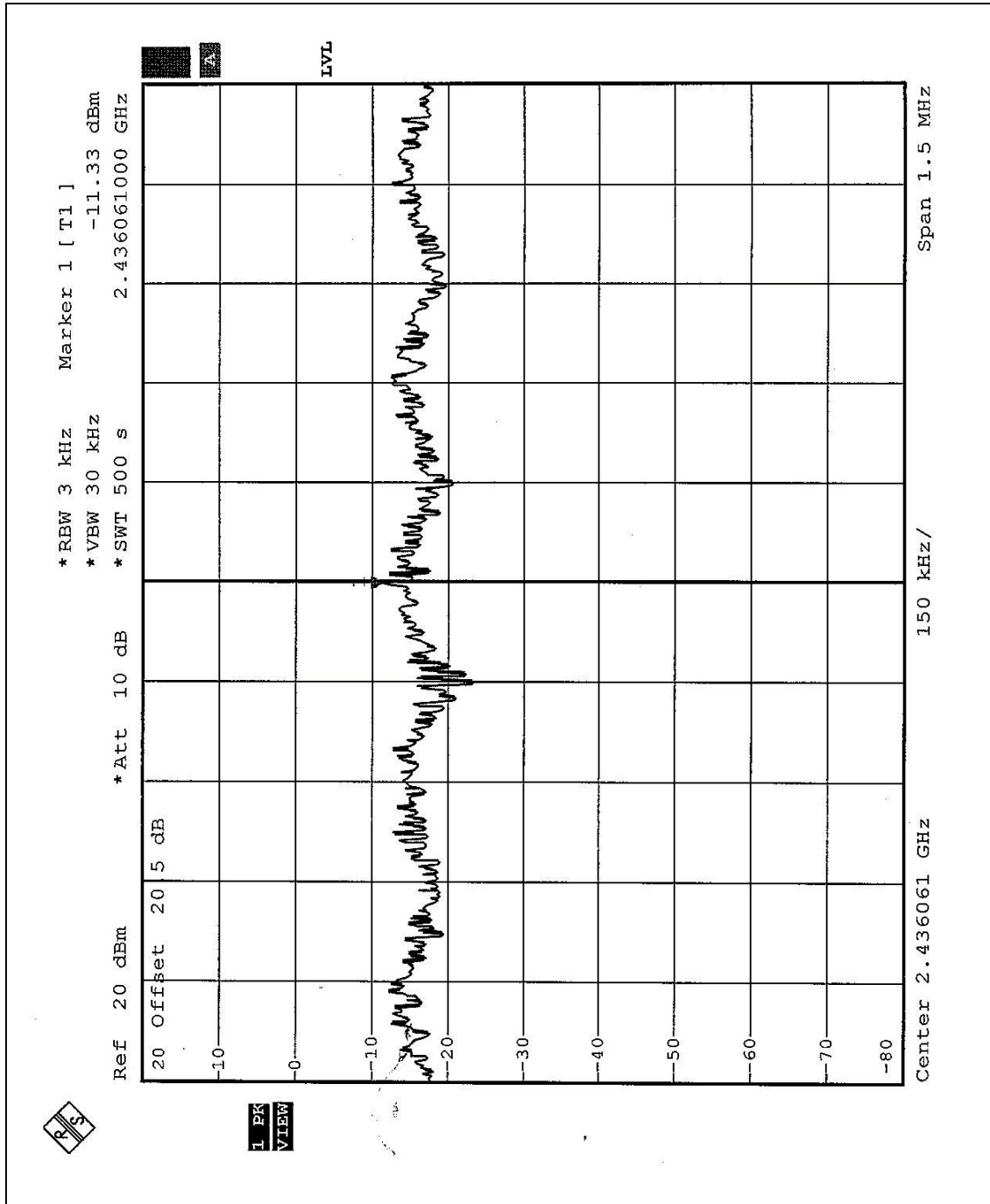



CH11

