

# TEST REPORT

## CERTIFICATE OF CONFORMITY

**Standard:** 47 CFR FCC Part 15, Subpart E (Section 15.407)

**Report No.:** RFBCMA-WTW-P23110753-1

**FCC ID:** RAXWE6204430

**Product:** Wi-Fi Extender

**Brand:** T-Mobile

**Model No.:** T-Mobile Internet Wi-Fi Mesh Access Point

**Received Date:** 2022/11/2

**Test Date:** 2023/10/30 ~ 2023/12/14

**Issued Date:** 2024/1/8

**Applicant:** Arcadyan Technology Corporation

**Address:** No.8, Sec.2, Guangfu Rd.,Hsinchu City 30071, Taiwan, R.O.C.

**Issued By:** Bureau Veritas Consumer Products Services (H.K.) Ltd., Taoyuan Branch  
Hsin Chu Laboratory

**Lab Address:** E-2, No.1, Li Hsin 1st Road, Hsinchu Science Park, Hsinchu City 300, Taiwan

**Test Location:** E-2, No.1, Li Hsin 1st Road, Hsinchu Science Park, Hsinchu City 300, Taiwan

**FCC Registration /** 723255 / TW2022

**Designation Number:**

**Approved by:** \_\_\_\_\_, **Date:** 2024/1/8  
May Chen / Manager

This test report consists of 185 pages in total. It may be duplicated completely for legal use with the approval of the applicant. It should not be reproduced except in full, without the written approval of our laboratory. The test results in the report only apply to the tested sample. The test results in this report are traceable to the national or international standards.



Prepared by : Claire Kuan / Specialist

This report is governed by, and incorporates by reference, the Conditions of Testing as posted at the date of issuance of this report at <http://www.bureauveritas.com/home/about-us/our-business/cps/about-us/terms-conditions/> and is intended for your exclusive use. Any copying or replication of this report to or for any other person or entity, or use of our name or trademark, is permitted only with our prior written permission. This report sets forth our findings solely with respect to the test samples identified herein. The results set forth in this report are not indicative or representative of the quality or characteristics of the lot from which a test sample was taken or any similar or identical product unless specifically and expressly noted. Our report includes all of the tests requested by you and the results thereof based upon the information that you provided to us. Measurement uncertainty is only provided upon request for accredited tests. Statements of conformity are based on simple acceptance criteria without taking measurement uncertainty into account, unless otherwise requested in writing. You have 60 days from date of issuance of this report to notify us of any material error or omission caused by our negligence or if you require measurement uncertainty; provided, however, that such notice shall be in writing and shall specifically address the issue you wish to raise. A failure to raise such issue within the prescribed time shall constitute your unqualified acceptance of the completeness of this report, the tests conducted and the correctness of the report contents.

## Table of Contents

<b>Release Control Record</b> .....	<b>4</b>
<b>1 Certificate</b> .....	<b>5</b>
<b>2 Summary of Test Results</b> .....	<b>6</b>
2.1 Measurement Uncertainty .....	6
2.2 Supplementary Information .....	7
<b>3 General Information</b> .....	<b>8</b>
3.1 General Description of EUT .....	8
3.2 Antenna Description of EUT .....	9
3.3 Channel List .....	10
3.4 Test Mode Applicability and Tested Channel Detail .....	12
3.5 Duty Cycle of Test Signal .....	14
3.6 Test Program Used and Operation Descriptions .....	16
3.7 Connection Diagram of EUT and Peripheral Devices .....	16
3.8 Configuration of Peripheral Devices and Cable Connections .....	16
<b>4 Test Instruments</b> .....	<b>17</b>
4.1 26 dB Bandwidth .....	17
4.2 RF Output Power .....	17
4.3 Power Spectral Density .....	17
4.4 6 dB Bandwidth .....	17
4.5 Occupied Bandwidth .....	17
4.6 Frequency Stability .....	18
4.7 AC Power Conducted Emissions .....	18
4.8 Unwanted Emissions below 1 GHz .....	19
4.9 Unwanted Emissions above 1 GHz .....	20
<b>5 Limits of Test Items</b> .....	<b>21</b>
5.1 26 dB Bandwidth .....	21
5.2 RF Output Power .....	21
5.3 Power Spectral Density .....	21
5.4 6 dB Bandwidth .....	21
5.5 Occupied Bandwidth .....	22
5.6 Frequency Stability .....	22
5.7 AC Power Conducted Emissions .....	22
5.8 Unwanted Emissions below 1 GHz .....	22
5.9 Unwanted Emissions above 1 GHz .....	23
<b>6 Test Arrangements</b> .....	<b>24</b>
6.1 26 dB Bandwidth .....	24
6.1.1 Test Setup .....	24
6.1.2 Test Procedure .....	24
6.2 RF Output Power .....	25
6.2.1 Test Setup .....	25
6.2.2 Test Procedure .....	25
6.3 Power Spectral Density .....	26
6.3.1 Test Setup .....	26
6.3.2 Test Procedure .....	26
6.4 6 dB Bandwidth .....	27
6.4.1 Test Setup .....	27
6.4.2 Test Procedure .....	27
6.5 Occupied Bandwidth .....	27
6.5.1 Test Setup .....	27
6.5.2 Test Procedure .....	27
6.6 Frequency Stability .....	28
6.6.1 Test Setup .....	28
6.6.2 Test Procedure .....	28
6.7 AC Power Conducted Emissions .....	29



6.7.1	Test Setup .....	29
6.7.2	Test Procedure .....	29
6.8	Unwanted Emissions below 1 GHz .....	30
6.8.1	Test Setup .....	30
6.8.2	Test Procedure .....	31
6.9	Unwanted Emissions above 1 GHz .....	32
6.9.1	Test Setup .....	32
6.9.2	Test Procedure .....	32
<b>7</b>	<b>Test Results of Test Item .....</b>	<b>33</b>
7.1	26 dB Bandwidth .....	33
7.2	RF Output Power .....	38
7.3	Power Spectral Density .....	60
7.4	6 dB Bandwidth .....	66
7.5	Occupied Bandwidth .....	68
7.6	Frequency Stability .....	77
7.7	AC Power Conducted Emissions .....	78
7.8	Unwanted Emissions below 1 GHz .....	80
7.9	Unwanted Emissions above 1 GHz .....	82
<b>8</b>	<b>Pictures of Test Arrangements .....</b>	<b>184</b>
<b>9</b>	<b>Information of the Testing Laboratories .....</b>	<b>185</b>



## Release Control Record

Issue No.	Description	Date Issued
RFBCMA-WTW-P23110753-1	Original release.	2024/1/8

## 1 Certificate

**Product:** Wi-Fi Extender

**Brand:** T-Mobile

**Test Model:** T-Mobile Internet Wi-Fi Mesh Access Point

**Sample Status:** Engineering sample

**Applicant:** Arcadyan Technology Corporation

**Test Date:** 2023/10/30 ~ 2023/12/14

**Standard:** 47 CFR FCC Part 15, Subpart E (Section 15.407)

**Measurement** ANSI C63.10-2013

**procedure:** KDB 789033 D02 General UNII Test Procedure New Rules v02r01

KDB 662911 D01 Multiple Transmitter Output v02r01

The above equipment has been tested by **Bureau Veritas Consumer Products Services (H.K.) Ltd., Taoyuan Branch**, and found compliance with the requirement of the above standards. The test record, data evaluation & Equipment Under Test (EUT) configurations represented herein are true and accurate accounts of the measurements of the sample's RF characteristics under the conditions specified in this report.

## 2 Summary of Test Results

47 CFR FCC Part 15, Subpart E (Section 15.407)			
Clause	Test Item	Result	Remark
15.407(a)(2)	26 dB Bandwidth	Pass	For U-NII-2A U-NII-2C Band output power limitation is determined based on 26dBc bandwidth.
15.407(a)(1) 15.407(a)(2) 15.407(a)(3)	RF Output Power	Pass	Meet the requirement of limit.
15.407(a)(1) 15.407(a)(2) 15.407(a)(3)	Power Spectral Density	Pass	Meet the requirement of limit.
15.407(e)	6 dB Bandwidth	Pass	Meet the requirement of limit. (U-NII-3 Band only)
---	Occupied Bandwidth	-	Reference only.
15.407(g)	Frequency Stability	Pass	Meet the requirement of limit.
15.407(b)(9)	AC Power Conducted Emissions	Pass	Minimum passing margin is -8.86 dB at 0.85703 MHz
15.407(b)(9)	Unwanted Emissions below 1 GHz	Pass	Minimum passing margin is -4.6 dB at 55.85 MHz
15.407(b) (1/10) 15.407(b) (2/10) 15.407(b) (3/10) 15.407(b) (4(i)/10)	Unwanted Emissions above 1 GHz	Pass	Minimum passing margin is -0.9 dB at 5648.88 MHz
15.203	Antenna Requirement	Pass	Antenna connector is ipex(MHF) not a standard connector.

### Notes:

- Determining compliance based on the results of the compliance measurement, not taking into account measurement instrumentation uncertainty.
- The "Dynamic Frequency Selection measurement" was recorded in DFS test report.

### 2.1 Measurement Uncertainty

Where relevant, the following measurement uncertainty levels have been estimated for tests performed on the EUT as specified in CISPR 16-4-2:

Measurement	Specification	Expanded Uncertainty (k=2) (±)
26 dB Bandwidth	-	1050.00 Hz
RF Output Power	-	1.1 dB
Power Spectral Density	-	1.3 dB
6 dB Bandwidth	-	1050.00 Hz
Occupied Bandwidth	-	1050.00 Hz
Frequency Stability	-	0.16 ppm
AC Power Conducted Emissions	150 kHz ~ 30 MHz	1.9 dB
Unwanted Emissions below 1 GHz	9 kHz ~ 30 MHz	3.1 dB
	30 MHz ~ 1 GHz	5.1 dB
Unwanted Emissions above 1 GHz	1 GHz ~ 18 GHz	5.1 dB
	18 GHz ~ 40 GHz	5.3 dB

The other instruments specified are routine verified to remain within the calibrated levels, no measurement uncertainty is required to be calculated.

## 2.2 Supplementary Information

There is not any deviation from the test standards for the test method, and no modifications required for compliance.

### 3 General Information

#### 3.1 General Description of EUT

Product	Wi-Fi Extender
Brand	T-Mobile
Test Model	T-Mobile Internet Wi-Fi Mesh Access Point
Status of EUT	Engineering sample
Power Supply Rating	15Vdc from adapter
Modulation Type	64QAM, 16QAM, QPSK, BPSK for OFDM 256QAM for OFDM in 11ac mode 1024QAM for OFDMA in 11ax HE mode
Modulation Technology	OFDM, OFDMA
Transfer Rate	802.11a: up to 54 Mbps 802.11n: up to 600 Mbps 802.11ac: up to 1733.3 Mbps 802.11ax: up to 4803.9 Mbps
Operating Frequency	5.18 GHz ~ 5.25 GHz 5.25 GHz ~ 5.32 GHz 5.5 GHz ~ 5.72 GHz 5.745 GHz ~ 5.825 GHz
Number of Channel	802.11a, 802.11n (HT20), 802.11ac (VHT20), 802.11ax (HE20): 25 802.11n (HT40), 802.11ac (VHT40), 802.11ax (HE40): 12 802.11ac (VHT80), 802.11ax (HE80): 6 802.11ac (VHT160), 802.11ax (HE160): 2
Output Power	<b>CDD Mode:</b> 5.18 GHz ~ 5.25 GHz: 650.512 mW (28.13 dBm) 5.25 GHz ~ 5.32 GHz: 248.735 mW (23.96 dBm) 5.5 GHz ~ 5.72 GHz: 248.199 mW (23.95 dBm) 5.745 GHz ~ 5.825 GHz: 997.226 mW (29.99 dBm) <b>Beamforming Mode:</b> 5.18 GHz ~ 5.25 GHz: 586.864 mW (27.69 dBm) 5.25 GHz ~ 5.32 GHz: 234.76 mW (23.71 dBm) 5.5 GHz ~ 5.72 GHz: 235.109 mW (23.71 dBm) 5.745 GHz ~ 5.825 GHz: 945.201 mW (29.76 dBm)
EUT Category	Indoor Access Point

Note:

1. The EUT uses following accessories.

Adapter		
Brand	Model	Specification
Lucent	1D17	AC Input : 100-240V, 0.8 A, 50/60Hz DC Output : 5.0V , 3.0A, 15.0W ; 9.0V, 3.0A, 27.0W ; 12.0V, 2.5A, 30.0W ; 15.0V, 2.0A, 30.0W DC Output Cable : 1.8 M , non-shielded cable, W/O ferrite core Plug : US

2. The EUT has two radios as following table:

Radio 1	Radio 2
WLAN 2.4GHz	WLAN 5GHz

3. Simultaneously transmission condition.

Condition	Technology	
1	WLAN 2.4GHz	WLAN 5GHz

Note: The emission of the simultaneous operation has been evaluated and no non-compliance was found.

4. The above EUT information is declared by manufacturer and for more detailed features description, please refers to the manufacturer's specifications or user's manual.



### 3.2 Antenna Description of EUT

1. The antenna information is listed as below.

Antenna NO.	RF Chain NO.	Brand	Model	Antenna Net Gain(dBi)	Frequency range	Antenna Type	Connector Type	Cable Length (mm)	Cable Loss (dB)
Blue	ant2	LITE	520101-7000-23R	3.58 4.09 2.57 3.12 2.39	2.4~2.4835GHz 5.15~5.25GHz 5.25~5.35GHz 5.47~5.725GHz 5.725~5.85GHz	Dipole	ipex(MHF)	83	Yes
White	ant3	LITE	520101-7003-23R	4.14 3.85 2.68 3.38 2.48	2.4~2.4835GHz 5.15~5.25GHz 5.25~5.35GHz 5.47~5.725GHz 5.725~5.85GHz	Dipole	ipex(MHF)	38	Yes
Black	ant1	LITE	520101-7002-23R	4.17 3.87 2.34 2.39 2.52	2.4~2.4835GHz 5.15~5.25GHz 5.25~5.35GHz 5.47~5.725GHz 5.725~5.85GHz	Dipole	ipex(MHF)	105	Yes
Gray	ant0	LITE	520101-7001-23R	3.59 3.79 2.64 3.29 2.64	2.4~2.4835GHz 5.15~5.25GHz 5.25~5.35GHz 5.47~5.725GHz 5.725~5.85GHz	Dipole	ipex(MHF)	70	Yes

\* Detail antenna specification please refer to antenna datasheet and/or antenna measurement report.

2. The directional antenna gain, please refer to the following table:

Frequency Range (GHz)	Directional Antenna Gain (dBi)	Antenna Type	Antenna Connector
2.4~2.4835	5.28	Dipole	ipex(MHF)
5.15 ~ 5.25	4.7		
5.25 ~ 5.35	3.39		
5.47 ~ 5.725	4.01		
5.725 ~ 5.85	3.13		

3. The EUT incorporates a MIMO function:

5 GHz Band		
Modulation Mode	TX & RX Configuration	
802.11a	4TX	4RX
802.11n (HT20)	4TX	4RX
802.11n (HT40)	4TX	4RX
802.11ac (VHT20)	4TX	4RX
802.11ac (VHT40)	4TX	4RX
802.11ac (VHT80)	4TX	4RX
802.11ac (VHT160)	4TX	4RX
802.11ax (HE20)	4TX	4RX
802.11ax (HE40)	4TX	4RX
802.11ax (HE80)	4TX	4RX
802.11ax (HE160)	4TX	4RX

- Note:
- All of modulation mode support beamforming function except 802.11a modulation mode.
  - The EUT support Beamforming and CDD mode, therefore both mode were investigated and the worst case scenario was identified. The worst case data were presented in test report.
  - The modulation and bandwidth are similar for 802.11n mode for 20 MHz (40 MHz), 802.11ac mode for 20 MHz (40 MHz, 80 MHz, 160 MHz) and 802.11ax mode for 20 MHz (40 MHz, 80 MHz, 160 MHz) therefore the manufacturer will control the power for 802.11n/ac/ax mode is same as the 802.11be mode or more lower than it and investigated worst case to representative mode in test report.

### 3.3 Channel List

#### FOR 5180 ~ 5320 MHz

8 channels are provided for 802.11a, 802.11n (HT20), 802.11ac (VHT20), 802.11ax (HE20):

Channel	Frequency	Channel	Frequency
36	5180 MHz	52	5260 MHz
40	5200 MHz	56	5280 MHz
44	5220 MHz	60	5300 MHz
48	5240 MHz	64	5320 MHz

4 channels are provided for 802.11n (HT40), 802.11ac (VHT40), 802.11ax (HE40):

Channel	Frequency	Channel	Frequency
38	5190 MHz	54	5270 MHz
46	5230 MHz	62	5310 MHz

2 channels are provided for 802.11ac (VHT80), 802.11ax (HE80):

Channel	Frequency	Channel	Frequency
42	5210 MHz	58	5290 MHz

1 straddle channel is provided for 802.11ac (VHT160), 802.11ax (HE160):

Channel	Frequency
50	5250 MHz

#### FOR 5500 ~ 5720 MHz

12 channels are provided for 802.11a, 802.11n (HT20), 802.11ac (VHT20), 802.11ax (HE20):

Channel	Frequency	Channel	Frequency
100	5500 MHz	124	5620 MHz
104	5520 MHz	128	5640 MHz
108	5540 MHz	132	5660 MHz
112	5560 MHz	136	5680 MHz
116	5580 MHz	140	5700 MHz
120	5600 MHz	144	5720 MHz

6 channels are provided for 802.11n (HT40), 802.11ac (VHT40), 802.11ax (HE40):

Channel	Frequency	Channel	Frequency
102	5510 MHz	126	5630 MHz
110	5550 MHz	134	5670 MHz
118	5590 MHz	142	5710 MHz

3 channels are provided for 802.11ac (VHT80), 802.11ax (HE80):

Channel	Frequency	Channel	Frequency
106	5530 MHz	138	5690 MHz
122	5610 MHz		

1 channel is provided for 802.11ac (VHT160), 802.11ax (HE160):

Channel	Frequency
114	5570 MHz

**FOR 5745 ~ 5825 MHz:**

5 channels are provided for 802.11a, 802.11n (HT20), 802.11ac (VHT20), 802.11ax (HE20):

Channel	Frequency	Channel	Frequency
149	5745 MHz	161	5805 MHz
153	5765 MHz	165	5825 MHz
157	5785 MHz		

2 channels are provided for 802.11n (HT40), 802.11ac (VHT40), 802.11ax (HE40):

Channel	Frequency	Channel	Frequency
151	5755 MHz	159	5795 MHz

1 channel is provided for 802.11ac (VHT80), 802.11ax (HE80):

Channel	Frequency
155	5775 MHz

### 3.4 Test Mode Applicability and Tested Channel Detail

Pre-Scan:	1. EUT can be used in the following ways: Wall Mount/ Standing. Pre-scan these ways and find the worst case as a representative test condition. 2. Pre-Scan has been conducted to determine the worst-case mode from all possible combinations between available modulations, data rates and antenna ports (if EUT with antenna diversity architecture).
Worst Case:	1. Wall Mount/ Standing Worst Condition: Standing Worst

Following channel(s) was (were) selected for the final test as listed below:

Test Item	Mode	Signal Mode	Tested Channel	Modulation	Data Rate Parameter
26 dB Bandwidth	802.11a	CDD	52, 60, 64, 100, 116, 140, 144	BPSK	6Mb/s
	802.11ax (HE20)	CDD	52, 60, 64, 100, 116, 140, 144	BPSK	MCS0
	802.11ax (HE40)	CDD	54, 62, 102, 110, 134, 142	BPSK	MCS0
	802.11ax (HE80)	CDD	58, 106, 122, 138	BPSK	MCS0
	802.11ax (HE160)	CDD	50, 114	BPSK	MCS0
RF Output Power	802.11a	CDD	36, 40, 48, 52, 60, 64, 100, 116, 140, 144, 149, 157, 165	BPSK	6Mb/s
	802.11ac (VHT20)	CDD & Beamforming	36, 40, 48, 52, 60, 64, 100, 116, 140, 144, 149, 157, 165	BPSK	MCS0
	802.11ac (VHT40)	CDD & Beamforming	38, 46, 54, 62, 102, 110, 134, 142, 151, 159	BPSK	MCS0
	802.11ac (VHT80)	CDD & Beamforming	42, 58, 106, 122, 138, 155	BPSK	MCS0
	802.11ac (VHT160)	CDD & Beamforming	50, 114	BPSK	MCS0
	802.11ax (HE20)	CDD & Beamforming	36, 40, 48, 52, 60, 64, 100, 116, 140, 144, 149, 157, 165	BPSK	MCS0
	802.11ax (HE40)	CDD & Beamforming	38, 46, 54, 62, 102, 110, 134, 142, 151, 159	BPSK	MCS0
	802.11ax (HE80)	CDD & Beamforming	42, 58, 106, 122, 138, 155	BPSK	MCS0
	802.11ax (HE160)	CDD & Beamforming	50, 114	BPSK	MCS0

Test Item	Mode	Signal Mode	Tested Channel	Modulation	Data Rate Parameter
6 dB Bandwidth	802.11a	CDD	144, 149, 157, 165	BPSK	6Mb/s
	802.11ax (HE20)	CDD	144, 149, 157, 165	BPSK	MCS0
	802.11ax (HE40)	CDD	142, 151, 159	BPSK	MCS0
	802.11ax (HE80)	CDD	138, 155	BPSK	MCS0
Occupied Bandwidth / Power Spectral Density	802.11a	CDD	36, 40, 48, 52, 60, 64, 100, 116, 140, 144, 149, 157, 165	BPSK	6Mb/s
	802.11ax (HE20)	CDD	36, 40, 48, 52, 60, 64, 100, 116, 140, 144, 149, 157, 165	BPSK	MCS0
	802.11ax (HE40)	CDD	38, 46, 54, 62, 102, 110, 134, 142, 151, 159	BPSK	MCS0
	802.11ax (HE80)	CDD	42, 58, 106, 122, 138, 155	BPSK	MCS0
	802.11ax (HE160)	CDD	50, 114	BPSK	MCS0
Frequency Stability	802.11a	-	36	unmodulated	-
AC Power Conducted Emissions	802.11ax (HE20)	CDD	157	BPSK	MCS0
Unwanted Emissions below 1 GHz	802.11ax (HE20)	CDD	157	BPSK	MCS0
Unwanted Emissions above 1 GHz	802.11a	CDD	36, 40, 48, 52, 60, 64, 100, 116, 140, 144, 149, 157, 165	BPSK	6Mb/s
	802.11ax (HE20)	CDD	36, 40, 48, 52, 60, 64, 100, 116, 140, 144, 149, 157, 165	BPSK	MCS0
	802.11ax (HE40)	CDD	38, 46, 54, 62, 102, 110, 134, 142, 151, 159	BPSK	MCS0
	802.11ax (HE80)	CDD	42, 58, 106, 122, 138, 155	BPSK	MCS0
	802.11ax (HE160)	CDD	50, 114	BPSK	MCS0

### 3.5 Duty Cycle of Test Signal

**802.11a:** Duty cycle = 2.761 ms / 2.817 ms x 100% = 98.0%

**802.11ax (HE20):** Duty cycle = 3.888 ms / 3.944 ms x 100% = 98.6%

**802.11ax (HE40):** Duty cycle = 2.928 ms / 2.984 ms x 100% = 98.1%

**802.11ax (HE80):** Duty cycle = 2.733 ms / 2.79 ms x 100% = 98.0%

**802.11ax (HE160):** Duty cycle = 1.4 ms / 1.456 ms x 100% = 96.2%, duty factor = 10 \* log (1/Duty cycle) = 0.17 dB

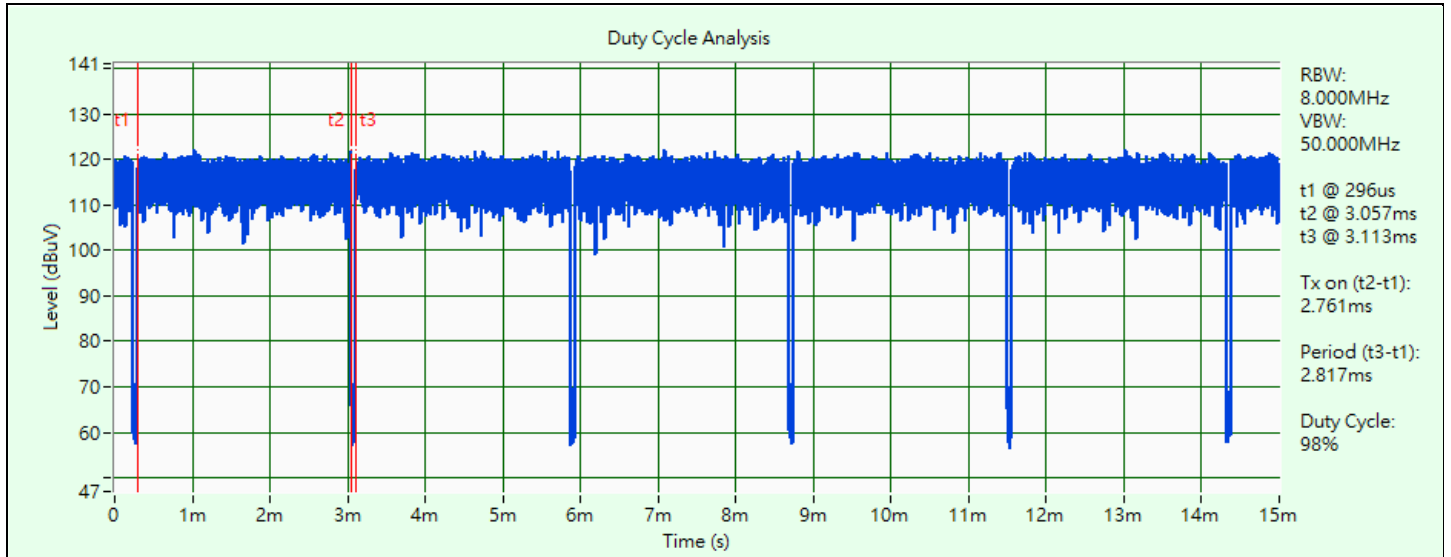

802.11a

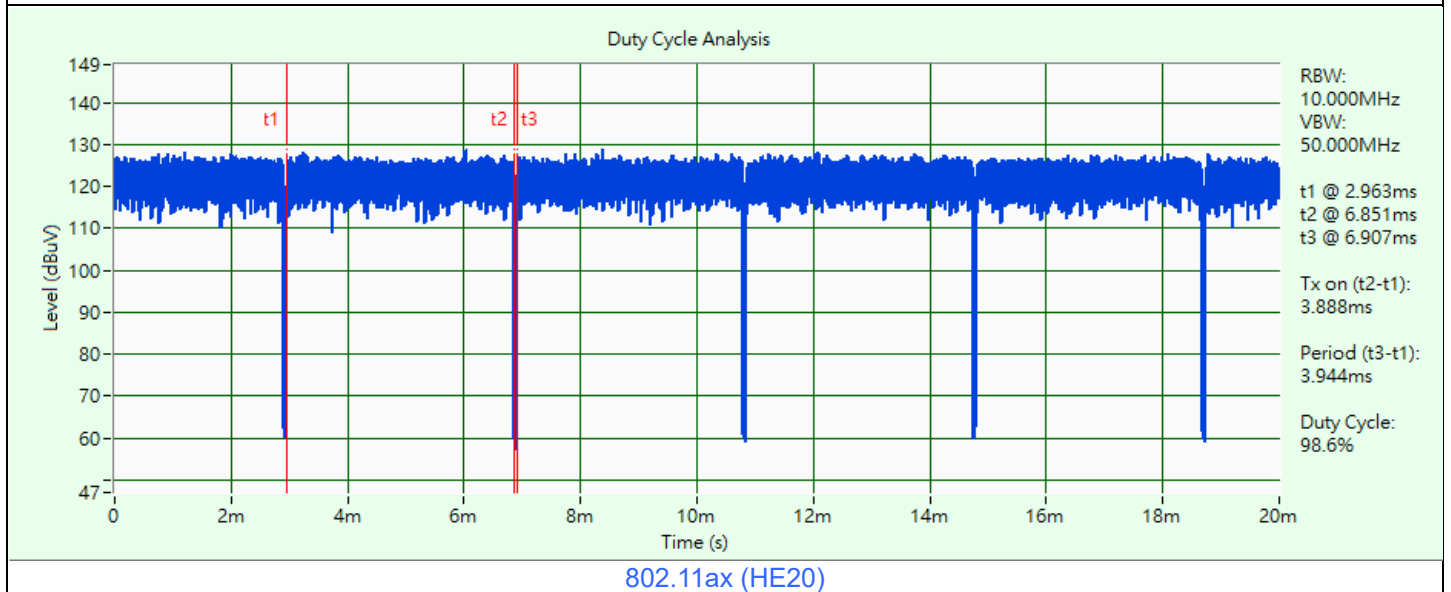

802.11ax (HE20)

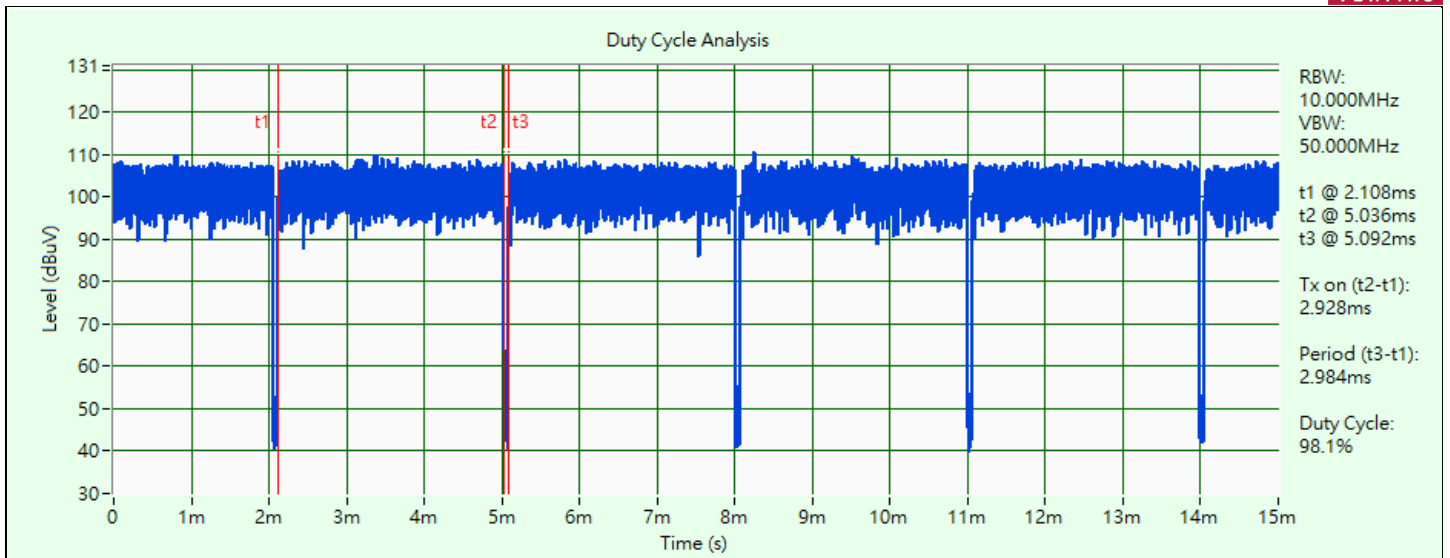

802.11ax (HE40)

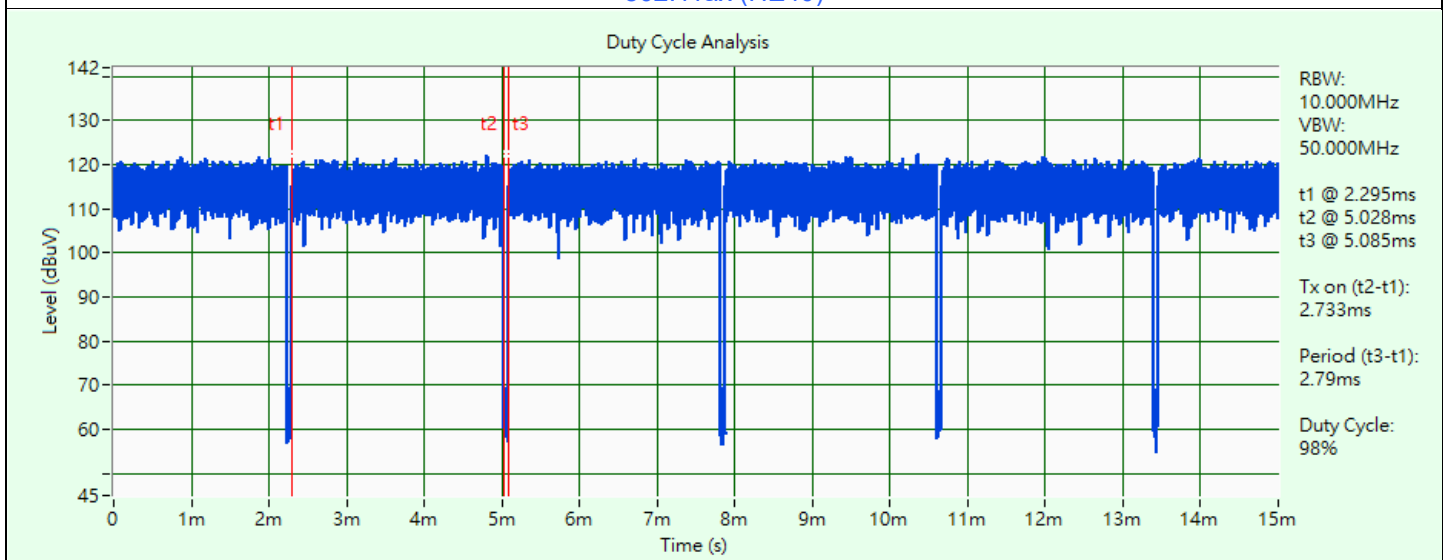

802.11ax (HE80)

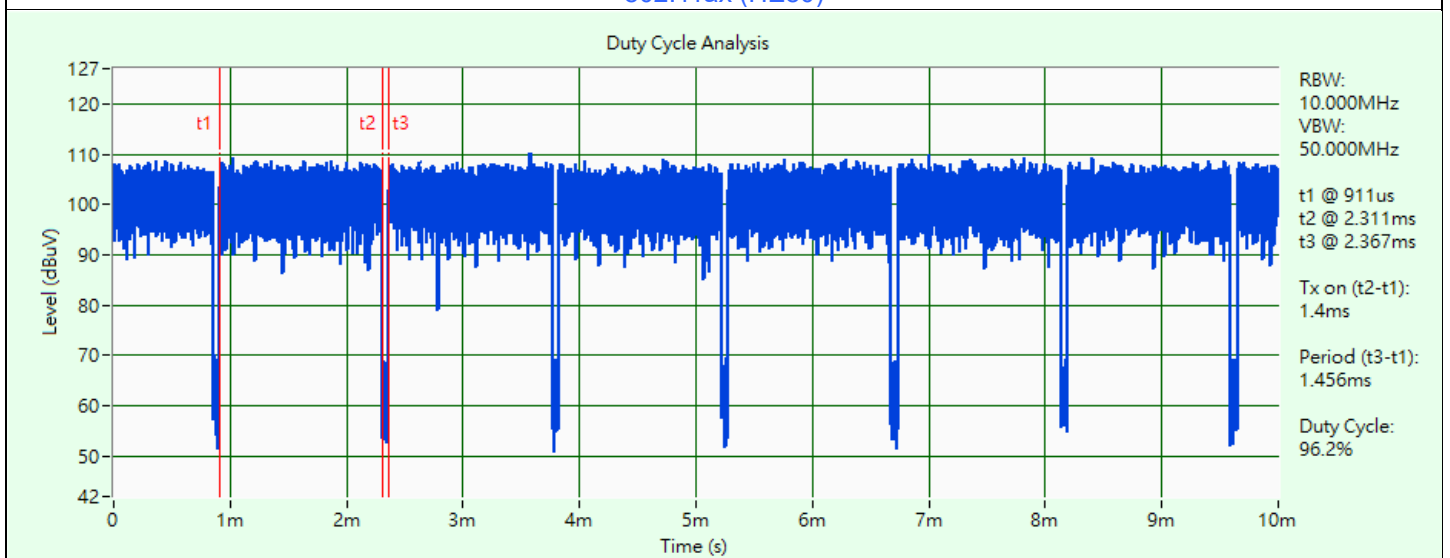

802.11ax (HE160)

### 3.6 Test Program Used and Operation Descriptions

Controlling software (QATool\_Ulv2.73\_DLLv6.79\_ap\_2021.11.02(V10)c) has been activated to set the EUT under transmission condition continuously at specific channel frequency.

### 3.7 Connection Diagram of EUT and Peripheral Devices

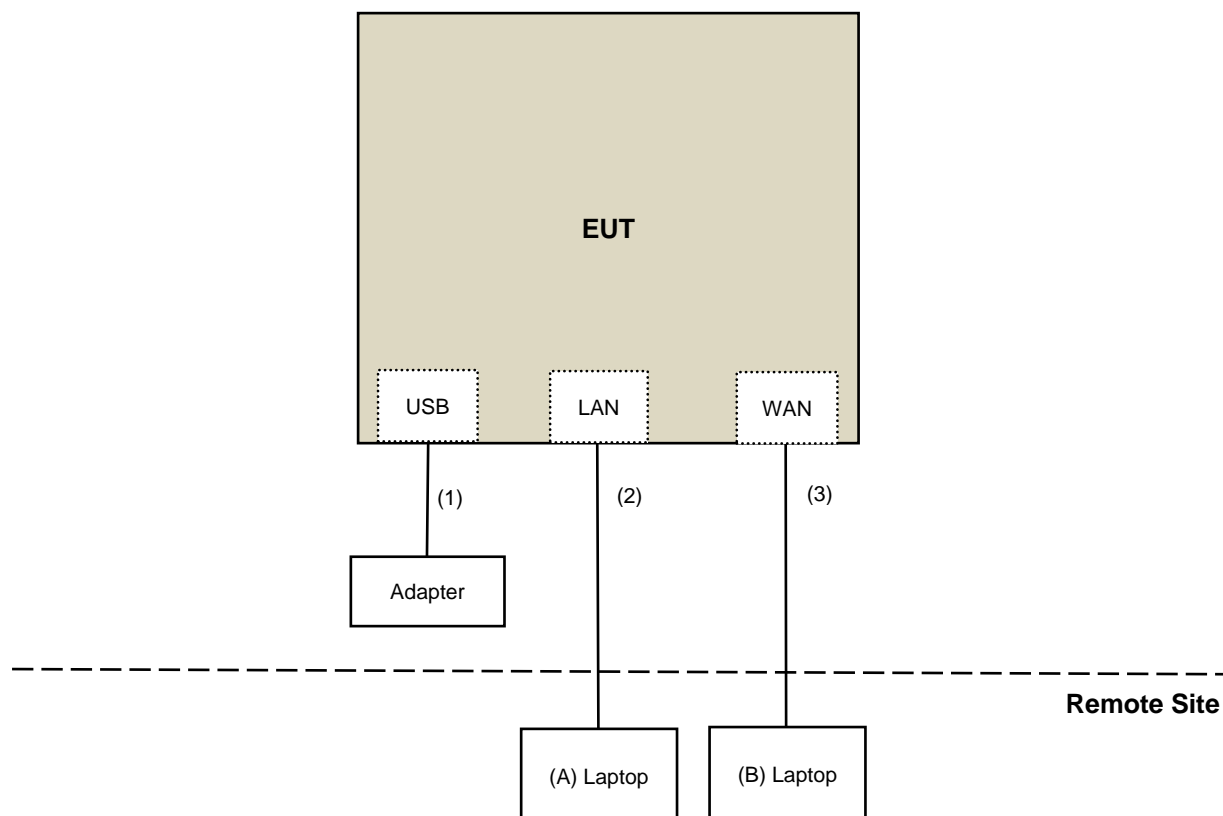

### 3.8 Configuration of Peripheral Devices and Cable Connections

ID	Product	Brand	Model No.	Serial No.	FCC ID	Remarks
A	Laptop	DELL	E5430	4YV4VY1	DoC	Provided by Lab
B	Laptop	DELL	E5430	HYV4VY1	DoC	Provided by Lab

ID	Cable Descriptions	Qty.	Length (m)	Shielding (Yes/No)	Cores (Qty.)	Remarks
1	DC Cable	1	1.8	No	0	Supplied by applicant
2	RJ-45 Cable	1	10	No	0	Provided by Lab
3	RJ-45 Cable	1	10	No	0	Provided by Lab



## 4 Test Instruments

The calibration interval of the all test instruments are 12 months and the calibrations are traceable to NML/ROC and NIST/USA.

### 4.1 26 dB Bandwidth

Description Manufacturer	Model No.	Serial No.	Calibrated Date	Calibrated Until
MXA Signal Analyzer Keysight	N9020B	MY60112409	2023/2/18	2024/2/17
Software	ADT_RF Test Software V7.6.5.4	N/A	N/A	N/A

Notes:

1. The test was performed in Oven room 2.
2. Tested Date: 2023/12/13 ~ 2023/12/14

### 4.2 RF Output Power

Description Manufacturer	Model No.	Serial No.	Calibrated Date	Calibrated Until
MXA Signal Analyzer Keysight	N9020B	MY60112409	2023/2/18	2024/2/17
Power Meter Anritsu	ML2495A	1529002	2023/6/17	2024/6/16
Pulse Power Sensor Anritsu	MA2411B	1726434	2023/6/19	2024/6/18
Software	ADT_RF Test Software V7.6.5.4	N/A	N/A	N/A

Notes:

1. The test was performed in Oven room 2.
2. Tested Date: 2023/12/13 ~ 2023/12/14

### 4.3 Power Spectral Density

Refer to section 4.1 to get information of the instruments.

### 4.4 6 dB Bandwidth

Refer to section 4.1 to get information of the instruments.

### 4.5 Occupied Bandwidth

Refer to section 4.1 to get information of the instruments.

#### 4.6 Frequency Stability

Description Manufacturer	Model No.	Serial No.	Calibrated Date	Calibrated Until
AC Power Source GOOD WILL	6905S	1991551	N/A	N/A
MXA Signal Analyzer Keysight	N9020B	MY60112409	2023/2/18	2024/2/17
Software	ADT_RF Test Software V7.6.5.4	N/A	N/A	N/A
Temperature & Humidity Chamber Giant Force	GTH-150-40-SP-AR	MAA0812-008	2022/12/26	2023/12/25
True RMS Clamp Meter FLUKE	325	31130711WS	2023/6/8	2024/6/7

Notes:

1. The test was performed in Oven room 2.
2. Tested Date: 2023/12/13 ~ 2023/12/14

#### 4.7 AC Power Conducted Emissions

Description Manufacturer	Model No.	Serial No.	Calibrated Date	Calibrated Until
50 ohm terminal resistance Telegartner	50 ohm	3	2023/10/20	2024/10/19
EMI Test Receiver R&S	ESCS 30	847124/029	2023/10/18	2024/10/17
Fixed Attenuator STI	STI02-2200-10	005	2023/7/1	2024/6/30
LISN R&S	ESH3-Z5	835239/001	2023/4/6	2024/4/5
		848773/004	2023/10/13	2024/10/12
RF Coaxial Cable JYEBAO	5D-FB	COCCAB-001	2023/7/1	2024/6/30
Software BVADT	BVADT_Cond_V7.3.7.4	N/A	N/A	N/A

Notes:

1. The test was performed in Conduction 1
2. Tested Date: 2023/12/13

#### 4.8 Unwanted Emissions below 1 GHz

Description Manufacturer	Model No.	Serial No.	Calibrated Date	Calibrated Until
Bi_Log Antenna Schwarzbeck	VULB 9168	9168-0842	2023/10/12	2024/10/11
Boresight Antenna Tower & Turn Table Max-Full	MF-7802BS	MF780208530	N/A	N/A
EMI Test Receiver R&S	ESR3	102528	2023/2/10	2024/2/9
Fixed Attenuator Mini-Circuits	UNAT-5+	PAD-ATT5-02	2022/12/28	2023/12/27
Loop Antenna Electro-Metrics	EM-6879	264	2023/2/21	2024/2/20
MXA Signal Analyzer Keysight	N9020B	MY60112410	2023/3/6	2024/3/5
Preamplifier EMCI	EMC330N	980538	2023/4/6	2024/4/5
	EMC001340	980142	2023/5/8	2024/5/7
PXA Signal Analyzer Keysight	N9030B	MY57141948	2023/5/19	2024/5/18
RF Coaxial Cable JYEBAO	5D-FB	LOOPCAB-001	2022/12/19	2023/12/18
		LOOPCAB-002	2022/12/19	2023/12/18
RF Coaxial Cable PEWC	8D	966-5-1	2023/4/6	2024/4/5
		966-5-2	2023/4/6	2024/4/5
		966-5-3	2023/4/6	2024/4/5
Software	ADT_Radiated_V8.7.08	N/A	N/A	N/A

Notes:

1. The test was performed in 966 Chamber No. 5.
2. Tested Date: 2023/12/1

#### 4.9 Unwanted Emissions above 1 GHz

Description Manufacturer	Model No.	Serial No.	Calibrated Date	Calibrated Until
Boresight Antenna Tower & Turn Table Max-Full	MF-7802BS	MF780208530	N/A	N/A
EMI Test Receiver R&S	ESR3	102528	2023/2/10	2024/2/9
Horn Antenna Schwarzbeck	BBHA 9120D	9120D-1819	2022/11/13 2023/11/12	2023/11/12 2024/11/11
	BBHA 9170	9170-739	2022/11/13 2023/11/12	2023/11/12 2024/11/11
MXA Signal Analyzer Keysight	N9020B	MY60112410	2023/3/6	2024/3/5
Preamplifier EMCI	EMC12630SE	980509	2023/4/7	2024/4/6
	EMC184045SE	980387	2023/8/9	2024/8/8
RF Coaxial Cable EMCI	EMC-KM-KM-4000	200214	2023/2/20	2024/2/19
	EMC102-KM-KM-1200	160924	2023/8/9	2024/8/8
	EMC104-SM-SM-1500	180503	2023/4/7	2024/4/6
	EMC104-SM-SM-2000	180501	2023/4/7	2024/4/6
	EMC104-SM-SM-6000	180506	2023/4/7	2024/4/6
Software	ADT_Radiated_V8.7.08	N/A	N/A	N/A

Notes:

1. The test was performed in 966 Chamber No. 5.
2. Tested Date: 2023/10/30 ~ 2023/12/4

## 5 Limits of Test Items

### 5.1 26 dB Bandwidth

The results are for reference only.

### 5.2 RF Output Power

Operation Band	EUT Category	Limit
U-NII-1	Outdoor Access Point	1 Watt (30 dBm) (Max. e.i.r.p $\leq$ 125mW(21 dBm) at any elevation angle above 30 degrees as measured from the horizon)
	Fixed point-to-point Access Point	1 Watt (30 dBm)
	Indoor Access Point	1 Watt (30 dBm)
	Mobile and Portable client device	250mW (24 dBm)

Operation Band	Limit
U-NII-2A	250 mW (24 dBm) or 11 dBm+10 log B*
U-NII-2C	250 mW (24 dBm) or 11 dBm+10 log B*
U-NII-3	1 Watt (30 dBm)

\*B is the 26 dB emission bandwidth in megahertz

Per KDB 662911 D01 Multiple Transmitter Output Method of conducted output power measurement on IEEE 802.11 devices,

Array Gain = 0 dB (i.e., no array gain) for  $N_{ANT} \leq 4$ ;

Array Gain = 0 dB (i.e., no array gain) for channel widths  $\geq 40$  MHz for any  $N_{ANT}$ ;

Array Gain =  $5 \log(N_{ANT}/N_{SS})$  dB or 3 dB, whichever is less, for 20-MHz channel widths with  $N_{ANT} \geq 5$ .

For power measurements on all other devices: Array Gain =  $10 \log(N_{ANT}/N_{SS})$  dB.

### 5.3 Power Spectral Density

Operation Band	EUT Category	Limit
U-NII-1	Outdoor Access Point	17 dBm/MHz
	Fixed point-to-point Access Point	
	Indoor Access Point	
	Mobile and Portable client device	11 dBm/MHz

Operation Band	Limit
U-NII-2A	11 dBm/MHz
U-NII-2C	11 dBm/MHz
U-NII-3	30 dBm/500 kHz

### 5.4 6 dB Bandwidth

Within the 5.725-5.850 GHz band, the minimum 6 dB bandwidth of U-NII devices shall be at least 500 kHz.

## 5.5 Occupied Bandwidth

The results are for reference only.

## 5.6 Frequency Stability

The frequency of the carrier signal shall be maintained within band of operation.

## 5.7 AC Power Conducted Emissions

Frequency (MHz)	Conducted Limit (dBuV)	
	Quasi-peak	Average
0.15 - 0.5	66 - 56	56 - 46
0.50 - 5.0	56	46
5.0 - 30.0	60	50

Notes:

1. The lower limit shall apply at the transition frequencies.
2. The limit decreases in line with the logarithm of the frequency in the range of 0.15 to 0.50 MHz.

## 5.8 Unwanted Emissions below 1 GHz

Radiated emissions which fall in the restricted bands must comply with the radiated emission limits specified as below table.

Frequencies (MHz)	Field Strength (microvolts/meter)	Measurement Distance (meters)
0.009 ~ 0.490	2400/F(kHz)	300
0.490 ~ 1.705	24000/F(kHz)	30
1.705 ~ 30.0	30	30
30 ~ 88	100	3
88 ~ 216	150	3
216 ~ 960	200	3
Above 960	500	3

Notes:

1. The lower limit shall apply at the transition frequencies.
2. Emission level (dBuV/m) = 20 log Emission level (uV/m).

## 5.9 Unwanted Emissions above 1 GHz

Radiated emissions which fall in the restricted bands must comply with the radiated emission limits specified as below table.

Frequencies (MHz)	Field Strength (microvolts/meter)	Measurement Distance (meters)
Above 960	500	3

Notes:

1. The lower limit shall apply at the transition frequencies.
2. Emission level (dBuV/m) = 20 log Emission level (uV/m).
3. For frequencies above 1000 MHz, the field strength limits are based on average detector, however, the peak field strength of any emission shall not exceed the maximum permitted average limits, specified above by more than 20 dB under any condition of modulation.

Limits of unwanted emission out of the restricted bands

Applicable To	Limit	
789033 D02 General UNII Test Procedure New Rules v02r01	Field Strength at 3 m	
	PK: 74 (dBμV/m)	AV: 54 (dBμV/m)

For transmitters operating in the 5.15-5.25 GHz band:

Applicable To	EIRP Limit	Equivalent Field Strength at 3 m
15.407(b)(1)	PK: -27 (dBm/MHz)	PK: 68.2 (dBμV/m)

For transmitters operating in the 5.25-5.35 GHz band:

Applicable To	EIRP Limit	Equivalent Field Strength at 3 m
15.407(b)(2)	PK: -27 (dBm/MHz)	PK: 68.2 (dBμV/m)

For transmitters operating in the 5.47-5.725 GHz band:

Applicable To	EIRP Limit	Equivalent Field Strength at 3 m
15.407(b)(3)	PK: -27 (dBm/MHz)	PK: 68.2 (dBμV/m)

For transmitters operating in the 5.725-5.850 GHz band:

Applicable To	EIRP Limit	Equivalent Field Strength at 3 m
15.407(b)(4)(i)	PK: -27 (dBm/MHz) <sup>*1</sup>	PK: 68.2 (dBμV/m) <sup>*1</sup>
	PK: 10 (dBm/MHz) <sup>*2</sup>	PK: 105.2 (dBμV/m) <sup>*2</sup>
	PK: 15.6 (dBm/MHz) <sup>*3</sup>	PK: 110.8 (dBμV/m) <sup>*3</sup>
	PK: 27 (dBm/MHz) <sup>*4</sup>	PK: 122.2 (dBμV/m) <sup>*4</sup>

<sup>\*1</sup> beyond 75 MHz or more above of the band edge.

<sup>\*2</sup> below the band edge increasing linearly to 10 dBm/MHz at 25 MHz above.

<sup>\*3</sup> below the band edge increasing linearly to a level of 15.6 dBm/MHz at 5 MHz above.

<sup>\*4</sup> from 5 MHz above or below the band edge increasing linearly to a level of 27 dBm/MHz at the band edge.

Note: The following formula is used to convert the equipment isotropic radiated power (eirp) to field strength:

$$E = \frac{1000000\sqrt{30P}}{3} \mu\text{V/m, where P is the eirp (Watts).}$$

## 6 Test Arrangements

### 6.1 26 dB Bandwidth

#### 6.1.1 Test Setup

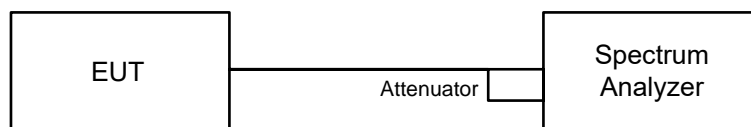

#### 6.1.2 Test Procedure

- a. Set RBW = approximately 1% of the emission bandwidth.
- b. Set the VBW > RBW.
- c. Detector = Peak.
- d. Trace mode = max hold.
- e. Measure the maximum width of the emission that is 26 dB down from the peak of the emission. Compare this with the RBW setting of the analyzer. Readjust RBW and repeat measurement as needed until the RBW/EBW ratio is approximately 1%.



## 6.2 RF Output Power

### 6.2.1 Test Setup

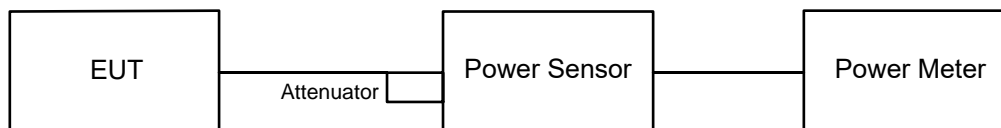

#### For channel straddling:

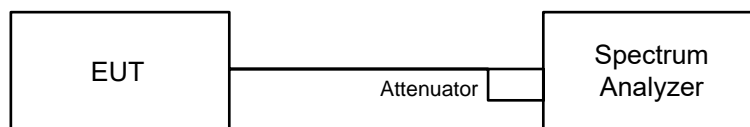

### 6.2.2 Test Procedure

Method PM is used to perform output power measurement, trigger and gating function of wide band power meter is enabled to measure max output power of TX on burst and set the detector to average. Duty factor is not added to measured value.

#### For channel straddling:

##### Method SA-1

- Set span to encompass the entire emission bandwidth (EBW) of the signal.
- Set RBW = 1 MHz, Set VBW  $\geq$  3 MHz, Detector = RMS
- Sweep points  $\geq$   $[2 \times \text{span} / \text{RBW}]$ . (This gives bin-to-bin spacing  $\leq$  RBW / 2, so that narrowband signals are not lost between frequency bins.)
- Sweep time = auto, trigger set to "free run".
- Trace average at least 100 traces in power averaging mode.
- Record the max value

Note: When measuring straddle channel power, use compute power by integrating the spectrum across the 26 dB EBW or 99% OBW of the signal using the instrument's band power measurement function, with band limits set equal to the EBW or OBW band edges. If the instrument does not have a band power function, then sum the spectrum levels (in power units) at 1 MHz intervals extending across the 26 dB EBW or 99% OBW of the spectrum.

#### For channel straddling:

##### Method SA-2

- Set span to encompass the entire emission bandwidth (EBW) of the signal.
- Set RBW = 1 MHz, Set VBW  $\geq$  3 MHz, Detector = RMS
- Sweep points  $\geq$   $[2 \times \text{span} / \text{RBW}]$ . (This gives bin-to-bin spacing  $\leq$  RBW / 2, so that narrowband signals are not lost between frequency bins.) Sweep time = auto, trigger set to "free run".
- Trace average at least 100 traces in power averaging mode.
- Use the peak search function on the instrument to find the peak of the spectrum and record its value.
- Record the max value and add  $10 \log (1/\text{duty cycle})$ .

Note: When measuring straddle channel power, use compute power by integrating the spectrum across the 26 dB EBW or 99% OBW of the signal using the instrument's band power measurement function, with band limits set equal to the EBW or OBW band edges. If the instrument does not have a band power function, then sum the spectrum levels (in power units) at 1 MHz intervals extending across the 26 dB EBW or 99% OBW of the spectrum.

## 6.3 Power Spectral Density

### 6.3.1 Test Setup

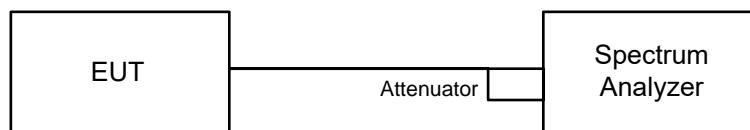

### 6.3.2 Test Procedure

#### For specified measurement bandwidth 1 MHz:

##### Method SA-1

- Set span to encompass the entire emission bandwidth (EBW) of the signal.
- Set RBW = 1 MHz, Set VBW  $\geq$  3 MHz, Detector = RMS
- Sweep points  $\geq [2 \times \text{span} / \text{RBW}]$ . (This gives bin-to-bin spacing  $\leq$  RBW / 2, so that narrowband signals are not lost between frequency bins.)
- Sweep time = auto, trigger set to "free run".
- Trace average at least 100 traces in power averaging mode.
- Record the max value

#### For specified measurement bandwidth 1 MHz:

##### Method SA-2

- Set span to encompass the entire emission bandwidth (EBW) of the signal.
- Set RBW = 1 MHz, Set VBW  $\geq$  3 MHz, Detector = RMS
- Sweep points  $\geq [2 \times \text{span} / \text{RBW}]$ . (This gives bin-to-bin spacing  $\leq$  RBW / 2, so that narrowband signals are not lost between frequency bins.)
- Sweep time = auto, trigger set to "free run".
- Trace average at least 100 traces in power averaging mode.
- Use the peak search function on the instrument to find the peak of the spectrum and record its value.
- Record the max value and add 10 log (1/duty cycle).

#### For specified measurement bandwidth 500 kHz:

##### Method SA-1

- Set span to encompass the entire emission bandwidth (EBW) of the signal.
- Set RBW = 300 kHz, Set VBW  $\geq$  1 MHz, Detector = RMS
- Scale the observed power level to an equivalent value in 500 kHz by adjusting (increasing) the measured power by a bandwidth correction factor (BWCF) where  $\text{BWCF} = 10\log(500 \text{ kHz}/300 \text{ kHz})$
- Sweep points  $\geq [2 \times \text{span} / \text{RBW}]$ . (This gives bin-to-bin spacing  $\leq$  RBW / 2, so that narrowband signals are not lost between frequency bins.)
- Sweep time = auto, trigger set to "free run".
- Trace average at least 100 traces in power averaging mode.
- Record the max value

#### For specified measurement bandwidth 500 kHz:

##### Method SA-2

- Set span to encompass the entire emission bandwidth (EBW) of the signal.
- Set RBW = 300 kHz, Set VBW  $\geq$  1 MHz, Detector = RMS
- Scale the observed power level to an equivalent value in 500 kHz by adjusting (increasing) the measured power by a bandwidth correction factor (BWCF) where  $\text{BWCF} = 10\log(500 \text{ kHz}/300 \text{ kHz})$
- Sweep points  $\geq [2 \times \text{span} / \text{RBW}]$ . (This gives bin-to-bin spacing  $\leq$  RBW / 2, so that narrowband signals are not lost between frequency bins.)
- Sweep time = auto, trigger set to "free run".

- f. Trace average at least 100 traces in power averaging mode.
- g. Use the peak search function on the instrument to find the peak of the spectrum and record its value.
- h. Record the max value and add  $10 \log (1/\text{duty cycle})$ .

## 6.4 6 dB Bandwidth

### 6.4.1 Test Setup

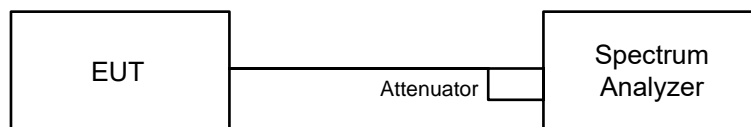

### 6.4.2 Test Procedure

- a. Set resolution bandwidth (RBW) = 100 kHz.
- b. Set the video bandwidth (VBW)  $\geq 3 \times$  RBW, Detector = Peak.
- c. Trace mode = max hold.
- d. Sweep = auto couple.
- e. Measure the maximum width of the emission that is constrained by the frequencies associated with the two amplitude points (upper and lower) that are attenuated by 6 dB relative to the maximum level measured in the fundamental emission.

## 6.5 Occupied Bandwidth

### 6.5.1 Test Setup

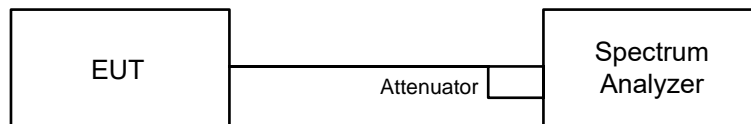

### 6.5.2 Test Procedure

The transmitter output was connected to the spectrum analyzer through an attenuator. The bandwidth of the fundamental frequency was measured by spectrum analyzer with resolution bandwidth in the range of 1% to 5% of the anticipated emission bandwidth, and a video bandwidth at least 3x the resolution bandwidth and set the detector to Sampling. The width of a frequency band such that, below the lower and above the upper frequency limits, the mean powers emitted are each equal to a specified percentage 0.5% of the total mean power of a given emission.

## 6.6 Frequency Stability

### 6.6.1 Test Setup

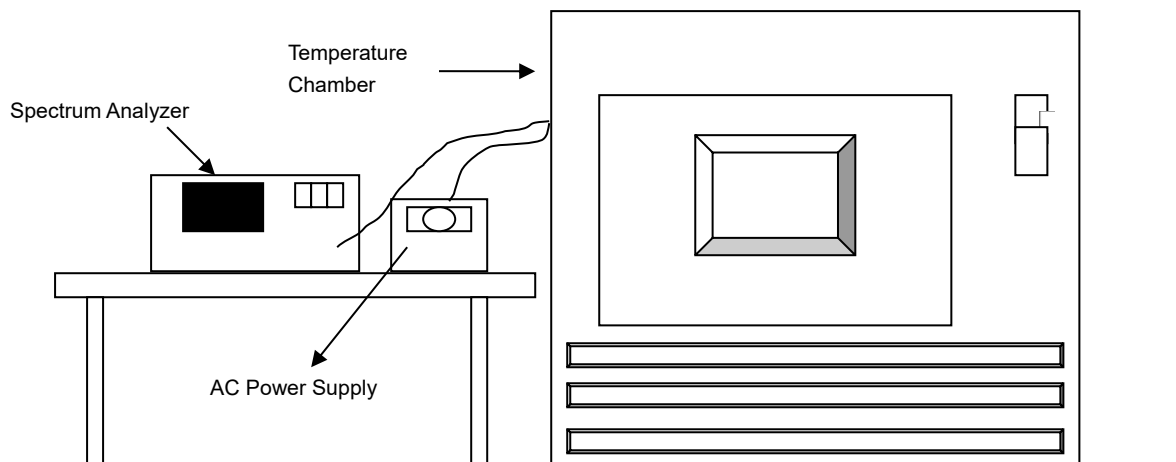

### 6.6.2 Test Procedure

- a. The EUT was placed inside the environmental test chamber and powered by nominal AC voltage.
- b. Turn the EUT on and couple its output to a spectrum analyzer.
- c. Turn the EUT off and set the chamber to the highest temperature specified.
- d. Allow sufficient time (approximately 30 min) for the temperature of the chamber to stabilize, turn the EUT on and measure the operating frequency after 2, 5, and 10 Minutes.
- e. Repeat step (d) with the temperature chamber set to the next desired temperature until measurements down to the lowest specified temperature have been completed.
- f. The test chamber was allowed to stabilize at +20 degree C for a minimum of 30 Minutes. The supply voltage was then adjusted on the EUT from 85% to 115% and the frequency record.

## 6.7 AC Power Conducted Emissions

### 6.7.1 Test Setup

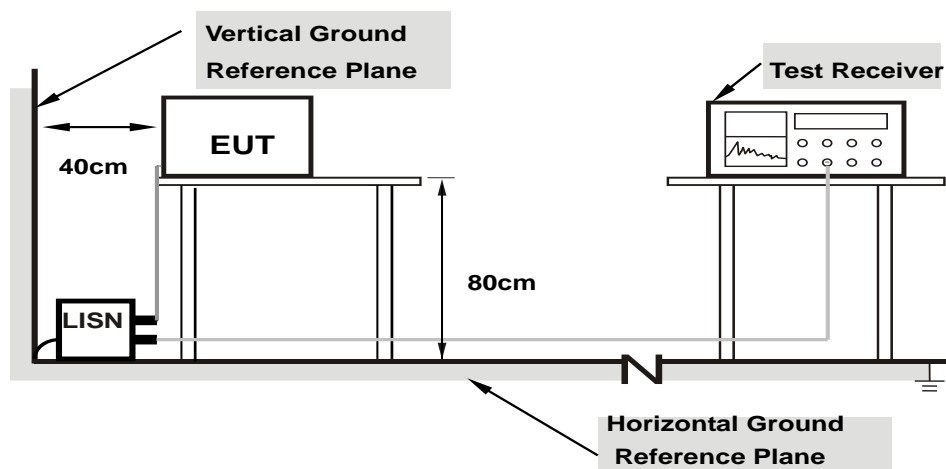

**Note: 1. Support units were connected to second LISN.**

For the actual test configuration, please refer to the attached file (Test Setup Photo).

### 6.7.2 Test Procedure

- The EUT was placed on a 0.8 meter to the top of table and placed 0.4 meters from the conducting wall of the shielded room with EUT being connected to the power mains through a line impedance stabilization network (LISN). Other support units were connected to the power mains through another LISN. The two LISNs provide 50 ohm/ 50 uH of coupling impedance for the measuring instrument.
- Both lines of the power mains connected to the EUT were checked for maximum conducted interference.
- The frequency range from 150 kHz to 30 MHz was searched. Emission levels under (Limit – 20 dB) was not recorded.

Note: The resolution bandwidth and video bandwidth of test receiver is 9 kHz for quasi-peak detection (QP) and average detection (AV) at frequency 0.15 MHz-30 MHz.

## 6.8 Unwanted Emissions below 1 GHz

### 6.8.1 Test Setup

#### For Radiated emission above 30 MHz

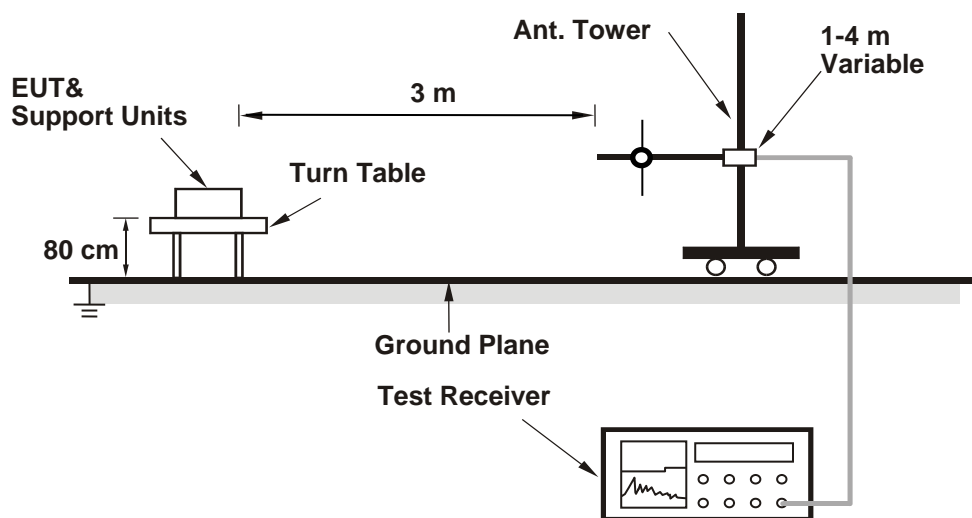

For the actual test configuration, please refer to the attached file (Test Setup Photo).

## 6.8.2 Test Procedure

### For Radiated emission above 30 MHz

- a. The EUT was placed on the top of a rotating table 0.8 meters above the ground at 3 meter chamber room for test. The table was rotated 360 degrees to determine the position of the highest radiation.
- b. The EUT was set 3 meters away from the interference-receiving antenna, which was mounted on the top of a variable-height antenna tower.
- c. The height of antenna is varied from one meter to four meters above the ground to determine the maximum value of the field strength. Both horizontal and vertical polarizations of the antenna are set to make the measurement.
- d. For each suspected emission, the EUT was arranged to its worst case and then the antenna was tuned to heights from 1 meter to 4 meters and the rotatable table was turned from 0 degrees to 360 degrees to find the maximum reading.
- e. The test-receiver system was set to quasi-peak detect function and specified bandwidth with maximum hold mode when the test frequency is below 1 GHz.

#### Notes:

1. The resolution bandwidth and video bandwidth of test receiver/spectrum analyzer is 120 kHz for Quasi-peak detection (QP) at frequency below 1 GHz.
2. All modes of operation were investigated and the worst-case emissions are reported.

## 6.9 Unwanted Emissions above 1 GHz

### 6.9.1 Test Setup

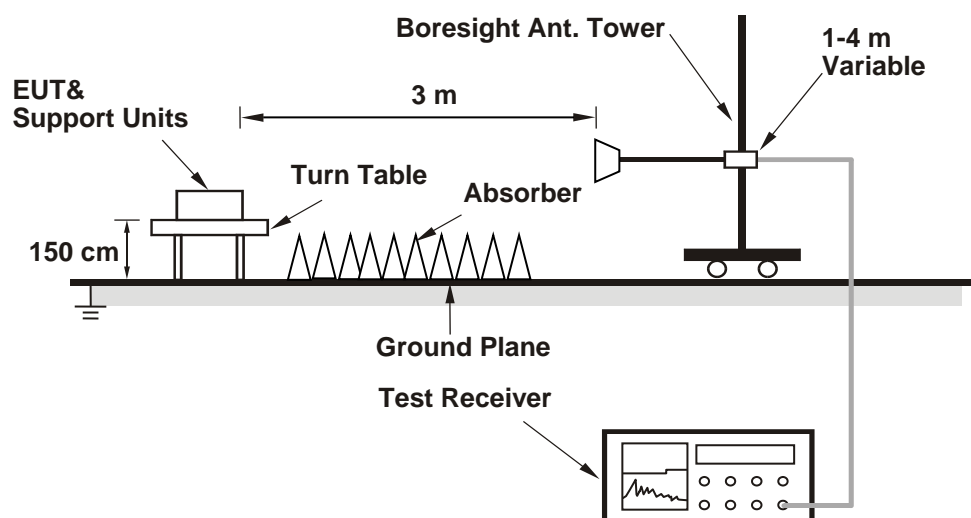

For the actual test configuration, please refer to the attached file (Test Setup Photo).

### 6.9.2 Test Procedure

- The EUT was placed on the top of a rotating table 1.5 meters above the ground at 3 meter chamber room for test. The table was rotated 360 degrees to determine the position of the highest radiation.
- The EUT was set 3 meters away from the interference-receiving antenna, which was mounted on the top of a variable-height antenna tower.
- The height of antenna is varied from one meter to four meters above the ground to determine the maximum value of the field strength. Both horizontal and vertical polarizations of the antenna are set to make the measurement.
- For each suspected emission, the EUT was arranged to its worst case and then the antenna was tuned to heights from 1 meter to 4 meters and the rotatable table was turned from 0 degrees to 360 degrees to find the maximum reading.
- The test-receiver system was set to peak and average detects function and specified bandwidth with maximum hold mode when the test frequency is above 1 GHz. If the peak reading value also meets average limit, measurement with the average detector is unnecessary.

#### Notes:

- The resolution bandwidth of test receiver/spectrum analyzer is 1 MHz and the video bandwidth is 3 MHz for Peak detection (PK) and Average detection (AV) at frequency above 1 GHz.
- For fundamental and harmonic signal measurement, the resolution bandwidth of test receiver/spectrum analyzer is 1 MHz and the video bandwidth is  $\geq 1/T$  (Duty cycle  $< 98\%$ ) or 10 Hz (Duty cycle  $\geq 98\%$ ) for Average detection (AV) at frequency above 1 GHz.
- All modes of operation were investigated and the worst-case emissions are reported.



## 7 Test Results of Test Item

### 7.1 26 dB Bandwidth

Input Power:	120 Vac, 60 Hz	Environmental Conditions:	25°C, 60% RH	Tested By:	Willy Lin
--------------	----------------	---------------------------	--------------	------------	-----------

#### 802.11a

Channel	Frequency (MHz)	26 dB Bandwidth (MHz)			
		Chain 0	Chain 1	Chain 2	Chain 3
52	5260	24.70	22.79	21.88	21.56
60	5300	28.71	34.34	36.53	31.05
64	5320	29.61	29.05	30.61	31.56
100	5500	35.80	34.86	33.39	29.77
116	5580	22.04	21.77	21.80	21.92
140	5700	28.54	27.30	27.27	27.79
144 (U-NII-2C)	5720	16.26	15.99	16.42	15.73
144 (U-NII-3)	5720	6.05	6.08	5.84	6.03

Determined Output Power Limit			
Channel Number	Freq.(MHz)	Min. B(MHz)	Determined Conducted Power Limit (dBm)
52	5260	21.56	24.33 > 24
60	5300	28.71	25.58 > 24
64	5320	29.05	25.63 > 24
100	5500	29.77	25.73 > 24
116	5580	21.77	24.37 > 24
140	5700	27.27	25.35 > 24
144 (U-NII-2C)	5720	15.73	22.96 < 24

Note: For U-NII-2A, U-NII-2C Band output power limitation is determined based on 26dBc bandwidth.

**802.11ax (HE20)**

Channel	Frequency (MHz)	26 dB Bandwidth (MHz)			
		Chain 0	Chain 1	Chain 2	Chain 3
52	5260	22.95	23.51	22.98	22.63
60	5300	36.73	38.62	32.74	39.01
64	5320	33.07	36.48	33.71	32.88
100	5500	33.54	28.10	32.08	29.69
116	5580	22.75	22.51	22.54	22.94
140	5700	29.16	26.90	30.03	28.26
144 (U-NII-2C)	5720	16.53	16.56	16.81	16.66
144 (U-NII-3)	5720	7.01	6.62	6.40	6.44

Determined Output Power Limit			
Channel Number	Freq.(MHz)	Min. B(MHz)	Determined Conducted Power Limit (dBm)
52	5260	22.63	24.54 > 24
60	5300	32.74	26.15 > 24
64	5320	32.88	26.16 > 24
100	5500	28.10	25.48 > 24
116	5580	22.51	24.52 > 24
140	5700	26.90	25.29 > 24
144 (U-NII-2C)	5720	16.53	23.18 < 24

Note: For U-NII-2A, U-NII-2C Band output power limitation is determined based on 26dBc bandwidth.

**802.11ax (HE40)**

Channel	Frequency (MHz)	26 dB Bandwidth (MHz)			
		Chain 0	Chain 1	Chain 2	Chain 3
54	5270	40.28	40.19	40.19	40.17
62	5310	51.07	45.87	48.59	51.93
102	5510	46.23	46.05	42.37	46.80
110	5550	40.30	40.13	40.25	40.25
134	5670	49.12	56.92	54.27	54.68
142 (U-NII-2C)	5710	35.19	35.29	35.11	35.11
142 (U-NII-3)	5710	4.99	4.97	5.07	13.03

Determined Output Power Limit			
Channel Number	Freq.(MHz)	Min. B(MHz)	Determined Conducted Power Limit (dBm)
54	5270	40.17	27.03 > 24
62	5310	45.87	27.61 > 24
102	5510	42.37	27.27 > 24
110	5550	40.13	27.03 > 24
134	5670	49.12	27.91 > 24
142 (U-NII-2C)	5710	35.11	26.45 > 24

Note: For U-NII-2A, U-NII-2C Band output power limitation is determined based on 26dBc bandwidth.

**802.11ax (HE80)**

Channel	Frequency (MHz)	26 dB Bandwidth (MHz)			
		Chain 0	Chain 1	Chain 2	Chain 3
58	5290	95.91	92.01	94.70	81.44
106	5530	84.90	88.07	95.93	87.70
122	5610	81.28	81.21	81.22	81.28
138 (U-NII-2C)	5690	75.66	75.69	75.64	75.71
138 (U-NII-3)	5690	5.59	5.63	5.56	5.58

Determined Output Power Limit			
Channel Number	Freq.(MHz)	Min. B(MHz)	Determined Conducted Power Limit (dBm)
58	5290	81.44	30.1 > 24
106	5530	84.90	30.28 > 24
122	5610	81.21	30.09 > 24
138 (U-NII-2C)	5690	75.64	29.78 > 24

Note: For U-NII-2A, U-NII-2C Band output power limitation is determined based on 26dBc bandwidth.

**802.11ax (HE160)**

Channel	Frequency (MHz)	26 dB Bandwidth (MHz)			
		Chain 0	Chain 1	Chain 2	Chain 3
50 (U-NII-1)	5250	82.14	81.80	82.18	81.59
50 (U-NII-2A)	5250	81.78	82.04	83.05	81.57
114	5570	165.36	165.55	165.65	165.57

Determined Output Power Limit			
Channel Number	Freq.(MHz)	Min. B(MHz)	Determined Conducted Power Limit (dBm)
50 (U-NII-2A)	5250	81.57	30.11 > 24
114	5570	165.36	33.18 > 24

Note: For U-NII-2A, U-NII-2C Band output power limitation is determined based on 26dBc bandwidth.

### Spectrum Plot of Minimum Value

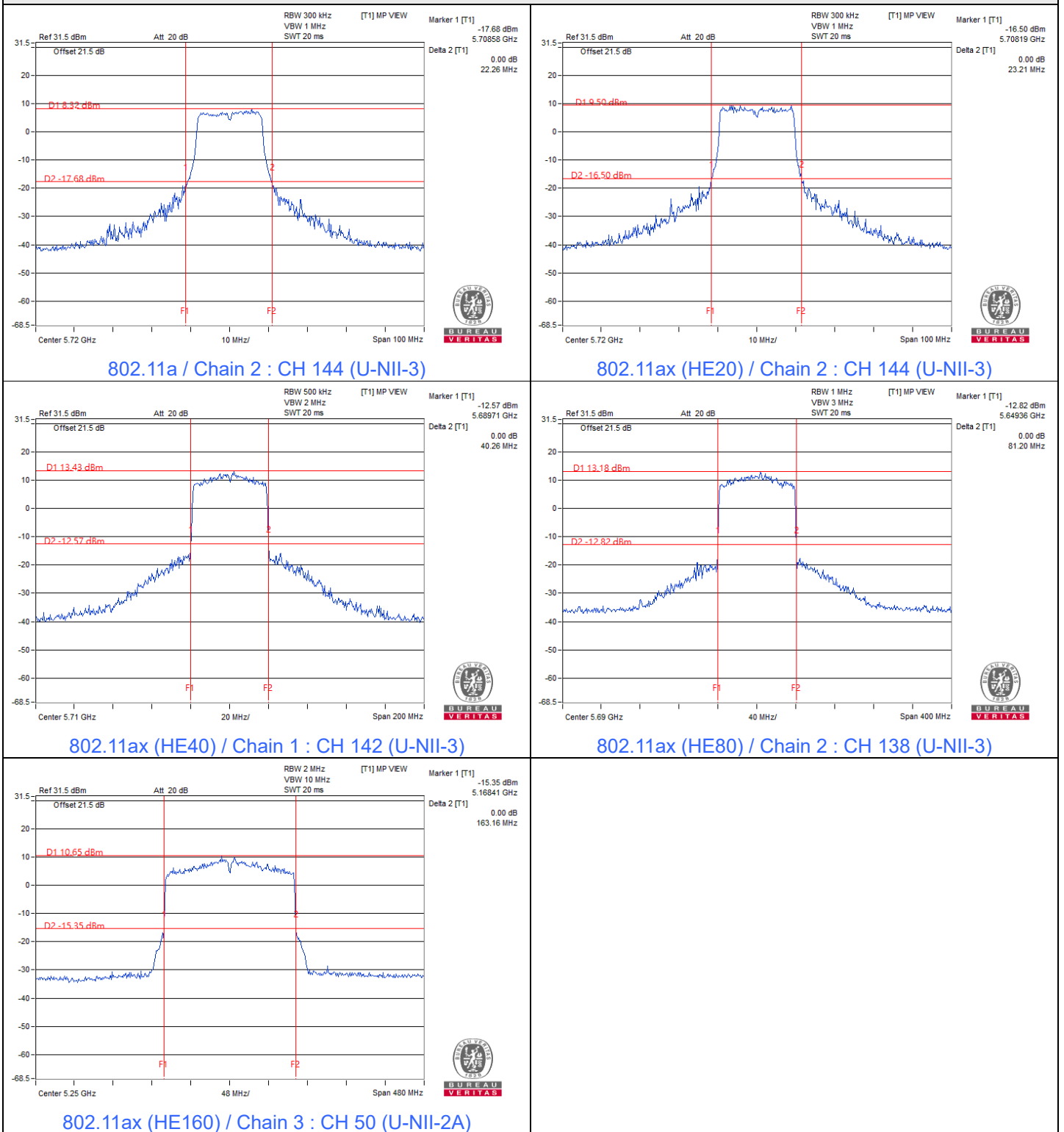

**Notes:**

1. For U-NII-2C straddle channel = 5725 MHz - Marker 1
2. For U-NII-3 straddle channel = Marker 1 + Delta 2 - 5725 MHz
3. For U-NII-1 straddle channel = 5250 MHz - Marker 1
4. For U-NII-2A straddle channel = Marker 1 + Delta 2 - 5250 MHz

## 7.2 RF Output Power

Input Power:	120 Vac, 60 Hz	Environmental Conditions:	25°C, 60% RH	Tested By:	Willy Lin
--------------	----------------	---------------------------	--------------	------------	-----------

### 802.11a CDD

Chan.	Chan. Freq. (MHz)	Average Power (dBm)				Total Power (mW)	Total Power (dBm)	Power Limit (dBm)	Test Result
		Chain 0	Chain 1	Chain 2	Chain 3				
36	5180	20.79	21.37	21.34	20.98	518.497	27.15	30	Pass
40	5200	21.86	22.32	22.28	21.97	650.512	28.13	30	Pass
48	5240	22.15	22.43	22.09	21.62	646.063	28.10	30	Pass
52	5260	17.71	18.17	17.83	17.58	242.588	23.85	24	Pass
60	5300	17.36	17.91	17.73	17.51	231.908	23.65	24	Pass
64	5320	17.03	17.98	17.69	17.33	226.096	23.54	24	Pass
100	5500	17.22	17.77	17.73	17.43	227.192	23.56	24	Pass
116	5580	17.37	17.89	18.12	17.34	235.157	23.71	24	Pass
140	5700	17.66	18.35	18.02	17.64	248.199	23.95	24	Pass
*144 (U-NII-2C)	5720	15.05	14.40	14.43	13.65	110.438	20.43	22.96	Pass
*144 (U-NII-3)	5720	9.02	8.96	8.95	7.67	29.551	14.71	30	Pass
149	5745	23.99	23.57	23.36	23.03	895.8	29.52	30	Pass
157	5785	24.13	23.87	23.87	23.36	963.154	29.84	30	Pass
165	5825	24.07	23.96	23.57	23.31	945.955	29.76	30	Pass

#### Notes:

- \* : Test was performed in accordance with measurement follow FCC KDB 789033 UNII test procedure Method SA-1 and use spectrum analyzer test.
- Directional gain is the maximum gain of antennas.
- For U-NII-1, the directional gain is 4.09 dBi < 6 dBi, so the output power limit shall not be reduced.
- For U-NII-2A, the directional gain is 2.68 dBi < 6 dBi, so the output power limit shall not be reduced.
- For U-NII-2C, the directional gain is 3.38 dBi < 6 dBi, so the output power limit shall not be reduced.
- For U-NII-3, the directional gain is 2.64 dBi < 6 dBi, so the output power limit shall not be reduced.

**802.11ac (VHT20) CDD**

Chan.	Chan. Freq. (MHz)	Average Power (dBm)				Total Power (mW)	Total Power (dBm)	Power Limit (dBm)	Test Result
		Chain 0	Chain 1	Chain 2	Chain 3				
36	5180	18.78	19.50	19.38	19.01	330.946	25.20	30	Pass
40	5200	19.94	20.56	20.47	20.08	425.679	26.29	30	Pass
48	5240	21.79	21.95	21.58	21.26	585.223	27.67	30	Pass
52	5260	17.15	17.52	17.18	16.96	210.273	23.23	24	Pass
60	5300	17.08	18.12	17.84	17.36	231.178	23.64	24	Pass
64	5320	17.13	18.32	17.82	17.53	236.72	23.74	24	Pass
100	5500	17.27	17.94	17.89	17.50	233.315	23.68	24	Pass
116	5580	17.08	17.69	18.10	17.02	224.715	23.52	24	Pass
140	5700	17.36	18.12	17.71	17.12	229.857	23.61	24	Pass
*144 (U-NII-2C)	5720	15.47	15.35	14.33	14.15	122.617	20.89	23.18	Pass
*144 (U-NII-3)	5720	10.01	10.06	8.86	8.94	35.688	15.53	30	Pass
149	5745	23.17	23.41	23.03	22.59	809.233	29.08	30	Pass
157	5785	23.54	23.89	23.77	23.64	940.288	29.73	30	Pass
165	5825	23.44	23.87	23.62	23.57	922.235	29.65	30	Pass

**Notes:**

1. \* : Test was performed in accordance with measurement follow FCC KDB 789033 UNII test procedure Method SA-1 and use spectrum analyzer test.
2. Directional gain is the maximum gain of antennas.
3. For U-NII-1, the directional gain is 4.09 dBi < 6 dBi, so the output power limit shall not be reduced.
4. For U-NII-2A, the directional gain is 2.68 dBi < 6 dBi, so the output power limit shall not be reduced.
5. For U-NII-2C, the directional gain is 3.38 dBi < 6 dBi, so the output power limit shall not be reduced.
6. For U-NII-3, the directional gain is 2.64 dBi < 6 dBi, so the output power limit shall not be reduced.

### 802.11ac (VHT40) CDD

Chan.	Chan. Freq. (MHz)	Average Power (dBm)				Total Power (mW)	Total Power (dBm)	Power Limit (dBm)	Test Result
		Chain 0	Chain 1	Chain 2	Chain 3				
38	5190	17.18	17.71	17.71	17.24	223.246	23.49	30	Pass
46	5230	20.08	20.36	20.10	18.48	383.3	25.84	30	Pass
54	5270	17.49	17.82	17.57	16.98	223.675	23.50	24	Pass
62	5310	17.14	17.87	17.79	17.14	224.874	23.52	24	Pass
102	5510	17.61	17.63	17.63	17.13	225.204	23.53	24	Pass
110	5550	17.73	17.18	17.62	17.02	219.692	23.42	24	Pass
134	5670	17.79	18.05	17.66	17.11	233.693	23.69	24	Pass
*142 (U-NII-2C)	5710	15.12	16.45	16.20	15.83	156.635	21.95	24	Pass
*142 (U-NII-3)	5710	3.26	4.93	3.85	3.98	10.157	10.07	30	Pass
151	5755	21.22	20.99	20.80	20.25	484.189	26.85	30	Pass
159	5795	22.53	22.25	22.01	21.71	654.047	28.16	30	Pass

**Notes:**

- \* : Test was performed in accordance with measurement follow FCC KDB 789033 UNII test procedure Method SA-1 and use spectrum analyzer test.
- Directional gain is the maximum gain of antennas.
- For U-NII-1, the maximum gain is 4.09 dBi < 6 dBi, so the output power limit shall not be reduced.
- For U-NII-2A, the maximum gain is 2.68 dBi < 6 dBi, so the output power limit shall not be reduced.
- For U-NII-2C, the maximum gain is 3.38 dBi < 6 dBi, so the output power limit shall not be reduced.
- For U-NII-3, the maximum gain is 2.64 dBi < 6 dBi, so the output power limit shall not be reduced.

### 802.11ac (VHT80) CDD

Chan.	Chan. Freq. (MHz)	Average Power (dBm)				Total Power (mW)	Total Power (dBm)	Power Limit (dBm)	Test Result
		Chain 0	Chain 1	Chain 2	Chain 3				
42	5210	14.60	15.40	15.33	14.88	128.394	21.09	30	Pass
58	5290	16.35	16.74	16.65	16.04	176.775	22.47	24	Pass
106	5530	16.32	16.65	16.65	16.07	175.789	22.45	24	Pass
122	5610	17.50	17.61	17.91	16.91	224.803	23.52	24	Pass
*138 (U-NII-2C)	5690	15.86	16.24	15.77	15.61	154.769	21.90	24	Pass
*138 (U-NII-3)	5690	0.60	1.43	-0.60	0.39	4.503	6.54	30	Pass
155	5775	18.66	18.55	18.88	18.12	287.197	24.58	30	Pass

**Notes:**

- \* : Test was performed in accordance with measurement follow FCC KDB 789033 UNII test procedure Method SA-1 and use spectrum analyzer test.
- Directional gain is the maximum gain of antennas.
- For U-NII-1, the maximum gain is 4.09 dBi < 6 dBi, so the output power limit shall not be reduced.
- For U-NII-2A, the maximum gain is 2.68 dBi < 6 dBi, so the output power limit shall not be reduced.
- For U-NII-2C, the maximum gain is 3.38 dBi < 6 dBi, so the output power limit shall not be reduced.
- For U-NII-3, the maximum gain is 2.64 dBi < 6 dBi, so the output power limit shall not be reduced.



### 802.11ac (VHT160) CDD

Chan.	Chan. Freq. (MHz)	Average Power (dBm)				Total Power (mW)	Total Power (dBm)	Power Limit (dBm)	Test Result
		Chain 0	Chain 1	Chain 2	Chain 3				
*50 (U-NII-1)	5250	10.34	9.86	7.01	10.24	37.532	15.74	30	Pass
*50 (U-NII-2A)	5250	8.87	8.75	9.30	10.40	36.072	15.57	24	Pass
114	5570	15.13	14.62	15.04	14.53	121.852	20.86	24	Pass

Notes:

- \* : Test was performed in accordance with measurement follow FCC KDB 789033 UNII test procedure Method SA-2 and use spectrum analyzer test , the duty factor was included in the total power.
- Directional gain is the maximum gain of antennas.
- For U-NII-1, the maximum gain is 4.09 dBi < 6 dBi, so the output power limit shall not be reduced.
- For U-NII-2A, the maximum gain is 2.68 dBi < 6 dBi, so the output power limit shall not be reduced.
- For U-NII-2C, the maximum gain is 3.38 dBi < 6 dBi, so the output power limit shall not be reduced.

### 802.11ax (HE20) CDD

Chan.	Chan. Freq. (MHz)	Average Power (dBm)				Total Power (mW)	Total Power (dBm)	Power Limit (dBm)	Test Result
		Chain 0	Chain 1	Chain 2	Chain 3				
36	5180	19.06	19.79	19.65	19.25	352.214	25.47	30	Pass
40	5200	20.16	20.81	20.71	20.36	450.66	26.54	30	Pass
48	5240	22.04	22.16	21.84	21.48	617.754	27.91	30	Pass
52	5260	17.41	17.76	17.43	17.25	223.208	23.49	24	Pass
60	5300	17.34	18.39	18.09	17.62	245.451	23.90	24	Pass
64	5320	17.34	18.52	18.07	17.73	248.735	23.96	24	Pass
100	5500	17.54	18.18	18.18	17.76	247.99	23.94	24	Pass
116	5580	17.34	17.98	18.37	17.25	238.801	23.78	24	Pass
140	5700	17.63	18.36	17.96	17.36	243.459	23.86	24	Pass
*144 (U-NII-2C)	5720	15.98	16.00	14.84	14.45	137.779	21.39	23.18	Pass
*144 (U-NII-3)	5720	10.87	10.99	9.86	9.34	43.051	16.34	30	Pass
149	5745	23.43	23.66	23.26	22.83	856.269	29.33	30	Pass
157	5785	23.79	24.15	24.05	23.87	997.226	29.99	30	Pass
165	5825	23.66	24.10	23.82	23.83	971.85	29.88	30	Pass

Notes:

- \* : Test was performed in accordance with measurement follow FCC KDB 789033 UNII test procedure Method SA-1 and use spectrum analyzer test.
- Directional gain is the maximum gain of antennas.
- For U-NII-1, the directional gain is 4.09 dBi < 6 dBi, so the output power limit shall not be reduced.
- For U-NII-2A, the directional gain is 2.68 dBi < 6 dBi, so the output power limit shall not be reduced.
- For U-NII-2C, the directional gain is 3.38 dBi < 6 dBi, so the output power limit shall not be reduced.
- For U-NII-3, the directional gain is 2.64 dBi < 6 dBi, so the output power limit shall not be reduced.

### 802.11ax (HE40) CDD

Chan.	Chan. Freq. (MHz)	Average Power (dBm)				Total Power (mW)	Total Power (dBm)	Power Limit (dBm)	Test Result
		Chain 0	Chain 1	Chain 2	Chain 3				
38	5190	17.45	17.95	17.98	17.52	237.263	23.75	30	Pass
46	5230	20.28	20.63	20.34	18.69	404.375	26.07	30	Pass
54	5270	17.73	18.03	17.82	17.26	236.571	23.74	24	Pass
62	5310	17.42	18.07	18.06	17.35	237.627	23.76	24	Pass
102	5510	17.84	17.91	17.91	17.34	238.617	23.78	24	Pass
110	5550	18.01	17.43	17.84	17.25	232.478	23.66	24	Pass
134	5670	18.04	18.33	17.93	17.32	247.794	23.94	24	Pass
*142 (U-NII-2C)	5710	16.56	18.04	16.32	15.97	191.361	22.82	24	Pass
*142 (U-NII-3)	5710	5.47	7.04	5.00	4.65	14.662	11.66	30	Pass
151	5755	21.42	21.26	21.02	20.53	511.788	27.09	30	Pass
159	5795	22.76	22.52	22.23	21.94	690.872	28.39	30	Pass

Notes:

- \* : Test was performed in accordance with measurement follow FCC KDB 789033 UNII test procedure Method SA-1 and use spectrum analyzer test.
- Directional gain is the maximum gain of antennas.
- For U-NII-1, the maximum gain is 4.09 dBi < 6 dBi, so the output power limit shall not be reduced.
- For U-NII-2A, the maximum gain is 2.68 dBi < 6 dBi, so the output power limit shall not be reduced.
- For U-NII-2C, the maximum gain is 3.38 dBi < 6 dBi, so the output power limit shall not be reduced.
- For U-NII-3, the maximum gain is 2.64 dBi < 6 dBi, so the output power limit shall not be reduced.

### 802.11ax (HE80) CDD

Chan.	Chan. Freq. (MHz)	Average Power (dBm)				Total Power (mW)	Total Power (dBm)	Power Limit (dBm)	Test Result
		Chain 0	Chain 1	Chain 2	Chain 3				
42	5210	14.87	15.63	15.59	15.16	136.284	21.34	30	Pass
58	5290	16.57	17.02	16.92	16.31	187.704	22.73	24	Pass
106	5530	16.56	16.87	16.85	16.34	185.4	22.68	24	Pass
122	5610	17.72	17.86	18.17	17.19	238.225	23.77	24	Pass
*138 (U-NII-2C)	5690	16.20	17.07	17.30	16.79	194.076	22.88	24	Pass
*138 (U-NII-3)	5690	1.53	2.77	2.42	2.14	6.697	8.26	30	Pass
155	5775	18.94	18.77	19.09	18.36	303.323	24.82	30	Pass

Notes:

- \* : Test was performed in accordance with measurement follow FCC KDB 789033 UNII test procedure Method SA-1 and use spectrum analyzer test.
- Directional gain is the maximum gain of antennas.
- For U-NII-1, the maximum gain is 4.09 dBi < 6 dBi, so the output power limit shall not be reduced.
- For U-NII-2A, the maximum gain is 2.68 dBi < 6 dBi, so the output power limit shall not be reduced.
- For U-NII-2C, the maximum gain is 3.38 dBi < 6 dBi, so the output power limit shall not be reduced.
- For U-NII-3, the maximum gain is 2.64 dBi < 6 dBi, so the output power limit shall not be reduced.

### 802.11ax (HE160) CDD

Chan.	Chan. Freq. (MHz)	Average Power (dBm)				Total Power (mW)	Total Power (dBm)	Power Limit (dBm)	Test Result
		Chain 0	Chain 1	Chain 2	Chain 3				
*50 (U-NII-1)	5250	11.77	10.97	11.17	10.76	54.64	17.38	30	Pass
*50 (U-NII-2A)	5250	12.07	11.27	11.51	10.91	58.232	17.65	24	Pass
114	5570	15.42	14.87	15.31	14.79	129.617	21.13	24	Pass

**Notes:**

- \* : Test was performed in accordance with measurement follow FCC KDB 789033 UNII test procedure Method SA-2 and use spectrum analyzer test , the duty factor was included in the total power.
- Directional gain is the maximum gain of antennas.
- For U-NII-1, the maximum gain is 4.09 dBi < 6 dBi, so the output power limit shall not be reduced.
- For U-NII-2A, the maximum gain is 2.68 dBi < 6 dBi, so the output power limit shall not be reduced.
- For U-NII-2C, the maximum gain is 3.38 dBi < 6 dBi, so the output power limit shall not be reduced.

### 802.11ac (VHT20) Beamforming

Chan.	Chan. Freq. (MHz)	Average Power (dBm)				Total Power (mW)	Total Power (dBm)	Power Limit (dBm)	Test Result
		Chain 0	Chain 1	Chain 2	Chain 3				
36	5180	18.56	19.23	19.11	18.76	312.165	24.94	30	Pass
40	5200	19.67	20.28	20.25	19.81	400.987	26.03	30	Pass
48	5240	21.59	21.67	21.36	21.00	553.77	27.43	30	Pass
52	5260	16.87	17.29	16.91	16.68	197.87	22.96	24	Pass
60	5300	16.85	17.86	17.63	17.15	219.334	23.41	24	Pass
64	5320	16.88	18.12	17.55	17.24	223.468	23.49	24	Pass
100	5500	17.03	17.69	17.62	17.24	219.991	23.42	24	Pass
116	5580	16.82	17.48	17.85	16.74	212.22	23.27	24	Pass
140	5700	17.14	17.90	17.44	16.92	218.087	23.39	24	Pass
*144 (U-NII-2C)	5720	15.47	15.35	14.33	14.15	122.617	20.89	23.18	Pass
*144 (U-NII-3)	5720	10.01	10.06	8.86	8.94	35.688	15.53	30	Pass
149	5745	22.95	23.13	22.79	22.34	764.335	28.83	30	Pass
157	5785	23.33	23.63	23.55	23.43	892.71	29.51	30	Pass
165	5825	23.22	23.65	23.39	23.35	876.178	29.43	30	Pass

**Notes:**

- \* : Test was performed in accordance with measurement follow FCC KDB 789033 UNII test procedure Method SA-1 and use spectrum analyzer test.
- Directional gain is the measured value according to KDB 662911 D03 Method of MIMO Antenna Gain Measurement.
- For U-NII-1, the directional gain is 4.7 dBi < 6 dBi, so the output power limit shall not be reduced.
- For U-NII-2A, the directional gain is 3.39 dBi < 6 dBi, so the output power limit shall not be reduced.
- For U-NII-2C, the directional gain is 4.01 dBi < 6 dBi, so the output power limit shall not be reduced.
- For U-NII-3, the directional gain is 3.13 dBi < 6 dBi, so the output power limit shall not be reduced.

### 802.11ac (VHT40) Beamforming

Chan.	Chan. Freq. (MHz)	Average Power (dBm)				Total Power (mW)	Total Power (dBm)	Power Limit (dBm)	Test Result
		Chain 0	Chain 1	Chain 2	Chain 3				
38	5190	16.93	17.44	17.44	16.97	210.016	23.22	30	Pass
46	5230	19.85	20.08	19.82	18.25	361.239	25.58	30	Pass
54	5270	17.28	17.54	17.35	16.71	211.417	23.25	24	Pass
62	5310	16.87	17.66	17.51	16.90	212.327	23.27	24	Pass
102	5510	17.34	17.39	17.40	16.92	213.186	23.29	24	Pass
110	5550	17.51	16.95	17.34	16.78	207.752	23.18	24	Pass
134	5670	17.52	17.84	17.38	16.85	220.426	23.43	24	Pass
*142 (U-NII-2C)	5710	15.12	16.45	16.20	15.83	156.635	21.95	24	Pass
*142 (U-NII-3)	5710	3.26	4.93	3.85	3.98	10.157	10.07	30	Pass
151	5755	21.01	20.77	20.51	20.01	458.273	26.61	30	Pass
159	5795	22.30	22.03	21.77	21.47	620.008	27.92	30	Pass

#### Notes:

- \* : Test was performed in accordance with measurement follow FCC KDB 789033 UNII test procedure Method SA-1 and use spectrum analyzer test.
- Directional gain is the measured value according to KDB 662911 D03 Method of MIMO Antenna Gain Measurement.
- For U-NII-1, the directional gain is 4.7 dBi < 6 dBi, so the output power limit shall not be reduced.
- For U-NII-2A, the directional gain is 3.39 dBi < 6 dBi, so the output power limit shall not be reduced.
- For U-NII-2C, the directional gain is 4.01 dBi < 6 dBi, so the output power limit shall not be reduced.
- For U-NII-3, the directional gain is 3.13 dBi < 6 dBi, so the output power limit shall not be reduced.

### 802.11ac (VHT80) Beamforming

Chan.	Chan. Freq. (MHz)	Average Power (dBm)				Total Power (mW)	Total Power (dBm)	Power Limit (dBm)	Test Result
		Chain 0	Chain 1	Chain 2	Chain 3				
42	5210	14.37	15.13	15.11	14.60	121.211	20.84	30	Pass
58	5290	16.09	16.47	16.40	15.79	166.588	22.22	24	Pass
106	5530	16.07	16.41	16.39	15.84	166.132	22.20	24	Pass
122	5610	17.30	17.40	17.63	16.66	212.945	23.28	24	Pass
*138 (U-NII-2C)	5690	15.86	16.24	15.77	15.61	154.769	21.90	24	Pass
*138 (U-NII-3)	5690	0.60	1.43	-0.60	0.39	4.503	6.54	30	Pass
155	5775	18.44	18.33	18.62	17.90	272.338	24.35	30	Pass

#### Notes:

- \* : Test was performed in accordance with measurement follow FCC KDB 789033 UNII test procedure Method SA-1 and use spectrum analyzer test.
- Directional gain is the measured value according to KDB 662911 D03 Method of MIMO Antenna Gain Measurement.
- For U-NII-1, the directional gain is 4.7 dBi < 6 dBi, so the output power limit shall not be reduced.
- For U-NII-2A, the directional gain is 3.39 dBi < 6 dBi, so the output power limit shall not be reduced.
- For U-NII-2C, the directional gain is 4.01 dBi < 6 dBi, so the output power limit shall not be reduced.
- For U-NII-3, the directional gain is 3.13 dBi < 6 dBi, so the output power limit shall not be reduced.

### 802.11ac (VHT160) Beamforming

Chan.	Chan. Freq. (MHz)	Average Power (dBm)				Total Power (mW)	Total Power (dBm)	Power Limit (dBm)	Test Result
		Chain 0	Chain 1	Chain 2	Chain 3				
*50 (U-NII-1)	5250	10.34	9.86	7.01	10.24	37.532	15.74	30	Pass
*50 (U-NII-2A)	5250	8.87	8.75	9.30	10.40	36.072	15.57	24	Pass
114	5570	14.91	14.35	14.81	14.30	115.386	20.62	24	Pass

Notes:

- \* : Test was performed in accordance with measurement follow FCC KDB 789033 UNII test procedure Method SA-2 and use spectrum analyzer test , the duty factor was included in the total power.
- Directional gain is the measured value according to KDB 662911 D03 Method of MIMO Antenna Gain Measurement.
- For U-NII-1, the directional gain is 4.7 dBi < 6 dBi, so the output power limit shall not be reduced.
- For U-NII-2A, the directional gain is 3.39 dBi < 6 dBi, so the output power limit shall not be reduced.
- For U-NII-2C, the directional gain is 4.01 dBi < 6 dBi, so the output power limit shall not be reduced.

### 802.11ax (HE20) Beamforming

Chan.	Chan. Freq. (MHz)	Average Power (dBm)				Total Power (mW)	Total Power (dBm)	Power Limit (dBm)	Test Result
		Chain 0	Chain 1	Chain 2	Chain 3				
36	5180	18.81	19.58	19.43	19.04	334.683	25.25	30	Pass
40	5200	19.92	20.59	20.42	20.13	425.919	26.29	30	Pass
48	5240	21.77	21.96	21.63	21.27	586.864	27.69	30	Pass
52	5260	17.20	17.48	17.15	17.04	210.919	23.24	24	Pass
60	5300	17.07	18.12	17.81	17.38	230.893	23.63	24	Pass
64	5320	17.11	18.27	17.78	17.50	234.76	23.71	24	Pass
100	5500	17.34	17.93	17.90	17.53	234.57	23.70	24	Pass
116	5580	17.13	17.73	18.15	17.01	226.481	23.55	24	Pass
140	5700	17.38	18.10	17.69	17.12	229.539	23.61	24	Pass
*144 (U-NII-2C)	5720	15.98	16.00	14.84	14.45	137.779	21.39	23.18	Pass
*144 (U-NII-3)	5720	10.87	10.99	9.86	9.34	43.051	16.34	30	Pass
149	5745	23.15	23.43	22.99	22.57	806.615	29.07	30	Pass
157	5785	23.57	23.90	23.83	23.63	945.201	29.76	30	Pass
165	5825	23.41	23.86	23.55	23.62	919.11	29.63	30	Pass

Notes:

- \* : Test was performed in accordance with measurement follow FCC KDB 789033 UNII test procedure Method SA-1 and use spectrum analyzer test.
- Directional gain is the measured value according to KDB 662911 D03 Method of MIMO Antenna Gain Measurement.
- For U-NII-1, the directional gain is 4.7 dBi < 6 dBi, so the output power limit shall not be reduced.
- For U-NII-2A, the directional gain is 3.39 dBi < 6 dBi, so the output power limit shall not be reduced.
- For U-NII-2C, the directional gain is 4.01 dBi < 6 dBi, so the output power limit shall not be reduced.
- For U-NII-3, the directional gain is 3.13 dBi < 6 dBi, so the output power limit shall not be reduced.

### 802.11ax (HE40) Beamforming

Chan.	Chan. Freq. (MHz)	Average Power (dBm)				Total Power (mW)	Total Power (dBm)	Power Limit (dBm)	Test Result
		Chain 0	Chain 1	Chain 2	Chain 3				
38	5190	17.19	17.68	17.74	17.29	223.983	23.50	30	Pass
46	5230	20.03	20.40	20.13	18.45	383.364	25.84	30	Pass
54	5270	17.51	17.81	17.58	17.04	224.621	23.51	24	Pass
62	5310	17.14	17.81	17.79	17.08	223.323	23.49	24	Pass
102	5510	17.58	17.69	17.66	17.11	225.777	23.54	24	Pass
110	5550	17.78	17.16	17.55	16.97	218.638	23.40	24	Pass
134	5670	17.82	18.08	17.71	17.10	235.109	23.71	24	Pass
*142 (U-NII-2C)	5710	16.56	18.04	16.32	15.97	191.361	22.82	24	Pass
*142 (U-NII-3)	5710	5.47	7.04	5.00	4.65	14.662	11.66	30	Pass
151	5755	21.16	20.97	20.79	20.24	481.275	26.82	30	Pass
159	5795	22.51	22.26	22.01	21.72	653.954	28.16	30	Pass

#### Notes:

- \* : Test was performed in accordance with measurement follow FCC KDB 789033 UNII test procedure Method SA-1 and use spectrum analyzer test.
- Directional gain is the measured value according to KDB 662911 D03 Method of MIMO Antenna Gain Measurement.
- For U-NII-1, the directional gain is 4.7 dBi < 6 dBi, so the output power limit shall not be reduced.
- For U-NII-2A, the directional gain is 3.39 dBi < 6 dBi, so the output power limit shall not be reduced.
- For U-NII-2C, the directional gain is 4.01 dBi < 6 dBi, so the output power limit shall not be reduced.
- For U-NII-3, the directional gain is 3.13 dBi < 6 dBi, so the output power limit shall not be reduced.

### 802.11ax (HE80) Beamforming

Chan.	Chan. Freq. (MHz)	Average Power (dBm)				Total Power (mW)	Total Power (dBm)	Power Limit (dBm)	Test Result
		Chain 0	Chain 1	Chain 2	Chain 3				
42	5210	14.59	15.39	15.33	14.91	128.461	21.09	30	Pass
58	5290	16.34	16.81	16.65	16.02	177.259	22.49	24	Pass
106	5530	16.28	16.66	16.64	16.12	175.864	22.45	24	Pass
122	5610	17.52	17.61	17.96	16.93	226.005	23.54	24	Pass
*138 (U-NII-2C)	5690	16.20	17.07	17.30	16.79	194.076	22.88	24	Pass
*138 (U-NII-3)	5690	1.53	2.77	2.42	2.14	6.697	8.26	30	Pass
155	5775	18.70	18.56	18.80	18.11	286.482	24.57	30	Pass

**Notes:**

- \* : Test was performed in accordance with measurement follow FCC KDB 789033 UNII test procedure Method SA-1 and use spectrum analyzer test.
- Directional gain is the measured value according to KDB 662911 D03 Method of MIMO Antenna Gain Measurement.
- For U-NII-1, the directional gain is 4.7 dBi < 6 dBi, so the output power limit shall not be reduced.
- For U-NII-2A, the directional gain is 3.39 dBi < 6 dBi, so the output power limit shall not be reduced.
- For U-NII-2C, the directional gain is 4.01 dBi < 6 dBi, so the output power limit shall not be reduced.
- For U-NII-3, the directional gain is 3.13 dBi < 6 dBi, so the output power limit shall not be reduced.

### 802.11ax (HE160) Beamforming

Chan.	Chan. Freq. (MHz)	Average Power (dBm)				Total Power (mW)	Total Power (dBm)	Power Limit (dBm)	Test Result
		Chain 0	Chain 1	Chain 2	Chain 3				
*50 (U-NII-1)	5250	11.77	10.97	11.17	10.76	54.64	17.38	30	Pass
*50 (U-NII-2A)	5250	12.07	11.27	11.51	10.91	58.232	17.65	24	Pass
114	5570	15.19	14.60	15.10	14.55	122.747	20.89	24	Pass

**Notes:**

- \* : Test was performed in accordance with measurement follow FCC KDB 789033 UNII test procedure Method SA-2 and use spectrum analyzer test , the duty factor was included in the total power.
- Directional gain is the measured value according to KDB 662911 D03 Method of MIMO Antenna Gain Measurement.
- For U-NII-1, the directional gain is 4.7 dBi < 6 dBi, so the output power limit shall not be reduced.
- For U-NII-2A, the directional gain is 3.39 dBi < 6 dBi, so the output power limit shall not be reduced.
- For U-NII-2C, the directional gain is 4.01 dBi < 6 dBi, so the output power limit shall not be reduced.



### Spectrum Plot for channel straddling

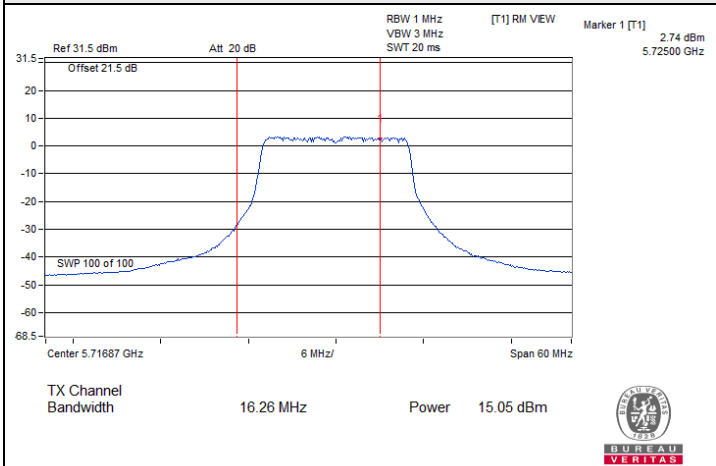

802.11a CDD / Chain 0 : CH 144 (U-NII-2C)

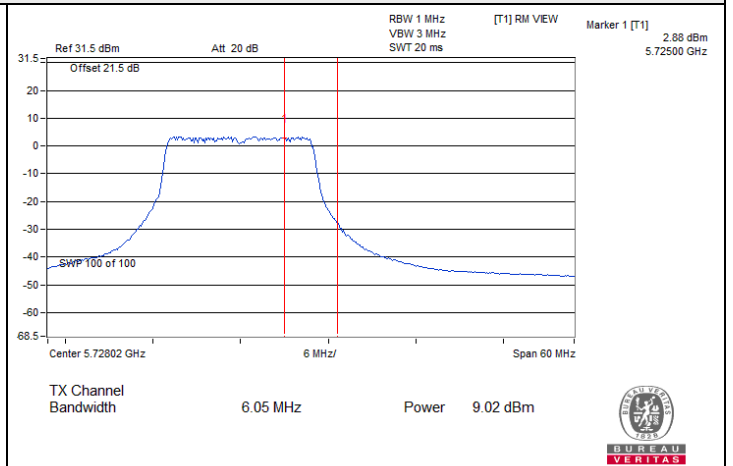

802.11a CDD / Chain 0 : CH 144 (U-NII-3)

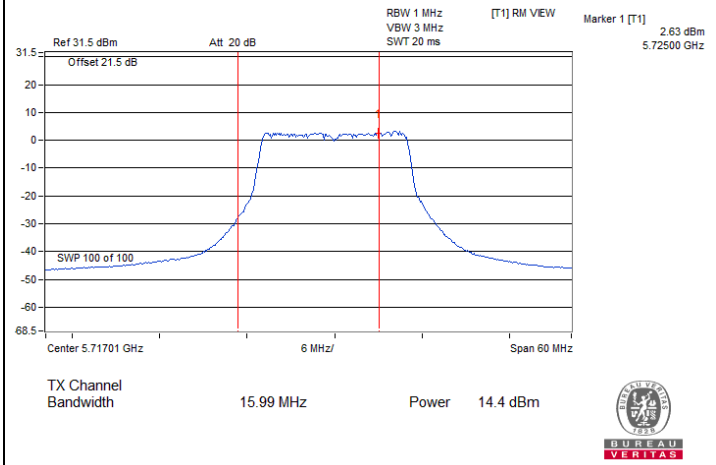

802.11a CDD / Chain 1 : CH 144 (U-NII-2C)

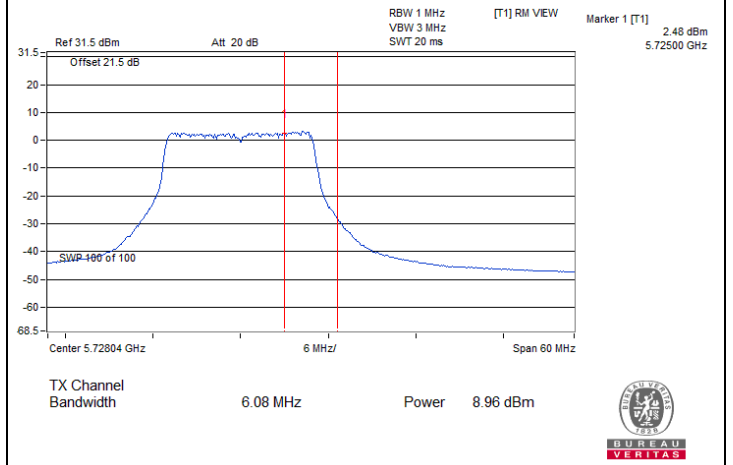

802.11a CDD / Chain 1 : CH 144 (U-NII-3)

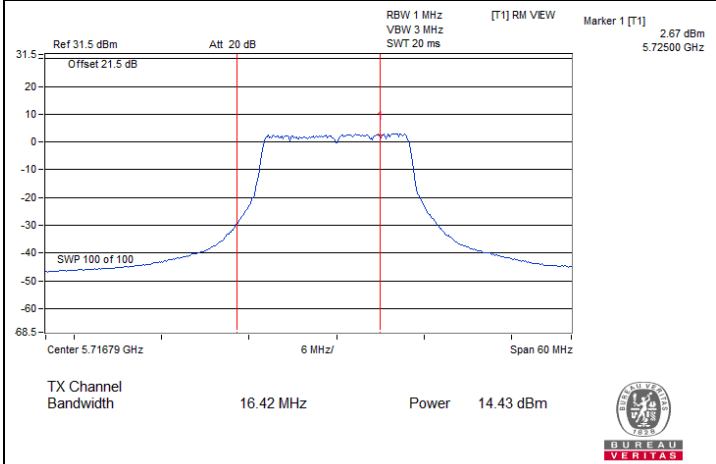

802.11a CDD / Chain 2 : CH 144 (U-NII-2C)

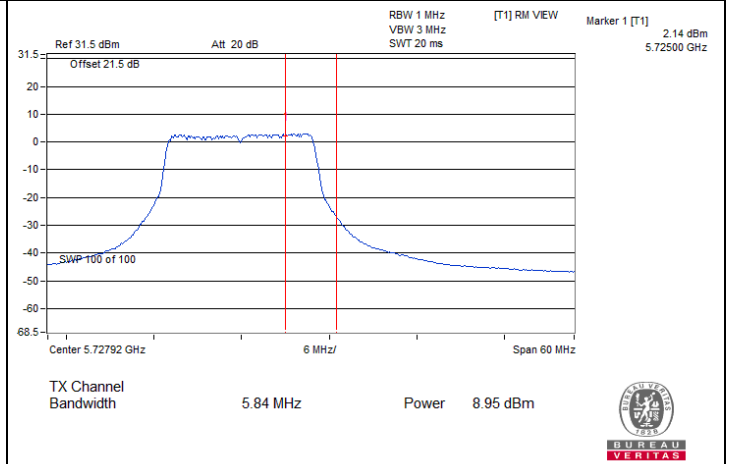

802.11a CDD / Chain 2 : CH 144 (U-NII-3)



### Spectrum Plot for channel straddling

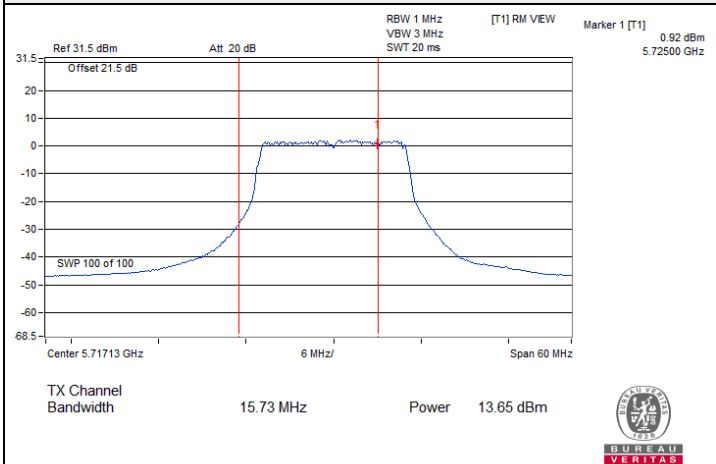

802.11a CDD / Chain 3 : CH 144 (U-NII-2C)

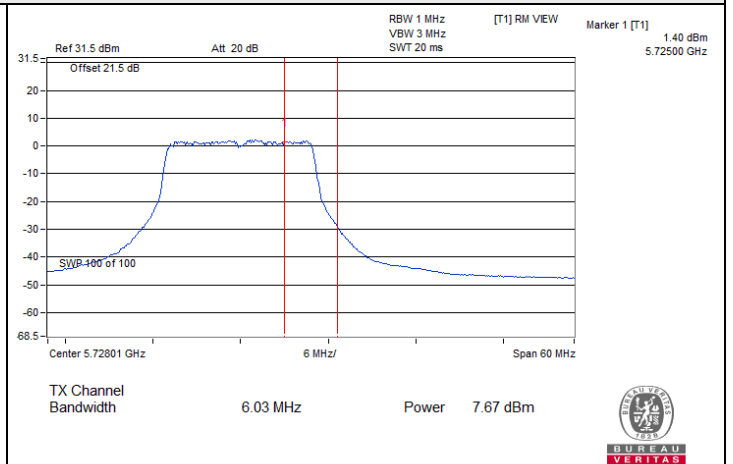

802.11a CDD / Chain 3 : CH 144 (U-NII-3)

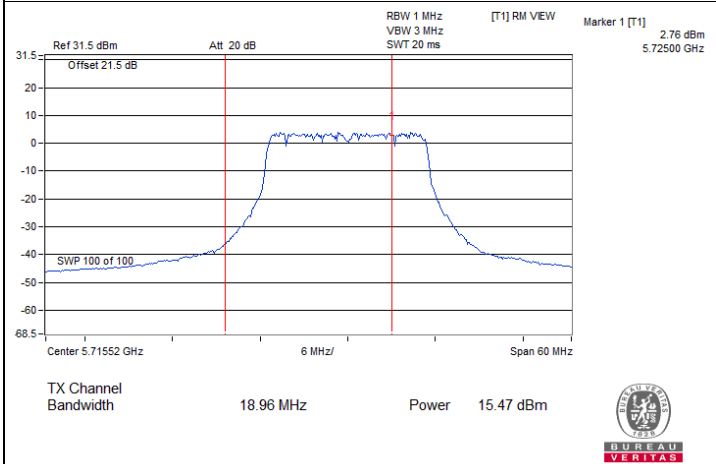

802.11ac (VHT20) CDD / Chain 0 : CH 144 (U-NII-2C)

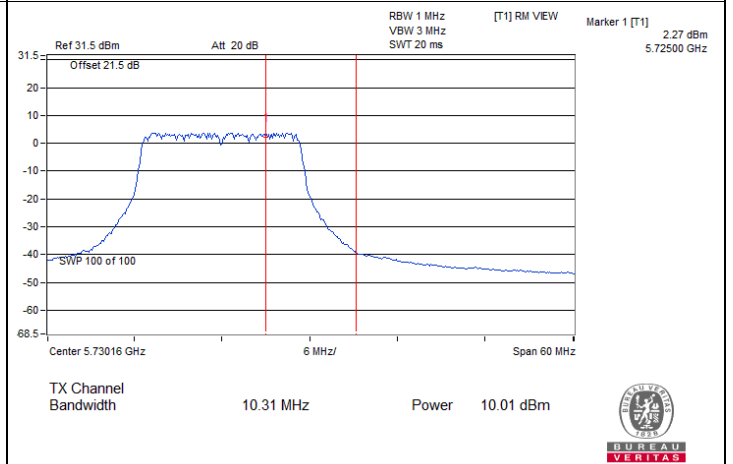

802.11ac (VHT20) CDD / Chain 0 : CH 144 (U-NII-3)

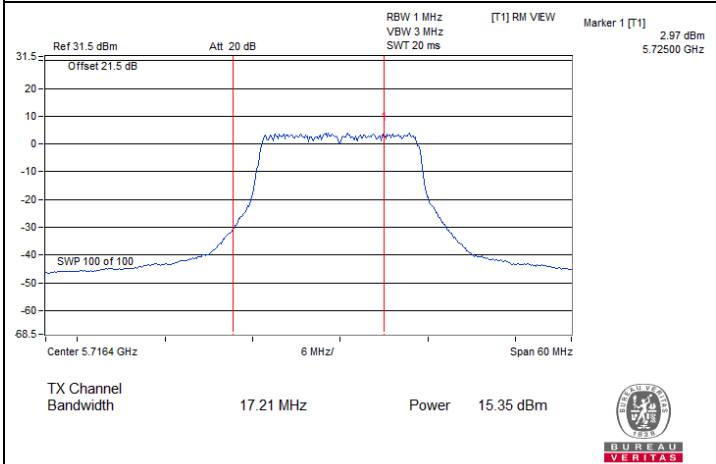

802.11ac (VHT20) CDD / Chain 1 : CH 144 (U-NII-2C)

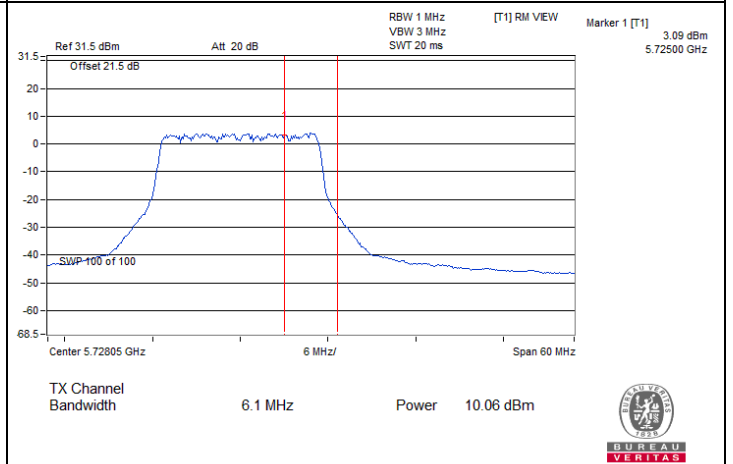

802.11ac (VHT20) CDD / Chain 1 : CH 144 (U-NII-3)

### Spectrum Plot for channel straddling

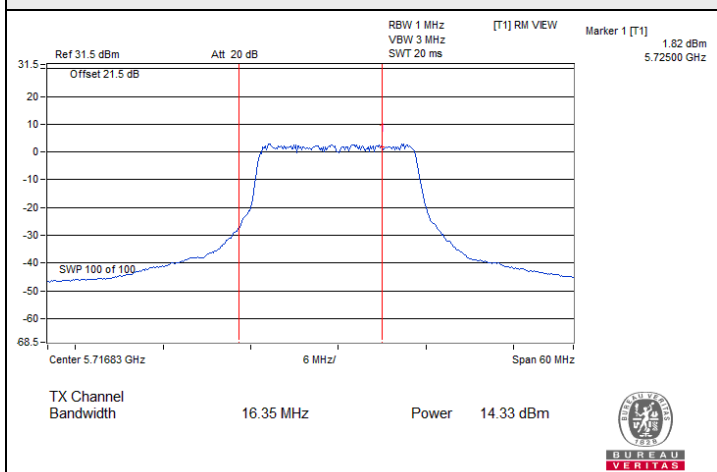

802.11ac (VHT20) CDD / Chain 2 : CH 144 (U-NII-2C)

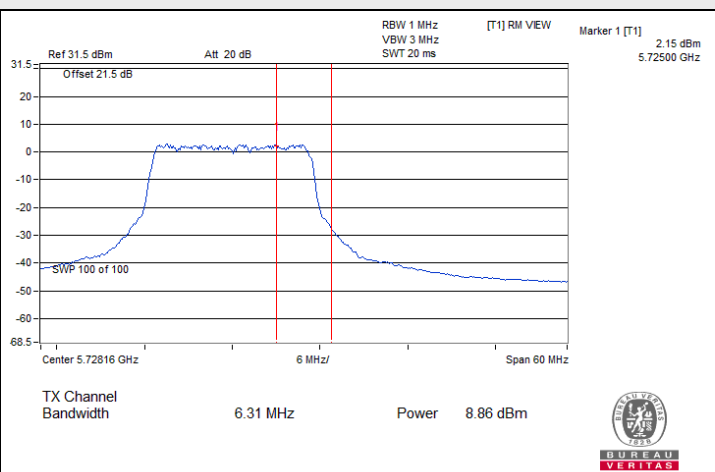

802.11ac (VHT20) CDD / Chain 2 : CH 144 (U-NII-3)

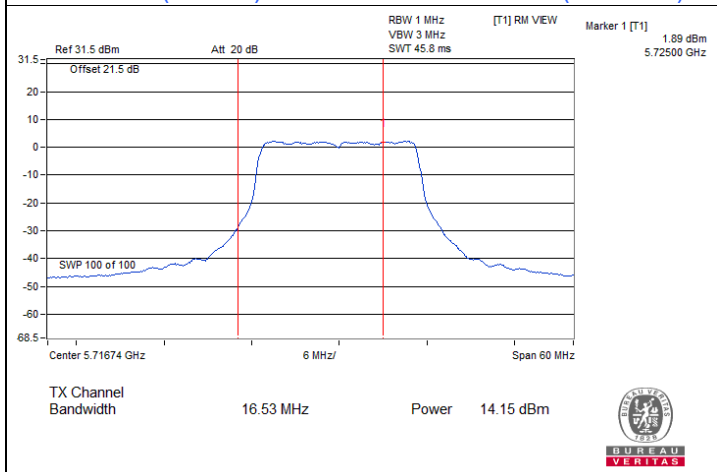

802.11ac (VHT20) CDD / Chain 3 : CH 144 (U-NII-2C)

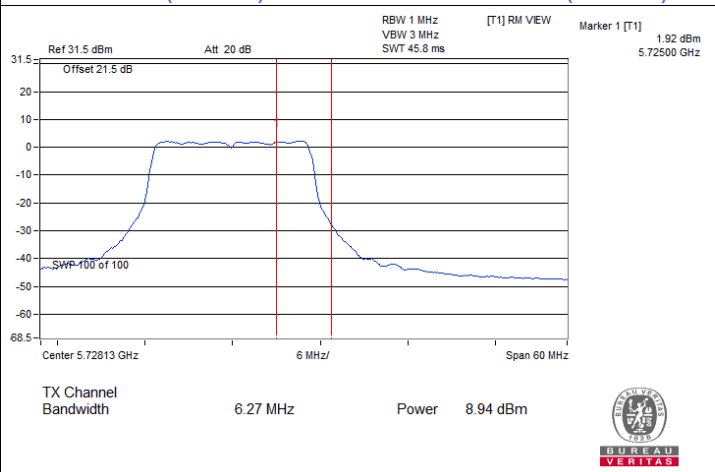

802.11ac (VHT20) CDD / Chain 3 : CH 144 (U-NII-3)

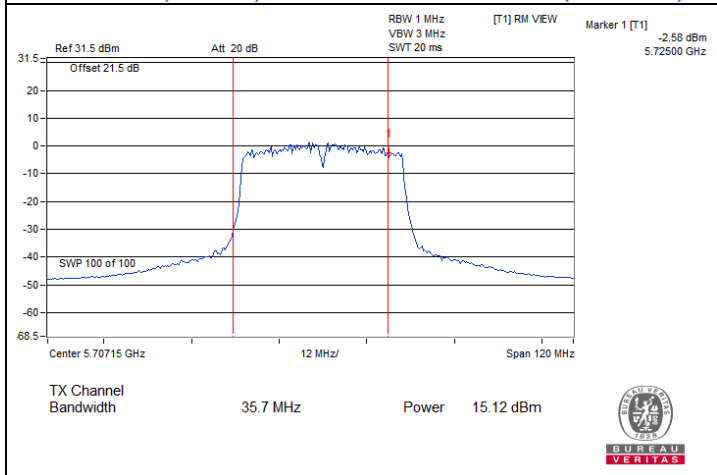

802.11ac (VHT40) CDD / Chain 0 : CH 142 (U-NII-2C)

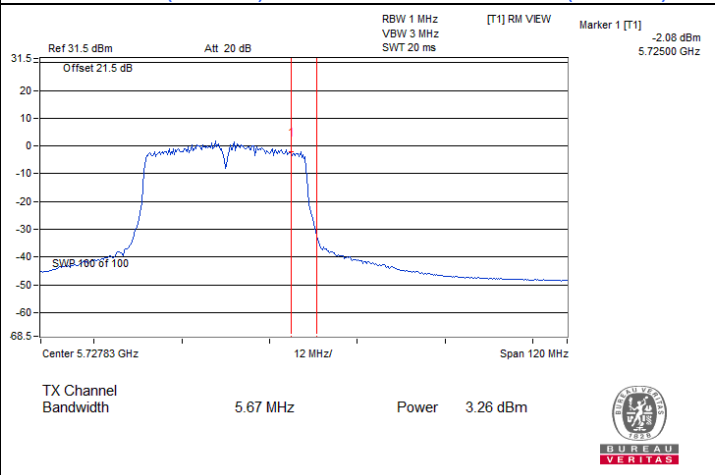

802.11ac (VHT40) CDD / Chain 0 : CH 142 (U-NII-3)



### Spectrum Plot for channel straddling

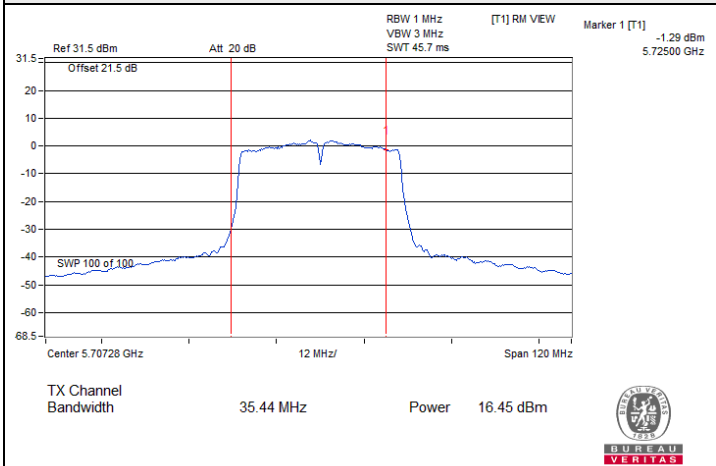

802.11ac (VHT40) CDD / Chain 1 : CH 142 (U-NII-2C)

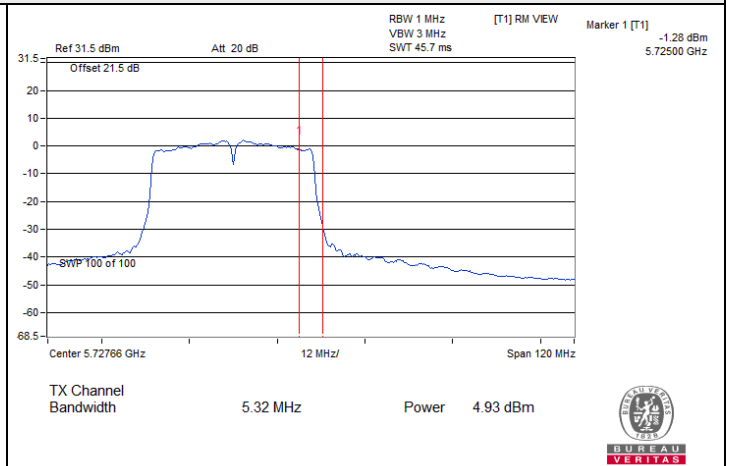

802.11ac (VHT40) CDD / Chain 1 : CH 142 (U-NII-3)

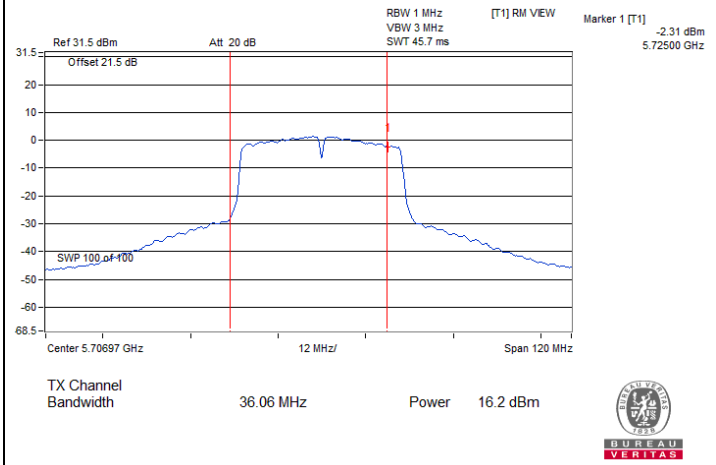

802.11ac (VHT40) CDD / Chain 2 : CH 142 (U-NII-2C)

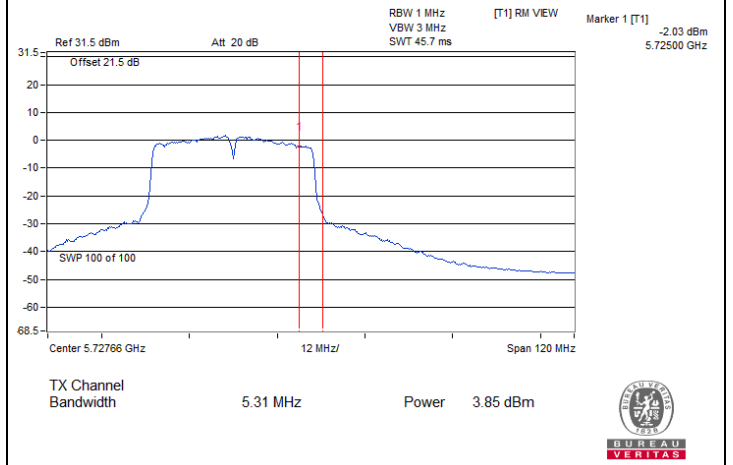

802.11ac (VHT40) CDD / Chain 2 : CH 142 (U-NII-3)

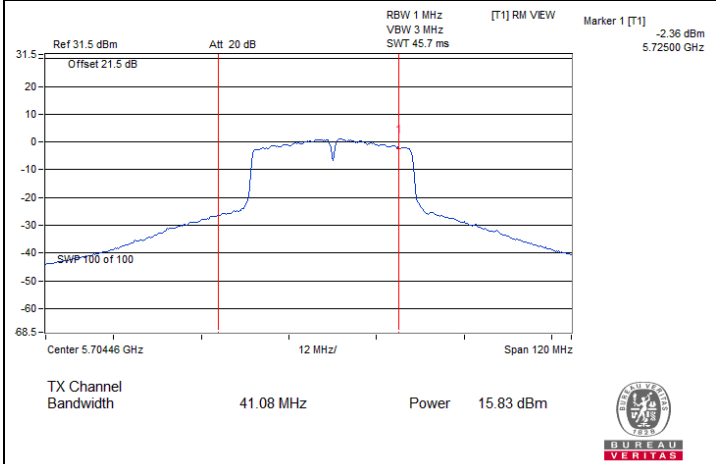

802.11ac (VHT40) CDD / Chain 3 : CH 142 (U-NII-2C)

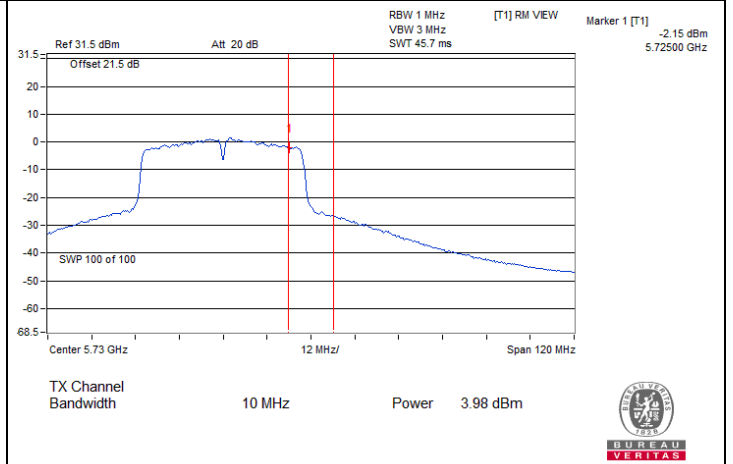

802.11ac (VHT40) CDD / Chain 3 : CH 142 (U-NII-3)

### Spectrum Plot for channel straddling

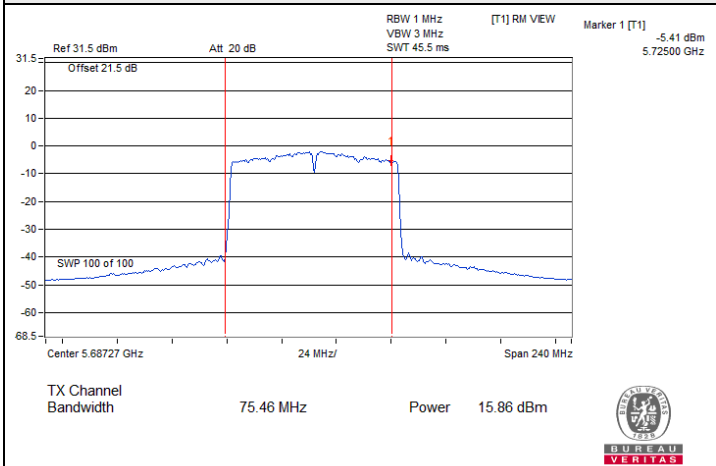

802.11ac (VHT80) CDD / Chain 0 : CH 138 (U-NII-2C)

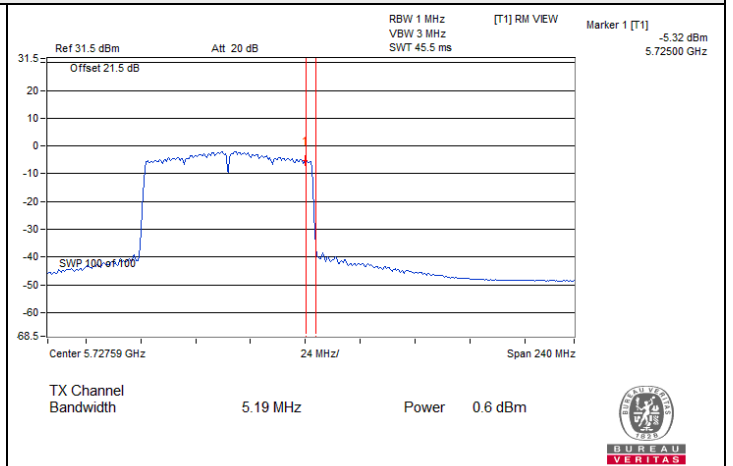

802.11ac (VHT80) CDD / Chain 0 : CH 138 (U-NII-3)

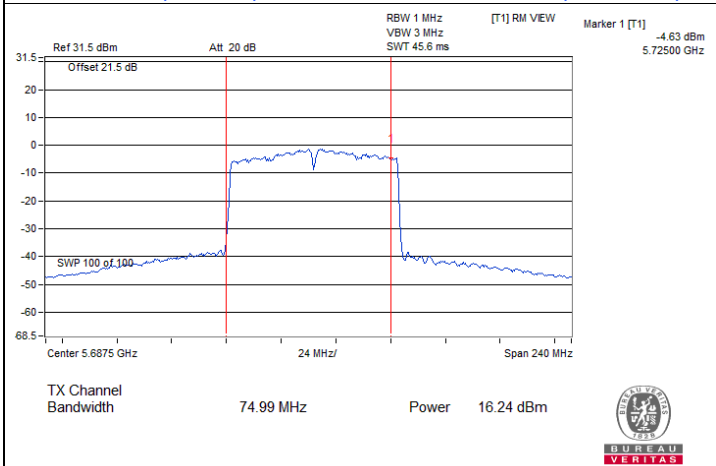

802.11ac (VHT80) CDD / Chain 1 : CH 138 (U-NII-2C)

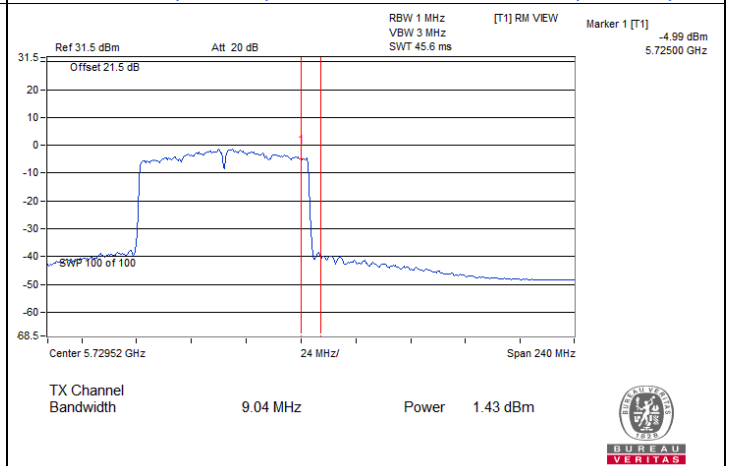

802.11ac (VHT80) CDD / Chain 1 : CH 138 (U-NII-3)

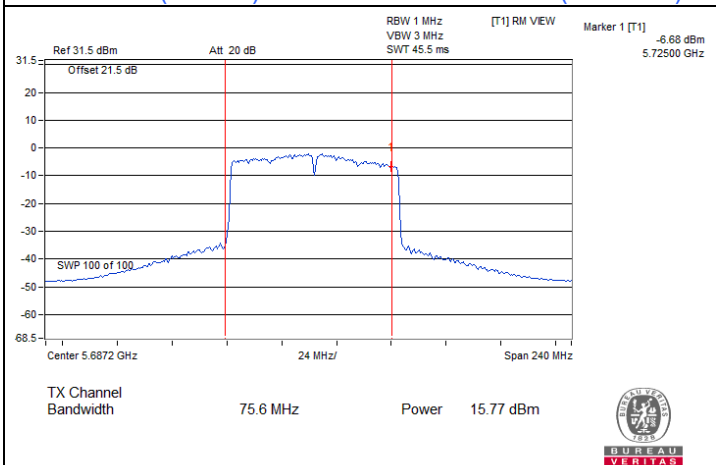

802.11ac (VHT80) CDD / Chain 2 : CH 138 (U-NII-2C)

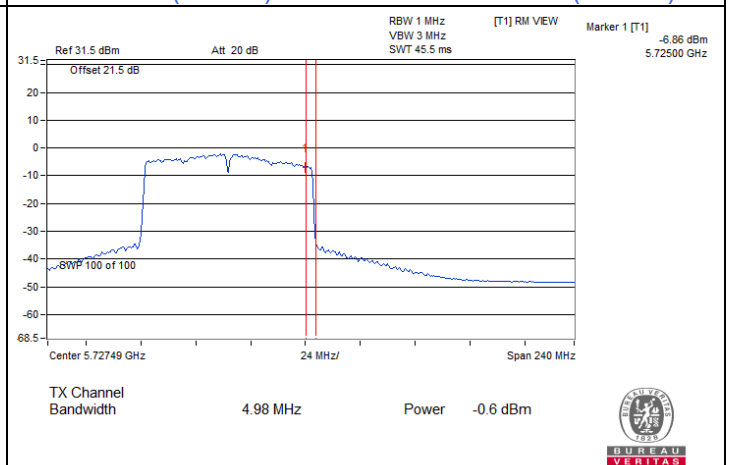

802.11ac (VHT80) CDD / Chain 2 : CH 138 (U-NII-3)



### Spectrum Plot for channel straddling

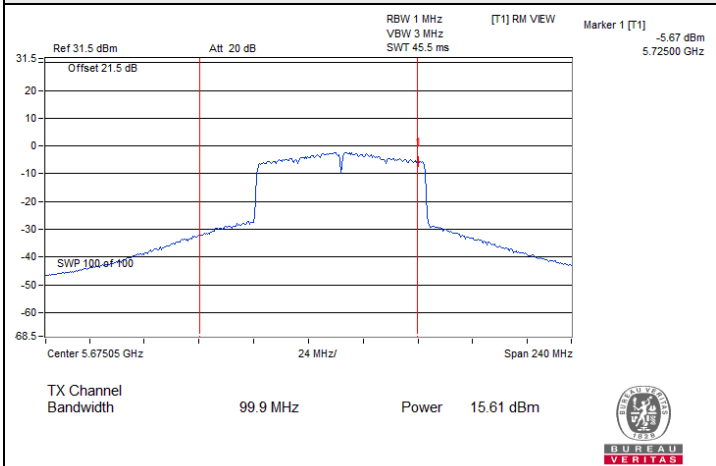

802.11ac (VHT80) CDD / Chain 3 : CH 138 (U-NII-2C)

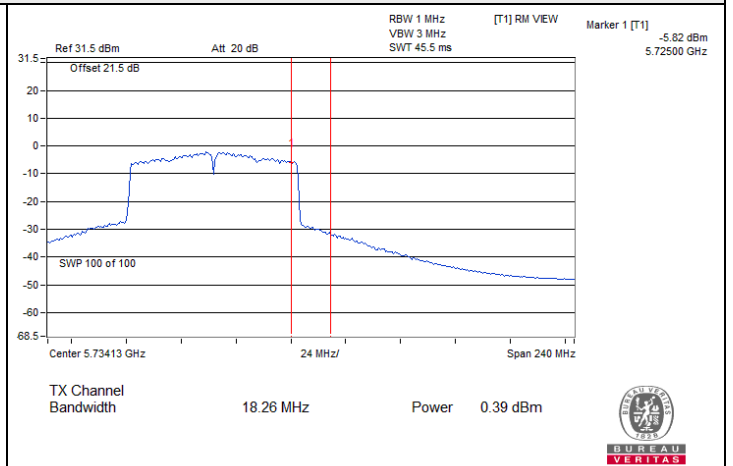

802.11ac (VHT80) CDD / Chain 3 : CH 138 (U-NII-3)

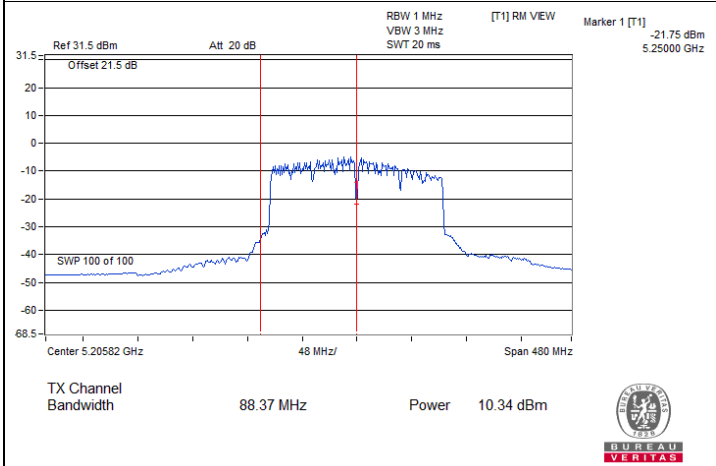

802.11ac (VHT160) CDD / Chain 0 : CH 50 (U-NII-1)

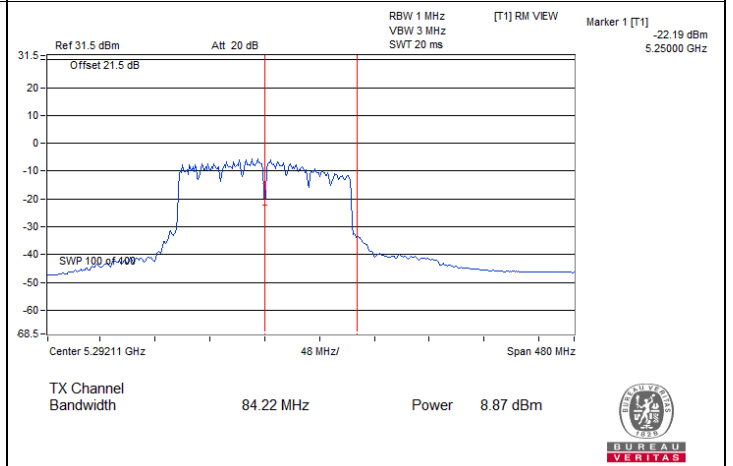

802.11ac (VHT160) CDD / Chain 0 : CH 50 (U-NII-2A)

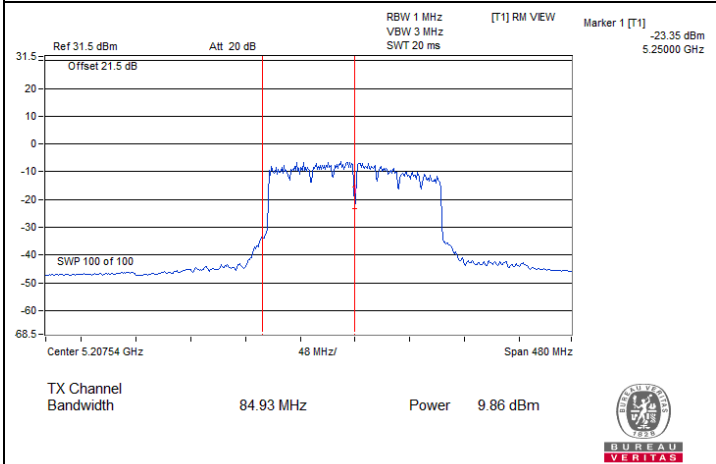

802.11ac (VHT160) CDD / Chain 1 : CH 50 (U-NII-1)

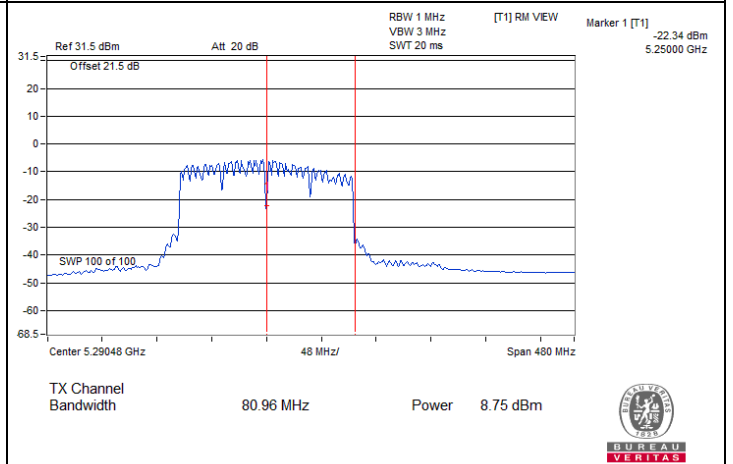

802.11ac (VHT160) CDD / Chain 1 : CH 50 (U-NII-2A)

### Spectrum Plot for channel straddling

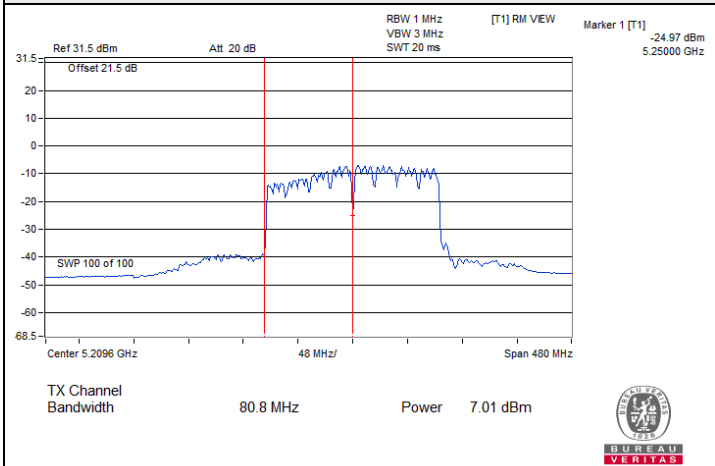

802.11ac (VHT160) CDD / Chain 2 : CH 50 (U-NII-1)

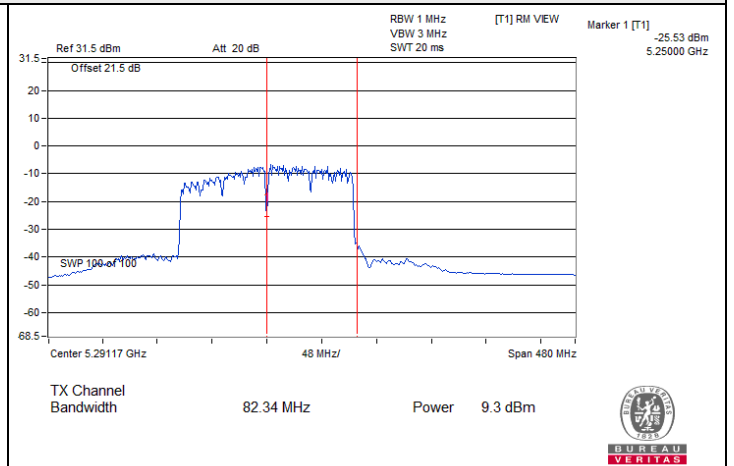

802.11ac (VHT160) CDD / Chain 2 : CH 50 (U-NII-2A)

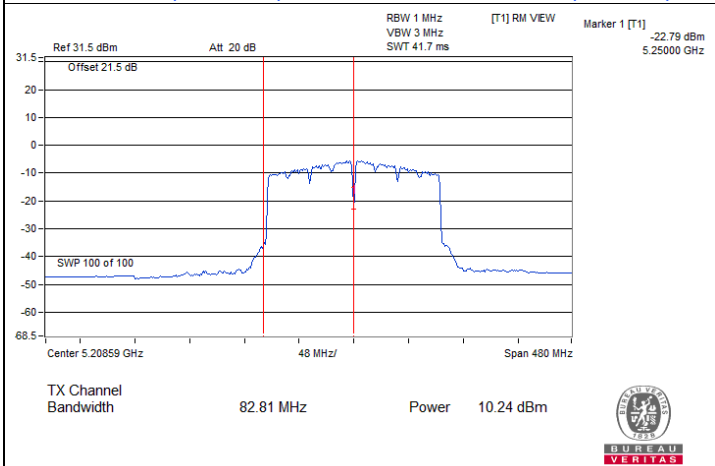

802.11ac (VHT160) CDD / Chain 3 : CH 50 (U-NII-1)

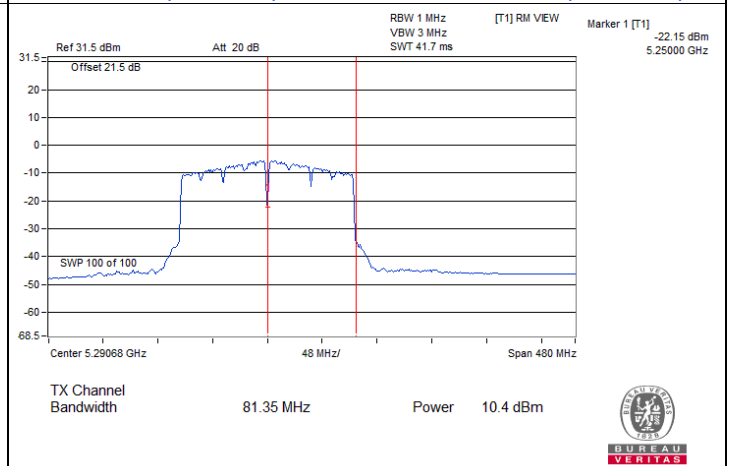

802.11ac (VHT160) CDD / Chain 3 : CH 50 (U-NII-2A)

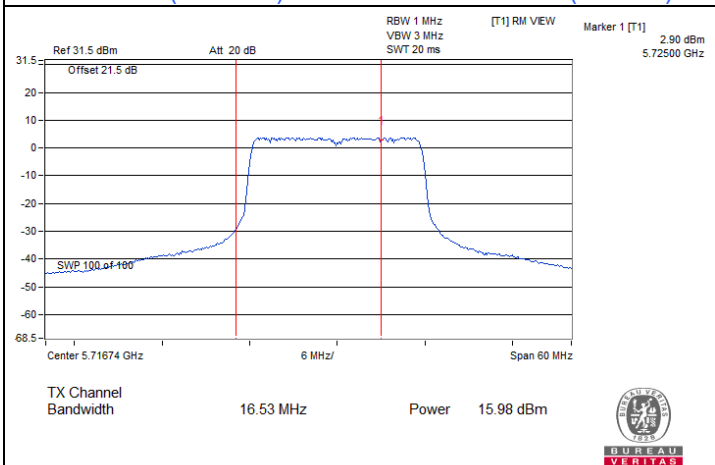

802.11ax (HE20) CDD / Chain 0 : CH 144 (U-NII-2C)

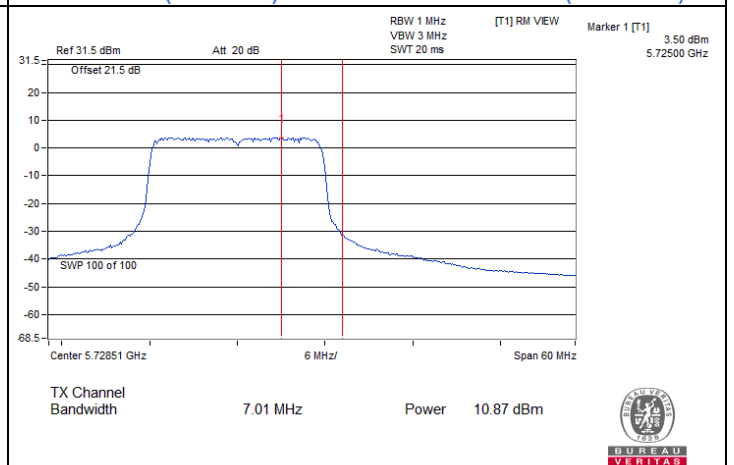

802.11ax (HE20) CDD / Chain 0 : CH 144 (U-NII-3)

### Spectrum Plot for channel straddling

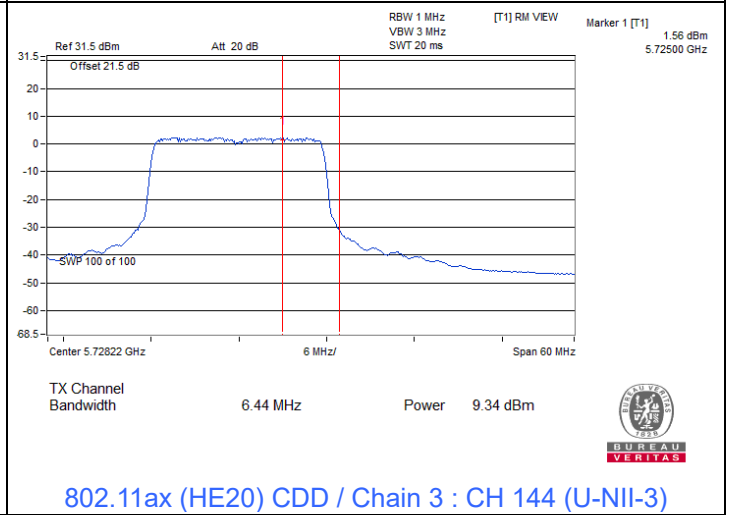
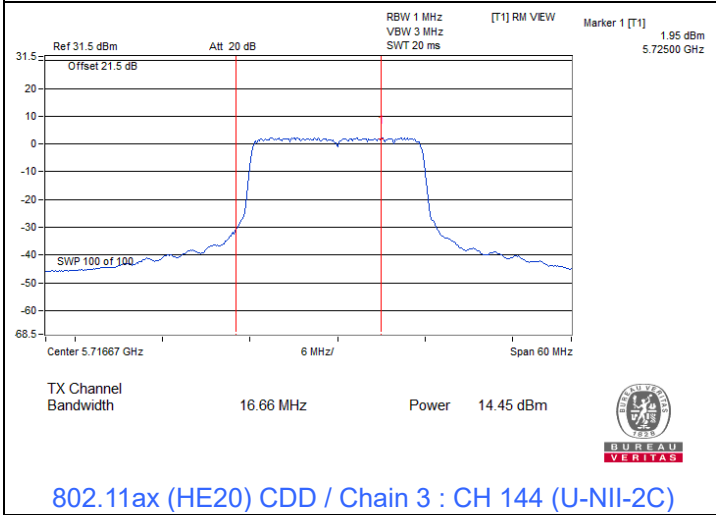
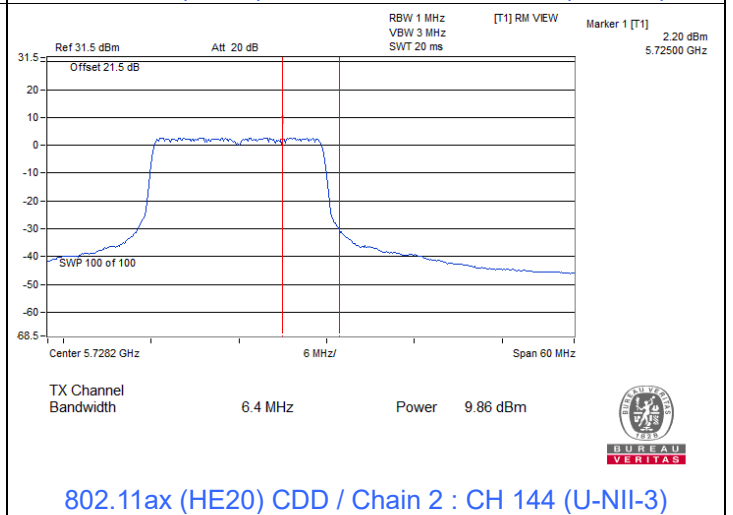
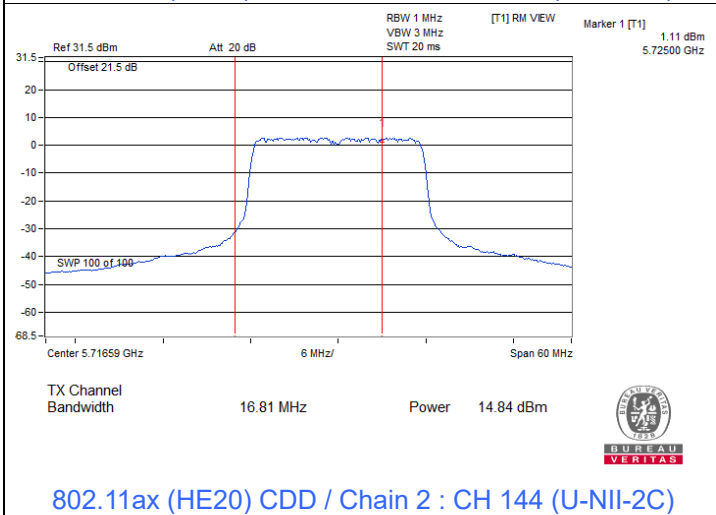
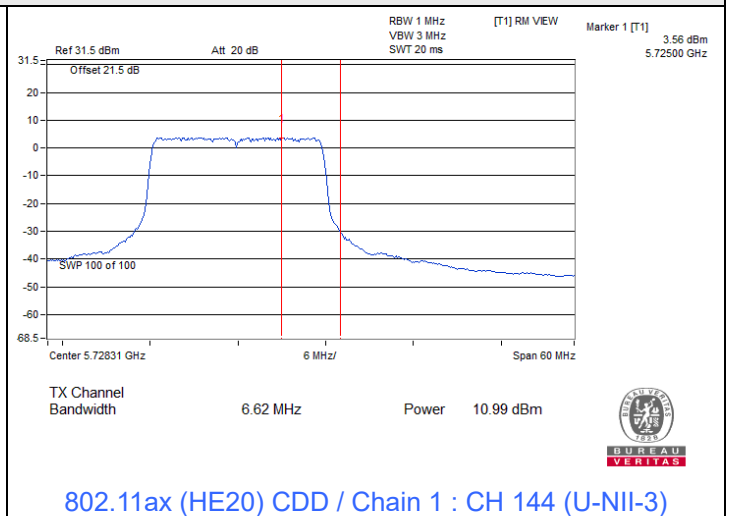
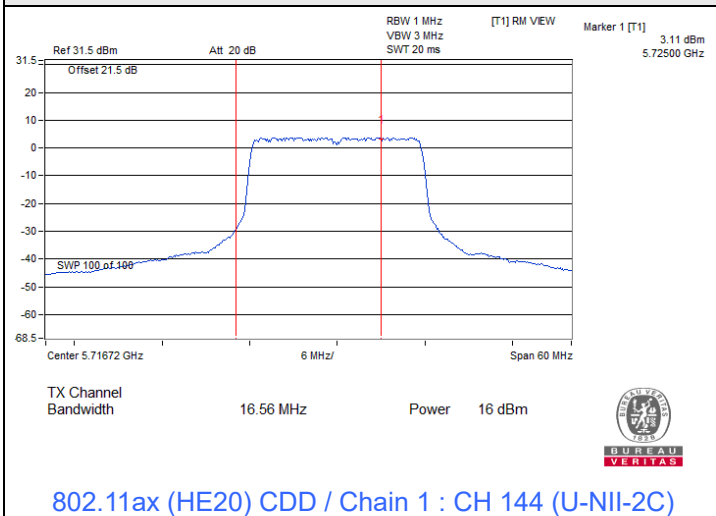



### Spectrum Plot for channel straddling

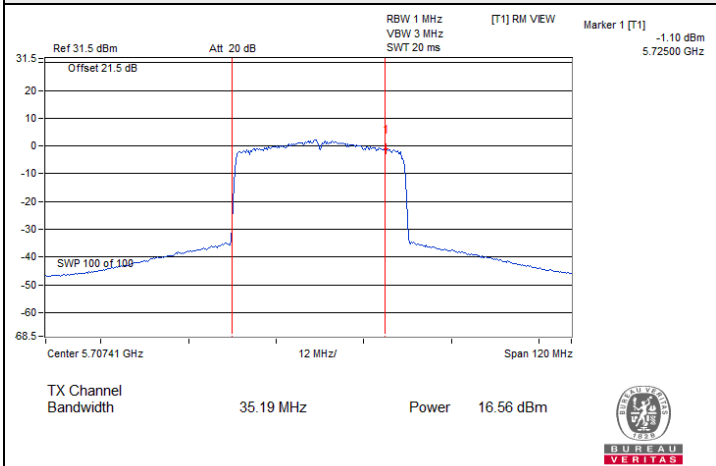

802.11ax (HE40) CDD / Chain 0 : CH 142 (U-NII-2C)

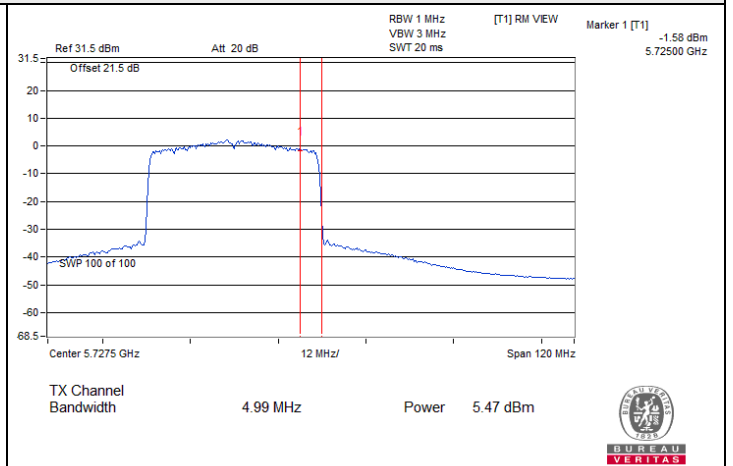

802.11ax (HE40) CDD / Chain 0 : CH 142 (U-NII-3)

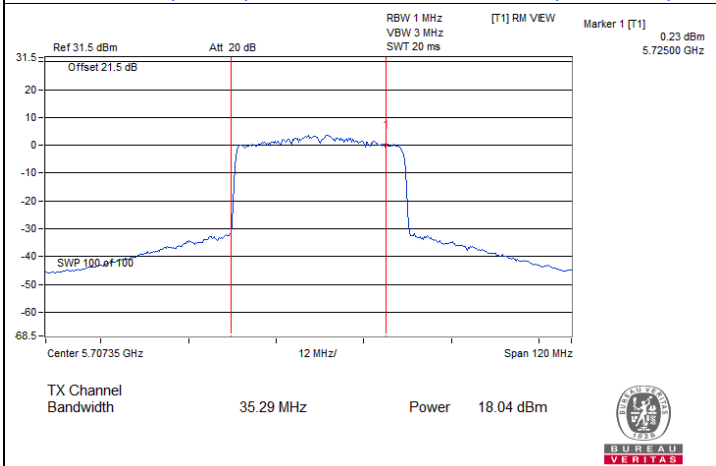

802.11ax (HE40) CDD / Chain 1 : CH 142 (U-NII-2C)

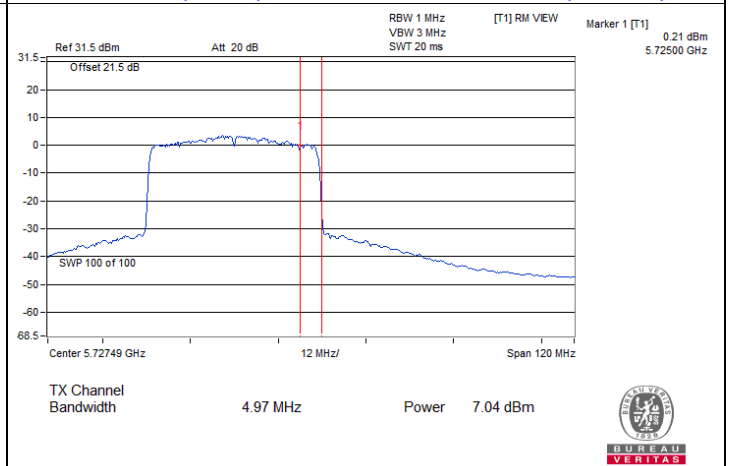

802.11ax (HE40) CDD / Chain 1 : CH 142 (U-NII-3)

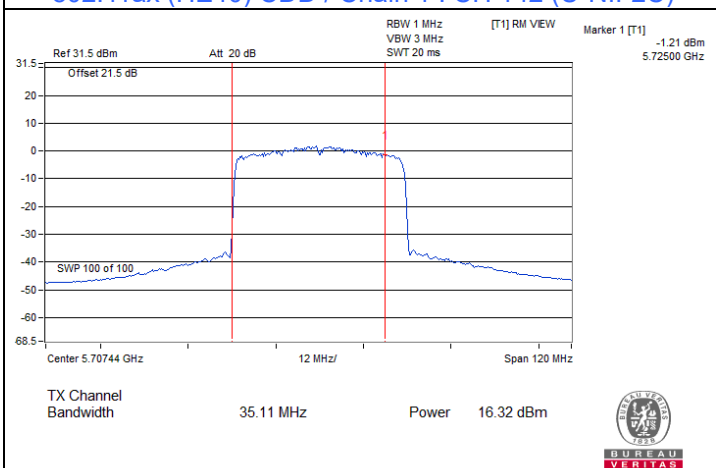

802.11ax (HE40) CDD / Chain 2 : CH 142 (U-NII-2C)

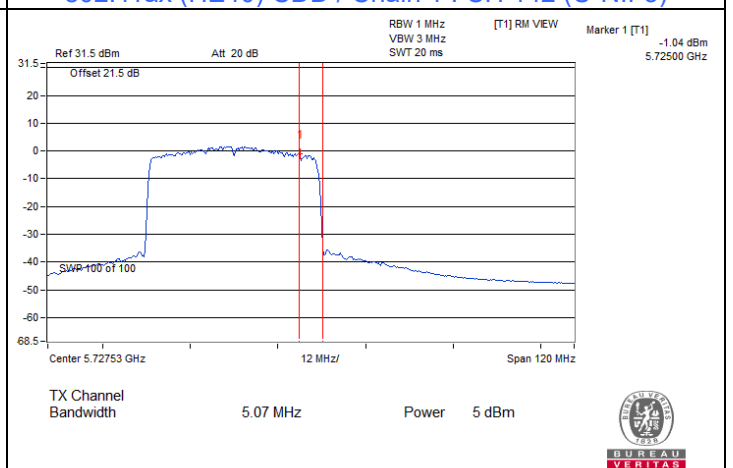

802.11ax (HE40) CDD / Chain 2 : CH 142 (U-NII-3)





### Spectrum Plot for channel straddling

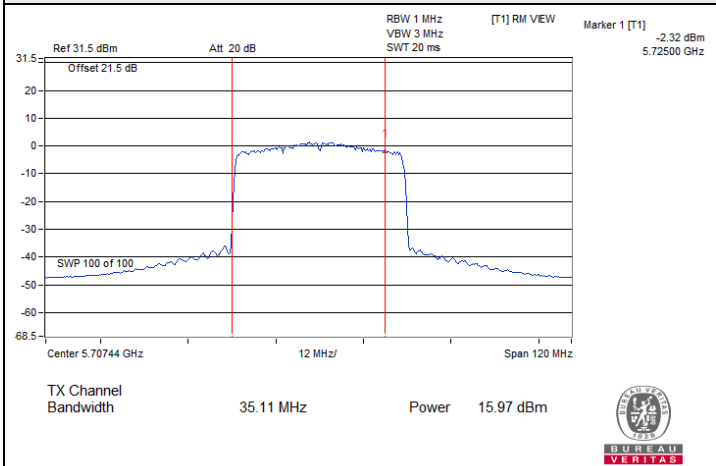

802.11ax (HE40) CDD / Chain 3 : CH 142 (U-NII-2C)

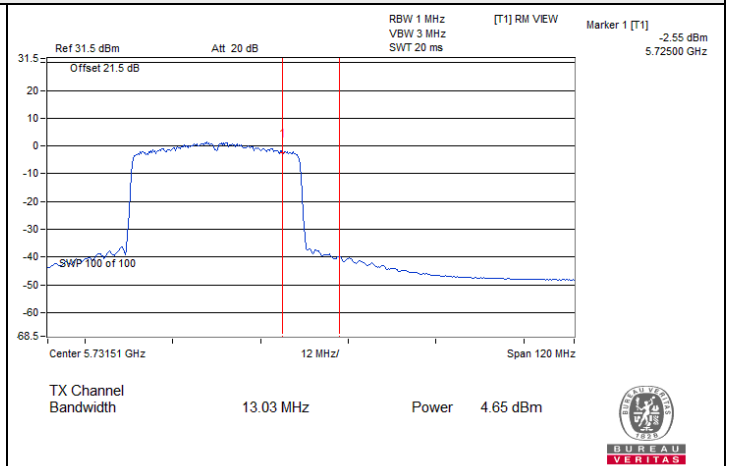

802.11ax (HE40) CDD / Chain 3 : CH 142 (U-NII-3)

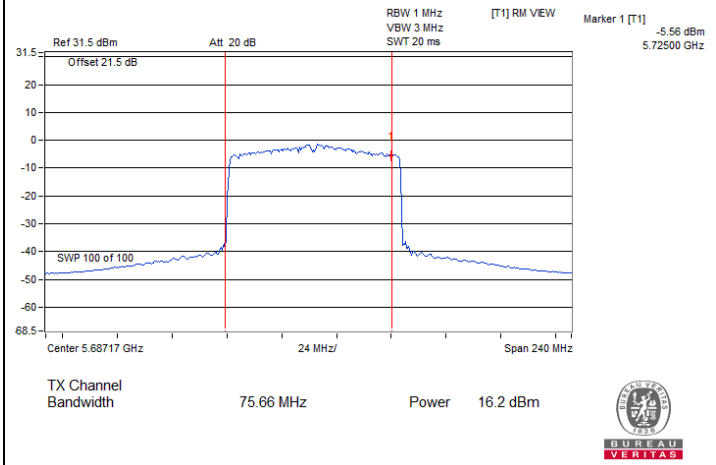

802.11ax (HE80) CDD / Chain 0 : CH 138 (U-NII-2C)

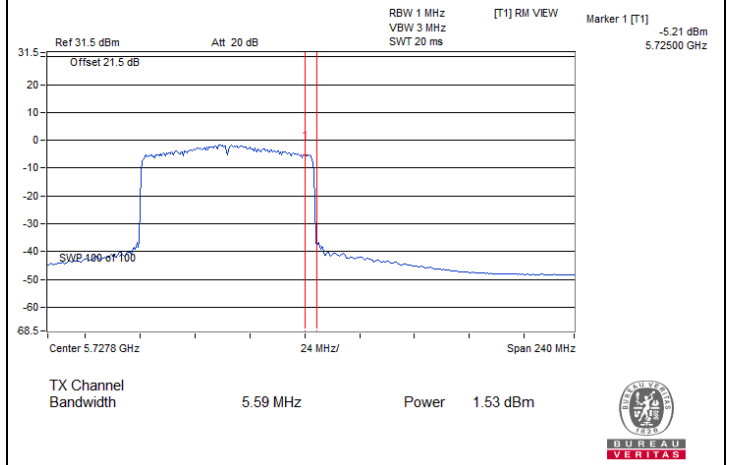

802.11ax (HE80) CDD / Chain 0 : CH 138 (U-NII-3)

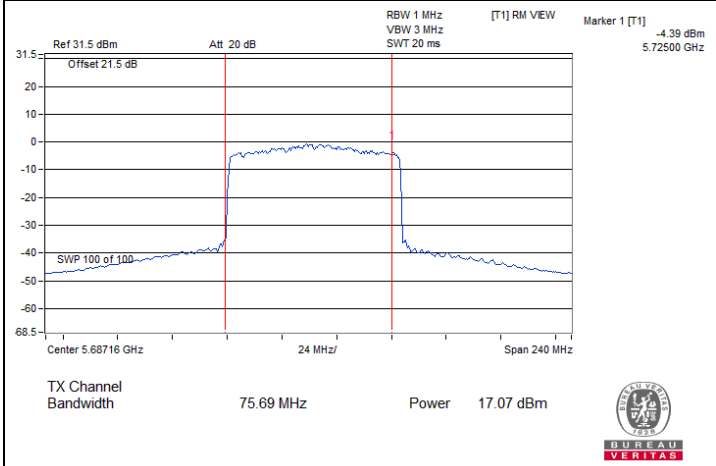

802.11ax (HE80) CDD / Chain 1 : CH 138 (U-NII-2C)

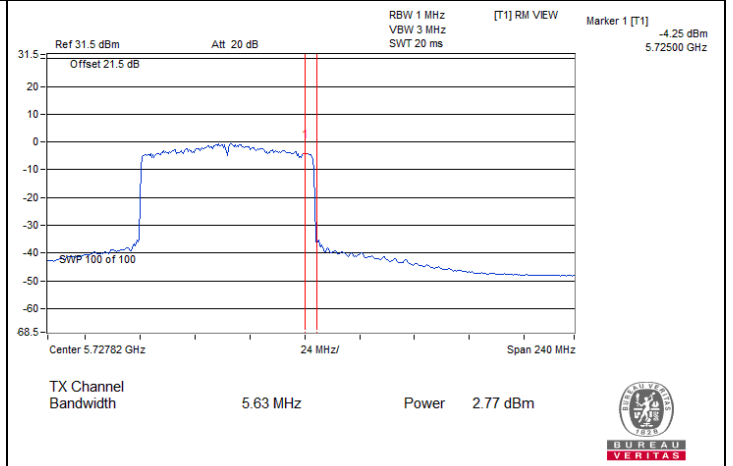

802.11ax (HE80) CDD / Chain 1 : CH 138 (U-NII-3)



### Spectrum Plot for channel straddling

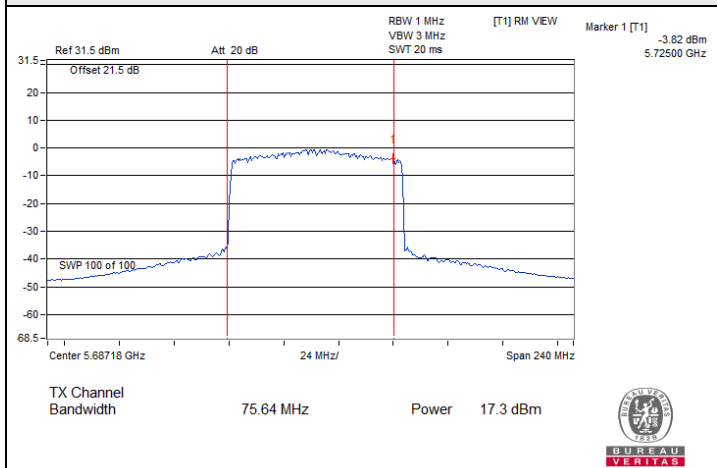

802.11ax (HE80) CDD / Chain 2 : CH 138 (U-NII-2C)

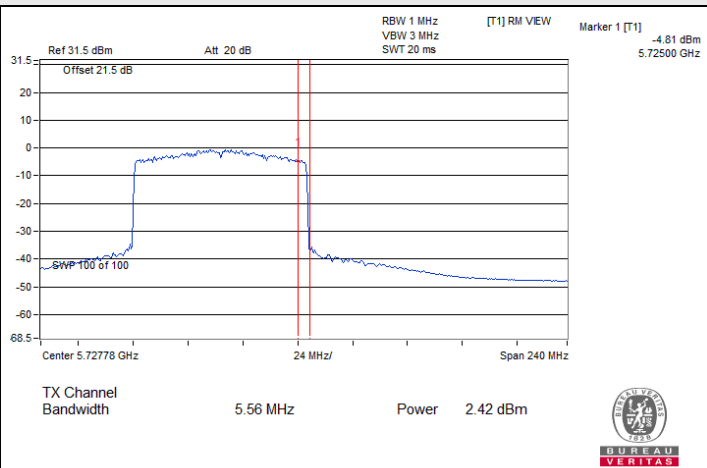

802.11ax (HE80) CDD / Chain 2 : CH 138 (U-NII-3)

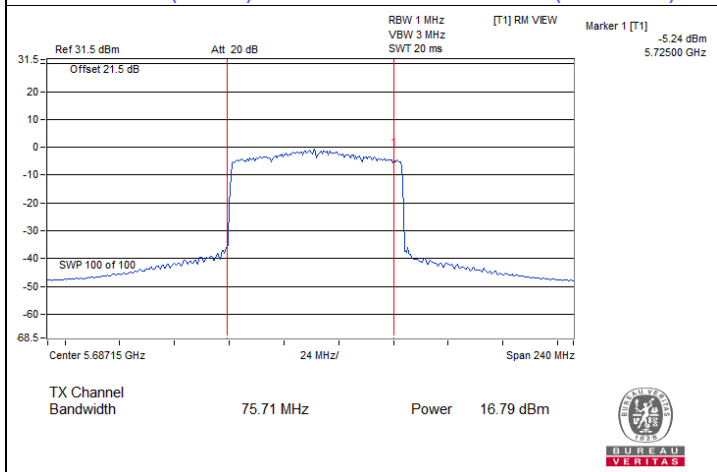

802.11ax (HE80) CDD / Chain 3 : CH 138 (U-NII-2C)

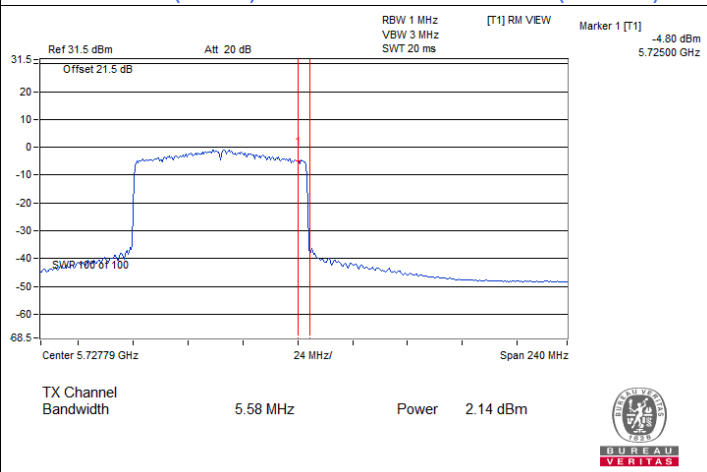

802.11ax (HE80) CDD / Chain 3 : CH 138 (U-NII-3)

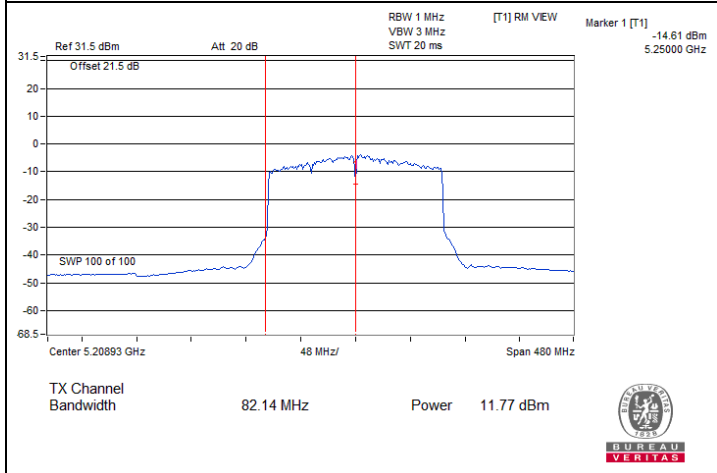

802.11ax (HE160) CDD / Chain 0 : CH 50 (U-NII-1)

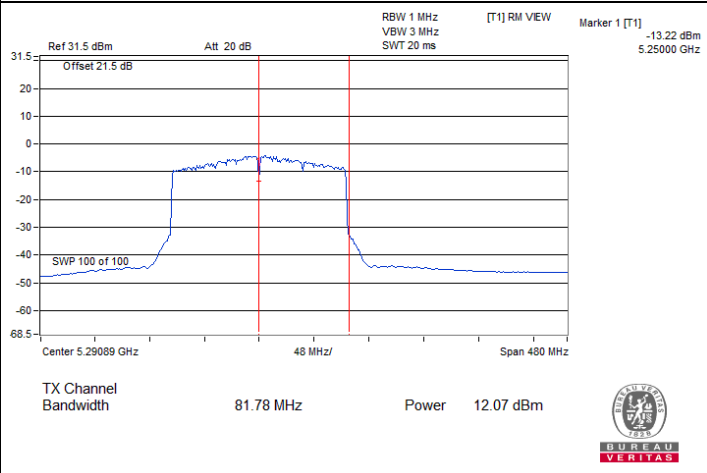

802.11ax (HE160) CDD / Chain 0 : CH 50 (U-NII-2A)

### Spectrum Plot for channel straddling

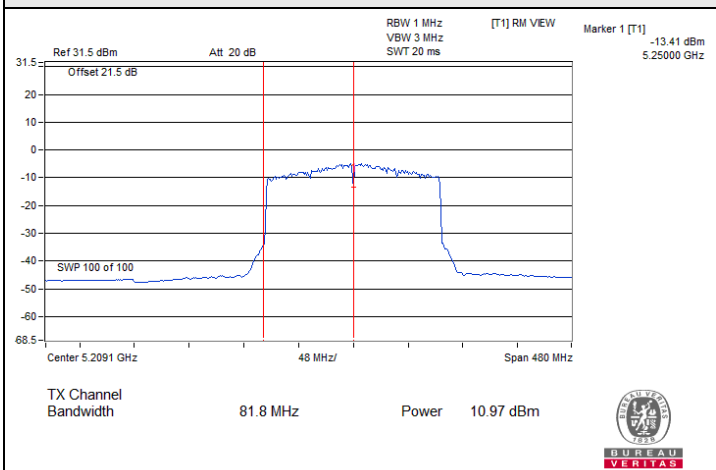

802.11ax (HE160) CDD / Chain 1 : CH 50 (U-NII-1)

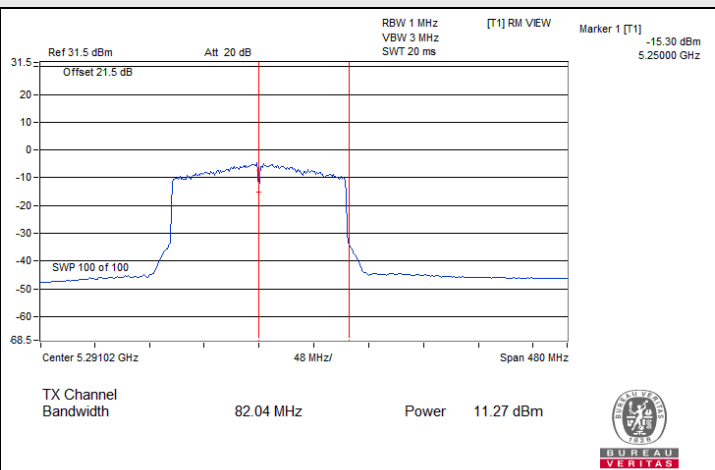

802.11ax (HE160) CDD / Chain 1 : CH 50 (U-NII-2A)

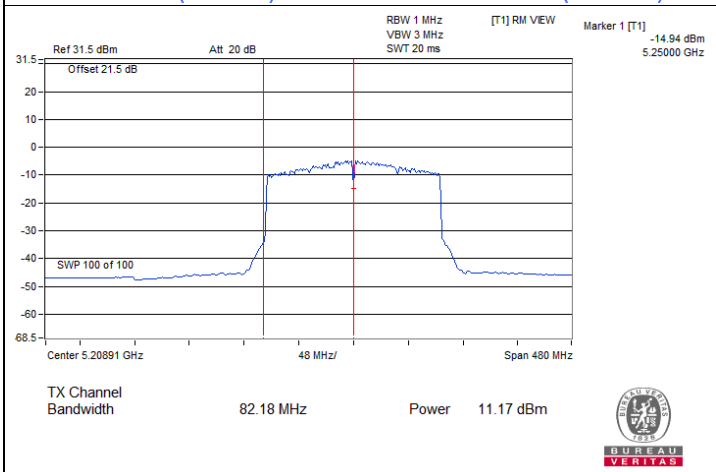

802.11ax (HE160) CDD / Chain 2 : CH 50 (U-NII-1)

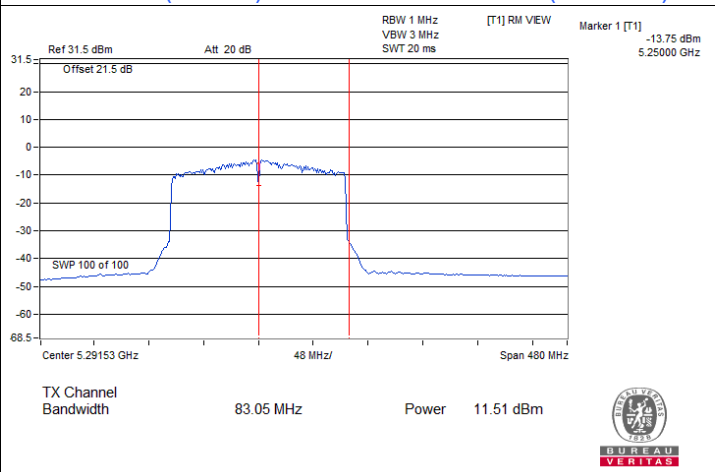

802.11ax (HE160) CDD / Chain 2 : CH 50 (U-NII-2A)

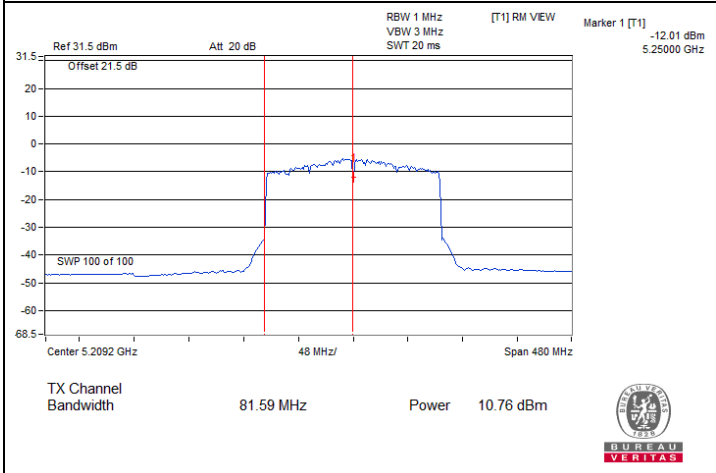

802.11ax (HE160) CDD / Chain 3 : CH 50 (U-NII-1)

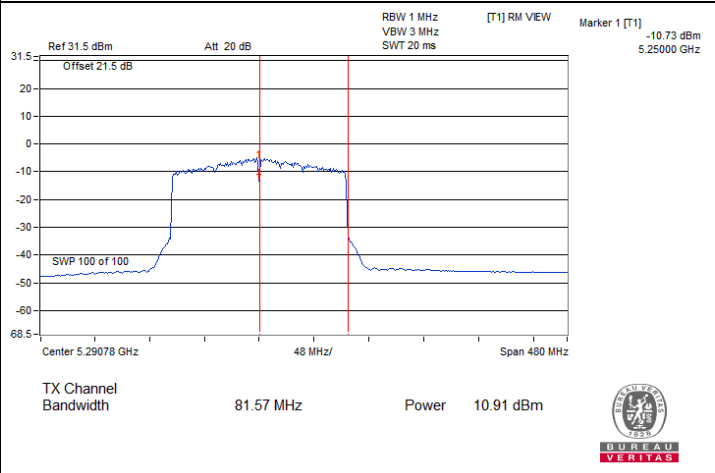

802.11ax (HE160) CDD / Chain 3 : CH 50 (U-NII-2A)

### 7.3 Power Spectral Density

Input Power:	120 Vac, 60 Hz	Environmental Conditions:	25°C, 60% RH	Tested By:	Willy Lin
--------------	----------------	---------------------------	--------------	------------	-----------

#### 802.11a

Chan.	Chan. Freq. (MHz)	PSD (dBm/MHz)				Total PSD (dBm/MHz)	Max. PSD Limit (dBm/MHz)	Test Result
		Chain 0	Chain 1	Chain 2	Chain 3			
36	5180	8.88	9.22	8.76	8.05	14.77	17	Pass
40	5200	9.48	9.83	9.53	8.42	15.37	17	Pass
48	5240	9.91	10.02	9.04	8.69	15.47	17	Pass
52	5260	4.92	5.40	5.03	4.00	10.89	11	Pass
60	5300	4.00	5.68	4.82	4.01	10.70	11	Pass
64	5320	4.02	5.64	4.69	3.74	10.61	11	Pass
100	5500	3.94	4.90	4.45	3.64	10.28	11	Pass
116	5580	4.17	5.18	4.43	3.76	10.44	11	Pass
140	5700	3.75	4.44	3.66	2.94	9.75	11	Pass
144 (U-NII-2C)	5720	4.52	4.89	4.10	3.53	10.31	11	Pass

#### Notes:

- Method E) 2) a) of power density measurement of KDB 662911 is using for calculating total power density. Total power density is summing entire spectra across corresponding frequency bins on the various outputs by computer.
- Directional gain is the measured value according to KDB 662911 D03 Method of MIMO Antenna Gain Measurement.
- For U-NII-1, the directional gain is 4.7 dBi < 6dBi, so the power density limit shall not be reduced.
- For U-NII-2A, the directional gain is 3.39 dBi < 6 dBi, so the power density limit shall not be reduced.
- For U-NII-2C, the directional gain is 4.01 dBi < 6 dBi, so the power density limit shall not be reduced.

**802.11ax (HE20)**

Chan.	Chan. Freq. (MHz)	PSD (dBm/MHz)				Total PSD (dBm/MHz)	Max. PSD Limit (dBm/MHz)	Test Result
		Chain 0	Chain 1	Chain 2	Chain 3			
36	5180	7.04	7.36	7.59	6.79	13.23	17	Pass
40	5200	7.68	8.36	8.81	7.69	14.18	17	Pass
48	5240	9.44	9.41	9.36	8.63	15.24	17	Pass
52	5260	4.96	5.14	4.96	4.79	10.98	11	Pass
60	5300	4.16	5.08	4.76	4.19	10.59	11	Pass
64	5320	4.19	5.00	5.15	4.67	10.79	11	Pass
100	5500	4.41	4.53	4.70	4.90	10.66	11	Pass
116	5580	4.48	5.24	5.39	4.37	10.91	11	Pass
140	5700	4.35	4.47	3.64	3.99	10.15	11	Pass
144 (U-NII-2C)	5720	5.06	5.23	3.94	3.39	10.49	11	Pass

**Notes:**

1. Method E) 2) a) of power density measurement of KDB 662911 is using for calculating total power density. Total power density is summing entire spectra across corresponding frequency bins on the various outputs by computer.
2. Directional gain is the measured value according to KDB 662911 D03 Method of MIMO Antenna Gain Measurement.
3. For U-NII-1, the directional gain is 4.7 dBi < 6dBi, so the power density limit shall not be reduced.
4. For U-NII-2A, the directional gain is 3.39 dBi < 6 dBi, so the power density limit shall not be reduced.
5. For U-NII-2C, the directional gain is 4.01 dBi < 6 dBi, so the power density limit shall not be reduced.

**802.11ax (HE40)**

Chan.	Chan. Freq. (MHz)	PSD (dBm/MHz)				Total PSD (dBm/MHz)	Max. PSD Limit (dBm/MHz)	Test Result
		Chain 0	Chain 1	Chain 2	Chain 3			
38	5190	3.23	4.14	4.53	4.18	10.07	17	Pass
46	5230	6.60	6.92	6.49	6.12	12.56	17	Pass
54	5270	3.73	3.99	4.68	3.72	10.07	11	Pass
62	5310	3.11	3.81	4.57	3.77	9.87	11	Pass
102	5510	3.15	3.75	4.46	4.53	10.03	11	Pass
110	5550	3.52	3.82	4.61	4.22	10.08	11	Pass
134	5670	3.17	4.40	4.04	3.67	9.86	11	Pass
142 (U-NII-2C)	5710	3.22	4.52	4.13	3.63	9.92	11	Pass

**Notes:**

1. Method E) 2) a) of power density measurement of KDB 662911 is using for calculating total power density. Total power density is summing entire spectra across corresponding frequency bins on the various outputs by computer.
2. Directional gain is the measured value according to KDB 662911 D03 Method of MIMO Antenna Gain Measurement.
3. For U-NII-1, the directional gain is 4.7 dBi < 6dBi, so the power density limit shall not be reduced.
4. For U-NII-2A, the directional gain is 3.39 dBi < 6 dBi, so the power density limit shall not be reduced.
5. For U-NII-2C, the directional gain is 4.01 dBi < 6 dBi, so the power density limit shall not be reduced.

### 802.11ax (HE80)

Chan.	Chan. Freq. (MHz)	PSD (dBm/MHz)				Total PSD (dBm/MHz)	Max. PSD Limit (dBm/MHz)	Test Result
		Chain 0	Chain 1	Chain 2	Chain 3			
42	5210	-2.34	-1.22	-0.42	-1.08	4.81	17	Pass
58	5290	-0.12	0.16	0.75	0.04	6.24	11	Pass
106	5530	0.04	0.09	0.57	0.27	6.27	11	Pass
122	5610	1.10	1.11	2.16	1.23	7.44	11	Pass
138 (U-NII-2C)	5690	-0.13	0.73	0.74	1.45	6.75	11	Pass

**Notes:**

1. Method E) 2) a) of power density measurement of KDB 662911 is using for calculating total power density. Total power density is summing entire spectra across corresponding frequency bins on the various outputs by computer.
2. Directional gain is the measured value according to KDB 662911 D03 Method of MIMO Antenna Gain Measurement.
3. For U-NII-1, the directional gain is 4.7 dBi < 6dBi, so the power density limit shall not be reduced.
4. For U-NII-2A, the directional gain is 3.39 dBi < 6 dBi, so the power density limit shall not be reduced.
5. For U-NII-2C, the directional gain is 4.01 dBi < 6 dBi, so the power density limit shall not be reduced.

### 802.11ax (HE160)

Chan.	Chan. Freq. (MHz)	PSD w/o Duty Factor (dBm/MHz)				Duty Factor (dB)	Total PSD (dBm/MHz)	Max. PSD Limit (dBm/MHz)	Test Result
		Chain 0	Chain 1	Chain 2	Chain 3				
50 (U-NII-1)	5250	-4.21	-4.66	-4.72	-5.23	0.17	1.50	17	Pass
50 (U-NII-2A)	5250	-4.06	-4.64	-4.65	-5.11	0.17	1.59	11	Pass
114	5570	-4.58	-4.55	-3.66	-3.81	0.17	2.06	11	Pass

**Notes:**

1. Method E) 2) a) of power density measurement of KDB 662911 is using for calculating total power density. Total power density is summing entire spectra across corresponding frequency bins on the various outputs by computer.
2. Directional gain is the measured value according to KDB 662911 D03 Method of MIMO Antenna Gain Measurement.
3. For U-NII-1, the directional gain is 4.7 dBi < 6dBi, so the power density limit shall not be reduced.
4. For U-NII-2A, the directional gain is 3.39 dBi < 6 dBi, so the power density limit shall not be reduced.
5. For U-NII-2C, the directional gain is 4.01 dBi < 6 dBi, so the power density limit shall not be reduced.

**802.11a**

Chan.	Chan. Freq. (MHz)	PSD (dBm/300kHz)				Total PSD (dBm/300kHz)	Total PSD (dBm/500kHz)	PSD Limit (dBm/500kHz)	Test Result
		Chain 0	Chain 1	Chain 2	Chain 3				
144 (U-NII-3)	5720	-0.65	0.42	-0.69	-1.92	5.39	7.61	30	Pass
149	5745	5.90	5.92	5.28	4.91	11.54	13.76	30	Pass
157	5785	6.54	3.90	6.90	6.75	12.2	14.42	30	Pass
165	5825	6.28	7.11	6.84	6.79	12.79	15.01	30	Pass

**Notes:**

1. Method E) 2) b) Measure and sum spectral maxima across the outputs of KDB 662911 is using for calculating total power density.
2. Directional gain is the measured value according to KDB 662911 D03 Method of MIMO Antenna Gain Measurement.
3. For U-NII-3, the directional gain is 3.13 dBi < 6 dBi, so the power density limit shall not be reduced.

**802.11ax (HE20)**

Chan.	Chan. Freq. (MHz)	PSD (dBm/300kHz)				Total PSD (dBm/300kHz)	Total PSD (dBm/500kHz)	PSD Limit (dBm/500kHz)	Test Result
		Chain 0	Chain 1	Chain 2	Chain 3				
144 (U-NII-3)	5720	-0.09	0.12	-1.12	-1.51	5.42	7.64	30	Pass
149	5745	5.23	5.76	4.78	4.64	11.15	13.37	30	Pass
157	5785	5.97	5.83	5.97	5.85	11.93	14.15	30	Pass
165	5825	5.51	5.84	5.84	5.83	11.78	14.00	30	Pass

**Notes:**

1. Method E) 2) b) Measure and sum spectral maxima across the outputs of KDB 662911 is using for calculating total power density.
2. Directional gain is the measured value according to KDB 662911 D03 Method of MIMO Antenna Gain Measurement.
3. For U-NII-3, the directional gain is 3.13 dBi < 6 dBi, so the power density limit shall not be reduced.

**802.11ax (HE40)**

Chan.	Chan. Freq. (MHz)	PSD (dBm/300kHz)				Total PSD (dBm/300kHz)	Total PSD (dBm/500kHz)	PSD Limit (dBm/500kHz)	Test Result
		Chain 0	Chain 1	Chain 2	Chain 3				
142 (U-NII-3)	5710	-4.79	-3.92	-3.77	-4.32	1.84	4.06	30	Pass
151	5755	1.63	2.21	2.38	1.80	8.04	10.26	30	Pass
159	5795	2.79	3.62	3.34	3.25	9.28	11.50	30	Pass

**Notes:**

1. Method E) 2) b) Measure and sum spectral maxima across the outputs of KDB 662911 is using for calculating total power density.
2. Directional gain is the measured value according to KDB 662911 D03 Method of MIMO Antenna Gain Measurement.
3. For U-NII-3, the directional gain is 3.13 dBi < 6 dBi, so the power density limit shall not be reduced.

802.11ax (HE80)

Chan.	Chan. Freq. (MHz)	PSD (dBm/300kHz)				Total PSD (dBm/300kHz)	Total PSD (dBm/500kHz)	PSD Limit (dBm/500kHz)	Test Result
		Chain 0	Chain 1	Chain 2	Chain 3				
138 (U-NII-3)	5690	-7.34	-6.39	-7.54	-7.26	-1.09	1.13	30	Pass
155	5775	-2.88	-2.95	-2.21	-2.71	3.34	5.56	30	Pass

Notes:

1. Method E) 2) b) Measure and sum spectral maxima across the outputs of KDB 662911 is using for calculating total power density.
2. Directional gain is the measured value according to KDB 662911 D03 Method of MIMO Antenna Gain Measurement.
3. For U-NII-3, the directional gain is 3.13 dBi < 6 dBi, so the power density limit shall not be reduced.

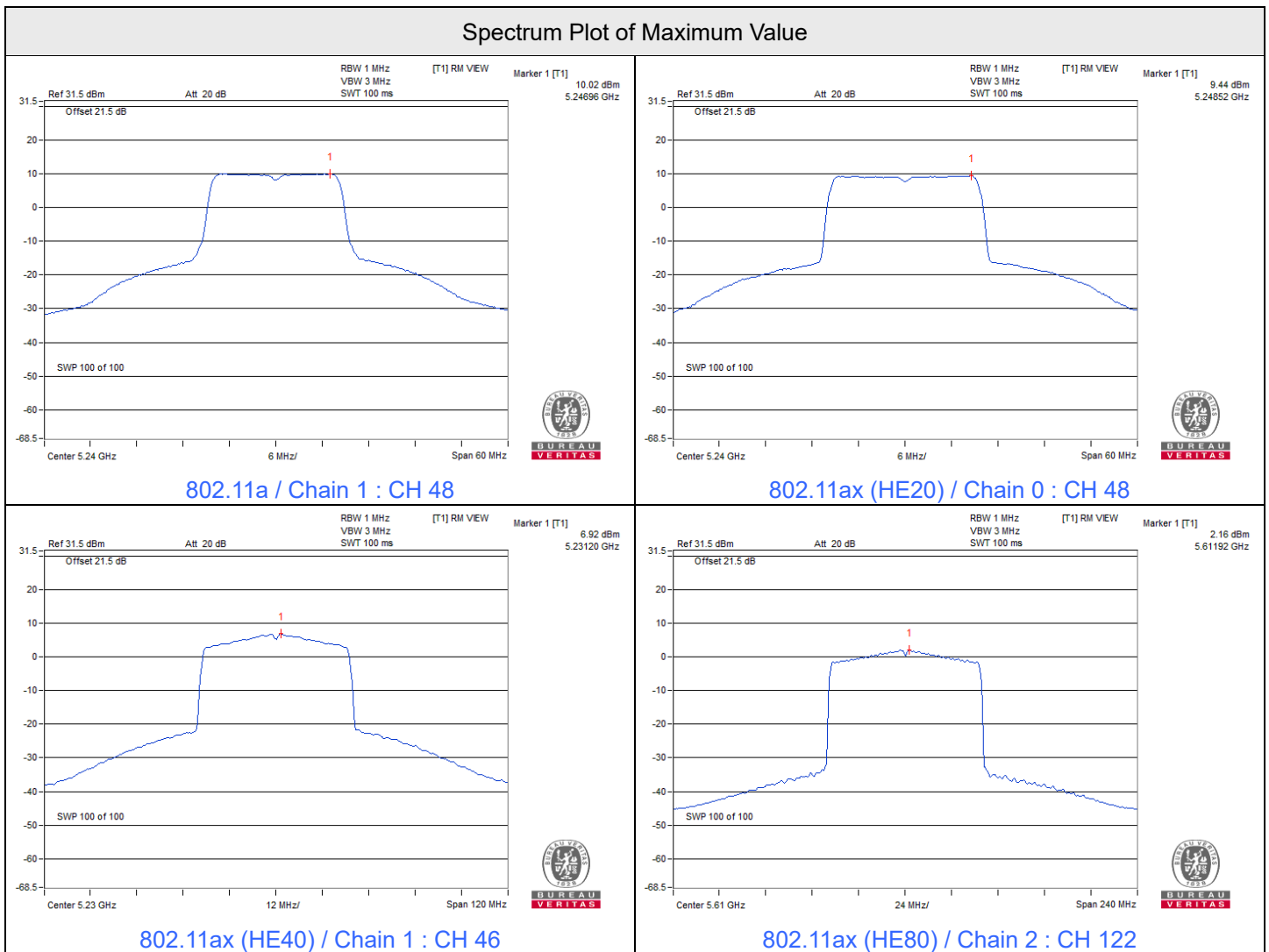



### Spectrum Plot of Maximum Value

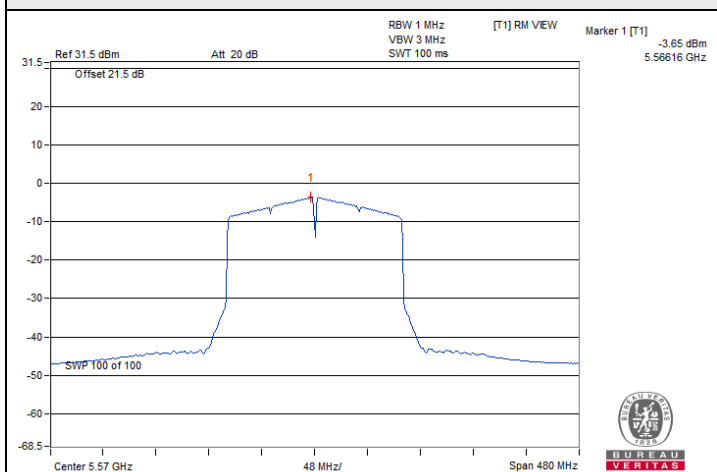

802.11ax (HE160) / Chain 2 : CH 114

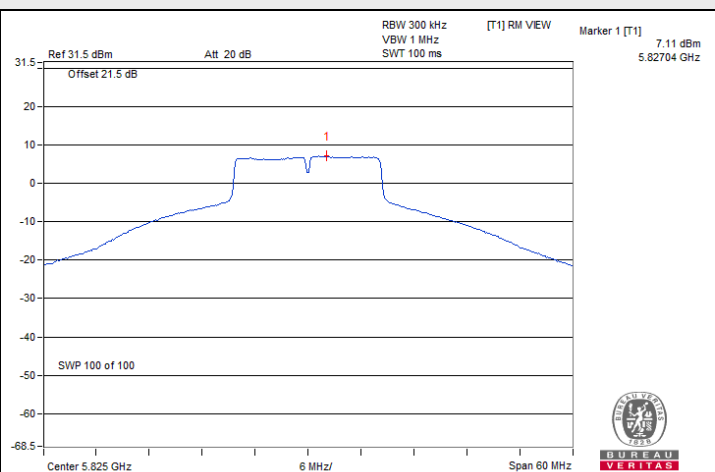

802.11a / Chain 1 : CH 165

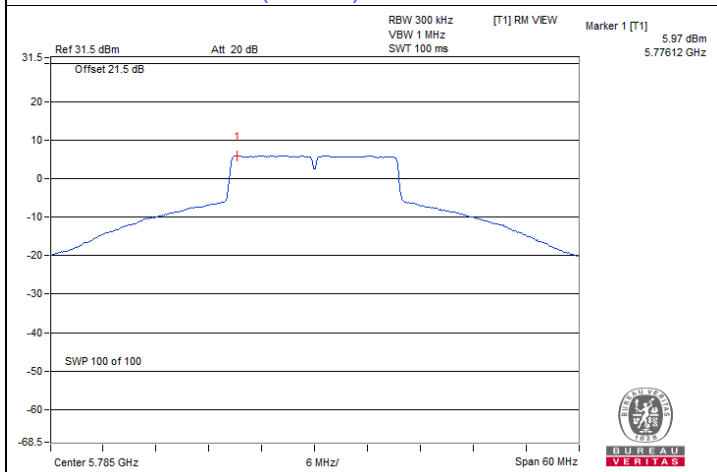

802.11ax (HE20) / Chain 0 : CH 157

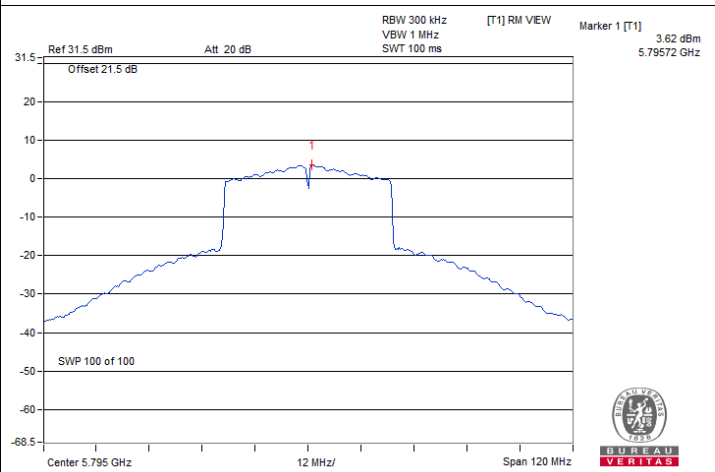

802.11ax (HE40) / Chain 1 : CH 159

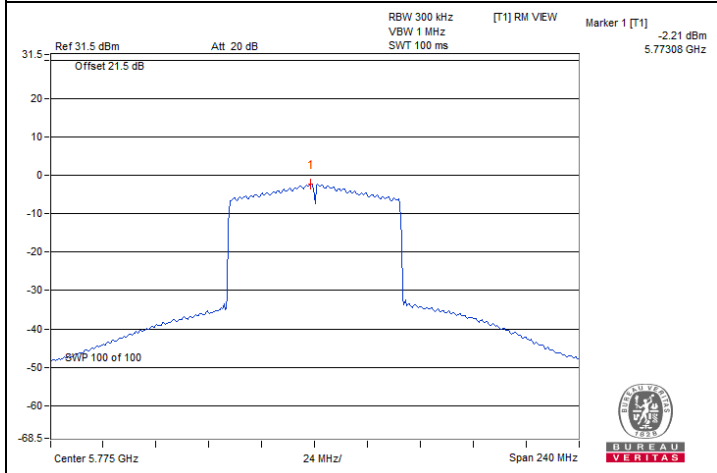

802.11ax (HE80) / Chain 2 : CH 155

#### 7.4 6 dB Bandwidth

Input Power:	120 Vac, 60 Hz	Environmental Conditions:	25°C, 60% RH	Tested By:	Willy Lin
--------------	----------------	---------------------------	--------------	------------	-----------

##### 802.11a

Channel	Frequency (MHz)	6 dB Bandwidth (MHz)				Minimum Limit (MHz)	Test Result
		Chain 0	Chain 1	Chain 2	Chain 3		
144 (U-NII-3)	5720	3.18	3.17	3.17	3.18	0.5	Pass
149	5745	16.44	16.42	16.45	16.46	0.5	Pass
157	5785	16.44	16.44	16.46	16.44	0.5	Pass
165	5825	16.43	16.44	16.44	16.46	0.5	Pass

##### 802.11ax (HE20)

Channel	Frequency (MHz)	6 dB Bandwidth (MHz)				Minimum Limit (MHz)	Test Result
		Chain 0	Chain 1	Chain 2	Chain 3		
144 (U-NII-3)	5720	4.52	4.49	4.51	4.49	0.5	Pass
149	5745	19.04	18.94	18.98	19.06	0.5	Pass
157	5785	19.03	18.96	19.02	19.05	0.5	Pass
165	5825	18.97	18.82	18.93	19.06	0.5	Pass

##### 802.11ax (HE40)

Channel	Frequency (MHz)	6 dB Bandwidth (MHz)				Minimum Limit (MHz)	Test Result
		Chain 0	Chain 1	Chain 2	Chain 3		
142 (U-NII-3)	5710	3.48	2.70	2.62	2.82	0.5	Pass
151	5755	37.29	36.37	36.15	35.98	0.5	Pass
159	5795	36.11	35.88	36.48	35.25	0.5	Pass

##### 802.11ax (HE80)

Channel	Frequency (MHz)	6 dB Bandwidth (MHz)				Minimum Limit (MHz)	Test Result
		Chain 0	Chain 1	Chain 2	Chain 3		
138 (U-NII-3)	5690	2.87	2.43	2.72	2.72	0.5	Pass
155	5775	76.20	75.43	75.46	75.46	0.5	Pass



### Spectrum Plot of Minimum Value

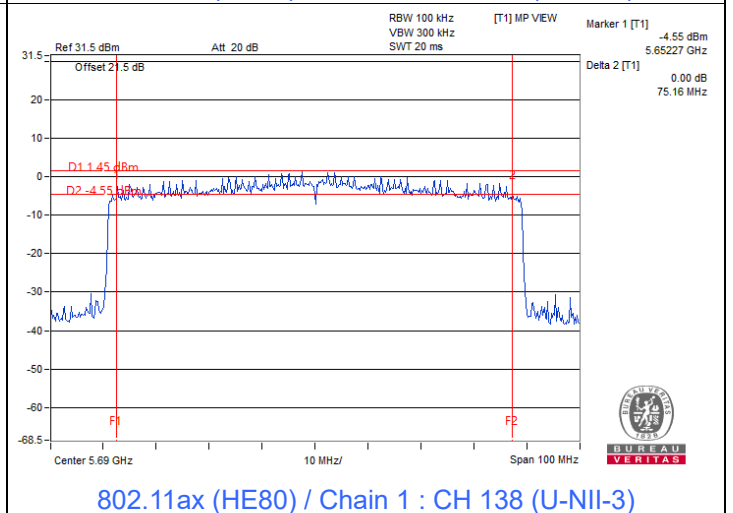
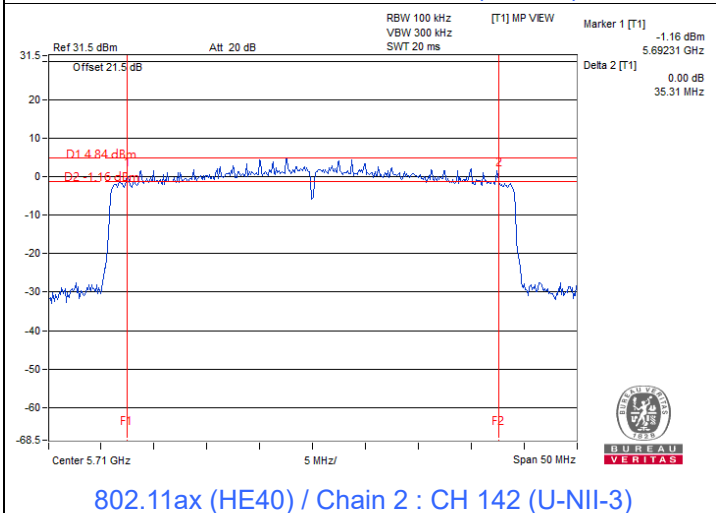
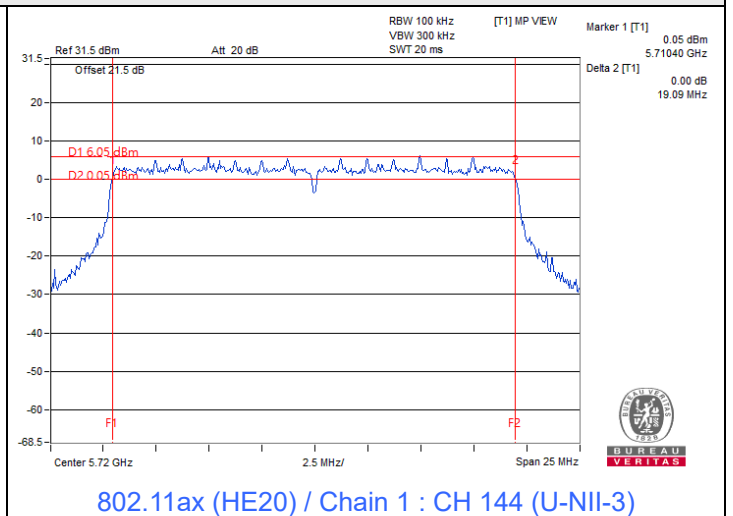
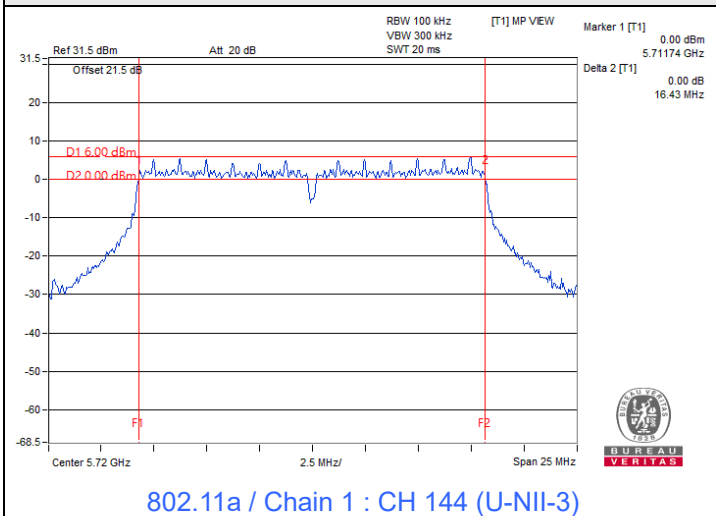

Note: For U-NII-3 straddle channel = Marker 1 + Delta 2 - 5725 MHz

## 7.5 Occupied Bandwidth

Input Power:	120 Vac, 60 Hz	Environmental Conditions:	25°C, 60% RH	Tested By:	Willy Lin
--------------	----------------	---------------------------	--------------	------------	-----------

### 802.11a

Channel	Frequency (MHz)	Occupied Bandwidth (MHz)			
		Chain 0	Chain 1	Chain 2	Chain 3
36	5180	17.28	17.16	17.16	17.16
40	5200	17.76	17.76	17.52	17.16
48	5240	19.44	18.48	17.40	17.28
52	5260	16.92	16.80	16.80	16.80
60	5300	17.16	17.04	17.04	17.04
64	5320	17.16	17.04	17.04	17.04
100	5500	17.16	17.16	17.04	17.04
116	5580	16.80	16.80	16.80	16.80
140	5700	17.04	17.04	16.92	16.92
144 (U-NII-2C)	5720	13.52	13.52	13.52	13.40
144 (U-NII-3)	5720	3.40	3.40	3.28	3.28
149	5745	32.80	29.28	27.48	24.72
157	5785	41.40	42.00	42.80	43.00
165	5825	42.00	41.60	43.80	42.80

### 802.11ax (HE20)

Channel	Frequency (MHz)	Occupied Bandwidth (MHz)			
		Chain 0	Chain 1	Chain 2	Chain 3
36	5180	19.32	19.32	19.32	19.32
40	5200	19.32	19.32	19.32	19.32
48	5240	19.20	19.32	19.32	19.08
52	5260	19.20	19.08	19.20	19.08
60	5300	19.32	19.44	19.32	19.20
64	5320	19.32	19.44	19.20	19.44
100	5500	19.32	19.32	19.32	19.32
116	5580	19.20	19.20	19.20	19.20
140	5700	19.20	19.20	19.32	19.20
144 (U-NII-2C)	5720	14.72	14.72	14.72	14.72
144 (U-NII-3)	5720	4.48	4.48	4.48	4.48
149	5745	31.20	37.20	30.00	32.20
157	5785	45.60	45.60	47.80	47.60
165	5825	45.60	46.60	46.80	46.40

**802.11ax (HE40)**

Channel	Frequency (MHz)	Occupied Bandwidth (MHz)			
		Chain 0	Chain 1	Chain 2	Chain 3
38	5190	37.92	37.92	38.16	37.92
46	5230	38.16	38.16	38.16	37.92
54	5270	37.68	37.68	37.92	37.92
62	5310	37.92	37.92	38.16	38.16
102	5510	37.92	37.92	38.16	37.92
110	5550	37.92	37.68	37.92	37.68
134	5670	38.16	38.16	38.16	38.16
142 (U-NII-2C)	5710	33.96	34.20	33.96	33.96
142 (U-NII-3)	5710	3.72	3.72	3.72	3.72
151	5755	38.64	38.40	38.64	38.40
159	5795	50.64	41.76	48.24	44.64

**802.11ax (HE80)**

Channel	Frequency (MHz)	Occupied Bandwidth (MHz)			
		Chain 0	Chain 1	Chain 2	Chain 3
42	5210	0.00	0.00	0.00	0.00
58	5290	77.28	77.28	77.28	77.28
106	5530	77.28	77.28	77.28	77.28
122	5610	77.28	77.28	77.28	77.28
138 (U-NII-2C)	5690	73.88	73.88	73.40	73.88
138 (U-NII-3)	5690	3.40	3.40	3.40	3.40
155	5775	77.28	77.28	77.28	77.28

**802.11ax (HE160)**

Channel	Frequency (MHz)	Occupied Bandwidth (MHz)			
		Chain 0	Chain 1	Chain 2	Chain 3
50 (U-NII-1)	5250	78.72	78.72	77.76	78.72
50 (U-NII-2A)	5250	77.76	77.76	77.76	77.76
114	5570	156.48	156.48	156.48	156.48



### Spectrum Plot of Maximum Value

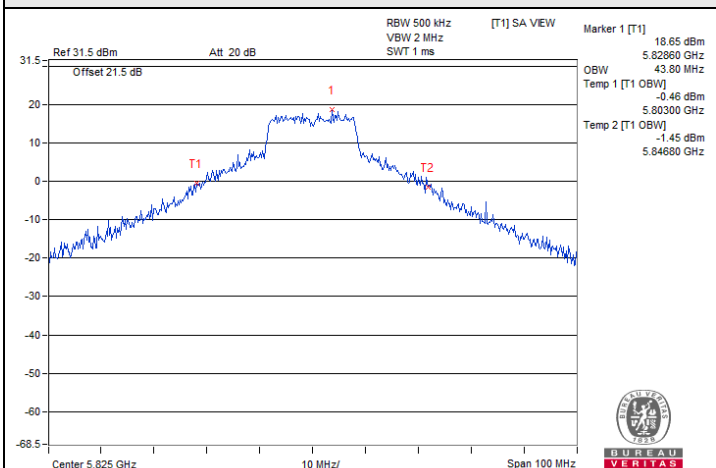

802.11a / Chain 2 : CH 165

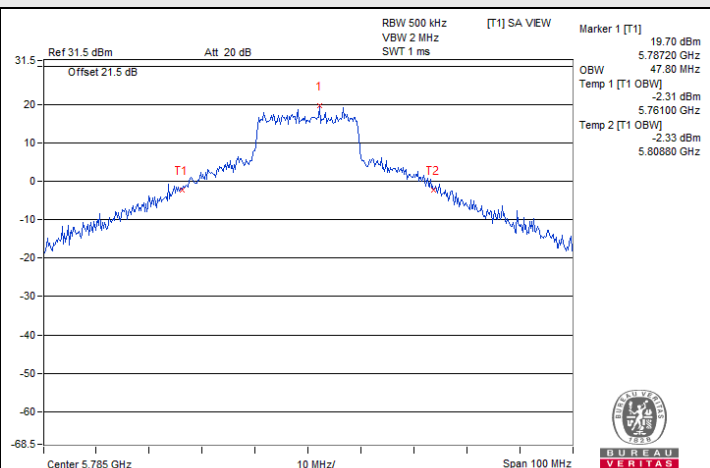

802.11ax (HE20) / Chain 2 : CH 157

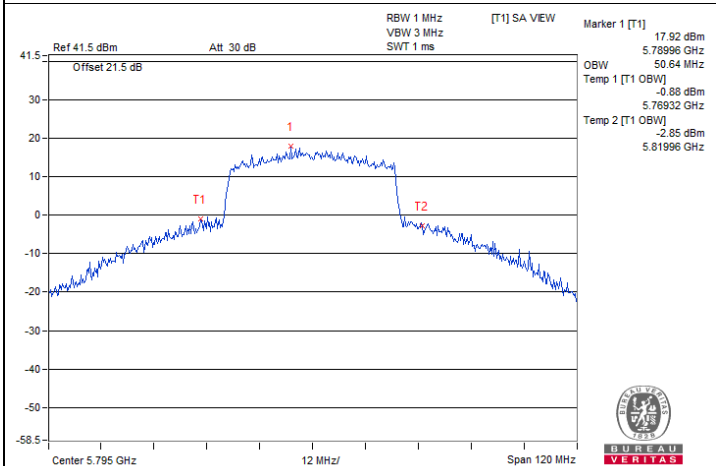

802.11ax (HE40) / Chain 0 : CH 159

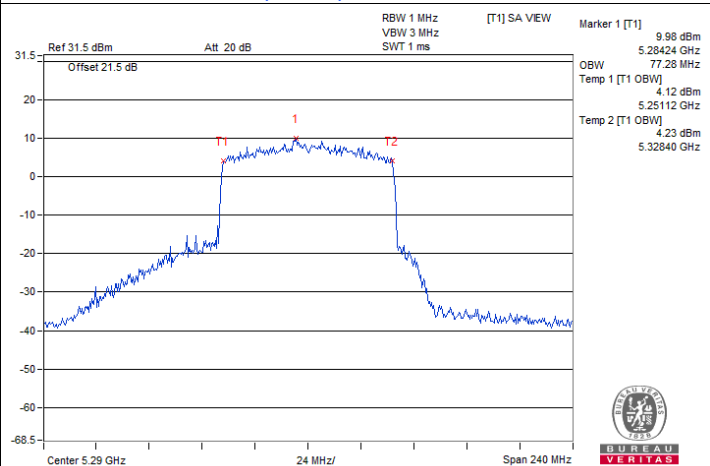

802.11ax (HE80) / Chain 0 : CH 58

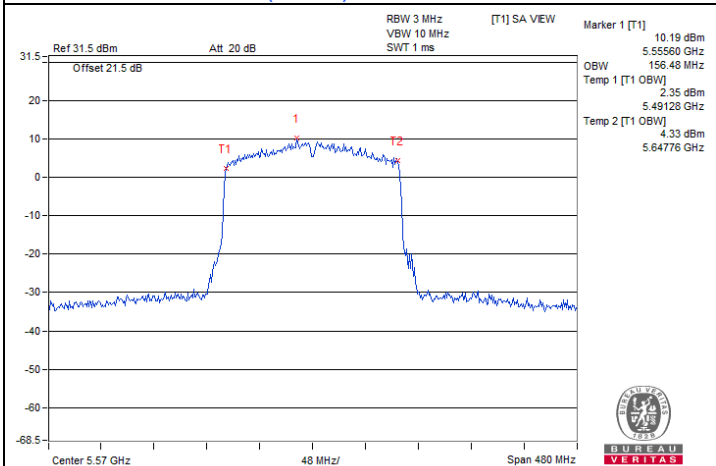

802.11ax (HE160) / Chain 0 : CH 114

### Spectrum Plot for nearby DFS band (DFS is required, if 99% OCP straddle into U-NII-2A)

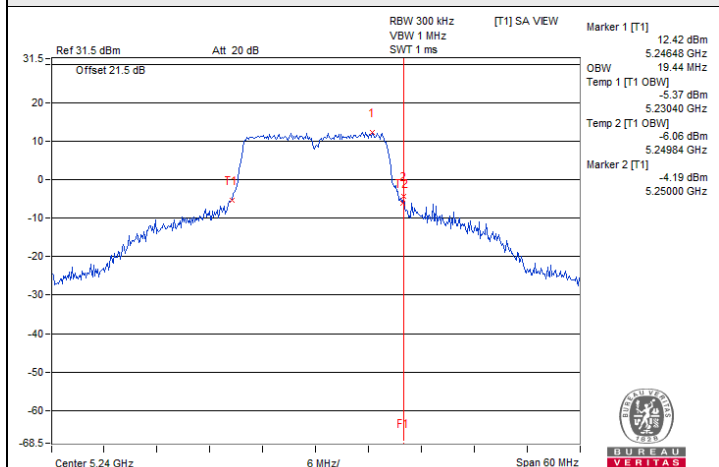

802.11a / Chain 0 : CH 48

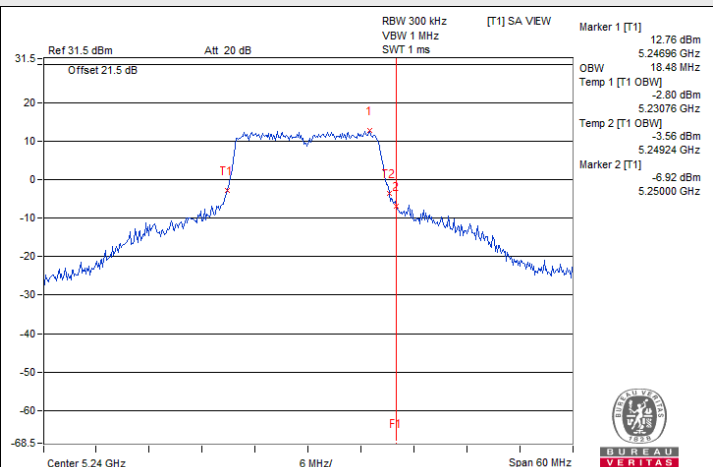

802.11a / Chain 1 : CH 48

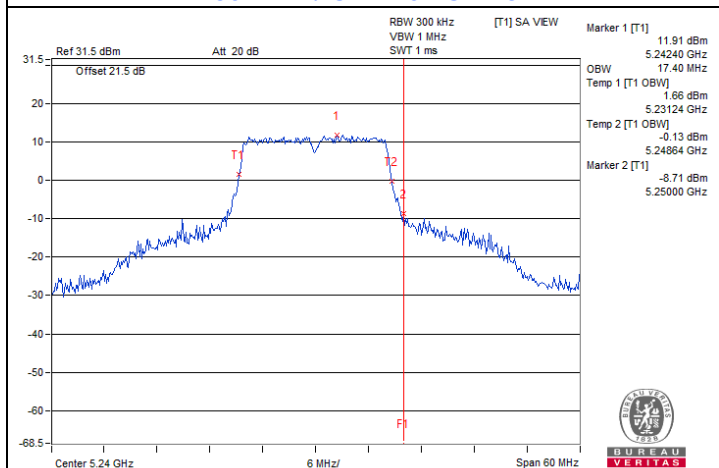

802.11a / Chain 2 : CH 48

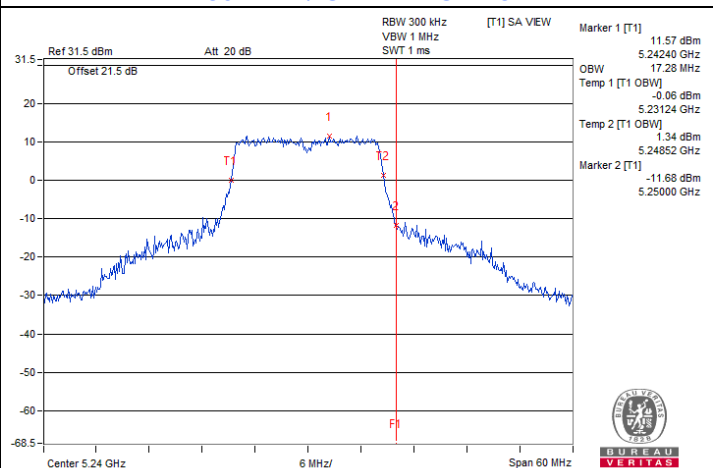

802.11a / Chain 3 : CH 48

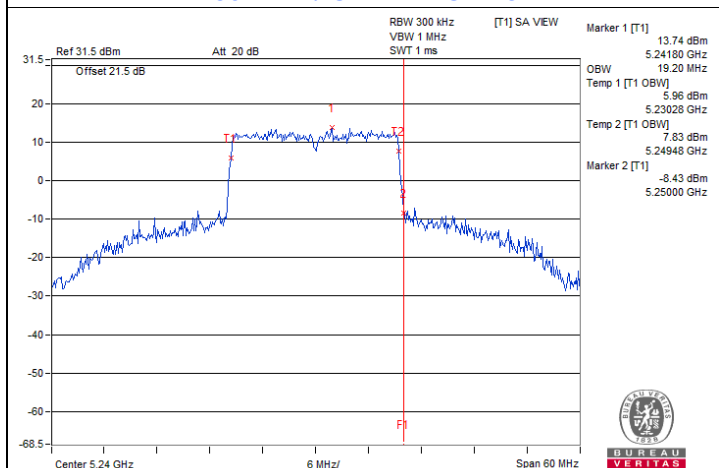

802.11ax (HE20) / Chain 0 : CH 48

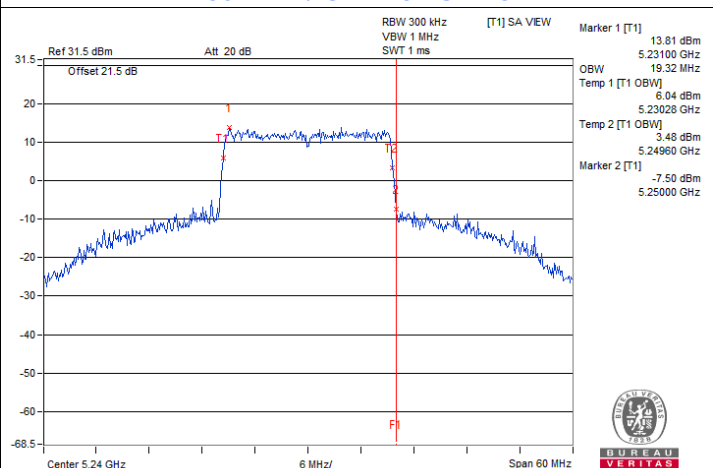

802.11ax (HE20) / Chain 1 : CH 48



### Spectrum Plot for nearby DFS band (DFS is required, if 99% OCP straddle into U-NII-2A)

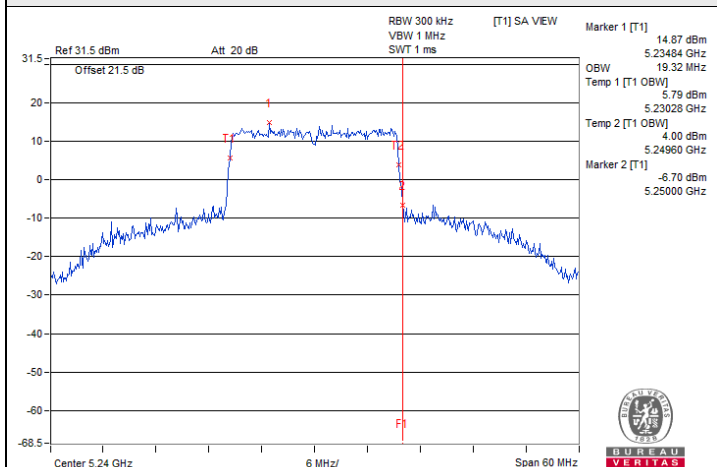

802.11ax (HE20) / Chain 2 : CH 48

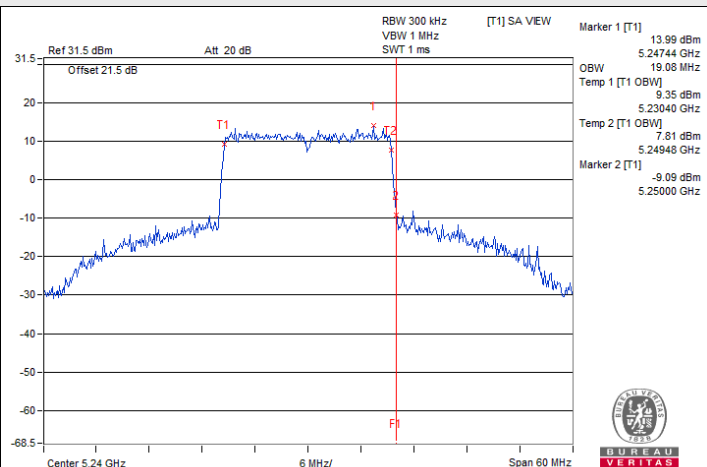

802.11ax (HE20) / Chain 3 : CH 48

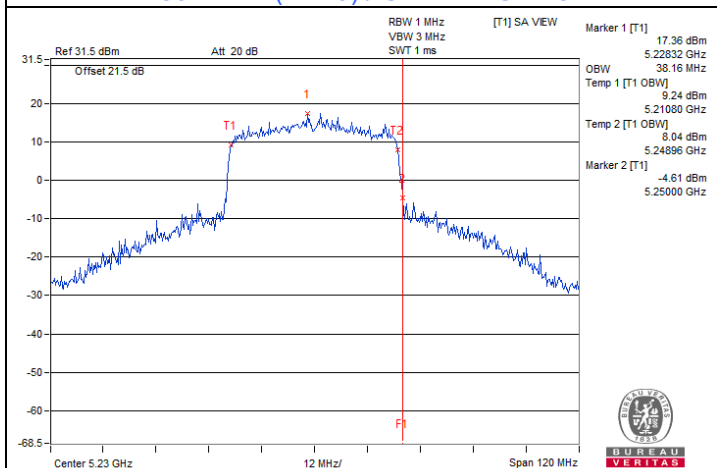

802.11ax (HE40) / Chain 0 : CH 46

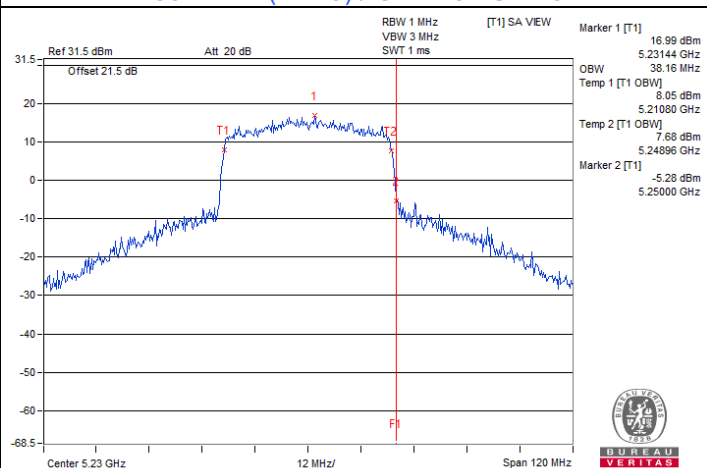

802.11ax (HE40) / Chain 1 : CH 46

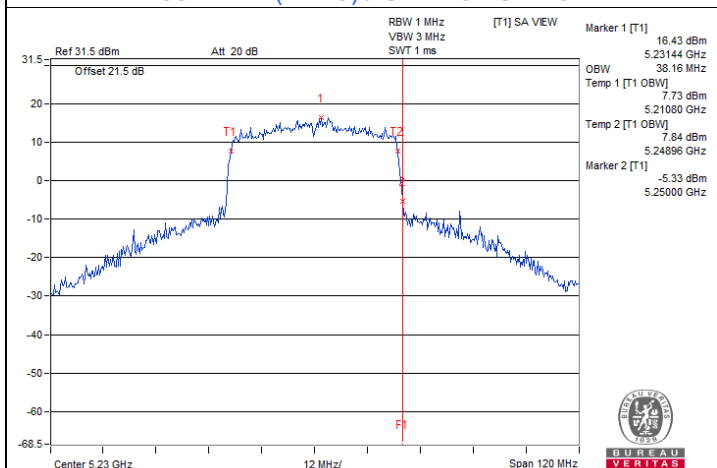

802.11ax (HE40) / Chain 2 : CH 46

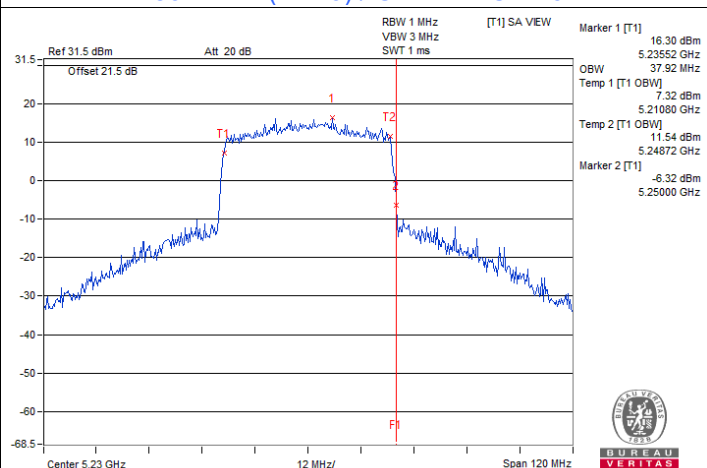

802.11ax (HE40) / Chain 3 : CH 46



### Spectrum Plot for nearby DFS band (DFS is required, if 99% OCP straddle into U-NII-2A)

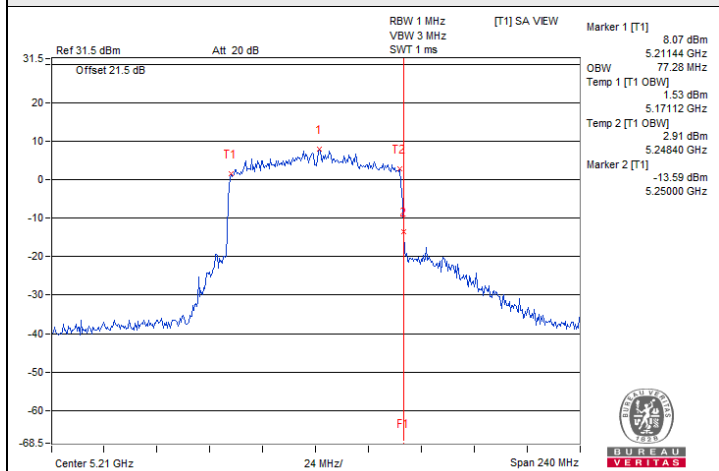

802.11ax (HE80) / Chain 0 : CH 42

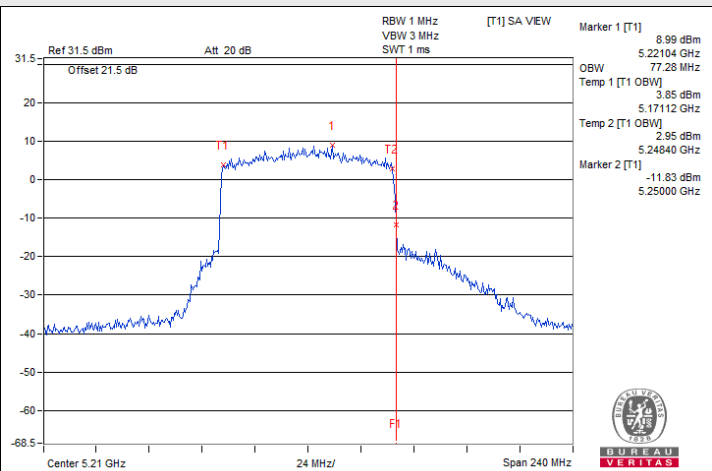

802.11ax (HE80) / Chain 1 : CH 42

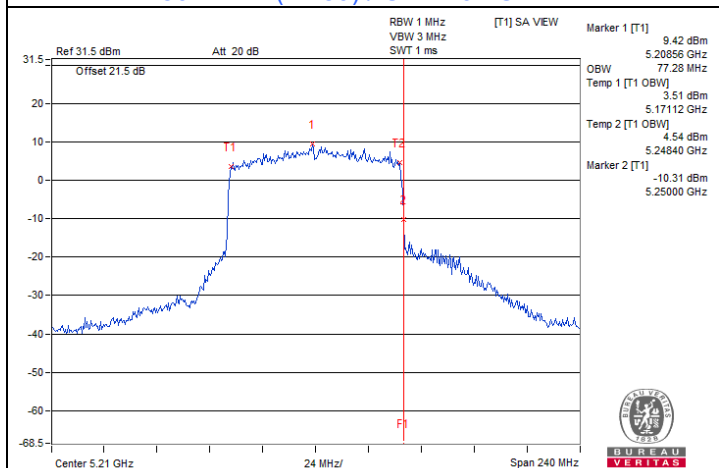

802.11ax (HE80) / Chain 2 : CH 42

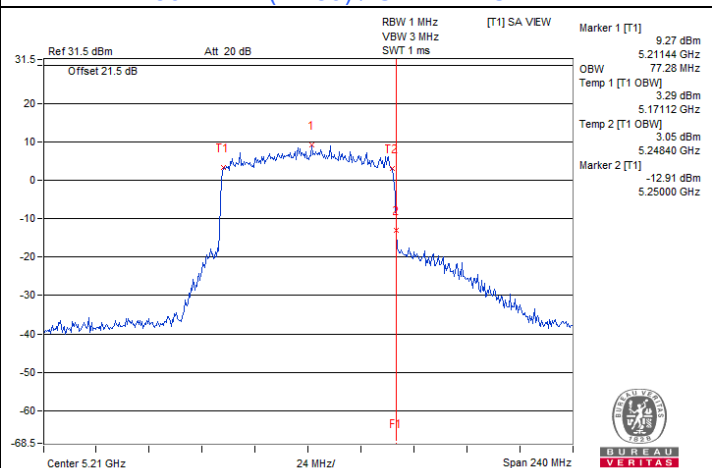

802.11ax (HE80) / Chain 3 : CH 42

### Spectrum Plot for nearby DFS band (DFS is required, if 99% OCP straddle into U-NII-2C)

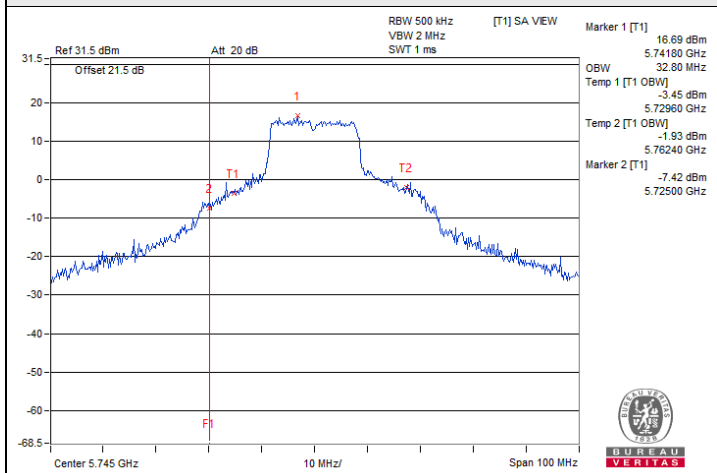

802.11a / Chain 0 : CH 149

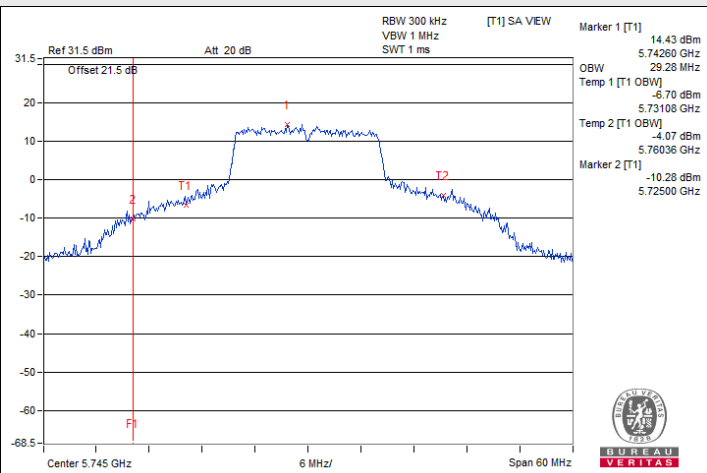

802.11a / Chain 1 : CH 149

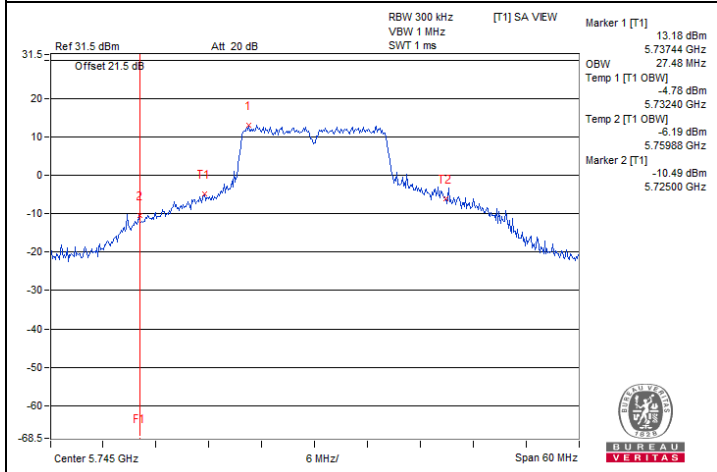

802.11a / Chain 2 : CH 149

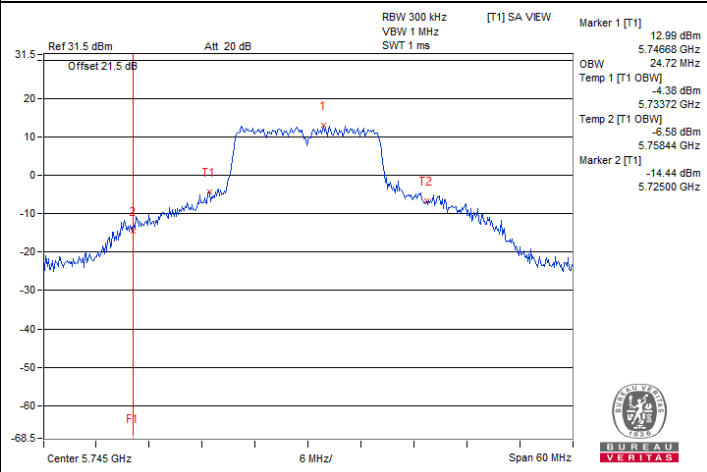

802.11a / Chain 3 : CH 149

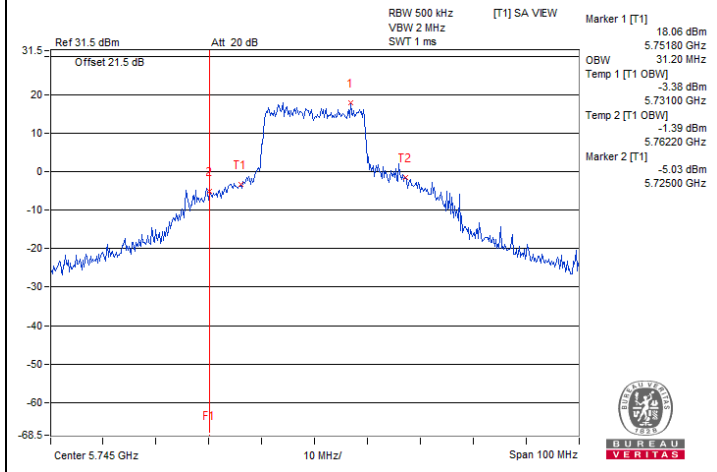

802.11ax (HE20) / Chain 0 : CH 149

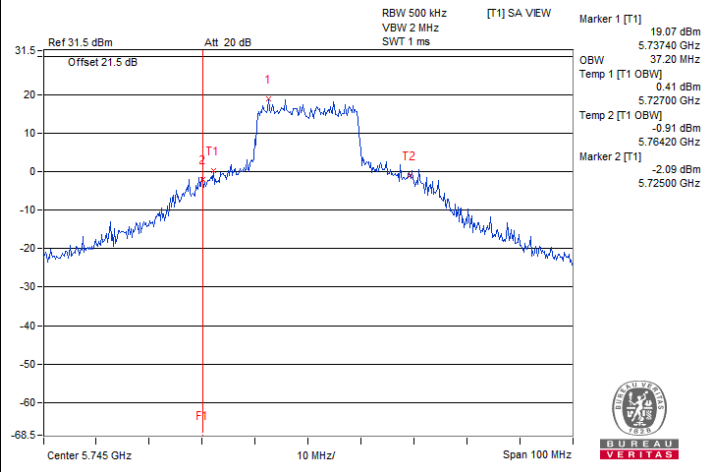

802.11ax (HE20) / Chain 1 : CH 149

### Spectrum Plot for nearby DFS band (DFS is required, if 99% OCP straddle into U-NII-2C)

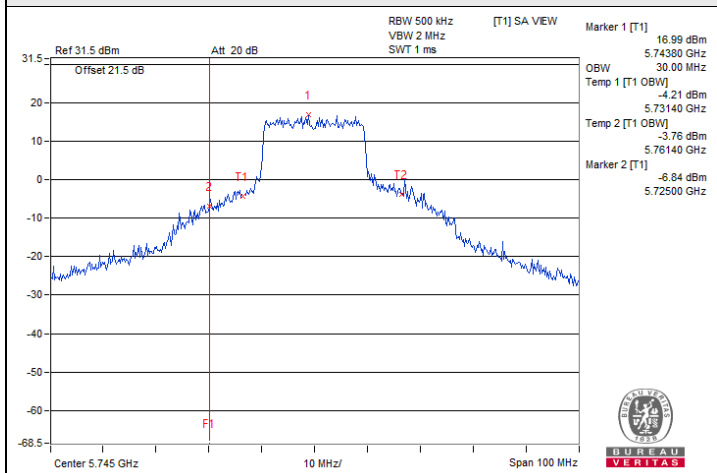

802.11ax (HE20) / Chain 2 : CH 149

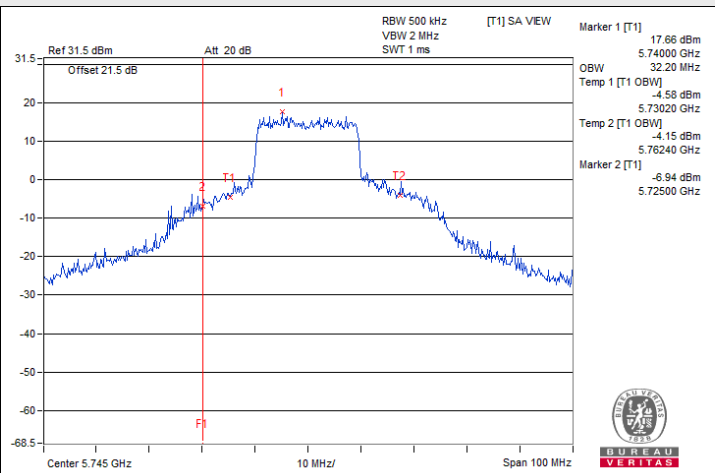

802.11ax (HE20) / Chain 3 : CH 149

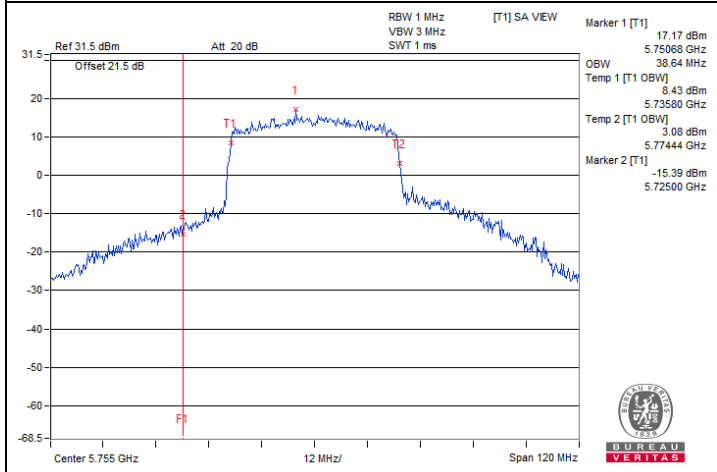

802.11ax (HE40) / Chain 0 : CH 151

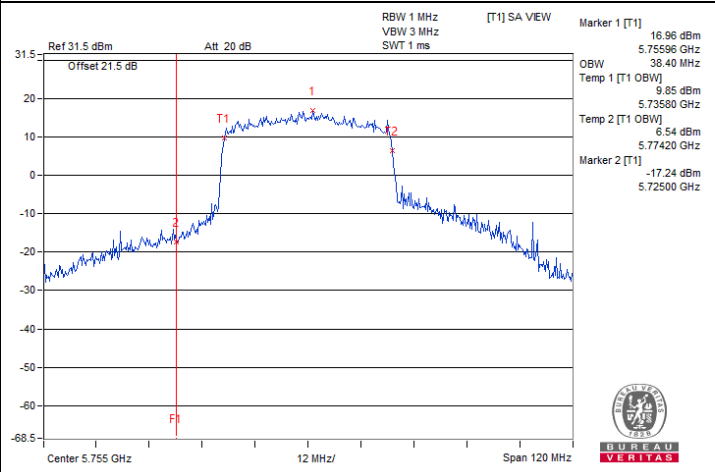

802.11ax (HE40) / Chain 1 : CH 151

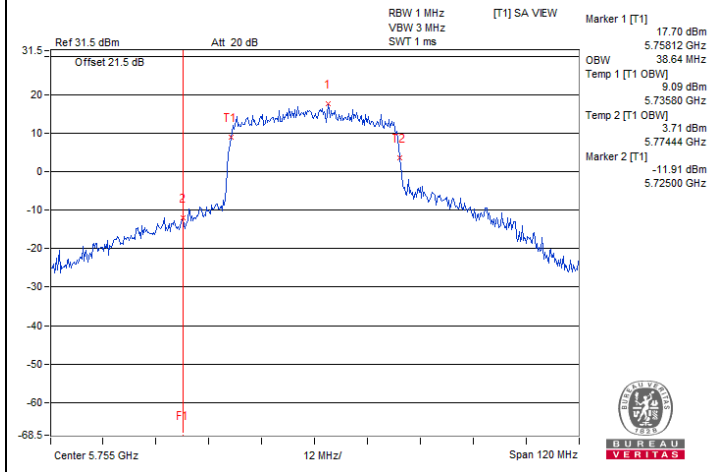

802.11ax (HE40) / Chain 2 : CH 151

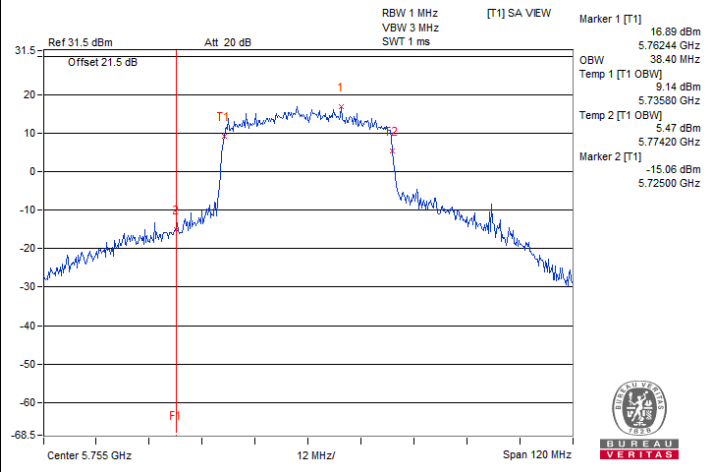

802.11ax (HE40) / Chain 3 : CH 151



### Spectrum Plot for nearby DFS band (DFS is required, if 99% OCP straddle into U-NII-2C)

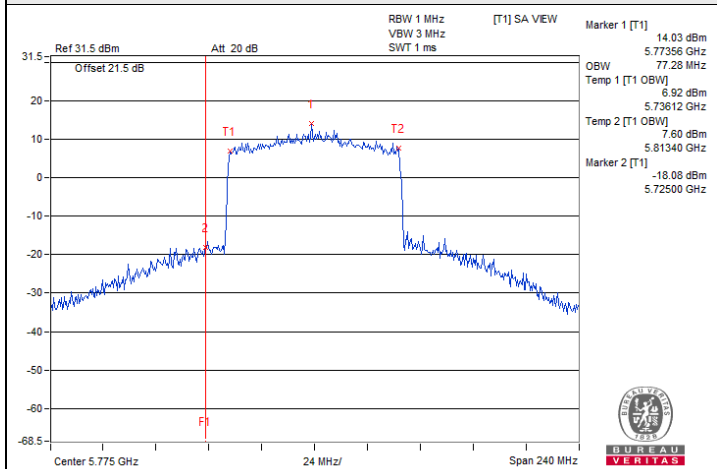

802.11ax (HE80) / Chain 0 : CH 155

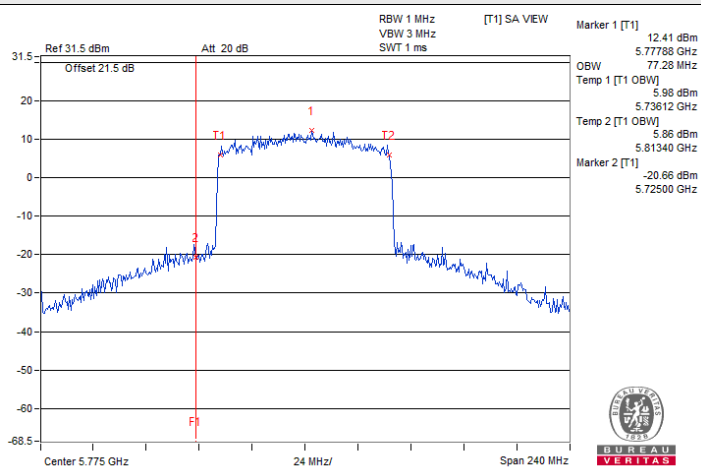

802.11ax (HE80) / Chain 1 : CH 155

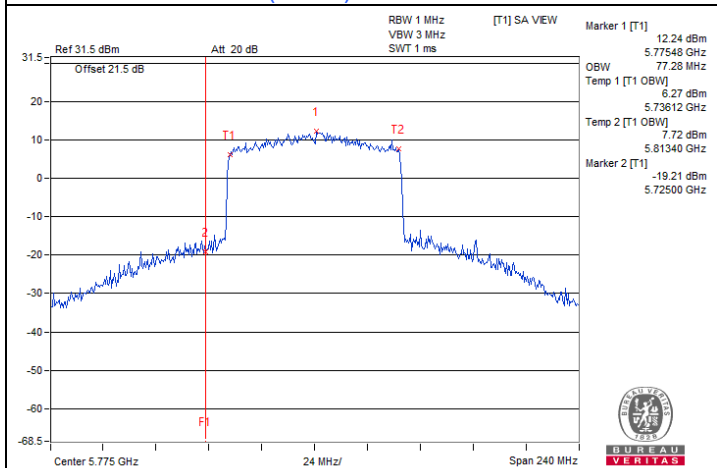

802.11ax (HE80) / Chain 2 : CH 155

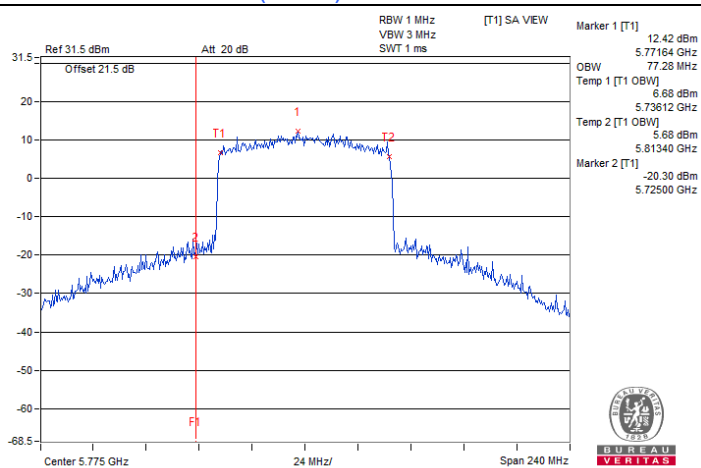

802.11ax (HE80) / Chain 3 : CH 155

## 7.6 Frequency Stability

Input Power:	120 Vac, 60 Hz	Environmental Conditions:	25°C, 60% RH	Tested By:	Willy Lin
--------------	----------------	---------------------------	--------------	------------	-----------

Frequency Stability Versus Temperature									
Operating Frequency: 5180 MHz									
Temp. (°C)	Power Supply (Vac)	0 Minute		2 Minutes		5 Minutes		10 Minutes	
		Measured Frequency (MHz)	Test Result	Measured Frequency (MHz)	Test Result	Measured Frequency (MHz)	Test Result	Measured Frequency (MHz)	Test Result
50	120	5179.9819	Pass	5179.9859	Pass	5179.9828	Pass	5179.9818	Pass
40	120	5180.0101	Pass	5180.0059	Pass	5180.0094	Pass	5180.0094	Pass
30	120	5180.0006	Pass	5180.0033	Pass	5180.0004	Pass	5180.0016	Pass
20	120	5180.0119	Pass	5180.0136	Pass	5180.0122	Pass	5180.0126	Pass
10	120	5179.9769	Pass	5179.9767	Pass	5179.9761	Pass	5179.9779	Pass
0	120	5180.0214	Pass	5180.0236	Pass	5180.0208	Pass	5180.0214	Pass
-10	120	5179.9895	Pass	5179.9898	Pass	5179.9913	Pass	5179.9883	Pass
-20	120	5179.9899	Pass	5179.9909	Pass	5179.9904	Pass	5179.9882	Pass
-30	120	5179.9988	Pass	5179.9956	Pass	5179.9975	Pass	5179.997	Pass

Frequency Stability Versus Voltage									
Operating Frequency: 5180 MHz									
Temp. (°C)	Power Supply (Vac)	0 Minute		2 Minutes		5 Minutes		10 Minutes	
		Measured Frequency (MHz)	Test Result	Measured Frequency (MHz)	Test Result	Measured Frequency (MHz)	Test Result	Measured Frequency (MHz)	Test Result
20	138	5180.0086	Pass	5180.0043	Pass	5180.0043	Pass	5180.0042	Pass
	120	5180.0119	Pass	5180.0136	Pass	5180.0122	Pass	5180.0126	Pass
	102	5180.0055	Pass	5180.0048	Pass	5180.0055	Pass	5180.0033	Pass

## 7.7 AC Power Conducted Emissions

<b>RF Mode</b>	802.11ax (HE20)	<b>Channel</b>	CH 157 : 5785 MHz
<b>Frequency Range</b>	150 kHz ~ 30 MHz	<b>Detector Function &amp; Resolution Bandwidth</b>	Quasi-Peak (QP) / Average (AV), 9 kHz
<b>Input Power</b>	120 Vac, 60 Hz	<b>Environmental Conditions</b>	25°C, 60% RH
<b>Tested By</b>	Willy Lin		

Phase Of Power : Line (L)										
No	Frequency (MHz)	Correction Factor (dB)	Reading Value (dBuV)		Emission Level (dBuV)		Limit (dBuV)		Margin (dB)	
			Q.P.	AV.	Q.P.	AV.	Q.P.	AV.	Q.P.	AV.
1	0.16953	9.93	34.11	4.48	44.04	14.41	64.98	54.98	-20.94	-40.57
2	0.22422	9.93	26.99	9.06	36.92	18.99	62.66	52.66	-25.74	-33.67
3	0.59531	9.95	24.94	11.82	34.89	21.77	56.00	46.00	-21.11	-24.23
4	0.85313	9.96	30.28	19.20	40.24	29.16	56.00	46.00	-15.76	-16.84
5	2.34375	10.02	21.80	11.32	31.82	21.34	56.00	46.00	-24.18	-24.66
6	7.44531	10.31	11.00	3.80	21.31	14.11	60.00	50.00	-38.69	-35.89

### Remarks:

1. Q.P. and AV. are abbreviations of quasi-peak and average individually.
2. The emission levels of other frequencies were very low against the limit.
3. Margin value = Emission level – Limit value
4. Correction factor = Insertion loss + Cable loss
5. Emission Level = Correction Factor + Reading Value

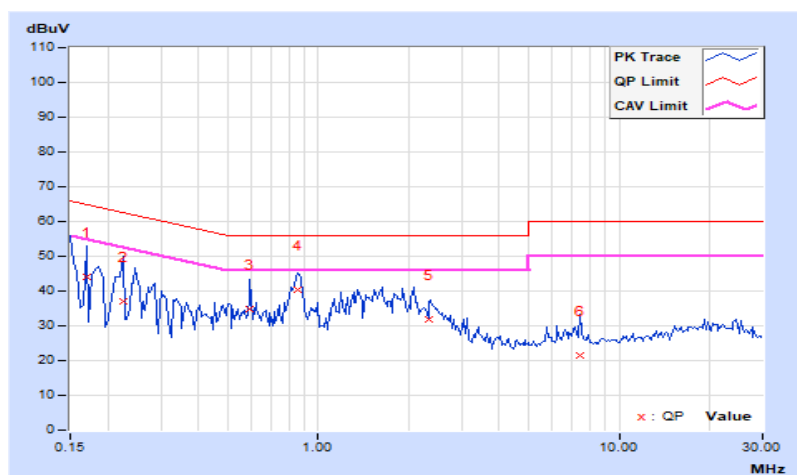

RF Mode	802.11ax (HE20)	Channel	CH 157 : 5785 MHz
Frequency Range	150 kHz ~ 30 MHz	Detector Function & Resolution Bandwidth	Quasi-Peak (QP) / Average (AV), 9 kHz
Input Power	120 Vac, 60 Hz	Environmental Conditions	25°C, 60% RH
Tested By	Willy Lin		

Phase Of Power : Neutral (N)										
No	Frequency (MHz)	Correction Factor (dB)	Reading Value (dBuV)		Emission Level (dBuV)		Limit (dBuV)		Margin (dB)	
			Q.P.	AV.	Q.P.	AV.	Q.P.	AV.	Q.P.	AV.
1	0.16172	9.99	35.81	17.90	45.80	27.89	65.38	55.38	-19.58	-27.49
2	0.21250	9.99	33.22	20.10	43.21	30.09	63.11	53.11	-19.90	-23.02
<b>3</b>	<b>0.85703</b>	<b>10.02</b>	<b>37.12</b>	<b>25.86</b>	<b>47.14</b>	<b>35.88</b>	<b>56.00</b>	<b>46.00</b>	<b>-8.86</b>	<b>-10.12</b>
4	1.70313	10.04	30.44	22.14	40.48	32.18	56.00	46.00	-15.52	-13.82
5	6.59766	10.26	18.40	9.83	28.66	20.09	60.00	50.00	-31.34	-29.91
6	23.57422	10.96	20.64	15.55	31.60	26.51	60.00	50.00	-28.40	-23.49

**Remarks:**

1. Q.P. and AV. are abbreviations of quasi-peak and average individually.
2. The emission levels of other frequencies were very low against the limit.
3. Margin value = Emission level – Limit value
4. Correction factor = Insertion loss + Cable loss
5. Emission Level = Correction Factor + Reading Value

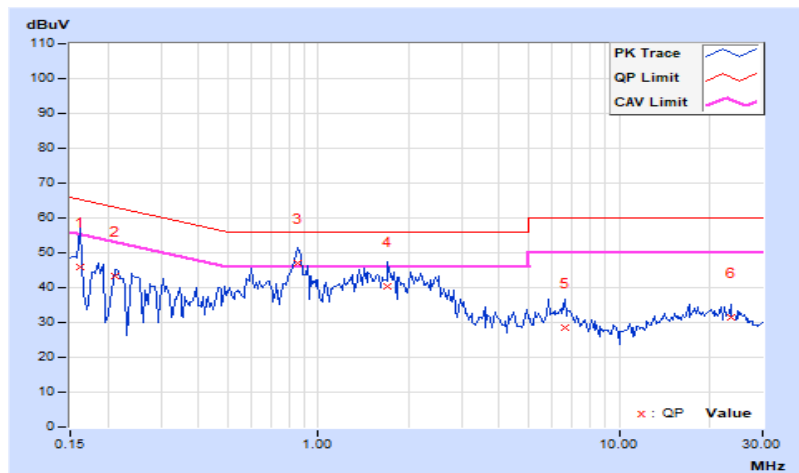

### 7.8 Unwanted Emissions below 1 GHz

<b>RF Mode</b>	802.11ax (HE20)	<b>Channel</b>	CH 157 : 5785 MHz
<b>Frequency Range</b>	30 MHz ~ 1 GHz	<b>Detector Function &amp; Bandwidth</b>	QP: RB=120kHz, DET=Quasi-Peak
<b>Input Power</b>	120 Vac, 60 Hz	<b>Environmental Conditions</b>	25°C, 72% RH
<b>Tested By</b>	Louis Yang		

Antenna Polarity & Test Distance : Horizontal at 3 m								
No	Frequency (MHz)	Emission Level (dBuV/m)	Limit (dBuV/m)	Margin (dB)	Antenna Height (m)	Table Angle (Degree)	Raw Value (dBuV)	Correction Factor (dB/m)
1	55.85	35.4 QP	40.0	-4.6	1.00 H	160	48.2	-12.8
2	106.68	36.9 QP	43.5	-6.6	2.00 H	284	53.1	-16.2
3	148.10	28.3 QP	43.5	-15.2	1.50 H	301	40.9	-12.6
4	186.03	28.9 QP	43.5	-14.6	1.50 H	74	43.9	-15.0
5	340.61	26.8 QP	46.0	-19.2	1.00 H	121	37.7	-10.9
6	493.59	28.7 QP	46.0	-17.3	2.00 H	142	36.0	-7.3

**Remarks:**

1. Emission Level(dBuV/m) = Raw Value(dBuV) + Correction Factor(dB/m)
2. Correction Factor(dB/m) = Antenna Factor(dB/m) + Cable Factor(dB) – Pre-Amplifier Factor(dB)
3. Margin value = Emission Level – Limit value
4. The other emission levels were very low against the limit of frequency range 30 MHz ~ 1 GHz.
5. The frequency range 9 kHz ~ 30 MHz: all emissions are more than 20 dB below the limit, therefore do not be recorded in this report.

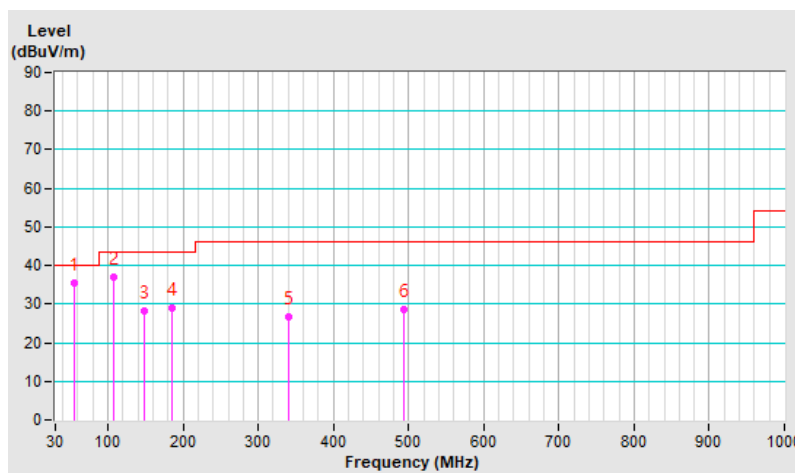



<b>RF Mode</b>	802.11ax (HE20)	<b>Channel</b>	CH 157 : 5785 MHz
<b>Frequency Range</b>	30 MHz ~ 1 GHz	<b>Detector Function &amp; Bandwidth</b>	QP: RB=120kHz, DET=Quasi-Peak
<b>Input Power</b>	120 Vac, 60 Hz	<b>Environmental Conditions</b>	25°C, 72% RH
<b>Tested By</b>	Louis Yang		

Antenna Polarity & Test Distance : Vertical at 3 m								
No	Frequency (MHz)	Emission Level (dBuV/m)	Limit (dBuV/m)	Margin (dB)	Antenna Height (m)	Table Angle (Degree)	Raw Value (dBuV)	Correction Factor (dB/m)
1	56.53	33.1 QP	40.0	-6.9	1.00 V	138	46.0	-12.9
2	90.34	34.5 QP	43.5	-9.0	1.00 V	238	53.0	-18.5
3	106.68	36.7 QP	43.5	-6.8	1.00 V	278	52.9	-16.2
4	143.25	29.7 QP	43.5	-13.8	1.00 V	190	42.4	-12.7
5	466.09	32.2 QP	46.0	-13.8	1.00 V	172	39.9	-7.7
6	490.68	29.5 QP	46.0	-16.5	1.00 V	248	36.8	-7.3

**Remarks:**

1. Emission Level(dBuV/m) = Raw Value(dBuV) + Correction Factor(dB/m)
2. Correction Factor(dB/m) = Antenna Factor(dB/m) + Cable Factor(dB) – Pre-Amplifier Factor(dB)
3. Margin value = Emission Level – Limit value
4. The other emission levels were very low against the limit of frequency range 30 MHz ~ 1 GHz.
5. The frequency range 9 kHz ~ 30 MHz: all emissions are more than 20 dB below the limit, therefore do not be recorded in this report.

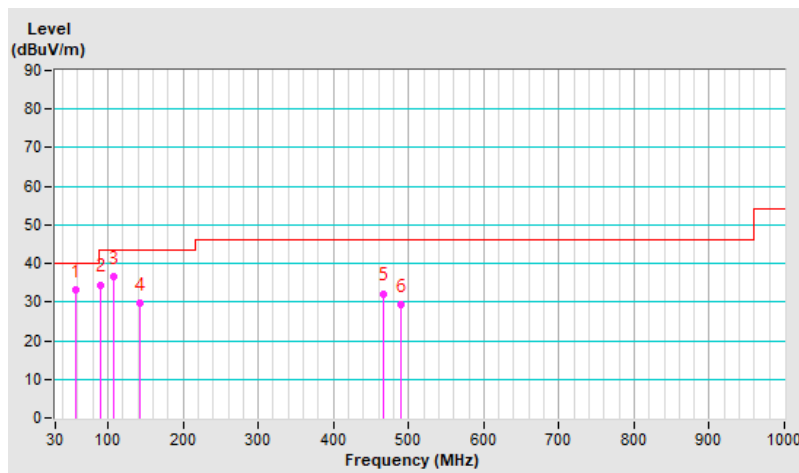

## 7.9 Unwanted Emissions above 1 GHz

RF Mode	802.11a	Channel	CH 36 : 5180 MHz
Frequency Range	1 GHz ~ 40 GHz	Detector Function & Bandwidth	PK: RB=1 MHz, VB=3 MHz, DET=Peak AV: RB=1 MHz, VB=10 Hz, DET=Peak
Input Power	120 Vac, 60 Hz	Environmental Conditions	25°C, 70% RH
Tested By	Louis Yang		

Antenna Polarity & Test Distance : Horizontal at 3 m								
No	Frequency (MHz)	Emission Level (dBuV/m)	Limit (dBuV/m)	Margin (dB)	Antenna Height (m)	Table Angle (Degree)	Raw Value (dBuV)	Correction Factor (dB/m)
1	5150.00	63.0 PK	74.0	-11.0	1.92 H	124	60.0	3.0
2	5150.00	46.9 AV	54.0	-7.1	1.92 H	124	43.9	3.0
3	*5180.00	106.3 PK			1.92 H	124	103.4	2.9
4	*5180.00	97.8 AV			1.92 H	124	94.9	2.9
5	#10360.00	55.5 PK	68.2	-12.7	1.45 H	212	43.1	12.4
6	15540.00	42.4 PK	74.0	-31.6	1.54 H	349	31.1	11.3
7	15540.00	28.9 AV	54.0	-25.1	1.54 H	349	17.6	11.3

### Remarks:

1. Emission Level(dBuV/m) = Raw Value(dBuV) + Correction Factor(dB/m)
2. Correction Factor(dB/m) = Antenna Factor(dB/m) + Cable Factor(dB) – Pre-Amplifier Factor(dB)
3. Margin value = Emission Level – Limit value
4. The other emission levels were very low against the limit.
5. " \* " : Fundamental frequency, the limit was restricted at the RF Output Power.
6. " # " : The radiated frequency is out of the restricted band.

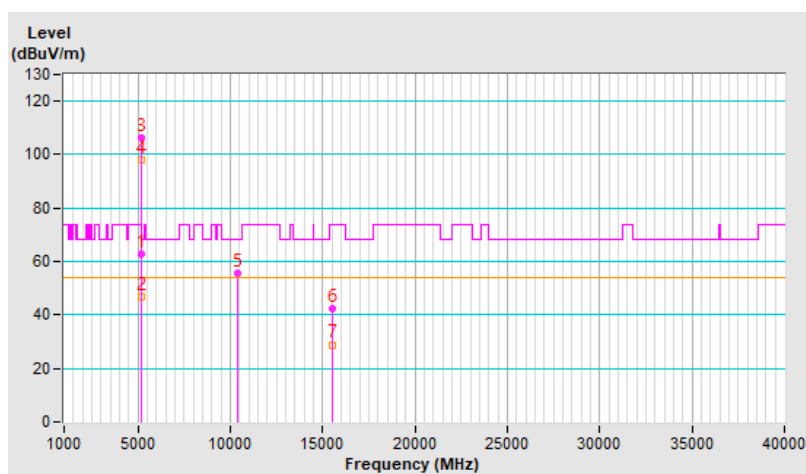

<b>RF Mode</b>	802.11a	<b>Channel</b>	CH 36 : 5180 MHz
<b>Frequency Range</b>	1 GHz ~ 40 GHz	<b>Detector Function &amp; Bandwidth</b>	PK: RB=1 MHz, VB=3 MHz, DET=Peak AV: RB=1 MHz, VB=10 Hz, DET=Peak
<b>Input Power</b>	120 Vac, 60 Hz	<b>Environmental Conditions</b>	25°C, 70% RH
<b>Tested By</b>	Louis Yang		

Antenna Polarity & Test Distance : Vertical at 3 m								
No	Frequency (MHz)	Emission Level (dBuV/m)	Limit (dBuV/m)	Margin (dB)	Antenna Height (m)	Table Angle (Degree)	Raw Value (dBuV)	Correction Factor (dB/m)
1	5150.00	66.0 PK	74.0	-8.0	1.98 V	260	63.0	3.0
2	5150.00	52.8 AV	54.0	-1.2	1.98 V	260	49.8	3.0
3	*5180.00	112.4 PK			1.98 V	260	109.5	2.9
4	*5180.00	103.5 AV			1.98 V	260	100.6	2.9
5	#10360.00	54.9 PK	68.2	-13.3	1.40 V	221	42.5	12.4
6	15540.00	42.4 PK	74.0	-31.6	1.51 V	340	31.1	11.3
7	15540.00	28.6 AV	54.0	-25.4	1.51 V	340	17.3	11.3

**Remarks:**

1. Emission Level(dBuV/m) = Raw Value(dBuV) + Correction Factor(dB/m)
2. Correction Factor(dB/m) = Antenna Factor(dB/m) + Cable Factor(dB) – Pre-Amplifier Factor(dB)
3. Margin value = Emission Level – Limit value
4. The other emission levels were very low against the limit.
5. " \* ": Fundamental frequency, the limit was restricted at the RF Output Power.
6. " # ": The radiated frequency is out of the restricted band.

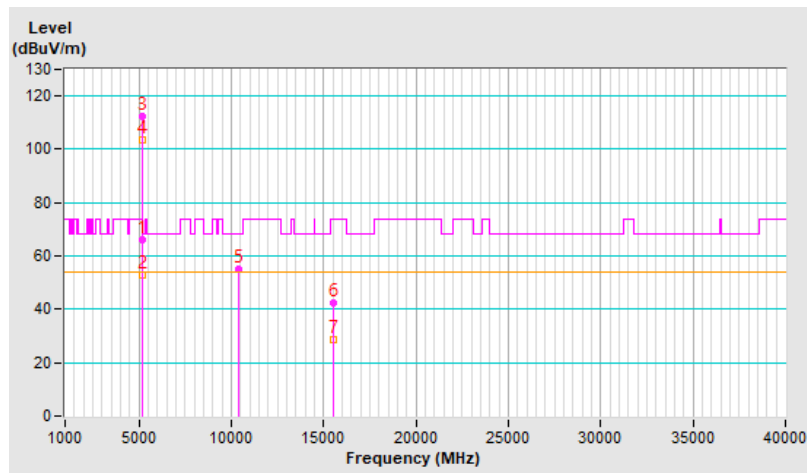

<b>RF Mode</b>	802.11a	<b>Channel</b>	CH 40 : 5200 MHz
<b>Frequency Range</b>	1 GHz ~ 40 GHz	<b>Detector Function &amp; Bandwidth</b>	PK: RB=1 MHz, VB=3 MHz, DET=Peak AV: RB=1 MHz, VB=10 Hz, DET=Peak
<b>Input Power</b>	120 Vac, 60 Hz	<b>Environmental Conditions</b>	25°C, 70% RH
<b>Tested By</b>	Louis Yang		

**Antenna Polarity & Test Distance : Horizontal at 3 m**

No	Frequency (MHz)	Emission Level (dBuV/m)	Limit (dBuV/m)	Margin (dB)	Antenna Height (m)	Table Angle (Degree)	Raw Value (dBuV)	Correction Factor (dB/m)
1	5150.00	60.5 PK	74.0	-13.5	1.98 H	122	57.5	3.0
2	5150.00	45.7 AV	54.0	-8.3	1.98 H	122	42.7	3.0
3	*5200.00	107.1 PK			1.98 H	122	104.2	2.9
4	*5200.00	97.9 AV			1.98 H	122	95.0	2.9
5	#10400.00	61.8 PK	68.2	-6.4	1.49 H	201	49.2	12.6
6	15600.00	49.2 PK	74.0	-24.8	1.54 H	360	38.5	10.7
7	15600.00	34.6 AV	54.0	-19.4	1.54 H	360	23.9	10.7

**Remarks:**

1. Emission Level(dBuV/m) = Raw Value(dBuV) + Correction Factor(dB/m)
2. Correction Factor(dB/m) = Antenna Factor(dB/m) + Cable Factor(dB) – Pre-Amplifier Factor(dB)
3. Margin value = Emission Level – Limit value
4. The other emission levels were very low against the limit.
5. " \* ": Fundamental frequency, the limit was restricted at the RF Output Power.
6. " # ": The radiated frequency is out of the restricted band.

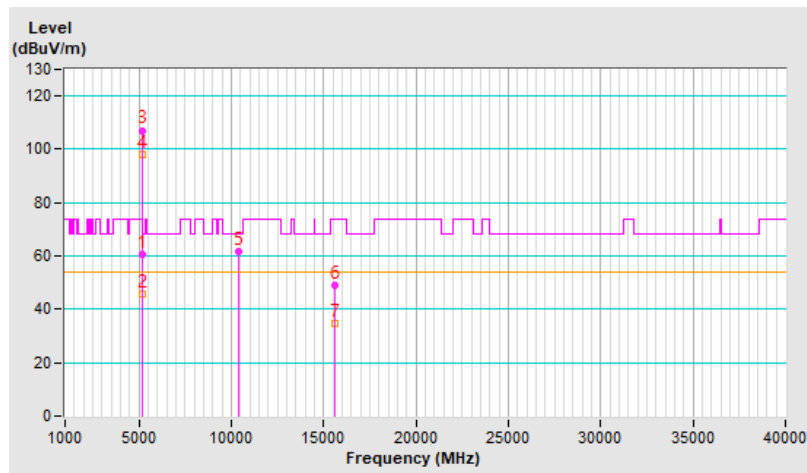

<b>RF Mode</b>	802.11a	<b>Channel</b>	CH 40 : 5200 MHz
<b>Frequency Range</b>	1 GHz ~ 40 GHz	<b>Detector Function &amp; Bandwidth</b>	PK: RB=1 MHz, VB=3 MHz, DET=Peak AV: RB=1 MHz, VB=10 Hz, DET=Peak
<b>Input Power</b>	120 Vac, 60 Hz	<b>Environmental Conditions</b>	25°C, 70% RH
<b>Tested By</b>	Louis Yang		

Antenna Polarity & Test Distance : Vertical at 3 m								
No	Frequency (MHz)	Emission Level (dBuV/m)	Limit (dBuV/m)	Margin (dB)	Antenna Height (m)	Table Angle (Degree)	Raw Value (dBuV)	Correction Factor (dB/m)
1	5150.00	66.2 PK	74.0	-7.8	1.87 V	255	63.2	3.0
2	5150.00	52.4 AV	54.0	-1.6	1.87 V	255	49.4	3.0
3	*5200.00	114.1 PK			1.87 V	255	111.2	2.9
4	*5200.00	105.0 AV			1.87 V	255	102.1	2.9
5	#10400.00	61.7 PK	68.2	-6.5	1.51 V	210	49.1	12.6
6	15600.00	49.0 PK	74.0	-25.0	1.53 V	349	38.3	10.7
7	15600.00	34.4 AV	54.0	-19.6	1.53 V	349	23.7	10.7

**Remarks:**

1. Emission Level(dBuV/m) = Raw Value(dBuV) + Correction Factor(dB/m)
2. Correction Factor(dB/m) = Antenna Factor(dB/m) + Cable Factor(dB) – Pre-Amplifier Factor(dB)
3. Margin value = Emission Level – Limit value
4. The other emission levels were very low against the limit.
5. " \* ": Fundamental frequency, the limit was restricted at the RF Output Power.
6. " # ": The radiated frequency is out of the restricted band.

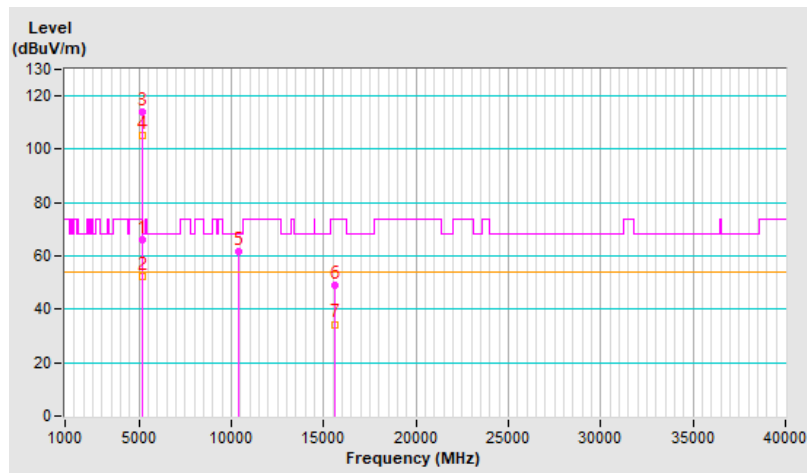

<b>RF Mode</b>	802.11a	<b>Channel</b>	CH 48 : 5240 MHz
<b>Frequency Range</b>	1 GHz ~ 40 GHz	<b>Detector Function &amp; Bandwidth</b>	PK: RB=1 MHz, VB=3 MHz, DET=Peak AV: RB=1 MHz, VB=10 Hz, DET=Peak
<b>Input Power</b>	120 Vac, 60 Hz	<b>Environmental Conditions</b>	25°C, 70% RH
<b>Tested By</b>	Louis Yang		

Antenna Polarity & Test Distance : Horizontal at 3 m								
No	Frequency (MHz)	Emission Level (dBuV/m)	Limit (dBuV/m)	Margin (dB)	Antenna Height (m)	Table Angle (Degree)	Raw Value (dBuV)	Correction Factor (dB/m)
1	*5240.00	106.4 PK			1.96 H	123	103.7	2.7
2	*5240.00	97.3 AV			1.96 H	123	94.6	2.7
3	5350.00	51.4 PK	74.0	-22.6	1.96 H	123	48.6	2.8
4	5350.00	37.8 AV	54.0	-16.2	1.96 H	123	35.0	2.8
5	#10480.00	61.3 PK	68.2	-6.9	1.55 H	217	48.6	12.7
6	15720.00	49.3 PK	74.0	-24.7	1.53 H	358	38.0	11.3
7	15720.00	34.8 AV	54.0	-19.2	1.53 H	358	23.5	11.3

**Remarks:**

1. Emission Level(dBuV/m) = Raw Value(dBuV) + Correction Factor(dB/m)
2. Correction Factor(dB/m) = Antenna Factor(dB/m) + Cable Factor(dB) – Pre-Amplifier Factor(dB)
3. Margin value = Emission Level – Limit value
4. The other emission levels were very low against the limit.
5. " \* " : Fundamental frequency, the limit was restricted at the RF Output Power.
6. " # " : The radiated frequency is out of the restricted band.

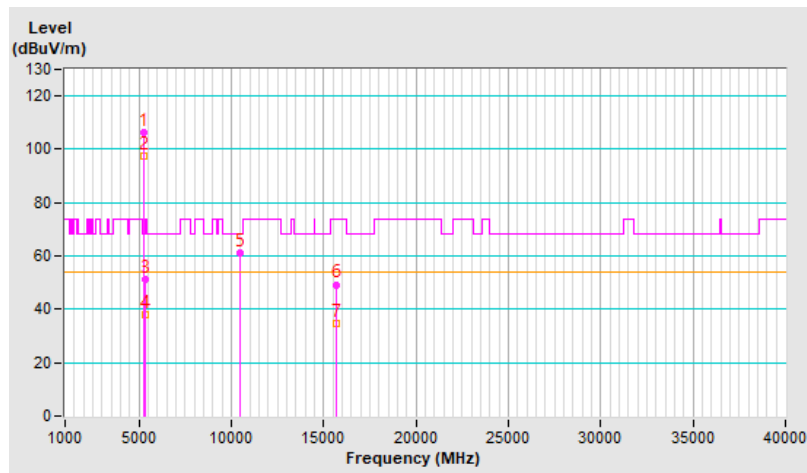

<b>RF Mode</b>	802.11a	<b>Channel</b>	CH 48 : 5240 MHz
<b>Frequency Range</b>	1 GHz ~ 40 GHz	<b>Detector Function &amp; Bandwidth</b>	PK: RB=1 MHz, VB=3 MHz, DET=Peak AV: RB=1 MHz, VB=10 Hz, DET=Peak
<b>Input Power</b>	120 Vac, 60 Hz	<b>Environmental Conditions</b>	25°C, 70% RH
<b>Tested By</b>	Louis Yang		

Antenna Polarity & Test Distance : Vertical at 3 m								
No	Frequency (MHz)	Emission Level (dBuV/m)	Limit (dBuV/m)	Margin (dB)	Antenna Height (m)	Table Angle (Degree)	Raw Value (dBuV)	Correction Factor (dB/m)
1	*5240.00	115.1 PK			1.97 V	261	112.4	2.7
2	*5240.00	105.2 AV			1.97 V	261	102.5	2.7
3	5350.00	52.2 PK	74.0	-21.8	1.97 V	261	49.4	2.8
4	5350.00	39.2 AV	54.0	-14.8	1.97 V	261	36.4	2.8
5	#10480.00	61.8 PK	68.2	-6.4	1.46 V	195	49.1	12.7
6	15720.00	48.9 PK	74.0	-25.1	1.49 V	358	37.6	11.3
7	15720.00	34.4 AV	54.0	-19.6	1.49 V	358	23.1	11.3

**Remarks:**

1. Emission Level(dBuV/m) = Raw Value(dBuV) + Correction Factor(dB/m)
2. Correction Factor(dB/m) = Antenna Factor(dB/m) + Cable Factor(dB) – Pre-Amplifier Factor(dB)
3. Margin value = Emission Level – Limit value
4. The other emission levels were very low against the limit.
5. " \* " : Fundamental frequency, the limit was restricted at the RF Output Power.
6. " # " : The radiated frequency is out of the restricted band.

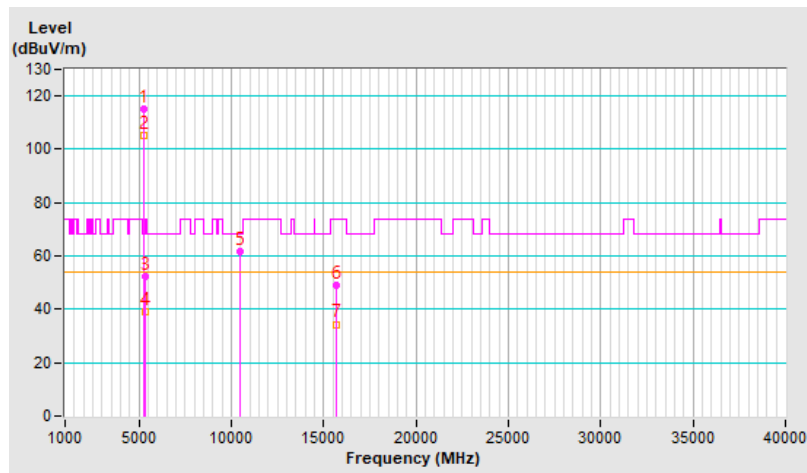

<b>RF Mode</b>	802.11a	<b>Channel</b>	CH 52 : 5260 MHz
<b>Frequency Range</b>	1 GHz ~ 40 GHz	<b>Detector Function &amp; Bandwidth</b>	PK: RB=1 MHz, VB=3 MHz, DET=Peak AV: RB=1 MHz, VB=10 Hz, DET=Peak
<b>Input Power</b>	120 Vac, 60 Hz	<b>Environmental Conditions</b>	25°C, 70% RH
<b>Tested By</b>	Louis Yang		

**Antenna Polarity & Test Distance : Horizontal at 3 m**

No	Frequency (MHz)	Emission Level (dBuV/m)	Limit (dBuV/m)	Margin (dB)	Antenna Height (m)	Table Angle (Degree)	Raw Value (dBuV)	Correction Factor (dB/m)
1	*5260.00	110.4 PK			1.99 H	108	107.8	2.6
2	*5260.00	100.7 AV			1.99 H	108	98.1	2.6
3	5350.00	56.1 PK	74.0	-17.9	1.99 H	108	53.3	2.8
4	5350.00	42.5 AV	54.0	-11.5	1.99 H	108	39.7	2.8
5	#10520.00	61.4 PK	68.2	-6.8	1.59 H	208	48.9	12.5
6	15780.00	49.0 PK	74.0	-25.0	1.52 H	348	37.3	11.7
7	15780.00	34.5 AV	54.0	-19.5	1.52 H	348	22.8	11.7

**Remarks:**

1. Emission Level(dBuV/m) = Raw Value(dBuV) + Correction Factor(dB/m)
2. Correction Factor(dB/m) = Antenna Factor(dB/m) + Cable Factor(dB) – Pre-Amplifier Factor(dB)
3. Margin value = Emission Level – Limit value
4. The other emission levels were very low against the limit.
5. " \* " : Fundamental frequency, the limit was restricted at the RF Output Power.
6. " # " : The radiated frequency is out of the restricted band.

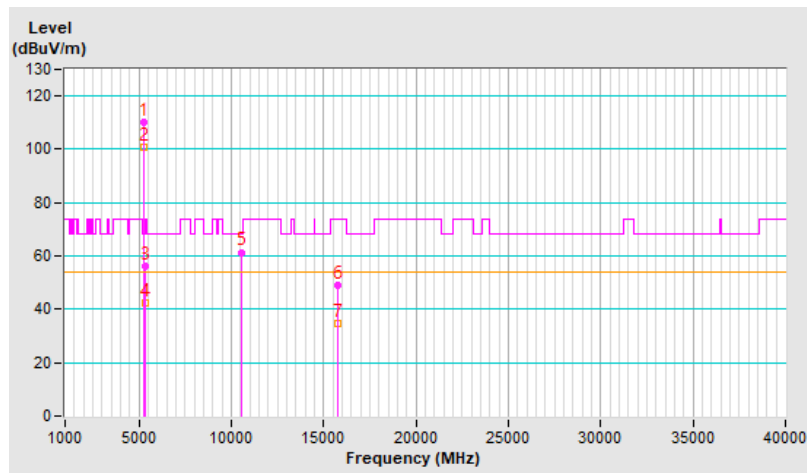



<b>RF Mode</b>	802.11a	<b>Channel</b>	CH 52 : 5260 MHz
<b>Frequency Range</b>	1 GHz ~ 40 GHz	<b>Detector Function &amp; Bandwidth</b>	PK: RB=1 MHz, VB=3 MHz, DET=Peak AV: RB=1 MHz, VB=10 Hz, DET=Peak
<b>Input Power</b>	120 Vac, 60 Hz	<b>Environmental Conditions</b>	25°C, 70% RH
<b>Tested By</b>	Louis Yang		

Antenna Polarity & Test Distance : Vertical at 3 m								
No	Frequency (MHz)	Emission Level (dBuV/m)	Limit (dBuV/m)	Margin (dB)	Antenna Height (m)	Table Angle (Degree)	Raw Value (dBuV)	Correction Factor (dB/m)
1	*5260.00	118.4 PK			1.97 V	264	115.8	2.6
2	*5260.00	108.1 AV			1.97 V	264	105.5	2.6
3	5350.00	66.6 PK	74.0	-7.4	1.97 V	264	63.8	2.8
4	5350.00	52.6 AV	54.0	-1.4	1.97 V	264	49.8	2.8
5	#10520.00	61.3 PK	68.2	-6.9	1.43 V	188	48.8	12.5
6	15780.00	48.5 PK	74.0	-25.5	1.47 V	359	36.8	11.7
7	15780.00	34.0 AV	54.0	-20.0	1.47 V	359	22.3	11.7

**Remarks:**

1. Emission Level(dBuV/m) = Raw Value(dBuV) + Correction Factor(dB/m)
2. Correction Factor(dB/m) = Antenna Factor(dB/m) + Cable Factor(dB) – Pre-Amplifier Factor(dB)
3. Margin value = Emission Level – Limit value
4. The other emission levels were very low against the limit.
5. " \* " : Fundamental frequency, the limit was restricted at the RF Output Power.
6. " # " : The radiated frequency is out of the restricted band.

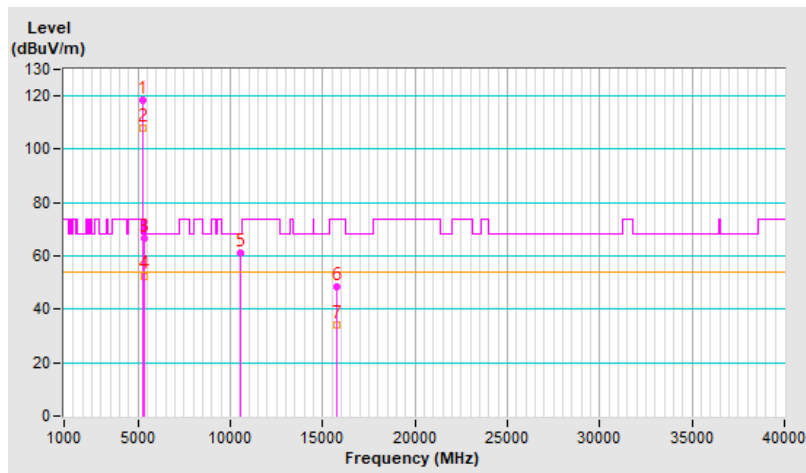

<b>RF Mode</b>	802.11a	<b>Channel</b>	CH 60 : 5300 MHz
<b>Frequency Range</b>	1 GHz ~ 40 GHz	<b>Detector Function &amp; Bandwidth</b>	PK: RB=1 MHz, VB=3 MHz, DET=Peak AV: RB=1 MHz, VB=10 Hz, DET=Peak
<b>Input Power</b>	120 Vac, 60 Hz	<b>Environmental Conditions</b>	25°C, 70% RH
<b>Tested By</b>	Louis Yang		

Antenna Polarity & Test Distance : Horizontal at 3 m								
No	Frequency (MHz)	Emission Level (dBuV/m)	Limit (dBuV/m)	Margin (dB)	Antenna Height (m)	Table Angle (Degree)	Raw Value (dBuV)	Correction Factor (dB/m)
1	*5300.00	106.4 PK			2.03 H	93	103.9	2.5
2	*5300.00	97.4 AV			2.03 H	93	94.9	2.5
3	5350.00	51.0 PK	74.0	-23.0	2.03 H	93	48.2	2.8
4	5350.00	41.5 AV	54.0	-12.5	2.03 H	93	38.7	2.8
5	10600.00	57.3 PK	74.0	-16.7	1.62 H	204	44.7	12.6
6	10600.00	44.7 AV	54.0	-9.3	1.62 H	204	32.1	12.6
7	15900.00	47.0 PK	74.0	-27.0	1.53 H	356	35.2	11.8
8	15900.00	34.5 AV	54.0	-19.5	1.53 H	356	22.7	11.8

**Remarks:**

1. Emission Level(dBuV/m) = Raw Value(dBuV) + Correction Factor(dB/m)
2. Correction Factor(dB/m) = Antenna Factor(dB/m) + Cable Factor(dB) – Pre-Amplifier Factor(dB)
3. Margin value = Emission Level – Limit value
4. The other emission levels were very low against the limit.
5. " \* ": Fundamental frequency, the limit was restricted at the RF Output Power.

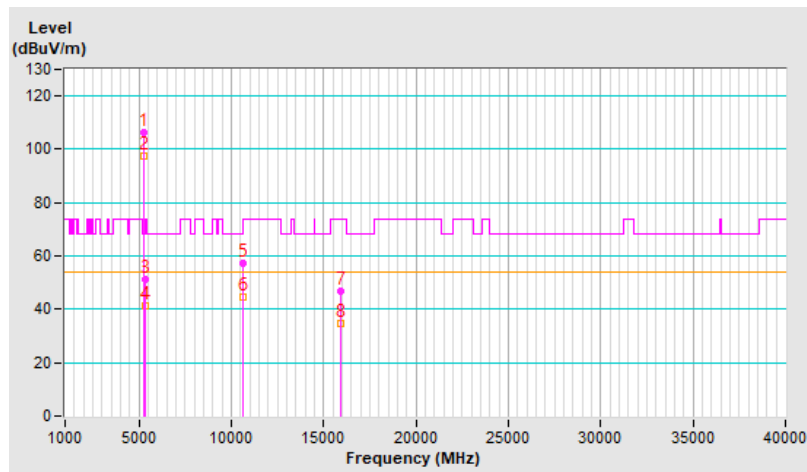

<b>RF Mode</b>	802.11a	<b>Channel</b>	CH 60 : 5300 MHz
<b>Frequency Range</b>	1 GHz ~ 40 GHz	<b>Detector Function &amp; Bandwidth</b>	PK: RB=1 MHz, VB=3 MHz, DET=Peak AV: RB=1 MHz, VB=10 Hz, DET=Peak
<b>Input Power</b>	120 Vac, 60 Hz	<b>Environmental Conditions</b>	25°C, 70% RH
<b>Tested By</b>	Louis Yang		

Antenna Polarity & Test Distance : Vertical at 3 m								
No	Frequency (MHz)	Emission Level (dBuV/m)	Limit (dBuV/m)	Margin (dB)	Antenna Height (m)	Table Angle (Degree)	Raw Value (dBuV)	Correction Factor (dB/m)
1	*5300.00	114.7 PK			1.98 V	269	112.2	2.5
2	*5300.00	105.5 AV			1.98 V	269	103.0	2.5
3	5350.00	67.9 PK	74.0	-6.1	1.98 V	269	65.1	2.8
4	5350.00	52.9 AV	54.0	-1.1	1.98 V	269	50.1	2.8
5	10600.00	56.7 PK	74.0	-17.3	1.63 V	207	44.1	12.6
6	10600.00	44.2 AV	54.0	-9.8	1.63 V	207	31.6	12.6
7	15900.00	46.6 PK	74.0	-27.4	1.56 V	347	34.8	11.8
8	15900.00	34.3 AV	54.0	-19.7	1.56 V	347	22.5	11.8

**Remarks:**

1. Emission Level(dBuV/m) = Raw Value(dBuV) + Correction Factor(dB/m)
2. Correction Factor(dB/m) = Antenna Factor(dB/m) + Cable Factor(dB) – Pre-Amplifier Factor(dB)
3. Margin value = Emission Level – Limit value
4. The other emission levels were very low against the limit.
5. " \* ": Fundamental frequency, the limit was restricted at the RF Output Power.

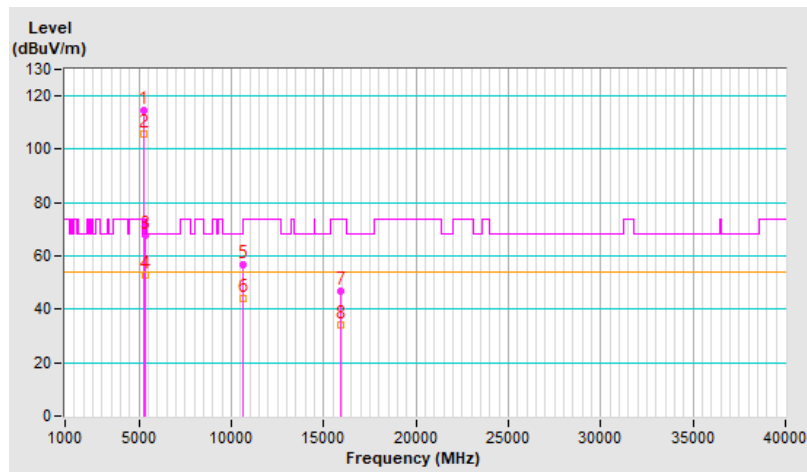

<b>RF Mode</b>	802.11a	<b>Channel</b>	CH 64 : 5320 MHz
<b>Frequency Range</b>	1 GHz ~ 40 GHz	<b>Detector Function &amp; Bandwidth</b>	PK: RB=1 MHz, VB=3 MHz, DET=Peak AV: RB=1 MHz, VB=10 Hz, DET=Peak
<b>Input Power</b>	120 Vac, 60 Hz	<b>Environmental Conditions</b>	25°C, 70% RH
<b>Tested By</b>	Louis Yang		

**Antenna Polarity & Test Distance : Horizontal at 3 m**

No	Frequency (MHz)	Emission Level (dBuV/m)	Limit (dBuV/m)	Margin (dB)	Antenna Height (m)	Table Angle (Degree)	Raw Value (dBuV)	Correction Factor (dB/m)
1	*5320.00	106.2 PK			1.92 H	139	103.5	2.7
2	*5320.00	97.5 AV			1.92 H	139	94.8	2.7
3	5350.00	62.8 PK	74.0	-11.2	1.92 H	139	60.0	2.8
4	5350.00	47.6 AV	54.0	-6.4	1.92 H	139	44.8	2.8
5	10640.00	54.8 PK	74.0	-19.2	1.32 H	244	42.0	12.8
6	10640.00	42.1 AV	54.0	-11.9	1.32 H	244	29.3	12.8
7	15960.00	41.7 PK	74.0	-32.3	1.56 H	313	29.5	12.2
8	15960.00	28.1 AV	54.0	-25.9	1.56 H	313	15.9	12.2

**Remarks:**

1. Emission Level(dBuV/m) = Raw Value(dBuV) + Correction Factor(dB/m)
2. Correction Factor(dB/m) = Antenna Factor(dB/m) + Cable Factor(dB) – Pre-Amplifier Factor(dB)
3. Margin value = Emission Level – Limit value
4. The other emission levels were very low against the limit.
5. " \* ": Fundamental frequency, the limit was restricted at the RF Output Power.

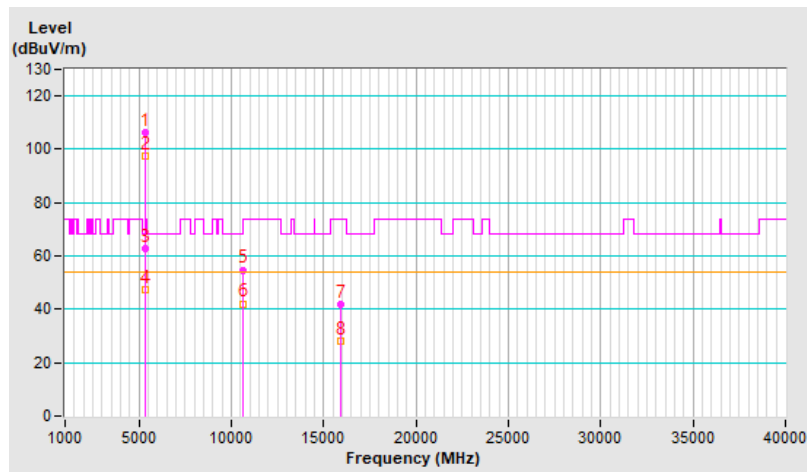

<b>RF Mode</b>	802.11a	<b>Channel</b>	CH 64 : 5320 MHz
<b>Frequency Range</b>	1 GHz ~ 40 GHz	<b>Detector Function &amp; Bandwidth</b>	PK: RB=1 MHz, VB=3 MHz, DET=Peak AV: RB=1 MHz, VB=10 Hz, DET=Peak
<b>Input Power</b>	120 Vac, 60 Hz	<b>Environmental Conditions</b>	25°C, 70% RH
<b>Tested By</b>	Louis Yang		

Antenna Polarity & Test Distance : Vertical at 3 m								
No	Frequency (MHz)	Emission Level (dBuV/m)	Limit (dBuV/m)	Margin (dB)	Antenna Height (m)	Table Angle (Degree)	Raw Value (dBuV)	Correction Factor (dB/m)
1	*5320.00	112.5 PK			1.94 V	260	109.8	2.7
2	*5320.00	103.2 AV			1.94 V	260	100.5	2.7
3	5350.00	71.5 PK	74.0	-2.5	1.94 V	260	68.7	2.8
4	5350.00	53.0 AV	54.0	-1.0	1.94 V	260	50.2	2.8
5	10640.00	55.1 PK	74.0	-18.9	1.44 V	233	42.3	12.8
6	10640.00	42.2 AV	54.0	-11.8	1.44 V	233	29.4	12.8
7	15960.00	42.1 PK	74.0	-31.9	1.52 V	341	29.9	12.2
8	15960.00	28.3 AV	54.0	-25.7	1.52 V	341	16.1	12.2

**Remarks:**

1. Emission Level(dBuV/m) = Raw Value(dBuV) + Correction Factor(dB/m)
2. Correction Factor(dB/m) = Antenna Factor(dB/m) + Cable Factor(dB) – Pre-Amplifier Factor(dB)
3. Margin value = Emission Level – Limit value
4. The other emission levels were very low against the limit.
5. " \* ": Fundamental frequency, the limit was restricted at the RF Output Power.

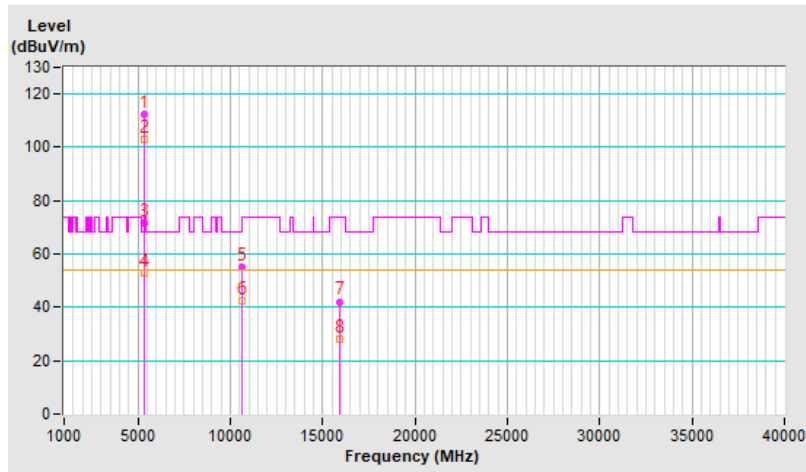

<b>RF Mode</b>	802.11a	<b>Channel</b>	CH 100 : 5500 MHz
<b>Frequency Range</b>	1 GHz ~ 40 GHz	<b>Detector Function &amp; Bandwidth</b>	PK: RB=1 MHz, VB=3 MHz, DET=Peak AV: RB=1 MHz, VB=10 Hz, DET=Peak
<b>Input Power</b>	120 Vac, 60 Hz	<b>Environmental Conditions</b>	24°C, 71% RH
<b>Tested By</b>	Louis Yang		

Antenna Polarity & Test Distance : Horizontal at 3 m								
No	Frequency (MHz)	Emission Level (dBuV/m)	Limit (dBuV/m)	Margin (dB)	Antenna Height (m)	Table Angle (Degree)	Raw Value (dBuV)	Correction Factor (dB/m)
1	5460.00	58.1 PK	74.0	-15.9	1.62 H	144	55.2	2.9
2	5460.00	40.3 AV	54.0	-13.7	1.62 H	144	37.4	2.9
3	#5470.00	57.4 PK	68.2	-10.8	1.62 H	144	54.5	2.9
4	*5500.00	107.5 PK			1.62 H	144	104.6	2.9
5	*5500.00	97.4 AV			1.62 H	144	94.5	2.9
6	11000.00	54.9 PK	74.0	-19.1	1.37 H	225	41.1	13.8
7	11000.00	42.5 AV	54.0	-11.5	1.37 H	225	28.7	13.8
8	#16500.00	41.5 PK	68.2	-26.7	1.57 H	326	26.8	14.7

**Remarks:**

1. Emission Level(dBuV/m) = Raw Value(dBuV) + Correction Factor(dB/m)
2. Correction Factor(dB/m) = Antenna Factor(dB/m) + Cable Factor(dB) – Pre-Amplifier Factor(dB)
3. Margin value = Emission Level – Limit value
4. The other emission levels were very low against the limit.
5. " \* ": Fundamental frequency, the limit was restricted at the RF Output Power.
6. " # ": The radiated frequency is out of the restricted band.

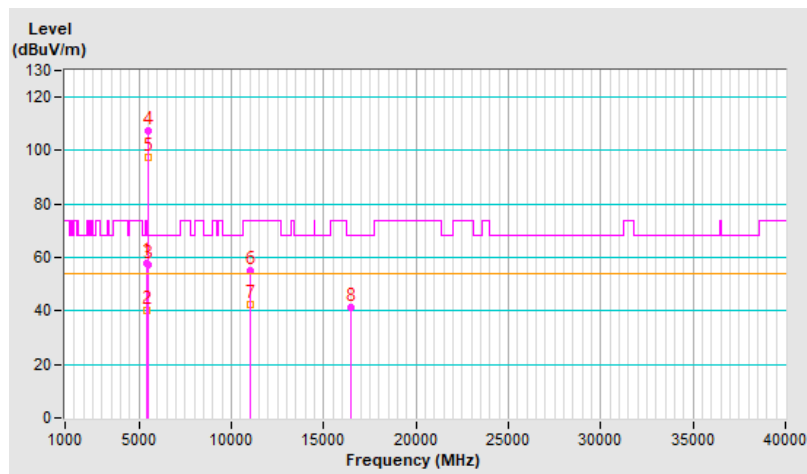

<b>RF Mode</b>	802.11a	<b>Channel</b>	CH 100 : 5500 MHz
<b>Frequency Range</b>	1 GHz ~ 40 GHz	<b>Detector Function &amp; Bandwidth</b>	PK: RB=1 MHz, VB=3 MHz, DET=Peak AV: RB=1 MHz, VB=10 Hz, DET=Peak
<b>Input Power</b>	120 Vac, 60 Hz	<b>Environmental Conditions</b>	24°C, 71% RH
<b>Tested By</b>	Louis Yang		

Antenna Polarity & Test Distance : Vertical at 3 m								
No	Frequency (MHz)	Emission Level (dBuV/m)	Limit (dBuV/m)	Margin (dB)	Antenna Height (m)	Table Angle (Degree)	Raw Value (dBuV)	Correction Factor (dB/m)
1	5460.00	61.2 PK	74.0	-12.8	1.98 V	259	58.3	2.9
2	5460.00	45.9 AV	54.0	-8.1	1.98 V	259	43.0	2.9
3	#5470.00	67.1 PK	68.2	-1.1	1.98 V	259	64.2	2.9
4	*5500.00	110.8 PK			1.98 V	259	107.9	2.9
5	*5500.00	101.3 AV			1.98 V	259	98.4	2.9
6	11000.00	54.8 PK	74.0	-19.2	1.38 V	233	41.0	13.8
7	11000.00	42.2 AV	54.0	-11.8	1.38 V	233	28.4	13.8
8	#16500.00	41.6 PK	68.2	-26.6	1.52 V	328	26.9	14.7

**Remarks:**

1. Emission Level(dBuV/m) = Raw Value(dBuV) + Correction Factor(dB/m)
2. Correction Factor(dB/m) = Antenna Factor(dB/m) + Cable Factor(dB) – Pre-Amplifier Factor(dB)
3. Margin value = Emission Level – Limit value
4. The other emission levels were very low against the limit.
5. " \* ": Fundamental frequency, the limit was restricted at the RF Output Power.
6. " # ": The radiated frequency is out of the restricted band.

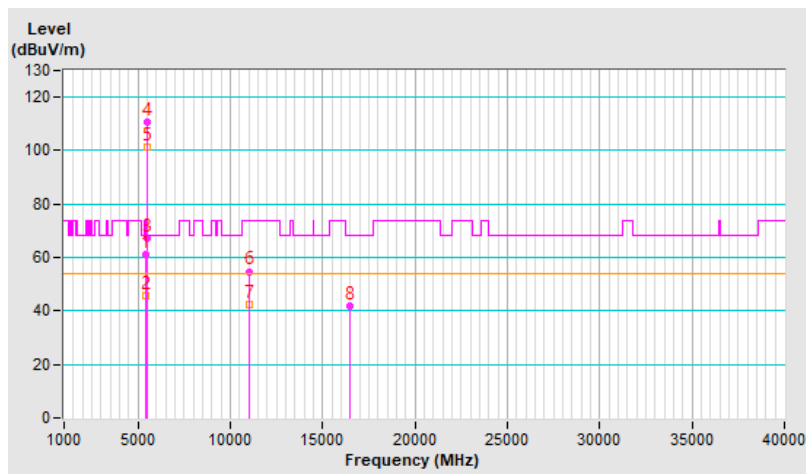

<b>RF Mode</b>	802.11a	<b>Channel</b>	CH 116 : 5580 MHz
<b>Frequency Range</b>	1 GHz ~ 40 GHz	<b>Detector Function &amp; Bandwidth</b>	PK: RB=1 MHz, VB=3 MHz, DET=Peak AV: RB=1 MHz, VB=10 Hz, DET=Peak
<b>Input Power</b>	120 Vac, 60 Hz	<b>Environmental Conditions</b>	24°C, 71% RH
<b>Tested By</b>	Louis Yang		

**Antenna Polarity & Test Distance : Horizontal at 3 m**

No	Frequency (MHz)	Emission Level (dBuV/m)	Limit (dBuV/m)	Margin (dB)	Antenna Height (m)	Table Angle (Degree)	Raw Value (dBuV)	Correction Factor (dB/m)
1	5460.00	57.9 PK	74.0	-16.1	1.68 H	132	55.0	2.9
2	5460.00	40.2 AV	54.0	-13.8	1.68 H	132	37.3	2.9
3	#5470.00	57.5 PK	68.2	-10.7	1.68 H	132	54.6	2.9
4	*5580.00	107.4 PK			1.68 H	132	104.7	2.7
5	*5580.00	97.3 AV			1.68 H	132	94.6	2.7
6	11160.00	55.1 PK	74.0	-18.9	1.43 H	247	41.9	13.2
7	11160.00	42.5 AV	54.0	-11.5	1.43 H	247	29.3	13.2
8	#16740.00	41.4 PK	68.2	-26.8	1.50 H	318	25.5	15.9

**Remarks:**

1. Emission Level(dBuV/m) = Raw Value(dBuV) + Correction Factor(dB/m)
2. Correction Factor(dB/m) = Antenna Factor(dB/m) + Cable Factor(dB) – Pre-Amplifier Factor(dB)
3. Margin value = Emission Level – Limit value
4. The other emission levels were very low against the limit.
5. " \* " : Fundamental frequency, the limit was restricted at the RF Output Power.
6. " # " : The radiated frequency is out of the restricted band.

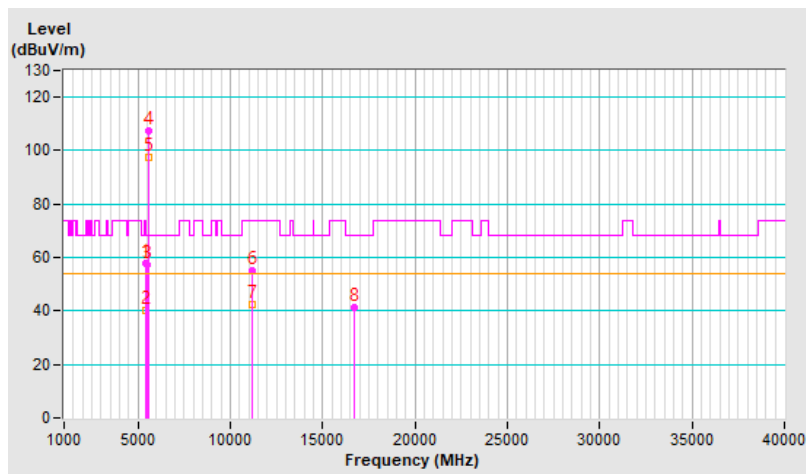



<b>RF Mode</b>	802.11a	<b>Channel</b>	CH 116 : 5580 MHz
<b>Frequency Range</b>	1 GHz ~ 40 GHz	<b>Detector Function &amp; Bandwidth</b>	PK: RB=1 MHz, VB=3 MHz, DET=Peak AV: RB=1 MHz, VB=10 Hz, DET=Peak
<b>Input Power</b>	120 Vac, 60 Hz	<b>Environmental Conditions</b>	24°C, 71% RH
<b>Tested By</b>	Louis Yang		

Antenna Polarity & Test Distance : Vertical at 3 m								
No	Frequency (MHz)	Emission Level (dBuV/m)	Limit (dBuV/m)	Margin (dB)	Antenna Height (m)	Table Angle (Degree)	Raw Value (dBuV)	Correction Factor (dB/m)
1	5460.00	56.6 PK	74.0	-17.4	1.91 V	267	53.7	2.9
2	5460.00	42.8 AV	54.0	-11.2	1.91 V	267	39.9	2.9
3	#5470.00	66.4 PK	68.2	-1.8	1.91 V	267	63.5	2.9
4	*5580.00	110.3 PK			1.91 V	267	107.6	2.7
5	*5580.00	102.4 AV			1.91 V	267	99.7	2.7
6	11160.00	55.0 PK	74.0	-19.0	1.32 V	228	41.8	13.2
7	11160.00	42.4 AV	54.0	-11.6	1.32 V	228	29.2	13.2
8	#16740.00	41.1 PK	68.2	-27.1	1.47 V	323	25.2	15.9

**Remarks:**

1. Emission Level(dBuV/m) = Raw Value(dBuV) + Correction Factor(dB/m)
2. Correction Factor(dB/m) = Antenna Factor(dB/m) + Cable Factor(dB) – Pre-Amplifier Factor(dB)
3. Margin value = Emission Level – Limit value
4. The other emission levels were very low against the limit.
5. " \* ": Fundamental frequency, the limit was restricted at the RF Output Power.
6. " # ": The radiated frequency is out of the restricted band.

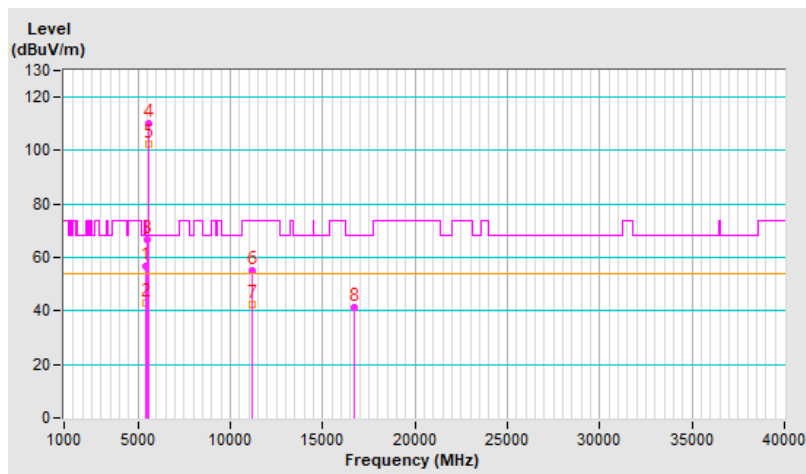

<b>RF Mode</b>	802.11a	<b>Channel</b>	CH 140 : 5700 MHz
<b>Frequency Range</b>	1 GHz ~ 40 GHz	<b>Detector Function &amp; Bandwidth</b>	PK: RB=1 MHz, VB=3 MHz, DET=Peak AV: RB=1 MHz, VB=10 Hz, DET=Peak
<b>Input Power</b>	120 Vac, 60 Hz	<b>Environmental Conditions</b>	24°C, 71% RH
<b>Tested By</b>	Louis Yang		

Antenna Polarity & Test Distance : Horizontal at 3 m								
No	Frequency (MHz)	Emission Level (dBuV/m)	Limit (dBuV/m)	Margin (dB)	Antenna Height (m)	Table Angle (Degree)	Raw Value (dBuV)	Correction Factor (dB/m)
1	*5700.00	106.8 PK			1.92 H	126	103.9	2.9
2	*5700.00	97.3 AV			1.92 H	126	94.4	2.9
3	#5725.00	61.4 PK	68.2	-6.8	1.92 H	126	58.5	2.9
4	11400.00	54.6 PK	74.0	-19.4	1.41 H	229	41.3	13.3
5	11400.00	41.9 AV	54.0	-12.1	1.41 H	229	28.6	13.3
6	#17100.00	41.6 PK	68.2	-26.6	1.47 H	329	25.2	16.4

**Remarks:**

1. Emission Level(dBuV/m) = Raw Value(dBuV) + Correction Factor(dB/m)
2. Correction Factor(dB/m) = Antenna Factor(dB/m) + Cable Factor(dB) – Pre-Amplifier Factor(dB)
3. Margin value = Emission Level – Limit value
4. The other emission levels were very low against the limit.
5. " \* " : Fundamental frequency, the limit was restricted at the RF Output Power.
6. " # " : The radiated frequency is out of the restricted band.

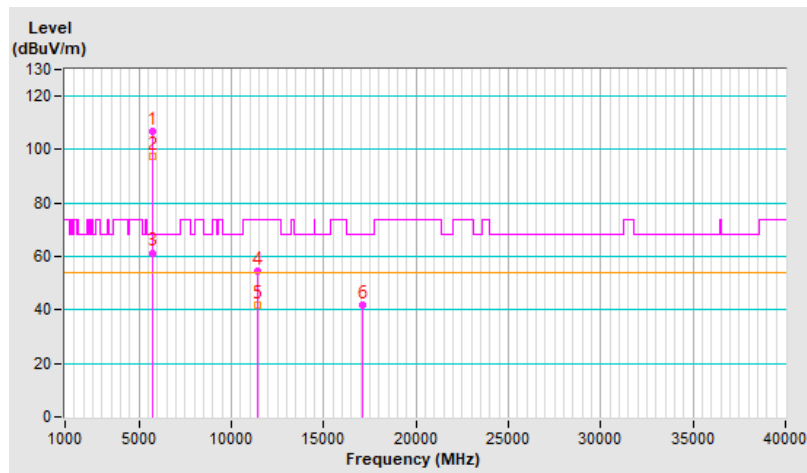

<b>RF Mode</b>	802.11a	<b>Channel</b>	CH 140 : 5700 MHz
<b>Frequency Range</b>	1 GHz ~ 40 GHz	<b>Detector Function &amp; Bandwidth</b>	PK: RB=1 MHz, VB=3 MHz, DET=Peak AV: RB=1 MHz, VB=10 Hz, DET=Peak
<b>Input Power</b>	120 Vac, 60 Hz	<b>Environmental Conditions</b>	24°C, 71% RH
<b>Tested By</b>	Louis Yang		

Antenna Polarity & Test Distance : Vertical at 3 m								
No	Frequency (MHz)	Emission Level (dBuV/m)	Limit (dBuV/m)	Margin (dB)	Antenna Height (m)	Table Angle (Degree)	Raw Value (dBuV)	Correction Factor (dB/m)
1	*5700.00	110.9 PK			1.81 V	258	108.0	2.9
2	*5700.00	101.8 AV			1.81 V	258	98.9	2.9
3	#5725.00	66.6 PK	68.2	-1.6	1.81 V	258	63.7	2.9
4	11400.00	55.0 PK	74.0	-19.0	1.41 V	229	41.7	13.3
5	11400.00	42.3 AV	54.0	-11.7	1.41 V	229	29.0	13.3
6	#17100.00	41.3 PK	68.2	-26.9	1.50 V	335	24.9	16.4

**Remarks:**

1. Emission Level(dBuV/m) = Raw Value(dBuV) + Correction Factor(dB/m)
2. Correction Factor(dB/m) = Antenna Factor(dB/m) + Cable Factor(dB) – Pre-Amplifier Factor(dB)
3. Margin value = Emission Level – Limit value
4. The other emission levels were very low against the limit.
5. " \* " : Fundamental frequency, the limit was restricted at the RF Output Power.
6. " # " : The radiated frequency is out of the restricted band.

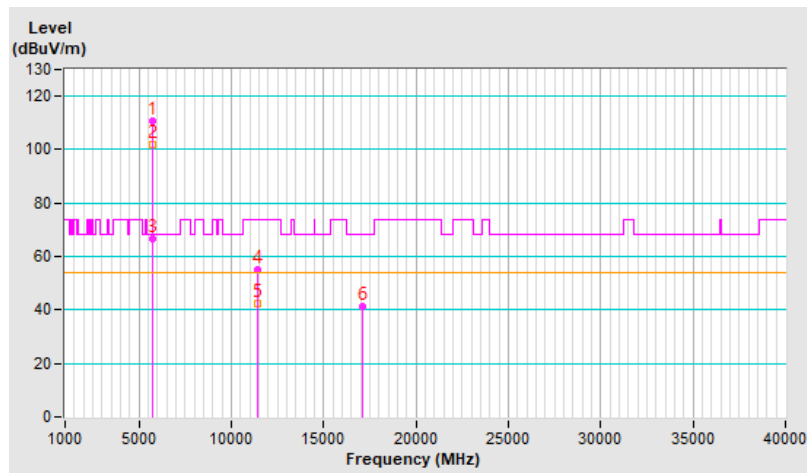

<b>RF Mode</b>	802.11a	<b>Channel</b>	CH 144 : 5720 MHz
<b>Frequency Range</b>	1 GHz ~ 40 GHz	<b>Detector Function &amp; Bandwidth</b>	PK: RB=1 MHz, VB=3 MHz, DET=Peak AV: RB=1 MHz, VB=10 Hz, DET=Peak
<b>Input Power</b>	120 Vac, 60 Hz	<b>Environmental Conditions</b>	24°C, 71% RH
<b>Tested By</b>	Louis Yang		

**Antenna Polarity & Test Distance : Horizontal at 3 m**

No	Frequency (MHz)	Emission Level (dBuV/m)	Limit (dBuV/m)	Margin (dB)	Antenna Height (m)	Table Angle (Degree)	Raw Value (dBuV)	Correction Factor (dB/m)
1	5460.00	48.4 PK	74.0	-25.6	1.94 H	121	45.5	2.9
2	5460.00	37.9 AV	54.0	-16.1	1.94 H	121	35.0	2.9
3	#5470.00	47.4 PK	68.2	-20.8	1.94 H	121	44.5	2.9
4	*5720.00	112.7 PK			1.94 H	121	109.8	2.9
5	*5720.00	102.2 AV			1.94 H	121	99.3	2.9
6	#5850.00	53.6 PK	68.2	-14.6	1.94 H	121	50.3	3.3
7	11440.00	61.5 PK	74.0	-12.5	1.59 H	216	48.3	13.2
8	11440.00	48.5 AV	54.0	-5.5	1.59 H	216	35.3	13.2
9	#17160.00	48.9 PK	68.2	-19.3	1.53 H	345	32.1	16.8

**Remarks:**

1. Emission Level(dBuV/m) = Raw Value(dBuV) + Correction Factor(dB/m)
2. Correction Factor(dB/m) = Antenna Factor(dB/m) + Cable Factor(dB) – Pre-Amplifier Factor(dB)
3. Margin value = Emission Level – Limit value
4. The other emission levels were very low against the limit.
5. " \* ": Fundamental frequency, the limit was restricted at the RF Output Power.
6. " # ": The radiated frequency is out of the restricted band.

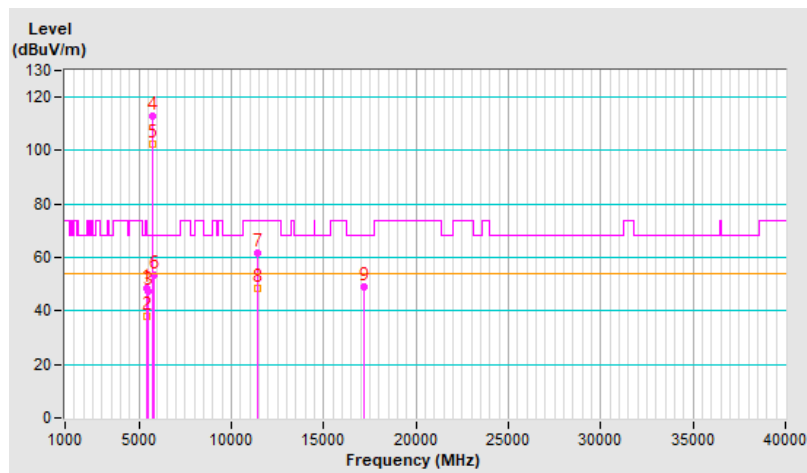

<b>RF Mode</b>	802.11a	<b>Channel</b>	CH 144 : 5720 MHz
<b>Frequency Range</b>	1 GHz ~ 40 GHz	<b>Detector Function &amp; Bandwidth</b>	PK: RB=1 MHz, VB=3 MHz, DET=Peak AV: RB=1 MHz, VB=10 Hz, DET=Peak
<b>Input Power</b>	120 Vac, 60 Hz	<b>Environmental Conditions</b>	24°C, 71% RH
<b>Tested By</b>	Louis Yang		

Antenna Polarity & Test Distance : Vertical at 3 m								
No	Frequency (MHz)	Emission Level (dBuV/m)	Limit (dBuV/m)	Margin (dB)	Antenna Height (m)	Table Angle (Degree)	Raw Value (dBuV)	Correction Factor (dB/m)
1	5460.00	48.0 PK	74.0	-26.0	1.83 V	255	45.1	2.9
2	5460.00	38.5 AV	54.0	-15.5	1.83 V	255	35.6	2.9
3	#5470.00	47.4 PK	68.2	-20.8	1.83 V	255	44.5	2.9
4	*5720.00	117.8 PK			1.83 V	255	114.9	2.9
5	*5720.00	106.2 AV			1.83 V	255	103.3	2.9
6	#5850.00	51.2 PK	68.2	-17.0	1.83 V	255	47.9	3.3
7	11440.00	62.1 PK	74.0	-11.9	1.49 V	212	48.9	13.2
8	11440.00	48.6 AV	54.0	-5.4	1.49 V	212	35.4	13.2
9	#17160.00	48.8 PK	68.2	-19.4	1.52 V	339	32.0	16.8

**Remarks:**

1. Emission Level(dBuV/m) = Raw Value(dBuV) + Correction Factor(dB/m)
2. Correction Factor(dB/m) = Antenna Factor(dB/m) + Cable Factor(dB) – Pre-Amplifier Factor(dB)
3. Margin value = Emission Level – Limit value
4. The other emission levels were very low against the limit.
5. " \* ": Fundamental frequency, the limit was restricted at the RF Output Power.
6. " # ": The radiated frequency is out of the restricted band.

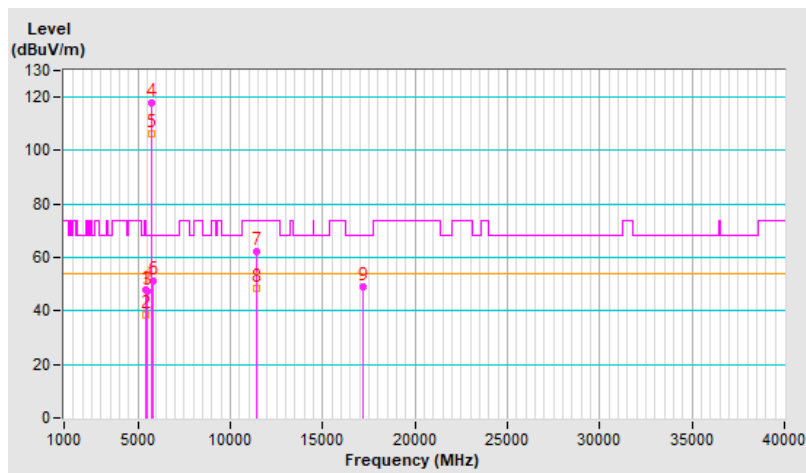

<b>RF Mode</b>	802.11a	<b>Channel</b>	CH 149 : 5745 MHz
<b>Frequency Range</b>	1 GHz ~ 40 GHz	<b>Detector Function &amp; Bandwidth</b>	PK: RB=1 MHz, VB=3 MHz, DET=Peak AV: RB=1 MHz, VB=10 Hz, DET=Peak
<b>Input Power</b>	120 Vac, 60 Hz	<b>Environmental Conditions</b>	24°C, 71% RH
<b>Tested By</b>	Louis Yang		

**Antenna Polarity & Test Distance : Horizontal at 3 m**

No	Frequency (MHz)	Emission Level (dBuV/m)	Limit (dBuV/m)	Margin (dB)	Antenna Height (m)	Table Angle (Degree)	Raw Value (dBuV)	Correction Factor (dB/m)
1	#5638.93	60.4 PK	68.2	-7.8	1.05 H	144	57.7	2.7
2	*5745.00	114.7 PK			1.05 H	144	111.7	3.0
3	*5745.00	103.7 AV			1.05 H	144	100.7	3.0
4	#5940.14	51.9 PK	68.2	-16.3	1.05 H	144	48.7	3.2
5	11490.00	54.7 PK	74.0	-19.3	1.54 H	154	41.7	13.0
6	11490.00	42.7 AV	54.0	-11.3	1.54 H	154	29.7	13.0
7	#17235.00	59.0 PK	68.2	-9.2	1.48 H	149	41.7	17.3

**Remarks:**

1. Emission Level(dBuV/m) = Raw Value(dBuV) + Correction Factor(dB/m)
2. Correction Factor(dB/m) = Antenna Factor(dB/m) + Cable Factor(dB) – Pre-Amplifier Factor(dB)
3. Margin value = Emission Level – Limit value
4. The other emission levels were very low against the limit.
5. " \* " : Fundamental frequency, the limit was restricted at the RF Output Power.
6. " # " : The radiated frequency is out of the restricted band.

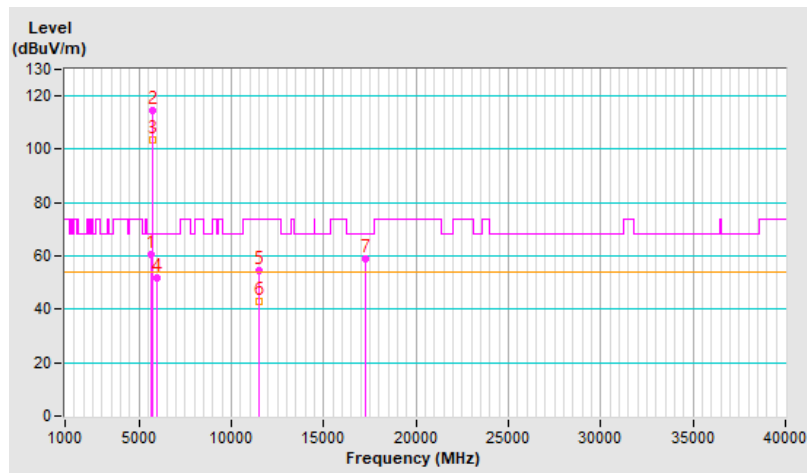

<b>RF Mode</b>	802.11a	<b>Channel</b>	CH 149 : 5745 MHz
<b>Frequency Range</b>	1 GHz ~ 40 GHz	<b>Detector Function &amp; Bandwidth</b>	PK: RB=1 MHz, VB=3 MHz, DET=Peak AV: RB=1 MHz, VB=10 Hz, DET=Peak
<b>Input Power</b>	120 Vac, 60 Hz	<b>Environmental Conditions</b>	24°C, 71% RH
<b>Tested By</b>	Louis Yang		

Antenna Polarity & Test Distance : Vertical at 3 m								
No	Frequency (MHz)	Emission Level (dBuV/m)	Limit (dBuV/m)	Margin (dB)	Antenna Height (m)	Table Angle (Degree)	Raw Value (dBuV)	Correction Factor (dB/m)
1	#5648.10	63.6 PK	68.2	-4.6	1.99 V	264	60.9	2.7
2	*5745.00	117.3 PK			1.99 V	264	114.3	3.0
3	*5745.00	105.7 AV			1.99 V	264	102.7	3.0
4	#5928.41	51.5 PK	68.2	-16.7	1.99 V	264	48.3	3.2
5	11490.00	55.6 PK	74.0	-18.4	1.60 V	177	42.6	13.0
6	11490.00	43.6 AV	54.0	-10.4	1.60 V	177	30.6	13.0
7	#17235.00	59.3 PK	68.2	-8.9	1.46 V	160	42.0	17.3

**Remarks:**

1. Emission Level(dBuV/m) = Raw Value(dBuV) + Correction Factor(dB/m)
2. Correction Factor(dB/m) = Antenna Factor(dB/m) + Cable Factor(dB) – Pre-Amplifier Factor(dB)
3. Margin value = Emission Level – Limit value
4. The other emission levels were very low against the limit.
5. " \* " : Fundamental frequency, the limit was restricted at the RF Output Power.
6. " # " : The radiated frequency is out of the restricted band.

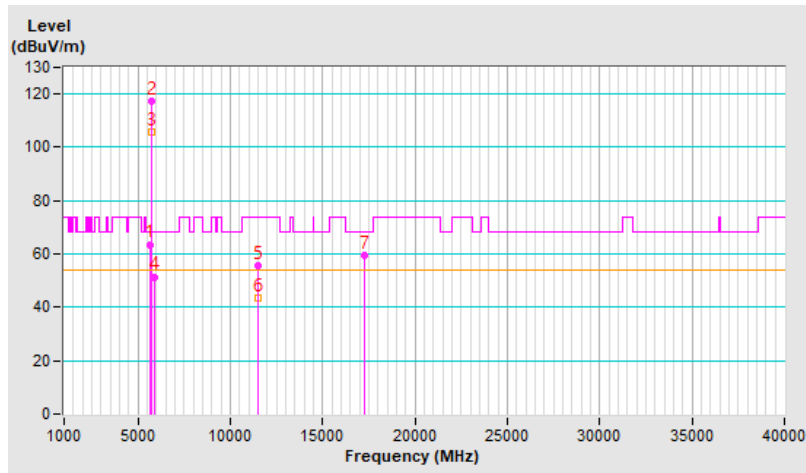

<b>RF Mode</b>	802.11a	<b>Channel</b>	CH 157 : 5785 MHz
<b>Frequency Range</b>	1 GHz ~ 40 GHz	<b>Detector Function &amp; Bandwidth</b>	PK: RB=1 MHz, VB=3 MHz, DET=Peak AV: RB=1 MHz, VB=10 Hz, DET=Peak
<b>Input Power</b>	120 Vac, 60 Hz	<b>Environmental Conditions</b>	24°C, 71% RH
<b>Tested By</b>	Louis Yang		

**Antenna Polarity & Test Distance : Horizontal at 3 m**

No	Frequency (MHz)	Emission Level (dBuV/m)	Limit (dBuV/m)	Margin (dB)	Antenna Height (m)	Table Angle (Degree)	Raw Value (dBuV)	Correction Factor (dB/m)
1	#5645.28	52.5 PK	68.2	-15.7	1.31 H	146	49.8	2.7
2	*5785.00	113.8 PK			1.31 H	146	110.6	3.2
3	*5785.00	103.2 AV			1.31 H	146	100.0	3.2
4	#5961.02	51.7 PK	68.2	-16.5	1.31 H	146	48.5	3.2
5	11570.00	61.5 PK	74.0	-12.5	1.54 H	207	48.3	13.2
6	11570.00	48.5 AV	54.0	-5.5	1.54 H	207	35.3	13.2
7	#17355.00	48.8 PK	68.2	-19.4	1.55 H	357	30.3	18.5

**Remarks:**

1. Emission Level(dBuV/m) = Raw Value(dBuV) + Correction Factor(dB/m)
2. Correction Factor(dB/m) = Antenna Factor(dB/m) + Cable Factor(dB) – Pre-Amplifier Factor(dB)
3. Margin value = Emission Level – Limit value
4. The other emission levels were very low against the limit.
5. " \* " : Fundamental frequency, the limit was restricted at the RF Output Power.
6. " # " : The radiated frequency is out of the restricted band.

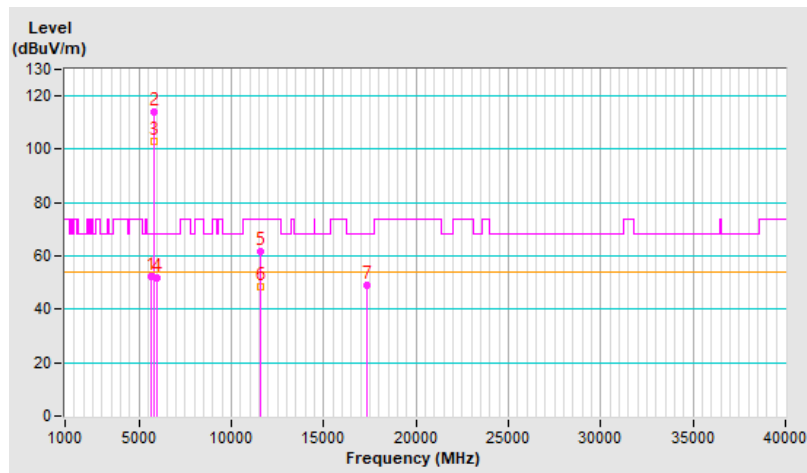



<b>RF Mode</b>	802.11a	<b>Channel</b>	CH 157 : 5785 MHz
<b>Frequency Range</b>	1 GHz ~ 40 GHz	<b>Detector Function &amp; Bandwidth</b>	PK: RB=1 MHz, VB=3 MHz, DET=Peak AV: RB=1 MHz, VB=10 Hz, DET=Peak
<b>Input Power</b>	120 Vac, 60 Hz	<b>Environmental Conditions</b>	24°C, 71% RH
<b>Tested By</b>	Louis Yang		

Antenna Polarity & Test Distance : Vertical at 3 m								
No	Frequency (MHz)	Emission Level (dBuV/m)	Limit (dBuV/m)	Margin (dB)	Antenna Height (m)	Table Angle (Degree)	Raw Value (dBuV)	Correction Factor (dB/m)
1	#5645.28	54.8 PK	68.2	-13.4	1.93 V	261	52.1	2.7
2	*5785.00	116.2 PK			1.93 V	261	113.0	3.2
3	*5785.00	105.6 AV			1.93 V	261	102.4	3.2
4	#5961.02	52.7 PK	68.2	-15.5	1.93 V	261	49.5	3.2
5	11570.00	61.7 PK	74.0	-12.3	1.56 V	205	48.5	13.2
6	11570.00	48.7 AV	54.0	-5.3	1.56 V	205	35.5	13.2
7	#17355.00	48.5 PK	68.2	-19.7	1.51 V	360	30.0	18.5

**Remarks:**

1. Emission Level(dBuV/m) = Raw Value(dBuV) + Correction Factor(dB/m)
2. Correction Factor(dB/m) = Antenna Factor(dB/m) + Cable Factor(dB) – Pre-Amplifier Factor(dB)
3. Margin value = Emission Level – Limit value
4. The other emission levels were very low against the limit.
5. " \* " : Fundamental frequency, the limit was restricted at the RF Output Power.
6. " # " : The radiated frequency is out of the restricted band.

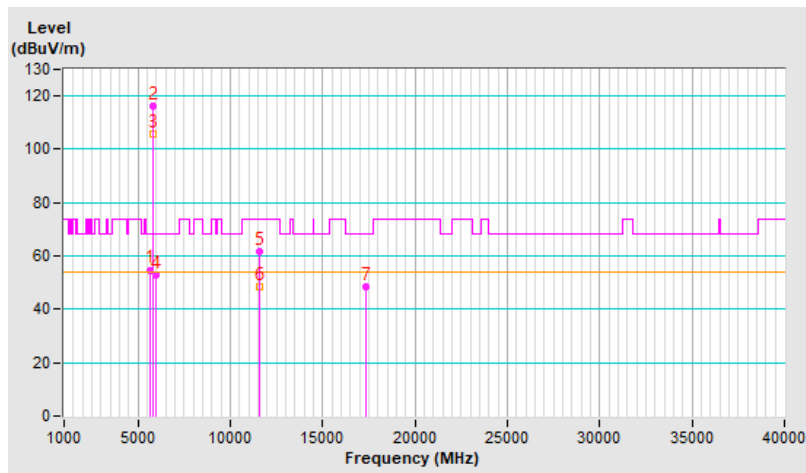

<b>RF Mode</b>	802.11a	<b>Channel</b>	CH 165 : 5825 MHz
<b>Frequency Range</b>	1 GHz ~ 40 GHz	<b>Detector Function &amp; Bandwidth</b>	PK: RB=1 MHz, VB=3 MHz, DET=Peak AV: RB=1 MHz, VB=10 Hz, DET=Peak
<b>Input Power</b>	120 Vac, 60 Hz	<b>Environmental Conditions</b>	24°C, 71% RH
<b>Tested By</b>	Louis Yang		

**Antenna Polarity & Test Distance : Horizontal at 3 m**

No	Frequency (MHz)	Emission Level (dBuV/m)	Limit (dBuV/m)	Margin (dB)	Antenna Height (m)	Table Angle (Degree)	Raw Value (dBuV)	Correction Factor (dB/m)
1	#5581.22	52.2 PK	68.2	-16.0	1.28 H	136	49.5	2.7
2	*5825.00	114.1 PK			1.28 H	136	110.8	3.3
3	*5825.00	103.4 AV			1.28 H	136	100.1	3.3
4	#5926.19	57.0 PK	68.2	-11.2	1.28 H	136	53.8	3.2
5	11650.00	61.1 PK	74.0	-12.9	1.58 H	193	48.0	13.1
6	11650.00	48.1 AV	54.0	-5.9	1.58 H	193	35.0	13.1
7	#17475.00	48.5 PK	68.2	-19.7	1.49 H	349	28.4	20.1

**Remarks:**

1. Emission Level(dBuV/m) = Raw Value(dBuV) + Correction Factor(dB/m)
2. Correction Factor(dB/m) = Antenna Factor(dB/m) + Cable Factor(dB) – Pre-Amplifier Factor(dB)
3. Margin value = Emission Level – Limit value
4. The other emission levels were very low against the limit.
5. " \* " : Fundamental frequency, the limit was restricted at the RF Output Power.
6. " # " : The radiated frequency is out of the restricted band.

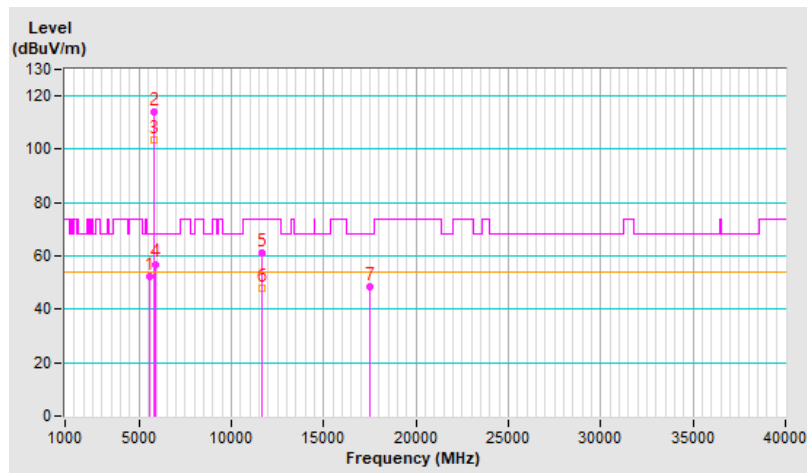

<b>RF Mode</b>	802.11a	<b>Channel</b>	CH 165 : 5825 MHz
<b>Frequency Range</b>	1 GHz ~ 40 GHz	<b>Detector Function &amp; Bandwidth</b>	PK: RB=1 MHz, VB=3 MHz, DET=Peak AV: RB=1 MHz, VB=10 Hz, DET=Peak
<b>Input Power</b>	120 Vac, 60 Hz	<b>Environmental Conditions</b>	24°C, 71% RH
<b>Tested By</b>	Louis Yang		

Antenna Polarity & Test Distance : Vertical at 3 m								
No	Frequency (MHz)	Emission Level (dBuV/m)	Limit (dBuV/m)	Margin (dB)	Antenna Height (m)	Table Angle (Degree)	Raw Value (dBuV)	Correction Factor (dB/m)
1	#5639.02	52.4 PK	68.2	-15.8	1.96 V	262	49.7	2.7
2	*5825.00	116.6 PK			1.96 V	262	113.3	3.3
3	*5825.00	105.9 AV			1.96 V	262	102.6	3.3
4	#5926.54	61.1 PK	68.2	-7.1	1.96 V	262	57.9	3.2
5	11650.00	62.1 PK	74.0	-11.9	1.54 V	208	49.0	13.1
6	11650.00	48.6 AV	54.0	-5.4	1.54 V	208	35.5	13.1
7	#17475.00	49.4 PK	68.2	-18.8	1.55 V	345	29.3	20.1

**Remarks:**

1. Emission Level(dBuV/m) = Raw Value(dBuV) + Correction Factor(dB/m)
2. Correction Factor(dB/m) = Antenna Factor(dB/m) + Cable Factor(dB) – Pre-Amplifier Factor(dB)
3. Margin value = Emission Level – Limit value
4. The other emission levels were very low against the limit.
5. " \* " : Fundamental frequency, the limit was restricted at the RF Output Power.
6. " # " : The radiated frequency is out of the restricted band.

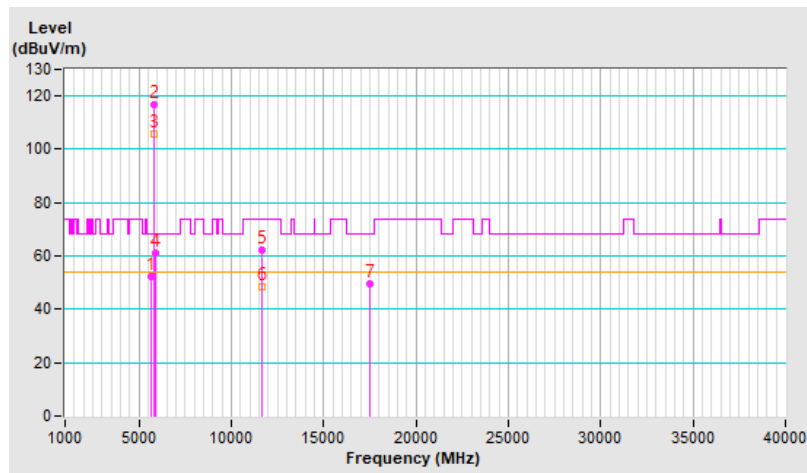

<b>RF Mode</b>	802.11ax (HE20)	<b>Channel</b>	CH 36 : 5180 MHz
<b>Frequency Range</b>	1 GHz ~ 40 GHz	<b>Detector Function &amp; Bandwidth</b>	PK: RB=1 MHz, VB=3 MHz, DET=Peak AV: RB=1 MHz, VB=10 Hz, DET=Peak
<b>Input Power</b>	120 Vac, 60 Hz	<b>Environmental Conditions</b>	24°C, 71% RH
<b>Tested By</b>	Louis Yang		

**Antenna Polarity & Test Distance : Horizontal at 3 m**

No	Frequency (MHz)	Emission Level (dBuV/m)	Limit (dBuV/m)	Margin (dB)	Antenna Height (m)	Table Angle (Degree)	Raw Value (dBuV)	Correction Factor (dB/m)
1	5150.00	64.7 PK	74.0	-9.3	1.96 H	101	61.3	3.4
2	5150.00	51.9 AV	54.0	-2.1	1.96 H	101	48.5	3.4
3	*5180.00	115.7 PK			1.96 H	101	112.6	3.1
4	*5180.00	105.5 AV			1.96 H	101	102.4	3.1
5	#10360.00	54.6 PK	68.2	-13.6	1.38 H	226	41.8	12.8
6	15540.00	41.6 PK	74.0	-32.4	1.62 H	328	30.3	11.3
7	15540.00	28.0 AV	54.0	-26.0	1.62 H	328	16.7	11.3

**Remarks:**

1. Emission Level(dBuV/m) = Raw Value(dBuV) + Correction Factor(dB/m)
2. Correction Factor(dB/m) = Antenna Factor(dB/m) + Cable Factor(dB) – Pre-Amplifier Factor(dB)
3. Margin value = Emission Level – Limit value
4. The other emission levels were very low against the limit.
5. " \* ": Fundamental frequency, the limit was restricted at the RF Output Power.
6. " # ": The radiated frequency is out of the restricted band.

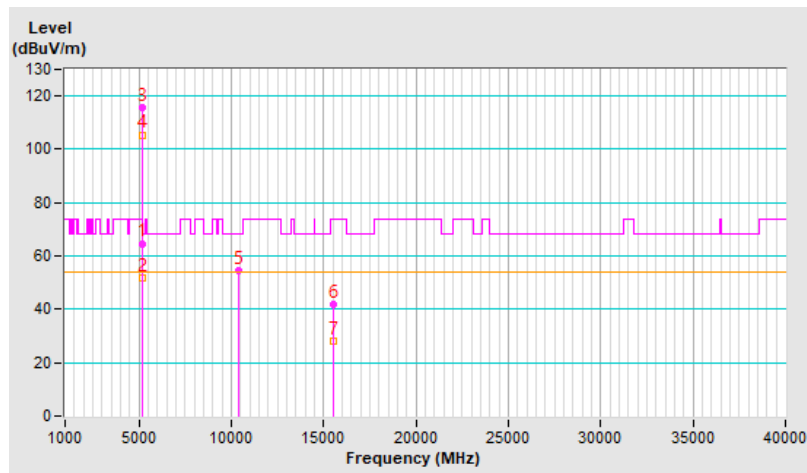

<b>RF Mode</b>	802.11ax (HE20)	<b>Channel</b>	CH 36 : 5180 MHz
<b>Frequency Range</b>	1 GHz ~ 40 GHz	<b>Detector Function &amp; Bandwidth</b>	PK: RB=1 MHz, VB=3 MHz, DET=Peak AV: RB=1 MHz, VB=10 Hz, DET=Peak
<b>Input Power</b>	120 Vac, 60 Hz	<b>Environmental Conditions</b>	24°C, 71% RH
<b>Tested By</b>	Louis Yang		

Antenna Polarity & Test Distance : Vertical at 3 m								
No	Frequency (MHz)	Emission Level (dBuV/m)	Limit (dBuV/m)	Margin (dB)	Antenna Height (m)	Table Angle (Degree)	Raw Value (dBuV)	Correction Factor (dB/m)
1	5150.00	67.2 PK	74.0	-6.8	2.57 V	186	63.8	3.4
2	5150.00	52.4 AV	54.0	-1.6	2.57 V	186	49.0	3.4
3	*5180.00	116.1 PK			2.57 V	186	113.0	3.1
4	*5180.00	106.9 AV			2.57 V	186	103.8	3.1
5	#10360.00	54.7 PK	68.2	-13.5	1.43 V	230	41.9	12.8
6	15540.00	41.8 PK	74.0	-32.2	1.57 V	331	30.5	11.3
7	15540.00	28.2 AV	54.0	-25.8	1.57 V	331	16.9	11.3

**Remarks:**

1. Emission Level(dBuV/m) = Raw Value(dBuV) + Correction Factor(dB/m)
2. Correction Factor(dB/m) = Antenna Factor(dB/m) + Cable Factor(dB) – Pre-Amplifier Factor(dB)
3. Margin value = Emission Level – Limit value
4. The other emission levels were very low against the limit.
5. " \* ": Fundamental frequency, the limit was restricted at the RF Output Power.
6. " # ": The radiated frequency is out of the restricted band.

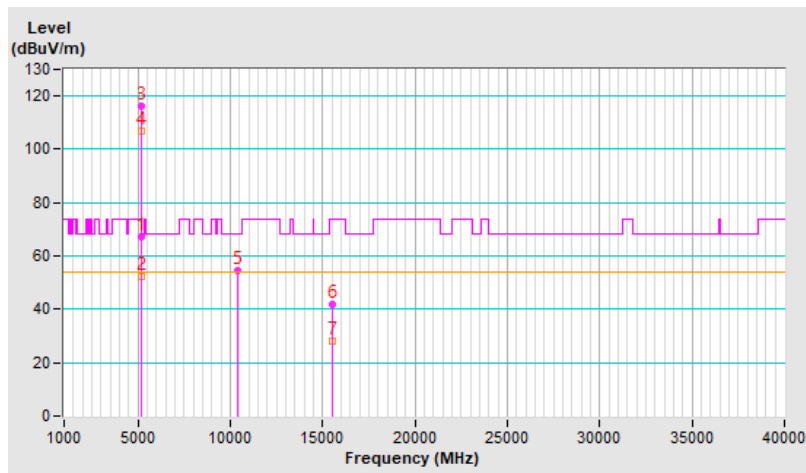

<b>RF Mode</b>	802.11ax (HE20)	<b>Channel</b>	CH 40 : 5200 MHz
<b>Frequency Range</b>	1 GHz ~ 40 GHz	<b>Detector Function &amp; Bandwidth</b>	PK: RB=1 MHz, VB=3 MHz, DET=Peak AV: RB=1 MHz, VB=10 Hz, DET=Peak
<b>Input Power</b>	120 Vac, 60 Hz	<b>Environmental Conditions</b>	24°C, 71% RH
<b>Tested By</b>	Louis Yang		

**Antenna Polarity & Test Distance : Horizontal at 3 m**

No	Frequency (MHz)	Emission Level (dBuV/m)	Limit (dBuV/m)	Margin (dB)	Antenna Height (m)	Table Angle (Degree)	Raw Value (dBuV)	Correction Factor (dB/m)
1	5150.00	62.9 PK	74.0	-11.1	1.98 H	88	59.5	3.4
2	5150.00	49.8 AV	54.0	-4.2	1.98 H	88	46.4	3.4
3	*5200.00	116.5 PK			1.98 H	88	113.5	3.0
4	*5200.00	106.5 AV			1.98 H	88	103.5	3.0
5	#10400.00	55.2 PK	68.2	-13.0	1.43 H	214	42.1	13.1
6	15600.00	42.5 PK	74.0	-31.5	1.53 H	343	31.8	10.7
7	15600.00	28.6 AV	54.0	-25.4	1.53 H	343	17.9	10.7

**Remarks:**

1. Emission Level(dBuV/m) = Raw Value(dBuV) + Correction Factor(dB/m)
2. Correction Factor(dB/m) = Antenna Factor(dB/m) + Cable Factor(dB) – Pre-Amplifier Factor(dB)
3. Margin value = Emission Level – Limit value
4. The other emission levels were very low against the limit.
5. " \* ": Fundamental frequency, the limit was restricted at the RF Output Power.
6. " # ": The radiated frequency is out of the restricted band.

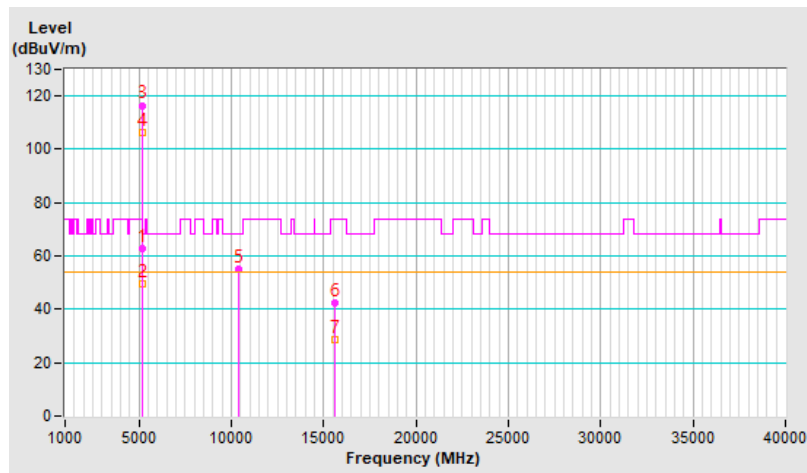

<b>RF Mode</b>	802.11ax (HE20)	<b>Channel</b>	CH 40 : 5200 MHz
<b>Frequency Range</b>	1 GHz ~ 40 GHz	<b>Detector Function &amp; Bandwidth</b>	PK: RB=1 MHz, VB=3 MHz, DET=Peak AV: RB=1 MHz, VB=10 Hz, DET=Peak
<b>Input Power</b>	120 Vac, 60 Hz	<b>Environmental Conditions</b>	24°C, 71% RH
<b>Tested By</b>	Louis Yang		

Antenna Polarity & Test Distance : Vertical at 3 m								
No	Frequency (MHz)	Emission Level (dBUV/m)	Limit (dBUV/m)	Margin (dB)	Antenna Height (m)	Table Angle (Degree)	Raw Value (dBUV)	Correction Factor (dB/m)
1	5150.00	65.0 PK	74.0	-9.0	1.00 V	88	61.6	3.4
2	5150.00	52.7 AV	54.0	-1.3	1.00 V	88	49.3	3.4
3	*5200.00	118.8 PK			1.00 V	88	115.8	3.0
4	*5200.00	108.0 AV			1.00 V	88	105.0	3.0
5	#10400.00	55.5 PK	68.2	-12.7	1.39 V	210	42.4	13.1
6	15600.00	42.3 PK	74.0	-31.7	1.55 V	335	31.6	10.7
7	15600.00	28.6 AV	54.0	-25.4	1.55 V	335	17.9	10.7

**Remarks:**

1. Emission Level(dBUV/m) = Raw Value(dBUV) + Correction Factor(dB/m)
2. Correction Factor(dB/m) = Antenna Factor(dB/m) + Cable Factor(dB) – Pre-Amplifier Factor(dB)
3. Margin value = Emission Level – Limit value
4. The other emission levels were very low against the limit.
5. " \* ": Fundamental frequency, the limit was restricted at the RF Output Power.
6. " # ": The radiated frequency is out of the restricted band.

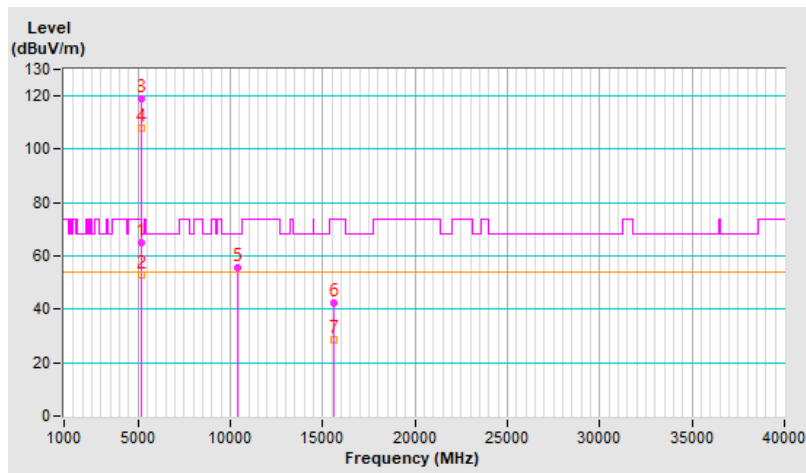

<b>RF Mode</b>	802.11ax (HE20)	<b>Channel</b>	CH 48 : 5240 MHz
<b>Frequency Range</b>	1 GHz ~ 40 GHz	<b>Detector Function &amp; Bandwidth</b>	PK: RB=1 MHz, VB=3 MHz, DET=Peak AV: RB=1 MHz, VB=10 Hz, DET=Peak
<b>Input Power</b>	120 Vac, 60 Hz	<b>Environmental Conditions</b>	24°C, 71% RH
<b>Tested By</b>	Louis Yang		

**Antenna Polarity & Test Distance : Horizontal at 3 m**

No	Frequency (MHz)	Emission Level (dBuV/m)	Limit (dBuV/m)	Margin (dB)	Antenna Height (m)	Table Angle (Degree)	Raw Value (dBuV)	Correction Factor (dB/m)
1	5150.00	63.1 PK	74.0	-10.9	1.97 H	88	59.7	3.4
2	5150.00	49.5 AV	54.0	-4.5	1.97 H	88	46.1	3.4
3	*5240.00	118.5 PK			1.97 H	88	115.8	2.7
4	*5240.00	109.8 AV			1.97 H	88	107.1	2.7
5	5350.00	59.4 PK	74.0	-14.6	1.97 H	88	56.6	2.8
6	5350.00	47.3 AV	54.0	-6.7	1.97 H	88	44.5	2.8
7	#10480.00	57.2 PK	68.2	-11.0	1.64 H	196	44.4	12.8
8	15720.00	46.3 PK	74.0	-27.7	1.49 H	360	34.9	11.4
9	15720.00	34.1 AV	54.0	-19.9	1.49 H	360	22.7	11.4

**Remarks:**

1. Emission Level(dBuV/m) = Raw Value(dBuV) + Correction Factor(dB/m)
2. Correction Factor(dB/m) = Antenna Factor(dB/m) + Cable Factor(dB) – Pre-Amplifier Factor(dB)
3. Margin value = Emission Level – Limit value
4. The other emission levels were very low against the limit.
5. " \* ": Fundamental frequency, the limit was restricted at the RF Output Power.
6. " # ": The radiated frequency is out of the restricted band.

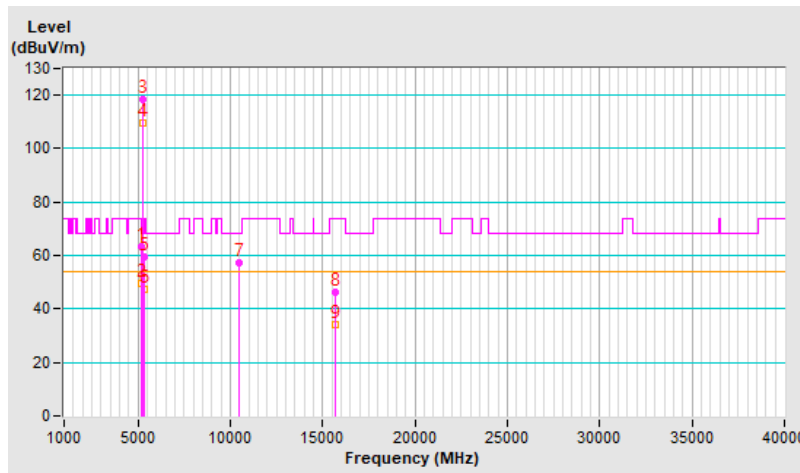



<b>RF Mode</b>	802.11ax (HE20)	<b>Channel</b>	CH 48 : 5240 MHz
<b>Frequency Range</b>	1 GHz ~ 40 GHz	<b>Detector Function &amp; Bandwidth</b>	PK: RB=1 MHz, VB=3 MHz, DET=Peak AV: RB=1 MHz, VB=10 Hz, DET=Peak
<b>Input Power</b>	120 Vac, 60 Hz	<b>Environmental Conditions</b>	24°C, 71% RH
<b>Tested By</b>	Louis Yang		

**Antenna Polarity & Test Distance : Vertical at 3 m**

No	Frequency (MHz)	Emission Level (dBuV/m)	Limit (dBuV/m)	Margin (dB)	Antenna Height (m)	Table Angle (Degree)	Raw Value (dBuV)	Correction Factor (dB/m)
1	5150.00	64.7 PK	74.0	-9.3	1.86 V	97	61.3	3.4
2	5150.00	52.5 AV	54.0	-1.5	1.86 V	97	49.1	3.4
3	*5240.00	119.5 PK			1.86 V	97	116.8	2.7
4	*5240.00	110.9 AV			1.86 V	97	108.2	2.7
5	5350.00	61.0 PK	74.0	-13.0	1.86 V	97	58.2	2.8
6	5350.00	49.0 AV	54.0	-5.0	1.86 V	97	46.2	2.8
7	#10480.00	56.9 PK	68.2	-11.3	1.63 V	179	44.1	12.8
8	15720.00	46.9 PK	74.0	-27.1	1.48 V	359	35.5	11.4
9	15720.00	34.6 AV	54.0	-19.4	1.48 V	359	23.2	11.4

**Remarks:**

1. Emission Level(dBuV/m) = Raw Value(dBuV) + Correction Factor(dB/m)
2. Correction Factor(dB/m) = Antenna Factor(dB/m) + Cable Factor(dB) – Pre-Amplifier Factor(dB)
3. Margin value = Emission Level – Limit value
4. The other emission levels were very low against the limit.
5. " \* ": Fundamental frequency, the limit was restricted at the RF Output Power.
6. " # ": The radiated frequency is out of the restricted band.

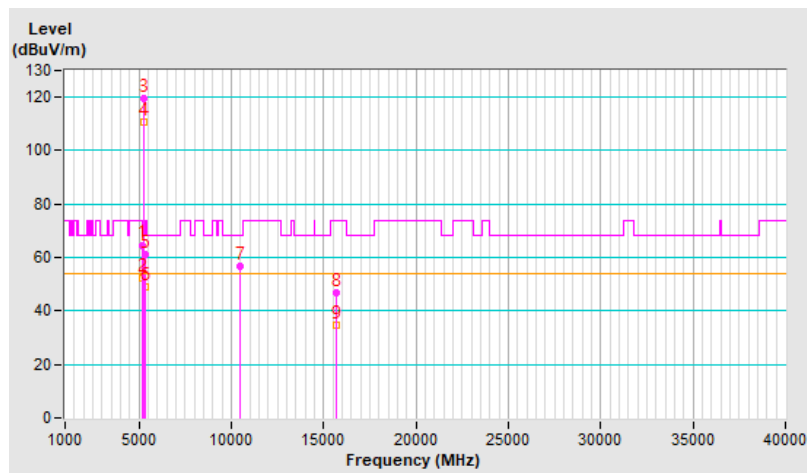

<b>RF Mode</b>	802.11ax (HE20)	<b>Channel</b>	CH 52 : 5260 MHz
<b>Frequency Range</b>	1 GHz ~ 40 GHz	<b>Detector Function &amp; Bandwidth</b>	PK: RB=1 MHz, VB=3 MHz, DET=Peak AV: RB=1 MHz, VB=10 Hz, DET=Peak
<b>Input Power</b>	120 Vac, 60 Hz	<b>Environmental Conditions</b>	24°C, 71% RH
<b>Tested By</b>	Louis Yang		

**Antenna Polarity & Test Distance : Horizontal at 3 m**

No	Frequency (MHz)	Emission Level (dBuV/m)	Limit (dBuV/m)	Margin (dB)	Antenna Height (m)	Table Angle (Degree)	Raw Value (dBuV)	Correction Factor (dB/m)
1	*5260.00	118.5 PK			1.95 H	84	115.9	2.6
2	*5260.00	108.5 AV			1.95 H	84	105.9	2.6
3	5350.00	62.4 PK	74.0	-11.6	1.95 H	84	59.6	2.8
4	5350.00	50.8 AV	54.0	-3.2	1.95 H	84	48.0	2.8
5	#10520.00	57.4 PK	68.2	-10.8	1.65 H	217	44.8	12.6
6	15780.00	47.0 PK	74.0	-27.0	1.49 H	360	35.2	11.8
7	15780.00	34.4 AV	54.0	-19.6	1.49 H	360	22.6	11.8

**Remarks:**

1. Emission Level(dBuV/m) = Raw Value(dBuV) + Correction Factor(dB/m)
2. Correction Factor(dB/m) = Antenna Factor(dB/m) + Cable Factor(dB) – Pre-Amplifier Factor(dB)
3. Margin value = Emission Level – Limit value
4. The other emission levels were very low against the limit.
5. " \* " : Fundamental frequency, the limit was restricted at the RF Output Power.
6. " # " : The radiated frequency is out of the restricted band.

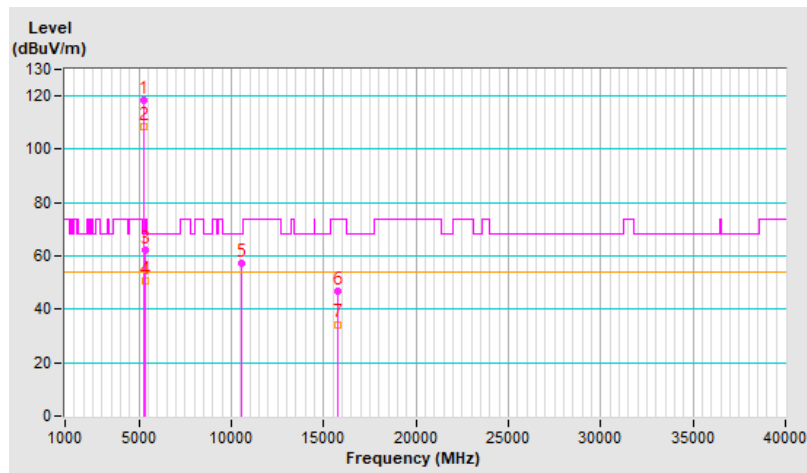

<b>RF Mode</b>	802.11ax (HE20)	<b>Channel</b>	CH 52 : 5260 MHz
<b>Frequency Range</b>	1 GHz ~ 40 GHz	<b>Detector Function &amp; Bandwidth</b>	PK: RB=1 MHz, VB=3 MHz, DET=Peak AV: RB=1 MHz, VB=10 Hz, DET=Peak
<b>Input Power</b>	120 Vac, 60 Hz	<b>Environmental Conditions</b>	24°C, 71% RH
<b>Tested By</b>	Louis Yang		

Antenna Polarity & Test Distance : Vertical at 3 m								
No	Frequency (MHz)	Emission Level (dBuV/m)	Limit (dBuV/m)	Margin (dB)	Antenna Height (m)	Table Angle (Degree)	Raw Value (dBuV)	Correction Factor (dB/m)
1	*5260.00	120.5 PK			1.98 V	100	117.9	2.6
2	*5260.00	110.3 AV			1.98 V	100	107.7	2.6
3	5350.00	63.9 PK	74.0	-10.1	1.98 V	100	61.1	2.8
4	5350.00	52.0 AV	54.0	-2.0	1.98 V	100	49.2	2.8
5	#10520.00	57.1 PK	68.2	-11.1	1.66 V	194	44.5	12.6
6	15780.00	46.6 PK	74.0	-27.4	1.48 V	352	34.8	11.8
7	15780.00	34.1 AV	54.0	-19.9	1.48 V	352	22.3	11.8

**Remarks:**

1. Emission Level(dBuV/m) = Raw Value(dBuV) + Correction Factor(dB/m)
2. Correction Factor(dB/m) = Antenna Factor(dB/m) + Cable Factor(dB) – Pre-Amplifier Factor(dB)
3. Margin value = Emission Level – Limit value
4. The other emission levels were very low against the limit.
5. " \* ": Fundamental frequency, the limit was restricted at the RF Output Power.
6. " # ": The radiated frequency is out of the restricted band.

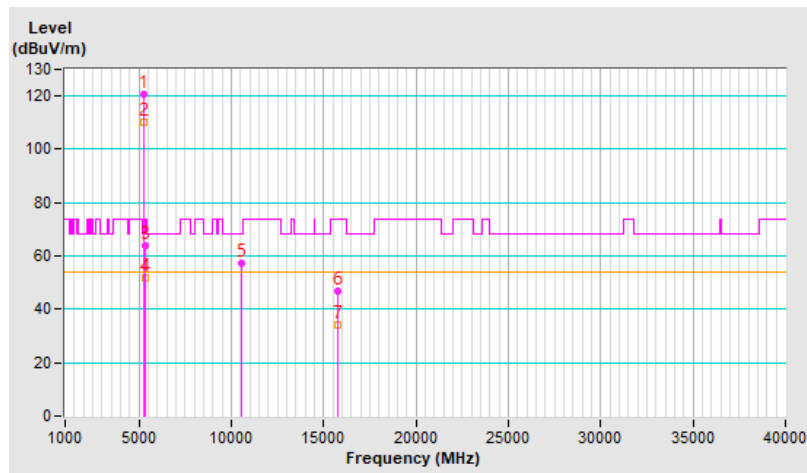

<b>RF Mode</b>	802.11ax (HE20)	<b>Channel</b>	CH 60 : 5300 MHz
<b>Frequency Range</b>	1 GHz ~ 40 GHz	<b>Detector Function &amp; Bandwidth</b>	PK: RB=1 MHz, VB=3 MHz, DET=Peak AV: RB=1 MHz, VB=10 Hz, DET=Peak
<b>Input Power</b>	120 Vac, 60 Hz	<b>Environmental Conditions</b>	24°C, 71% RH
<b>Tested By</b>	Louis Yang		

**Antenna Polarity & Test Distance : Horizontal at 3 m**

No	Frequency (MHz)	Emission Level (dBuV/m)	Limit (dBuV/m)	Margin (dB)	Antenna Height (m)	Table Angle (Degree)	Raw Value (dBuV)	Correction Factor (dB/m)
1	*5300.00	117.8 PK			1.93 H	83	115.4	2.4
2	*5300.00	106.5 AV			1.93 H	83	104.1	2.4
3	5350.00	64.2 PK	74.0	-9.8	1.93 H	83	61.4	2.8
4	5350.00	51.2 AV	54.0	-2.8	1.93 H	83	48.4	2.8
5	10600.00	55.6 PK	74.0	-18.4	1.35 H	200	42.7	12.9
6	10600.00	42.6 AV	54.0	-11.4	1.35 H	200	29.7	12.9
7	15900.00	42.2 PK	74.0	-31.8	1.58 H	324	30.1	12.1
8	15900.00	28.6 AV	54.0	-25.4	1.58 H	324	16.5	12.1

**Remarks:**

1. Emission Level(dBuV/m) = Raw Value(dBuV) + Correction Factor(dB/m)
2. Correction Factor(dB/m) = Antenna Factor(dB/m) + Cable Factor(dB) – Pre-Amplifier Factor(dB)
3. Margin value = Emission Level – Limit value
4. The other emission levels were very low against the limit.
5. " \* ": Fundamental frequency, the limit was restricted at the RF Output Power.

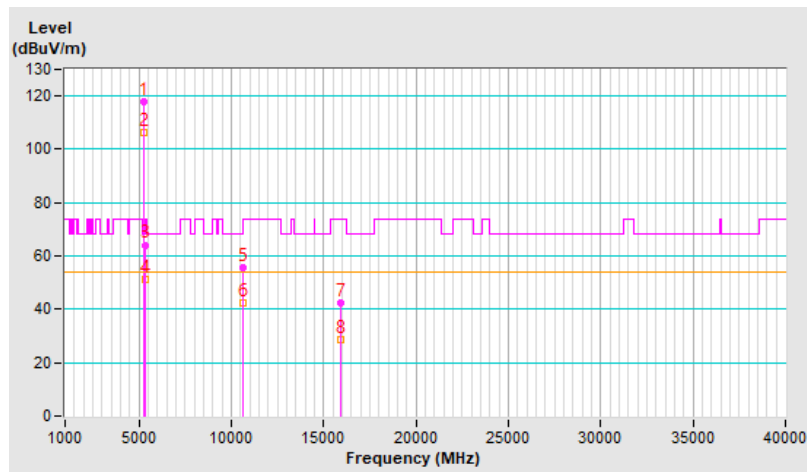

<b>RF Mode</b>	802.11ax (HE20)	<b>Channel</b>	CH 60 : 5300 MHz
<b>Frequency Range</b>	1 GHz ~ 40 GHz	<b>Detector Function &amp; Bandwidth</b>	PK: RB=1 MHz, VB=3 MHz, DET=Peak AV: RB=1 MHz, VB=10 Hz, DET=Peak
<b>Input Power</b>	120 Vac, 60 Hz	<b>Environmental Conditions</b>	24°C, 71% RH
<b>Tested By</b>	Louis Yang		

Antenna Polarity & Test Distance : Vertical at 3 m								
No	Frequency (MHz)	Emission Level (dBuV/m)	Limit (dBuV/m)	Margin (dB)	Antenna Height (m)	Table Angle (Degree)	Raw Value (dBuV)	Correction Factor (dB/m)
1	*5300.00	119.2 PK			1.95 V	83	116.8	2.4
2	*5300.00	108.9 AV			1.95 V	83	106.5	2.4
3	5350.00	66.9 PK	74.0	-7.1	1.95 V	83	64.1	2.8
4	5350.00	52.5 AV	54.0	-1.5	1.95 V	83	49.7	2.8
5	10600.00	54.9 PK	74.0	-19.1	1.37 V	200	42.0	12.9
6	10600.00	42.1 AV	54.0	-11.9	1.37 V	200	29.2	12.9
7	15900.00	41.8 PK	74.0	-32.2	1.52 V	335	29.7	12.1
8	15900.00	28.3 AV	54.0	-25.7	1.52 V	335	16.2	12.1

**Remarks:**

1. Emission Level(dBuV/m) = Raw Value(dBuV) + Correction Factor(dB/m)
2. Correction Factor(dB/m) = Antenna Factor(dB/m) + Cable Factor(dB) – Pre-Amplifier Factor(dB)
3. Margin value = Emission Level – Limit value
4. The other emission levels were very low against the limit.
5. " \* ": Fundamental frequency, the limit was restricted at the RF Output Power.

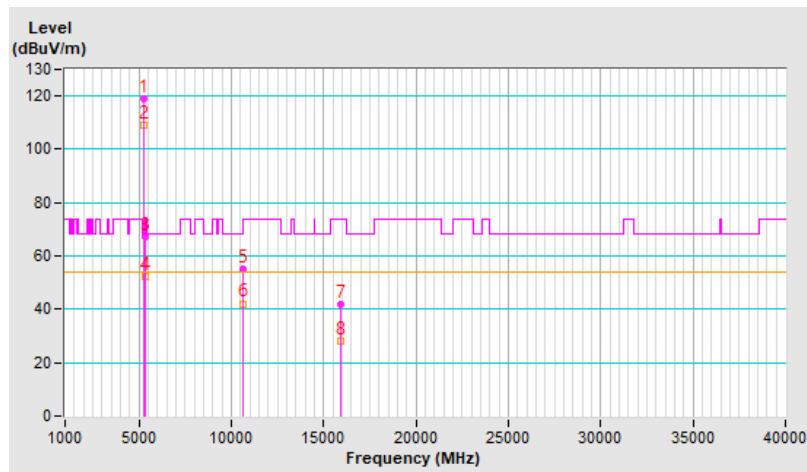

<b>RF Mode</b>	802.11ax (HE20)	<b>Channel</b>	CH 64 : 5320 MHz
<b>Frequency Range</b>	1 GHz ~ 40 GHz	<b>Detector Function &amp; Bandwidth</b>	PK: RB=1 MHz, VB=3 MHz, DET=Peak AV: RB=1 MHz, VB=10 Hz, DET=Peak
<b>Input Power</b>	120 Vac, 60 Hz	<b>Environmental Conditions</b>	24°C, 71% RH
<b>Tested By</b>	Louis Yang		

**Antenna Polarity & Test Distance : Horizontal at 3 m**

No	Frequency (MHz)	Emission Level (dBuV/m)	Limit (dBuV/m)	Margin (dB)	Antenna Height (m)	Table Angle (Degree)	Raw Value (dBuV)	Correction Factor (dB/m)
1	*5320.00	115.3 PK			1.88 H	95	112.7	2.6
2	*5320.00	105.9 AV			1.88 H	95	103.3	2.6
3	5350.00	71.1 PK	74.0	-2.9	1.88 H	95	68.3	2.8
4	5350.00	53.0 AV	54.0	-1.0	1.88 H	95	50.2	2.8
5	10640.00	55.7 PK	74.0	-18.3	1.39 H	226	42.6	13.1
6	10640.00	42.9 AV	54.0	-11.1	1.39 H	226	29.8	13.1
7	15960.00	42.5 PK	74.0	-31.5	1.61 H	353	30.1	12.4
8	15960.00	28.7 AV	54.0	-25.3	1.61 H	353	16.3	12.4

**Remarks:**

1. Emission Level(dBuV/m) = Raw Value(dBuV) + Correction Factor(dB/m)
2. Correction Factor(dB/m) = Antenna Factor(dB/m) + Cable Factor(dB) – Pre-Amplifier Factor(dB)
3. Margin value = Emission Level – Limit value
4. The other emission levels were very low against the limit.
5. " \* ": Fundamental frequency, the limit was restricted at the RF Output Power.

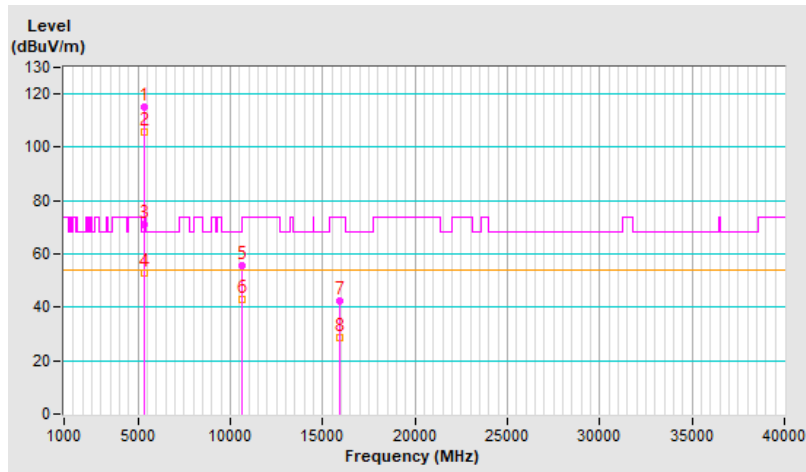

<b>RF Mode</b>	802.11ax (HE20)	<b>Channel</b>	CH 64 : 5320 MHz
<b>Frequency Range</b>	1 GHz ~ 40 GHz	<b>Detector Function &amp; Bandwidth</b>	PK: RB=1 MHz, VB=3 MHz, DET=Peak AV: RB=1 MHz, VB=10 Hz, DET=Peak
<b>Input Power</b>	120 Vac, 60 Hz	<b>Environmental Conditions</b>	24°C, 71% RH
<b>Tested By</b>	Louis Yang		

Antenna Polarity & Test Distance : Vertical at 3 m								
No	Frequency (MHz)	Emission Level (dBuV/m)	Limit (dBuV/m)	Margin (dB)	Antenna Height (m)	Table Angle (Degree)	Raw Value (dBuV)	Correction Factor (dB/m)
1	*5320.00	116.6 PK			1.04 V	77	114.0	2.6
2	*5320.00	107.1 AV			1.04 V	77	104.5	2.6
3	5350.00	68.4 PK	74.0	-5.6	1.04 V	77	65.6	2.8
4	5350.00	52.6 AV	54.0	-1.4	1.04 V	77	49.8	2.8
5	10640.00	55.9 PK	74.0	-18.1	1.42 V	213	42.8	13.1
6	10640.00	42.9 AV	54.0	-11.1	1.42 V	213	29.8	13.1
7	15960.00	42.5 PK	74.0	-31.5	1.55 V	338	30.1	12.4
8	15960.00	28.9 AV	54.0	-25.1	1.55 V	338	16.5	12.4

**Remarks:**

1. Emission Level(dBuV/m) = Raw Value(dBuV) + Correction Factor(dB/m)
2. Correction Factor(dB/m) = Antenna Factor(dB/m) + Cable Factor(dB) – Pre-Amplifier Factor(dB)
3. Margin value = Emission Level – Limit value
4. The other emission levels were very low against the limit.
5. " \* ": Fundamental frequency, the limit was restricted at the RF Output Power.

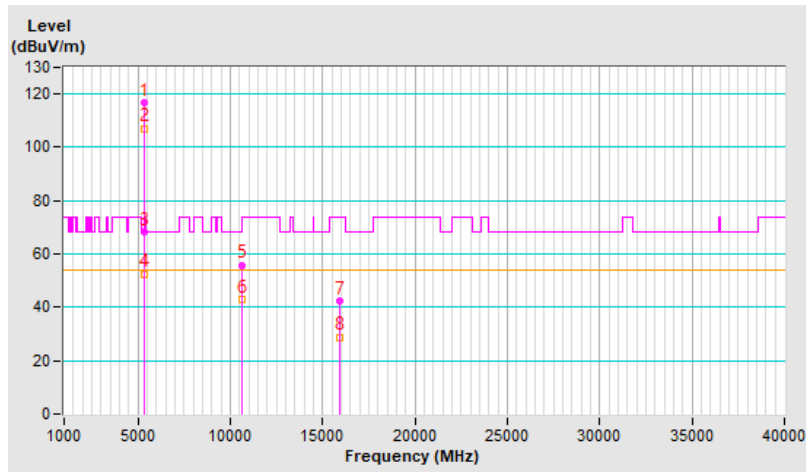

<b>RF Mode</b>	802.11ax (HE20)	<b>Channel</b>	CH 100 : 5500 MHz
<b>Frequency Range</b>	1 GHz ~ 40 GHz	<b>Detector Function &amp; Bandwidth</b>	PK: RB=1 MHz, VB=3 MHz, DET=Peak AV: RB=1 MHz, VB=10 Hz, DET=Peak
<b>Input Power</b>	120 Vac, 60 Hz	<b>Environmental Conditions</b>	24°C, 71% RH
<b>Tested By</b>	Louis Yang		

**Antenna Polarity & Test Distance : Horizontal at 3 m**

No	Frequency (MHz)	Emission Level (dBuV/m)	Limit (dBuV/m)	Margin (dB)	Antenna Height (m)	Table Angle (Degree)	Raw Value (dBuV)	Correction Factor (dB/m)
1	5460.00	55.1 PK	74.0	-18.9	1.88 H	96	52.2	2.9
2	5460.00	44.6 AV	54.0	-9.4	1.88 H	96	41.7	2.9
3	#5470.00	57.6 PK	68.2	-10.6	1.88 H	96	54.7	2.9
4	*5500.00	115.9 PK			1.88 H	96	113.0	2.9
5	*5500.00	106.2 AV			1.88 H	96	103.3	2.9
6	11000.00	56.2 PK	74.0	-17.8	1.34 H	219	42.4	13.8
7	11000.00	43.3 AV	54.0	-10.7	1.34 H	219	29.5	13.8
8	#16500.00	43.0 PK	68.2	-25.2	1.60 H	341	28.3	14.7

**Remarks:**

1. Emission Level(dBuV/m) = Raw Value(dBuV) + Correction Factor(dB/m)
2. Correction Factor(dB/m) = Antenna Factor(dB/m) + Cable Factor(dB) – Pre-Amplifier Factor(dB)
3. Margin value = Emission Level – Limit value
4. The other emission levels were very low against the limit.
5. " \* ": Fundamental frequency, the limit was restricted at the RF Output Power.
6. " # ": The radiated frequency is out of the restricted band.

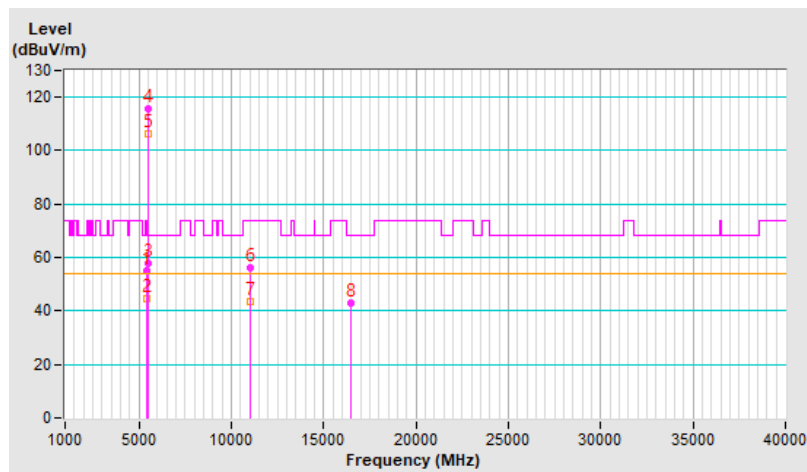



<b>RF Mode</b>	802.11ax (HE20)	<b>Channel</b>	CH 100 : 5500 MHz
<b>Frequency Range</b>	1 GHz ~ 40 GHz	<b>Detector Function &amp; Bandwidth</b>	PK: RB=1 MHz, VB=3 MHz, DET=Peak AV: RB=1 MHz, VB=10 Hz, DET=Peak
<b>Input Power</b>	120 Vac, 60 Hz	<b>Environmental Conditions</b>	24°C, 71% RH
<b>Tested By</b>	Louis Yang		

Antenna Polarity & Test Distance : Vertical at 3 m								
No	Frequency (MHz)	Emission Level (dBuV/m)	Limit (dBuV/m)	Margin (dB)	Antenna Height (m)	Table Angle (Degree)	Raw Value (dBuV)	Correction Factor (dB/m)
1	5460.00	60.1 PK	74.0	-13.9	1.62 V	114	57.2	2.9
2	5460.00	50.1 AV	54.0	-3.9	1.62 V	114	47.2	2.9
3	#5470.00	66.7 PK	68.2	-1.5	1.62 V	114	63.8	2.9
4	*5500.00	118.2 PK			1.62 V	114	115.3	2.9
5	*5500.00	107.3 AV			1.62 V	114	104.4	2.9
6	11000.00	55.9 PK	74.0	-18.1	1.35 V	222	42.1	13.8
7	11000.00	43.0 AV	54.0	-11.0	1.35 V	222	29.2	13.8
8	#16500.00	42.9 PK	68.2	-25.3	1.61 V	345	28.2	14.7

**Remarks:**

1. Emission Level(dBuV/m) = Raw Value(dBuV) + Correction Factor(dB/m)
2. Correction Factor(dB/m) = Antenna Factor(dB/m) + Cable Factor(dB) – Pre-Amplifier Factor(dB)
3. Margin value = Emission Level – Limit value
4. The other emission levels were very low against the limit.
5. " \* ": Fundamental frequency, the limit was restricted at the RF Output Power.
6. " # ": The radiated frequency is out of the restricted band.

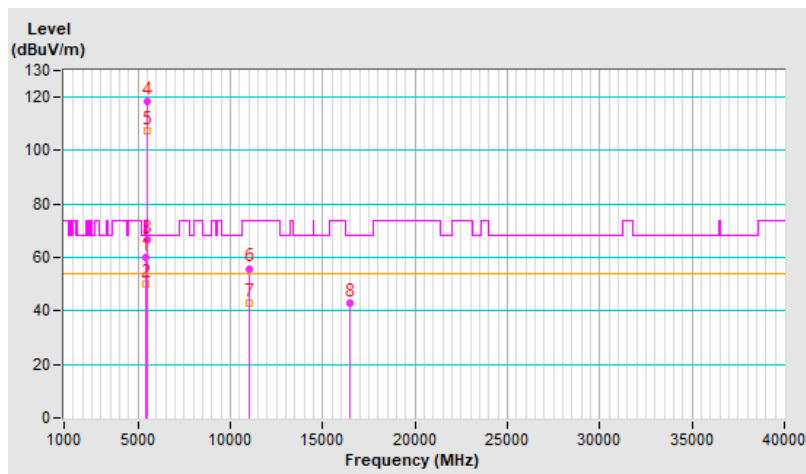

<b>RF Mode</b>	802.11ax (HE20)	<b>Channel</b>	CH 116 : 5580 MHz
<b>Frequency Range</b>	1 GHz ~ 40 GHz	<b>Detector Function &amp; Bandwidth</b>	PK: RB=1 MHz, VB=3 MHz, DET=Peak AV: RB=1 MHz, VB=10 Hz, DET=Peak
<b>Input Power</b>	120 Vac, 60 Hz	<b>Environmental Conditions</b>	24°C, 71% RH
<b>Tested By</b>	Louis Yang		

**Antenna Polarity & Test Distance : Horizontal at 3 m**

No	Frequency (MHz)	Emission Level (dBuV/m)	Limit (dBuV/m)	Margin (dB)	Antenna Height (m)	Table Angle (Degree)	Raw Value (dBuV)	Correction Factor (dB/m)
1	5460.00	63.1 PK	74.0	-10.9	1.85 H	92	60.2	2.9
2	5460.00	46.4 AV	54.0	-7.6	1.85 H	92	43.5	2.9
3	#5470.00	65.7 PK	68.2	-2.5	1.85 H	92	62.8	2.9
4	*5580.00	118.3 PK			1.85 H	92	115.6	2.7
5	*5580.00	88.9 AV			1.85 H	92	86.2	2.7
6	11160.00	57.6 PK	74.0	-16.4	1.70 H	182	44.4	13.2
7	11160.00	45.1 AV	54.0	-8.9	1.70 H	182	31.9	13.2
8	#16740.00	46.2 PK	68.2	-22.0	1.44 H	348	30.3	15.9

**Remarks:**

1. Emission Level(dBuV/m) = Raw Value(dBuV) + Correction Factor(dB/m)
2. Correction Factor(dB/m) = Antenna Factor(dB/m) + Cable Factor(dB) – Pre-Amplifier Factor(dB)
3. Margin value = Emission Level – Limit value
4. The other emission levels were very low against the limit.
5. " \* ": Fundamental frequency, the limit was restricted at the RF Output Power.
6. " # ": The radiated frequency is out of the restricted band.

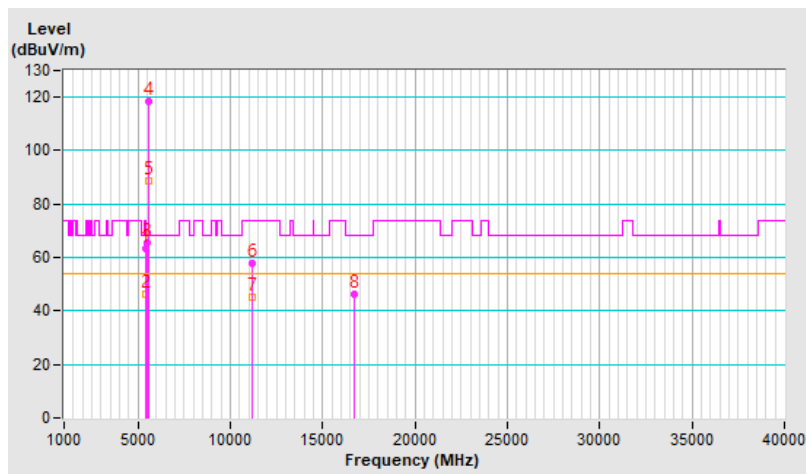

<b>RF Mode</b>	802.11ax (HE20)	<b>Channel</b>	CH 116 : 5580 MHz
<b>Frequency Range</b>	1 GHz ~ 40 GHz	<b>Detector Function &amp; Bandwidth</b>	PK: RB=1 MHz, VB=3 MHz, DET=Peak AV: RB=1 MHz, VB=10 Hz, DET=Peak
<b>Input Power</b>	120 Vac, 60 Hz	<b>Environmental Conditions</b>	24°C, 71% RH
<b>Tested By</b>	Louis Yang		

**Antenna Polarity & Test Distance : Vertical at 3 m**

No	Frequency (MHz)	Emission Level (dBuV/m)	Limit (dBuV/m)	Margin (dB)	Antenna Height (m)	Table Angle (Degree)	Raw Value (dBuV)	Correction Factor (dB/m)
1	5460.00	65.5 PK	74.0	-8.5	1.08 V	81	62.6	2.9
2	5460.00	48.8 AV	54.0	-5.2	1.08 V	81	45.9	2.9
3	#5470.00	67.2 PK	68.2	-1.0	1.08 V	81	64.3	2.9
4	*5580.00	120.6 PK			1.08 V	81	117.9	2.7
5	*5580.00	91.5 AV			1.08 V	81	88.8	2.7
6	11160.00	57.7 PK	74.0	-16.3	1.64 V	194	44.5	13.2
7	11160.00	45.0 AV	54.0	-9.0	1.64 V	194	31.8	13.2
8	#16740.00	47.0 PK	68.2	-21.2	1.49 V	349	31.1	15.9

**Remarks:**

1. Emission Level(dBuV/m) = Raw Value(dBuV) + Correction Factor(dB/m)
2. Correction Factor(dB/m) = Antenna Factor(dB/m) + Cable Factor(dB) – Pre-Amplifier Factor(dB)
3. Margin value = Emission Level – Limit value
4. The other emission levels were very low against the limit.
5. " \* ": Fundamental frequency, the limit was restricted at the RF Output Power.
6. " # ": The radiated frequency is out of the restricted band.

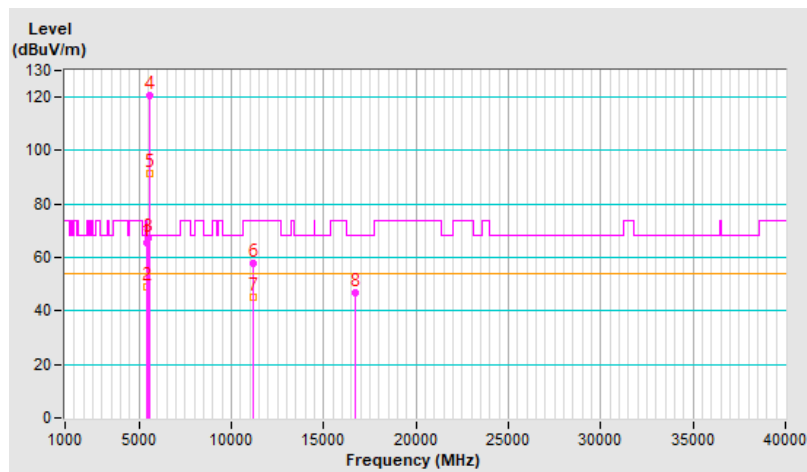

<b>RF Mode</b>	802.11ax (HE20)	<b>Channel</b>	CH 140 : 5700 MHz
<b>Frequency Range</b>	1 GHz ~ 40 GHz	<b>Detector Function &amp; Bandwidth</b>	PK: RB=1 MHz, VB=3 MHz, DET=Peak AV: RB=1 MHz, VB=10 Hz, DET=Peak
<b>Input Power</b>	120 Vac, 60 Hz	<b>Environmental Conditions</b>	24°C, 71% RH
<b>Tested By</b>	Louis Yang		

**Antenna Polarity & Test Distance : Horizontal at 3 m**

No	Frequency (MHz)	Emission Level (dBuV/m)	Limit (dBuV/m)	Margin (dB)	Antenna Height (m)	Table Angle (Degree)	Raw Value (dBuV)	Correction Factor (dB/m)
1	*5700.00	113.4 PK			1.90 H	107	110.5	2.9
2	*5700.00	103.9 AV			1.90 H	107	101.0	2.9
3	#5725.00	65.7 PK	68.2	-2.5	1.90 H	107	62.8	2.9
4	11400.00	55.6 PK	74.0	-18.4	1.47 H	206	42.3	13.3
5	11400.00	42.9 AV	54.0	-11.1	1.47 H	206	29.6	13.3
6	#17100.00	42.7 PK	68.2	-25.5	1.58 H	321	26.3	16.4

**Remarks:**

1. Emission Level(dBuV/m) = Raw Value(dBuV) + Correction Factor(dB/m)
2. Correction Factor(dB/m) = Antenna Factor(dB/m) + Cable Factor(dB) – Pre-Amplifier Factor(dB)
3. Margin value = Emission Level – Limit value
4. The other emission levels were very low against the limit.
5. " \* " : Fundamental frequency, the limit was restricted at the RF Output Power.
6. " # " : The radiated frequency is out of the restricted band.

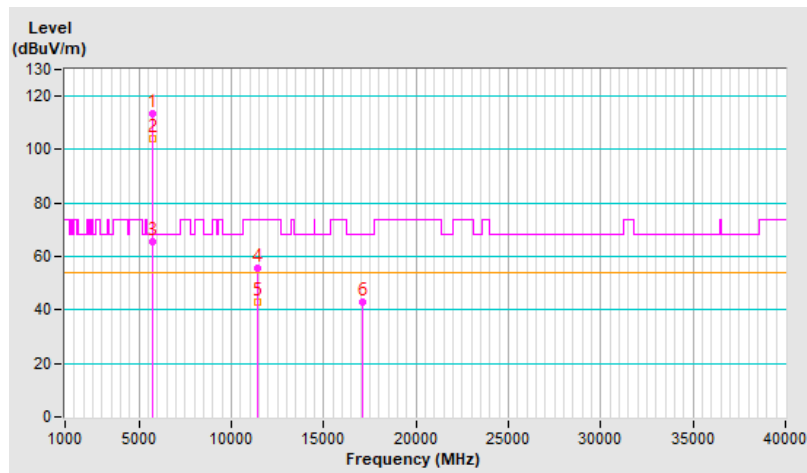

<b>RF Mode</b>	802.11ax (HE20)	<b>Channel</b>	CH 140 : 5700 MHz
<b>Frequency Range</b>	1 GHz ~ 40 GHz	<b>Detector Function &amp; Bandwidth</b>	PK: RB=1 MHz, VB=3 MHz, DET=Peak AV: RB=1 MHz, VB=10 Hz, DET=Peak
<b>Input Power</b>	120 Vac, 60 Hz	<b>Environmental Conditions</b>	24°C, 71% RH
<b>Tested By</b>	Louis Yang		

**Antenna Polarity & Test Distance : Vertical at 3 m**

No	Frequency (MHz)	Emission Level (dBuV/m)	Limit (dBuV/m)	Margin (dB)	Antenna Height (m)	Table Angle (Degree)	Raw Value (dBuV)	Correction Factor (dB/m)
1	*5700.00	115.8 PK			1.72 V	91	112.9	2.9
2	*5700.00	105.7 AV			1.72 V	91	102.8	2.9
3	#5725.00	66.9 PK	68.2	-1.3	1.72 V	91	64.0	2.9
4	11400.00	55.3 PK	74.0	-18.7	1.43 V	207	42.0	13.3
5	11400.00	42.6 AV	54.0	-11.4	1.43 V	207	29.3	13.3
6	#17100.00	42.7 PK	68.2	-25.5	1.58 V	335	26.3	16.4

**Remarks:**

1. Emission Level(dBuV/m) = Raw Value(dBuV) + Correction Factor(dB/m)
2. Correction Factor(dB/m) = Antenna Factor(dB/m) + Cable Factor(dB) – Pre-Amplifier Factor(dB)
3. Margin value = Emission Level – Limit value
4. The other emission levels were very low against the limit.
5. " \* " : Fundamental frequency, the limit was restricted at the RF Output Power.
6. " # " : The radiated frequency is out of the restricted band.

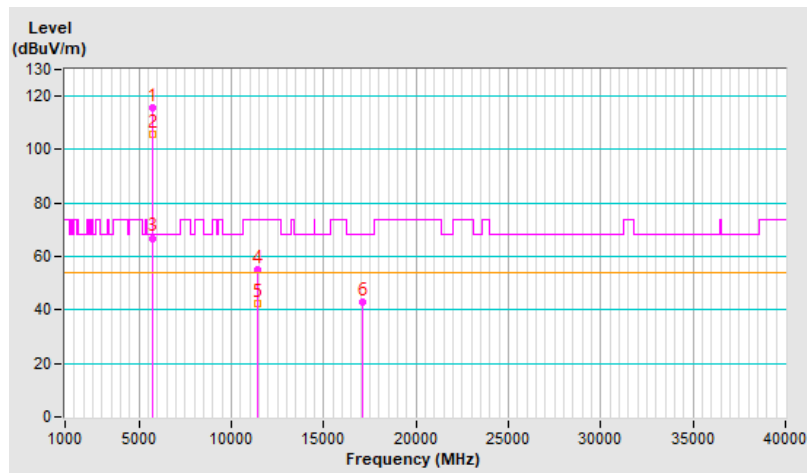

<b>RF Mode</b>	802.11ax (HE20)	<b>Channel</b>	CH 144 : 5720 MHz
<b>Frequency Range</b>	1 GHz ~ 40 GHz	<b>Detector Function &amp; Bandwidth</b>	PK: RB=1 MHz, VB=3 MHz, DET=Peak AV: RB=1 MHz, VB=10 Hz, DET=Peak
<b>Input Power</b>	120 Vac, 60 Hz	<b>Environmental Conditions</b>	24°C, 71% RH
<b>Tested By</b>	Louis Yang		

**Antenna Polarity & Test Distance : Horizontal at 3 m**

No	Frequency (MHz)	Emission Level (dBuV/m)	Limit (dBuV/m)	Margin (dB)	Antenna Height (m)	Table Angle (Degree)	Raw Value (dBuV)	Correction Factor (dB/m)
1	5460.00	48.2 PK	74.0	-25.8	1.86 H	88	45.3	2.9
2	5460.00	39.6 AV	54.0	-14.4	1.86 H	88	36.7	2.9
3	#5470.00	46.7 PK	68.2	-21.5	1.86 H	88	43.8	2.9
4	*5720.00	116.5 PK			1.86 H	88	113.6	2.9
5	*5720.00	107.5 AV			1.86 H	88	104.6	2.9
6	#5850.00	64.3 PK	68.2	-3.9	1.86 H	88	61.0	3.3
7	11440.00	57.1 PK	74.0	-16.9	1.67 H	199	43.9	13.2
8	11440.00	44.8 AV	54.0	-9.2	1.67 H	199	31.6	13.2
9	#17160.00	47.3 PK	68.2	-20.9	1.50 H	360	30.5	16.8

**Remarks:**

1. Emission Level(dBuV/m) = Raw Value(dBuV) + Correction Factor(dB/m)
2. Correction Factor(dB/m) = Antenna Factor(dB/m) + Cable Factor(dB) – Pre-Amplifier Factor(dB)
3. Margin value = Emission Level – Limit value
4. The other emission levels were very low against the limit.
5. " \* " : Fundamental frequency, the limit was restricted at the RF Output Power.
6. " # " : The radiated frequency is out of the restricted band.

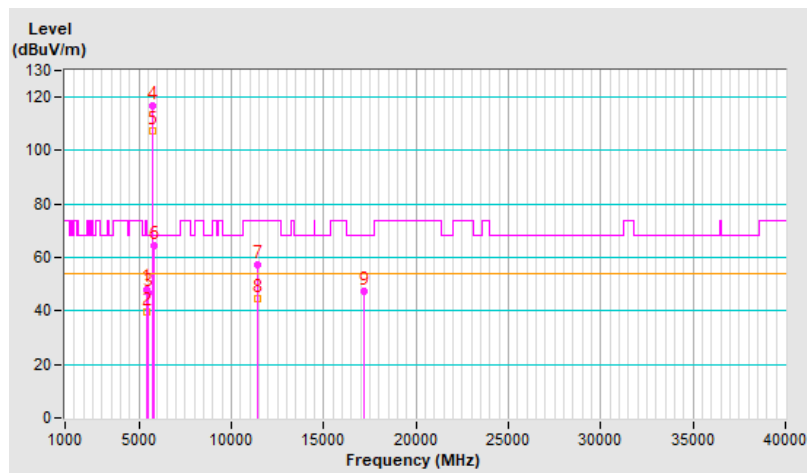

<b>RF Mode</b>	802.11ax (HE20)	<b>Channel</b>	CH 144 : 5720 MHz
<b>Frequency Range</b>	1 GHz ~ 40 GHz	<b>Detector Function &amp; Bandwidth</b>	PK: RB=1 MHz, VB=3 MHz, DET=Peak AV: RB=1 MHz, VB=10 Hz, DET=Peak
<b>Input Power</b>	120 Vac, 60 Hz	<b>Environmental Conditions</b>	24°C, 71% RH
<b>Tested By</b>	Louis Yang		

Antenna Polarity & Test Distance : Vertical at 3 m								
No	Frequency (MHz)	Emission Level (dBuV/m)	Limit (dBuV/m)	Margin (dB)	Antenna Height (m)	Table Angle (Degree)	Raw Value (dBuV)	Correction Factor (dB/m)
1	5460.00	50.1 PK	74.0	-23.9	2.07 V	244	47.2	2.9
2	5460.00	41.6 AV	54.0	-12.4	2.07 V	244	38.7	2.9
3	#5470.00	48.8 PK	68.2	-19.4	2.07 V	244	45.9	2.9
4	*5720.00	118.9 PK			2.07 V	244	116.0	2.9
5	*5720.00	110.2 AV			2.07 V	244	107.3	2.9
6	#5850.00	66.7 PK	68.2	-1.5	2.07 V	244	63.4	3.3
7	11440.00	57.3 PK	74.0	-16.7	1.59 V	175	44.1	13.2
8	11440.00	44.8 AV	54.0	-9.2	1.59 V	175	31.6	13.2
9	#17160.00	47.8 PK	68.2	-20.4	1.53 V	348	31.0	16.8

**Remarks:**

1. Emission Level(dBuV/m) = Raw Value(dBuV) + Correction Factor(dB/m)
2. Correction Factor(dB/m) = Antenna Factor(dB/m) + Cable Factor(dB) – Pre-Amplifier Factor(dB)
3. Margin value = Emission Level – Limit value
4. The other emission levels were very low against the limit.
5. " \* ": Fundamental frequency, the limit was restricted at the RF Output Power.
6. " # ": The radiated frequency is out of the restricted band.

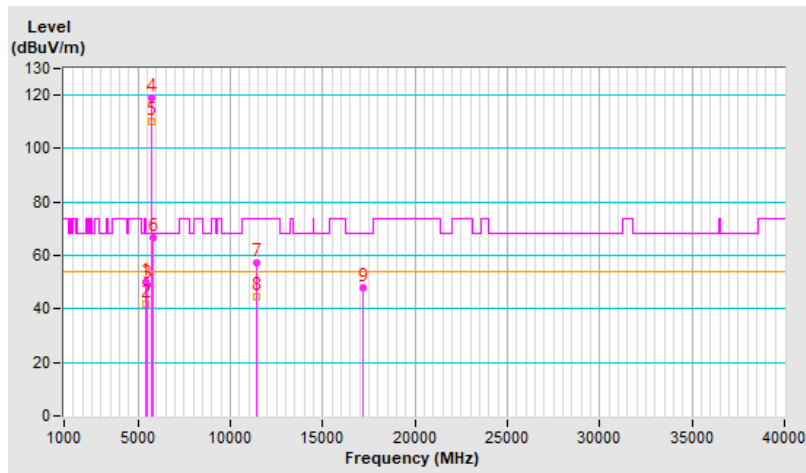

<b>RF Mode</b>	802.11ax (HE20)	<b>Channel</b>	CH 149 : 5745 MHz
<b>Frequency Range</b>	1 GHz ~ 40 GHz	<b>Detector Function &amp; Bandwidth</b>	PK: RB=1 MHz, VB=3 MHz, DET=Peak AV: RB=1 MHz, VB=10 Hz, DET=Peak
<b>Input Power</b>	120 Vac, 60 Hz	<b>Environmental Conditions</b>	24°C, 71% RH
<b>Tested By</b>	Louis Yang		

Antenna Polarity & Test Distance : Horizontal at 3 m								
No	Frequency (MHz)	Emission Level (dBuV/m)	Limit (dBuV/m)	Margin (dB)	Antenna Height (m)	Table Angle (Degree)	Raw Value (dBuV)	Correction Factor (dB/m)
1	#5644.72	66.7 PK	68.2	-1.5	1.85 H	97	64.0	2.7
2	*5745.00	119.8 PK			1.85 H	97	116.8	3.0
3	*5745.00	108.7 AV			1.85 H	97	105.7	3.0
4	#5927.76	52.1 PK	68.2	-16.1	1.85 H	97	48.9	3.2
5	11490.00	57.6 PK	74.0	-16.4	1.62 H	215	44.6	13.0
6	11490.00	45.1 AV	54.0	-8.9	1.62 H	215	32.1	13.0
7	#17235.00	46.8 PK	68.2	-21.4	1.49 H	360	29.5	17.3

**Remarks:**

1. Emission Level(dBuV/m) = Raw Value(dBuV) + Correction Factor(dB/m)
2. Correction Factor(dB/m) = Antenna Factor(dB/m) + Cable Factor(dB) – Pre-Amplifier Factor(dB)
3. Margin value = Emission Level – Limit value
4. The other emission levels were very low against the limit.
5. " \* " : Fundamental frequency, the limit was restricted at the RF Output Power.
6. " # " : The radiated frequency is out of the restricted band.

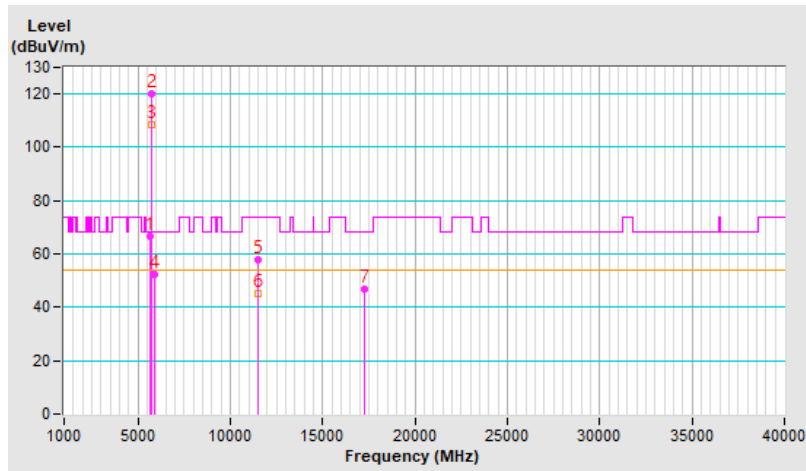



<b>RF Mode</b>	802.11ax (HE20)	<b>Channel</b>	CH 149 : 5745 MHz
<b>Frequency Range</b>	1 GHz ~ 40 GHz	<b>Detector Function &amp; Bandwidth</b>	PK: RB=1 MHz, VB=3 MHz, DET=Peak AV: RB=1 MHz, VB=10 Hz, DET=Peak
<b>Input Power</b>	120 Vac, 60 Hz	<b>Environmental Conditions</b>	24°C, 71% RH
<b>Tested By</b>	Louis Yang		

Antenna Polarity & Test Distance : Vertical at 3 m								
No	Frequency (MHz)	Emission Level (dBuV/m)	Limit (dBuV/m)	Margin (dB)	Antenna Height (m)	Table Angle (Degree)	Raw Value (dBuV)	Correction Factor (dB/m)
1	#5641.08	67.2 PK	68.2	-1.0	1.83 V	97	64.5	2.7
2	*5745.00	121.7 PK			1.83 V	97	118.7	3.0
3	*5745.00	110.6 AV			1.83 V	97	107.6	3.0
4	#5925.30	54.1 PK	68.2	-14.1	1.83 V	97	50.9	3.2
5	11490.00	57.6 PK	74.0	-16.4	1.57 V	190	44.6	13.0
6	11490.00	45.0 AV	54.0	-9.0	1.57 V	190	32.0	13.0
7	#17235.00	47.7 PK	68.2	-20.5	1.53 V	356	30.4	17.3

**Remarks:**

1. Emission Level(dBuV/m) = Raw Value(dBuV) + Correction Factor(dB/m)
2. Correction Factor(dB/m) = Antenna Factor(dB/m) + Cable Factor(dB) – Pre-Amplifier Factor(dB)
3. Margin value = Emission Level – Limit value
4. The other emission levels were very low against the limit.
5. " \* " : Fundamental frequency, the limit was restricted at the RF Output Power.
6. " # " : The radiated frequency is out of the restricted band.

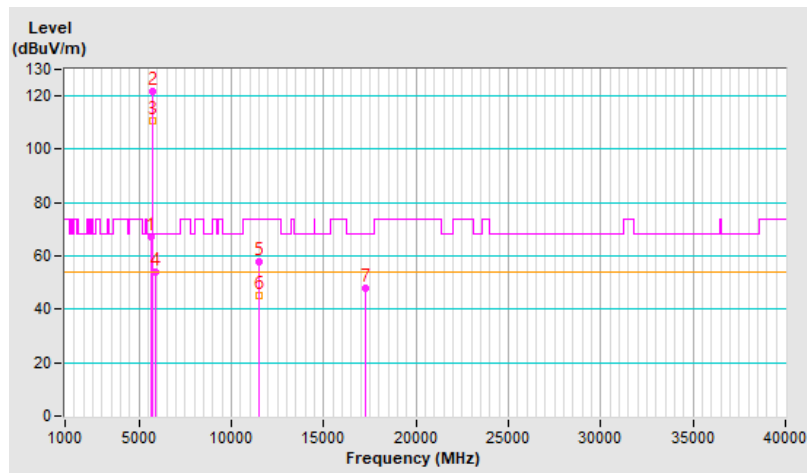

<b>RF Mode</b>	802.11ax (HE20)	<b>Channel</b>	CH 157 : 5785 MHz
<b>Frequency Range</b>	1 GHz ~ 40 GHz	<b>Detector Function &amp; Bandwidth</b>	PK: RB=1 MHz, VB=3 MHz, DET=Peak AV: RB=1 MHz, VB=10 Hz, DET=Peak
<b>Input Power</b>	120 Vac, 60 Hz	<b>Environmental Conditions</b>	24°C, 71% RH
<b>Tested By</b>	Louis Yang		

**Antenna Polarity & Test Distance : Horizontal at 3 m**

No	Frequency (MHz)	Emission Level (dBuV/m)	Limit (dBuV/m)	Margin (dB)	Antenna Height (m)	Table Angle (Degree)	Raw Value (dBuV)	Correction Factor (dB/m)
1	#5636.65	61.0 PK	68.2	-7.2	1.94 H	87	58.3	2.7
2	*5785.00	119.8 PK			1.94 H	87	116.6	3.2
3	*5785.00	108.3 AV			1.94 H	87	105.1	3.2
4	#5929.03	55.7 PK	68.2	-12.5	1.94 H	87	52.5	3.2
5	11570.00	57.1 PK	74.0	-16.9	1.64 H	206	43.9	13.2
6	11570.00	44.4 AV	54.0	-9.6	1.64 H	206	31.2	13.2
7	#17355.00	46.6 PK	68.2	-21.6	1.53 H	350	28.1	18.5

**Remarks:**

1. Emission Level(dBuV/m) = Raw Value(dBuV) + Correction Factor(dB/m)
2. Correction Factor(dB/m) = Antenna Factor(dB/m) + Cable Factor(dB) – Pre-Amplifier Factor(dB)
3. Margin value = Emission Level – Limit value
4. The other emission levels were very low against the limit.
5. " \* ": Fundamental frequency, the limit was restricted at the RF Output Power.
6. " # ": The radiated frequency is out of the restricted band.

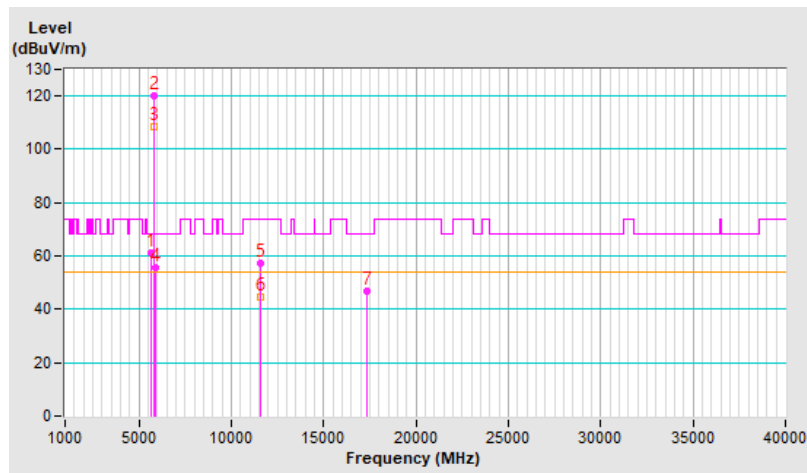

<b>RF Mode</b>	802.11ax (HE20)	<b>Channel</b>	CH 157 : 5785 MHz
<b>Frequency Range</b>	1 GHz ~ 40 GHz	<b>Detector Function &amp; Bandwidth</b>	PK: RB=1 MHz, VB=3 MHz, DET=Peak AV: RB=1 MHz, VB=10 Hz, DET=Peak
<b>Input Power</b>	120 Vac, 60 Hz	<b>Environmental Conditions</b>	24°C, 71% RH
<b>Tested By</b>	Louis Yang		

Antenna Polarity & Test Distance : Vertical at 3 m								
No	Frequency (MHz)	Emission Level (dBuV/m)	Limit (dBuV/m)	Margin (dB)	Antenna Height (m)	Table Angle (Degree)	Raw Value (dBuV)	Correction Factor (dB/m)
1	#5640.52	59.8 PK	68.2	-8.4	1.66 V	101	57.1	2.7
2	*5785.00	121.6 PK			1.66 V	101	118.4	3.2
3	*5785.00	111.5 AV			1.66 V	101	108.3	3.2
4	#5935.82	62.2 PK	68.2	-6.0	1.66 V	101	59.0	3.2
5	11570.00	57.3 PK	74.0	-16.7	1.64 V	208	44.1	13.2
6	11570.00	45.0 AV	54.0	-9.0	1.64 V	208	31.8	13.2
7	#17355.00	46.5 PK	68.2	-21.7	1.49 V	358	28.0	18.5

**Remarks:**

1. Emission Level(dBuV/m) = Raw Value(dBuV) + Correction Factor(dB/m)
2. Correction Factor(dB/m) = Antenna Factor(dB/m) + Cable Factor(dB) – Pre-Amplifier Factor(dB)
3. Margin value = Emission Level – Limit value
4. The other emission levels were very low against the limit.
5. " \* ": Fundamental frequency, the limit was restricted at the RF Output Power.
6. " # ": The radiated frequency is out of the restricted band.

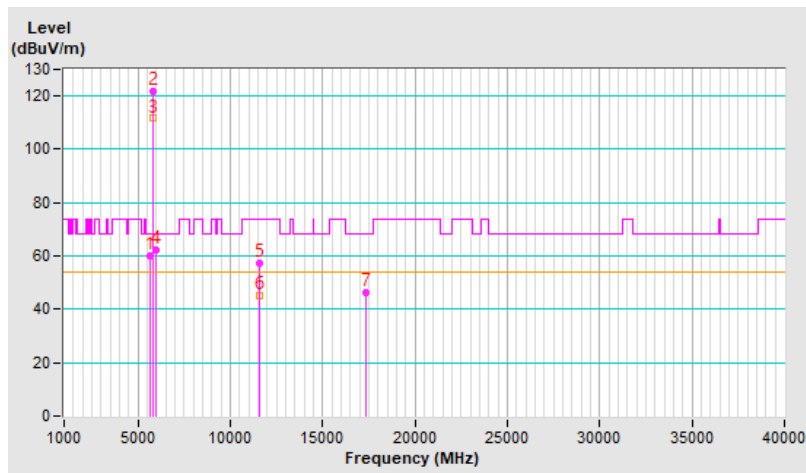

<b>RF Mode</b>	802.11ax (HE20)	<b>Channel</b>	CH 165 : 5825 MHz
<b>Frequency Range</b>	1 GHz ~ 40 GHz	<b>Detector Function &amp; Bandwidth</b>	PK: RB=1 MHz, VB=3 MHz, DET=Peak AV: RB=1 MHz, VB=10 Hz, DET=Peak
<b>Input Power</b>	120 Vac, 60 Hz	<b>Environmental Conditions</b>	24°C, 71% RH
<b>Tested By</b>	Louis Yang		

**Antenna Polarity & Test Distance : Horizontal at 3 m**

No	Frequency (MHz)	Emission Level (dBuV/m)	Limit (dBuV/m)	Margin (dB)	Antenna Height (m)	Table Angle (Degree)	Raw Value (dBuV)	Correction Factor (dB/m)
1	#5641.98	52.6 PK	68.2	-15.6	1.89 H	93	49.9	2.7
2	*5825.00	119.2 PK			1.89 H	93	115.9	3.3
3	*5825.00	107.2 AV			1.89 H	93	103.9	3.3
4	#5919.88	63.2 PK	68.2	-5.0	1.89 H	93	60.0	3.2
5	11650.00	57.0 PK	74.0	-17.0	1.62 H	201	43.9	13.1
6	11650.00	44.3 AV	54.0	-9.7	1.62 H	201	31.2	13.1
7	#17475.00	46.6 PK	68.2	-21.6	1.44 H	360	26.5	20.1

**Remarks:**

1. Emission Level(dBuV/m) = Raw Value(dBuV) + Correction Factor(dB/m)
2. Correction Factor(dB/m) = Antenna Factor(dB/m) + Cable Factor(dB) – Pre-Amplifier Factor(dB)
3. Margin value = Emission Level – Limit value
4. The other emission levels were very low against the limit.
5. " \* " : Fundamental frequency, the limit was restricted at the RF Output Power.
6. " # " : The radiated frequency is out of the restricted band.

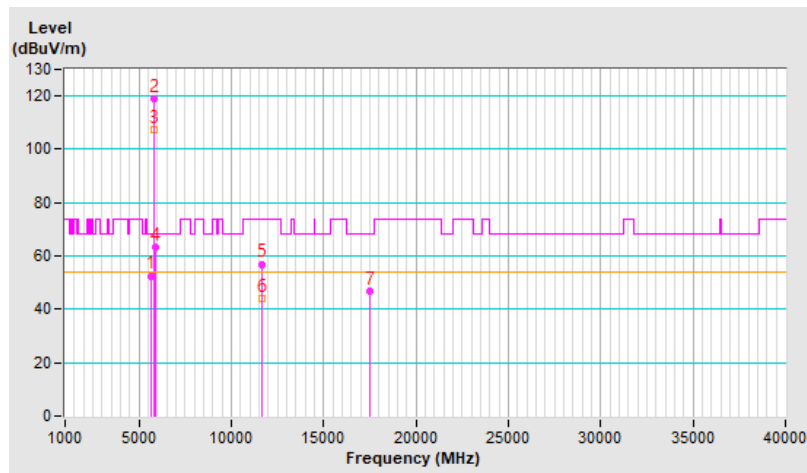

<b>RF Mode</b>	802.11ax (HE20)	<b>Channel</b>	CH 165 : 5825 MHz
<b>Frequency Range</b>	1 GHz ~ 40 GHz	<b>Detector Function &amp; Bandwidth</b>	PK: RB=1 MHz, VB=3 MHz, DET=Peak AV: RB=1 MHz, VB=10 Hz, DET=Peak
<b>Input Power</b>	120 Vac, 60 Hz	<b>Environmental Conditions</b>	24°C, 71% RH
<b>Tested By</b>	Louis Yang		

Antenna Polarity & Test Distance : Vertical at 3 m								
No	Frequency (MHz)	Emission Level (dBuV/m)	Limit (dBuV/m)	Margin (dB)	Antenna Height (m)	Table Angle (Degree)	Raw Value (dBuV)	Correction Factor (dB/m)
1	#5645.52	57.1 PK	68.2	-11.1	1.67 V	100	54.4	2.7
2	*5825.00	121.9 PK			1.67 V	100	118.6	3.3
3	*5825.00	111.1 AV			1.67 V	100	107.8	3.3
4	#5925.51	66.2 PK	68.2	-2.0	1.67 V	100	63.0	3.2
5	11650.00	57.0 PK	74.0	-17.0	1.67 V	202	43.9	13.1
6	11650.00	44.3 AV	54.0	-9.7	1.67 V	202	31.2	13.1
7	#17475.00	46.5 PK	68.2	-21.7	1.46 V	355	26.4	20.1

**Remarks:**

1. Emission Level(dBuV/m) = Raw Value(dBuV) + Correction Factor(dB/m)
2. Correction Factor(dB/m) = Antenna Factor(dB/m) + Cable Factor(dB) – Pre-Amplifier Factor(dB)
3. Margin value = Emission Level – Limit value
4. The other emission levels were very low against the limit.
5. " \* " : Fundamental frequency, the limit was restricted at the RF Output Power.
6. " # " : The radiated frequency is out of the restricted band.

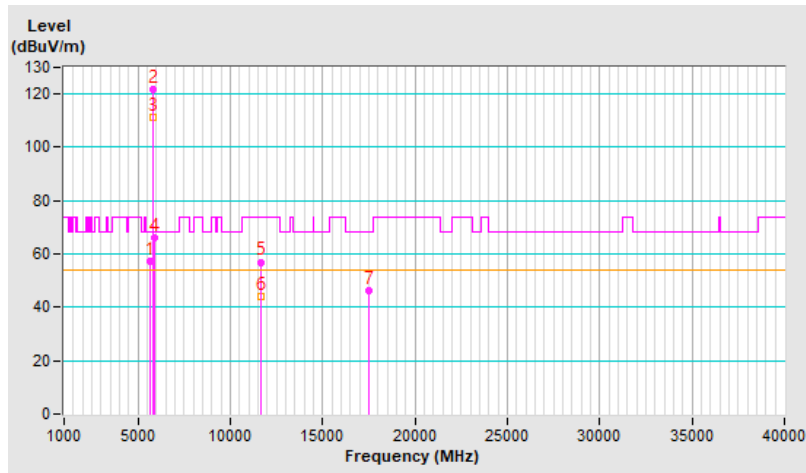

<b>RF Mode</b>	802.11ax (HE40)	<b>Channel</b>	CH 38 : 5190 MHz
<b>Frequency Range</b>	1 GHz ~ 40 GHz	<b>Detector Function &amp; Bandwidth</b>	PK: RB=1 MHz, VB=3 MHz, DET=Peak AV: RB=1 MHz, VB=10 Hz, DET=Peak
<b>Input Power</b>	120 Vac, 60 Hz	<b>Environmental Conditions</b>	24°C, 71% RH
<b>Tested By</b>	Louis Yang		

**Antenna Polarity & Test Distance : Horizontal at 3 m**

No	Frequency (MHz)	Emission Level (dBuV/m)	Limit (dBuV/m)	Margin (dB)	Antenna Height (m)	Table Angle (Degree)	Raw Value (dBuV)	Correction Factor (dB/m)
1	5150.00	62.2 PK	74.0	-11.8	1.93 H	105	58.8	3.4
2	5150.00	51.4 AV	54.0	-2.6	1.93 H	105	48.0	3.4
3	*5190.00	112.1 PK			1.93 H	105	109.1	3.0
4	*5190.00	101.0 AV			1.93 H	105	98.0	3.0
5	#10380.00	55.3 PK	68.2	-12.9	1.40 H	189	42.3	13.0
6	15570.00	41.6 PK	74.0	-32.4	1.55 H	351	30.6	11.0
7	15570.00	28.3 AV	54.0	-25.7	1.55 H	351	17.3	11.0

**Remarks:**

1. Emission Level(dBuV/m) = Raw Value(dBuV) + Correction Factor(dB/m)
2. Correction Factor(dB/m) = Antenna Factor(dB/m) + Cable Factor(dB) – Pre-Amplifier Factor(dB)
3. Margin value = Emission Level – Limit value
4. The other emission levels were very low against the limit.
5. " \* ": Fundamental frequency, the limit was restricted at the RF Output Power.
6. " # ": The radiated frequency is out of the restricted band.

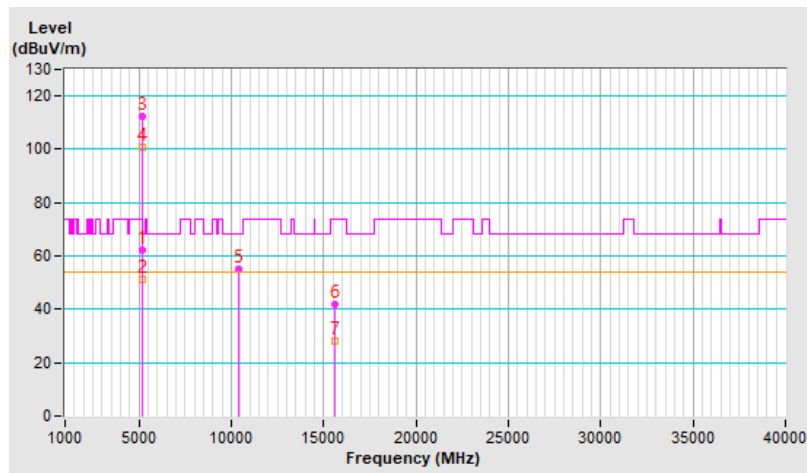

<b>RF Mode</b>	802.11ax (HE40)	<b>Channel</b>	CH 38 : 5190 MHz
<b>Frequency Range</b>	1 GHz ~ 40 GHz	<b>Detector Function &amp; Bandwidth</b>	PK: RB=1 MHz, VB=3 MHz, DET=Peak AV: RB=1 MHz, VB=10 Hz, DET=Peak
<b>Input Power</b>	120 Vac, 60 Hz	<b>Environmental Conditions</b>	24°C, 71% RH
<b>Tested By</b>	Louis Yang		

Antenna Polarity & Test Distance : Vertical at 3 m								
No	Frequency (MHz)	Emission Level (dBuV/m)	Limit (dBuV/m)	Margin (dB)	Antenna Height (m)	Table Angle (Degree)	Raw Value (dBuV)	Correction Factor (dB/m)
1	5150.00	61.4 PK	74.0	-12.6	1.42 V	85	58.0	3.4
2	5150.00	52.9 AV	54.0	-1.1	1.42 V	85	49.5	3.4
3	*5190.00	113.9 PK			1.42 V	85	110.9	3.0
4	*5190.00	103.6 AV			1.42 V	85	100.6	3.0
5	#10380.00	55.2 PK	68.2	-13.0	1.41 V	202	42.2	13.0
6	15570.00	41.8 PK	74.0	-32.2	1.57 V	339	30.8	11.0
7	15570.00	28.4 AV	54.0	-25.6	1.57 V	339	17.4	11.0

**Remarks:**

1. Emission Level(dBuV/m) = Raw Value(dBuV) + Correction Factor(dB/m)
2. Correction Factor(dB/m) = Antenna Factor(dB/m) + Cable Factor(dB) – Pre-Amplifier Factor(dB)
3. Margin value = Emission Level – Limit value
4. The other emission levels were very low against the limit.
5. " \* ": Fundamental frequency, the limit was restricted at the RF Output Power.
6. " # ": The radiated frequency is out of the restricted band.

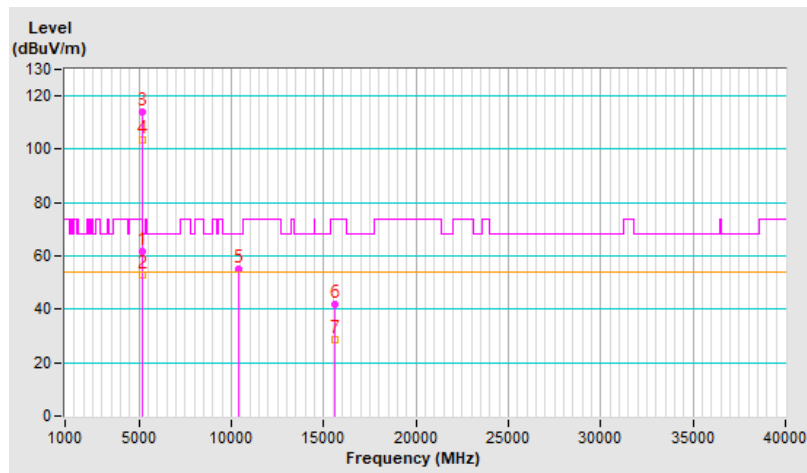

<b>RF Mode</b>	802.11ax (HE40)	<b>Channel</b>	CH 46 : 5230 MHz
<b>Frequency Range</b>	1 GHz ~ 40 GHz	<b>Detector Function &amp; Bandwidth</b>	PK: RB=1 MHz, VB=3 MHz, DET=Peak AV: RB=1 MHz, VB=10 Hz, DET=Peak
<b>Input Power</b>	120 Vac, 60 Hz	<b>Environmental Conditions</b>	24°C, 71% RH
<b>Tested By</b>	Louis Yang		

**Antenna Polarity & Test Distance : Horizontal at 3 m**

No	Frequency (MHz)	Emission Level (dBuV/m)	Limit (dBuV/m)	Margin (dB)	Antenna Height (m)	Table Angle (Degree)	Raw Value (dBuV)	Correction Factor (dB/m)
1	5150.00	63.4 PK	74.0	-10.6	1.88 H	115	60.0	3.4
2	5150.00	50.1 AV	54.0	-3.9	1.88 H	115	46.7	3.4
3	*5230.00	113.7 PK			1.88 H	115	110.9	2.8
4	*5230.00	103.6 AV			1.88 H	115	100.8	2.8
5	5350.00	54.6 PK	74.0	-19.4	1.88 H	115	51.8	2.8
6	5350.00	42.6 AV	54.0	-11.4	1.88 H	115	39.8	2.8
7	#10460.00	55.5 PK	68.2	-12.7	1.38 H	221	42.7	12.8
8	15690.00	42.9 PK	74.0	-31.1	1.45 H	337	31.7	11.2
9	15690.00	29.0 AV	54.0	-25.0	1.45 H	337	17.8	11.2

**Remarks:**

1. Emission Level(dBuV/m) = Raw Value(dBuV) + Correction Factor(dB/m)
2. Correction Factor(dB/m) = Antenna Factor(dB/m) + Cable Factor(dB) – Pre-Amplifier Factor(dB)
3. Margin value = Emission Level – Limit value
4. The other emission levels were very low against the limit.
5. " \* ": Fundamental frequency, the limit was restricted at the RF Output Power.
6. " # ": The radiated frequency is out of the restricted band.

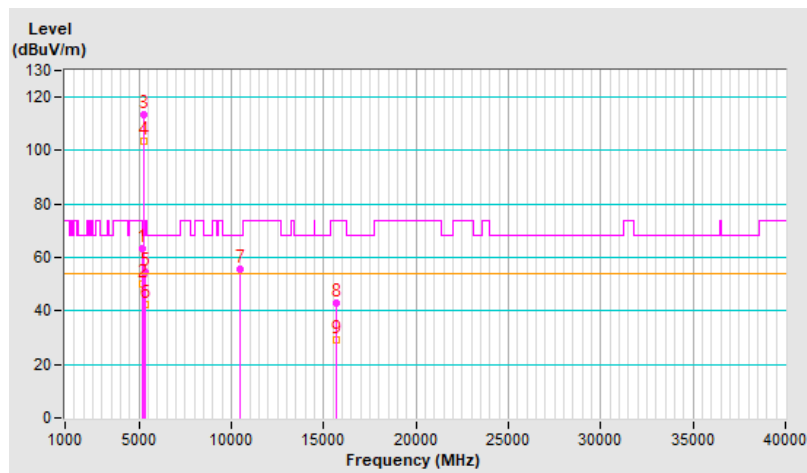



<b>RF Mode</b>	802.11ax (HE40)	<b>Channel</b>	CH 46 : 5230 MHz
<b>Frequency Range</b>	1 GHz ~ 40 GHz	<b>Detector Function &amp; Bandwidth</b>	PK: RB=1 MHz, VB=3 MHz, DET=Peak AV: RB=1 MHz, VB=10 Hz, DET=Peak
<b>Input Power</b>	120 Vac, 60 Hz	<b>Environmental Conditions</b>	24°C, 71% RH
<b>Tested By</b>	Louis Yang		

Antenna Polarity & Test Distance : Vertical at 3 m								
No	Frequency (MHz)	Emission Level (dBuV/m)	Limit (dBuV/m)	Margin (dB)	Antenna Height (m)	Table Angle (Degree)	Raw Value (dBuV)	Correction Factor (dB/m)
1	5150.00	64.9 PK	74.0	-9.1	1.06 V	88	61.5	3.4
2	5150.00	52.5 AV	54.0	-1.5	1.06 V	88	49.1	3.4
3	*5230.00	116.5 PK			1.06 V	88	113.7	2.8
4	*5230.00	105.5 AV			1.06 V	88	102.7	2.8
5	5350.00	57.4 PK	74.0	-16.6	1.06 V	88	54.6	2.8
6	5350.00	43.9 AV	54.0	-10.1	1.06 V	88	41.1	2.8
7	#10460.00	55.2 PK	68.2	-13.0	1.40 V	209	42.4	12.8
8	15690.00	42.9 PK	74.0	-31.1	1.50 V	331	31.7	11.2
9	15690.00	28.9 AV	54.0	-25.1	1.50 V	331	17.7	11.2

**Remarks:**

1. Emission Level(dBuV/m) = Raw Value(dBuV) + Correction Factor(dB/m)
2. Correction Factor(dB/m) = Antenna Factor(dB/m) + Cable Factor(dB) – Pre-Amplifier Factor(dB)
3. Margin value = Emission Level – Limit value
4. The other emission levels were very low against the limit.
5. " \* ": Fundamental frequency, the limit was restricted at the RF Output Power.
6. " # ": The radiated frequency is out of the restricted band.

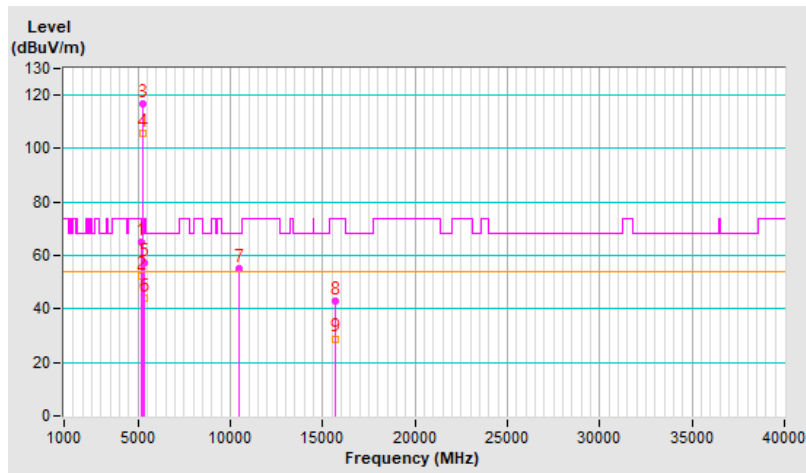

<b>RF Mode</b>	802.11ax (HE40)	<b>Channel</b>	CH 54 : 5270 MHz
<b>Frequency Range</b>	1 GHz ~ 40 GHz	<b>Detector Function &amp; Bandwidth</b>	PK: RB=1 MHz, VB=3 MHz, DET=Peak AV: RB=1 MHz, VB=10 Hz, DET=Peak
<b>Input Power</b>	120 Vac, 60 Hz	<b>Environmental Conditions</b>	24°C, 71% RH
<b>Tested By</b>	Louis Yang		

**Antenna Polarity & Test Distance : Horizontal at 3 m**

No	Frequency (MHz)	Emission Level (dBuV/m)	Limit (dBuV/m)	Margin (dB)	Antenna Height (m)	Table Angle (Degree)	Raw Value (dBuV)	Correction Factor (dB/m)
1	*5270.00	113.4 PK			1.87 H	124	110.8	2.6
2	*5270.00	103.5 AV			1.87 H	124	100.9	2.6
3	5350.00	64.8 PK	74.0	-9.2	1.87 H	124	62.0	2.8
4	5350.00	49.9 AV	54.0	-4.1	1.87 H	124	47.1	2.8
5	#10540.00	55.5 PK	68.2	-12.7	1.45 H	206	42.7	12.8
6	15810.00	42.8 PK	74.0	-31.2	1.53 H	354	30.9	11.9
7	15810.00	28.6 AV	54.0	-25.4	1.53 H	354	16.7	11.9

**Remarks:**

1. Emission Level(dBuV/m) = Raw Value(dBuV) + Correction Factor(dB/m)
2. Correction Factor(dB/m) = Antenna Factor(dB/m) + Cable Factor(dB) – Pre-Amplifier Factor(dB)
3. Margin value = Emission Level – Limit value
4. The other emission levels were very low against the limit.
5. " \* " : Fundamental frequency, the limit was restricted at the RF Output Power.
6. " # " : The radiated frequency is out of the restricted band.

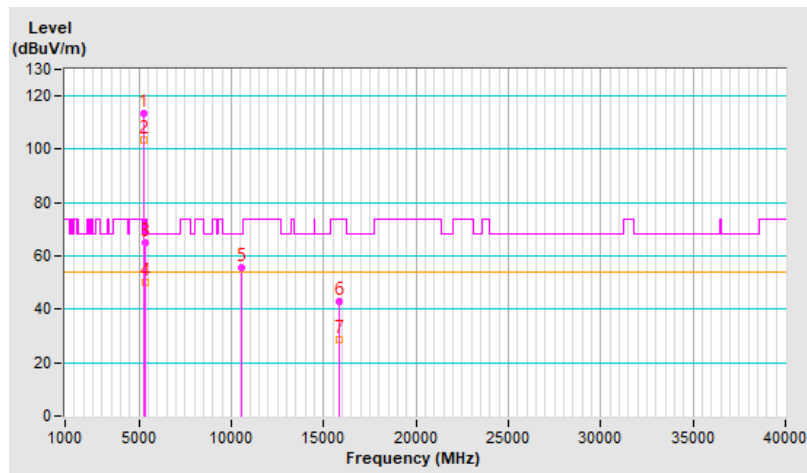

<b>RF Mode</b>	802.11ax (HE40)	<b>Channel</b>	CH 54 : 5270 MHz
<b>Frequency Range</b>	1 GHz ~ 40 GHz	<b>Detector Function &amp; Bandwidth</b>	PK: RB=1 MHz, VB=3 MHz, DET=Peak AV: RB=1 MHz, VB=10 Hz, DET=Peak
<b>Input Power</b>	120 Vac, 60 Hz	<b>Environmental Conditions</b>	24°C, 71% RH
<b>Tested By</b>	Louis Yang		

**Antenna Polarity & Test Distance : Vertical at 3 m**

No	Frequency (MHz)	Emission Level (dBuV/m)	Limit (dBuV/m)	Margin (dB)	Antenna Height (m)	Table Angle (Degree)	Raw Value (dBuV)	Correction Factor (dB/m)
1	*5270.00	115.3 PK			1.09 V	81	112.7	2.6
2	*5270.00	105.4 AV			1.09 V	81	102.8	2.6
3	5350.00	67.6 PK	74.0	-6.4	1.09 V	81	64.8	2.8
4	5350.00	52.6 AV	54.0	-1.4	1.09 V	81	49.8	2.8
5	#10540.00	55.5 PK	68.2	-12.7	1.43 V	196	42.7	12.8
6	15810.00	42.5 PK	74.0	-31.5	1.58 V	343	30.6	11.9
7	15810.00	28.5 AV	54.0	-25.5	1.58 V	343	16.6	11.9

**Remarks:**

1. Emission Level(dBuV/m) = Raw Value(dBuV) + Correction Factor(dB/m)
2. Correction Factor(dB/m) = Antenna Factor(dB/m) + Cable Factor(dB) – Pre-Amplifier Factor(dB)
3. Margin value = Emission Level – Limit value
4. The other emission levels were very low against the limit.
5. " \* " : Fundamental frequency, the limit was restricted at the RF Output Power.
6. " # " : The radiated frequency is out of the restricted band.

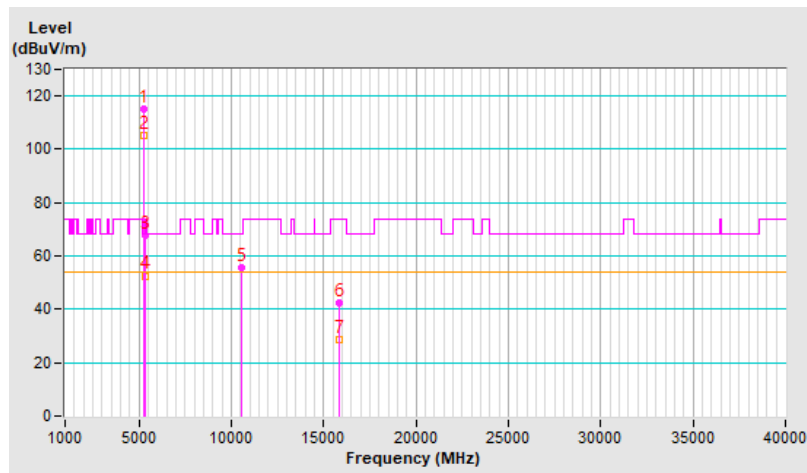

<b>RF Mode</b>	802.11ax (HE40)	<b>Channel</b>	CH 62 : 5310 MHz
<b>Frequency Range</b>	1 GHz ~ 40 GHz	<b>Detector Function &amp; Bandwidth</b>	PK: RB=1 MHz, VB=3 MHz, DET=Peak AV: RB=1 MHz, VB=10 Hz, DET=Peak
<b>Input Power</b>	120 Vac, 60 Hz	<b>Environmental Conditions</b>	24°C, 71% RH
<b>Tested By</b>	Louis Yang		

**Antenna Polarity & Test Distance : Horizontal at 3 m**

No	Frequency (MHz)	Emission Level (dBuV/m)	Limit (dBuV/m)	Margin (dB)	Antenna Height (m)	Table Angle (Degree)	Raw Value (dBuV)	Correction Factor (dB/m)
1	5150.00	53.9 PK	74.0	-20.1	1.87 H	94	50.5	3.4
2	5150.00	41.0 AV	54.0	-13.0	1.87 H	94	37.6	3.4
3	*5310.00	115.8 PK			1.87 H	94	113.2	2.6
4	*5310.00	103.9 AV			1.87 H	94	101.3	2.6
5	5350.00	68.4 PK	74.0	-5.6	1.87 H	94	65.6	2.8
6	5350.00	53.0 AV	54.0	-1.0	1.87 H	94	50.2	2.8
7	10620.00	55.0 PK	74.0	-19.0	1.39 H	221	41.9	13.1
8	10620.00	42.3 AV	54.0	-11.7	1.39 H	221	29.2	13.1
9	15930.00	41.7 PK	74.0	-32.3	1.55 H	335	29.4	12.3
10	15930.00	28.4 AV	54.0	-25.6	1.55 H	335	16.1	12.3

**Remarks:**

1. Emission Level(dBuV/m) = Raw Value(dBuV) + Correction Factor(dB/m)
2. Correction Factor(dB/m) = Antenna Factor(dB/m) + Cable Factor(dB) – Pre-Amplifier Factor(dB)
3. Margin value = Emission Level – Limit value
4. The other emission levels were very low against the limit.
5. " \* ": Fundamental frequency, the limit was restricted at the RF Output Power.

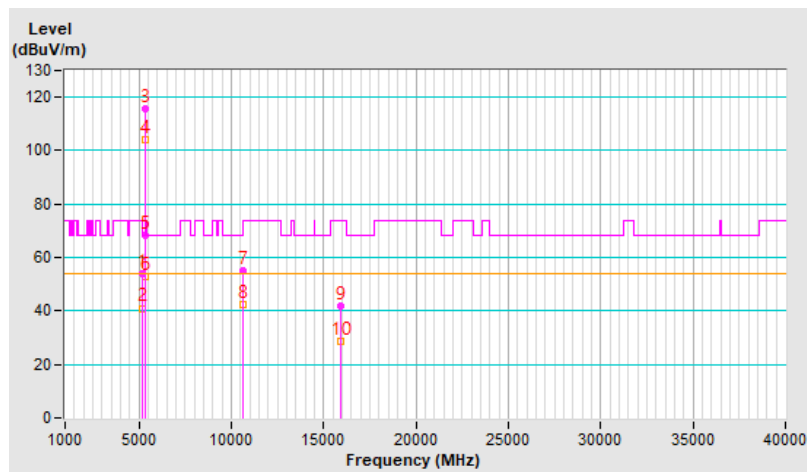

<b>RF Mode</b>	802.11ax (HE40)	<b>Channel</b>	CH 62 : 5310 MHz
<b>Frequency Range</b>	1 GHz ~ 40 GHz	<b>Detector Function &amp; Bandwidth</b>	PK: RB=1 MHz, VB=3 MHz, DET=Peak AV: RB=1 MHz, VB=10 Hz, DET=Peak
<b>Input Power</b>	120 Vac, 60 Hz	<b>Environmental Conditions</b>	24°C, 71% RH
<b>Tested By</b>	Louis Yang		

Antenna Polarity & Test Distance : Vertical at 3 m								
No	Frequency (MHz)	Emission Level (dBuV/m)	Limit (dBuV/m)	Margin (dB)	Antenna Height (m)	Table Angle (Degree)	Raw Value (dBuV)	Correction Factor (dB/m)
1	5150.00	65.8 PK	74.0	-8.2	1.06 V	89	62.4	3.4
2	5150.00	52.5 AV	54.0	-1.5	1.06 V	89	49.1	3.4
3	*5310.00	114.2 PK			1.06 V	89	111.6	2.6
4	*5310.00	104.6 AV			1.06 V	89	102.0	2.6
5	5350.00	65.8 PK	74.0	-8.2	1.06 V	89	63.0	2.8
6	5350.00	52.5 AV	54.0	-1.5	1.06 V	89	49.7	2.8
7	10620.00	55.1 PK	74.0	-18.9	1.39 V	213	42.0	13.1
8	10620.00	42.3 AV	54.0	-11.7	1.39 V	213	29.2	13.1
9	15930.00	42.4 PK	74.0	-31.6	1.55 V	342	30.1	12.3
10	15930.00	28.9 AV	54.0	-25.1	1.55 V	342	16.6	12.3

**Remarks:**

1. Emission Level(dBuV/m) = Raw Value(dBuV) + Correction Factor(dB/m)
2. Correction Factor(dB/m) = Antenna Factor(dB/m) + Cable Factor(dB) – Pre-Amplifier Factor(dB)
3. Margin value = Emission Level – Limit value
4. The other emission levels were very low against the limit.
5. " \* ": Fundamental frequency, the limit was restricted at the RF Output Power.

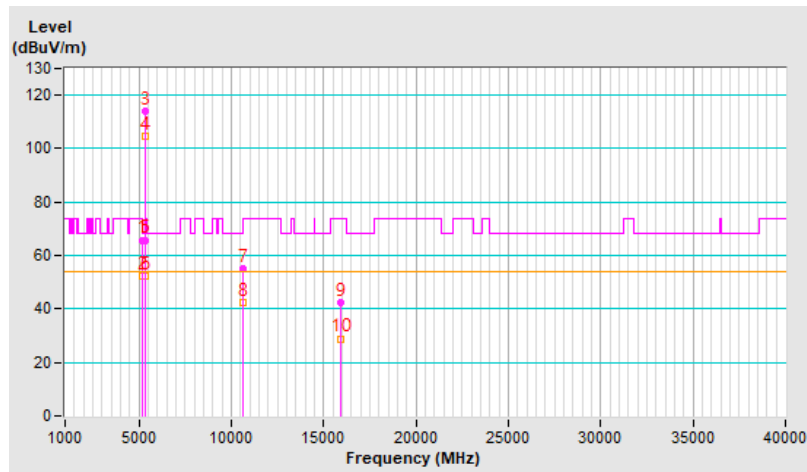

<b>RF Mode</b>	802.11ax (HE40)	<b>Channel</b>	CH 102 : 5510 MHz
<b>Frequency Range</b>	1 GHz ~ 40 GHz	<b>Detector Function &amp; Bandwidth</b>	PK: RB=1 MHz, VB=3 MHz, DET=Peak AV: RB=1 MHz, VB=10 Hz, DET=Peak
<b>Input Power</b>	120 Vac, 60 Hz	<b>Environmental Conditions</b>	24°C, 71% RH
<b>Tested By</b>	Louis Yang		

**Antenna Polarity & Test Distance : Horizontal at 3 m**

No	Frequency (MHz)	Emission Level (dBuV/m)	Limit (dBuV/m)	Margin (dB)	Antenna Height (m)	Table Angle (Degree)	Raw Value (dBuV)	Correction Factor (dB/m)
1	5460.00	58.1 PK	74.0	-15.9	1.77 H	93	55.2	2.9
2	5460.00	49.1 AV	54.0	-4.9	1.77 H	93	46.2	2.9
3	#5470.00	65.8 PK	68.2	-2.4	1.77 H	93	62.9	2.9
4	*5510.00	113.2 PK			1.77 H	93	110.3	2.9
5	*5510.00	104.7 AV			1.77 H	93	101.8	2.9
6	11020.00	56.0 PK	74.0	-18.0	1.50 H	220	42.2	13.8
7	11020.00	42.7 AV	54.0	-11.3	1.50 H	220	28.9	13.8
8	#16530.00	41.5 PK	68.2	-26.7	1.58 H	337	26.8	14.7

**Remarks:**

1. Emission Level(dBuV/m) = Raw Value(dBuV) + Correction Factor(dB/m)
2. Correction Factor(dB/m) = Antenna Factor(dB/m) + Cable Factor(dB) – Pre-Amplifier Factor(dB)
3. Margin value = Emission Level – Limit value
4. The other emission levels were very low against the limit.
5. " \* ": Fundamental frequency, the limit was restricted at the RF Output Power.
6. " # ": The radiated frequency is out of the restricted band.

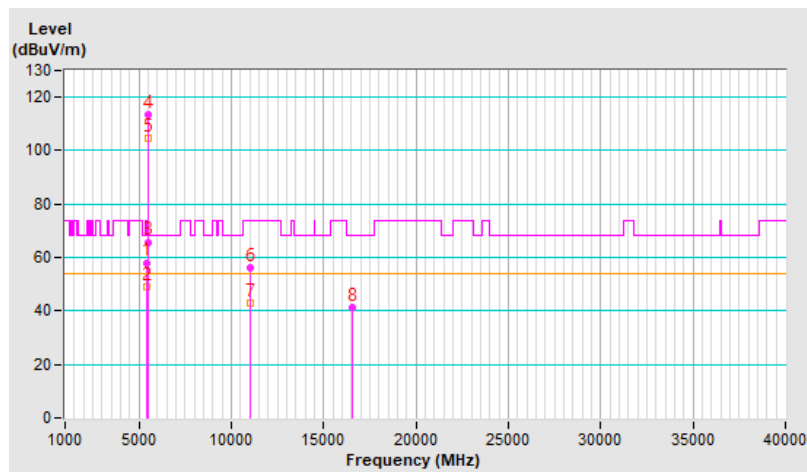

<b>RF Mode</b>	802.11ax (HE40)	<b>Channel</b>	CH 102 : 5510 MHz
<b>Frequency Range</b>	1 GHz ~ 40 GHz	<b>Detector Function &amp; Bandwidth</b>	PK: RB=1 MHz, VB=3 MHz, DET=Peak AV: RB=1 MHz, VB=10 Hz, DET=Peak
<b>Input Power</b>	120 Vac, 60 Hz	<b>Environmental Conditions</b>	24°C, 71% RH
<b>Tested By</b>	Louis Yang		

Antenna Polarity & Test Distance : Vertical at 3 m								
No	Frequency (MHz)	Emission Level (dBuV/m)	Limit (dBuV/m)	Margin (dB)	Antenna Height (m)	Table Angle (Degree)	Raw Value (dBuV)	Correction Factor (dB/m)
1	5460.00	66.6 PK	74.0	-7.4	1.30 V	81	63.7	2.9
2	5460.00	50.1 AV	54.0	-3.9	1.30 V	81	47.2	2.9
3	#5470.00	67.2 PK	68.2	-1.0	1.30 V	81	64.3	2.9
4	*5510.00	114.0 PK			1.30 V	81	111.1	2.9
5	*5510.00	105.6 AV			1.30 V	81	102.7	2.9
6	11020.00	55.8 PK	74.0	-18.2	1.45 V	224	42.0	13.8
7	11020.00	42.7 AV	54.0	-11.3	1.45 V	224	28.9	13.8
8	#16530.00	41.7 PK	68.2	-26.5	1.56 V	323	27.0	14.7

**Remarks:**

1. Emission Level(dBuV/m) = Raw Value(dBuV) + Correction Factor(dB/m)
2. Correction Factor(dB/m) = Antenna Factor(dB/m) + Cable Factor(dB) – Pre-Amplifier Factor(dB)
3. Margin value = Emission Level – Limit value
4. The other emission levels were very low against the limit.
5. " \* ": Fundamental frequency, the limit was restricted at the RF Output Power.
6. " # ": The radiated frequency is out of the restricted band.

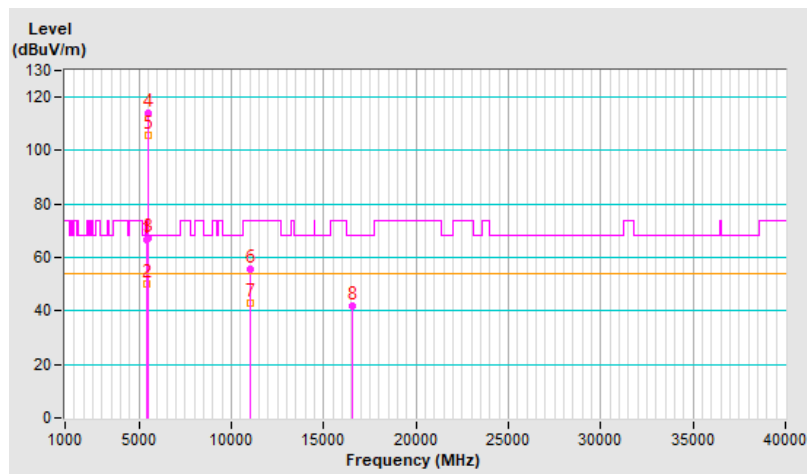

<b>RF Mode</b>	802.11ax (HE40)	<b>Channel</b>	CH 110 : 5550 MHz
<b>Frequency Range</b>	1 GHz ~ 40 GHz	<b>Detector Function &amp; Bandwidth</b>	PK: RB=1 MHz, VB=3 MHz, DET=Peak AV: RB=1 MHz, VB=10 Hz, DET=Peak
<b>Input Power</b>	120 Vac, 60 Hz	<b>Environmental Conditions</b>	24°C, 71% RH
<b>Tested By</b>	Louis Yang		

**Antenna Polarity & Test Distance : Horizontal at 3 m**

No	Frequency (MHz)	Emission Level (dBuV/m)	Limit (dBuV/m)	Margin (dB)	Antenna Height (m)	Table Angle (Degree)	Raw Value (dBuV)	Correction Factor (dB/m)
1	5460.00	57.7 PK	74.0	-16.3	1.78 H	85	54.8	2.9
2	5460.00	44.0 AV	54.0	-10.0	1.78 H	85	41.1	2.9
3	#5470.00	64.2 PK	68.2	-4.0	1.78 H	85	61.3	2.9
4	*5550.00	114.3 PK			1.78 H	85	111.4	2.9
5	*5550.00	105.8 AV			1.78 H	85	102.9	2.9
6	11100.00	56.1 PK	74.0	-17.9	1.36 H	195	42.4	13.7
7	11100.00	42.8 AV	54.0	-11.2	1.36 H	195	29.1	13.7
8	#16650.00	42.2 PK	68.2	-26.0	1.53 H	360	26.8	15.4

**Remarks:**

1. Emission Level(dBuV/m) = Raw Value(dBuV) + Correction Factor(dB/m)
2. Correction Factor(dB/m) = Antenna Factor(dB/m) + Cable Factor(dB) – Pre-Amplifier Factor(dB)
3. Margin value = Emission Level – Limit value
4. The other emission levels were very low against the limit.
5. " \* ": Fundamental frequency, the limit was restricted at the RF Output Power.
6. " # ": The radiated frequency is out of the restricted band.

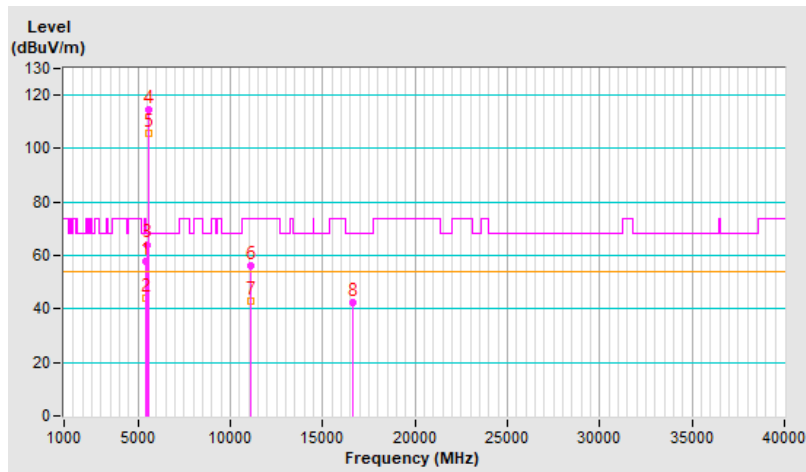



<b>RF Mode</b>	802.11ax (HE40)	<b>Channel</b>	CH 110 : 5550 MHz
<b>Frequency Range</b>	1 GHz ~ 40 GHz	<b>Detector Function &amp; Bandwidth</b>	PK: RB=1 MHz, VB=3 MHz, DET=Peak AV: RB=1 MHz, VB=10 Hz, DET=Peak
<b>Input Power</b>	120 Vac, 60 Hz	<b>Environmental Conditions</b>	24°C, 71% RH
<b>Tested By</b>	Louis Yang		

Antenna Polarity & Test Distance : Vertical at 3 m								
No	Frequency (MHz)	Emission Level (dBuV/m)	Limit (dBuV/m)	Margin (dB)	Antenna Height (m)	Table Angle (Degree)	Raw Value (dBuV)	Correction Factor (dB/m)
1	5460.00	60.5 PK	74.0	-13.5	1.78 V	93	57.6	2.9
2	5460.00	45.7 AV	54.0	-8.3	1.78 V	93	42.8	2.9
3	#5470.00	66.8 PK	68.2	-1.4	1.78 V	93	63.9	2.9
4	*5550.00	116.9 PK			1.78 V	93	114.0	2.9
5	*5550.00	106.9 AV			1.78 V	93	104.0	2.9
6	11100.00	56.1 PK	74.0	-17.9	1.42 V	196	42.4	13.7
7	11100.00	43.0 AV	54.0	-11.0	1.42 V	196	29.3	13.7
8	#16650.00	42.7 PK	68.2	-25.5	1.52 V	351	27.3	15.4

**Remarks:**

1. Emission Level(dBuV/m) = Raw Value(dBuV) + Correction Factor(dB/m)
2. Correction Factor(dB/m) = Antenna Factor(dB/m) + Cable Factor(dB) – Pre-Amplifier Factor(dB)
3. Margin value = Emission Level – Limit value
4. The other emission levels were very low against the limit.
5. " \* ": Fundamental frequency, the limit was restricted at the RF Output Power.
6. " # ": The radiated frequency is out of the restricted band.

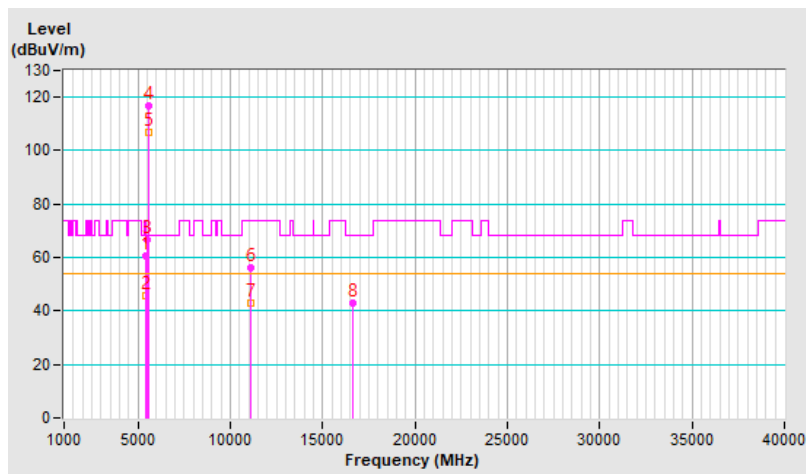

<b>RF Mode</b>	802.11ax (HE40)	<b>Channel</b>	CH 134 : 5670 MHz
<b>Frequency Range</b>	1 GHz ~ 40 GHz	<b>Detector Function &amp; Bandwidth</b>	PK: RB=1 MHz, VB=3 MHz, DET=Peak AV: RB=1 MHz, VB=10 Hz, DET=Peak
<b>Input Power</b>	120 Vac, 60 Hz	<b>Environmental Conditions</b>	24°C, 71% RH
<b>Tested By</b>	Louis Yang		

**Antenna Polarity & Test Distance : Horizontal at 3 m**

No	Frequency (MHz)	Emission Level (dBuV/m)	Limit (dBuV/m)	Margin (dB)	Antenna Height (m)	Table Angle (Degree)	Raw Value (dBuV)	Correction Factor (dB/m)
1	*5670.00	112.0 PK			1.77 H	99	109.2	2.8
2	*5670.00	102.3 AV			1.77 H	99	99.5	2.8
3	#5725.00	63.4 PK	68.2	-4.8	1.77 H	99	60.5	2.9
4	11340.00	55.6 PK	74.0	-18.4	1.45 H	235	42.3	13.3
5	11340.00	42.3 AV	54.0	-11.7	1.45 H	235	29.0	13.3
6	#17010.00	41.7 PK	68.2	-26.5	1.60 H	333	24.8	16.9

**Remarks:**

1. Emission Level(dBuV/m) = Raw Value(dBuV) + Correction Factor(dB/m)
2. Correction Factor(dB/m) = Antenna Factor(dB/m) + Cable Factor(dB) – Pre-Amplifier Factor(dB)
3. Margin value = Emission Level – Limit value
4. The other emission levels were very low against the limit.
5. " \* " : Fundamental frequency, the limit was restricted at the RF Output Power.
6. " # " : The radiated frequency is out of the restricted band.

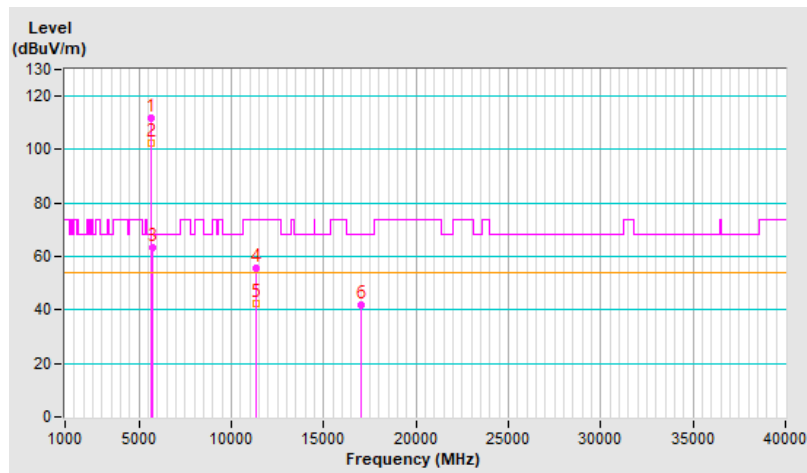

<b>RF Mode</b>	802.11ax (HE40)	<b>Channel</b>	CH 134 : 5670 MHz
<b>Frequency Range</b>	1 GHz ~ 40 GHz	<b>Detector Function &amp; Bandwidth</b>	PK: RB=1 MHz, VB=3 MHz, DET=Peak AV: RB=1 MHz, VB=10 Hz, DET=Peak
<b>Input Power</b>	120 Vac, 60 Hz	<b>Environmental Conditions</b>	24°C, 71% RH
<b>Tested By</b>	Louis Yang		

Antenna Polarity & Test Distance : Vertical at 3 m								
No	Frequency (MHz)	Emission Level (dBuV/m)	Limit (dBuV/m)	Margin (dB)	Antenna Height (m)	Table Angle (Degree)	Raw Value (dBuV)	Correction Factor (dB/m)
1	*5670.00	113.3 PK			1.89 V	101	110.5	2.8
2	*5670.00	105.2 AV			1.89 V	101	102.4	2.8
3	#5725.00	66.3 PK	68.2	-1.9	1.89 V	101	63.4	2.9
4	11340.00	56.3 PK	74.0	-17.7	1.44 V	211	43.0	13.3
5	11340.00	43.0 AV	54.0	-11.0	1.44 V	211	29.7	13.3
6	#17010.00	42.2 PK	68.2	-26.0	1.55 V	309	25.3	16.9

**Remarks:**

1. Emission Level(dBuV/m) = Raw Value(dBuV) + Correction Factor(dB/m)
2. Correction Factor(dB/m) = Antenna Factor(dB/m) + Cable Factor(dB) – Pre-Amplifier Factor(dB)
3. Margin value = Emission Level – Limit value
4. The other emission levels were very low against the limit.
5. " \* " : Fundamental frequency, the limit was restricted at the RF Output Power.
6. " # " : The radiated frequency is out of the restricted band.

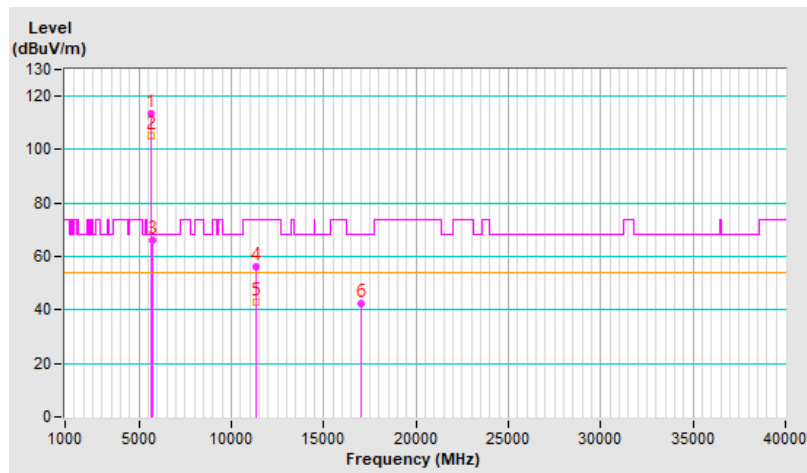

<b>RF Mode</b>	802.11ax (HE40)	<b>Channel</b>	CH 142 : 5710 MHz
<b>Frequency Range</b>	1 GHz ~ 40 GHz	<b>Detector Function &amp; Bandwidth</b>	PK: RB=1 MHz, VB=3 MHz, DET=Peak AV: RB=1 MHz, VB=10 Hz, DET=Peak
<b>Input Power</b>	120 Vac, 60 Hz	<b>Environmental Conditions</b>	24°C, 71% RH
<b>Tested By</b>	Louis Yang		

**Antenna Polarity & Test Distance : Horizontal at 3 m**

No	Frequency (MHz)	Emission Level (dBuV/m)	Limit (dBuV/m)	Margin (dB)	Antenna Height (m)	Table Angle (Degree)	Raw Value (dBuV)	Correction Factor (dB/m)
1	5460.00	48.3 PK	74.0	-25.7	1.83 H	103	45.4	2.9
2	5460.00	38.0 AV	54.0	-16.0	1.83 H	103	35.1	2.9
3	#5470.00	47.6 PK	68.2	-20.6	1.83 H	103	44.7	2.9
4	*5710.00	116.1 PK			1.83 H	103	113.2	2.9
5	*5710.00	104.9 AV			1.83 H	103	102.0	2.9
6	#5850.00	65.5 PK	68.2	-2.7	1.83 H	103	62.2	3.3
7	11420.00	57.3 PK	74.0	-16.7	1.66 H	194	44.0	13.3
8	11420.00	44.9 AV	54.0	-9.1	1.66 H	194	31.6	13.3
9	#17130.00	47.2 PK	68.2	-21.0	1.56 H	360	30.6	16.6

**Remarks:**

1. Emission Level(dBuV/m) = Raw Value(dBuV) + Correction Factor(dB/m)
2. Correction Factor(dB/m) = Antenna Factor(dB/m) + Cable Factor(dB) – Pre-Amplifier Factor(dB)
3. Margin value = Emission Level – Limit value
4. The other emission levels were very low against the limit.
5. " \* ": Fundamental frequency, the limit was restricted at the RF Output Power.
6. " # ": The radiated frequency is out of the restricted band.

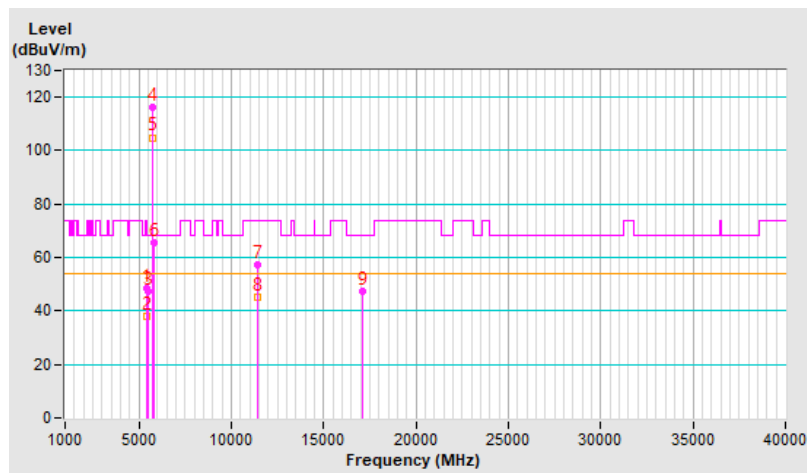

<b>RF Mode</b>	802.11ax (HE40)	<b>Channel</b>	CH 142 : 5710 MHz
<b>Frequency Range</b>	1 GHz ~ 40 GHz	<b>Detector Function &amp; Bandwidth</b>	PK: RB=1 MHz, VB=3 MHz, DET=Peak AV: RB=1 MHz, VB=10 Hz, DET=Peak
<b>Input Power</b>	120 Vac, 60 Hz	<b>Environmental Conditions</b>	24°C, 71% RH
<b>Tested By</b>	Louis Yang		

**Antenna Polarity & Test Distance : Vertical at 3 m**

No	Frequency (MHz)	Emission Level (dBuV/m)	Limit (dBuV/m)	Margin (dB)	Antenna Height (m)	Table Angle (Degree)	Raw Value (dBuV)	Correction Factor (dB/m)
1	5460.00	50.6 PK	74.0	-23.4	1.76 V	95	47.7	2.9
2	5460.00	39.1 AV	54.0	-14.9	1.76 V	95	36.2	2.9
3	#5470.00	49.3 PK	68.2	-18.9	1.76 V	95	46.4	2.9
4	*5710.00	118.0 PK			1.76 V	95	115.1	2.9
5	*5710.00	107.8 AV			1.76 V	95	104.9	2.9
6	#5850.00	66.7 PK	68.2	-1.5	1.76 V	95	63.4	3.3
7	11420.00	57.9 PK	74.0	-16.1	1.57 V	217	44.6	13.3
8	11420.00	45.2 AV	54.0	-8.8	1.57 V	217	31.9	13.3
9	#17130.00	47.4 PK	68.2	-20.8	1.56 V	360	30.8	16.6

**Remarks:**

1. Emission Level(dBuV/m) = Raw Value(dBuV) + Correction Factor(dB/m)
2. Correction Factor(dB/m) = Antenna Factor(dB/m) + Cable Factor(dB) – Pre-Amplifier Factor(dB)
3. Margin value = Emission Level – Limit value
4. The other emission levels were very low against the limit.
5. " \* ": Fundamental frequency, the limit was restricted at the RF Output Power.
6. " # ": The radiated frequency is out of the restricted band.

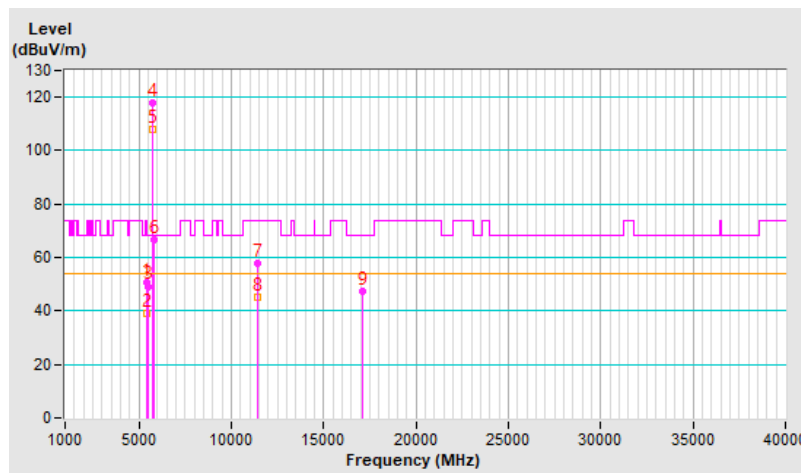

<b>RF Mode</b>	802.11ax (HE40)	<b>Channel</b>	CH 151 : 5755 MHz
<b>Frequency Range</b>	1 GHz ~ 40 GHz	<b>Detector Function &amp; Bandwidth</b>	PK: RB=1 MHz, VB=3 MHz, DET=Peak AV: RB=1 MHz, VB=10 Hz, DET=Peak
<b>Input Power</b>	120 Vac, 60 Hz	<b>Environmental Conditions</b>	24°C, 71% RH
<b>Tested By</b>	Louis Yang		

**Antenna Polarity & Test Distance : Horizontal at 3 m**

No	Frequency (MHz)	Emission Level (dBuV/m)	Limit (dBuV/m)	Margin (dB)	Antenna Height (m)	Table Angle (Degree)	Raw Value (dBuV)	Correction Factor (dB/m)
1	#5649.31	65.4 PK	68.2	-2.8	1.94 H	94	62.7	2.7
2	*5755.00	116.0 PK			1.94 H	94	112.9	3.1
3	*5755.00	105.6 AV			1.94 H	94	102.5	3.1
4	#5944.35	51.4 PK	68.2	-16.8	1.94 H	94	48.2	3.2
5	11510.00	55.4 PK	74.0	-18.6	1.38 H	202	42.4	13.0
6	11510.00	42.4 AV	54.0	-11.6	1.38 H	202	29.4	13.0
7	#17265.00	41.6 PK	68.2	-26.6	1.56 H	328	24.1	17.5

**Remarks:**

1. Emission Level(dBuV/m) = Raw Value(dBuV) + Correction Factor(dB/m)
2. Correction Factor(dB/m) = Antenna Factor(dB/m) + Cable Factor(dB) – Pre-Amplifier Factor(dB)
3. Margin value = Emission Level – Limit value
4. The other emission levels were very low against the limit.
5. " \* " : Fundamental frequency, the limit was restricted at the RF Output Power.
6. " # " : The radiated frequency is out of the restricted band.

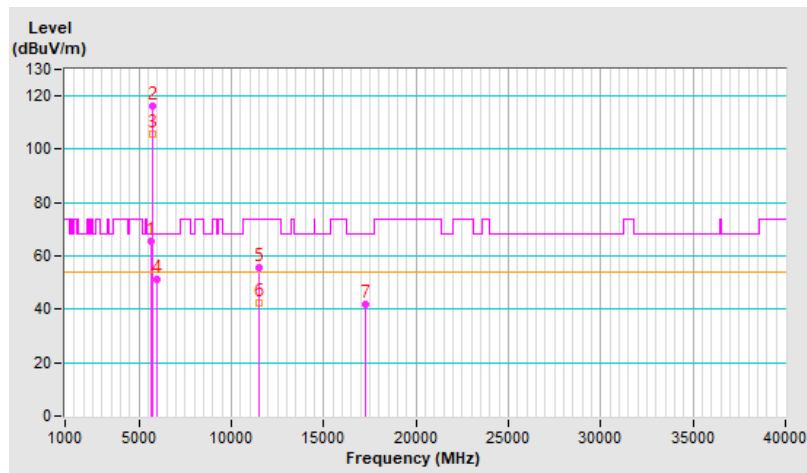

<b>RF Mode</b>	802.11ax (HE40)	<b>Channel</b>	CH 151 : 5755 MHz
<b>Frequency Range</b>	1 GHz ~ 40 GHz	<b>Detector Function &amp; Bandwidth</b>	PK: RB=1 MHz, VB=3 MHz, DET=Peak AV: RB=1 MHz, VB=10 Hz, DET=Peak
<b>Input Power</b>	120 Vac, 60 Hz	<b>Environmental Conditions</b>	24°C, 71% RH
<b>Tested By</b>	Louis Yang		

Antenna Polarity & Test Distance : Vertical at 3 m								
No	Frequency (MHz)	Emission Level (dBuV/m)	Limit (dBuV/m)	Margin (dB)	Antenna Height (m)	Table Angle (Degree)	Raw Value (dBuV)	Correction Factor (dB/m)
1	#5648.88	67.3 PK	68.2	-0.9	1.76 V	99	64.6	2.7
2	*5755.00	117.4 PK			1.76 V	99	114.3	3.1
3	*5755.00	107.5 AV			1.76 V	99	104.4	3.1
4	#5929.42	53.3 PK	68.2	-14.9	1.76 V	99	50.1	3.2
5	11510.00	55.6 PK	74.0	-18.4	1.39 V	200	42.6	13.0
6	11510.00	42.4 AV	54.0	-11.6	1.39 V	200	29.4	13.0
7	#17265.00	42.0 PK	68.2	-26.2	1.55 V	331	24.5	17.5

**Remarks:**

1. Emission Level(dBuV/m) = Raw Value(dBuV) + Correction Factor(dB/m)
2. Correction Factor(dB/m) = Antenna Factor(dB/m) + Cable Factor(dB) – Pre-Amplifier Factor(dB)
3. Margin value = Emission Level – Limit value
4. The other emission levels were very low against the limit.
5. " \* " : Fundamental frequency, the limit was restricted at the RF Output Power.
6. " # " : The radiated frequency is out of the restricted band.

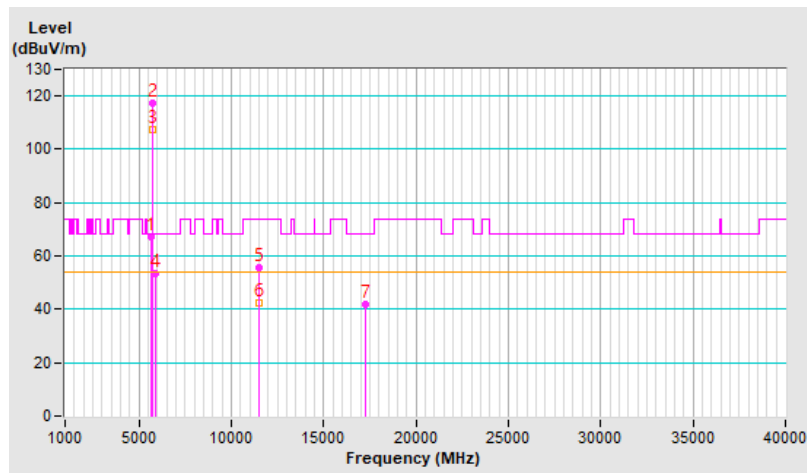

<b>RF Mode</b>	802.11ax (HE40)	<b>Channel</b>	CH 159 : 5795 MHz
<b>Frequency Range</b>	1 GHz ~ 40 GHz	<b>Detector Function &amp; Bandwidth</b>	PK: RB=1 MHz, VB=3 MHz, DET=Peak AV: RB=1 MHz, VB=10 Hz, DET=Peak
<b>Input Power</b>	120 Vac, 60 Hz	<b>Environmental Conditions</b>	24°C, 71% RH
<b>Tested By</b>	Louis Yang		

**Antenna Polarity & Test Distance : Horizontal at 3 m**

No	Frequency (MHz)	Emission Level (dBuV/m)	Limit (dBuV/m)	Margin (dB)	Antenna Height (m)	Table Angle (Degree)	Raw Value (dBuV)	Correction Factor (dB/m)
1	#5642.46	62.5 PK	68.2	-5.7	1.99 H	105	59.8	2.7
2	*5795.00	116.4 PK			1.99 H	105	113.2	3.2
3	*5795.00	105.1 AV			1.99 H	105	101.9	3.2
4	#5932.62	61.8 PK	68.2	-6.4	1.99 H	105	58.6	3.2
5	11590.00	57.9 PK	74.0	-16.1	1.67 H	203	44.7	13.2
6	11590.00	45.1 AV	54.0	-8.9	1.67 H	203	31.9	13.2
7	#17385.00	46.8 PK	68.2	-21.4	1.48 H	360	27.9	18.9

**Remarks:**

1. Emission Level(dBuV/m) = Raw Value(dBuV) + Correction Factor(dB/m)
2. Correction Factor(dB/m) = Antenna Factor(dB/m) + Cable Factor(dB) – Pre-Amplifier Factor(dB)
3. Margin value = Emission Level – Limit value
4. The other emission levels were very low against the limit.
5. " \* " : Fundamental frequency, the limit was restricted at the RF Output Power.
6. " # " : The radiated frequency is out of the restricted band.

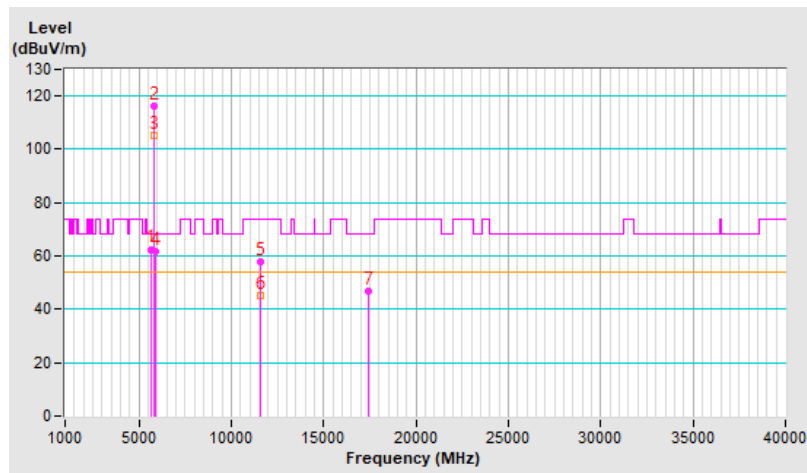



<b>RF Mode</b>	802.11ax (HE40)	<b>Channel</b>	CH 159 : 5795 MHz
<b>Frequency Range</b>	1 GHz ~ 40 GHz	<b>Detector Function &amp; Bandwidth</b>	PK: RB=1 MHz, VB=3 MHz, DET=Peak AV: RB=1 MHz, VB=10 Hz, DET=Peak
<b>Input Power</b>	120 Vac, 60 Hz	<b>Environmental Conditions</b>	24°C, 71% RH
<b>Tested By</b>	Louis Yang		

Antenna Polarity & Test Distance : Vertical at 3 m								
No	Frequency (MHz)	Emission Level (dBuV/m)	Limit (dBuV/m)	Margin (dB)	Antenna Height (m)	Table Angle (Degree)	Raw Value (dBuV)	Correction Factor (dB/m)
1	#5648.78	63.9 PK	68.2	-4.3	1.87 V	99	61.2	2.7
2	*5795.00	119.6 PK			1.87 V	99	116.4	3.2
3	*5795.00	109.4 AV			1.87 V	99	106.2	3.2
4	#5927.91	67.2 PK	68.2	-1.0	1.87 V	99	64.0	3.2
5	11590.00	57.3 PK	74.0	-16.7	1.60 V	219	44.1	13.2
6	11590.00	44.8 AV	54.0	-9.2	1.60 V	219	31.6	13.2
7	#17385.00	46.9 PK	68.2	-21.3	1.48 V	359	28.0	18.9

**Remarks:**

1. Emission Level(dBuV/m) = Raw Value(dBuV) + Correction Factor(dB/m)
2. Correction Factor(dB/m) = Antenna Factor(dB/m) + Cable Factor(dB) – Pre-Amplifier Factor(dB)
3. Margin value = Emission Level – Limit value
4. The other emission levels were very low against the limit.
5. " \* " : Fundamental frequency, the limit was restricted at the RF Output Power.
6. " # " : The radiated frequency is out of the restricted band.

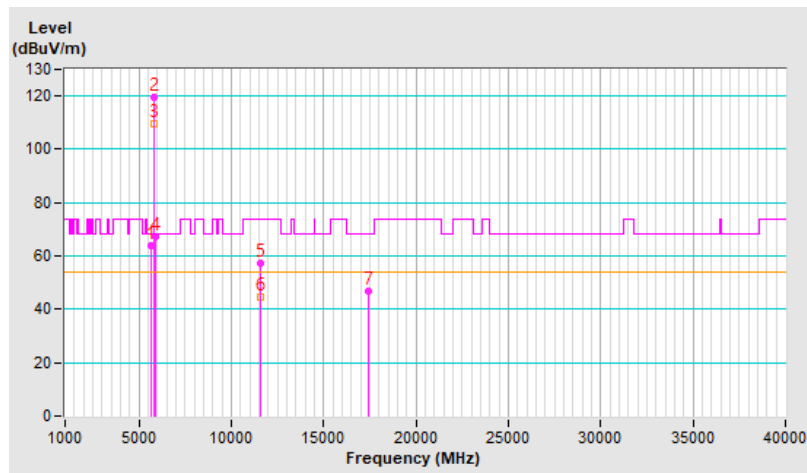

<b>RF Mode</b>	802.11ax (HE80)	<b>Channel</b>	CH 42 : 5210 MHz
<b>Frequency Range</b>	1 GHz ~ 40 GHz	<b>Detector Function &amp; Bandwidth</b>	PK: RB=1 MHz, VB=3 MHz, DET=Peak AV: RB=1 MHz, VB=10 Hz, DET=Peak
<b>Input Power</b>	120 Vac, 60 Hz	<b>Environmental Conditions</b>	24°C, 71% RH
<b>Tested By</b>	Louis Yang		

**Antenna Polarity & Test Distance : Horizontal at 3 m**

No	Frequency (MHz)	Emission Level (dBuV/m)	Limit (dBuV/m)	Margin (dB)	Antenna Height (m)	Table Angle (Degree)	Raw Value (dBuV)	Correction Factor (dB/m)
1	5150.00	60.5 PK	74.0	-13.5	2.03 H	90	57.1	3.4
2	5150.00	53.0 AV	54.0	-1.0	2.03 H	90	49.6	3.4
3	*5210.00	108.8 PK			2.03 H	90	105.8	3.0
4	*5210.00	96.6 AV			2.03 H	90	93.6	3.0
5	5350.00	50.7 PK	74.0	-23.3	2.03 H	90	47.9	2.8
6	5350.00	39.8 AV	54.0	-14.2	2.03 H	90	37.0	2.8
7	#10420.00	54.8 PK	68.2	-13.4	1.41 H	212	41.8	13.0
8	15630.00	41.6 PK	74.0	-32.4	1.51 H	320	30.7	10.9
9	15630.00	28.1 AV	54.0	-25.9	1.51 H	320	17.2	10.9

**Remarks:**

1. Emission Level(dBuV/m) = Raw Value(dBuV) + Correction Factor(dB/m)
2. Correction Factor(dB/m) = Antenna Factor(dB/m) + Cable Factor(dB) – Pre-Amplifier Factor(dB)
3. Margin value = Emission Level – Limit value
4. The other emission levels were very low against the limit.
5. " \* ": Fundamental frequency, the limit was restricted at the RF Output Power.
6. " # ": The radiated frequency is out of the restricted band.

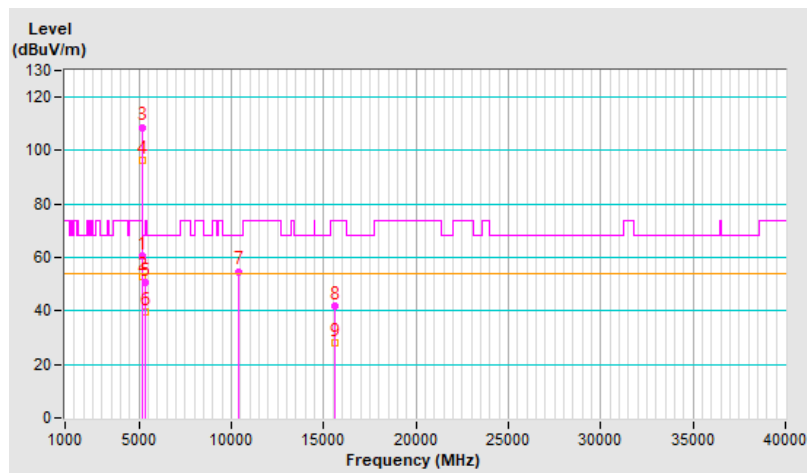

<b>RF Mode</b>	802.11ax (HE80)	<b>Channel</b>	CH 42 : 5210 MHz
<b>Frequency Range</b>	1 GHz ~ 40 GHz	<b>Detector Function &amp; Bandwidth</b>	PK: RB=1 MHz, VB=3 MHz, DET=Peak AV: RB=1 MHz, VB=10 Hz, DET=Peak
<b>Input Power</b>	120 Vac, 60 Hz	<b>Environmental Conditions</b>	24°C, 71% RH
<b>Tested By</b>	Louis Yang		

**Antenna Polarity & Test Distance : Vertical at 3 m**

No	Frequency (MHz)	Emission Level (dBuV/m)	Limit (dBuV/m)	Margin (dB)	Antenna Height (m)	Table Angle (Degree)	Raw Value (dBuV)	Correction Factor (dB/m)
1	5150.00	63.4 PK	74.0	-10.6	1.64 V	93	60.0	3.4
2	5150.00	52.4 AV	54.0	-1.6	1.64 V	93	49.0	3.4
3	*5210.00	108.1 PK			1.64 V	93	105.1	3.0
4	*5210.00	99.0 AV			1.64 V	93	96.0	3.0
5	5350.00	51.8 PK	74.0	-22.2	1.64 V	93	49.0	2.8
6	5350.00	40.5 AV	54.0	-13.5	1.64 V	93	37.7	2.8
7	#10420.00	55.3 PK	68.2	-12.9	1.39 V	211	42.3	13.0
8	15630.00	41.9 PK	74.0	-32.1	1.56 V	330	31.0	10.9
9	15630.00	28.4 AV	54.0	-25.6	1.56 V	330	17.5	10.9

**Remarks:**

1. Emission Level(dBuV/m) = Raw Value(dBuV) + Correction Factor(dB/m)
2. Correction Factor(dB/m) = Antenna Factor(dB/m) + Cable Factor(dB) – Pre-Amplifier Factor(dB)
3. Margin value = Emission Level – Limit value
4. The other emission levels were very low against the limit.
5. " \* ": Fundamental frequency, the limit was restricted at the RF Output Power.
6. " # ": The radiated frequency is out of the restricted band.

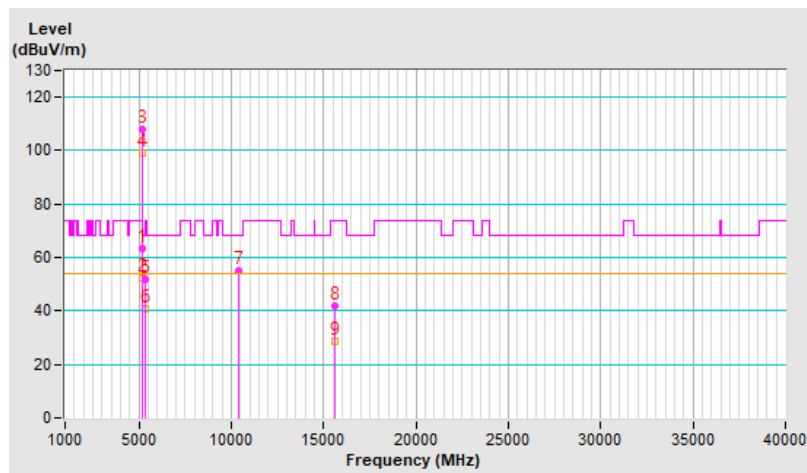

<b>RF Mode</b>	802.11ax (HE80)	<b>Channel</b>	CH 58 : 5290 MHz
<b>Frequency Range</b>	1 GHz ~ 40 GHz	<b>Detector Function &amp; Bandwidth</b>	PK: RB=1 MHz, VB=3 MHz, DET=Peak AV: RB=1 MHz, VB=10 Hz, DET=Peak
<b>Input Power</b>	120 Vac, 60 Hz	<b>Environmental Conditions</b>	24°C, 71% RH
<b>Tested By</b>	Louis Yang		

**Antenna Polarity & Test Distance : Horizontal at 3 m**

No	Frequency (MHz)	Emission Level (dBuV/m)	Limit (dBuV/m)	Margin (dB)	Antenna Height (m)	Table Angle (Degree)	Raw Value (dBuV)	Correction Factor (dB/m)
1	5150.00	54.3 PK	74.0	-19.7	1.85 H	70	50.9	3.4
2	5150.00	42.1 AV	54.0	-11.9	1.85 H	70	38.7	3.4
3	*5290.00	109.1 PK			1.85 H	70	106.7	2.4
4	*5290.00	98.1 AV			1.85 H	70	95.7	2.4
5	5350.00	62.9 PK	74.0	-11.1	1.85 H	70	60.1	2.8
6	5350.00	52.9 AV	54.0	-1.1	1.85 H	70	50.1	2.8
7	#10580.00	56.1 PK	68.2	-12.1	1.42 H	211	43.3	12.8
8	15870.00	42.4 PK	74.0	-31.6	1.52 H	328	30.4	12.0
9	15870.00	28.6 AV	54.0	-25.4	1.52 H	328	16.6	12.0

**Remarks:**

1. Emission Level(dBuV/m) = Raw Value(dBuV) + Correction Factor(dB/m)
2. Correction Factor(dB/m) = Antenna Factor(dB/m) + Cable Factor(dB) – Pre-Amplifier Factor(dB)
3. Margin value = Emission Level – Limit value
4. The other emission levels were very low against the limit.
5. " \* ": Fundamental frequency, the limit was restricted at the RF Output Power.
6. " # ": The radiated frequency is out of the restricted band.

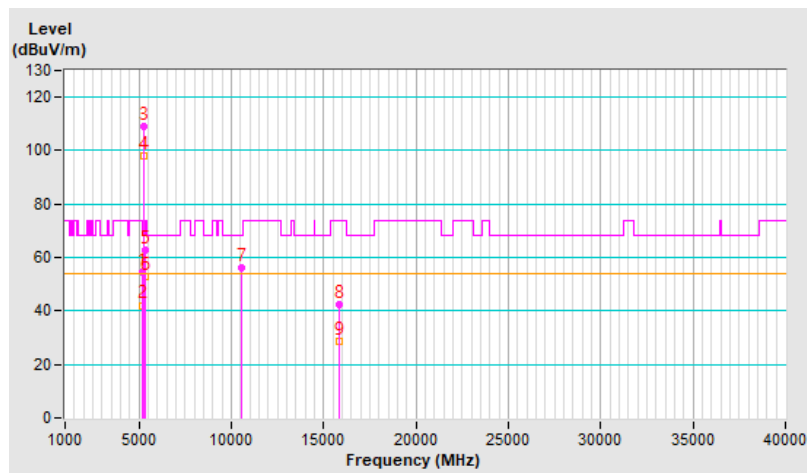

<b>RF Mode</b>	802.11ax (HE80)	<b>Channel</b>	CH 58 : 5290 MHz
<b>Frequency Range</b>	1 GHz ~ 40 GHz	<b>Detector Function &amp; Bandwidth</b>	PK: RB=1 MHz, VB=3 MHz, DET=Peak AV: RB=1 MHz, VB=10 Hz, DET=Peak
<b>Input Power</b>	120 Vac, 60 Hz	<b>Environmental Conditions</b>	24°C, 71% RH
<b>Tested By</b>	Louis Yang		

**Antenna Polarity & Test Distance : Vertical at 3 m**

No	Frequency (MHz)	Emission Level (dBuV/m)	Limit (dBuV/m)	Margin (dB)	Antenna Height (m)	Table Angle (Degree)	Raw Value (dBuV)	Correction Factor (dB/m)
1	5150.00	55.9 PK	74.0	-18.1	1.55 V	91	52.5	3.4
2	5150.00	43.6 AV	54.0	-10.4	1.55 V	91	40.2	3.4
3	*5290.00	111.0 PK			1.55 V	91	108.6	2.4
4	*5290.00	100.5 AV			1.55 V	91	98.1	2.4
5	5350.00	63.7 PK	74.0	-10.3	1.55 V	91	60.9	2.8
6	5350.00	51.8 AV	54.0	-2.2	1.55 V	91	49.0	2.8
7	#10580.00	55.5 PK	68.2	-12.7	1.40 V	194	42.7	12.8
8	15870.00	42.0 PK	74.0	-32.0	1.60 V	343	30.0	12.0
9	15870.00	27.9 AV	54.0	-26.1	1.60 V	343	15.9	12.0

**Remarks:**

1. Emission Level(dBuV/m) = Raw Value(dBuV) + Correction Factor(dB/m)
2. Correction Factor(dB/m) = Antenna Factor(dB/m) + Cable Factor(dB) – Pre-Amplifier Factor(dB)
3. Margin value = Emission Level – Limit value
4. The other emission levels were very low against the limit.
5. " \* ": Fundamental frequency, the limit was restricted at the RF Output Power.
6. " # ": The radiated frequency is out of the restricted band.

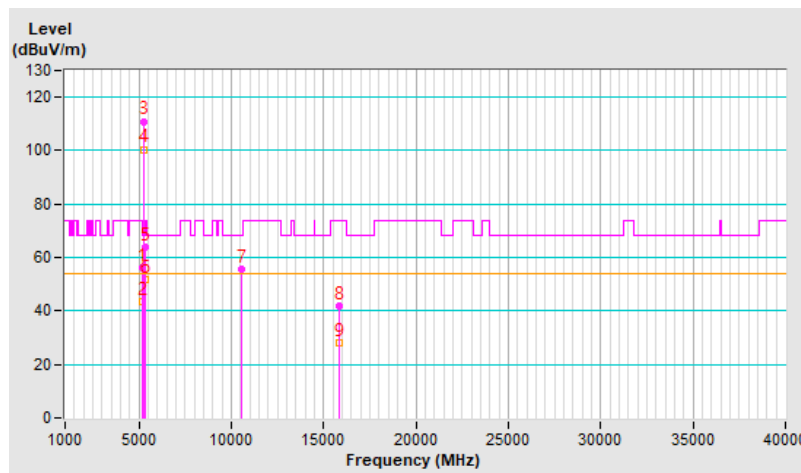

<b>RF Mode</b>	802.11ax (HE80)	<b>Channel</b>	CH 106 : 5530 MHz
<b>Frequency Range</b>	1 GHz ~ 40 GHz	<b>Detector Function &amp; Bandwidth</b>	PK: RB=1 MHz, VB=3 MHz, DET=Peak AV: RB=1 MHz, VB=10 Hz, DET=Peak
<b>Input Power</b>	120 Vac, 60 Hz	<b>Environmental Conditions</b>	24°C, 71% RH
<b>Tested By</b>	Louis Yang		

**Antenna Polarity & Test Distance : Horizontal at 3 m**

No	Frequency (MHz)	Emission Level (dBuV/m)	Limit (dBuV/m)	Margin (dB)	Antenna Height (m)	Table Angle (Degree)	Raw Value (dBuV)	Correction Factor (dB/m)
1	5460.00	63.7 PK	74.0	-10.3	2.10 H	92	60.8	2.9
2	5460.00	51.6 AV	54.0	-2.4	2.10 H	92	48.7	2.9
3	#5470.00	62.9 PK	68.2	-5.3	2.10 H	92	60.0	2.9
4	*5530.00	107.9 PK			2.10 H	92	105.0	2.9
5	*5530.00	98.8 AV			2.10 H	92	95.9	2.9
6	#5725.00	51.0 PK	68.2	-17.2	2.10 H	92	48.1	2.9
7	11060.00	56.4 PK	74.0	-17.6	1.37 H	221	42.6	13.8
8	11060.00	42.9 AV	54.0	-11.1	1.37 H	221	29.1	13.8
9	#16590.00	42.1 PK	68.2	-26.1	1.54 H	325	27.3	14.8

**Remarks:**

1. Emission Level(dBuV/m) = Raw Value(dBuV) + Correction Factor(dB/m)
2. Correction Factor(dB/m) = Antenna Factor(dB/m) + Cable Factor(dB) – Pre-Amplifier Factor(dB)
3. Margin value = Emission Level – Limit value
4. The other emission levels were very low against the limit.
5. " \* ": Fundamental frequency, the limit was restricted at the RF Output Power.
6. " # ": The radiated frequency is out of the restricted band.

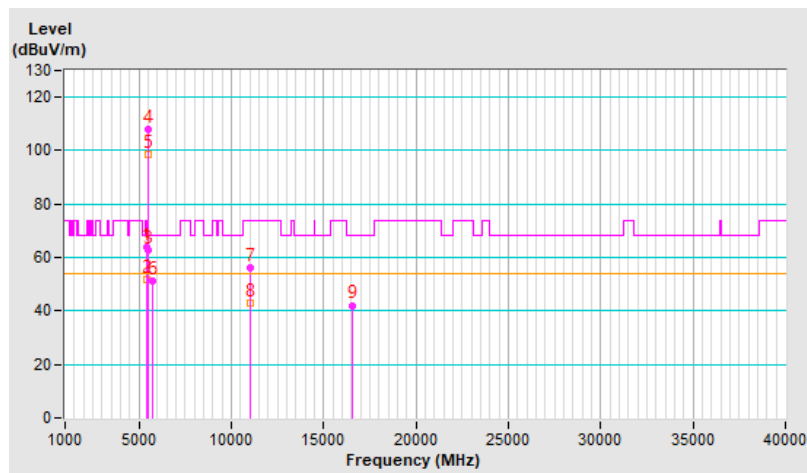

<b>RF Mode</b>	802.11ax (HE80)	<b>Channel</b>	CH 106 : 5530 MHz
<b>Frequency Range</b>	1 GHz ~ 40 GHz	<b>Detector Function &amp; Bandwidth</b>	PK: RB=1 MHz, VB=3 MHz, DET=Peak AV: RB=1 MHz, VB=10 Hz, DET=Peak
<b>Input Power</b>	120 Vac, 60 Hz	<b>Environmental Conditions</b>	24°C, 71% RH
<b>Tested By</b>	Louis Yang		

**Antenna Polarity & Test Distance : Vertical at 3 m**

No	Frequency (MHz)	Emission Level (dBuV/m)	Limit (dBuV/m)	Margin (dB)	Antenna Height (m)	Table Angle (Degree)	Raw Value (dBuV)	Correction Factor (dB/m)
1	5460.00	63.6 PK	74.0	-10.4	1.41 V	82	60.7	2.9
2	5460.00	52.7 AV	54.0	-1.3	1.41 V	82	49.8	2.9
3	#5470.00	66.7 PK	68.2	-1.5	1.41 V	82	63.8	2.9
4	*5530.00	108.5 PK			1.41 V	82	105.6	2.9
5	*5530.00	99.6 AV			1.41 V	82	96.7	2.9
6	#5725.00	54.6 PK	68.2	-13.6	1.41 V	82	51.7	2.9
7	11060.00	55.7 PK	74.0	-18.3	1.41 V	181	41.9	13.8
8	11060.00	42.9 AV	54.0	-11.1	1.41 V	181	29.1	13.8
9	#16590.00	41.5 PK	68.2	-26.7	1.65 V	354	26.7	14.8

**Remarks:**

1. Emission Level(dBuV/m) = Raw Value(dBuV) + Correction Factor(dB/m)
2. Correction Factor(dB/m) = Antenna Factor(dB/m) + Cable Factor(dB) – Pre-Amplifier Factor(dB)
3. Margin value = Emission Level – Limit value
4. The other emission levels were very low against the limit.
5. " \* ": Fundamental frequency, the limit was restricted at the RF Output Power.
6. " # ": The radiated frequency is out of the restricted band.

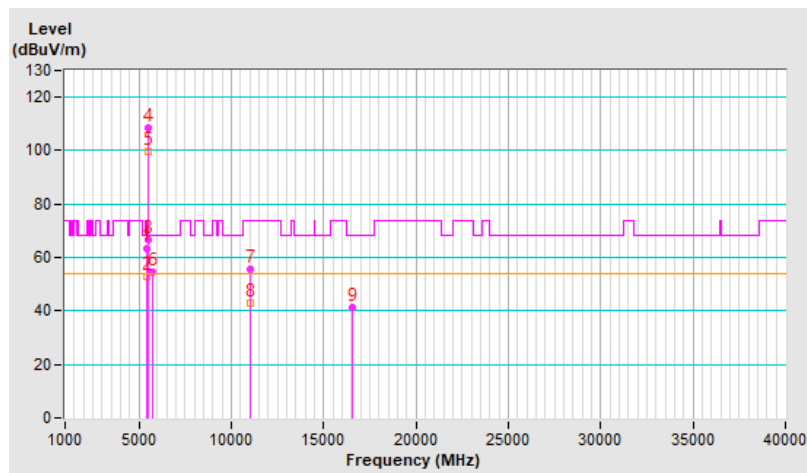

<b>RF Mode</b>	802.11ax (HE80)	<b>Channel</b>	CH 122 : 5610 MHz
<b>Frequency Range</b>	1 GHz ~ 40 GHz	<b>Detector Function &amp; Bandwidth</b>	PK: RB=1 MHz, VB=3 MHz, DET=Peak AV: RB=1 MHz, VB=10 Hz, DET=Peak
<b>Input Power</b>	120 Vac, 60 Hz	<b>Environmental Conditions</b>	24°C, 71% RH
<b>Tested By</b>	Louis Yang		

**Antenna Polarity & Test Distance : Horizontal at 3 m**

No	Frequency (MHz)	Emission Level (dBuV/m)	Limit (dBuV/m)	Margin (dB)	Antenna Height (m)	Table Angle (Degree)	Raw Value (dBuV)	Correction Factor (dB/m)
1	*5610.00	109.1 PK			2.06 H	108	106.4	2.7
2	*5610.00	100.4 AV			2.06 H	108	97.7	2.7
3	#5725.00	64.9 PK	68.2	-3.3	2.06 H	108	62.0	2.9
4	11220.00	55.3 PK	74.0	-18.7	1.39 H	209	42.4	12.9
5	11220.00	42.3 AV	54.0	-11.7	1.39 H	209	29.4	12.9
6	#16830.00	42.6 PK	68.2	-25.6	1.54 H	319	26.5	16.1

**Remarks:**

1. Emission Level(dBuV/m) = Raw Value(dBuV) + Correction Factor(dB/m)
2. Correction Factor(dB/m) = Antenna Factor(dB/m) + Cable Factor(dB) – Pre-Amplifier Factor(dB)
3. Margin value = Emission Level – Limit value
4. The other emission levels were very low against the limit.
5. " \* " : Fundamental frequency, the limit was restricted at the RF Output Power.
6. " # " : The radiated frequency is out of the restricted band.

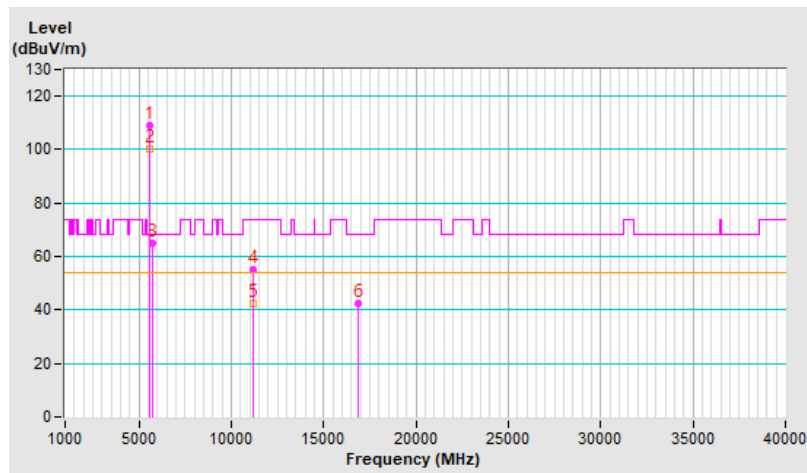



<b>RF Mode</b>	802.11ax (HE80)	<b>Channel</b>	CH 122 : 5610 MHz
<b>Frequency Range</b>	1 GHz ~ 40 GHz	<b>Detector Function &amp; Bandwidth</b>	PK: RB=1 MHz, VB=3 MHz, DET=Peak AV: RB=1 MHz, VB=10 Hz, DET=Peak
<b>Input Power</b>	120 Vac, 60 Hz	<b>Environmental Conditions</b>	24°C, 71% RH
<b>Tested By</b>	Louis Yang		

Antenna Polarity & Test Distance : Vertical at 3 m								
No	Frequency (MHz)	Emission Level (dBuV/m)	Limit (dBuV/m)	Margin (dB)	Antenna Height (m)	Table Angle (Degree)	Raw Value (dBuV)	Correction Factor (dB/m)
1	*5610.00	111.7 PK			1.40 V	83	109.0	2.7
2	*5610.00	101.7 AV			1.40 V	83	99.0	2.7
3	#5725.00	66.2 PK	68.2	-2.0	1.40 V	83	63.3	2.9
4	11220.00	55.4 PK	74.0	-18.6	1.40 V	201	42.5	12.9
5	11220.00	42.2 AV	54.0	-11.8	1.40 V	201	29.3	12.9
6	#16830.00	42.9 PK	68.2	-25.3	1.54 V	332	26.8	16.1

**Remarks:**

1. Emission Level(dBuV/m) = Raw Value(dBuV) + Correction Factor(dB/m)
2. Correction Factor(dB/m) = Antenna Factor(dB/m) + Cable Factor(dB) – Pre-Amplifier Factor(dB)
3. Margin value = Emission Level – Limit value
4. The other emission levels were very low against the limit.
5. " \* " : Fundamental frequency, the limit was restricted at the RF Output Power.
6. " # " : The radiated frequency is out of the restricted band.

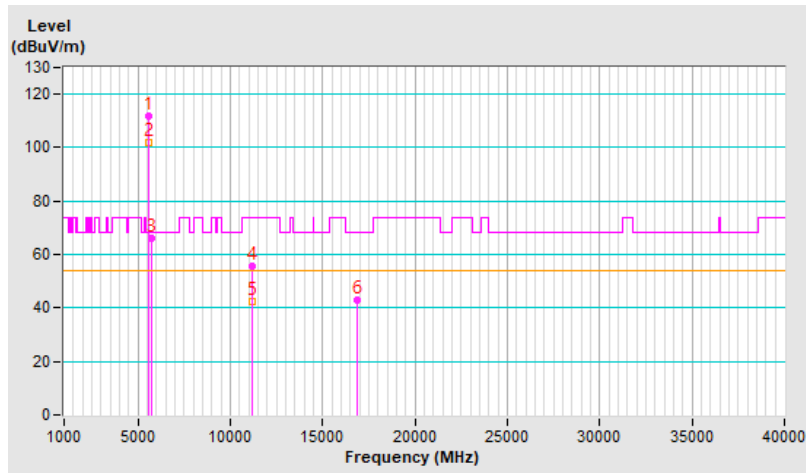

<b>RF Mode</b>	802.11ax (HE80)	<b>Channel</b>	CH 138 : 5690 MHz
<b>Frequency Range</b>	1 GHz ~ 40 GHz	<b>Detector Function &amp; Bandwidth</b>	PK: RB=1 MHz, VB=3 MHz, DET=Peak AV: RB=1 MHz, VB=10 Hz, DET=Peak
<b>Input Power</b>	120 Vac, 60 Hz	<b>Environmental Conditions</b>	24°C, 71% RH
<b>Tested By</b>	Louis Yang		

**Antenna Polarity & Test Distance : Horizontal at 3 m**

No	Frequency (MHz)	Emission Level (dBuV/m)	Limit (dBuV/m)	Margin (dB)	Antenna Height (m)	Table Angle (Degree)	Raw Value (dBuV)	Correction Factor (dB/m)
1	5460.00	59.6 PK	74.0	-14.4	2.12 H	118	56.7	2.9
2	5460.00	49.5 AV	54.0	-4.5	2.12 H	118	46.6	2.9
3	#5470.00	60.2 PK	68.2	-8.0	2.12 H	118	57.3	2.9
4	*5690.00	109.2 PK			2.12 H	118	106.4	2.8
5	*5690.00	98.9 AV			2.12 H	118	96.1	2.8
6	#5850.00	64.6 PK	68.2	-3.6	2.12 H	118	61.3	3.3
7	11380.00	56.8 PK	74.0	-17.2	1.64 H	191	43.5	13.3
8	11380.00	44.5 AV	54.0	-9.5	1.64 H	191	31.2	13.3
9	#17070.00	46.3 PK	68.2	-21.9	1.52 H	341	29.6	16.7

**Remarks:**

1. Emission Level(dBuV/m) = Raw Value(dBuV) + Correction Factor(dB/m)
2. Correction Factor(dB/m) = Antenna Factor(dB/m) + Cable Factor(dB) – Pre-Amplifier Factor(dB)
3. Margin value = Emission Level – Limit value
4. The other emission levels were very low against the limit.
5. " \* ": Fundamental frequency, the limit was restricted at the RF Output Power.
6. " # ": The radiated frequency is out of the restricted band.

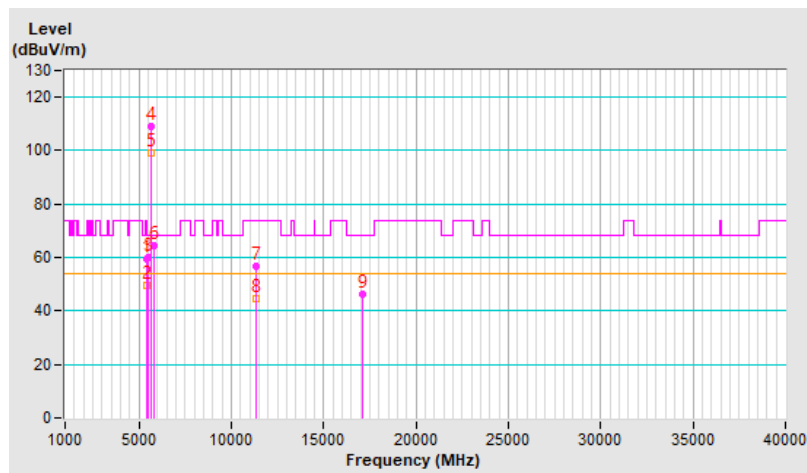

<b>RF Mode</b>	802.11ax (HE80)	<b>Channel</b>	CH 138 : 5690 MHz
<b>Frequency Range</b>	1 GHz ~ 40 GHz	<b>Detector Function &amp; Bandwidth</b>	PK: RB=1 MHz, VB=3 MHz, DET=Peak AV: RB=1 MHz, VB=10 Hz, DET=Peak
<b>Input Power</b>	120 Vac, 60 Hz	<b>Environmental Conditions</b>	24°C, 71% RH
<b>Tested By</b>	Louis Yang		

Antenna Polarity & Test Distance : Vertical at 3 m								
No	Frequency (MHz)	Emission Level (dBuV/m)	Limit (dBuV/m)	Margin (dB)	Antenna Height (m)	Table Angle (Degree)	Raw Value (dBuV)	Correction Factor (dB/m)
1	5460.00	62.3 PK	74.0	-11.7	1.21 V	72	59.4	2.9
2	5460.00	51.2 AV	54.0	-2.8	1.21 V	72	48.3	2.9
3	#5470.00	62.8 PK	68.2	-5.4	1.21 V	72	59.9	2.9
4	*5690.00	112.2 PK			1.21 V	72	109.4	2.8
5	*5690.00	101.5 AV			1.21 V	72	98.7	2.8
6	#5850.00	66.3 PK	68.2	-1.9	1.21 V	72	63.0	3.3
7	11380.00	57.3 PK	74.0	-16.7	1.65 V	202	44.0	13.3
8	11380.00	44.9 AV	54.0	-9.1	1.65 V	202	31.6	13.3
9	#17070.00	46.6 PK	68.2	-21.6	1.55 V	348	29.9	16.7

**Remarks:**

1. Emission Level(dBuV/m) = Raw Value(dBuV) + Correction Factor(dB/m)
2. Correction Factor(dB/m) = Antenna Factor(dB/m) + Cable Factor(dB) – Pre-Amplifier Factor(dB)
3. Margin value = Emission Level – Limit value
4. The other emission levels were very low against the limit.
5. " \* ": Fundamental frequency, the limit was restricted at the RF Output Power.
6. " # ": The radiated frequency is out of the restricted band.

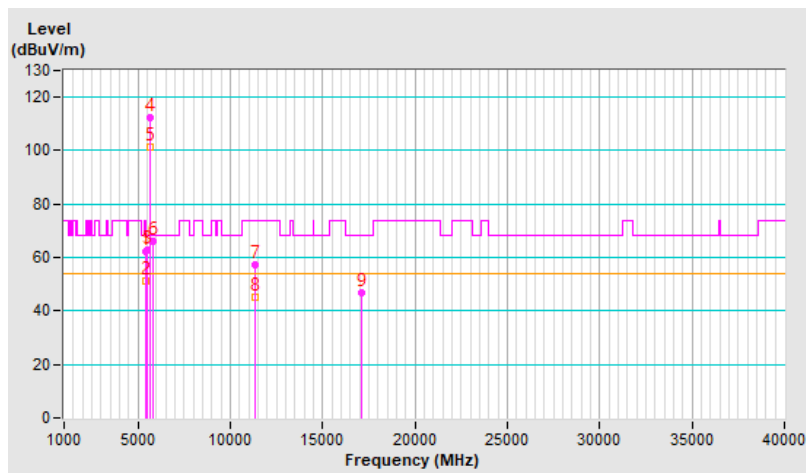

<b>RF Mode</b>	802.11ax (HE80)	<b>Channel</b>	CH 155 : 5775 MHz
<b>Frequency Range</b>	1 GHz ~ 40 GHz	<b>Detector Function &amp; Bandwidth</b>	PK: RB=1 MHz, VB=3 MHz, DET=Peak AV: RB=1 MHz, VB=10 Hz, DET=Peak
<b>Input Power</b>	120 Vac, 60 Hz	<b>Environmental Conditions</b>	24°C, 71% RH
<b>Tested By</b>	Louis Yang		

**Antenna Polarity & Test Distance : Horizontal at 3 m**

No	Frequency (MHz)	Emission Level (dBuV/m)	Limit (dBuV/m)	Margin (dB)	Antenna Height (m)	Table Angle (Degree)	Raw Value (dBuV)	Correction Factor (dB/m)
1	#5641.91	65.1 PK	68.2	-3.1	2.00 H	99	62.4	2.7
2	*5775.00	112.3 PK			2.00 H	99	109.2	3.1
3	*5775.00	100.0 AV			2.00 H	99	96.9	3.1
4	#5933.74	58.0 PK	68.2	-10.2	2.00 H	99	54.8	3.2
5	11550.00	55.6 PK	74.0	-18.4	1.33 H	239	42.4	13.2
6	11550.00	42.4 AV	54.0	-11.6	1.33 H	239	29.2	13.2
7	#17325.00	42.7 PK	68.2	-25.5	1.54 H	331	24.6	18.1

**Remarks:**

1. Emission Level(dBuV/m) = Raw Value(dBuV) + Correction Factor(dB/m)
2. Correction Factor(dB/m) = Antenna Factor(dB/m) + Cable Factor(dB) – Pre-Amplifier Factor(dB)
3. Margin value = Emission Level – Limit value
4. The other emission levels were very low against the limit.
5. " \* " : Fundamental frequency, the limit was restricted at the RF Output Power.
6. " # " : The radiated frequency is out of the restricted band.

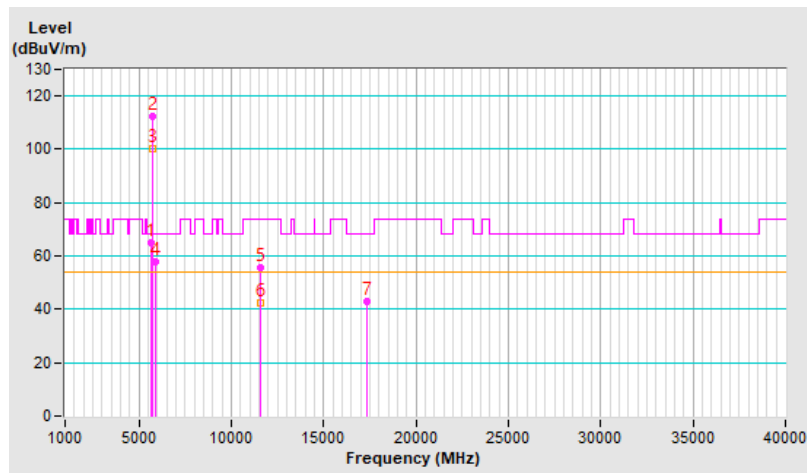

<b>RF Mode</b>	802.11ax (HE80)	<b>Channel</b>	CH 155 : 5775 MHz
<b>Frequency Range</b>	1 GHz ~ 40 GHz	<b>Detector Function &amp; Bandwidth</b>	PK: RB=1 MHz, VB=3 MHz, DET=Peak AV: RB=1 MHz, VB=10 Hz, DET=Peak
<b>Input Power</b>	120 Vac, 60 Hz	<b>Environmental Conditions</b>	24°C, 71% RH
<b>Tested By</b>	Louis Yang		

Antenna Polarity & Test Distance : Vertical at 3 m								
No	Frequency (MHz)	Emission Level (dBuV/m)	Limit (dBuV/m)	Margin (dB)	Antenna Height (m)	Table Angle (Degree)	Raw Value (dBuV)	Correction Factor (dB/m)
1	#5645.10	66.4 PK	68.2	-1.8	1.98 V	102	63.7	2.7
2	*5775.00	113.8 PK			1.98 V	102	110.7	3.1
3	*5775.00	102.3 AV			1.98 V	102	99.2	3.1
4	#5925.53	64.8 PK	68.2	-3.4	1.98 V	102	61.6	3.2
5	11550.00	56.1 PK	74.0	-17.9	1.38 V	225	42.9	13.2
6	11550.00	42.9 AV	54.0	-11.1	1.38 V	225	29.7	13.2
7	#17325.00	42.4 PK	68.2	-25.8	1.59 V	346	24.3	18.1

**Remarks:**

1. Emission Level(dBuV/m) = Raw Value(dBuV) + Correction Factor(dB/m)
2. Correction Factor(dB/m) = Antenna Factor(dB/m) + Cable Factor(dB) – Pre-Amplifier Factor(dB)
3. Margin value = Emission Level – Limit value
4. The other emission levels were very low against the limit.
5. " \* " : Fundamental frequency, the limit was restricted at the RF Output Power.
6. " # " : The radiated frequency is out of the restricted band.

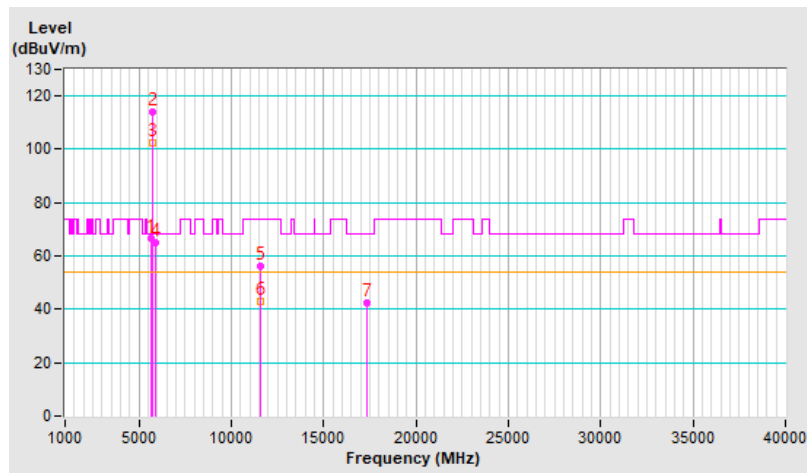

<b>RF Mode</b>	802.11ax (HE160)	<b>Channel</b>	CH 50 : 5250 MHz
<b>Frequency Range</b>	1 GHz ~ 40 GHz	<b>Detector Function &amp; Bandwidth</b>	PK: RB=1 MHz, VB=3 MHz, DET=Peak AV: RB=1 MHz, VB=1 kHz, DET=Peak
<b>Input Power</b>	120 Vac, 60 Hz	<b>Environmental Conditions</b>	24°C, 71% RH
<b>Tested By</b>	Louis Yang		

**Antenna Polarity & Test Distance : Horizontal at 3 m**

No	Frequency (MHz)	Emission Level (dBuV/m)	Limit (dBuV/m)	Margin (dB)	Antenna Height (m)	Table Angle (Degree)	Raw Value (dBuV)	Correction Factor (dB/m)
1	5150.00	66.7 PK	74.0	-7.3	1.71 H	104	63.3	3.4
2	5150.00	52.7 AV	54.0	-1.3	1.71 H	104	49.3	3.4
3	*5250.00	104.5 PK			1.71 H	104	101.9	2.6
4	*5250.00	93.9 AV			1.71 H	104	91.3	2.6
5	5350.00	60.3 PK	74.0	-13.7	1.71 H	104	57.5	2.8
6	5350.00	50.0 AV	54.0	-4.0	1.71 H	104	47.2	2.8
7	#10500.00	54.1 PK	68.2	-14.1	1.37 H	223	41.4	12.7
8	15750.00	42.4 PK	74.0	-31.6	1.49 H	342	30.9	11.5
9	15750.00	28.7 AV	54.0	-25.3	1.49 H	342	17.2	11.5

**Remarks:**

1. Emission Level(dBuV/m) = Raw Value(dBuV) + Correction Factor(dB/m)
2. Correction Factor(dB/m) = Antenna Factor(dB/m) + Cable Factor(dB) – Pre-Amplifier Factor(dB)
3. Margin value = Emission Level – Limit value
4. The other emission levels were very low against the limit.
5. " \* ": Fundamental frequency, the limit was restricted at the RF Output Power.
6. " # ": The radiated frequency is out of the restricted band.

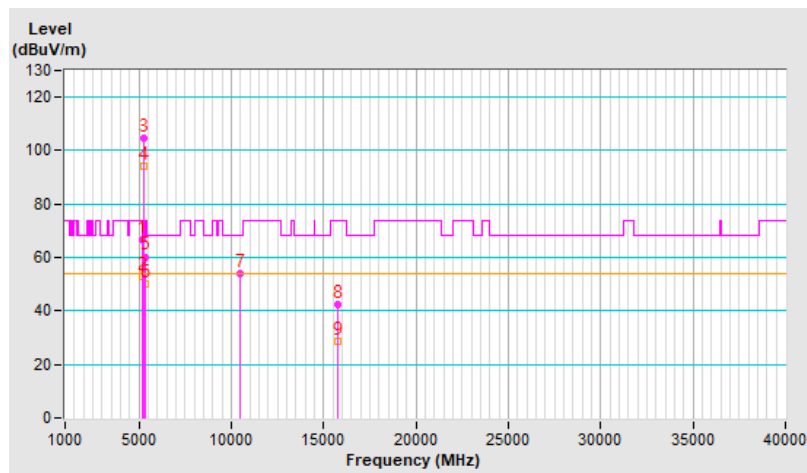

<b>RF Mode</b>	802.11ax (HE160)	<b>Channel</b>	CH 50 : 5250 MHz
<b>Frequency Range</b>	1 GHz ~ 40 GHz	<b>Detector Function &amp; Bandwidth</b>	PK: RB=1 MHz, VB=3 MHz, DET=Peak AV: RB=1 MHz, VB=1 kHz, DET=Peak
<b>Input Power</b>	120 Vac, 60 Hz	<b>Environmental Conditions</b>	24°C, 71% RH
<b>Tested By</b>	Louis Yang		

Antenna Polarity & Test Distance : Vertical at 3 m								
No	Frequency (MHz)	Emission Level (dBuV/m)	Limit (dBuV/m)	Margin (dB)	Antenna Height (m)	Table Angle (Degree)	Raw Value (dBuV)	Correction Factor (dB/m)
1	5150.00	63.9 PK	74.0	-10.1	1.84 V	84	60.5	3.4
2	5150.00	53.0 AV	54.0	-1.0	1.84 V	84	49.6	3.4
3	*5250.00	105.1 PK			1.84 V	84	102.5	2.6
4	*5250.00	95.7 AV			1.84 V	84	93.1	2.6
5	5350.00	64.0 PK	74.0	-10.0	1.84 V	84	61.2	2.8
6	5350.00	52.3 AV	54.0	-1.7	1.84 V	84	49.5	2.8
7	#10500.00	54.7 PK	68.2	-13.5	1.40 V	221	42.0	12.7
8	15750.00	42.4 PK	74.0	-31.6	1.54 V	342	30.9	11.5
9	15750.00	28.5 AV	54.0	-25.5	1.54 V	342	17.0	11.5

**Remarks:**

1. Emission Level(dBuV/m) = Raw Value(dBuV) + Correction Factor(dB/m)
2. Correction Factor(dB/m) = Antenna Factor(dB/m) + Cable Factor(dB) – Pre-Amplifier Factor(dB)
3. Margin value = Emission Level – Limit value
4. The other emission levels were very low against the limit.
5. " \* ": Fundamental frequency, the limit was restricted at the RF Output Power.
6. " # ": The radiated frequency is out of the restricted band.

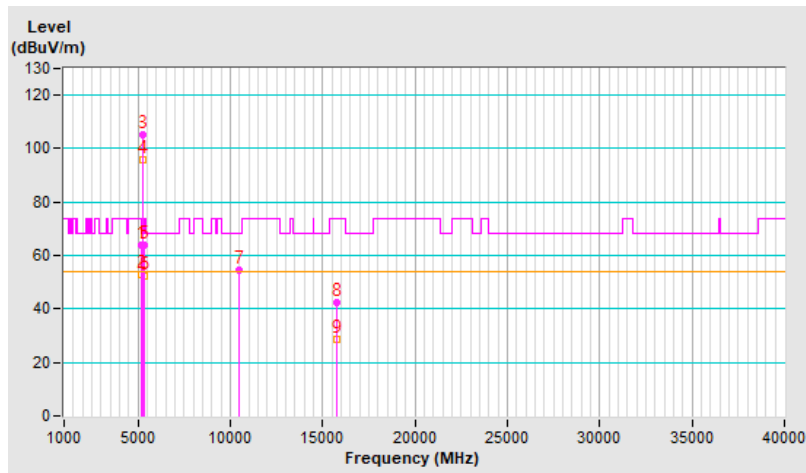

<b>RF Mode</b>	802.11ax (HE160)	<b>Channel</b>	CH 114 : 5570 MHz
<b>Frequency Range</b>	1 GHz ~ 40 GHz	<b>Detector Function &amp; Bandwidth</b>	PK: RB=1 MHz, VB=3 MHz, DET=Peak AV: RB=1 MHz, VB=1 kHz, DET=Peak
<b>Input Power</b>	120 Vac, 60 Hz	<b>Environmental Conditions</b>	24°C, 71% RH
<b>Tested By</b>	Louis Yang		

**Antenna Polarity & Test Distance : Horizontal at 3 m**

No	Frequency (MHz)	Emission Level (dBuV/m)	Limit (dBuV/m)	Margin (dB)	Antenna Height (m)	Table Angle (Degree)	Raw Value (dBuV)	Correction Factor (dB/m)
1	5457.06	62.0 PK	74.0	-12.0	1.74 H	88	59.1	2.9
2	5457.06	52.6 AV	54.0	-1.4	1.74 H	88	49.7	2.9
3	#5470.00	61.9 PK	68.2	-6.3	1.74 H	88	59.0	2.9
4	*5570.00	105.2 PK			1.74 H	88	102.5	2.7
5	*5570.00	95.4 AV			1.74 H	88	92.7	2.7
6	#5725.00	58.8 PK	68.2	-9.4	1.74 H	88	55.9	2.9
7	11140.00	55.9 PK	74.0	-18.1	1.43 H	224	42.6	13.3
8	11140.00	42.7 AV	54.0	-11.3	1.43 H	224	29.4	13.3
9	#16710.00	42.1 PK	68.2	-26.1	1.59 H	318	26.2	15.9

**Remarks:**

1. Emission Level(dBuV/m) = Raw Value(dBuV) + Correction Factor(dB/m)
2. Correction Factor(dB/m) = Antenna Factor(dB/m) + Cable Factor(dB) – Pre-Amplifier Factor(dB)
3. Margin value = Emission Level – Limit value
4. The other emission levels were very low against the limit.
5. " \* " : Fundamental frequency, the limit was restricted at the RF Output Power.
6. " # " : The radiated frequency is out of the restricted band.

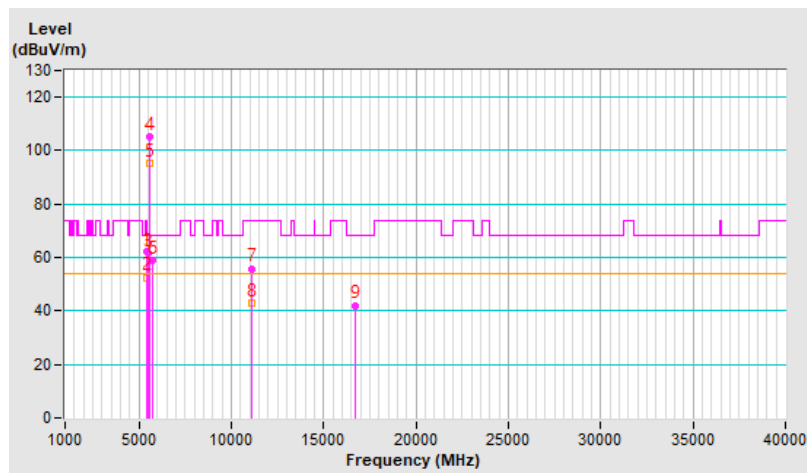



<b>RF Mode</b>	802.11ax (HE160)	<b>Channel</b>	CH 114 : 5570 MHz
<b>Frequency Range</b>	1 GHz ~ 40 GHz	<b>Detector Function &amp; Bandwidth</b>	PK: RB=1 MHz, VB=3 MHz, DET=Peak AV: RB=1 MHz, VB=1 kHz, DET=Peak
<b>Input Power</b>	120 Vac, 60 Hz	<b>Environmental Conditions</b>	24°C, 71% RH
<b>Tested By</b>	Louis Yang		

Antenna Polarity & Test Distance : Vertical at 3 m								
No	Frequency (MHz)	Emission Level (dBuV/m)	Limit (dBuV/m)	Margin (dB)	Antenna Height (m)	Table Angle (Degree)	Raw Value (dBuV)	Correction Factor (dB/m)
1	5434.26	64.2 PK	74.0	-9.8	1.85 V	78	61.4	2.8
2	5434.26	52.7 AV	54.0	-1.3	1.85 V	78	49.9	2.8
3	#5470.00	50.9 PK	68.2	-17.3	1.85 V	78	48.0	2.9
4	*5570.00	107.8 PK			1.85 V	78	105.1	2.7
5	*5570.00	96.7 AV			1.85 V	78	94.0	2.7
6	#5725.00	58.2 PK	68.2	-10.0	1.85 V	78	55.3	2.9
7	11140.00	55.4 PK	74.0	-18.6	1.39 V	224	42.1	13.3
8	11140.00	42.4 AV	54.0	-11.6	1.39 V	224	29.1	13.3
9	#16710.00	42.6 PK	68.2	-25.6	1.60 V	330	26.7	15.9

**Remarks:**

1. Emission Level(dBuV/m) = Raw Value(dBuV) + Correction Factor(dB/m)
2. Correction Factor(dB/m) = Antenna Factor(dB/m) + Cable Factor(dB) – Pre-Amplifier Factor(dB)
3. Margin value = Emission Level – Limit value
4. The other emission levels were very low against the limit.
5. " \* " : Fundamental frequency, the limit was restricted at the RF Output Power.
6. " # " : The radiated frequency is out of the restricted band.

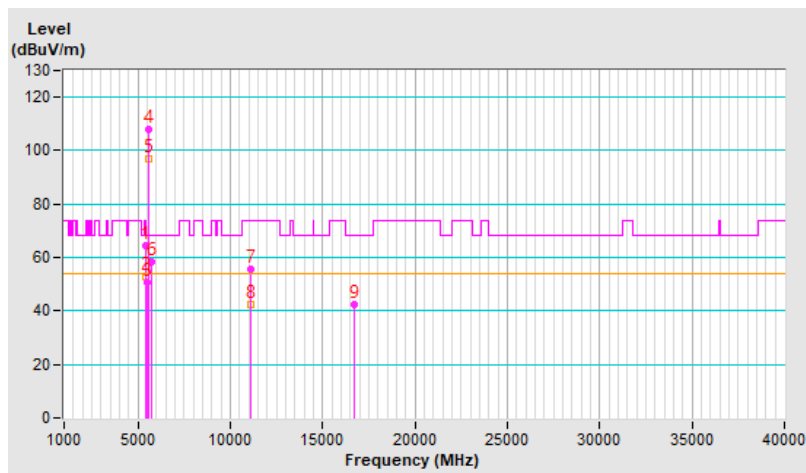

### Plot of Band Edge

Frequency Range	4.5 GHz ~ 5.46 GHz	Detector Function & Bandwidth	PK: RB=1 MHz, VB=3 MHz, DET=Peak AV: RB=1 MHz, VB=10 Hz, DET=Peak
-----------------	--------------------	-------------------------------	--

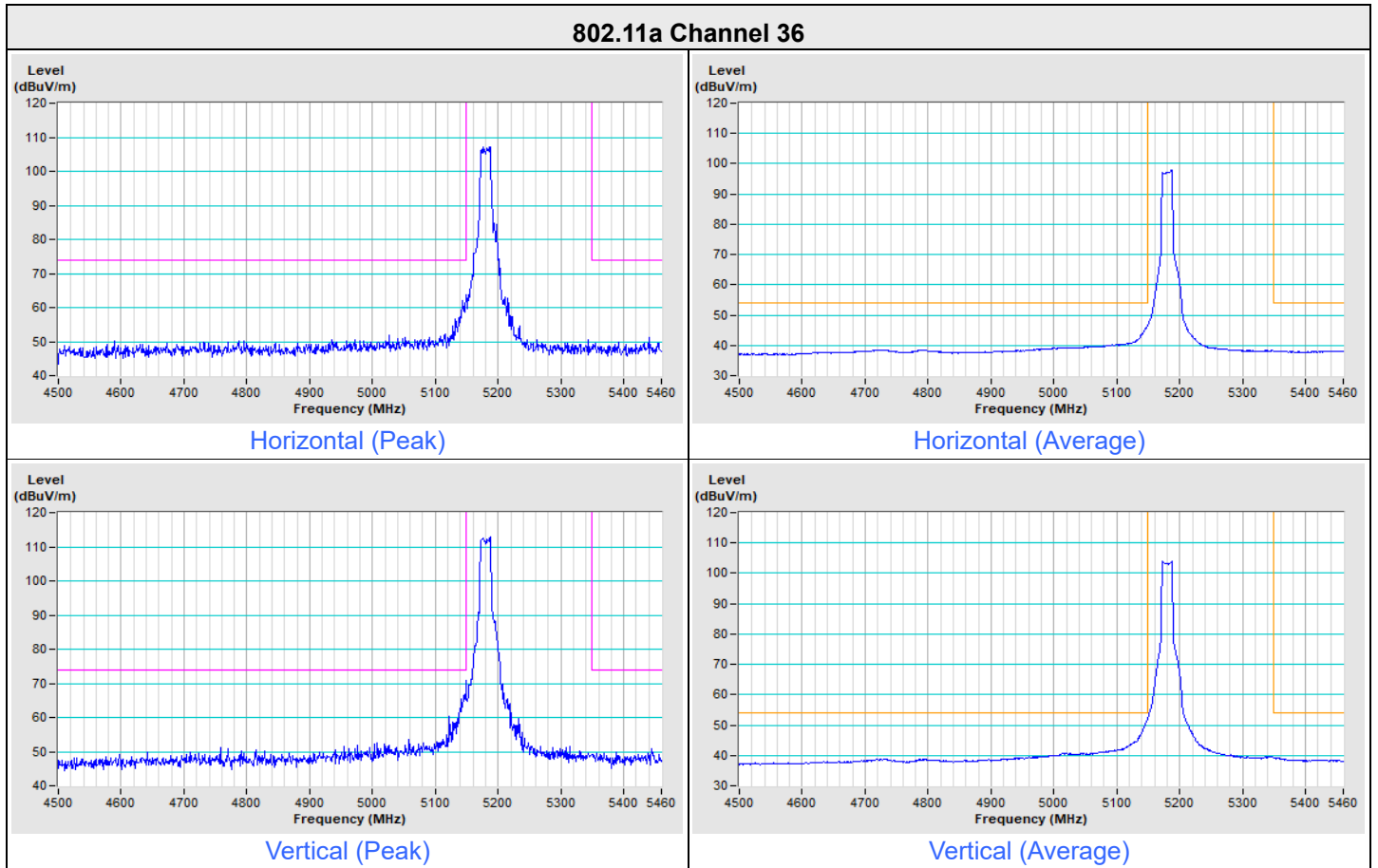

### 802.11a Channel 64

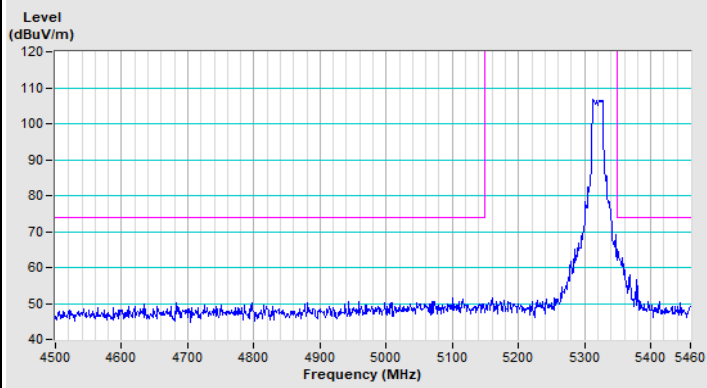

Horizontal (Peak)

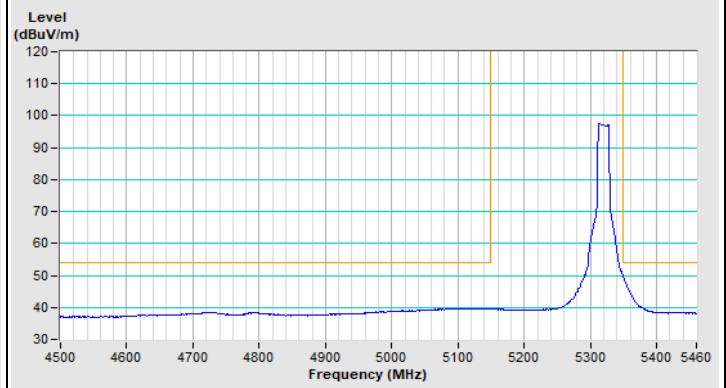

Horizontal (Average)

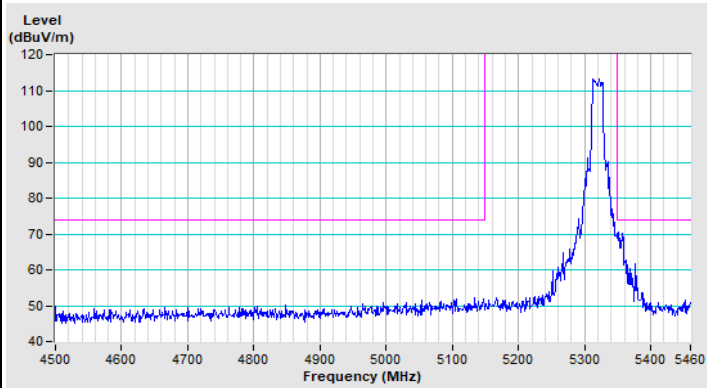

Vertical (Peak)

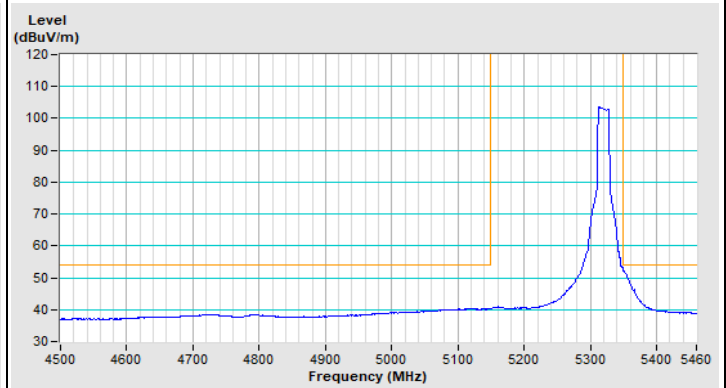

Vertical (Average)

### 802.11a Channel 100

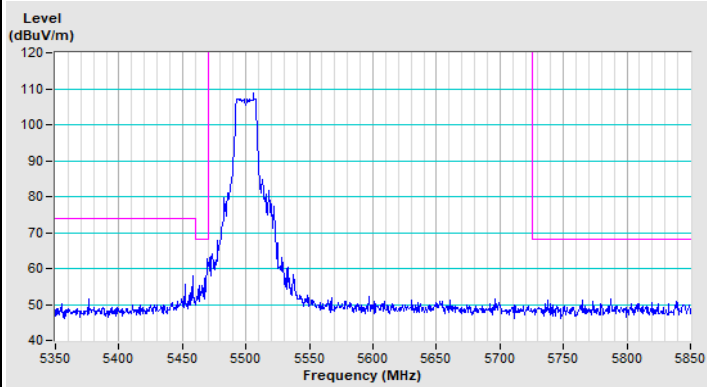

Horizontal (Peak)

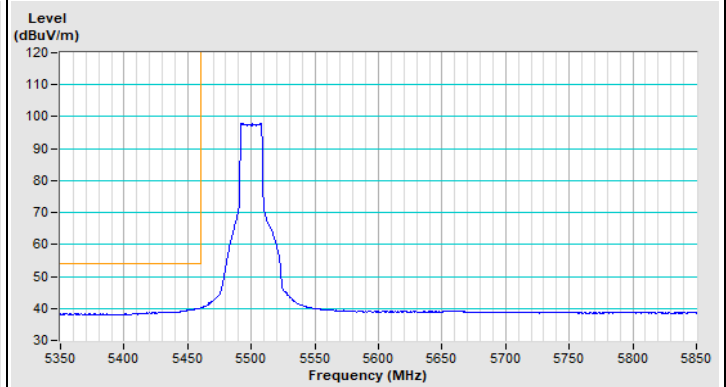

Horizontal (Average)

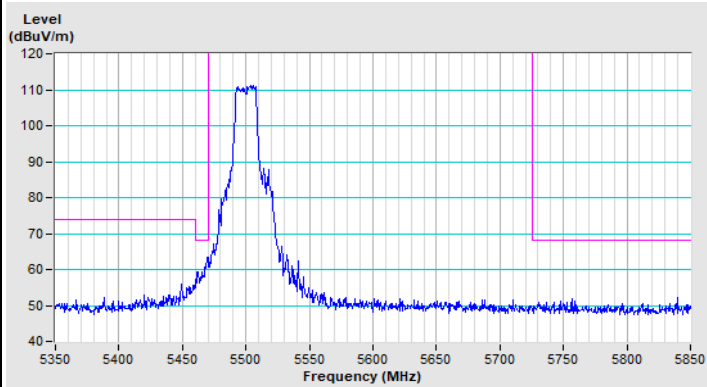

Vertical (Peak)

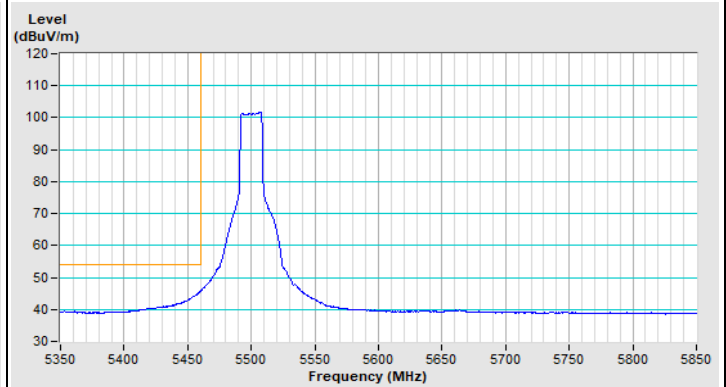

Vertical (Average)

### 802.11a Channel 149

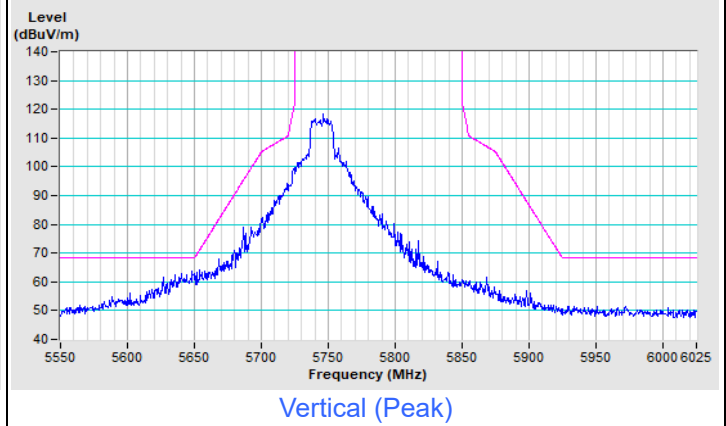
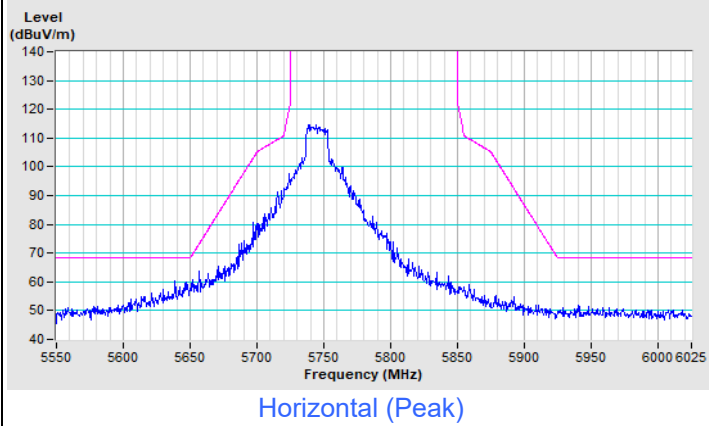

### 802.11a Channel 157

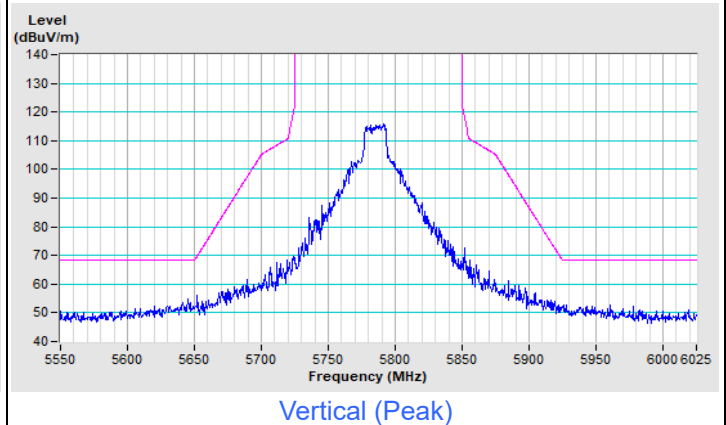
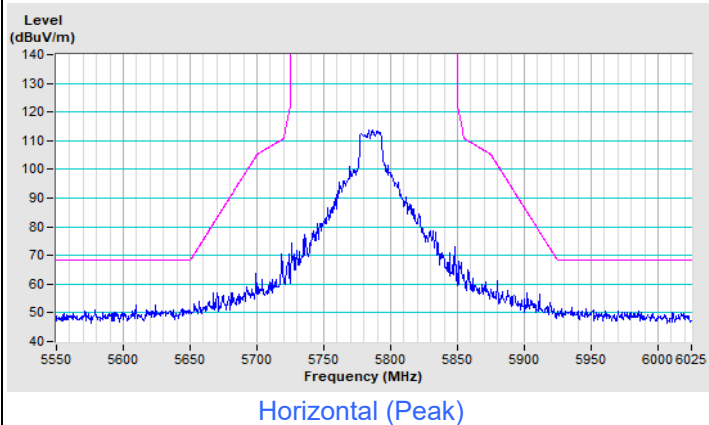

### 802.11a Channel 165

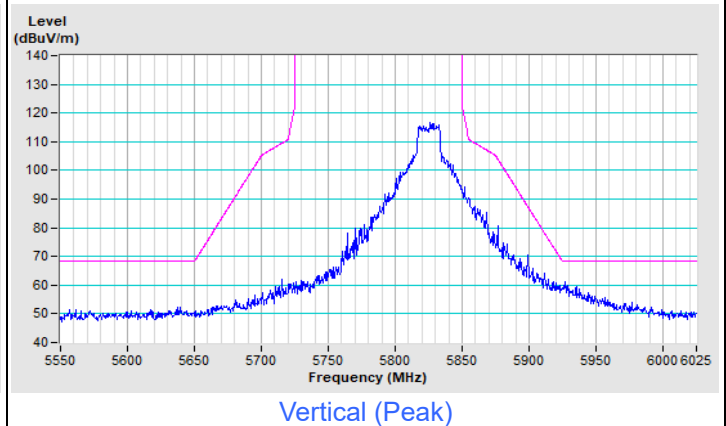
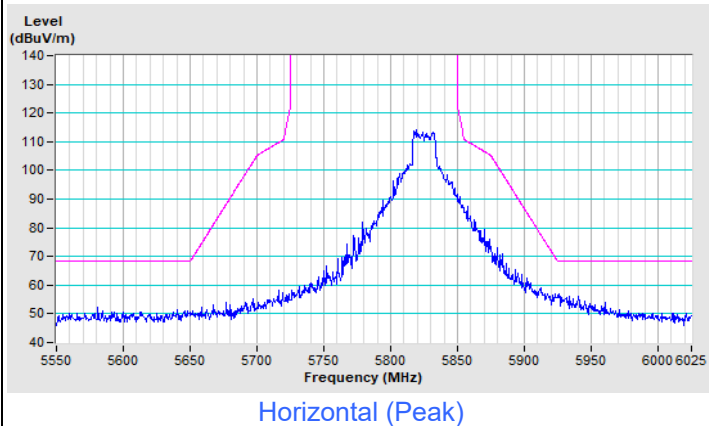

Frequency Range	4.5 GHz ~ 5.46 GHz	Detector Function & Bandwidth	PK: RB=1 MHz, VB=3 MHz, DET=Peak AV: RB=1 MHz, VB=10 Hz, DET=Peak
-----------------	--------------------	-------------------------------	--

### 802.11ax (HE20) Channel 36

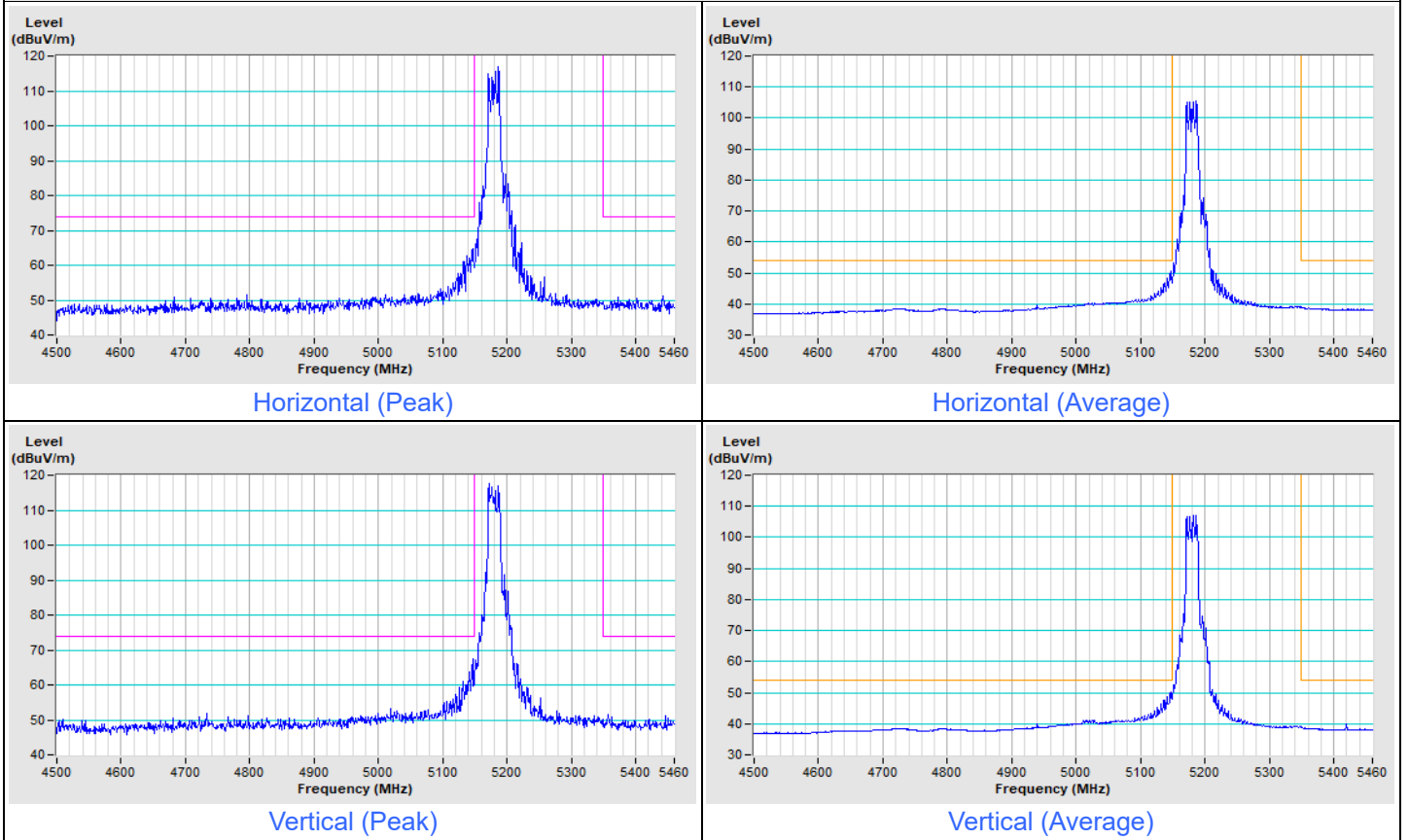

### 802.11ax (HE20) Channel 64

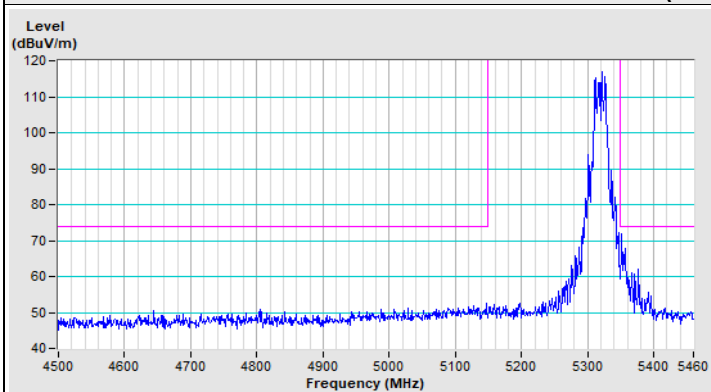

Horizontal (Peak)

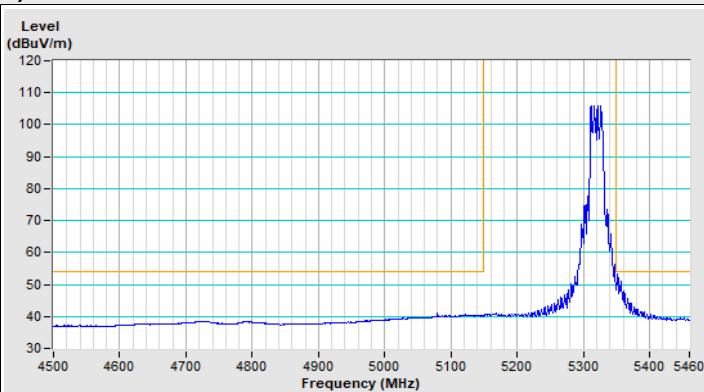

Horizontal (Average)

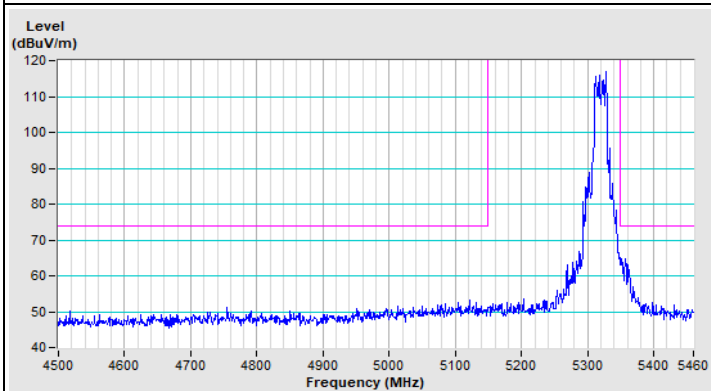

Vertical (Peak)

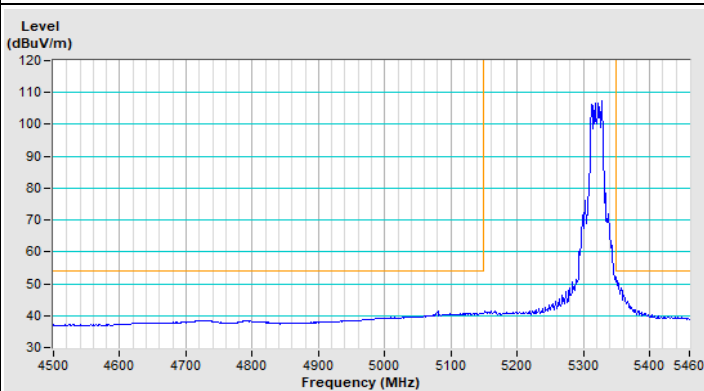

Vertical (Average)

### 802.11ax (HE20) Channel 100

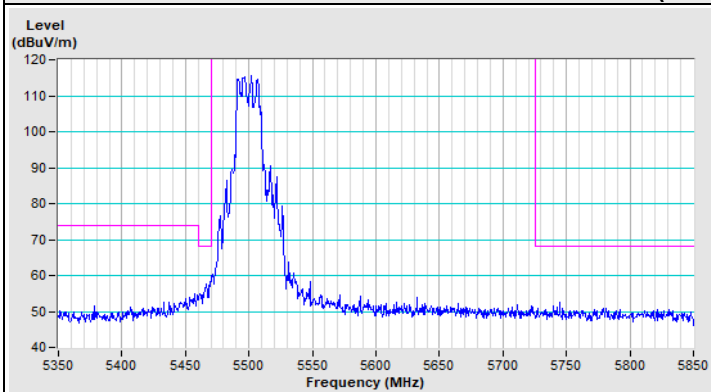

Horizontal (Peak)

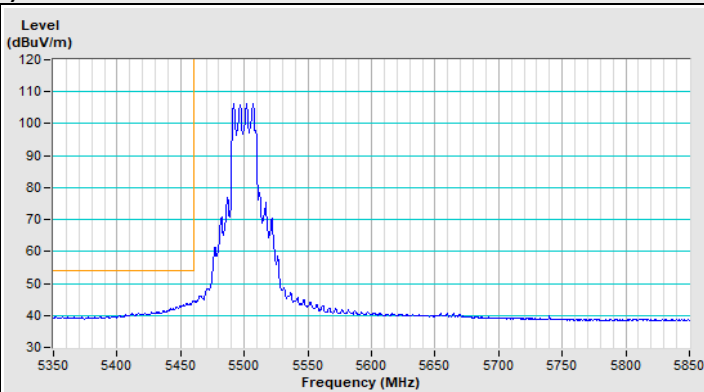

Horizontal (Average)

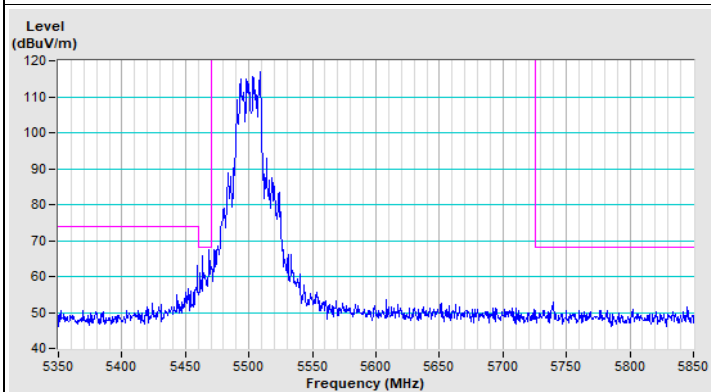

Vertical (Peak)

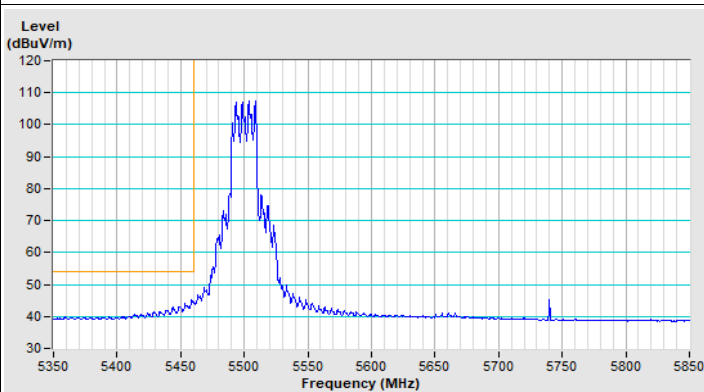

Vertical (Average)

### 802.11ax (HE20) Channel 149

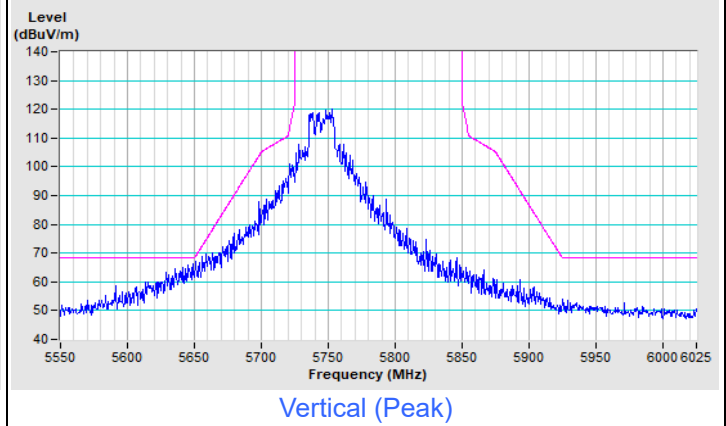
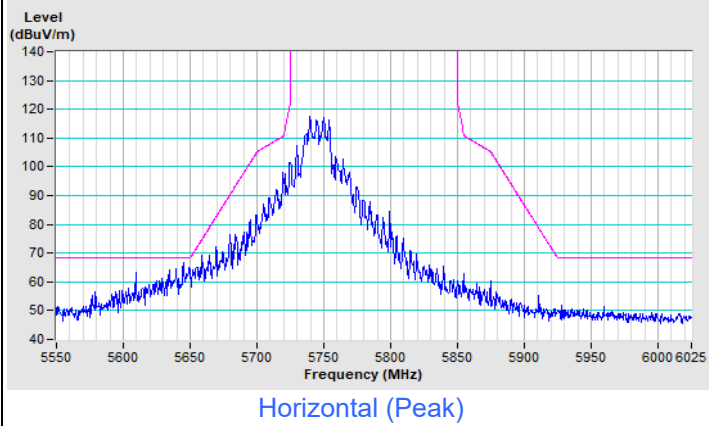

### 802.11ax (HE20) Channel 157

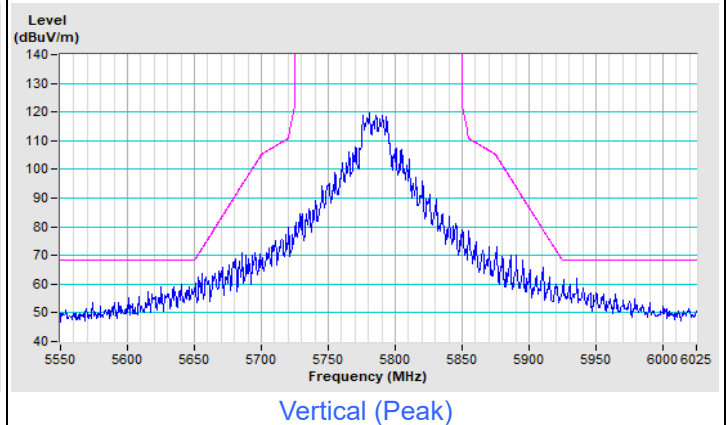
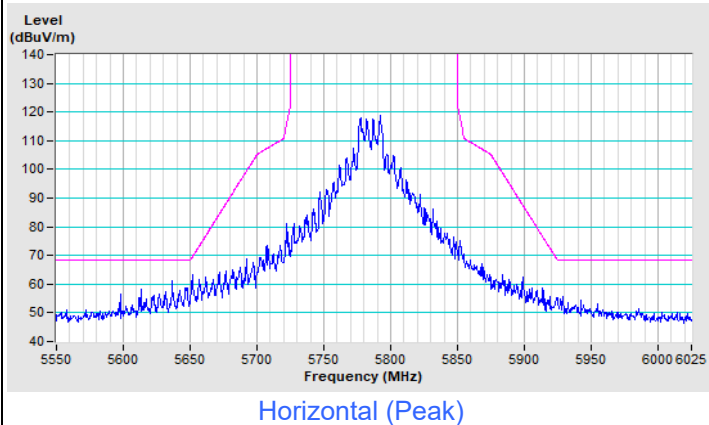

### 802.11ax (HE20) Channel 165

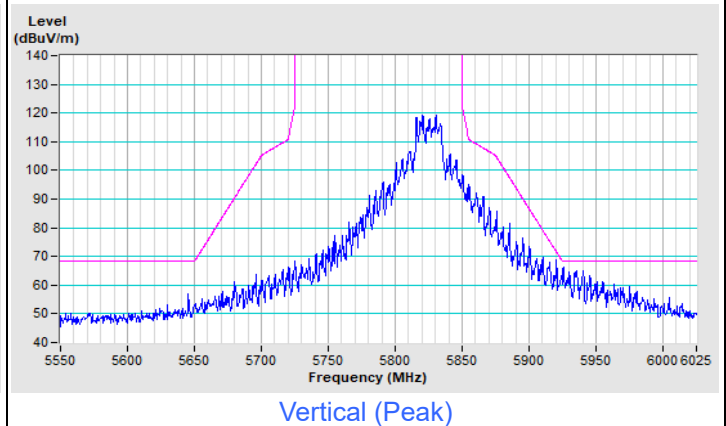
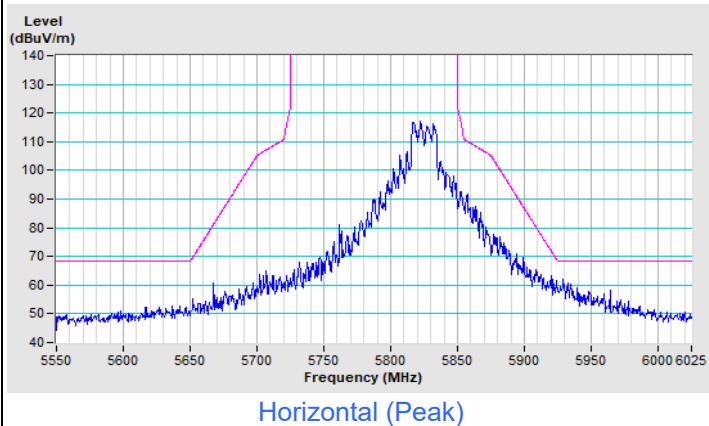

Frequency Range	4.5 GHz ~ 5.46 GHz	Detector Function & Bandwidth	PK: RB=1 MHz, VB=3 MHz, DET=Peak AV: RB=1 MHz, VB=10 Hz, DET=Peak
-----------------	--------------------	-------------------------------	--

**802.11ax (HE40) Channel 38**

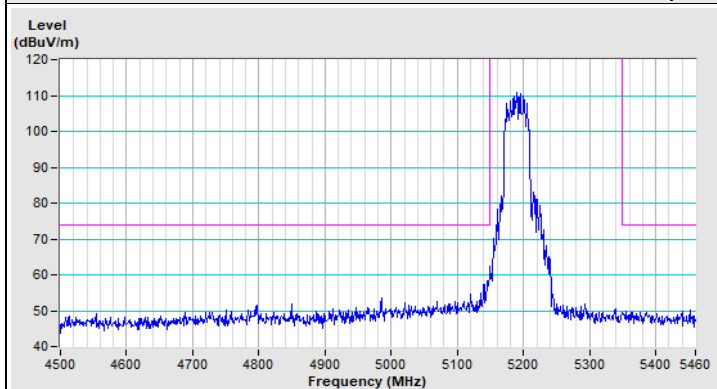

Horizontal (Peak)

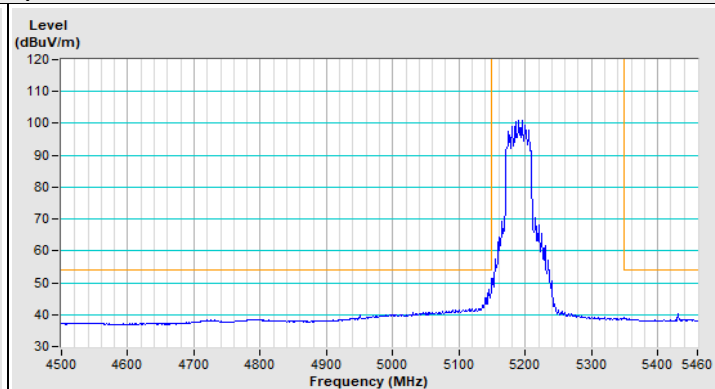

Horizontal (Average)

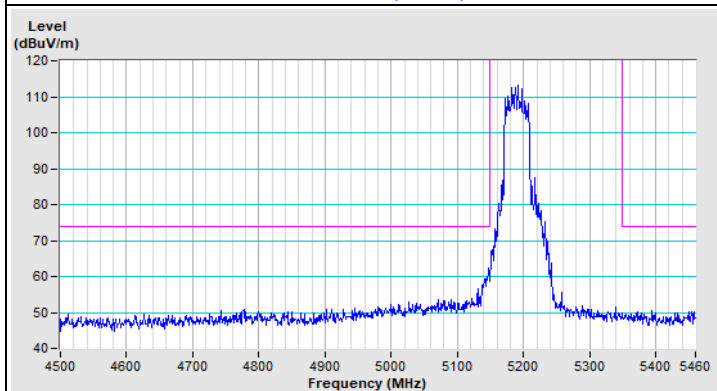

Vertical (Peak)

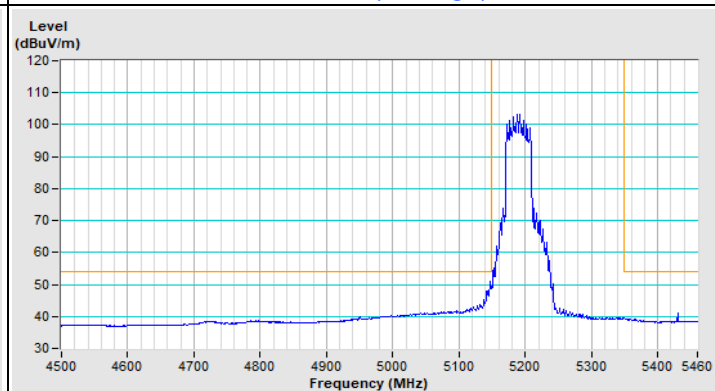

Vertical (Average)



### 802.11ax (HE40) Channel 62

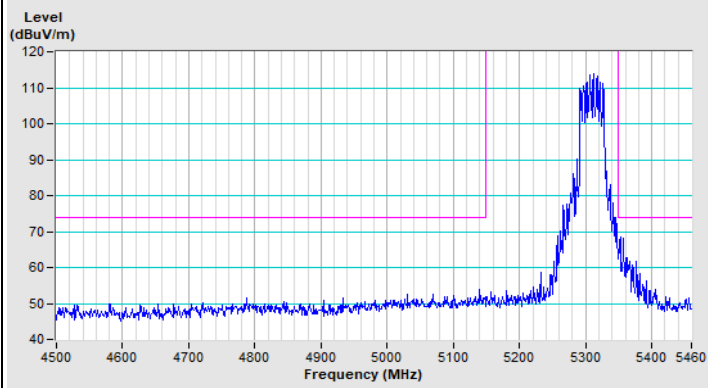

Horizontal (Peak)

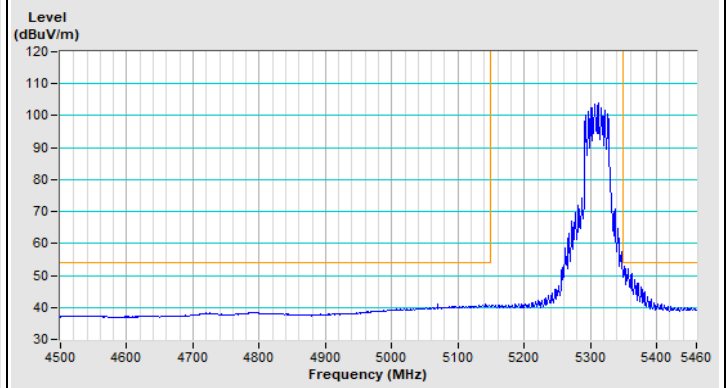

Horizontal (Average)

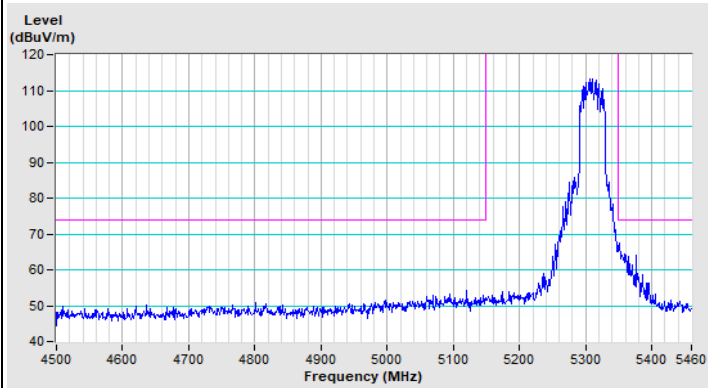

Vertical (Peak)

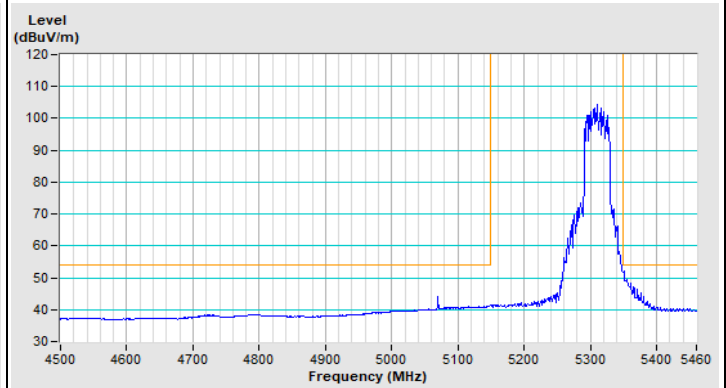

Vertical (Average)

### 802.11ax (HE40) Channel 102

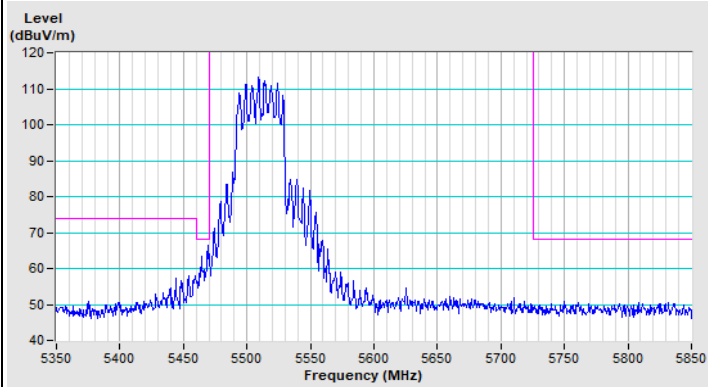

Horizontal (Peak)

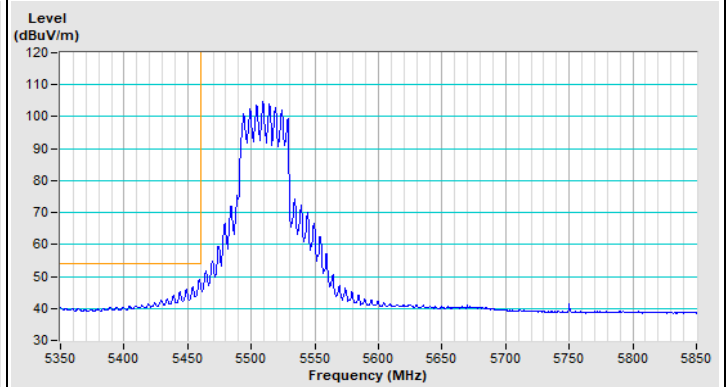

Horizontal (Average)

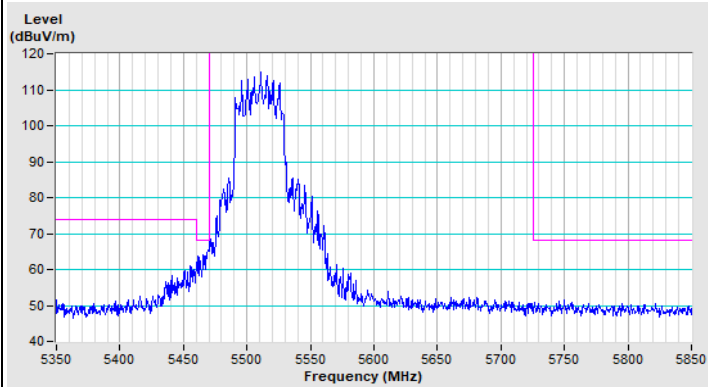

Vertical (Peak)

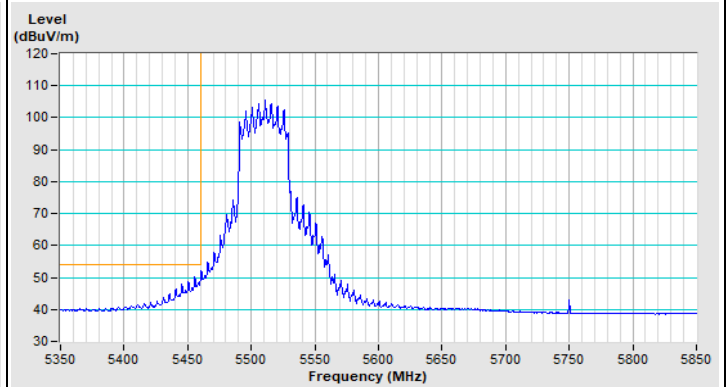

Vertical (Average)

### 802.11ax (HE40) Channel 151

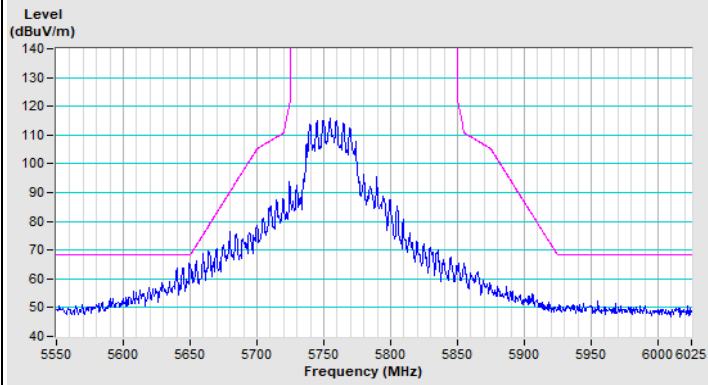

Horizontal (Peak)

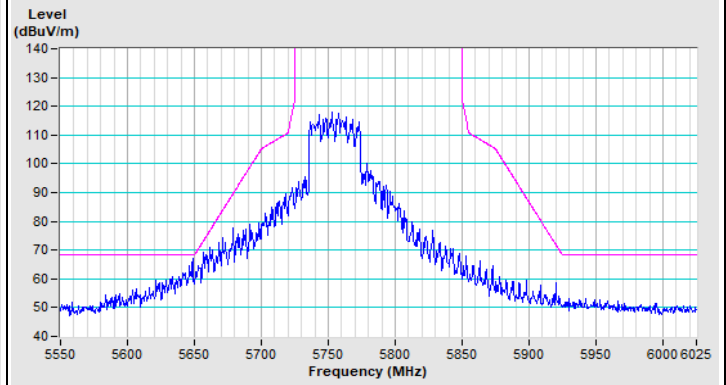

Vertical (Peak)

### 802.11ax (HE40) Channel 159

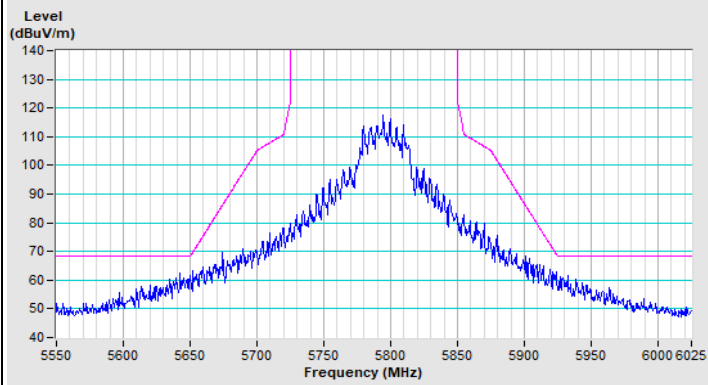

Horizontal (Peak)

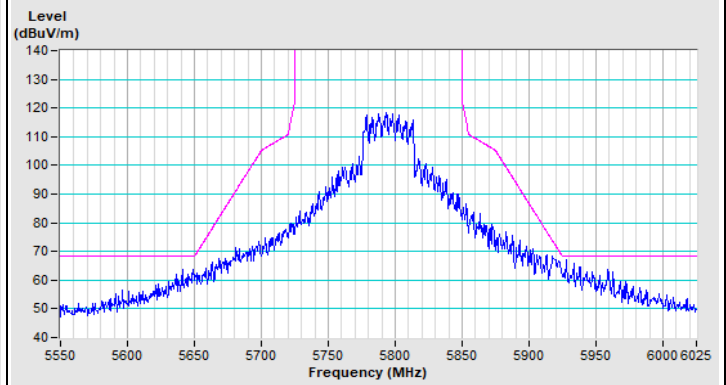

Vertical (Peak)

Frequency Range	4.5 GHz ~ 5.46 GHz	Detector Function & Bandwidth	PK: RB=1 MHz, VB=3 MHz, DET=Peak AV: RB=1 MHz, VB=10 Hz, DET=Peak
-----------------	--------------------	-------------------------------	--

**802.11ax (HE80) Channel 42**

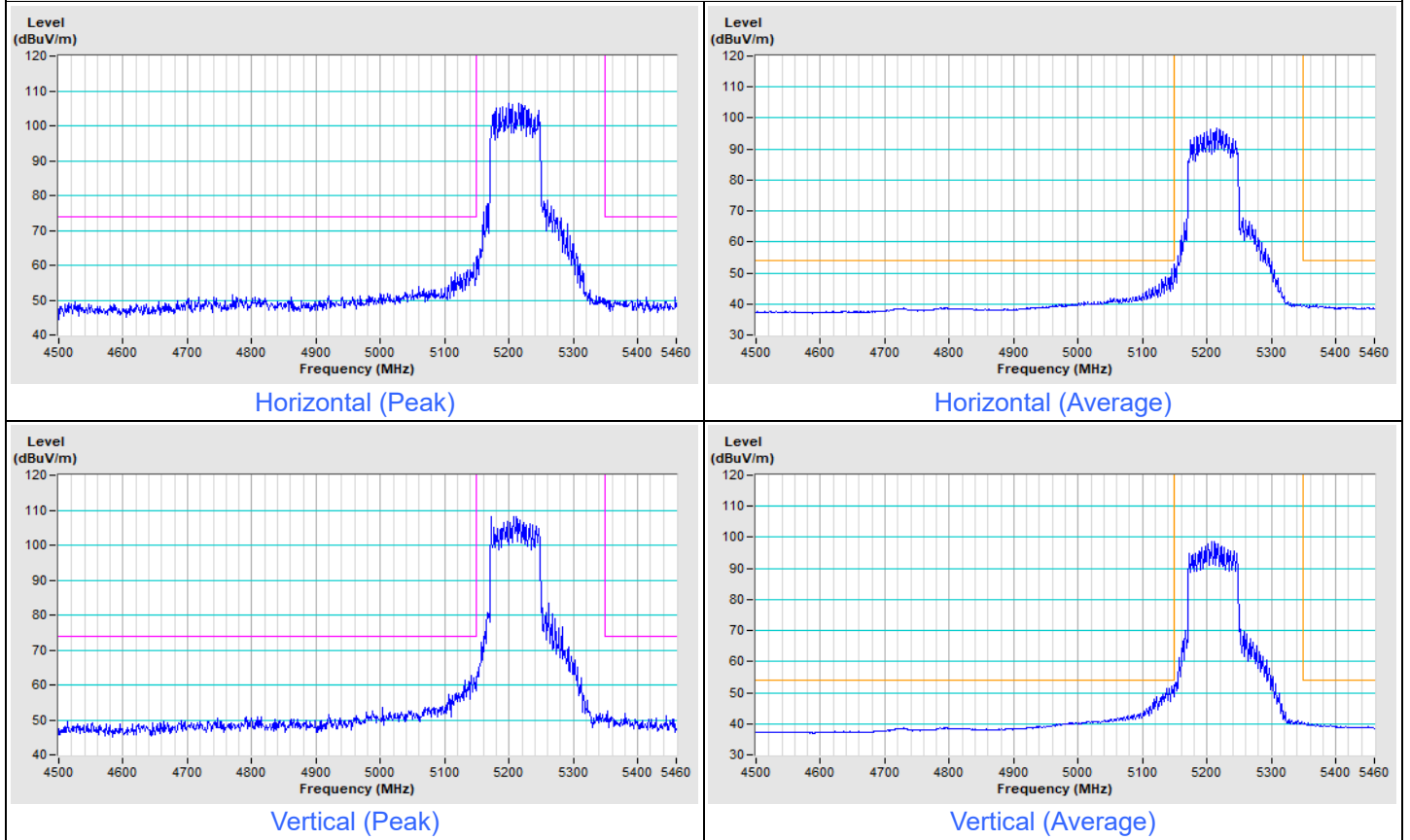

### 802.11ax (HE80) Channel 58

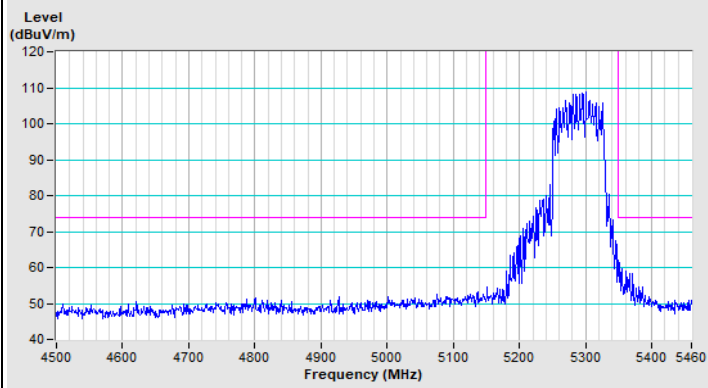

Horizontal (Peak)

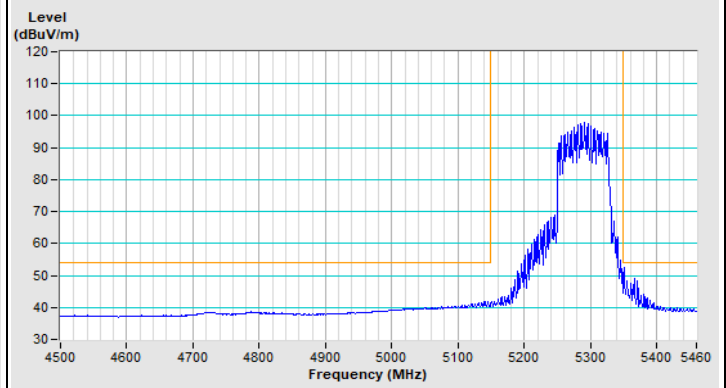

Horizontal (Average)

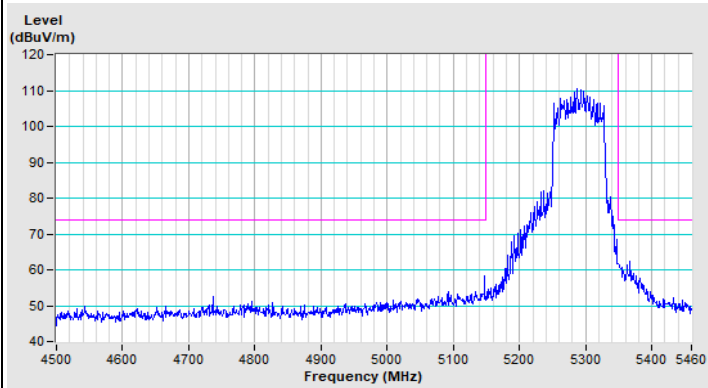

Vertical (Peak)

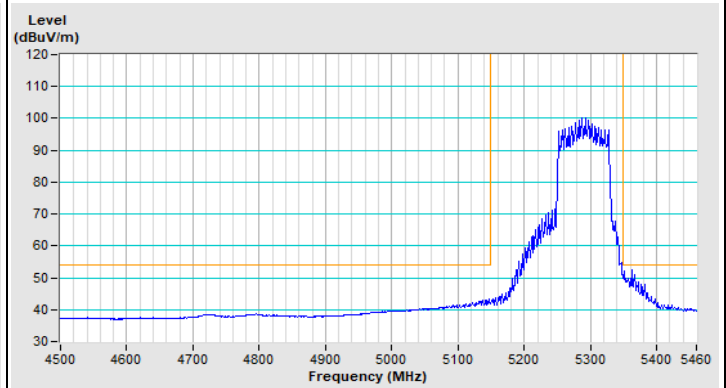

Vertical (Average)

### 802.11ax (HE80) Channel 106

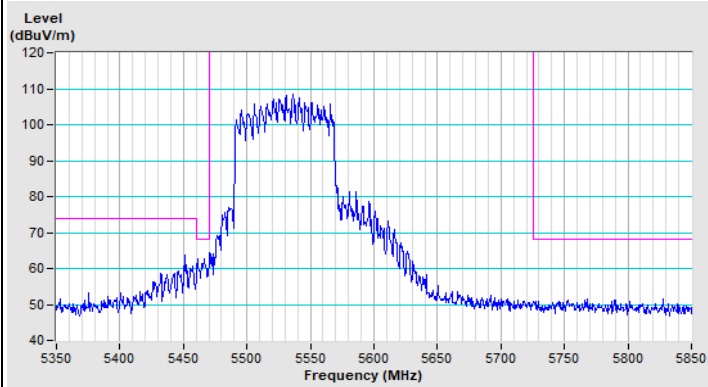

Horizontal (Peak)

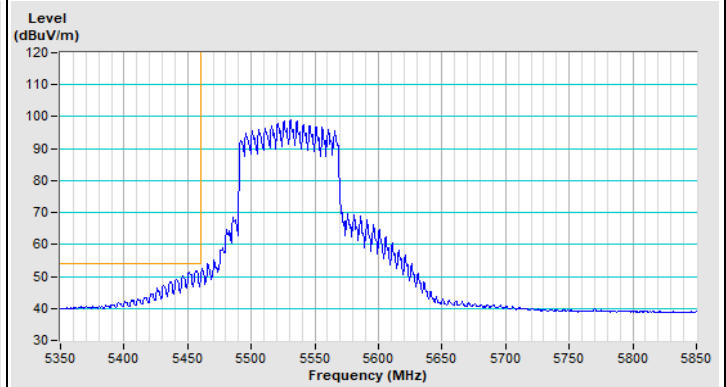

Horizontal (Average)

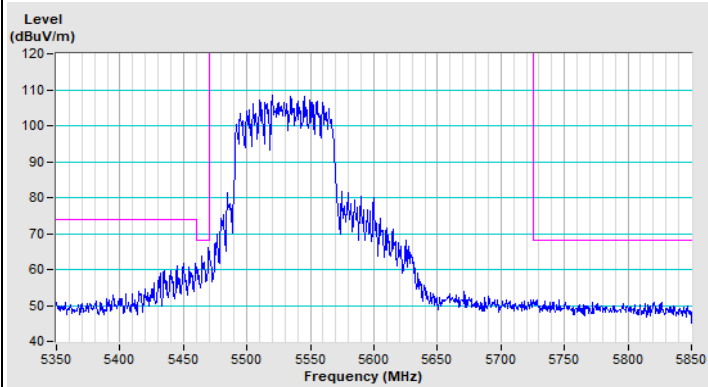

Vertical (Peak)

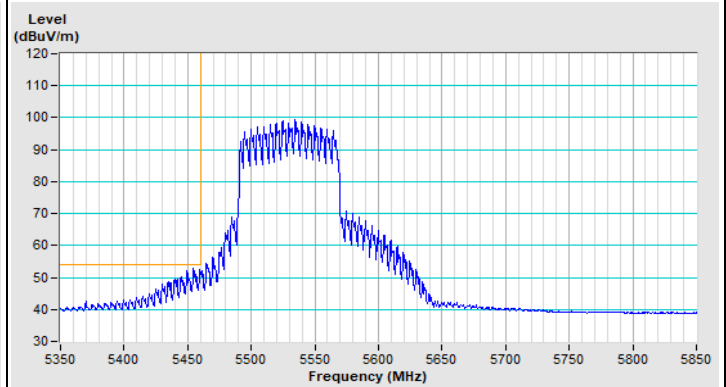

Vertical (Average)

### 802.11ax (HE80) Channel 155

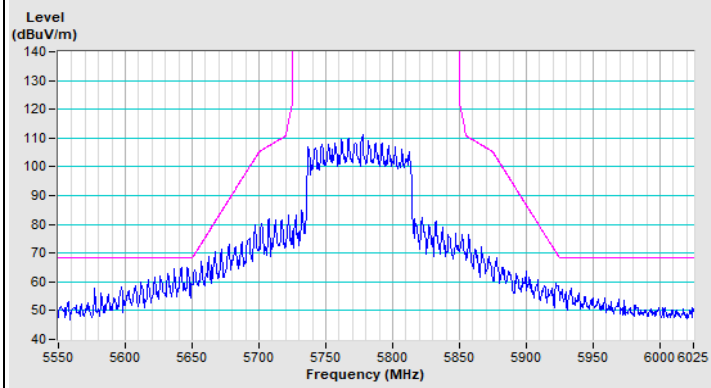

Horizontal (Peak)

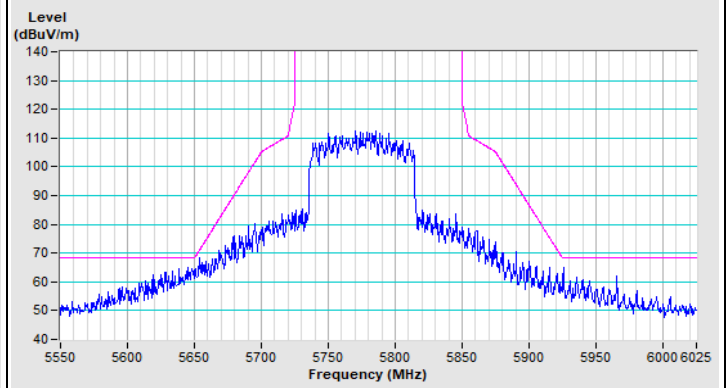

Vertical (Peak)

Frequency Range	4.5 GHz ~ 5.46 GHz	Detector Function & Bandwidth	PK: RB=1 MHz, VB=3 MHz, DET=Peak AV: RB=1 MHz, VB=1 kHz, DET=Peak
-----------------	--------------------	-------------------------------	--

### 802.11ax (HE160) Channel 50

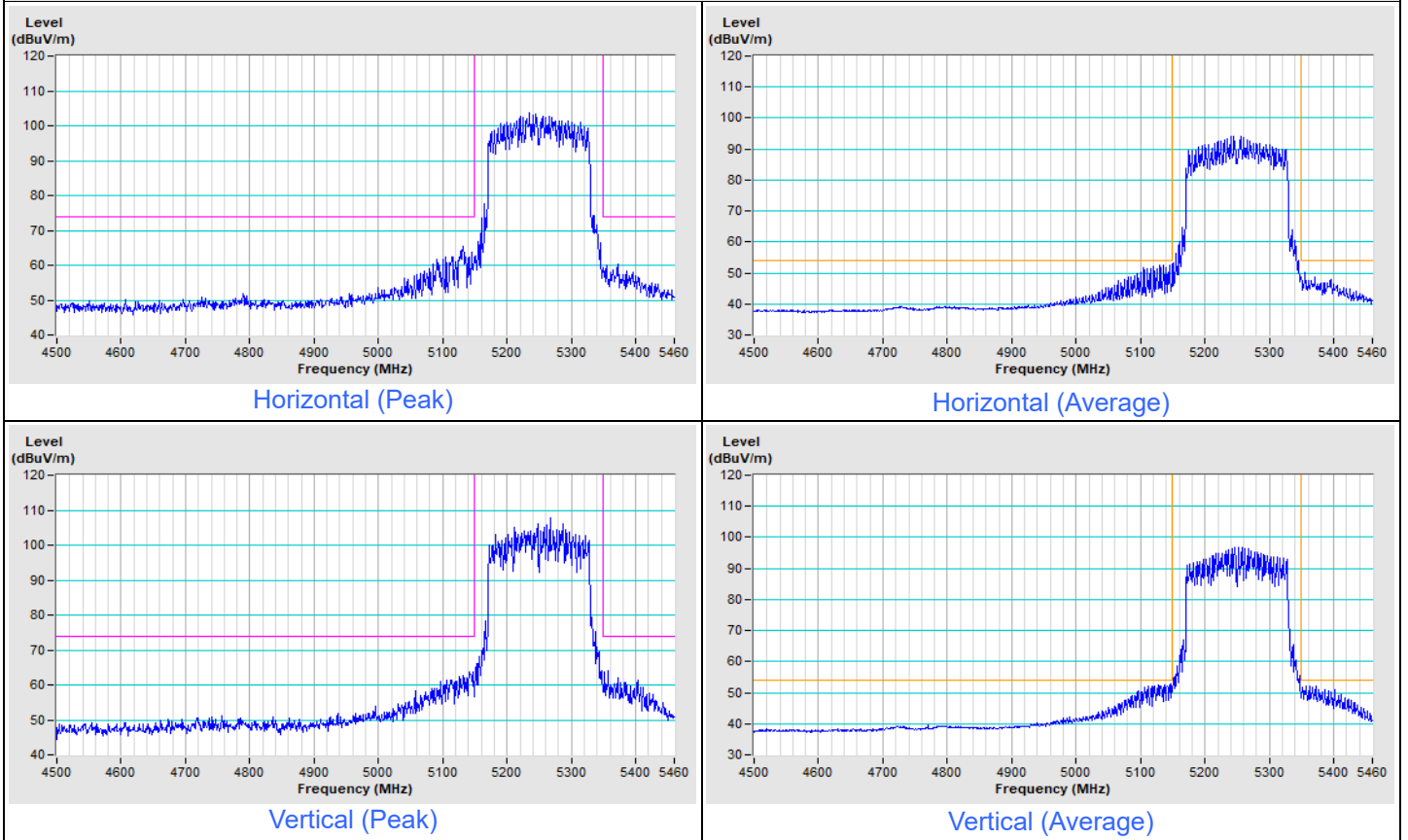

### 802.11ax (HE160) Channel 114

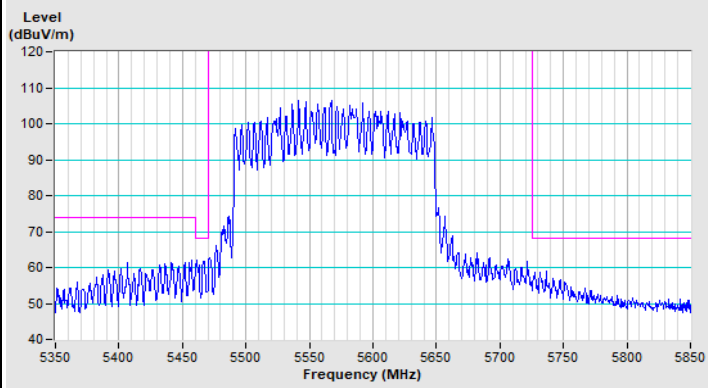

Horizontal (Peak)

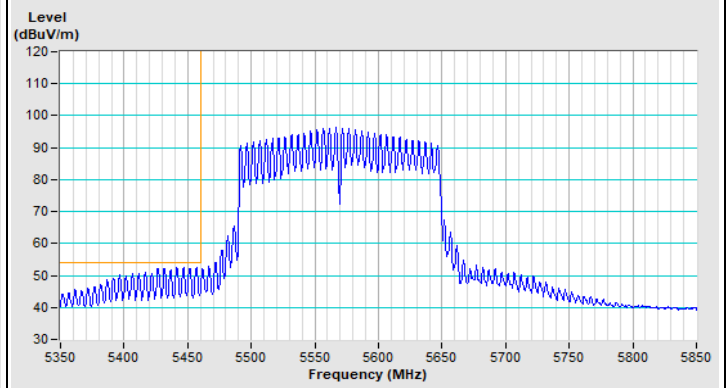

Horizontal (Average)

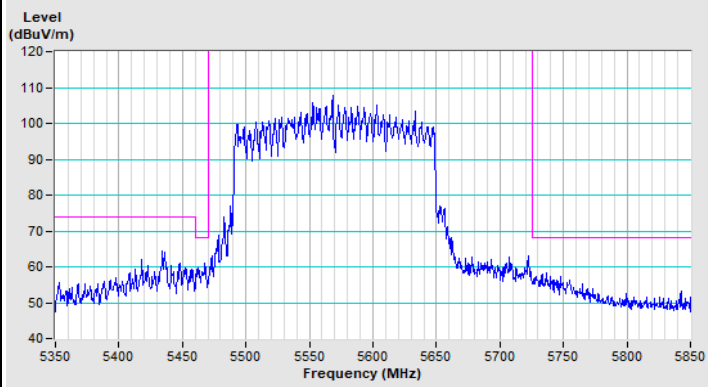

Vertical (Peak)

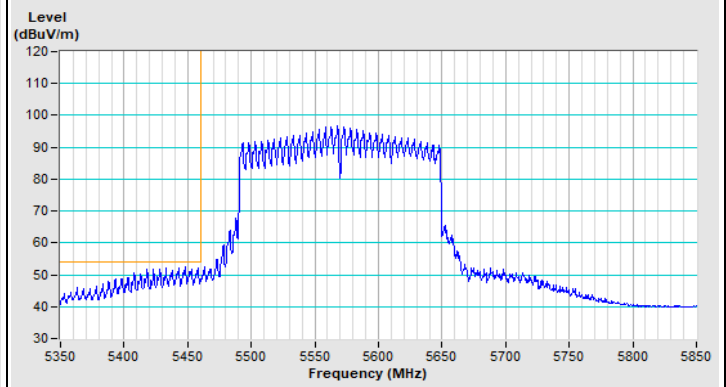

Vertical (Average)

## 8 Pictures of Test Arrangements

Please refer to the attached file (Test Setup Photo)



## 9 Information of the Testing Laboratories

We, Bureau Veritas Consumer Products Services (H.K.) Ltd., Taoyuan Branch, were founded in 1988 to provide our best service in EMC, Radio, Telecom and Safety consultation. Our laboratories are FCC recognized accredited test firms and accredited according to ISO/IEC 17025.

If you have any comments, please feel free to contact us at the following:

**Lin Kou EMC/RF Lab**

Tel: 886-2-26052180

Fax: 886-2-26051924

**Hsin Chu EMC/RF/Telecom Lab**

Tel: 886-3-6668565

Fax: 886-3-6668323

**Hwa Ya EMC/RF/Safety Lab**

Tel: 886-3-3183232

Fax: 886-3-3270892

**Email:** [service.adt@bureauveritas.com](mailto:service.adt@bureauveritas.com)

**Web Site:** <http://ee.bureauveritas.com.tw>

The address and road map of all our labs can be found in our web site also.

--- END ---