



# FCC TEST REPORT

**REPORT NO.:** RF920909H01B

**MODEL NO.:** ST180

**RECEIVED:** Feb. 17, 2004

**TESTED:** Mar. 12 to 13, 2004

**APPLICANT:** Arcadyan Technology Corporation

**ADDRESS:** 4F, No. 9, Park Avenue II, Science-based  
Industrial Park, Hsinchu 300, Taiwan, R.O.C.

**ISSUED BY:** Advance Data Technology Corporation

**LAB LOCATION:** No. 81-1, Lu Liao Keng, 9 Ling, Wu Lung Tsuen,  
Chiung Lin Hsiang, Hsin Chu Hsien,  
Taiwan, R.O.C.

This test report consists of 58 pages in total. It may be duplicated completely for legal use with the approval of the applicant. It should not be reproduced except in full, without the written approval of our laboratory. The test results in the report only apply to the tested sample.



0536  
ILAC MRA



## Table of Contents

1	CERTIFICATION.....	4
2	SUMMARY OF TEST RESULTS.....	5
3	GENERAL INFORMATION .....	6
3.1	GENERAL DESCRIPTION OF EUT.....	6
3.2	DESCRIPTION OF TEST MODES.....	7
3.3	GENERAL DESCRIPTION OF APPLIED STANDARDS .....	7
3.4	DESCRIPTION OF SUPPORT UNITS.....	8
4	TEST TYPES AND RESULTS.....	9
4.1	CONDUCTED EMISSION MEASUREMENT .....	9
4.1.1	LIMITS OF CONDUCTED EMISSION MEASUREMENT .....	9
4.1.2	TEST INSTRUMENTS .....	9
4.1.3	TEST SETUP.....	10
4.1.4	EUT OPERATING CONDITIONS.....	11
4.1.5	TEST RESULTS.....	12
4.2	RADIATED EMISSION MEASUREMENT .....	14
4.2.1	LIMITS OF RADIATED EMISSION MEASUREMENT .....	14
4.2.2	TEST INSTRUMENTS .....	15
4.2.3	TEST PROCEDURES.....	16
4.2.4	TEST SETUP.....	17
4.2.5	EUT OPERATING CONDITIONS.....	17
4.2.6	TEST RESULTS.....	18
4.2.7	TEST RESULTS - DSSS .....	19
4.2.8	TEST RESULTS -OFDM .....	22
4.3	6dB BANDWIDTH MEASUREMENT .....	25
4.3.1	LIMITS OF 6dB BANDWIDTH MEASUREMENT.....	25
4.3.2	TEST INSTRUMENTS .....	25
4.3.3	TEST PROCEDURE .....	26
4.3.4	TEST SETUP .....	26
4.3.5	EUT OPERATING CONDITIONS.....	26
4.3.6	TEST RESULTS-DSSS.....	27
4.3.7	TEST RESULTS-OFDM .....	31
4.4	MAXIMUM PEAK OUTPUT POWER .....	35
4.4.1	LIMITS OF MAXIMUM PEAK OUTPUT POWER MEASUREMENT .....	35
4.4.2	TEST INSTRUMENTS.....	35
4.4.3	TEST PROCEDURES.....	36



4.4.4	TEST SETUP.....	36
4.4.5	EUT OPERATING CONDITIONS.....	36
4.4.6	TEST RESULTS- DSSS.....	37
4.4.7	TEST RESULTS- OFDM.....	37
4.5	POWER SPECTRAL DENSITY MEASUREMENT.....	38
4.5.1	LIMITS OF POWER SPECTRAL DENSITY MEASUREMENT.....	38
4.5.2	TEST INSTRUMENTS.....	38
4.5.3	TEST PROCEDURE.....	39
4.5.4	TEST SETUP.....	39
4.5.5	EUT OPERATING CONDITIONS.....	39
4.5.6	TEST RESULTS-DSSS.....	40
4.5.7	TEST RESULTS-OFDM.....	44
4.6	BAND EDGES MEASUREMENT.....	48
4.6.1	LIMITS OF BAND EDGES MEASUREMENT.....	48
4.6.2	TEST INSTRUMENTS.....	48
4.6.3	TEST PROCEDURE.....	48
4.6.4	EUT OPERATING CONDITION.....	48
4.6.5	TEST RESULTS - DSSS.....	49
4.6.6	TEST RESULTS-OFDM.....	52
4.7	ANTENNA REQUIREMENT.....	55
4.7.1	STANDARD APPLICABLE.....	55
4.7.2	ANTENNA CONNECTED CONSTRUCTION.....	55
5	PHOTOGRAPHS OF THE TEST CONFIGURATION.....	56
6	INFORMATION ON THE TESTING LABORATORIES.....	58



## 1 CERTIFICATION

Reference No.: 930217H02

**PRODUCT :** SpeedTouch 180 Wireless Access Point  
**BRAND NAME :** THOMSON  
**MODEL NO. :** ST180  
**APPLICANT :** Arcadyan Technology Corporation  
**STANDARDS :** 47 CFR Part 15, Subpart C (Section 15.247),  
ANSI C63.4-1992

We, **Advance Data Technology Corporation**, hereby certify that one sample (Model: ST180) of the designation has been tested in our facility from Mar. 12 to 13, 2004. The test record, data evaluation and Equipment Under Test (EUT) configurations represented herein are true and accurate accounts of the measurements of the sample's characteristics under the conditions herein specified.

**PREPARED BY:** Amanda Chu, **DATE:** Mar. 23, 2004  
( Amanda Chu )

**APPROVED BY:** Eric Lin, **DATE:** Mar. 23, 2004  
( Eric Lin, Manager )



## 2 SUMMARY OF TEST RESULTS

The EUT has been tested according to the following specifications:

<b>APPLIED STANDARD: 47 CFR Part 15, Subpart C</b>			
<b>Standard Section</b>	<b>Test Type and Limit</b>	<b>Result</b>	<b>REMARK</b>
15.207	AC Power Conducted Emission Limit: 48dBuV	PASS	Meet the requirement of limit Minimum passing margin is -12.00 dBuV at 0.572 MHz
15.247(a)(2)	Spectrum Bandwidth of a Direct Sequence Spread Spectrum System Limit: min. 500kHz	PASS	Meet the requirement of limit
15.247(b)	Maximum Peak Output Power Limit: max. 30dBm	PASS	Meet the requirement of limit
15.247(c)	Transmitter Radiated Emissions Limit: Table 15.209	PASS	Meet the requirement of limit Minimum passing margin is -2.0 dBuV at 80.00 MHz
15.247(d)	Power Spectral Density Limit: max. 8dBm	PASS	Meet the requirement of limit
15.247(c)	Band Edge Measurement Limit: 20 dB less than the peak value of fundamental frequency	PASS	Meet the requirement of limit



### 3 GENERAL INFORMATION

#### 3.1 GENERAL DESCRIPTION OF EUT

<b>PRODUCT</b>	SpeedTouch 180 Wireless Access Point
<b>MODEL NO.</b>	ST180
<b>POWER SUPPLY</b>	5VDC from power adapter
<b>MODULATION TYPE</b>	CCK, OFDM, DBPSK, DQPSK
<b>RADIO TECHNOLOGY</b>	DSSS, OFDM
<b>TRANSFER RATE</b>	1/2/5.5/6/9/11/12/18/24/36/48/54Mbps
<b>FREQUENCY RANGE</b>	2412MHz ~ 2462MHz
<b>NUMBER OF CHANNEL</b>	11
<b>OUTPUT POWER</b>	21.50dBm
<b>ANTENNA TYPE</b>	Dipole Antenna
<b>DATA CABLE</b>	NA
<b>I/O PORT</b>	LAN (RJ-45 port x1)
<b>ASSOCIATED DEVICES</b>	NA

**NOTE:**

1. The EUT was powered by the following power adapter:

<b>Brand:</b>	DVE
<b>Model No.:</b>	DSA-0151A-05 A
<b>Input power :</b>	100-120Vac 50-60Hz 40VA
<b>Output power :</b>	5Vdc 2.4A

2. The EUT operates in the 2.4GHz frequency spectrum with throughput of up to 54Mbps.
3. The EUT complies with IEEE 802.11g draft standards, and backwards compatible with IEEE 802.11b products.
4. For a more detailed features description, please refer to the manufacturer's specifications or User's Manual.



### 3.2 DESCRIPTION OF TEST MODES

Eleven channels are provided in this EUT.

Channel	Frequency	Channel	Frequency
1	2412 MHz	7	2442 MHz
2	2417 MHz	8	2447 MHz
3	2422 MHz	9	2452 MHz
4	2427 MHz	10	2457 MHz
5	2432 MHz	11	2462 MHz
6	2437 MHz		

**NOTE:**

1. Below 1 GHz, the channel 1, 6, and 11 were pre-tested in chamber. The channel 11, worst case one, was chosen for final test.
2. Above 1 GHz, the channel 1, 6, and 11 were tested individually.
3. Test result, which were mentioned on section 3.1.
4. Transfer rate, 11Mbps with CCK technique and 6Mbps with OFDM technique, the worst case, were chosen for final test.

### 3.3 GENERAL DESCRIPTION OF APPLIED STANDARDS

The EUT is a SpeedTouch 180 Wireless Access Point. According to the specifications of the manufacturer, it must comply with the requirements of the following standards:

**47 CFR Part 15, Subpart C. (15.247)**  
**ANSI C63.4 : 1992**

All tests have been performed and recorded as per the above standards.

**NOTE:** The EUT is also considered as a kind of computer peripheral, because the connection to computer is necessary for typical use. It has been verified to comply with the requirements of 47 CFR Part 15, Subpart B, Class B (DoC). The test report has been issued separately.



### 3.4 DESCRIPTION OF SUPPORT UNITS

The EUT has been tested as an independent unit together with other necessary accessories or support units. The following support units or accessories were used to form a representative test configuration during the tests.

No.	Product	Brand	Model No.	Serial No.	FCC ID
1	NOTEBOOK COMPUTER	DELL	PP01L	TW-09C748-12800-1A3-1999	FCC DoC

No.	Signal cable description
1	NA

Note: 1. All power cords of the above support units are unshielded (1.8m).

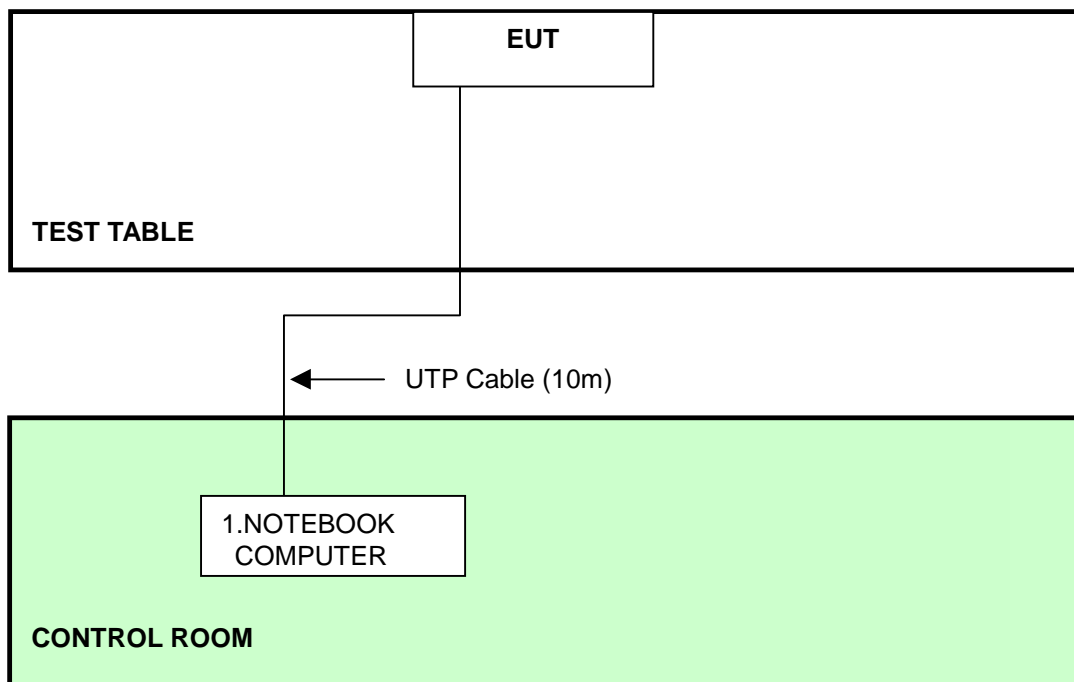

**NOTE:** 1. Support unit 1 was kept in the control room during the test.  
 2. Please refer to the photos of test configuration in Item 5 also.





## 4 TEST TYPES AND RESULTS

### 4.1 CONDUCTED EMISSION MEASUREMENT

#### 4.1.1 LIMITS OF CONDUCTED EMISSION MEASUREMENT

FREQUENCY OF EMISSION (MHz)	CONDUCTED LIMIT (dB $\mu$ V)	
	Quasi-peak	Average
0.15-0.5	66 to 56	56 to 46
0.5-5	56	46
5-30	60	50

**NOTE:**

1. The lower limit shall apply at the transition frequencies.
2. All emanations from a class B digital device or system, including any network of conductors and apparatus connected thereto, shall not exceed the level of field strengths specified above.

#### 4.1.2 TEST INSTRUMENTS

DESCRIPTION & MANUFACTURER	MODEL NO.	SERIAL NO.	CALIBRATED UNTIL
ROHDE & SCHWARZ Test Receiver	ESCS 30	847124/029	Dec. 04, 2004
ROHDE & SCHWARZ LISN (for EUT)	ESHS-Z5	848773/004	Nov. 04, 2004
KYORITSU LISN (for peripheral)	KNW-407	8/1395/12	Jul. 27, 2004
RF Cable (JETBAO)	RG233/U	Cable_CA_01	Jul. 03, 2004
Terminator(for KYORITSU)	50	3	Apr. 11, 2004
Software	Cond-V2e	NA	NA

- NOTE: 1. The calibration interval of the above test instruments is 12 months and the calibrations are traceable to NML/ROC and NIST/USA.  
 2. The test was performed in ADT Shielded Room No. A.  
 3. The VCCI Con A Registration No. is C-817.

### 3. TEST PROCEDURES

- a. The EUT was placed 0.4 meters from the conducting wall of the shielded room with EUT being connected to the power mains through a line impedance stabilization network (LISN). Other support units were connected to the power mains through another LISN. The two LISNs provide 50 ohm/ 50uH of coupling impedance for the measuring instrument.
- b. Both lines of the power mains connected to the EUT were checked for maximum conducted interference.
- c. The frequency range from 150 kHz to 30 MHz was searched. Emission levels over 10dB under the prescribed limits could not be reported

#### 4.1.3 TEST SETUP

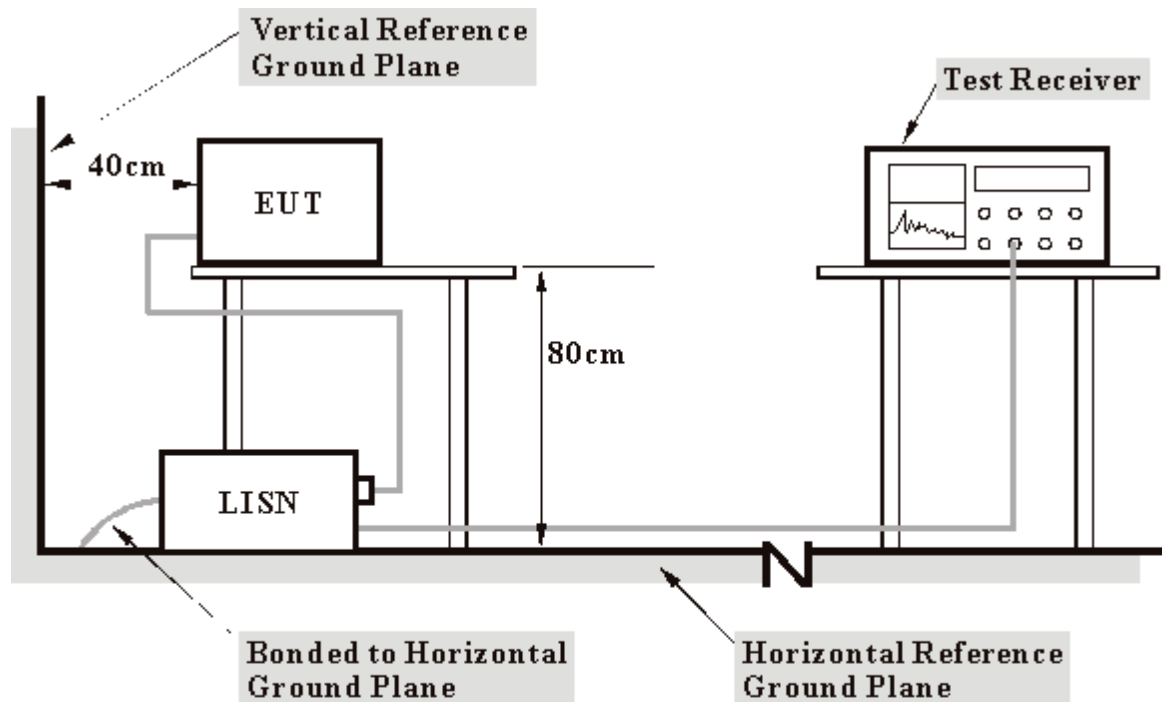

- Note:**
1. Support units were connected to second LISN.
  2. Both of LISNs (AMN) 80 cm from EUT and at the least 80 cm from other units and other metal planes support units.

For the actual test configuration, please refer to the related item – Photographs of the Test Configuration.



#### 4.1.4 EUT OPERATING CONDITIONS

- a. Connected the EUT to a notebook system placed on a testing table.
- b. The computer system ran hyperterminal program to enable EUT under transmission/receiving condition continuously at specific channel frequency.
- c. The notebook system sent "H" messages to its screen.
- d. The notebook system sent "H" messages to modem.
- e. The notebook system sent "H" messages to printer, and the printer prints them on paper.
- f. Repeat c ~ e.



4.1.5 TEST RESULTS

<b>EUT</b>	SpeedTouch 180 Wireless Access Point	<b>MODEL</b>	ST180
<b>MODE</b>	Channel 11	<b>6dB BANDWIDTH</b>	9 kHz
<b>INPUT POWER (SYSTEM)</b>	120Vac, 60 Hz	<b>PHASE</b>	Line (L)
<b>ENVIRONMENTAL CONDITIONS</b>	24 deg. C, 58%RH, 975 hPa	<b>TESTED BY</b>	Eric Lee

No	Freq. [MHz]	Corr. Factor (dB)	Reading Value [dB (uV)]		Emission Level [dB (uV)]		Limit [dB (uV)]		Margin (dB)	
			Q.P.	AV.	Q.P.	AV.	Q.P.	AV.	Q.P.	AV.
1	0.229	0.20	49.12	-	49.32	-	62.50	52.50	-13.18	-
2	0.459	0.21	39.71	-	39.92	-	56.72	46.72	-16.80	-
<b>3</b>	<b>0.572</b>	<b>0.23</b>	<b>43.77</b>	-	<b>44.00</b>	-	<b>56.00</b>	<b>46.00</b>	<b>-12.00</b>	-
4	0.689	0.25	41.81	-	42.06	-	56.00	46.00	-13.94	-
5	0.916	0.29	40.28	-	40.57	-	56.00	46.00	-15.43	-
6	2.193	0.31	32.81	-	33.12	-	56.00	46.00	-22.88	-

- NOTES: (1) "-": Undetectable  
 (2) Q.P. and AV. are abbreviations of quasi-peak and average.  
 (3) "-": The Quasi-peak reading value also meets an average limit, thus measurement with the average detector is unnecessary.  
 (4) The emission levels of other frequencies were very low against the limit.  
 (5) Correction Factor = Insertion loss + Cable loss  
 (6) Margin value = Emission level - Limit value

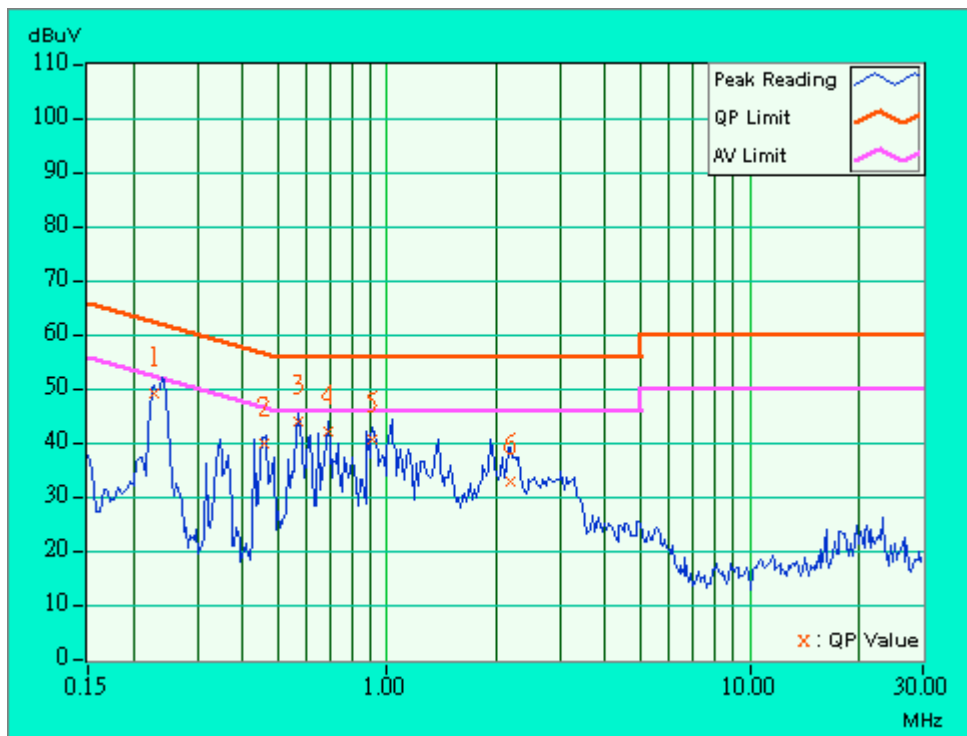



<b>EUT</b>	SpeedTouch 180 Wireless Access Point	<b>MODEL</b>	ST180
<b>MODE</b>	Channel 11	<b>6dB BANDWIDTH</b>	9 kHz
<b>INPUT POWER (SYSTEM)</b>	120Vac, 60 Hz	<b>PHASE</b>	Neutral (N)
<b>ENVIRONMENTAL CONDITIONS</b>	24 deg. C, 58%RH, 975 hPa	<b>TESTED BY</b>	Eric Lee

No	Freq. [MHz]	Corr. Factor (dB)	Reading Value [dB (uV)]		Emission Level [dB (uV)]		Limit [dB (uV)]		Margin (dB)	
			Q.P.	AV.	Q.P.	AV.	Q.P.	AV.	Q.P.	AV.
1	0.228	0.20	46.85	-	47.05	-	62.52	52.52	-15.47	-
2	0.455	0.21	38.36	-	38.57	-	56.79	46.79	-18.22	-
3	0.689	0.25	40.52	-	40.77	-	56.00	46.00	-15.23	-
4	0.916	0.29	39.46	-	39.75	-	56.00	46.00	-16.25	-
5	1.033	0.30	40.64	-	40.94	-	56.00	46.00	-15.06	-
6	2.181	0.31	35.27	-	35.58	-	56.00	46.00	-20.42	-

- NOTES: (1) "x": Undetectable  
 (2) Q.P. and AV. are abbreviations of quasi-peak and average.  
 (3) "-": The Quasi-peak reading value also meets an average limit, thus measurement with the average detector is unnecessary.  
 (4) The emission levels of other frequencies were very low against the limit.  
 (5) Correction Factor = Insertion loss + Cable loss  
 (6) Margin value = Emission level - Limit value

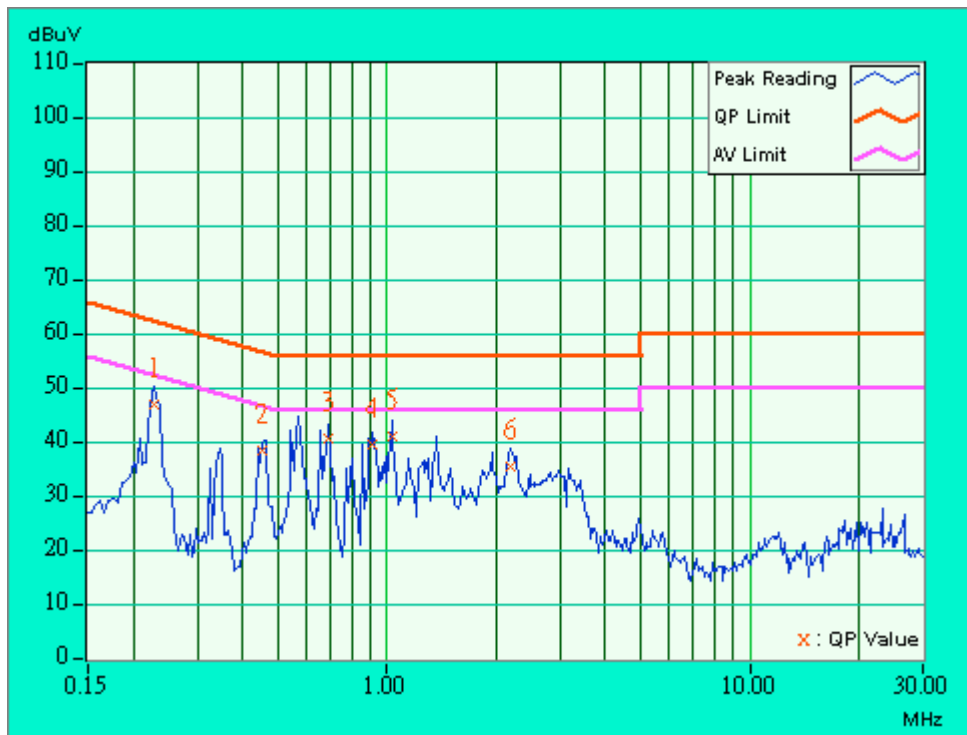



## 4.2 RADIATED EMISSION MEASUREMENT

### 4.2.1 LIMITS OF RADIATED EMISSION MEASUREMENT

Field strength limits are at the distance of 3 meters, emissions radiated outside of the specified bands, shall be according to the general radiated limits in 15.209 as following:

Frequencies (MHz)	Field Strength of Fundamental	
	uV/m	dBuV/m
30-88	100	40.0
88-216	150	43.5
216-960	200	46.0
Above 960	500	54.0

**NOTE:**

1. The lower limit shall apply at the transition frequencies.
2. Emission level (dBuV/m) = 20 log Emission level (uV/m).
3. As shown in 15.35(b), for frequencies above 1000MHz, the field strength limits are based on average detector, however, the peak field strength of any emission shall not exceed the maximum permitted average limits, specified above by more than 20dB under any condition of modulation.



#### 4.2.2 TEST INSTRUMENTS

DESCRIPTION & MANUFACTURER	MODEL NO.	SERIAL NO.	CALIBRATED UNTIL
HP Spectrum Analyzer	8594ER	3829U04676	Aug. 30, 2004
ADVANTEST Spectrum Analyzer	R3271A	85060311	Jun. 16, 2004
CHASE RF Pre_Amplifier	CPA9232	1057	May. 10, 2004
HP Pre_Amplifier	8449B	3008A01922	Oct. 13, 2004
ROHDE & SCHWARZ Test Receiver	ESVS 10	849231 /019	Sep. 30, 2004
CHASE Broadband Antenna	CBL6111c	2730	Jul 30, 2004
Schwarzbeck Horn_Antenna	3115	5619	Jul. 17, 2004
Schwarzbeck Horn_Antenna	BBHA 9170	BBHA9170192	Feb. 16, 2005
SCHWARZBECK Tunable Dipole Antenna	UHAP	897	Mar. 07, 2005
SCHWARZBECK Tunable Dipole Antenna	VHAP	880	Mar. 07, 2005
RF Switches (ARNITSU)	CS-201	1565157	Dec. 01, 2004
RF CABLE (Chaintek) 1GHz-20GHz	SF102	22054-2	Feb. 10. 2005
RF Cable(RICHTEC)	9913-30M	STCCAB-30M- 1GHz-021	Dec. 01, 2004
Software	AS60P8	NA	NA
CHANCE MOST Antenna Tower	AT-100	0203	NA
CHANCE MOST Turn Table	TT-100	0203	NA

Note: 1. The calibration interval of the above test instruments is 12 months (36 months for Tunable Dipole Antenna) and the calibrations are traceable to NML/ROC and NIST/USA.

2. \* = These equipment are used for the final measurement.
3. The horn antenna and HP preamplifier (model: 8449B) are used only for the measurement of emission frequency above 1GHz if tested.
4. The test was performed in ADT Open Site No. C.
5. The FCC Site Registration No. is 656396.
6. The VCCI Site Registration No. is R-1626.
7. The CANADA Site Registration No. is IC 4824-3.



#### 4.2.3 TEST PROCEDURES

- a. The EUT was placed on the top of a rotating table 0.8 meters above the ground at a 10 meter open area test site. The table was rotated 360 degrees to determine the position of the highest radiation.
- b. The EUT was set 3 meters away from the interference-receiving antenna, which was mounted on the top of a variable-height antenna tower.
- c. The antenna is a broadband antenna, and its height is varied from one meter to four meters above the ground to determine the maximum value of the field strength. Both horizontal and vertical polarizations of the antenna are set to make the measurement.
- d. For each suspected emission, the EUT was arranged to its worst case and then the antenna was tuned to heights from 1 meter to 4 meters and the rotatable table was turned from 0 degrees to 360 degrees to find the maximum reading.
- e. The test-receiver system was set to Peak Detect Function and Specified Bandwidth with Maximum Hold Mode.
- f. If the emission level of the EUT in peak mode was 10 dB lower than the limit specified, then testing could be stopped and the peak values of the EUT would be reported. Otherwise the emissions that did not have 10 dB margin would be re-tested one by one using peak, quasi-peak or average method as specified and then reported in a data sheet.

**NOTE:**

1. The resolution bandwidth and video bandwidth of test receiver/spectrum analyzer is 120kHz for Peak detection (PK) and Quasi-peak detection (QP) at frequency below 1GHz.
2. The resolution bandwidth and video bandwidth of test receiver/spectrum analyzer is 1 MHz for Peak detection at frequency above 1GHz.
3. The resolution bandwidth of test receiver/spectrum analyzer is 1 MHz and the video bandwidth is 300 Hz for Average detection (AV) at frequency above 1GHz.



#### 4.2.4 TEST SETUP

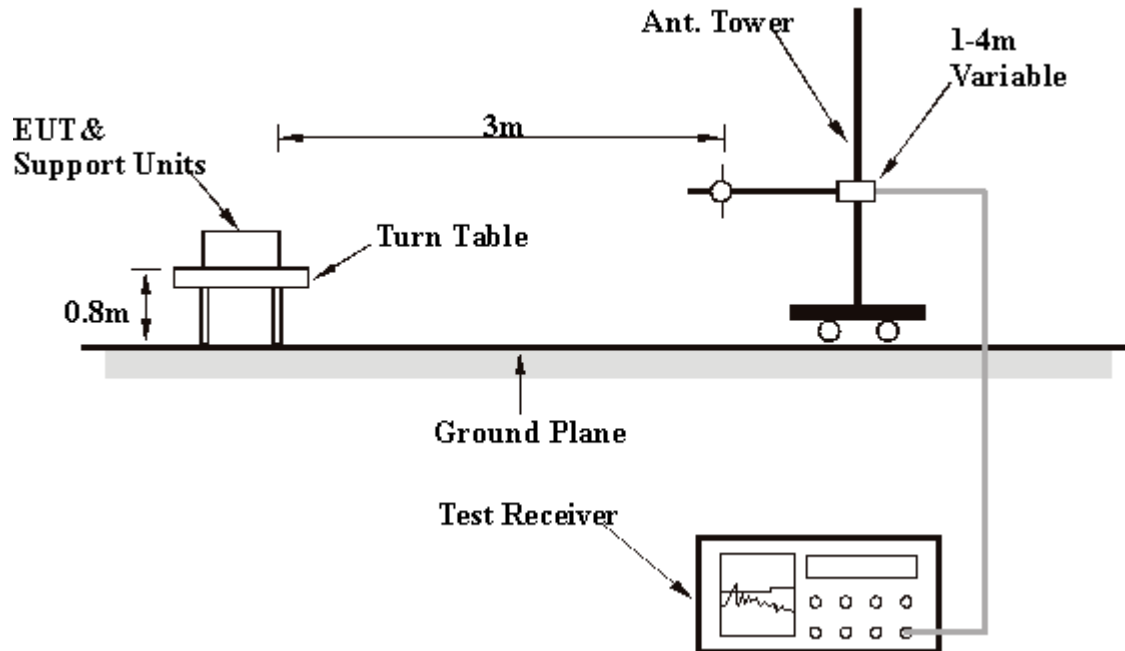

For the actual test configuration, please refer to the related item – Photographs of the Test Configuration.

#### 4.2.5 EUT OPERATING CONDITIONS

Same as 4.1.5.



## 4.2.6 TEST RESULTS

<b>EUT</b>	SpeedTouch 180 Wireless Access Point	<b>MODEL</b>	ST180
<b>MODE</b>	Channel 11	<b>FREQUENCY RANGE</b>	30-1000 MHz
<b>INPUT POWER (SYSTEM)</b>	120Vac, 60 Hz	<b>DETECTOR FUNCTION</b>	Quasi-Peak
<b>ENVIRONMENTAL CONDITIONS</b>	25 deg. C, 70%RH, 975 hPa	<b>TESTED BY</b>	Eric Lee

**ANTENNA POLARITY & TEST DISTANCE: HORIZONTAL AT 3 M**

No.	Freq. (MHz)	Emission Level (dBuV/m)	Limit (dBuV/m)	Margin (dB)	Antenna Height (m)	Table Angle (Degree)	Raw Value (dBuV)	Correction Factor (dB/m)
1	80.00	29.70 QP	40.00	-10.30	2.64 H	4	18.60	11.10
2	120.00	39.10 QP	43.50	-4.40	2.70 H	245	27.20	11.80
3	160.00	38.30 QP	43.50	-5.20	1.97 H	220	23.90	14.40
4	240.00	39.90 QP	46.00	-6.10	1.34 H	23	27.10	12.80
5	280.00	36.50 QP	46.00	-9.50	1.09 H	19	22.00	14.50
6	350.02	41.20 QP	46.00	-4.80	1.00 H	28	24.50	16.70
7	360.00	41.90 QP	46.00	-4.10	1.00 H	13	24.90	16.90
8	375.02	40.50 QP	46.00	-5.50	1.00 H	41	23.10	17.40
9	400.00	40.30 QP	46.00	-5.70	1.00 H	351	22.20	18.10
10	450.00	37.80 QP	46.00	-8.20	1.00 H	2	18.50	19.40
11	500.00	35.30 QP	46.00	-10.70	1.00 H	23	14.40	20.90
12	600.00	35.10 QP	46.00	-10.90	1.00 H	254	12.10	23.00

**ANTENNA POLARITY & TEST DISTANCE: VERTICAL AT 3 M**

No.	Freq. (MHz)	Emission Level (dBuV/m)	Limit (dBuV/m)	Margin (dB)	Antenna Height (m)	Table Angle (Degree)	Raw Value (dBuV)	Correction Factor (dB/m)
1	75.00	35.30 QP	40.00	-4.70	1.00 V	3	24.00	11.30
<b>2</b>	<b>80.00</b>	<b>38.00 QP</b>	<b>40.00</b>	<b>-2.00</b>	<b>1.00 V</b>	<b>296</b>	<b>26.80</b>	<b>11.10</b>
3	120.00	36.80 QP	43.50	-6.70	1.06 V	218	25.00	11.80
4	160.00	35.80 QP	43.50	-7.70	1.29 V	3	21.40	14.40
5	240.00	35.10 QP	46.00	-10.90	1.00 V	184	22.30	12.80
6	350.01	36.50 QP	46.00	-9.50	1.00 V	37	19.90	16.70
7	360.00	36.60 QP	46.00	-9.40	1.00 V	39	19.60	16.90
8	400.00	40.90 QP	46.00	-5.10	1.37 V	348	22.80	18.10
9	480.06	35.50 QP	46.00	-10.50	1.00 V	351	15.20	20.30
10	600.00	35.80 QP	46.00	-10.20	1.67 V	3	12.80	23.00
11	879.99	35.70 QP	46.00	-10.30	1.18 V	340	8.10	27.60

- REMARKS:**
1. Emission level(dBuV/m)=Raw Value(dBuV) + Correction Factor(dB)
  2. Correction Factor(dB/m) = Antenna Factor (dB/m) + Cable Factor (dB)
  3. The other emission levels were very low against the limit.
  4. Margin value = Emission level – Limit value.



## 4.2.7 TEST RESULTS - DSSS

<b>EUT</b>	SpeedTouch 180 Wireless Access Point	<b>MODEL</b>	ST180
<b>MODE</b>	Channel 1	<b>FREQUENCY RANGE</b>	1000~25000MHz
<b>INPUT POWER (SYSTEM)</b>	120Vac, 60 Hz	<b>DETECTOR FUNCTION</b>	Peak(PK) Average(AV)
<b>ENVIRONMENTAL CONDITIONS</b>	15 deg. C, 69%RH, 975 hPa	<b>TESTED BY</b>	Eric Lee

**ANTENNA POLARITY & TEST DISTANCE: HORIZONTAL AT 3 M**

No.	Freq. (MHz)	Emission Level (dBuV/m)	Limit (dBuV/m)	Margin (dB)	Antenna Height (m)	Table Angle (Degree)	Raw Value (dBuV)	Correction Factor (dB/m)
1	2375.00	45.50 PK	74.00	-28.50	1.15 H	25	15.10	30.40
2	2390.00	46.90 PK	74.00	-27.10	1.37 H	27	16.50	30.40
3	*2412.00	105.00 PK			1.35 H	11	74.50	30.50
3	*2412.00	99.80 AV			1.35 H	11	69.30	30.50
4	4824.00	48.30 PK	74.00	-25.70	1.20 H	40	12.10	36.20
5	7236.00	48.10 PK	74.00	-25.90	1.01 H	109	6.40	41.70
6	9648.00	50.80 PK	74.00	-23.20	1.00 H	0	5.90	44.90

**ANTENNA POLARITY & TEST DISTANCE: VERTICAL AT 3 M**

No.	Freq. (MHz)	Emission Level (dBuV/m)	Limit (dBuV/m)	Margin (dB)	Antenna Height (m)	Table Angle (Degree)	Raw Value (dBuV)	Correction Factor (dB/m)
1	2375.00	50.60 PK	74.00	-23.40	1.14 V	4	20.20	30.40
2	2390.00	51.90 PK	74.00	-22.10	1.41 V	300	21.50	30.40
2	2390.00	44.80 AV	54.00	-9.20	1.41 V	300	14.40	30.40
3	*2412.00	108.10 PK			1.40 V	315	77.50	30.50
3	*2412.00	101.00 AV			1.40 V	315	70.40	30.50
4	4824.00	50.30 PK	74.00	-23.70	1.01 V	16	14.10	36.20
5	7236.00	48.50 PK	74.00	-25.50	1.05 V	183	6.90	41.70
6	9648.00	54.50 PK	74.00	-19.50	1.00 V	12	9.60	44.90
6	9648.00	49.10 AV	54.00	-4.90	1.00 V	12	4.10	44.90

- REMARKS:**
1. Emission level(dBuV/m)=Raw Value(dBuV) + Correction Factor(dB)
  2. Correction Factor(dB/m) = Antenna Factor (dB/m) + Cable Factor (dB)
  3. The other emission levels were very low against the limit.
  4. Margin value = Emission level – Limit value.
  5. The limit value is defined as per 15.247
  6. “ \* “ : Fundamental frequency



<b>EUT</b>	SpeedTouch 180 Wireless Access Point	<b>MODEL</b>	ST180
<b>MODE</b>	Channel 6	<b>FREQUENCY RANGE</b>	1000~25000MHz
<b>INPUT POWER (SYSTEM)</b>	120Vac, 60 Hz	<b>DETECTOR FUNCTION</b>	Peak(PK) Average (AV)
<b>ENVIRONMENTAL CONDITIONS</b>	15 deg. C, 69%RH, 975 hPa	<b>TESTED BY</b>	Eric Lee

#### ANTENNA POLARITY & TEST DISTANCE: HORIZONTAL AT 3 M

No.	Freq. (MHz)	Emission Level (dBuV/m)	Limit (dBuV/m)	Margin (dB)	Antenna Height (m)	Table Angle (Degree)	Raw Value (dBuV)	Correction Factor (dB/m)
1	*2437.00	105.00 PK			1.08 H	29	74.30	30.70
1	*2437.00	98.30 AV			1.08 H	29	67.60	30.70
2	4874.00	48.10 PK	74.00	-25.90	1.17 H	248	11.70	36.50
3	7311.00	48.70 PK	74.00	-25.30	1.15 H	22	6.90	41.80
4	9748.00	51.20 PK	74.00	-22.80	1.13 H	267	6.60	44.60
4	9748.00	41.10 AV	54.00	-12.90	1.13 H	267	-3.50	44.60

#### ANTENNA POLARITY & TEST DISTANCE: VERTICAL AT 3 M

No.	Freq. (MHz)	Emission Level (dBuV/m)	Limit (dBuV/m)	Margin (dB)	Antenna Height (m)	Table Angle (Degree)	Raw Value (dBuV)	Correction Factor (dB/m)
1	*2437.00	109.50 PK			1.12 V	1	78.80	30.70
1	*2437.00	102.50 AV			1.12 V	1	71.80	30.70
2	4874.00	49.60 PK	74.00	-24.40	1.10 V	340	13.20	36.50
3	7311.00	48.90 PK	74.00	-25.10	1.07 V	19	7.10	41.80
4	9748.00	54.50 PK	74.00	-19.50	1.25 V	22	9.90	44.60
4	9748.00	47.30 AV	54.00	-6.70	1.25 V	22	2.70	44.60

- REMARKS:**
1. Emission level(dBuV/m)=Raw Value(dBuV) + Correction Factor(dB)
  2. Correction Factor(dB/m) = Antenna Factor (dB/m) + Cable Factor (dB)
  3. The other emission levels were very low against the limit.
  4. Margin value = Emission level – Limit value.
  5. The limit value is defined as per 15.247
  6. " \* " : Fundamental frequency



<b>EUT</b>	SpeedTouch 180 Wireless Access Point	<b>MODEL</b>	ST180
<b>MODE</b>	Channel 11	<b>FREQUENCY RANGE</b>	1000~25000MHz
<b>INPUT POWER (SYSTEM)</b>	120Vac, 60 Hz	<b>DETECTOR FUNCTION</b>	Peak(PK) Average (AV)
<b>ENVIRONMENTAL CONDITIONS</b>	15 deg. C, 69%RH, 975 hPa	<b>TESTED BY</b>	Eric Lee

#### ANTENNA POLARITY & TEST DISTANCE: HORIZONTAL AT 3 M

No.	Freq. (MHz)	Emission Level (dBuV/m)	Limit (dBuV/m)	Margin (dB)	Antenna Height (m)	Table Angle (Degree)	Raw Value (dBuV)	Correction Factor (dB/m)
1	*2462.00	103.10 PK			1.08 H	5	72.30	30.80
1	*2462.00	96.40 AV			1.08 H	5	65.60	30.80
2	2483.50	45.50 PK	74.00	-28.50	1.10 H	12	14.60	31.00
3	2500.00	44.00 PK	74.00	-30.00	1.16 H	19	13.30	30.70
4	4924.00	47.00 PK	74.00	-27.00	1.10 H	27	10.30	36.70
5	7386.00	47.70 PK	74.00	-26.30	1.05 H	353	5.90	41.80
6	9848.00	51.00 PK	74.00	-23.00	1.07 H	264	6.60	44.40
6	9848.00	40.90 AV	54.00	-13.10	1.07 H	264	-3.50	44.40

#### ANTENNA POLARITY & TEST DISTANCE: VERTICAL AT 3 M

No.	Freq. (MHz)	Emission Level (dBuV/m)	Limit (dBuV/m)	Margin (dB)	Antenna Height (m)	Table Angle (Degree)	Raw Value (dBuV)	Correction Factor (dB/m)
1	*2462.00	111.40 PK			1.10 V	2	80.60	30.80
1	*2462.00	104.20 AV			1.10 V	2	73.30	30.80
2	2483.50	53.80 PK	74.00	-20.20	1.15 V	13	22.80	31.00
2	2483.50	46.60 AV	54.00	-7.40	1.15 V	13	15.60	31.00
3	2500.00	53.50 PK	74.00	-20.50	1.12 V	35	22.80	30.70
3	2500.00	43.80 AV	54.00	-10.20	1.12 V	35	13.10	30.70
4	4924.00	49.30 PK	74.00	-24.70	1.00 V	11	12.70	36.70
5	7386.00	48.10 PK	74.00	-25.90	1.03 V	39	6.20	41.80
6	9848.00	54.50 PK	74.00	-19.50	1.06 V	17	10.10	44.40
6	9848.00	48.80 AV	54.00	-5.20	1.06 V	17	4.40	44.40

- REMARKS:**
1. Emission level(dBuV/m)=Raw Value(dBuV) + Correction Factor(dB)
  2. Correction Factor(dB/m) = Antenna Factor (dB/m) + Cable Factor (dB)
  3. The other emission levels were very low against the limit.
  4. Margin value = Emission level – Limit value.
  5. The limit value is defined as per 15.247
  6. “ \* “ : Fundamental frequency



## 4.2.8 TEST RESULTS -OFDM

<b>EUT</b>	SpeedTouch 180 Wireless Access Point	<b>MODEL</b>	ST180
<b>MODE</b>	Channel 1	<b>FREQUENCY RANGE</b>	1000~25000MHz
<b>INPUT POWER (SYSTEM)</b>	120Vac, 60 Hz	<b>DETECTOR FUNCTION</b>	Peak(PK) Average(AV)
<b>ENVIRONMENTAL CONDITIONS</b>	15 deg. C, 69%RH, 975 hPa	<b>TESTED BY</b>	Eric Lee

**ANTENNA POLARITY & TEST DISTANCE: HORIZONTAL AT 3 M**

No.	Freq. (MHz)	Emission Level (dBuV/m)	Limit (dBuV/m)	Margin (dB)	Antenna Height (m)	Table Angle (Degree)	Raw Value (dBuV)	Correction Factor (dB/m)
1	2375.00	39.70 PK	74.00	-34.30	1.00 H	352	9.40	30.40
2	2390.00	52.10 PK	74.00	-21.90	1.05 H	12	21.70	30.40
2	2390.00	44.40 AV	54.00	-9.60	1.05 H	12	13.90	30.40
3	*2412.00	99.50 PK			1.10 H	1	68.90	30.50
3	*2412.00	91.70 AV			1.10 H	1	61.20	30.50
4	4824.00	48.00 PK	74.00	-26.00	1.54 H	41	11.80	36.20
5	7236.00	48.70 PK	74.00	-25.30	1.50 H	0	7.00	41.70
6	9648.00	50.00 PK	74.00	-24.00	1.00 H	57	5.10	44.90

**ANTENNA POLARITY & TEST DISTANCE: VERTICAL AT 3 M**

No.	Freq. (MHz)	Emission Level (dBuV/m)	Limit (dBuV/m)	Margin (dB)	Antenna Height (m)	Table Angle (Degree)	Raw Value (dBuV)	Correction Factor (dB/m)
1	2375.00	47.10 PK	74.00	-26.90	1.00 V	252	16.70	30.40
2	2390.00	58.30 PK	74.00	-15.70	1.15 V	257	27.90	30.40
2	2390.00	50.80 AV	54.00	-3.20	1.15 V	257	20.40	30.40
3	*2412.00	105.70 PK			1.11 V	310	75.10	30.50
3	*2412.00	98.20 AV			1.11 V	310	67.60	30.50
4	4824.00	49.40 PK	74.00	-24.60	1.00 V	4	13.20	36.20
5	7236.00	48.80 PK	74.00	-25.20	1.00 V	22	7.10	41.70
6	9648.00	54.70 PK	74.00	-19.30	1.00 V	11	9.80	44.90
6	9648.00	50.00 AV	54.00	-4.00	1.00 V	11	5.10	44.90

- REMARKS:**
1. Emission level(dBuV/m)=Raw Value(dBuV) + Correction Factor(dB)
  2. Correction Factor(dB/m) = Antenna Factor (dB/m) + Cable Factor (dB)
  3. The other emission levels were very low against the limit.
  4. Margin value = Emission level – Limit value.
  5. The limit value is defined as per 15.247
  6. “ \* “ : Fundamental frequency



<b>EUT</b>	SpeedTouch 180 Wireless Access Point	<b>MODEL</b>	ST180
<b>MODE</b>	Channel 6	<b>FREQUENCY RANGE</b>	1000~25000MHz
<b>INPUT POWER (SYSTEM)</b>	120Vac, 60 Hz	<b>DETECTOR FUNCTION</b>	Peak(PK) Average (AV)
<b>ENVIRONMENTAL CONDITIONS</b>	15 deg. C, 69%RH, 975 hPa	<b>TESTED BY</b>	Eric Lee

**ANTENNA POLARITY & TEST DISTANCE: HORIZONTAL AT 3 M**

No.	Freq. (MHz)	Emission Level (dBuV/m)	Limit (dBuV/m)	Margin (dB)	Antenna Height (m)	Table Angle (Degree)	Raw Value (dBuV)	Correction Factor (dB/m)
1	*2437.00	104.20 PK			1.33 H	12	73.60	30.70
1	*2437.00	96.10 AV			1.33 H	12	65.40	30.70
2	4874.00	47.90 PK	74.00	-26.10	1.28 H	15	11.40	36.50
3	7311.00	48.70 PK	74.00	-25.30	1.20 H	113	7.00	41.80
4	9748.00	51.20 PK	74.00	-22.80	1.27 H	46	6.60	44.60
4	9748.00	40.70 AV	54.00	-13.30	1.27 H	46	-3.90	44.60

**ANTENNA POLARITY & TEST DISTANCE: VERTICAL AT 3 M**

No.	Freq. (MHz)	Emission Level (dBuV/m)	Limit (dBuV/m)	Margin (dB)	Antenna Height (m)	Table Angle (Degree)	Raw Value (dBuV)	Correction Factor (dB/m)
1	*2437.00	108.10 PK			1.28 V	245	77.40	30.70
1	*2437.00	100.40 AV			1.28 V	245	69.80	30.70
2	4874.00	49.40 PK	74.00	-24.60	1.12 V	338	12.90	36.50
3	7311.00	47.60 PK	74.00	-26.40	1.10 V	0	5.80	41.80
4	9748.00	54.10 PK	74.00	-19.90	1.30 V	344	9.50	44.60
4	9748.00	47.20 AV	54.00	-6.80	1.30 V	344	2.60	44.60

- REMARKS:**
1. Emission level(dBuV/m)=Raw Value(dBuV) + Correction Factor(dB)
  2. Correction Factor(dB/m) = Antenna Factor (dB/m) + Cable Factor (dB)
  3. The other emission levels were very low against the limit.
  4. Margin value = Emission level – Limit value.
  5. The limit value is defined as per 15.247
  6. “ \* “ : Fundamental frequency



<b>EUT</b>	SpeedTouch 180 Wireless Access Point	<b>MODEL</b>	ST180
<b>MODE</b>	Channel 11	<b>FREQUENCY RANGE</b>	1000~25000MHz
<b>INPUT POWER (SYSTEM)</b>	120Vac, 60 Hz	<b>DETECTOR FUNCTION</b>	Peak(PK) Average (AV)
<b>ENVIRONMENTAL CONDITIONS</b>	15 deg. C, 69%RH, 975 hPa	<b>TESTED BY</b>	Eric Lee

#### ANTENNA POLARITY & TEST DISTANCE: HORIZONTAL AT 3 M

No.	Freq. (MHz)	Emission Level (dBuV/m)	Limit (dBuV/m)	Margin (dB)	Antenna Height (m)	Table Angle (Degree)	Raw Value (dBuV)	Correction Factor (dB/m)
1	*2462.00	98.00 PK			1.09 H	7	67.10	30.80
1	*2462.00	89.70 AV			1.09 H	7	58.90	30.80
2	2483.50	49.10 PK	74.00	-24.90	1.07 H	10	18.10	31.00
3	2498.00	43.80 PK	74.00	-30.20	1.06 H	28	13.10	30.70
4	4924.00	47.20 PK	74.00	-26.80	1.07 H	29	10.50	36.70
5	7386.00	48.40 PK	74.00	-25.60	1.10 H	106	6.60	41.80
6	9848.00	53.30 PK	74.00	-20.70	1.08 H	0	8.90	44.40
6	9848.00	41.50 AV	54.00	-12.50	1.08 H	0	-2.90	44.40

#### ANTENNA POLARITY & TEST DISTANCE: VERTICAL AT 3 M

No.	Freq. (MHz)	Emission Level (dBuV/m)	Limit (dBuV/m)	Margin (dB)	Antenna Height (m)	Table Angle (Degree)	Raw Value (dBuV)	Correction Factor (dB/m)
1	*2462.00	105.80 PK			1.09 V	3	75.00	30.80
1	*2462.00	97.90 AV			1.09 V	3	67.10	30.80
2	2483.50	56.90 PK	74.00	-17.10	1.05 V	12	26.00	31.00
2	2483.50	49.20 AV	54.00	-4.80	1.05 V	12	18.30	31.00
3	2498.00	54.20 PK	74.00	-19.80	1.05 V	310	23.40	30.70
3	2498.00	43.00 AV	54.00	-11.00	1.05 V	310	12.20	30.70
4	4924.00	49.10 PK	74.00	-24.90	1.06 V	258	12.40	36.70
5	7386.00	48.60 PK	74.00	-25.40	1.04 V	0	6.80	41.80
6	9848.00	55.10 PK	74.00	-18.90	1.06 V	17	10.70	44.40
6	9848.00	48.90 AV	54.00	-5.10	1.06 V	17	4.60	44.40

- REMARKS:**
1. Emission level(dBuV/m)=Raw Value(dBuV) + Correction Factor(dB)
  2. Correction Factor(dB/m) = Antenna Factor (dB/m) + Cable Factor (dB)
  3. The other emission levels were very low against the limit.
  4. Margin value = Emission level – Limit value.
  5. The limit value is defined as per 15.247
  6. “ \* “ : Fundamental frequency





### 4.3 6dB BANDWIDTH MEASUREMENT

#### 4.3.1 LIMITS OF 6dB BANDWIDTH MEASUREMENT

The minimum of 6dB Bandwidth Measurement is 0.5 MHz.

#### 4.3.2 TEST INSTRUMENTS

Description & Manufacturer	Model No.	Serial No.	Calibrated Until
R&S SPECTRUM ANALYZER	FSP40	100037	May. 06, 2004

**NOTE:**

- 1.The measurement uncertainty is less than +/- 2.6dB, which is calculated as per the NAMAS document NIS81.
- 2.The calibration interval of the above test instruments is 12 months and the calibrations are traceable to NML/ROC and NIST/USA.

### 4.3.3 TEST PROCEDURE

The transmitter output was connected to the spectrum analyzer through an attenuator. The bandwidth of the fundamental frequency was measured by spectrum analyzer with 100 kHz RBW and 100 kHz VBW. The 6 dB bandwidth is defined as the total spectrum the power of which is higher than peak power minus 6 dB.

### 4.3.4 TEST SETUP



For the actual test configuration, please refer to the related Item – Photographs of the Test Configuration.

### 4.3.5 EUT OPERATING CONDITIONS

The software provided by client to enable the EUT under transmission condition continuously at lowest, middle and highest channel frequencies individually.



## 4.3.6 TEST RESULTS-DSSS

<b>EUT</b>	SpeedTouch 180 Wireless Access Point		
<b>MODEL</b>	ST180	<b>ENVIRONMENTAL CONDITIONS</b>	21 deg. C, 58%RH, 975 hPa
<b>INPUT POWER (SYSTEM)</b>	120Vac, 60 Hz	<b>TESTED BY</b>	Eric Lee

<b>CHANNEL</b>	<b>CHANNEL FREQUENCY (MHz)</b>	<b>6 dB BANDWIDTH (MHz)</b>	<b>MINIMUM LIMIT (MHz)</b>	<b>PASS/FAIL</b>
1	2412	11.55	0.5	PASS
6	2437	11.55	0.5	PASS
11	2462	11.62	0.5	PASS



CH1

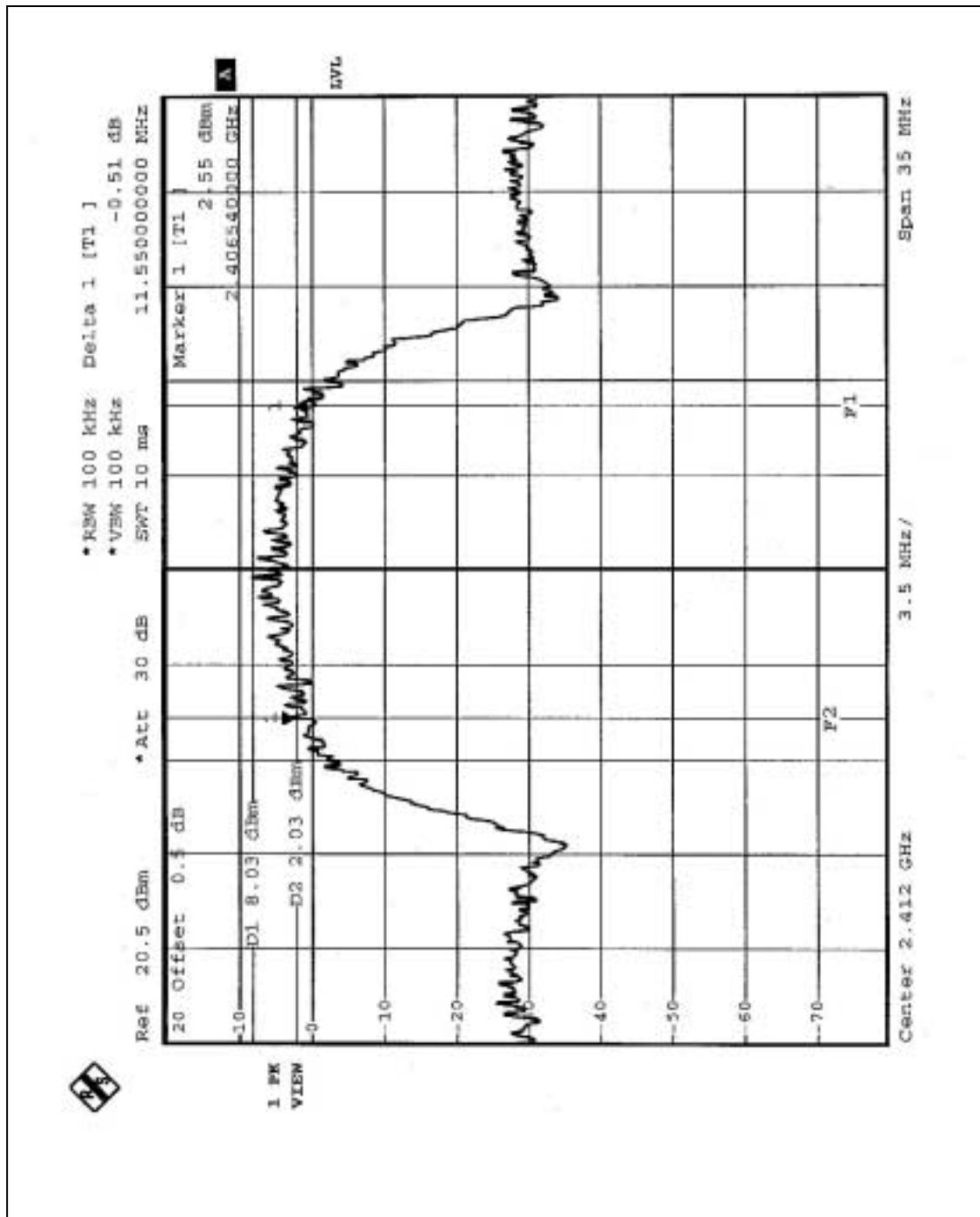



CH6

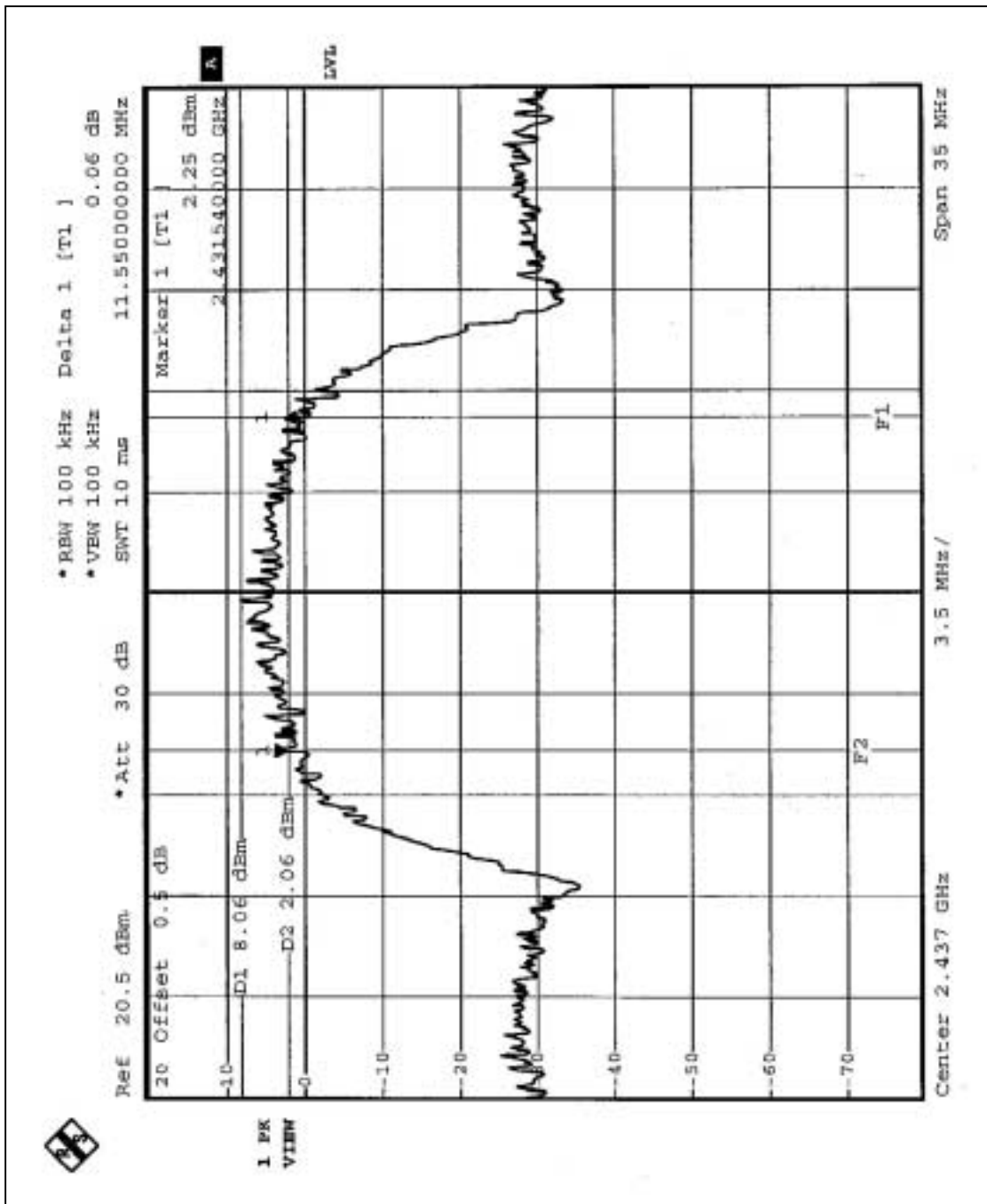



CH11

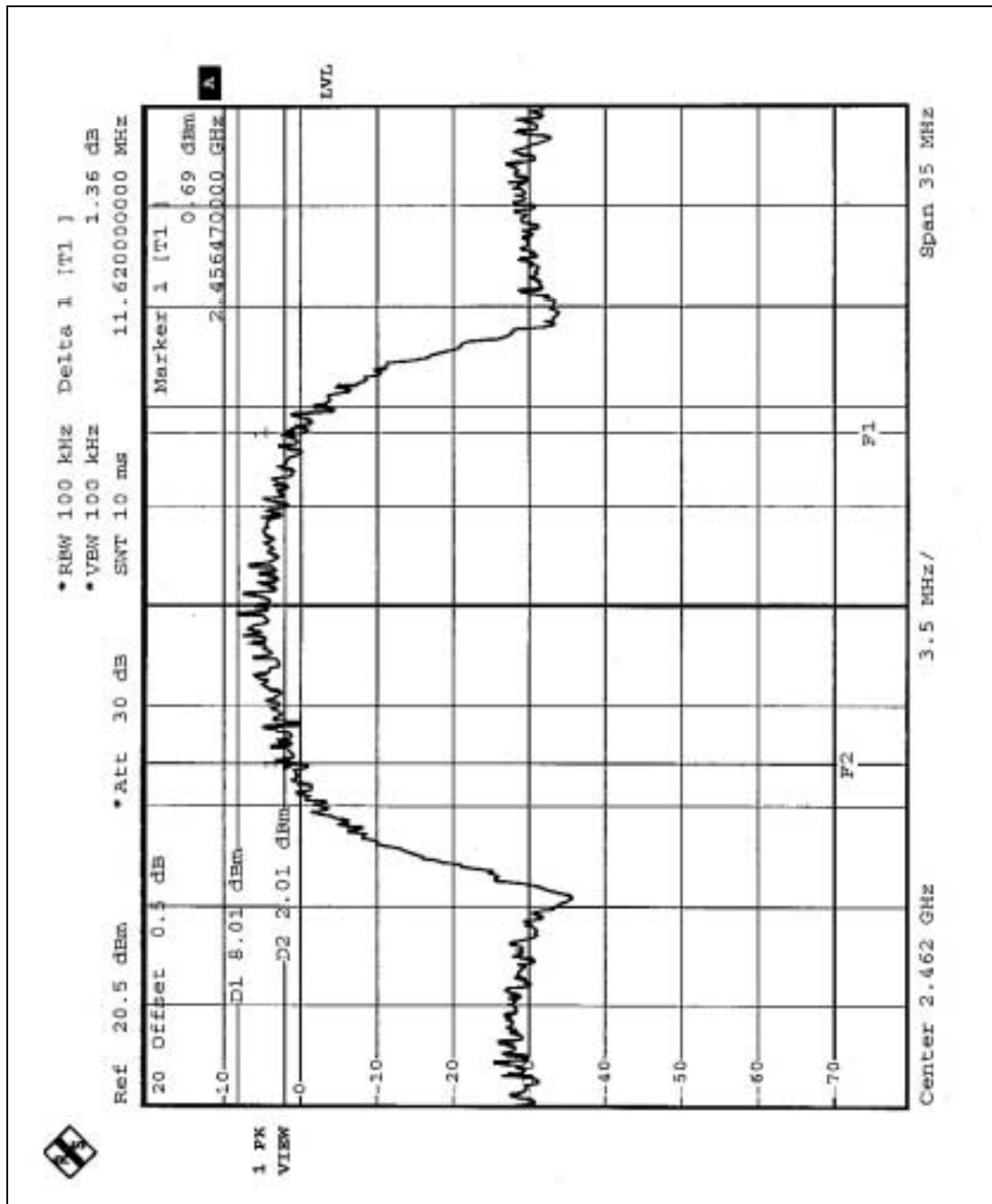



## 4.3.7 TEST RESULTS-OFDM

<b>EUT</b>	SpeedTouch 180 Wireless Access Point		
<b>MODEL</b>	ST180	<b>ENVIRONMENTAL CONDITIONS</b>	21 deg. C, 58%RH, 975 hPa
<b>INPUT POWER (SYSTEM)</b>	120Vac, 60 Hz	<b>TESTED BY</b>	Eric Lee

<b>CHANNEL</b>	<b>CHANNEL FREQUENCY (MHz)</b>	<b>6 dB BANDWIDTH (MHz)</b>	<b>MINIMUM LIMIT (MHz)</b>	<b>PASS/FAIL</b>
1	2412	16.38	0.5	PASS
6	2437	16.45	0.5	PASS
11	2462	16.52	0.5	PASS



CH1

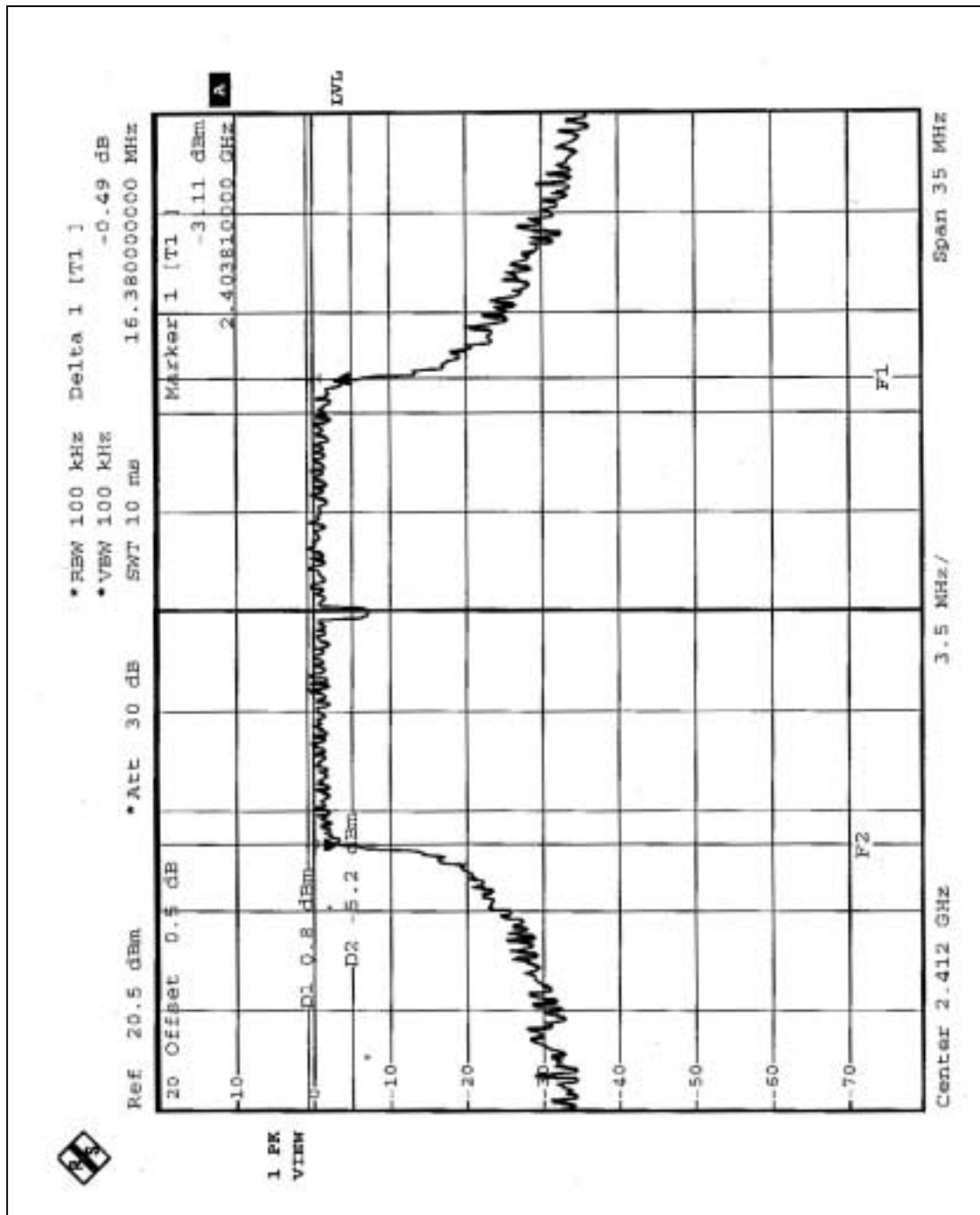





CH6

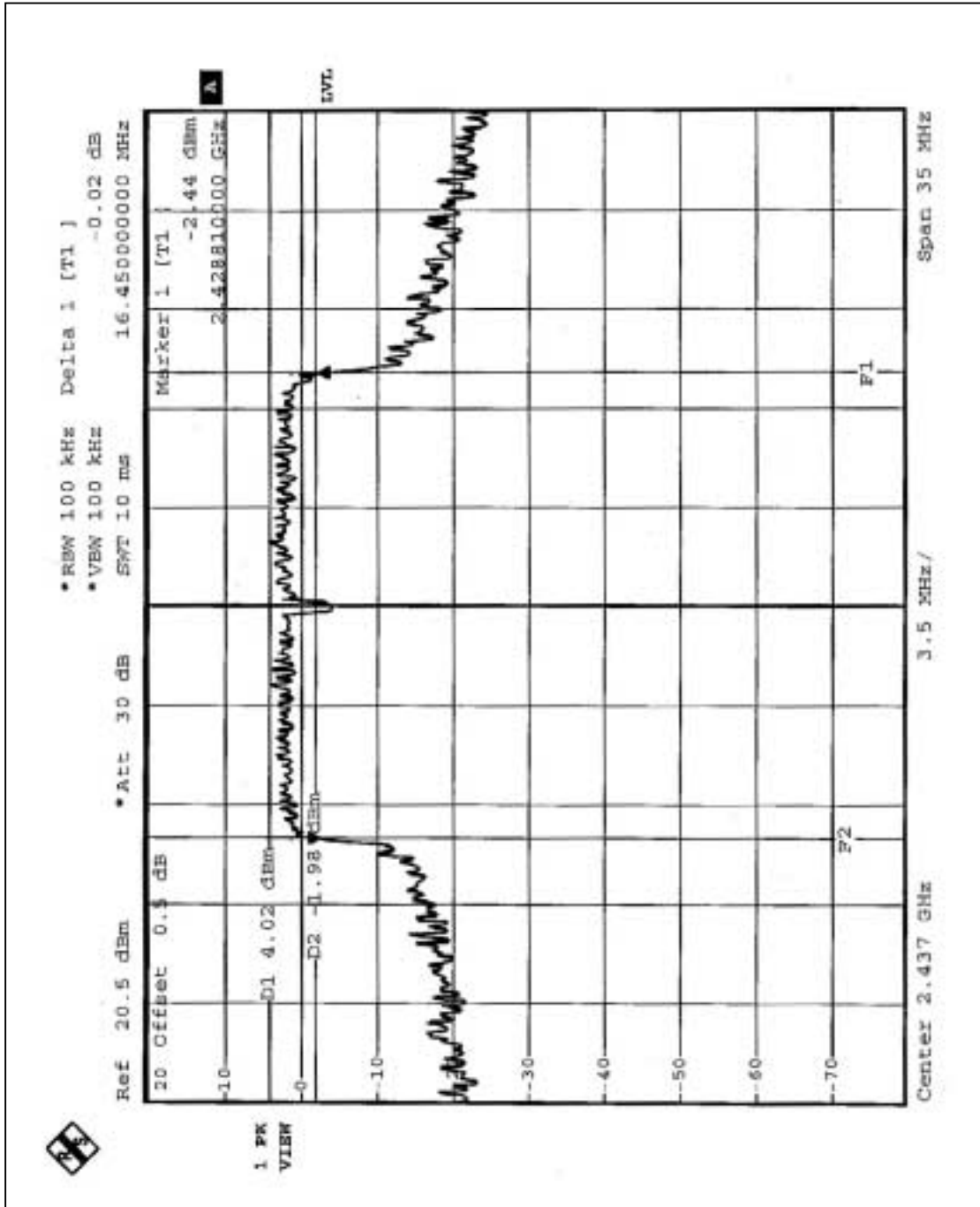



CH11

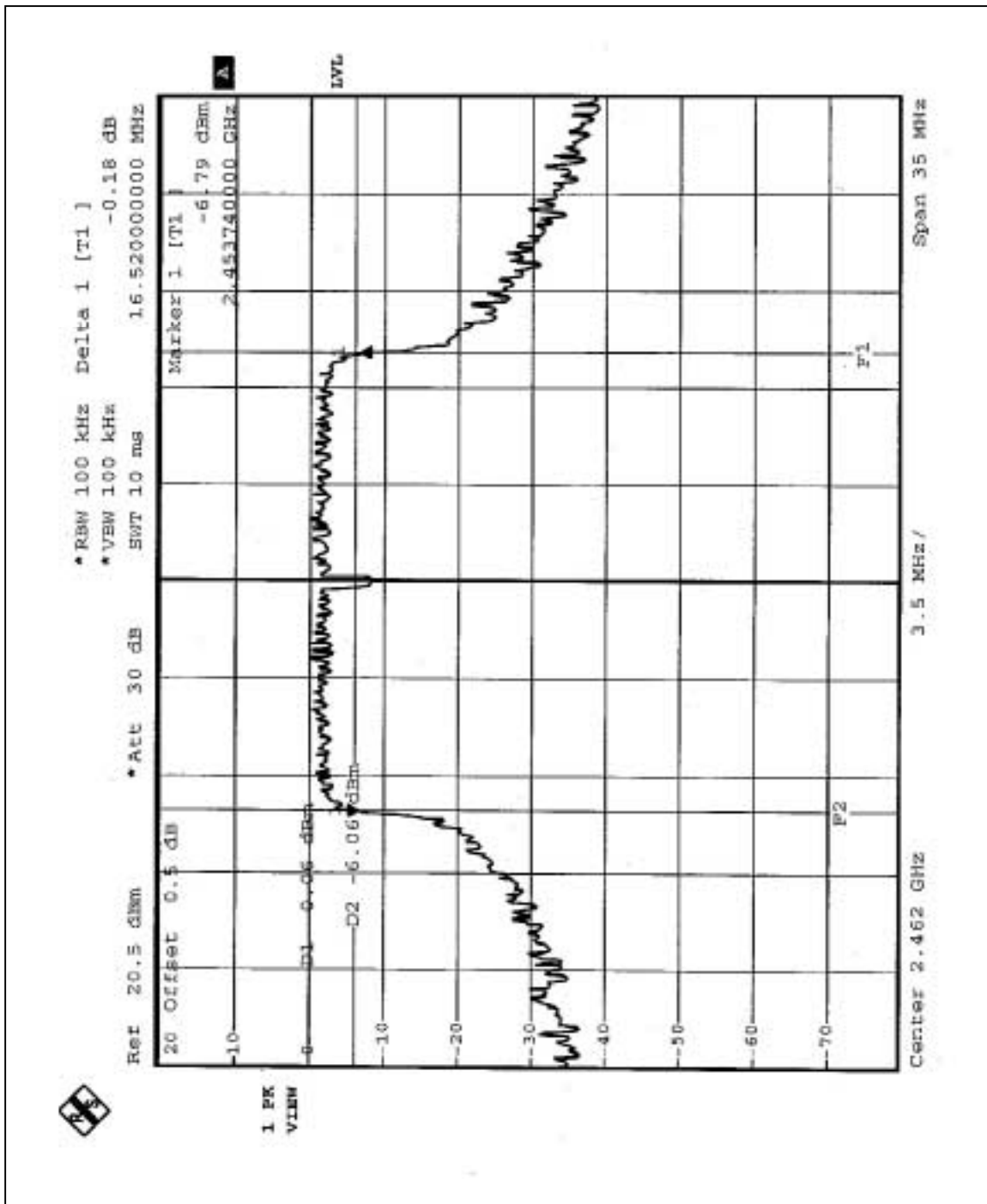



#### 4.4 MAXIMUM PEAK OUTPUT POWER

##### 4.4.1 LIMITS OF MAXIMUM PEAK OUTPUT POWER MEASUREMENT

The Maximum Peak Output Power Measurement is 30dBm.

##### 4.4.2 TEST INSTRUMENTS

Description & Manufacturer	Model No.	Serial No.	Calibrated Until
R&S SPECTRUM ANALYZER	FSP40	100037	May. 06, 2004
R&S SIGNAL GENERATOR	SMP04	100011	May 28, 2004
TEKTRONIX OSCILLOSCOPE	TDS 220	B048470	Mar. 05, 2005
NARDA DETECTOR	4503A	FSCM99899	NA

**NOTE:**

The calibration interval of the above test instruments is 12 months and the calibrations are traceable to NML/ROC and NIST/USA.



#### 4.4.3 TEST PROCEDURES

1. A detector was used on the output port of the EUT. An oscilloscope was used to read the peak response of the detector.
2. Replaced the EUT by the signal generator. The center frequency of the S.G was adjusted to the center frequency of the measured channel.
3. Adjusted the power to have the same peak reading on oscilloscope. Record the power level.

#### 4.4.4 TEST SETUP

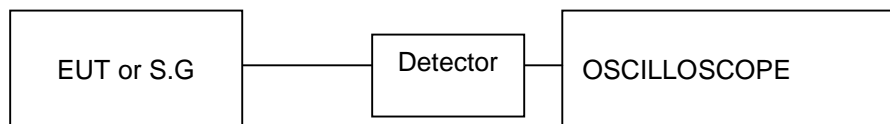

#### 4.4.5 EUT OPERATING CONDITIONS

Same as Item 4.3.5



## 4.4.6 TEST RESULTS- DSSS

<b>EUT</b>	SpeedTouch 180 Wireless Access Point		
<b>MODEL</b>	ST180	<b>ENVIRONMENTAL CONDITIONS</b>	21 deg. C, 58%RH, 975 hPa
<b>INPUT POWER (SYSTEM)</b>	120Vac, 60 Hz	<b>TESTED BY</b>	Eric Lee

CHANNEL	CHANNEL FREQUENCY (MHz)	PEAK POWER OUTPUT (dBm)	PEAK POWER LIMIT (dBm)	PASS/FAIL
1	2412	19.4	30	PASS
6	2437	19.5	30	PASS
11	2462	19.5	30	PASS

## 4.4.7 TEST RESULTS- OFDM

<b>EUT</b>	SpeedTouch 180 Wireless Access Point		
<b>MODEL</b>	ST180	<b>ENVIRONMENTAL CONDITIONS</b>	21 deg. C, 58%RH, 975 hPa
<b>INPUT POWER (SYSTEM)</b>	120Vac, 60 Hz	<b>TESTED BY</b>	Eric Lee

CHANNEL	CHANNEL FREQUENCY (MHz)	PEAK POWER OUTPUT (dBm)	PEAK POWER LIMIT (dBm)	PASS/FAIL
1	2412	18.5	30	PASS
6	2437	21.5	30	PASS
11	2462	18.3	30	PASS



## 4.5 POWER SPECTRAL DENSITY MEASUREMENT

### 4.5.1 LIMITS OF POWER SPECTRAL DENSITY MEASUREMENT

The Maximum of Power Spectral Density Measurement is 8dBm.

### 4.5.2 TEST INSTRUMENTS

Description & Manufacturer	Model No.	Serial No.	Calibrated Until
R&S SPECTRUM ANALYZER	FSP40	100037	May. 06, 2004

**NOTE:**

- 1.The measurement uncertainty is less than +/- 2.6dB, which is calculated as per the NAMAS document NIS81.
- 2.The calibration interval of the above test instruments is 12 months and the calibrations are traceable to NML/ROC and NIST/USA.

#### 4.5.3 TEST PROCEDURE

The transmitter output was connected to the spectrum analyzer through an attenuator, the bandwidth of the fundamental frequency was measured with the spectrum analyzer using 3 kHz RBW and 30 kHz VBW, set sweep time=span/3kHz. The power spectral density was measured and recorded.

The sweep time is allowed to be longer than span/3KHz for a full response of the mixer in the spectrum analyzer.

#### 4.5.4 TEST SETUP

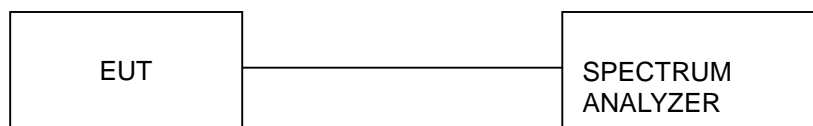

#### 4.5.5 EUT OPERATING CONDITIONS

Same as 4.3.5



## 4.5.6 TEST RESULTS-DSSS

<b>EUT</b>	SpeedTouch 180 Wireless Access Point		
<b>MODEL</b>	ST180	<b>ENVIRONMENTAL CONDITIONS</b>	21 deg. C, 58%RH, 975 hPa
<b>INPUT POWER (SYSTEM)</b>	120Vac, 60 Hz	<b>TESTED BY</b>	Eric Lee

<b>CHANNEL NUMBER</b>	<b>CHANNEL FREQUENCY (MHz)</b>	<b>RF POWER LEVEL IN 3 KHz BW (dBm)</b>	<b>MAXIMUM LIMIT (dBm)</b>	<b>PASS/FAIL</b>
1	2412	-5.83	8	PASS
6	2437	-5.84	8	PASS
11	2462	-5.81	8	PASS





CH1

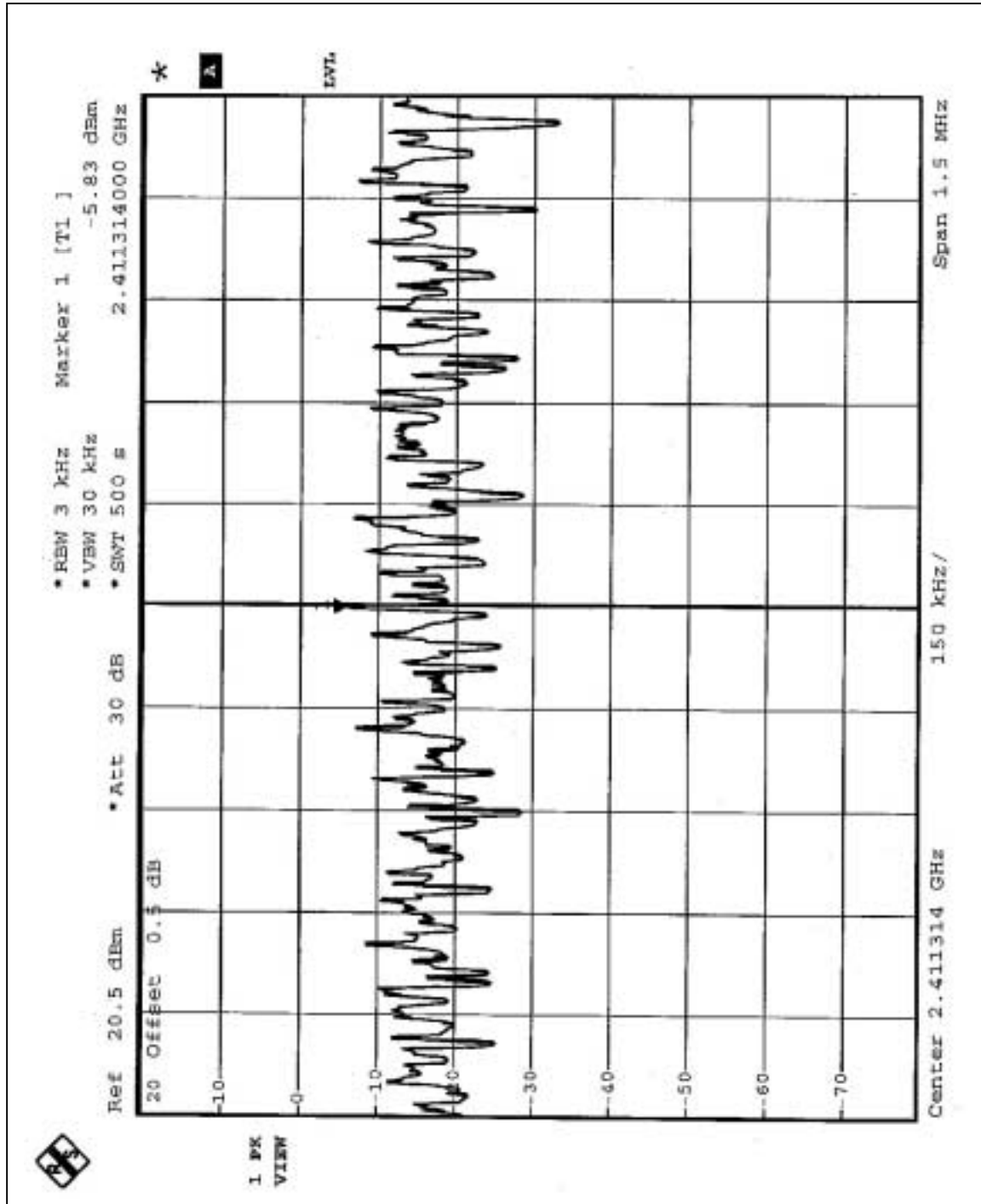



CH6

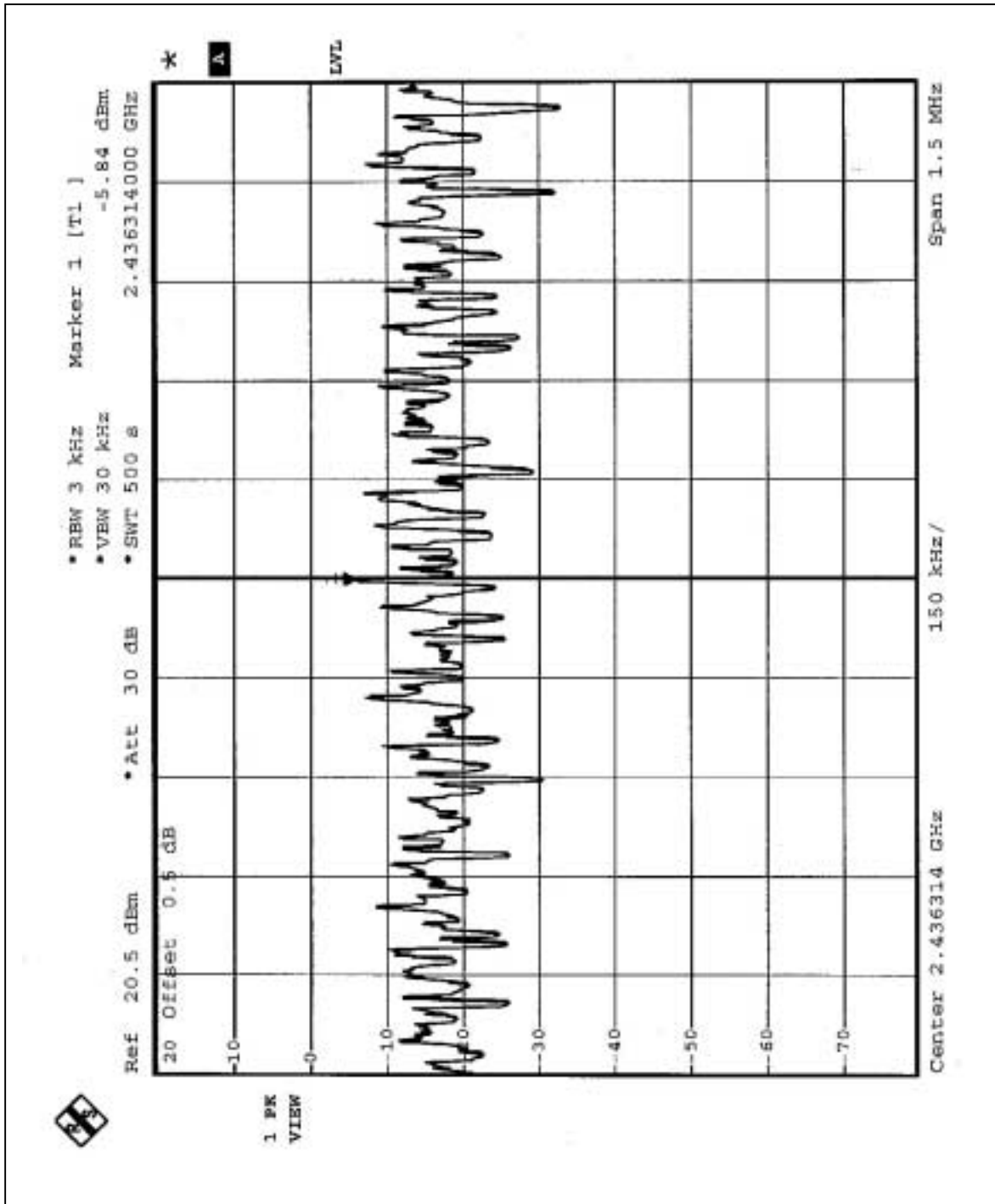



CH11

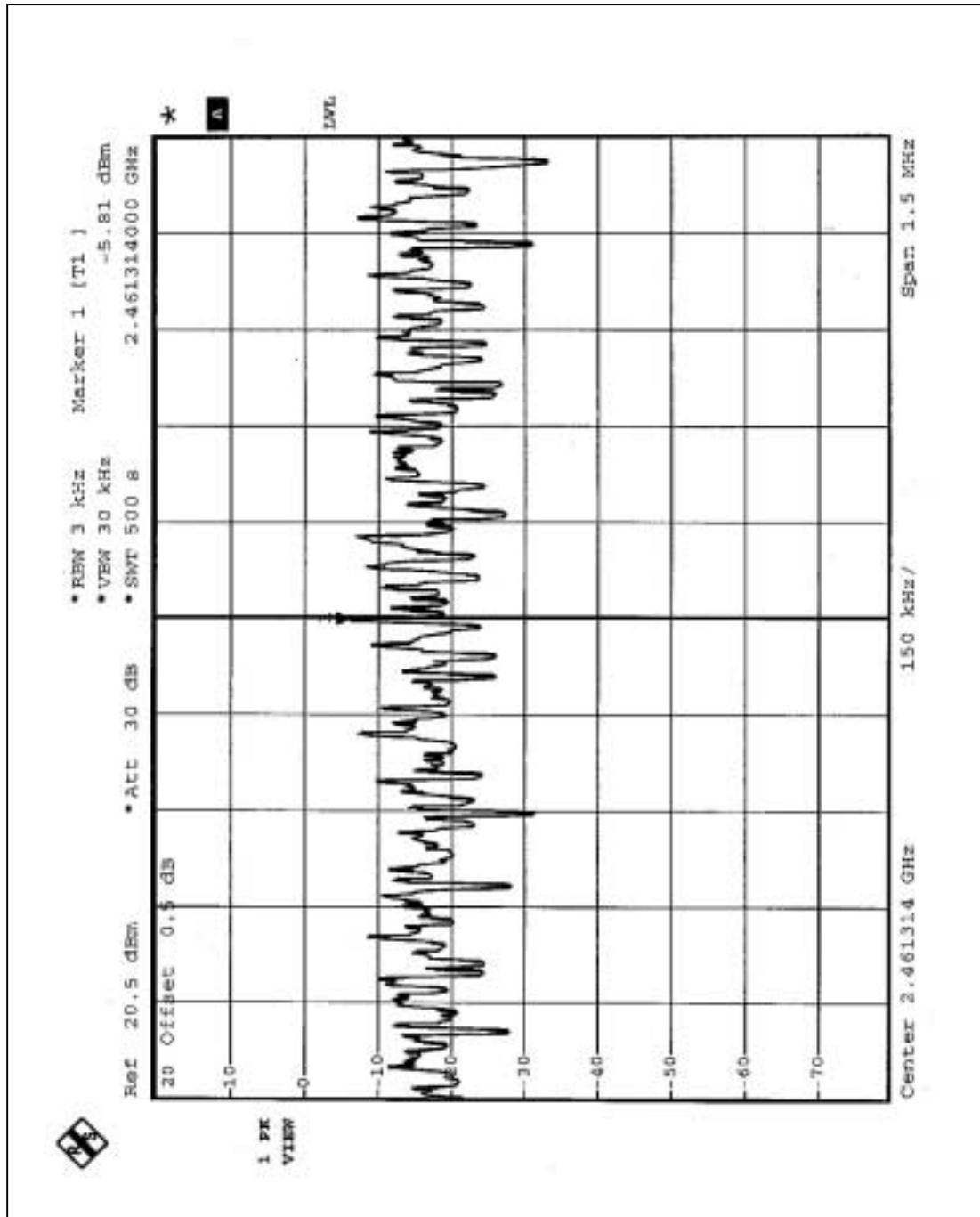



## 4.5.7 TEST RESULTS-OFDM

<b>EUT</b>	SpeedTouch 180 Wireless Access Point		
<b>MODEL</b>	ST180	<b>ENVIRONMENTAL CONDITIONS</b>	21 deg. C, 58%RH, 975 hPa
<b>INPUT POWER (SYSTEM)</b>	120Vac, 60 Hz	<b>TESTED BY</b>	Eric Lee

<b>CHANNEL NUMBER</b>	<b>CHANNEL FREQUENCY (MHz)</b>	<b>RF POWER LEVEL IN 3 KHz BW (dBm)</b>	<b>MAXIMUM LIMIT (dBm)</b>	<b>PASS/FAIL</b>
1	2412	-13.86	8	PASS
6	2437	-10.19	8	PASS
11	2462	-14.13	8	PASS



CH1

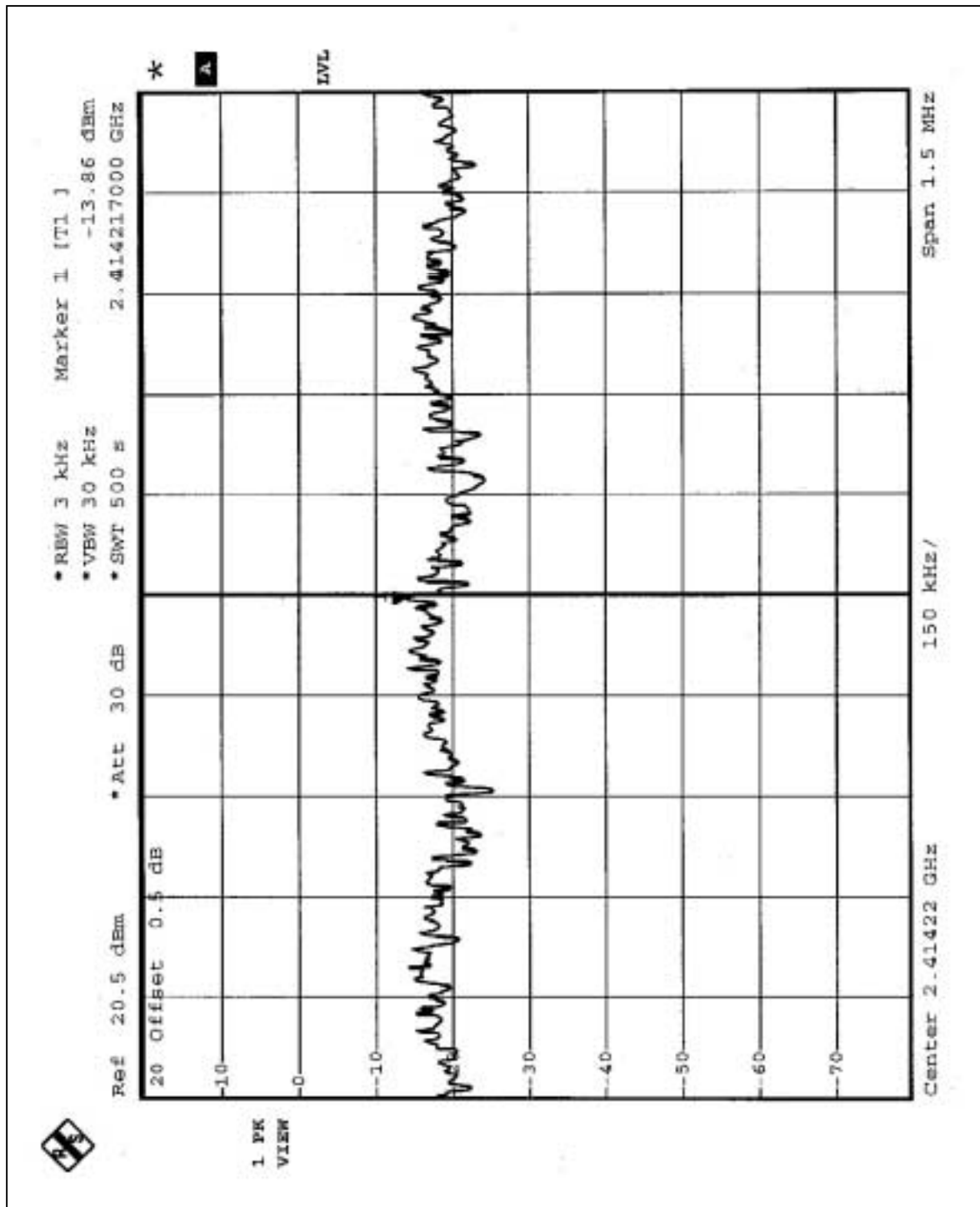



CH6

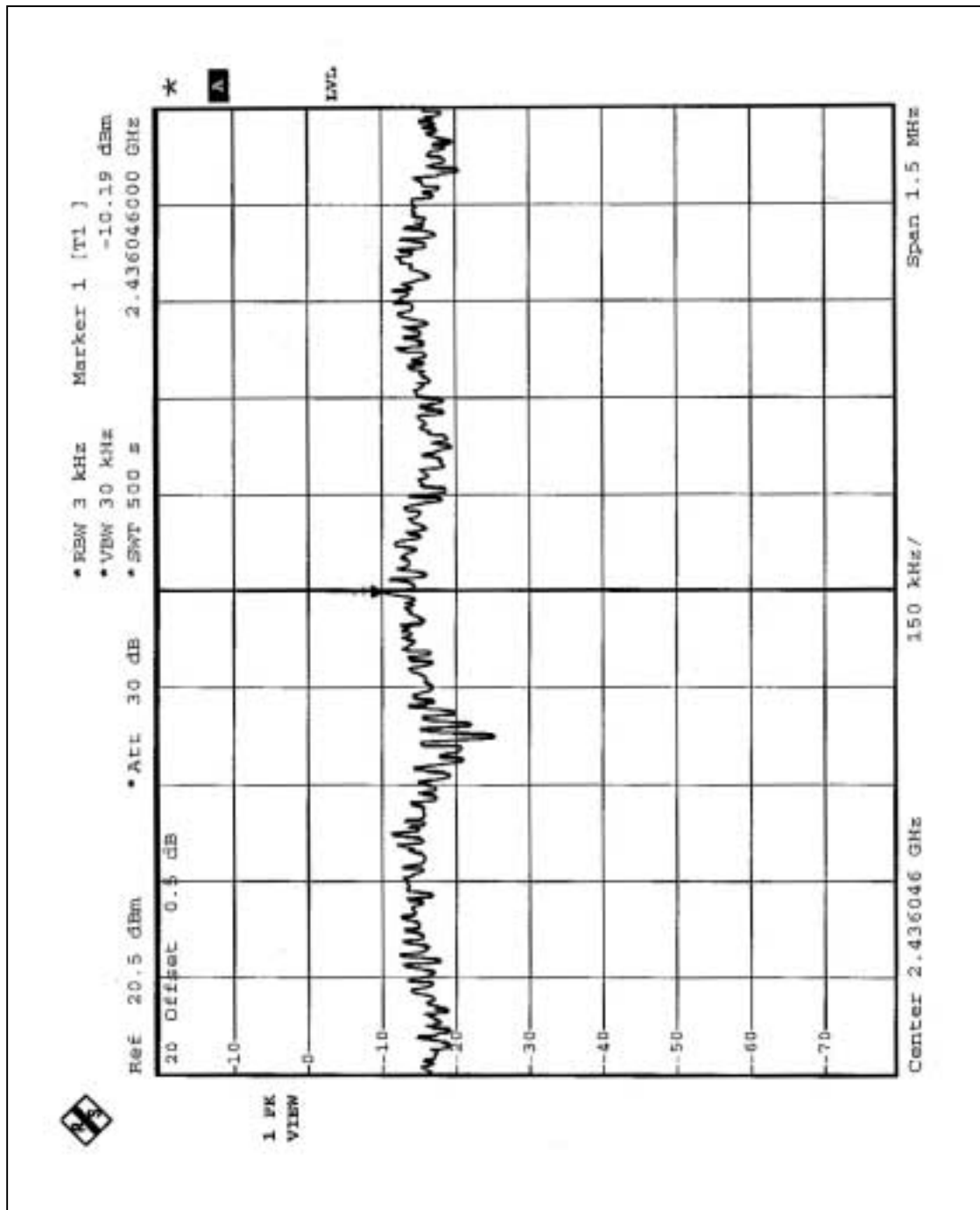



CH11

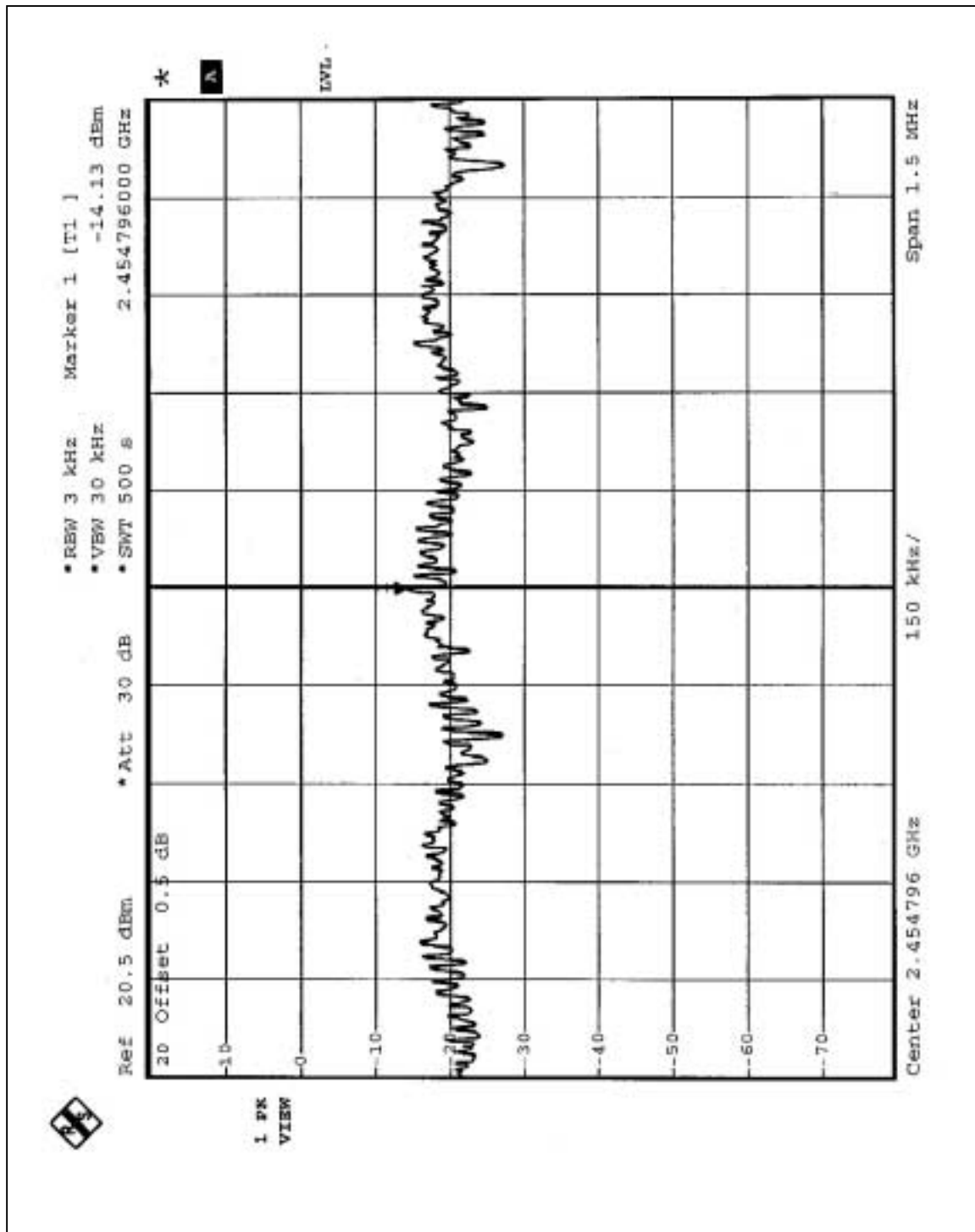



## 4.6 BAND EDGES MEASUREMENT

### 4.6.1 LIMITS OF BAND EDGES MEASUREMENT

Below  $-20\text{dB}$  of the highest emission level of operating band (in 100KHz Resolution Bandwidth).

### 4.6.2 TEST INSTRUMENTS

Description & Manufacturer	Model No.	Serial No.	Calibrated Until
R&S SPECTRUM ANALYZER	FSP40	100037	May. 06, 2004

**NOTE:**

- 1.The measurement uncertainty is less than  $\pm 2.6\text{dB}$ , which is calculated as per the NAMAS document NIS81.
- 2.The calibration interval of the above test instruments is 12 months and the calibrations are traceable to NML/ROC and NIST/USA.

### 4.6.3 TEST PROCEDURE

The transmitter output was connected to the spectrum analyzer via a low lose cable. Set both RBW and VBW of spectrum analyzer to 100 kHz with suitable frequency span including 100 kHz bandwidth from band edge. The band edges was measured and recorded.

### 4.6.4 EUT OPERATING CONDITION

Same as Item 4.3.5





#### 4.6.5 TEST RESULTS - DSSS

The spectrum plots are attached on the following 2 pages. D1 line indicates the highest level, D2 line indicates the 20dB offset below D1. It shows compliance with the requirement in part 15.247(C).

Note - The delta method is only used up to 2 MHz away from the restricted bandage, The radiated emissions which located in other restricted frequency band, the result, please refer to 4.2.7.

**NOTE (1):** The band edge emission plot on the following first page shows 55.95dB delta between carrier maximum power and local maximum emission in restrict band (2.3900GHz). The emission of carrier strength list in the test result of channel 1 at the item 4.2.7 is 101.00dBuV/m, so the maximum field strength in restrict band is  $101.00 - 55.95 = 45.05$  dBuV/m which is under 54 dBuV/m limit.

**NOTE (2):** The band edge emission plot on the following second page shows 57.52dB delta between carrier maximum power and local maximum emission in restrict band (2.4835GHz). The emission of carrier strength list in the test result of channel 11 at the item 4.2.7 is 104.2dBuV/m, so the maximum field strength in restrict band is  $104.2 - 57.52 = 46.68$  dBuV/m which is under 54 dBuV/m limit.

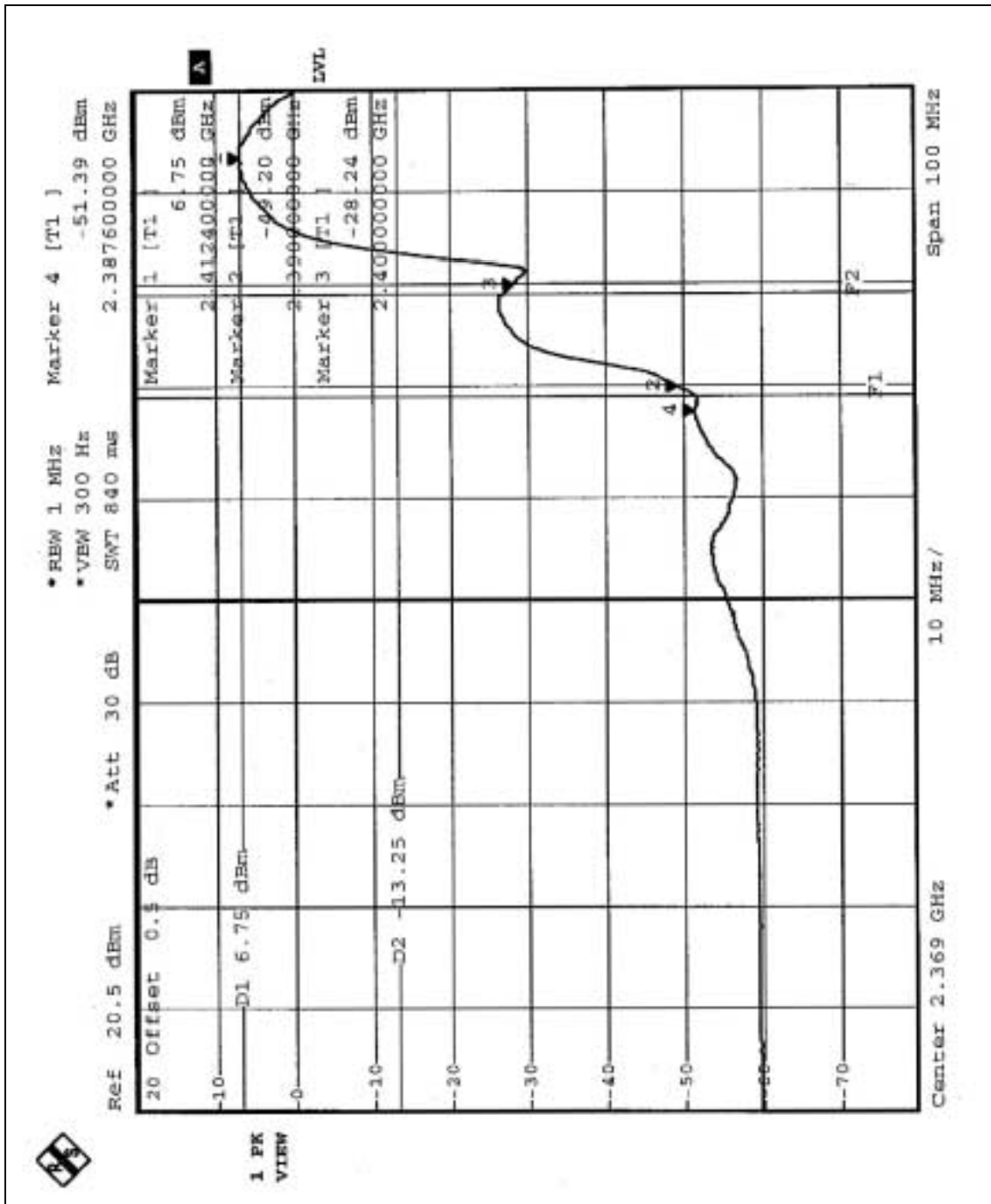

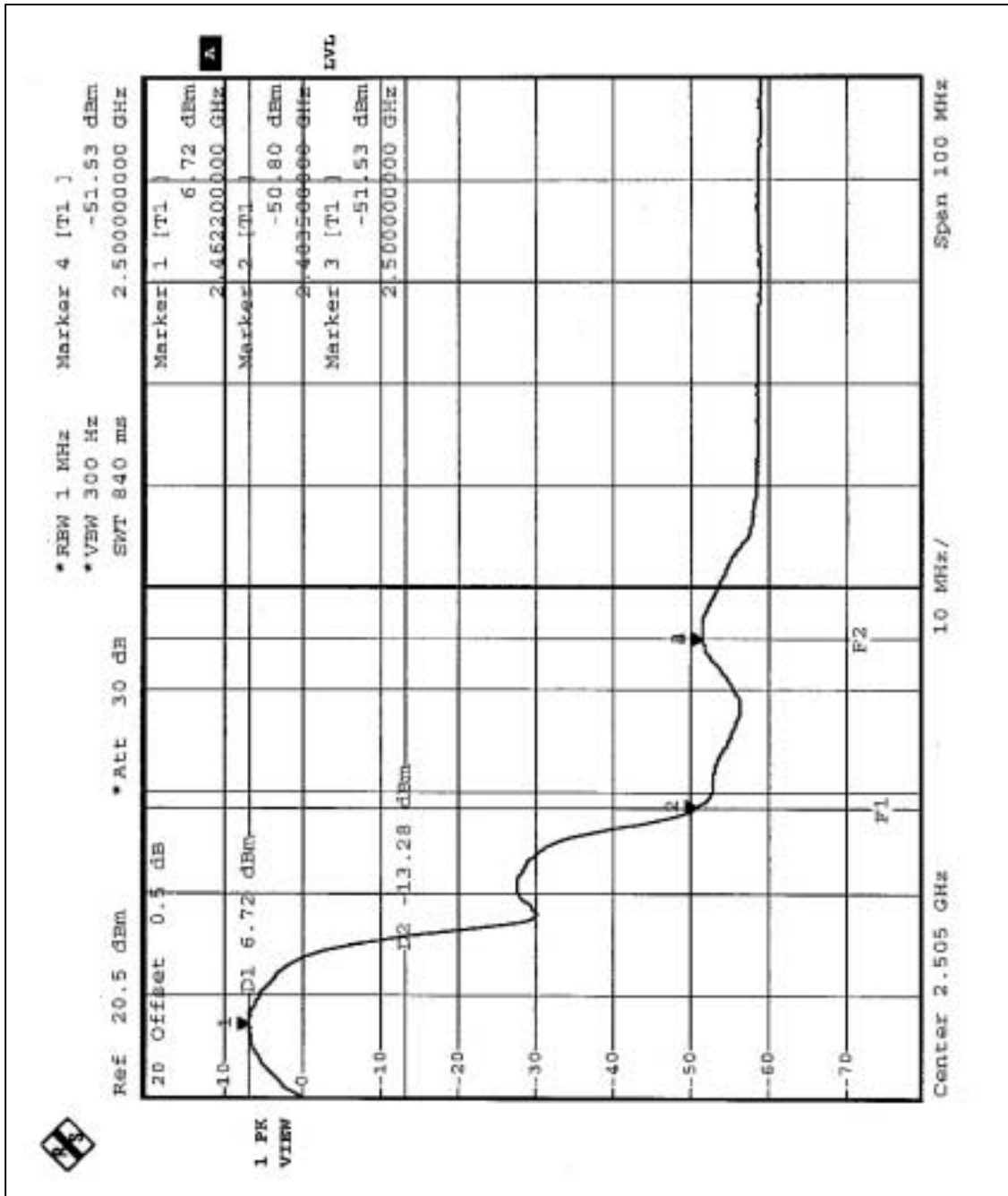



#### 4.6.6 TEST RESULTS-OFDM

The spectrum plots are attached on the following 2 pages. D1 line indicates the highest level, D2 line indicates the 20dB offset below D1. It shows compliance with the requirement in part 15.247(C).

Note - The delta method is only used up to 2 MHz away from the restricted bandage, The radiated emissions which located in other restricted frequency band, the result, please refer to 4.2.8.

**NOTE (1):** The band edge emission plot on the following first page shows 47.83dB delta between carrier maximum power and local maximum emission in restrict band (2.3900GHz). The emission of carrier strength list in the test result of channel 1 at the item 4.2.8 is 98.2dBuV/m, so the maximum field strength in restrict band is  $98.2 - 47.83 = 50.37$ dBuV/m which is under 54 dBuV/m limit.

**NOTE (2):** The band edge emission plot on the following second page shows 49.01B delta between carrier maximum power and local maximum emission in restrict band (2.4835GHz). The emission of carrier strength list in the test result of channel 11 at the item 4.2.8 is 97.9dBuV/m, so the maximum field strength in restrict band is  $97.9 - 49.01 = 48.89$ dBuV/m which is under 54 dBuV/m limit.

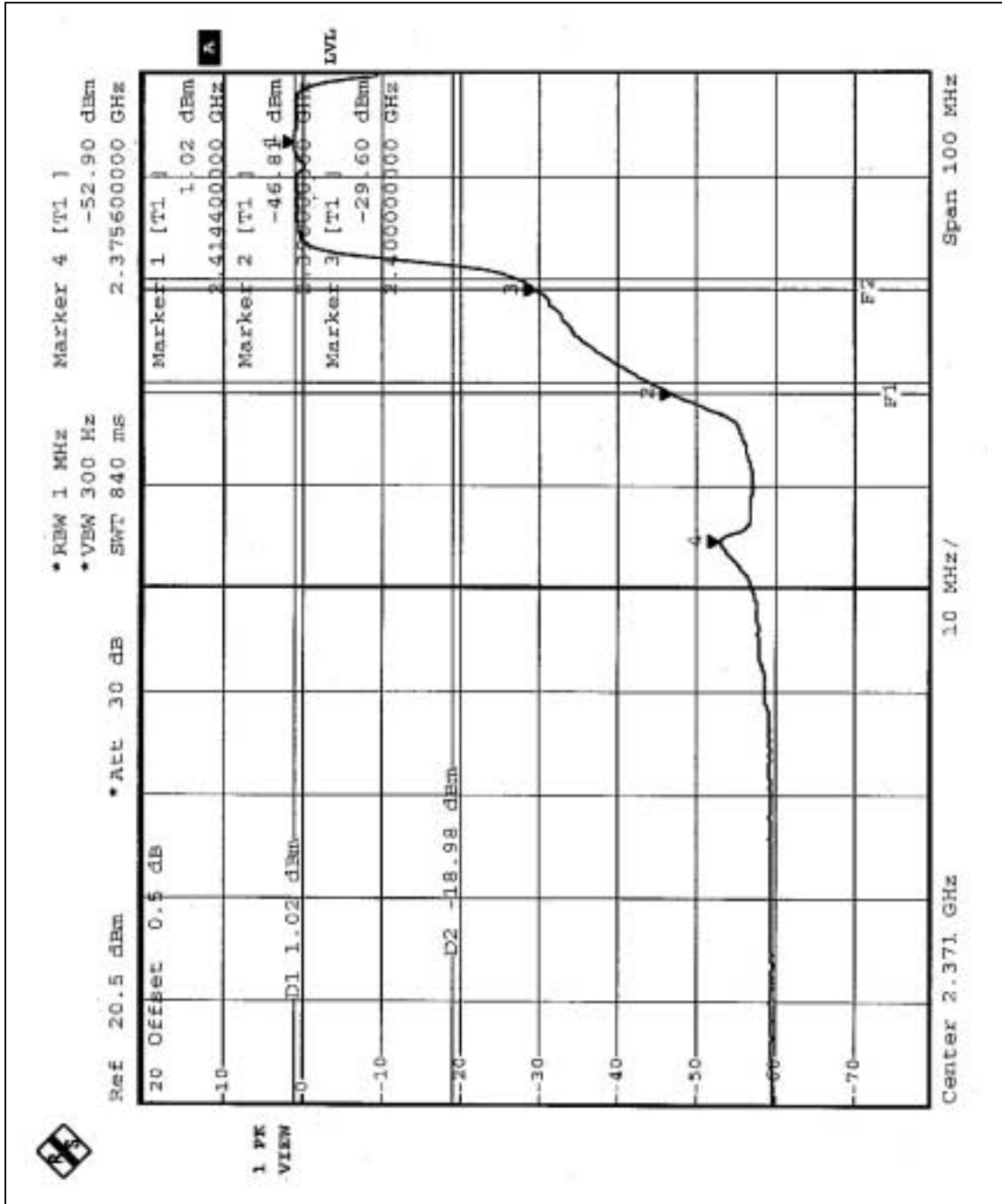

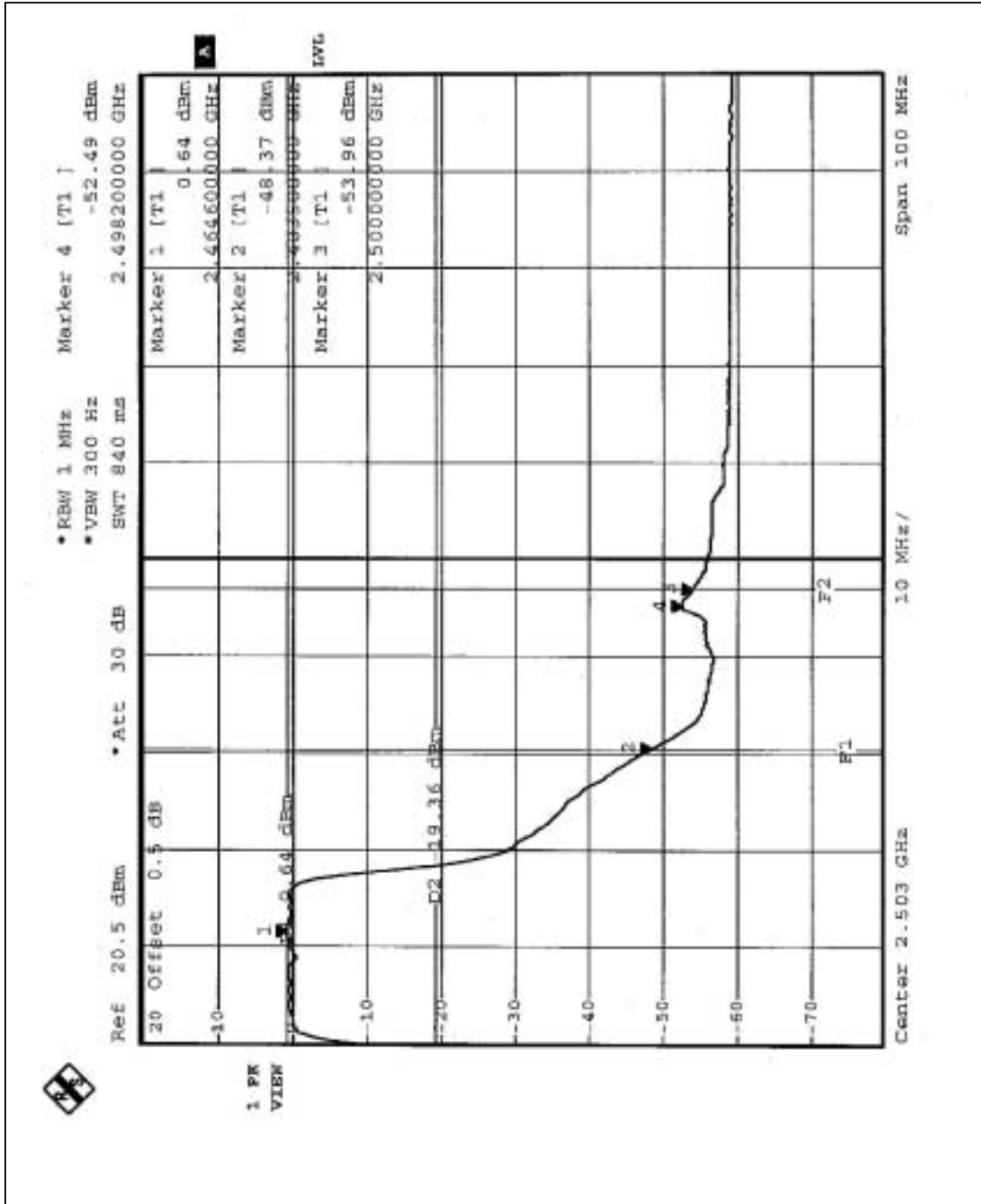



## **4.7 ANTENNA REQUIREMENT**

### **4.7.1 STANDARD APPLICABLE**

For intentional device, according to FCC 47 CFR Section 15.203, an intentional radiator shall be designed to ensure that no antenna other than that furnished by the responsible party shall be used with the device.

And according to FCC 47 CFR Section 15.247 (b), if transmitting antennas of directional gain greater than 6dBi are used, the power shall be reduced by the amount in dB that the directional gain of the antenna exceeds 6dBi.

### **4.7.2 ANTENNA CONNECTED CONSTRUCTION**

The antenna type used in this product is Dipole Antenna without connector. And the maximum Gain of this antenna is only 1.5 dBi.

## 5 PHOTOGRAPHS OF THE TEST CONFIGURATION CONDUCTED EMISSION TEST





### RADIATED EMISSION TEST

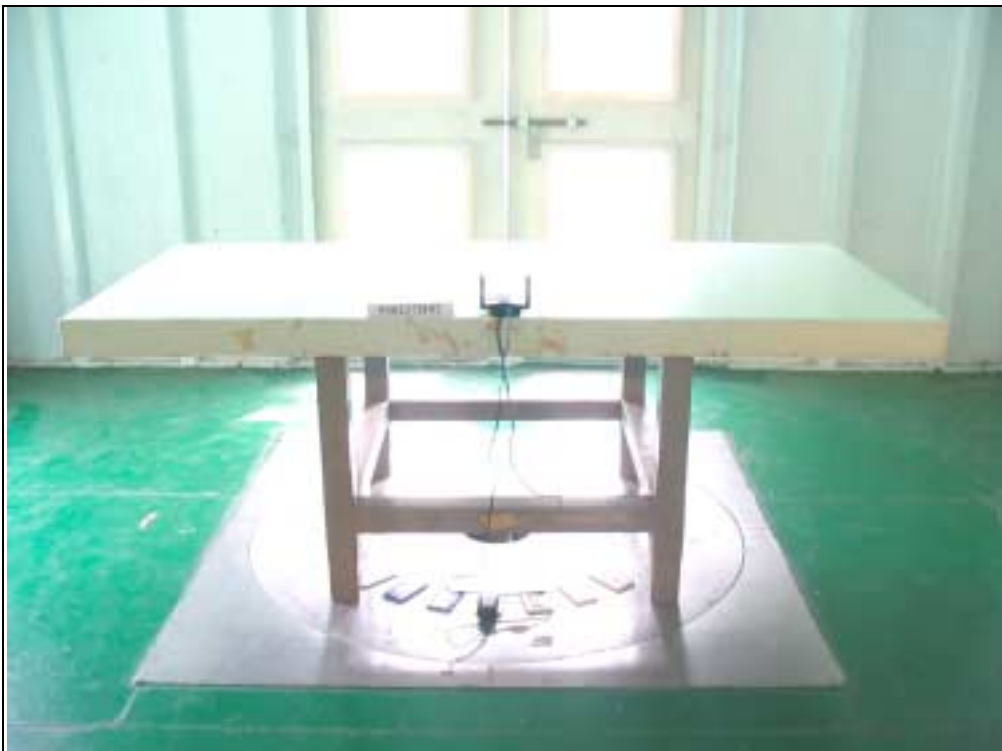



## 6 INFORMATION ON THE TESTING LABORATORIES

We, ADT Corp., were founded in 1988 to provide our best service in EMC, Radio, Telecom and Safety consultation. Our laboratories are accredited and approved by the following approval agencies according to ISO/IEC 17025, Guide 25 or EN 45001:

<b>USA</b>	FCC, NVLAP, UL
<b>Germany</b>	TUV Rheinland
<b>Japan</b>	VCCI
<b>Norway</b>	NEMKO
<b>Canada</b>	INDUSTRY CANADA , CSA
<b>R.O.C.</b>	CNLA, BSMI, DGT
<b>Netherlands</b>	Telefication
<b>Singapore</b>	PSB , GOST-ASIA(MOU)
<b>Russia</b>	CERTIS(MOU)

Copies of accreditation certificates of our laboratories obtained from approval agencies can be downloaded from our web site: [www.adt.com.tw/index.5/phtml](http://www.adt.com.tw/index.5/phtml). If you have any comments, please feel free to contact us at the following:

**Linko EMC/RF Lab:**

Tel: 886-2-26052180

Fax: 886-2-26052943

**Hsin Chu EMC/RF Lab:**

Tel: 886-3-5935343

Fax: 886-3-5935342

**Hwa Ya EMC/RF/Safety Lab:**

Tel: 886-3-3183232

Fax: 886-3-3185050

**Linko RF & Telecom Lab.**

Tel: 886-3-3270910

Fax: 886-3-3270892

**Email:** [service@mail.adt.com.tw](mailto:service@mail.adt.com.tw)

**Web Site:** [www.adt.com.tw](http://www.adt.com.tw)

The address and road map of all our labs can be found in our web site also.