

T Mobile™

User Guide

**TM0-G4AR
5G Gateway**



Release 1.0.0

Manufacturer	Arcadyan Technology Corporation No.8, Sec.2, Guangfu Rd., Hsinchu City 30071, Taiwan
Import from	Arcadyan Technology Corporation
Distributor	T-Mobile USA, Inc.

© 2023 T-Mobile USA, Inc. All rights reserved.

T-Mobile, the T logo, Magenta, the magenta color and the T-Mobile Internet logo are registered trademarks of Deutsche Telekom AG.

Contents

Safety Guidelines.....	5
Potential Equipment Damage	5
Risk of Electric Shock or Fire	5
Introduction	6
Getting to Know Your T-Mobile 5G Gateway	6
Physical Interfaces.....	7
Setting up the T-Mobile 5G Gateway	7
Recommended Setup: Use the T-Mobile Internet mobile app.....	7
Manual Setup: Identify An Ideal Location.....	8
Connecting Power to the T-Mobile 5G Gateway.....	8
Starting the T-Mobile 5G Gateway.....	9
Connecting Devices	9
Connecting Wi-Fi Devices	9
Connecting Ethernet Devices	10
Viewing Connected Devices	10
Accessing Your Web GUI (Graphical User Interface).....	11
Home Screen	11
Language Selection	12
Support Screen.....	12
Replacing the SIM Card	13
Factory Resetting the T-Mobile 5G Gateway.....	14

Troubleshooting	15
No Internet	15
No Signal.....	15
Prevent Overheating.....	15
T-Mobile 5G Gateway Does Not Start	15
Poor Internet Experience	15
Forget Your Admin Password?.....	15
Understanding the LCD	16
Connection.....	16
Devices.....	17
Internet Line Number	17
Messages.....	18
Antenna Settings.....	20
Language Settings.....	22
Technical Specifications.....	24
Terms and Conditions	25
Privacy Policy	25
Customer Support	25

Safety Guidelines

Potential Equipment Damage

Follow these recommendations to protect yourself and the 5G Gateway from harm:

- Use the 5G Gateway only in upright position as shown in the Quick Start Guide.
- Do not insert any sharp object into the openings of the 5G Gateway.
- Do not put the 5G Gateway near a heat source.
- Avoid placing the 5G Gateway in areas where the gateway will be in intense or prolonged direct sunlight.
- The 5G Gateway is intended for indoor use only. Do not use the 5G Gateway outside, and make sure all the connections are indoors.
- Do not put the 5G Gateway in damp or wet locations; for example, near a bathtub, washbowl, kitchen sink or laundry tub, in a wet basement, or near a swimming pool. Do not spill any liquid on the 5G Gateway.
- Do not touch the 5G Gateway or its power adapter or cord with wet hands.
- Do not place the 5G Gateway on an unstable surface or support.
- Do not place anything on top of the 5G Gateway.
- Do not use liquid or aerosol cleaners; unplug the 5G Gateway and use a soft, dry cloth for cleaning.
- When connecting a PC or other electronic device to the 5G Gateway, make sure you use the provided cables and connect the device to the right port of the gateway.
- Incorrect connections may damage the device and/or the 5G Gateway.
- Do not open or try to open the 5G Gateway.
- Opening or removing covers can expose you to dangerous high voltage points or other risks.
- Do not attempt to access, manipulate, insert foreign objects into, remanufacture, or immerse or otherwise expose it to water.
- Use care to avoid accidental drops or sprays of water on the 5G Gateway.
- If the T-Mobile 5G Gateway is dropped—especially on a hard surface—or in the case of suspected damage, contact your nearest T-Mobile service center for inspection.

Risk of Electric Shock or Fire

Follow these guidelines when using the T-Mobile 5G Gateway:

- Connect the power adapter or cord to the right supply voltage (120V AC in USA).
- Pay attention to the power load of the electrical outlet and possible extension cord.
- An overburdened power outlet or damaged cords and plugs may cause electric shock or fire.
- Check the power adapter regularly. If you find any damage, replace the power adapter immediately.
- Do not connect the plug into an extension cord, receptacle, or other outlet unless the plug can be fully inserted with no part of the blades exposed.

- Leave adequate space for heat dissipation to avoid any damage caused by overheating the 5G Gateway.
- Do not cover the 5G Gateway or its ventilation holes. Blocking the ventilation holes may cause fire.
- Use the power adapter provided with your 5G Gateway and do not fasten the power cable to building surfaces.
- Ensure the cable can move freely. Do not place heavy objects on the cable.
- Do not use the 5G Gateway outside, and make sure all the connections are indoors.
- Do not install, use, or service the 5G Gateway during a thunderstorm.
- There is a remote risk of electric shock from lightning.
- The standby power consumption of the 5G Gateway is 4.5W.

Introduction

This document explains how to operate the T-Mobile 5G Gateway at home using visual cues to achieve the best placement and performance.

NOTE

This document is a supplement to the Quick Start Guide and T-Mobile Internet mobile app. Use the Quick Start Guide to get up and running quickly.

The contents of this guide are subject to change without notice.

Getting to Know Your T-Mobile 5G Gateway

You will find the following items in the box:

- Gateway
- Windowsill Bracket
- Power Adapter
- Quick Start Guide
- T-Mobile Terms and Conditions
- Safety and Regulatory Notice

The gateway offers 4G/LTE or 5G/NR WAN (Wide Area Network) mobile network connectivity by way of four wide band omni or semi directional antennas that supports all LTE/5G bands. It functions as the connection point between the WAN outside your home and the LAN (Local Area Network) inside your home.

Physical Interfaces

The gateway's physical interfaces include those shown in the following diagrams.

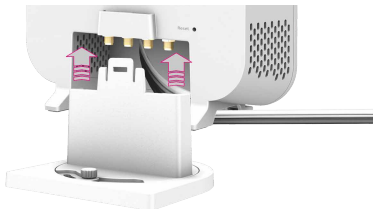
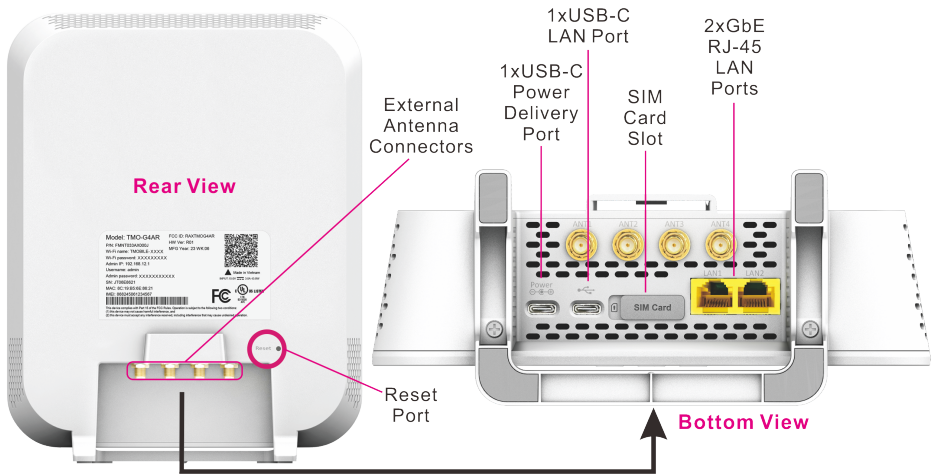

- Be sure the Ethernet and power cables are securely plugged into the connectors of the 5G Gateway before attaching the windowsill bracket.



- Twist to loosen or tighten the windowsill bracket screw for adjusting the 5G Gateway's orientation.

Setting up the T-Mobile 5G Gateway

Recommended Setup: Use the T-Mobile Internet mobile app

Using the Quick Start Guide and the T-Mobile Internet mobile app provides the easiest and best setup experience. The T-Mobile Internet mobile app can be downloaded from either Google Play Store or the Apple App Store.



NOTE

The first time you setup your gateway, “How to navigate this interface” displays on the LCD panel. Select “OK” to continue the start up.

Download the T-Mobile Internet app onto your smart phone. Follow the on-screen prompts in app and complete first time setup. Then the app establishes communication and connects to the gateway.

Manual Setup: Identify An Ideal Location

Start by identifying the ideal location for your gateway — that location will meet the following criteria:

- Position the 5G Gateway on elevated surface for getting the best signal strength
- Near a window where the signal strength is strongest

NOTE

Low-e glass windows may weaken signal strength. Avoid placing the 5G Gateway near low-e glass windows.

- In an open space away from:
 - Basements
 - Devices that may cause interference such as Wi-Fi routers
 - Behind TVs or monitors
 - Walls or obstructions
 - Heavy-duty appliances or electronics such as microwave ovens and baby monitors
 - Metal fixtures, enclosures, cabinets, reinforced concrete, or pipes
- Near a power outlet
- On an upper floor of the home or at least 6 feet off the floor

Connecting Power to the T-Mobile 5G Gateway

- Place the gateway on a flat surface, such as a tabletop or similar; close to a window and near an electrical outlet
- Minimize the number of obstructions as much as possible
- Connect the provided USB Type-C power cable to gateway’s power port, then plug the other end of the power cable into a grounded electrical outlet

- The USB Type-C power cable must be capable of supporting 100–240V (volts) AC adapter, 50–60Hz frequency and 3A of current at DC 15V

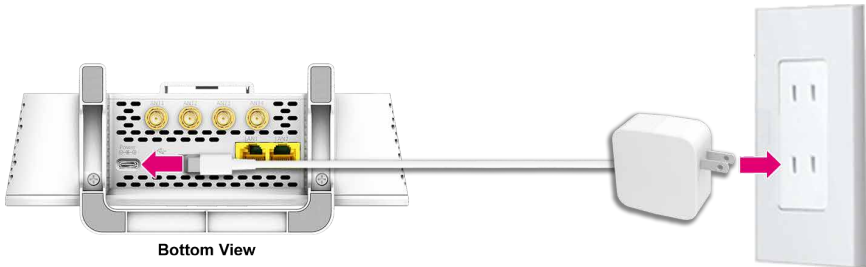

Starting the T-Mobile 5G Gateway

After the gateway is connected to a power source, the LCD screen displays an animated T-Mobile logo that indicates the gateway is starting up.

Six small dots displayed on the LCD panel indicates available screens of:

- Connection
- Devices
- Internet Line Number
- Messages
- Antenna
- Language

Take a moment to browse these screens to see what information is available. For more information about the LCD screen display, refer to the section “Understanding the LCD” on page 16.

When the start up sequence is complete, the LCD displays the Connection screen.

Connecting Devices

Connecting Wi-Fi Devices

Connect your wireless devices to your network using the Wi-Fi SSID (Wi-Fi name) and Wi-Fi Key (Wi-Fi password), which are found on the gateway’s rear panel. Here is an example of the label:

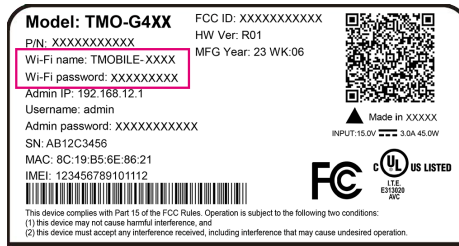

The QR code on the label provides easy set up when the T-Mobile Internet mobile app is installed.

Connecting Ethernet Devices

The gateway has two (2) Ethernet LAN ports. Use an Ethernet cable to connect devices that don't have Wi-Fi adapters or capabilities.

Viewing Connected Devices

The Devices LCD screen on the front of the gateway shows the number of devices currently connected to the network by way of either Wi-Fi or Ethernet.

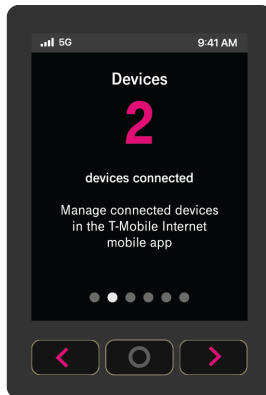

To view how many devices are connected:

1. Observe the LCD Connection screen
2. Press the right arrow on the LCD panel to display the Devices screen

Accessing Your Web GUI (Graphical User Interface)

NOTE

You can configure the gateway and any connected client devices via the T-Mobile Internet mobile app on a smartphone.

Ensure the Local Area Connection setting on your PC, laptop, smart phone, or tablet is configured to obtain an IP address automatically.

On your device, open a web browser, and enter <http://192.168.12.1>

NOTE

If you are unable to access the GUI at the above address, please contact customer support.

Home Screen

You should now see the dashboard screen, which provides network connection status and information about the gateway.

The screenshot shows the Home screen of the T-Mobile 5G Gateway web GUI. The page is titled "Home" and includes a navigation menu on the left with icons for Home and Settings. The main content area is divided into several sections:

- Connection status:** A diagram showing a smartphone connected to a Wi-Fi gateway, which is connected to the Internet.
- Connection quality:** A bar chart showing connection quality levels: Excellent, Very Good, Good, Weak, and Poor. The current quality is Excellent.
- Gateway:** A table displaying gateway information:

Firmware version	84631
UI version	v1.0.1
Serial Number	GVH123456789
Running Time	7d 21h 7m 23s
- Mobile app:** A section promoting the T-Mobile Internet app, featuring a QR code and a "Learn more" link.

At the bottom of the screen, there is a footer with the text "Questions? Our Support team is here for you" and "© T-Mobile, Inc. Privacy Policy Terms of Service".

The Home screen contains four sections:

- Connection status: shows network status of the connected devices, the gateway, and the T-Mobile network connection
- Connection quality: signal strength is represented by number of bars
- Gateway information
 - Firmware version: variable
 - UI version: variable
 - Serial Number: variable
 - Running Time: how long it has been since the gateway's last reset/power-cycle
- T-Mobile Internet mobile app: scanning the QR code with your smart phone and downloading the mobile app for the easiest setup experience

NOTE

Gateway settings are available in the T-Mobile Internet mobile app.

Language Selection

From the GUI's top-right corner of the screen, select your preferred language, English or Español, from the dropdown menu for user interface language.

Support Screen

Use the Support tab for useful FAQ and T-Mobile Community Forum links, and customer support information.

Support English ▾

Contact us or review our FAQs to get the help you need.

Frequently asked questions

Have questions about T-Mobile Internet?
[Check out FAQ's](#)

Ask a specific question

Ask a question in our community forum or share your knowledge with other customers
[Visit the T-Mobile Community Forum](#)

Contact customer care

Need more T-Mobile support? We're a team of real people, dedicated to your account, and here to help.

Home
[1-844-275-9310](#)

Business
[1-844-371-1373](#)

Metro
[1-888-8METRO8](#)

Replacing the SIM Card

The gateway comes with a pre-installed SIM card. You can replace the SIM card by pressing the card into the card slot.

Before replacing the SIM card, please read the following safety information.



Danger 1: Hazardous electrical voltages and currents can cause serious physical harm. Always use insulated tools and follow proper safety precautions when connecting or disconnecting power circuits.

Danger 2: Ensure the gateway's power supply is unplugged from the power strip or wall outlet before proceeding.



Caution: Keep indoor devices out of direct sunlight. Prolonged exposure to direct sunlight can damage the device.

Refer to the section "Technical Specifications" for the gateway's operating temperature ranges.

Access the SIM card from the bottom side of the gateway.

1. Power off the gateway by removing the power cable from the electrical outlet and from the gateway
2. Press and release the top latch of windowsill bracket to detach the bracket from the gateway
3. Remove any Ethernet cables connected to the gateway's LAN ports (LAN1 and LAN 2)
4. Use the finger pull to open the SIM door

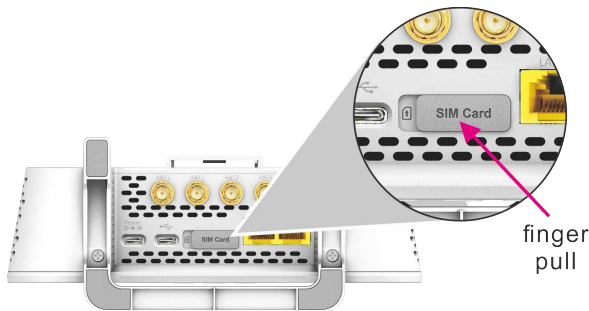

5. The SIM card socket supports push-in and push-out installation
6. With the SIM door open, press the pre-installed SIM card into the slot and the SIM card pops out
7. Carefully remove the pre-installed SIM card
8. Insert and press the new SIM card into the slot

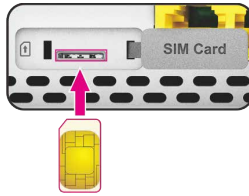

9. Be sure the SIM card clicks into place to ensure that it is properly installed
10. Close the cover of the SIM card slot and ensure the cover is securely closed on the SIM door

Factory Resetting the T-Mobile 5G Gateway

Resetting the T-Mobile 5G Gateway to factory default deletes all configuration changes made since setup.

Using the Reset Port

You can reset the gateway using a paperclip and the Reset port, which is located on the device's backside.

1. Press-and-hold a paperclip in the Reset port for 5 seconds



2. Withdraw the paperclip. LCD shows:
 - Factory reset in progress
 - T-Mobile animated logo
 - Power up animation
3. On the LCD, press **OK** and you will see the **Connection** screen

Troubleshooting

No Internet

- Verify device is powered on with LCD screen
- Check SIM card is present and seated correctly
- Try placing the gateway in a different location
- Try factory reset

No Signal

This LCD alert indicates there is no network signal, which could mean local cellular equipment is down for any number of reasons, or the gateway may need to be re-positioned.

If the connection does not improve in a reasonable amount of time, you can contact T-Mobile customer service or refer to the section “Manual Setup: Identify An Ideal Location”.

Prevent Overheating

Avoid prolonged exposure to the direct sunlight, particular in warm climates.

Also, make sure that obstacles never obstruct airflow vents on the top or bottom of the gateway’s enclosure. Allow at least 100mm/4in clearance on all sides of the enclosure. Ensure the gateway is at least 3 feet from baseboard heaters.

If the gateway feels hot to touch, unplug it immediately and let the device cool before plugging it in again.

T-Mobile 5G Gateway Does Not Start

If the gateway does not start up, verify the provided power adapter is connected to a working outlet and plugged into the power USB-C port on the gateway. If the gateway is connected to an outlet and power still does not start, contact T-Mobile technical support.

Poor Internet Experience

If you feel your overall internet experience is poor, try repositioning the gateway; refer to the section “Manual Setup: Identify An Ideal Location”.

Forget Your Admin Password?

If you configure a custom admin password and forget it, use the password reset function found within the T-Mobile Internet mobile app to reset the password to factory default.

Understanding the LCD

The gateway's LCD is located on front of the device. The LCD serves as a dashboard where you can quickly obtain information of the following types:

- Connection
- Devices
- Internet Line Number
- Messages
- Antenna
- Language Settings

Press left or right arrow (< or >) on the LCD panel with your finger to move between screens. The position of the illuminated dot on the bottom of the screen indicates where you are in the screen sequence.

The **Connection** screen is the first displayed after a successful start up sequence.

Connection

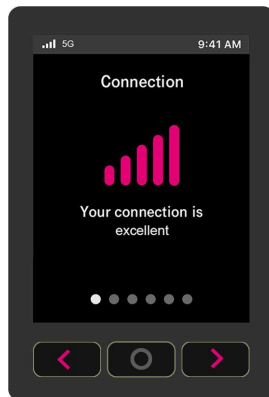

Like your phone, the gateway displays up to five bars on its Connection screen, indicating signal strength.

The number of bars you see represents the strength of the gateway's current connection to the cellular network.

An X indicates the gateway is not connected to the T-Mobile network.

Devices

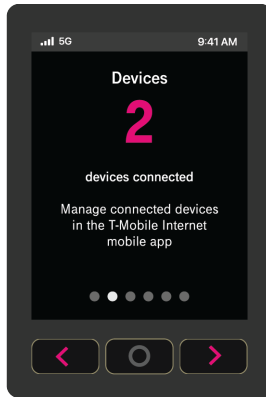

The Devices screen indicates how many devices are currently connected to the gateway. This is true for both wireless and wired devices.

Internet Line Number

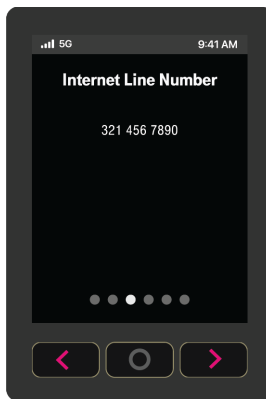

The Internet Line Number screen displays your internet number of the SIM card installed.

Messages

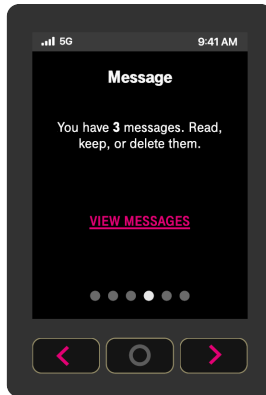

These messages come from the T-Mobile network and may provide outage information or other important updates.

The Messages screen allows you to view the message contents by pressing < and > to scroll between messages.

To delete a message:

1. Press **O** (OK) on the panel to select **VIEW MESSAGES** and view unread messages
2. Select **NEXT** and read next message

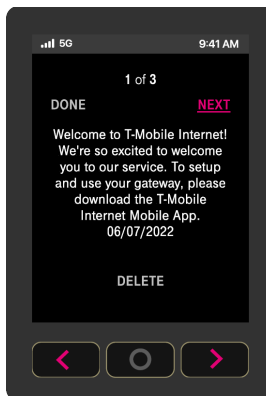

3. Select **DONE** when you read all messages

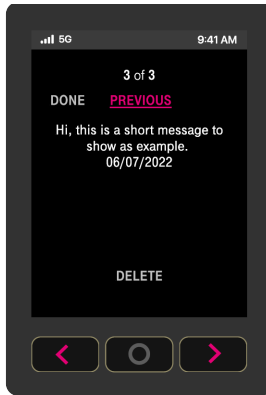

4. Select **DELETE** to delete a message

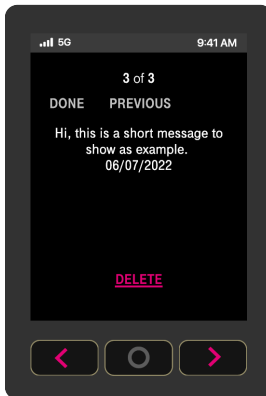

5. When prompted a message of asking you to confirm deletion, select **YES** to confirm

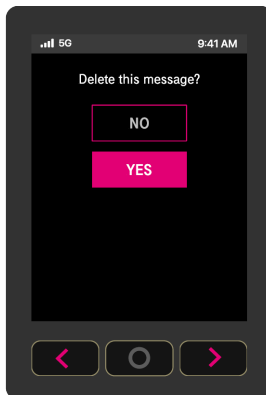

6. Select **DONE** when you finish

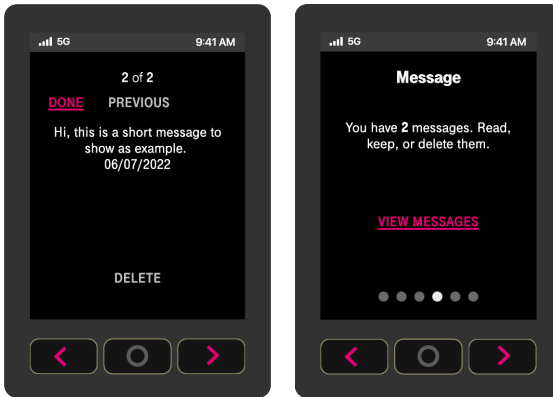

Antenna Settings

In addition to the embedded internal antenna, the gateway also provides optional external antenna ports for optimal performance of cellular signal strength. You may change the antenna settings to EXTERNAL if an external antenna is attached.

1. From the Antenna screen, select **CHANGE**

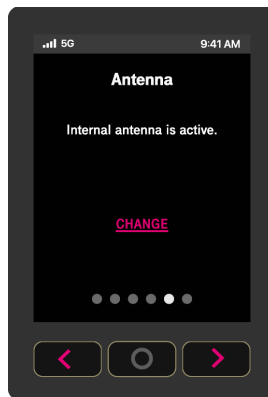

- From the Antenna screen, you can choose:
 - INTERNAL**
 - EXTERNAL** if an external antenna is attached

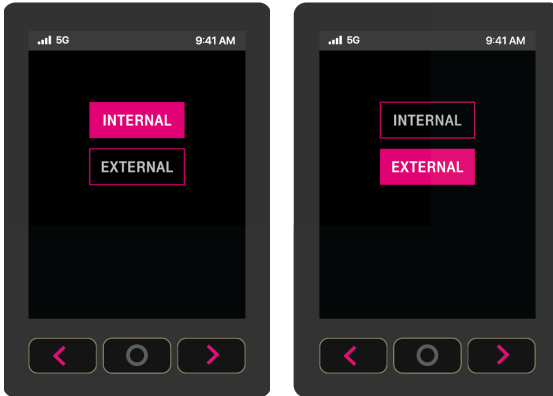
**NOTE**

Only change this setting to EXTERNAL when an external antenna is attached.

- When prompted a message of asking you to confirm your selection, tab **OK** to confirm

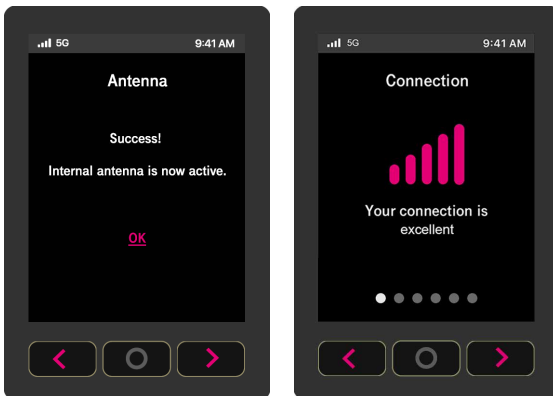



Language Settings

The gateway supports both English and Spanish on its LCD. You may change the language by doing:

1. From the Language screen, select **CHANGE**



- From the Language screen, choose **English** or **Español**

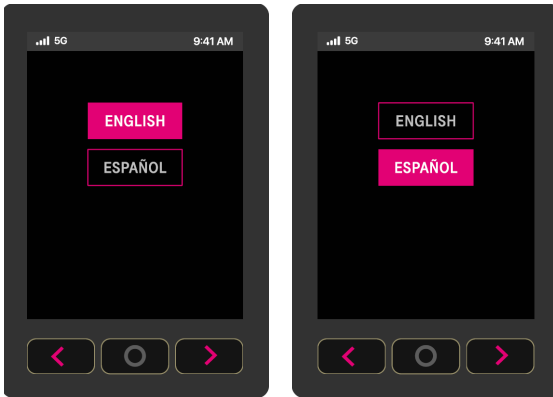

- Press **O** (OK) on the panel to set the language

Technical Specifications

Dimensions	228 (H) x 180 (W) x 76 (D) mm
Weight	880 g 1.94 lbs
Operating environment	0 to 40 °C 32 to 104 °F
IoT / GPS	Bluetooth 5.1 GPS
Power adapter	AC
Power input	100 – 240V, 3A @ DC 15V, 50/60Hz
Theoretical power consumption	45 W
Wi-Fi connectivity	11ax 4x4 2.4G 11ax 4x4 5G Seamless roaming
Security	WPA/WPA2/WPA3
Buttons	Reset (recessed switch) Arrow Keys (Left & Right) Enter (OK)
Display	TFT LCD Non-Touch Panel 2.4-Inch 240x320 Resolution
Mobile Band	5G NR: n25, n41, n48, n66, n71, n77 (DoD and C-Band) 4G LTE: B2, B4, B5, B12, B25, B48, B66, B71
Physical Interfaces	GE LAN (Yellow) SIM Card Socket (4FF Only) USB Type C x 1 (Regular Power Source) USB Type C x 1 (Data and other USB Port Purpose)

Terms and Conditions

t-mobile.com/responsibility/legal/terms-and-conditions

Privacy Policy

t-mobile.com/privacy-center/our-practices/privacy-policy

Customer Support

24/7 Tech Support Line: 1-844-275-9310

Metro Support Line: 1-888-8Metro8