

TEST REPORT

CERTIFICATE OF CONFORMITY

Standard: 47 CFR FCC Part 15, Subpart E (Section 15.407)

Report No.: RFBCMA-WTW-P23030799-1

FCC ID: RAXTMOG4AR

Product: 5G Gateway

Brand: T-Mobile

Model No.: TMO-G4AR

Received Date: 2023/3/15

Test Date: 2023/3/30 ~ 2023/4/29

Issued Date: 2023/5/23

Applicant: Arcadyan Technology Corporation

Address: No.8, Sec.2, Guangfu Rd., Hsinchu City 30071, Taiwan, R.O.C.

Issued By: Bureau Veritas Consumer Products Services (H.K.) Ltd., Taoyuan Branch
Hsin Chu Laboratory

Lab Address: E-2, No.1, Li Hsin 1st Road, Hsinchu Science Park, Hsinchu City 300, Taiwan

Test Location: E-2, No.1, Li Hsin 1st Road, Hsinchu Science Park, Hsinchu City 300, Taiwan

FCC Registration / 723255 / TW2022

Designation Number:

Approved by: _____



May Chen / Manager

, Date: _____

2023/5/23

This test report consists of 98 pages in total. It may be duplicated completely for legal use with the approval of the applicant. It should not be reproduced except in full, without the written approval of our laboratory. The test results in the report only apply to the tested sample. The test results in this report are traceable to the national or international standards.



Prepared by : Phoebe Wang / Specialist

This report is governed by, and incorporates by reference, the Conditions of Testing as posted at the date of issuance of this report at <http://www.bureauveritas.com/home/about-us/our-business/cps/about-us/terms-conditions/> and is intended for your exclusive use. Any copying or replication of this report to or for any other person or entity, or use of our name or trademark, is permitted only with our prior written permission. This report sets forth our findings solely with respect to the test samples identified herein. The results set forth in this report are not indicative or representative of the quality or characteristics of the lot from which a test sample was taken or any similar or identical product unless specifically and expressly noted. Our report includes all of the tests requested by you and the results thereof based upon the information that you provided to us. Measurement uncertainty is only provided upon request for accredited tests. Statements of conformity are based on simple acceptance criteria without taking measurement uncertainty into account, unless otherwise requested in writing. You have 60 days from date of issuance of this report to notify us of any material error or omission caused by our negligence or if you require measurement uncertainty; provided, however, that such notice shall be in writing and shall specifically address the issue you wish to raise. A failure to raise such issue within the prescribed time shall constitute your unqualified acceptance of the completeness of this report, the tests conducted and the correctness of the report contents.

Table of Contents

Release Control Record	4
1 Certificate.....	5
2 Summary of Test Results	6
2.1 Measurement Uncertainty	6
2.2 Supplementary Information	6
3 General Information	7
3.1 General Description of EUT	7
3.2 Antenna Description of EUT	8
3.3 Channel List.....	10
3.4 Test Mode Applicability and Tested Channel Detail.....	11
3.5 Duty Cycle of Test Signal.....	12
3.6 Test Program Used and Operation Descriptions	14
3.7 Connection Diagram of EUT and Peripheral Devices	14
3.8 Configuration of Peripheral Devices and Cable Connections	15
4 Test Instruments	16
4.1 RF Output Power.....	16
4.2 Power Spectral Density	16
4.3 6 dB Bandwidth	16
4.4 Occupied Bandwidth.....	16
4.5 Frequency Stability	17
4.6 AC Power Conducted Emissions	17
4.7 Unwanted Emissions below 1 GHz	18
4.8 Unwanted Emissions above 1 GHz.....	19
5 Limits of Test Items.....	20
5.1 RF Output Power.....	20
5.2 Power Spectral Density	20
5.3 6 dB Bandwidth	20
5.4 Occupied Bandwidth.....	20
5.5 Frequency Stability	20
5.6 AC Power Conducted Emissions	21
5.7 Unwanted Emissions below 1 GHz	21
5.8 Unwanted Emissions above 1 GHz.....	22
6 Test Arrangements.....	23
6.1 RF Output Power.....	23
6.1.1 Test Setup	23
6.1.2 Test Procedure.....	23
6.2 Power Spectral Density	23
6.2.1 Test Setup	23
6.2.2 Test Procedure.....	23
6.3 6 dB Bandwidth	24
6.3.1 Test Setup	24
6.3.2 Test Procedure.....	24
6.4 Occupied Bandwidth.....	24
6.4.1 Test Setup	24
6.4.2 Test Procedure.....	24
6.5 Frequency Stability	25
6.5.1 Test Setup	25
6.5.2 Test Procedure.....	25
6.6 AC Power Conducted Emissions	26
6.6.1 Test Setup	26
6.6.2 Test Procedure.....	26
6.7 Unwanted Emissions below 1 GHz	27
6.7.1 Test Setup	27
6.7.2 Test Procedure.....	28



6.8	Unwanted Emissions above 1 GHz.....	29
6.8.1	Test Setup	29
6.8.2	Test Procedure.....	29
7	Test Results of Test Item	30
7.1	RF Output Power.....	30
7.2	Power Spectral Density	35
7.3	6 dB Bandwidth	39
7.4	Occupied Bandwidth.....	41
7.5	Frequency Stability	49
7.6	AC Power Conducted Emissions	50
7.7	Unwanted Emissions below 1 GHz	52
7.8	Unwanted Emissions above 1 GHz.....	54
8	Pictures of Test Arrangements	97
9	Information of the Testing Laboratories	98



Release Control Record

Issue No.	Description	Date Issued
RFBCMA-WTW-P23030799-1	Original release.	2023/5/23

1 Certificate

Product: 5G Gateway

Brand: T-Mobile

Test Model: TMO-G4AR

Sample Status: Engineering sample

Applicant: Arcadyan Technology Corporation

Test Date: 2023/3/30 ~ 2023/4/29

Standard: 47 CFR FCC Part 15, Subpart E (Section 15.407)

Measurement ANSI C63.10-2013

procedure: KDB 789033 D02 General UNII Test Procedure New Rules v02r01

KDB 662911 D01 Multiple Transmitter Output v02r01

The above equipment has been tested by **Bureau Veritas Consumer Products Services (H.K.) Ltd., Taoyuan Branch**, and found compliance with the requirement of the above standards. The test record, data evaluation & Equipment Under Test (EUT) configurations represented herein are true and accurate accounts of the measurements of the sample's RF characteristics under the conditions specified in this report.

2 Summary of Test Results

47 CFR FCC Part 15, Subpart E (Section 15.407)			
Clause	Test Item	Result	Remark
15.407(a)(1) 15.407(a)(3)	RF Output Power	Pass	Meet the requirement of limit.
15.407(a)(1) 15.407(a)(3)	Power Spectral Density	Pass	Meet the requirement of limit.
15.407(e)	6 dB Bandwidth	Pass	Meet the requirement of limit. (U-NII-3 Band only)
---	Occupied Bandwidth	-	Reference only.
15.407(g)	Frequency Stability	Pass	Meet the requirement of limit.
15.407(b)(9)	AC Power Conducted Emissions	Pass	Minimum passing margin is -3.80 dB at 0.42344 MHz
15.407(b)(9)	Unwanted Emissions below 1 GHz	Pass	Minimum passing margin is -8.1 dB at 59.63 MHz
15.407(b) (1/10) 15.407(b) (4(i)/10)	Unwanted Emissions above 1 GHz	Pass	Minimum passing margin is -0.2 dB at 5150.00, 5646.00 MHz
15.203	Antenna Requirement	Pass	Antenna connector is ipex(MHF1) not a standard connector.

Note: Determining compliance based on the results of the compliance measurement, not taking into account measurement instrumentation uncertainty.

2.1 Measurement Uncertainty

Where relevant, the following measurement uncertainty levels have been estimated for tests performed on the EUT as specified in CISPR 16-4-2:

Measurement	Specification	Expanded Uncertainty (k=2) (±)
AC Power Conducted Emissions	150 kHz ~ 30 MHz	1.9 dB
Unwanted Emissions below 1 GHz	9 kHz ~ 30 MHz	3.1 dB
	30 MHz ~ 1 GHz	5.1 dB
Unwanted Emissions above 1 GHz	9 kHz ~ 30 MHz	3.1 dB
	1 GHz ~ 18 GHz	5.0 dB
	18 GHz ~ 40 GHz	5.3 dB

The other instruments specified are routine verified to remain within the calibrated levels, no measurement uncertainty is required to be calculated.

2.2 Supplementary Information

There is not any deviation from the test standards for the test method, and no modifications required for compliance.

3 General Information

3.1 General Description of EUT

Product	5G Gateway
Brand	T-Mobile
Test Model	TMO-G4AR
Status of EUT	Engineering sample
Power Supply Rating	Refer to Note
Modulation Type	64QAM, 16QAM, QPSK, BPSK for OFDM 256QAM for OFDM in 11ac mode 1024QAM for OFDMA in 11ax mode
Modulation Technology	OFDM, OFDMA
Transfer Rate	802.11a: up to 54 Mbps 802.11n: up to 600 Mbps 802.11ac: up to 3466.7 Mbps 802.11ax: up to 4803.9 Mbps
Operating Frequency	5.18 GHz ~ 5.24 GHz 5.745 GHz ~ 5.825 GHz
Number of Channel	802.11a, 802.11n (HT20), 802.11ac (VHT20), 802.11ax (HE20): 9 802.11n (HT40), 802.11ac (VHT40), 802.11ax (HE40): 4 802.11ac (VHT80), 802.11ax (HE80): 2
Output Power	5.18 GHz ~ 5.24 GHz : 863.913 mW (29.36 dBm) 5.745 GHz ~ 5.825 GHz : 997.474 mW (29.99 dBm)
EUT Category	Indoor Access Point

Note:

1. The EUT uses following accessories.

AC Adapter 1		
Brand	Model	Specification
LUCENT TRANS	1A78	AC Input: 100~240V, 1.2A, 50-60Hz DC Output: 5.0V 3.0A 15W, 9.0V 3.0A 27W, 12.0V 3.0A 36W, 15.0V 3.0A 45W, 20.0V 2.25A 45W DC Output Cable: 1.85 m, non-shielded cable, W/O ferrite core Plug: US
AC Adapter 2		
Brand	Model	Specification
MASS POWER	PD045E-C1C0AVU	AC Input: 100~240V, 1.0A, 50-60Hz DC Output: 5.0V 3.0A, 9.0V 3.0A, 12.0V 3.0A, 15.0V 3.0A, 20.0V 2.25A, 45W DC Output Cable: 1.8 m, non-shielded cable, W/O ferrite core Plug: US

2. There are Bluetooth, WLAN (2.4 GHz & 5 GHz), and WWAN (LTE + 5G nR) technology used for the EUT.

3. Simultaneously transmission condition.

Condition	Technology		
1	LTE		WLAN (2.4 GHz)
2	5G nR		WLAN (2.4 GHz)
3	LTE	WLAN (5 GHz)	Bluetooth
4	5G nR	WLAN (5 GHz)	Bluetooth

Note: The emission of the simultaneous operation has been evaluated and no non-compliance was found.

4. The above EUT information is declared by manufacturer and for more detailed features description, please refers to the manufacturer's specifications or user's manual.

3.2 Antenna Description of EUT

1. The antenna information is listed as below.

Antenna NO.	RF Chain NO.	Brand	Model	Antenna Net Gain (dBi)	Frequency range	Antenna Type	Connector Type	Cable Length (mm)
Wi-Fi + BT	Ant. 0	PSA	RFPCA261017IMLB403_A	1.77	2.4~2.4835 GHz	Dipole	ipex(MHF1)	171
				0.68	5.15~5.25 GHz			
				0.81	5.25~5.35 GHz			
				1.25	5.47~5.725 GHz			
				2.35	5.725~5.85 GHz			
	Ant. 1	PSA	RFPCA261013IMLB402_A	1.49	2.4~2.4835 GHz	Dipole	ipex(MHF1)	130
				0.42	5.15~5.25 GHz			
				1.01	5.25~5.35 GHz			
				1.68	5.47~5.725 GHz			
				2.14	5.725~5.85 GHz			
	Ant. 2	PSA	RFPCA261007IMLB402_A	1.33	2.4~2.4835 GHz	Dipole	ipex(MHF1)	75
				0.71	5.15~5.25 GHz			
				1.12	5.25~5.35 GHz			
				1.54	5.47~5.725 GHz			
				2.13	5.725~5.85 GHz			
	Ant. 3	PSA	RFPCA261008IMLB401_A	1.25	2.4~2.4835 GHz	Dipole	ipex(MHF1)	80
				0.58	5.15~5.25 GHz			
				1.23	5.25~5.35 GHz			
				1.49	5.47~5.725 GHz			
				2.32	5.725~5.85 GHz			
BT+DFS(RX)	PSA	RFPCA261024IMLB401_A	4.72	2.4~2.4835 GHz	Dipole	ipex(MHF1)	245	
			3.90	5.15~5.25 GHz				
			4.23	5.25~5.35 GHz				
			4.43	5.47~5.725 GHz				
			4.43	5.725~5.85 GHz				

* Detail antenna specification please refer to antenna datasheet and/or antenna measurement report.

2. The EUT incorporates a MIMO function:

5 GHz Band		
Modulation Mode	TX & RX Configuration	
802.11a	4TX	4RX
802.11n (HT20)	4TX	4RX
802.11n (HT40)	4TX	4RX
802.11ac (VHT20)	4TX	4RX
802.11ac (VHT40)	4TX	4RX
802.11ac (VHT80)	4TX	4RX
802.11ax (HE20)	4TX	4RX
802.11ax (HE40)	4TX	4RX
802.11ax (HE80)	4TX	4RX

Note:

1. All of modulation mode support beamforming function except 802.11a modulation mode.
2. The EUT support Beamforming and CDD mode, therefore both mode were investigated and the worst case scenario was identified. The worst case data were presented in test report.
3. The modulation and bandwidth are similar for 802.11n mode for 20 MHz (40 MHz), 802.11ac mode for 20 MHz (40 MHz, 80 MHz) and 802.11ax mode for 20 MHz (40 MHz, 80 MHz), therefore the manufacturer will control the power for 802.11ac mode is the same as the 802.11ax or more lower than it and investigated worst case to representative mode in test report.

3.3 Channel List

FOR 5180 ~ 5240 MHz

4 channels are provided for 802.11a, 802.11n (HT20), 802.11ac (VHT20), 802.11ax (HE20):

Channel	Frequency	Channel	Frequency
36	5180 MHz	44	5220 MHz
40	5200 MHz	48	5240 MHz

2 channels are provided for 802.11n (HT40), 802.11ac (VHT40), 802.11ax (HE40):

Channel	Frequency	Channel	Frequency
38	5190 MHz	46	5230 MHz

1 channel is provided for 802.11ac (VHT80), 802.11ax (HE80):

Channel	Frequency
42	5210 MHz

FOR 5745 ~ 5825 MHz:

5 channels are provided for 802.11a, 802.11n (HT20), 802.11ac (VHT20), 802.11ax (HE20):

Channel	Frequency	Channel	Frequency
149	5745 MHz	161	5805 MHz
153	5765 MHz	165	5825 MHz
157	5785 MHz		

2 channels are provided for 802.11n (HT40), 802.11ac (VHT40), 802.11ax (HE40):

Channel	Frequency	Channel	Frequency
151	5755 MHz	159	5795 MHz

1 channel is provided for 802.11ac (VHT80), 802.11ax (HE80):

Channel	Frequency
155	5775 MHz

3.4 Test Mode Applicability and Tested Channel Detail

Pre-Scan:	<p>1. EUT can be used in the following ways: X-axis/ Y-axis/ Z-axis. Pre-scan these ways and find the worst case as a representative test condition.</p> <p>2. The AC Adapter has the following models: LUCENT TRANS 1A78/ MASS POWER PD045E-C1C0AVU. Pre-scan these models of AC Adapters and find the worst case as a representative test condition.</p> <p>3. Pre-Scan has been conducted to determine the worst-case mode from all possible combinations between available modulations, data rates and antenna ports (if EUT with antenna diversity architecture).</p>
Worst Case:	<p>1. X-axis/ Y-axis/ Z-axis Worst Condition:Y-axis</p> <p>2. AC Adapter Worst Condition:LUCENT TRANS 1A78</p>

Following channel(s) was (were) selected for the final test as listed below:

Test Item	Mode	Signal Mode	Tested Channel	Modulation	Data Rate Parameter
RF Output Power	802.11a	CDD	36, 40, 48, 149, 157, 165	BPSK	6Mb/s
	802.11ac (VHT20)	CDD & Beamforming	36, 40, 48, 149, 157, 165	BPSK	MCS0
	802.11ac (VHT40)	CDD & Beamforming	38, 46, 151, 159	BPSK	MCS0
	802.11ac (VHT80)	CDD & Beamforming	42, 155	BPSK	MCS0
	802.11ax (HE20)	CDD & Beamforming	36, 40, 48, 149, 157, 165	BPSK	MCS0
	802.11ax (HE40)	CDD & Beamforming	38, 46, 151, 159	BPSK	MCS0
	802.11ax (HE80)	CDD & Beamforming	42, 155	BPSK	MCS0
6 dB Bandwidth	802.11a	CDD	149, 157, 165	BPSK	6Mb/s
	802.11ax (HE20)	CDD	149, 157, 165	BPSK	MCS0
	802.11ax (HE40)	CDD	151, 159	BPSK	MCS0
	802.11ax (HE80)	CDD	155	BPSK	MCS0
Occupied Bandwidth / Power Spectral Density	802.11a	CDD	36, 40, 48, 149, 157, 165	BPSK	6Mb/s
	802.11ax (HE20)	CDD	36, 40, 48, 149, 157, 165	BPSK	MCS0
	802.11ax (HE40)	CDD	38, 46, 151, 159	BPSK	MCS0
	802.11ax (HE80)	CDD	42, 155	BPSK	MCS0
Frequency Stability	802.11a	-	36	-	-
AC Power Conducted Emissions	802.11ax (HE20)	CDD	48	BPSK	MCS0
Unwanted Emissions below 1 GHz	802.11ax (HE20)	CDD	48	BPSK	MCS0
Unwanted Emissions above 1 GHz	802.11a	CDD	36, 40, 48, 149, 157, 165	BPSK	6Mb/s
	802.11ax (HE20)	CDD	36, 40, 48, 149, 157, 165	BPSK	MCS0
	802.11ax (HE40)	CDD	38, 46, 151, 159	BPSK	MCS0
	802.11ax (HE80)	CDD	42, 155	BPSK	MCS0

Note:
Partial RU (resource unit) reduction mechanisms are not supported.

3.5 Duty Cycle of Test Signal

802.11a: Duty cycle = 3.107 ms / 3.161 ms x 100% = 98.3%

802.11ax (HE20): Duty cycle = 2.626 ms / 2.68 ms x 100% = 98.0%

802.11ax (HE40): Duty cycle = 4.418 ms / 4.474 ms x 100% = 98.7%

802.11ax (HE80): Duty cycle = 4.744 ms / 4.8 ms x 100% = 98.8%

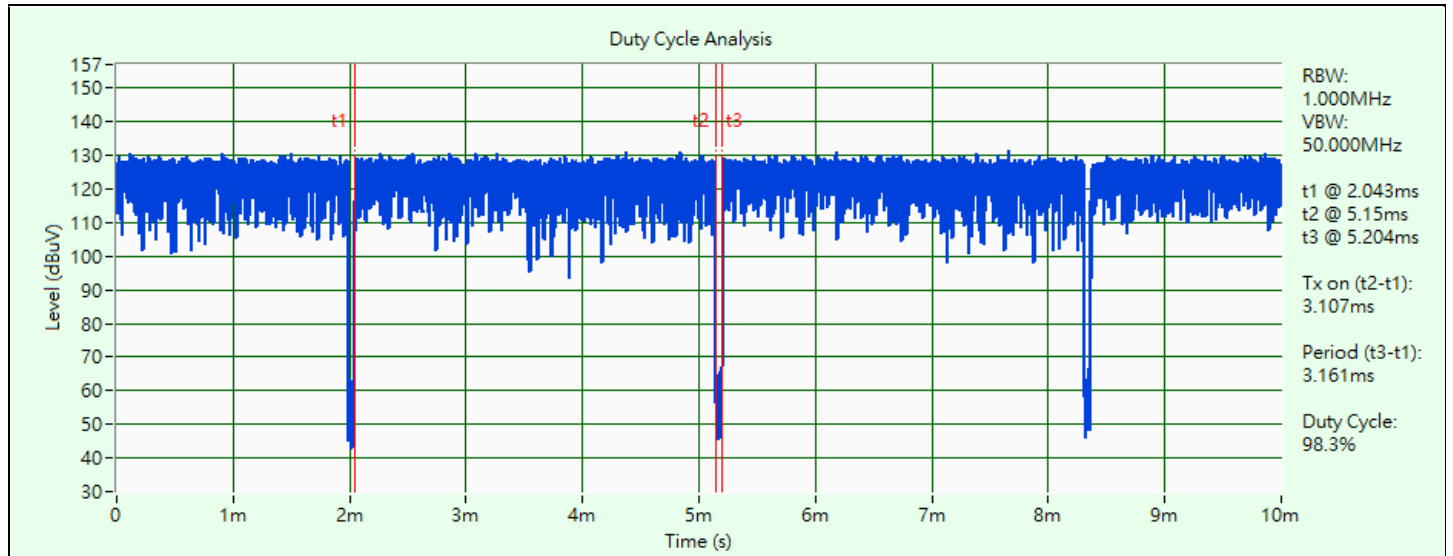

802.11a

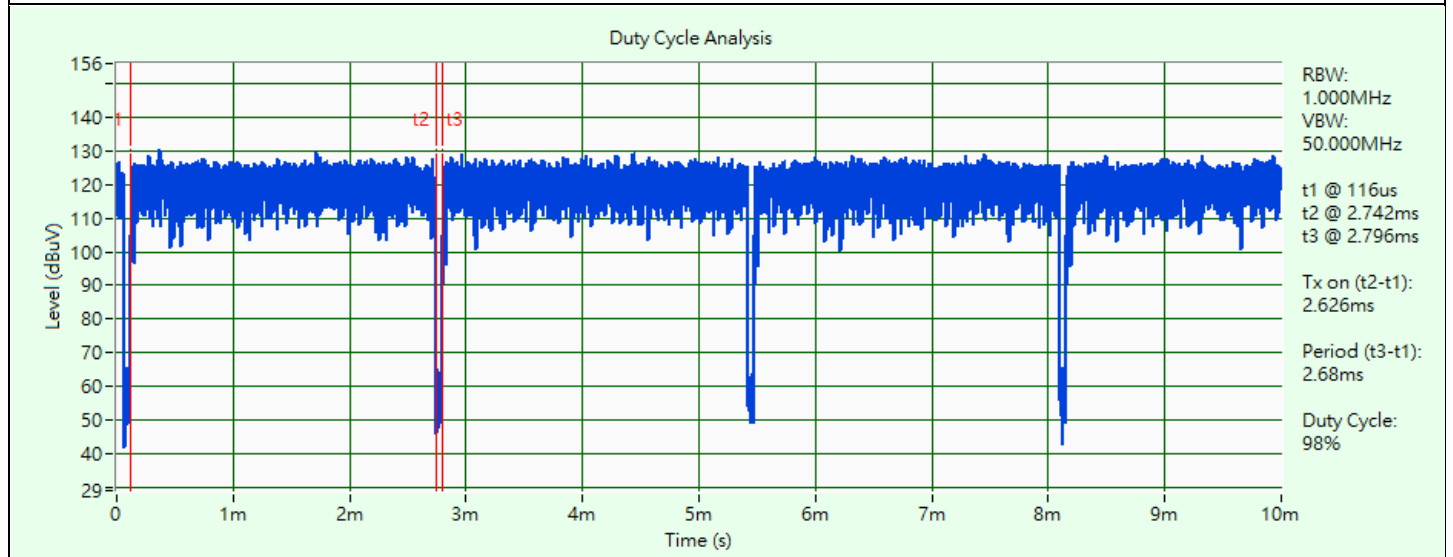

802.11ax (HE20)

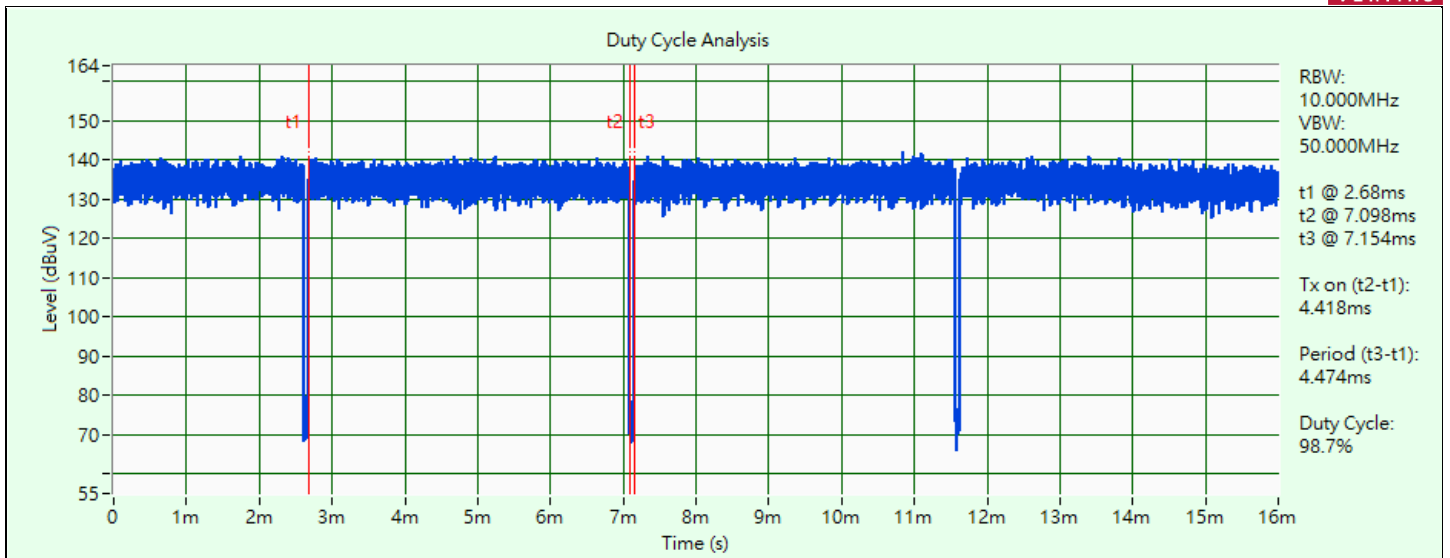

802.11ax (HE40)

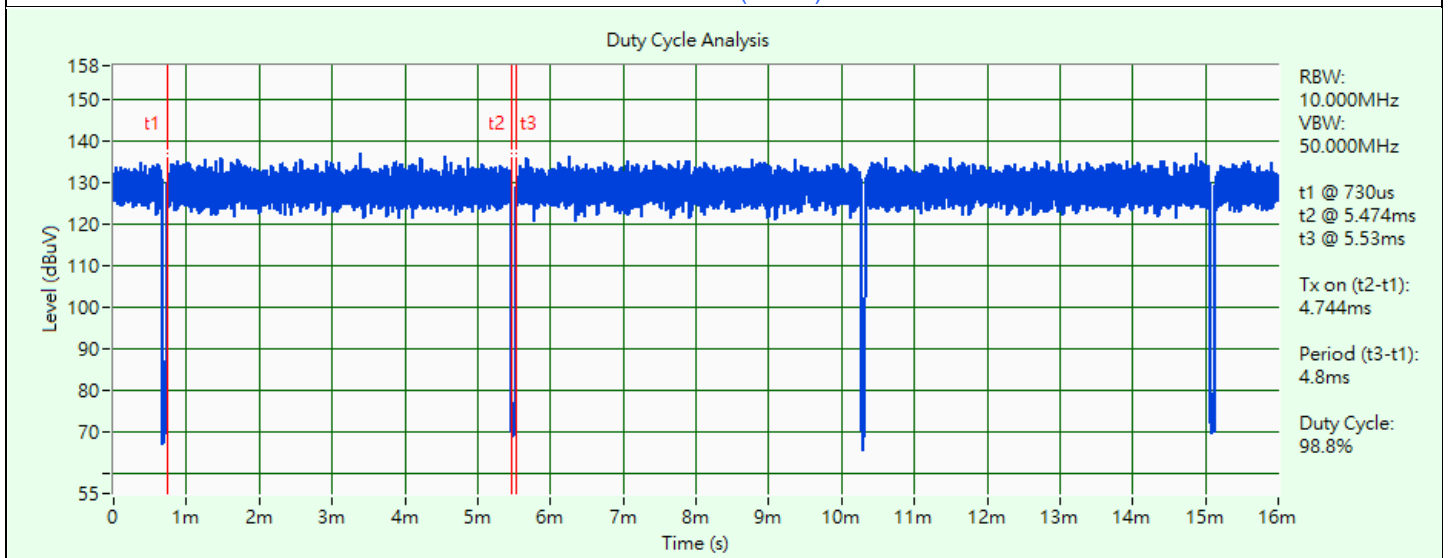

802.11ax (HE80)

3.6 Test Program Used and Operation Descriptions

Controlling software (package_Ulv2.33_DLLv6.28_ap_29.2020.07.1554_SHA.695dcd7) has been activated to set the EUT under transmission condition continuously at specific channel frequency.

3.7 Connection Diagram of EUT and Peripheral Devices

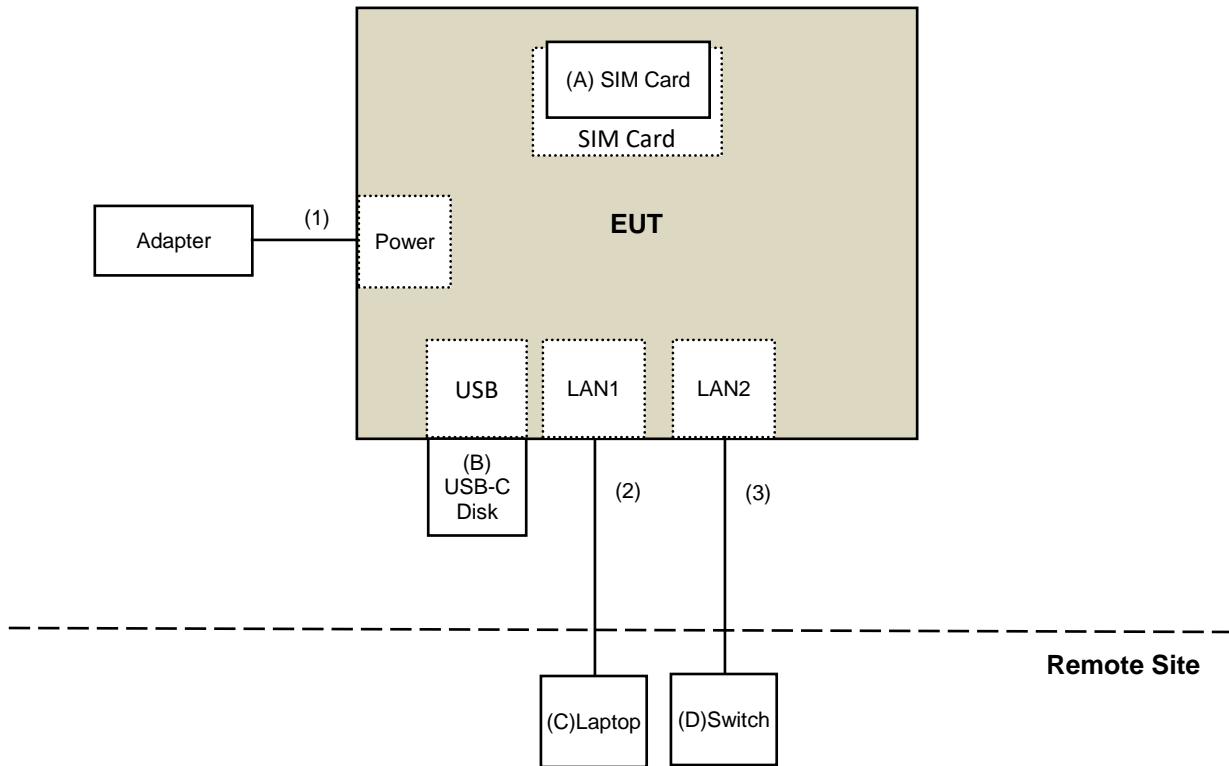

3.8 Configuration of Peripheral Devices and Cable Connections

ID	Product	Brand	Model No.	Serial No.	FCC ID	Remarks
A	Sim Card	KeysSight	E7515-10910	N/A	N/A	Provided by Lab
B	USB-C Disk	Silicon Power	SP064GBUC3C31V1K	N/A	N/A	Provided by Lab
C	Laptop	Lenovo	20U5S01X00 L14	PF-1ANPYA	N/A	Provided by Lab
D	Switch	D-Link	DGS-1005D	DR8WC92000523	N/A	Provided by Lab

ID	Cable Descriptions	Qty.	Length (m)	Shielding (Yes/No)	Cores (Qty.)	Remarks
1	DC Cable	1	1.85	No	0	Supplied by applicant
2	RJ-45 Cable	1	10	No	0	Provided by Lab
3	RJ-45 Cable	1	10	No	0	Provided by Lab

4 Test Instruments

The calibration interval of the all test instruments are 12 months and the calibrations are traceable to NML/ROC and NIST/USA.

4.1 RF Output Power

Description Manufacturer	Model No.	Serial No.	Calibrated Date	Calibrated Until
Power Meter Anritsu	ML2495A	1529002	2022/6/22	2023/6/21
Pulse Power Sensor Anritsu	MA2411B	1726434	2022/6/22	2023/6/21
Attenuator WOKEN	MDCS18N-10	MDCS18N-10-01	2023/3/27	2024/3/26

Notes:

1. The test was performed in Oven room 2.
2. Tested Date: 2023/4/24

4.2 Power Spectral Density

Description Manufacturer	Model No.	Serial No.	Calibrated Date	Calibrated Until
Attenuator WOKEN	MDCS18N-10	MDCS18N-10-01	2023/3/27	2024/3/26
Software	ADT_RF Test Software V6.6.5.4	N/A	N/A	N/A
Spectrum Analyzer Keysight	N9020B	MY60112409	2023/2/18	2024/2/17

Notes:

1. The test was performed in Oven room 2.
2. Tested Date: 2023/4/24

4.3 6 dB Bandwidth

Refer to section 4.2 to get information of the instruments.

4.4 Occupied Bandwidth

Refer to section 4.2 to get information of the instruments.

4.5 Frequency Stability

Description Manufacturer	Model No.	Serial No.	Calibrated Date	Calibrated Until
AC Power Source GOOD WILL	6905S	1991551	N/A	N/A
Attenuator WOKEN	MDCS18N-10	MDCS18N-10-01	2023/3/27	2024/3/26
Software	ADT_RF Test Software V6.6.5.4	N/A	N/A	N/A
Spectrum Analyzer Keysight	N9020B	MY60112409	2023/2/18	2024/2/17
Temperature & Humidity Chamber Giant Force	GTH-150-40-SP-AR	MAA0812-008	2022/12/26	2023/12/25
True RMS Clamp Meter Fluke	325	31130711WS	2022/6/9	2023/6/8

Notes:

1. The test was performed in Oven room 2.
2. Tested Date: 2023/4/24

4.6 AC Power Conducted Emissions

Description Manufacturer	Model No.	Serial No.	Calibrated Date	Calibrated Until
50 ohm terminal resistance	N/A	EMC-01	2022/9/27	2023/9/26
Fixed attenuator STI	STI02-2200-10	005	2022/8/24	2023/8/23
LISN R&S	ESH3-Z5	848773/004	2022/10/18	2023/10/17
RF Coaxial Cable JYEBO	5D-FB	COCCAB-001	2022/8/24	2023/8/23
Software BVADT	BVADT_Cond_V7.3.7.4	N/A	N/A	N/A
TEST RECEIVER R&S	ESCS 30	847124/029	2022/10/14	2023/10/13

Notes:

1. The test was performed in Conduction 1
2. Tested Date: 2023/4/26

4.7 Unwanted Emissions below 1 GHz

Description Manufacturer	Model No.	Serial No.	Calibrated Date	Calibrated Until
Bilog Antenna Schwarzbeck	VULB 9168	9168-0942	2022/10/20	2023/10/19
Boresight Antenna Tower & Turn Table Max-Full	MF-7802BS	MF780208530	N/A	N/A
Fixed attenuator Mini-Circuits	UNAT-5+	PAD-ATT5-01	2022/12/28	2023/12/27
LOOP ANTENNA Electro-Metrics	EM-6879	264	2023/2/21	2024/2/20
Pre_Amplifier EMCI	EMC001340	980142	2022/6/2	2023/6/1
Pre_Amplifier(20M-3G) EMCI	EMC330N	980852	2023/2/20	2024/2/19
RF Coaxial Cable COMMATE/PEWC	8D	966-6-1	2023/4/6	2024/4/5
		966-6-2	2023/4/6	2024/4/5
		966-6-3	2023/4/6	2024/4/5
RF Coaxial Cable JYEBO	5D-FB	LOOPCAB-001	2022/12/19	2023/12/18
		LOOPCAB-002	2022/12/19	2023/12/18
Software	ADT_Radiated_V8.7.08	N/A	N/A	N/A
Spectrum Analyzer Keysight	N9020B	MY60112410	2023/3/6	2024/3/5
Test Receiver KEYSIGHT	N9038A	MY59050100	2022/6/20	2023/6/19

Notes:

1. The test was performed in 966 Chamber No. 6.
2. Tested Date: 2023/4/27 ~ 2023/4/28

4.8 Unwanted Emissions above 1 GHz

Description Manufacturer	Model No.	Serial No.	Calibrated Date	Calibrated Until
Boresight Antenna Tower & Turn Table Max-Full	MF-7802BS	MF780208530	N/A	N/A
Horn Antenna Schwarzbeck	BBHA 9120D	9120D-2035	2022/11/13	2023/11/12
	BBHA 9170	BBHA9170519	2022/11/13	2023/11/12
LOOP ANTENNA Electro-Metrics	EM-6879	264	2023/2/21	2024/2/20
Pre_Amplifier EMCI	EMC001340	980142	2022/6/2	2023/6/1
	EMC12630SE	980385	2022/8/15	2023/8/14
	EMC184045SE	980387	2022/12/28	2023/12/27
RF Cable EMCI	EMC104-SM-SM-1300	210205	2022/5/10	2023/5/9
RF Cable-Frequency range: 1- 40GHz EMCI	EMC102-KM-KM-1200	160924	2022/12/28	2023/12/27
RF Coaxial Cable EMCI	EMC-KM-KM-4000	200214	2023/2/20	2024/2/19
	EMC101G-KM-KM-10000	210708	2022/11/4	2023/11/3
RF Coaxial Cable JYEBO	5D-FB	LOOPCAB-001	2022/12/19	2023/12/18
		LOOPCAB-002	2022/12/19	2023/12/18
Software	ADT_Radiated_V8.7.08	N/A	N/A	N/A
Spectrum Analyzer Keysight	N9020B	MY60112410	2023/3/6	2024/3/5
Test Receiver KEYSIGHT	N9038A	MY59050100	2022/6/20	2023/6/19

Notes:

1. The test was performed in 966 Chamber No. 6.
2. Tested Date: 2023/3/30 ~ 2023/4/29

5 Limits of Test Items

5.1 RF Output Power

Operation Band	EUT Category	Limit
U-NII-1	Outdoor Access Point	1 Watt (30 dBm) (Max. e.i.r.p \leq 125mW(21 dBm) at any elevation angle above 30 degrees as measured from the horizon)
	Fixed point-to-point Access Point	1 Watt (30 dBm)
	Indoor Access Point	1 Watt (30 dBm)
	Mobile and Portable client device	250mW (24 dBm)

Operation Band	Limit
U-NII-3	1 Watt (30 dBm)

Per KDB 662911 D01 Multiple Transmitter Output Method of conducted output power measurement on IEEE 802.11 devices,

Array Gain = 0 dB (i.e., no array gain) for $N_{ANT} \leq 4$;

Array Gain = 0 dB (i.e., no array gain) for channel widths ≥ 40 MHz for any N_{ANT} ;

Array Gain = $5 \log(N_{ANT}/N_{SS})$ dB or 3 dB, whichever is less, for 20-MHz channel widths with $N_{ANT} \geq 5$.

For power measurements on all other devices: Array Gain = $10 \log(N_{ANT}/N_{SS})$ dB.

5.2 Power Spectral Density

Operation Band	EUT Category	Limit
U-NII-1	Outdoor Access Point	17 dBm/MHz
	Fixed point-to-point Access Point	
	Indoor Access Point	
	Mobile and Portable client device	11 dBm/MHz

Operation Band	Limit
U-NII-3	30 dBm/500 kHz

5.3 6 dB Bandwidth

Within the 5.725-5.850 GHz band, the minimum 6 dB bandwidth of U-NII devices shall be at least 500 kHz.

5.4 Occupied Bandwidth

The results are for reference only.

5.5 Frequency Stability

The frequency of the carrier signal shall be maintained within band of operation.

5.6 AC Power Conducted Emissions

Frequency (MHz)	Conducted Limit (dBuV)	
	Quasi-peak	Average
0.15 - 0.5	66 - 56	56 - 46
0.50 - 5.0	56	46
5.0 - 30.0	60	50

Notes:

1. The lower limit shall apply at the transition frequencies.
2. The limit decreases in line with the logarithm of the frequency in the range of 0.15 to 0.50 MHz.

5.7 Unwanted Emissions below 1 GHz

Radiated emissions which fall in the restricted bands must comply with the radiated emission limits specified as below table.

Frequencies (MHz)	Field Strength (microvolts/meter)	Measurement Distance (meters)
0.009 ~ 0.490	2400/F(kHz)	300
0.490 ~ 1.705	24000/F(kHz)	30
1.705 ~ 30.0	30	30
30 ~ 88	100	3
88 ~ 216	150	3
216 ~ 960	200	3
Above 960	500	3

Notes:

1. The lower limit shall apply at the transition frequencies.
2. Emission level (dBuV/m) = 20 log Emission level (uV/m).

5.8 Unwanted Emissions above 1 GHz

Radiated emissions which fall in the restricted bands must comply with the radiated emission limits specified as below table.

Frequencies (MHz)	Field Strength (microvolts/meter)	Measurement Distance (meters)
Above 960	500	3

Notes:

1. The lower limit shall apply at the transition frequencies.
2. Emission level (dBuV/m) = 20 log Emission level (uV/m).
3. For frequencies above 1000 MHz, the field strength limits are based on average detector, however, the peak field strength of any emission shall not exceed the maximum permitted average limits, specified above by more than 20 dB under any condition of modulation.

Limits of unwanted emission out of the restricted bands

Applicable To	Limit	
789033 D02 General UNII Test Procedure New Rules v02r01	Field Strength at 3 m	
	PK: 74 (dBµV/m)	AV: 54 (dBµV/m)

For transmitters operating in the 5.15-5.25 GHz band:

Applicable To	EIRP Limit	Equivalent Field Strength at 3 m
15.407(b)(1)	PK: -27 (dBm/MHz)	PK: 68.2 (dBµV/m)

For transmitters operating in the 5.725-5.850 GHz band:

Applicable To	EIRP Limit	Equivalent Field Strength at 3 m
15.407(b)(4)(i)	PK: -27 (dBm/MHz) ^{*1} PK: 10 (dBm/MHz) ^{*2} PK: 15.6 (dBm/MHz) ^{*3} PK: 27 (dBm/MHz) ^{*4}	PK: 68.2 (dBµV/m) ^{*1} PK: 105.2 (dBµV/m) ^{*2} PK: 110.8 (dBµV/m) ^{*3} PK: 122.2 (dBµV/m) ^{*4}

^{*1} beyond 75 MHz or more above of the band edge.

^{*2} below the band edge increasing linearly to 10 dBm/MHz at 25 MHz above.

^{*3} below the band edge increasing linearly to a level of 15.6 dBm/MHz at 5 MHz above.

^{*4} from 5 MHz above or below the band edge increasing linearly to a level of 27 dBm/MHz at the band edge.

Note: The following formula is used to convert the equipment isotropic radiated power (eirp) to field strength:

$$E = \frac{1000000\sqrt{30P}}{3} \mu\text{V/m, where P is the eirp (Watts).}$$

6 Test Arrangements

6.1 RF Output Power

6.1.1 Test Setup

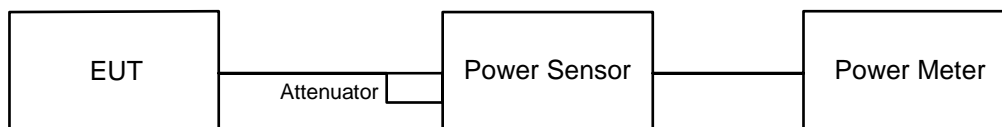

6.1.2 Test Procedure

Method PM is used to perform output power measurement, trigger and gating function of wide band power meter is enabled to measure max output power of TX on burst and set the detector to average. Duty factor is not added to measured value.

6.2 Power Spectral Density

6.2.1 Test Setup

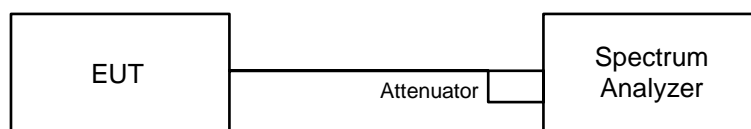

6.2.2 Test Procedure

For specified measurement bandwidth 1 MHz:

Method SA-1

- Set span to encompass the entire emission bandwidth (EBW) of the signal.
- Set RBW = 1 MHz, Set VBW \geq 3 MHz, Detector = RMS
- Sweep points \geq $[2 \times \text{span} / \text{RBW}]$. (This gives bin-to-bin spacing \leq RBW / 2, so that narrowband signals are not lost between frequency bins.)
- Sweep time = auto, trigger set to "free run".
- Trace average at least 100 traces in power averaging mode.
- Record the max value

For specified measurement bandwidth 500 kHz:

Method SA-1

- Set span to encompass the entire emission bandwidth (EBW) of the signal.
- Set RBW = 300 kHz, Set VBW \geq 1 MHz, Detector = RMS
- Scale the observed power level to an equivalent value in 500 kHz by adjusting (increasing) the measured power by a bandwidth correction factor (BWCF) where $\text{BWCF} = 10\log(500 \text{ kHz}/300 \text{ kHz})$
- Sweep points \geq $[2 \times \text{span} / \text{RBW}]$. (This gives bin-to-bin spacing \leq RBW / 2, so that narrowband signals are not lost between frequency bins.)
- Sweep time = auto, trigger set to "free run".
- Trace average at least 100 traces in power averaging mode.
- Record the max value

6.3 6 dB Bandwidth

6.3.1 Test Setup

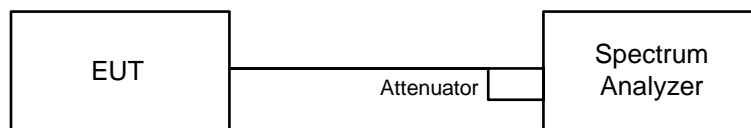

6.3.2 Test Procedure

- Set resolution bandwidth (RBW) = 100 kHz.
- Set the video bandwidth (VBW) $\geq 3 \times$ RBW, Detector = Peak.
- Trace mode = max hold.
- Sweep = auto couple.
- Measure the maximum width of the emission that is constrained by the frequencies associated with the two amplitude points (upper and lower) that are attenuated by 6 dB relative to the maximum level measured in the fundamental emission.

6.4 Occupied Bandwidth

6.4.1 Test Setup

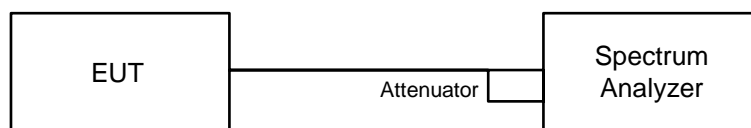

6.4.2 Test Procedure

The transmitter output was connected to the spectrum analyzer through an attenuator. The bandwidth of the fundamental frequency was measured by spectrum analyzer with resolution bandwidth in the range of 1% to 5% of the anticipated emission bandwidth, and a video bandwidth at least 3x the resolution bandwidth and set the detector to Sampling. The width of a frequency band such that, below the lower and above the upper frequency limits, the mean powers emitted are each equal to a specified percentage 0.5% of the total mean power of a given emission.

6.5 Frequency Stability

6.5.1 Test Setup

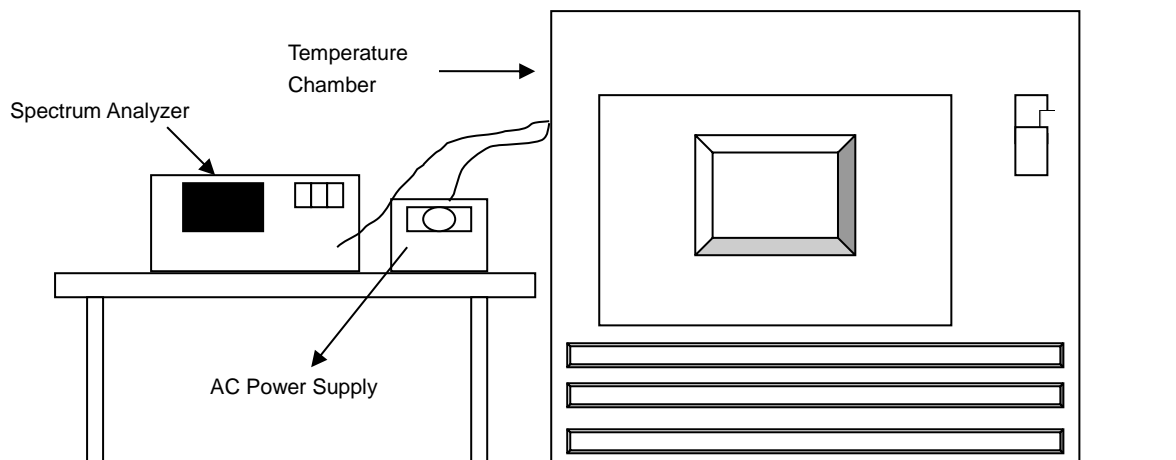

6.5.2 Test Procedure

- The EUT was placed inside the environmental test chamber and powered by nominal AC voltage.
- Turn the EUT on and couple its output to a spectrum analyzer.
- Turn the EUT off and set the chamber to the highest temperature specified.
- Allow sufficient time (approximately 30 min) for the temperature of the chamber to stabilize, turn the EUT on and measure the operating frequency after 2, 5, and 10 Minutes.
- Repeat step (d) with the temperature chamber set to the next desired temperature until measurements down to the lowest specified temperature have been completed.
- The test chamber was allowed to stabilize at +20 degree C for a minimum of 30 Minutes. The supply voltage was then adjusted on the EUT from 85% to 115% and the frequency record.

6.6 AC Power Conducted Emissions

6.6.1 Test Setup

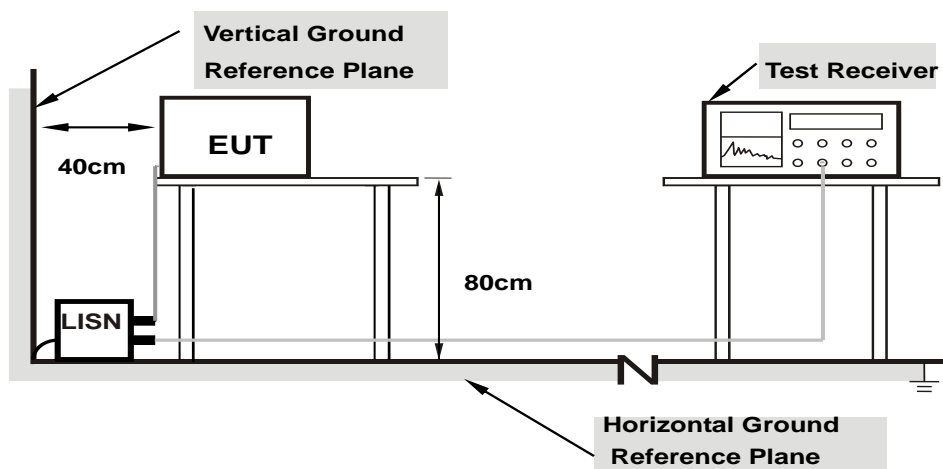

Note: 1.Support units were connected to second LISN.

For the actual test configuration, please refer to the attached file (Test Setup Photo).

6.6.2 Test Procedure

- The EUT was placed on a 0.8 meter to the top of table and placed 0.4 meters from the conducting wall of the shielded room with EUT being connected to the power mains through a line impedance stabilization network (LISN). Other support units were connected to the power mains through another LISN. The two LISNs provide 50 ohm/ 50 uH of coupling impedance for the measuring instrument.
- Both lines of the power mains connected to the EUT were checked for maximum conducted interference.
- The frequency range from 150 kHz to 30 MHz was searched. Emission levels under (Limit – 20 dB) was not recorded.

Note: The resolution bandwidth and video bandwidth of test receiver is 9 kHz for quasi-peak detection (QP) and average detection (AV) at frequency 0.15 MHz-30 MHz.

6.7 Unwanted Emissions below 1 GHz

6.7.1 Test Setup

For Radiated emission below 30 MHz

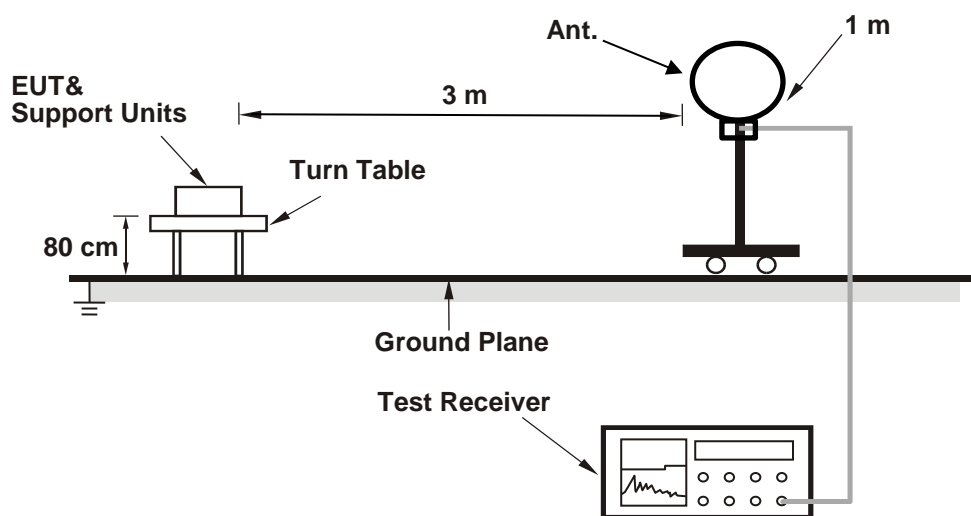

For Radiated emission above 30 MHz

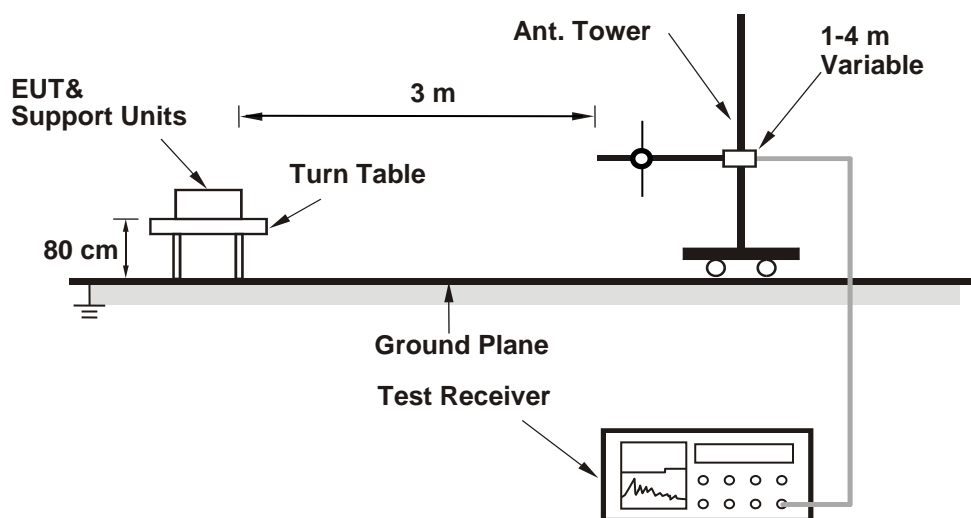

For the actual test configuration, please refer to the attached file (Test Setup Photo).

6.7.2 Test Procedure

For Radiated emission below 30 MHz

- a. The EUT was placed on the top of a rotating table 0.8 meters above the ground at 3 meter chamber room for test. The table was rotated 360 degrees to determine the position of the highest radiation.
- b. The EUT was set 3 meters away from the interference-receiving antenna, which was mounted on the top of a variable-height antenna tower.
- c. Parallel, perpendicular, and ground-parallel orientations of the antenna are set to make the measurement.
- d. For each suspected emission, the EUT was arranged to its worst case and the rotatable table was turned from 0 degrees to 360 degrees to find the maximum reading.
- e. The test-receiver system was set to Quasi-Peak Detect Function and Specified Bandwidth with Maximum Hold Mode, except for the frequency band (9 kHz to 90 kHz and 110 kHz to 490 kHz) set to average detect function and peak detect function.

Notes:

1. The resolution bandwidth and video bandwidth of test receiver/spectrum analyzer is 200 Hz at frequency below 150 kHz.
2. The resolution bandwidth and video bandwidth of test receiver/spectrum analyzer is 9 kHz or 10 kHz at frequency (150 kHz to 30 MHz).
3. All modes of operation were investigated and the worst-case emissions are reported.

For Radiated emission above 30 MHz

- a. The EUT was placed on the top of a rotating table 0.8 meters above the ground at 3 meter chamber room for test. The table was rotated 360 degrees to determine the position of the highest radiation.
- b. The EUT was set 3 meters away from the interference-receiving antenna, which was mounted on the top of a variable-height antenna tower.
- c. The height of antenna is varied from one meter to four meters above the ground to determine the maximum value of the field strength. Both horizontal and vertical polarizations of the antenna are set to make the measurement.
- d. For each suspected emission, the EUT was arranged to its worst case and then the antenna was tuned to heights from 1 meter to 4 meters and the rotatable table was turned from 0 degrees to 360 degrees to find the maximum reading.
- e. The test-receiver system was set to quasi-peak detect function and specified bandwidth with maximum hold mode when the test frequency is below 1 GHz.

Notes:

1. The resolution bandwidth and video bandwidth of test receiver/spectrum analyzer is 120 kHz for Quasi-peak detection (QP) at frequency below 1 GHz.
2. All modes of operation were investigated and the worst-case emissions are reported.

6.8 Unwanted Emissions above 1 GHz

6.8.1 Test Setup

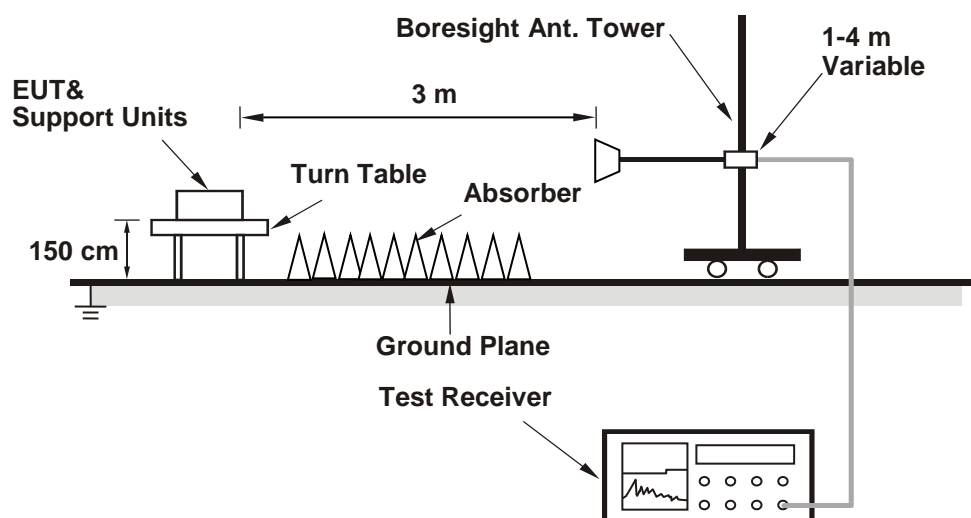

For the actual test configuration, please refer to the attached file (Test Setup Photo).

6.8.2 Test Procedure

- The EUT was placed on the top of a rotating table 1.5 meters above the ground at 3 meter chamber room for test. The table was rotated 360 degrees to determine the position of the highest radiation.
- The EUT was set 3 meters away from the interference-receiving antenna, which was mounted on the top of a variable-height antenna tower.
- The height of antenna is varied from one meter to four meters above the ground to determine the maximum value of the field strength. Both horizontal and vertical polarizations of the antenna are set to make the measurement.
- For each suspected emission, the EUT was arranged to its worst case and then the antenna was tuned to heights from 1 meter to 4 meters and the rotatable table was turned from 0 degrees to 360 degrees to find the maximum reading.
- The test-receiver system was set to peak and average detects function and specified bandwidth with maximum hold mode when the test frequency is above 1 GHz. If the peak reading value also meets average limit, measurement with the average detector is unnecessary.

Notes:

- The resolution bandwidth of test receiver/spectrum analyzer is 1 MHz and the video bandwidth is 3 MHz for Peak detection (PK) and Average detection (AV) at frequency above 1 GHz.
- For fundamental and harmonic signal measurement, the resolution bandwidth of test receiver/spectrum analyzer is 1 MHz and the video bandwidth is $\geq 1/T$ (Duty cycle $< 98\%$) or 10 Hz (Duty cycle $\geq 98\%$) for Average detection (AV) at frequency above 1 GHz.
- All modes of operation were investigated and the worst-case emissions are reported.

7 Test Results of Test Item

7.1 RF Output Power

Input Power:	120 Vac, 60 Hz	Environmental Conditions:	22°C, 61% RH	Tested By:	Katina Lu
--------------	----------------	---------------------------	--------------	------------	-----------

802.11a CDD

Chan.	Chan. Freq. (MHz)	Average Power (dBm)				Total Power (mW)	Total Power (dBm)	Power Limit (dBm)	Test Result
		Chain 0	Chain 1	Chain 2	Chain 3				
36	5180	23.16	23.52	23.28	23.22	854.627	29.32	30	Pass
40	5200	23.14	23.35	23.33	23.39	855.886	29.32	30	Pass
48	5240	23.34	23.06	23.23	23.24	839.317	29.24	30	Pass
149	5745	24.15	23.96	23.94	23.77	994.876	29.98	30	Pass
157	5785	23.98	23.83	24.08	23.98	997.474	29.99	30	Pass
165	5825	23.79	23.82	23.45	23.95	949.945	29.78	30	Pass

Notes:

1. Directional gain is the maximum gain of antennas.
2. For U-NII-1, the directional gain is 0.71 dBi < 6 dBi, so the output power limit shall not be reduced.
3. For U-NII-3, the directional gain is 2.35 dBi < 6 dBi, so the output power limit shall not be reduced.

802.11ac (VHT20) CDD

Chan.	Chan. Freq. (MHz)	Average Power (dBm)				Total Power (mW)	Total Power (dBm)	Power Limit (dBm)	Test Result
		Chain 0	Chain 1	Chain 2	Chain 3				
36	5180	23.28	23.19	23.26	23.43	853.392	29.31	30	Pass
40	5200	23.08	23.27	23.39	23.29	847.138	29.28	30	Pass
48	5240	22.96	23.15	23.58	23.30	846.065	29.27	30	Pass
149	5745	23.77	23.61	23.79	23.74	943.77	29.75	30	Pass
157	5785	23.81	23.33	23.76	23.80	933.282	29.70	30	Pass
165	5825	23.65	23.71	23.39	24.04	938.489	29.72	30	Pass

Notes:

1. Directional gain is the maximum gain of antennas.
2. For U-NII-1, the directional gain is 0.71 dBi < 6 dBi, so the output power limit shall not be reduced.
3. For U-NII-3, the directional gain is 2.35 dBi < 6 dBi, so the output power limit shall not be reduced.

802.11ac (VHT40) CDD

Chan.	Chan. Freq. (MHz)	Average Power (dBm)				Total Power (mW)	Total Power (dBm)	Power Limit (dBm)	Test Result
		Chain 0	Chain 1	Chain 2	Chain 3				
38	5190	16.32	16.81	16.86	17.17	191.477	22.82	30	Pass
46	5230	22.37	22.50	22.89	22.51	723.186	28.59	30	Pass
151	5755	23.66	23.63	23.74	23.76	937.224	29.72	30	Pass
159	5795	23.59	23.52	23.75	23.72	926.108	29.67	30	Pass

Notes:

1. Directional gain is the maximum gain of antennas.
2. For U-NII-1, the maximum gain is 0.71 dBi < 6 dBi, so the output power limit shall not be reduced.
3. For U-NII-3, the maximum gain is 2.35 dBi < 6 dBi, so the output power limit shall not be reduced.

802.11ac (VHT80) CDD

Chan.	Chan. Freq. (MHz)	Average Power (dBm)				Total Power (mW)	Total Power (dBm)	Power Limit (dBm)	Test Result
		Chain 0	Chain 1	Chain 2	Chain 3				
42	5210	14.30	15.15	15.10	15.13	124.592	20.95	30	Pass
155	5775	22.51	22.65	22.81	22.74	741.232	28.70	30	Pass

Notes:

1. Directional gain is the maximum gain of antennas.
2. For U-NII-1, the maximum gain is 0.71 dBi < 6 dBi, so the output power limit shall not be reduced.
3. For U-NII-3, the maximum gain is 2.35 dBi < 6 dBi, so the output power limit shall not be reduced.

802.11ax (HE20) CDD

Chan.	Chan. Freq. (MHz)	Average Power (dBm)				Total Power (mW)	Total Power (dBm)	Power Limit (dBm)	Test Result
		Chain 0	Chain 1	Chain 2	Chain 3				
36	5180	23.31	23.22	23.35	23.48	863.298	29.36	30	Pass
40	5200	23.17	23.35	23.48	23.32	861.39	29.35	30	Pass
48	5240	23.10	23.27	23.62	23.37	863.913	29.36	30	Pass
149	5745	23.98	23.87	24.01	23.96	994.469	29.98	30	Pass
157	5785	24.02	23.62	24.00	24.05	987.778	29.95	30	Pass
165	5825	23.85	23.93	23.61	24.33	990.467	29.96	30	Pass

Notes:

1. Directional gain is the maximum gain of antennas.
2. For U-NII-1, the directional gain is 0.71 dBi < 6 dBi, so the output power limit shall not be reduced.
3. For U-NII-3, the directional gain is 2.35 dBi < 6 dBi, so the output power limit shall not be reduced.

802.11ax (HE40) CDD

Chan.	Chan. Freq. (MHz)	Average Power (dBm)				Total Power (mW)	Total Power (dBm)	Power Limit (dBm)	Test Result
		Chain 0	Chain 1	Chain 2	Chain 3				
38	5190	16.55	17.09	17.06	17.45	202.76	23.07	30	Pass
46	5230	22.66	22.75	23.14	22.77	768.164	28.85	30	Pass
151	5755	23.90	23.87	24.01	23.97	990.479	29.96	30	Pass
159	5795	23.85	23.81	24.04	23.97	986.07	29.94	30	Pass

Notes:

1. Directional gain is the maximum gain of antennas.
2. For U-NII-1, the maximum gain is 0.71 dBi < 6 dBi, so the output power limit shall not be reduced.
3. For U-NII-3, the maximum gain is 2.35 dBi < 6 dBi, so the output power limit shall not be reduced.

802.11ax (HE80) CDD

Chan.	Chan. Freq. (MHz)	Average Power (dBm)				Total Power (mW)	Total Power (dBm)	Power Limit (dBm)	Test Result
		Chain 0	Chain 1	Chain 2	Chain 3				
42	5210	14.61	15.41	15.43	15.40	133.248	21.25	30	Pass
155	5775	22.75	22.89	23.03	22.96	781.507	28.93	30	Pass

Notes:

1. Directional gain is the maximum gain of antennas.
2. For U-NII-1, the maximum gain is 0.71 dBi < 6 dBi, so the output power limit shall not be reduced.
3. For U-NII-3, the maximum gain is 2.35 dBi < 6 dBi, so the output power limit shall not be reduced.

802.11ac (VHT20) Beamforming

Chan.	Chan. Freq. (MHz)	Average Power (dBm)				Total Power (mW)	Total Power (dBm)	Power Limit (dBm)	Test Result
		Chain 0	Chain 1	Chain 2	Chain 3				
36	5180	23.28	23.19	23.26	23.43	853.392	29.31	29.38	Pass
40	5200	23.08	23.27	23.39	23.29	847.138	29.28	29.38	Pass
48	5240	22.96	23.15	23.58	23.30	846.065	29.27	29.38	Pass
149	5745	21.20	21.12	21.21	21.18	524.595	27.20	27.74	Pass
157	5785	21.24	20.88	21.31	21.28	524.991	27.20	27.74	Pass
165	5825	21.13	21.22	20.80	21.59	526.59	27.21	27.74	Pass

Notes:

1. Directional gain = $10 \log[(10^{\text{Chain0}/20} + 10^{\text{Chain1}/20} + 10^{\text{Chain2}/20} + 10^{\text{Chain3}/20})^2 / 4]$
2. For U-NII-1, the directional gain is 6.62 dBi > 6 dBi, so the output power limit shall be reduced to $30 - (6.62 - 6) = 29.38$ dBm.
3. For U-NII-3, the directional gain is 8.26 dBi > 6 dBi, so the output power limit shall be reduced to $30 - (8.26 - 6) = 27.74$ dBm.

802.11ac (VHT40) Beamforming

Chan.	Chan. Freq. (MHz)	Average Power (dBm)				Total Power (mW)	Total Power (dBm)	Power Limit (dBm)	Test Result
		Chain 0	Chain 1	Chain 2	Chain 3				
38	5190	16.34	16.88	16.84	17.23	192.956	22.85	29.38	Pass
46	5230	22.37	22.50	22.89	22.51	723.186	28.59	29.38	Pass
151	5755	21.22	21.07	21.22	21.22	525.241	27.20	27.74	Pass
159	5795	21.13	21.01	21.29	21.24	523.532	27.19	27.74	Pass

Notes:

1. Directional gain = $10 \log[(10^{\text{Chain0}/20} + 10^{\text{Chain1}/20} + 10^{\text{Chain2}/20} + 10^{\text{Chain3}/20})^2 / 4]$
2. For U-NII-1, the directional gain is 6.62 dBi > 6 dBi, so the output power limit shall be reduced to $30 - (6.62 - 6) = 29.38$ dBm.
3. For U-NII-3, the directional gain is 8.26 dBi > 6 dBi, so the output power limit shall be reduced to $30 - (8.26 - 6) = 27.74$ dBm.

802.11ac (VHT80) Beamforming

Chan.	Chan. Freq. (MHz)	Average Power (dBm)				Total Power (mW)	Total Power (dBm)	Power Limit (dBm)	Test Result
		Chain 0	Chain 1	Chain 2	Chain 3				
42	5210	14.30	15.15	15.10	15.13	124.592	20.95	29.38	Pass
155	5775	20.95	21.03	21.18	21.08	510.67	27.08	27.74	Pass

Notes:

1. Directional gain = $10 \log[(10^{\text{Chain0}/20} + 10^{\text{Chain1}/20} + 10^{\text{Chain2}/20} + 10^{\text{Chain3}/20})^2 / 4]$
2. For U-NII-1, the directional gain is 6.62 dBi > 6 dBi, so the output power limit shall be reduced to $30 - (6.62 - 6) = 29.38$ dBm.
3. For U-NII-3, the directional gain is 8.26 dBi > 6 dBi, so the output power limit shall be reduced to $30 - (8.26 - 6) = 27.74$ dBm.

802.11ax (HE20) Beamforming

Chan.	Chan. Freq. (MHz)	Average Power (dBm)				Total Power (mW)	Total Power (dBm)	Power Limit (dBm)	Test Result
		Chain 0	Chain 1	Chain 2	Chain 3				
36	5180	23.31	23.22	23.35	23.48	863.298	29.36	29.38	Pass
40	5200	23.17	23.35	23.48	23.32	861.39	29.35	29.38	Pass
48	5240	23.10	23.27	23.62	23.37	863.913	29.36	29.38	Pass
149	5745	21.35	21.25	21.36	21.30	541.48	27.34	27.74	Pass
157	5785	21.40	21.03	21.48	21.48	546.013	27.37	27.74	Pass
165	5825	21.29	21.35	20.95	21.72	544.089	27.36	27.74	Pass

Notes:

1. Directional gain = $10 \log[(10^{\text{Chain0}/20} + 10^{\text{Chain1}/20} + 10^{\text{Chain2}/20} + 10^{\text{Chain3}/20})^2 / 4]$
2. For U-NII-1, the directional gain is 6.62 dBi > 6 dBi, so the output power limit shall be reduced to $30 - (6.62 - 6) = 29.38$ dBm.
3. For U-NII-3, the directional gain is 8.26 dBi > 6 dBi, so the output power limit shall be reduced to $30 - (8.26 - 6) = 27.74$ dBm.

802.11ax (HE40) Beamforming

Chan.	Chan. Freq. (MHz)	Average Power (dBm)				Total Power (mW)	Total Power (dBm)	Power Limit (dBm)	Test Result
		Chain 0	Chain 1	Chain 2	Chain 3				
38	5190	16.55	17.09	17.06	17.45	202.76	23.07	29.38	Pass
46	5230	22.66	22.75	23.14	22.77	768.164	28.85	29.38	Pass
151	5755	21.38	21.26	21.37	21.35	544.61	27.36	27.74	Pass
159	5795	21.23	21.20	21.44	21.35	540.339	27.33	27.74	Pass

Notes:

1. Directional gain = $10 \log[(10^{\text{Chain0}/20} + 10^{\text{Chain1}/20} + 10^{\text{Chain2}/20} + 10^{\text{Chain3}/20})^2 / 4]$
2. For U-NII-1, the directional gain is 6.62 dBi > 6 dBi, so the output power limit shall be reduced to $30 - (6.62 - 6) = 29.38$ dBm.
3. For U-NII-3, the directional gain is 8.26 dBi > 6 dBi, so the output power limit shall be reduced to $30 - (8.26 - 6) = 27.74$ dBm.

802.11ax (HE80) Beamforming

Chan.	Chan. Freq. (MHz)	Average Power (dBm)				Total Power (mW)	Total Power (dBm)	Power Limit (dBm)	Test Result
		Chain 0	Chain 1	Chain 2	Chain 3				
42	5210	14.61	15.41	15.43	15.40	133.248	21.25	29.38	Pass
155	5775	21.03	21.16	21.27	21.20	523.176	27.19	27.74	Pass

Notes:

1. Directional gain = $10 \log[(10^{\text{Chain0}/20} + 10^{\text{Chain1}/20} + 10^{\text{Chain2}/20} + 10^{\text{Chain3}/20})^2 / 4]$
2. For U-NII-1, the directional gain is 6.62 dBi > 6 dBi, so the output power limit shall be reduced to $30 - (6.62 - 6) = 29.38$ dBm.
3. For U-NII-3, the directional gain is 8.26 dBi > 6 dBi, so the output power limit shall be reduced to $30 - (8.26 - 6) = 27.74$ dBm.

7.2 Power Spectral Density

Input Power:	120 Vac, 60 Hz	Environmental Conditions:	22°C, 61% RH	Tested By:	Katina Lu
--------------	----------------	---------------------------	--------------	------------	-----------

802.11a

Chan.	Chan. Freq. (MHz)	PSD (dBm/MHz)				Total PSD (dBm/MHz)	Max. PSD Limit (dBm/MHz)	Test Result
		Chain 0	Chain 1	Chain 2	Chain 3			
36	5180	9.40	10.09	10.33	10.00	15.99	16.38	Pass
40	5200	9.63	10.50	10.54	10.20	16.25	16.38	Pass
48	5240	10.06	10.39	10.63	10.12	16.33	16.38	Pass

Notes:

- Method E) 2) a) of power density measurement of KDB 662911 is using for calculating total power density. Total power density is summing entire spectra across corresponding frequency bins on the various outputs by computer.
- Directional gain = $10 \log[(10^{\text{Chain0}/20} + 10^{\text{Chain1}/20} + 10^{\text{Chain2}/20} + 10^{\text{Chain3}/20})^2 / 4]$
- For U-NII-1, the directional gain is 6.62 dBi > 6dBi, so the power density limit shall be reduced to $17-(6.62-6) = 16.38$ dBm/MHz.

802.11ax (HE20)

Chan.	Chan. Freq. (MHz)	PSD (dBm/MHz)				Total PSD (dBm/MHz)	Max. PSD Limit (dBm/MHz)	Test Result
		Chain 0	Chain 1	Chain 2	Chain 3			
36	5180	9.63	9.82	9.98	10.17	15.93	16.38	Pass
40	5200	9.37	9.64	9.93	9.77	15.70	16.38	Pass
48	5240	9.61	9.53	10.10	9.65	15.75	16.38	Pass

Notes:

- Method E) 2) a) of power density measurement of KDB 662911 is using for calculating total power density. Total power density is summing entire spectra across corresponding frequency bins on the various outputs by computer.
- Directional gain = $10 \log[(10^{\text{Chain0}/20} + 10^{\text{Chain1}/20} + 10^{\text{Chain2}/20} + 10^{\text{Chain3}/20})^2 / 4]$
- For U-NII-1, the directional gain is 6.62 dBi > 6dBi, so the power density limit shall be reduced to $17-(6.62-6) = 16.38$ dBm/MHz.

802.11ax (HE40)

Chan.	Chan. Freq. (MHz)	PSD (dBm/MHz)				Total PSD (dBm/MHz)	Max. PSD Limit (dBm/MHz)	Test Result
		Chain 0	Chain 1	Chain 2	Chain 3			
38	5190	0.22	0.34	0.35	0.59	6.40	16.38	Pass
46	5230	6.63	6.38	7.07	6.81	12.75	16.38	Pass

Notes:

- Method E) 2) a) of power density measurement of KDB 662911 is using for calculating total power density. Total power density is summing entire spectra across corresponding frequency bins on the various outputs by computer.
- Directional gain = $10 \log[(10^{\text{Chain0}/20} + 10^{\text{Chain1}/20} + 10^{\text{Chain2}/20} + 10^{\text{Chain3}/20})^2 / 4]$
- For U-NII-1, the directional gain is 6.62 dBi > 6dBi, so the power density limit shall be reduced to $17-(6.62-6) = 16.38$ dBm/MHz.

802.11ax (HE80)

Chan.	Chan. Freq. (MHz)	PSD (dBm/MHz)				Total PSD (dBm/MHz)	Max. PSD Limit (dBm/MHz)	Test Result
		Chain 0	Chain 1	Chain 2	Chain 3			
42	5210	-4.67	-4.27	-4.22	-3.88	1.77	16.38	Pass

Notes:

- Method E) 2) a) of power density measurement of KDB 662911 is using for calculating total power density. Total power density is summing entire spectra across corresponding frequency bins on the various outputs by computer.
- Directional gain = $10 \log[(10^{\text{Chain0}/20} + 10^{\text{Chain1}/20} + 10^{\text{Chain2}/20} + 10^{\text{Chain3}/20})^2 / 4]$
- For U-NII-1, the directional gain is 6.62 dBi > 6dBi, so the power density limit shall be reduced to $17-(6.62-6) = 16.38$ dBm/MHz.

802.11a

Chan.	Chan. Freq. (MHz)	PSD (dBm/300kHz)				Total PSD (dBm/300kHz)	Total PSD (dBm/500kHz)	PSD Limit (dBm/500kHz)	Test Result
		Chain 0	Chain 1	Chain 2	Chain 3				
149	5745	3.54	3.15	3.68	3.42	9.47	11.69	27.74	Pass
157	5785	3.26	3.09	3.44	3.51	9.35	11.57	27.74	Pass
165	5825	3.13	3.19	2.61	3.59	9.16	11.38	27.74	Pass

Notes:

- Method E) 2) b) Measure and sum spectral maxima across the outputs of KDB 662911 is using for calculating total power density.
- Directional gain = $10 \log[(10^{\text{Chain0}/20} + 10^{\text{Chain1}/20} + 10^{\text{Chain2}/20} + 10^{\text{Chain3}/20})^2 / 4]$
- For U-NII-3, the directional gain is 8.26 dBi > 6 dBi, so the power density limit shall be reduced to $30-(8.26-6) = 27.74$ dBm/500kHz.

802.11ax (HE20)

Chan.	Chan. Freq. (MHz)	PSD (dBm/300kHz)				Total PSD (dBm/300kHz)	Total PSD (dBm/500kHz)	PSD Limit (dBm/500kHz)	Test Result
		Chain 0	Chain 1	Chain 2	Chain 3				
149	5745	1.64	0.90	1.52	1.47	7.41	9.63	27.74	Pass
157	5785	1.55	1.19	1.59	1.62	7.51	9.73	27.74	Pass
165	5825	1.79	1.54	1.23	2.03	7.68	9.90	27.74	Pass

Notes:

- Method E) 2) b) Measure and sum spectral maxima across the outputs of KDB 662911 is using for calculating total power density.
- Directional gain = $10 \log[(10^{\text{Chain0}/20} + 10^{\text{Chain1}/20} + 10^{\text{Chain2}/20} + 10^{\text{Chain3}/20})^2 / 4]$
- For U-NII-3, the directional gain is 8.26 dBi > 6 dBi, so the power density limit shall be reduced to $30-(8.26-6) = 27.74$ dBm/500kHz.

802.11ax (HE40)

Chan.	Chan. Freq. (MHz)	PSD (dBm/300kHz)				Total PSD (dBm/300kHz)	Total PSD (dBm/500kHz)	PSD Limit (dBm/500kHz)	Test Result
		Chain 0	Chain 1	Chain 2	Chain 3				
151	5755	-1.84	-2.44	-1.66	-1.83	4.09	6.31	27.74	Pass
159	5795	-2.04	-2.34	-1.66	-1.77	4.08	6.30	27.74	Pass

Notes:

1. Method E) 2) b) Measure and sum spectral maxima across the outputs of KDB 662911 is using for calculating total power density.
2. Directional gain = $10 \log[(10^{\text{Chain0}/20} + 10^{\text{Chain1}/20} + 10^{\text{Chain2}/20} + 10^{\text{Chain3}/20})^2 / 4]$
3. For U-NII-3, the directional gain is 8.26 dBi > 6 dBi, so the power density limit shall be reduced to $30 - (8.26 - 6) = 27.74 \text{ dBm/500kHz}$.

802.11ax (HE80)

Chan.	Chan. Freq. (MHz)	PSD (dBm/300kHz)				Total PSD (dBm/300kHz)	Total PSD (dBm/500kHz)	PSD Limit (dBm/500kHz)	Test Result
		Chain 0	Chain 1	Chain 2	Chain 3				
155	5775	-5.66	-6.27	-5.74	-5.57	0.22	2.44	27.74	Pass

Notes:

1. Method E) 2) b) Measure and sum spectral maxima across the outputs of KDB 662911 is using for calculating total power density.
2. Directional gain = $10 \log[(10^{\text{Chain0}/20} + 10^{\text{Chain1}/20} + 10^{\text{Chain2}/20} + 10^{\text{Chain3}/20})^2 / 4]$
3. For U-NII-3, the directional gain is 8.26 dBi > 6 dBi, so the power density limit shall be reduced to $30 - (8.26 - 6) = 27.74 \text{ dBm/500kHz}$.

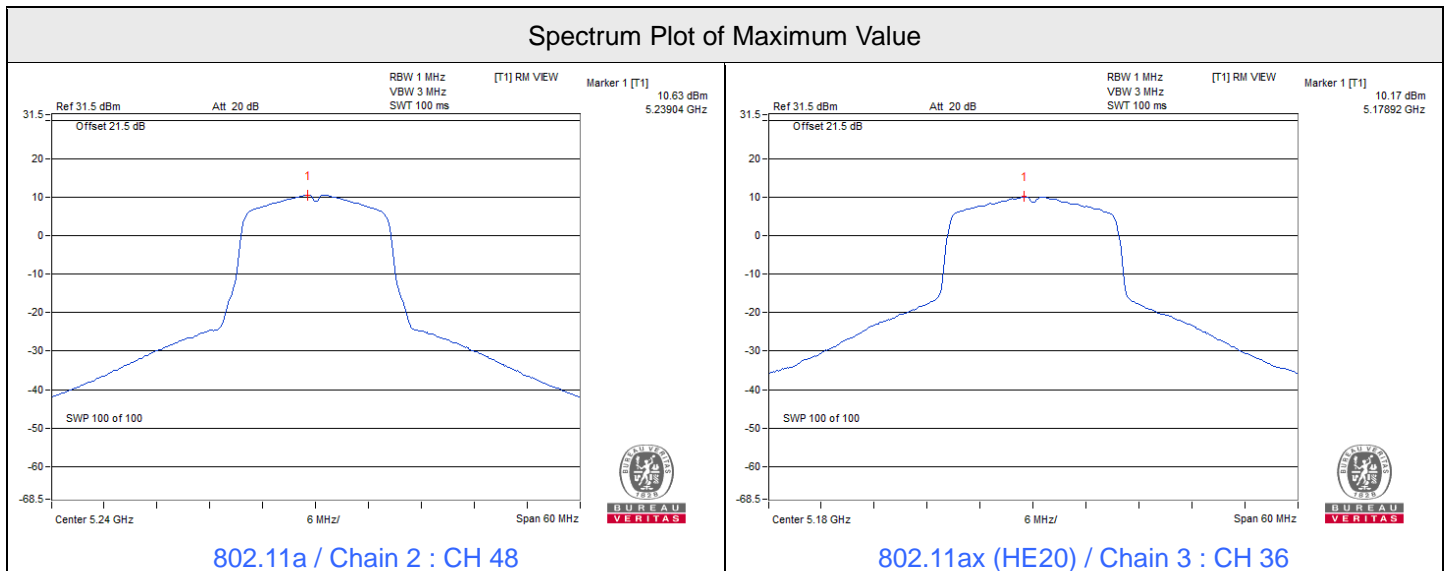



Spectrum Plot of Maximum Value

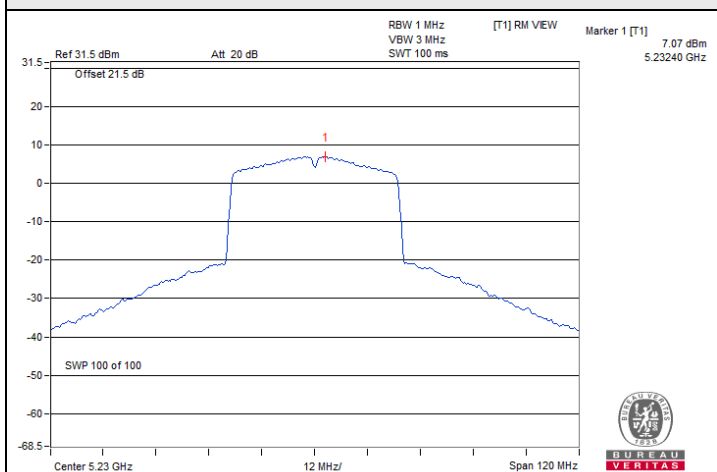

802.11ax (HE40) / Chain 2 : CH 46

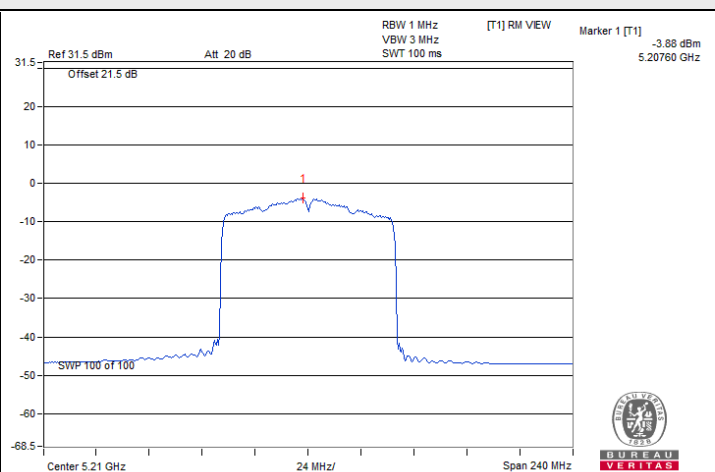

802.11ax (HE80) / Chain 3 : CH 42

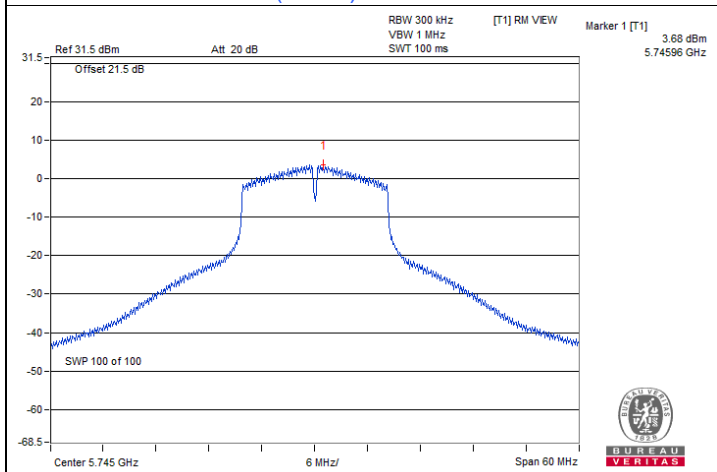

802.11a / Chain 2 : CH 149

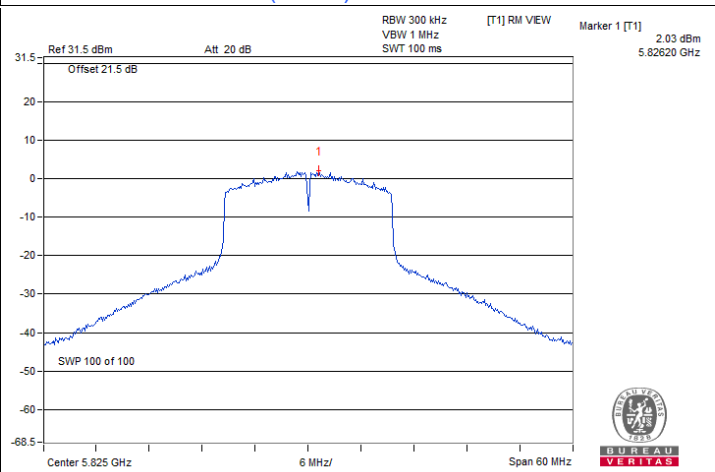

802.11ax (HE20) / Chain 3 : CH 165

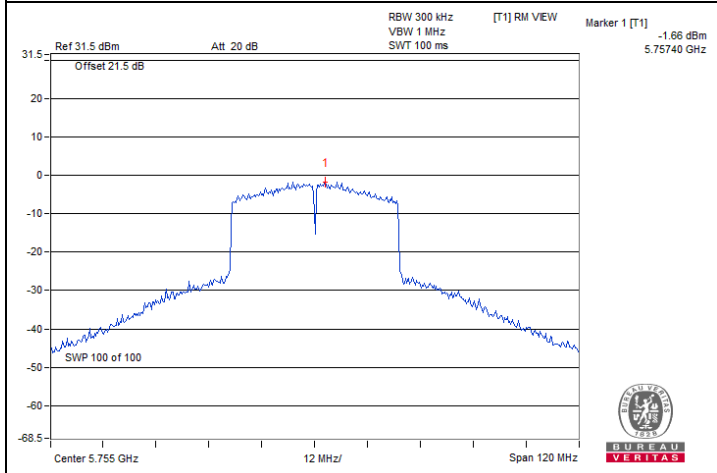

802.11ax (HE40) / Chain 2 : CH 151

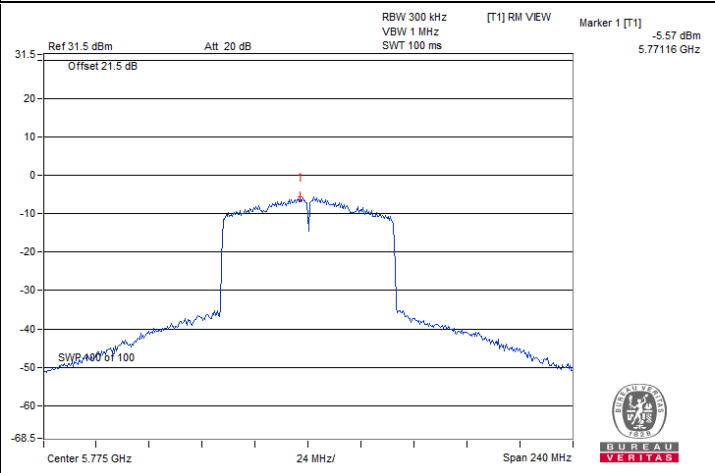

802.11ax (HE80) / Chain 3 : CH 155

7.3 6 dB Bandwidth

Input Power:	120 Vac, 60 Hz	Environmental Conditions:	22°C, 61% RH	Tested By:	Katina Lu
--------------	----------------	---------------------------	--------------	------------	-----------

802.11a

Channel	Frequency (MHz)	6 dB Bandwidth (MHz)				Minimum Limit (MHz)	Test Result
		Chain 0	Chain 1	Chain 2	Chain 3		
149	5745	15.16	15.14	15.15	15.14	0.5	Pass
157	5785	15.14	15.16	15.16	15.16	0.5	Pass
165	5825	15.17	15.14	15.16	15.15	0.5	Pass

802.11ax (HE20)

Channel	Frequency (MHz)	6 dB Bandwidth (MHz)				Minimum Limit (MHz)	Test Result
		Chain 0	Chain 1	Chain 2	Chain 3		
149	5745	16.62	17.58	15.56	17.61	0.5	Pass
157	5785	17.27	17.82	15.95	17.38	0.5	Pass
165	5825	17.76	16.86	16.46	18.28	0.5	Pass

802.11ax (HE40)

Channel	Frequency (MHz)	6 dB Bandwidth (MHz)				Minimum Limit (MHz)	Test Result
		Chain 0	Chain 1	Chain 2	Chain 3		
151	5755	35.45	35.44	35.27	35.94	0.5	Pass
159	5795	35.30	35.95	35.94	36.43	0.5	Pass

802.11ax (HE80)

Channel	Frequency (MHz)	6 dB Bandwidth (MHz)				Minimum Limit (MHz)	Test Result
		Chain 0	Chain 1	Chain 2	Chain 3		
155	5775	75.27	75.32	75.31	75.32	0.5	Pass



Spectrum Plot of Minimum Value

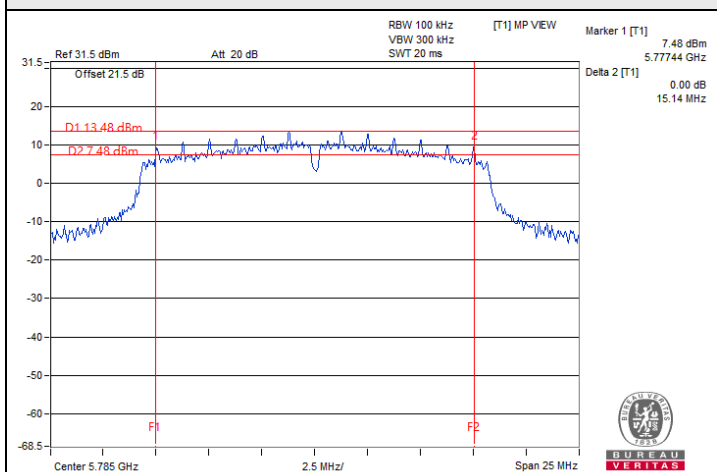

802.11a / Chain 0 : CH 157

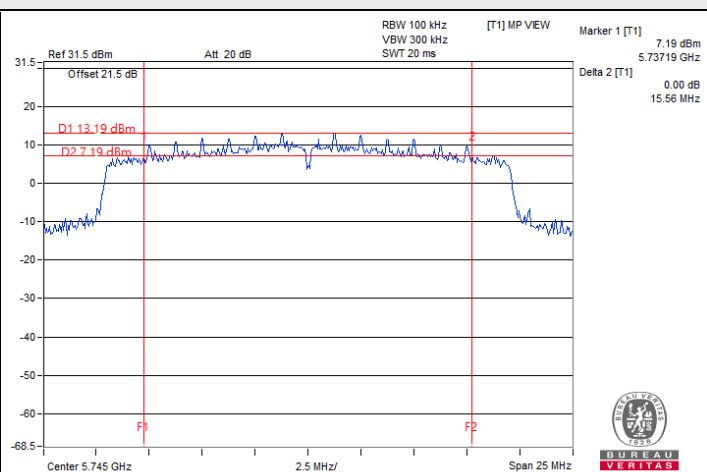

802.11ax (HE20) / Chain 2 : CH 149

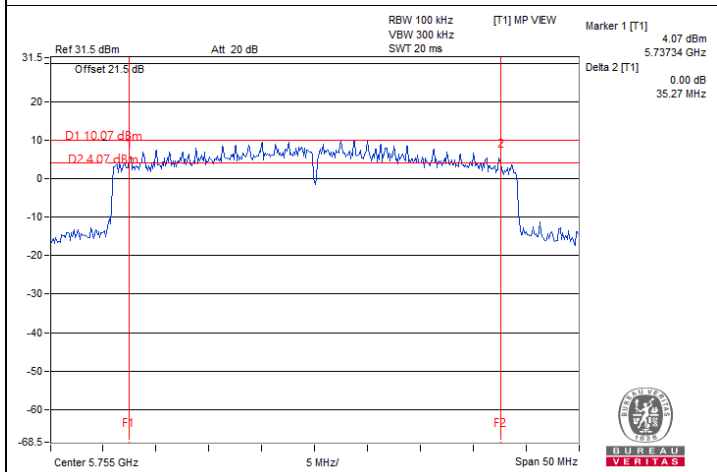

802.11ax (HE40) / Chain 2 : CH 151

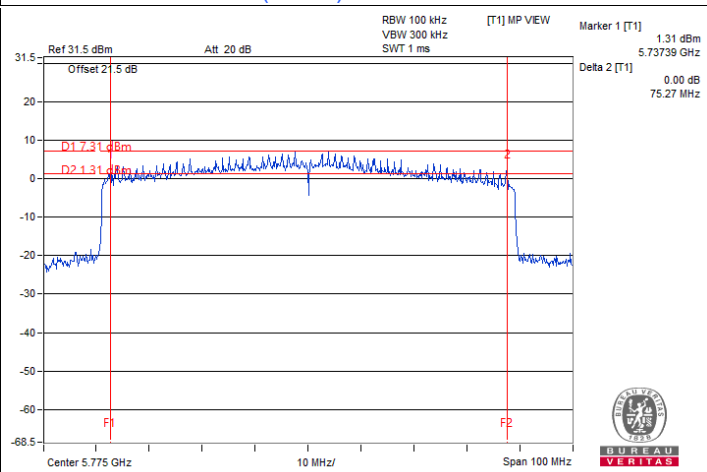

802.11ax (HE80) / Chain 0 : CH 155

Note: For U-NII-3 straddle channel = Marker 1 + Delta 2 - 5725 MHz

7.4 Occupied Bandwidth

Input Power:	120 Vac, 60 Hz	Environmental Conditions:	22°C, 61% RH	Tested By:	Katina Lu
--------------	----------------	---------------------------	--------------	------------	-----------

802.11a

Channel	Frequency (MHz)	Occupied Bandwidth (MHz)			
		Chain 0	Chain 1	Chain 2	Chain 3
36	5180	16.68	16.92	16.92	16.92
40	5200	16.68	16.80	16.80	16.80
48	5240	16.80	16.92	16.92	16.80
149	5745	17.40	17.04	17.64	17.28
157	5785	17.40	17.16	18.60	17.64
165	5825	17.40	17.40	17.28	17.52

802.11ax (HE20)

Channel	Frequency (MHz)	Occupied Bandwidth (MHz)			
		Chain 0	Chain 1	Chain 2	Chain 3
36	5180	19.08	19.08	19.08	19.08
40	5200	19.08	19.32	19.20	19.08
48	5240	18.84	18.84	18.96	18.84
149	5745	19.32	19.20	19.32	19.32
157	5785	19.44	19.20	19.56	19.32
165	5825	19.32	19.32	19.32	19.44

802.11ax (HE40)

Channel	Frequency (MHz)	Occupied Bandwidth (MHz)			
		Chain 0	Chain 1	Chain 2	Chain 3
38	5190	37.68	37.68	37.68	38.16
46	5230	38.16	38.16	38.16	38.16
151	5755	38.64	38.16	38.64	38.40
159	5795	38.40	38.16	39.12	38.64

802.11ax (HE80)

Channel	Frequency (MHz)	Occupied Bandwidth (MHz)			
		Chain 0	Chain 1	Chain 2	Chain 3
42	5210	76.32	76.80	76.80	76.80
155	5775	76.87	77.28	77.28	77.28



Spectrum Plot of Maximum Value

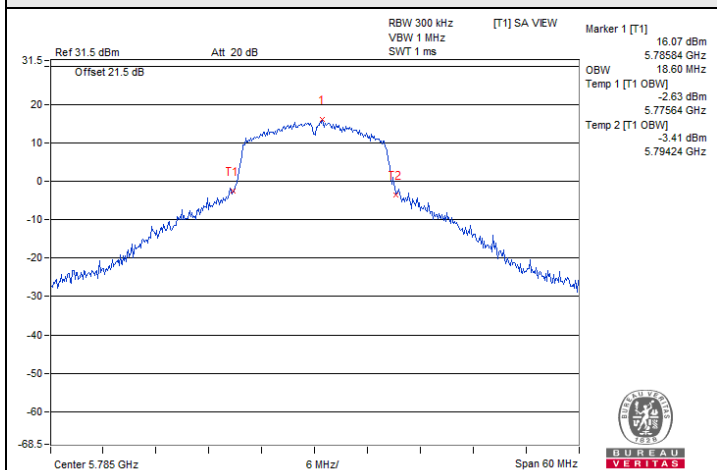

802.11a / Chain 2 : CH 157

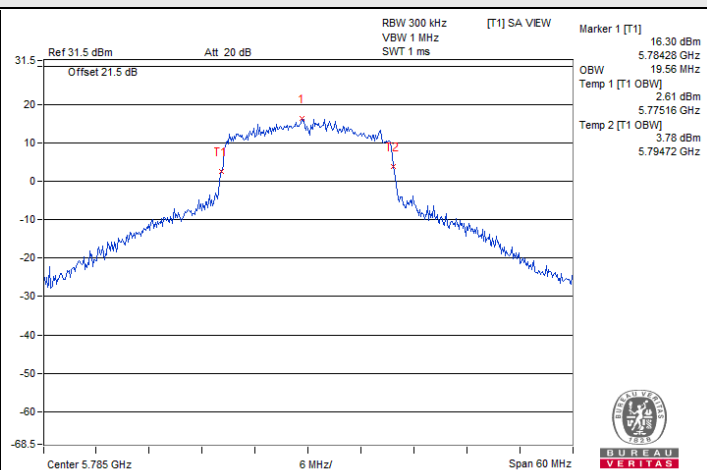

802.11ax (HE20) / Chain 2 : CH 157

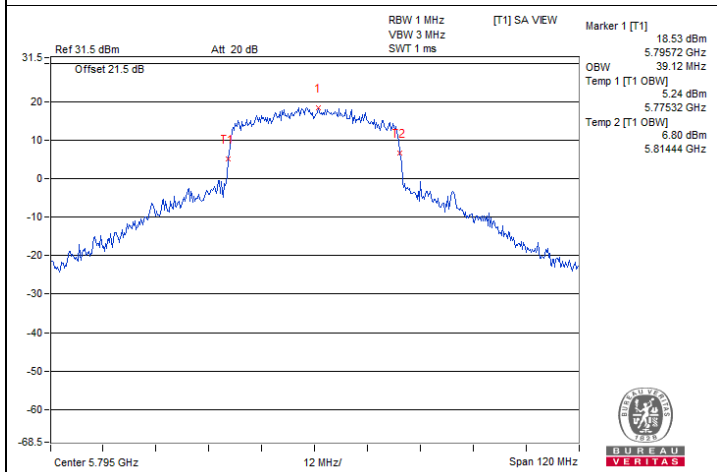

802.11ax (HE40) / Chain 2 : CH 159

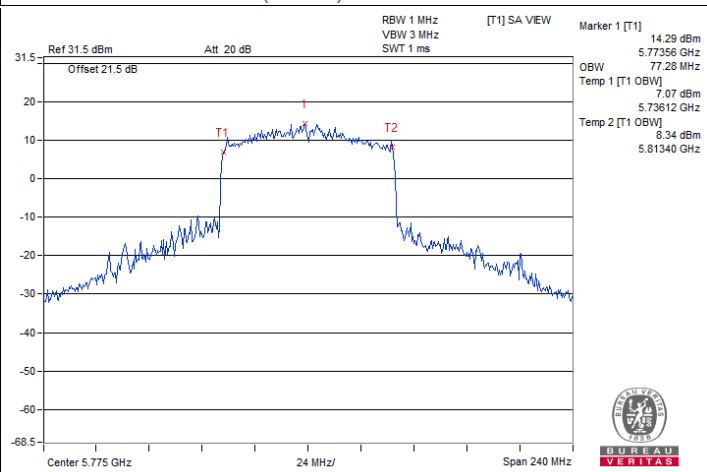

802.11ax (HE80) / Chain 1 : CH 155

Spectrum Plot for nearby DFS band (DFS is required, if 99% OCP straddle into U-NII-2A)

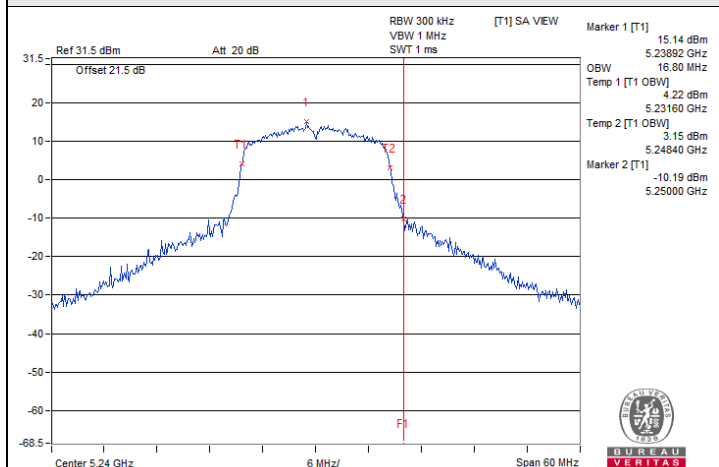
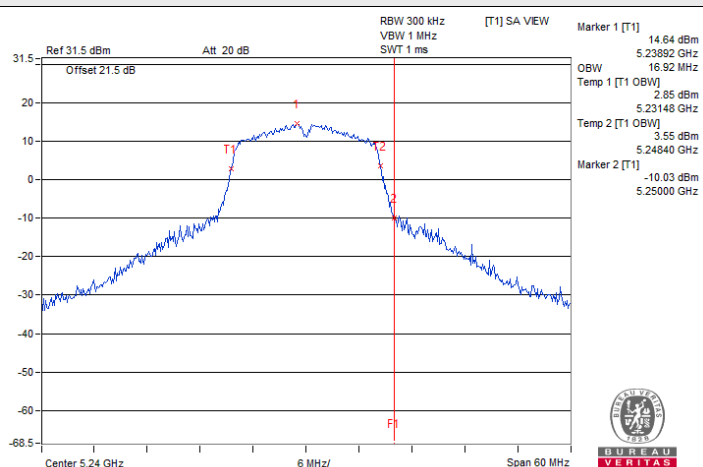
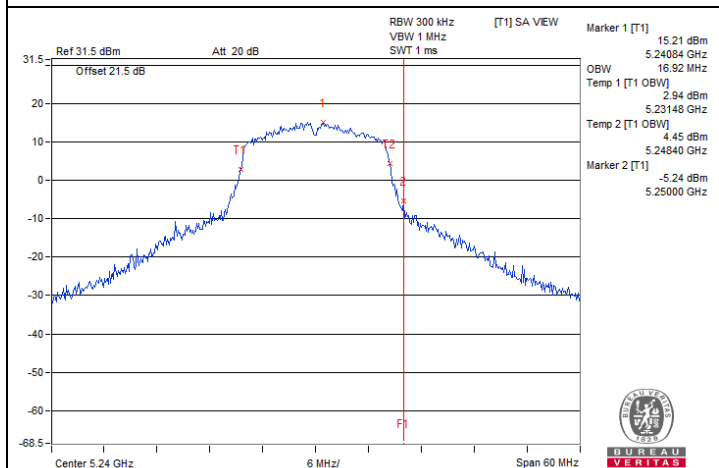
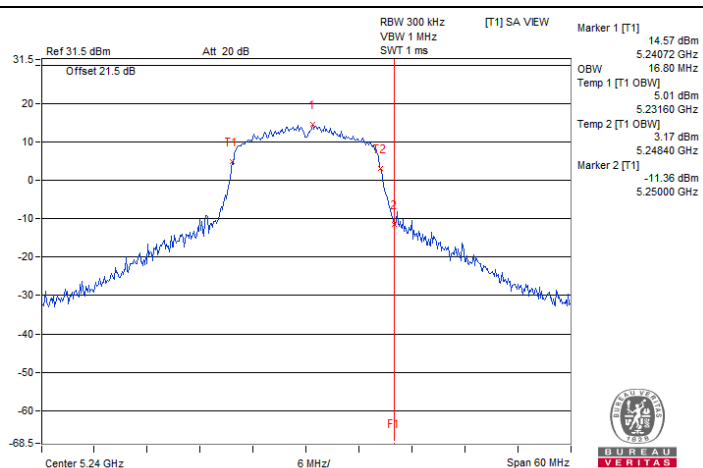
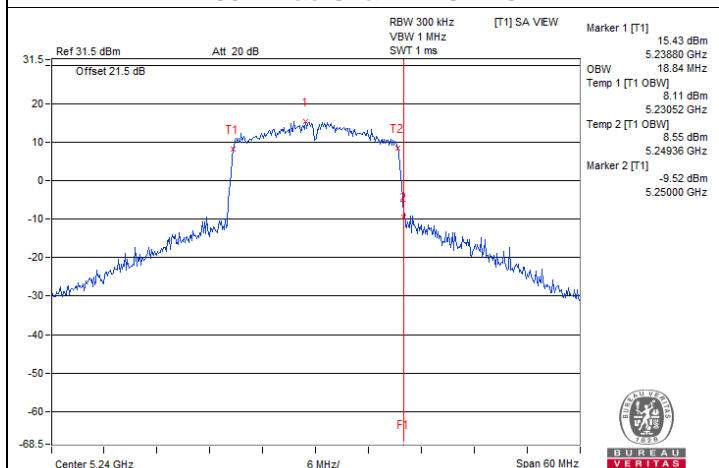
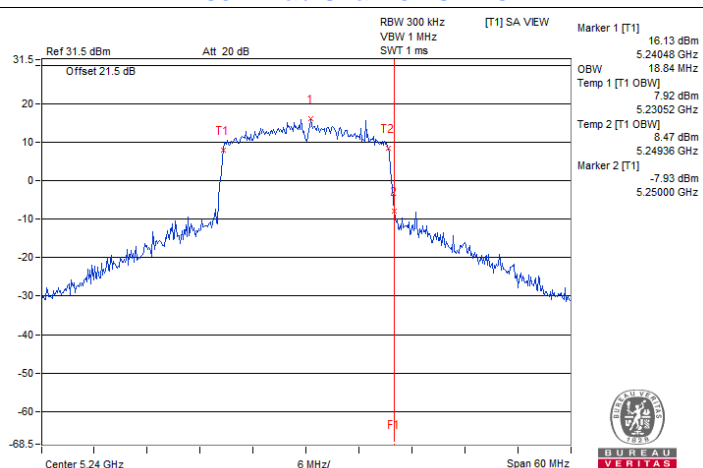
**802.11a / Chain 0 : CH 48****802.11a / Chain 1 : CH 48****802.11a / Chain 2 : CH 48****802.11a / Chain 3 : CH 48****802.11ax (HE20) / Chain 0 : CH 48****802.11ax (HE20) / Chain 1 : CH 48**

Spectrum Plot for nearby DFS band (DFS is required, if 99% OCP straddle into U-NII-2A)

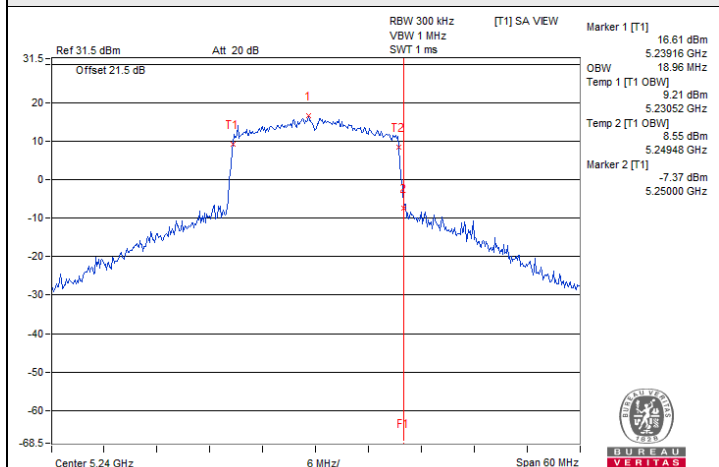
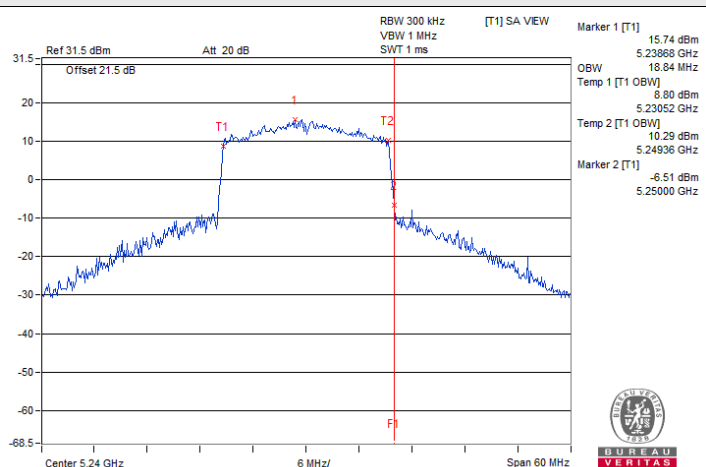
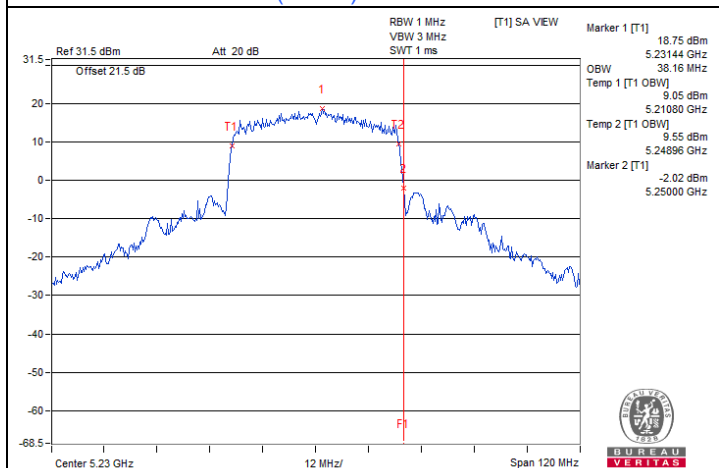
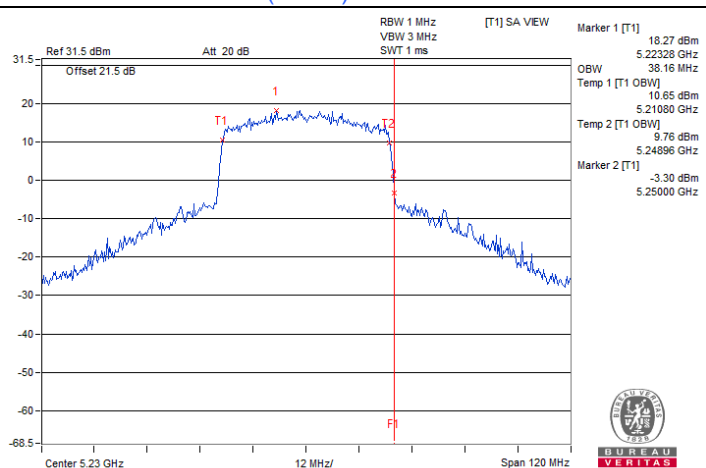
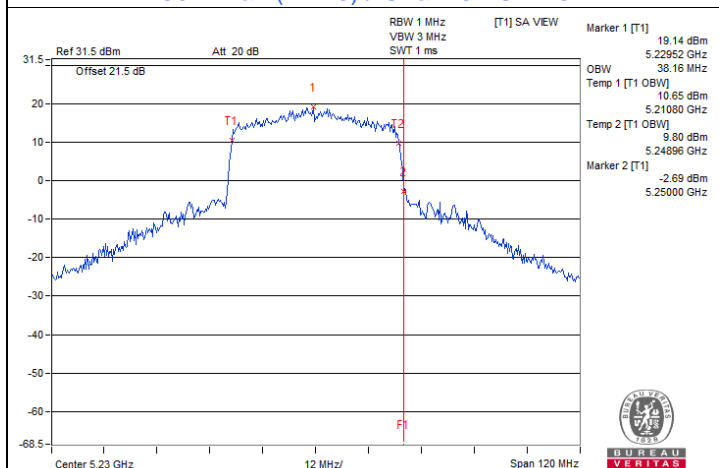
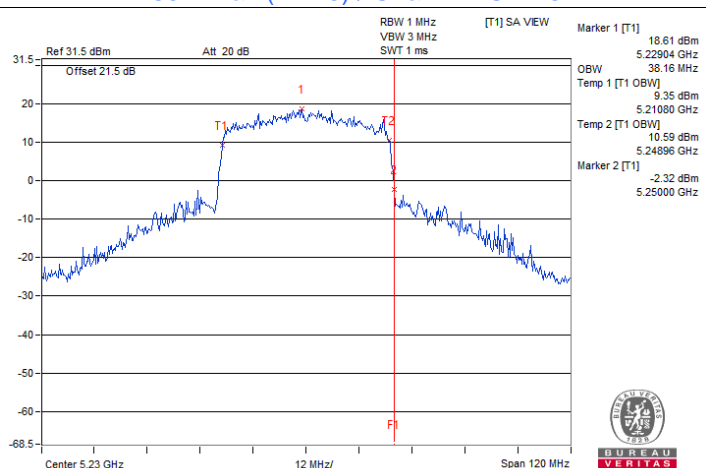
**802.11ax (HE20) / Chain 2 : CH 48****802.11ax (HE20) / Chain 3 : CH 48****802.11ax (HE40) / Chain 0 : CH 46****802.11ax (HE40) / Chain 1 : CH 46****802.11ax (HE40) / Chain 2 : CH 46****802.11ax (HE40) / Chain 3 : CH 46**

Spectrum Plot for nearby DFS band (DFS is required, if 99% OCP straddle into U-NII-2A)

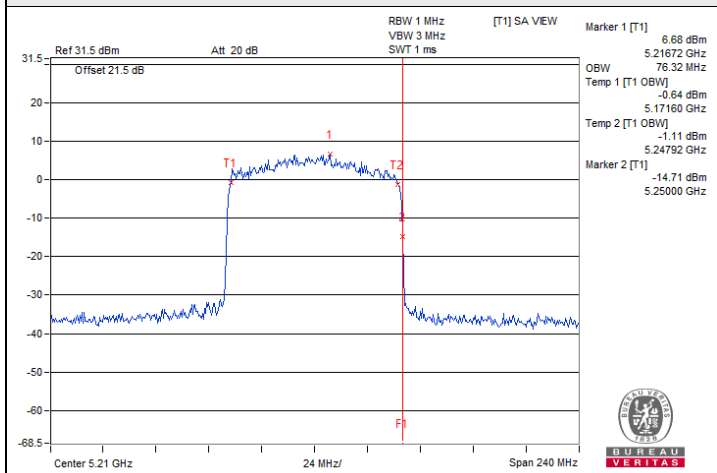

802.11ax (HE80) / Chain 0 : CH 42

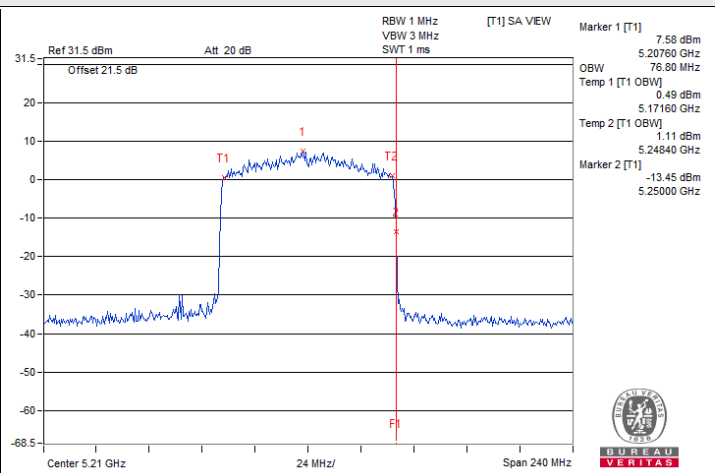

802.11ax (HE80) / Chain 1 : CH 42

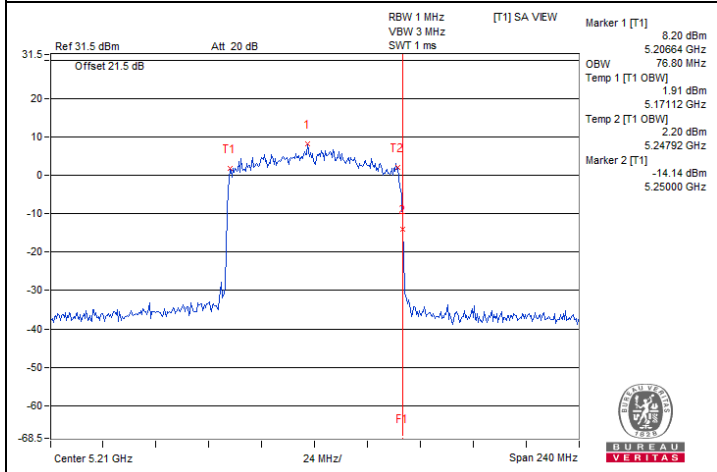

802.11ax (HE80) / Chain 2 : CH 42

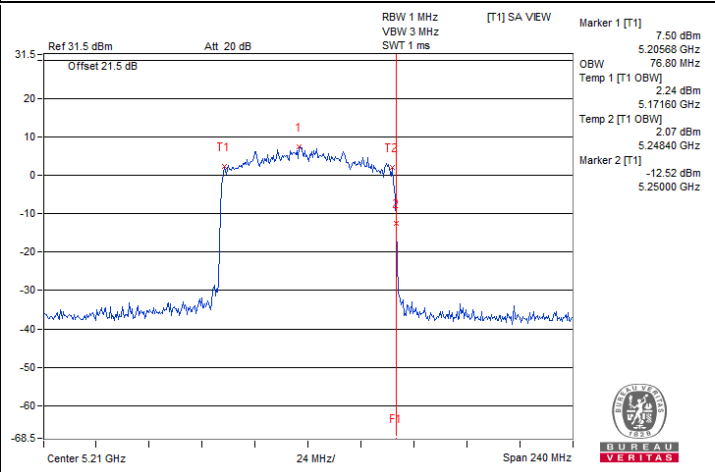

802.11ax (HE80) / Chain 3 : CH 42



Spectrum Plot for nearby DFS band (DFS is required, if 99% OCP straddle into U-NII-2C)

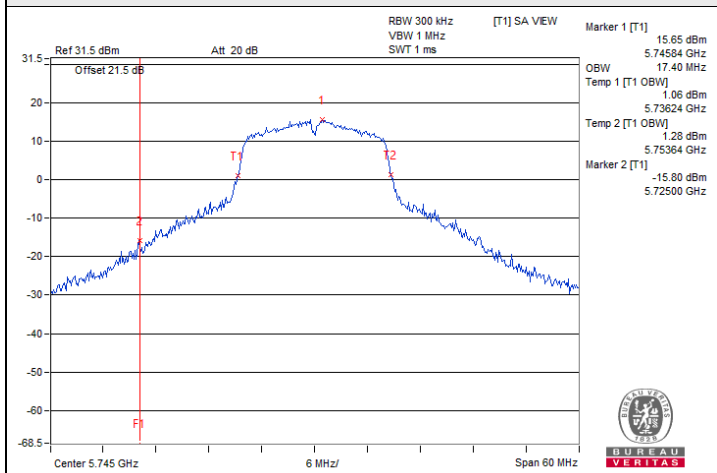

802.11a / Chain 0 : CH 149

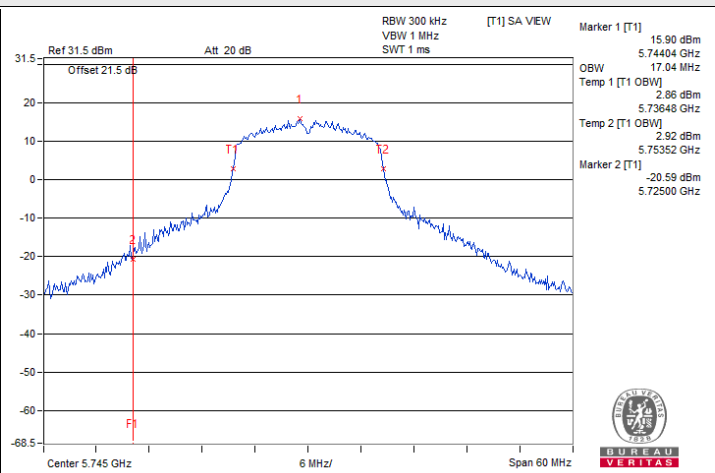

802.11a / Chain 1 : CH 149

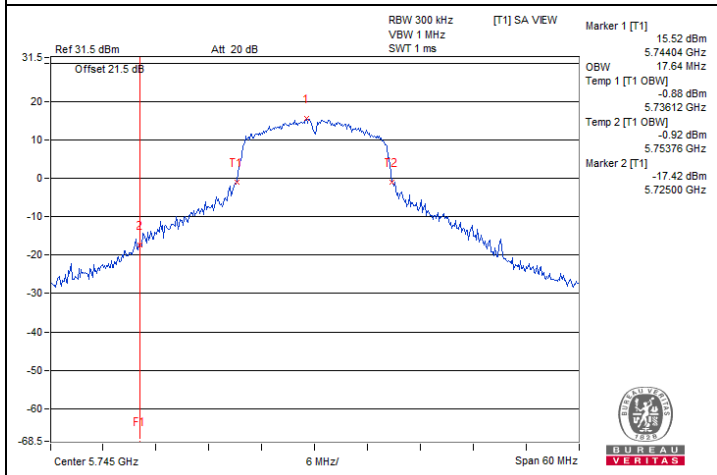

802.11a / Chain 2 : CH 149

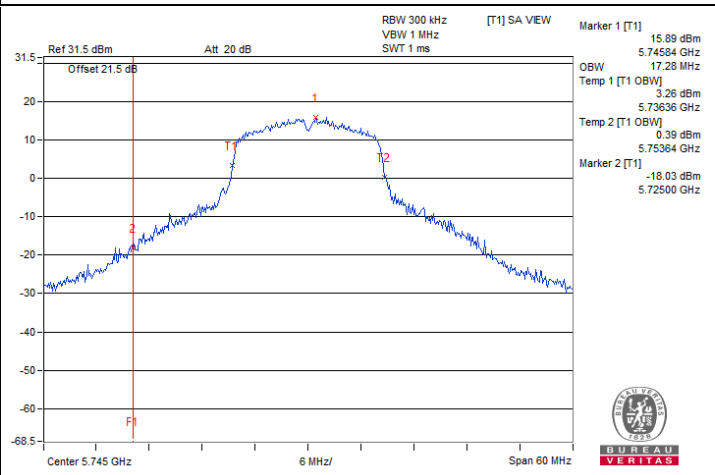

802.11a / Chain 3 : CH 149

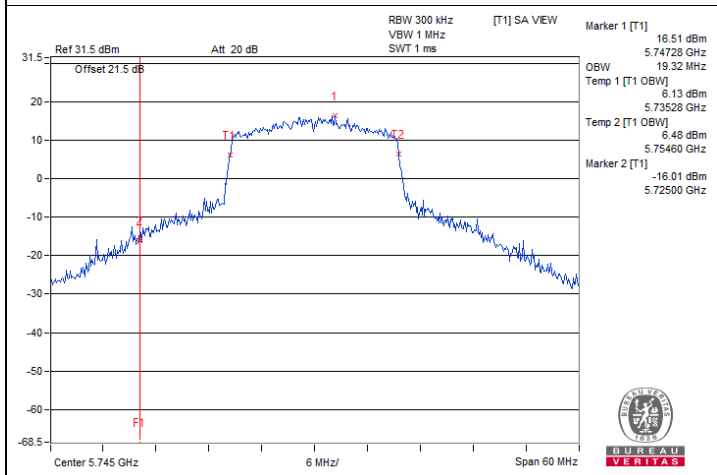

802.11ax (HE20) / Chain 0 : CH 149

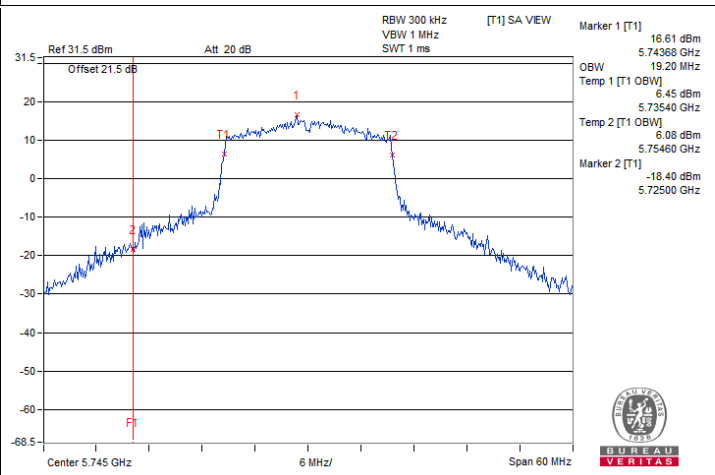

802.11ax (HE20) / Chain 1 : CH 149



Spectrum Plot for nearby DFS band (DFS is required, if 99% OCP straddle into U-NII-2C)

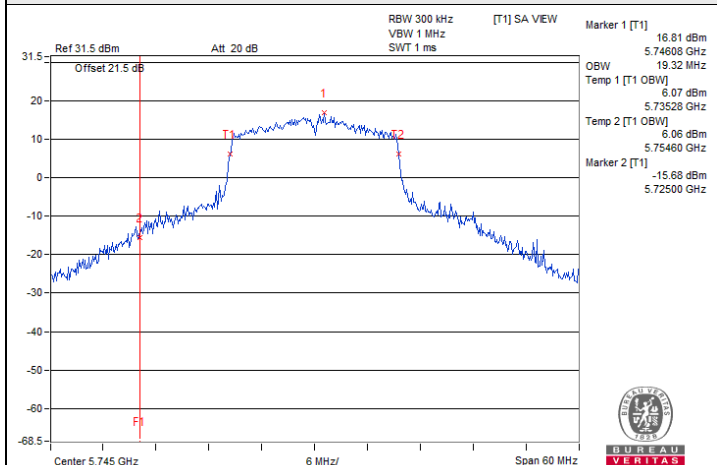

802.11ax (HE20) / Chain 2 : CH 149

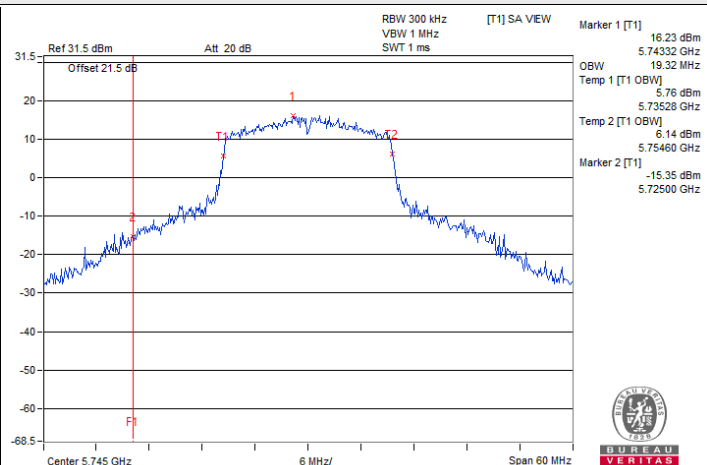

802.11ax (HE20) / Chain 3 : CH 149

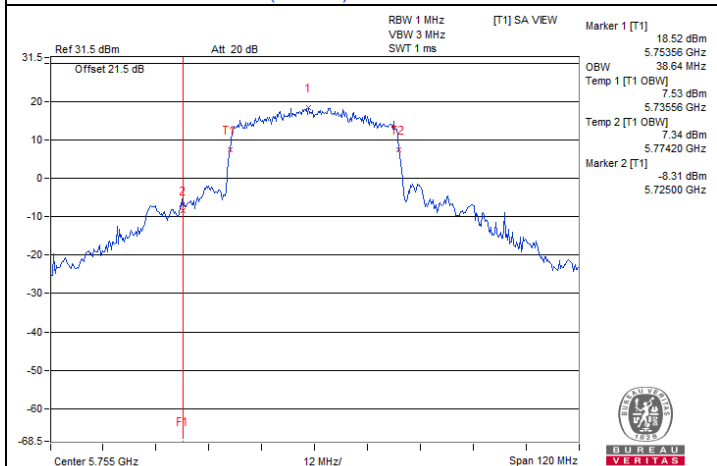

802.11ax (HE40) / Chain 0 : CH 151

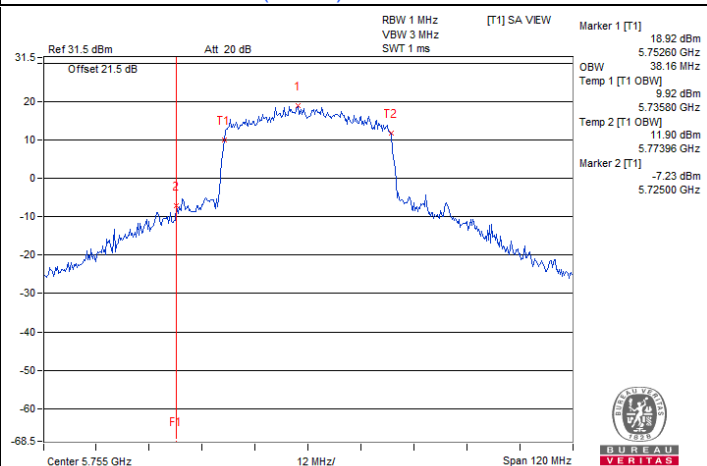

802.11ax (HE40) / Chain 1 : CH 151

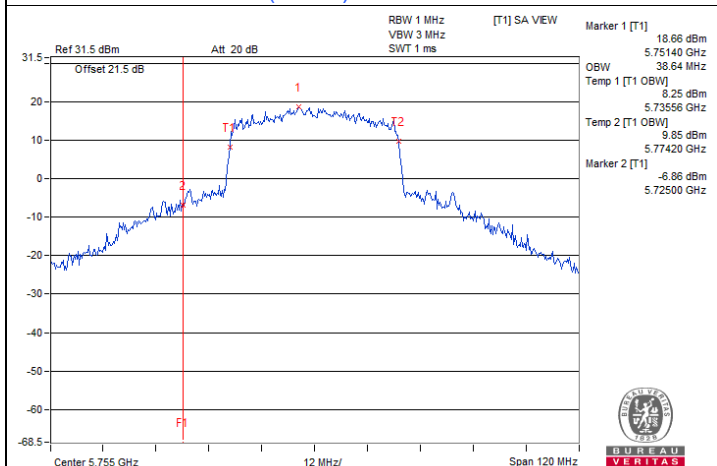

802.11ax (HE40) / Chain 2 : CH 151

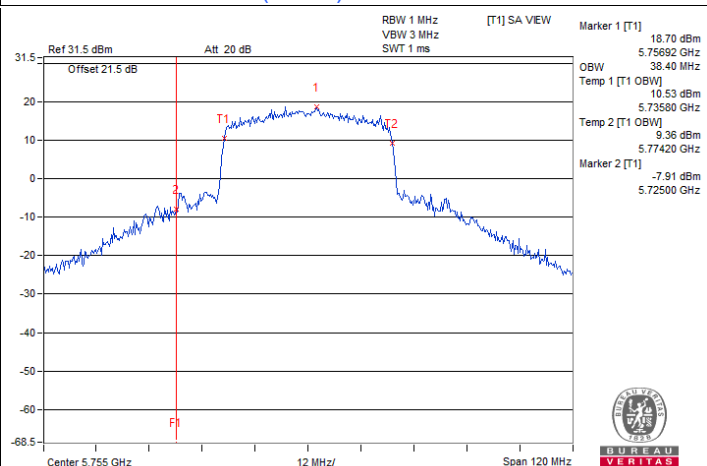

802.11ax (HE40) / Chain 3 : CH 151

Spectrum Plot for nearby DFS band (DFS is required, if 99% OCP straddle into U-NII-2C)

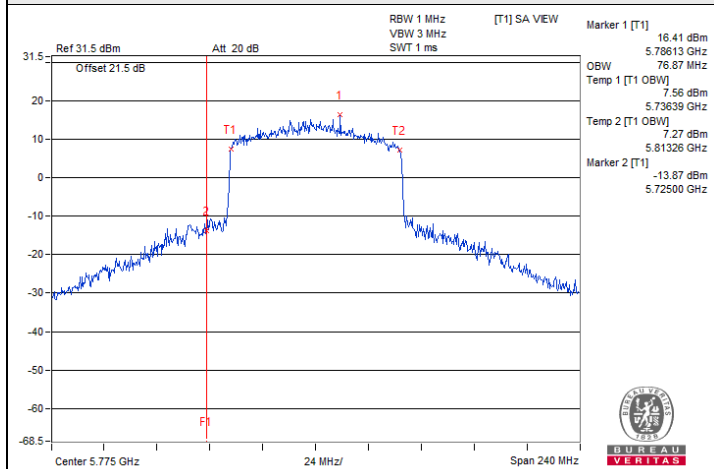

802.11ax (HE80) / Chain 0 : CH 155

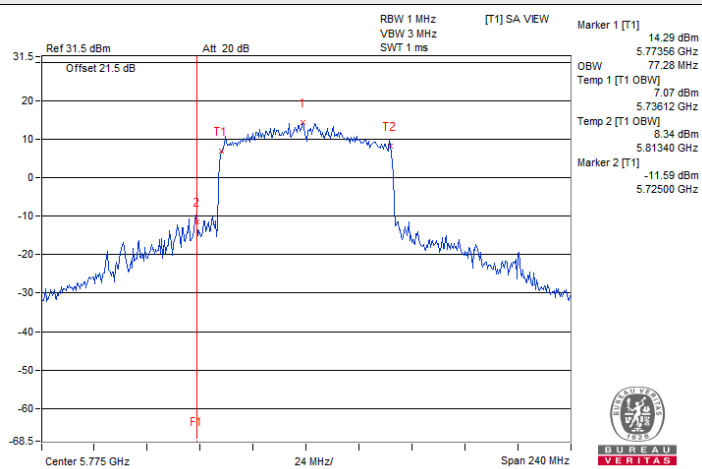

802.11ax (HE80) / Chain 1 : CH 155

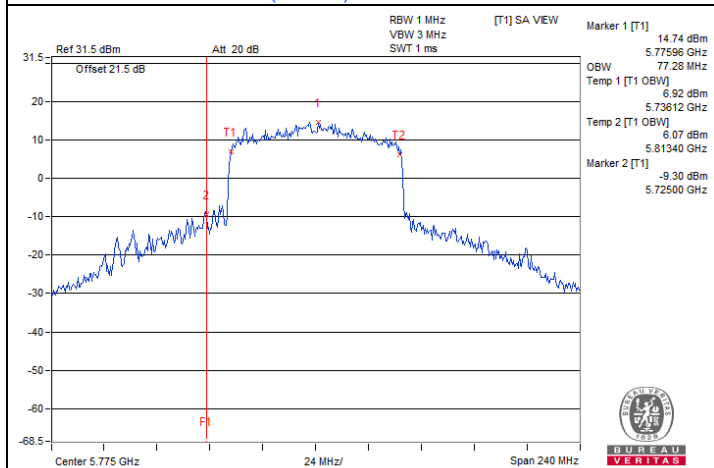

802.11ax (HE80) / Chain 2 : CH 155

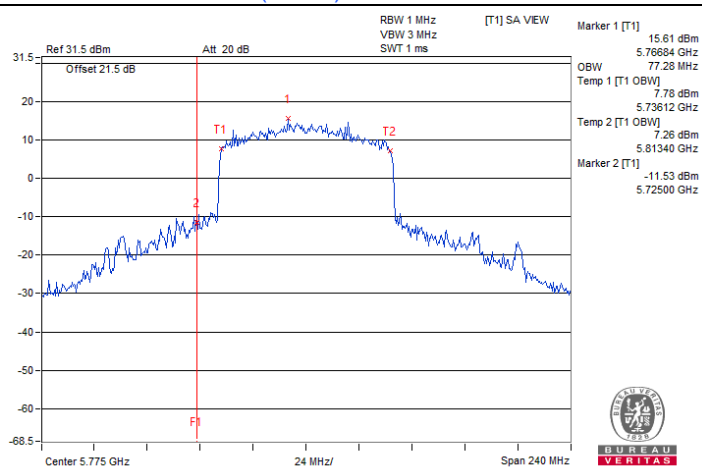

802.11ax (HE80) / Chain 3 : CH 155

7.5 Frequency Stability

Input Power:	120 Vac, 60 Hz	Environmental Conditions:	22°C, 61% RH	Tested By:	Katina Lu
--------------	----------------	---------------------------	--------------	------------	-----------

802.11a

Frequency Stability Versus Temperature									
Operating Frequency: 5180 MHz									
Temp. (°C)	Power Supply (Vac)	0 Minute		2 Minutes		5 Minutes		10 Minutes	
		Measured Frequency (MHz)	Test Result	Measured Frequency (MHz)	Test Result	Measured Frequency (MHz)	Test Result	Measured Frequency (MHz)	Test Result
40	120	5179.9767	Pass	5179.9807	Pass	5179.9776	Pass	5179.9766	Pass
30	120	5180.0148	Pass	5180.0158	Pass	5180.0193	Pass	5180.0156	Pass
20	120	5179.9756	Pass	5179.9731	Pass	5179.9753	Pass	5179.9766	Pass
10	120	5179.9869	Pass	5179.9835	Pass	5179.9873	Pass	5179.9877	Pass
0	120	5179.9986	Pass	5179.9983	Pass	5179.9977	Pass	5179.9996	Pass

Frequency Stability Versus Voltage									
Operating Frequency: 5180 MHz									
Temp. (°C)	Power Supply (Vac)	0 Minute		2 Minutes		5 Minutes		10 Minutes	
		Measured Frequency (MHz)	Test Result	Measured Frequency (MHz)	Test Result	Measured Frequency (MHz)	Test Result	Measured Frequency (MHz)	Test Result
20	138	5179.9751	Pass	5179.9721	Pass	5179.9746	Pass	5179.9752	Pass
	120	5179.9756	Pass	5179.9731	Pass	5179.9753	Pass	5179.9766	Pass
	102	5179.9836	Pass	5179.9788	Pass	5179.9802	Pass	5179.9824	Pass

7.6 AC Power Conducted Emissions

RF Mode	802.11ax (HE20)	Channel	CH 48 : 5240 MHz
Frequency Range	150 kHz ~ 30 MHz	Detector Function & Resolution Bandwidth	Quasi-Peak (QP) / Average (AV), 9 kHz
Input Power	120 Vac, 60 Hz	Environmental Conditions	24°C, 66% RH
Tested By	Sampson Chen		

Phase Of Power : Line (L)										
No	Frequency (MHz)	Correction Factor (dB)	Reading Value (dBuV)		Emission Level (dBuV)		Limit (dBuV)		Margin (dB)	
			Q.P.	AV.	Q.P.	AV.	Q.P.	AV.	Q.P.	AV.
1	0.15000	9.98	30.02	16.95	40.00	26.93	66.00	56.00	-26.00	-29.07
2	0.38828	9.99	33.81	32.34	43.80	42.33	58.10	48.10	-14.30	-5.77
3	0.42344	9.99	35.62	33.59	45.61	43.58	57.38	47.38	-11.77	-3.80
4	0.45469	9.99	36.36	31.69	46.35	41.68	56.79	46.79	-10.44	-5.11
5	0.93125	10.03	22.83	15.58	32.86	25.61	56.00	46.00	-23.14	-20.39
6	2.19141	10.12	24.46	18.76	34.58	28.88	56.00	46.00	-21.42	-17.12

Remarks:

1. Q.P. and AV. are abbreviations of quasi-peak and average individually.
2. The emission levels of other frequencies were very low against the limit.
3. Margin value = Emission level – Limit value
4. Correction factor = Insertion loss + Cable loss
5. Emission Level = Correction Factor + Reading Value

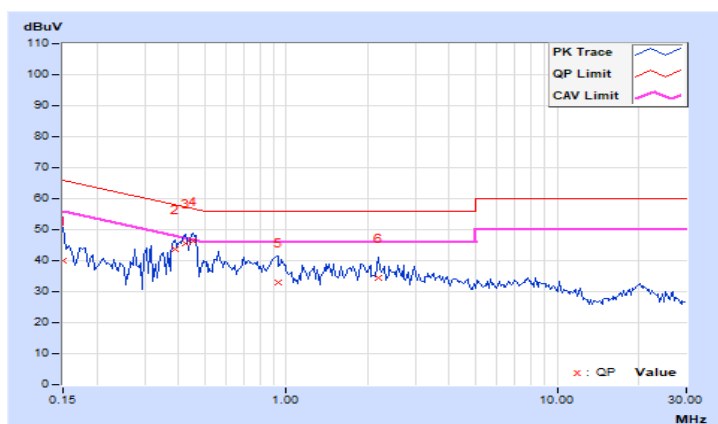

RF Mode	802.11ax (HE20)	Channel	CH 48 : 5240 MHz
Frequency Range	150 kHz ~ 30 MHz	Detector Function & Resolution Bandwidth	Quasi-Peak (QP) / Average (AV), 9 kHz
Input Power	120 Vac, 60 Hz	Environmental Conditions	24°C, 66% RH
Tested By	Sampson Chen		

Phase Of Power : Neutral (N)										
No	Frequency (MHz)	Correction Factor (dB)	Reading Value (dBuV)		Emission Level (dBuV)		Limit (dBuV)		Margin (dB)	
			Q.P.	AV.	Q.P.	AV.	Q.P.	AV.	Q.P.	AV.
1	0.38828	10.04	33.68	25.85	43.72	35.89	58.10	48.10	-14.38	-12.21
2	0.42734	10.04	36.72	31.81	46.76	41.85	57.30	47.30	-10.54	-5.45
3	0.45469	10.04	36.70	32.59	46.74	42.63	56.79	46.79	-10.05	-4.16
4	0.54844	10.05	26.02	15.29	36.07	25.34	56.00	46.00	-19.93	-20.66
5	0.88828	10.07	23.50	16.04	33.57	26.11	56.00	46.00	-22.43	-19.89
6	2.18750	10.16	22.14	15.67	32.30	25.83	56.00	46.00	-23.70	-20.17

Remarks:

1. Q.P. and AV. are abbreviations of quasi-peak and average individually.
2. The emission levels of other frequencies were very low against the limit.
3. Margin value = Emission level – Limit value
4. Correction factor = Insertion loss + Cable loss
5. Emission Level = Correction Factor + Reading Value

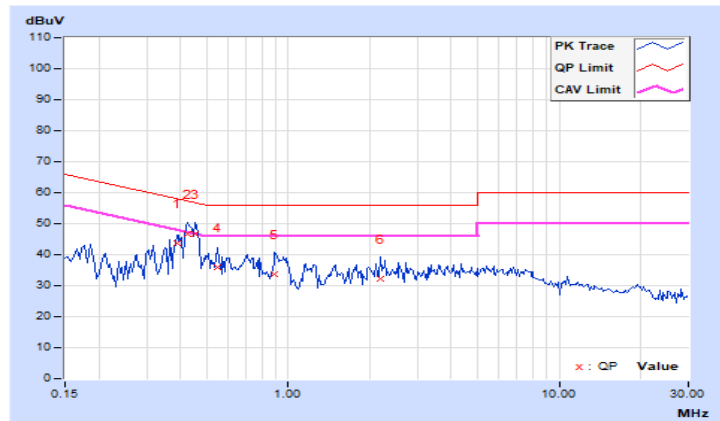

7.7 Unwanted Emissions below 1 GHz

RF Mode	802.11ax (HE20)	Channel	CH 48 : 5240 MHz
Frequency Range	30 MHz ~ 1 GHz	Detector Function & Bandwidth	(QP) RB = 120kHz
Input Power	120 Vac, 60 Hz	Environmental Conditions	23°C, 67% RH
Tested By	Nick Tsou		

Antenna Polarity & Test Distance : Horizontal at 3 m								
No	Frequency (MHz)	Emission Level (dBuV/m)	Limit (dBuV/m)	Margin (dB)	Antenna Height (m)	Table Angle (Degree)	Raw Value (dBuV)	Correction Factor (dB/m)
1	37.83	31.2 QP	40.0	-8.8	3.00 H	65	44.4	-13.2
2	90.60	33.0 QP	43.5	-10.5	2.00 H	226	51.4	-18.4
3	147.39	28.8 QP	43.5	-14.7	1.50 H	112	41.3	-12.5
4	250.00	34.6 QP	46.0	-11.4	1.00 H	245	48.6	-14.0
5	499.99	35.9 QP	46.0	-10.1	1.50 H	219	43.3	-7.4
6	722.94	33.9 QP	46.0	-12.1	2.00 H	360	37.2	-3.3

Remarks:

1. Emission Level(dBuV/m) = Raw Value(dBuV) + Correction Factor(dB/m)
2. Correction Factor(dB/m) = Antenna Factor(dB/m) + Cable Factor(dB) – Pre-Amplifier Factor(dB)
3. Margin value = Emission Level – Limit value
4. The other emission levels were very low against the limit of frequency range 30 MHz ~ 1 GHz.
5. The emission levels were very low against the limit of frequency range 9 kHz ~ 30 MHz: the amplitude of spurious emissions attenuated more than 20 dB below the permissible value to be report.

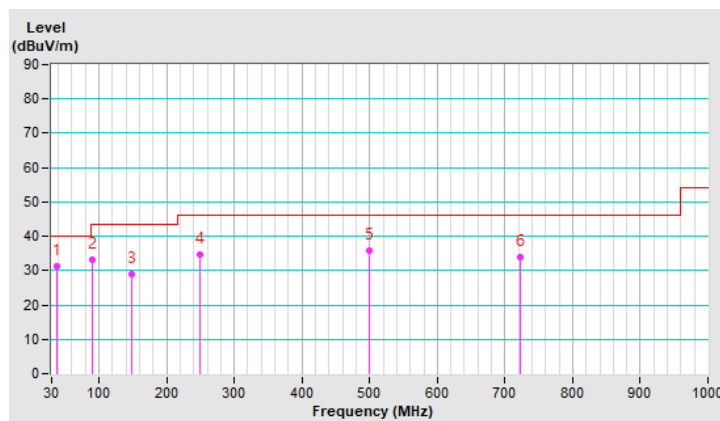

RF Mode	802.11ax (HE20)	Channel	CH 48 : 5240 MHz
Frequency Range	30 MHz ~ 1 GHz	Detector Function & Bandwidth	(QP) RB = 120kHz
Input Power	120 Vac, 60 Hz	Environmental Conditions	23°C, 67% RH
Tested By	Nick Tsou		

Antenna Polarity & Test Distance : Vertical at 3 m								
No	Frequency (MHz)	Emission Level (dBuV/m)	Limit (dBuV/m)	Margin (dB)	Antenna Height (m)	Table Angle (Degree)	Raw Value (dBuV)	Correction Factor (dB/m)
1	59.63	31.9 QP	40.0	-8.1	1.50 V	148	44.7	-12.8
2	104.79	27.4 QP	43.5	-16.1	1.00 V	223	43.8	-16.4
3	150.30	25.9 QP	43.5	-17.6	2.00 V	308	38.3	-12.4
4	249.97	27.4 QP	46.0	-18.6	2.00 V	267	41.4	-14.0
5	499.99	35.0 QP	46.0	-11.0	3.00 V	264	42.4	-7.4
6	749.98	33.7 QP	46.0	-12.3	3.00 V	173	36.5	-2.8

Remarks:

1. Emission Level(dBuV/m) = Raw Value(dBuV) + Correction Factor(dB/m)
2. Correction Factor(dB/m) = Antenna Factor(dB/m) + Cable Factor(dB) – Pre-Amplifier Factor(dB)
3. Margin value = Emission Level – Limit value
4. The other emission levels were very low against the limit of frequency range 30 MHz ~ 1 GHz.
5. The emission levels were very low against the limit of frequency range 9 kHz ~ 30 MHz: the amplitude of spurious emissions attenuated more than 20 dB below the permissible value to be report.

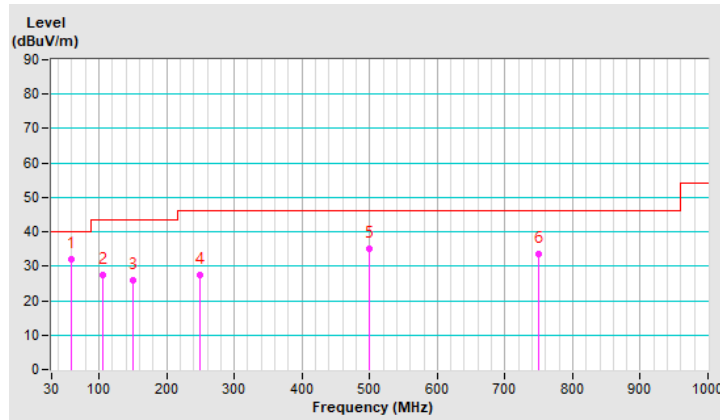

7.8 Unwanted Emissions above 1 GHz

RF Mode	802.11a	Channel	CH 36 : 5180 MHz
Frequency Range	1 GHz ~ 40 GHz	Detector Function & Bandwidth	(PK) RB = 1 MHz, VB = 3 MHz (AV) RB = 1 MHz, VB = 10 Hz
Input Power	120 Vac, 60 Hz	Environmental Conditions	29°C, 75% RH
Tested By	Nick Tsou		

Antenna Polarity & Test Distance : Horizontal at 3 m								
No	Frequency (MHz)	Emission Level (dBuV/m)	Limit (dBuV/m)	Margin (dB)	Antenna Height (m)	Table Angle (Degree)	Raw Value (dBuV)	Correction Factor (dB/m)
1	5140.50	63.1 PK	74.0	-10.9	1.46 H	52	58.9	4.2
2	5140.50	49.0 AV	54.0	-5.0	1.46 H	52	44.8	4.2
3	*5180.00	119.7 PK			1.46 H	52	115.6	4.1
4	*5180.00	108.6 AV			1.46 H	52	104.5	4.1
5	#10360.00	48.5 PK	68.2	-19.7	2.06 H	360	32.8	15.7
6	15540.00	51.3 PK	74.0	-22.7	2.30 H	163	33.2	18.1
7	15540.00	39.2 AV	54.0	-14.8	2.30 H	163	21.1	18.1

Remarks:

1. Emission Level(dBuV/m) = Raw Value(dBuV) + Correction Factor(dB/m)
2. Correction Factor(dB/m) = Antenna Factor(dB/m) + Cable Factor(dB) – Pre-Amplifier Factor(dB)
3. Margin value = Emission Level – Limit value
4. The other emission levels were very low against the limit.
5. " * " : Fundamental frequency, the limit was restricted at the RF Output Power.
6. " # " : The radiated frequency is out of the restricted band.

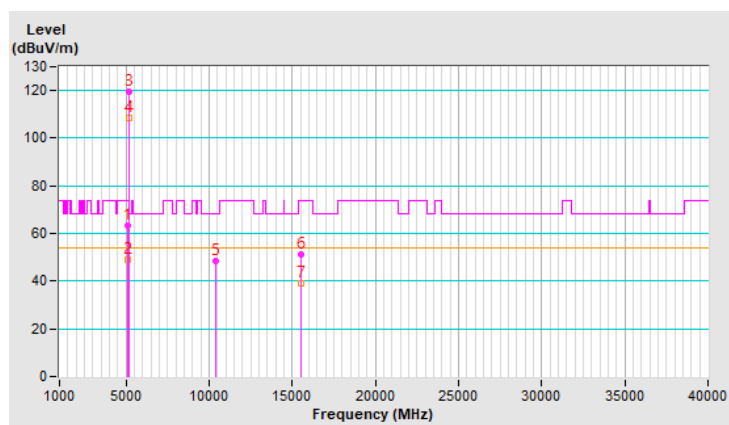

RF Mode	802.11a	Channel	CH 36 : 5180 MHz
Frequency Range	1 GHz ~ 40 GHz	Detector Function & Bandwidth	(PK) RB = 1 MHz, VB = 3 MHz (AV) RB = 1 MHz, VB = 10 Hz
Input Power	120 Vac, 60 Hz	Environmental Conditions	29°C, 75% RH
Tested By	Nick Tsou		

Antenna Polarity & Test Distance : Vertical at 3 m

No	Frequency (MHz)	Emission Level (dBuV/m)	Limit (dBuV/m)	Margin (dB)	Antenna Height (m)	Table Angle (Degree)	Raw Value (dBuV)	Correction Factor (dB/m)
1	5150.00	65.5 PK	74.0	-8.5	1.00 V	0	61.3	4.2
2	5150.00	53.4 AV	54.0	-0.6	1.00 V	0	49.2	4.2
3	*5180.00	123.3 PK			1.62 V	344	119.2	4.1
4	*5180.00	115.2 AV			1.62 V	344	111.1	4.1
5	#10360.00	48.5 PK	68.2	-19.7	1.49 V	360	32.8	15.7
6	15540.00	50.4 PK	74.0	-23.6	2.51 V	360	32.3	18.1
7	15540.00	38.2 AV	54.0	-15.8	2.51 V	360	20.1	18.1

Remarks:

1. Emission Level(dBuV/m) = Raw Value(dBuV) + Correction Factor(dB/m)
2. Correction Factor(dB/m) = Antenna Factor(dB/m) + Cable Factor(dB) – Pre-Amplifier Factor(dB)
3. Margin value = Emission Level – Limit value
4. The other emission levels were very low against the limit.
5. " * ": Fundamental frequency, the limit was restricted at the RF Output Power.
6. " # ": The radiated frequency is out of the restricted band.

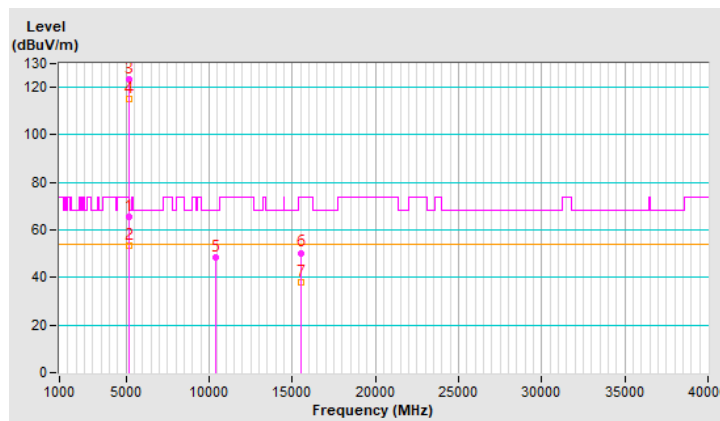

RF Mode	802.11a	Channel	CH 40 : 5200 MHz
Frequency Range	1 GHz ~ 40 GHz	Detector Function & Bandwidth	(PK) RB = 1 MHz, VB = 3 MHz (AV) RB = 1 MHz, VB = 10 Hz
Input Power	120 Vac, 60 Hz	Environmental Conditions	29°C, 75% RH
Tested By	Nick Tsou		

Antenna Polarity & Test Distance : Horizontal at 3 m								
No	Frequency (MHz)	Emission Level (dBuV/m)	Limit (dBuV/m)	Margin (dB)	Antenna Height (m)	Table Angle (Degree)	Raw Value (dBuV)	Correction Factor (dB/m)
1	*5200.00	120.2 PK			1.67 H	58	116.2	4.0
2	*5200.00	109.3 AV			1.67 H	58	105.3	4.0
3	#10400.00	47.5 PK	68.2	-20.7	2.16 H	357	31.6	15.9
4	15600.00	51.9 PK	74.0	-22.1	2.38 H	151	33.9	18.0
5	15600.00	39.4 AV	54.0	-14.6	2.38 H	151	21.4	18.0

Remarks:

1. Emission Level(dBuV/m) = Raw Value(dBuV) + Correction Factor(dB/m)
2. Correction Factor(dB/m) = Antenna Factor(dB/m) + Cable Factor(dB) – Pre-Amplifier Factor(dB)
3. Margin value = Emission Level – Limit value
4. The other emission levels were very low against the limit.
5. " * " : Fundamental frequency, the limit was restricted at the RF Output Power.
6. " # " : The radiated frequency is out of the restricted band.

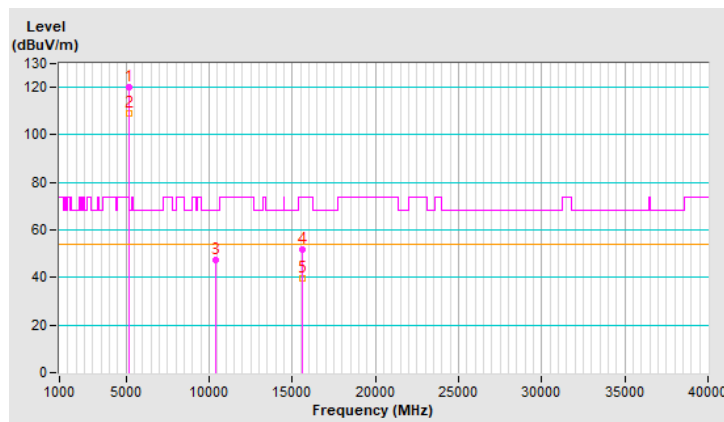

RF Mode	802.11a	Channel	CH 40 : 5200 MHz
Frequency Range	1 GHz ~ 40 GHz	Detector Function & Bandwidth	(PK) RB = 1 MHz, VB = 3 MHz (AV) RB = 1 MHz, VB = 10 Hz
Input Power	120 Vac, 60 Hz	Environmental Conditions	29°C, 75% RH
Tested By	Nick Tsou		

Antenna Polarity & Test Distance : Vertical at 3 m								
No	Frequency (MHz)	Emission Level (dBuV/m)	Limit (dBuV/m)	Margin (dB)	Antenna Height (m)	Table Angle (Degree)	Raw Value (dBuV)	Correction Factor (dB/m)
1	*5200.00	124.9 PK			1.52 V	34	120.9	4.0
2	*5200.00	116.2 AV			1.52 V	34	112.2	4.0
3	#10400.00	48.2 PK	68.2	-20.0	1.45 V	360	32.3	15.9
4	15600.00	50.5 PK	74.0	-23.5	2.54 V	355	32.5	18.0
5	15600.00	38.1 AV	54.0	-15.9	2.54 V	355	20.1	18.0

Remarks:

1. Emission Level(dBuV/m) = Raw Value(dBuV) + Correction Factor(dB/m)
2. Correction Factor(dB/m) = Antenna Factor(dB/m) + Cable Factor(dB) – Pre-Amplifier Factor(dB)
3. Margin value = Emission Level – Limit value
4. The other emission levels were very low against the limit.
5. " * " : Fundamental frequency, the limit was restricted at the RF Output Power.
6. " # " : The radiated frequency is out of the restricted band.

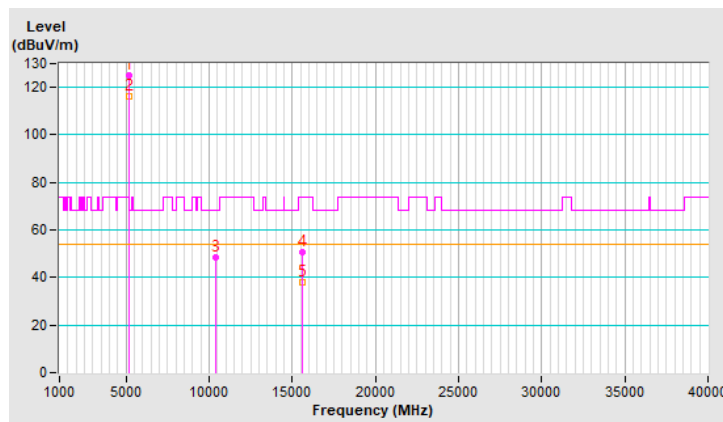

RF Mode	802.11a	Channel	CH 48 : 5240 MHz
Frequency Range	1 GHz ~ 40 GHz	Detector Function & Bandwidth	(PK) RB = 1 MHz, VB = 3 MHz (AV) RB = 1 MHz, VB = 10 Hz
Input Power	120 Vac, 60 Hz	Environmental Conditions	29°C, 75% RH
Tested By	Nick Tsou		

Antenna Polarity & Test Distance : Horizontal at 3 m								
No	Frequency (MHz)	Emission Level (dBuV/m)	Limit (dBuV/m)	Margin (dB)	Antenna Height (m)	Table Angle (Degree)	Raw Value (dBuV)	Correction Factor (dB/m)
1	*5240.00	121.2 PK			1.82 H	1	117.3	3.9
2	*5240.00	111.7 AV			1.82 H	1	107.8	3.9
3	5350.00	53.3 PK	74.0	-20.7	1.82 H	1	49.2	4.1
4	5350.00	42.7 AV	54.0	-11.3	1.82 H	1	38.6	4.1
5	#10480.00	47.6 PK	68.2	-20.6	2.15 H	344	31.7	15.9
6	15720.00	51.8 PK	74.0	-22.2	2.37 H	159	35.1	16.7
7	15720.00	39.4 AV	54.0	-14.6	2.37 H	159	22.7	16.7

Remarks:

1. Emission Level(dBuV/m) = Raw Value(dBuV) + Correction Factor(dB/m)
2. Correction Factor(dB/m) = Antenna Factor(dB/m) + Cable Factor(dB) – Pre-Amplifier Factor(dB)
3. Margin value = Emission Level – Limit value
4. The other emission levels were very low against the limit.
5. " * " : Fundamental frequency, the limit was restricted at the RF Output Power.
6. " # " : The radiated frequency is out of the restricted band.

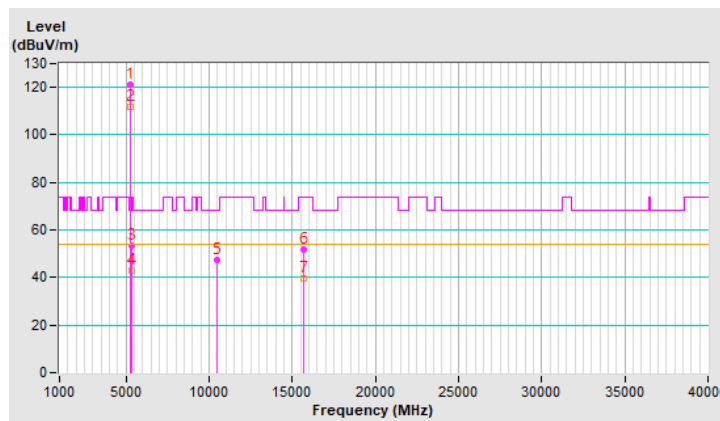

RF Mode	802.11a	Channel	CH 48 : 5240 MHz
Frequency Range	1 GHz ~ 40 GHz	Detector Function & Bandwidth	(PK) RB = 1 MHz, VB = 3 MHz (AV) RB = 1 MHz, VB = 10 Hz
Input Power	120 Vac, 60 Hz	Environmental Conditions	29°C, 75% RH
Tested By	Nick Tsou		

Antenna Polarity & Test Distance : Vertical at 3 m								
No	Frequency (MHz)	Emission Level (dBuV/m)	Limit (dBuV/m)	Margin (dB)	Antenna Height (m)	Table Angle (Degree)	Raw Value (dBuV)	Correction Factor (dB/m)
1	*5240.00	128.6 PK			1.92 V	31	124.7	3.9
2	*5240.00	118.8 AV			1.92 V	31	114.9	3.9
3	5350.00	55.9 PK	74.0	-18.1	1.92 V	31	51.8	4.1
4	5350.00	47.5 AV	54.0	-6.5	1.92 V	31	43.4	4.1
5	#10480.00	48.6 PK	68.2	-19.6	1.49 V	360	32.7	15.9
6	15720.00	50.4 PK	74.0	-23.6	2.49 V	360	33.7	16.7
7	15720.00	38.0 AV	54.0	-16.0	2.49 V	360	21.3	16.7

Remarks:

1. Emission Level(dBuV/m) = Raw Value(dBuV) + Correction Factor(dB/m)
2. Correction Factor(dB/m) = Antenna Factor(dB/m) + Cable Factor(dB) – Pre-Amplifier Factor(dB)
3. Margin value = Emission Level – Limit value
4. The other emission levels were very low against the limit.
5. " * ": Fundamental frequency, the limit was restricted at the RF Output Power.
6. " # ": The radiated frequency is out of the restricted band.

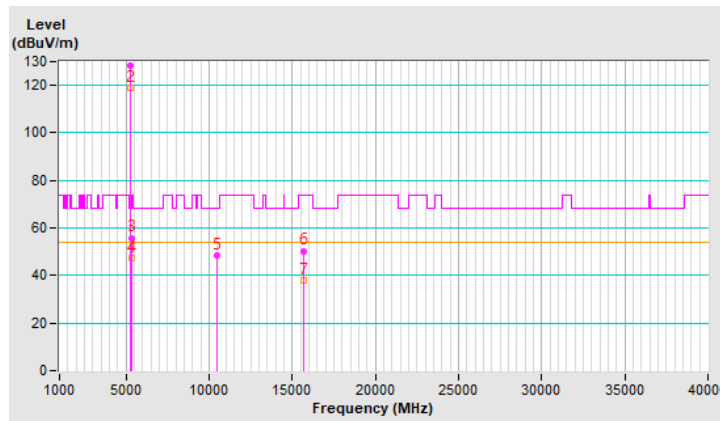

RF Mode	802.11a	Channel	CH 149 : 5745 MHz
Frequency Range	1 GHz ~ 40 GHz	Detector Function & Bandwidth	(PK) RB = 1 MHz, VB = 3 MHz (AV) RB = 1 MHz, VB = 10 Hz
Input Power	120 Vac, 60 Hz	Environmental Conditions	29°C, 75% RH
Tested By	Nick Tsou		

Antenna Polarity & Test Distance : Horizontal at 3 m								
No	Frequency (MHz)	Emission Level (dBuV/m)	Limit (dBuV/m)	Margin (dB)	Antenna Height (m)	Table Angle (Degree)	Raw Value (dBuV)	Correction Factor (dB/m)
1	#5638.00	55.6 PK	68.2	-12.6	1.30 H	358	50.9	4.7
2	*5745.00	122.2 PK			1.30 H	358	117.2	5.0
3	*5745.00	111.6 AV			1.30 H	358	106.6	5.0
4	#5950.00	52.3 PK	68.2	-15.9	1.30 H	358	46.6	5.7
5	11490.00	47.2 PK	74.0	-26.8	2.17 H	360	30.2	17.0
6	11490.00	35.0 AV	54.0	-19.0	2.17 H	360	18.0	17.0
7	#17235.00	51.9 PK	68.2	-16.3	2.36 H	154	30.6	21.3

Remarks:

1. Emission Level(dBuV/m) = Raw Value(dBuV) + Correction Factor(dB/m)
2. Correction Factor(dB/m) = Antenna Factor(dB/m) + Cable Factor(dB) – Pre-Amplifier Factor(dB)
3. Margin value = Emission Level – Limit value
4. The other emission levels were very low against the limit.
5. " * " : Fundamental frequency, the limit was restricted at the RF Output Power.
6. " # " : The radiated frequency is out of the restricted band.

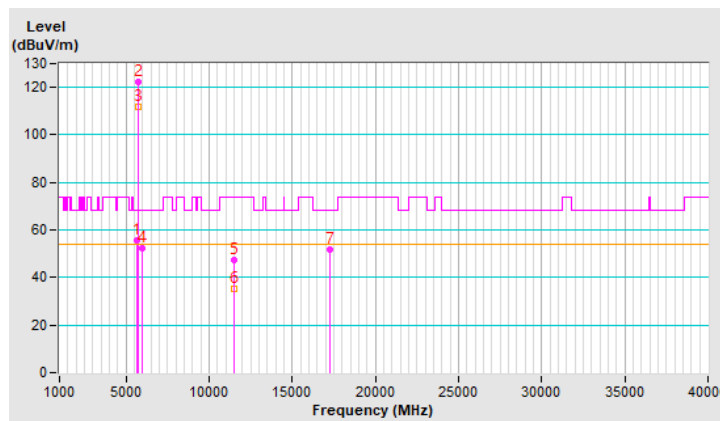

RF Mode	802.11a	Channel	CH 149 : 5745 MHz
Frequency Range	1 GHz ~ 40 GHz	Detector Function & Bandwidth	(PK) RB = 1 MHz, VB = 3 MHz (AV) RB = 1 MHz, VB = 10 Hz
Input Power	120 Vac, 60 Hz	Environmental Conditions	29°C, 75% RH
Tested By	Nick Tsou		

Antenna Polarity & Test Distance : Vertical at 3 m								
No	Frequency (MHz)	Emission Level (dBUV/m)	Limit (dBUV/m)	Margin (dB)	Antenna Height (m)	Table Angle (Degree)	Raw Value (dBUV)	Correction Factor (dB/m)
1	#5638.00	59.0 PK	68.2	-9.2	1.52 V	22	54.3	4.7
2	*5745.00	125.3 PK			1.52 V	22	120.3	5.0
3	*5745.00	115.1 AV			1.52 V	22	110.1	5.0
4	#5950.00	54.0 PK	68.2	-14.2	1.52 V	22	48.3	5.7
5	11490.00	48.1 PK	74.0	-25.9	1.49 V	360	31.1	17.0
6	11490.00	35.6 AV	54.0	-18.4	1.49 V	360	18.6	17.0
7	#17235.00	50.9 PK	68.2	-17.3	2.50 V	360	29.6	21.3

Remarks:

1. Emission Level(dBUV/m) = Raw Value(dBUV) + Correction Factor(dB/m)
2. Correction Factor(dB/m) = Antenna Factor(dB/m) + Cable Factor(dB) – Pre-Amplifier Factor(dB)
3. Margin value = Emission Level – Limit value
4. The other emission levels were very low against the limit.
5. " * " : Fundamental frequency, the limit was restricted at the RF Output Power.
6. " # " : The radiated frequency is out of the restricted band.

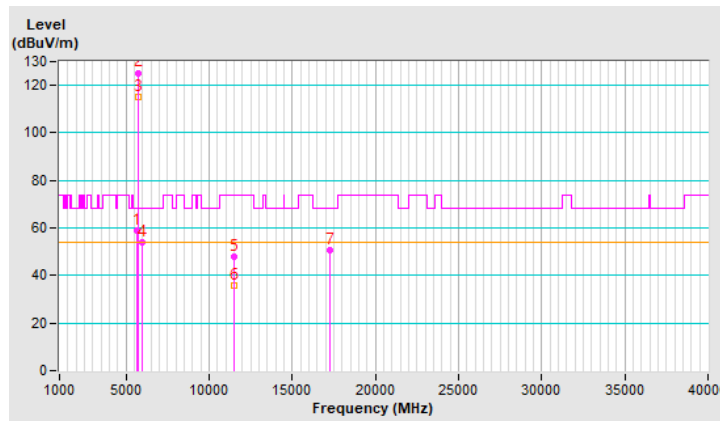

RF Mode	802.11a	Channel	CH 157 : 5785 MHz
Frequency Range	1 GHz ~ 40 GHz	Detector Function & Bandwidth	(PK) RB = 1 MHz, VB = 3 MHz (AV) RB = 1 MHz, VB = 10 Hz
Input Power	120 Vac, 60 Hz	Environmental Conditions	29°C, 75% RH
Tested By	Nick Tsou		

Antenna Polarity & Test Distance : Horizontal at 3 m								
No	Frequency (MHz)	Emission Level (dBuV/m)	Limit (dBuV/m)	Margin (dB)	Antenna Height (m)	Table Angle (Degree)	Raw Value (dBuV)	Correction Factor (dB/m)
1	#5568.74	55.1 PK	68.2	-13.1	1.22 H	333	50.6	4.5
2	*5785.00	122.0 PK			1.22 H	333	116.7	5.3
3	*5785.00	112.1 AV			1.22 H	333	106.8	5.3
4	#5947.37	53.3 PK	68.2	-14.9	1.22 H	333	47.6	5.7
5	11570.00	48.0 PK	74.0	-26.0	2.15 H	359	31.2	16.8
6	11570.00	35.8 AV	54.0	-18.2	2.15 H	359	19.0	16.8
7	#17355.00	51.6 PK	68.2	-16.6	2.39 H	141	29.2	22.4

Remarks:

1. Emission Level(dBuV/m) = Raw Value(dBuV) + Correction Factor(dB/m)
2. Correction Factor(dB/m) = Antenna Factor(dB/m) + Cable Factor(dB) – Pre-Amplifier Factor(dB)
3. Margin value = Emission Level – Limit value
4. The other emission levels were very low against the limit.
5. " * ": Fundamental frequency, the limit was restricted at the RF Output Power.
6. " # ": The radiated frequency is out of the restricted band.

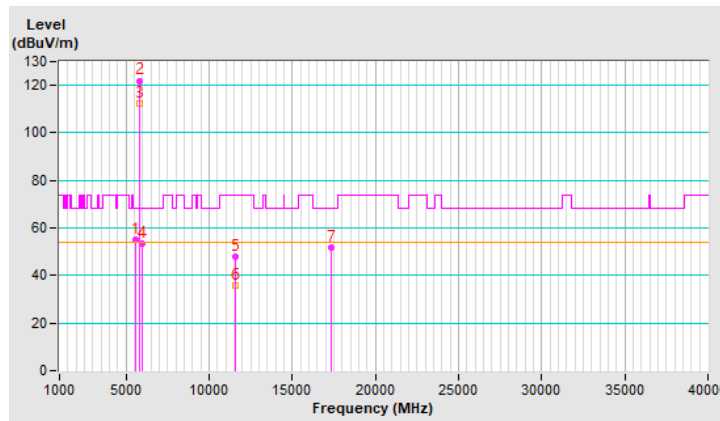

RF Mode	802.11a	Channel	CH 157 : 5785 MHz
Frequency Range	1 GHz ~ 40 GHz	Detector Function & Bandwidth	(PK) RB = 1 MHz, VB = 3 MHz (AV) RB = 1 MHz, VB = 10 Hz
Input Power	120 Vac, 60 Hz	Environmental Conditions	29°C, 75% RH
Tested By	Nick Tsou		

Antenna Polarity & Test Distance : Vertical at 3 m								
No	Frequency (MHz)	Emission Level (dBUV/m)	Limit (dBUV/m)	Margin (dB)	Antenna Height (m)	Table Angle (Degree)	Raw Value (dBUV)	Correction Factor (dB/m)
1	#5625.00	56.1 PK	68.2	-12.1	1.73 V	334	51.5	4.6
2	*5785.00	124.7 PK			1.73 V	334	119.4	5.3
3	*5785.00	114.9 AV			1.73 V	334	109.6	5.3
4	#5947.00	54.6 PK	68.2	-13.6	1.73 V	334	48.9	5.7
5	11570.00	47.4 PK	74.0	-26.6	1.54 V	360	30.6	16.8
6	11570.00	35.3 AV	54.0	-18.7	1.54 V	360	18.5	16.8
7	#17355.00	50.7 PK	68.2	-17.5	2.48 V	360	28.3	22.4

Remarks:

1. Emission Level(dBUV/m) = Raw Value(dBUV) + Correction Factor(dB/m)
2. Correction Factor(dB/m) = Antenna Factor(dB/m) + Cable Factor(dB) – Pre-Amplifier Factor(dB)
3. Margin value = Emission Level – Limit value
4. The other emission levels were very low against the limit.
5. " * ": Fundamental frequency, the limit was restricted at the RF Output Power.
6. " # ": The radiated frequency is out of the restricted band.

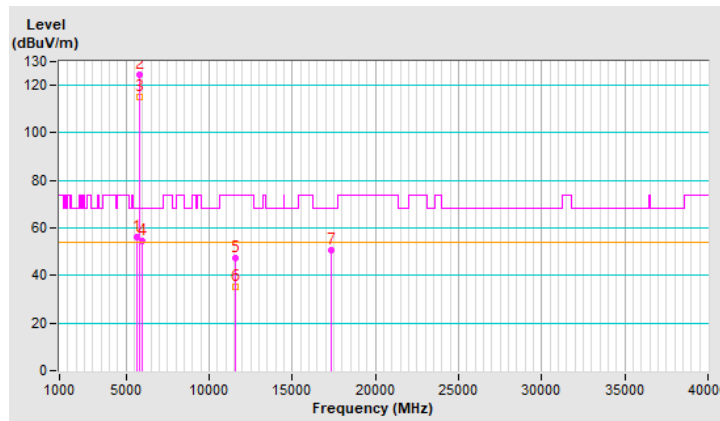

RF Mode	802.11a	Channel	CH 165 : 5825 MHz
Frequency Range	1 GHz ~ 40 GHz	Detector Function & Bandwidth	(PK) RB = 1 MHz, VB = 3 MHz (AV) RB = 1 MHz, VB = 10 Hz
Input Power	120 Vac, 60 Hz	Environmental Conditions	29°C, 75% RH
Tested By	Nick Tsou		

Antenna Polarity & Test Distance : Horizontal at 3 m								
No	Frequency (MHz)	Emission Level (dBUV/m)	Limit (dBUV/m)	Margin (dB)	Antenna Height (m)	Table Angle (Degree)	Raw Value (dBUV)	Correction Factor (dB/m)
1	#5645.96	56.2 PK	68.2	-12.0	1.43 H	332	51.5	4.7
2	*5825.00	122.3 PK			1.43 H	332	116.9	5.4
3	*5825.00	112.4 AV			1.43 H	332	107.0	5.4
4	#5927.39	54.0 PK	68.2	-14.2	1.43 H	332	48.4	5.6
5	11650.00	48.0 PK	74.0	-26.0	2.14 H	346	31.3	16.7
6	11650.00	35.5 AV	54.0	-18.5	2.14 H	346	18.8	16.7
7	#17475.00	51.5 PK	68.2	-16.7	2.31 H	135	27.7	23.8

Remarks:

1. Emission Level(dBUV/m) = Raw Value(dBUV) + Correction Factor(dB/m)
2. Correction Factor(dB/m) = Antenna Factor(dB/m) + Cable Factor(dB) – Pre-Amplifier Factor(dB)
3. Margin value = Emission Level – Limit value
4. The other emission levels were very low against the limit.
5. " * ": Fundamental frequency, the limit was restricted at the RF Output Power.
6. " # ": The radiated frequency is out of the restricted band.

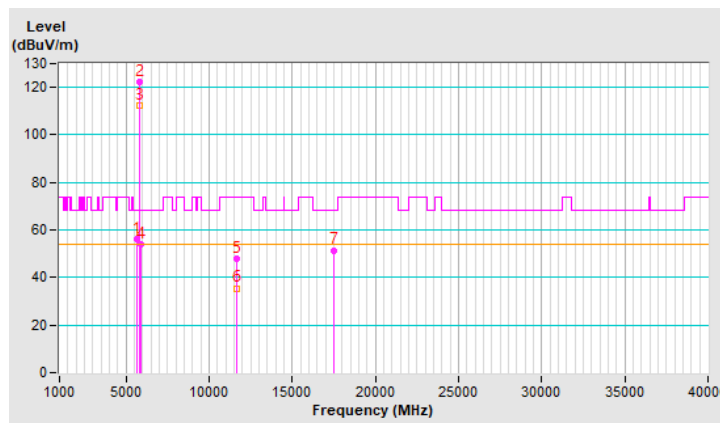

RF Mode	802.11a	Channel	CH 165 : 5825 MHz
Frequency Range	1 GHz ~ 40 GHz	Detector Function & Bandwidth	(PK) RB = 1 MHz, VB = 3 MHz (AV) RB = 1 MHz, VB = 10 Hz
Input Power	120 Vac, 60 Hz	Environmental Conditions	29°C, 75% RH
Tested By	Nick Tsou		

Antenna Polarity & Test Distance : Vertical at 3 m

No	Frequency (MHz)	Emission Level (dBUV/m)	Limit (dBUV/m)	Margin (dB)	Antenna Height (m)	Table Angle (Degree)	Raw Value (dBUV)	Correction Factor (dB/m)
1	#5637.00	57.3 PK	68.2	-10.9	1.43 V	20	52.6	4.7
2	*5825.00	124.9 PK			1.43 V	20	119.5	5.4
3	*5825.00	114.5 AV			1.43 V	20	109.1	5.4
4	#5937.00	54.7 PK	68.2	-13.5	1.43 V	20	49.1	5.6
5	11650.00	47.8 PK	74.0	-26.2	1.55 V	360	31.1	16.7
6	11650.00	35.4 AV	54.0	-18.6	1.55 V	360	18.7	16.7
7	#17475.00	51.1 PK	68.2	-17.1	2.52 V	360	27.3	23.8

Remarks:

1. Emission Level(dBUV/m) = Raw Value(dBUV) + Correction Factor(dB/m)
2. Correction Factor(dB/m) = Antenna Factor(dB/m) + Cable Factor(dB) – Pre-Amplifier Factor(dB)
3. Margin value = Emission Level – Limit value
4. The other emission levels were very low against the limit.
5. " * ": Fundamental frequency, the limit was restricted at the RF Output Power.
6. " # ": The radiated frequency is out of the restricted band.

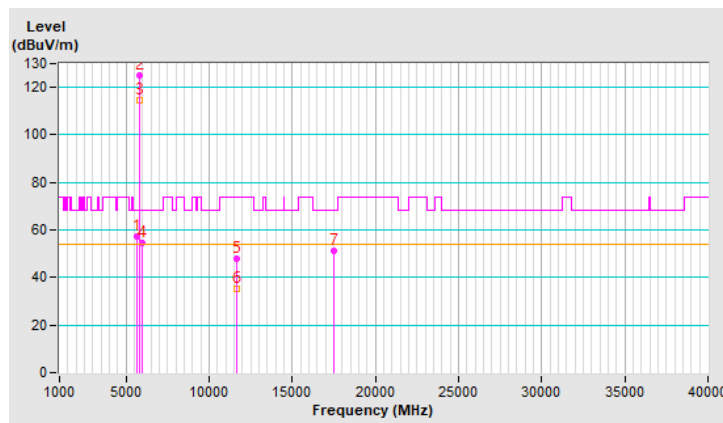

RF Mode	802.11ax (HE20)	Channel	CH 36 : 5180 MHz
Frequency Range	1 GHz ~ 40 GHz	Detector Function & Bandwidth	(PK) RB = 1 MHz, VB = 3 MHz (AV) RB = 1 MHz, VB = 10 Hz
Input Power	120 Vac, 60 Hz	Environmental Conditions	21°C, 71% RH
Tested By	Nick Tsou		

Antenna Polarity & Test Distance : Horizontal at 3 m								
No	Frequency (MHz)	Emission Level (dBuV/m)	Limit (dBuV/m)	Margin (dB)	Antenna Height (m)	Table Angle (Degree)	Raw Value (dBuV)	Correction Factor (dB/m)
1	5150.00	67.9 PK	74.0	-6.1	1.37 H	5	61.8	6.1
2	5150.00	50.6 AV	54.0	-3.4	1.37 H	5	44.5	6.1
3	*5180.00	117.4 PK			1.37 H	5	111.4	6.0
4	*5180.00	108.3 AV			1.37 H	5	102.3	6.0
5	#10360.00	47.8 PK	68.2	-20.4	2.15 H	345	30.3	17.5
6	15540.00	51.9 PK	74.0	-22.1	2.30 H	138	32.2	19.7
7	15540.00	39.5 AV	54.0	-14.5	2.30 H	138	19.8	19.7

Remarks:

1. Emission Level(dBuV/m) = Raw Value(dBuV) + Correction Factor(dB/m)
2. Correction Factor(dB/m) = Antenna Factor(dB/m) + Cable Factor(dB) – Pre-Amplifier Factor(dB)
3. Margin value = Emission Level – Limit value
4. The other emission levels were very low against the limit.
5. " * ": Fundamental frequency, the limit was restricted at the RF Output Power.
6. " # ": The radiated frequency is out of the restricted band.

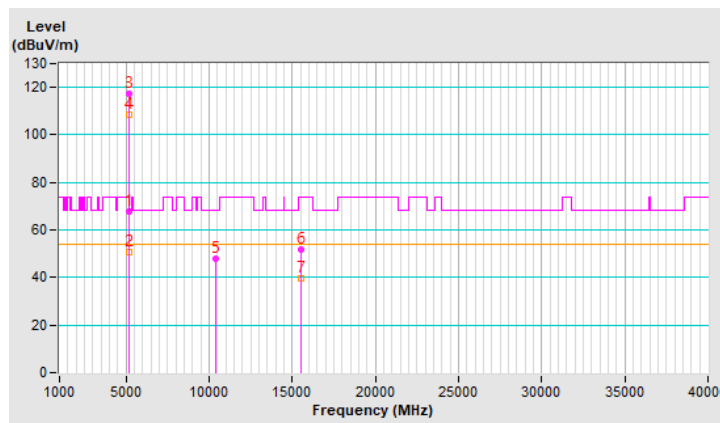

RF Mode	802.11ax (HE20)	Channel	CH 36 : 5180 MHz
Frequency Range	1 GHz ~ 40 GHz	Detector Function & Bandwidth	(PK) RB = 1 MHz, VB = 3 MHz (AV) RB = 1 MHz, VB = 10 Hz
Input Power	120 Vac, 60 Hz	Environmental Conditions	21°C, 71% RH
Tested By	Nick Tsou		

Antenna Polarity & Test Distance : Vertical at 3 m

No	Frequency (MHz)	Emission Level (dBuV/m)	Limit (dBuV/m)	Margin (dB)	Antenna Height (m)	Table Angle (Degree)	Raw Value (dBuV)	Correction Factor (dB/m)
1	5150.00	70.2 PK	74.0	-3.8	1.91 V	23	64.1	6.1
2	5150.00	53.4 AV	54.0	-0.6	1.91 V	23	47.3	6.1
3	*5180.00	119.9 PK			1.91 V	23	113.9	6.0
4	*5180.00	111.3 AV			1.91 V	23	105.3	6.0
5	#10360.00	48.5 PK	68.2	-19.7	1.48 V	360	31.0	17.5
6	15540.00	51.2 PK	74.0	-22.8	2.44 V	360	31.5	19.7
7	15540.00	38.6 AV	54.0	-15.4	2.44 V	360	18.9	19.7

Remarks:

1. Emission Level(dBuV/m) = Raw Value(dBuV) + Correction Factor(dB/m)
2. Correction Factor(dB/m) = Antenna Factor(dB/m) + Cable Factor(dB) – Pre-Amplifier Factor(dB)
3. Margin value = Emission Level – Limit value
4. The other emission levels were very low against the limit.
5. " * ": Fundamental frequency, the limit was restricted at the RF Output Power.
6. " # ": The radiated frequency is out of the restricted band.

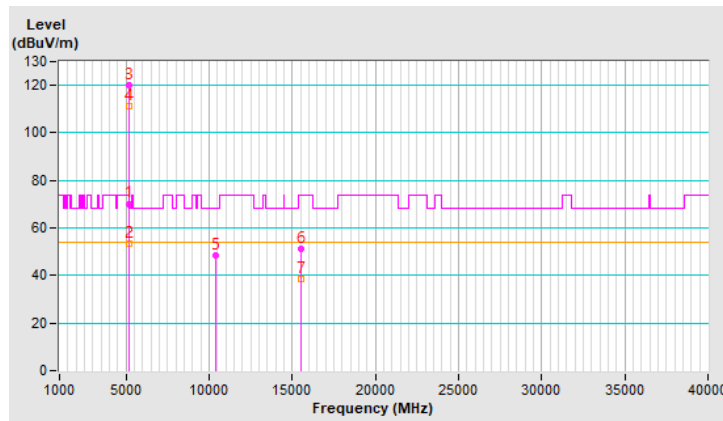

RF Mode	802.11ax (HE20)	Channel	CH 40 : 5200 MHz
Frequency Range	1 GHz ~ 40 GHz	Detector Function & Bandwidth	(PK) RB = 1 MHz, VB = 3 MHz (AV) RB = 1 MHz, VB = 10 Hz
Input Power	120 Vac, 60 Hz	Environmental Conditions	21°C, 71% RH
Tested By	Nick Tsou		

Antenna Polarity & Test Distance : Horizontal at 3 m								
No	Frequency (MHz)	Emission Level (dBuV/m)	Limit (dBuV/m)	Margin (dB)	Antenna Height (m)	Table Angle (Degree)	Raw Value (dBuV)	Correction Factor (dB/m)
1	*5200.00	122.8 PK			1.23 H	10	116.8	6.0
2	*5200.00	112.7 AV			1.23 H	10	106.7	6.0
3	#10400.00	47.4 PK	68.2	-20.8	2.13 H	350	29.7	17.7
4	15600.00	51.6 PK	74.0	-22.4	2.36 H	156	31.8	19.8
5	15600.00	39.2 AV	54.0	-14.8	2.36 H	156	19.4	19.8

Remarks:

1. Emission Level(dBuV/m) = Raw Value(dBuV) + Correction Factor(dB/m)
2. Correction Factor(dB/m) = Antenna Factor(dB/m) + Cable Factor(dB) – Pre-Amplifier Factor(dB)
3. Margin value = Emission Level – Limit value
4. The other emission levels were very low against the limit.
5. " * " : Fundamental frequency, the limit was restricted at the RF Output Power.
6. " # " : The radiated frequency is out of the restricted band.

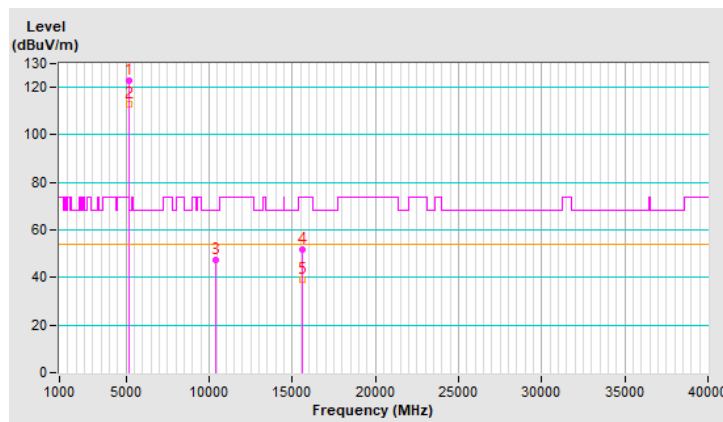

RF Mode	802.11ax (HE20)	Channel	CH 40 : 5200 MHz
Frequency Range	1 GHz ~ 40 GHz	Detector Function & Bandwidth	(PK) RB = 1 MHz, VB = 3 MHz (AV) RB = 1 MHz, VB = 10 Hz
Input Power	120 Vac, 60 Hz	Environmental Conditions	21°C, 71% RH
Tested By	Nick Tsou		

Antenna Polarity & Test Distance : Vertical at 3 m								
No	Frequency (MHz)	Emission Level (dBuV/m)	Limit (dBuV/m)	Margin (dB)	Antenna Height (m)	Table Angle (Degree)	Raw Value (dBuV)	Correction Factor (dB/m)
1	*5200.00	122.5 PK			2.44 V	32	116.5	6.0
2	*5200.00	114.6 AV			2.44 V	32	108.6	6.0
3	#10400.00	48.2 PK	68.2	-20.0	1.54 V	360	30.5	17.7
4	15600.00	50.8 PK	74.0	-23.2	2.55 V	360	31.0	19.8
5	15600.00	38.5 AV	54.0	-15.5	2.55 V	360	18.7	19.8

Remarks:

1. Emission Level(dBuV/m) = Raw Value(dBuV) + Correction Factor(dB/m)
2. Correction Factor(dB/m) = Antenna Factor(dB/m) + Cable Factor(dB) – Pre-Amplifier Factor(dB)
3. Margin value = Emission Level – Limit value
4. The other emission levels were very low against the limit.
5. " * " : Fundamental frequency, the limit was restricted at the RF Output Power.
6. " # " : The radiated frequency is out of the restricted band.

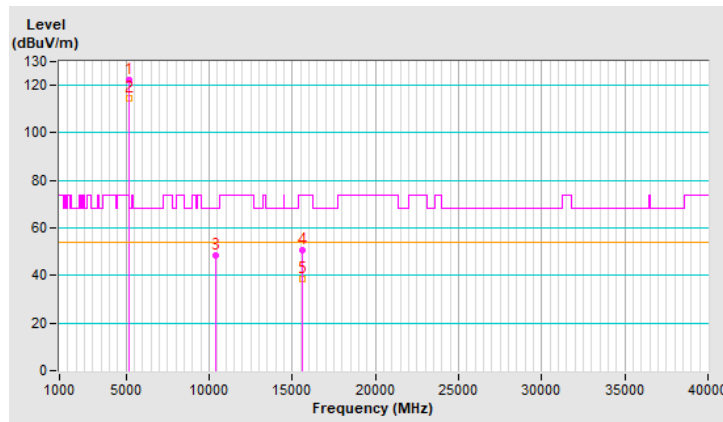

RF Mode	802.11ax (HE20)	Channel	CH 48 : 5240 MHz
Frequency Range	1 GHz ~ 40 GHz	Detector Function & Bandwidth	(PK) RB = 1 MHz, VB = 3 MHz (AV) RB = 1 MHz, VB = 10 Hz
Input Power	120 Vac, 60 Hz	Environmental Conditions	21°C, 71% RH
Tested By	Nick Tsou		

Antenna Polarity & Test Distance : Horizontal at 3 m								
No	Frequency (MHz)	Emission Level (dBuV/m)	Limit (dBuV/m)	Margin (dB)	Antenna Height (m)	Table Angle (Degree)	Raw Value (dBuV)	Correction Factor (dB/m)
1	*5240.00	121.1 PK			1.35 H	20	115.3	5.8
2	*5240.00	110.3 AV			1.35 H	20	104.5	5.8
3	5350.00	54.9 PK	74.0	-19.1	1.00 H	0	49.0	5.9
4	5350.00	44.7 AV	54.0	-9.3	1.00 H	0	38.8	5.9
5	#10480.00	47.9 PK	68.2	-20.3	2.15 H	347	30.1	17.8
6	15720.00	52.0 PK	74.0	-22.0	2.28 H	156	33.4	18.6
7	15720.00	39.9 AV	54.0	-14.1	2.28 H	156	21.3	18.6

Remarks:

1. Emission Level(dBuV/m) = Raw Value(dBuV) + Correction Factor(dB/m)
2. Correction Factor(dB/m) = Antenna Factor(dB/m) + Cable Factor(dB) – Pre-Amplifier Factor(dB)
3. Margin value = Emission Level – Limit value
4. The other emission levels were very low against the limit.
5. " * " : Fundamental frequency, the limit was restricted at the RF Output Power.
6. " # " : The radiated frequency is out of the restricted band.

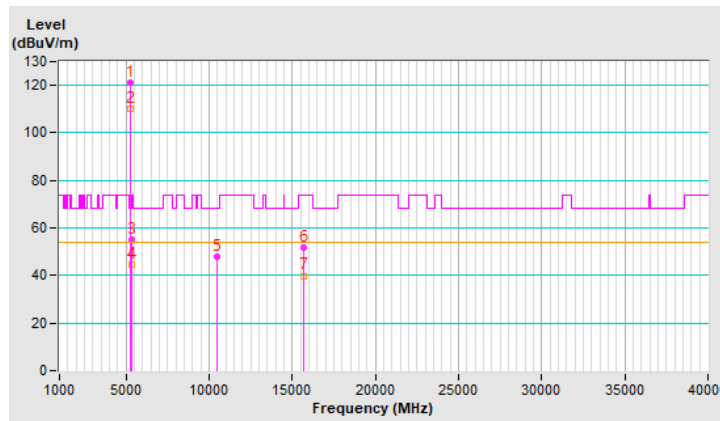

RF Mode	802.11ax (HE20)	Channel	CH 48 : 5240 MHz
Frequency Range	1 GHz ~ 40 GHz	Detector Function & Bandwidth	(PK) RB = 1 MHz, VB = 3 MHz (AV) RB = 1 MHz, VB = 10 Hz
Input Power	120 Vac, 60 Hz	Environmental Conditions	21°C, 71% RH
Tested By	Nick Tsou		

Antenna Polarity & Test Distance : Vertical at 3 m								
No	Frequency (MHz)	Emission Level (dBuV/m)	Limit (dBuV/m)	Margin (dB)	Antenna Height (m)	Table Angle (Degree)	Raw Value (dBuV)	Correction Factor (dB/m)
1	*5240.00	123.5 PK			1.60 V	20	117.7	5.8
2	*5240.00	115.2 AV			1.60 V	20	109.4	5.8
3	5350.00	55.3 PK	74.0	-18.7	1.60 V	20	49.4	5.9
4	5350.00	46.8 AV	54.0	-7.2	1.60 V	20	40.9	5.9
5	#10480.00	47.7 PK	68.2	-20.5	1.45 V	360	29.9	17.8
6	15720.00	50.6 PK	74.0	-23.4	2.52 V	360	32.0	18.6
7	15720.00	38.3 AV	54.0	-15.7	2.52 V	360	19.7	18.6

Remarks:

1. Emission Level(dBuV/m) = Raw Value(dBuV) + Correction Factor(dB/m)
2. Correction Factor(dB/m) = Antenna Factor(dB/m) + Cable Factor(dB) – Pre-Amplifier Factor(dB)
3. Margin value = Emission Level – Limit value
4. The other emission levels were very low against the limit.
5. " * ": Fundamental frequency, the limit was restricted at the RF Output Power.
6. " # ": The radiated frequency is out of the restricted band.

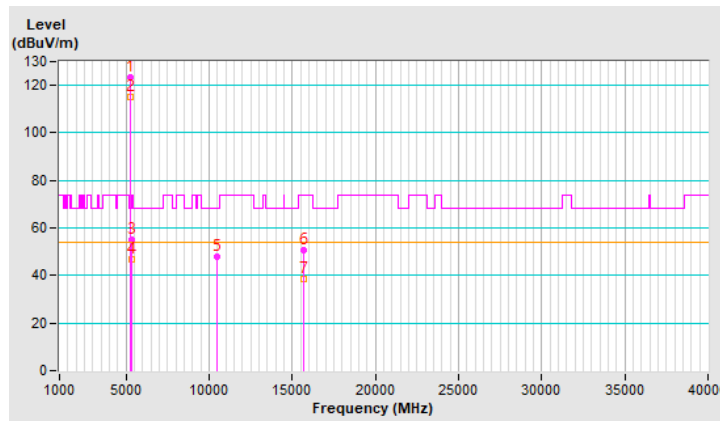

RF Mode	802.11ax (HE20)	Channel	CH 149 : 5745 MHz
Frequency Range	1 GHz ~ 40 GHz	Detector Function & Bandwidth	(PK) RB = 1 MHz, VB = 3 MHz (AV) RB = 1 MHz, VB = 10 Hz
Input Power	120 Vac, 60 Hz	Environmental Conditions	21°C, 71% RH
Tested By	Nick Tsou		

Antenna Polarity & Test Distance : Horizontal at 3 m								
No	Frequency (MHz)	Emission Level (dBUV/m)	Limit (dBUV/m)	Margin (dB)	Antenna Height (m)	Table Angle (Degree)	Raw Value (dBUV)	Correction Factor (dB/m)
1	#5615.00	57.7 PK	68.2	-10.5	1.45 H	5	51.1	6.6
2	*5745.00	124.7 PK			1.45 H	5	118.0	6.7
3	*5745.00	112.3 AV			1.45 H	5	105.6	6.7
4	#5927.00	52.8 PK	68.2	-15.4	1.45 H	5	45.5	7.3
5	11490.00	47.1 PK	74.0	-26.9	1.50 H	0	28.1	19.0
6	11490.00	35.5 AV	54.0	-18.5	1.50 H	0	16.5	19.0
7	#17235.00	51.5 PK	68.2	-16.7	2.50 H	360	28.9	22.6

Remarks:

1. Emission Level(dBUV/m) = Raw Value(dBUV) + Correction Factor(dB/m)
2. Correction Factor(dB/m) = Antenna Factor(dB/m) + Cable Factor(dB) – Pre-Amplifier Factor(dB)
3. Margin value = Emission Level – Limit value
4. The other emission levels were very low against the limit.
5. " * " : Fundamental frequency, the limit was restricted at the RF Output Power.
6. " # " : The radiated frequency is out of the restricted band.

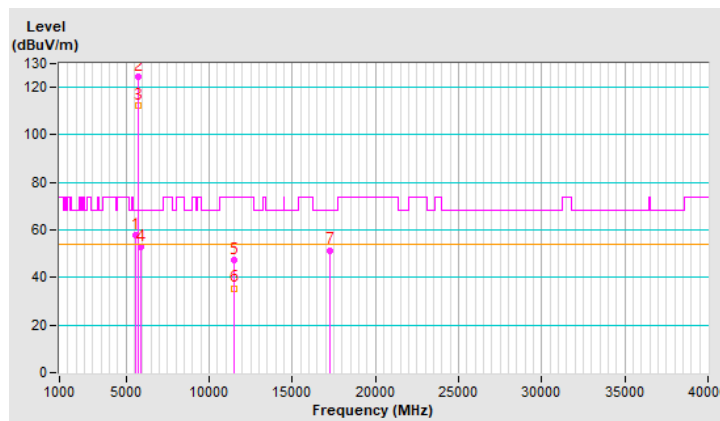

RF Mode	802.11ax (HE20)	Channel	CH 149 : 5745 MHz
Frequency Range	1 GHz ~ 40 GHz	Detector Function & Bandwidth	(PK) RB = 1 MHz, VB = 3 MHz (AV) RB = 1 MHz, VB = 10 Hz
Input Power	120 Vac, 60 Hz	Environmental Conditions	21°C, 71% RH
Tested By	Nick Tsou		

Antenna Polarity & Test Distance : Vertical at 3 m

No	Frequency (MHz)	Emission Level (dBuV/m)	Limit (dBuV/m)	Margin (dB)	Antenna Height (m)	Table Angle (Degree)	Raw Value (dBuV)	Correction Factor (dB/m)
1	#5615.00	57.5 PK	68.2	-10.7	2.04 V	20	50.9	6.6
2	*5745.00	127.4 PK			2.04 V	20	120.7	6.7
3	*5745.00	114.3 AV			2.04 V	20	107.6	6.7
4	#5927.00	54.9 PK	68.2	-13.3	2.04 V	20	47.6	7.3
5	11490.00	47.8 PK	74.0	-26.2	1.50 V	360	28.8	19.0
6	11490.00	35.5 AV	54.0	-18.5	1.50 V	360	16.5	19.0
7	#17235.00	51.4 PK	68.2	-16.8	2.50 V	360	28.8	22.6

Remarks:

1. Emission Level(dBuV/m) = Raw Value(dBuV) + Correction Factor(dB/m)
2. Correction Factor(dB/m) = Antenna Factor(dB/m) + Cable Factor(dB) – Pre-Amplifier Factor(dB)
3. Margin value = Emission Level – Limit value
4. The other emission levels were very low against the limit.
5. " * ": Fundamental frequency, the limit was restricted at the RF Output Power.
6. " # ": The radiated frequency is out of the restricted band.

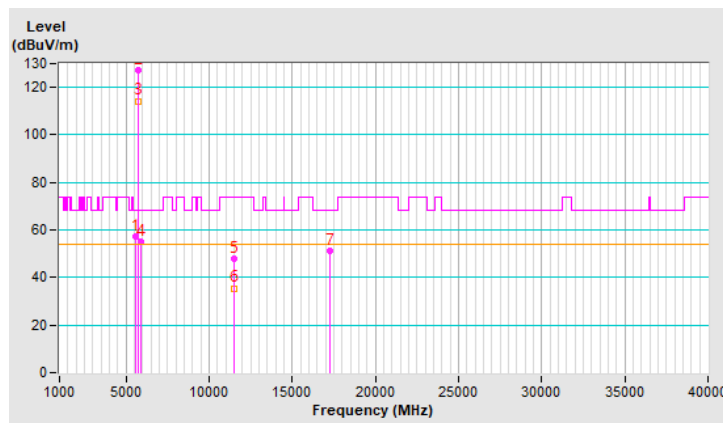

RF Mode	802.11ax (HE20)	Channel	CH 157 : 5785 MHz
Frequency Range	1 GHz ~ 40 GHz	Detector Function & Bandwidth	(PK) RB = 1 MHz, VB = 3 MHz (AV) RB = 1 MHz, VB = 10 Hz
Input Power	120 Vac, 60 Hz	Environmental Conditions	21°C, 71% RH
Tested By	Nick Tsou		

Antenna Polarity & Test Distance : Horizontal at 3 m								
No	Frequency (MHz)	Emission Level (dBUV/m)	Limit (dBUV/m)	Margin (dB)	Antenna Height (m)	Table Angle (Degree)	Raw Value (dBUV)	Correction Factor (dB/m)
1	#5646.00	55.7 PK	68.2	-12.5	1.45 H	29	49.1	6.6
2	*5785.00	120.8 PK			1.45 H	29	113.9	6.9
3	*5785.00	111.2 AV			1.45 H	29	104.3	6.9
4	#5925.00	54.7 PK	68.2	-13.5	1.45 H	29	47.4	7.3
5	11570.00	47.8 PK	74.0	-26.2	2.11 H	355	29.1	18.7
6	11570.00	35.4 AV	54.0	-18.6	2.11 H	355	16.7	18.7
7	#17355.00	51.8 PK	68.2	-16.4	2.33 H	148	28.4	23.4

Remarks:

1. Emission Level(dBUV/m) = Raw Value(dBUV) + Correction Factor(dB/m)
2. Correction Factor(dB/m) = Antenna Factor(dB/m) + Cable Factor(dB) – Pre-Amplifier Factor(dB)
3. Margin value = Emission Level – Limit value
4. The other emission levels were very low against the limit.
5. " * ": Fundamental frequency, the limit was restricted at the RF Output Power.
6. " # ": The radiated frequency is out of the restricted band.

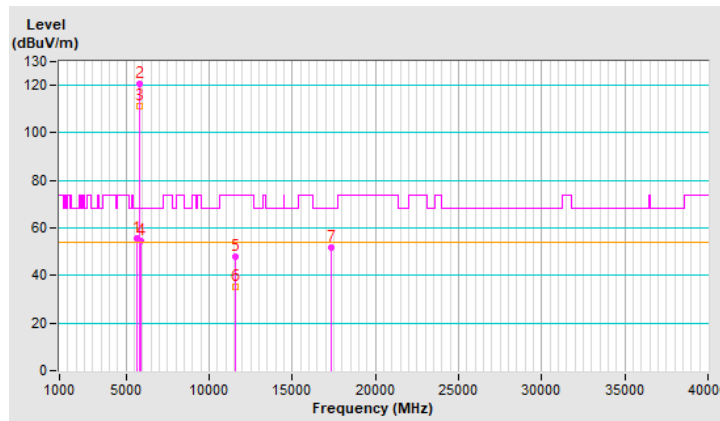

RF Mode	802.11ax (HE20)	Channel	CH 157 : 5785 MHz
Frequency Range	1 GHz ~ 40 GHz	Detector Function & Bandwidth	(PK) RB = 1 MHz, VB = 3 MHz (AV) RB = 1 MHz, VB = 10 Hz
Input Power	120 Vac, 60 Hz	Environmental Conditions	21°C, 71% RH
Tested By	Nick Tsou		

Antenna Polarity & Test Distance : Vertical at 3 m								
No	Frequency (MHz)	Emission Level (dBUV/m)	Limit (dBUV/m)	Margin (dB)	Antenna Height (m)	Table Angle (Degree)	Raw Value (dBUV)	Correction Factor (dB/m)
1	#5646.00	56.1 PK	68.2	-12.1	2.05 V	22	49.5	6.6
2	*5785.00	123.5 PK			2.05 V	22	116.6	6.9
3	*5785.00	114.3 AV			2.05 V	22	107.4	6.9
4	#5925.00	54.7 PK	68.2	-13.5	2.05 V	22	47.4	7.3
5	11570.00	47.6 PK	74.0	-26.4	1.49 V	360	28.9	18.7
6	11570.00	35.2 AV	54.0	-18.8	1.49 V	360	16.5	18.7
7	#17355.00	51.0 PK	68.2	-17.2	2.45 V	360	27.6	23.4

Remarks:

1. Emission Level(dBUV/m) = Raw Value(dBuV) + Correction Factor(dB/m)
2. Correction Factor(dB/m) = Antenna Factor(dB/m) + Cable Factor(dB) – Pre-Amplifier Factor(dB)
3. Margin value = Emission Level – Limit value
4. The other emission levels were very low against the limit.
5. " * " : Fundamental frequency, the limit was restricted at the RF Output Power.
6. " # " : The radiated frequency is out of the restricted band.

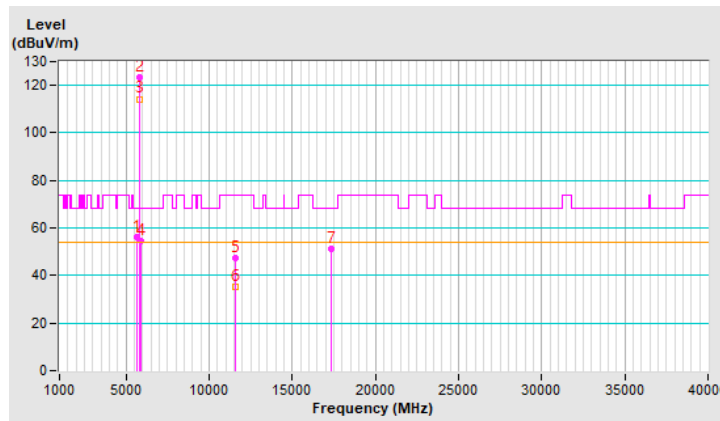

RF Mode	802.11ax (HE20)	Channel	CH 165 : 5825 MHz
Frequency Range	1 GHz ~ 40 GHz	Detector Function & Bandwidth	(PK) RB = 1 MHz, VB = 3 MHz (AV) RB = 1 MHz, VB = 10 Hz
Input Power	120 Vac, 60 Hz	Environmental Conditions	21°C, 71% RH
Tested By	Nick Tsou		

Antenna Polarity & Test Distance : Horizontal at 3 m								
No	Frequency (MHz)	Emission Level (dBUV/m)	Limit (dBUV/m)	Margin (dB)	Antenna Height (m)	Table Angle (Degree)	Raw Value (dBUV)	Correction Factor (dB/m)
1	#5627.69	55.4 PK	68.2	-12.8	1.44 H	4	48.8	6.6
2	*5825.00	121.6 PK			1.44 H	4	114.6	7.0
3	*5825.00	111.9 AV			1.44 H	4	104.9	7.0
4	#5940.71	56.4 PK	68.2	-11.8	1.44 H	4	49.1	7.3
5	11650.00	47.6 PK	74.0	-26.4	2.11 H	349	29.2	18.4
6	11650.00	35.0 AV	54.0	-19.0	2.11 H	349	16.6	18.4
7	#17475.00	52.3 PK	68.2	-15.9	2.28 H	132	27.3	25.0

Remarks:

1. Emission Level(dBUV/m) = Raw Value(dBUV) + Correction Factor(dB/m)
2. Correction Factor(dB/m) = Antenna Factor(dB/m) + Cable Factor(dB) – Pre-Amplifier Factor(dB)
3. Margin value = Emission Level – Limit value
4. The other emission levels were very low against the limit.
5. " * ": Fundamental frequency, the limit was restricted at the RF Output Power.
6. " # ": The radiated frequency is out of the restricted band.

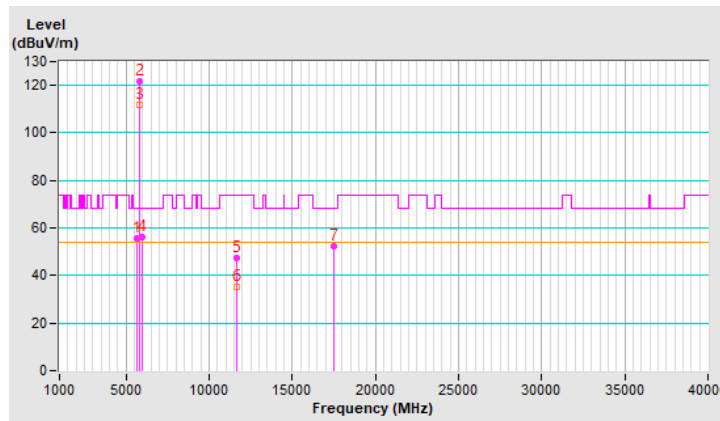

RF Mode	802.11ax (HE20)	Channel	CH 165 : 5825 MHz
Frequency Range	1 GHz ~ 40 GHz	Detector Function & Bandwidth	(PK) RB = 1 MHz, VB = 3 MHz (AV) RB = 1 MHz, VB = 10 Hz
Input Power	120 Vac, 60 Hz	Environmental Conditions	21°C, 71% RH
Tested By	Nick Tsou		

Antenna Polarity & Test Distance : Vertical at 3 m

No	Frequency (MHz)	Emission Level (dBUV/m)	Limit (dBUV/m)	Margin (dB)	Antenna Height (m)	Table Angle (Degree)	Raw Value (dBUV)	Correction Factor (dB/m)
1	#5627.69	56.7 PK	68.2	-11.5	1.41 V	325	50.1	6.6
2	*5825.00	125.8 PK			1.41 V	325	118.8	7.0
3	*5825.00	114.2 AV			1.41 V	325	107.2	7.0
4	#5940.71	56.6 PK	68.2	-11.6	1.41 V	325	49.3	7.3
5	11650.00	47.7 PK	74.0	-26.3	1.46 V	360	29.3	18.4
6	11650.00	35.6 AV	54.0	-18.4	1.46 V	360	17.2	18.4
7	#17475.00	51.4 PK	68.2	-16.8	2.53 V	360	26.4	25.0

Remarks:

1. Emission Level(dBUV/m) = Raw Value(dBUV) + Correction Factor(dB/m)
2. Correction Factor(dB/m) = Antenna Factor(dB/m) + Cable Factor(dB) – Pre-Amplifier Factor(dB)
3. Margin value = Emission Level – Limit value
4. The other emission levels were very low against the limit.
5. " * ": Fundamental frequency, the limit was restricted at the RF Output Power.
6. " # ": The radiated frequency is out of the restricted band.

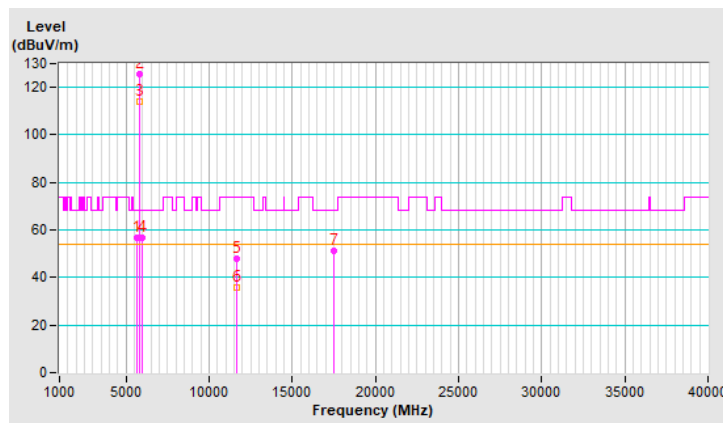

RF Mode	802.11ax (HE40)	Channel	CH 38 : 5190 MHz
Frequency Range	1 GHz ~ 40 GHz	Detector Function & Bandwidth	(PK) RB = 1 MHz, VB = 3 MHz (AV) RB = 1 MHz, VB = 10 Hz
Input Power	120 Vac, 60 Hz	Environmental Conditions	21°C, 71% RH
Tested By	Nick Tsou		

Antenna Polarity & Test Distance : Horizontal at 3 m								
No	Frequency (MHz)	Emission Level (dBUV/m)	Limit (dBUV/m)	Margin (dB)	Antenna Height (m)	Table Angle (Degree)	Raw Value (dBUV)	Correction Factor (dB/m)
1	5150.00	60.0 PK	74.0	-14.0	1.39 H	16	53.9	6.1
2	5150.00	49.8 AV	54.0	-4.2	1.39 H	16	43.7	6.1
3	*5190.00	111.2 PK			1.39 H	16	105.2	6.0
4	*5190.00	100.4 AV			1.39 H	16	94.4	6.0
5	#10380.00	47.7 PK	68.2	-20.5	2.15 H	326	30.2	17.5
6	15570.00	51.8 PK	74.0	-22.2	2.29 H	156	32.0	19.8
7	15570.00	39.7 AV	54.0	-14.3	2.29 H	156	19.9	19.8

Remarks:

1. Emission Level(dBUV/m) = Raw Value(dBUV) + Correction Factor(dB/m)
2. Correction Factor(dB/m) = Antenna Factor(dB/m) + Cable Factor(dB) – Pre-Amplifier Factor(dB)
3. Margin value = Emission Level – Limit value
4. The other emission levels were very low against the limit.
5. " * ": Fundamental frequency, the limit was restricted at the RF Output Power.
6. " # ": The radiated frequency is out of the restricted band.

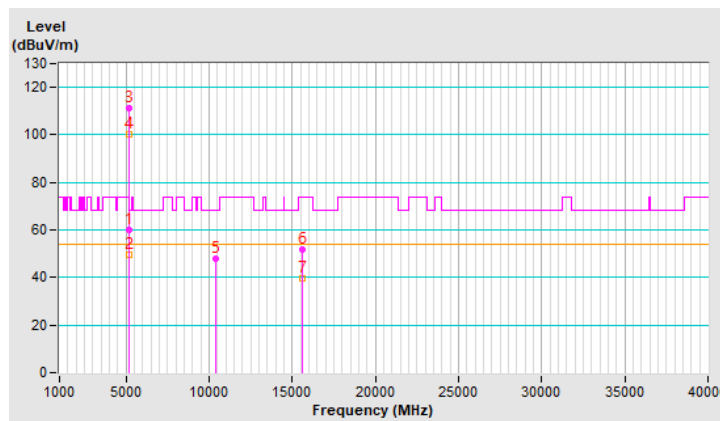

RF Mode	802.11ax (HE40)	Channel	CH 38 : 5190 MHz
Frequency Range	1 GHz ~ 40 GHz	Detector Function & Bandwidth	(PK) RB = 1 MHz, VB = 3 MHz (AV) RB = 1 MHz, VB = 10 Hz
Input Power	120 Vac, 60 Hz	Environmental Conditions	21°C, 71% RH
Tested By	Nick Tsou		

Antenna Polarity & Test Distance : Vertical at 3 m

No	Frequency (MHz)	Emission Level (dBUV/m)	Limit (dBUV/m)	Margin (dB)	Antenna Height (m)	Table Angle (Degree)	Raw Value (dBUV)	Correction Factor (dB/m)
1	5150.00	66.0 PK	74.0	-8.0	1.38 V	198	59.9	6.1
2	5150.00	53.8 AV	54.0	-0.2	1.38 V	198	47.7	6.1
3	*5190.00	114.9 PK			1.38 V	198	108.9	6.0
4	*5190.00	106.2 AV			1.38 V	198	100.2	6.0
5	#10380.00	48.3 PK	68.2	-19.9	1.46 V	360	30.8	17.5
6	15570.00	51.2 PK	74.0	-22.8	2.53 V	360	31.4	19.8
7	15570.00	38.5 AV	54.0	-15.5	2.53 V	360	18.7	19.8

Remarks:

1. Emission Level(dBUV/m) = Raw Value(dBUV) + Correction Factor(dB/m)
2. Correction Factor(dB/m) = Antenna Factor(dB/m) + Cable Factor(dB) – Pre-Amplifier Factor(dB)
3. Margin value = Emission Level – Limit value
4. The other emission levels were very low against the limit.
5. " * ": Fundamental frequency, the limit was restricted at the RF Output Power.
6. " # ": The radiated frequency is out of the restricted band.

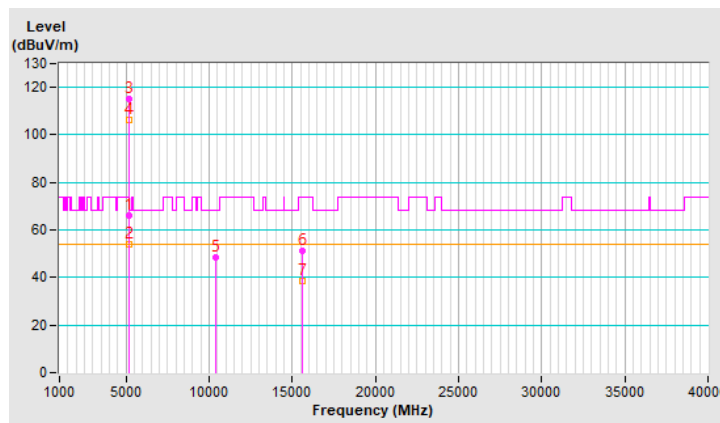

RF Mode	802.11ax (HE40)	Channel	CH 46 : 5230 MHz
Frequency Range	1 GHz ~ 40 GHz	Detector Function & Bandwidth	(PK) RB = 1 MHz, VB = 3 MHz (AV) RB = 1 MHz, VB = 10 Hz
Input Power	120 Vac, 60 Hz	Environmental Conditions	21°C, 71% RH
Tested By	Nick Tsou		

Antenna Polarity & Test Distance : Horizontal at 3 m								
No	Frequency (MHz)	Emission Level (dBuV/m)	Limit (dBuV/m)	Margin (dB)	Antenna Height (m)	Table Angle (Degree)	Raw Value (dBuV)	Correction Factor (dB/m)
1	5150.00	61.5 PK	74.0	-12.5	1.78 H	0	55.4	6.1
2	5150.00	49.7 AV	54.0	-4.3	1.78 H	0	43.6	6.1
3	*5230.00	115.1 PK			1.78 H	0	109.3	5.8
4	*5230.00	105.8 AV			1.78 H	0	100.0	5.8
5	5350.00	52.6 PK	74.0	-21.4	1.78 H	0	46.7	5.9
6	5350.00	41.9 AV	54.0	-12.1	1.78 H	0	36.0	5.9
7	#10460.00	47.7 PK	68.2	-20.5	2.16 H	337	29.9	17.8
8	15690.00	51.9 PK	74.0	-22.1	2.31 H	149	33.2	18.7
9	15690.00	39.9 AV	54.0	-14.1	2.31 H	149	21.2	18.7

Remarks:

1. Emission Level(dBuV/m) = Raw Value(dBuV) + Correction Factor(dB/m)
2. Correction Factor(dB/m) = Antenna Factor(dB/m) + Cable Factor(dB) – Pre-Amplifier Factor(dB)
3. Margin value = Emission Level – Limit value
4. The other emission levels were very low against the limit.
5. " * ": Fundamental frequency, the limit was restricted at the RF Output Power.
6. " # ": The radiated frequency is out of the restricted band.

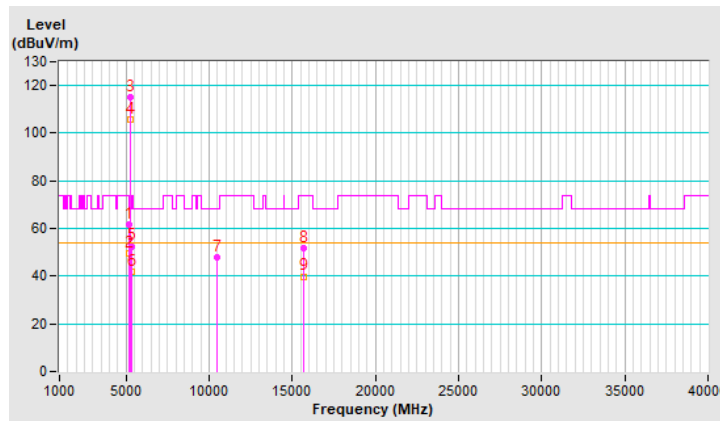

RF Mode	802.11ax (HE40)	Channel	CH 46 : 5230 MHz
Frequency Range	1 GHz ~ 40 GHz	Detector Function & Bandwidth	(PK) RB = 1 MHz, VB = 3 MHz (AV) RB = 1 MHz, VB = 10 Hz
Input Power	120 Vac, 60 Hz	Environmental Conditions	21°C, 71% RH
Tested By	Nick Tsou		

Antenna Polarity & Test Distance : Vertical at 3 m

No	Frequency (MHz)	Emission Level (dBuV/m)	Limit (dBuV/m)	Margin (dB)	Antenna Height (m)	Table Angle (Degree)	Raw Value (dBuV)	Correction Factor (dB/m)
1	5150.00	65.2 PK	74.0	-8.8	1.70 V	29	59.1	6.1
2	5150.00	53.7 AV	54.0	-0.3	1.70 V	29	47.6	6.1
3	*5230.00	121.0 PK			1.70 V	29	115.2	5.8
4	*5230.00	110.9 AV			1.70 V	29	105.1	5.8
5	5350.00	55.5 PK	74.0	-18.5	1.70 V	29	49.6	5.9
6	5350.00	44.6 AV	54.0	-9.4	1.70 V	29	38.7	5.9
7	#10460.00	48.7 PK	68.2	-19.5	1.47 V	360	30.9	17.8
8	15690.00	51.0 PK	74.0	-23.0	2.45 V	355	32.3	18.7
9	15690.00	38.5 AV	54.0	-15.5	2.45 V	355	19.8	18.7

Remarks:

1. Emission Level(dBuV/m) = Raw Value(dBuV) + Correction Factor(dB/m)
2. Correction Factor(dB/m) = Antenna Factor(dB/m) + Cable Factor(dB) – Pre-Amplifier Factor(dB)
3. Margin value = Emission Level – Limit value
4. The other emission levels were very low against the limit.
5. " * ": Fundamental frequency, the limit was restricted at the RF Output Power.
6. " # ": The radiated frequency is out of the restricted band.

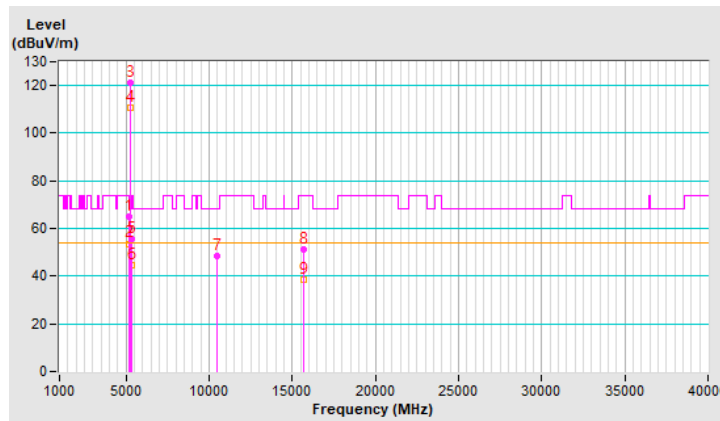

RF Mode	802.11ax (HE40)	Channel	CH 151 : 5755 MHz
Frequency Range	1 GHz ~ 40 GHz	Detector Function & Bandwidth	(PK) RB = 1 MHz, VB = 3 MHz (AV) RB = 1 MHz, VB = 10 Hz
Input Power	120 Vac, 60 Hz	Environmental Conditions	21°C, 71% RH
Tested By	Nick Tsou		

Antenna Polarity & Test Distance : Horizontal at 3 m								
No	Frequency (MHz)	Emission Level (dBuV/m)	Limit (dBuV/m)	Margin (dB)	Antenna Height (m)	Table Angle (Degree)	Raw Value (dBuV)	Correction Factor (dB/m)
1	#5646.00	65.2 PK	68.2	-3.0	1.70 H	318	58.6	6.6
2	*5755.00	118.4 PK			1.70 H	318	111.6	6.8
3	*5755.00	108.9 AV			1.70 H	318	102.1	6.8
4	#5946.00	54.3 PK	68.2	-13.9	1.70 H	318	46.9	7.4
5	11510.00	47.8 PK	74.0	-26.2	2.09 H	357	28.9	18.9
6	11510.00	35.3 AV	54.0	-18.7	2.09 H	357	16.4	18.9
7	#17265.00	50.9 PK	68.2	-17.3	2.27 H	158	28.0	22.9

Remarks:

1. Emission Level(dBuV/m) = Raw Value(dBuV) + Correction Factor(dB/m)
2. Correction Factor(dB/m) = Antenna Factor(dB/m) + Cable Factor(dB) – Pre-Amplifier Factor(dB)
3. Margin value = Emission Level – Limit value
4. The other emission levels were very low against the limit.
5. " * ": Fundamental frequency, the limit was restricted at the RF Output Power.
6. " # ": The radiated frequency is out of the restricted band.

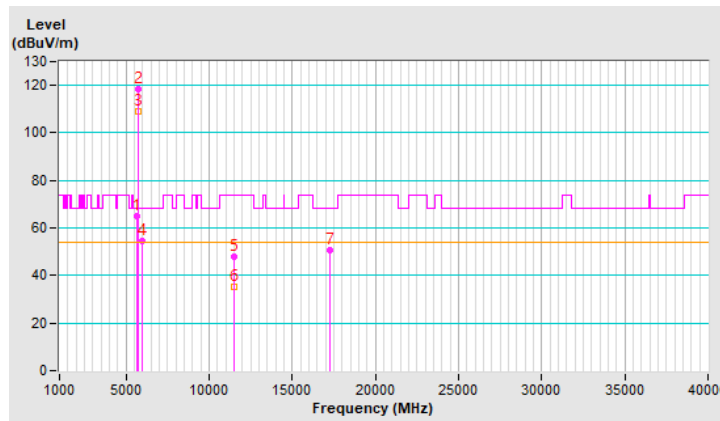

RF Mode	802.11ax (HE40)	Channel	CH 151 : 5755 MHz
Frequency Range	1 GHz ~ 40 GHz	Detector Function & Bandwidth	(PK) RB = 1 MHz, VB = 3 MHz (AV) RB = 1 MHz, VB = 10 Hz
Input Power	120 Vac, 60 Hz	Environmental Conditions	21°C, 71% RH
Tested By	Nick Tsou		

Antenna Polarity & Test Distance : Vertical at 3 m								
No	Frequency (MHz)	Emission Level (dBuV/m)	Limit (dBuV/m)	Margin (dB)	Antenna Height (m)	Table Angle (Degree)	Raw Value (dBuV)	Correction Factor (dB/m)
1	#5646.00	68.0 PK	68.2	-0.2	1.22 V	23	61.4	6.6
2	*5755.00	122.6 PK			1.22 V	23	115.8	6.8
3	*5755.00	111.3 AV			1.22 V	23	104.5	6.8
4	#5946.00	56.4 PK	68.2	-11.8	1.22 V	23	49.0	7.4
5	11510.00	47.4 PK	74.0	-26.6	1.49 V	360	28.5	18.9
6	11510.00	35.3 AV	54.0	-18.7	1.49 V	360	16.4	18.9
7	#17265.00	51.3 PK	68.2	-16.9	2.48 V	360	28.4	22.9

Remarks:

1. Emission Level(dBuV/m) = Raw Value(dBuV) + Correction Factor(dB/m)
2. Correction Factor(dB/m) = Antenna Factor(dB/m) + Cable Factor(dB) – Pre-Amplifier Factor(dB)
3. Margin value = Emission Level – Limit value
4. The other emission levels were very low against the limit.
5. " * ": Fundamental frequency, the limit was restricted at the RF Output Power.
6. " # ": The radiated frequency is out of the restricted band.

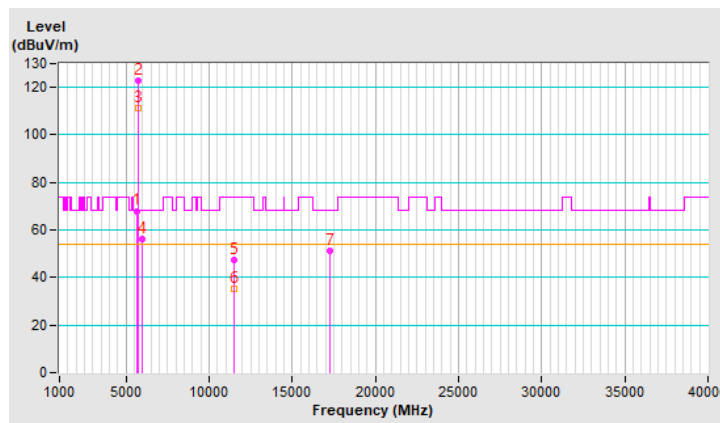

RF Mode	802.11ax (HE40)	Channel	CH 159 : 5795 MHz
Frequency Range	1 GHz ~ 40 GHz	Detector Function & Bandwidth	(PK) RB = 1 MHz, VB = 3 MHz (AV) RB = 1 MHz, VB = 10 Hz
Input Power	120 Vac, 60 Hz	Environmental Conditions	21°C, 71% RH
Tested By	Nick Tsou		

Antenna Polarity & Test Distance : Horizontal at 3 m								
No	Frequency (MHz)	Emission Level (dBUV/m)	Limit (dBUV/m)	Margin (dB)	Antenna Height (m)	Table Angle (Degree)	Raw Value (dBUV)	Correction Factor (dB/m)
1	#5636.00	55.8 PK	68.2	-12.4	1.67 H	316	49.2	6.6
2	*5795.00	118.8 PK			1.67 H	316	111.9	6.9
3	*5795.00	108.7 AV			1.67 H	316	101.8	6.9
4	#5926.00	59.0 PK	68.2	-9.2	1.67 H	316	51.7	7.3
5	11590.00	47.7 PK	74.0	-26.3	2.08 H	351	29.1	18.6
6	11590.00	35.3 AV	54.0	-18.7	2.08 H	351	16.7	18.6
7	#17385.00	52.1 PK	68.2	-16.1	2.28 H	159	28.6	23.5

Remarks:

1. Emission Level(dBUV/m) = Raw Value(dBUV) + Correction Factor(dB/m)
2. Correction Factor(dB/m) = Antenna Factor(dB/m) + Cable Factor(dB) – Pre-Amplifier Factor(dB)
3. Margin value = Emission Level – Limit value
4. The other emission levels were very low against the limit.
5. " * " : Fundamental frequency, the limit was restricted at the RF Output Power.
6. " # " : The radiated frequency is out of the restricted band.

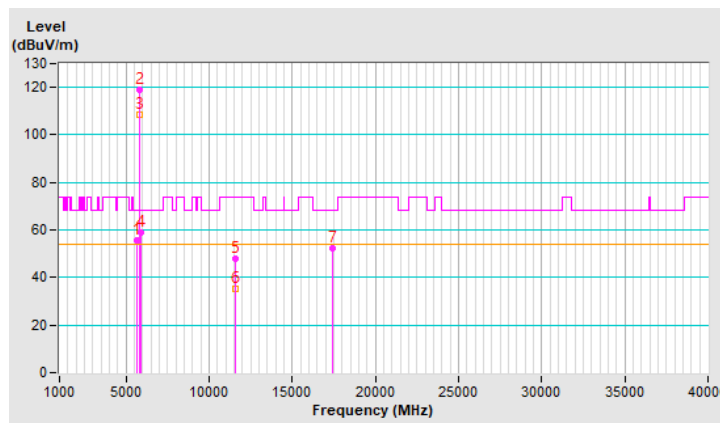

RF Mode	802.11ax (HE40)	Channel	CH 159 : 5795 MHz
Frequency Range	1 GHz ~ 40 GHz	Detector Function & Bandwidth	(PK) RB = 1 MHz, VB = 3 MHz (AV) RB = 1 MHz, VB = 10 Hz
Input Power	120 Vac, 60 Hz	Environmental Conditions	21°C, 71% RH
Tested By	Nick Tsou		

Antenna Polarity & Test Distance : Vertical at 3 m								
No	Frequency (MHz)	Emission Level (dBuV/m)	Limit (dBuV/m)	Margin (dB)	Antenna Height (m)	Table Angle (Degree)	Raw Value (dBuV)	Correction Factor (dB/m)
1	#5636.00	57.8 PK	68.2	-10.4	1.72 V	335	51.2	6.6
2	*5795.00	120.8 PK			1.72 V	335	113.9	6.9
3	*5795.00	110.4 AV			1.72 V	335	103.5	6.9
4	#5926.00	59.1 PK	68.2	-9.1	1.72 V	335	51.8	7.3
5	11590.00	47.1 PK	74.0	-26.9	1.50 V	360	28.5	18.6
6	11590.00	35.0 AV	54.0	-19.0	1.50 V	360	16.4	18.6
7	#17385.00	51.3 PK	68.2	-16.9	2.45 V	360	27.8	23.5

Remarks:

1. Emission Level(dBuV/m) = Raw Value(dBuV) + Correction Factor(dB/m)
2. Correction Factor(dB/m) = Antenna Factor(dB/m) + Cable Factor(dB) – Pre-Amplifier Factor(dB)
3. Margin value = Emission Level – Limit value
4. The other emission levels were very low against the limit.
5. " * " : Fundamental frequency, the limit was restricted at the RF Output Power.
6. " # " : The radiated frequency is out of the restricted band.

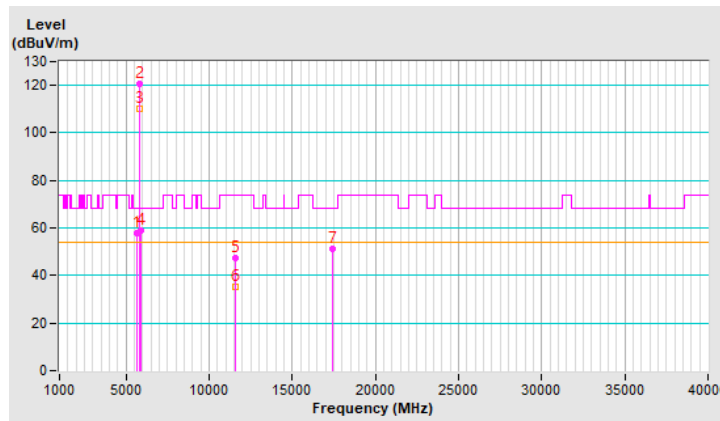

RF Mode	802.11ax (HE80)	Channel	CH 42 : 5210 MHz
Frequency Range	1 GHz ~ 40 GHz	Detector Function & Bandwidth	(PK) RB = 1 MHz, VB = 3 MHz (AV) RB = 1 MHz, VB = 10 Hz
Input Power	120 Vac, 60 Hz	Environmental Conditions	21°C, 71% RH
Tested By	Nick Tsou		

Antenna Polarity & Test Distance : Horizontal at 3 m								
No	Frequency (MHz)	Emission Level (dBuV/m)	Limit (dBuV/m)	Margin (dB)	Antenna Height (m)	Table Angle (Degree)	Raw Value (dBuV)	Correction Factor (dB/m)
1	5150.00	57.8 PK	74.0	-16.2	2.22 H	20	51.7	6.1
2	5150.00	47.4 AV	54.0	-6.6	2.22 H	20	41.3	6.1
3	*5210.00	102.7 PK			2.22 H	20	96.8	5.9
4	*5210.00	93.5 AV			2.22 H	20	87.6	5.9
5	5350.00	51.1 PK	74.0	-22.9	2.22 H	20	45.2	5.9
6	5350.00	39.1 AV	54.0	-14.9	2.22 H	20	33.2	5.9
7	#10420.00	47.7 PK	68.2	-20.5	2.11 H	341	30.1	17.6
8	15630.00	51.7 PK	74.0	-22.3	2.31 H	145	32.3	19.4
9	15630.00	39.6 AV	54.0	-14.4	2.31 H	145	20.2	19.4

Remarks:

1. Emission Level(dBuV/m) = Raw Value(dBuV) + Correction Factor(dB/m)
2. Correction Factor(dB/m) = Antenna Factor(dB/m) + Cable Factor(dB) – Pre-Amplifier Factor(dB)
3. Margin value = Emission Level – Limit value
4. The other emission levels were very low against the limit.
5. " * ": Fundamental frequency, the limit was restricted at the RF Output Power.
6. " # ": The radiated frequency is out of the restricted band.

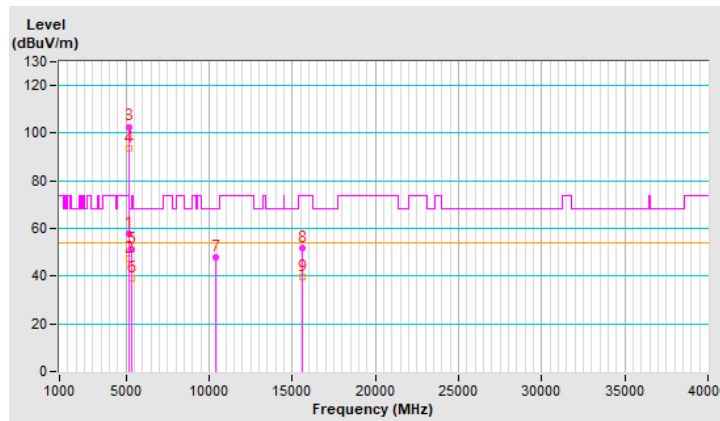

RF Mode	802.11ax (HE80)	Channel	CH 42 : 5210 MHz
Frequency Range	1 GHz ~ 40 GHz	Detector Function & Bandwidth	(PK) RB = 1 MHz, VB = 3 MHz (AV) RB = 1 MHz, VB = 10 Hz
Input Power	120 Vac, 60 Hz	Environmental Conditions	21°C, 71% RH
Tested By	Nick Tsou		

Antenna Polarity & Test Distance : Vertical at 3 m								
No	Frequency (MHz)	Emission Level (dBuV/m)	Limit (dBuV/m)	Margin (dB)	Antenna Height (m)	Table Angle (Degree)	Raw Value (dBuV)	Correction Factor (dB/m)
1	5150.00	62.7 PK	74.0	-11.3	1.72 V	20	56.6	6.1
2	5150.00	53.6 AV	54.0	-0.4	1.72 V	20	47.5	6.1
3	*5210.00	108.2 PK			1.72 V	20	102.3	5.9
4	*5210.00	98.5 AV			1.72 V	20	92.6	5.9
5	5350.00	52.2 PK	74.0	-21.8	1.72 V	20	46.3	5.9
6	5350.00	41.5 AV	54.0	-12.5	1.72 V	20	35.6	5.9
7	#10420.00	48.7 PK	68.2	-19.5	1.46 V	360	31.1	17.6
8	15630.00	50.5 PK	74.0	-23.5	2.49 V	360	31.1	19.4
9	15630.00	38.1 AV	54.0	-15.9	2.49 V	360	18.7	19.4

Remarks:

1. Emission Level(dBuV/m) = Raw Value(dBuV) + Correction Factor(dB/m)
2. Correction Factor(dB/m) = Antenna Factor(dB/m) + Cable Factor(dB) – Pre-Amplifier Factor(dB)
3. Margin value = Emission Level – Limit value
4. The other emission levels were very low against the limit.
5. " * ": Fundamental frequency, the limit was restricted at the RF Output Power.
6. " # ": The radiated frequency is out of the restricted band.

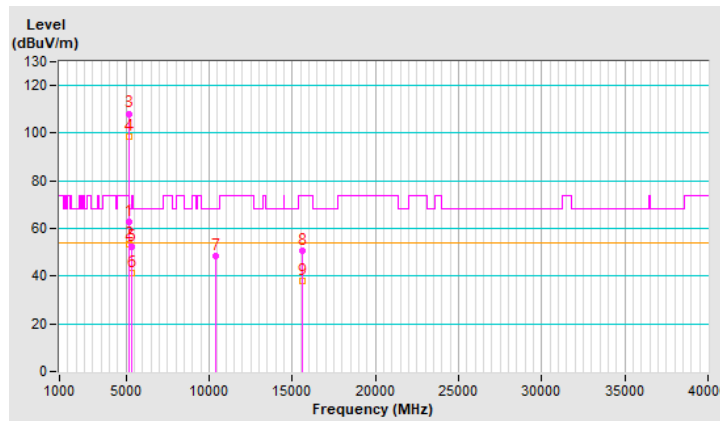

RF Mode	802.11ax (HE80)	Channel	CH 155 : 5775 MHz
Frequency Range	1 GHz ~ 40 GHz	Detector Function & Bandwidth	(PK) RB = 1 MHz, VB = 3 MHz (AV) RB = 1 MHz, VB = 10 Hz
Input Power	120 Vac, 60 Hz	Environmental Conditions	21°C, 71% RH
Tested By	Nick Tsou		

Antenna Polarity & Test Distance : Horizontal at 3 m								
No	Frequency (MHz)	Emission Level (dBUV/m)	Limit (dBUV/m)	Margin (dB)	Antenna Height (m)	Table Angle (Degree)	Raw Value (dBUV)	Correction Factor (dB/m)
1	#5641.00	64.3 PK	68.2	-3.9	1.47 H	323	57.7	6.6
2	*5775.00	114.1 PK			1.47 H	323	107.2	6.9
3	*5775.00	103.1 AV			1.47 H	323	96.2	6.9
4	#5925.00	61.4 PK	68.2	-6.8	1.47 H	323	54.1	7.3
5	11550.00	47.7 PK	74.0	-26.3	2.15 H	347	28.9	18.8
6	11550.00	35.7 AV	54.0	-18.3	2.15 H	347	16.9	18.8
7	#17325.00	51.8 PK	68.2	-16.4	2.33 H	146	28.3	23.5

Remarks:

1. Emission Level(dBUV/m) = Raw Value(dBUV) + Correction Factor(dB/m)
2. Correction Factor(dB/m) = Antenna Factor(dB/m) + Cable Factor(dB) – Pre-Amplifier Factor(dB)
3. Margin value = Emission Level – Limit value
4. The other emission levels were very low against the limit.
5. " * ": Fundamental frequency, the limit was restricted at the RF Output Power.
6. " # ": The radiated frequency is out of the restricted band.

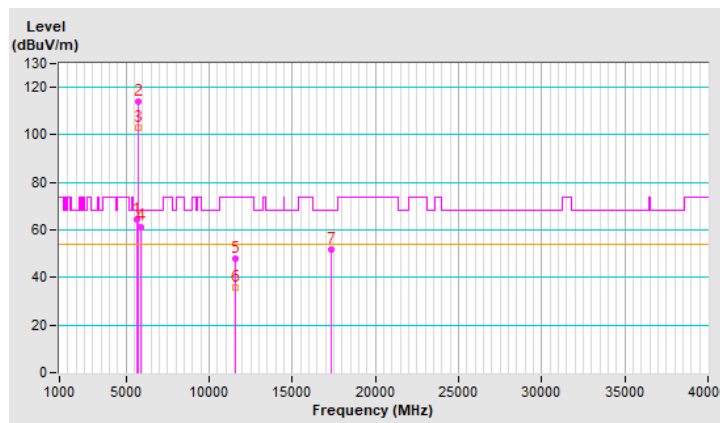

RF Mode	802.11ax (HE80)	Channel	CH 155 : 5775 MHz
Frequency Range	1 GHz ~ 40 GHz	Detector Function & Bandwidth	(PK) RB = 1 MHz, VB = 3 MHz (AV) RB = 1 MHz, VB = 10 Hz
Input Power	120 Vac, 60 Hz	Environmental Conditions	21°C, 71% RH
Tested By	Nick Tsou		

Antenna Polarity & Test Distance : Vertical at 3 m

No	Frequency (MHz)	Emission Level (dBuV/m)	Limit (dBuV/m)	Margin (dB)	Antenna Height (m)	Table Angle (Degree)	Raw Value (dBuV)	Correction Factor (dB/m)
1	#5641.00	67.7 PK	68.2	-0.5	1.18 V	23	61.1	6.6
2	*5775.00	116.8 PK			1.18 V	23	109.9	6.9
3	*5775.00	105.6 AV			1.18 V	23	98.7	6.9
4	#5925.00	66.2 PK	68.2	-2.0	1.18 V	23	58.9	7.3
5	11550.00	46.7 PK	74.0	-27.3	1.47 V	360	27.9	18.8
6	11550.00	34.7 AV	54.0	-19.3	1.47 V	360	15.9	18.8
7	#17325.00	51.3 PK	68.2	-16.9	2.42 V	360	27.8	23.5

Remarks:

1. Emission Level(dBuV/m) = Raw Value(dBuV) + Correction Factor(dB/m)
2. Correction Factor(dB/m) = Antenna Factor(dB/m) + Cable Factor(dB) – Pre-Amplifier Factor(dB)
3. Margin value = Emission Level – Limit value
4. The other emission levels were very low against the limit.
5. " * " : Fundamental frequency, the limit was restricted at the RF Output Power.
6. " # " : The radiated frequency is out of the restricted band.

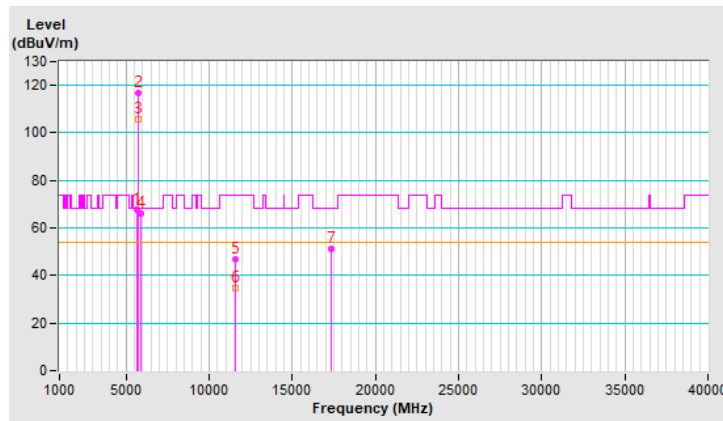

Plot of Band Edge

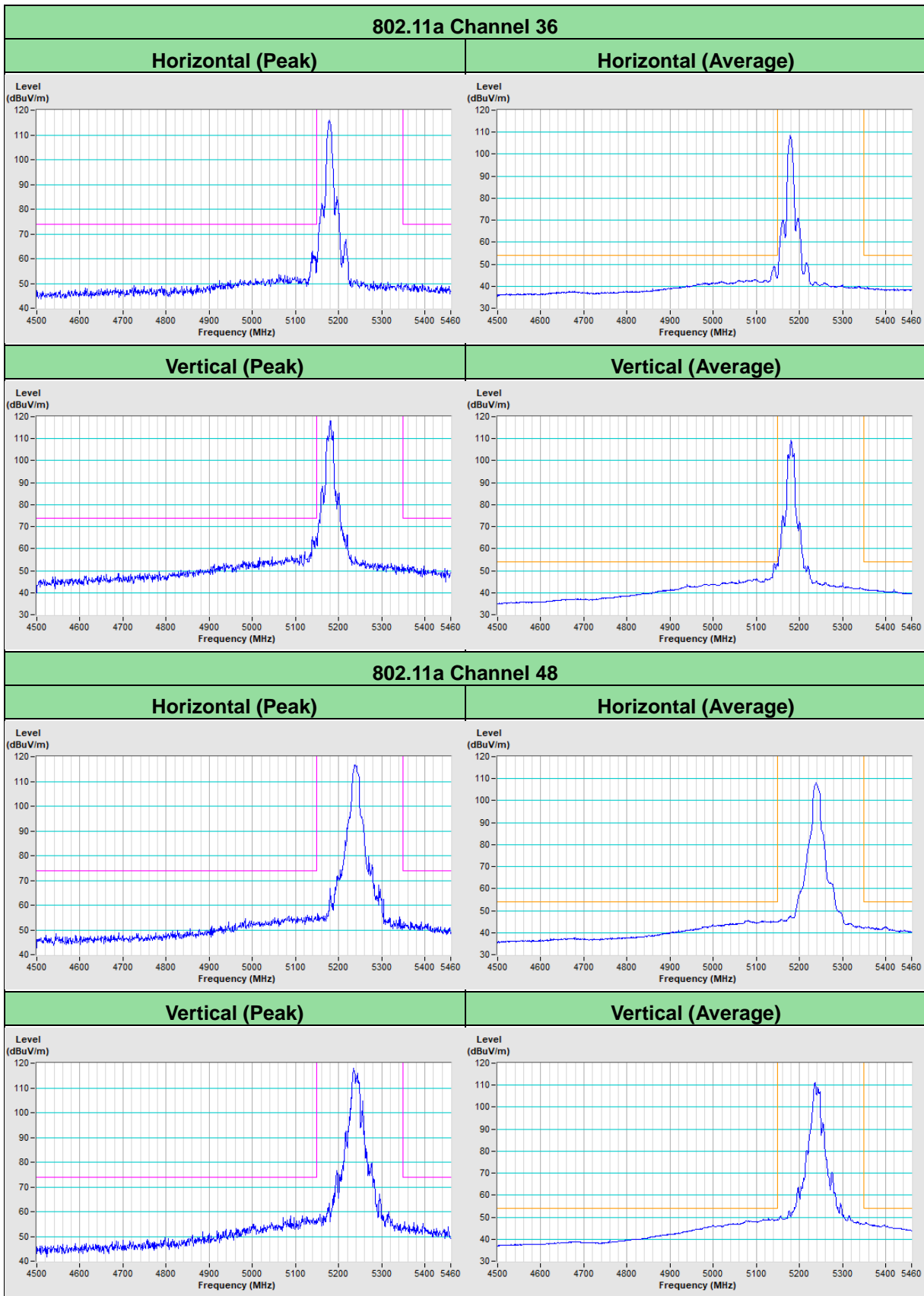

802.11a Channel 149

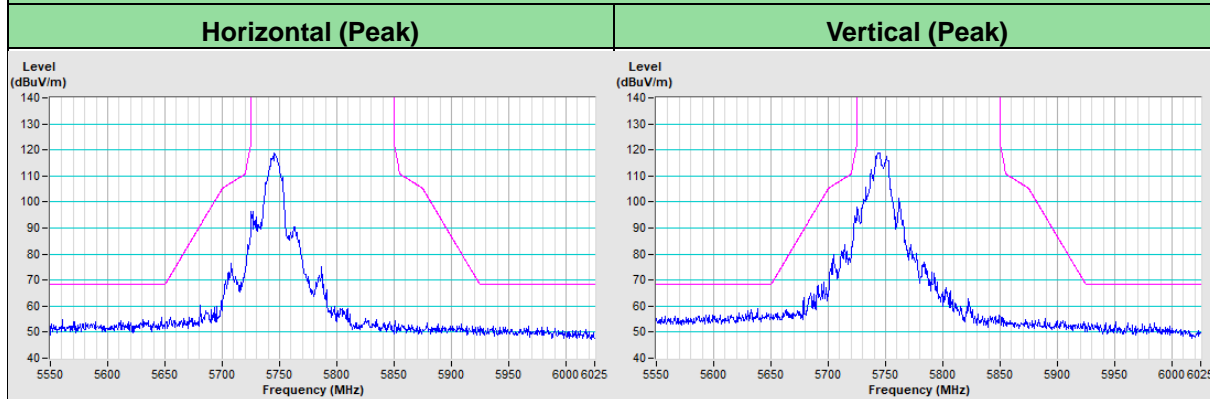

802.11a Channel 157

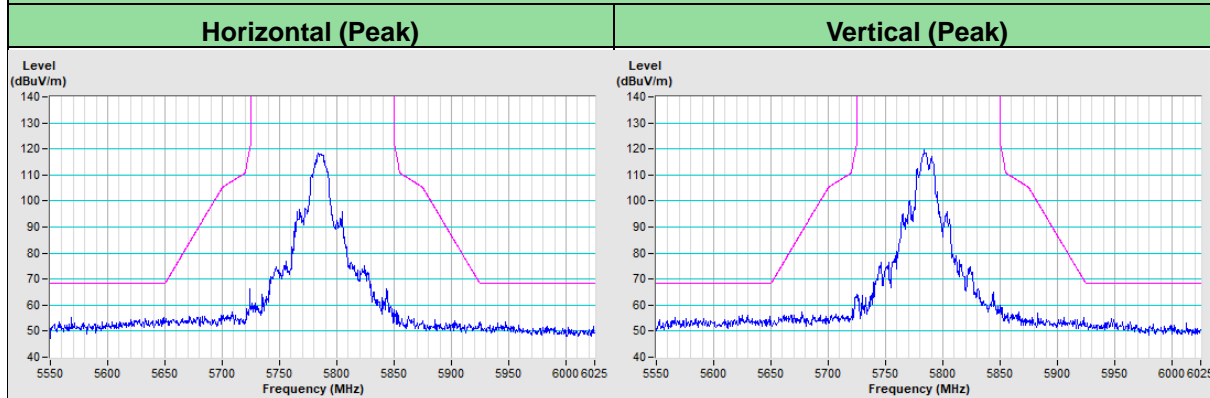

802.11a Channel 165

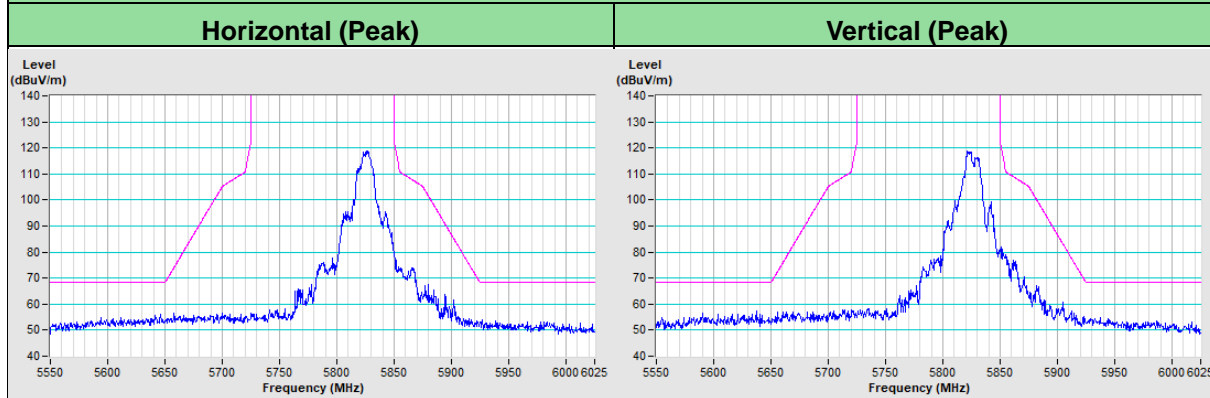

802.11ax (HE20) Channel 36

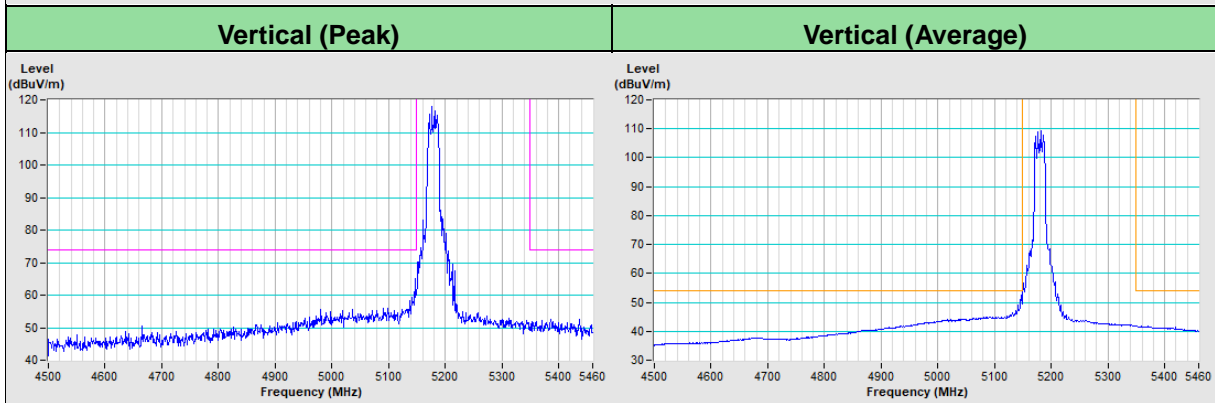
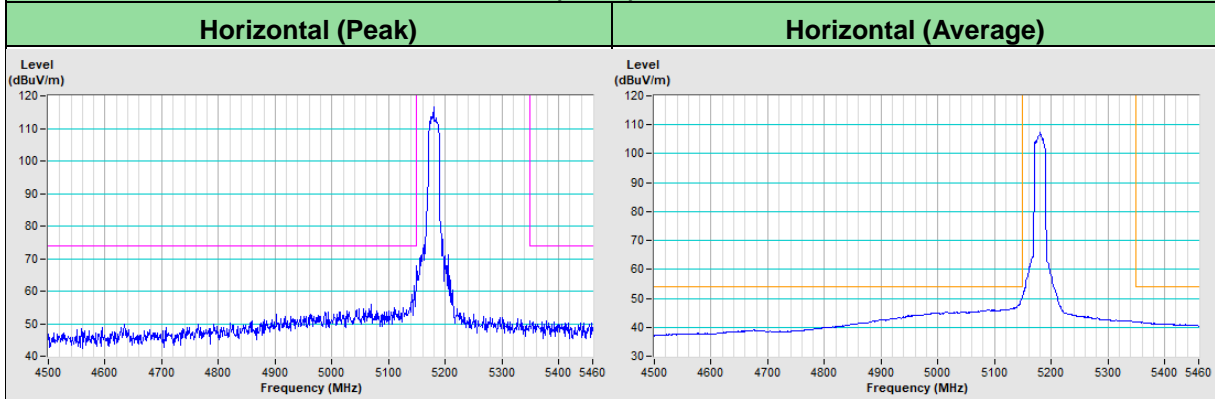

802.11ax (HE20) Channel 48

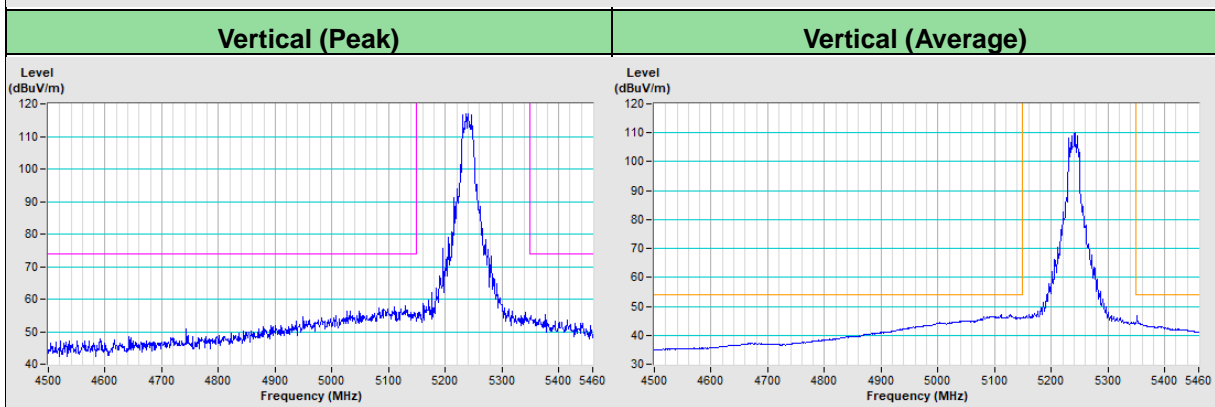
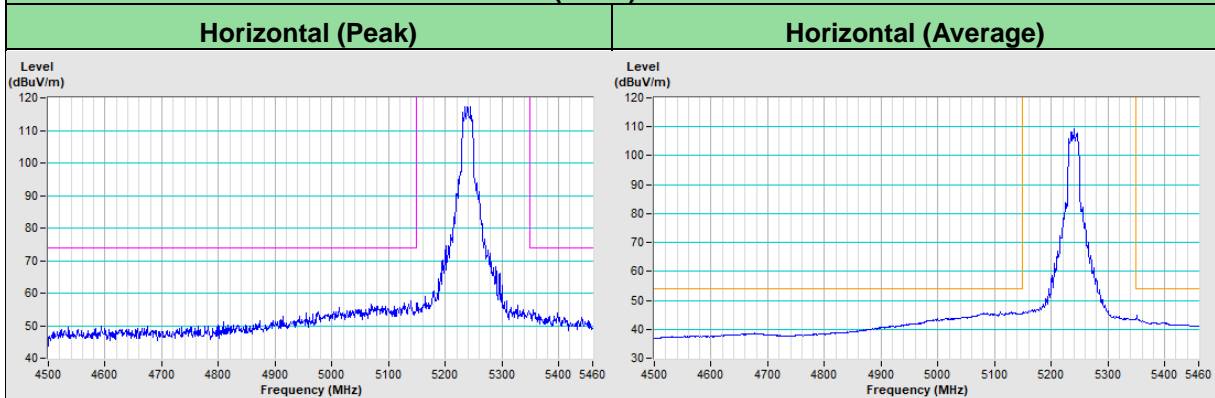

802.11ax (HE20) Channel 149

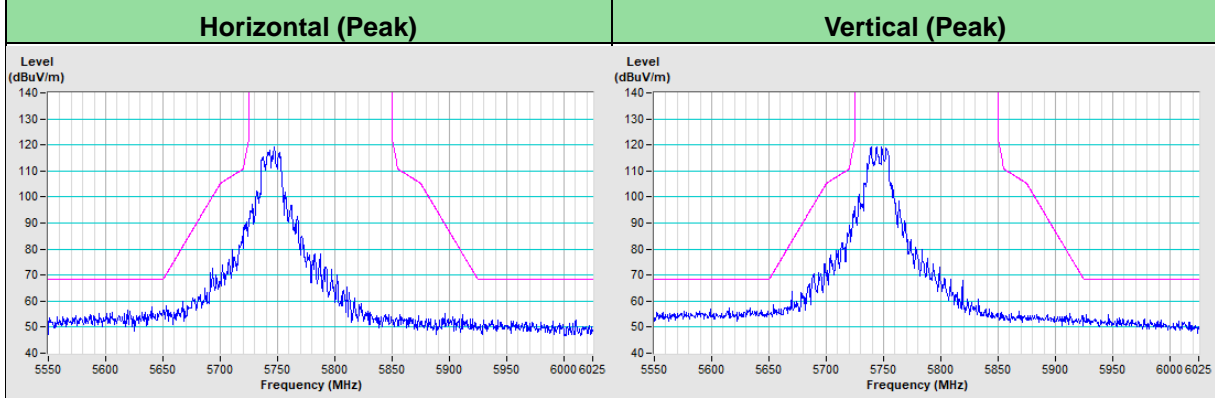

802.11ax (HE20) Channel 157

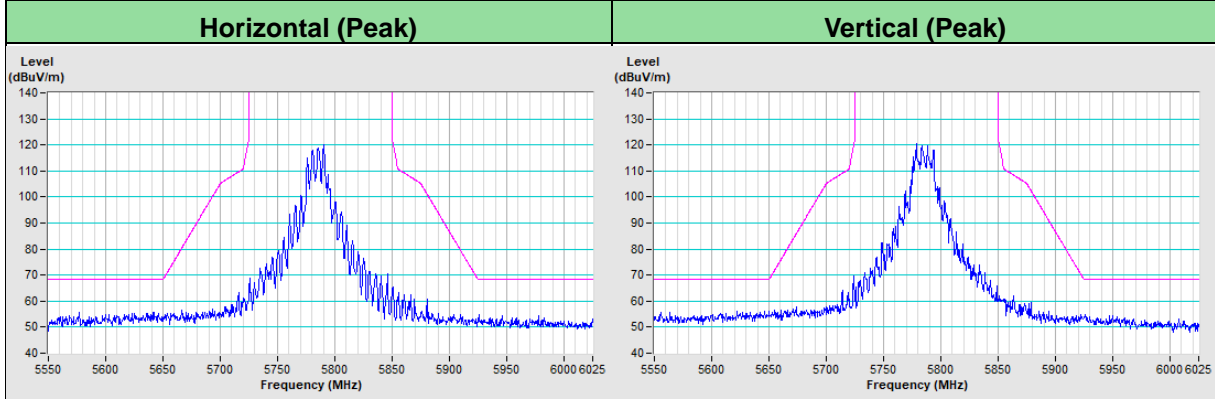

802.11ax (HE20) Channel 165

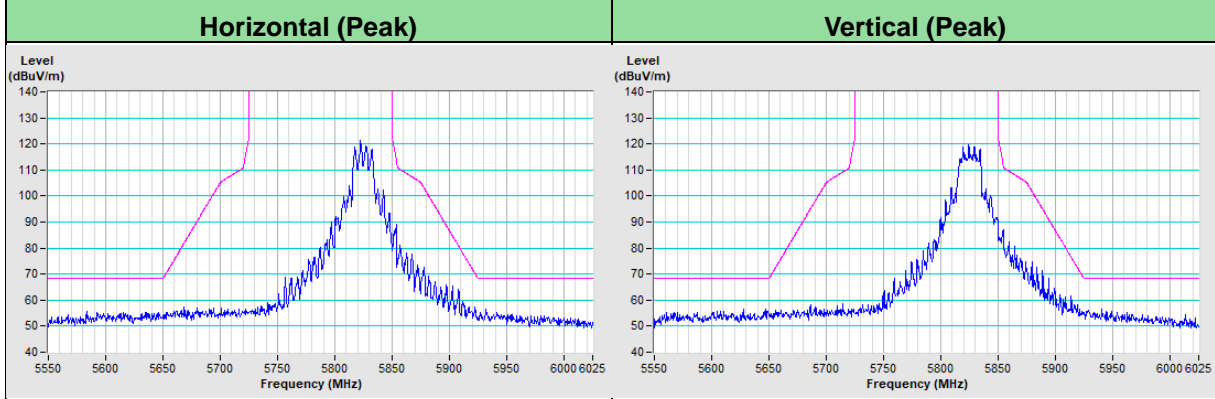

802.11ax (HE40) Channel 38

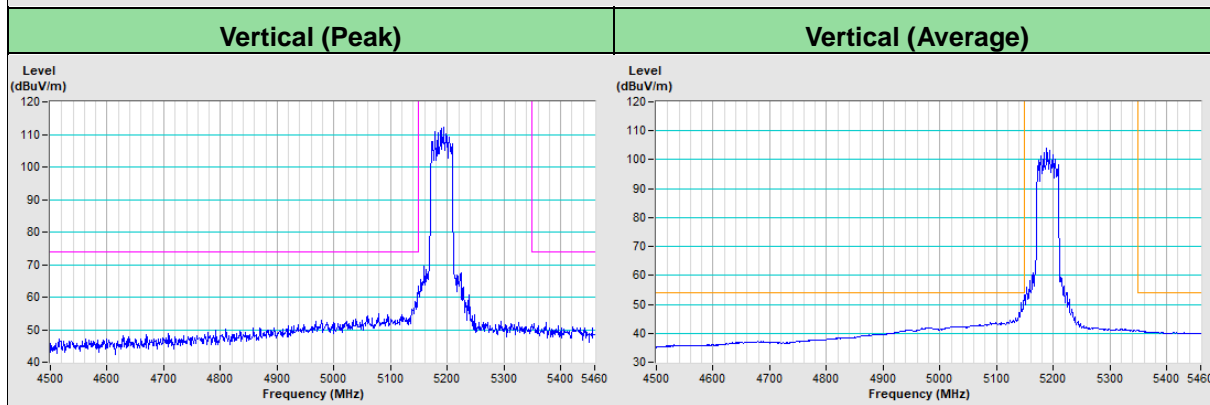
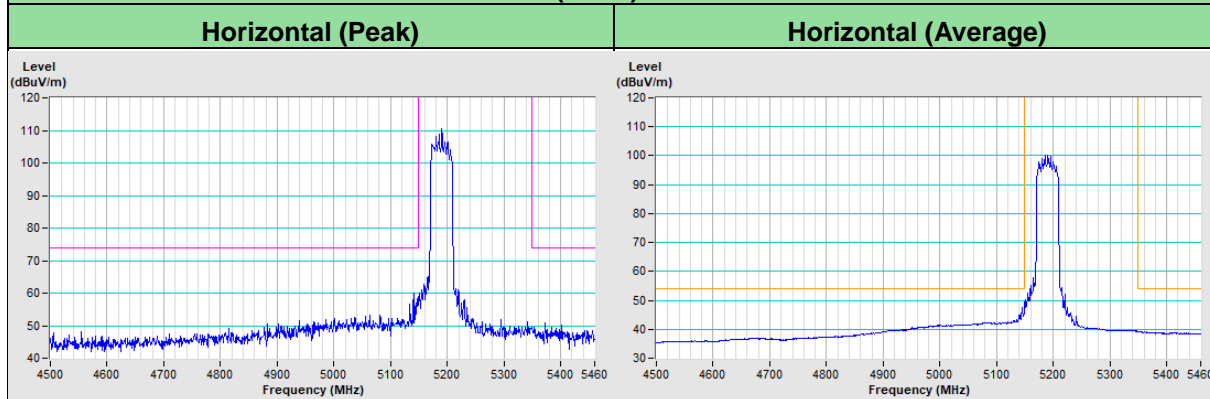

802.11ax (HE40) Channel 46

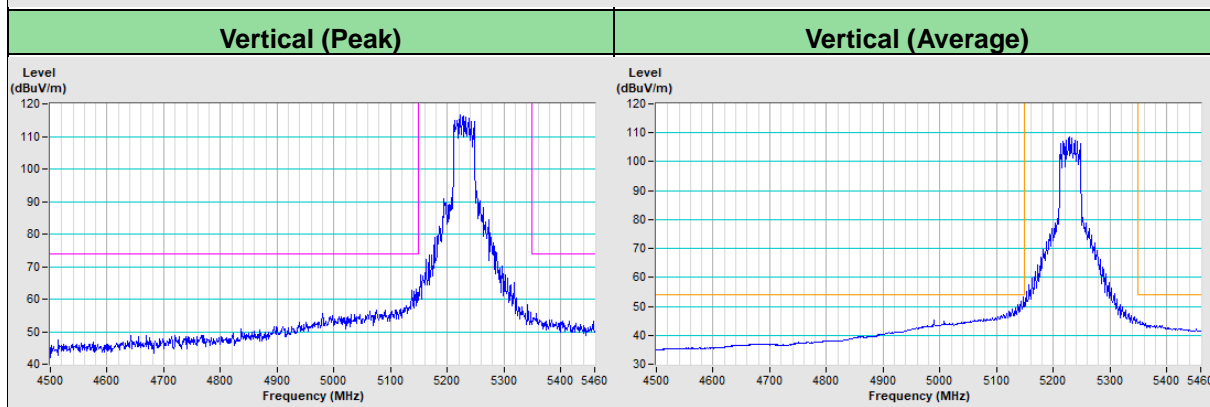
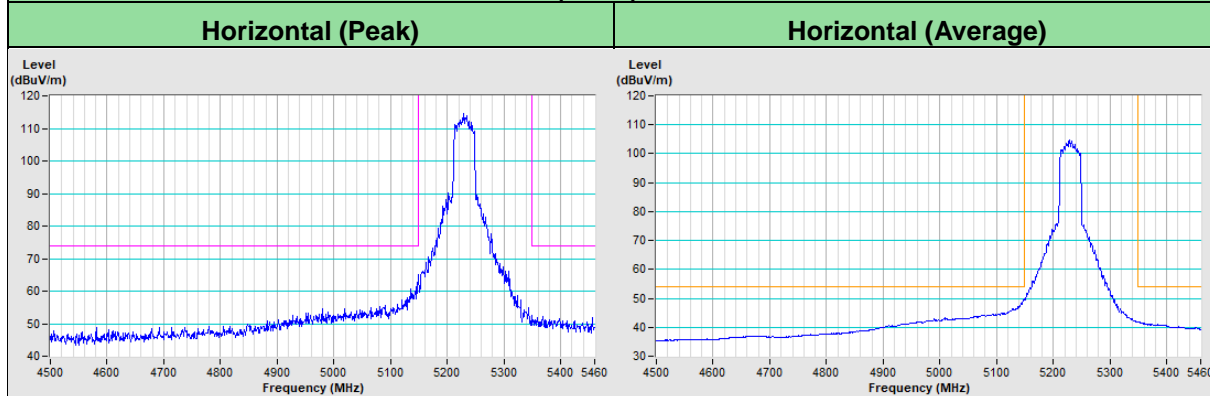

802.11ax (HE40) Channel 151

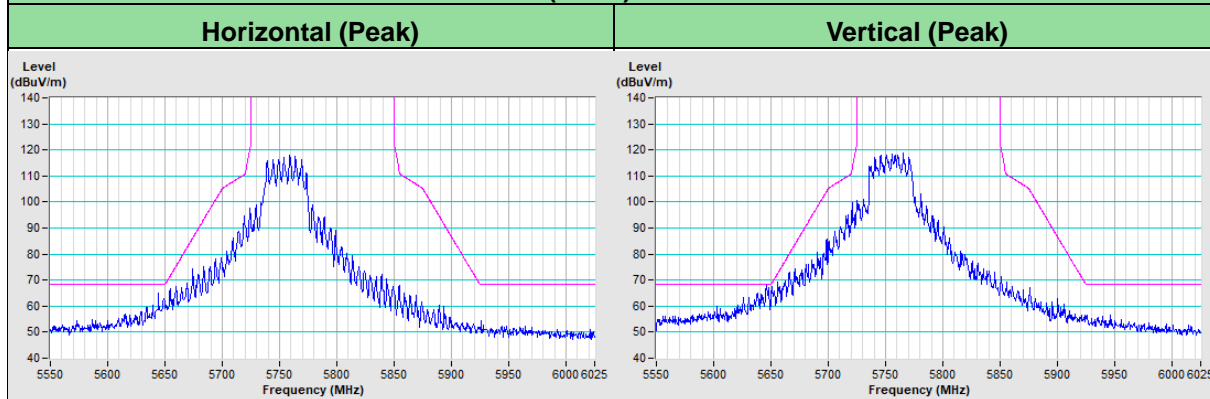

802.11ax (HE40) Channel 159

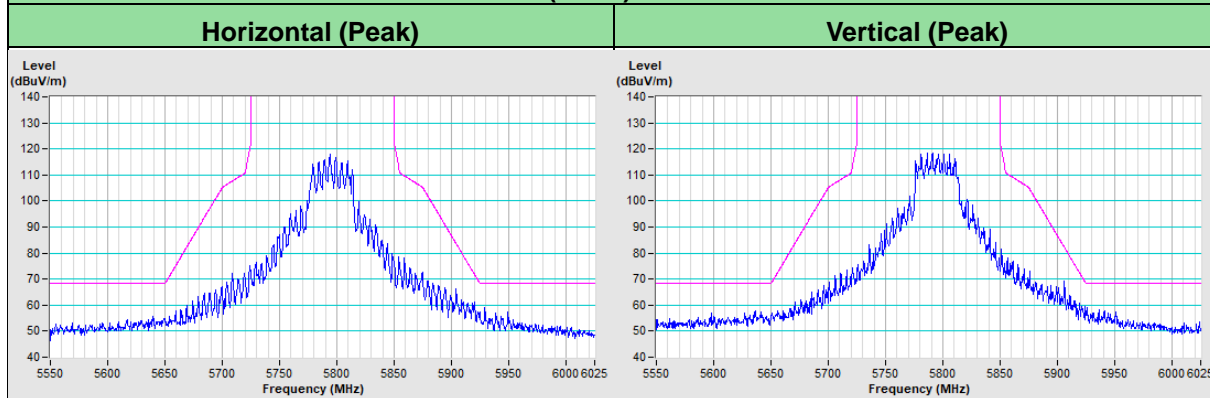



802.11ax (HE80) Channel 42

Horizontal (Peak)	Horizontal (Average)
-------------------	----------------------

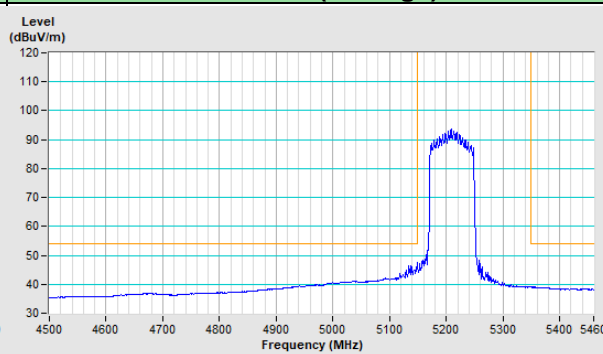
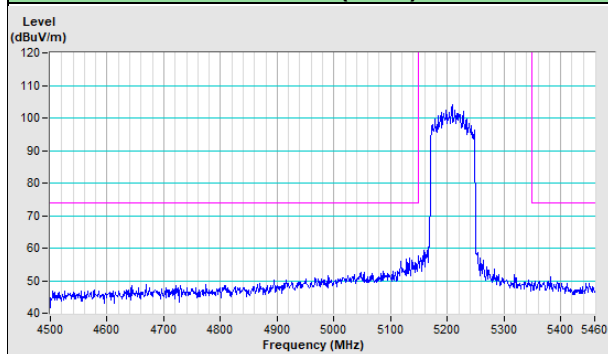

Vertical (Peak)

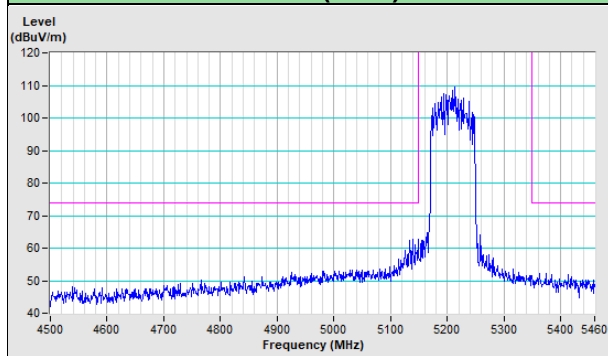

Vertical (Average)

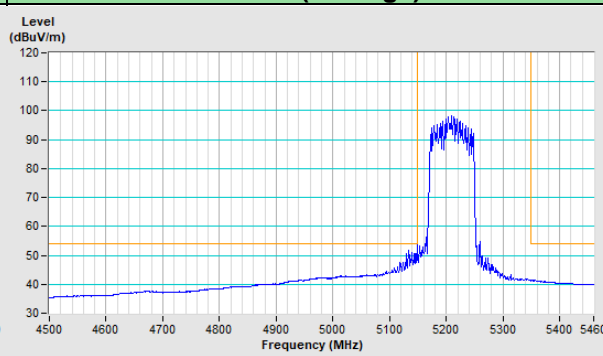

802.11ax (HE80) Channel 155

Horizontal (Peak)

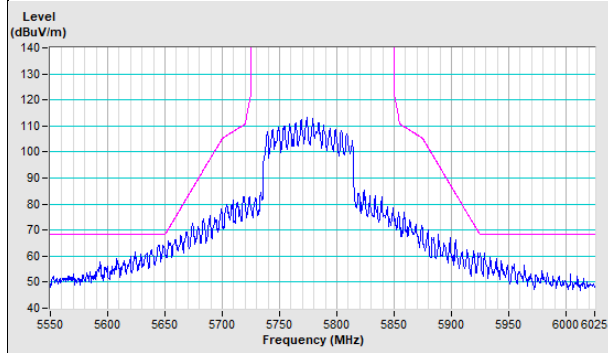

Vertical (Peak)

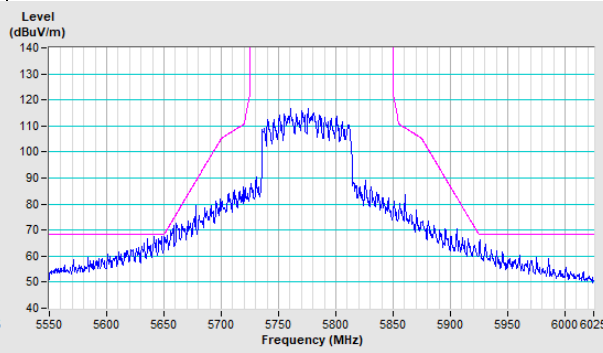

8 Pictures of Test Arrangements

Please refer to the attached file (Test Setup Photo)

9 Information of the Testing Laboratories

We, Bureau Veritas Consumer Products Services (H.K.) Ltd., Taoyuan Branch, were founded in 1988 to provide our best service in EMC, Radio, Telecom and Safety consultation. Our laboratories are FCC recognized accredited test firms and accredited according to ISO/IEC 17025.

If you have any comments, please feel free to contact us at the following:

Lin Kou EMC/RF Lab

Tel: 886-2-26052180

Fax: 886-2-26051924

Hsin Chu EMC/RF/Telecom Lab

Tel: 886-3-6668565

Fax: 886-3-6668323

Hwa Ya EMC/RF/Safety Lab

Tel: 886-3-3183232

Fax: 886-3-3270892

Email: service.adt@bureauveritas.com

Web Site: <http://ee.bureauveritas.com.tw>

The address and road map of all our labs can be found in our web site also.

--- END ---