



SPORTON International Inc.

No. 52, Hwa Ya 1st Rd., Hwa Ya Technology Park, Kwei-Shan Hsiang, Tao Yuan Hsien, Taiwan, R.O.C.
Ph: 886-3-327-3456 / FAX: 886-3-327-0973 / www.sporton.com.tw

FCC RADIO TEST REPORT

Applicant's company	Arcadyan Technology Corporation
Applicant Address	No.8, Sec.2, Guangfu Rd.,Hsinchu, 30071 Taiwan
FCC ID	RAXHMB2213PW
Manufacturer's company	Arcadyan Technology Corporation
Manufacturer Address	No.8, Sec.2, Guangfu Rd.,Hsinchu, 30071 Taiwan

Product Name	TELUS TVX
Brand Name	arcadyan
Model Name	HMB2213PW22TS
Test Rule	47 CFR FCC Part 15 Subpart C § 15.247
Test Freq. Range	2402 ~ 2480MHz
Received Date	Sep. 07, 2016
Final Test Date	Sep. 30, 2016
Submission Type	Original Equipment

Statement

Test result included is only for the Bluetooth BR/EDR of the product.

The test result in this report refers exclusively to the presented test model / sample.

Without written approval of SPORTON International Inc., the test report shall not be reproduced except in full.

The measurements and test results shown in this test report were made in accordance with the procedures and found in compliance with the limit given in **ANSI C63.10-2013, DA-00705** and **47 CFR FCC Part 15 Subpart C**.

The test equipment used to perform the test is calibrated and traceable to NML/ROC.



Table of Contents

1. VERIFICATION OF COMPLIANCE	1
2. SUMMARY OF THE TEST RESULT	2
3. GENERAL INFORMATION	3
3.1. Product Details.....	3
3.2. Accessories.....	3
3.3. Table for Filed Antenna.....	4
3.4. Table for Carrier Frequencies	4
3.5. Table for Test Modes.....	5
3.6. Table for Testing Locations.....	6
3.7. Table for Supporting Units	6
3.8. Table for Parameters of Test Software Setting	7
3.9. EUT Operation during Test	7
3.10. Duty Cycle.....	7
3.11. Test Configurations	8
4. TEST RESULT	11
4.1. AC Power Line Conducted Emissions Measurement.....	11
4.2. Maximum Conducted Output Power Measurement.....	15
4.3. Hopping Channel Separation Measurement	17
4.4. Number of Hopping Frequency Measurement.....	28
4.5. Dwell Time Measurement.....	30
4.6. Radiated Emissions Measurement	37
4.7. Emissions Measurement	50
4.8. Antenna Requirements	68
5. LIST OF MEASURING EQUIPMENTS	69
6. MEASUREMENT UNCERTAINTY	70
APPENDIX A. PHOTOGRAPHS OF EUT	A1 ~ A15
APPENDIX B. TEST PHOTOS	B1 ~ B4



History of This Test Report

REPORT NO.	VERSION	DESCRIPTION	ISSUED DATE
FR672701AC	Rev. 01	Initial issue of report	Oct. 07, 2016



1. VERIFICATION OF COMPLIANCE

Product Name : TELUS TVX
Brand Name : arcadyan
Model No. : HMB2213PW22TS
Applicant : Arcadyan Technology Corporation
Test Rule Part(s) : 47 CFR FCC Part 15 Subpart C § 15.247

Sporton International as requested by the applicant to evaluate the EMC performance of the product sample received on Sep. 07, 2016 would like to declare that the tested sample has been evaluated and found to be in compliance with the tested rule parts. The data recorded as well as the test configuration specified is true and accurate for showing the sample's EMC nature.



Sam Chen

SPORTON INTERNATIONAL INC.

2. SUMMARY OF THE TEST RESULT

Applied Standard: 47 CFR FCC Part 15 Subpart C			
Part	Rule Section	Description of Test	Result
4.1	15.207	AC Power Line Conducted Emissions	Complies
4.2	15.247(b)(1)	Maximum Conducted Output Power	Complies
4.3	15.247(a)(1)	Hopping Channel Separation	Complies
4.4	15.247(b)(1)	Number of Hopping Frequency	Complies
4.5	15.247(a)(1)	Dwell Time	Complies
4.6	15.247(d)	Radiated Emissions	Complies
4.7	15.247(d)	Band Edge Emissions	Complies
4.8	15.203	Antenna Requirements	Complies

3. GENERAL INFORMATION

3.1. Product Details

Items	Description
Power Type	From power adapter
Modulation	FHSS (GFSK / $\pi/4$ -DQPSK / 8DPSK)
Data Rate (Mbps)	GFSK: 1 ; $\pi/4$ -DQPSK: 2 ; 8DPSK: 3
Frequency Range	2402 ~ 2480MHz
Channel Number	79
Channel Bandwidth (99%)	BR (GFSK) 1 Mbps: 0.903 MHz EDR ($\pi/4$ -DQPSK) 2 Mbps: 1.207 MHz EDR (8DPSK) 3 Mbps: 1.211 MHz
Maximum Conducted Peak Output Power	BR (GFSK) 1 Mbps: 8.29 dBm EDR ($\pi/4$ -DQPSK) 2 Mbps: 6.93 dBm EDR (8DPSK) 3 Mbps: 7.27 dBm
Maximum Conducted Average Output Power	BR (GFSK) 1 Mbps: 8.04 dBm EDR ($\pi/4$ -DQPSK) 2 Mbps: 4.52 dBm EDR (8DPSK) 3 Mbps: 4.56 dBm
Carrier Frequencies	Please refer to section 3.4
Antenna	Please refer to section 3.3
Note 1: Bluetooth BR uses a combination of GFSK (1Mbps).	
Note 2: Bluetooth EDR uses a combination of $\pi/4$ -DQPSK (2Mbps) and 8DPSK (3Mbps).	

3.2. Accessories

Power	Brand	Model No.	Rating
Adapter	APD	WB-18D12FU	Input: 100-240Vac, 50-60Hz, 0.5A Max. Output: 12Vdc, 1.5A
Other			
HDMI cable: Shielded, 1.8m			

3.3. Table for Filed Antenna

Ant.	Brand	Part No.	Type	Connector	Gain (dBi)	
					2.4GHz WLAN	5GHz WLAN
1	arcadyan	120800031900J	PCB	N/A	4.14	4.18
2	arcadyan	120800031900J	PCB	N/A	4.91	4.73
Ant.	Brand	Part No.	Type	Connector	Gain (dBi)	
					Bluetooth	
3	arcadyan	120700035500J	Print PCB	N/A	3.93	

Note: The EUT has three antennas.

For WLAN function:

Ant. 1 and Ant. 2 can be used as transmitting/receiving antenna.

Ant. 1 and Ant. 2 could transmit/receive simultaneously.

For Bluetooth function:

Only Ant. 3 can be used as transmitting/receiving antenna.

3.4. Table for Carrier Frequencies

Frequency Band	Channel No.	Frequency	Channel No.	Frequency
2400~2483.5MHz	0	2402 MHz	40	2442 MHz
	1	2403 MHz	:	:
	:	:	77	2479 MHz
	38	2440 MHz	78	2480 MHz
	39	2441 MHz	-	-

3.5. Table for Test Modes

Preliminary tests were performed in different data rate to find the worst radiated emission. The data rate shown in the table below is the worst-case rate with respect to the specific test item. Investigation has been done on all the possible configurations for searching the worst cases. The following table is a list of the test modes shown in this test report.

Test Items	Mode	Data Rate	Channel	Ant.
AC Power Conducted Emissions	Normal Link	-	-	-
Maximum Conducted Output Power	BR (GFSK)	1 Mbps	0/39/78	3
	EDR ($\pi/4$ -DQPSK)	2 Mbps	0/39/78	3
	EDR (8DPSK)	3 Mbps	0/39/78	3
Hopping Channel Separation	BR (GFSK)	1 Mbps	0~1 39~40 77~78	3
	EDR ($\pi/4$ -DQPSK)	2 Mbps	0~1 39~40 77~78	3
	EDR (8DPSK)	3 Mbps	0~1 39~40 77~78	3
Number of Hopping Frequency	EDR (8DPSK)	3 Mbps	0~78	3
Dwell Time	BR (GFSK) (DH1, DH3, DH5)	1 Mbps	0/39/78	3
Radiated Emissions Below 1GHz	Normal Link	-	-	-
Radiated Emissions Above 1GHz	BR (GFSK)	1 Mbps	0/39/78	3
	EDR (8DPSK)	3 Mbps	0/39/78	3
Band Edge Emissions	BR (GFSK)	1 Mbps	0/39/78	3
	EDR (8DPSK)	3 Mbps	0/39/78	3

Note: The EUT can only be used at Z axis position.

The following test modes were performed for all tests:

For AC Power Conducted Emissions test:

Mode 1. 2.4GHz WLAN + Bluetooth

Mode 2. 5GHz WLAN + Bluetooth

Mode 2 is the worst case, so it was selected to record in this test report

For Radiated Emission Below 1GHz test:

Mode 1. 2.4GHz WLAN + Bluetooth

Mode 2. 5GHz WLAN + Bluetooth

Mode 1 is the worst case, so it was selected to record in this test report

For Co-location MPE test:

The EUT could be applied with 2.4GHz WLAN function, 5GHz WLAN function and Bluetooth function; therefore Co-location Maximum Permissible Exposure (Please refer to FA672701) test is added for simultaneously transmit between 2.4GHz WLAN function, 5GHz WLAN function and Bluetooth function.

3.6. Table for Testing Locations

Test Site Location					
Address:	No.8, Lane 724, Bo-ai St., Jhubei City, Hsinchu County 302, Taiwan, R.O.C.				
TEL:	886-3-656-9065				
FAX:	886-3-656-9085				
Test Site No.	Site Category	Location	FCC Designation No.	IC File No.	VCCI Reg. No
03CH01-CB	SAC	Hsin Chu	TW0006	IC 4086D	-
CO01-CB	Conduction	Hsin Chu	TW0006	IC 4086D	-
TH01-CB	OVEN Room	Hsin Chu	-	-	-

Open Area Test Site (OATS); Semi Anechoic Chamber (SAC).

3.7. Table for Supporting Units

For Test Site No: 03CH01-CB (Below 1GHz)

Support Unit	Brand	Model	FCC ID
NB	DELL	E4300	DoC
Converter	UPMOST	DCT3	N/A
Flash disk	Silicon Power	I-Series	DoC
Earphone	SHYARO CHI	MIC-04	N/A
TV	SONY	KLV-32U300A	DoC
AP	Planex	GW-AP54SGX	KA220030603014-1
iPad	Apple	A1430	DoC

For Test Site No: 03CH01-CB (Above 1GHz) and TH01-CB

Support Unit	Brand	Model	FCC ID
NB	DELL	E4300	DoC

For Test Site No: CO01-CB

Support Unit	Brand	Model	FCC ID
AP	Planex	GW-AP54SGX	KA220030603014-1
NB	DELL	E6430	DoC
iPad	Apple	A1430	DoC
Converter	UPMOST	DCT3	N/A
Earphone	SHYARO CHI	MIC-04	N/A
TV	SONY	KLV-32U300A	DoC
Flash disk	Transcend	604108 8255	DoC

3.8. Table for Parameters of Test Software Setting

During testing, Channel and Power Controlling Software provided by the customer was used to control the operating channel as well as the output power level. The RF output power selection is for the setting of RF output power expected by the customer and is going to be fixed on the firmware of the final end product.

Power Parameters of Bluetooth

For BR (GFSK) 1 Mbps:

Test Software Version	Telnet		
Frequency	2402 MHz	2441 MHz	2480 MHz
Power Parameters	Default	Default	Default

For EDR ($\pi/4$ -DQPSK) 2 Mbps:

Test Software Version	Telnet		
Frequency	2402 MHz	2441 MHz	2480 MHz
Power Parameters	Default	Default	Default

For EDR (8DPSK) 3 Mbps:

Test Software Version	Telnet		
Frequency	2402 MHz	2441 MHz	2480 MHz
Power Parameters	Default	Default	Default

3.9. EUT Operation during Test

The EUT was programmed to be in continuously transmitting mode.

3.10. Duty Cycle

Mode	On Time (ms)	On+Off Time (ms)	Duty Cycle (%)	Duty Factor (dB)	1/T Minimum VBW (kHz)
BR (GFSK)	6.000	100.000	6.00	12.22	0.17
EDR (8DPSK)	6.000	100.000	6.00	12.22	0.17

3.11. Test Configurations

3.11.1. AC Power Line Conduction Emissions Test Configuration

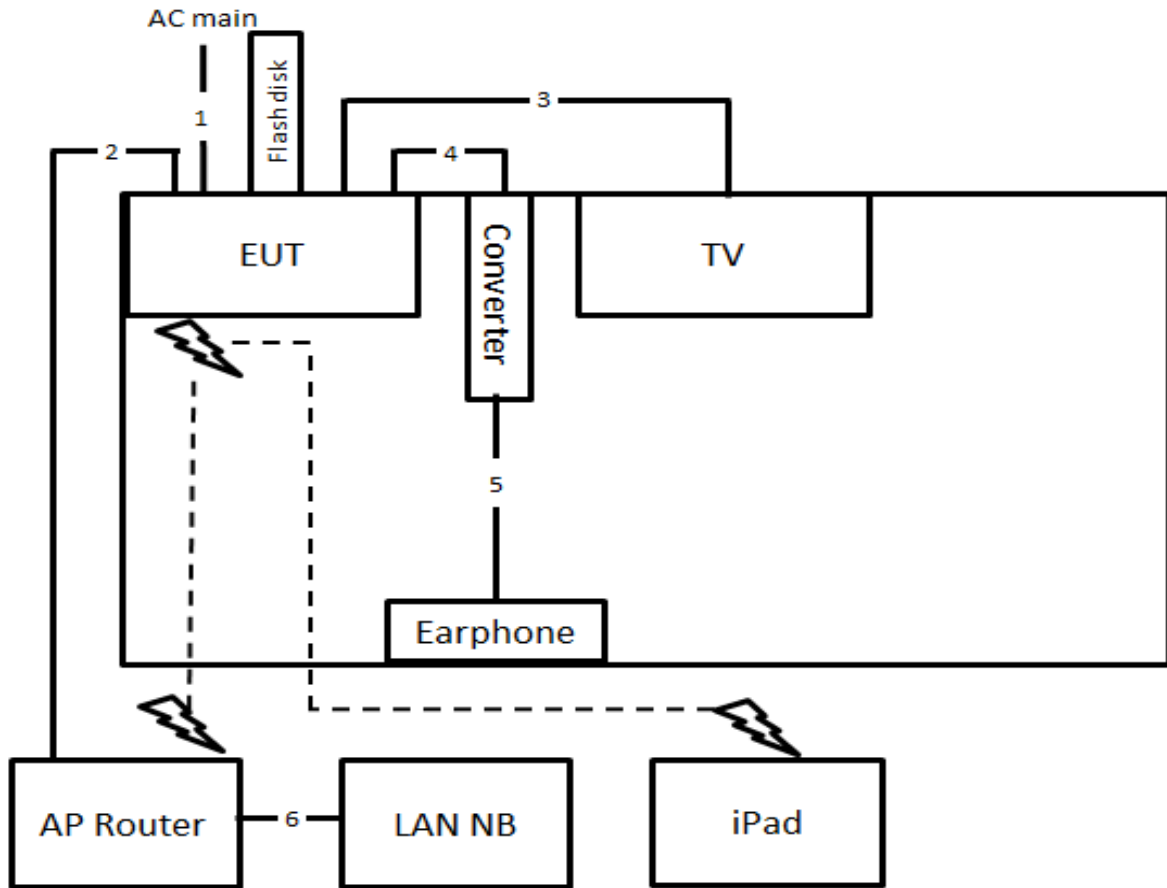

Item	Connection	Shielded	Length
1	Power cable	No	1.5m
2	RJ-45 cable	No	10m
3	HDMI cable	Yes	1.8m
4	Optical cable	No	1m
5	Audio cable	No	1.1m
6	RJ-45 cable	No	3m

3.11.2. Radiation Emissions Test Configuration

Test Configuration: 30MHz~1GHz

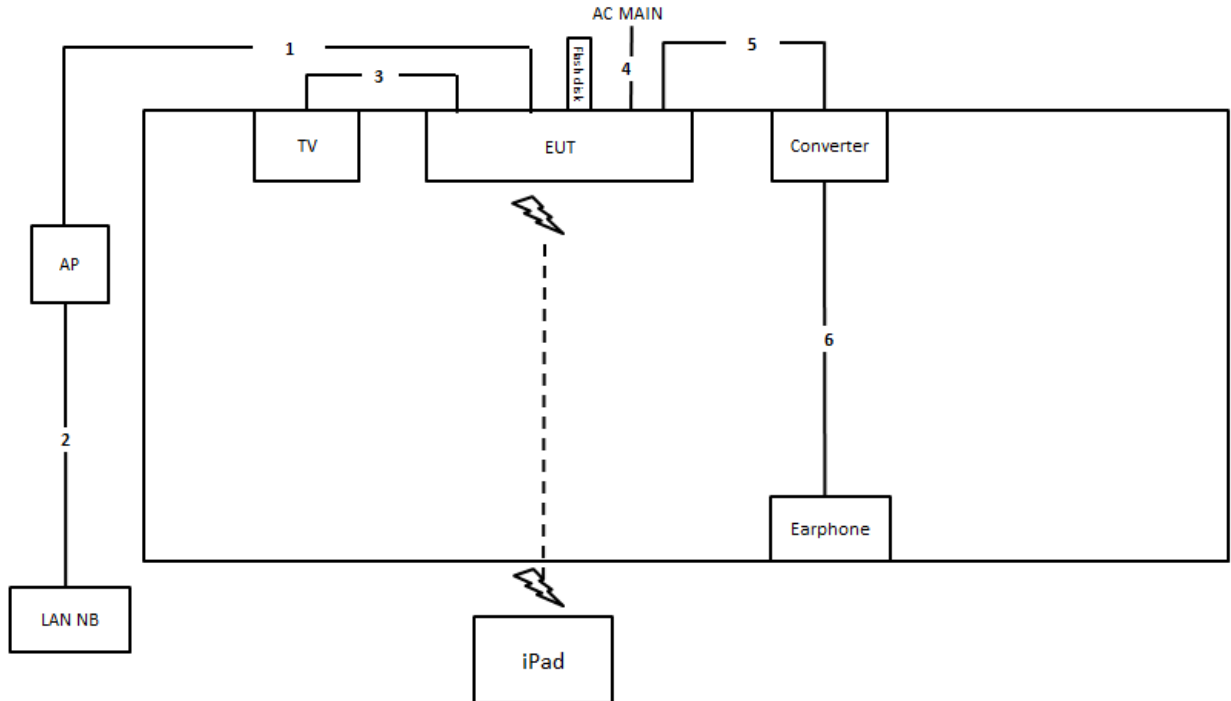

Item	Connection	Shielded	Length
1	RJ-45 cable	No	10m
2	RJ-45 cable	No	10m
3	HDMI cable	Yes	1.8m
4	Power cable	No	1.5m
5	Optical cable	No	1m
6	Audio cable	No	1.4m

Test Configuration: above 1GHz

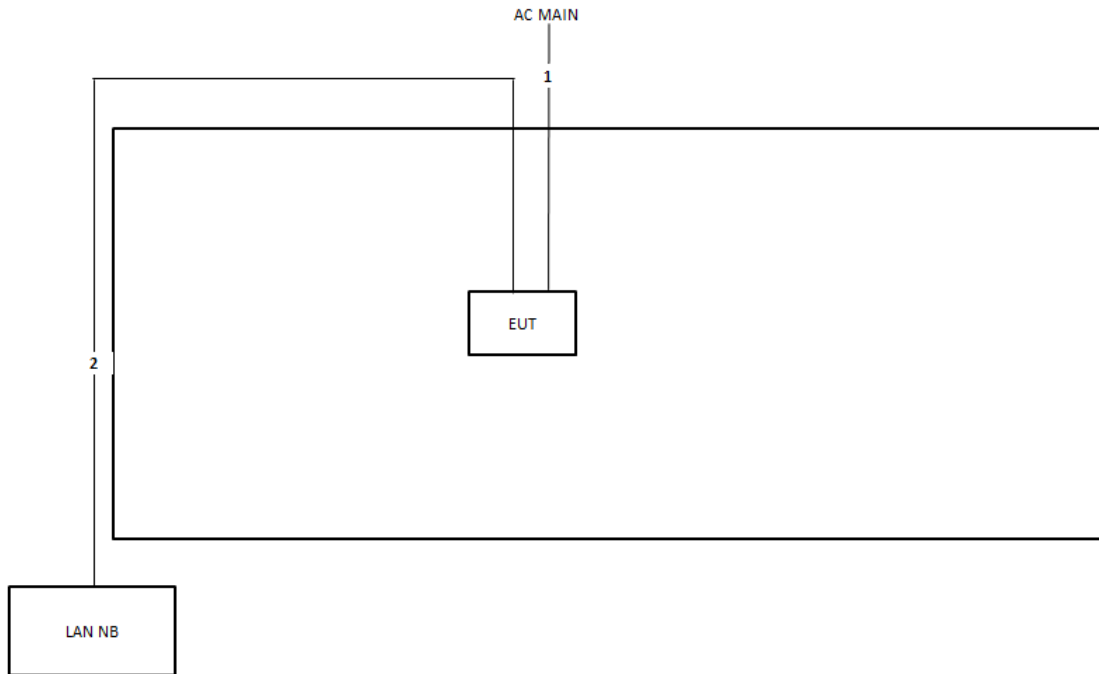

Item	Connection	Shielded	Length
1	Power cable	No	1.5m
2	RJ-45 cable	No	10m

4. TEST RESULT

4.1. AC Power Line Conducted Emissions Measurement

4.1.1. Limit

For a Low-power Radio-frequency Device which is designed to be connected to the AC power line, the radio frequency voltage that is conducted back onto the AC power line on any frequency or frequencies within the band 150 kHz to 30 MHz shall not exceed below limits table.

Frequency (MHz)	QP Limit (dBuV)	AV Limit (dBuV)
0.15~0.5	66~56	56~46
0.5~5	56	46
5~30	60	50

4.1.2. Measuring Instruments and Setting

Please refer to section 5 of equipments list in this report. The following table is the setting of the receiver.

Receiver Parameters	Setting
Attenuation	10 dB
Start Frequency	0.15 MHz
Stop Frequency	30 MHz
IF Bandwidth	9 kHz

4.1.3. Test Procedures

1. Configure the EUT according to ANSI C63.10. The EUT or host of EUT has to be placed 0.4 meter far from the conducting wall of the shielding room and at least 80 centimeters from any other grounded conducting surface.
2. Connect EUT or host of EUT to the power mains through a line impedance stabilization network (LISN).
3. All the support units are connected to the other LISNs. The LISN should provide 50uH/50ohms coupling impedance.
4. The frequency range from 150 kHz to 30 MHz was searched.
5. Set the test-receiver system to Peak Detect Function and Specified Bandwidth with Maximum Hold Mode.
6. The measurement has to be done between each power line and ground at the power terminal.

4.1.4. Test Setup Layout

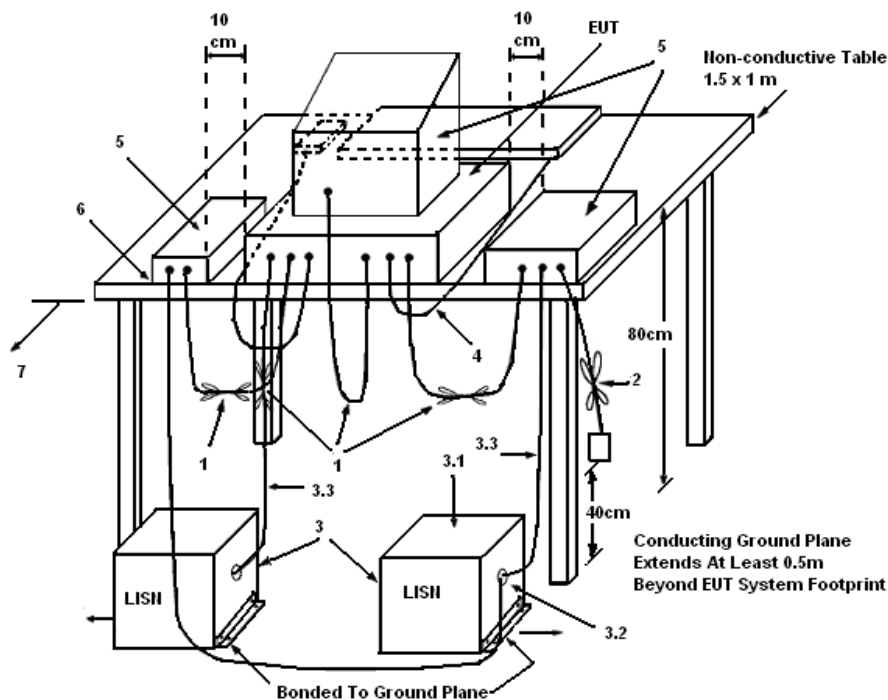

LEGEND:

- (1) Interconnecting cables that hang closer than 40 cm to the ground plane shall be folded back and forth in the center forming a bundle 30 to 40 cm long.
- (2) I/O cables that are not connected to a peripheral shall be bundled in the center. The end of the cable may be terminated, if required, using the correct terminating impedance. The overall length shall not exceed 1 m.
- (3) EUT connected to one LISN. Unused LISN measuring port connectors shall be terminated in 50 Ω . LISN can be placed on top of, or immediately beneath, reference ground plane.
 - (3.1) All other equipment powered from additional LISN(s).
 - (3.2) Multiple outlet strip can be used for multiple power cords of non-EUT equipment.
 - (3.3) LISN at least 80 cm from nearest part of EUT chassis.
- (4) Cables of hand-operated devices, such as keyboards, mice, etc., shall be placed as for normal use.
- (5) Non-EUT components of EUT system being tested.
- (6) Rear of EUT, including peripherals, shall all be aligned and flush with rear of tabletop.
- (7) Rear of tabletop shall be 40 cm removed from a vertical conducting plane that is bonded to the ground plane.

4.1.5. Test Deviation

There is no deviation with the original standard.

4.1.6. EUT Operation during Test

The EUT was placed on the test table and programmed in normal function.

4.1.7. Results of AC Power Line Conducted Emissions Measurement

Temperature	25°C	Humidity	57%
Test Engineer	Hank Yang	Phase	Line
Configuration	Normal Link	Test Mode	Mode 2

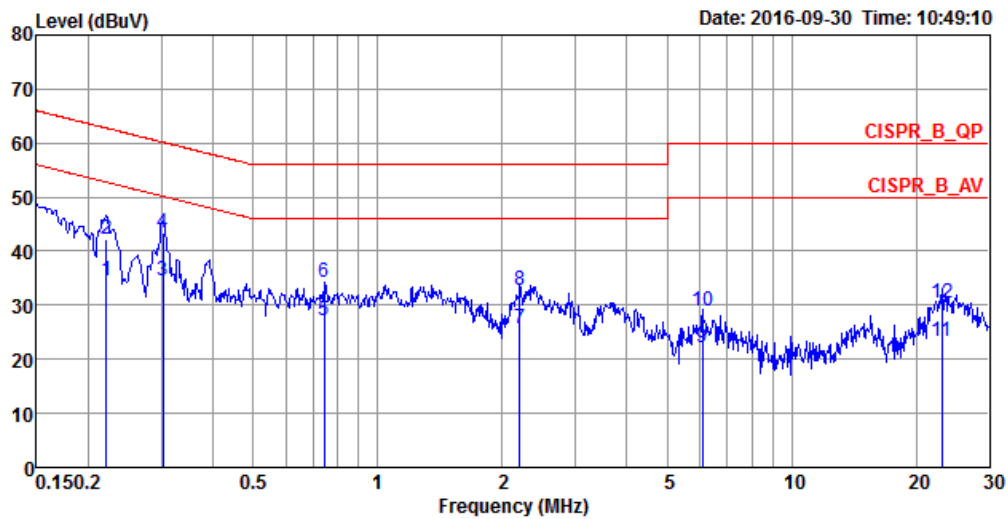

	Freq	Level	Over Limit	Limit Line	Read Level	LISN Factor	Cable Loss	Pol/Phase	Remark
	MHz	dBuV	dB	dBuV	dBuV	dB	dB		
1	0.2208	34.48	-18.31	52.79	24.49	9.96	0.03	LINE	Average
2	0.2208	42.21	-20.58	62.79	32.22	9.96	0.03	LINE	QP
3	0.3035	34.63	-15.52	50.15	24.64	9.95	0.04	LINE	Average
4	0.3035	43.44	-16.71	60.15	33.45	9.95	0.04	LINE	QP
5	0.7430	27.25	-18.75	46.00	17.25	9.96	0.04	LINE	Average
6	0.7430	34.13	-21.87	56.00	24.13	9.96	0.04	LINE	QP
7	2.2015	25.81	-20.19	46.00	15.75	10.00	0.06	LINE	Average
8	2.2015	32.82	-23.18	56.00	22.76	10.00	0.06	LINE	QP
9	6.0885	22.11	-27.89	50.00	11.90	10.08	0.13	LINE	Average
10	6.0885	28.85	-31.15	60.00	18.64	10.08	0.13	LINE	QP
11	23.0181	23.37	-26.63	50.00	12.70	10.40	0.27	LINE	Average
12	23.0181	30.37	-29.63	60.00	19.70	10.40	0.27	LINE	QP

Temperature	25°C	Humidity	57%
Test Engineer	Hank Yang	Phase	Neutral
Configuration	Normal Link	Test Mode	Mode 2

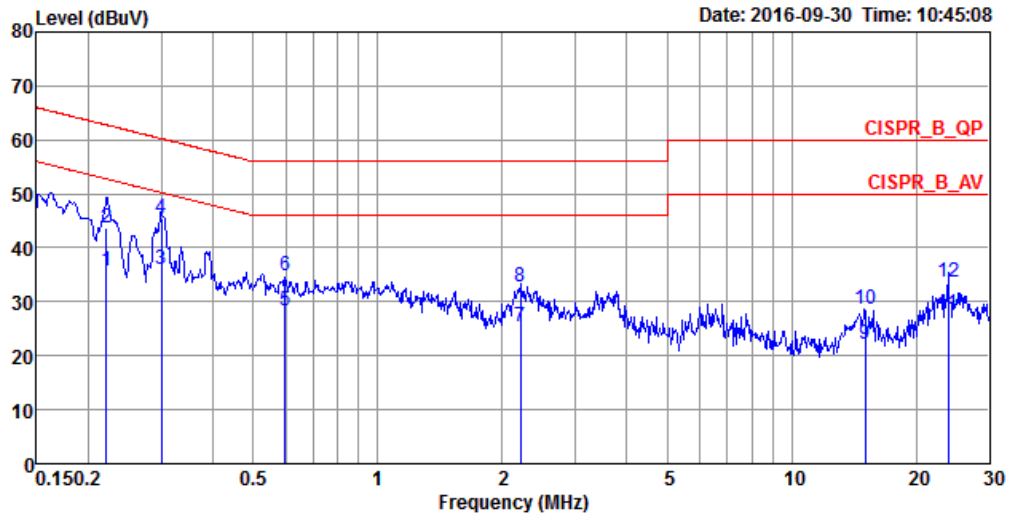

	Freq	Level	Over Limit	Limit Line	Read Level	LISN Factor	Cable Loss	Pol/Phase	Remark
	MHz	dBuV	dB	dBuV	dBuV	dB	dB		
1	0.2208	35.61	-17.18	52.79	25.61	9.97	0.03	NEUTRAL	Average
2	0.2208	43.60	-19.19	62.79	33.60	9.97	0.03	NEUTRAL	QP
3	0.3003	35.94	-14.30	50.24	25.94	9.96	0.04	NEUTRAL	Average
4	0.3003	45.33	-14.91	60.24	35.33	9.96	0.04	NEUTRAL	QP
5	0.5979	28.26	-17.74	46.00	18.25	9.97	0.04	NEUTRAL	Average
6	0.5979	34.98	-21.02	56.00	24.97	9.97	0.04	NEUTRAL	QP
7	2.2132	25.49	-20.51	46.00	15.43	10.00	0.06	NEUTRAL	Average
8	2.2132	32.67	-23.33	56.00	22.61	10.00	0.06	NEUTRAL	QP
9	15.0750	22.02	-27.98	50.00	11.53	10.23	0.26	NEUTRAL	Average
10	15.0750	28.66	-31.34	60.00	18.17	10.23	0.26	NEUTRAL	QP
11	23.8476	27.64	-22.36	50.00	17.03	10.34	0.27	NEUTRAL	Average
12	23.8476	33.65	-26.35	60.00	23.04	10.34	0.27	NEUTRAL	QP

Note: Level = Read Level + LISN Factor + Cable Loss.

4.2. Maximum Conducted Output Power Measurement

4.2.1. Limit

For frequency hopping systems operating in the 2400-2483.5 MHz band employing at least 75 non-overlapping hopping channels, the limit for peak output power is 1Watt (30dBm). For all other frequency hopping systems in the 2400-2483.5 MHz band: 0.125 watts (21dBm).

4.2.2. Measuring Instruments and Setting

Please refer to section 5 of equipments list in this report. The following table is the setting of the power meter.

Power Meter Parameter	Setting
Bandwidth	50MHz bandwidth is greater than the EUT emission bandwidth
Detector	Peak and Average

4.2.3. Test Procedures

This procedure provides an alternative for determining the RMS output power using a broadband RF average power meter with a thermocouple detector.

4.2.4. Test Setup Layout

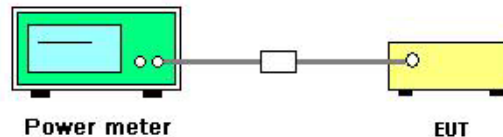

4.2.5. Test Deviation

There is no deviation with the original standard.

4.2.6. EUT Operation during Test

The EUT was programmed to be in continuously transmitting mode.

4.2.7. Test Result of Maximum Conducted Output Power

Temperature	20°C	Humidity	50%
Test Engineer	Eddie Weng	Configurations	GFSK, $\pi/4$ -DQPSK, 8DPSK
Test Date	Sep. 19, 2016~Sep. 23, 2016		

For BR (GFSK) 1 Mbps:

Channel	Frequency	Conducted Peak Power (dBm)	Conducted Average Power (dBm)	Max. Limit (dBm)	Result
0	2402 MHz	8.29	8.04	21.00	Complies
39	2441 MHz	7.59	7.34	21.00	Complies
78	2480 MHz	5.96	5.53	21.00	Complies

For EDR ($\pi/4$ -DQPSK) 2 Mbps:

Channel	Frequency	Conducted Peak Power (dBm)	Conducted Average Power (dBm)	Max. Limit (dBm)	Result
0	2402 MHz	6.93	4.52	21.00	Complies
39	2441 MHz	6.47	3.92	21.00	Complies
78	2480 MHz	5.02	2.31	21.00	Complies

For EDR (8DPSK) 3 Mbps:

Channel	Frequency	Conducted Peak Power (dBm)	Conducted Average Power (dBm)	Max. Limit (dBm)	Result
0	2402 MHz	7.27	4.56	21.00	Complies
39	2441 MHz	6.57	3.97	21.00	Complies
78	2480 MHz	5.36	2.35	21.00	Complies

4.3. Hopping Channel Separation Measurement

4.3.1. Limit

Frequency hopping systems shall have hopping channel carrier frequencies separated by a minimum of 25 kHz or the 20 dB bandwidth of the hopping channel, whichever is greater. Alternatively, frequency hopping systems operating in the 2400-2483.5 MHz band may have hopping channel carrier frequencies that are separated by 25 kHz or two-thirds of the 20 dB bandwidth of the hopping channel, whichever is greater.

4.3.2. Measuring Instruments and Setting

Please refer to section 5 of equipments list in this report. The following table is the setting of spectrum analyzer.

Spectrum Parameter	Setting
Attenuation	Auto
Span Frequency	> Measurement Bandwidth or Channel Separation
RBW	30 kHz (20dB Bandwidth) / 100 kHz (Channel Separation)
VBW	100 kHz (20dB Bandwidth) / 100 kHz (Channel Separation)
Detector	Peak
Trace	Max Hold
Sweep Time	Auto

4.3.3. Test Procedures

1. The transmitter output (antenna port) was connected to the spectrum analyzer in peak hold mode.
2. The resolution bandwidth of 30 kHz and the video bandwidth of 100 kHz were utilized for 20 dB bandwidth measurement.
3. The resolution bandwidth of 100 kHz and the video bandwidth of 100 kHz were utilized for channel separation measurement.

4.3.4. Test Setup Layout

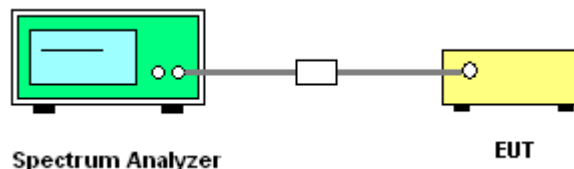

4.3.5. Test Deviation

There is no deviation with the original standard.

4.3.6. EUT Operation during Test

The EUT was programmed to be in continuously transmitting mode.

4.3.7. Test Result of Hopping Channel Separation

Temperature	20°C	Humidity	50%
Test Engineer	Eddie Weng	Configurations	GFSK, $\pi/4$ -DQPSK, 8DPSK

For BR (GFSK) 1 Mbps:

Frequency	20dB Bandwidth (MHz)	99% Occupied Bandwidth (MHz)	Ch. Separation (MHz)	Two-Thirds of 20dB Bandwidth (MHz)	Result
2402 MHz	0.939	0.894	1.00	0.626	Complies
2441 MHz	0.965	0.903	1.00	0.643	Complies
2480 MHz	0.939	0.903	1.00	0.626	Complies

Ch. Separation Limits: >20dB bandwidth or > Two-Thirds of 20dB bandwidth

For EDR ($\pi/4$ -DQPSK) 2 Mbps:

Frequency	20dB Bandwidth (MHz)	99% Occupied Bandwidth (MHz)	Ch. Separation (MHz)	Two-Thirds of 20dB Bandwidth (MHz)	Result
2402 MHz	1.352	1.207	1.00	0.901	Complies
2441 MHz	1.357	1.207	1.00	0.905	Complies
2480 MHz	1.352	1.207	1.00	0.901	Complies

Ch. Separation Limits: >20dB bandwidth or > Two-Thirds of 20dB bandwidth

For EDR (8DPSK) 3 Mbps:

Frequency	20dB Bandwidth (MHz)	99% Occupied Bandwidth (MHz)	Ch. Separation (MHz)	Two-Thirds of 20dB Bandwidth (MHz)	Result
2402 MHz	1.322	1.211	1.00	0.881	Complies
2441 MHz	1.322	1.203	1.00	0.881	Complies
2480 MHz	1.326	1.207	1.00	0.884	Complies

Ch. Separation Limits: >20dB bandwidth or > Two-Thirds of 20dB bandwidth

20 dB Bandwidth Plot on BR (GFSK) 1 Mbps / Channel 0 / 2402 MHz

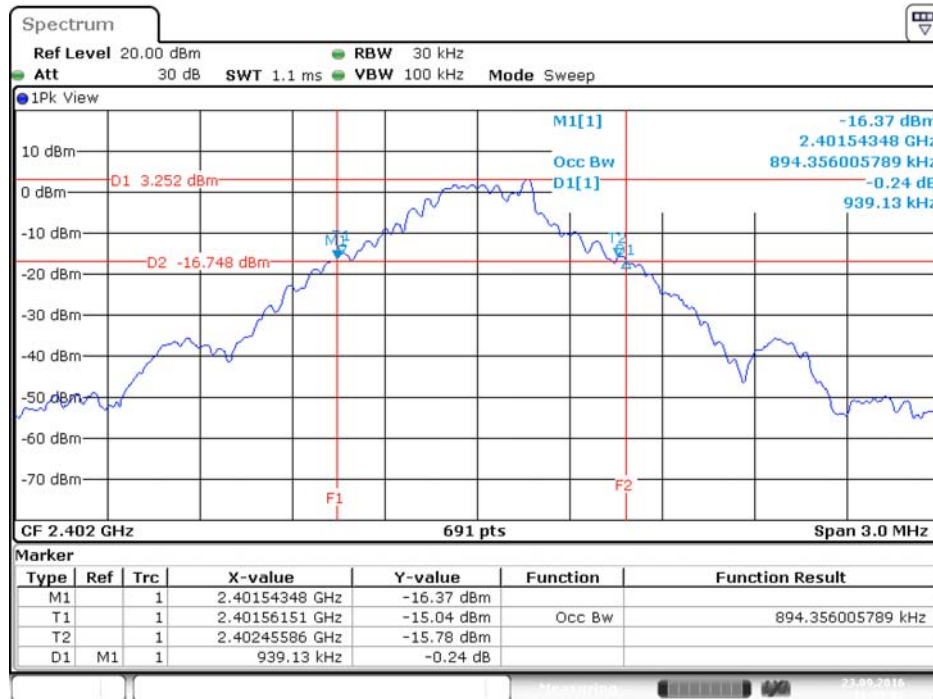

Date: 23.SEP.2016 16:37:00

20 dB Bandwidth Plot on BR (GFSK) 1 Mbps / Channel 39 / 2441 MHz

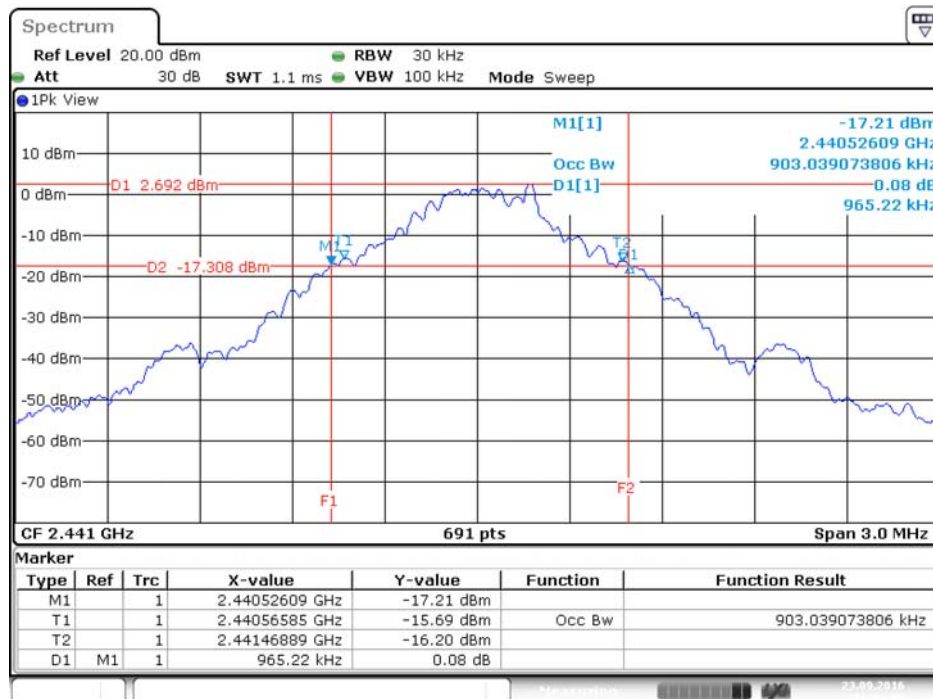

Date: 23.SEP.2016 16:39:56

20 dB Bandwidth Plot on BR (GFSK) 1 Mbps / Channel 78 / 2480 MHz

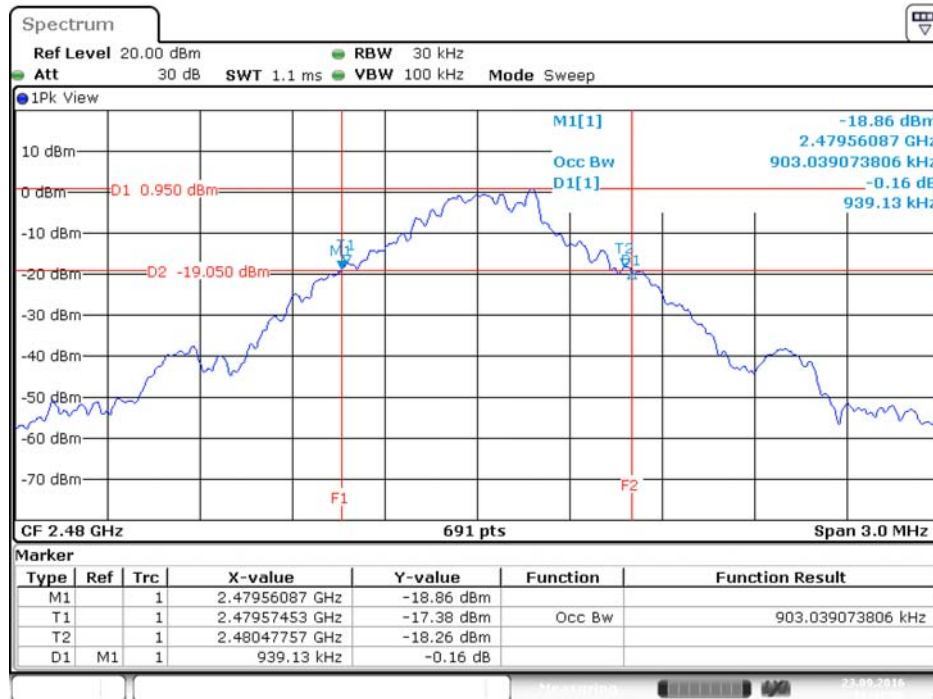

Date: 23.SEP.2016 16:41:26

Channel Separation Plot on BR (GFSK) 1 Mbps / Channel 0~1 / 2402 MHz ~ 2403 MHz

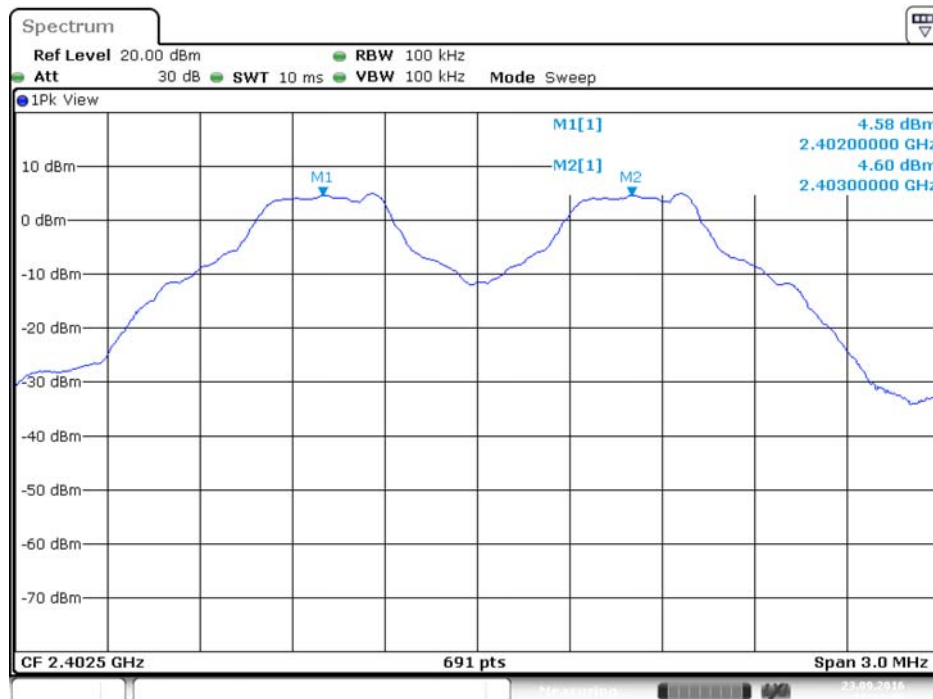

Date: 23.SEP.2016 17:11:50

Channel Separation Plot on BR (GFSK) 1 Mbps / Channel 39~40 / 2441 MHz ~ 2442 MHz

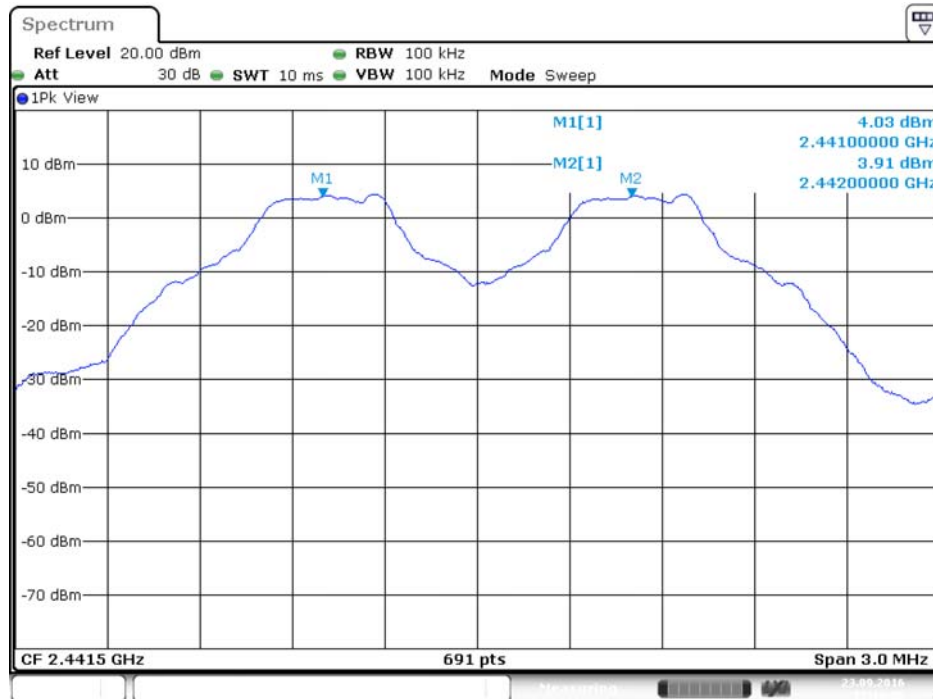

Date: 23.SEP.2016 17:14:26

Channel Separation Plot on BR (GFSK) 1 Mbps / Channel 77~78 / 2479 MHz ~ 2480 MHz

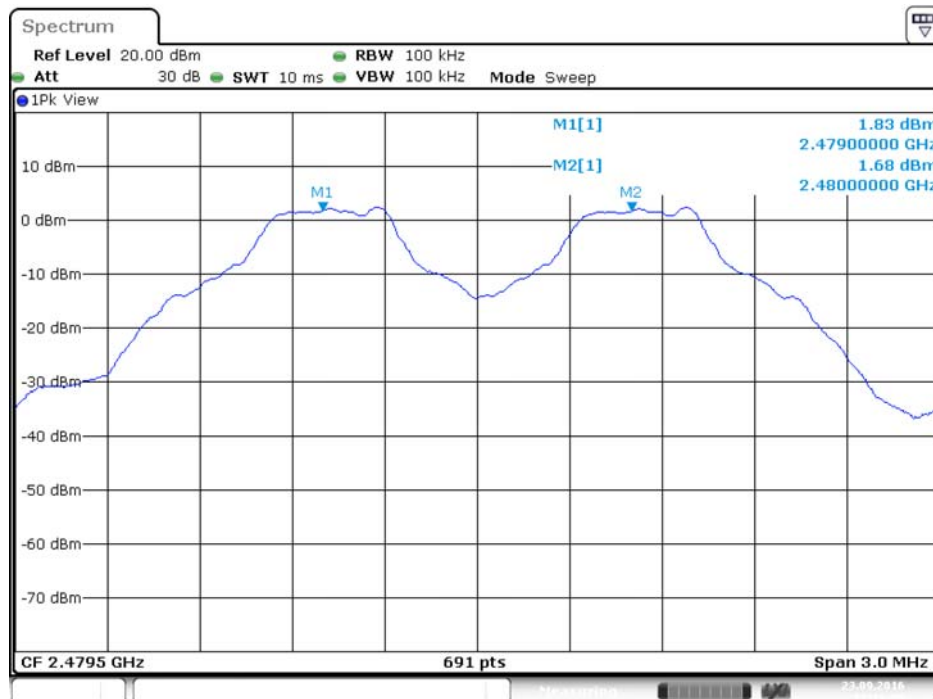

Date: 23.SEP.2016 17:16:30

20 dB Bandwidth Plot on EDR ($\pi/4$ -DQPSK) 2 Mbps / Channel 0 / 2402 MHz

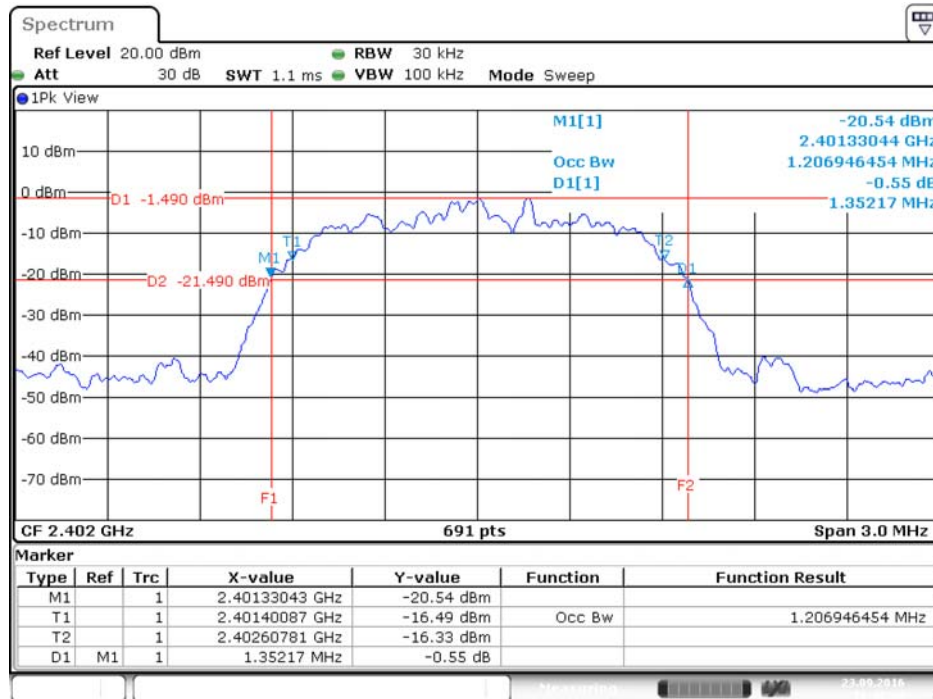

Date: 23.SEP.2016 16:42:34

20 dB Bandwidth Plot on EDR ($\pi/4$ -DQPSK) 2 Mbps / Channel 39 / 2441 MHz

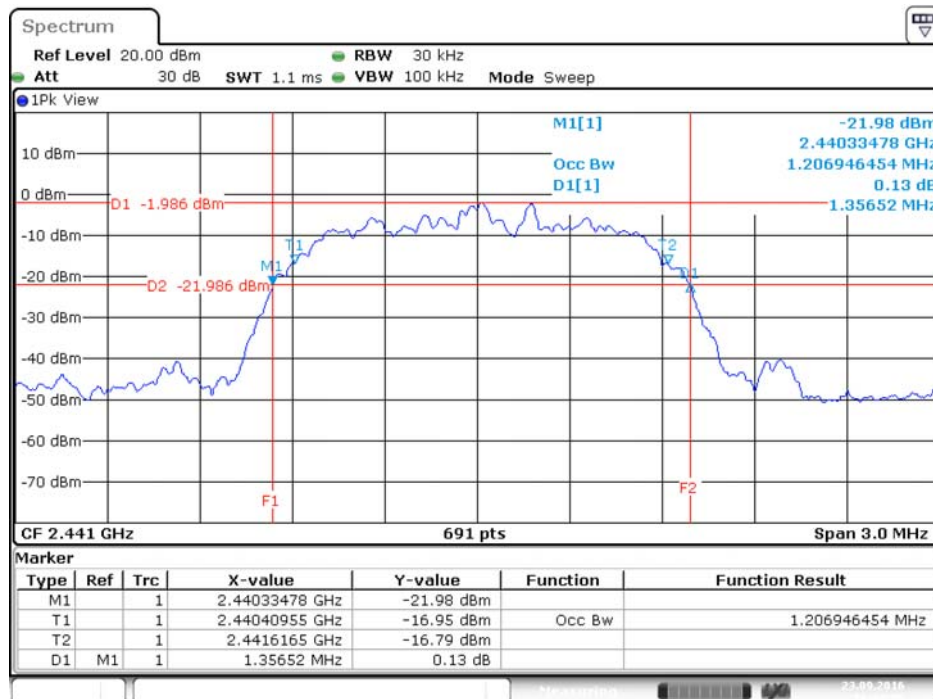

Date: 23.SEP.2016 16:43:36

20 dB Bandwidth Plot on EDR ($\pi/4$ -DQPSK) 2 Mbps / Channel 78 / 2480 MHz

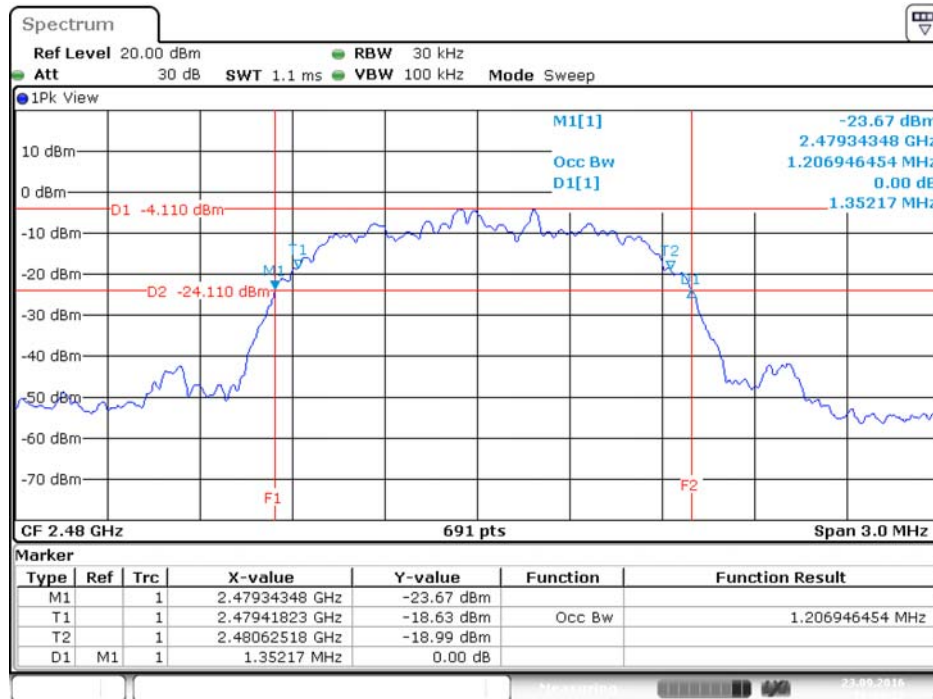

Date: 23.SEP.2016 16:44:37

Channel Separation Plot on EDR ($\pi/4$ -DQPSK) 2 Mbps / Channel 0~1 / 2402 MHz ~ 2403 MHz

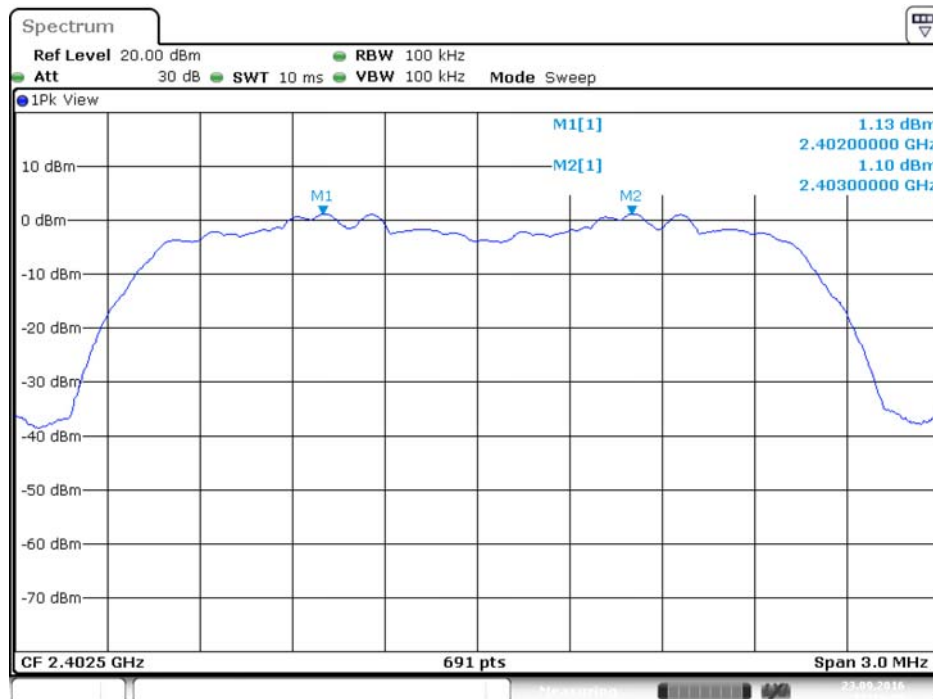

Date: 23.SEP.2016 17:19:09

Channel Separation Plot on EDR ($\pi/4$ -DQPSK) 2 Mbps / Channel 39~40 / 2441 MHz ~ 2442 MHz

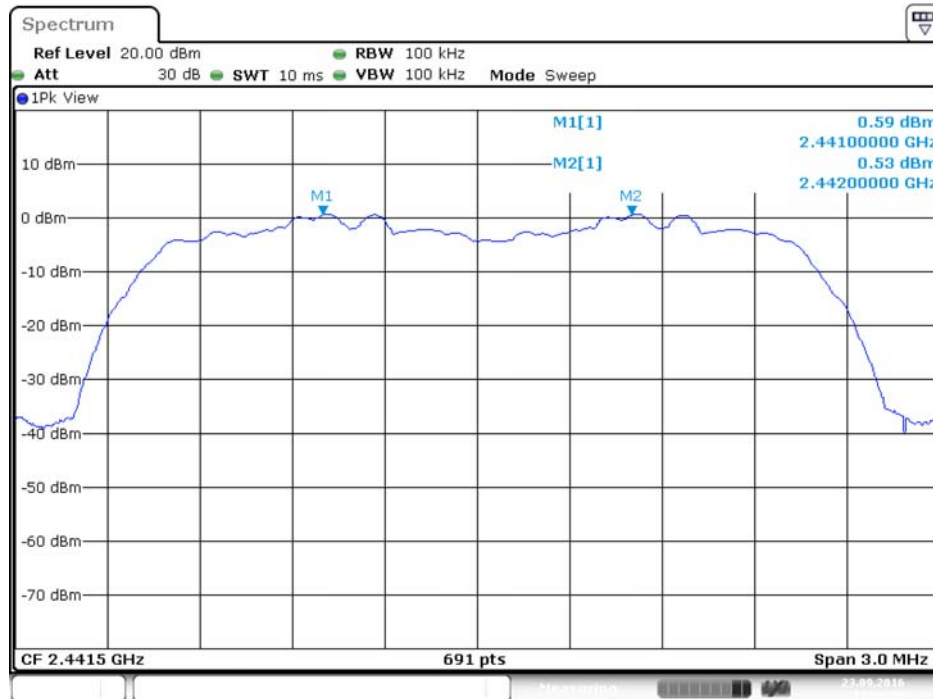

Date: 23.SEP.2016 17:20:53

Channel Separation Plot on EDR ($\pi/4$ -DQPSK) 2 Mbps / Channel 77~78 / 2479 MHz ~ 2480 MHz

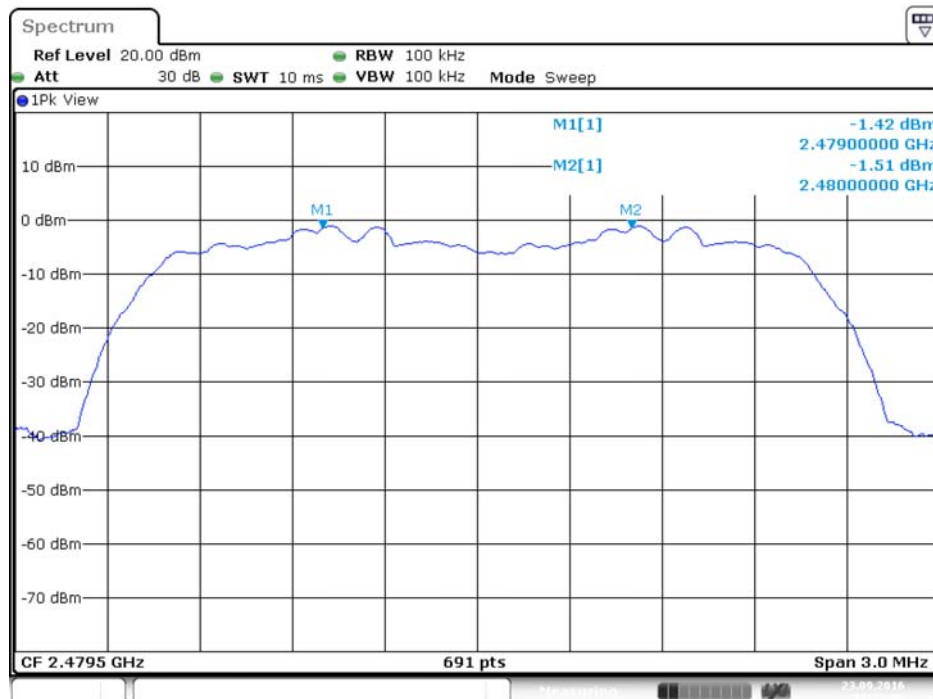

Date: 23.SEP.2016 17:23:06

20 dB Bandwidth Plot on EDR (8DPSK) 3 Mbps / Channel 0 / 2402 MHz

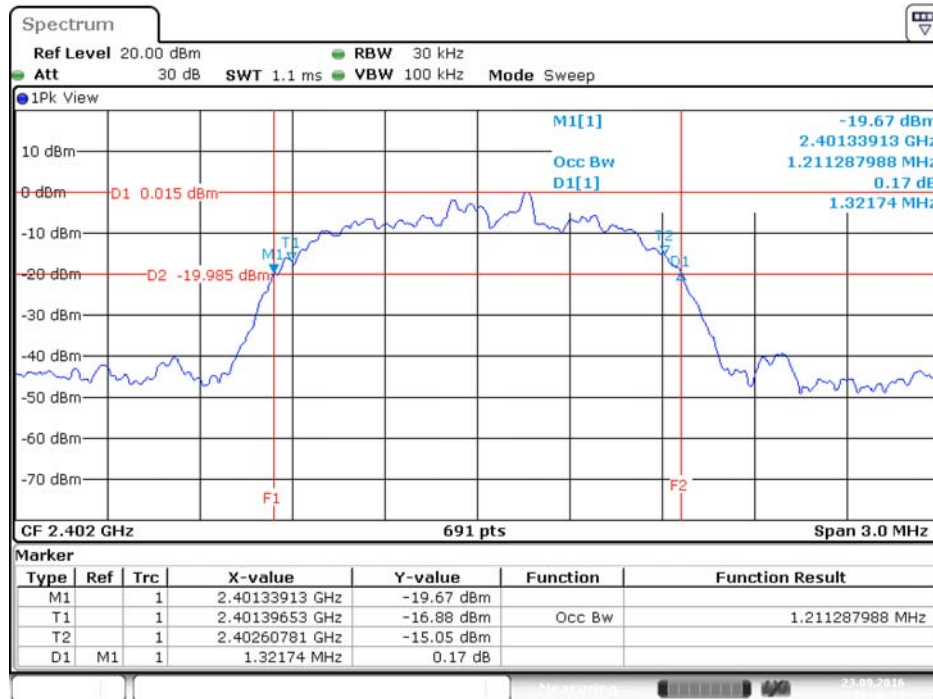

20 dB Bandwidth Plot on EDR (8DPSK) 3 Mbps / Channel 39 / 2441 MHz

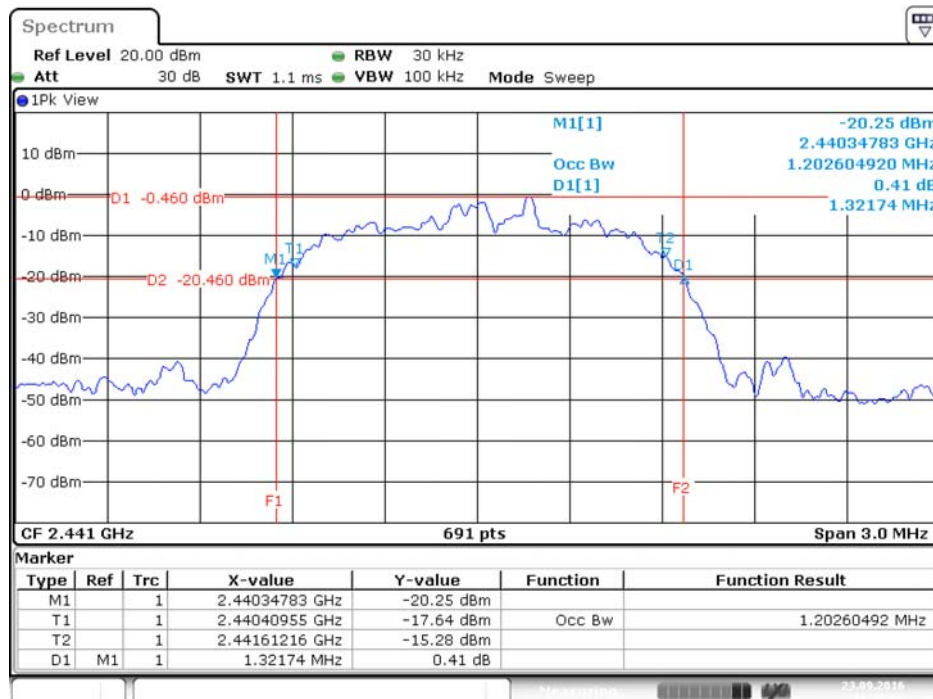

20 dB Bandwidth Plot on EDR (8DPSK) 3 Mbps / Channel 78 / 2480 MHz

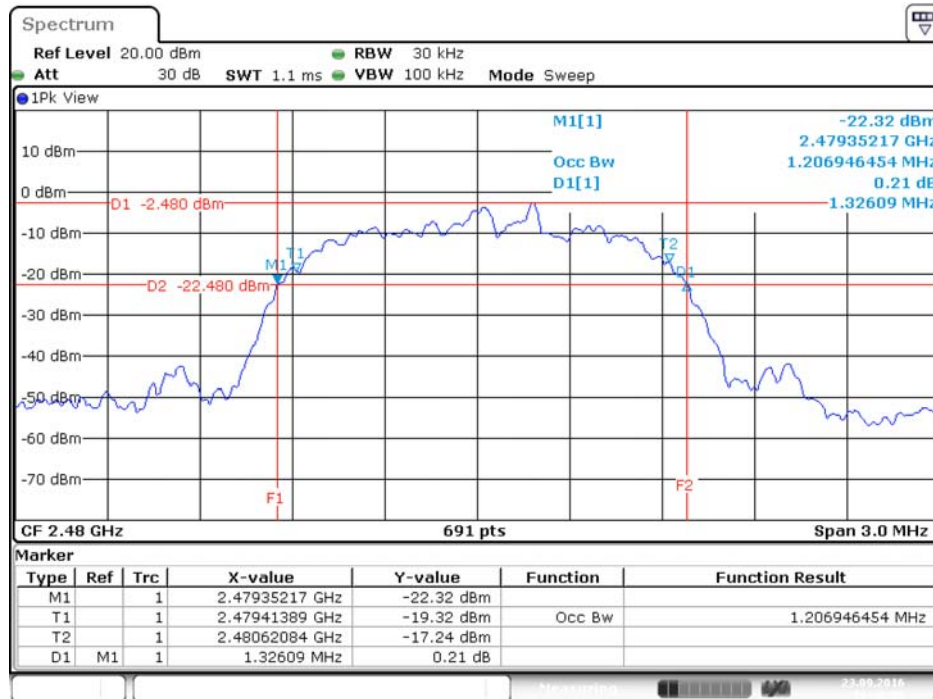

Date: 23.SEP.2016 16:48:36

Channel Separation Plot on EDR (8DPSK) 3 Mbps / Channel 0~1 / 2402 MHz ~ 2403 MHz

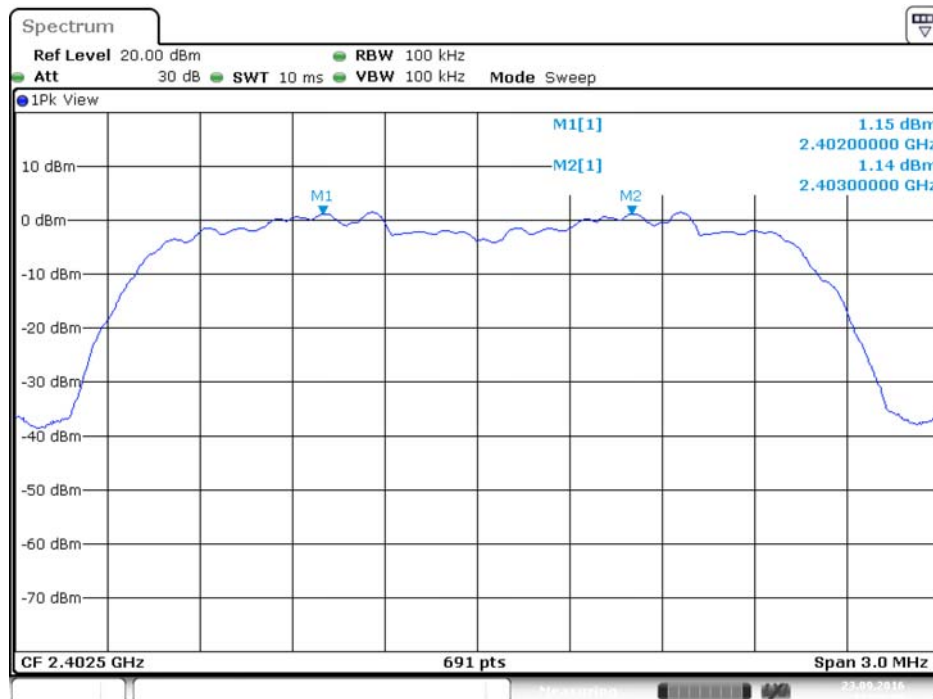

Date: 23.SEP.2016 17:25:00

Channel Separation Plot on EDR (8DPSK) 3 Mbps / Channel 39~40 / 2441 MHz ~ 2442 MHz

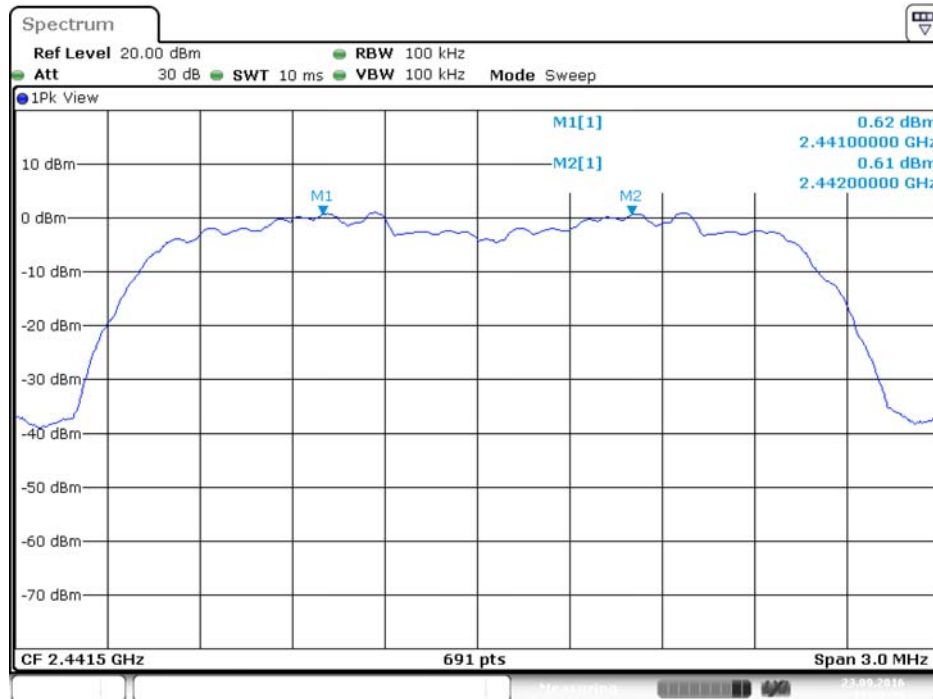

Channel Separation Plot on EDR (8DPSK) 3 Mbps / Channel 77~78 / 2479 MHz ~ 2480 MHz

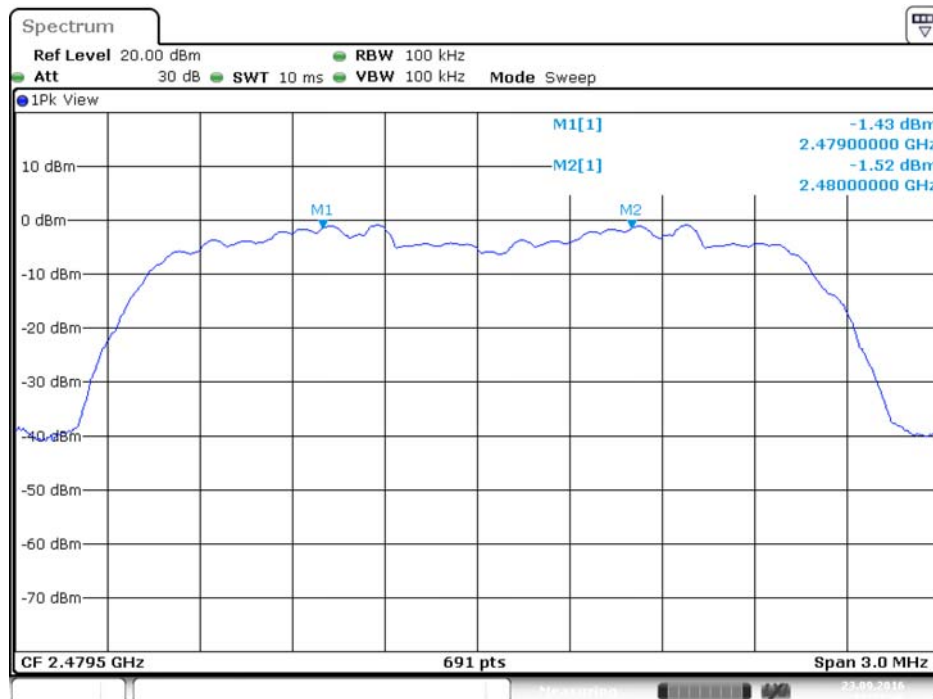

4.4. Number of Hopping Frequency Measurement

4.4.1. Limit

At least 15 hopping frequencies, and should be equally spaced.

4.4.2. Measuring Instruments and Setting

Please refer to section 5 of equipments list in this report. The following table is the setting of spectrum analyzer.

Spectrum Parameters	Setting
Attenuation	Auto
Span Frequency	> Operating Frequency Range
RBW	1000 kHz
VBW	1000 kHz
Detector	Peak
Trace	Max Hold
Sweep Time	Auto

4.4.3. Test Procedures

1. The transmitter output (antenna port) was connected to the spectrum analyzer in peak hold mode.
2. The resolution bandwidth of 1000 kHz and the video bandwidth of 1000 kHz were utilized.
3. Observe frequency hopping in 2400MHz~2483.5MHz, there are at least 75 non-overlapping channels.

4.4.4. Test Setup Layout

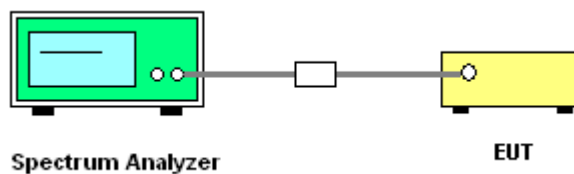

4.4.5. Test Deviation

There is no deviation with the original standard.

4.4.6. EUT Operation during Test

The EUT was programmed to be in continuously transmitting mode.

4.4.7. Test Result of Number of Hopping Frequency

Temperature	20°C	Humidity	50%
Test Engineer	Eddie Weng	Configurations	EDR (8DPSK)

Modulation Type	Channel No.	Frequency (MHz)	Hopping Ch. (Channels)	Min. Limit (Channels)	Test Result
EDR (8DPSK)	0 ~ 78	2402 ~ 2480MHz	79	15	Complies

Number of Hopping Channel Plot on EDR (8DPSK) / Channel 0~78 / 2402 MHz ~ 2480 MHz

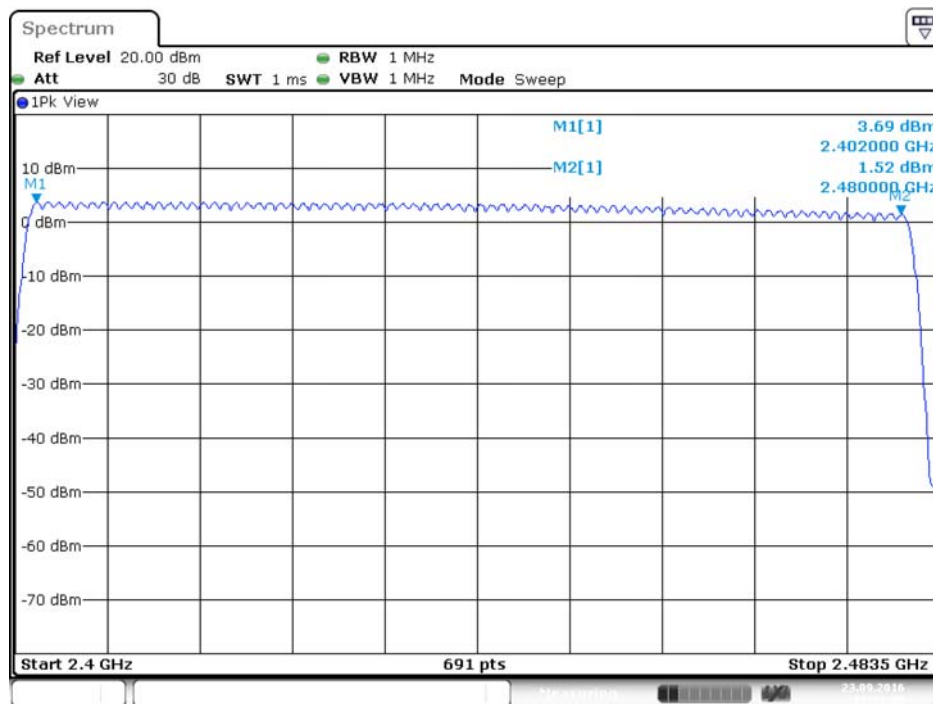

Date: 23.SEP.2016 17:31:50

4.5. Dwell Time Measurement

4.5.1. Limit

Frequency hopping systems in the 2400-2483.5 MHz band shall use at least 15 channels. The average time of occupancy on any channel shall not be greater than 0.4 seconds within a period of 0.4 seconds multiplied by the number of hopping channels employed.

4.5.2. Measuring Instruments and Setting

Please refer to section 5 of equipments list in this report. The following table is the setting of spectrum analyzer.

Spectrum Parameter	Setting
Attenuation	Auto
Span Frequency	0 MHz
RBW	1000 kHz
VBW	1000 kHz
Detector	Peak
Trace	Single Trigger

4.5.3. Test Procedures

1. The transmitter output (antenna port) was connected to the spectrum analyzer
2. Set RBW of spectrum analyzer to 1000kHz and VBW to 1000kHz.
3. Use a video trigger with the trigger level set to enable triggering only on full pulses.
4. Sweep Time is more than once pulse time.
5. Set the center frequency on any frequency would be measure and set the frequency span to zero span.
6. Measure the maximum time duration of one single pulse.
7. Set the EUT for DH1, DH3, DH5 packet transmitting.
8. Measure the maximum time duration of one single pulse.

4.5.4. Test Setup Layout

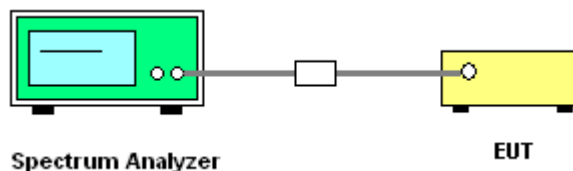

4.5.5. Test Deviation

There is no deviation with the original standard.

4.5.6. EUT Operation during Test

The EUT was programmed to be in continuously transmitting mode.

4.5.7. Test Result of Dwell Time

Temperature	20°C	Humidity	50%
Test Engineer	Eddie Weng	Configurations	BR (GFSK) / DH1, DH3, DH5

Data Packet	Frequency (MHz)	Pulse Duration (ms)	Dwell Time (s)	Limits (s)	Test Result
DH1	2402 MHz	0.3913	0.1252	0.4000	Complies
DH3	2402 MHz	1.6435	0.2630	0.4000	Complies
DH5	2402 MHz	2.8319	0.3021	0.4000	Complies
DH1	2441 MHz	0.3870	0.1238	0.4000	Complies
DH3	2441 MHz	1.6319	0.2611	0.4000	Complies
DH5	2441 MHz	2.8174	0.3005	0.4000	Complies
DH1	2480 MHz	0.3913	0.1252	0.4000	Complies
DH3	2480 MHz	1.6435	0.2630	0.4000	Complies
DH5	2480 MHz	2.8174	0.3005	0.4000	Complies

Note: Pulse Duration * Number of Pulses*(Dwell time / measure time)

Remark:

Dwell Time = 79(channels) x 0.4(s) x average hopping channel x package transfer time (us)

79 channels come from the Hopping Channel number.

Average Hopping Channel = hops / sweep time

Dwell Time Plot on BR (GFSK) / Channel 0 / DH1 / 2402 MHz

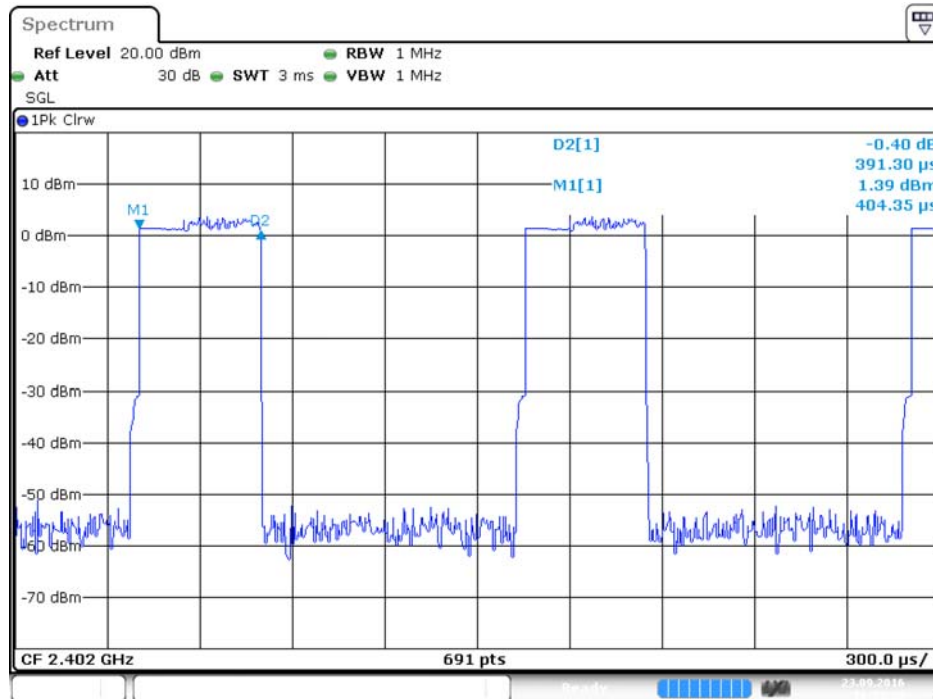

Date: 23.SEP.2016 16:53:25

Dwell Time Plot on BR (GFSK) / Channel 39 / DH1 / 2441 MHz

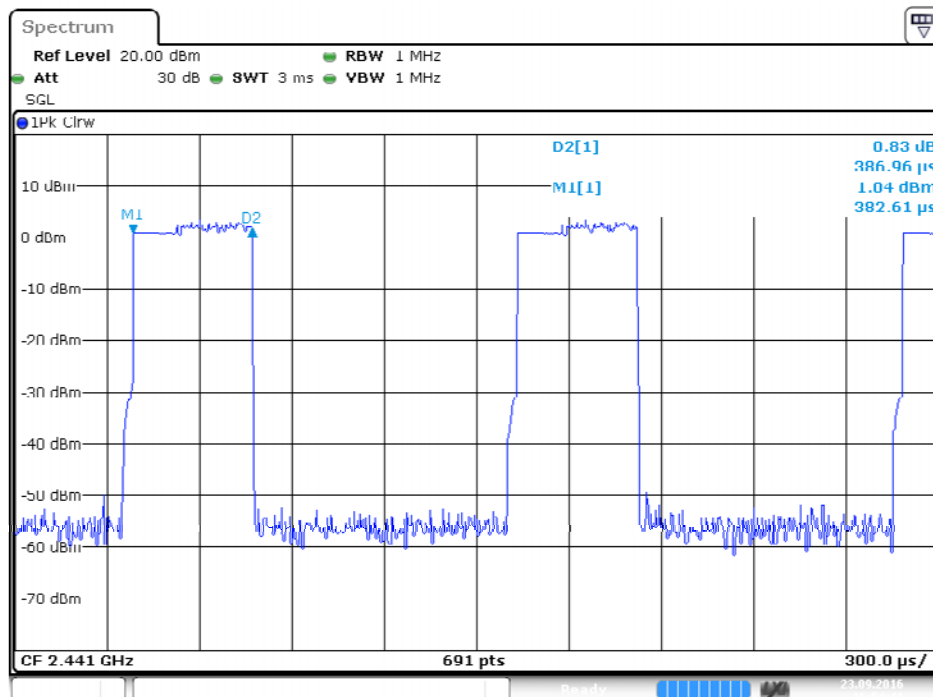

Date: 23.SEP.2016 16:54:41

Dwell Time Plot on BR (GFSK) / Channel 78 / DH1 / 2480 MHz

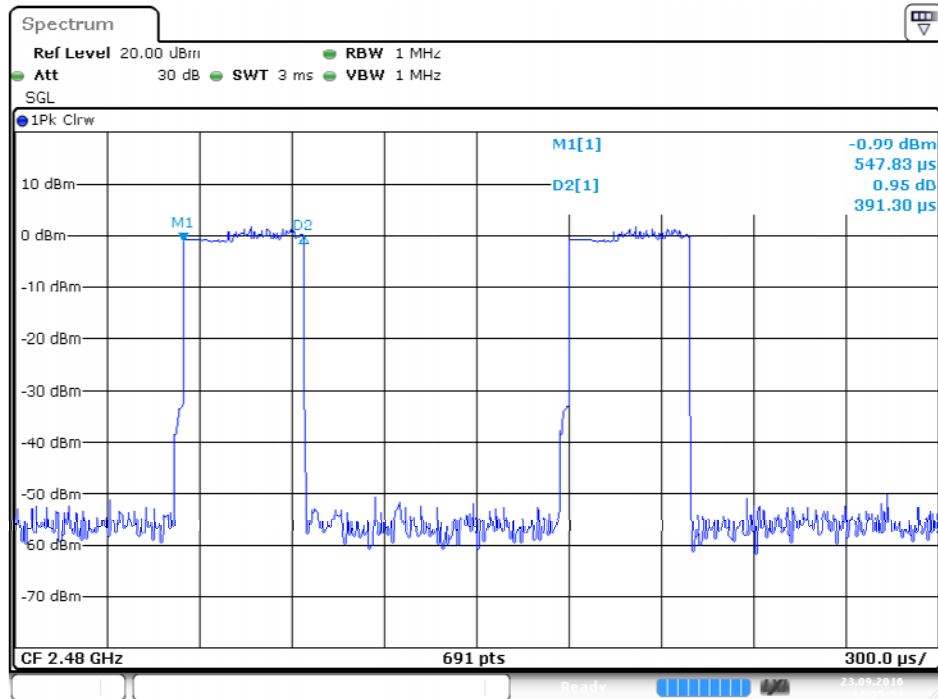

Dwell Time Plot on BR (GFSK) / Channel 0 / DH3 / 2402 MHz

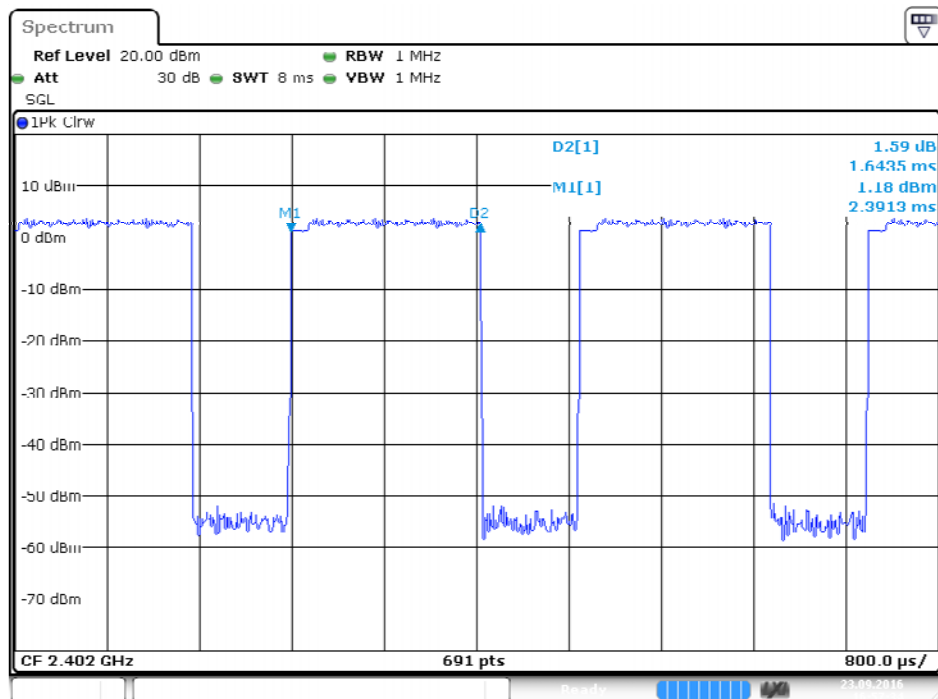

Dwell Time Plot on BR (GFSK) / Channel 39 / DH3 / 2441 MHz

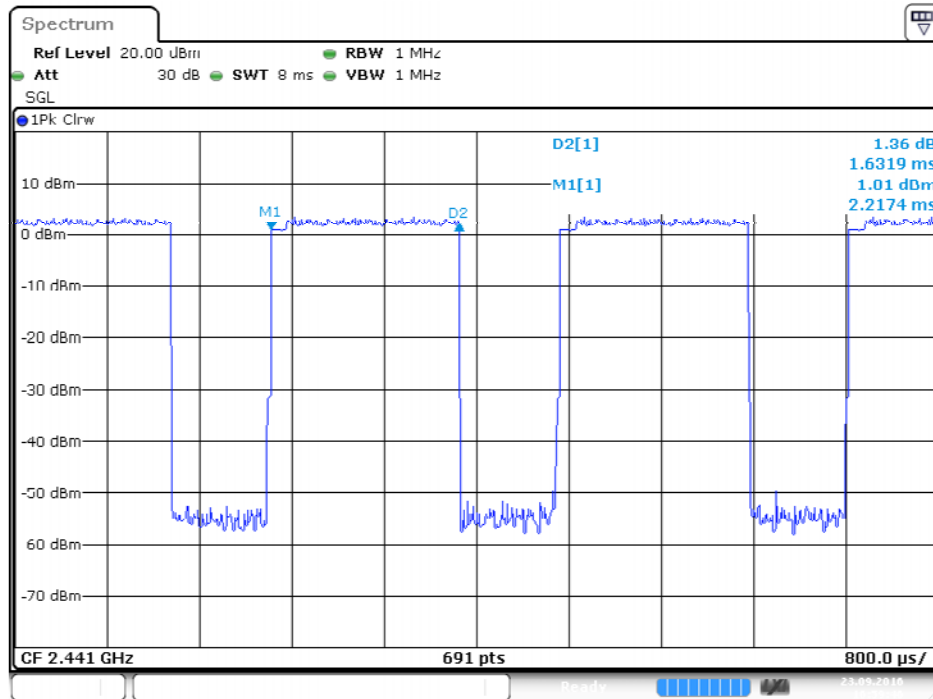

Dwell Time Plot on BR (GFSK) / Channel 78 / DH3 / 2480 MHz

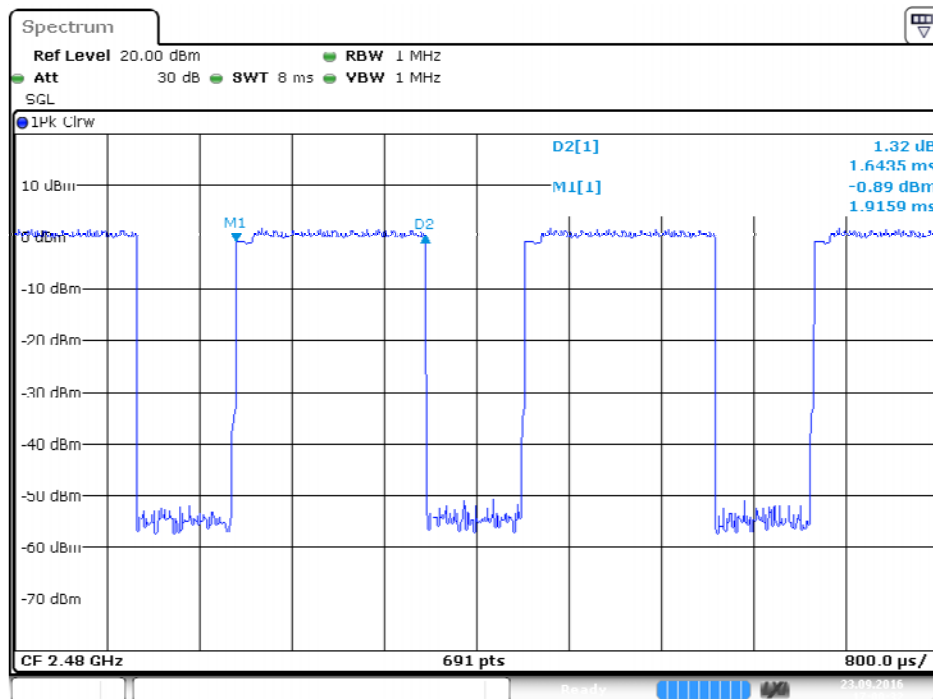

Dwell Time Plot on BR (GFSK) / Channel 0 / DH5 / 2402 MHz

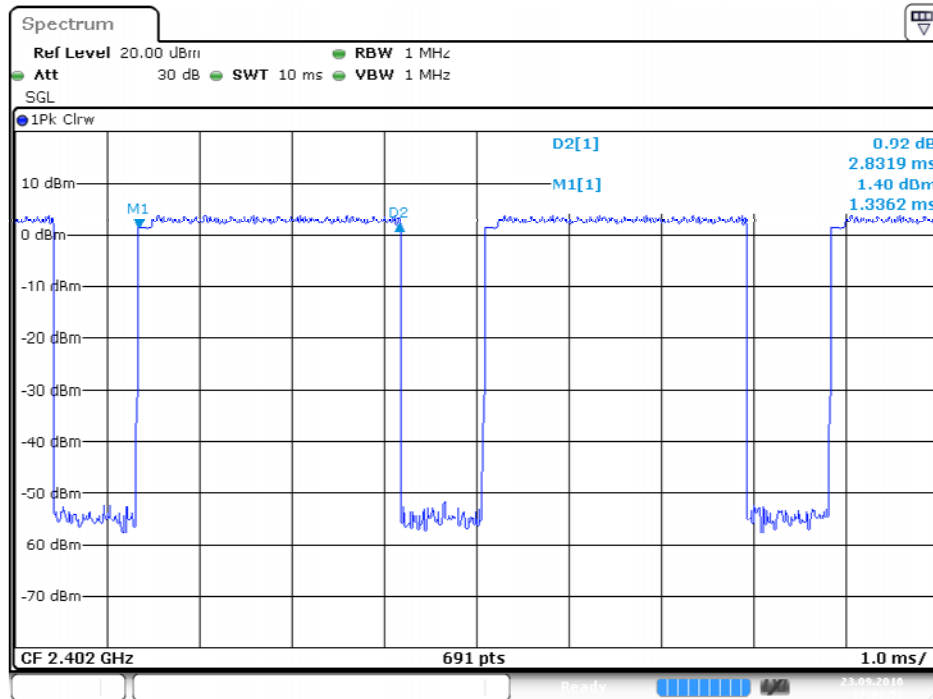

Date: 23.SEP.2016 17:01:52

Dwell Time Plot on BR (GFSK) / Channel 39 / DH5 / 2441 MHz

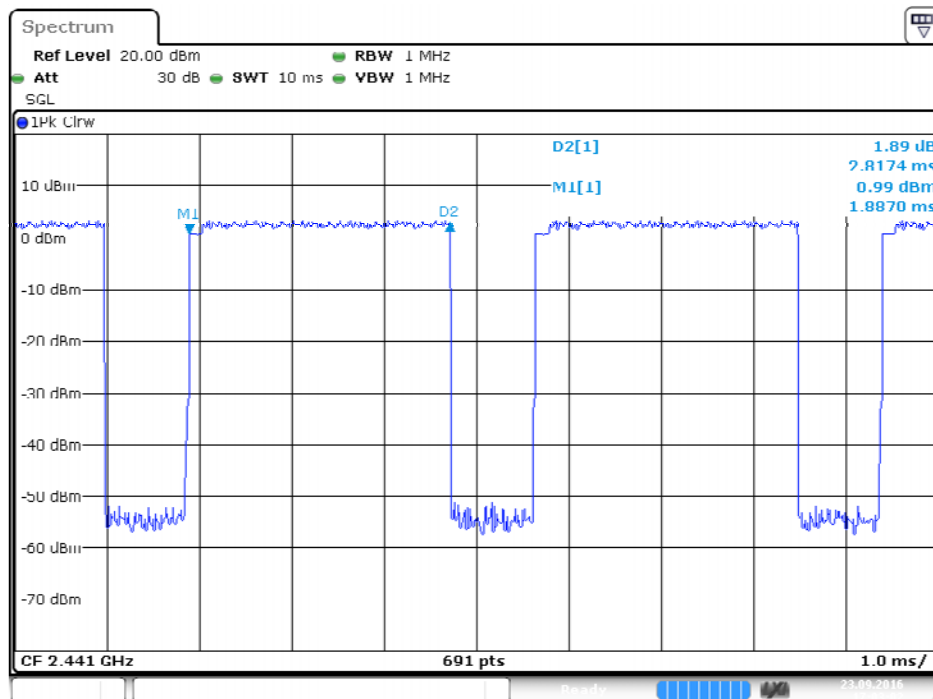

Date: 23.SEP.2016 17:03:02

Dwell Time Plot on BR (GFSK) / Channel 78 / DH5 / 2480 MHz

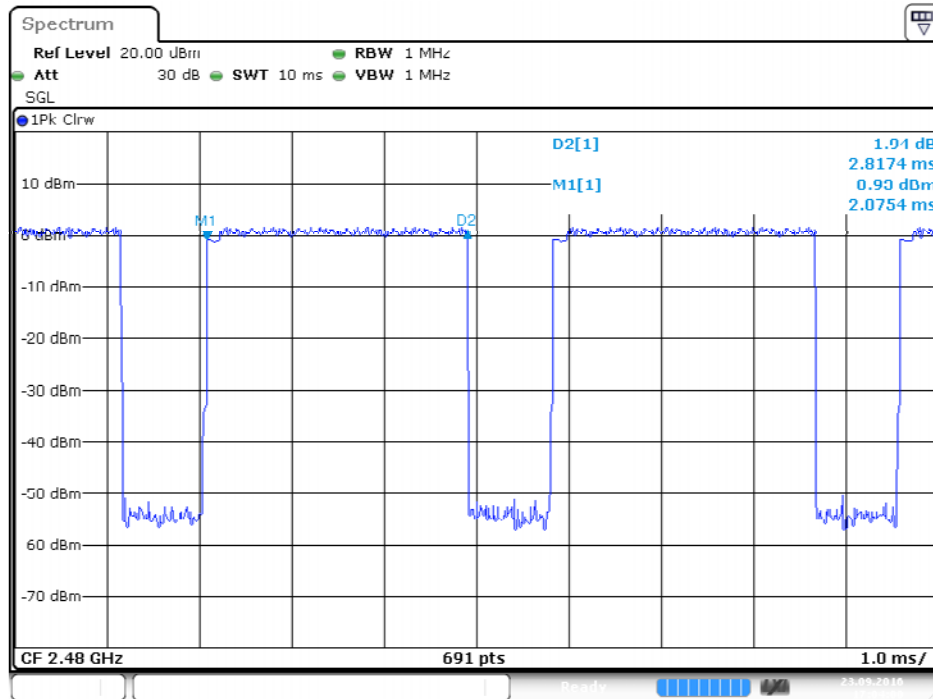

Date: 23.SEP.2016 17:04:00

4.6. Radiated Emissions Measurement

4.6.1. Limit

20dBc in any 100 kHz bandwidth outside the operating frequency band. In case the emission fall within the restricted band specified on 15.205(a), then the 15.209(a) limit in the table below has to be followed.

Frequencies (MHz)	Field Strength (micorvolts/meter)	Measurement Distance (meters)
0.009~0.490	2400/F(kHz)	300
0.490~1.705	24000/F(kHz)	30
1.705~30.0	30	30
30~88	100	3
88~216	150	3
216~960	200	3
Above 960	500	3

4.6.2. Measuring Instruments and Setting

Please refer to section 5 of equipments list in this report. The following table is the setting of spectrum analyzer and receiver.

Spectrum Parameter	Setting
Attenuation	Auto
Start Frequency	1000 MHz
Stop Frequency	10th carrier harmonic
RBW / VBW (Emission in restricted band)	1 MHz / 3MHz for Peak, 1 MHz / 1/T for Average
RBW / VBW (Emission in non-restricted band)	100kHz, 300kHz for peak

Receiver Parameter	Setting
Attenuation	Auto
Start ~ Stop Frequency	9kHz~150kHz, RBW 200Hz for QP
Start ~ Stop Frequency	150kHz~30MHz, RBW 9kHz for QP
Start ~ Stop Frequency	30MHz~1000MHz, RBW 120kHz for QP

4.6.3. Test Procedures

1. Configure the EUT according to ANSI C63.10. The EUT was placed on the top of the turntable 1.5 meter above ground. The phase center of the receiving antenna mounted on the top of a height-variable antenna tower was placed 1m & 3m far away from the turntable.
2. Power on the EUT and all the supporting units. The turntable was rotated by 360 degrees to determine the position of the highest radiation.
3. The height of the broadband receiving antenna was varied between one meter and four meters above ground to find the maximum emissions field strength of both horizontal and vertical polarization.
4. For each suspected emissions, the antenna tower was scan (from 1 M to 4 M) and then the turntable was rotated (from 0 degree to 360 degrees) to find the maximum reading.
5. Set the test-receiver system to Peak or CISPR quasi-peak Detect Function with specified bandwidth under Maximum Hold Mode.
6. For emissions above 1GHz, use 1MHz VBW and 3MHz RBW for peak reading. Then 1MHz RBW and 1/T VBW for average reading in spectrum analyzer.
7. When the radiated emissions limits are expressed in terms of the average value of the emissions, and pulsed operation is employed, the measurement field strength shall be determined by averaging over one complete pulse train, including blanking intervals, as long as the pulse train does not exceed 0.1 seconds. As an alternative (provided the transmitter operates for longer than 0.1 seconds) or in cases where the pulse train exceeds 0.1 seconds, the measured field strength shall be determined from the average absolute voltage during a 0.1 second interval during which the field strength is at its maximum value.
8. If the emissions level of the EUT in peak mode was 3 dB lower than the average limit specified, then testing will be stopped and peak values of EUT will be reported, otherwise, the emissions which do not have 3 dB margin will be repeated one by one using the quasi-peak method for below 1GHz.
9. For testing above 1GHz, the emissions level of the EUT in peak mode was lower than average limit (that means the emissions level in peak mode also complies with the limit in average mode), then testing will be stopped and peak values of EUT will be reported, otherwise, the emissions will be measured in average mode again and reported.
10. In case the emission is lower than 30MHz, loop antenna has to be used for measurement and the recorded data should be QP measured by receiver. High – Low scan is not required in this case.

4.6.4. Test Setup Layout

For Radiated Emissions: 9kHz ~30MHz

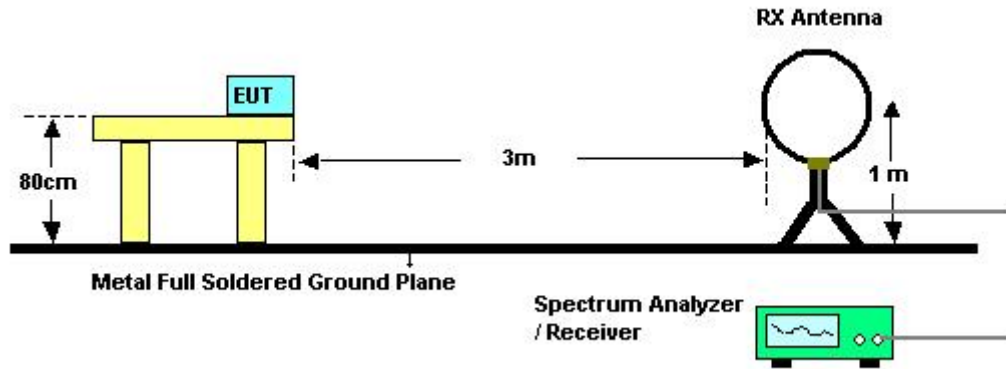

For Radiated Emissions: 30MHz~1GHz

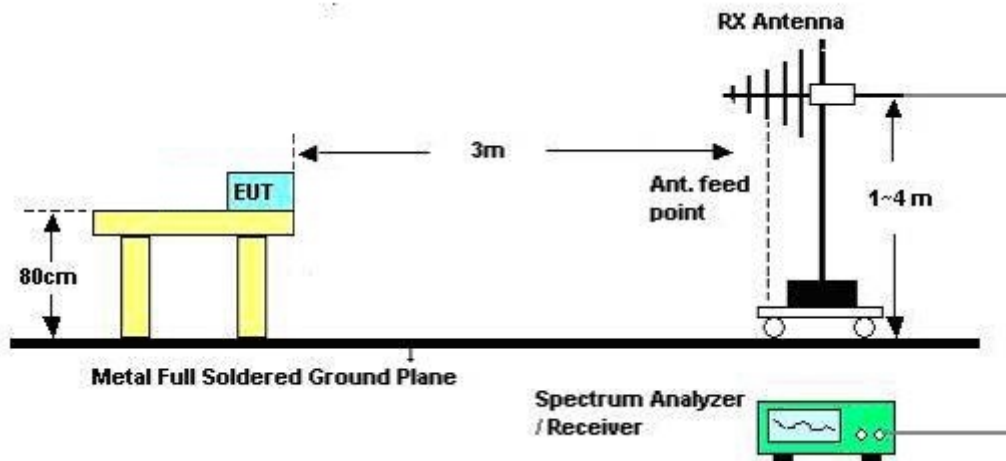

For Radiated Emissions: Above 1GHz

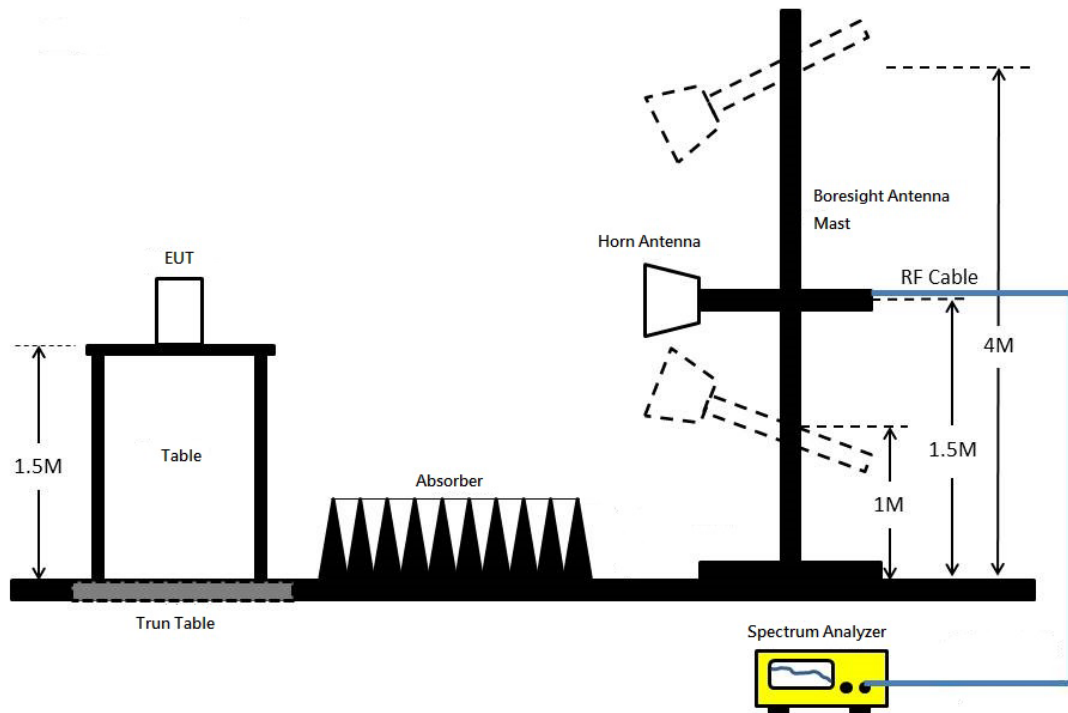

4.6.5. Test Deviation

There is no deviation with the original standard.

4.6.6. EUT Operation during Test

The EUT was programmed to be in continuously transmitting mode.

4.6.7. Results of Radiated Emissions (9kHz~30MHz)

Temperature	22°C	Humidity	54%
Test Engineer	Nyle Chang, Zero Chen, Jay Luo	Configurations	Normal Link
Test Date	Sep. 21, 2016	Test Mode	Mode 2

Freq. (MHz)	Level (dBuV)	Over Limit (dB)	Limit Line (dBuV)	Remark
-	-	-	-	See Note

Note:

The amplitude of spurious emissions which are attenuated by more than 20dB below the permissible value has no need to be reported.

Distance extrapolation factor = $40 \log(\text{specific distance} / \text{test distance})$ (dB);

Limit line = specific limits (dBuV) + distance extrapolation factor.

4.6.8. Results of Radiated Emissions (30MHz~1GHz)

Temperature	22°C	Humidity	54%
Test Engineer	Nyle Chang, Zero Chen, Jay Luo	Configurations	Normal Link
Test Mode	Mode 2		

Horizontal

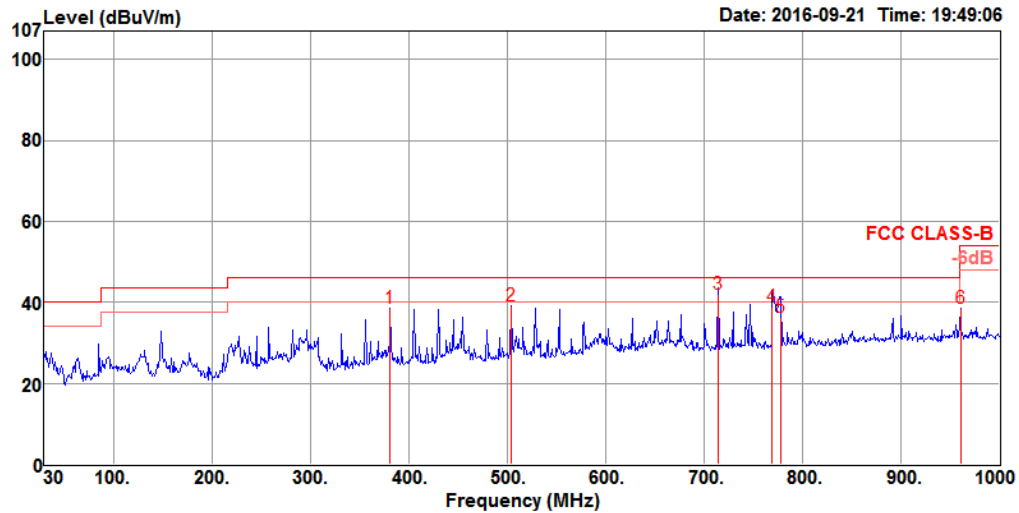

	Freq	Level	Limit	Over	Read	CableAntenna	Preamp	A/Pos	T/Pos	Remark	Pol/Phase
	MHz	dBuV/m	dBuV/m	dB	dBuV	dB	dB/m	dB	cm	deg	
1	381.14	38.59	46.00	-7.41	47.20	1.91	21.76	32.28	100	346 Peak	HORIZONTAL
2	503.36	39.24	46.00	-6.76	45.63	2.19	23.76	32.34	100	286 Peak	HORIZONTAL
3	713.85	41.93	46.00	-4.07	45.96	2.61	25.68	32.32	125	121 QP	HORIZONTAL
4	769.14	38.96	46.00	-7.04	42.19	2.72	26.29	32.24	300	37 QP	HORIZONTAL
5	777.87	36.42	46.00	-9.58	39.54	2.73	26.38	32.23	200	2 QP	HORIZONTAL
6	960.23	38.53	54.00	-15.47	38.74	3.06	27.86	31.13	100	164 Peak	HORIZONTAL

Vertical

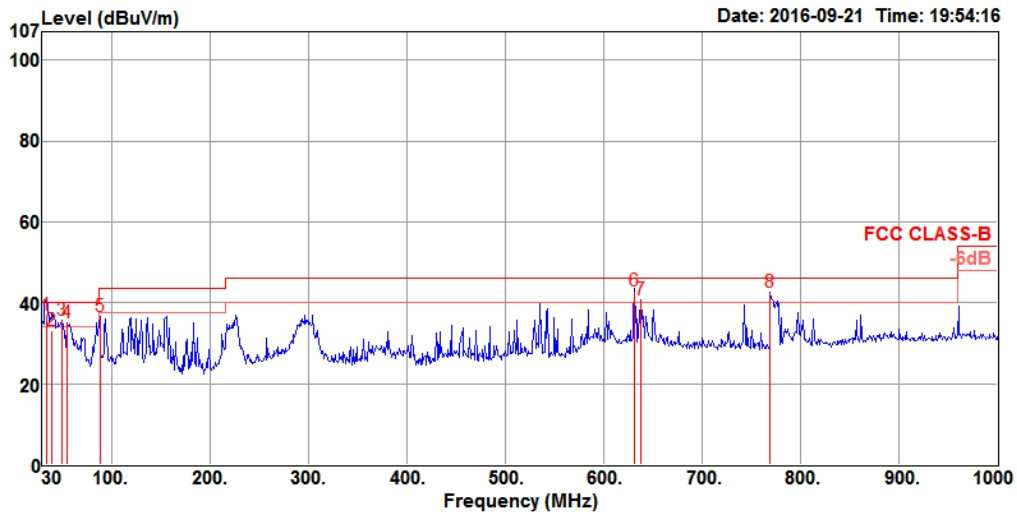

	Freq	Level	Limit	Over	Read	CableAntenna	Preamp	A/Pos	T/Pos	Remark	Pol/Phase
	MHz	dBuV/m	dBuV/m	dB	dBuV	dB	dB/m	dB	cm	deg	
1	33.88	36.94	40.00	-3.06	45.65	0.59	23.09	32.39	100	132 QP	VERTICAL
2	39.70	33.24	40.00	-6.76	45.33	0.63	19.66	32.38	100	284 QP	VERTICAL
3	49.40	35.70	40.00	-4.30	52.67	0.71	14.69	32.37	150	202 Peak	VERTICAL
4	55.22	35.15	40.00	-4.85	53.51	0.74	13.27	32.37	150	7 Peak	VERTICAL
5	88.20	36.58	43.50	-6.92	53.49	0.94	14.54	32.39	125	288 Peak	VERTICAL
6	631.40	42.93	46.00	-3.07	47.73	2.45	25.13	32.38	125	266 QP	VERTICAL
7	638.19	40.77	46.00	-5.23	45.49	2.47	25.19	32.38	125	271 Peak	VERTICAL
8	769.14	42.54	46.00	-3.46	45.77	2.72	26.29	32.24	175	188 Peak	VERTICAL

Note:

The amplitude of spurious emissions which are attenuated by more than 20 dB below the permissible value has no need to be reported.

Emission level (dBuV/m) = 20 log Emission level (uV/m).

Corrected Reading: Antenna Factor + Cable Loss + Read Level - Preamp Factor = Level.

4.6.9. Results for Radiated Emissions (1GHz~10th Harmonic)

Temperature	22°C	Humidity	54%
Test Engineer	Nyle Chang, Zero Chen, Jay Luo	Configurations	BR (GFSK) / Channel 0
Test Date	Sep. 16, 2016		

Horizontal

	Freq	Level	Limit	Over	Read	Cable	Antenna	Preamp	A/Pos	T/Pos	Remark	Pol/Phase
	MHz	dBuV/m	dBuV/m	dB	dBuV	dB	dB/m	dB	cm	deg		
1	4804.39	46.97	74.00	-27.03	41.13	7.57	32.80	34.53	134	242	Peak	HORIZONTAL
2	4804.39	22.53	54.00	-31.47	16.69	7.57	32.80	34.53	134	242	Average	HORIZONTAL

Vertical

	Freq	Level	Limit	Over	Read	Cable	Antenna	Preamp	A/Pos	T/Pos	Remark	Pol/Phase
	MHz	dBuV/m	dBuV/m	dB	dBuV	dB	dB/m	dB	cm	deg		
1	4803.34	47.56	74.00	-26.44	41.72	7.57	32.80	34.53	139	63	Peak	VERTICAL
2	4803.34	23.12	54.00	-30.88	17.28	7.57	32.80	34.53	139	63	Average	VERTICAL

Temperature	22°C	Humidity	54%
Test Engineer	Nyle Chang, Zero Chen, Jay Luo	Configurations	BR (GFSK) / Channel 39
Test Date	Sep. 16, 2016		

Horizontal

	Freq	Level	Limit Line	Over Limit	Read Level	CableAntenna Loss	Antenna Factor	Preamp Factor	A/Pos	T/Pos	Remark	Pol/Phase
	MHz	dBuV/m	dBuV/m	dB	dBuV	dB	dB/m	dB	cm	deg		
1	4882.03	47.39	74.00	-26.61	41.36	7.60	32.93	34.50	128	5	Peak	HORIZONTAL
2	4882.03	22.95	54.00	-31.05	16.92	7.60	32.93	34.50	128	5	Average	HORIZONTAL

Vertical

	Freq	Level	Limit Line	Over Limit	Read Level	CableAntenna Loss	Antenna Factor	Preamp Factor	A/Pos	T/Pos	Remark	Pol/Phase
	MHz	dBuV/m	dBuV/m	dB	dBuV	dB	dB/m	dB	cm	deg		
1	4881.39	47.30	74.00	-26.70	41.27	7.60	32.93	34.50	121	192	Peak	VERTICAL
2	4881.39	22.86	54.00	-31.14	16.83	7.60	32.93	34.50	121	192	Average	VERTICAL

Temperature	22°C	Humidity	54%
Test Engineer	Nyle Chang, Zero Chen, Jay Luo	Configurations	BR (GFSK) / Channel 78
Test Date	Sep. 16, 2016		

Horizontal

	Freq	Level	Limit Line	Over Limit	Read Level	CableAntenna Loss	Antenna Factor	Preamp Factor	A/Pos	T/Pos	Remark	Pol/Phase
	MHz	dBuV/m	dBuV/m	dB	dBuV	dB	dB/m	dB	cm	deg		
1	4960.33	52.45	74.00	-21.55	46.26	7.63	33.04	34.48	114	335	Peak	HORIZONTAL
2	4960.33	28.01	54.00	-25.99	21.82	7.63	33.04	34.48	114	335	Average	HORIZONTAL

Vertical

	Freq	Level	Limit Line	Over Limit	Read Level	CableAntenna Loss	Antenna Factor	Preamp Factor	A/Pos	T/Pos	Remark	Pol/Phase
	MHz	dBuV/m	dBuV/m	dB	dBuV	dB	dB/m	dB	cm	deg		
1	4960.02	50.29	74.00	-23.71	44.10	7.63	33.04	34.48	103	134	Peak	VERTICAL
2	4960.02	25.85	54.00	-28.15	19.66	7.63	33.04	34.48	103	134	Average	VERTICAL

Temperature	22°C	Humidity	54%
Test Engineer	Nyle Chang, Zero Chen, Jay Luo	Configurations	EDR (8DPSK) / Channel 0
Test Date	Sep. 16, 2016		

Horizontal

	Freq	Level	Limit Line	Over Limit	Read Level	CableAntenna Loss	Antenna Factor	Preamp Factor	A/Pos	T/Pos	Remark	Pol/Phase
	MHz	dBuV/m	dBuV/m	dB	dBuV	dB	dB/m	dB	cm	deg		
1	4803.91	47.31	74.00	-26.69	41.47	7.57	32.80	34.53	134	269	Peak	HORIZONTAL
2	4803.91	22.87	54.00	-31.13	17.03	7.57	32.80	34.53	134	269	Average	HORIZONTAL

Vertical

	Freq	Level	Limit Line	Over Limit	Read Level	CableAntenna Loss	Antenna Factor	Preamp Factor	A/Pos	T/Pos	Remark	Pol/Phase
	MHz	dBuV/m	dBuV/m	dB	dBuV	dB	dB/m	dB	cm	deg		
1	4802.07	47.69	74.00	-26.31	41.85	7.57	32.80	34.53	114	153	Peak	VERTICAL
2	4802.07	23.25	54.00	-30.75	17.41	7.57	32.80	34.53	114	153	Average	VERTICAL

Temperature	22°C	Humidity	54%
Test Engineer	Nyle Chang, Zero Chen, Jay Luo	Configurations	EDR (8DPSK) / Channel 39
Test Date	Sep. 16, 2016		

Horizontal

	Freq	Level	Limit Line	Over Limit	Read Level	Cable Loss	Antenna Factor	Preamp Factor	A/Pos	T/Pos	Remark	Pol/Phase
	MHz	dBuV/m	dBuV/m	dB	dBuV	dB	dB/m	dB	cm	deg		
1	4884.31	47.33	74.00	-26.67	41.30	7.60	32.93	34.50	157	143	Peak	HORIZONTAL
2	4884.31	22.89	54.00	-31.11	16.86	7.60	32.93	34.50	157	143	Average	HORIZONTAL

Vertical

	Freq	Level	Limit Line	Over Limit	Read Level	Cable Loss	Antenna Factor	Preamp Factor	A/Pos	T/Pos	Remark	Pol/Phase
	MHz	dBuV/m	dBuV/m	dB	dBuV	dB	dB/m	dB	cm	deg		
1	4884.09	47.58	74.00	-26.42	41.55	7.60	32.93	34.50	104	239	Peak	VERTICAL
2	4884.09	23.14	54.00	-30.86	17.11	7.60	32.93	34.50	104	239	Average	VERTICAL

Temperature	22°C	Humidity	54%
Test Engineer	Nyle Chang, Zero Chen, Jay Luo	Configurations	EDR (8DPSK) / Channel 78
Test Date	Sep. 16, 2016		

Horizontal

	Freq	Level	Limit Line	Over Limit	Read Level	Cable Loss	Antenna Factor	Preamp Factor	A/Pos	T/Pos	Remark	Pol/Phase
	MHz	dBuV/m	dBuV/m	dB	dBuV	dB	dB/m	dB	cm	deg		
1	4961.05	47.58	74.00	-26.42	41.39	7.63	33.04	34.48	118	232	Peak	HORIZONTAL
2	4961.05	23.14	54.00	-30.86	16.95	7.63	33.04	34.48	118	232	Average	HORIZONTAL

Vertical

	Freq	Level	Limit Line	Over Limit	Read Level	Cable Loss	Antenna Factor	Preamp Factor	A/Pos	T/Pos	Remark	Pol/Phase
	MHz	dBuV/m	dBuV/m	dB	dBuV	dB	dB/m	dB	cm	deg		
1	4959.78	47.65	74.00	-26.35	41.46	7.63	33.04	34.48	124	271	Peak	VERTICAL
2	4959.78	23.21	54.00	-30.79	17.02	7.63	33.04	34.48	124	271	Average	VERTICAL

Note:

The amplitude of spurious emissions which are attenuated by more than 20dB below the permissible value has no need to be reported.

Emission level (dBuV/m) = 20 log Emission level (uV/m).

Corrected Reading: Antenna Factor + Cable Loss + Read Level - Preamp Factor = Level.

4.7. Emissions Measurement

4.7.1. Limit

20dBc in any 100 kHz bandwidth outside the operating frequency band. In case the emission fall within the restricted band specified on 15.205(a), then the 15.209(a) limit in the table below has to be followed.

Frequencies (MHz)	Field Strength (micovolts/meter)	Measurement Distance (meters)
0.009~0.490	2400/F(kHz)	300
0.490~1.705	24000/F(kHz)	30
1.705~30.0	30	30
30~88	100	3
88~216	150	3
216~960	200	3
Above 960	500	3

4.7.2. Measuring Instruments and Setting

Please refer to section 5 of equipments list in this report. The following table is the setting of the spectrum analyzer.

Spectrum Parameter	Setting
Attenuation	Auto
Span Frequency	100 MHz
RBW / VBW (Emission in restricted band)	1MHz / 3MHz for Peak, 1MHz / 1/T for Average
RBW / VBW (20dBc in any 100 kHz bandwidth emission)	100 kHz /100 kHz for Peak

4.7.3. Test Procedures

For Radiated band edges Measurement:

The test procedure is the same as section 4.6.3.

For Radiated Out of Band Emission Measurement:

The test procedure is follow 15.247(d).

4.7.4. Test Setup Layout

For Radiated band edges Measurement:

This test setup layout is the same as that shown in section 4.6.4.

For Radiated Out of Band Emission Measurement:

This test setup layout is the same as that shown in section 4.6.4.

4.7.5. Test Deviation

There is no deviation with the original standard.

4.7.6. EUT Operation during Test

The EUT was programmed to be in continuously transmitting mode.

4.7.7. Test Result of Band Edge and Fundamental Emissions

Temperature	22°C	Humidity	54%
Test Engineer	Nyle Chang, Zero Chen, Jay Luo	Configurations	BR (GFSK) / Channel 0, 39, 78

Channel 0

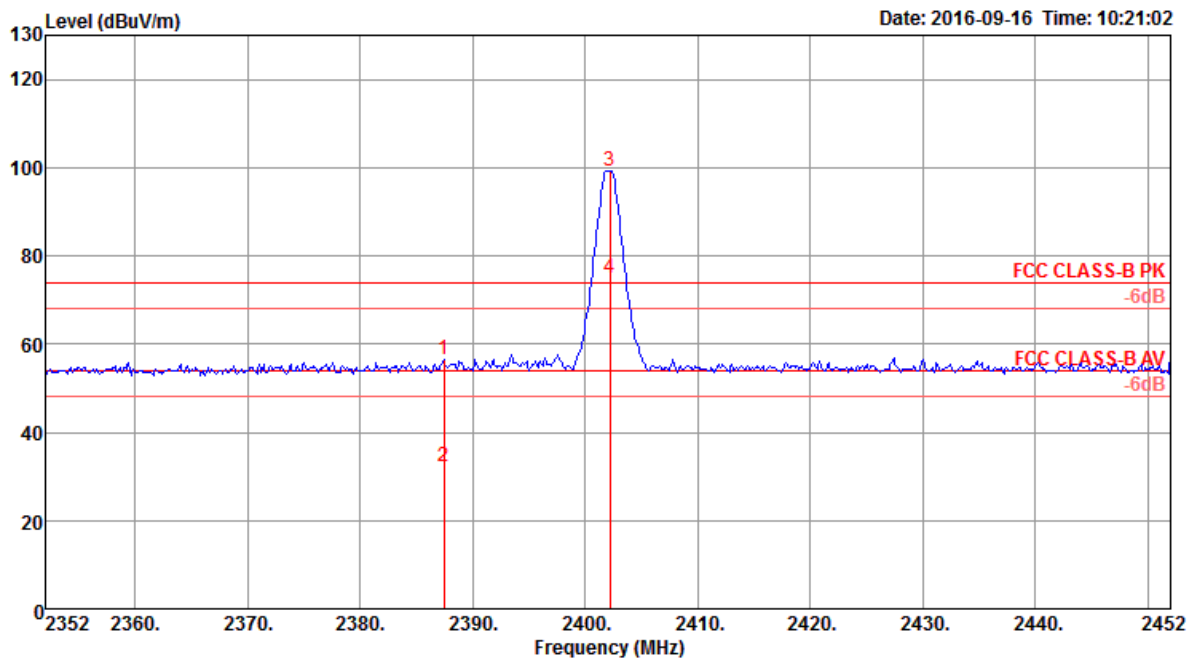

	Freq	Level	Limit	Over	Read	CableAntenna	Preamp	A/Pos	T/Pos	Remark	Pol/Phase
	MHz	dBuV/m	dBuV/m	dB	dBuV	dB	dB/m	dB	cm	deg	
1	2387.40	56.62	74.00	-17.38	24.07	4.53	28.02	0.00	110	181 Peak	VERTICAL
2	2387.40	32.18	54.00	-21.82	-0.37	4.53	28.02	0.00	110	181 Average	VERTICAL
3 @	2402.20	99.31			66.75	4.55	28.01	0.00	110	181 Peak	VERTICAL
4 @	2402.20	74.87			42.31	4.55	28.01	0.00	110	181 Average	VERTICAL

Item 3, 4 are the fundamental frequency at 2402 MHz.

Channel 39

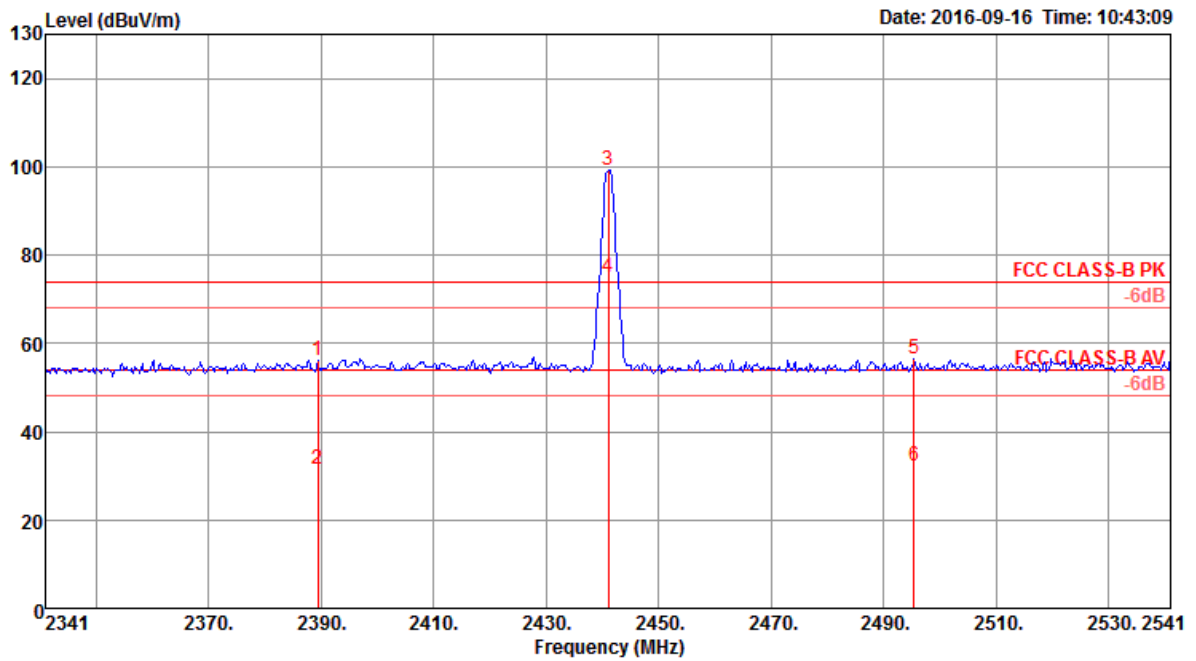

	Freq	Level	Limit	Over	Read	CableAntenna	Preamp	A/Pos	T/Pos	Remark	Pol/Phase
	MHz	dBuV/m	dBuV/m	dB	dBuV	dB	dB/m	dB	cm	deg	
1	2389.40	56.06	74.00	-17.94	23.51	4.53	28.02	0.00	109	149 Peak	VERTICAL
2	2389.40	31.62	54.00	-22.38	-0.93	4.53	28.02	0.00	109	149 Average	VERTICAL
3 @	2441.00	99.29			66.72	4.61	27.96	0.00	109	149 Peak	VERTICAL
4 @	2441.00	74.85			42.28	4.61	27.96	0.00	109	149 Average	VERTICAL
5	2495.40	56.59	74.00	-17.41	23.99	4.69	27.91	0.00	109	149 Peak	VERTICAL
6	2495.40	32.15	54.00	-21.85	-0.45	4.69	27.91	0.00	109	149 Average	VERTICAL

Item 3, 4 are the fundamental frequency at 2441 MHz.

Channel 78

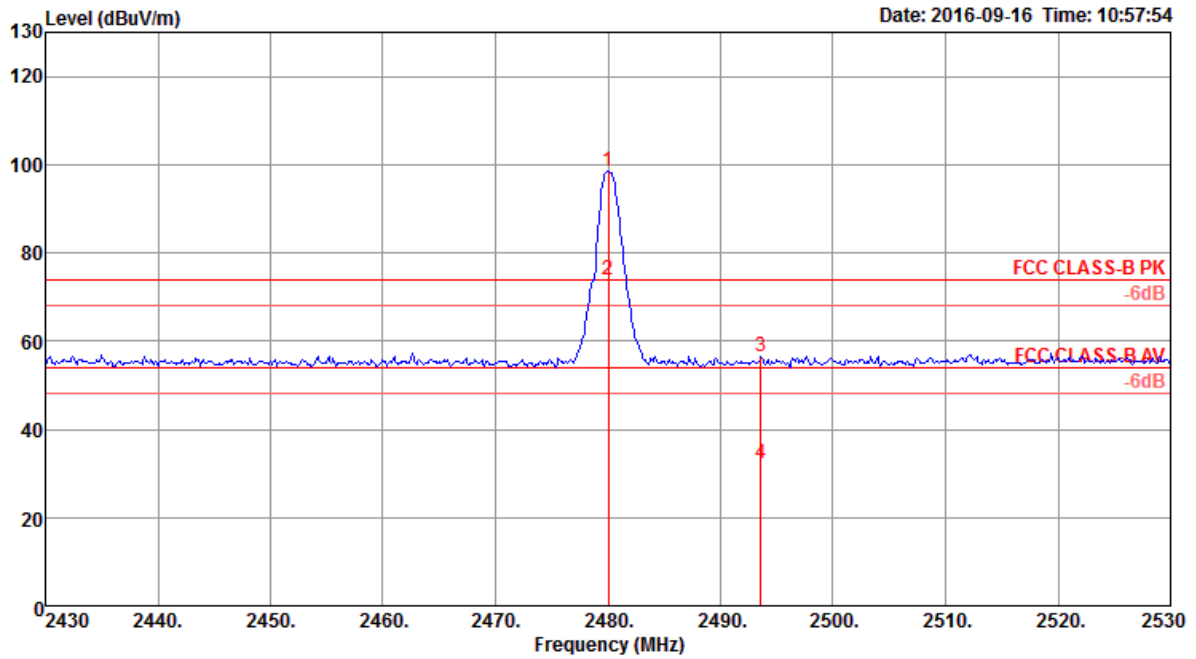

	Freq	Level	Limit	Over	Read	CableAntenna	Preamp	A/Pos	T/Pos	Remark	Pol/Phase
	MHz	dBuV/m	dBuV/m	dB	dBuV	dB	dB/m	dB	cm	deg	
1 @	2480.00	98.33			65.74	4.67	27.92	0.00	112	144 Peak	VERTICAL
2 @	2480.00	73.89			41.30	4.67	27.92	0.00	112	144 Average	VERTICAL
3	2493.60	56.53	74.00	-17.47	23.93	4.69	27.91	0.00	112	144 Peak	VERTICAL
4	2493.60	32.09	54.00	-21.91	-0.51	4.69	27.91	0.00	112	144 Average	VERTICAL

Item 1, 2 are the fundamental frequency at 2480 MHz.

Temperature	22°C	Humidity	54%
Test Engineer	Nyle Chang, Zero Chen, Jay Luo	Configurations	EDR (8DPSK) / Channel 0, 39, 78

Channel 0

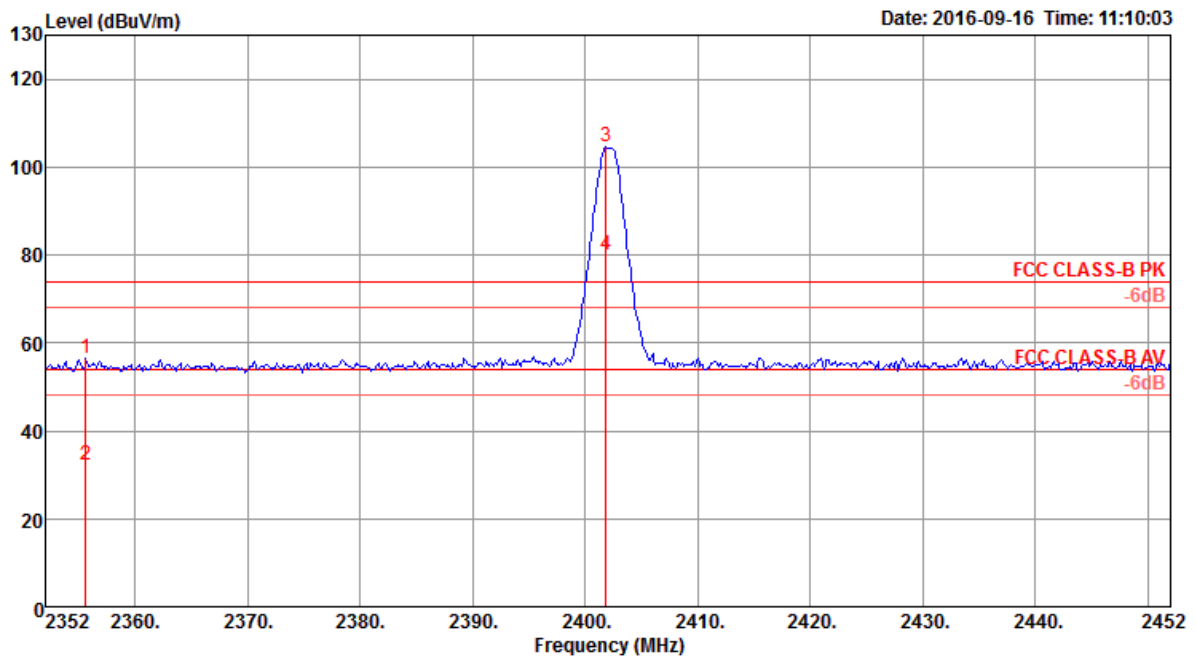

	Freq	Level	Limit	Over	Read	Cable	Antenna	Preamp	A/Pos	T/Pos	Remark	Pol/Phase
	MHz	dBuV/m	dBuV/m	dB	dBuV	dB	dB/m	dB	cm	deg		
1	2355.60	56.64	74.00	-17.36	24.09	4.49	28.06	0.00	158	239	Peak	HORIZONTAL
2	2355.60	32.20	54.00	-21.80	-0.35	4.49	28.06	0.00	158	239	Average	HORIZONTAL
3 @	2401.80	104.50			71.94	4.55	28.01	0.00	158	239	Peak	HORIZONTAL
4 @	2401.80	80.06			47.50	4.55	28.01	0.00	158	239	Average	HORIZONTAL

Item 3, 4 are the fundamental frequency at 2402 MHz.

Channel 39

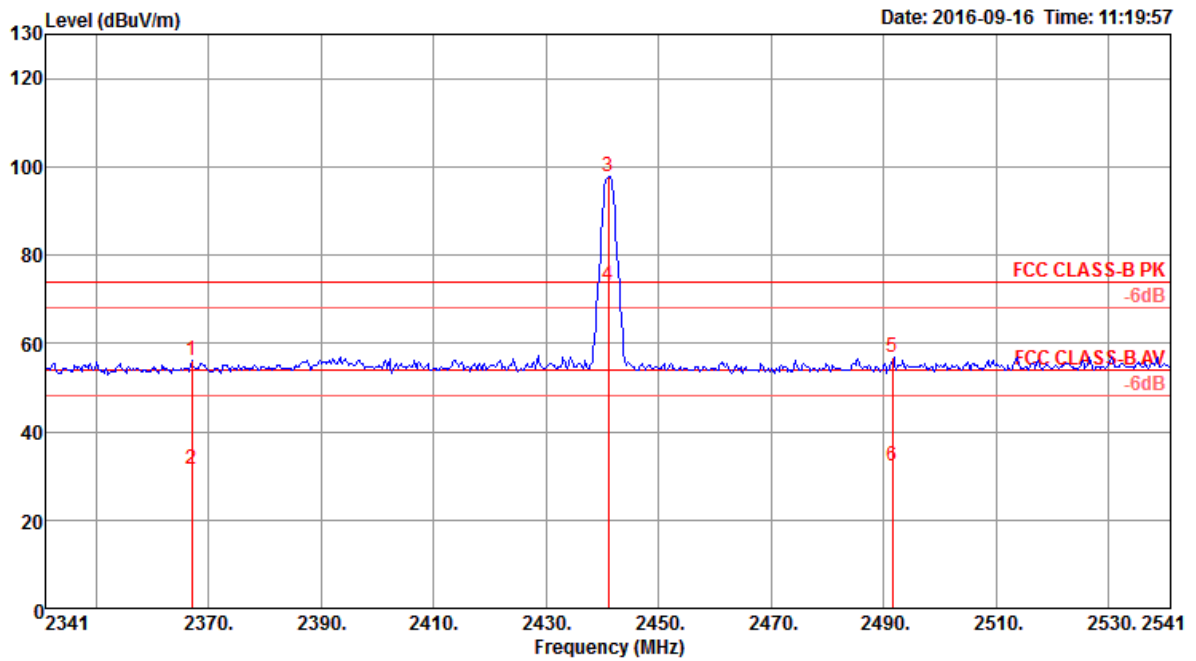

	Freq	Level	Limit	Over	Read	CableAntenna	Preamp	A/Pos	T/Pos	Remark	Pol/Phase
	MHz	dBuV/m	dBuV/m	dB	dBuV	dB	dB/m	dB	cm	deg	
1	2367.00	56.11	74.00	-17.89	23.56	4.50	28.05	0.00	110	149 Peak	VERTICAL
2	2367.00	31.67	54.00	-22.33	-0.88	4.50	28.05	0.00	110	149 Average	VERTICAL
3 @	2441.00	97.72			65.15	4.61	27.96	0.00	110	149 Peak	VERTICAL
4 @	2441.00	73.28			40.71	4.61	27.96	0.00	110	149 Average	VERTICAL
5	2491.60	56.67	74.00	-17.33	24.07	4.69	27.91	0.00	110	149 Peak	VERTICAL
6	2491.60	32.23	54.00	-21.77	-0.37	4.69	27.91	0.00	110	149 Average	VERTICAL

Item 3, 4 are the fundamental frequency at 2441 MHz.

Channel 78

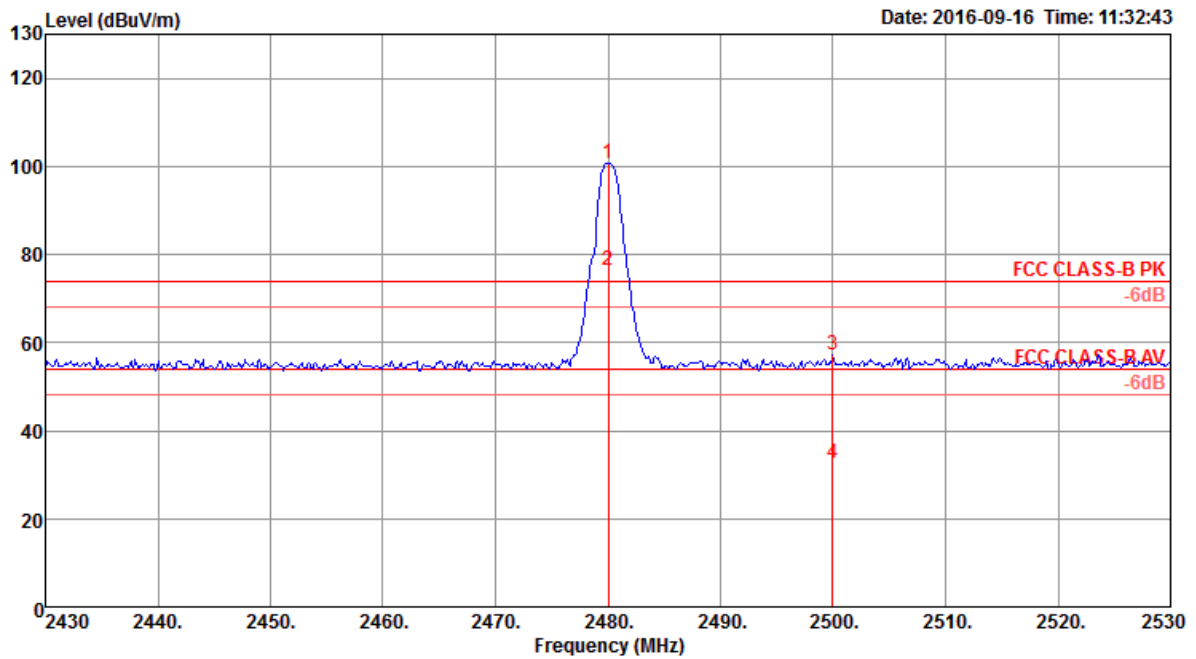

	Freq	Level	Limit	Over	Read	Cable	Antenna	Preamp	A/Pos	T/Pos	Remark	Pol/Phase
	MHz	dBuV/m	dBuV/m	dB	dBuV	dB	dB/m	dB	cm	deg		
1 @	2480.00	100.75			68.16	4.67	27.92	0.00	118	214	Peak	HORIZONTAL
2 @	2480.00	76.31			43.72	4.67	27.92	0.00	118	214	Average	HORIZONTAL
3	2500.00	57.07	74.00	-16.93	24.47	4.70	27.90	0.00	118	214	Peak	HORIZONTAL
4	2500.00	32.63	54.00	-21.37	0.03	4.70	27.90	0.00	118	214	Average	HORIZONTAL

Item 1, 2 are the fundamental frequency at 2480 MHz.

Note:

Emission level (dBuV/m) = 20 log Emission level (uV/m).

Corrected Reading: Antenna Factor + Cable Loss + Read Level - Preamp Factor = Level.

Plot on Configuration For BR (GFSK) / Channel 0 / Reference Level

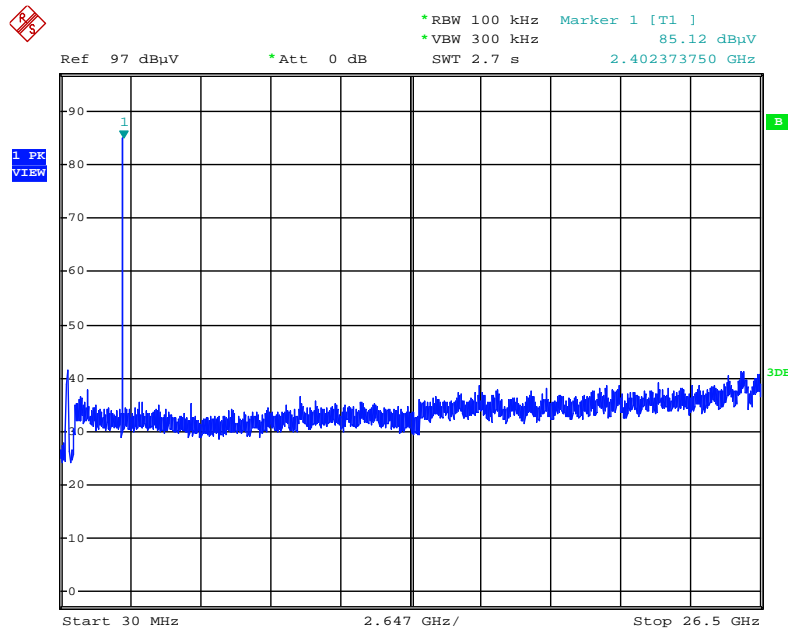

Date: 16.SEP.2016 15:52:53

Plot on Configuration For BR (GFSK) / Channel 0 / 30MHz~2400MHz (down 20dBc)

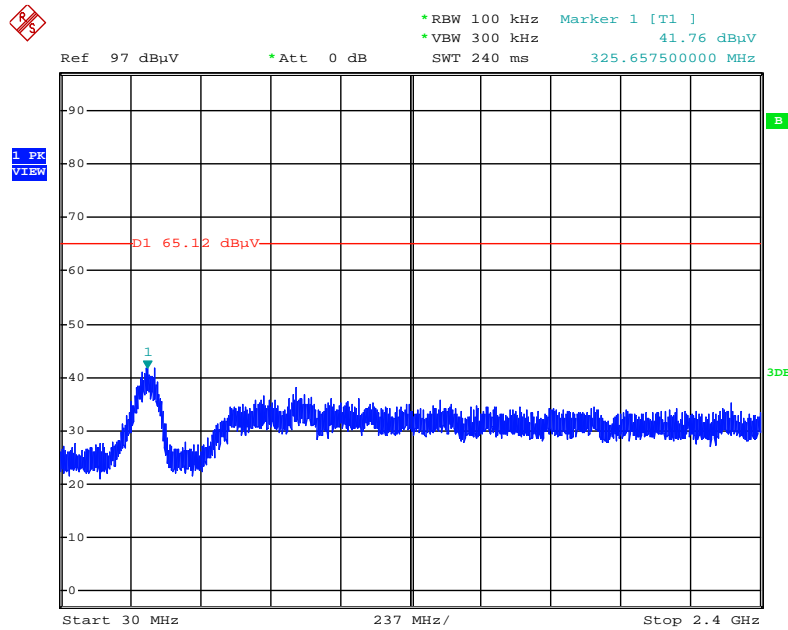

Date: 16.SEP.2016 15:53:24

Plot on Configuration For BR (GFSK) / Channel 0 / 2483.5MHz~26500MHz (down 20dBc)

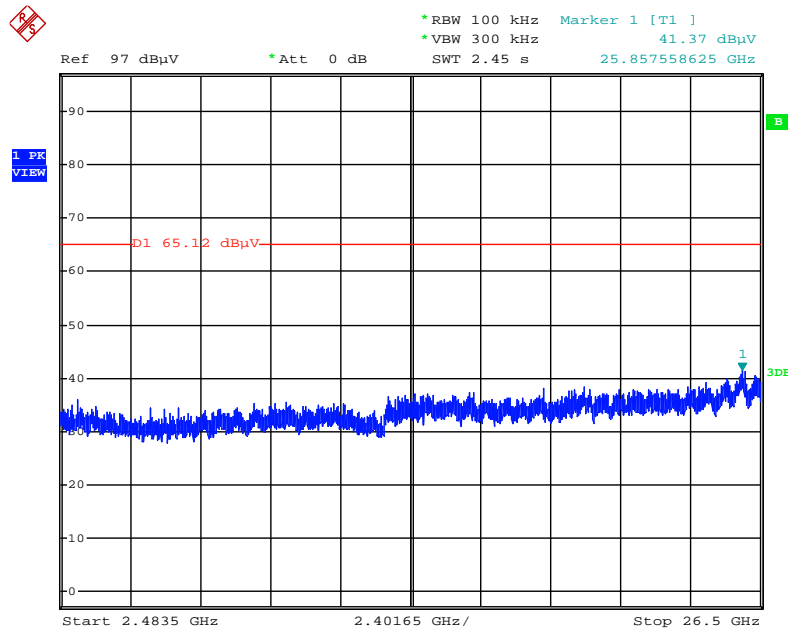

Date: 16.SEP.2016 15:54:01

Plot on Configuration For BR (GFSK) / Channel 78 / Reference Level

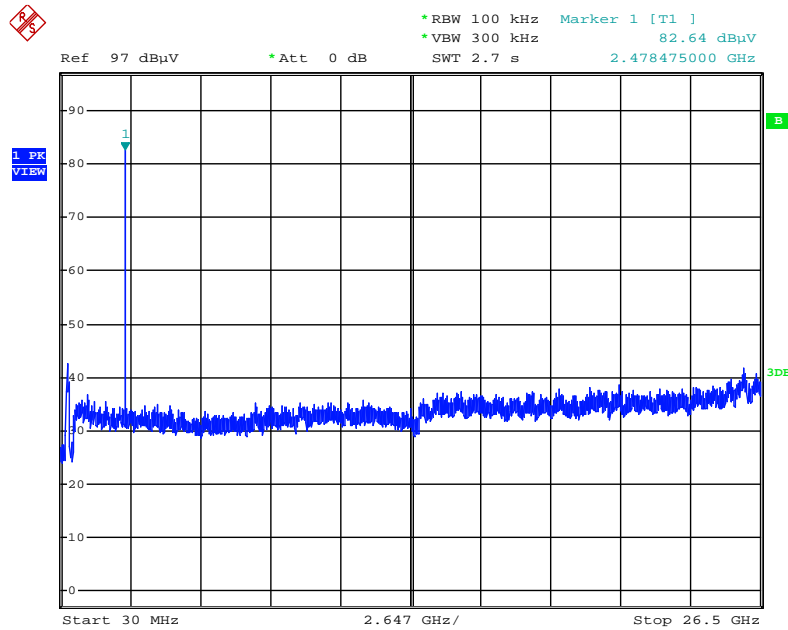

Date: 16.SEP.2016 15:55:42

Plot on Configuration For BR (GFSK) / Channel 78 / 30MHz~2400MHz (down 20dBc)

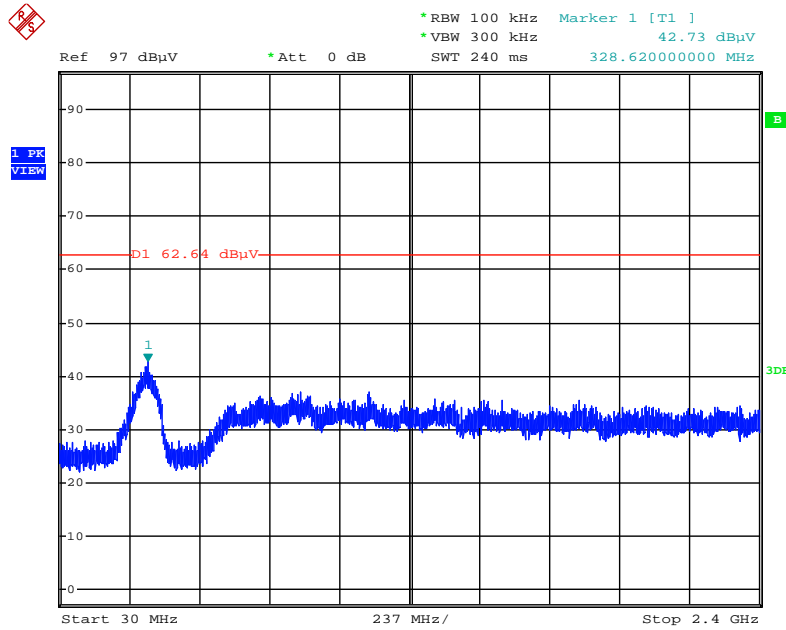

Date: 16.SEP.2016 15:56:16

Plot on Configuration For BR (GFSK) / Channel 78 / 2483.5MHz~26500MHz (down 20dBc)

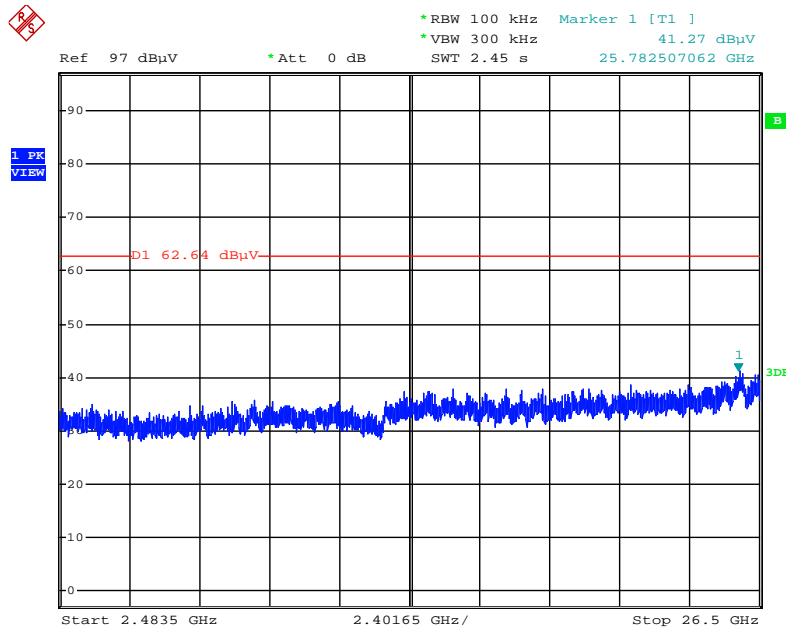

Date: 16.SEP.2016 15:56:49

Plot on Configuration For BR (GFSK) / Hopping / Reference Level

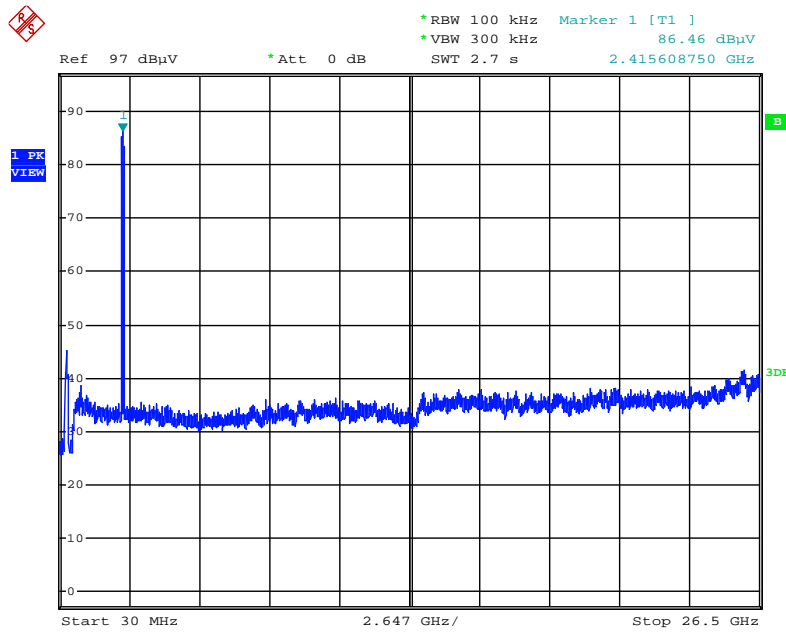

Date: 16.SEP.2016 16:07:28

Plot on Configuration For BR (GFSK) / Hopping / 30MHz~2400MHz (down 20dBc)

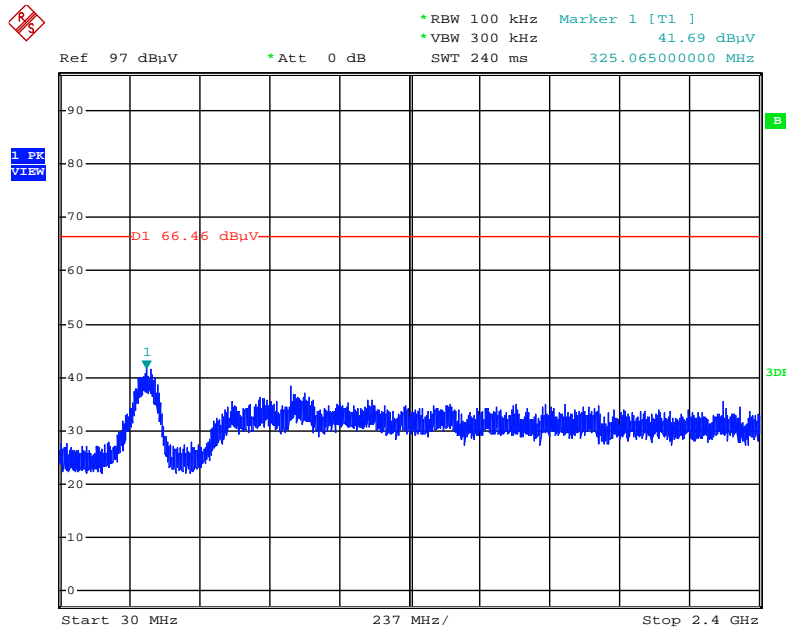

Date: 16.SEP.2016 16:08:15

Plot on Configuration For BR (GFSK) / Hopping / 2483.5MHz~26500MHz (down 20dBc)

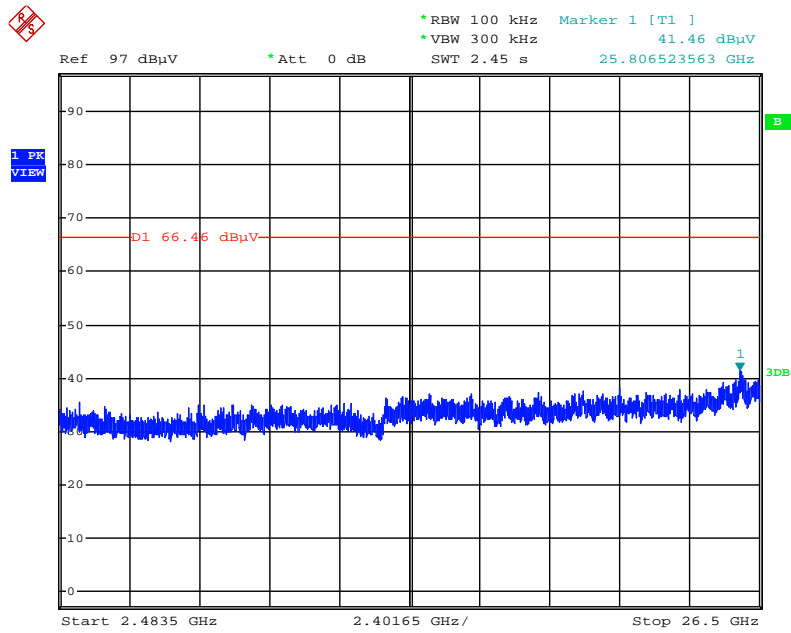

Date: 16.SEP.2016 16:08:49

Plot on Configuration For EDR (8DPSK) / Channel 0 / Reference Level

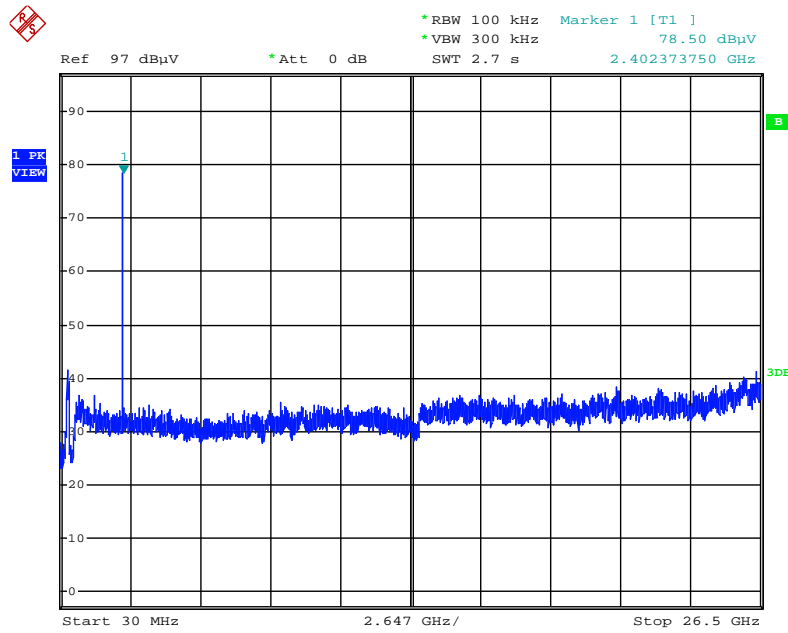

Date: 16.SEP.2016 15:59:06

Plot on Configuration For EDR (8DPSK) / Channel 0 / 30MHz~2400MHz (down 20dBc)

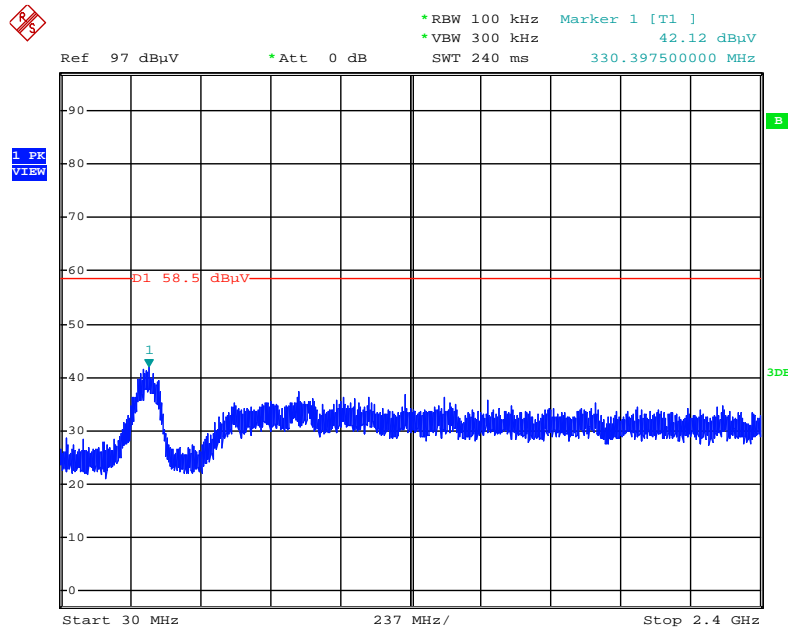

Date: 16.SEP.2016 15:59:45

Plot on Configuration For EDR (8DPSK) / Channel 78 / 30MHz~2400MHz (down 20dBc)

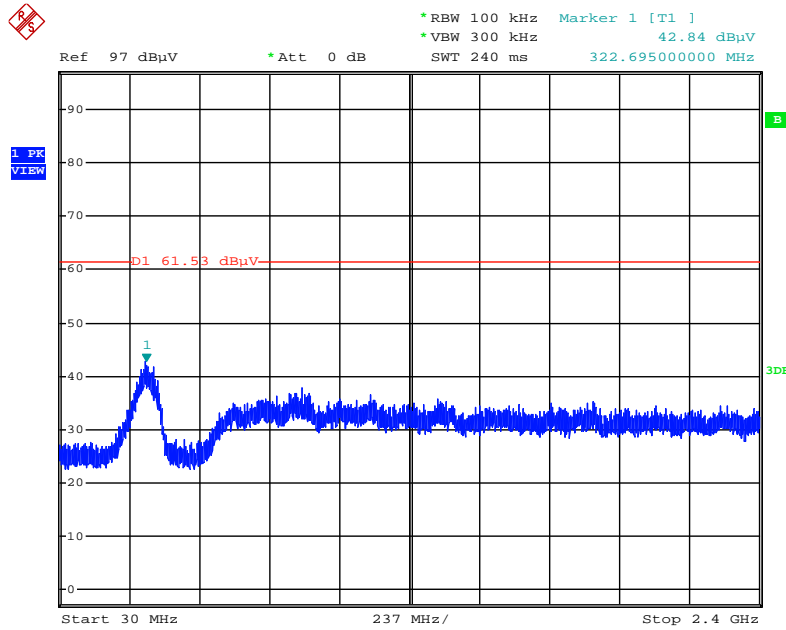

Date: 16.SEP.2016 16:01:52

Plot on Configuration For EDR (8DPSK) / Channel 78 / 2483.5MHz~26500MHz (down 20dBc)

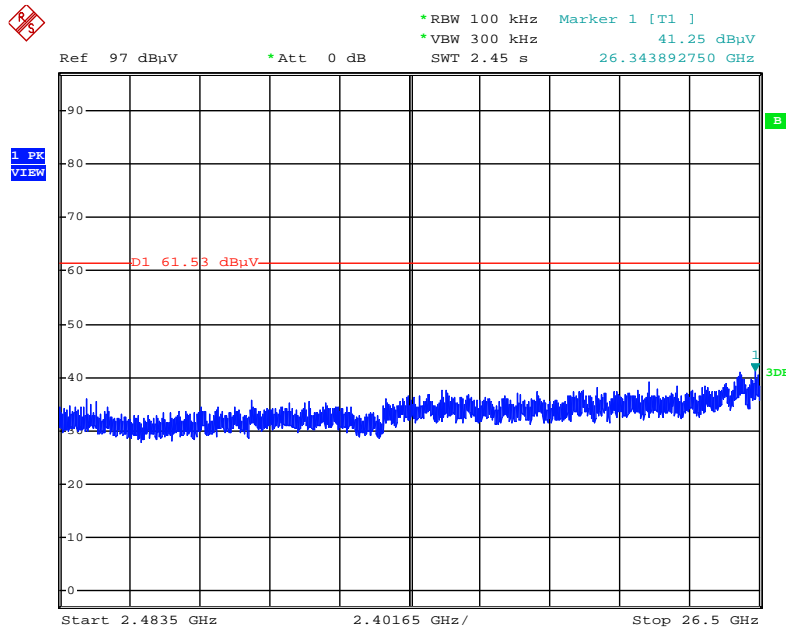

Date: 16.SEP.2016 16:02:29

Plot on Configuration For EDR (8DPSK) / Hopping / Reference Level

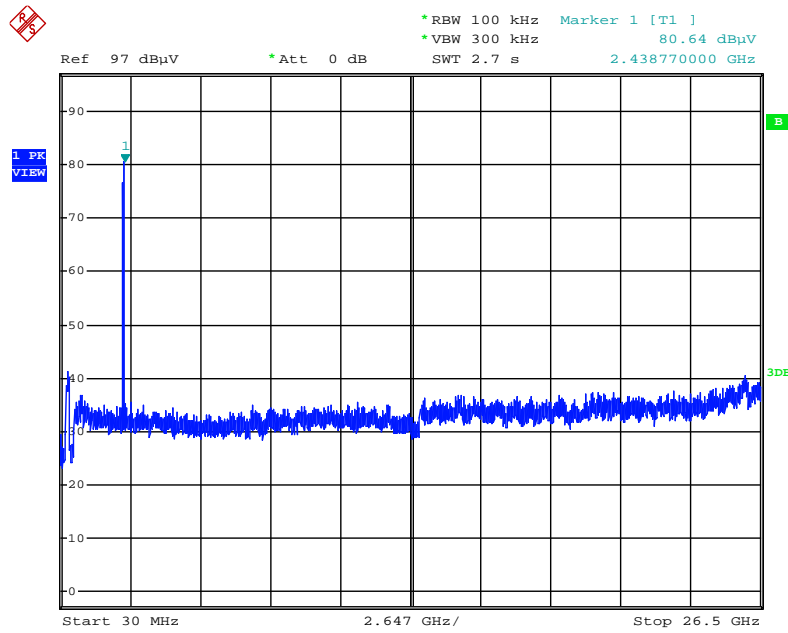

Date: 16.SEP.2016 16:10:28

Plot on Configuration For EDR (8DPSK) / Hopping / 30MHz~2400MHz (down 20dBc)

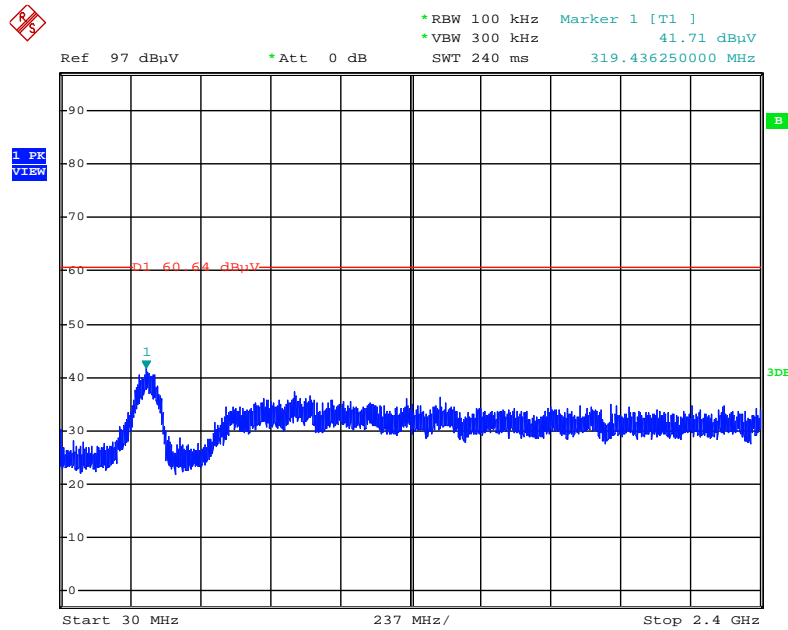

Date: 16.SEP.2016 16:11:16

Plot on Configuration For EDR (8DPSK) / Hopping / 2483.5MHz~26500MHz (down 20dBc)

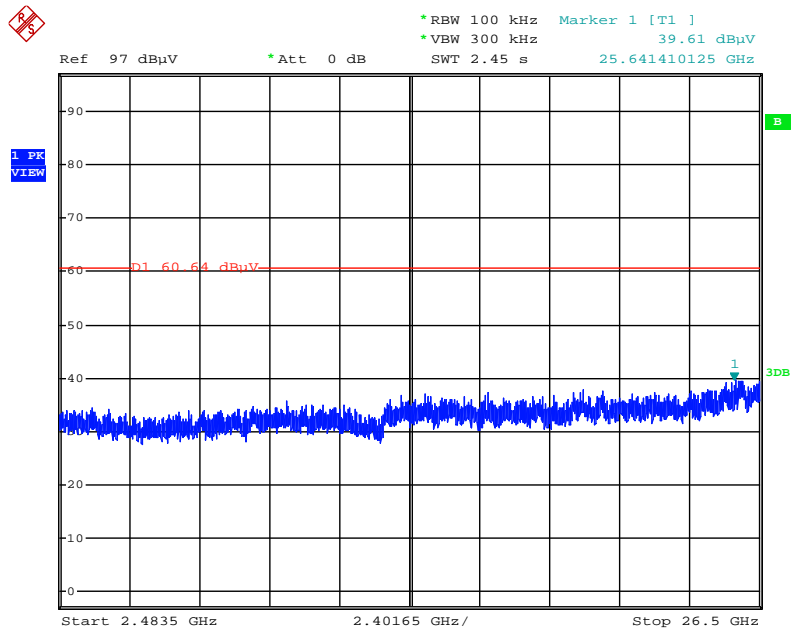

Date: 16.SEP.2016 16:11:54

4.8. Antenna Requirements

4.8.1. Limit

Except for special regulations, the Low-power Radio-frequency Devices must not be equipped with any jacket for installing an antenna with extension cable. An intentional radiator shall be designed to ensure that no antenna other than that furnished by the responsible party shall be used with the device. The use of a permanently attached antenna or of an antenna that uses a unique coupling to the intentional radiator shall be considered sufficient to comply with the provisions of this Section. The manufacturer may design the unit so that the user can replace a broken antenna, but the use of a standard antenna jack or electrical connector is prohibited.

4.8.2. Antenna Connector Construction

Please refer to section 3.3 in this test report, antenna connector complied with the requirements.

5. LIST OF MEASURING EQUIPMENTS

Instrument	Manufacturer	Model No.	Serial No.	Characteristics	Calibration Date	Remark
EMI Receiver	Agilent	N9038A	My52260123	9kHz ~ 8.45GHz	Jan. 27, 2016	Conduction (CO01-CB)
LISN	F.C.C.	FCC-LISN-50-16-2	04083	150kHz ~ 100MHz	Dec. 08, 2015	Conduction (CO01-CB)
LISN	Schwarzbeck	NSLK 8127	8127647	9kHz ~ 30MHz	Dec. 23, 2015	Conduction (CO01-CB)
COND Cable	Woken	Cable	01	150kHz ~ 30MHz	May 24, 2016	Conduction (CO01-CB)
Software	Audix	E3	6.120210n	-	N.C.R.	Conduction (CO01-CB)
BILOG ANTENNA	TESEQ	CBL6112D	37880	20MHz ~ 2GHz	Aug. 30, 2016	Radiation (03CH01-CB)
Horn Antenna	EMCO	3115	00075790	750MHz ~ 18GHz	Oct. 22, 2015	Radiation (03CH01-CB)
Horn Antenna	Schwarzbeck	BBHA 9170	BBHA9170252	15GHz ~ 40GHz	Jul. 25, 2016	Radiation (03CH01-CB)
Pre-Amplifier	Agilent	8447D	2944A10991	0.1MHz ~ 1.3GHz	Mar. 15, 2016	Radiation (03CH01-CB)
Pre-Amplifier	Agilent	8449B	3008A02310	1GHz ~ 26.5GHz	Jan. 18, 2016	Radiation (03CH01-CB)
Pre-Amplifier	WM	TF-130N-R1	923365	26GHz ~ 40GHz	Nov. 13, 2015	Radiation (03CH01-CB)
Spectrum Analyzer	R&S	FSP40	100056	9kHz ~ 40GHz	Oct. 27, 2015	Radiation (03CH01-CB)
EMI Test	R&S	ESCS	100355	9kHz ~ 2.75GHz	May 16, 2016	Radiation (03CH01-CB)
RF Cable-low	Woken	Low Cable-1	N/A	30 MHz ~ 1 GHz	Nov. 02, 2015	Radiation (03CH01-CB)
RF Cable-high	Woken	High Cable-16	N/A	1 GHz ~ 18 GHz	Nov. 02, 2015	Radiation (03CH01-CB)
RF Cable-high	Woken	High Cable-17	N/A	1 GHz ~ 18 GHz	Nov. 02, 2015	Radiation (03CH01-CB)
RF Cable-high	Woken	High Cable-40G-1	N/A	18GHz ~ 40 GHz	Nov. 02, 2015	Radiation (03CH01-CB)
RF Cable-high	Woken	High Cable-40G-2	N/A	18GHz ~ 40 GHz	Nov. 02, 2015	Radiation (03CH01-CB)
Test Software	Audix	E3	6.2009-10-7	N/A	N/A	Radiation (03CH01-CB)
Loop Antenna	Teseq	HLA 6120	24155	9kHz - 30 MHz	Mar. 16, 2016*	Radiation (03CH01-CB)
Spectrum analyzer	R&S	FSV40	100979	9kHz~40GHz	Dec. 09, 2015	Conducted (TH01-CB)
RF Cable-high	Woken	RG402	High Cable-6	1 GHz – 26.5 GHz	Nov. 02, 2015	Conducted (TH01-CB)
RF Cable-high	Woken	RG402	High Cable-7	1 GHz – 26.5 GHz	Nov. 02, 2015	Conducted (TH01-CB)
RF Cable-high	Woken	RG402	High Cable-8	1 GHz – 26.5 GHz	Nov. 02, 2015	Conducted (TH01-CB)
RF Cable-high	Woken	RG402	High Cable-9	1 GHz – 26.5 GHz	Nov. 02, 2015	Conducted (TH01-CB)
RF Cable-high	Woken	RG402	High Cable-10	1 GHz – 26.5 GHz	Nov. 02, 2015	Conducted (TH01-CB)
Power Sensor	Agilent	U2021XA	MY53410001	50MHz~18GHz	Nov. 02, 2015	Conducted (TH01-CB)

Note: Calibration Interval of instruments listed above is one year.

* Calibration Interval of instruments listed above is two years.

N.C.R. means Non-Calibration required.

6. MEASUREMENT UNCERTAINTY

Test Items	Uncertainty	Remark
Conducted Emission (150kHz ~ 30MHz)	3.2 dB	Confidence levels of 95%
Radiated Emission (30MHz ~ 1,000MHz)	3.6 dB	Confidence levels of 95%
Radiated Emission (1GHz ~ 18GHz)	3.7 dB	Confidence levels of 95%
Radiated Emission (18GHz ~ 40GHz)	3.5 dB	Confidence levels of 95%
Conducted Emission	1.7 dB	Confidence levels of 95%