

FCC Test Report

Report No.: RFBCMA-WTW-P21010371-1

FCC ID: RAXCM4642342

Test Model: CM4642342XXX

Series Model: CG4634XXXXXX

(where X character can be replaced by either alphanumeric character between A and Z and between 0 and 9 or "-" or "." or "blank")

Received Date: Dec. 22, 2020

Test Date: Dec. 22, 2020 to Feb. 02, 2021

Issued Date: Feb. 24, 2021

Applicant: Arcadyan Technology Corporation

Address: No.8, Sec.2, Guangfu Rd., Hsinchu City 30071, Taiwan, R.O.C.

Issued By: Bureau Veritas Consumer Products Services (H.K.) Ltd., Taoyuan Branch
Hsin Chu Laboratory

Lab Address: E-2, No.1, Li Hsin 1st Road, Hsinchu Science Park, Hsinchu City 300,
Taiwan

Test Location: E-2, No.1, Li Hsin 1st Road, Hsinchu Science Park, Hsinchu City 300,
Taiwan

**FCC Registration /
Designation Number:** 723255 / TW2022



This report is for your exclusive use. Any copying or replication of this report to or for any other person or entity, or use of our name or trademark, is permitted only with our prior written permission. This report sets forth our findings solely with respect to the test samples identified herein. The results set forth in this report are not indicative or representative of the quality or characteristics of the lot from which a test sample was taken or any similar or identical product unless specifically and expressly noted. Our report includes all of the tests requested by you and the results thereof based upon the information that you provided to us. You have 60 days from date of issuance of this report to notify us of any material error or omission caused by our negligence, provided, however, that such notice shall be in writing and shall specifically address the issue you wish to raise. A failure to raise such issue within the prescribed time shall constitute your unqualified acceptance of the completeness of this report, the tests conducted and the correctness of the report contents. Unless specifically mentioned, the uncertainty of measurement has been explicitly taken into account to declare the compliance or non-compliance to the specification.

Table of Contents

Release Control Record	4
1 Certificate of Conformity	5
2 Summary of Test Results	6
2.1 Measurement Uncertainty	6
2.2 Modification Record	6
3 General Information	7
3.1 General Description of EUT	7
3.2 Description of Test Modes	10
3.2.1 Test Mode Applicability and Tested Channel Detail	11
3.3 Duty Cycle of Test Signal	14
3.4 Description of Support Units	15
3.4.1 Configuration of System under Test	16
3.5 General Description of Applied Standard and references	17
4 Test Types and Results	18
4.1 Radiated Emission and Bandedge Measurement	18
4.1.1 Limits of Radiated Emission and Bandedge Measurement	18
4.1.2 Test Instruments	19
4.1.3 Test Procedure	22
4.1.4 Deviation from Test Standard	23
4.1.5 Test Setup	23
4.1.6 EUT Operating Condition	24
4.1.7 Test Results	25
4.2 Conducted Emission Measurement	45
4.2.1 Limits of Conducted Emission Measurement	45
4.2.2 Test Instruments	45
4.2.3 Test Procedure	45
4.2.4 Deviation from Test Standard	46
4.2.5 Test Setup	46
4.2.6 EUT Operating Condition	46
4.2.7 Test Results	47
4.3 Transmit Power Measurement	49
4.3.1 Limits of Transmit Power Measurement	49
4.3.2 Test Setup	49
4.3.3 Test Instruments	49
4.3.4 Test Procedure	49
4.3.5 Deviation from Test Standard	49
4.3.6 EUT Operating Condition	49
4.3.7 Test Results	50
4.4 Occupied Bandwidth Measurement	54
4.4.1 Test Setup	54
4.4.2 Test Instruments	54
4.4.3 Test Procedure	54
4.4.4 Test Results	55
4.5 Peak Power Spectral Density Measurement	61
4.5.1 Limits of Peak Power Spectral Density Measurement	61
4.5.2 Test Setup	61
4.5.3 Test Instruments	61
4.5.4 Test Procedure	61
4.5.5 Deviation from Test Standard	62
4.5.6 EUT Operating Condition	62
4.5.7 Test Results	63
4.6 Frequency Stability Measurement	67
4.6.1 Limits of Frequency Stability Measurement	67

4.6.2 Test Setup.....	67
4.6.3 Test Instruments	67
4.6.4 Test Procedure	67
4.6.5 Deviation from Test Standard	67
4.6.6 EUT Operating Condition	67
4.6.7 Test Results	68
4.7 6dB Bandwidth Measurement	69
4.7.1 Limits of 6dB Bandwidth Measurement.....	69
4.7.2 Test Setup.....	69
4.7.3 Test Instruments	69
4.7.4 Test Procedure	69
4.7.5 Deviation from Test Standard	69
4.7.6 EUT Operating Condition	69
4.7.7 Test Results	70
5 Pictures of Test Arrangements.....	72
Annex A- Radiated Out of Band Emission (OOBE) Measurement (For U-NII-3 band)	73
Annex B- Band-edge measurement (For U-NII-1 band)	73
Appendix – Information of the Testing Laboratories	80

Release Control Record

Issue No.	Description	Date Issued
RFBCMA-WTW-P21010371-1	Original release.	Feb. 24, 2021

1 Certificate of Conformity

Product: DOCSIS® 3.1 Dual-Band AX5660 Wi-Fi 6 Cable Gateway

Brand: XTREAM

Test Model: CM4642342XXX

Series Model: CG4634XXXXXX

(where X character can be replaced by either alphanumeric character between A and Z and between 0 and 9 or “-” or “.” or “blank”)

Sample Status: ENGINEERING SAMPLE

Applicant: Arcadyan Technology Corporation

Test Date: Dec. 22, 2020 to Feb. 02, 2021

Standard: 47 CFR FCC Part 15, Subpart E (Section 15.407)
ANSI C63.10: 2013

The above equipment has been tested by **Bureau Veritas Consumer Products Services (H.K.) Ltd., Taoyuan Branch**, and found compliance with the requirement of the above standards. The test record, data evaluation & Equipment Under Test (EUT) configurations represented herein are true and accurate accounts of the measurements of the sample's EMC characteristics under the conditions specified in this report.

Prepared by : Cherry Chuo , **Date:** Feb. 24, 2021
Cherry Chuo/ Specialist

Approved by : Clark Lin , **Date:** Feb. 24, 2021
Clark Lin / Technical Manager

2 Summary of Test Results

47 CFR FCC Part 15, Subpart E (Section 15.407)			
FCC Clause	Test Item	Result	Remarks
15.407(b)(6)	AC Power Conducted Emissions	Pass	Meet the requirement of limit. Minimum passing margin is -17.15dB at 0.30625MHz.
15.407(b) (1/2/3/4(i/ii)/6)	Radiated Emissions & Band Edge Measurement*	Pass	Meet the requirement of limit. Minimum passing margin is -0.1dB at 17475.00MHz and 5150.00MHz.
15.407(a)(1/2/3)	Max Average Transmit Power	Pass	Meet the requirement of limit.
---	Occupied Bandwidth Measurement	-	Reference only.
15.407(a)(1/2/3)	Peak Power Spectral Density	Pass	Meet the requirement of limit.
15.407(e)	6dB bandwidth	Pass	Meet the requirement of limit. (U-NII-3 Band only)
15.407(g)	Frequency Stability	Pass	Meet the requirement of limit.
15.203	Antenna Requirement	Pass	No antenna connector is used.

Note:

1. For U-NII-3 band compliance with rule part 15.407(b)(4)(i), the OOB test plots were recorded in Annex A.
2. For U-NII-1 band compliance with rule 15.407(b) of the band-edge items, the test plots were recorded in Annex B. Test Procedures refer to report 4.1.3.
3. Determining compliance based on the results of the compliance measurement, not taking into account measurement instrumentation uncertainty.

2.1 Measurement Uncertainty

Where relevant, the following measurement uncertainty levels have been estimated for tests performed on the EUT as specified in CISPR 16-4-2:

Measurement	Frequency	Expanded Uncertainty (k=2) (\pm)
Conducted Emissions at mains ports	150kHz ~ 30MHz	1.9 dB
Radiated Emissions up to 1 GHz	9kHz ~ 30MHz	3.1 dB
	30MHz ~ 1GHz	5.1 dB
Radiated Emissions above 1 GHz	1GHz ~ 18GHz	5.1 dB
	18GHz ~ 40GHz	5.3 dB

2.2 Modification Record

There were no modifications required for compliance.

3 General Information

3.1 General Description of EUT

Product	DOCSIS® 3.1 Dual-Band AX5660 Wi-Fi 6 Cable Gateway
Brand	XTREAM
Test Model	CM4642342XXX
Series Model	CG4634XXXXXX (where X character can be replaced by either alphanumeric character between A and Z and between 0 and 9 or “-“ or “.” or “blank”)
Status of EUT	ENGINEERING SAMPLE
Power Supply Rating	12Vdc from power adapter
Modulation Type	CCK, DQPSK, DBPSK for DSSS 64QAM, 16QAM, QPSK, BPSK for OFDM 256QAM for OFDM in 11ac mode and VHT20/40 in 2.4GHz 1024QAM for OFDMA in 11ax HE mode
Modulation Technology	DSSS, OFDM, OFDMA
Transfer Rate	802.11b: up to 11 Mbps 802.11a/g: up to 54 Mbps 802.11n: up to 600 Mbps 802.11ac: up to 1733.3 Mbps 802.11ax: up to 2401.9 Mbps
Operating Frequency	2.4GHz: 2.412GHz ~ 2.462GHz 5GHz: 5.18 ~ 5.24GHz, 5.745 ~ 5.825GHz
Number of Channel	2.4GHz: 802.11b, 802.11g, 802.11n (HT20), VHT20, 802.11ax (HE20): 11 802.11n (HT40), VHT40, 802.11ax (HE40): 7 5GHz: 802.11a, 802.11n (HT20), 802.11ac (VHT20), 802.11ax (HE20): 9 802.11n (HT40), 802.11ac (VHT40), 802.11ax (HE40): 4 802.11ac (VHT80), 802.11ax (HE80): 2
Output Power	CDD Mode: 2.412 ~ 2.462 GHz: 986.76 mW 5.18 ~ 5.24 GHz: 990.208 mW 5.745 ~ 5.825 GHz: 972.881 mW Beamforming Mode: 2.412 ~ 2.462 GHz: 935.568 mW 5.18 ~ 5.24 GHz: 567.847 mW 5.745 ~ 5.825 GHz: 567.273 mW
Antenna Type	Refer to Note
Antenna Connector	Refer to Note
Accessory Device	Adapter x1

Note:

1. The EUT has two radios as following table:

Radio 1	Radio 2
WLAN 2.4GHz	WLAN 5GHz

2. Simultaneously transmission condition.

Condition	Technology	
1	WLAN 2.4GHz	WLAN 5GHz

Note: The emission of the simultaneous operation has been evaluated and no non-compliance was found.

3. The EUT has below model names, which are identical to each other in all aspects except for the following information:

Brand	Model No.	Differences
XTREAM	CM4642342XXX	NA
	CG4634XXXXXX (where X character can be replaced by either alphanumeric character between A and Z and between 0 and 9 or "-" or "." or "blank")	For marketing reason the same product will be covered by different name.

From the above models, model: **CM4642342XXX** was selected as representative model for the test and its data was recorded in this report.

4. The EUT must be supplied with a power adapter as following table:

Brand	Model No.	Spec.
HONOTO	ADS-36FKJ-12 12036EPCU	AC Input: 100-240Vac, 1A, 50/60Hz DC Output: 12V, 3.0A DC Output Cable: 1.5m unshielded

5. The antennas provided to the EUT, please refer to the following table:

Ant. No	RF Chain No.	Ant. Net Gain (dBi)	Freq. Range (GHz)	Ant. Type	Connector Type
1	2.4GHz Chain 0	1.83	2.4~2.4835	PCB	none
2	2.4GHz Chain 1	0.03	2.4~2.4835	PCB	none
3	2.4GHz Chain 2	1.97	2.4~2.4835	PCB	none
4	5GHz Chain 0	1.81	5.15~5.85	PCB	none
5	5GHz Chain 1	3.32	5.15~5.85	PCB	none
6	5GHz Chain 2	2.37	5.15~5.85	PCB	none
7	5GHz Chain 3	2.07	5.15~5.85	PCB	none

6. The EUT incorporates a MIMO function:

2.4GHz Band		
MODULATION MODE	TX & RX CONFIGURATION	
802.11b	3TX	3RX
802.11g	3TX	3RX
802.11n (HT20)	3TX	3RX
802.11n (HT40)	3TX	3RX
VHT20	3TX	3RX
VHT40	3TX	3RX
802.11ax (HE20)	3TX	3RX
802.11ax (HE40)	3TX	3RX
5GHz Band		
MODULATION MODE	TX & RX CONFIGURATION	
802.11a	4TX	4RX
802.11n (HT20)	4TX	4RX
802.11n (HT40)	4TX	4RX
802.11ac (VHT20)	4TX	4RX
802.11ac (VHT40)	4TX	4RX
802.11ac (VHT80)	4TX	4RX
802.11ax (HE20)	4TX	4RX
802.11ax (HE40)	4TX	4RX
802.11ax (HE80)	4TX	4RX

Note:

1. All of modulation mode support beamforming function except 802.11a/b/g modulation mode.
2. The EUT support Beamforming and CDD mode, therefore both mode were investigated and the worst case scenario was identified. The worst case data were presented in test report.
3. The modulation and bandwidth are similar for 802.11n mode for 20MHz (40MHz), 802.11ac mode for 20MHz (40MHz, 80MHz) and 802.11ax mode for 20MHz (40MHz, 80MHz), therefore the manufacturer will control the power for 802.11ac mode is the same as the 802.11ax mode or more lower than it and investigated worst case to representative mode in test report. (Final test mode refer to section 3.2.1)

7. The above EUT information is declared by manufacturer and for more detailed features description, please refers to the manufacturer's specifications or user's manual.
8. The above Antenna information is declared by manufacturer and for more detailed features description, please refer to the manufacturer's specifications, the laboratory shall not be held responsible.

3.2 Description of Test Modes

FOR 5180 ~ 5240MHz

4 channels are provided for 802.11a, 802.11n (HT20), 802.11ac (VHT20), 802.11ax (HE20):

Channel	Frequency	Channel	Frequency
36	5180 MHz	44	5220 MHz
40	5200 MHz	48	5240 MHz

2 channels are provided for 802.11n (HT40), 802.11ac (VHT40), 802.11ax (HE40):

Channel	Frequency	Channel	Frequency
38	5190 MHz	46	5230 MHz

1 channel is provided for 802.11ac (VHT80) , 802.11ax (HE80):

Channel	Frequency
42	5210 MHz

FOR 5745 ~ 5825MHz:

5 channels are provided for 802.11a, 802.11n (HT20), 802.11ac (VHT20), 802.11ax (HE20):

Channel	Frequency	Channel	Frequency
149	5745 MHz	161	5805 MHz
153	5765 MHz	165	5825 MHz
157	5785 MHz		

2 channels are provided for 802.11n (HT40), 802.11ac (VHT40), 802.11ax (HE40):

Channel	Frequency	Channel	Frequency
151	5755 MHz	159	5795 MHz

1 channel is provided for 802.11ac (VHT80), 802.11ax (HE80):

Channel	Frequency
155	5775 MHz

3.2.1 Test Mode Applicability and Tested Channel Detail

EUT Configure Mode	Applicable To				Description
	RE \geq 1G	RE<1G	PLC	APCM	
-	√	√	√	√	-

Where **RE \geq 1G**: Radiated Emission above 1GHz

RE<1G: Radiated Emission below 1GHz

PLC: Power Line Conducted Emission

APCM: Antenna Port Conducted Measurement

Note: The EUT had been pre-tested on the positioned of laying-flat and Standing Plane. The worst case was found when positioned of on **Standing Plane**.

Radiated Emission Test (Above 1GHz):

- Pre-Scan has been conducted to determine the worst-case mode from all possible combinations between available modulations, data rates and antenna ports (if EUT with antenna diversity architecture).
- Following channel(s) was (were) selected for the final test as listed below.

CDD Mode						
Mode	FREQ. Band (MHz)	Available Channel	Tested Channel	Modulation Technology	Modulation Type	Data Rate Parameter
802.11a	5180-5240	36 to 48	36, 40, 48	OFDM	BPSK	6Mb/s
802.11ax (HE20)		36 to 48	36, 40, 48	OFDMA	BPSK	MCS0
802.11ax (HE40)		38 to 46	38, 46	OFDMA	BPSK	MCS0
802.11ax (HE80)		42	42	OFDMA	BPSK	MCS0
802.11a	5745-5825	149 to 165	149, 157, 165	OFDM	BPSK	6Mb/s
802.11ax (HE20)		149 to 165	149, 157, 165	OFDMA	BPSK	MCS0
802.11ax (HE40)		151 to 159	151, 159	OFDMA	BPSK	MCS0
802.11ax (HE80)		155	155	OFDMA	BPSK	MCS0

Radiated Emission Test (Below 1GHz):

- Pre-Scan has been conducted to determine the worst-case mode from all possible combinations between available modulations, data rates and antenna ports (if EUT with antenna diversity architecture).
- Following channel(s) was (were) selected for the final test as listed below.

CDD Mode						
Mode	FREQ. Band (MHz)	Available Channel	Tested Channel	Modulation Technology	Modulation Type	Data Rate Parameter
802.11ax (HE40)	5180-5240 5745-5825	38 to 46 151 to 159	46	OFDMA	BPSK	MCS0

Power Line Conducted Emission Test:

- Pre-Scan has been conducted to determine the worst-case mode from all possible combinations between available modulations, data rates and antenna ports (if EUT with antenna diversity architecture).
- Following channel(s) was (were) selected for the final test as listed below.

CDD Mode						
Mode	FREQ. Band (MHz)	Available Channel	Tested Channel	Modulation Technology	Modulation Type	Data Rate Parameter
802.11ax (HE40)	5180-5240 5745-5825	36 to 48 149 to 165	46	OFDMA	BPSK	MCS0

Antenna Port Conducted Measurement:

- This item includes all test value of each mode, but only includes spectrum plot of worst value of each mode.
- Pre-Scan has been conducted to determine the worst-case mode from all possible combinations between available modulations, data rates and antenna ports (if EUT with antenna diversity architecture).
- Following channel(s) was (were) selected for the final test as listed below.

CDD Mode						
Mode	FREQ. Band (MHz)	Available Channel	Tested Channel	Modulation Technology	Modulation Type	Data Rate Parameter
802.11a	5180-5240	36 to 48	36, 40, 48	OFDM	BPSK	6Mb/s
802.11ac (VHT20) (for output power)		36 to 48	36, 40, 48	OFDM	BPSK	MCS0
802.11ac (VHT40) (for output power)		38 to 46	38, 46	OFDM	BPSK	MCS0
802.11ac (VHT80) (for output power)		42	42	OFDM	BPSK	MCS0
802.11ax (HE20)		36 to 48	36, 40, 48	OFDMA	BPSK	MCS0
802.11ax (HE40)		38 to 46	38, 46	OFDMA	BPSK	MCS0
802.11ax (HE80)		42	42	OFDMA	BPSK	MCS0
802.11a		5745-5825	149 to 165	149, 157, 165	OFDM	BPSK
802.11ac (VHT20) (for output power)	149 to 165		149, 157, 165	OFDM	BPSK	MCS0
802.11ac (VHT40) (for output power)	151 to 159		151, 159	OFDM	BPSK	MCS0
802.11ac (VHT80) (for output power)	155		155	OFDM	BPSK	MCS0
802.11ax (HE20)	149 to 165		149, 157, 165	OFDMA	BPSK	MCS0
802.11ax (HE40)	151 to 159		151, 159	OFDMA	BPSK	MCS0
802.11ax (HE80)	155		155	OFDMA	BPSK	MCS0

Beamforming Mode (output power only)						
Mode	FREQ. Band (MHz)	Available Channel	Tested Channel	Modulation Technology	Modulation Type	Data Rate Parameter
802.11ac (VHT20)	5180-5240	36 to 48	36, 40, 48	OFDM	BPSK	MCS0
802.11ac (VHT40)		38 to 46	38, 46	OFDM	BPSK	MCS0
802.11ac (VHT80)		42	42	OFDM	BPSK	MCS0
802.11ax (HE20)		36 to 48	36, 40, 48	OFDMA	BPSK	MCS0
802.11ax (HE40)		38 to 46	38, 46	OFDMA	BPSK	MCS0
802.11ax (HE80)		42	42	OFDMA	BPSK	MCS0
802.11ac (VHT20)	5745-5825	149 to 165	149, 157, 165	OFDM	BPSK	MCS0
802.11ac (VHT40)		151 to 159	151, 159	OFDM	BPSK	MCS0
802.11ac (VHT80)		155	155	OFDM	BPSK	MCS0
802.11ax (HE20)		149 to 165	149, 157, 165	OFDMA	BPSK	MCS0
802.11ax (HE40)		151 to 159	151, 159	OFDMA	BPSK	MCS0
802.11ax (HE80)		155	155	OFDMA	BPSK	MCS0

Test Condition:

Applicable To	Environmental Conditions	Input Power	Tested By
RE \geq 1G	25deg. C, 68%RH	120Vac, 60Hz	Benson Chao
RE $<$ 1G	22deg. C, 66%RH	120Vac, 60Hz	Benson Chao
PLC	25deg. C, 71%RH	120Vac, 60Hz	Sampson Chen
APCM	25deg. C, 60%RH	120Vac, 60Hz	Eric Peng

3.3 Duty Cycle of Test Signal

Duty cycle of test signal is $\geq 98\%$, duty factor is not required.

802.11a: Duty cycle = $2.972\text{ms} / 3.002\text{ms} = 0.99$

802.11ax (HE20): Duty cycle = $3.31\text{ms} / 3.342\text{ms} = 0.991$

802.11ax (HE40): Duty cycle = $2.498\text{ms} / 2.538\text{ms} = 0.984$

802.11ax (HE80): Duty cycle = $2.451\text{ms} / 2.487\text{ms} = 0.986$

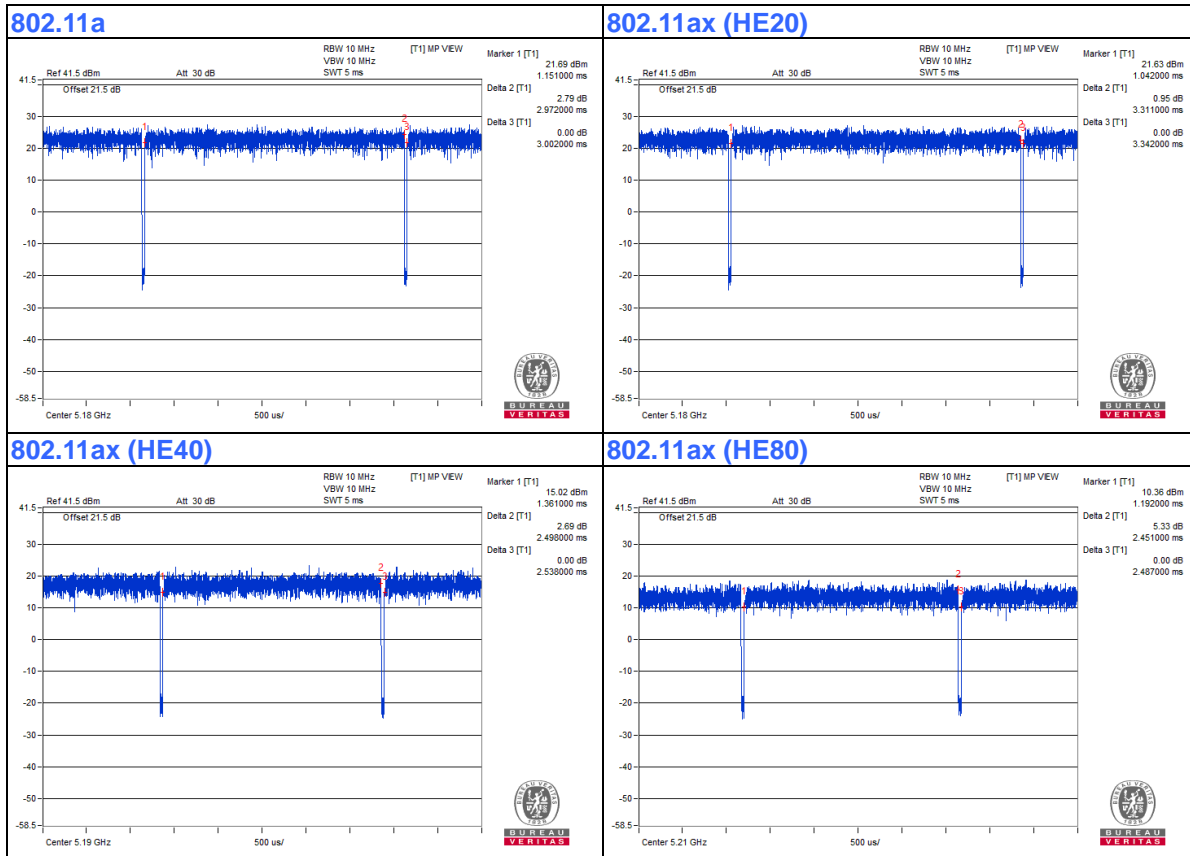

3.4 Description of Support Units

The EUT has been tested as an independent unit together with other necessary accessories or support units. The following support units or accessories were used to form a representative test configuration during the tests.

ID	Product	Brand	Model No.	Serial No.	FCC ID	Remarks
A.	Laptop	DELL	E6420	482T3R1	FCC DoC	Provided by Lab
B.	Laptop	DELL	E5430	GM1SKV1	FCC DoC	Provided by Lab
C.	Switch	D-Link	DGS-1005D	DR8WC92000523	NA	Provided by Lab
D.	Telephone	ROMEO	TE-812	97280903	NA	Provided by Lab

Note:

- All power cords of the above support units are non-shielded (1.8m).

ID	Descriptions	Qty.	Length (m)	Shielding (Yes/No)	Cores (Qty.)	Remarks
1.	DC Cable	1	1.5	No	0	Supplied by client
2.	RJ-11 Cable	1	10	No	0	Provided by Lab
3.	Coaxial Cable	1	10	Yes	0	Provided by Lab
4.	RJ-45 Cable	1	10	No	0	Provided by Lab
5.	RJ-45 Cable	1	10	No	0	Provided by Lab
6.	RJ-45 Cable	1	10	No	0	Provided by Lab

3.4.1 Configuration of System under Test

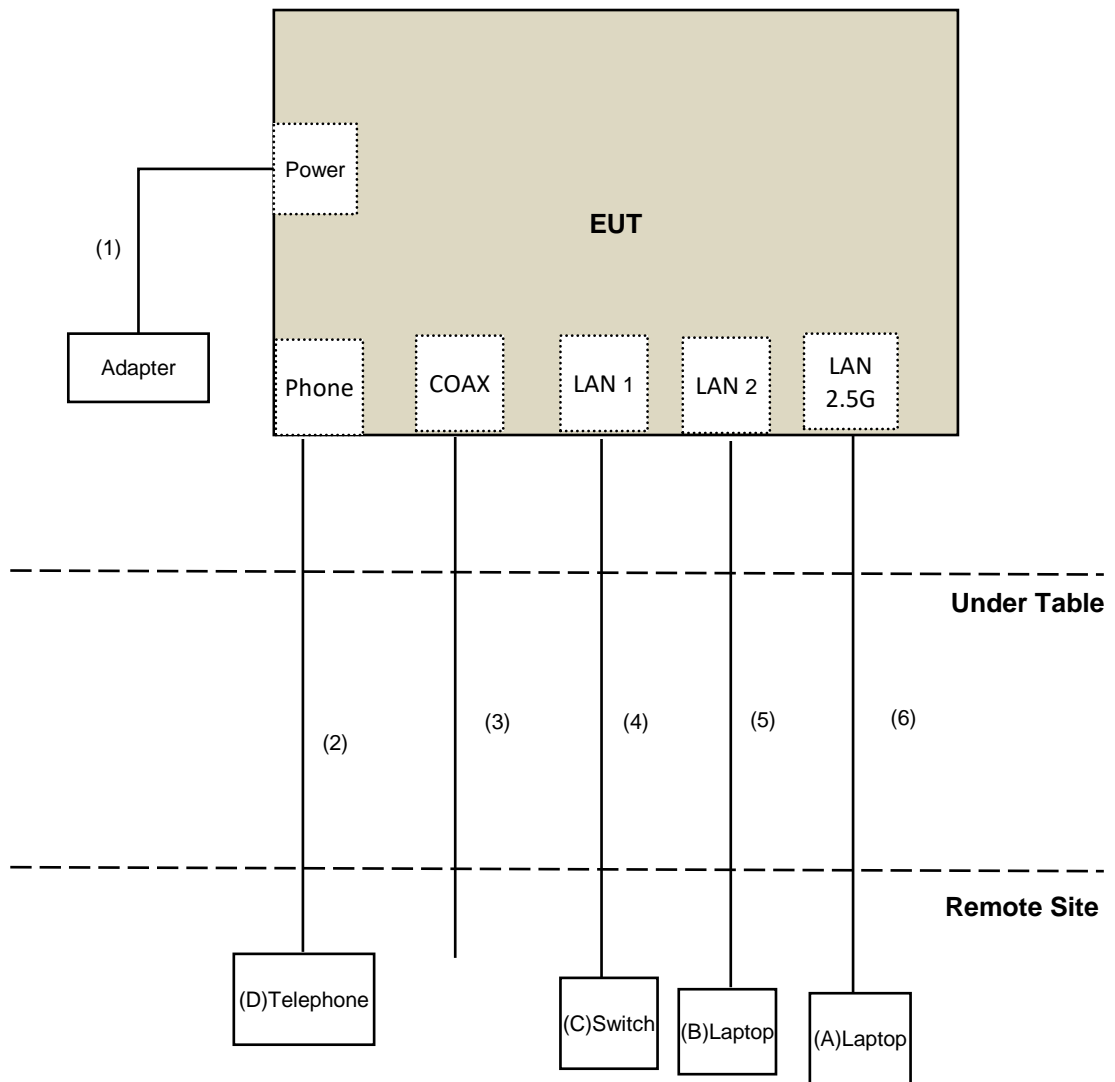

3.5 General Description of Applied Standard and references

The EUT is a RF Product. According to the specifications of the manufacturer, it must comply with the requirements of the following standards and references:

Test Standard:

FCC Part 15, Subpart E (15.407)
ANSI C63.10-2013

All test items have been performed and recorded as per the above standards.

References Test Guidance:

KDB 789033 D02 General UNII Test Procedure New Rules v02r01
KDB 662911 D01 Multiple Transmitter Output v02r01

All test items have been performed as a reference to the above KDB test guidance.

4 Test Types and Results

4.1 Radiated Emission and Bandedge Measurement

4.1.1 Limits of Radiated Emission and Bandedge Measurement

Radiated emissions which fall in the restricted bands must comply with the radiated emission limits specified as below table.

Frequencies (MHz)	Field Strength (microvolts/meter)	Measurement Distance (meters)
0.009 ~ 0.490	2400/F(kHz)	300
0.490 ~ 1.705	24000/F(kHz)	30
1.705 ~ 30.0	30	30
30 ~ 88	100	3
88 ~ 216	150	3
216 ~ 960	200	3
Above 960	500	3

NOTE:

- The lower limit shall apply at the transition frequencies.
- Emission level (dBuV/m) = 20 log Emission level (uV/m).
- For frequencies above 1000MHz, the field strength limits are based on average detector, however, the peak field strength of any emission shall not exceed the maximum permitted average limits, specified above by more than 20dB under any condition of modulation.

Limits of unwanted emission out of the restricted bands

Applicable To		Limit	
789033 D02 General UNII Test Procedure New Rules v02r01		Field Strength at 3m	
		PK:74 (dBuV/m)	AV:54 (dBuV/m)
Frequency Band	Applicable To	EIRP Limit	Equivalent Field Strength at 3m
5150~5250 MHz	15.407(b)(1)	PK:-27 (dBm/MHz)	PK:68.2(dBuV/m)
5250~5350 MHz	15.407(b)(2)		
5470~5725 MHz	15.407(b)(3)		
5725~5850 MHz	15.407(b)(4)(i)	PK:-27 (dBm/MHz) ^{*1} PK:10 (dBm/MHz) ^{*2} PK:15.6 (dBm/MHz) ^{*3} PK:27 (dBm/MHz) ^{*4}	PK: 68.2(dBuV/m) ^{*1} PK:105.2 (dBuV/m) ^{*2} PK: 110.8(dBuV/m) ^{*3} PK:122.2 (dBuV/m) ^{*4}
*1 beyond 75 MHz or more above of the band edge.		*2 below the band edge increasing linearly to 10 dBm/MHz at 25 MHz above.	
*3 below the band edge increasing linearly to a level of 15.6 dBm/MHz at 5 MHz above.		*4 from 5 MHz above or below the band edge increasing linearly to a level of 27 dBm/MHz at the band edge.	

Note:

The following formula is used to convert the equipment isotropic radiated power (eirp) to field strength:

$$E = \frac{1000000\sqrt{30P}}{3} \mu\text{V/m, where P is the eirp (Watts).}$$

4.1.2 Test Instruments
 For Radiated emission test

DESCRIPTION & MANUFACTURER	MODEL NO.	SERIAL NO.	CALIBRATED DATE	CALIBRATED UNTIL
Test Receiver R&S	ESR7	102026	Apr. 22, 2020	Apr. 21, 2021
Spectrum Analyzer Keysight	N9030B	MY57141948	May 22, 2020	May 21, 2021
Pre-Amplifier EMCI	EMC001340	980142	May 25, 2020	May 24, 2021
Loop Antenna Electro-Metrics	EM-6879	264	Feb. 18, 2020	Feb. 17, 2021
RF Cable	5D-FB	LOOPCAB-001	Jan. 07, 2021	Jan. 06, 2022
RF Cable	5D-FB	LOOPCAB-002	Jan. 07, 2021	Jan. 06, 2022
Pre-Amplifier EMCI	EMC330N	980538	Apr. 28, 2020	Apr. 27, 2021
Trilog Broadband Antenna SCHWARZBECK	VULB9168	9168-0842	Nov. 03, 2020	Nov. 02, 2021
RF Cable	8D	966-5-1	Apr. 29, 2020	Apr. 28, 2021
RF Cable	8D	966-5-2	Apr. 29, 2020	Apr. 28, 2021
RF Cable	8D	966-5-3	Apr. 29, 2020	Apr. 28, 2021
Fixed attenuator Mini-Circuits	UNAT-5+	PAD-ATT5-02	Jan. 11, 2021	Jan. 10, 2022
Horn_Antenna SCHWARZBECK	BBHA 9120D	9120D-1819	Nov. 22, 2020	Nov. 21, 2021
Pre-Amplifier EMCI	EMC12630SE	980509	Apr. 29, 2020	Apr. 28, 2021
RF Cable EMCI	EMC104-SM-SM-1500	180503	Apr. 29, 2020	Apr. 28, 2021
RF Cable EMCI	EMC104-SM-SM-2000	180501	Apr. 29, 2020	Apr. 28, 2021
RF Cable EMCI	EMC104-SM-SM-6000	180506	Apr. 29, 2020	Apr. 28, 2021
Pre-Amplifier EMCI	EMC184045SE	980387	Jan. 11, 2021	Jan. 10, 2022
Horn_Antenna SCHWARZBECK	BBHA 9170	BBHA9170519	Nov. 22, 2020	Nov. 21, 2021
RF Cable	EMC102-KM-KM-1200	160924	Jan. 11, 2021	Jan. 10, 2022
RF Cable	EMC-KM-KM-4000	200214	Mar. 11, 2020	Mar. 10, 2021
Software	ADT_Radiated_V8.7.08	NA	NA	NA
Boresight Antenna Tower & Turn Table Max-Full	MF-7802BS	MF780208530	NA	NA

Note:

1. The calibration interval of the above test instruments is 12 months and the calibrations are traceable to NML/ROC and NIST/USA.
2. The test was performed in 966 Chamber No. 5.
3. Tested Date: Jan. 18 to Feb. 01, 2021

For Bandedge & OOBE test

DESCRIPTION & MANUFACTURER	MODEL NO.	SERIAL NO.	CALIBRATED DATE	CALIBRATED UNTIL
Test Receiver R&S	ESR7	102026	Apr. 22, 2020	Apr. 21, 2021
Spectrum Analyzer Keysight	N9030B	MY57141948	May 22, 2020	May 21, 2021
Horn_Antenna SCHWARZBECK	BBHA 9120D	9120D-1819	Nov. 22, 2020	Nov. 21, 2021
Pre-Amplifier EMCI	EMC12630SE	980509	Apr. 29, 2020	Apr. 28, 2021
RF Cable EMCI	EMC104-SM-SM-1500	180503	Apr. 29, 2020	Apr. 28, 2021
RF Cable EMCI	EMC104-SM-SM-2000	180501	Apr. 29, 2020	Apr. 28, 2021
RF Cable EMCI	EMC104-SM-SM-6000	180506	Apr. 29, 2020	Apr. 28, 2021
Pre-Amplifier EMCI	EMC184045SE	980387	Jan. 15, 2020	Jan. 14, 2021
Horn_Antenna SCHWARZBECK	BBHA 9170	BBHA9170519	Nov. 22, 2020	Nov. 21, 2021
RF Cable	EMC102-KM-KM-1200	160924	Jan. 15, 2020	Jan. 14, 2021
RF Cable	EMC-KM-KM-4000	200214	Mar. 11, 2020	Mar. 10, 2021
Software	ADT_Radiated_V8.7.08	NA	NA	NA
Boresight Antenna Tower & Turn Table Max-Full	MF-7802BS	MF780208530	NA	NA

Note:

1. The calibration interval of the above test instruments is 12 months and the calibrations are traceable to NML/ROC and NIST/USA.
2. The test was performed in 966 Chamber No. 5.
3. Tested Date: Dec. 22, 2020 to Jan. 07, 2021

For other test

DESCRIPTION & MANUFACTURER	MODEL NO.	SERIAL NO.	CALIBRATED DATE	CALIBRATED UNTIL
Spectrum Analyzer R&S	FSV40	100964	May 29, 2020	May 28, 2021
Power meter Anritsu	ML2495A	1529002	July 22, 2020	July 21, 2021
Power sensor Anritsu	MA2411B	1339443	July 22, 2020	July 21, 2021
Fixed Attenuator Mini-Circuits	MDCS18N-10	MDCS18N-10-01	Apr. 14, 2020	Apr. 13, 2021
AC Power Source Extech Electronics	6205	1440452	NA	NA
Temperature & Humidity Chamber Giant Force	GTH-150-40-SP-AR	MAA0812-008	Jan. 14, 2021	Jan. 13, 2022
True RMS Clamp Meter FLUKE	325	31130711WS	June 06, 2020	June 05, 2021
Software	ADT_RF Test Software V6.6.5.4	NA	NA	NA

- NOTE:**
1. The test was performed in Oven room 2.
 2. The calibration interval of the above test instruments is 12 months and the calibrations are traceable to NML/ROC and NIST/USA.
 3. Tested Date: Feb. 02, 2021

4.1.3 Test Procedure

For Radiated emission below 30MHz

- a. The EUT was placed on the top of a rotating table 0.8 meters above the ground at a 3 meter chamber room. The table was rotated 360 degrees to determine the position of the highest radiation.
- b. The EUT was set 3 meters away from the interference-receiving antenna, which was mounted on the top of a variable-height antenna tower.
- c. Parallel, perpendicular, and ground-parallel orientations of the antenna are set to make the measurement.
- d. For each suspected emission, the EUT was arranged to its worst case and the rotatable table was turned from 0 degrees to 360 degrees to find the maximum reading.
- e. The test-receiver system was set to Quasi-Peak Detect Function and Specified Bandwidth with Maximum Hold Mode.

Note:

1. The resolution bandwidth and video bandwidth of test receiver/spectrum analyzer is 9kHz at frequency below 30MHz.

For Radiated emission above 30MHz

- a. The EUT was placed on the top of a rotating table 0.8 meters (for 30MHz ~ 1GHz) / 1.5 meters (for above 1GHz) above the ground at 3 meter chamber room for test. The table was rotated 360 degrees to determine the position of the highest radiation.
- b. The EUT was set 3 meters away from the interference-receiving antenna, which was mounted on the top of a variable-height antenna tower.
- c. The height of antenna is varied from one meter to four meters above the ground to determine the maximum value of the field strength. Both horizontal and vertical polarizations of the antenna are set to make the measurement.
- d. For each suspected emission, the EUT was arranged to its worst case and then the antenna was tuned to heights from 1 meter to 4 meters and the rotatable table was turned from 0 degrees to 360 degrees to find the maximum reading.
- e. The test-receiver system was set to quasi-peak detect function and specified bandwidth with maximum hold mode when the test frequency is below 1 GHz.
- f. The test-receiver system was set to peak and average detects function and specified bandwidth with maximum hold mode when the test frequency is above 1 GHz. If the peak reading value also meets average limit, measurement with the average detector is unnecessary.

Note:

1. The resolution bandwidth and video bandwidth of test receiver/spectrum analyzer is 120kHz for Quasi-peak detection (QP) at frequency below 1GHz.
2. The resolution bandwidth of test receiver/spectrum analyzer is 1 MHz and the video bandwidth is 3 MHz for Peak detection (PK) at frequency above 1GHz.
3. The resolution bandwidth of test receiver/spectrum analyzer is 1MHz and the video bandwidth is $\geq 1/T$ (Duty cycle < 98%) or 10Hz (Duty cycle $\geq 98\%$) for Average detection (AV) at frequency above 1GHz.
4. All modes of operation were investigated and the worst-case emissions are reported.

4.1.4 Deviation from Test Standard

No deviation.

4.1.5 Test Setup

For Radiated emission below 30MHz

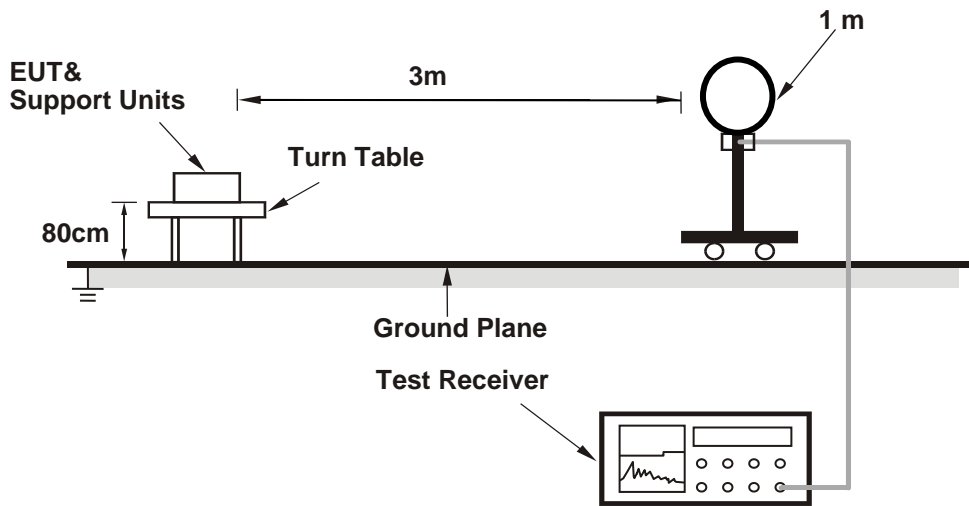

For Radiated emission 30MHz to 1GHz

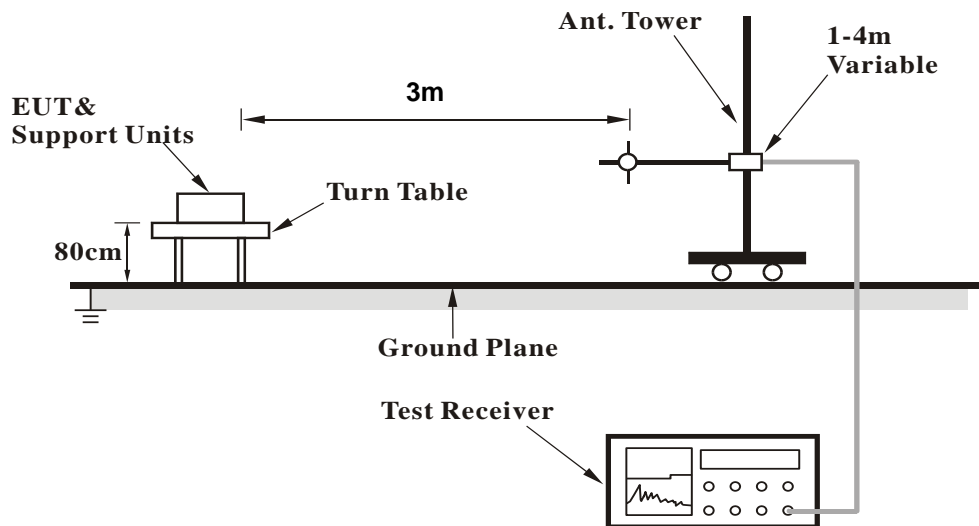

For Radiated emission above 1GHz

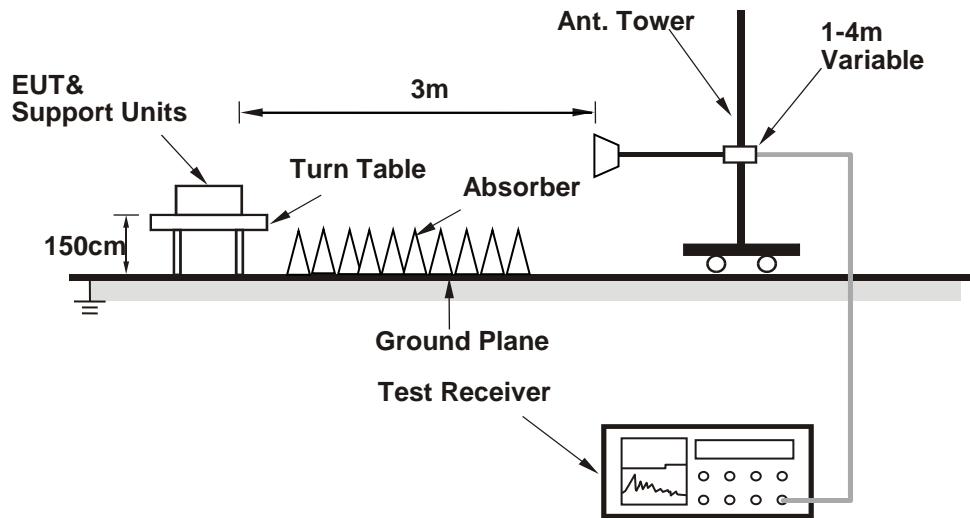

For the actual test configuration, please refer to the attached file (Test Setup Photo).

4.1.6 EUT Operating Condition

- a. Connected the EUT with the Laptop Computer which is placed on remote site.
- b. Controlling software (CM4642342_MM.rtf) has been activated to set the EUT under transmission condition continuously at specific channel frequency.

4.1.7 Test Results

ABOVE 1GHz DATA

RF Mode	TX 802.11a	Channel	CH 36 : 5180 MHz
Frequency Range	1GHz ~ 40GHz	Detector Function	Peak (PK) Average (AV)

Antenna Polarity & Test Distance : Horizontal at 3 m								
No	Frequency (MHz)	Emission Level (dBuV/m)	Limit (dBuV/m)	Margin (dB)	Antenna Height (m)	Table Angle (Degree)	Raw Value (dBuV)	Correction Factor (dB/m)
1	5145.29	72.1 PK	74.0	-1.9	2.05 H	355	70.1	2.0
2	5145.29	53.2 AV	54.0	-0.8	2.05 H	355	51.2	2.0
3	*5180.00	120.8 PK			2.05 H	355	119.0	1.8
4	*5180.00	110.6 AV			2.05 H	355	108.8	1.8
5	#10360.00	57.4 PK	68.2	-10.8	1.77 H	81	46.0	11.4
6	15540.00	60.9 PK	74.0	-13.1	1.49 H	259	49.0	11.9
7	15540.00	45.4 AV	54.0	-8.6	1.49 H	259	33.5	11.9

Antenna Polarity & Test Distance : Vertical at 3 m								
No	Frequency (MHz)	Emission Level (dBuV/m)	Limit (dBuV/m)	Margin (dB)	Antenna Height (m)	Table Angle (Degree)	Raw Value (dBuV)	Correction Factor (dB/m)
1	5148.72	67.9 PK	74.0	-6.1	1.92 V	358	65.9	2.0
2	5148.72	52.1 AV	54.0	-1.9	1.92 V	358	50.1	2.0
3	*5180.00	118.9 PK			1.92 V	358	117.1	1.8
4	*5180.00	109.0 AV			1.92 V	358	107.2	1.8
5	#10360.00	59.2 PK	68.2	-9.0	1.83 V	49	47.8	11.4
6	15540.00	55.0 PK	74.0	-19.0	1.46 V	270	43.1	11.9
7	15540.00	41.1 AV	54.0	-12.9	1.46 V	270	29.2	11.9

Remarks:

1. Emission Level(dBuV/m) = Raw Value(dBuV) + Correction Factor(dB/m)
2. Correction Factor(dB/m) = Antenna Factor(dB/m) + Cable Factor(dB) – Pre-Amplifier Factor(dB)
3. Margin value = Emission Level – Limit value
4. The other emission levels were very low against the limit.
5. " * ": Fundamental frequency.
6. " # ": The radiated frequency is out of the restricted band.

RF Mode	TX 802.11a	Channel	CH 40 : 5200 MHz
Frequency Range	1GHz ~ 40GHz	Detector Function	Peak (PK) Average (AV)

Antenna Polarity & Test Distance : Horizontal at 3 m

No	Frequency (MHz)	Emission Level (dBuV/m)	Limit (dBuV/m)	Margin (dB)	Antenna Height (m)	Table Angle (Degree)	Raw Value (dBuV)	Correction Factor (dB/m)
1	5150.00	66.3 PK	74.0	-7.7	1.82 H	349	64.3	2.0
2	5150.00	49.3 AV	54.0	-4.7	1.82 H	349	47.3	2.0
3	*5200.00	122.9 PK			1.82 H	349	121.2	1.7
4	*5200.00	112.8 AV			1.82 H	349	111.1	1.7
5	5350.00	59.0 PK	74.0	-15.0	1.82 H	349	57.4	1.6
6	5350.00	46.5 AV	54.0	-7.5	1.82 H	349	44.9	1.6
7	#10400.00	57.4 PK	68.2	-10.8	1.74 H	84	45.8	11.6
8	15600.00	61.2 PK	74.0	-12.8	1.49 H	270	49.6	11.6
9	15600.00	45.8 AV	54.0	-8.2	1.49 H	270	34.2	11.6

Antenna Polarity & Test Distance : Vertical at 3 m

No	Frequency (MHz)	Emission Level (dBuV/m)	Limit (dBuV/m)	Margin (dB)	Antenna Height (m)	Table Angle (Degree)	Raw Value (dBuV)	Correction Factor (dB/m)
1	5150.00	56.6 PK	74.0	-17.4	1.78 V	355	54.6	2.0
2	5150.00	45.3 AV	54.0	-8.7	1.78 V	355	43.3	2.0
3	*5200.00	119.6 PK			1.78 V	355	117.9	1.7
4	*5200.00	110.9 AV			1.78 V	355	109.2	1.7
5	5350.00	54.9 PK	74.0	-19.1	1.78 V	355	53.3	1.6
6	5350.00	43.2 AV	54.0	-10.8	1.78 V	355	41.6	1.6
7	#10400.00	59.1 PK	68.2	-9.1	1.82 V	54	47.5	11.6
8	15600.00	55.0 PK	74.0	-19.0	1.44 V	258	43.4	11.6
9	15600.00	41.3 AV	54.0	-12.7	1.44 V	258	29.7	11.6

Remarks:

1. Emission Level(dBuV/m) = Raw Value(dBuV) + Correction Factor(dB/m)
2. Correction Factor(dB/m) = Antenna Factor(dB/m) + Cable Factor(dB) – Pre-Amplifier Factor(dB)
3. Margin value = Emission Level – Limit value
4. The other emission levels were very low against the limit.
5. " * ": Fundamental frequency.
6. " # ": The radiated frequency is out of the restricted band.

RF Mode	TX 802.11a	Channel	CH 48 : 5240 MHz
Frequency Range	1GHz ~ 40GHz	Detector Function	Peak (PK) Average (AV)

Antenna Polarity & Test Distance : Horizontal at 3 m

No	Frequency (MHz)	Emission Level (dBuV/m)	Limit (dBuV/m)	Margin (dB)	Antenna Height (m)	Table Angle (Degree)	Raw Value (dBuV)	Correction Factor (dB/m)
1	*5240.00	123.6 PK			1.67 H	349	122.1	1.5
2	*5240.00	113.4 AV			1.67 H	349	111.9	1.5
3	5362.66	59.7 PK	74.0	-14.3	1.67 H	349	58.0	1.7
4	5362.66	47.6 AV	54.0	-6.4	1.67 H	349	45.9	1.7
5	#10480.00	57.6 PK	68.2	-10.6	1.76 H	77	46.0	11.6
6	15720.00	61.8 PK	74.0	-12.2	1.50 H	266	50.5	11.3
7	15720.00	46.2 AV	54.0	-7.8	1.50 H	266	34.9	11.3

Antenna Polarity & Test Distance : Vertical at 3 m

No	Frequency (MHz)	Emission Level (dBuV/m)	Limit (dBuV/m)	Margin (dB)	Antenna Height (m)	Table Angle (Degree)	Raw Value (dBuV)	Correction Factor (dB/m)
1	*5240.00	121.9 PK			1.78 V	359	120.4	1.5
2	*5240.00	112.0 AV			1.78 V	359	110.5	1.5
3	5351.57	56.1 PK	74.0	-17.9	1.78 V	359	54.5	1.6
4	5351.57	45.0 AV	54.0	-9.0	1.78 V	359	43.4	1.6
5	#10480.00	59.3 PK	68.2	-8.9	1.76 V	58	47.7	11.6
6	15720.00	54.6 PK	74.0	-19.4	1.39 V	261	43.3	11.3
7	15720.00	41.0 AV	54.0	-13.0	1.39 V	261	29.7	11.3

Remarks:

1. Emission Level(dBuV/m) = Raw Value(dBuV) + Correction Factor(dB/m)
2. Correction Factor(dB/m) = Antenna Factor(dB/m) + Cable Factor(dB) – Pre-Amplifier Factor(dB)
3. Margin value = Emission Level – Limit value
4. The other emission levels were very low against the limit.
5. " * ": Fundamental frequency.
6. " # ": The radiated frequency is out of the restricted band.

RF Mode	TX 802.11a	Channel	CH 149 : 5745 MHz
Frequency Range	1GHz ~ 40GHz	Detector Function	Peak (PK) Average (AV)

Antenna Polarity & Test Distance : Horizontal at 3 m

No	Frequency (MHz)	Emission Level (dBuV/m)	Limit (dBuV/m)	Margin (dB)	Antenna Height (m)	Table Angle (Degree)	Raw Value (dBuV)	Correction Factor (dB/m)
1	#5637.84	55.6 PK	68.2	-12.6	2.01 H	355	53.6	2.0
2	*5745.00	120.3 PK			2.01 H	355	118.2	2.1
3	*5745.00	111.0 AV			2.01 H	355	108.9	2.1
4	#5928.09	57.3 PK	68.2	-10.9	2.01 H	355	54.6	2.7
5	11490.00	57.9 PK	74.0	-16.1	1.72 H	95	44.9	13.0
6	11490.00	46.2 AV	54.0	-7.8	1.72 H	95	33.2	13.0
7	#17235.00	67.6 PK	68.2	-0.6	1.48 H	263	51.4	16.2

Antenna Polarity & Test Distance : Vertical at 3 m

No	Frequency (MHz)	Emission Level (dBuV/m)	Limit (dBuV/m)	Margin (dB)	Antenna Height (m)	Table Angle (Degree)	Raw Value (dBuV)	Correction Factor (dB/m)
1	#5649.95	56.6 PK	68.2	-11.6	2.81 V	330	54.6	2.0
2	*5745.00	121.5 PK			2.81 V	330	119.4	2.1
3	*5745.00	111.2 AV			2.81 V	330	109.1	2.1
4	#5976.74	56.0 PK	68.2	-12.2	2.81 V	330	53.3	2.7
5	11490.00	61.4 PK	74.0	-12.6	2.43 V	31	48.4	13.0
6	11490.00	49.3 AV	54.0	-4.7	2.43 V	31	36.3	13.0
7	#17235.00	59.3 PK	68.2	-8.9	1.43 V	258	43.1	16.2

Remarks:

1. Emission Level(dBuV/m) = Raw Value(dBuV) + Correction Factor(dB/m)
2. Correction Factor(dB/m) = Antenna Factor(dB/m) + Cable Factor(dB) – Pre-Amplifier Factor(dB)
3. Margin value = Emission Level – Limit value
4. The other emission levels were very low against the limit.
5. " * ": Fundamental frequency.
6. " # ": The radiated frequency is out of the restricted band.

RF Mode	TX 802.11a	Channel	CH 157 : 5785 MHz
Frequency Range	1GHz ~ 40GHz	Detector Function	Peak (PK) Average (AV)

Antenna Polarity & Test Distance : Horizontal at 3 m

No	Frequency (MHz)	Emission Level (dBuV/m)	Limit (dBuV/m)	Margin (dB)	Antenna Height (m)	Table Angle (Degree)	Raw Value (dBuV)	Correction Factor (dB/m)
1	#5644.79	56.5 PK	68.2	-11.7	1.40 H	150	54.5	2.0
2	*5785.00	120.9 PK			1.40 H	150	118.6	2.3
3	*5785.00	110.6 AV			1.40 H	150	108.3	2.3
4	#5943.19	56.3 PK	68.2	-11.9	1.40 H	150	53.6	2.7
5	11570.00	63.1 PK	74.0	-10.9	1.96 H	103	49.6	13.5
6	11570.00	50.2 AV	54.0	-3.8	1.96 H	103	36.7	13.5
7	#17355.00	67.8 PK	68.2	-0.4	1.41 H	260	50.6	17.2

Antenna Polarity & Test Distance : Vertical at 3 m

No	Frequency (MHz)	Emission Level (dBuV/m)	Limit (dBuV/m)	Margin (dB)	Antenna Height (m)	Table Angle (Degree)	Raw Value (dBuV)	Correction Factor (dB/m)
1	#5625.99	55.7 PK	68.2	-12.5	2.24 V	323	53.7	2.0
2	*5785.00	120.5 PK			2.24 V	323	118.2	2.3
3	*5785.00	110.4 AV			2.24 V	323	108.1	2.3
4	#5932.23	55.3 PK	68.2	-12.9	2.24 V	323	52.6	2.7
5	11570.00	64.1 PK	74.0	-9.9	2.76 V	47	50.6	13.5
6	11570.00	51.7 AV	54.0	-2.3	2.76 V	47	38.2	13.5
7	#17355.00	58.4 PK	68.2	-9.8	1.61 V	267	41.2	17.2

Remarks:

1. Emission Level(dBuV/m) = Raw Value(dBuV) + Correction Factor(dB/m)
2. Correction Factor(dB/m) = Antenna Factor(dB/m) + Cable Factor(dB) – Pre-Amplifier Factor(dB)
3. Margin value = Emission Level – Limit value
4. The other emission levels were very low against the limit.
5. " * ": Fundamental frequency.
6. " # ": The radiated frequency is out of the restricted band.

RF Mode	TX 802.11a	Channel	CH 165 : 5825 MHz
Frequency Range	1GHz ~ 40GHz	Detector Function	Peak (PK) Average (AV)

Antenna Polarity & Test Distance : Horizontal at 3 m

No	Frequency (MHz)	Emission Level (dBuV/m)	Limit (dBuV/m)	Margin (dB)	Antenna Height (m)	Table Angle (Degree)	Raw Value (dBuV)	Correction Factor (dB/m)
1	#5649.48	55.7 PK	68.2	-12.5	2.07 H	356	53.7	2.0
2	*5825.00	121.2 PK			2.07 H	356	118.9	2.3
3	*5825.00	111.2 AV			2.07 H	356	108.9	2.3
4	#5978.24	57.9 PK	68.2	-10.3	2.07 H	356	55.2	2.7
5	11650.00	64.8 PK	74.0	-9.2	1.95 H	98	51.3	13.5
6	11650.00	52.1 AV	54.0	-1.9	1.95 H	98	38.6	13.5
7	#17475.00	68.1 PK	68.2	-0.1	1.24 H	257	49.0	19.1

Antenna Polarity & Test Distance : Vertical at 3 m

No	Frequency (MHz)	Emission Level (dBuV/m)	Limit (dBuV/m)	Margin (dB)	Antenna Height (m)	Table Angle (Degree)	Raw Value (dBuV)	Correction Factor (dB/m)
1	#5606.87	55.5 PK	68.2	-12.7	2.75 V	325	53.7	1.8
2	*5825.00	120.5 PK			2.75 V	325	118.2	2.3
3	*5825.00	110.8 AV			2.75 V	325	108.5	2.3
4	#5952.86	55.2 PK	68.2	-13.0	2.75 V	325	52.5	2.7
5	11650.00	66.5 PK	74.0	-7.5	2.52 V	52	53.0	13.5
6	11650.00	53.0 AV	54.0	-1.0	2.52 V	52	39.5	13.5
7	#17475.00	58.5 PK	68.2	-9.7	1.66 V	260	39.4	19.1

Remarks:

1. Emission Level(dBuV/m) = Raw Value(dBuV) + Correction Factor(dB/m)
2. Correction Factor(dB/m) = Antenna Factor(dB/m) + Cable Factor(dB) – Pre-Amplifier Factor(dB)
3. Margin value = Emission Level – Limit value
4. The other emission levels were very low against the limit.
5. " * ": Fundamental frequency.
6. " # ": The radiated frequency is out of the restricted band.

RF Mode	TX 802.11ax (HE20)	Channel	CH 36 : 5180 MHz
Frequency Range	1GHz ~ 40GHz	Detector Function	Peak (PK) Average (AV)

Antenna Polarity & Test Distance : Horizontal at 3 m

No	Frequency (MHz)	Emission Level (dBuV/m)	Limit (dBuV/m)	Margin (dB)	Antenna Height (m)	Table Angle (Degree)	Raw Value (dBuV)	Correction Factor (dB/m)
1	5150.00	73.6 PK	74.0	-0.4	1.76 H	351	71.6	2.0
2	5150.00	53.9 AV	54.0	-0.1	1.76 H	351	51.9	2.0
3	*5180.00	119.9 PK			1.76 H	351	118.1	1.8
4	*5180.00	107.3 AV			1.76 H	351	105.5	1.8
5	#10360.00	55.7 PK	68.2	-12.5	1.72 H	96	44.3	11.4
6	15540.00	58.7 PK	74.0	-15.3	1.46 H	257	46.8	11.9
7	15540.00	43.4 AV	54.0	-10.6	1.46 H	257	31.5	11.9

Antenna Polarity & Test Distance : Vertical at 3 m

No	Frequency (MHz)	Emission Level (dBuV/m)	Limit (dBuV/m)	Margin (dB)	Antenna Height (m)	Table Angle (Degree)	Raw Value (dBuV)	Correction Factor (dB/m)
1	5147.62	68.8 PK	74.0	-5.2	2.43 V	331	66.8	2.0
2	5147.62	51.6 AV	54.0	-2.4	2.43 V	331	49.6	2.0
3	*5180.00	117.7 PK			2.43 V	331	115.9	1.8
4	*5180.00	105.8 AV			2.43 V	331	104.0	1.8
5	#10360.00	58.3 PK	68.2	-9.9	2.80 V	35	46.9	11.4
6	15540.00	52.6 PK	74.0	-21.4	1.57 V	274	40.7	11.9
7	15540.00	40.5 AV	54.0	-13.5	1.57 V	274	28.6	11.9

Remarks:

1. Emission Level(dBuV/m) = Raw Value(dBuV) + Correction Factor(dB/m)
2. Correction Factor(dB/m) = Antenna Factor(dB/m) + Cable Factor(dB) – Pre-Amplifier Factor(dB)
3. Margin value = Emission Level – Limit value
4. The other emission levels were very low against the limit.
5. " * ": Fundamental frequency.
6. " # ": The radiated frequency is out of the restricted band.

RF Mode	TX 802.11ax (HE20)	Channel	CH 40 : 5200 MHz
Frequency Range	1GHz ~ 40GHz	Detector Function	Peak (PK) Average (AV)

Antenna Polarity & Test Distance : Horizontal at 3 m

No	Frequency (MHz)	Emission Level (dBuV/m)	Limit (dBuV/m)	Margin (dB)	Antenna Height (m)	Table Angle (Degree)	Raw Value (dBuV)	Correction Factor (dB/m)
1	5150.00	67.7 PK	74.0	-6.3	1.74 H	351	65.7	2.0
2	5150.00	52.4 AV	54.0	-1.6	1.74 H	351	50.4	2.0
3	*5200.00	121.8 PK			1.74 H	351	120.1	1.7
4	*5200.00	111.0 AV			1.74 H	351	109.3	1.7
5	#10400.00	55.6 PK	68.2	-12.6	1.76 H	86	44.0	11.6
6	15600.00	59.4 PK	74.0	-14.6	1.46 H	256	47.8	11.6
7	15600.00	43.9 AV	54.0	-10.1	1.46 H	256	32.3	11.6

Antenna Polarity & Test Distance : Vertical at 3 m

No	Frequency (MHz)	Emission Level (dBuV/m)	Limit (dBuV/m)	Margin (dB)	Antenna Height (m)	Table Angle (Degree)	Raw Value (dBuV)	Correction Factor (dB/m)
1	5150.00	68.4 PK	74.0	-5.6	1.35 V	7	66.4	2.0
2	5150.00	51.6 AV	54.0	-2.4	1.35 V	7	49.6	2.0
3	*5200.00	121.3 PK			1.35 V	7	119.6	1.7
4	*5200.00	109.2 AV			1.35 V	7	107.5	1.7
5	#10400.00	58.2 PK	68.2	-10.0	2.86 V	24	46.6	11.6
6	15600.00	52.6 PK	74.0	-21.4	1.59 V	274	41.0	11.6
7	15600.00	40.6 AV	54.0	-13.4	1.59 V	274	29.0	11.6

Remarks:

1. Emission Level(dBuV/m) = Raw Value(dBuV) + Correction Factor(dB/m)
2. Correction Factor(dB/m) = Antenna Factor(dB/m) + Cable Factor(dB) – Pre-Amplifier Factor(dB)
3. Margin value = Emission Level – Limit value
4. The other emission levels were very low against the limit.
5. " * ": Fundamental frequency.
6. " # ": The radiated frequency is out of the restricted band.

RF Mode	TX 802.11ax (HE20)	Channel	CH 48 : 5240 MHz
Frequency Range	1GHz ~ 40GHz	Detector Function	Peak (PK) Average (AV)

Antenna Polarity & Test Distance : Horizontal at 3 m

No	Frequency (MHz)	Emission Level (dBuV/m)	Limit (dBuV/m)	Margin (dB)	Antenna Height (m)	Table Angle (Degree)	Raw Value (dBuV)	Correction Factor (dB/m)
1	*5240.00	123.7 PK			1.79 H	348	122.2	1.5
2	*5240.00	111.6 AV			1.79 H	348	110.1	1.5
3	5369.59	58.8 PK	74.0	-15.2	1.79 H	348	57.1	1.7
4	5369.59	47.0 AV	54.0	-7.0	1.79 H	348	45.3	1.7
5	#10480.00	55.9 PK	68.2	-12.3	1.79 H	95	44.3	11.6
6	15720.00	59.1 PK	74.0	-14.9	1.41 H	260	47.8	11.3
7	15720.00	43.5 AV	54.0	-10.5	1.41 H	260	32.2	11.3

Antenna Polarity & Test Distance : Vertical at 3 m

No	Frequency (MHz)	Emission Level (dBuV/m)	Limit (dBuV/m)	Margin (dB)	Antenna Height (m)	Table Angle (Degree)	Raw Value (dBuV)	Correction Factor (dB/m)
1	*5240.00	119.8 PK			1.72 V	325	118.3	1.5
2	*5240.00	108.8 AV			1.72 V	325	107.3	1.5
3	5362.37	54.9 PK	74.0	-19.1	1.72 V	325	53.2	1.7
4	5362.37	44.2 AV	54.0	-9.8	1.72 V	325	42.5	1.7
5	#10480.00	58.2 PK	68.2	-10.0	2.87 V	22	46.6	11.6
6	15720.00	52.7 PK	74.0	-21.3	1.64 V	287	41.4	11.3
7	15720.00	40.5 AV	54.0	-13.5	1.64 V	287	29.2	11.3

Remarks:

1. Emission Level(dBuV/m) = Raw Value(dBuV) + Correction Factor(dB/m)
2. Correction Factor(dB/m) = Antenna Factor(dB/m) + Cable Factor(dB) – Pre-Amplifier Factor(dB)
3. Margin value = Emission Level – Limit value
4. The other emission levels were very low against the limit.
5. " * ": Fundamental frequency.
6. " # ": The radiated frequency is out of the restricted band.

RF Mode	TX 802.11ax (HE20)	Channel	CH 149 : 5745 MHz
Frequency Range	1GHz ~ 40GHz	Detector Function	Peak (PK) Average (AV)

Antenna Polarity & Test Distance : Horizontal at 3 m

No	Frequency (MHz)	Emission Level (dBuV/m)	Limit (dBuV/m)	Margin (dB)	Antenna Height (m)	Table Angle (Degree)	Raw Value (dBuV)	Correction Factor (dB/m)
1	#5647.68	58.7 PK	68.2	-9.5	2.01 H	356	56.7	2.0
2	*5745.00	124.3 PK			2.01 H	356	122.2	2.1
3	*5745.00	111.7 AV			2.01 H	356	109.6	2.1
4	#5928.92	58.1 PK	68.2	-10.1	2.01 H	356	55.4	2.7
5	11490.00	57.4 PK	74.0	-16.6	1.78 H	96	44.4	13.0
6	11490.00	47.3 AV	54.0	-6.7	1.78 H	96	34.3	13.0
7	#17235.00	67.8 PK	68.2	-0.4	1.30 H	260	51.6	16.2

Antenna Polarity & Test Distance : Vertical at 3 m

No	Frequency (MHz)	Emission Level (dBuV/m)	Limit (dBuV/m)	Margin (dB)	Antenna Height (m)	Table Angle (Degree)	Raw Value (dBuV)	Correction Factor (dB/m)
1	#5637.51	55.2 PK	68.2	-13.0	2.38 V	318	53.2	2.0
2	*5745.00	119.7 PK			2.38 V	318	117.6	2.1
3	*5745.00	108.7 AV			2.38 V	318	106.6	2.1
4	#5954.89	54.7 PK	68.2	-13.5	2.38 V	318	52.0	2.7
5	11490.00	59.8 PK	74.0	-14.2	2.80 V	17	46.8	13.0
6	11490.00	48.4 AV	54.0	-5.6	2.80 V	17	35.4	13.0
7	#17235.00	65.5 PK	68.2	-2.7	1.69 V	270	49.3	16.2

Remarks:

1. Emission Level(dBuV/m) = Raw Value(dBuV) + Correction Factor(dB/m)
2. Correction Factor(dB/m) = Antenna Factor(dB/m) + Cable Factor(dB) – Pre-Amplifier Factor(dB)
3. Margin value = Emission Level – Limit value
4. The other emission levels were very low against the limit.
5. " * ": Fundamental frequency.
6. " # ": The radiated frequency is out of the restricted band.

RF Mode	TX 802.11ax (HE20)	Channel	CH 157 : 5785 MHz
Frequency Range	1GHz ~ 40GHz	Detector Function	Peak (PK) Average (AV)

Antenna Polarity & Test Distance : Horizontal at 3 m

No	Frequency (MHz)	Emission Level (dBuV/m)	Limit (dBuV/m)	Margin (dB)	Antenna Height (m)	Table Angle (Degree)	Raw Value (dBuV)	Correction Factor (dB/m)
1	#5647.01	57.6 PK	68.2	-10.6	1.64 H	350	55.6	2.0
2	*5785.00	124.3 PK			1.64 H	350	122.0	2.3
3	*5785.00	112.1 AV			1.64 H	350	109.8	2.3
4	#5926.70	57.9 PK	68.2	-10.3	1.64 H	350	55.2	2.7
5	11570.00	57.2 PK	74.0	-16.8	1.73 H	108	43.7	13.5
6	11570.00	47.2 AV	54.0	-6.8	1.73 H	108	33.7	13.5
7	#17355.00	67.8 PK	68.2	-0.4	1.23 H	257	50.6	17.2

Antenna Polarity & Test Distance : Vertical at 3 m

No	Frequency (MHz)	Emission Level (dBuV/m)	Limit (dBuV/m)	Margin (dB)	Antenna Height (m)	Table Angle (Degree)	Raw Value (dBuV)	Correction Factor (dB/m)
1	#5629.53	54.9 PK	68.2	-13.3	2.10 V	334	52.9	2.0
2	*5785.00	120.1 PK			2.10 V	334	117.8	2.3
3	*5785.00	108.7 AV			2.10 V	334	106.4	2.3
4	#5978.88	55.2 PK	68.2	-13.0	2.10 V	334	52.5	2.7
5	11570.00	59.2 PK	74.0	-14.8	2.76 V	30	45.7	13.5
6	11570.00	48.0 AV	54.0	-6.0	2.76 V	30	34.5	13.5
7	#17355.00	65.3 PK	68.2	-2.9	1.72 V	277	48.1	17.2

Remarks:

1. Emission Level(dBuV/m) = Raw Value(dBuV) + Correction Factor(dB/m)
2. Correction Factor(dB/m) = Antenna Factor(dB/m) + Cable Factor(dB) – Pre-Amplifier Factor(dB)
3. Margin value = Emission Level – Limit value
4. The other emission levels were very low against the limit.
5. " * ": Fundamental frequency.
6. " # ": The radiated frequency is out of the restricted band.

RF Mode	TX 802.11ax (HE20)	Channel	CH 165 : 5825 MHz
Frequency Range	1GHz ~ 40GHz	Detector Function	Peak (PK) Average (AV)

Antenna Polarity & Test Distance : Horizontal at 3 m

No	Frequency (MHz)	Emission Level (dBuV/m)	Limit (dBuV/m)	Margin (dB)	Antenna Height (m)	Table Angle (Degree)	Raw Value (dBuV)	Correction Factor (dB/m)
1	#5637.93	56.9 PK	68.2	-11.3	1.99 H	351	54.9	2.0
2	*5825.00	124.6 PK			1.99 H	351	122.3	2.3
3	*5825.00	112.7 AV			1.99 H	351	110.4	2.3
4	#5978.02	57.6 PK	68.2	-10.6	1.99 H	351	54.9	2.7
5	11650.00	57.0 PK	74.0	-17.0	1.78 H	109	43.5	13.5
6	11650.00	47.0 AV	54.0	-7.0	1.78 H	109	33.5	13.5
7	#17475.00	67.4 PK	68.2	-0.8	1.46 H	249	48.3	19.1

Antenna Polarity & Test Distance : Vertical at 3 m

No	Frequency (MHz)	Emission Level (dBuV/m)	Limit (dBuV/m)	Margin (dB)	Antenna Height (m)	Table Angle (Degree)	Raw Value (dBuV)	Correction Factor (dB/m)
1	#5634.59	55.8 PK	68.2	-12.4	2.20 V	329	53.8	2.0
2	*5825.00	120.5 PK			2.20 V	329	118.2	2.3
3	*5825.00	108.6 AV			2.20 V	329	106.3	2.3
4	#5956.07	55.8 PK	68.2	-12.4	2.20 V	329	53.1	2.7
5	11650.00	59.1 PK	74.0	-14.9	2.73 V	37	45.6	13.5
6	11650.00	47.8 AV	54.0	-6.2	2.73 V	37	34.3	13.5
7	#17475.00	65.0 PK	68.2	-3.2	1.74 V	287	45.9	19.1

Remarks:

1. Emission Level(dBuV/m) = Raw Value(dBuV) + Correction Factor(dB/m)
2. Correction Factor(dB/m) = Antenna Factor(dB/m) + Cable Factor(dB) – Pre-Amplifier Factor(dB)
3. Margin value = Emission Level – Limit value
4. The other emission levels were very low against the limit.
5. " * ": Fundamental frequency.
6. " # ": The radiated frequency is out of the restricted band.

RF Mode	TX 802.11ax (HE40)	Channel	CH 38 : 5190 MHz
Frequency Range	1GHz ~ 40GHz	Detector Function	Peak (PK) Average (AV)

Antenna Polarity & Test Distance : Horizontal at 3 m

No	Frequency (MHz)	Emission Level (dBuV/m)	Limit (dBuV/m)	Margin (dB)	Antenna Height (m)	Table Angle (Degree)	Raw Value (dBuV)	Correction Factor (dB/m)
1	5148.05	65.3 PK	74.0	-8.7	1.70 H	348	63.3	2.0
2	5148.05	53.6 AV	54.0	-0.4	1.70 H	348	51.6	2.0
3	*5190.00	114.5 PK			1.70 H	348	112.8	1.7
4	*5190.00	101.8 AV			1.70 H	348	100.1	1.7
5	#10380.00	53.1 PK	68.2	-15.1	1.80 H	98	41.6	11.5
6	15570.00	55.6 PK	74.0	-18.4	1.41 H	235	43.9	11.7
7	15570.00	41.7 AV	54.0	-12.3	1.41 H	235	30.0	11.7

Antenna Polarity & Test Distance : Vertical at 3 m

No	Frequency (MHz)	Emission Level (dBuV/m)	Limit (dBuV/m)	Margin (dB)	Antenna Height (m)	Table Angle (Degree)	Raw Value (dBuV)	Correction Factor (dB/m)
1	5149.38	61.9 PK	74.0	-12.1	1.81 V	9	59.9	2.0
2	5149.38	52.9 AV	54.0	-1.1	1.81 V	9	50.9	2.0
3	*5190.00	112.3 PK			1.81 V	9	110.6	1.7
4	*5190.00	99.6 AV			1.81 V	9	97.9	1.7
5	#10380.00	55.6 PK	68.2	-12.6	2.77 V	27	44.1	11.5
6	15570.00	51.5 PK	74.0	-22.5	1.74 V	289	39.8	11.7
7	15570.00	39.7 AV	54.0	-14.3	1.74 V	289	28.0	11.7

Remarks:

1. Emission Level(dBuV/m) = Raw Value(dBuV) + Correction Factor(dB/m)
2. Correction Factor(dB/m) = Antenna Factor(dB/m) + Cable Factor(dB) – Pre-Amplifier Factor(dB)
3. Margin value = Emission Level – Limit value
4. The other emission levels were very low against the limit.
5. " * ": Fundamental frequency.
6. " # ": The radiated frequency is out of the restricted band.

RF Mode	TX 802.11ax (HE40)	Channel	CH 46 : 5230 MHz
Frequency Range	1GHz ~ 40GHz	Detector Function	Peak (PK) Average (AV)

Antenna Polarity & Test Distance : Horizontal at 3 m

No	Frequency (MHz)	Emission Level (dBuV/m)	Limit (dBuV/m)	Margin (dB)	Antenna Height (m)	Table Angle (Degree)	Raw Value (dBuV)	Correction Factor (dB/m)
1	5149.62	71.0 PK	74.0	-3.0	1.78 H	345	69.0	2.0
2	5149.62	53.2 AV	54.0	-0.8	1.78 H	345	51.2	2.0
3	*5230.00	119.7 PK			1.78 H	345	118.1	1.6
4	*5230.00	108.2 AV			1.78 H	345	106.6	1.6
5	5354.40	60.3 PK	74.0	-13.7	1.78 H	345	58.6	1.7
6	5354.40	48.0 AV	54.0	-6.0	1.78 H	345	46.3	1.7
7	#10460.00	53.0 PK	68.2	-15.2	1.74 H	99	41.5	11.5
8	15690.00	56.0 PK	74.0	-18.0	1.46 H	239	44.6	11.4
9	15690.00	42.1 AV	54.0	-11.9	1.46 H	239	30.7	11.4

Antenna Polarity & Test Distance : Vertical at 3 m

No	Frequency (MHz)	Emission Level (dBuV/m)	Limit (dBuV/m)	Margin (dB)	Antenna Height (m)	Table Angle (Degree)	Raw Value (dBuV)	Correction Factor (dB/m)
1	5146.97	65.3 PK	74.0	-8.7	1.79 V	7	63.3	2.0
2	5146.97	49.6 AV	54.0	-4.4	1.79 V	7	47.6	2.0
3	*5230.00	116.9 PK			1.79 V	7	115.3	1.6
4	*5230.00	104.1 AV			1.79 V	7	102.5	1.6
5	5351.01	56.5 PK	74.0	-17.5	1.79 V	7	54.9	1.6
6	5351.01	45.5 AV	54.0	-8.5	1.79 V	7	43.9	1.6
7	#10460.00	55.4 PK	68.2	-12.8	2.73 V	37	43.9	11.5
8	15690.00	51.8 PK	74.0	-22.2	1.75 V	273	40.4	11.4
9	15690.00	40.0 AV	54.0	-14.0	1.75 V	273	28.6	11.4

Remarks:

1. Emission Level(dBuV/m) = Raw Value(dBuV) + Correction Factor(dB/m)
2. Correction Factor(dB/m) = Antenna Factor(dB/m) + Cable Factor(dB) – Pre-Amplifier Factor(dB)
3. Margin value = Emission Level – Limit value
4. The other emission levels were very low against the limit.
5. " * ": Fundamental frequency.
6. " # ": The radiated frequency is out of the restricted band.

RF Mode	TX 802.11ax (HE40)	Channel	CH 151 : 5755 MHz
Frequency Range	1GHz ~ 40GHz	Detector Function	Peak (PK) Average (AV)

Antenna Polarity & Test Distance : Horizontal at 3 m

No	Frequency (MHz)	Emission Level (dBuV/m)	Limit (dBuV/m)	Margin (dB)	Antenna Height (m)	Table Angle (Degree)	Raw Value (dBuV)	Correction Factor (dB/m)
1	#5645.17	64.2 PK	68.2	-4.0	2.10 H	357	62.2	2.0
2	*5755.00	120.0 PK			2.10 H	357	117.8	2.2
3	*5755.00	107.9 AV			2.10 H	357	105.7	2.2
4	#5930.63	58.4 PK	68.2	-9.8	2.10 H	357	55.7	2.7
5	11510.00	53.5 PK	74.0	-20.5	1.82 H	98	40.5	13.0
6	11510.00	41.2 AV	54.0	-12.8	1.82 H	98	28.2	13.0
7	#17265.00	64.1 PK	68.2	-4.1	1.54 H	247	47.7	16.4

Antenna Polarity & Test Distance : Vertical at 3 m

No	Frequency (MHz)	Emission Level (dBuV/m)	Limit (dBuV/m)	Margin (dB)	Antenna Height (m)	Table Angle (Degree)	Raw Value (dBuV)	Correction Factor (dB/m)
1	#5645.23	66.0 PK	68.2	-2.2	2.23 V	334	64.0	2.0
2	*5755.00	116.8 PK			2.23 V	334	114.6	2.2
3	*5755.00	104.4 AV			2.23 V	334	102.2	2.2
4	#5928.43	57.1 PK	68.2	-11.1	2.23 V	334	54.4	2.7
5	11510.00	55.6 PK	74.0	-18.4	2.77 V	55	42.6	13.0
6	11510.00	39.9 AV	54.0	-14.1	2.77 V	55	26.9	13.0
7	#17265.00	59.3 PK	68.2	-8.9	1.70 V	257	42.9	16.4

Remarks:

1. Emission Level(dBuV/m) = Raw Value(dBuV) + Correction Factor(dB/m)
2. Correction Factor(dB/m) = Antenna Factor(dB/m) + Cable Factor(dB) – Pre-Amplifier Factor(dB)
3. Margin value = Emission Level – Limit value
4. The other emission levels were very low against the limit.
5. " * ": Fundamental frequency.
6. " # ": The radiated frequency is out of the restricted band.

RF Mode	TX 802.11ax (HE40)	Channel	CH 159 : 5795 MHz
Frequency Range	1GHz ~ 40GHz	Detector Function	Peak (PK) Average (AV)

Antenna Polarity & Test Distance : Horizontal at 3 m

No	Frequency (MHz)	Emission Level (dBuV/m)	Limit (dBuV/m)	Margin (dB)	Antenna Height (m)	Table Angle (Degree)	Raw Value (dBuV)	Correction Factor (dB/m)
1	#5634.75	59.9 PK	68.2	-8.3	1.48 H	348	57.9	2.0
2	*5795.00	119.8 PK			1.48 H	348	117.5	2.3
3	*5795.00	108.2 AV			1.48 H	348	105.9	2.3
4	#5940.33	60.9 PK	68.2	-7.3	1.48 H	348	58.2	2.7
5	11590.00	53.1 PK	74.0	-20.9	1.82 H	94	39.6	13.5
6	11590.00	41.4 AV	54.0	-12.6	1.82 H	94	27.9	13.5
7	#17385.00	65.2 PK	68.2	-3.0	1.67 H	261	47.6	17.6

Antenna Polarity & Test Distance : Vertical at 3 m

No	Frequency (MHz)	Emission Level (dBuV/m)	Limit (dBuV/m)	Margin (dB)	Antenna Height (m)	Table Angle (Degree)	Raw Value (dBuV)	Correction Factor (dB/m)
1	#5617.15	63.5 PK	68.2	-4.7	2.58 V	353	61.7	1.8
2	*5795.00	118.2 PK			2.58 V	353	115.9	2.3
3	*5795.00	104.6 AV			2.58 V	353	102.3	2.3
4	#5930.17	62.3 PK	68.2	-5.9	2.58 V	353	59.6	2.7
5	11590.00	55.1 PK	74.0	-18.9	2.74 V	48	41.6	13.5
6	11590.00	39.6 AV	54.0	-14.4	2.74 V	48	26.1	13.5
7	#17385.00	59.5 PK	68.2	-8.7	1.68 V	283	41.9	17.6

Remarks:

1. Emission Level(dBuV/m) = Raw Value(dBuV) + Correction Factor(dB/m)
2. Correction Factor(dB/m) = Antenna Factor(dB/m) + Cable Factor(dB) – Pre-Amplifier Factor(dB)
3. Margin value = Emission Level – Limit value
4. The other emission levels were very low against the limit.
5. " * ": Fundamental frequency.
6. " # ": The radiated frequency is out of the restricted band.

RF Mode	TX 802.11ax (HE80)	Channel	CH 42 : 5210 MHz
Frequency Range	1GHz ~ 40GHz	Detector Function	Peak (PK) Average (AV)

Antenna Polarity & Test Distance : Horizontal at 3 m

No	Frequency (MHz)	Emission Level (dBuV/m)	Limit (dBuV/m)	Margin (dB)	Antenna Height (m)	Table Angle (Degree)	Raw Value (dBuV)	Correction Factor (dB/m)
1	5148.05	64.9 PK	74.0	-9.1	1.91 H	348	62.9	2.0
2	5148.05	53.4 AV	54.0	-0.6	1.91 H	348	51.4	2.0
3	*5210.00	108.8 PK			1.91 H	348	107.1	1.7
4	*5210.00	96.9 AV			1.91 H	348	95.2	1.7
5	5355.07	56.3 PK	74.0	-17.7	1.91 H	348	54.6	1.7
6	5355.07	44.2 AV	54.0	-9.8	1.91 H	348	42.5	1.7
7	#10420.00	49.8 PK	68.2	-18.4	1.82 H	88	38.2	11.6
8	15630.00	50.6 PK	74.0	-23.4	1.62 H	268	39.0	11.6
9	15630.00	39.7 AV	54.0	-14.3	1.62 H	268	28.1	11.6

Antenna Polarity & Test Distance : Vertical at 3 m

No	Frequency (MHz)	Emission Level (dBuV/m)	Limit (dBuV/m)	Margin (dB)	Antenna Height (m)	Table Angle (Degree)	Raw Value (dBuV)	Correction Factor (dB/m)
1	5147.09	63.7 PK	74.0	-10.3	1.89 V	358	61.7	2.0
2	5147.09	52.4 AV	54.0	-1.6	1.89 V	358	50.4	2.0
3	*5210.00	107.5 PK			1.89 V	358	105.8	1.7
4	*5210.00	95.6 AV			1.89 V	358	93.9	1.7
5	5355.50	53.3 PK	74.0	-20.7	1.89 V	358	51.6	1.7
6	5355.50	42.7 AV	54.0	-11.3	1.89 V	358	41.0	1.7
7	#10420.00	50.4 PK	68.2	-17.8	2.93 V	57	38.8	11.6
8	15630.00	48.8 PK	74.0	-25.2	1.85 V	276	37.2	11.6
9	15630.00	37.6 AV	54.0	-16.4	1.85 V	276	26.0	11.6

Remarks:

1. Emission Level(dBuV/m) = Raw Value(dBuV) + Correction Factor(dB/m)
2. Correction Factor(dB/m) = Antenna Factor(dB/m) + Cable Factor(dB) – Pre-Amplifier Factor(dB)
3. Margin value = Emission Level – Limit value
4. The other emission levels were very low against the limit.
5. " * ": Fundamental frequency.
6. " # ": The radiated frequency is out of the restricted band.

RF Mode	TX 802.11ax (HE80)	Channel	CH 155 : 5775 MHz
Frequency Range	1GHz ~ 40GHz	Detector Function	Peak (PK) Average (AV)

Antenna Polarity & Test Distance : Horizontal at 3 m

No	Frequency (MHz)	Emission Level (dBuV/m)	Limit (dBuV/m)	Margin (dB)	Antenna Height (m)	Table Angle (Degree)	Raw Value (dBuV)	Correction Factor (dB/m)
1	#5640.29	67.2 PK	68.2	-1.0	1.97 H	348	65.2	2.0
2	*5775.00	114.5 PK			1.97 H	348	112.3	2.2
3	*5775.00	102.9 AV			1.97 H	348	100.7	2.2
4	#5926.75	65.9 PK	68.2	-2.3	1.97 H	348	63.2	2.7
5	11550.00	51.4 PK	74.0	-22.6	1.81 H	103	38.1	13.3
6	11550.00	40.0 AV	54.0	-14.0	1.81 H	103	26.7	13.3
7	#17325.00	61.2 PK	68.2	-7.0	1.60 H	248	44.4	16.8

Antenna Polarity & Test Distance : Vertical at 3 m

No	Frequency (MHz)	Emission Level (dBuV/m)	Limit (dBuV/m)	Margin (dB)	Antenna Height (m)	Table Angle (Degree)	Raw Value (dBuV)	Correction Factor (dB/m)
1	#5636.18	63.2 PK	68.2	-5.0	2.85 V	352	61.2	2.0
2	*5775.00	113.4 PK			2.85 V	352	111.2	2.2
3	*5775.00	102.5 AV			2.85 V	352	100.3	2.2
4	#5929.34	63.2 PK	68.2	-5.0	2.85 V	352	60.5	2.7
5	11550.00	52.6 PK	74.0	-21.4	2.83 V	43	39.3	13.3
6	11550.00	37.5 AV	54.0	-16.5	2.83 V	43	24.2	13.3
7	#17325.00	58.3 PK	68.2	-9.9	1.67 V	282	41.5	16.8

Remarks:

1. Emission Level(dBuV/m) = Raw Value(dBuV) + Correction Factor(dB/m)
2. Correction Factor(dB/m) = Antenna Factor(dB/m) + Cable Factor(dB) – Pre-Amplifier Factor(dB)
3. Margin value = Emission Level – Limit value
4. The other emission levels were very low against the limit.
5. " * ": Fundamental frequency.
6. " # ": The radiated frequency is out of the restricted band.

Below 1GHz Data:

RF Mode	TX 802.11ax (HE40)	Channel	CH 46 : 5230 MHz
Frequency Range	9kHz ~ 1GHz	Detector Function	Quasi-Peak (QP)

Antenna Polarity & Test Distance : Horizontal at 3 m								
No	Frequency (MHz)	Emission Level (dBuV/m)	Limit (dBuV/m)	Margin (dB)	Antenna Height (m)	Table Angle (Degree)	Raw Value (dBuV)	Correction Factor (dB/m)
1	108.82	29.7 QP	43.5	-13.8	2.00 H	299	45.5	-15.8
2	175.02	28.3 QP	43.5	-15.2	1.50 H	94	42.0	-13.7
3	292.06	36.9 QP	46.0	-9.1	1.00 H	142	49.2	-12.3
4	326.64	36.0 QP	46.0	-10.0	1.00 H	281	47.3	-11.3
5	533.46	29.3 QP	46.0	-16.7	1.50 H	75	36.1	-6.8
6	729.65	33.7 QP	46.0	-12.3	1.00 H	159	37.0	-3.3

Remarks:

1. Emission Level(dBuV/m) = Raw Value(dBuV) + Correction Factor(dB/m)
2. Correction Factor(dB/m) = Antenna Factor(dB/m) + Cable Factor(dB) – Pre-Amplifier Factor(dB)
3. Margin value = Emission Level – Limit value
4. The other emission levels were very low against the limit of frequency range 30MHz~1000MHz.
5. The emission levels were very low against the limit of frequency range 9kHz~30MHz: the amplitude of spurious emissions attenuated more than 20 dB below the permissible value to be report.

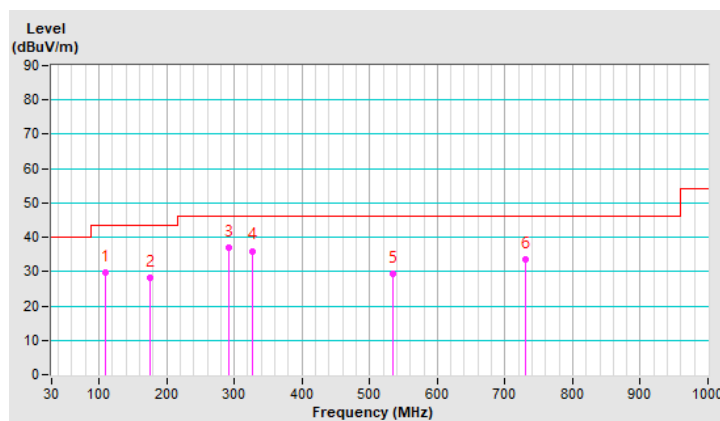

RF Mode	TX 802.11ax (HE40)	Channel	CH 46 : 5230 MHz
Frequency Range	9kHz ~ 1GHz	Detector Function	Quasi-Peak (QP)

Antenna Polarity & Test Distance : Vertical at 3 m

No	Frequency (MHz)	Emission Level (dBuV/m)	Limit (dBuV/m)	Margin (dB)	Antenna Height (m)	Table Angle (Degree)	Raw Value (dBuV)	Correction Factor (dB/m)
1	73.31	34.2 QP	40.0	-5.8	1.00 V	84	50.0	-15.8
2	169.83	28.0 QP	43.5	-15.5	1.00 V	360	41.3	-13.3
3	289.29	33.0 QP	46.0	-13.0	1.00 V	319	45.3	-12.3
4	357.49	30.9 QP	46.0	-15.1	1.50 V	0	41.9	-11.0
5	621.54	31.0 QP	46.0	-15.0	1.00 V	71	35.7	-4.7
6	740.37	30.0 QP	46.0	-16.0	1.50 V	107	32.9	-2.9

Remarks:

1. Emission Level(dBuV/m) = Raw Value(dBuV) + Correction Factor(dB/m)
2. Correction Factor(dB/m) = Antenna Factor(dB/m) + Cable Factor(dB) – Pre-Amplifier Factor(dB)
3. Margin value = Emission Level – Limit value
4. The other emission levels were very low against the limit of frequency range 30MHz~1000MHz.
5. The emission levels were very low against the limit of frequency range 9kHz~30MHz: the amplitude of spurious emissions attenuated more than 20 dB below the permissible value to be report.

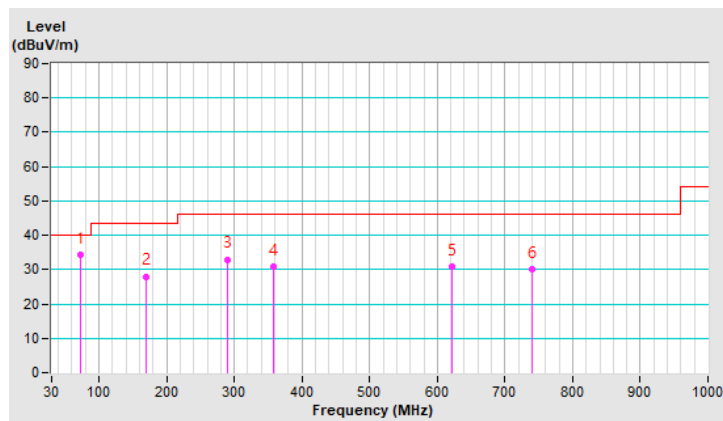

4.2 Conducted Emission Measurement

4.2.1 Limits of Conducted Emission Measurement

Frequency (MHz)	Conducted Limit (dBuV)	
	Quasi-peak	Average
0.15 - 0.5	66 - 56	56 - 46
0.50 - 5.0	56	46
5.0 - 30.0	60	50

Note: 1. The lower limit shall apply at the transition frequencies.

2. The limit decreases in line with the logarithm of the frequency in the range of 0.15 to 0.50MHz.

4.2.2 Test Instruments

DESCRIPTION & MANUFACTURER	MODEL NO.	SERIAL NO.	CALIBRATED DATE	CALIBRATED UNTIL
Test Receiver R&S	ESCS 30	847124/029	Oct. 20, 2020	Oct. 19, 2021
Line-Impedance Stabilization Network (for EUT) R&S	ESH3-Z5	848773/004	Oct. 27, 2020	Oct. 26, 2021
Line-Impedance Stabilization Network (for Peripheral) R&S	ESH3-Z5	835239/001	Mar. 19, 2020	Mar. 18, 2021
50 ohms Terminator	50	3	Oct. 26, 2020	Oct. 25, 2021
RF Cable	5D-FB	COCCAB-001	Sep. 26, 2020	Sep. 25, 2021
Fixed attenuator EMCI	STI02-2200-10	005	Aug. 29, 2020	Aug. 28, 2021
Software BVADT	BVADT_Cond_ V7.3.7.4	NA	NA	NA

Note:

1. The calibration interval of the above test instruments are 12 months and the calibrations are traceable to NML/ROC and NIST/USA.
2. The test was performed in Conduction 1.
3. Tested Date: Jan. 30, 2021

4.2.3 Test Procedure

- a. The EUT was placed 0.4 meters from the conducting wall of the shielded room with EUT being connected to the power mains through a line impedance stabilization network (LISN). Other support units were connected to the power mains through another LISN. The two LISNs provide 50 ohm/ 50uH of coupling impedance for the measuring instrument.
- b. Both lines of the power mains connected to the EUT were checked for maximum conducted interference.
- c. The frequency range from 150kHz to 30MHz was searched. Emission levels under (Limit - 20dB) was not recorded.

NOTE: All modes of operation were investigated and the worst-case emissions are reported.

4.2.4 Deviation from Test Standard

No deviation.

4.2.5 Test Setup

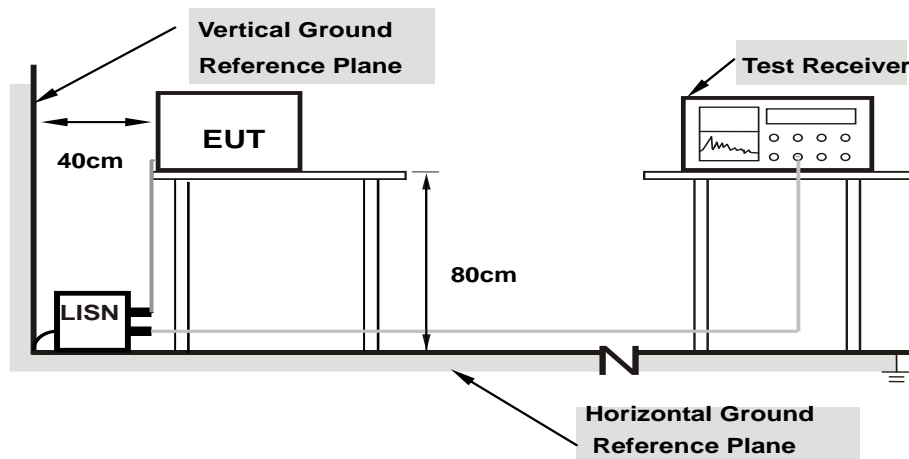

Note: 1.Support units were connected to second LISN.

For the actual test configuration, please refer to the attached file (Test Setup Photo).

4.2.6 EUT Operating Condition

Same as 4.1.6.

4.2.7 Test Results

Phase	Line (L)	Detector Function	Quasi-Peak (QP) / Average (AV)
-------	----------	-------------------	--------------------------------

No	Freq. [MHz]	Corr. Factor	Reading Value [dB (uV)]		Emission Level [dB (uV)]		Limit [dB (uV)]		Margin (dB)	
		(dB)	Q.P.	AV.	Q.P.	AV.	Q.P.	AV.	Q.P.	AV.
	1	0.15000	9.96	30.78	22.06	40.74	32.02	66.00	56.00	-25.26
2	0.18906	9.98	29.00	17.10	38.98	27.08	64.08	54.08	-25.10	-27.00
3	0.30625	10.01	29.37	22.91	39.38	32.92	60.07	50.07	-20.69	-17.15
4	0.35703	10.01	26.25	17.56	36.26	27.57	58.80	48.80	-22.54	-21.23
5	5.94141	10.42	24.11	18.23	34.53	28.65	60.00	50.00	-25.47	-21.35
6	16.23438	11.19	16.36	10.39	27.55	21.58	60.00	50.00	-32.45	-28.42

Remarks:

1. Q.P. and AV. are abbreviations of quasi-peak and average individually.
2. The emission levels of other frequencies were very low against the limit.
3. Margin value = Emission level – Limit value
4. Correction factor = Insertion loss + Cable loss
5. Emission Level = Correction Factor + Reading Value

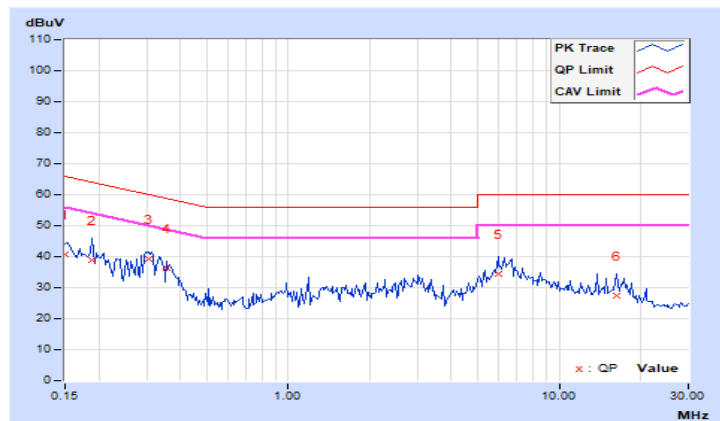

Phase	Neutral (N)	Detector Function	Quasi-Peak (QP) / Average (AV)
-------	-------------	-------------------	--------------------------------

No	Freq. [MHz]	Corr. Factor	Reading Value [dB (uV)]		Emission Level [dB (uV)]		Limit [dB (uV)]		Margin (dB)	
		(dB)	Q.P.	AV.	Q.P.	AV.	Q.P.	AV.	Q.P.	AV.
	1	0.17344	9.96	29.01	19.22	38.97	29.18	64.79	54.79	-25.82
2	0.33750	10.00	30.32	21.57	40.32	31.57	59.26	49.26	-18.94	-17.69
3	0.89219	10.06	21.57	14.98	31.63	25.04	56.00	46.00	-24.37	-20.96
4	2.88672	10.19	19.50	10.78	29.69	20.97	56.00	46.00	-26.31	-25.03
5	5.71484	10.36	22.66	16.75	33.02	27.11	60.00	50.00	-26.98	-22.89
6	17.11328	11.02	17.04	11.70	28.06	22.72	60.00	50.00	-31.94	-27.28

Remarks:

1. Q.P. and AV. are abbreviations of quasi-peak and average individually.
2. The emission levels of other frequencies were very low against the limit.
3. Margin value = Emission level – Limit value
4. Correction factor = Insertion loss + Cable loss
5. Emission Level = Correction Factor + Reading Value

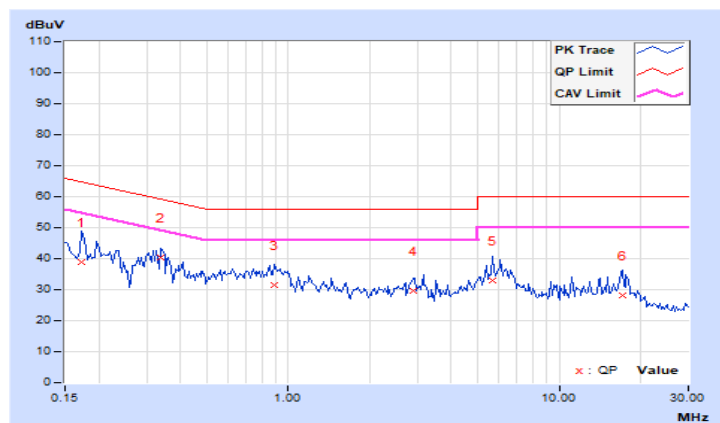

4.3 Transmit Power Measurement

4.3.1 Limits of Transmit Power Measurement

Operation Band	EUT Category		Limit
U-NII-1		Outdoor Access Point	1 Watt (30 dBm) (Max. e.i.r.p \leq 125mW(21 dBm) at any elevation angle above 30 degrees as measured from the horizon)
		Fixed point-to-point Access Point	1 Watt (30 dBm)
	√	Indoor Access Point	1 Watt (30 dBm)
		Client device	250mW (24 dBm)
U-NII-2A			250mW (24 dBm) or 11 dBm+10 log B*
U-NII-2C			250mW (24 dBm) or 11 dBm+10 log B*
U-NII-3	√		1 Watt (30 dBm)

*B is the 26 dB emission bandwidth in megahertz

Per KDB 662911 Method of conducted output power measurement on IEEE 802.11 devices,

Array Gain = 0 dB (i.e., no array gain) for $N_{ANT} \leq 4$;

Array Gain = 0 dB (i.e., no array gain) for channel widths ≥ 40 MHz for any N_{ANT} ;

Array Gain = $5 \log(N_{ANT}/N_{SS})$ dB or 3 dB, whichever is less for 20-MHz channel widths with $N_{ANT} \geq 5$.

For power measurements on all other devices: Array Gain = $10 \log(N_{ANT}/N_{SS})$ dB.

4.3.2 Test Setup

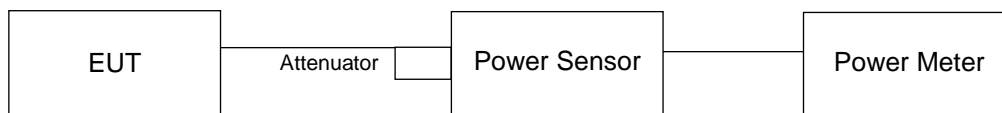

4.3.3 Test Instruments

Refer to section 4.1.2 to get information of above instrument.

4.3.4 Test Procedure

Method PM is used to perform output power measurement, trigger and gating function of wide band power meter is enabled to measure max output power of TX on burst. Duty factor is not added to measured value.

4.3.5 Deviation from Test Standard

No deviation.

4.3.6 EUT Operating Condition

The software provided by client to enable the EUT under transmission condition continuously at lowest, middle and highest channel frequencies individually.

4.3.7 Test Results

CDD Mode

802.11a

Chan.	Chan. Freq. (MHz)	Maximum Conducted Power (dBm)				Total Power (mW)	Total Power (dBm)	Limit (dBm)	Pass / Fail
		Chain 0	Chain 1	Chain 2	Chain 3				
36	5180	21.54	21.77	21.24	21.61	570.798	27.56	30	Pass
40	5200	21.58	21.64	21.20	21.54	564.148	27.51	30	Pass
48	5240	21.43	21.68	20.97	21.44	550.568	27.41	30	Pass
149	5745	22.50	23.08	22.90	23.68	809.394	29.08	30	Pass
157	5785	22.32	22.97	22.72	23.31	770.118	28.87	30	Pass
165	5825	22.29	22.87	22.54	23.12	747.666	28.74	30	Pass

802.11ac (VHT20)

Chan.	Chan. Freq. (MHz)	Maximum Conducted Power (dBm)				Total Power (mW)	Total Power (dBm)	Limit (dBm)	Pass / Fail
		Chain 0	Chain 1	Chain 2	Chain 3				
36	5180	21.38	21.84	21.33	21.45	565.629	27.53	30	Pass
40	5200	21.27	21.76	21.36	21.43	559.704	27.48	30	Pass
48	5240	21.20	21.64	21.28	21.39	549.705	27.40	30	Pass
149	5745	23.28	23.48	23.42	23.62	885.588	29.47	30	Pass
157	5785	23.19	23.28	23.25	23.48	855.455	29.32	30	Pass
165	5825	22.09	23.03	23.18	23.40	789.463	28.97	30	Pass

802.11ac (VHT40)

Chan.	Chan. Freq. (MHz)	Maximum Conducted Power (dBm)				Total Power (mW)	Total Power (dBm)	Limit (dBm)	Pass / Fail
		Chain 0	Chain 1	Chain 2	Chain 3				
38	5190	18.59	18.49	18.69	19.01	296.485	24.72	30	Pass
46	5230	23.53	23.49	23.65	23.97	929.98	29.68	30	Pass
151	5755	23.28	23.87	23.19	23.67	897.853	29.53	30	Pass
159	5795	23.23	24.02	23.28	23.77	913.772	29.61	30	Pass

802.11ac (VHT80)

Chan.	Chan. Freq. (MHz)	Maximum Conducted Power (dBm)				Total Power (mW)	Total Power (dBm)	Limit (dBm)	Pass / Fail
		Chain 0	Chain 1	Chain 2	Chain 3				
42	5210	18.18	18.14	18.30	18.71	272.839	24.36	30	Pass
155	5775	22.75	22.59	22.85	23.14	768.732	28.86	30	Pass

802.11ax (HE20)

Chan.	Chan. Freq. (MHz)	Maximum Conducted Power (dBm)				Total Power (mW)	Total Power (dBm)	Limit (dBm)	Pass / Fail
		Chain 0	Chain 1	Chain 2	Chain 3				
36	5180	21.68	22.17	21.70	21.80	611.314	27.86	30	Pass
40	5200	21.57	22.05	21.62	21.72	597.678	27.76	30	Pass
48	5240	21.47	21.94	21.57	21.64	586.027	27.68	30	Pass
149	5745	23.58	23.74	23.69	23.88	942.853	29.74	30	Pass
157	5785	23.46	23.54	23.51	23.77	910.383	29.59	30	Pass
165	5825	22.38	23.31	23.44	23.69	841.955	29.25	30	Pass

802.11ax (HE40)

Chan.	Chan. Freq. (MHz)	Maximum Conducted Power (dBm)				Total Power (mW)	Total Power (dBm)	Limit (dBm)	Pass / Fail
		Chain 0	Chain 1	Chain 2	Chain 3				
38	5190	18.84	18.78	18.98	19.28	315.859	24.99	30	Pass
46	5230	23.80	23.78	23.90	24.25	990.208	29.96	30	Pass
151	5755	23.55	24.13	23.48	23.94	955.871	29.80	30	Pass
159	5795	23.49	24.28	23.57	24.05	972.881	29.88	30	Pass

802.11ax (HE80)

Chan.	Chan. Freq. (MHz)	Maximum Conducted Power (dBm)				Total Power (mW)	Total Power (dBm)	Limit (dBm)	Pass / Fail
		Chain 0	Chain 1	Chain 2	Chain 3				
42	5210	18.46	18.41	18.57	18.96	290.138	24.63	30	Pass
155	5775	23.01	22.84	23.14	23.41	817.639	29.13	30	Pass

Beamforming Mode

802.11ac (VHT20)

Chan.	Chan. Freq. (MHz)	Maximum Conducted Power (dBm)				Total Power (mW)	Total Power (dBm)	Limit (dBm)	Pass / Fail
		Chain 0	Chain 1	Chain 2	Chain 3				
36	5180	21.12	21.63	21.09	21.27	537.462	27.30	27.57	Pass
40	5200	21.06	21.54	21.05	21.24	530.6	27.25	27.57	Pass
48	5240	20.99	21.44	21.12	21.17	525.256	27.20	27.57	Pass
149	5745	21.17	21.52	21.18	21.22	536.478	27.30	27.57	Pass
157	5785	21.10	21.64	21.16	21.23	538.063	27.31	27.57	Pass
165	5825	21.05	21.48	21.11	21.16	527.694	27.22	27.57	Pass

- Note: 1. For U-NII-1: The directional gain= $10 \log[(10^{G0/20} + 10^{G1/20} + 10^{G2/20} + 10^{G3/20})^2 / 4] = 8.43 \text{ dBi} > 6 \text{ dBi}$, so the power limit shall be reduced to $30 - (8.43 - 6) = 27.57 \text{ dBm}$.
2. For U-NII-3: The directional gain= $10 \log[(10^{G0/20} + 10^{G1/20} + 10^{G2/20} + 10^{G3/20})^2 / 4] = 8.43 \text{ dBi} > 6 \text{ dBi}$, so the power limit shall be reduced to $30 - (8.43 - 6) = 27.57 \text{ dBm}$.

802.11ac (VHT40)

Chan.	Chan. Freq. (MHz)	Maximum Conducted Power (dBm)				Total Power (mW)	Total Power (dBm)	Limit (dBm)	Pass / Fail
		Chain 0	Chain 1	Chain 2	Chain 3				
38	5190	18.59	18.49	18.69	19.01	296.485	24.72	27.57	Pass
46	5230	21.18	21.52	21.13	21.20	534.669	27.28	27.57	Pass
151	5755	21.01	21.60	21.15	21.28	535.32	27.29	27.57	Pass
159	5795	20.96	21.44	21.05	21.15	521.721	27.17	27.57	Pass

- Note: 1. For U-NII-1: The directional gain= $10 \log[(10^{G0/20} + 10^{G1/20} + 10^{G2/20} + 10^{G3/20})^2 / 4] = 8.43 \text{ dBi} > 6 \text{ dBi}$, so the power limit shall be reduced to $30 - (8.43 - 6) = 27.57 \text{ dBm}$.
2. For U-NII-3: The directional gain= $10 \log[(10^{G0/20} + 10^{G1/20} + 10^{G2/20} + 10^{G3/20})^2 / 4] = 8.43 \text{ dBi} > 6 \text{ dBi}$, so the power limit shall be reduced to $30 - (8.43 - 6) = 27.57 \text{ dBm}$.

802.11ac (VHT80)

Chan.	Chan. Freq. (MHz)	Maximum Conducted Power (dBm)				Total Power (mW)	Total Power (dBm)	Limit (dBm)	Pass / Fail
		Chain 0	Chain 1	Chain 2	Chain 3				
42	5210	18.18	18.14	18.30	18.71	272.839	24.36	27.57	Pass
155	5775	21.12	21.55	21.19	21.23	536.571	27.30	27.57	Pass

- Note: 1. For U-NII-1: The directional gain= $10 \log[(10^{G0/20} + 10^{G1/20} + 10^{G2/20} + 10^{G3/20})^2 / 4] = 8.43 \text{ dBi} > 6 \text{ dBi}$, so the power limit shall be reduced to $30 - (8.43 - 6) = 27.57 \text{ dBm}$.
2. For U-NII-3: The directional gain= $10 \log[(10^{G0/20} + 10^{G1/20} + 10^{G2/20} + 10^{G3/20})^2 / 4] = 8.43 \text{ dBi} > 6 \text{ dBi}$, so the power limit shall be reduced to $30 - (8.43 - 6) = 27.57 \text{ dBm}$.

802.11ax (HE20)

Chan.	Chan. Freq. (MHz)	Maximum Conducted Power (dBm)				Total Power (mW)	Total Power (dBm)	Limit (dBm)	Pass / Fail
		Chain 0	Chain 1	Chain 2	Chain 3				
36	5180	21.39	21.84	21.37	21.47	567.847	27.54	27.57	Pass
40	5200	21.33	21.80	21.33	21.49	563.948	27.51	27.57	Pass
48	5240	21.26	21.73	21.36	21.40	557.407	27.46	27.57	Pass
149	5745	21.40	21.74	21.40	21.50	566.61	27.53	27.57	Pass
157	5785	21.33	21.85	21.38	21.49	567.273	27.54	27.57	Pass
165	5825	21.27	21.69	21.36	21.44	557.627	27.46	27.57	Pass

- Note: 1. For U-NII-1: The directional gain= $10 \log[(10^{G0/20} + 10^{G1/20} + 10^{G2/20} + 10^{G3/20})^2 / 4] = 8.43 \text{ dBi} > 6 \text{ dBi}$, so the power limit shall be reduced to $30 - (8.43 - 6) = 27.57 \text{ dBm}$.
2. For U-NII-3: The directional gain= $10 \log[(10^{G0/20} + 10^{G1/20} + 10^{G2/20} + 10^{G3/20})^2 / 4] = 8.43 \text{ dBi} > 6 \text{ dBi}$, so the power limit shall be reduced to $30 - (8.43 - 6) = 27.57 \text{ dBm}$.

802.11ax (HE40)

Chan.	Chan. Freq. (MHz)	Maximum Conducted Power (dBm)				Total Power (mW)	Total Power (dBm)	Limit (dBm)	Pass / Fail
		Chain 0	Chain 1	Chain 2	Chain 3				
38	5190	18.84	18.78	18.98	19.28	315.859	24.99	27.57	Pass
46	5230	21.39	21.81	21.44	21.41	567.098	27.54	27.57	Pass
151	5755	21.27	21.83	21.40	21.50	565.665	27.53	27.57	Pass
159	5795	21.22	21.65	21.30	21.35	550.006	27.40	27.57	Pass

- Note: 1. For U-NII-1: The directional gain= $10 \log[(10^{G0/20} + 10^{G1/20} + 10^{G2/20} + 10^{G3/20})^2 / 4] = 8.43 \text{ dBi} > 6 \text{ dBi}$, so the power limit shall be reduced to $30 - (8.43 - 6) = 27.57 \text{ dBm}$.
2. For U-NII-3: The directional gain= $10 \log[(10^{G0/20} + 10^{G1/20} + 10^{G2/20} + 10^{G3/20})^2 / 4] = 8.43 \text{ dBi} > 6 \text{ dBi}$, so the power limit shall be reduced to $30 - (8.43 - 6) = 27.57 \text{ dBm}$.

802.11ax (HE80)

Chan.	Chan. Freq. (MHz)	Maximum Conducted Power (dBm)				Total Power (mW)	Total Power (dBm)	Limit (dBm)	Pass / Fail
		Chain 0	Chain 1	Chain 2	Chain 3				
42	5210	18.46	18.41	18.57	18.96	290.138	24.63	27.57	Pass
155	5775	21.37	21.81	21.40	21.47	567.113	27.54	27.57	Pass

- Note: 1. For U-NII-1: The directional gain= $10 \log[(10^{G0/20} + 10^{G1/20} + 10^{G2/20} + 10^{G3/20})^2 / 4] = 8.43 \text{ dBi} > 6 \text{ dBi}$, so the power limit shall be reduced to $30 - (8.43 - 6) = 27.57 \text{ dBm}$.
2. For U-NII-3: The directional gain= $10 \log[(10^{G0/20} + 10^{G1/20} + 10^{G2/20} + 10^{G3/20})^2 / 4] = 8.43 \text{ dBi} > 6 \text{ dBi}$, so the power limit shall be reduced to $30 - (8.43 - 6) = 27.57 \text{ dBm}$.

4.4 Occupied Bandwidth Measurement

4.4.1 Test Setup

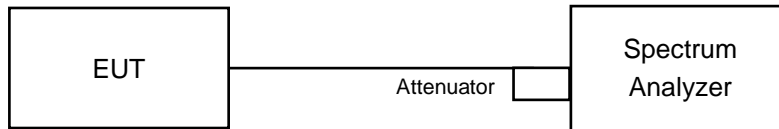

4.4.2 Test Instruments

Refer to section 4.1.2 to get information of above instrument.

4.4.3 Test Procedure

The transmitter output was connected to the spectrum analyzer through an attenuator. The bandwidth of the fundamental frequency was measured by spectrum analyzer with resolution bandwidth in the range of 1% to 5% of the anticipated emission bandwidth, and a video bandwidth at least 3x the resolution bandwidth and set the detector to SAMPLE. The width of a frequency band such that, below the lower and above the upper frequency limits, the mean powers emitted are each equal to a specified percentage 0.5% of the total mean power of a given emission.

4.4.4 Test Results

802.11a

Channel	Channel Frequency (MHz)	Occupied Bandwidth (MHz)			
		Chain 0	Chain 1	Chain 2	Chain 3
36	5180	17.04	17.28	17.16	16.92
40	5200	17.04	17.16	17.16	17.04
48	5240	17.04	17.28	17.16	17.04
149	5745	18.6	19.68	18	19.8
157	5785	19.08	20.28	18.48	20.52
165	5825	18.96	20.64	18.84	20.16

802.11ax (HE20)

Channel	Channel Frequency (MHz)	Occupied Bandwidth (MHz)			
		Chain 0	Chain 1	Chain 2	Chain 3
36	5180	19.2	19.08	19.2	19.08
40	5200	19.2	19.08	19.2	19.08
48	5240	19.2	19.08	19.2	19.2
149	5745	20.04	20.76	19.68	23.64
157	5785	20.28	22.68	19.92	24.48
165	5825	20.4	23.16	20.04	24.24

802.11ax (HE40)

Channel	Channel Frequency (MHz)	Occupied Bandwidth (MHz)			
		Chain 0	Chain 1	Chain 2	Chain 3
38	5190	37.92	37.68	37.68	37.68
46	5230	38.16	37.92	38.16	38.16
151	5755	44.64	44.4	39.36	50.88
159	5795	45.84	46.08	40.08	53.28

802.11ax (HE80)

Channel	Channel Frequency (MHz)	Occupied Bandwidth (MHz)			
		Chain 0	Chain 1	Chain 2	Chain 3
42	5210	77.28	77.28	77.28	76.8
155	5775	77.76	77.76	77.28	78.72

Spectrum Plot of Max. Value

802.11a_Chain 1 / CH165

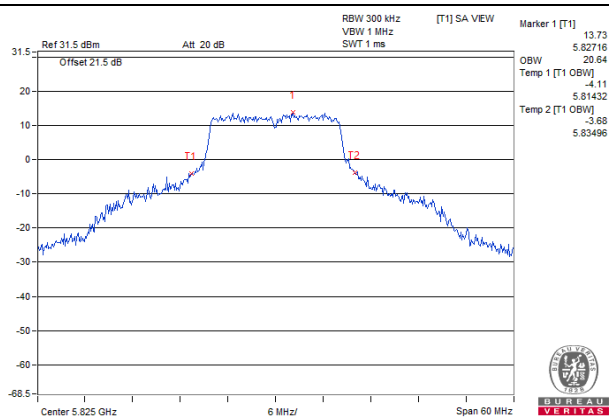

802.11ax (HE20)_Chain 3 / CH157

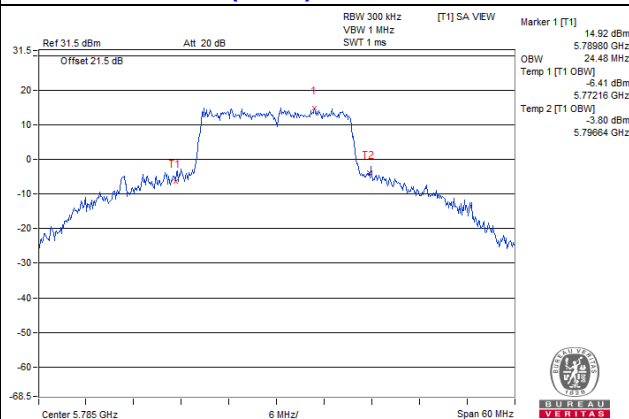

802.11ax (HE40)_Chain 3 / CH159

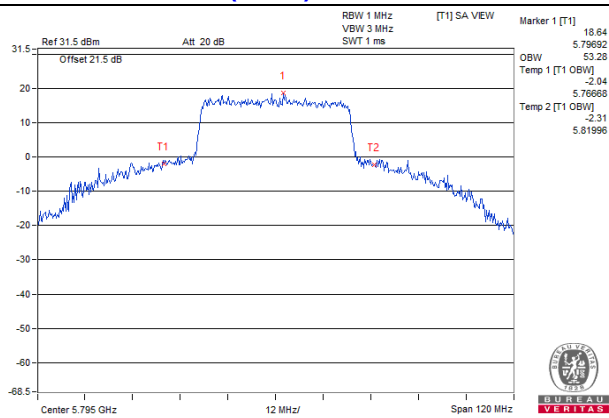

802.11ax (HE80)_Chain 3 / CH155

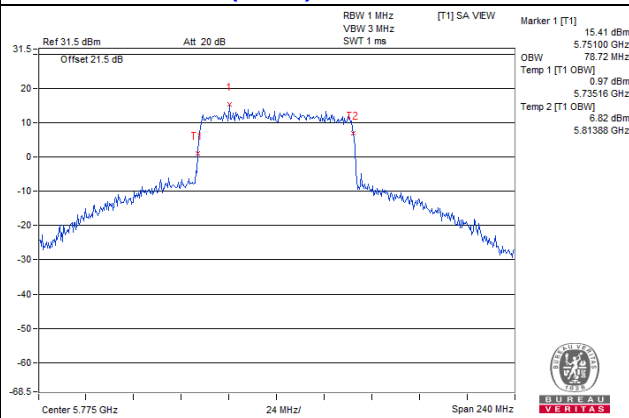

Spectrum Plot for near by DFS band
(DFS is required, if 99% OCP straddle into U-NII-2A band)

802.11a_Chain 0 / CH48

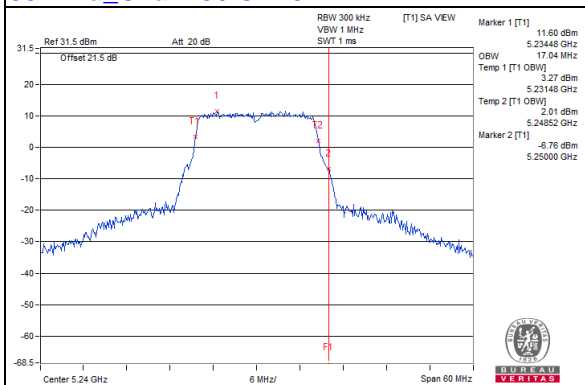

802.11a_Chain 1 / CH48

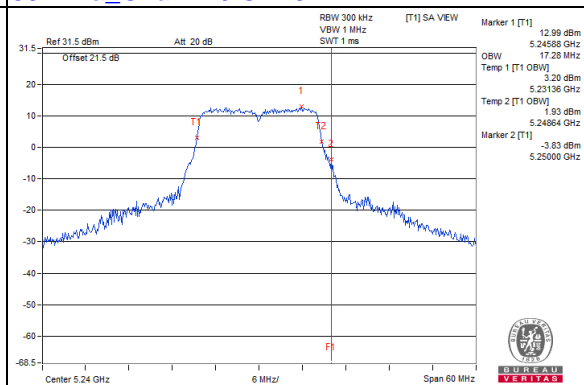

802.11a_Chain 2 / CH48

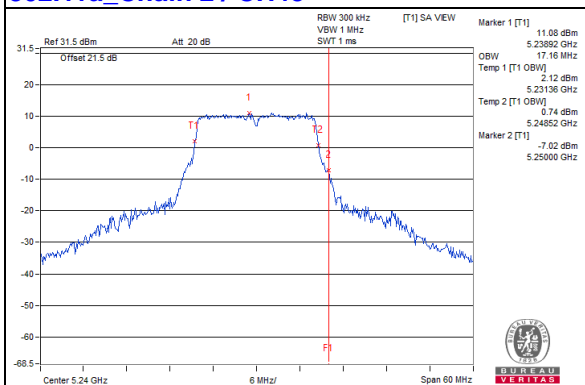

802.11a_Chain 3 / CH48

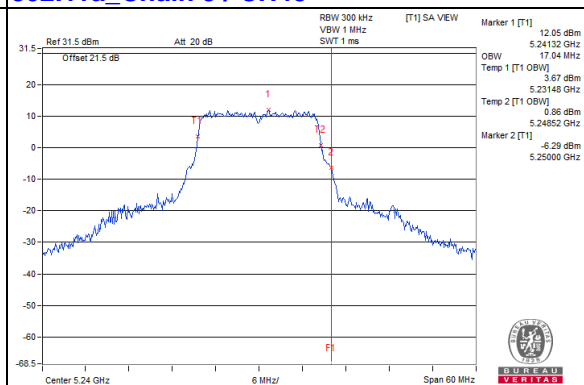

802.11ax (HE20)_Chain 0 / CH48

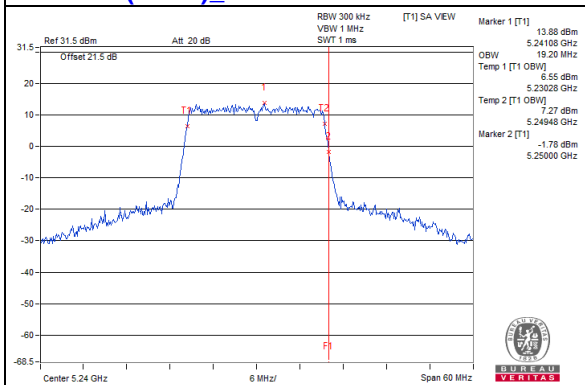

802.11ax (HE20)_Chain 1 / CH48

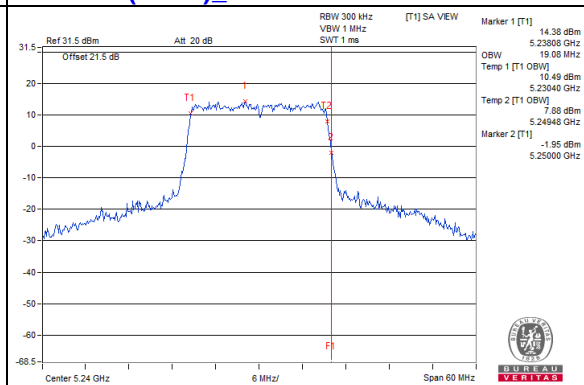

802.11ax (HE20)_Chain 2 / CH48

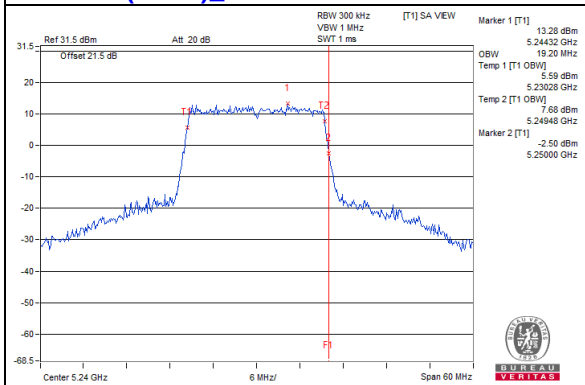

802.11ax (HE20)_Chain 3 / CH48

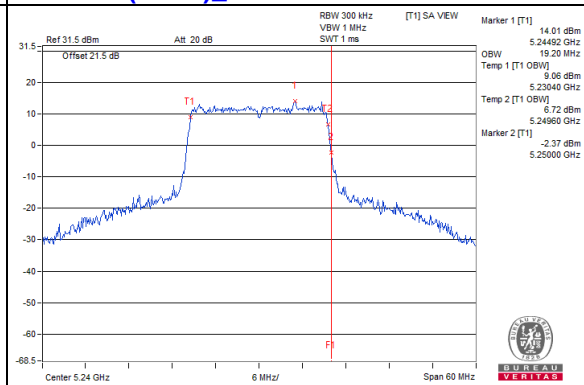

**Spectrum Plot for near by DFS band
(DFS is required, if 99% OCP straddle into U-NII-2A band)**

802.11ax (HE40)_Chain 0 / CH46

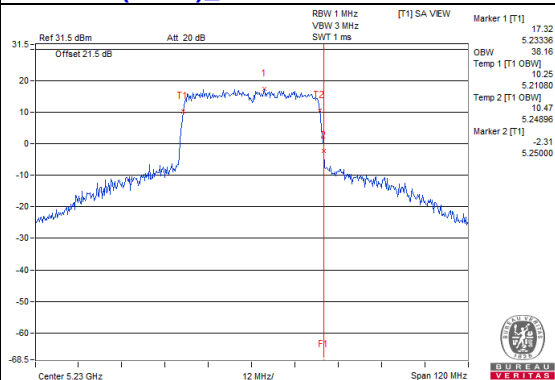

802.11ax (HE40)_Chain 1 / CH46

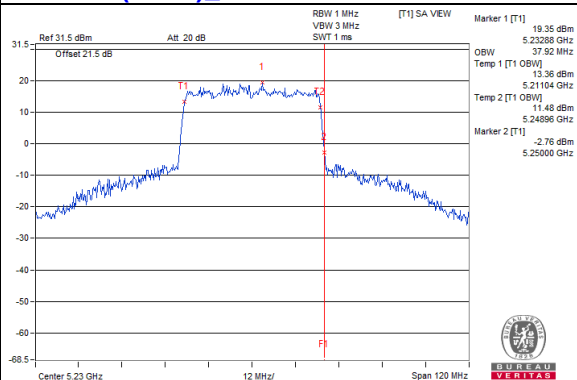

802.11ax (HE40)_Chain 2 / CH46

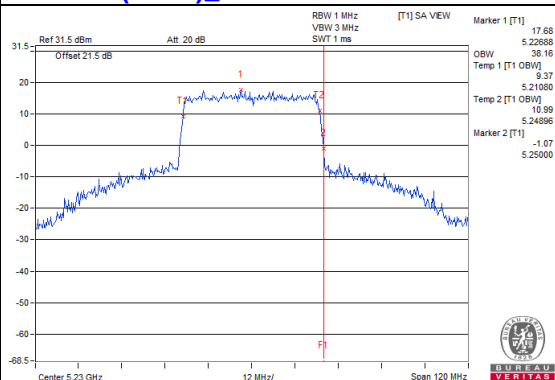

802.11ax (HE40)_Chain 3 / CH46

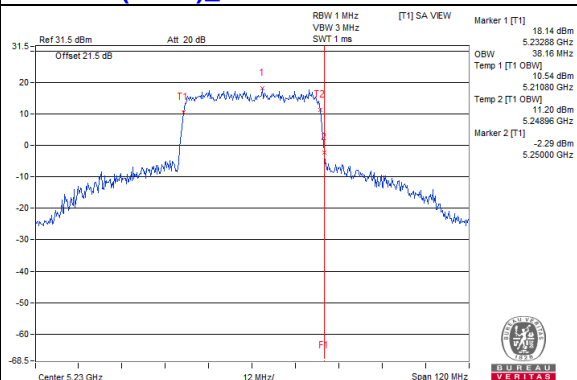

802.11ax (HE80)_Chain 0 / CH42

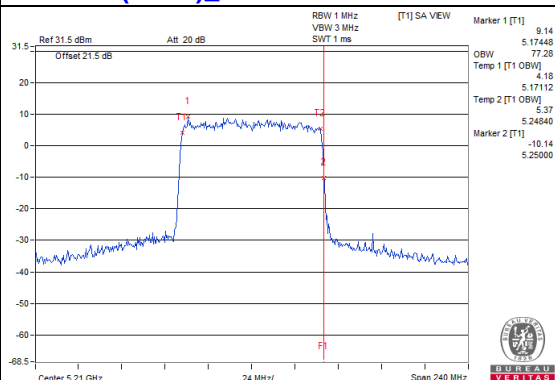

802.11ax (HE80)_Chain 1 / CH42

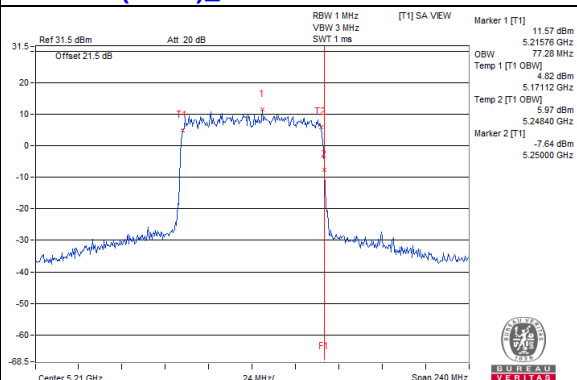

802.11ax (HE80)_Chain 2 / CH42

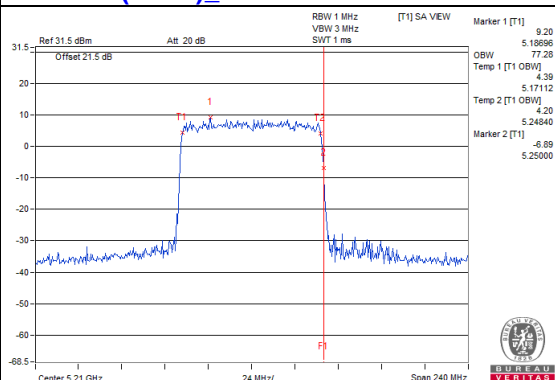

802.11ax (HE80)_Chain 3 / CH42

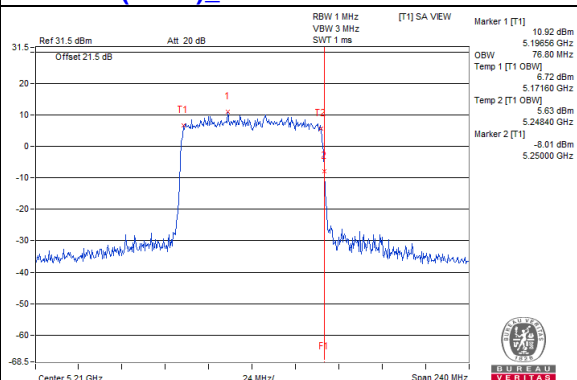

Spectrum Plot for near by DFS band
(DFS is required, if 99% OCP straddle into U-NII-2C band)

802.11a_Chain 0 / CH149

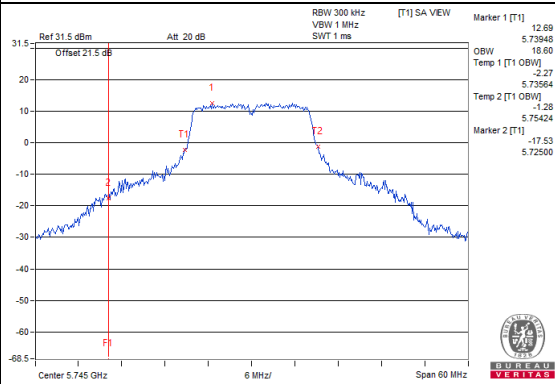

802.11a_Chain 1 / CH149

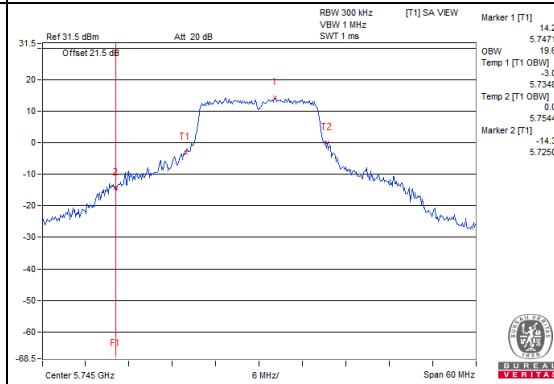

802.11a_Chain 2 / CH149

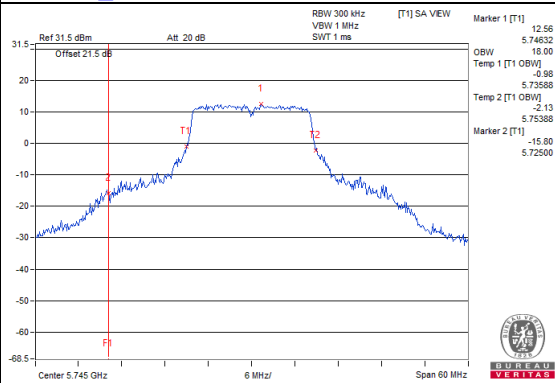

802.11a_Chain 3 / CH149

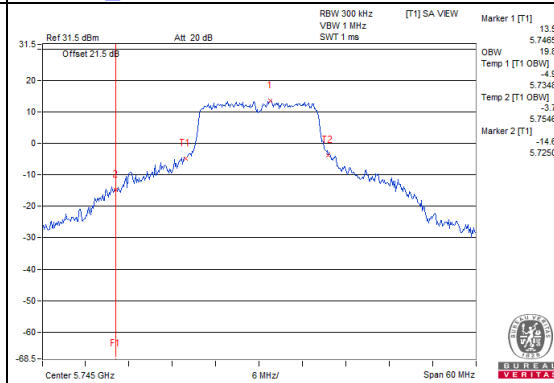

802.11ax (HE20)_Chain 0 / CH149

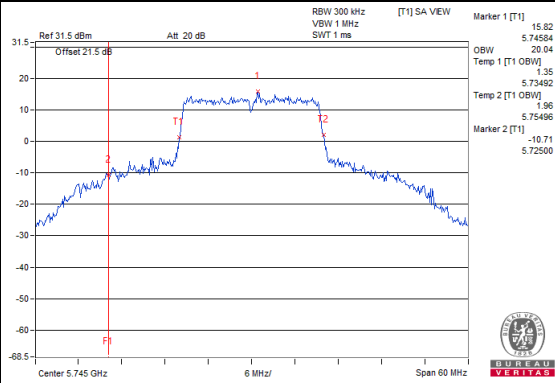

802.11ax (HE20)_Chain 1 / CH149

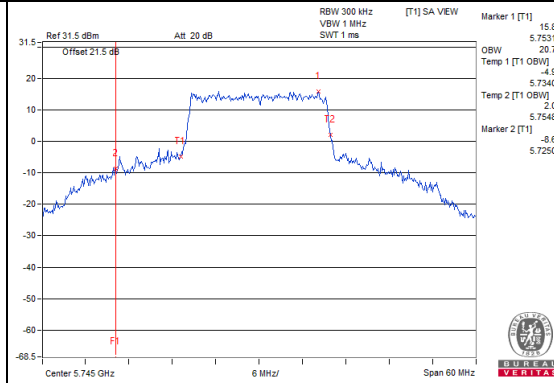

802.11ax (HE20)_Chain 2 / CH149

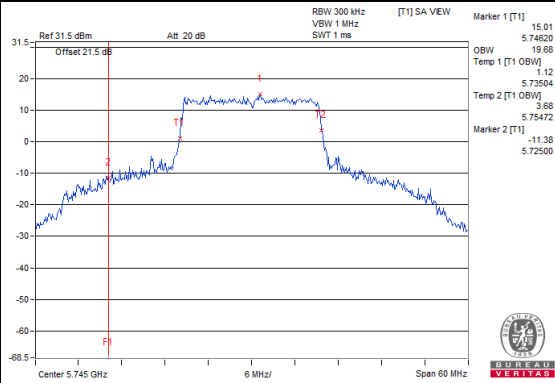

802.11ax (HE20)_Chain 3 / CH149

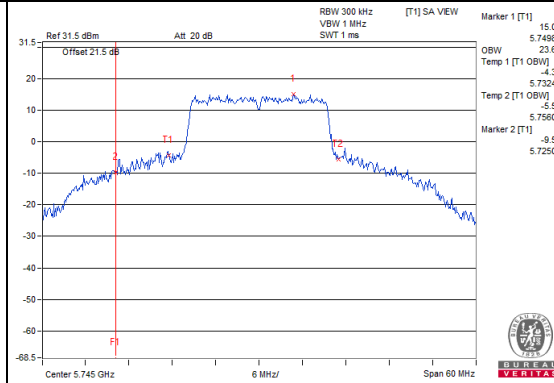

**Spectrum Plot for near by DFS band
(DFS is required, if 99% OCP straddle into U-NII-2C band)**

802.11ax (HE40)_Chain 0 / CH151

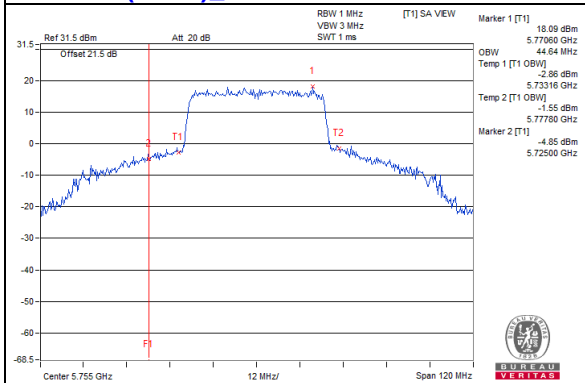

802.11ax (HE40)_Chain 1 / CH151

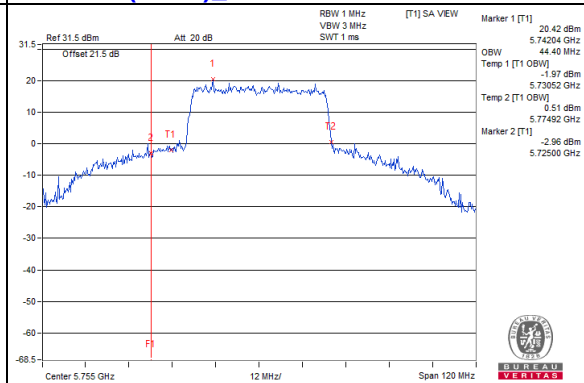

802.11ax (HE40)_Chain 2 / CH151

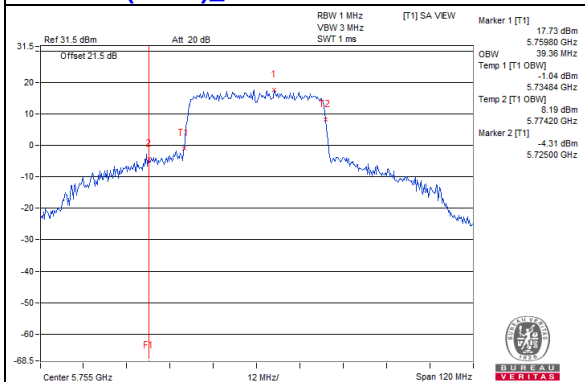

802.11ax (HE40)_Chain 3 / CH151

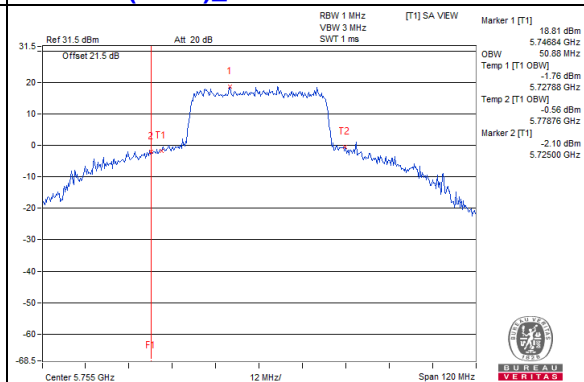

802.11ax (HE80)_Chain 0 / CH155

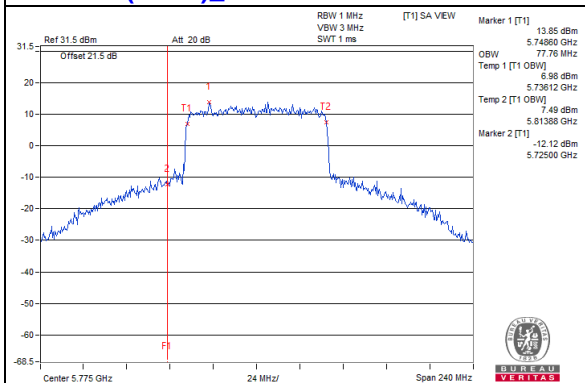

802.11ax (HE80)_Chain 1 / CH155

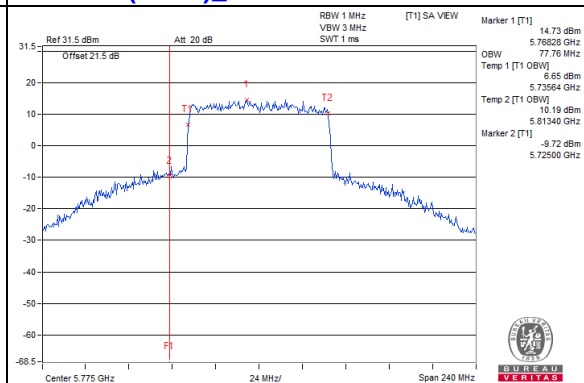

802.11ax (HE80)_Chain 2 / CH155

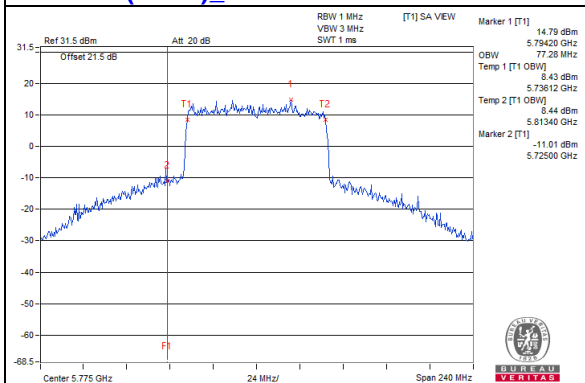

802.11ax (HE80)_Chain 3 / CH155

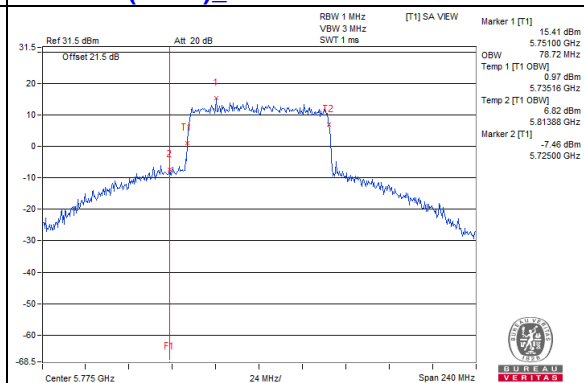

4.5 Peak Power Spectral Density Measurement

4.5.1 Limits of Peak Power Spectral Density Measurement

Operation Band	EUT Category		Limit
U-NII-1		Outdoor Access Point	17dBm/ MHz
		Fixed point-to-point Access Point	
	√	Indoor Access Point	
		Client device	
U-NII-2A			11dBm/ MHz
U-NII-2C			11dBm/ MHz
U-NII-3	√		30dBm/ 500kHz

4.5.2 Test Setup

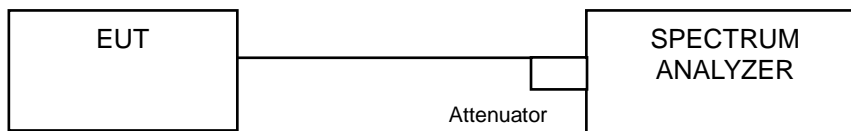

4.5.3 Test Instruments

Refer to section 4.1.2 to get information of above instrument.

4.5.4 Test Procedure

For U-NII-1:

Using method SA-1

1. Set span to encompass the entire emission bandwidth (EBW) of the signal.
2. Set RBW = 1 MHz, Set VBW ≥ 3 MHz, Detector = RMS
3. Sweep time = auto, trigger set to “free run”.
4. Trace average at least 100 traces in power averaging mode.
5. Record the max value

For U-NII-3:

1. Set span to encompass the entire emission bandwidth (EBW) of the signal.
2. Set RBW = 300 kHz, Set VBW ≥ 1 MHz, Detector = RMS
3. Use the peak marker function to determine the maximum power level in any 300 kHz band segment within the fundamental EBW.
4. Scale the observed power level to an equivalent value in 500 kHz by adjusting (increasing) the measured power by a bandwidth correction factor (BWCF) where $BWCF = 10\log(500\text{ kHz}/300\text{ kHz})$
5. Sweep time = auto, trigger set to “free run”.
6. Trace average at least 100 traces in power averaging mode.
7. Record the max value

4.5.5 Deviation from Test Standard

No deviation.

4.5.6 EUT Operating Condition

Same as Item 4.3.6.

4.5.7 Test Results

CDD Mode

For U-NII-1:

802.11a

Chan.	Chan. Freq. (MHz)	PSD (dBm/MHz)				Total Power Density (dBm/MHz)	MAX. Limit (dBm/MHz)	Pass / Fail
		Chain 0	Chain 1	Chain 2	Chain 3			
36	5180	7.42	8.71	6.67	7.17	13.58	14.57	Pass
40	5200	7.49	8.84	6.85	7.36	13.72	14.57	Pass
48	5240	7.55	8.73	6.89	7.39	13.71	14.57	Pass

Note: 1. Method a) of power density measurement of KDB 662911 is using for calculating total power density. Total power density is summing entire spectra across corresponding frequency bins on the various outputs by computer.

2. The directional gain= $10 \log[(10^{G0/20} + 10^{G1/20} + 10^{G2/20} + 10^{G3/20})^2 / 4] = 8.43 \text{ dBi} > 6 \text{ dBi}$, so the power density limit shall be reduced to $17-(8.43-6) = 14.57 \text{ dBm}$.

802.11ax (HE20)

Chan.	Chan. Freq. (MHz)	PSD (dBm/MHz)				Total Power Density (dBm/MHz)	MAX. Limit (dBm/MHz)	Pass / Fail
		Chain 0	Chain 1	Chain 2	Chain 3			
36	5180	7.29	9.09	6.41	7.17	13.63	14.57	Pass
40	5200	7.31	9.05	6.69	7.28	13.70	14.57	Pass
48	5240	7.48	8.87	6.85	7.50	13.76	14.57	Pass

Note: 1. Method a) of power density measurement of KDB 662911 is using for calculating total power density. Total power density is summing entire spectra across corresponding frequency bins on the various outputs by computer.

2. The directional gain= $10 \log[(10^{G0/20} + 10^{G1/20} + 10^{G2/20} + 10^{G3/20})^2 / 4] = 8.43 \text{ dBi} > 6 \text{ dBi}$, so the power density limit shall be reduced to $17-(8.43-6) = 14.57 \text{ dBm}$.

802.11ax (HE40)

Chan.	Chan. Freq. (MHz)	PSD (dBm/MHz)				Total Power Density (dBm/MHz)	MAX. Limit (dBm/MHz)	Pass / Fail
		Chain 0	Chain 1	Chain 2	Chain 3			
38	5190	1.50	2.73	1.03	1.52	7.76	14.57	Pass
46	5230	6.43	7.53	6.27	6.34	12.70	14.57	Pass

Note: 1. Method a) of power density measurement of KDB 662911 is using for calculating total power density. Total power density is summing entire spectra across corresponding frequency bins on the various outputs by computer.

2. The directional gain= $10 \log[(10^{G0/20} + 10^{G1/20} + 10^{G2/20} + 10^{G3/20})^2 / 4] = 8.43 \text{ dBi} > 6 \text{ dBi}$, so the power density limit shall be reduced to $17-(8.43-6) = 14.57 \text{ dBm}$.

802.11ax (HE80)

Chan.	Chan. Freq. (MHz)	PSD (dBm/MHz)				Total Power Density (dBm/MHz)	MAX. Limit (dBm/MHz)	Pass / Fail
		Chain 0	Chain 1	Chain 2	Chain 3			
42	5210	-1.89	-0.74	-2.38	-1.71	4.38	14.57	Pass

- Note: 1. Method a) of power density measurement of KDB 662911 is using for calculating total power density. Total power density is summing entire spectra across corresponding frequency bins on the various outputs by computer.
2. The directional gain = $10 \log[(10^{G0/20} + 10^{G1/20} + 10^{G2/20} + 10^{G3/20})^2 / 4] = 8.43 \text{ dBi} > 6 \text{ dBi}$, so the power density limit shall be reduced to $17 - (8.43 - 6) = 14.57 \text{ dBm}$.

Spectrum Plot of Worst Value

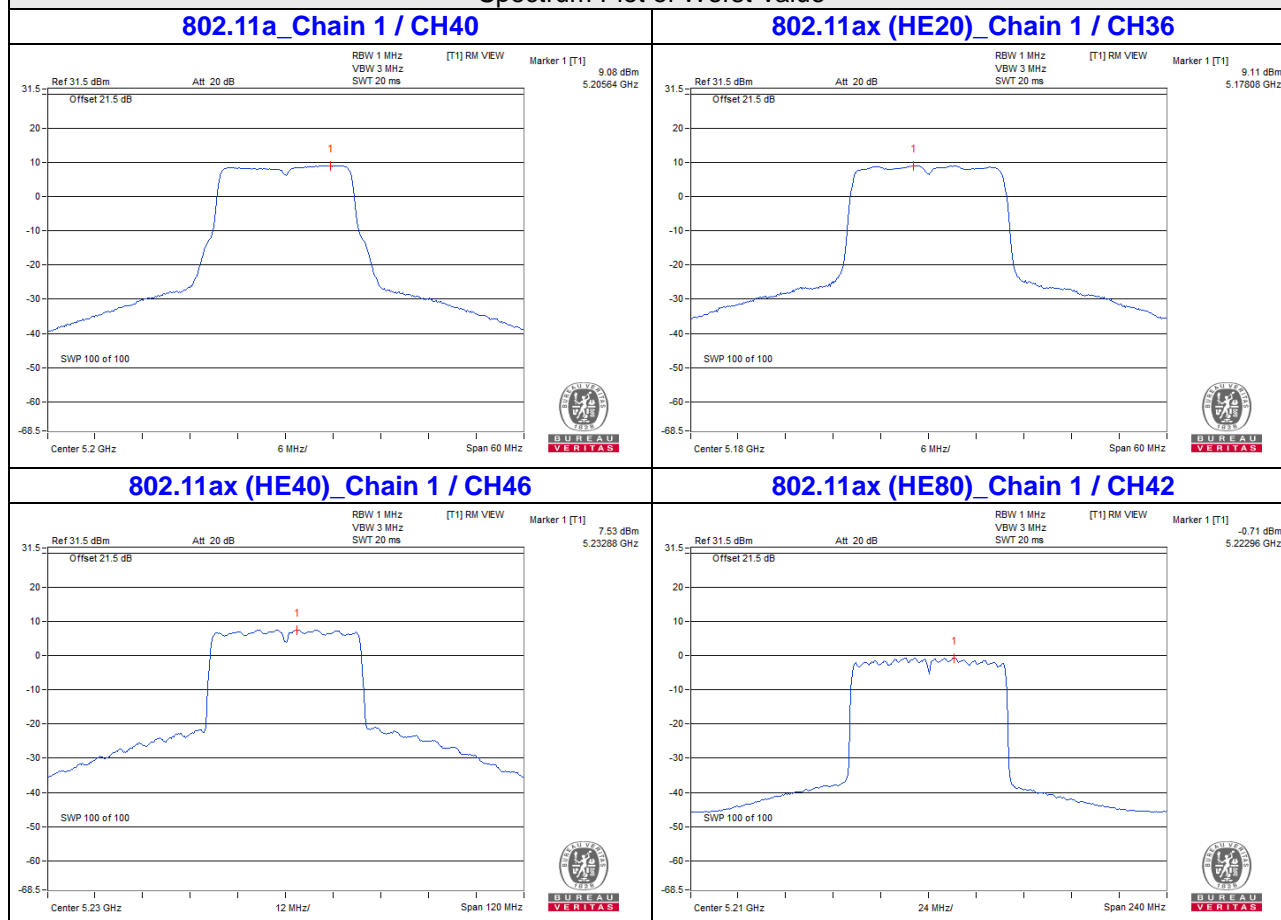

For U-NII-3:

802.11a

Chan.	Chan. Freq. (MHz)	PSD (dBm/300kHz)				Total PSD (mW/300kHz)	Total PSD (dBm/300kHz)	Total PSD (dBm/500kHz)	PSD Limit (dBm/500kHz)	Pass / Fail
		Chain 0	Chain 1	Chain 2	Chain 3					
149	5745	0.21	1.63	0.00	0.62	4.658	6.68	8.90	27.57	PASS
157	5785	0.10	1.22	-0.06	0.45	4.4431	6.48	8.70	27.57	PASS
165	5825	-0.22	1.11	-0.14	0.40	4.3066	6.34	8.56	27.57	PASS

- Note: 1. Method b) Measure and sum spectral maxima across the outputs of KDB 662911 is using for calculating total power density.
 2. The directional gain= $10 \log[(10^{G0/20} + 10^{G1/20} + 10^{G2/20} + 10^{G3/20})^2 / 4] = 8.43 \text{ dBi} > 6 \text{ dBi}$, so the power limit shall be reduced to $30 - (8.43 - 6) = 27.57 \text{ dBm}$.

802.11ax (HE20)

Chan.	Chan. Freq. (MHz)	PSD (dBm/300kHz)				Total PSD (mW/300kHz)	Total PSD (dBm/300kHz)	Total PSD (dBm/500kHz)	PSD Limit (dBm/500kHz)	Pass / Fail
		Chain 0	Chain 1	Chain 2	Chain 3					
149	5745	-0.55	0.81	-0.62	-0.01	3.9507	5.97	8.19	27.57	PASS
157	5785	-0.69	0.58	-0.62	-0.26	3.8048	5.80	8.02	27.57	PASS
165	5825	-0.96	0.33	-0.83	-0.29	3.6421	5.61	7.83	27.57	PASS

- Note: 1. Method b) Measure and sum spectral maxima across the outputs of KDB 662911 is using for calculating total power density.
 2. The directional gain= $10 \log[(10^{G0/20} + 10^{G1/20} + 10^{G2/20} + 10^{G3/20})^2 / 4] = 8.43 \text{ dBi} > 6 \text{ dBi}$, so the power limit shall be reduced to $30 - (8.43 - 6) = 27.57 \text{ dBm}$.

802.11ax (HE40)

Chan.	Chan. Freq. (MHz)	PSD (dBm/300kHz)				Total PSD (mW/300kHz)	Total PSD (dBm/300kHz)	Total PSD (dBm/500kHz)	PSD Limit (dBm/500kHz)	Pass / Fail
		Chain 0	Chain 1	Chain 2	Chain 3					
151	5755	-2.88	-1.91	-3.10	-2.44	2.2193	3.46	5.68	27.57	PASS
159	5795	-3.24	-2.14	-3.41	-2.62	2.0882	3.20	5.42	27.57	PASS

- Note: 1. Method b) Measure and sum spectral maxima across the outputs of KDB 662911 is using for calculating total power density.
 2. The directional gain= $10 \log[(10^{G0/20} + 10^{G1/20} + 10^{G2/20} + 10^{G3/20})^2 / 4] = 8.43 \text{ dBi} > 6 \text{ dBi}$, so the power limit shall be reduced to $30 - (8.43 - 6) = 27.57 \text{ dBm}$.

802.11ax (HE80)

Chan.	Chan. Freq. (MHz)	PSD (dBm/300kHz)				Total PSD (mW/300kHz)	Total PSD (dBm/300kHz)	Total PSD (dBm/500kHz)	PSD Limit (dBm/500kHz)	Pass / Fail
		Chain 0	Chain 1	Chain 2	Chain 3					
155	5775	-7.16	-5.81	-7.07	-6.16	0.8932	-0.49	1.73	27.57	PASS

- Note: 1. Method b) Measure and sum spectral maxima across the outputs of KDB 662911 is using for calculating total power density.
 2. The directional gain = $10 \log[(10^{G0/20} + 10^{G1/20} + 10^{G2/20} + 10^{G3/20})^2 / 4] = 8.43 \text{ dBi} > 6 \text{ dBi}$, so the power limit shall be reduced to $30 - (8.43 - 6) = 27.57 \text{ dBm}$.

Spectrum Plot of Worst Value

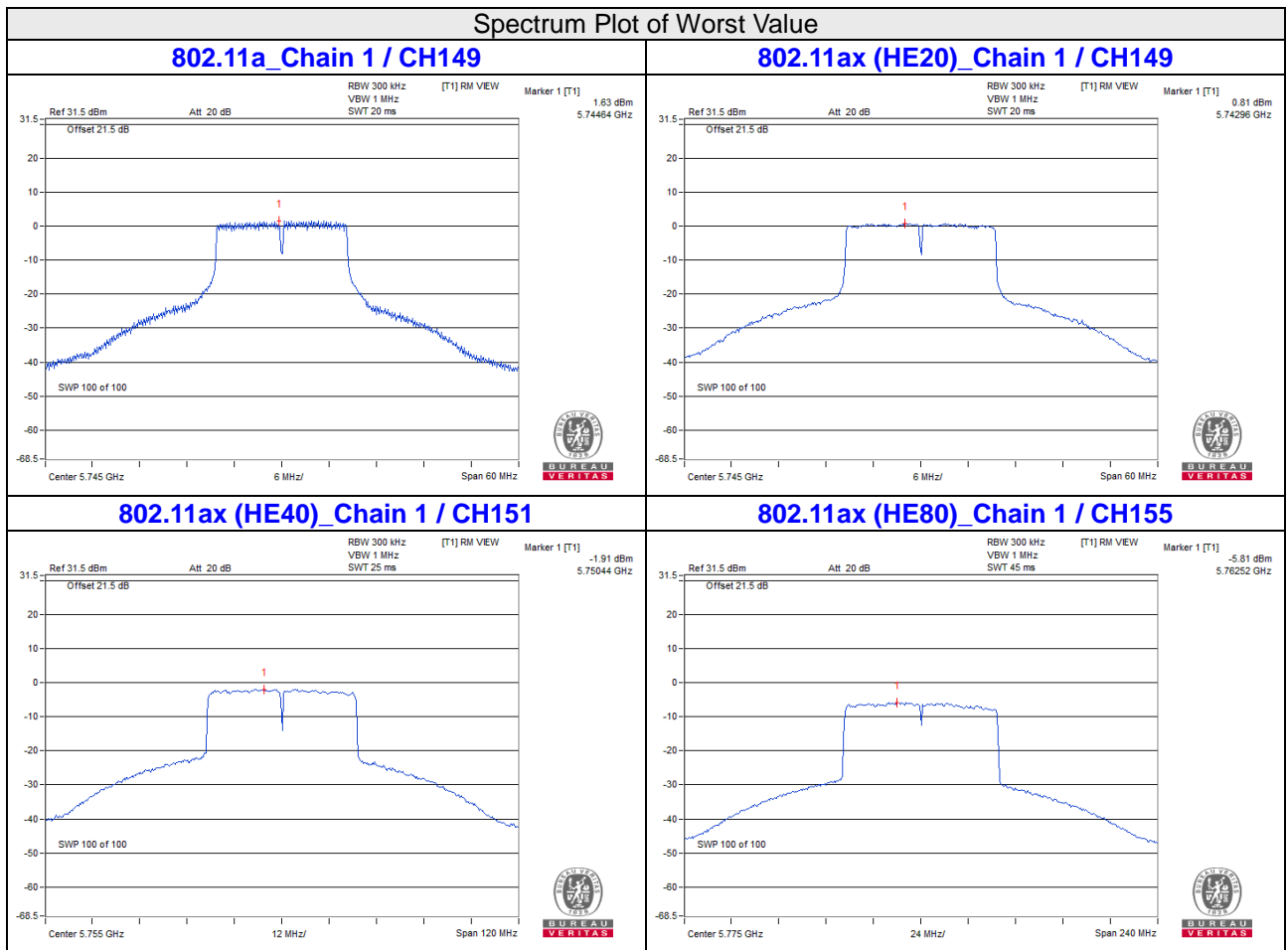

4.6 Frequency Stability Measurement

4.6.1 Limits of Frequency Stability Measurement

The frequency of the carrier signal shall be maintained within band of operation

4.6.2 Test Setup

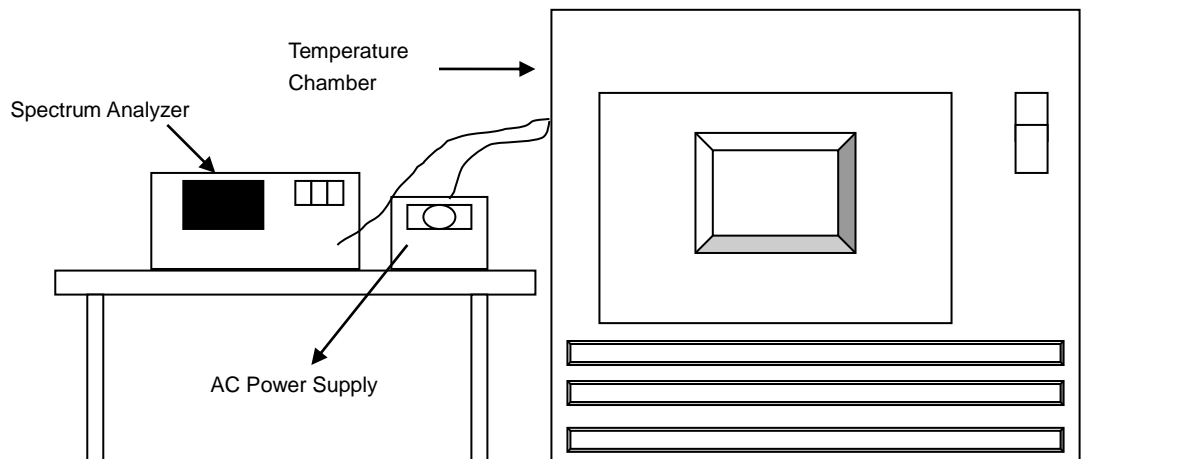

4.6.3 Test Instruments

Refer to section 4.1.2 to get information of above instrument.

4.6.4 Test Procedure

- The EUT was placed inside the environmental test chamber and powered by nominal AC voltage.
- Turn the EUT on and couple its output to a spectrum analyzer.
- Turn the EUT off and set the chamber to the highest temperature specified.
- Allow sufficient time (approximately 30 min) for the temperature of the chamber to stabilize, turn the EUT on and measure the operating frequency after 2, 5, and 10 Minutes.
- Repeat step (d) with the temperature chamber set to the next desired temperature until measurements down to the lowest specified temperature have been completed.
- The test chamber was allowed to stabilize at +20 degree C for a minimum of 30 Minutes. The supply voltage was then adjusted on the EUT from 85% to 115% and the frequency record.

4.6.5 Deviation from Test Standard

No deviation.

4.6.6 EUT Operating Condition

Set the EUT transmit at un-modulation mode to test frequency stability.

4.6.7 Test Results

Frequency Stability Versus Temp.									
Operating Frequency: 5180 MHz									
TEMP. (°C)	Power Supply (Vac)	0 Minute		2 Minutes		5 Minutes		10 Minutes	
		Measured Frequency (MHz)	Pass/Fail	Measured Frequency (MHz)	Pass/Fail	Measured Frequency (MHz)	Pass/Fail	Measured Frequency (MHz)	Pass/Fail
40	120	5179.9898	Pass	5179.988	Pass	5179.9929	Pass	5179.9883	Pass
30	120	5180.0173	Pass	5180.0184	Pass	5180.0158	Pass	5180.0164	Pass
20	120	5179.9957	Pass	5179.9931	Pass	5179.9949	Pass	5179.9931	Pass
10	120	5180.0206	Pass	5180.0219	Pass	5180.0221	Pass	5180.0221	Pass
0	120	5180	Pass	5180.0022	Pass	5180.003	Pass	5180.0022	Pass

Frequency Stability Versus Voltage									
Operating Frequency: 5180 MHz									
TEMP. (°C)	Power Supply (Vac)	0 Minute		2 Minutes		5 Minutes		10 Minutes	
		Measured Frequency (MHz)	Pass/Fail	Measured Frequency (MHz)	Pass/Fail	Measured Frequency (MHz)	Pass/Fail	Measured Frequency (MHz)	Pass/Fail
20	138	5179.9949	Pass	5179.994	Pass	5179.9957	Pass	5179.9939	Pass
	120	5179.9957	Pass	5179.9931	Pass	5179.9949	Pass	5179.9931	Pass
	102	5179.9961	Pass	5179.9935	Pass	5179.9944	Pass	5179.9931	Pass

4.7 6dB Bandwidth Measurement

4.7.1 Limits of 6dB Bandwidth Measurement

The minimum of 6dB Bandwidth Measurement is 0.5MHz.

4.7.2 Test Setup

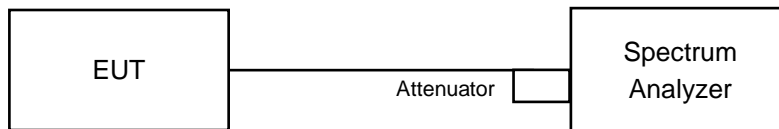

4.7.3 Test Instruments

Refer to section 4.1.2 to get information of above instrument.

4.7.4 Test Procedure

MEASUREMENT PROCEDURE REF

- Set resolution bandwidth (RBW) = 100kHz
- Set the video bandwidth (VBW) $\geq 3 \times$ RBW, Detector = Peak.
- Trace mode = max hold.
- Sweep = auto couple.
- Measure the maximum width of the emission that is constrained by the frequencies associated with the two amplitude points (upper and lower) that are attenuated by 6 dB relative to the maximum level measured in the fundamental emission.

4.7.5 Deviation from Test Standard

No deviation.

4.7.6 EUT Operating Condition

The software provided by client to enable the EUT under transmission condition continuously at lowest, middle and highest channel frequencies individually.

4.7.7 Test Results

802.11a

Channel	Frequency (MHz)	6dB Bandwidth (MHz)				Minimum Limit (MHz)	Pass / Fail
		Chain 0	Chain 1	Chain 2	Chain 3		
149	5745	16.4	16.39	16.43	16.41	0.5	Pass
157	5785	16.41	16.39	16.43	16.4	0.5	Pass
165	5825	16.41	16.39	16.4	16.42	0.5	Pass

802.11ax (HE20)

Channel	Frequency (MHz)	6dB Bandwidth (MHz)				Minimum Limit (MHz)	Pass / Fail
		Chain 0	Chain 1	Chain 2	Chain 3		
149	5745	19	18.98	18.97	18.98	0.5	Pass
157	5785	18.96	18.97	19.05	18.97	0.5	Pass
165	5825	18.93	18.89	19.03	18.97	0.5	Pass

802.11ax (HE40)

Channel	Frequency (MHz)	6dB Bandwidth (MHz)				Minimum Limit (MHz)	Pass / Fail
		Chain 0	Chain 1	Chain 2	Chain 3		
151	5755	37.72	37.31	37.75	37.54	0.5	Pass
159	5795	37.76	37.31	37.69	37.77	0.5	Pass

802.11ax (HE80)

Channel	Frequency (MHz)	6dB Bandwidth (MHz)				Minimum Limit (MHz)	Pass / Fail
		Chain 0	Chain 1	Chain 2	Chain 3		
155	5775	77.24	77.55	76.84	76.21	0.5	Pass

Spectrum Plot of Worst Value

802.11a_Chain 1 / CH149

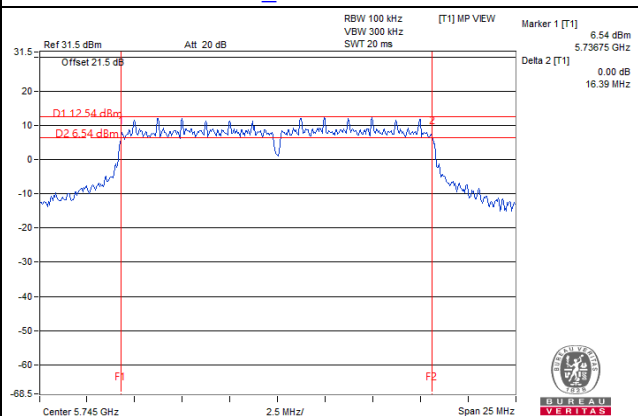

802.11ax (HE20)_Chain 1 / CH165

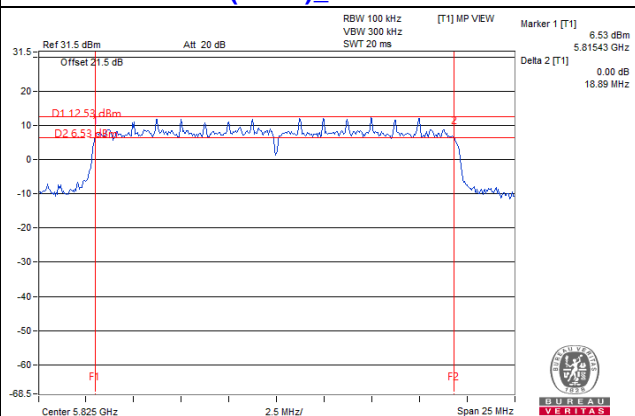

802.11ax (HE40)_Chain 1 / CH151

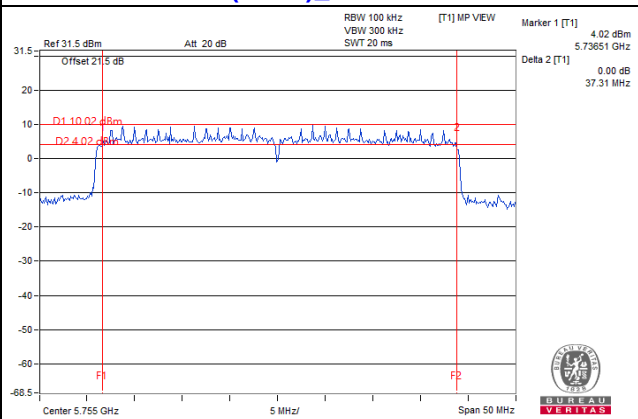

802.11ax (HE80)_Chain 3 / CH155

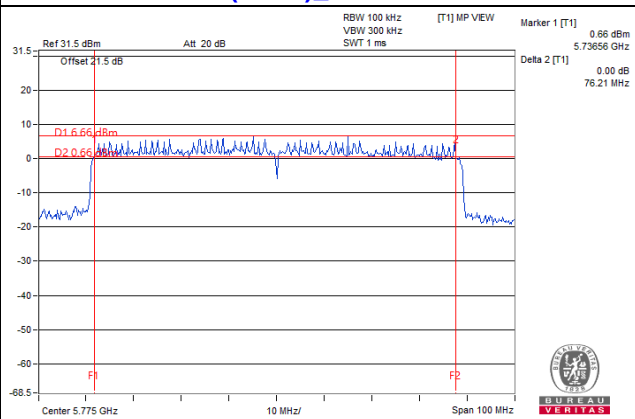

5 Pictures of Test Arrangements

Please refer to the attached file (Test Setup Photo).

Annex A- Radiated Out of Band Emission (OOBE) Measurement (For U-NII-3 band)

802.11a CH 149 : 5745 MHz

Horizontal

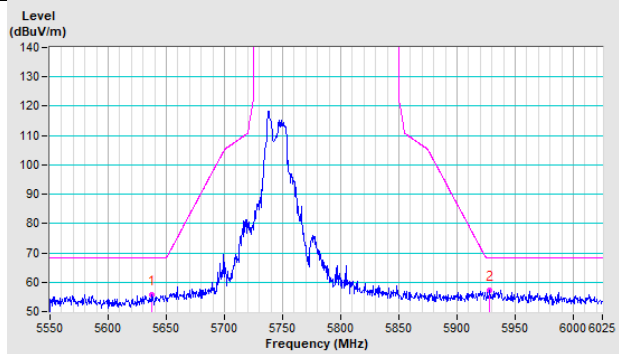

Vertical

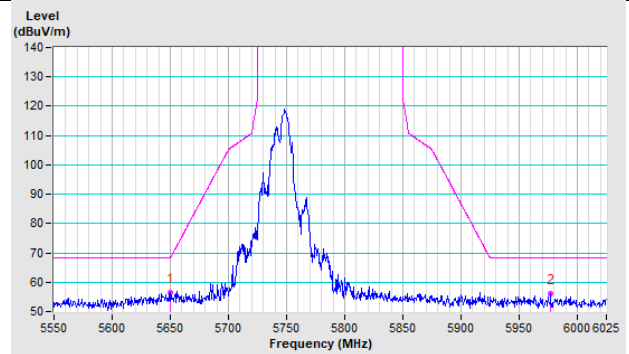

802.11a CH 157 : 5785 MHz

Horizontal

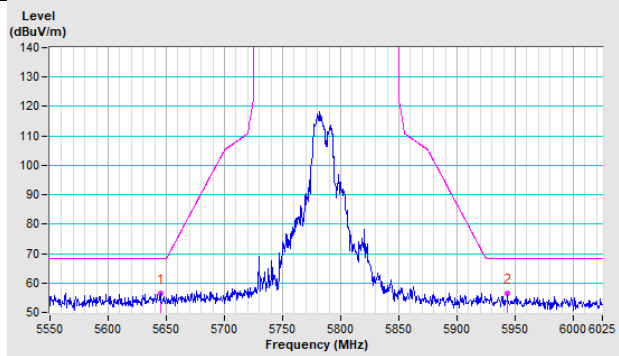

Vertical

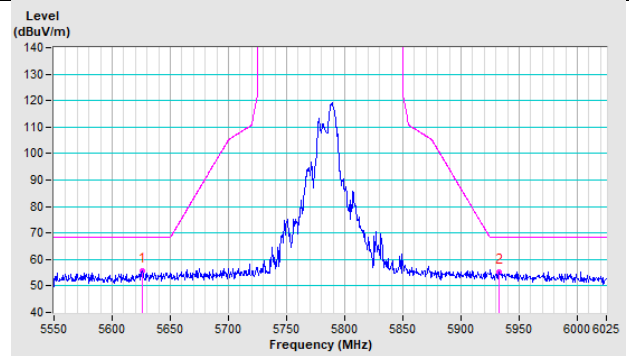

802.11a CH 165 : 5825 MHz

Horizontal

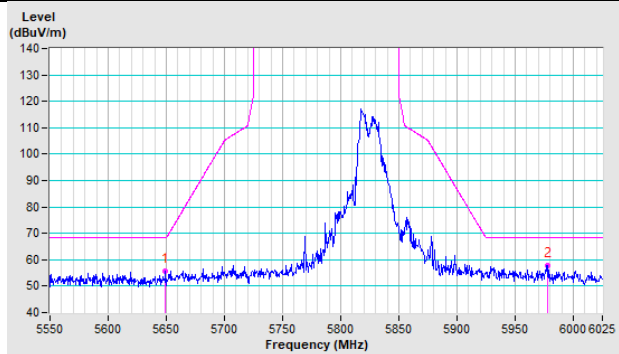

Vertical

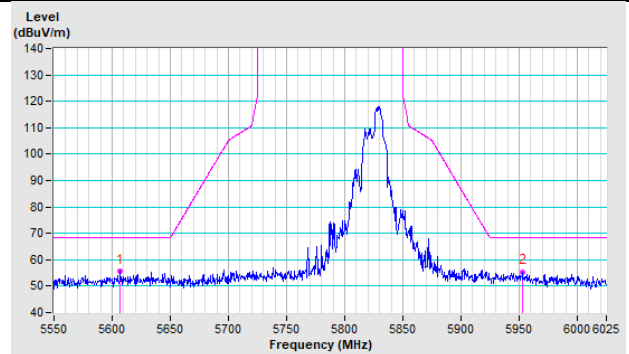

802.11ax (HE20) CH 149 : 5745 MHz

Horizontal

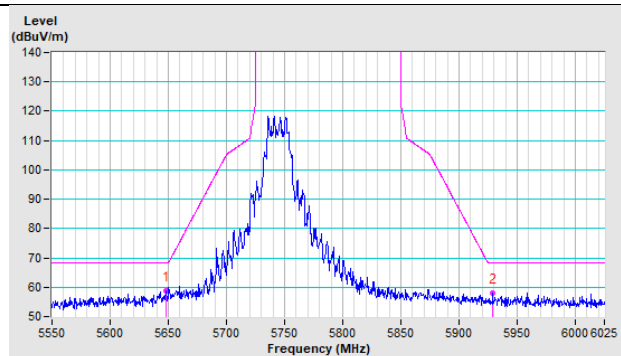

Vertical

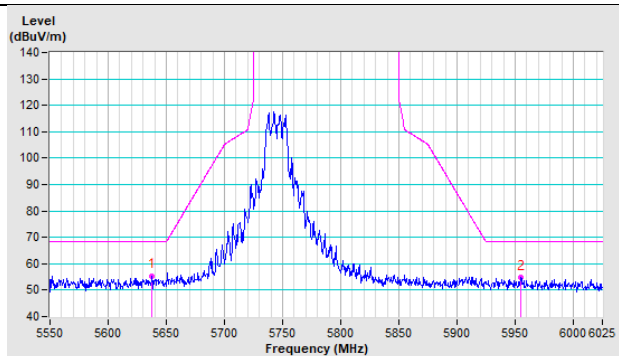

802.11ax (HE20) CH 157 : 5785 MHz

Horizontal

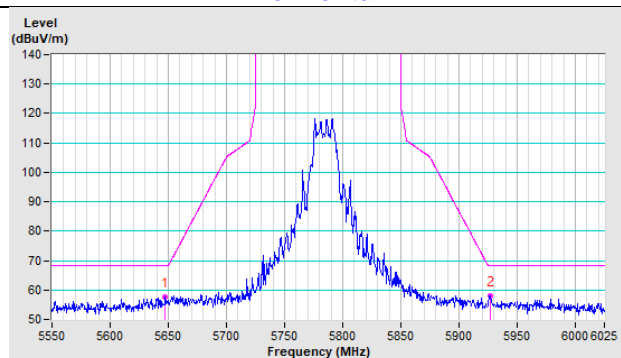

Vertical

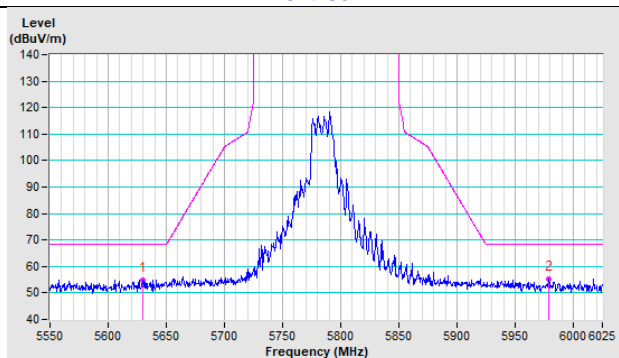

802.11ax (HE20) CH 165 : 5825 MHz

Horizontal

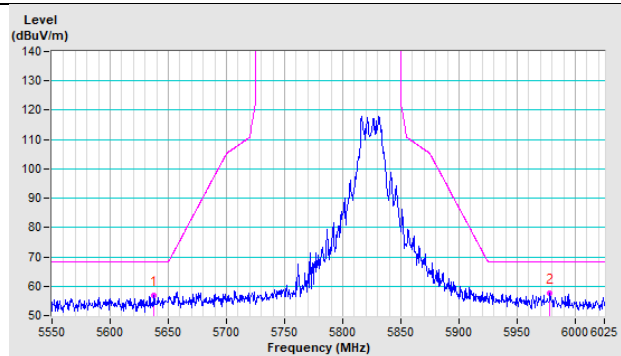

Vertical

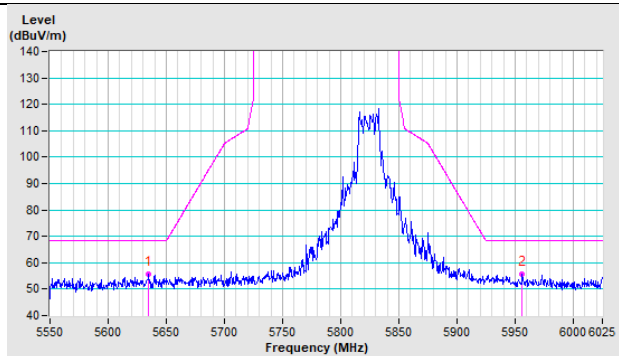

802.11ax (HE40) CH 151 : 5755 MHz

Horizontal

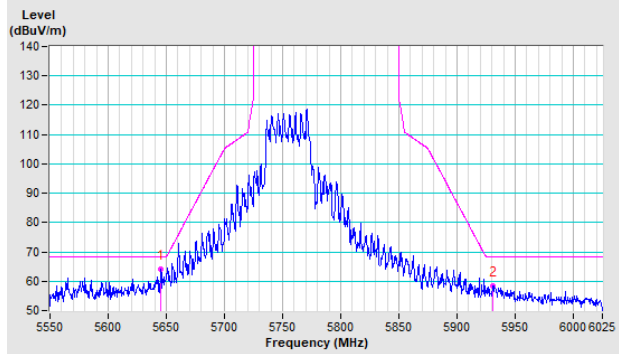

Vertical

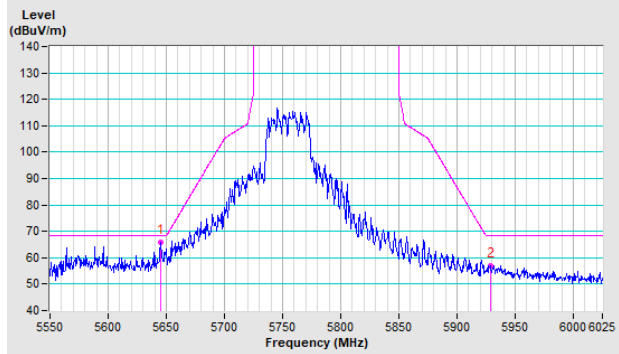

802.11ax (HE40) CH 159 : 5795 MHz

Horizontal

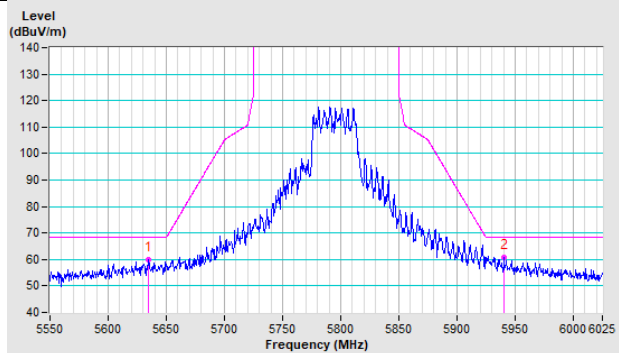

Vertical

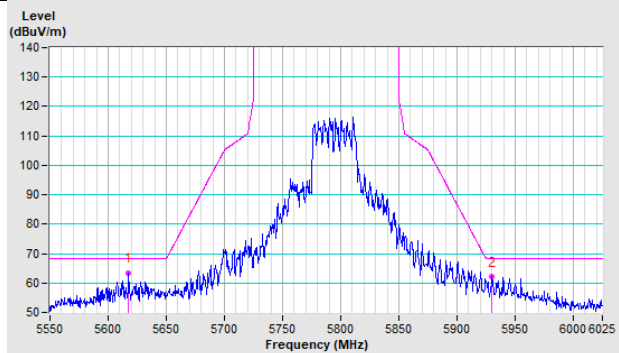

802.11ax (HE80) CH 155 : 5775 MHz

Horizontal

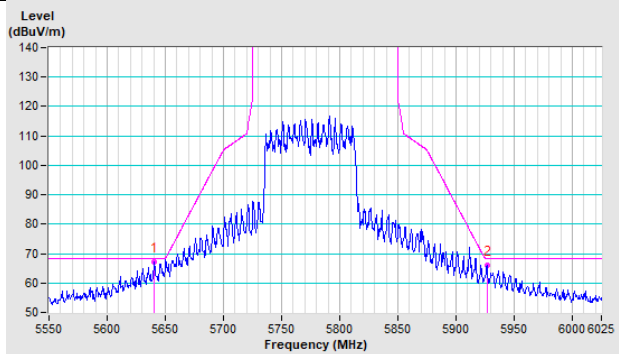

Vertical

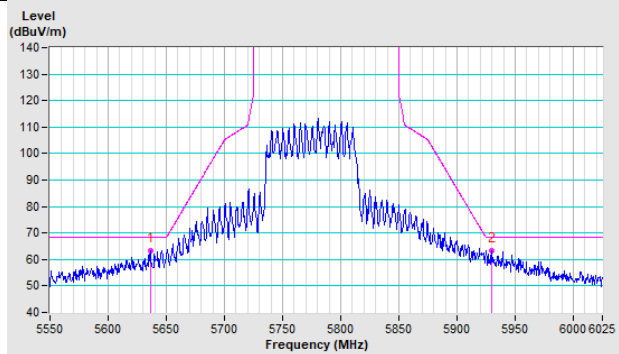

Annex B- Band-edge measurement (For U-NII-1 band)

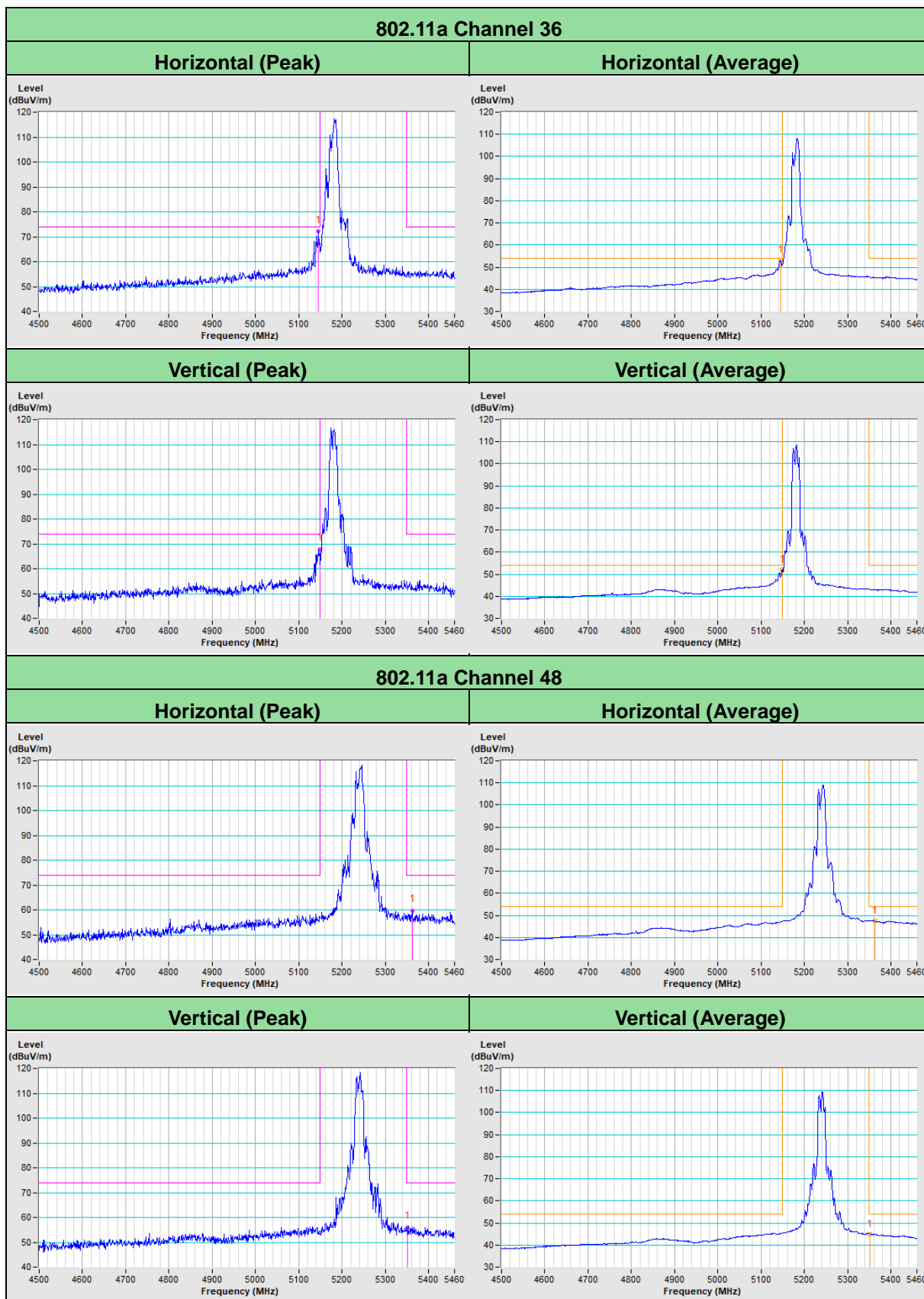

802.11ax (HE20) Channel 36

Horizontal (Peak)	Horizontal (Average)
-------------------	----------------------

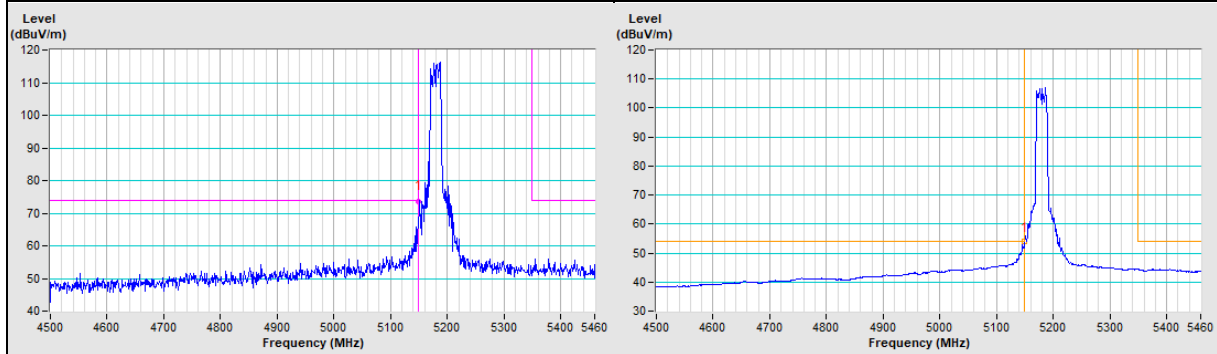

Vertical (Peak)	Vertical (Average)
-----------------	--------------------

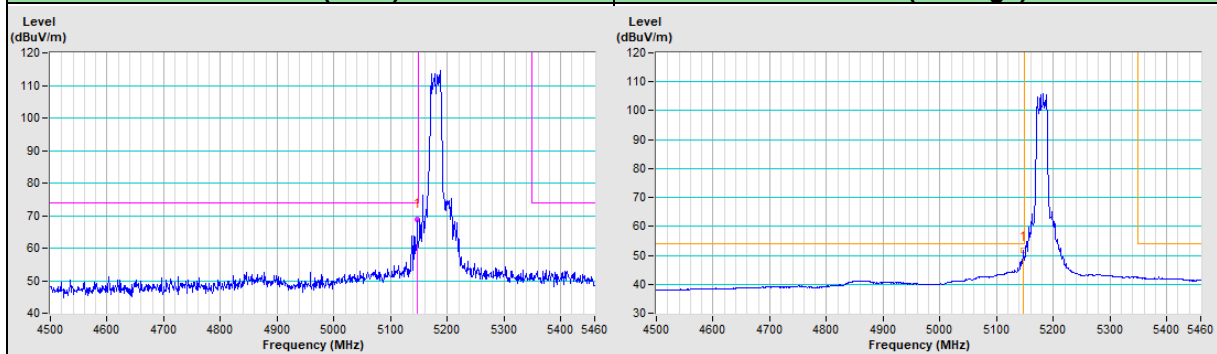

802.11ax (HE20) Channel 48

Horizontal (Peak)	Horizontal (Average)
-------------------	----------------------

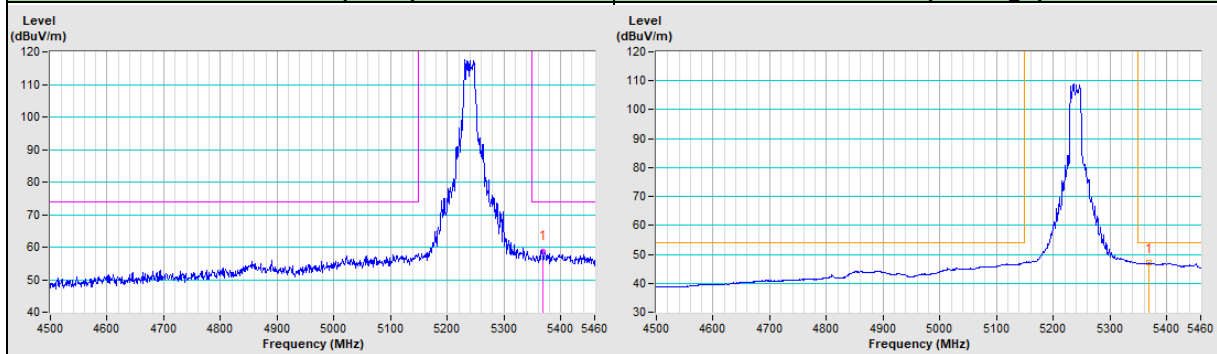

Vertical (Peak)	Vertical (Average)
-----------------	--------------------

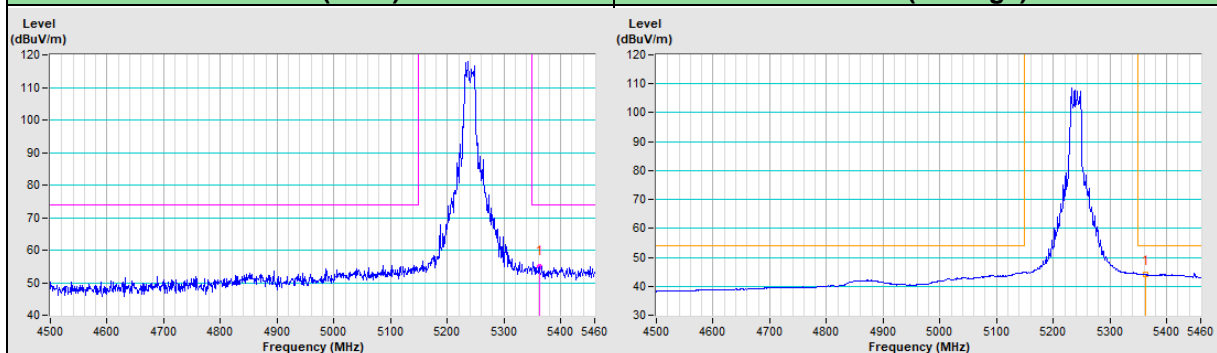

802.11ax (HE40) Channel 38

Horizontal (Peak)	Horizontal (Average)
--------------------------	-----------------------------

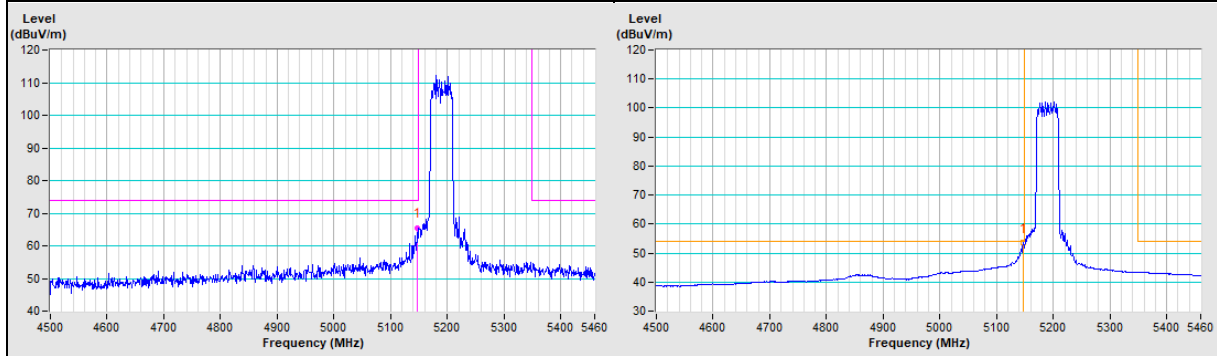

Vertical (Peak)	Vertical (Average)
------------------------	---------------------------

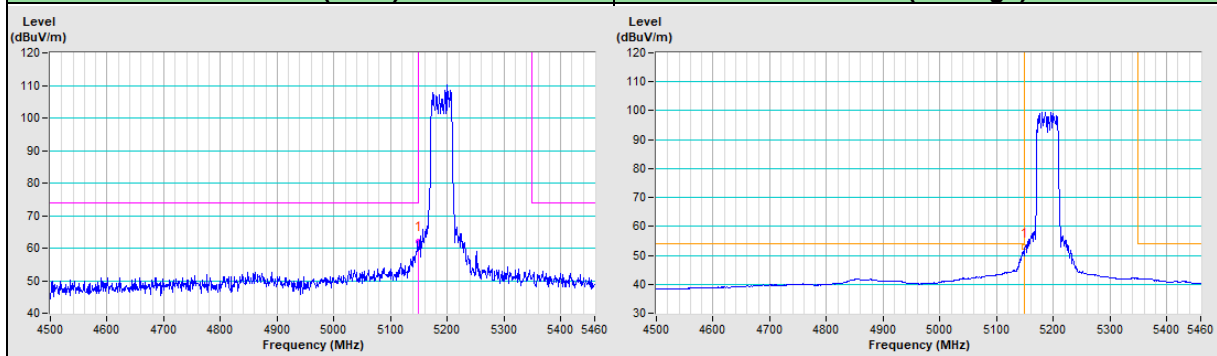

802.11ax (HE40) Channel 46

Horizontal (Peak)	Horizontal (Average)
--------------------------	-----------------------------

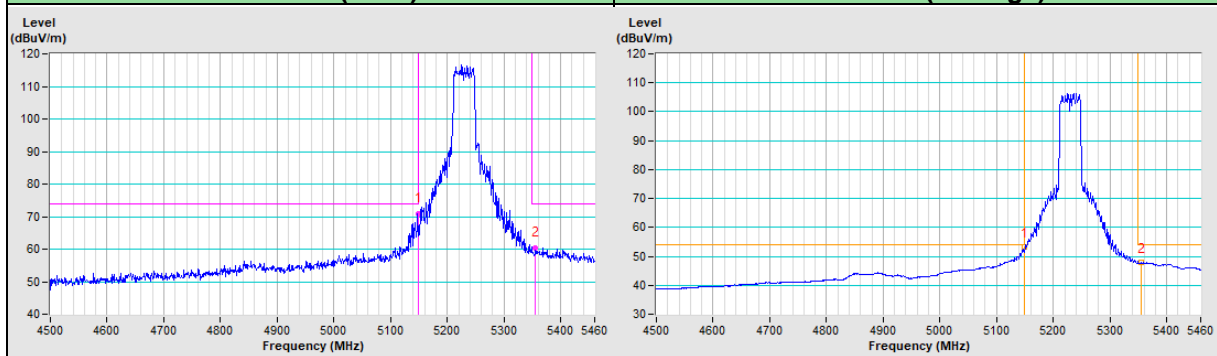

Vertical (Peak)	Vertical (Average)
------------------------	---------------------------

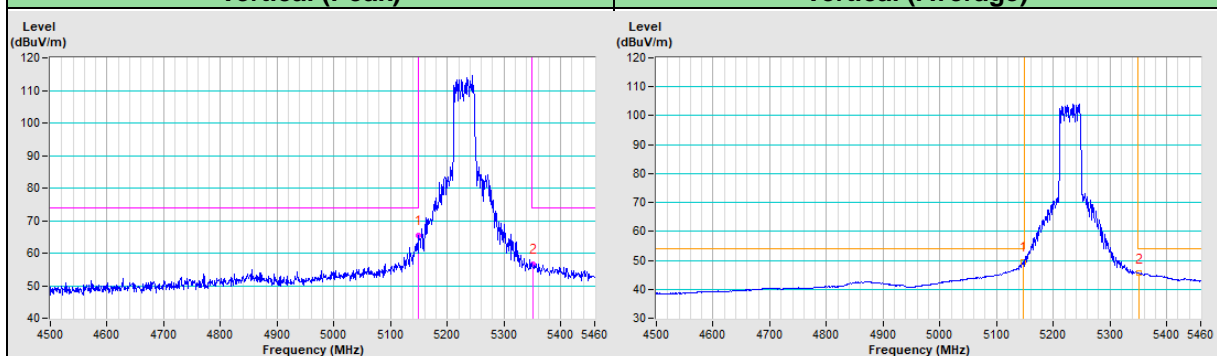

802.11ax (HE80) Channel 42

Horizontal (Peak)

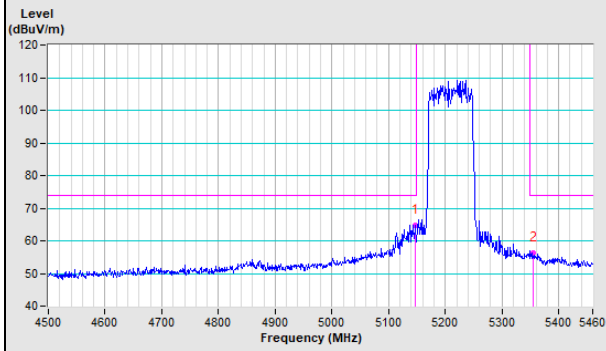

Horizontal (Average)

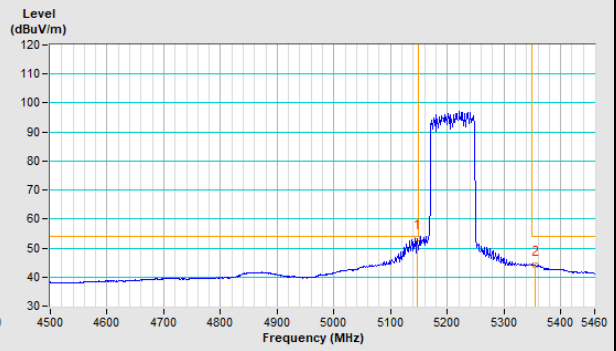

Vertical (Peak)

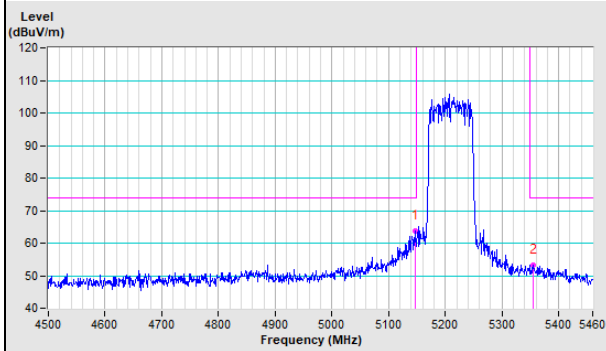

Vertical (Average)

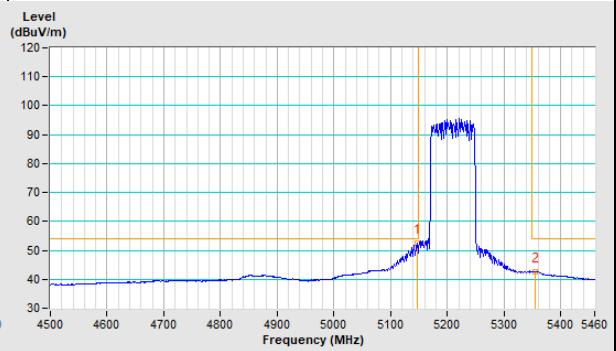

Appendix – Information of the Testing Laboratories

We, Bureau Veritas Consumer Products Services (H.K.) Ltd., Taoyuan Branch, were founded in 1988 to provide our best service in EMC, Radio, Telecom and Safety consultation. Our laboratories are FCC recognized accredited test firms and accredited according to ISO/IEC 17025.

If you have any comments, please feel free to contact us at the following:

Lin Kou EMC/RF Lab

Tel: 886-2-26052180

Fax: 886-2-26051924

Hsin Chu EMC/RF/Telecom Lab

Tel: 886-3-6668565

Fax: 886-3-6668323

Hwa Ya EMC/RF/Safety Lab

Tel: 886-3-3183232

Fax: 886-3-3270892

Email: service.adt@tw.bureauveritas.com

Web Site: www.bureauveritas-adt.com

The address and road map of all our labs can be found in our web site also.

--- END ---