

# 承認書

## SPECIFICATION FOR APPROVAL

CUSTOMER: D&M holdings Inc.

D&M PN:

Description: REMOVABLE ANTENNA + CABLE(L=300)

Arcadyan part no: 120300055601J + 120700034000J

Description: ANT2. 4G/5G EXTERNAL SMA-BLACK LITE +  
RF CABLE + IPEX CONN 300mm GRAY OD1.13  
LITE(Model No:WN9722A-DM)

DATE: 2016/9/19

APPROVED NO:

Arcadyan Tech. Co. ,		Customer Approval	
Prepare	Approval	Check	Approval
Amy <i>Amy</i>	David <i>David</i>		

Antenna Type          Dipole

120300055601J + 120700034000J

Specifications	
Standard	IEEE802.11n and 802.11 a/b/g/ac
Frequency range	2.4 to 2.49GHz , 4.9 to 5.9 GHz
Peak gain with	2.72 dBi @ 2.4 GHz
Cable Loss	2.97 dBi @ 5 GHz

# Liteconn Co.,Ltd.

## APPROVAL INDEX

1 Front cover	-----	pages 1
2 Antenna Type & Specifications	-----	pages 2
3 Directory	-----	pages 3
4 Drawing & packing	-----	pages 4~6
5 測試報告	-----	pages 7~15
12030005560 J 資料 without cable loss	-----	
6 Cable 資料	-----	pages 16~21
7 塑件資料	-----	pages 22~55
8 PCB 資料	-----	pages 56~69
9 SMA 接頭資料	-----	pages 70~114
120700034000J 資料	-----	
10 Cable 資料	-----	pages 115~120
11 端子資料	-----	pages 121~134
12 套管資料	-----	pages 135~139
13 SMA 接頭資料	-----	pages 140~172

REV.	FILE No.	DRAWN BY	DATE
X0	TWRFQA1503008	Eva_long	2015.10.20

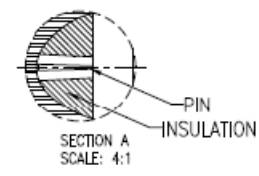
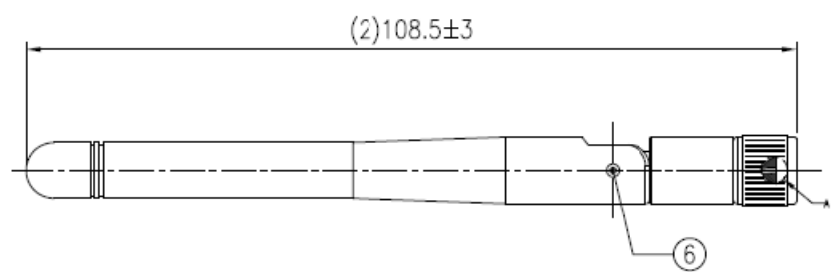
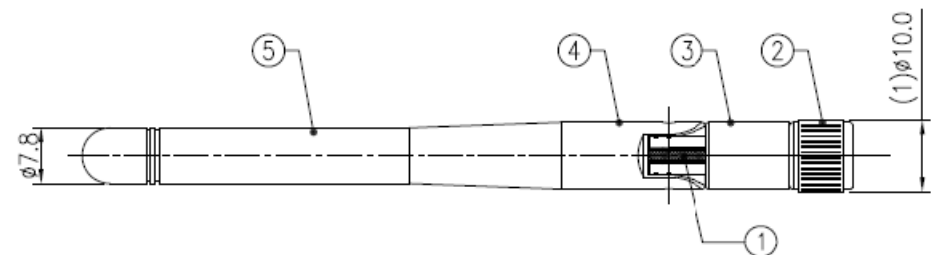

- SPECIFICATION:
1. NORMAL IMPEDANCE: 50 $\Omega$ ;
  2. FREQUENCY RANGE: 2.4~2.5GHz&5.15~5.85GHz;
  3. VSWR: 2.4~2.5GHz&5.15~5.85GHz $\leq$ 2.0;
  4. Peak Gain: 2.4~2.5GHz $\geq$ 2dBi,5.15~5.85GHz $\geq$ 2dBi;
  5. 圖面上標有“(\*)”符號的尺寸為重點管控尺寸。
  6. Arcadyan PN: 120300055601J;
  7. WEIGHT: 8.1 $\pm$ 0.3g
  8. MADE IN CHINA;
  9. SMA connector the rotated torque:400~600gf.

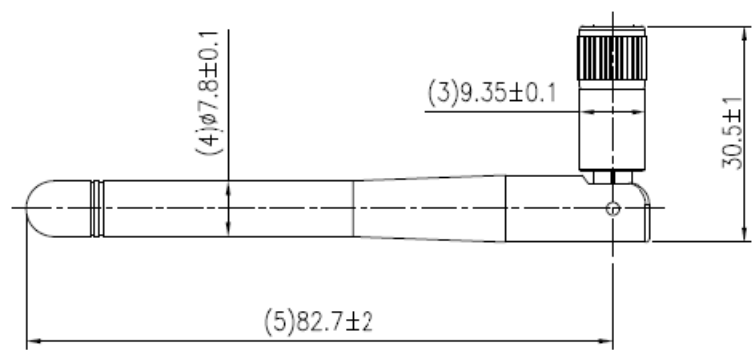

6	REVT	MATERIAL:POM,COLOR:BLACK	2	N/A
5	ANT. SLEEVE	MATERIAL:TPE,COLOR:BLACK	1	N/A
4	UPPER BASE	MATERIAL:PC,COLOR:BLACK	1	N/A
3	BOTTOM BASE	MATERIAL:PC/PBT,COLOR:BLACK	1	N/A
2	SMA	SMA PLUG/REVERSE 轉	1	N/A
1	RF CABLE	RG178 CABLE BROWN	1	N/A
ITEM	PART NAME	DESCRIPTION	Q'TY	REMARK

DWG TYPE:		CUSTOMER DRAWING		Liteconn Co., Ltd.				
GENERAL TOLERANCE: UNLESS OTHERWISE SPECIFIED						TITLE RF ANTENNA ASSEMBLY 50 $\Omega$ ,2.4GHz&5GHz,DIPOLE,BLACK +RG178,+SMA		
X.X	$\pm 0.35$	X.X'	$\pm 3'$	APPD:	DWG No.: 501301-0019-1BC			
X.XX	$\pm 0.25$	X.XX'	$\pm 2'$	CHECK:				
X.XXX	$\pm 0.15$	X.XXX'	$\pm 1'$	DRAW: Eva_long	DATE: 2015.10.20	SCALE: 1:1	UNIT: mm	PAGE: 1/1

COPIANCE WITH THE REQUIREMENT:  RoHS;  HF;  SONY SS-00259;  OTHER.  
\*NO USING RESTRICTED AND BANNED SUBSTANCE

REV.	FILE No.	DRAWN BY	DATE
XO	NEW DWG	Eva_long	2015.10.22

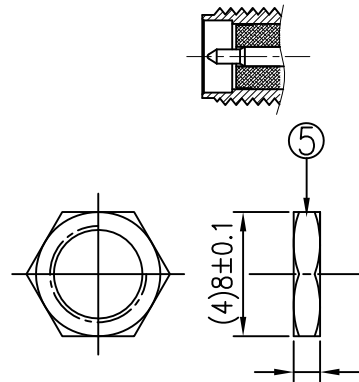
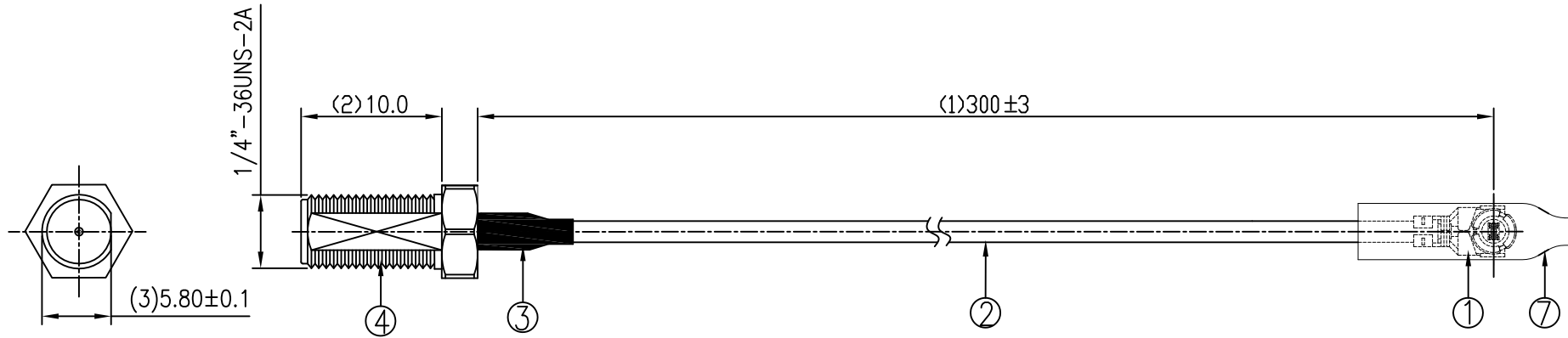

NUT

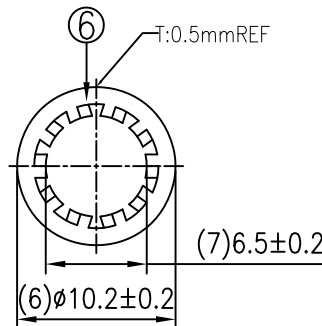

WASHER

- SPECIFICATION:
1. NORMAL IMPEDANCE: 50Ω;
  2. FREQUENCY RANGE: 0GHz~6GHz;
  3. VSWR: 1.5Max.;
  4. 圖面上標有“(\*)”符號的尺寸為重點管控尺寸;
  5. Arcadyan PN: 120700034000J;
  6. WEIGHT: 4.4±0.3g
  7. MADE IN CHINA;
  8. PART NUMBER SYSTEM:SEE TABLE A

TABLE A: PART NUMBER SYSTEM

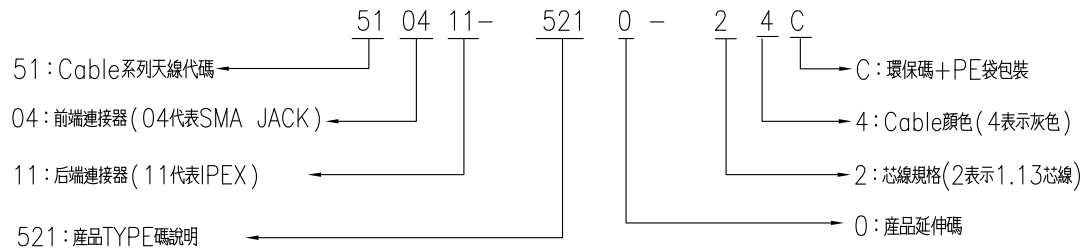

7	H.S. TUBE	MATERIAL:PVC,COLOR:透明的,φ2.5*15mm	1	N/A
6	WASHER	BRASS,GOLD-PLATED	1	N/A
5	NUT	BRASS,GOLD-PLATED	1	N/A
4	RF CONNECTOR	SMA STRAIGHT JACK/Reverse(公PIN)	1	N/A
3	H.S. TUBE	MATERIAL:EVA,COLOR:BLACK,L15mm	1	N/A
2	RF CABLE	φ1.13 CABLE,GRAY	1	N/A
1	RF CONNECTOR	IPEX FOR 1.13 CABLE	1	N/A
ITEM	PART NAME	DESCRIPTION	Q'TY	REMARK

DWG TYPE: CUSTOMER DRAWING		<b>LITE</b> Liteconn Co., Ltd.	
GENERAL TOLERANCE: UNLESS OTHERWISE SPECIFIED		TITLE: RF CABLE φ1.13mm- GRAY-L:300mm IPEX TO SMA JACK	
X.X ±0.35	X.X* ±3'	APPD:	DWG No.: 510411-5210-24C
X.XX ±0.20	X.XX* ±2'	CHECK:	
X.XXX ±0.10	X.XXX* ±1'	DRAW: Eva_long	DATE: 2015.10.22
		SCALE: 1:1	UNIT: mm
			PAGE: 1/1

COPIANCE WITH THE REQUIEMENT:  RoHS;  HF;  SONY SS-00259;  OTHER.  
 \*NO USING RESTRICTED AND BANNED SUBSTANCE

# 蘇州利慶電子有限公司

## 包裝作業規範

<b>LITE</b>	標題	小S天線+ SMA CABLE	料號	501301-0019-1BC+510411-5210-24C		備注: 僅供參考
文件編號	AAA-CAR-00XX	版次	A0	頁次	1/1	
<p>包裝作業示意圖：</p> <p><b>A圖</b></p> <p>20PCS/袋 (SMA CABLE) 20PCS/袋 (小S天線)</p> <p>120700034000J 200PCS/層 放置紙箱第三、四層</p> <p>120300055601J 200PCS/層 放置紙箱第一、二層</p> <p><b>B圖</b></p> <p>4層/箱 (2層120300055601J) (2層120700034000J)</p> <p>用樣品袋單獨包裝螺母及墊圈 每袋各100PCS</p> <p>固定放置在最上層隔板上</p> <p><b>C圖</b></p> <p>800PCS(400SET)/箱</p>						<p>作業說明：</p> <ol style="list-style-type: none"> <li>將檢驗好的成品,每20PCS和1包干燥劑放入一個膠袋裡面(SMA CABLE與小S天線都是20PCS一袋),注意成品要平齊;再將膠袋放入封口機上封口,封口時注意不能熔太久,以免將膠袋損壞(如圖A所示),然後帖上相關標籤(根據客戶要求來帖).</li> <li>將1PCS平板放入紙箱底部,內箱四角落放4PCS護角,再將包裝好的120300055601J成品放入紙箱第一層與第二層,第一層即是從紙箱最底層開始計算,一層放10袋,共計20袋400PCS(如圖C所示);第三層與第四層放120700034000J的成品,也是每一層放10袋,共計20袋400PCS.(如圖C所示);每裝一層放1PCS平板,一個紙箱共放4層,第4層放滿後,再放一平板,依客戶要求將螺母和墊片每袋各100PCS,每種20袋放在上面,螺母和墊片放在第五層,放好後用膠儀袋固定,再將1PCS平板蓋在紙箱頂部,共需6PCS隔板;每箱裝800PCS產品,小S天線與SMA CALBE兩款各400PCS.</li> <li>包裝好一箱後,再用膠帶封好紙箱,按客戶要求貼上相應的標籤(如圖C所示).</li> </ol>

核准:孫文飛

審核:龍陳麗

制定:龍陳麗



CONNECTOR & RF ANTENNA

# 堅詠股份有限公司

Liteconn Co., Ltd.

TEL:+886-2-2995-0485 FAX:+886-2-2995-7395 <http://www.liteconn.com>

## 測試報告

### TEST REPORT

120300055601J only and no Cable loss.

CUSTOMER : 智易

CUSTOMER NO. : \_\_\_\_\_

FILE NO : \_\_\_\_\_

DESCRIPTION : RF ANTENNA 2.4GHz&5GHz

LITE P/N : \_\_\_\_\_

DATE : \_\_\_\_\_

#### 堅詠股份有限公司

ADD : NO. 19, LANE 188, CHUNG—HSIN N. ST.

SANCHUAN, TAIPEI HSIEN, TAIWAN R.O.C

TEL : (886-2) 2995-0485

FAX : (886-2) 2995-7395

[http : //www.liteconn.com](http://www.liteconn.com)



CONNECTOR & RF ANTENNA

# 堅詠股份有限公司

Liteconn Co., Ltd.

TEL:+886-2-2995-0485 FAX:+886-2-2995-7395 <http://www.liteconn.com>

## SPECIFICATIONS :

### Electrical Properties

<u>Frequency Range</u>	: <u>2.4GHz~2.5GHz&amp;5.15GHz~5.85GHz</u>
<u>Impedance</u>	: <u>50Ohms nominal</u>
<u>VSWR</u>	: <u>2.4GHz~2.5GHz&amp;5.15GHz~5.85GHz <math>\leq</math> 2.0</u>
<u>Peak Gain</u>	: <u>2.4GHz~2.5GHz<math>\geq</math>2dBi ,5.15GHz~5.85GHz<math>\geq</math>2dBi</u>
<u>Standard Connector</u>	: <u>SMA Connector</u>





CONNECTOR & RF ANTENNA

# 堅詠股份有限公司

Liteconn Co., Ltd.

TEL:+886-2-2995-0485 FAX:+886-2-2995-7395 <http://www.liteconn.com>

Test time :

Company : 智易

Model :

Project : Dual Band Antenna 套桿天線

Photo :

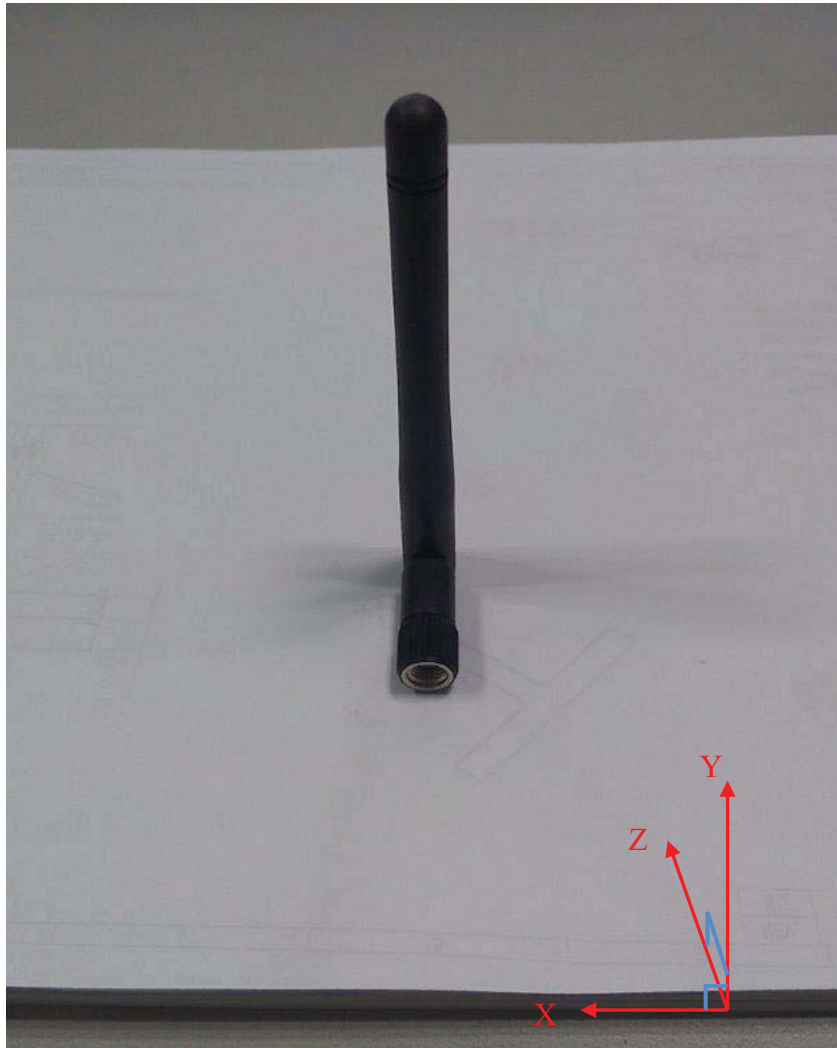



# 堅詠股份有限公司

Liteconn Co., Ltd.

TEL:+886-2-2995-0485 FAX:+886-2-2995-7395 http://www.liteconn.com

CONNECTOR & RF ANTENNA

Test time :

Company : 智易

Model :

Project : Dual Band Antenna 套桿天線

## Return Loss & VSWR & Smith :

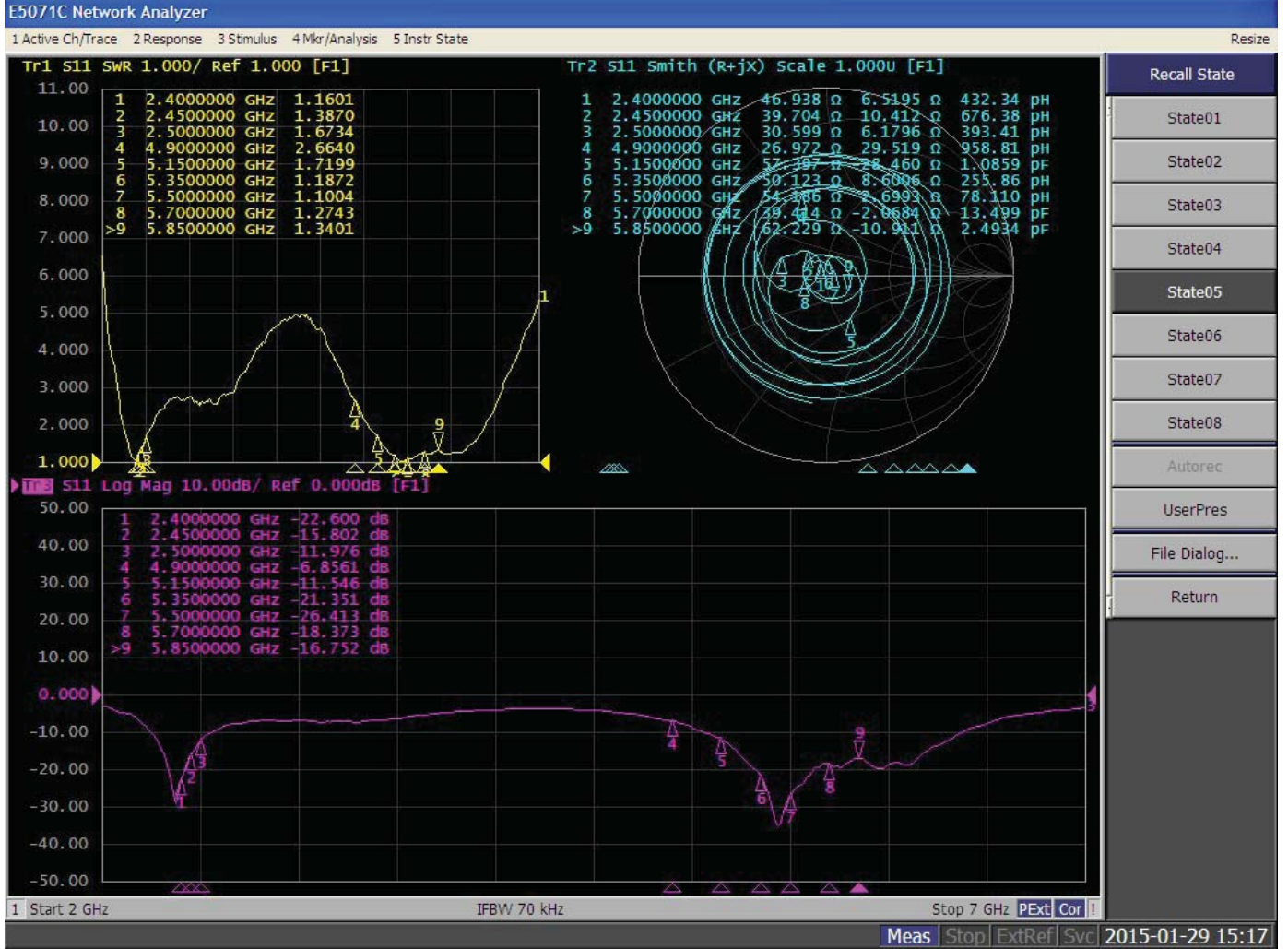



# 堅詠股份有限公司

Liteconn Co., Ltd.

TEL:+886-2-2995-0485 FAX:+886-2-2995-7395 <http://www.liteconn.com>

CONNECTOR & RF ANTENNA

Test time :

Company : 智易

Model :

Project : Dual Band Antenna 套桿天線

## 2D Antenna Gain :

2D Antenna Gain							
	Plane	Peak Gain (dBi)			Average Gain (dBi)		
		H V		H+V	H	V	H+V
2400	ZX Plane	0.99	1.74	1.91	-13.82	-6.84	-3.26
2450	ZX Plane	1.06	1.90	2.05	-15.72	-8.65	-3.61
2500	ZX Plane	0.06	1.00	1.08	-18.10	-9.12	-5.18
4900 ZX	Plane	0.60	-0.68	0.60	-19.36	-11.72	-7.16
5150 ZX	Plane	-0.05	-2.44	0.01	-19.44	-11.09	-8.56
5350 ZX	Plane	-1.40	-1.11	-1.09	-18.78	-9.84	-7.29
5500 ZX	Plane	1.03	0.67	1.03	-18.39	-9.68	-5.82
5700 ZX	Plane	1.24	0.73	1.27	-19.26	-9.34	-5.69
5825 ZX	Plane	-1.00	0.65	0.86	-16.32	-10.70	-6.13

Test time :

Company : 智易

Model :

Project : Dual Band Antenna 套桿天線

### 3D Radiation Pattern

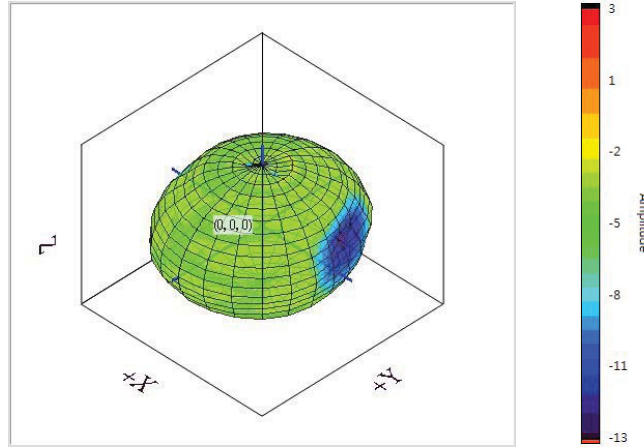

2400 MHz

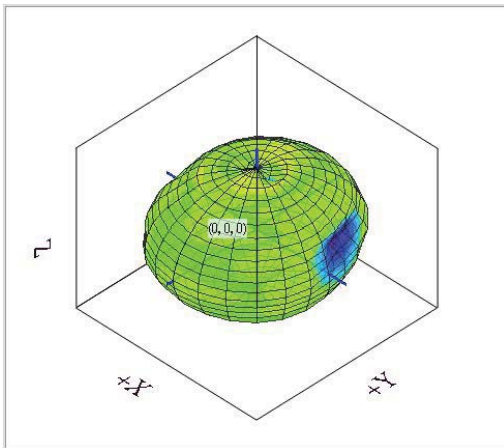

2450 MHz

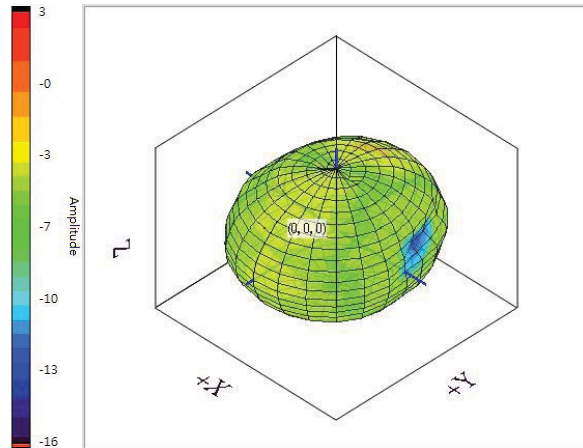

2500 MHz

### 3D Antenna Gain :

Frequency (MHz)	Peak Gain (dBi)	Efficiency (%)	Average Gain (dB)
2400	3.48	82.99	-0.81
2450	3.21	79.37	-1
2500	3.04	77.62	-1.1



Test time :

Company : 智易

Model :

Project : Dual Band Antenna 套桿天線

### 3D Radiation Pattern

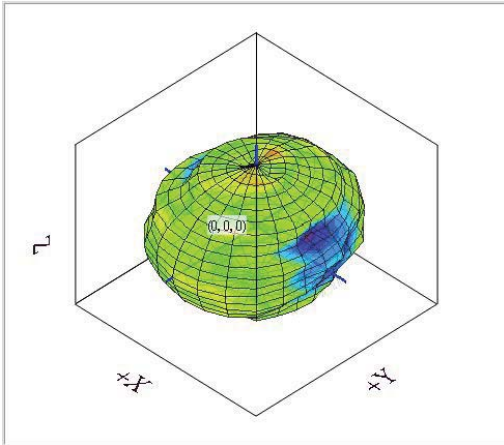

4900 MHz

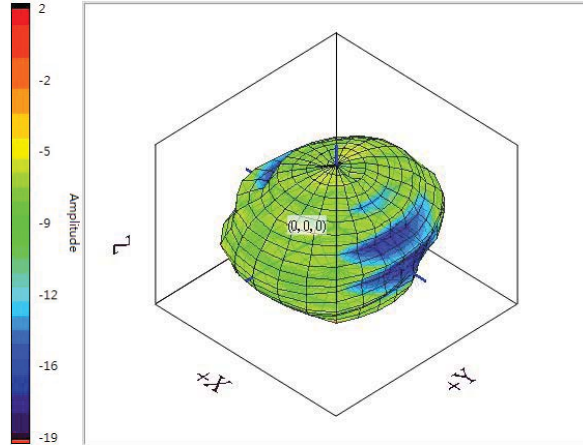

5150 MHz

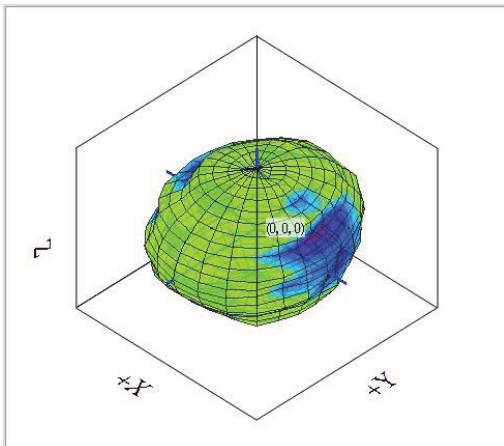

5350 MHz

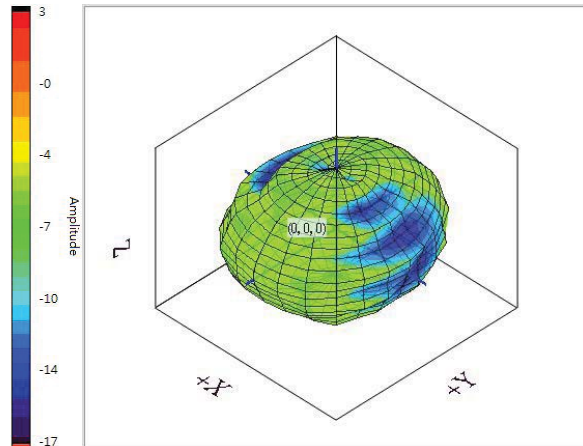

5500 MHz

Test time :

Company : 智易

Model :

Project : Dual Band Antenna 套桿天線

### 3D Antenna Pattern:

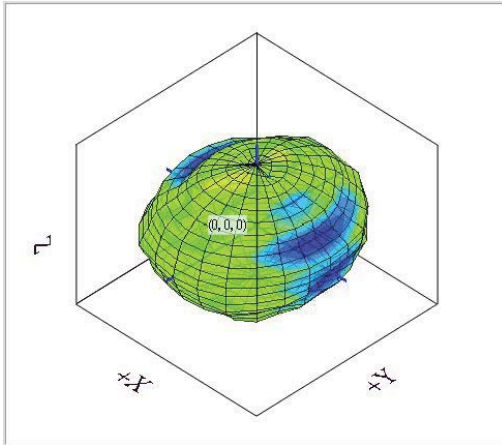

5700 MHz

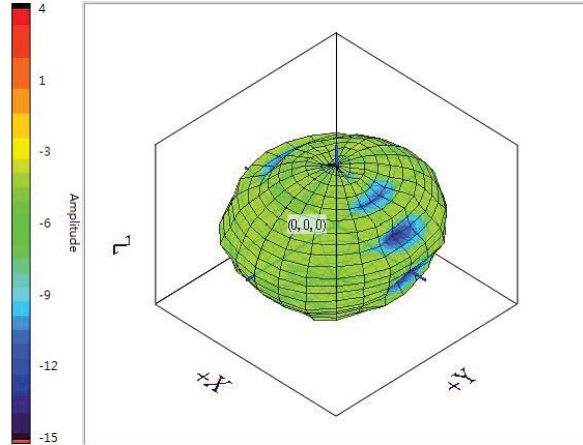

5825 MHz

### 3D Antenna Gain :

Frequency (MHz)	Peak Gain (dBi)	Efficiency (%)	Average Gain (dB)
4900	2.99	67.14	-1.73
5150	3.85	69.98	-1.55
5350	3.78	77.09	-1.13
5500	4.29	78.16	-1.07
5700	3.77	75.16	-1.24
5825	3.26	74.3	-1.29



# 蘇州利慶電子有限公司

SuZhou LiteTek Technology CO.,LTD

## 測試報告

### TEST REPORT

品名規格 Product Name	ANT	料號 (P/N)	501301-0019-1BC	報告編號 Report NO.	16042101
測試日期 Test Date	20146.04.21	樣品數量 Quantity	7PCS	測試環境 Environment	Temp:21°C RH.:45%

#### 一.測試項目條件及要求

測試項目 Item	測試條件 Conditions	测试要求	測試工具 Equipment
扭力测试	测试速度：50次/minute	扭力：0.3~0.7Kgf	扭力测试机 

#### 二.扭力测试数据与图片

单位：Kgf



测试前



测试中



测试後

樣品序号	1	2	3	4	5	6	7				判定
扭力數據	0.5~0.6	0.5~0.6	0.5~0.6	0.5~0.6	0.5~0.6	0.5~0.6	0.5~0.6				PASS

注：因產品在做測試時是旋轉運動的，測試設備也並非數顯而是刻度，所以數據是在一定範圍內波動。

綜合判定	<input checked="" type="checkbox"/> 合格	<input type="checkbox"/> 不合格
------	--	------------------------------

審核：孫文飛 2016.04.21

測試人：龍陳麗 2016.04.21

型号 Type	RG178/50	料号 P/N	SY178/50-019(Brown)
---------	----------	--------	---------------------

结构图 Structure drawing			
-----------------------	--	--	--

### 结构特性 Structure characteristics

结构 Structure	项目 Item	标准值 Standard value
①内导体 Inner conductor	材料 Material	镀银铜线 Silverplated copper wire
	组成:总根数/单根外径(mm) Makeup:total / O.D. of every wire(mm)	7/0.102
	(综合)标称外径(mm) (Intertwist)NOM.O.D.(mm)	0.306±0.02
②绝缘层 Insulation	材料 Material	聚全氟乙丙烯 FEP
	颜色 Color	本色 Natural
	标称外径(mm) NOM.O.D.(mm)	0.86±0.05
③外导体 Outer conductor	材料 Material	镀锡铜线 Tinned copper wire
	组成:总根数/单根外径(mm) Makeup:total / O.D. of every wire(mm)	3/0.1
	标称外径(mm) NOM.O.D.(mm)	1.3±0.05
	覆盖率(%) Coverage ratio(%)	≥90
④护套层 Jacket	材料 Material	聚全氟乙丙烯 FEP
	颜色 Color	棕 Brown
	标称外径(mm) NOM.O.D.(mm)	1.78±0.05

### 电性能特性 Electrical characteristics

项目 Item	标准值 Standard value	项目 Item	频率 Frequency	标准值 Standard value 单位 Unit:dB/m
电容(pF/m) Capacitance(pF/m)	96	衰减 Attenuation	0.1GHz	≤0.52
速率(%) Velocity(%)	70		0.4GHz	≤1.2
阻抗(Ω) Impedance(Ω)	50±2		1GHz	≤1.7
驻波比 Standing wave ratio	≤1.3@0~6GHz		2GHz	≤2.42
最大工作电压(V) Max.operating voltage(V)	1000		3GHz	≤3.08
最大工作频率(GHz) Max.operating frequency(GHz)	3		4GHz	≤3.63
			5GHz	≤4.15
			6GHz	≤4.8

### 可靠性 Dependability

项目 Item	单位 Unit	标准值 Standard value
最小弯曲半径(一次) Min.bending radius static	mm	10
最小弯曲半径(重复) Min.bending radius repeated	mm	—
工作温度范围 Operating temperature	℃	-55~+150

### 包装 Packing

项目 Item	单位 Unit	标准值 Standard value
包装方式 Packing mode	/	纸盘 Papery plate
每盘长度 The length of each plate	m	500
每盘接头数 Each connector plate number	/	≤3
每段最短长度 The shortest length of each root	m	≥10

### 使用提示 Use tips

存储环境 Storage environment	温度: 30℃以下; 湿度: 20%~65%
最佳保存周期 The best save cycle	2个月; 2个月以上作业性下降, 如上锡效果变差, 但电性能不受影响。夏季高温高湿环境开剥后需尽快流转
加工温度 Processing temperature	260℃的极限情况下, 可短时间承受; 300℃以上分子通常带有的等端基会分解; 400℃以上发生显著的热分解
铁氟龙收缩 Teflon Shrink	固有材料特性。绝缘: 0.2mm以下; 护套: 0.3mm以下
护套窜动 Jacket traverse	加工长度(护套残留长度)低于5cm易发生

### 其他 Other

特殊加工工艺, 请与供方协商后使用
-------------------



神宇通信科技股份有限公司

# 材 质 证 明

编订日期：2013-5-28

公司名稱 Company Name	神宇通信科技股份有限公司	产品名称 Product Name	同轴电缆 Coaxial Cable	产品重量 Product Weight	7.876 g/m
神宇料号 SY Product No.	SY178/50-019	客户料号 Customer No.		E-Mail	<a href="mailto:yangdong@shenyucable.com">yangdong@shenyucable.com</a>
填写人部门 Dept.	品保部 QA	姓名 Name	徐君昱	聯絡電話 Telephone	0510-86279705

茲證明向貴公司銷售的產品和半成品中，使用之原材料，包裝材料以及生產工程中，不含有相關禁止使用物質。另，向貴公司報告成品、半成品中使用的原材料、包裝材料以及生產工程中的添加劑成分如下所述：

使用材料(Use material)

項次	零件名稱	原料廠	材質	重量(g)	組成成份	含百分比	化驗報告NO.	限用物質含量(單位：PPM)														
								鉛	鎘	汞	六價鉻	PBB	PBD	PCB	多氯萘	PCT	CP	甲醛	石綿	AZO	有機錫	PV
Item	Material Name	Vendor	Substance	Weight	Substance Composition	Substance Amount	Test Report No.	(Pb)	(Cd)	(Hg)	(Cr+6)		E	s	PC			Asbestos	偶氮類	錫	C	
1	导体	恒丰	镀银铜线	0.519	铜	6.19%	SHAEC1307968212	ND	ND	ND	ND	N/A	N/A	N/A	N/A	N/A	N/A	N/A	N/A	N/A	N/A	N/A
					银	0.40%																
2	绝缘	大金	FEP	1.148	FEP	14.58%	SHAEC1301214305	ND	ND	ND	ND	ND	ND	N/A	N/A	N/A	N/A	N/A	N/A	N/A	N/A	N/A
3	编织	正导	镀锡铜线	3.656	铜	42.71%	RLNBE000117020001	ND	ND	ND	ND	N/A	N/A	N/A	N/A	N/A	N/A	N/A	N/A	N/A	N/A	N/A
					锡	3.71%																
4.1	护套	大金	FEP	2.553	FEP	31.44%	SHAEC1301126805	ND	ND	ND	ND	ND	ND	NA	NA	NA	NA	NA	NA	NA	NA	NA
4.2	色母料(棕)	寇兰	FEP		FEP	0.97%	SHAEC1304390302	ND	ND	ND	ND	ND	ND	NA	NA	NA	NA	NA	NA	NA	NA	NA

使用材料請貼圖示於此欄，並標項次：



化驗報告注意事項：

- (1) 須為通過ISO 17025認證過之公司所提供之化驗報告資料 (如SGS、ITS、ETC、BVQI )
- (2) 有效期限為一年
- (3) 報告內容&文字必須清晰，易辨別 (不可模糊不清)
- (4) 限用物質含量之未測項目請填” N/A” ，  
ND. =Not Detected (報告限定值)



## AVLV2.E318898 Appliance Wiring Material - Component

Page Bottom

### Appliance Wiring Material - Component

See General Information for Appliance Wiring Material - Component

**SHENYU COMMUNICATION TECHNOLOGY INC**

E318898

275 E WAIHUAN RD

JIANGYIN, JIANGSU 214400 CHINA

Table of Recognized Styles							
Single-conductor, thermoplastic insulation.							
<u>1226</u>	<u>1333</u>	<u>1591</u>	<u>1723</u>	<u>1857</u>	<u>1886</u>	<u>10064</u>	<u>10518</u>
<u>1227</u>	<u>1354</u>	<u>1592</u>	<u>1726</u>	<u>1858</u>	<u>1887</u>	<u>10072</u>	<u>11149</u>
<u>1330</u>	<u>1371</u>	<u>1708</u>	<u>1727</u>	<u>1859</u>	<u>1901</u>	<u>10111</u>	
<u>1331</u>	<u>1538</u>	<u>1709</u>	<u>1766</u>	<u>1860</u>	<u>1927</u>	<u>10248</u>	
<u>1332</u>	<u>1577</u>	<u>1710</u>	<u>1847</u>	<u>1882</u>	<u>10011</u>	<u>10362</u>	

Marking: Company name, voltage rating, temperature rating, conductor size, conductor material if other than copper, and use.  
Last Updated on 2010-11-09

[Questions?](#)[Print this page](#)[Notice of Disclaimer](#)[Page Top](#)

Copyright ©2011 Underwriters Laboratories Inc.®

The appearance of a company's name or product in this database does not in itself assure that products so identified have been manufactured under UL's Follow-Up Service. Only those products bearing the UL Mark should be considered to be Listed and covered under UL's Follow-Up Service. Always look for the Mark on the product.

UL permits the reproduction of the material contained in the Online Certification Directory subject to the following conditions: 1. The Guide Information, Designs and/or Listings (files) must be presented in their entirety and in a non-misleading manner, without any manipulation of the data (or drawings). 2. The statement "Reprinted from the Online Certifications Directory with permission from Underwriters Laboratories Inc." must appear adjacent to the extracted material. In addition, the reprinted material must include a copyright notice in the following format: "Copyright © 2011 Underwriters Laboratories Inc.®"

An independent organization working for a safer world with integrity, precision and knowledge.



# 神宇通信科技股份有限公司

## 物 质 安 全 资 料 表 (MSDS)

### 一、物品和厂商资料

中英文物品名称:	同轴电缆 Coaxial Cable
物品编号:	Normal 系列
制造商或供应商名称、地址及电话:	神宇通信科技股份有限公司 江阴市东外环路 275 号/0510-86279705
紧急联络电话/传真电话:	0510-86278808/0510-86279701

### 二、成分辨识资料

纯物质:

中英文名称:	聚全氟乙丙烯 Fluorinated Ethylene Propylene 镀银铜线 Silverplated Copper 镀锡铜线 Tinned Copper
同义名称:	FEP/SC/TX
化学文摘社登记号码 (CAS No.):	FEP: 25067-11-2; Cu: 7440-50-8; Ag: 7440-22-4; Sn: 7440-31-5;
危害物质成分 (成分百分比):	/

危害物质:

危害物质	浓度或浓度范围 (单位: ppm)	
铅及其化合物 Pb	<1000	
镉及其化合物 Cd	<100	
汞及其化合物 Hg	<1000	
六价铬以及化合物 Cr	<1000	
卤素	氯 Cl<900	氯 Cl+溴 Br<1500
	溴 Br<900	
SVHC 15 种物质	禁止使用	

### 三、危害辨识资料

最重要危害效应:	健康危害效应:	在 260℃以上, 可能会有吸入分解气体的危险, 一定要安装排气装置。
	环境影响:	要按照废弃物处理及清扫法律法规处理, 绝对不可燃烧。
	物理性及化学性危害:	物理化学性能稳定, 不易降解, 不得擅自填埋。
	特殊危害:	无。
主要症状:	对人的神经系统产生损害。	
物品危害分类:	大气和水源。	

#### 四、急救措施

不同暴露途径之急救方法:	吸入:	到空气流通处换气。
	皮肤接触:	无。
	眼睛接触:	无。
	食入:	不消化, 排出。
最重要症状及危害效应:	无。	
就急救人员之防护:	对流换气。	
对医师之提示:	吸氧。	

#### 五、灭火措施

适用灭火剂:	通用。
灭火时可能遭遇之特殊危害:	避免分解气体吸入。
特殊灭火程序:	无。
消防人员之特殊防护装备:	防毒面具。

#### 六、泄漏处理方法

个人应注意事项:	粉状树脂。
环境注意事项:	不可填埋。
清理方法:	要按废弃物处理及清扫法律法规处理, 绝对不可燃烧。

#### 七、安全处置与储存方法:

处置:	避免高温和火源接触。
储存:	通风干燥处。

#### 八、暴露预防措施

工程控制:	无。	
控制参数:	八小时日时常平均容许浓度/ 短时间时量平均容许浓度/ 最高容许浓度:	无。
	生物指标:	无。
个人防护措施:	呼吸防护:	安装排气装置。
	手部防护:	无。
	眼睛防护:	无。
	皮肤及身体防护:	无。
卫生措施:	应将衣服上附着的灰尘抖落, 手脸洗净, 不要让其附着在香烟上。	

#### 九、物理及化学性质

物质状态:	固体。	形状:	透明颗粒。
颜色:	透明。	气味:	无。
PH 值:	7。	沸点/沸点范围:	/
分解温度:	360℃。	闪火点:	/

自然温度:	/	爆炸界限:	/
蒸气压:	/	蒸气密度:	/
密度:	2.2 g/cm <sup>3</sup> 。	溶解度:	/

十、安全性及反应性:

安全性:	很稳定。
特殊情况下可能之危害反应:	高温或燃烧分解气体对人体神经系统的损害。
应避免之状况:	绝对不可燃烧。
应避免之物质:	金属钠及其强酸的混合物。
危害分解物:	气体及粉尘。

十一、毒性资料

危毒性:	/
局部效应:	/
致敏效应:	/
慢毒性或长期毒性:	/
特殊效应:	/

十二、生态资料

可能之环境影响/环境流布:	不降解, 禁填埋。
---------------	-----------

十三、废弃处置方法

废弃处置方法:	按废弃物处理及清扫法律法规要求送专业资质公司处置。
---------	---------------------------

十四、运送资料

国际运送规定:	/
联合国编号:	/
国内运送规定:	无。
特殊运送方法及注意事项:	无。

十五、法规资料

适用法规:	遵循欧盟 REACH 法规相关要求。
-------	--------------------

十六、其他资料

参考文献:	杜邦产品说明/SONY 限用物质标准。
制表单位:	名称: 神宇通信科技股份有限公司 地址/电话: 江阴市东外环路 275 号/TEL: 0510-86279705
制表人:	职称: 品保经理 姓名: 葛晓磊
制表日期:	2009/7/22

# SHINITE® ALLOY

A724NA  
AD4011  
ALLOY High Impact / Natural  
ALLOY超韌級 / 本色

		Unit	Test Method	Values
<b>Mechanical properties</b>		<b>機械性質</b>		
Izod Impact(Notched)	衝擊強度	Kg-cm/cm	ASTM D256	80
-20°C	衝擊強度	Kg-cm/cm	ASTM D256	75
-40°C	衝擊強度	Kg-cm/cm	ASTM D256	70
Tensile Strength	拉伸強度	Kg/cm <sup>2</sup>	ASTM D638	530
Nominal Tensile Strain at Break	拉伸率	%	ASTM D638	> 50
Flexural Strength	彎曲強度	Kg/cm <sup>2</sup>	ASTM D790	780
Flexural Modulus	彎曲模數	Kg/cm <sup>2</sup>	ASTM D790	20000
<b>Thermal properties</b>		<b>熱性質</b>		
Heat Deflection Temperature	熱變形溫度		ASTM D648	
66psi		°C		-
264psi		°C		74
Flammability	防火性	-	UL94	HB
Melting Point	熔點	°C	DSC	223
Melt Index	熔融指數	g/10min	ASTM D1238	14
<b>Electrical properties</b>		<b>電氣性質</b>		
Dielectric Strength	介電強度	KV/MM	ASTM D149	38
Dielectric Constant	介電常數	...	ASTM D150	-
Volume Resistivity	體積電阻	Ω-CM	ASTM D257	1E+17
<b>Other properties</b>		<b>其它性質</b>		
Specific Gravity	比重	-	ASTM D792	1.20
Water Absorption	吸水率	%	ASTM D570	0.14
Mold Shrinkage	成形收縮率		ASTM D955	
Flow	流動方向	%		0.4~0.6
Cross Flow	垂直方向	%		0.5~0.7
<b>Injection Molding</b>		<b>成型條件</b>		
INJECTION MACHINE	成型機台	OZ		3
DRYING	乾燥			2 HR ×140 (°C) 4 HR ×120 (°C) 6 HR ×100 (°C)
BARREL TEMPERATURE	成型溫度	°C		
REAR				240-230
MIDDLE				245-235
FRONT				250-240
NOZZLE				255-245
MOLD TEMPERATURE	模溫	°C		60-80
INJECTION PRESSURE	射出壓力	kg/cm <sup>2</sup>		600-1000
INJECTION SPEED	射出速度	-		FAST

以上數據僅供參考，實際數據以產品出廠檢驗報告為準

Data listed above is for reference. The actual quality of certain batch is varied within a specific range, as indicated in each COA.

此塑料規格獲得UL防火認證，並經第三公正檢測單位檢驗通過RoHS和SVHC法規，歡迎至新光網站或來信查詢檢測報告  
This grade is UL V-0 approved, and comply with RoHS & SVHC regulatio

Feel free to inquire the testing report on [www.shinkong.com.tw](http://www.shinkong.com.tw) or mail to [service@shinkong.com.tw](mailto:service@shinkong.com.tw)

新光合成纖維股份有限公司  
中 壢 廠  
臺 灣

8th F1., 123, Sec.2, Nanking East Road , Taipei, Taiwan  
Tel: 886-2-2507-0131 886-2-2507-1251(30Lines) 886-3-4932131  
Fax:886-2-2506-8047 886-3-491-5763

產 品 材 質 證 明

新耐特 (SHINITE) PC/PBT

規格(GRADE) : A724

新耐特 (SHINITE) PC/PBT 為新光合成纖維股份有限公司，所產製的工程塑膠系列之一，經由混練程序製得。具有優越的機械性、高剛性、尺寸安定性、耐熱老化性和化學性質。

此外新耐特 (SHINITE) PC/PBT A724

製品 組成如下：

組成 CHEMICAL NAME	GRADE 規 格	A724
polycarbonate ( PC ) 樹脂 CAS NO: 25971-63-5		40%~80%
Polybutylene Terephthalate ( PBT ) 樹脂 CAS NO: 30965-26-5		20%~60%
Additives 添加劑 CAS NO: N.A.		1%~10%

**GREEN PRODUCT (無毒材料) 符合 RoHS**

如有任何的問題及意見，歡迎撥空指教，謝謝。

送出日期:2007/01/26

# EC SAFETY DATA SHEET

1. COMPANY Shinkong Synthetic Fibers Corporation,  
Engineering Plastic Division,  
8F, 123, Sec. 2, Nanking East Road,  
Taipei, Taiwan

PHONE 02-2507-1251, 03-493-2131

FAX 02-2507-7594, 03-491-5763

1. COMMERCIAL PRODUCT NAME : SHINITE A724

Chemical Characterization : Blends of polycarbonate (CAS#25971-63-5) and Polybutylene Terephthalate ( PBT )

CAS# 30965-26-5

Physical State : Solid

Odor and Form : Pellet with slight odor

2. Hazardous Decomposition Products :

Processing fumes evolved at recommended processing conditions contain trace levels of carbon monoxide, carbon dioxide, aromatic and aliphatic hydrocarbons and may also contain trace levels of THF ( tetrahydrofuran ).

4. First Aide :

If molten polymer contacts the skin or eyes , cool rapidly with cold water . DO NOT use solvent for removal.

DO NOT attempt to remove the polymer from the skin!

Obtain IMMEDIATE medical attention.

5. Measures in Case of Accidents and Fires

After Spillage/Leakage/Gas Leakage :

Sweep up and dispose in proper containers to prevent slipping hazards.

Fire Extinguishing Media :

Suitable - water spray and foam. Water is the best.

Not recommended - carbon dioxide and dry chemicals.

Fire Fighting : Approved pressure demand breathing apparatus and protective clothing should be used for all fires.

6. Industrial Hygiene :

A continuous supply of fresh air to the workplace together with removal of processing fumes through exhaust systems is recommended.

7. Storage and Handling

Storage :

Store in a cool and dry place. Keep containers tightly closed to prevent moisture absorption and contamination.

Handling :

Follow recommendations in processing guide. Prevent contact with skin and eyes.

Provide adequate ventilation.

8. Protective Measures

Respiratory protection - dust mask

Eye protection - safety glasses



Hand protection - thermal protective gloves should be worn around molten plastic

#### 9. Physical Data and Safety Data

Melting Point ( °C ) : -(because of PC/PBT alloy is Alloy type)

Density @ 25°C : 1.10~1.30 g/cm<sup>3</sup> ASTM D 1505

Vapor Pressure : Not applicable

Viscosity : Not applicable

Solubility in Water : Insoluble

PH value : Not applicable

Flash Point : Not applicable

Ignition Temperature ( °C ) : 450°C, estimated

Explosion : Not sensitive to impact and static discharge.

Thermal Decomposition : None under 400°C

Stability : Stable under recommended conditions of storage and handling.

Reactivity : Not reactive under recommended conditions of storage, handling, processing and use.

Conditions to Avoid : Do not exceed temperature recommended. Purgings should be collected in small shapes to allow for rapid cooling.

#### 10. Protection Against Fire and Explosion :

Large, molten masses of plastic may ignite spontaneously in air.

Water quenching of plastic fires is recommended.

#### 11. Information on Toxicity TOXIC : N/A

Product not considered primary eye and skin irritant.

#### 12. Information on Ecological Effects

We recommend this material be disposed of by properly scrubbed incineration or recycling. Not expected to present any significant ecological problems.

#### 13. Disposal :

Product is not a RCRA hazardous waste. Recycling is encouraged. Dispose of using good manufacturing practices under local regulations for your area.

#### 14. Transport

GGVSEE/IMDG Code : UN No. : None

ICAO/IATA-DGR : Not Regulated GGVE/GGVS :

RID/ADR : ADNR :

DOT Hazard Class : Not Regulated

Proper Shipping Name : Not Regulated

Identification Number : Not Listed

TDGA : Not Listed

#### 15. Regulations

TSCA Status : This product complies with Chemical Substance Inventory requirements of the US EPA Toxic Substances Control Act ( TSCA ).

WHMIS Classification : Not a controlled product.

Commercial Product Name : Shinite A724

#### 16. Further Information

SHINITE is a registered trademark of the SHINKONG SYNTHETIC FIBERS CO..

QMFZ2 Component - Plastics	Wednesday, September 14, 2005	E107536
----------------------------	-------------------------------	---------

**SHINKONG SYNTHETIC FIBERS CORP**  
 223 YEN PING RD SEC 3 PIN CHENG TAOYUAN HSIEN 324 TW

Material Designation: [A724](#)

Product Description: Polybutylene Terephthalate/Polycarbonate (PBT/PC), furnished as pellets.

Color	Min. Thick. (mm)	Flame Class	HWI	HAI	RTI Elec	RTI Imp	RTI Str	IEC GWIT	IEC GWFI
NC	0.8	HB	4	1	75	75	75	-	-
	1.6	HB	4	1	75	75	75	-	-
	3.2	HB	2	1	75	75	75	-	-

CTI: -	IEC CTI (V): -	HVTR: 2	D495: -	IEC Ball Pressure (°C): -
--------	----------------	---------	---------	---------------------------

Dielectric Strength (kV/mm): 38	Volume Resistivity (10 <sup>7</sup> ohm-cm): 17	Dimensional Stability(%): -
ISO Tensile Strength (MPa): -	ISO Flexural Strength (MPa): -	ISO Heat Deflection (°C): -
ISO Tensile Impact (kJ/m <sup>2</sup> ): -	ISO Izod Impact (kJ/m <sup>2</sup> ): -	ISO Charpy Impact (kJ/m <sup>2</sup> ): -

Report Date: 4/6/1992	Underwriters Laboratories Inc®
-----------------------	--------------------------------

UL94 small-scale test data does not pertain to building materials, furnishings and related contents. UL 94 small-scale test data is intended solely for determining the flammability of plastic materials used in components and parts of end-product devices and appliances, where the acceptability of the combination is determined by ULI.

POM (共聚甲醛)

**夺钢™**

**DURACON®**

M90-44

(标准品级)

宝理塑料

***Polyplastics***

# 目录

---

## 1. M90-44的一般性质

## 客户注意事项

- 本资料所记载的物性值是按各种规格及实验方法规定的条件下制得的实验片的代表性测试值。
- 有关适当的操作规程，请根据使用目的参考相应材料的[技术资料]。
- 本资料是根据本公司积累的经验及实验数据作成的，本文所示数据对在不同的条件下使用的制品不一定能完全适用。  
因此其内容并非能保证完全适用于客户的使用条件，引用或借用时请客户作最终判断。
- 有关本公司材料的安全使用，请参考与所用材料、品级相对应的制品安全数据表 [MSDS]。
- 有关本资料所介绍的应用例、使用例等技术及数据、使用寿命、可能性等请客户自作考虑。  
此外，本公司材料并没有考虑到在医疗和齿科方面的应用（用作移植组织片），故不推荐用在此方面。
- 本资料是根据现阶段搜集到的资料、信息、数据而作成的，如有新的见解时，有可能不加预告而作更改，敬请注意。
- 对本公司制品的说明材料，或者是这里所说的注意事项等，如有任何不明白的地方，敬请与本公司联系商谈。

---

\*[DURACON®]（夺钢）是宝理塑料株式会社在日本及其他国家的注册商标。

# 1. M90-44的一般物性

表1-1 一般物性(ISO)

项 目	单 位	试验方法	标准
			M90-44
			标准
密度	g/cm <sup>3</sup>	ISO 1183	1.41
拉伸强度	MPa	ISO 527-1,2	62
断裂应变	%	ISO 527-1,2	35 <sup>*1</sup>
拉伸弹性模量	MPa	ISO 527-1,2	2700
弯曲强度	MPa	ISO 178	87
弯曲模量	MPa	ISO 178	2500
简支梁冲击强度(有缺口)	kJ/m <sup>2</sup>	ISO 179/1eA	6
负荷变形温度(1.8MPa)	°C	ISO 75-1,2	95
线性热膨胀系数((23×55° C)流动方向)	x10 <sup>-5</sup> /°C	ISO 11359-2	12
线性热膨胀系数((23×55° C)垂直方向)	x10 <sup>-5</sup> /°C	ISO 11359-2	12
绝缘破坏强度(3mmt)	kV/mm	IEC 60243-1	19
体积电阻率	Ω · cm	IEC 60093	1×10 <sup>14</sup>
表面电阻率	Ω	IEC 60093	1×10 <sup>16</sup>
阻燃性		UL94	HB

以上数值为材料的代表性测试值、并非该规格材料的最低值。

\*1)断裂公称应变

\*2)有关UL (Underwriters Laboratories Inc.) 的认定值、请参照UL发行的黄卡 (File No.E45034)。

\*3)本品级受以日本国外汇管理及外国贸易法为依据的出口贸易管理条例表中的第1条第16项的制约。

表1-2 一般物性(ASTM)

项 目	单 位	试验方法	标准
			M90-44
			标准
比重		ASTM D792	1.41
拉伸强度	MPa	ASTM D638	60
拉伸率	%	ASTM D638	60
弯曲强度	MPa	ASTM D790	90
弯曲模量	MPa	ASTM D790	2580
悬臂梁冲击强度(有缺口)	J/m	ASTM D256	63
悬臂梁冲击强度(无缺口)	J/m	ASTM D256	760
负荷变形温度(1.82MPa)	°C	ASTM D648	110
线性热膨胀系数(常温、流动方向)	$\times 10^{-5}/^{\circ}\text{C}$	ASTM D696	10
线性热膨胀系数(常温、垂直方向)	$\times 10^{-5}/^{\circ}\text{C}$	ASTM D696	10
绝缘破坏强度(短时间法:2mmt)	MV/m	ASTM D149	24
体积电阻率(3mmt)	$\Omega \cdot \text{cm}$	ASTM D257	$1 \times 10^{14}$
表面电阻率(3mmt)	$\Omega$	ASTM D257	$1 \times 10^{16}$
阻燃性		UL94	HB

以上数值为材料的代表性测试值、并非该规格材料的最低值。

\*1)有关UL (Underwriters Laboratories Inc.) 的认定值、请参照UL发行的黄卡 (File No.E45034) 。

\*2)本品级受以日本国外汇管理及外国贸易法为依据的出口贸易管理条例表中的第1条第16项的制约。

# **Polyplastics**

## **宝理塑料株式会社**

日本东京都港区港南2丁目18番1号  
JR品川East Building (邮编:108-8280)  
Phone:81-3-6711-8600 Fax:81-3-6711-8606

### *Affiliates*

**Polyplastics Asia Pacific Sdn. Bnd. (Kuala Lumpur)**

**Polyplastics Asia Pacific Singapore Pte. Ltd. (Singapore)**

**Polyplastics Marketing (T) Ltd. (Bangkok)**

宝理塑料(中国)有限公司(香港)

宝理工程塑料贸易(上海)有限公司(上海)

宝理塑料贸易(上海)有限公司(上海)

台湾宝理塑料有限公司(台北)

宝泰菱工程塑料(南通)有限公司(南通)

# MATERIAL SAFETY DATA SHEET (MSDS)

Issued: Dec 27 , 2001

Revised: May 7 , 2002

File No. 1001

## 1. CHEMICAL PRODUCT & COMPANY IDENTIFICATION

CHEMICAL PRODUCT NAME : DURACON M90-44  
NAME OF COMPANY : Polyplastics Co.,Ltd.  
SECTION IN CHARGE : Quality Assurance Dept.  
ADDRESS : 3-2-5 Kasumigaseki, Chiyoda-ku, Tokyo  
TELEPHONE NUMBER : 03-3593-2280  
FACSIMILE NUMBER : 03-3593-2189

## 2. COMPOSITION/INFORMATION ON INGREDIENTS

SUBSTANCE/PREPARATION : Substance  
RATION  
COMMON CHEMICAL NAME : Polyoxymethylene  
SYNONYMS : Polyacetal(POM)  
INGREDIENTS AND COMPOSITION : POM  $\geq$  98%, Stabilizers etc.  $\leq$  2%  
CHEMICAL FORMULA :  $\left[ \text{CH}_2 - \text{O} \right]_p / \left[ \text{CH}_2 \text{CH}_2 \text{O} \right]_q$   
SERIAL No IN OFFICIAL GAZETTE : 7-129(base resin)  
(Law Concerning Examination and Regulation of Manufacture, etc., of Chemical Substances)  
CAS No : 24969-26-4 (base resin)  
INGREDIENTS CONTRIBUTING TO THE HAZARD : Formaldehyde

## 3. HAZARDS IDENTIFICATION

MOST IMPORTANT HAZARDS : Incomplete combustion leads to generation of toxic gases such as carbon monoxide, in addition to carbonic acid gas and water.  
Decomposition of polymer also leads to generation of formaldehyde.  
HUMAN HEALTH EFFECTS : Not applicable  
ENVIRONMENTAL EFFECTS : Not applicable  
PHYSICAL AND CHEMICAL HAZARDS : It is inflammable substance and combustible if an igniting source is existent. Neither dangerous reaction, fire nor explosion can be caused under normal conditions.  
THE CLASSIFICATION : Not applicable

## 4. FIRST-AID MEASURES

INGESTION : Help to vomit as much as possible. If sick feeling continues, ask a physician for advice.  
INHALATION : When a gas generated from the molten polymer has been inhaled, remove fresh air without delay and wait until the victim is recovered. If sick feeling continues, ask a physician for advice.



- SKIN CONTACT : Cool the contacted skin with clean water without delay,if a contact with the polymer In a molten form. Do not force to remove the solid resin on the skin. If any burns are observed on the skin,ask a physician for advice.
- EYE CONTACT : Cool and rinse the eye with clean water for at least 15 minutes when the eyes had contact with molten polymer. In case of wearing contact lenses,remove the lenses as soon as possible,and ask a physician for advice. When the eye had contact with the polymer in an ordinary solid form,rinse the eye with clean water without delay. If the discomfort persists,ask a physician for advice.
- 

#### 5. FIRE-FIGHTING MEASURES

- EXTINGUISHING MEDIA : Water,form fire-extinguishing agent,powder fire-extinguishing agent,and carbon dioxide gas.
- SPECIFIC METHODS : Extinguish the fire with water. A method of extinguishing an ordinary fire may be applied. Do not apply water directly to processing machines.
- SPECIFIC HAZARDS : Incomplete combustion leads to generation of toxic gases such as carbon monoxide or formaldehyde,in addition to carbonic acid gas and water.
- SPECIAL EQUIPMENT FOR THE PROTECTION OF FIREFIGHTERS : In case the fire gained force,use a gas mask or other protective equipment.
- 

#### 6. ACCIDENTAL LEAKAGE MEASURES

- PERSONAL PRECAUTIONS : When pellets were spilled on the road or floor,wipe them off with a besom or cleaner not to cause slipping.
- ENVIRONMENTAL PRECAUTION : Handle the spillage in accordance with provisions given in the "Resin pellet spillage preventive manual",in order to prevent intakes by marine animals and birds.
- 

#### 7. HANDLING AND STORAGE

- HANDLING : Polyacetal resin in a pellet form will neither ignite nor explode at room temperatures, but it falls under the inflammables designated by the Fire Service Law. Keep it away from the igniting sources, as it quickly gains force once it is ignited.
- HANDLING 2 : Polyacetal resin in a powdered form is likely to cause dust explosion and is therefore designated in the Guideline for Hazard of Dust Explosion in U.S.Bureau of Mines. Effective earthing means or use of inert gas like N<sub>2</sub> are required for dust handling equipment to eliminate static electricity.
- HANDLING 3 : Polyacetal pellets spilled on the floor are likely to cause slipping. Remove such spillage at any times.
- HANDLING 4 : For molding work,effective means for local exhaust are required to discharge gases generated by melt processing.
- HANDLING 5 : Avoid inhaling of gases generated in moulding work. Do not directly touch resin of high temperature.
- HANDLING 6 : Avoid retaining hot resin in the processing machines for many hours.
- HANDLING 7 : Avoid mixed extrusion with strong acid,oxidizing agents and PVC.
- STORAGE : Keep the substance away from any fire or heat sources for the sake of safe storage.
- STORAGE 2 : This polymer is a synthetic resin designated as an inflammable substance by the Fire Service Law and should be handled in accordance with municipal rules and regulations (concerning fire-fighting equipment, indoor storage, for instance).

RECOMMENDED : No information.  
PACKAGING  
MATERIALS

---

#### 8. EXPOSURE CONTROL / PERSONAL PROTECTION

CONTROL : None at present  
CONCENTRATION

PERMISSIBLE : OSHA PEL/1985  
CONCENTRATION Max. permissible concentration of inactive powder 15mg/m<sup>3</sup>  
- ditto - (Aspiration ) 5mg/m<sup>3</sup>  
ACGIH TLV/1992 1993  
Exposure limit of the powder TWA 10 mg/m<sup>3</sup>  
(Reference) Human exposure to formaldehyde  
- Ministry of Health & Welfare/2002  
Guideline value 0.08 ppm  
OSHA Parameter/1992  
TWA 0.75 ppm  
STEL 2 ppm  
ACGIH TLV/1992 1993  
TWA 0.3 ppm

ENGINEERING : When handling dust: Use totally enclosed containers resisting dust  
MEASURE explosion.  
When heat melted in molding: Effective local ventilation must be provided.

PERSONAL :  
PROTECTIVE  
EQUIPMENT

RESPIRATORY : Wear a dust-proof mask.  
PROTECTION

EYE PROTECTION : Wear protective glasses or goggles.

HAND PROTECTION : Wear heat-resisting gloves against burns, when handling molten  
polymer.

SKIN & BODY : Wear long sleeve clothes against burns, when handling molten polymer.  
PROTECTION

---

#### 9. PHYSICAL AND CHEMICAL PROPERTIES

APPEARANCE etc. : Pellet

BOILING POINT : Not applicable

VAPOUR : Not applicable  
PRESSURE

VOLATILITY : Not applicable

SUBLIMATION : None

MELTING POINT : 165°C

DENSITY : 1.41

SOLUBILITY : Insoluble in water

FLASH POINT : 320°C or higher

IGNITION POINT : 400°C or higher

EXPLOSION : Not applicable  
PROPERTY

INFLAMMABILITY : Inflammable(Designated as inflammable resin by the Fire Service Law)

REACTIVITY WITH : None  
WATER

OXIDIZABILITY : None  
SELF-REACTIVITY : None  
DUST : Upper explosion limit : Not applicable.  
EXPLOSIVENESS : Lower explosion limit : 35g/m<sup>3</sup>

---

#### 10. STABILITY AND REACTIVITY

STABILITY AND REACTIVITY : Stable for normal storage or handling.  
CONDITIONS TO AVOID : Avoid contacts with strong acid, oxidizing agent or PVC under hot melt conditions.  
HAZARDOUS DECOMPOSITION PRODUCTS : Formaldehyde will be generated when heated (for drying or melting) or burnt.

---

#### 11. TOXICOLOGICAL INFORMATION

SKIN CORROSIVE PROPERTIES : No finding.  
SENSITIZING & IRRITANT EFFECTS : Gas generated in drying or melting is irritating eyes and skins.  
ACUTE TOXICITY (INCLUDING LD50) : No finding.  
SUBACUTE TOXICITY : No finding.  
CHRONIC TOXICITY : No finding.  
CARCINOGENECITY : No finding.  
MUTAGENECITY (Microorganisms, chromosomal aberration) : No finding.  
REPRODUCTIVE TOXICITY : No finding.  
TERATOGENICITY : No finding.  
OTHERS (Including generation of hazardous gases by reaction with water, for example) : No finding in this report means that there will be no hazard in general, but no proving data available at the time of reporting.  
OTHER CAUTIONS : With regard to dust, the maximum permissible concentration and limits are fixed by OSHA and ACGIH.  
OTHER CAUTIONS : Formaldehyde will be generated when heated (for drying or melting) or burnt.

---

#### 12. ECOLOGICAL INFORMATION

BIODEGRADABILITY : No finding.  
BIOACCUMULATION : No finding.  
FISH TOXICITY : No finding.

---

#### 13. DISPOSAL CONSIDERATION

WASTE FROM RESIDUES : This is designated as waste plastics among industrial wastes by the Wastes Disposal Law. Disposal waste Duracon through licensed waste handlers or local autonomous bodies if they are handling waste disposal.

WASTE FROM RESIDUES 2 : When disposed by incineration, use the well controlled incinerators in accordance with the Wastes Disposal Law, Air Pollution Control Law and Water Pollution Prevention Law.

---

#### 14. TRANSPORT CONSIDERATION

UN CLASSIFICATION NUMBER : Not applicable

OTHER CAUTIONS : Handle with care so as not to give damages to containers or not to be subjected to wetting.

OTHER CAUTIONS 2 : Secure the containers firmly so as not to cause collapsing.

---

#### 15. REGULATORY INFORMATION

FIRE SERVICE LAW : Inflammable synthetic resin  
Designated quantity: More than 20m<sup>3</sup> for the foamed product.  
More than 3,000 kg for other types.

WASTE DISPOSAL LAW : Waste plastics among industrial wastes.

OTHERS : Formaldehyde is designated as Class 3 substance by the Industrial Safety and Health Law (Regulations concerning hazards caused by specific chemicals) and designated as deleterious substance by the Poisons and Deleterious Substance Control Law. Recommended usage, criteria, and limit values are provided by Japan Industrial Safety and Health Society, OSHA and ACGIH.

---

#### 16. OTHER INFORMATION

HANDLING OF THE DETAILS GIVEN ABOVE : This MSDS is the English version translated from the Japanese MSDS which is prepared for domestic use.  
Details given above are based on references, information and data available at this moment, but no warranty can be made on exactness of these details. They are also prepared on the assumption that the product will be handled in a normal way. For special handling, adequate safety and environmental measures should be taken in respect to its applications. Our products are not specifically intended for implants for medical and dental applications, and therefore they are not recommended for such applications.  
"No finding" in this report means that there will be no hazard in general, but no proving data is available at the time of reporting.

WHERE TO CALL FOR FURTHER INFORMATION : Polyplastics Co., Ltd. Quality Assurance Dept.  
Tel. No 03-3593-2280

## Panlite L-1250Z 100

Category	Unit	Test Method	Condition	L-1250Z 100
Melt volume flow rate	cm <sup>3</sup> /10min	ISO 1133	300deg.C load 1.2kg	8
Density	kg/m <sup>3</sup>	ISO 1183	-	1200
Water absorption rate	%	ISO 62	in water 23deg.C 24h	0.2
Light transmission	%	ASTM D 1003	thickness 3mm	88
Refractive index	-	ASTM D 542	-	1.585
Tensile modulus	MPa	ISO 527-1 and ISO 527-2	1mm/min	2400
Tensile stress at yield	MPa		50mm/min	61
Tensile strain at yield	%		50mm/min	6
Nominal tensile strain at break	%		50mm/min	>50
Flexural modulus	MPa	ISO 178	2mm/min	2350
Flexural strength	MPa		2mm/min	93
Charpy impact strength	kJ/m <sup>2</sup>	ISO 179	unnotched	NB
			notched	76
Heat deflection temperature	deg.C	ISO 75-1 and ISO 75-2	1.80MPa	129
			0.45MPa	142
Vicat softening temperature	deg.C	ISO 306	50deg.C/h 50N	149
Mold shrinkage	%	In-house method	parallel	0.5-0.7
			vertical	0.5-0.7
Coefficient of linear expansion	×10 <sup>-4</sup> /k	ISO 11359-2	parallel	0.7
			vertical	0.7
Specific inductive capacity	-	IEC 60250	100Hz	3.1
	-		1MHz	3
Dielectric loss tangent	×10 <sup>-4</sup>	IEC 60250	100Hz	10
	×10 <sup>-4</sup>		1MHz	90
Volume resistivity	ohm-m	IEC 60093	-	>1×10 <sup>13</sup>
Surface resistivity	ohm	IEC 60093	-	>1×10 <sup>15</sup>
Withstand voltage	MV/m	IEC 60243-1	short time test	30
Tracking resistance	-	IEC 60112	-	250
Flammability	-	UL 94	-	V-2(0.40mm) HB(1.5mm)
Temperature index	deg.C	UL 746B	electric 1.47mmt	125
			impact 1.47mmt	115
			non-impact 1.47mmt	125

\* The values listed are specification values, not certified values.

## 製品安全データシート

整理番号  
作成・改訂日  
製品の名称・製品コード

011101-2J  
2002-4-19

® L-\*\*\*\*

備考

\*: 数字、#: 1又は2文字の記号がつくものも含む

## 1. 製品及び会社情報

会社名	帝人化成株式会社
住所	〒100-0011 東京都千代田区内幸町1-2-2 日比谷
担当部門	環境・品質管理部
電話番号	03-3506-4717
FAX番号	03-3580-6680
緊急連絡先	帝人化成(株)三原工場 品質保証課
緊急連絡先 TEL	0848-63-9966
緊急連絡先 FAX	0848-63-5634

## 2. 組成、成分情報

単一化学物質・混合物の区別	単一製品
化学物質名又は一般名	99wt%以上
別名・CAS No.	25971-63-5(主成分)
(単一化学物質の場合)危険有害	該当しない
(混合物の場合)化学特性	-
(混合物の場合)危険有害成分	-
化学式又は構造式	(C16H14O3)n
官報公示整理番号	化審法;(7)-738 安衛法; 該当しない
化学物質管理促進法	該当しない

## 3. 危険有害性の要約

分類の名称	分類基準に該当しない。
最重要危険有害性	該当しない
特定の危険有害性	該当しない

## 4. 応急措置

吸入した場合	溶融物から発生するガスを吸い、気分が悪くなった場合は直ちに新鮮な空気のある場所に移し、回復を待つ。回復しないときは医師の手当を受ける。粉塵等を吸い込んだ場合は、良くうがいをし、新鮮な空気を吸う等の処置をする。
皮膚に付着した場合	溶融物の場合は、ただちに清浄な水で冷やす。皮膚上の固まった樹脂を無理に剥がさない。火傷があれば医師の手当を受ける。通常の場合は、水、石鹼を使用して付着した部分を良く洗い流しておく。
目に入った場合	溶融物の場合は、ただちに清浄な水で15分間以上冷やすと同時に洗浄し（コンタクトレンズをしていれば外し）、医師の手当を受ける。通常の固体の場合は、まず数分間多量の水で洗い流し（コンタクトレンズをしていれば外し）、不快感が残るようであれば医師の
飲み込んだ場合	出来るだけ吐き出し、不快感が残るようであれば医師の手当を受け

## 5. 火災時の措置

消火剤	水、各種消火剤（粉末、泡）を使用することが出来るが、特に水の使用が冷却効果の観点から望ましい。
消火方法	一般の火災と同じ消火方法を用いることができる。燃焼時には炭酸ガスの他に一酸化炭素等の有害なガスが発生するため注意を要する

## 6. 漏出時の措置

人体に対する注意事項	道路や床にこぼした場合、転倒の恐れがあるので漏出物は全量回収する。 <sup>1, 2)</sup>
環境に対する注意事項	排水系に流出した場合は、海洋生物、鳥類が摂取することを防止するため全量回収する。

## 7. 取扱い及び保管上の注意

取扱い	ペレット状の樹脂は、常温で引火の恐れはないが、作業では火気をみだりに使用しない。機械加工時に粉末が発生する場合は、粉塵爆発の可能性があるのでアースを設け静電気を除去する。加熱加工時は、熔融によって発生するガスを吸収しないように有効な局所排気装置等を設置する。熱分解を起こすので、長時間高温状態で滞留させない。火傷の恐れがあるので、熔融した高温の樹脂には触れないようにする。床上にこぼれたペレット等は、放置すると足下が滑って転倒を招く恐れがあるので、速やかに清掃して取り除く。
保管	直射日光に当たらない熱、発火源から離れた乾燥した場所に保管する。静電気災害を防止する対策をとる。

## 8. 暴露防止及び保護措置

設備対策	粉塵が発生する場合や高温加工時に有害なガスが発生する場合には、快適な作業環境を得るために有効な局所排気装置を設ける。
許容濃度	日本産業衛生学会、ACGIHともに設定されていない。しかし、ポリカーボネートの粉塵に対しては、次の値を採用するのが妥当と考える（参考値）。日本産業衛生学会勧告値（92年版）第3種粉塵 時間加重平均値 吸入性粉塵 2 mg/m <sup>3</sup> 総粉塵 8 mg/m <sup>3</sup> ACGIH勧告値（92～93年版）総粉塵 10 mg/m <sup>3</sup> （データの御使用にあたっては、最新版をご確認下さい。）

## 9. 物理的および化学的性質

外観等	ペレット
PH	該当しない
物理的状態が変化する特定の温度 / 温度範囲	沸点： 該当しない 融点： はっきりとした融点を示さないが、240℃以上で流動する。
引火点	522℃以上 <sup>3)</sup>
発火点	550℃以上 <sup>3)</sup>
爆発特性	粉塵の爆発下限界濃度 25 g/m <sup>3</sup> <sup>4)</sup>
蒸気圧	無視しうる。

蒸気密度	該当しない
密度	1.2
溶媒に対する溶解度	不溶/水
その他のデータ	知見無し

### 1 0 . 安定性及び反応性

可燃性	消防法上酸素指数 2 6 以上の難燃性を有するものにランクされてい
発火性	無し
酸化性	無し
自己反応性	無し
粉じん爆発性	最小着火エネルギー 2 5 mJ (ミリジュール) <sup>4)</sup> 最大爆発圧力 6 . 7 kg/cm <sup>2</sup> (0 . 6 MPa) (ゲージ圧力)
安定性・危険な反応性	常温・常圧で単独では安定で反応性はない。
危険有害な分解生成物	無し
UL性 (L-****Z)	無し

### 1 1 . 有害性情報

注釈	(記載グレードについてのデータではないが、主成分である一般的なポリカーボネートのデータを参考までに記載する。)
局所効果	皮膚腐食性: 知見無し 刺激性: 乾燥、溶融時に発生するガスは、眼、皮膚を刺激することがある。また、粉末が眼、皮膚を刺激することがある。
急性毒性	知見無し
亜急性毒性	3 0 ~ 4 0 匹の雄雌のラットに、微粉化したポリカーボネートを 6 % 含む粥状の飼料を自由に摂取させ、8 週間飼育した。体重の低下はなかった。血液像、X 線検査、病理解剖、臓器の組織検査の結果は正常であった。 <sup>6)</sup>
慢性毒性・長期毒性	知見無し
発がん性	知見無し
変異原性	無し <sup>7)</sup>
催奇形性	知見無し
生殖毒性	3 0 ~ 4 0 匹の雄雌のラットに、微粉化したポリカーボネートを 6 % 含む粥状の飼料を自由に摂取させ、8 週間飼育した。生殖機能は正常であった。 <sup>6)</sup>

### 1 2 . 環境影響情報

環境中での製品の予測される挙動 / 起こり得る環境影響 / 生態毒性	海洋生物、鳥類が摂取することを防止するため、いかなる海洋や水域でも投棄、放出してはならない。
------------------------------------	--

### 1 3 . 廃棄上の注意

廃棄上の注意	「廃棄物の処理及び清掃に関する法律」に従い、公認の産業廃棄物処理業者、もしくは地方自治体が処理を行っている場合には、その自治体に委託して処理する。 <sup>2)</sup> 焼却する場合は、管理された焼却設備を用いて、廃掃法、大気汚染防止法、水質汚濁防止法等の諸法令に適合した処理を施して処理する。 <sup>2)</sup>
--------	--



## 14. 輸送上の注意

国連分類・国連番号	該当しない
特定の安全対策・条件	空気輸送を行う場合は、静電気災害防止対策をとる。梱包袋が破れないように、水濡れや乱暴な取扱いを避ける。もし、破袋してペレットが飛散した場合は、滑って転倒しないように注意する。

## 15. 適用法令

法規制	労働安全衛生法： 該当しない。 消防法： 該当しない。 毒物及び劇物取締法： 該当しない。 船舶安全法・航空法： 該当しない。 廃掃法： 産業廃棄物、廃プラスチック類に該当する。
-----	---

## 16. その他の情報

引用文献	<sup>1)</sup> 樹脂ペレット流出防止マニュアル，日本プラスチック工業連盟，平成5年2月 <sup>2)</sup> 廃プラ Q & A，工業用熱可塑性樹脂技術連絡会 (1992) <sup>3)</sup> R.M.Asseva and G.E.Zaikov: "Combustion of Polymer Materials" Hanser Publishes, p46 (1986) <sup>4)</sup> 粉体と工業 1984年5月号 66ページ <sup>5)</sup> 消防予第184号、消防庁予防救急課長通知，昭和54年10月2日 <sup>6)</sup> G. Bormann et al., Arzneimittel – Forsch. 9, 9 (1959) <sup>7)</sup> ポリカーボネート樹脂技術研究会資料
注	記載の情報は現時点で入手できる資料、情報、データに基づいて作成しておりますが、新しい知見により改訂される場合があります。注意事項は、通常取扱いを対象としたものなので、特殊な取扱いの場合には、用途、用法に適した安全対策を実施の上、ご利用下さい。本資料に記載の内容は、情報提供であって保証するものではありません。

# QMFZ2. E245526

## Plastics - Component

TEIJIN POLYCARBONATE CHINA LTD

E245526

ZHAPU DEVELOPMENT RD

888 YASHAN W RD

JIAXING

ZHEJIANG 314201, CHINA

									H	D	
		Min.		H	H	R T I			V	4	C
		Thk	Flame	W	A	Elec	Mech		T	9	T
Material Dsg	Color	mm	Class	I	I		Imp	Str	R	5	I
<b>Polycarbonate (PC), "Panlite", furnished as pellets, powder.</b>											
<b>L-1250(#)(f2)</b>											
	ALL	0.40	V-2	4	3	80	80	80	4	5	2
		0.84	V-2	4	3	80	80	80			
		1.5	HB	4	0	125	115	125			
		3.0	HB	1	0	125	115	125			
		6.0	HB	1	0	125	115	125			

(#) - Material designation may be suffixed with any one or two letters.

(f2) - Subjected to one or more of the following tests: Ultraviolet Light, Water Exposure or Immersion in accordance with UL 746C, where the acceptability for outdoor use is to be determined by UL Inc

Marking: Company name and material designation on container, wrapper or finished part.

This page and all contents are Copyright © 2005 by Underwriters Laboratories Inc.®

The appearance of a company's name or product in this database does not in itself assure that products so identified have been manufactured under UL's Follow-Up Service. Only those products bearing the UL Mark should be considered to be Listed and covered under UL's Follow-Up Service. Always look for the Mark on the product.

UL permits the reproduction of the material contained in the Online Certification Directory subject to the following conditions: 1. The Guide Information, Designs and/or Listings (files) must be presented in their entirety and in a non-misleading manner, without any manipulation of the data (or drawings). 2. The statement "Reprinted from the Online Certifications Directory with permission from Underwriters Laboratories Inc." must appear adjacent to the extracted material. In addition, the reprinted material must include a copyright notice in the following format: "Copyright © 2005 Underwriters Laboratories Inc.®"

## KEYFLEX BT-1063D

### Application

Shock absorber in bed system, Cellularphone soft cap parts, Noseless gear

### Feature

KEYFLEX BT-1063D has flexibility and elastic resiliency similar to those of rubber as well as mechanical strength, heat-resistance and weather-resistance better than those of rubber. All grades of KEYFLEX BT are block copolymers consisting of a hard (crystalline) segment of polybutylene-terephthalate and a soft (amorphous) segment based on long-chain polyether glycol. Properties are determined by the ratio of hard to soft segment.

### Properties

Physical	Method	Condition	Unit	Value
Hardness	ASTM D2240	-	shore D	63
Specific Gravity	ASTM D792	-	-	1.22
Water Absorption	ASTM D570	24hr	%	0.3
Mold Shrinkage	ASTM D955	-	%	1.5

Mechanical	Method	Condition	Unit	Value
Flexural Modulus	ASTM D790	-	kg/cm <sup>2</sup>	3100
			MPa	306
			psi	44082
Tensile Strength	ASTM D638	at5%Strain	kg/cm <sup>2</sup>	110
	ASTM D638	at10%Strain	kg/cm <sup>2</sup>	175
	ASTM D638	atBreak	kg/cm <sup>2</sup>	420
Elongation at break	ASTM D638	-	%	550
Yield Strength	ASTM D638	-	kg/cm <sup>2</sup>	160
Tear Strength	ASTM D624	-	kg/cm <sup>2</sup>	160
			MPa	15.8
			psi	2275.2
IZOD Impact strength	ASTM D256	23°C	kg·cm/cm	NB
			J/m	NB
			ft·lb/in	NB
	ASTM D256	-40°C	kg·cm/cm	5
			J/m	49
			ft·lb/in	0.9
Compression Set	ASTM D395B	70°C, 22hrs	%	-

Thermal	Method	Condition	Unit	Value
Melt Flow Index	ASTM D1238	2.16Kg	10min	(*3)24
Melting Temp.	DSC	-	°C	212
Heat Deflection Temperature	ASTM D648	4.6kg/cm <sup>2</sup>	°C	115
			°C	115
			°F	239
Possion Ratio		-	-	-

Electrical	Method	Condition	Unit	Value
DC Volume Resistivity	ASTM D257	-	Ω·cm	>10 <sup>13</sup>
Dielectric Strength	ASTM D149	-	kV/mm	16.1

1) The listed values should be used for referential purpose only.

	<b>MSDS</b> (Material Safety Data Sheet)	Internal Registration number	GHS-PBT- 010
	<b>KEYFLEX BT</b> (CAS No. 37282-12-5)	Pages	1/10

## 1. Identification of the substance or mixture and of the supplier

1) Product name : "KEYFLEX BT - " 1028D, 1030D, 1033D, 1035D, 1040D, 1045D  
"KEYFLEX BT - " 1047D, 1055D, 1055DJ, 1063D, 1068D, 1072D  
"KEYFLEX BT - " 1140D, 1145D, 1155D, 1155DM, 1163D, 1172D, 1182D  
"KEYFLEX BT - " 2042D, 2045D, 2140D, 3028D, 3038D, 3047D, 3055D, 3140D

2) GHS product identifier : Thermoplastic Polyester Elastomer

3) Appearance : Pellet type plastic solid

4) Recommended use of the chemical and restrictions on use :

- Recommended use: Automotive parts, Electric & electronic parts, Industrial parts, etc.
- Restrictions on use: Used for recommended use.

5) Supplier/Manufacturer :

- Supplier name : LG Chem. / 20, Yoido-dong, Yongdungpo-gu, Seoul, 150-721, Korea
- Manufacturer name : LG Chem. Yeosu ABS/EP plant  
70-1 Hwachi-dong, Yeosu-si, Jeollanam-do
- Contact phone number : +82-61-680-1280
- Responsibility : ABS/EP plant, PBT production Team

## 2. Hazard identification

1) GHS classification of the substance/mixture: Not classified

2) GHS label elements, including precautionary statements:

<input type="radio"/> Pictogram and symbol	<input type="radio"/> Signal word	<input type="radio"/> Hazard statements
Not applicable	Not applicable	Not applicable

Precautionary statements

[Precaution] Not applicable

[Treatment] Not applicable

[Storage] Not applicable

[Disposal] Not applicable



**3) Other hazard information not included in hazard classification**

- NFPA :
  - Health: - Flammability: 1 Reactivity: -
- Other : Not available

**3. Composition/information on ingredients**

Chemical Name	Common name Synonyms	CAS No	Content (%)
KEYFLEX BT	Thermoplastic Polyester Elastomer	37282-12-5	100%

**4. First-aid measures**

**1) Eye contact :**

- Keep away from exposure if exposure effect occurred.
- In case of contact with substance, flush eyes with amount of water for at least 15 minutes.
- In case of contact with chemicals, get medical advice/attention.

**2) Skin contact:**

- Remove contaminated clothing and shoes. Wash skin with soap and water for at least 15 minutes.
- Get medical attention if skin symptoms occurred.
- Wash contaminated clothing and shoes before reuse.

**3) Inhalation:**

- Move victim to non-contaminated place in fresh air.
- Get medical attention if irritation or symptoms occurred.
- Give artificial respiration if victim is not breathing.

**4) Ingestion:**

- Get medical attention if swallowed amount of substance.
- Get medical attention if irritation or symptoms occurred.

**5) Indication of immediate medical attention and notes for physician:**

- Call emergency medical service. Get medical advice/attention if needed.
- Ensure that medical personnel are aware of the material(s) involved and take precautions to protect themselves.



## 5. Fire-fighting measures

### 1) Suitable (and unsuitable) extinguishing media:

- Suitable extinguishing media: Not available
- unsuitable extinguishing media: Not available

### 2) Specific hazards arising from the chemical:

- It emits toxic fumes when burned.
- Containers may explode when heated.

### 3) Special protective equipment and precautions for fire-fighters:

- Wear positive pressure self-contained breathing apparatus (SCBA).
- Structural firefighters' protective clothing will only provide limited protection.

## 6. Accidental release measures

### 1) Personal precautions, protective equipment and emergency procedures:

- Stop leak if you can do it without risk.
- Isolate exposed area.
- Keep unauthorized personnel away.
- Use certificated protective equipment.
- Ventilate the leaked area.

### 2) Environmental precautions and protective procedures:

- Ensure adequate ventilation.
- Prevent entry into waterways, sewers or basements.

### 3) The methods of purification and removal:

- Do not touch or walk through spilled material.
- Prevent entry into waterways, sewers, basements or confined areas.

## 7. Handling and storage

### 1) Precautions for safe handling:

- Wash thoroughly after handling.

### 2) Conditions for safe storage (include conditions to avoid):

- Store in a closed container.
- Keep away from waterways and sewers.



## 8. Exposure controls/personal protection

### 1) Occupational Exposure Limits:

Chemical Name	Korean Occupation of Safety and Health Regulation	International regulations	Biological exposure index
KEYFLEX BT	Not available	Not available	Not available

### 2) Appropriate engineering controls:

- Provide local exhaust ventilation system or other engineering controls to keep the airborne concentrations of vapors below their respective threshold limit value.
- Check legal suitability of exposure level.

### 3) Personal protective equipment:

- Respiratory protection : Respiratory protection: Wear NIOSH or European Standard EN 149 approved full or half face piece (with goggles) respiratory protective equipment when necessary.
- Eye protection:
  - An eye wash unit and safety shower station should be available nearby work place.
  - Wear safety glasses to protect eyes from scattering toxic substance.
- Hand protection: Wear chemical resistant gloves to avoid direct contact with chemical substance.
- Body protection: Wear appropriate protective chemical resistant clothing to prevent exposure of skin.





## 9. Physical and chemical properties

Properties	KEYFLEX BT
1) Appearance	Yellow solid
2) Odor	Odorless
3) Odor threshold	Not available
4) pH	Not available
5) Melting point/freezing point	Not available
6) Initial boiling point and boiling range	140-230 °C
7) Flash point	300-340 °C
8) Evaporation rate	Not available
9) Flammability	Not available
10) Upper/lower flammability or explosive limits	Not available
11) Vapor pressure	Not available
12) Solubility (ies)	1.565 mg/L at 25°C
13) Vapor density	Not available
14) Specific gravity	1.05-1.30
15) Partition coefficient: n-octanol/water	4.02
16) Auto ignition temperature	Not available
17) Decomposition temperature	Not available
18) Viscosity	Not available
19) Molecular weight	458.458

## 10. Stability and reactivity

**1) Chemical stability and Possibility of hazardous reactions:**

- Stable under normal temperatures and pressures.

**2) Conditions to avoid (e.g., static discharge, shock or vibration):**

- Avoid heat, flames, sparks and other sources of ignition.
- Avoid contact with incompatible materials.
- Avoid release to the environment.



3) Incompatible materials: Not available

4) Hazardous decomposition products: Not available

## 11. Toxicological information

1) Information on the likely routes of exposure:

- Not available

2) Information of Health Hazardous :

Division		KEYFLEX BT
○ Acute toxicity	Oral	Not available
	Dermal	Not available
	Inhalation	Not available
○ Skin Corrosion/ Irritation		Not available
○ Serious Eye Damage/ Irritation		Not available
○ Respiratory sensitizer		Not available
○ Skin Sensitization		Not available
○ Carcinogenicity		Not available
○ Mutagenicity		Not available
○ Reproductive toxicity		Not available
○ Specific target organ toxicity (single exposure)		Not available
○ Specific target organ toxicity (repeat exposure)		Not available
○ Aspiration Hazard		Not available



## 12. Ecological information

Division	KEYFLEX BT
1) Acute toxicity	Not available
2) Persistence and degradability	Not available
3) Bioaccumulative potential	-Low Bioaccumulation (BCF = 3.162(estimated)) -This substance is considered to be high persistency (Log Kow: 4.02(estimated))
4) Mobility in soil	Low potency of mobility to soil.(Koc values = 68.66)
5) Other harmful effects	Not available

## 13. Disposal considerations

**1) Disposal method :**

- Waste must be disposed of in accordance with federal, state and local environmental control regulations.

**2) Disposal precaution:**

- Consider the require attentions in accordance with waste treatment management regulation.

## 14. Transport information

1) **UN Number:** Not applicable

2) **UN Proper shipping name:** Not applicable

3) **Transport Hazard class:** Not applicable

4) **Packing group:** Not applicable

5) **Marine pollutant:** Not applicable

6) **Special safety response for transportation or transportation measure:**

- Emergency schedule for fire: Not applicable
- Emergency schedule for spillage: Not applicable

## 15. Regulatory information

1) **Korea Occupational Safety and Health Regulation:** Not regulated

2) **Toxic Chemical Control Act:** Not regulated

3) **Dangerous Material Safety Management Regulation:** Not regulated

4) **Wastes Control Act:** Not regulated



#### 5) Other Korea and overseas regulation

- Korea regulation:
  - Persistent Organic Pollutants Management Act: Not regulated
- EU classification:
  - Classification: Not available
  - Risk phrases: Not available
  - Safety phrases: Not available
- U.S.A management information:
  - OSHA regulation(29CFR1910.119): Not regulated
  - CERCLA 103 regulation(40CFR302.4): Not regulated
  - EPCRA 302 regulation(40CFR355.3): Not regulated
  - EPCRA 304 regulation(40CFR355.4): Not regulated
  - EPCRA 313 regulation(40CFR372.65): Not regulated
- Other management information
  - Japan management information:
    - ; Existing and New Chemical Substances (ENCS) = (7)-1079
  - China management information:
    - ; Inventory of Existing Chemical Substances (IECSC) = Present
  - Canada management information:
    - ; Domestic Substances List (DSL) = Present
  - New Zealand management information:
    - ; Inventory of Chemicals (NZIoC) = Present
- Substance of Roterdame Protocol: Not applicable
- Substance of Stockholme Protocol: Not applicable
- Substance of Montreal Protocol: Not applicable

## 16. Other information

### 1) Information source and references:

- Pubchem;<http://pubchem.ncbi.nlm.nih.gov/summary/summary.cgi?cid=71943>
- EPISUITE v4.0;<http://www.epa.gov/opt/exposure/pubs/episuitedl.htm>
- LOLi  
; <http://csi.micromedex.com/pgLOLI.asp?cas=37282-12-5&ChemName=1%2C4%2DBenzenedicarboxylic+acid%2C+polymer+with+1%2C4%2Dbutanediol+and+%2Ealpha%2E%2Dhydro%2D%2Eome>



2) Issue date: 2010. 12. 10.

3) Revision number and date :

- revision number: 4<sup>th</sup>
- date of the latest revision: 2010. 12. 10.

4) Other material safety data sheet information:

- The contents of this MSDS documented and the information based on current knowledge and information. Some of the information contained in the information provided by the Korea Occupational Safety & Health Agency.

This MSDS were made of the informational purposes for the safe handling when education or use of the production department workers. Therefore we make no guarantee for result obtained, and assume no responsibility for damages incurred by use of this product. But the material used for the purpose of the data requested is available for further information.



<Additional Data>

<Historical Information>

Revision degree	Revision item	Revision matter	Date	
0	ALL	Newly	'97. 6. 30.	M.B.T
1 <sup>st</sup>	ALL	GHS Version Up-date	'08. 4. 1.	K.Y.C
2 <sup>nd</sup>	2. Hazard identification 15. Regulatory information	ALL	'10.5.17	K.S.I

**LG CHEMICAL LTD**

20 YOIDO-DONG, YONGDUNGPO-GU, SEOUL 150-721 KR

**BT-1063D****Thermoplastic Elastomer (TPE), "KEYFLEX", furnished as pellets**

Color	Min Thk	Flame			RTI	RTI	RTI
	(mm)	Class	HWI	HAI	Elec	Imp	Str
NC, BK	1.5	HB	2	0	50	50	50
	3.0	HB	2	0	50	50	50

Comparative Tracking Index (CTI): **0**

Dimensional Stability (%): -

High-Voltage Arc Tracking Rate  
(HVTR): **0**High Volt, Low Current Arc Resis (D495): **4**

Dielectric Strength (kV/mm): -

Volume Resistivity (10xohm-cm): -

UL94 small-scale test data does not pertain to building materials, furnishings and related contents. UL94 small-scale test data is intended solely for determining the flammability of plastic materials used in the components and parts of end-product devices and appliances, where the acceptability of the combination is determined by ULI.

Report Date: 2004-11-05

Last Revised: 2004-11-05

Underwriters Laboratories Inc®

**IEC and ISO Test Methods**

Test Name	Test Method	Units	Thickness	
			Tested (mm)	Value
IEC Flammability	IEC 60695-11-10	Class (color)	1.5	HB75 (NC, BK)
			3.0	HB40 (NC, BK)
Glow-Wire Flammability (GWFI)	IEC 60695-2-12	C	-	-
Glow-Wire Ignition (GWIT)	IEC 60695-2-13	C	-	-
IEC Comparative Tracking Index	IEC 60112	Volts (Max)	-	-
IEC Ball Pressure	IEC 60695-10-2	C	-	-
ISO Heat Deflection (1.80 MPa)	ISO 75-2	C	-	-
ISO Tensile Strength	ISO 527-2	MPa	-	-
ISO Flexural Strength	ISO 178	MPa	-	-
ISO Tensile Impact	ISO 8256	kJ/m <sup>2</sup>	-	-
ISO Izod Impact	ISO 180	kJ/m <sup>2</sup>	-	-
ISO Charpy Impact	ISO 179-2	kJ/m <sup>2</sup>	-	-

Underwriters Laboratories Inc®

产品编号: NY3150

Middle Tg, Halogen-free, PN Curing and Contains Fillers, CAF Resistance, UL94 V-0

### 特点

- Tg  $\geq 150^{\circ}\text{C}$  无卤素无铅兼容 FR-4 板材
- 优秀的剥离强度
- 低 Z-CTE 值
- 优秀的耐 CAF 性能
- UV Blocking 和 AOI 兼容
- 优秀的阻燃性符合 UL94 V-0 要求
- 优秀的尺寸安定性

### 应用领域

- 消费电子类
- 电源、仪器仪表类
- 通讯设备类
- 汽车电子类

### FEATURES

- Tg  $\geq 150^{\circ}\text{C}$  Halogen-free and Lead-free compatible
- Excellent Peel Strength
- Low Z-axis CTE
- Excellent Anti-CAF Performance
- UV Blocking/AOI Compatible
- Excellent Flammability Resistance
- Excellent Dimension Stability

### APPLICATIONS

- Consumer Electronics
- Power supplies, Instrumentations
- Communications
- Automotives, and etc.

### 优秀的耐热稳定性 Excellent Thermal Resistance

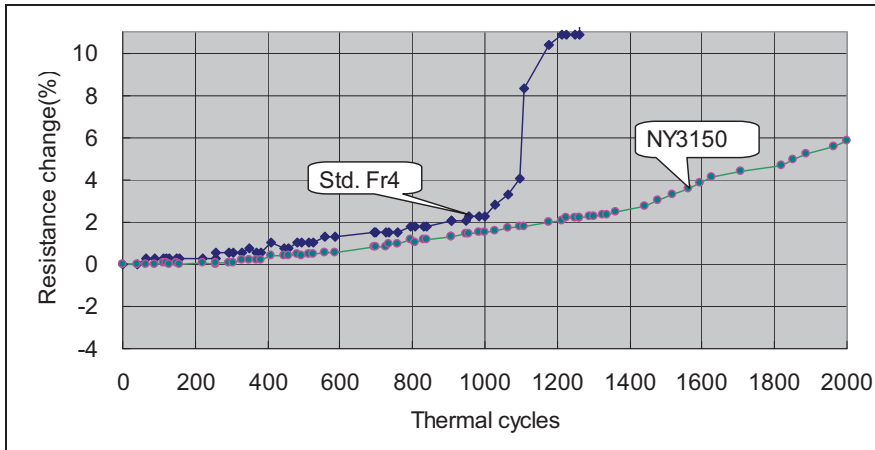

Test condition:  
(IPC-TM-650 2.6.7.2)  
-55°C × 15min.  $\Leftrightarrow$  125°C × 15mins, transfer time  $\leq$  2min.  
Test samples: PCB 6 layers, thickness 2.0mm hole diameter: 0.4mm pitch:0.9mm

### 优秀的耐 CAF 稳定性 Excellent Anti-CAF Performance

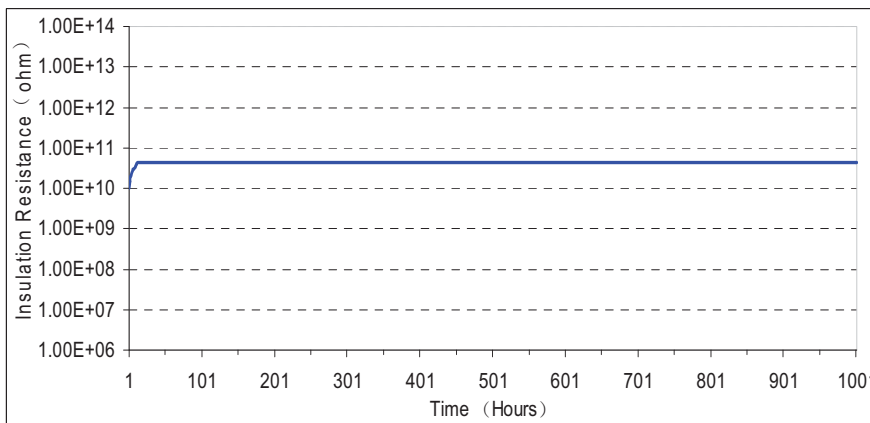

TEST ITEM	CONDITIONS	RESULTS
TH-TH (0.7mm)	SONY 6 Layer TV 85°C/85%RH 50V DC bias	>1000 hr
PA-PA (0.1/0.1mm)		>1000 hr
TH-PA (0.3mm)		>1000 hr
LA-LA		>1000 hr





● **NY3150 采购信息 PURCHASING INFORMATION**

基板厚度 Thickness	厚度公差 Tolerance	铜箔 Copper foil	标准供应尺寸 Standard Size
0.03mm to 3.2mm	IPC4101 Class C/M	1/4 oz to 6 oz	915×1220mm (36"×48"), 1020×1220mm (40"×48"), 1070×1220mm (42"×48"), 1830×1220mm (72"×48"), 2040×1220mm (80"×48"), 2140×1220mm (84"×48")

\*其它尺寸和厚度亦可供应 Other sheet size and thickness could be available upon request.

半固化片 Prepreg	标准供应尺寸 Standard Size	常用玻纤布型号 Normal Glass Type
Anti-CAF LDPP	49.5" ×115 m	For Anti-CAF (106, 1080, 2113, 2313, 3313, 2116, 1652, 1506, 7628) For Laser Drillable (106, 1037, 1067,1078, 1086)

\*其它裁片尺寸和卷长度亦可供应 Other sheet size and roll length could be available upon request.

● **半固化片产品规格表 Specification Sheet for Prepreg**

NY3150 半固化片 NY3150 Prepreg	单位 Units	产品规格 Specification	典型值 Typical Value	测试方法 Test Method
1. 玻纤布 Reinforcement	-	As per IPC-4412 or AABUS		
2. 树脂含量 Resin Content	%	±2	±2	2.3.16.1C By treated weight
3. 胶化时间 Gel Time	sec	±20	±20	2.3.18A
4. 树脂流量 Resin Flow	%	±5	±5	2.3.17D
5. 挥发份含量 Volatile content	%	<1.5	<1.5	2.3.19C
6. 储存期 Shelf Life (条件1Condition 1 /条件2Condition 2)	Days	180/90	180/90	AABUS
7. 燃烧性 Flammability (压合后as laminated)	rating	V-0	V-0	UL94
8. 其它 Other	-	As per IPC-4101 or AABUS		

\*AABUS = 供需双方商定 As agreed upon between user and supplier.

\*储存期 Shelf Life (条件1Condition 1 / Temp.: <5℃, 条件2Condition 2/Temp.: <23℃ R.H.: <50%).

● NY3150基板产品规格表 Specification Sheet for Laminate

NY3150覆铜箔板 NY3150 Laminate	单位Units	产品规格 Specification		典型值 Typical Value	测试方法 Test Method
	Metric(English)	<0.50mm	≧0.50mm	1.60mm CCL	IPC-TM-650
1. 抗剥强度 Peel Strength, 收货时 As received A. 1/2 盎司及以下铜箔 17 micron copper B. 1盎司铜箔 35 micron copper C. 2盎司铜箔 70 micron copper D. 3,4,5盎司及以上铜箔 105, 140, 175 micron copper and above	N/mm(lb/inch), minimum	≥0.70 (4.0) ≥0.79 (4.5) ≥0.88 (5.0) ≥0.96 (5.5)	≥0.70 (4.0) ≥1.05 (6.0) ≥1.40 (8.0) ≥1.58 (9.0)	1.50 (1oz)	2.4.8 2.4.8.2 2.4.8.3
2. 体积电阻 Volume Resistivity, A. 恒温恒湿C-96/35/90 B. 耐湿后After moisture resistance C. 高温下 At elevated temperature E-24/125	MΩ-cm, minimum	10 <sup>6</sup> --- 10 <sup>3</sup>	--- 10 <sup>4</sup> 10 <sup>3</sup>	--- 1.5×10 <sup>8</sup> 4.0×10 <sup>6</sup>	2.5.17.1
3. 表面电阻 Surface Resistivity, A. 恒温恒湿C-96/35/90 B. 耐湿后After moisture resistance C. 高温下 At elevated temperature E-24/125	MΩ, minimum	10 <sup>4</sup> --- 10 <sup>3</sup>	--- 10 <sup>4</sup> 10 <sup>3</sup>	--- 2.0×10 <sup>7</sup> 4.5×10 <sup>6</sup>	2.5.17.1
4. 吸水率 Moisture Absorption	% maximum	-	0.8	0.15	2.6.2.1
5. 击穿电压 Dielectric Breakdown	kV minimum	-	40	58	2.5.6
6. 介电常数 Permittivity at 1 MHz, (Laminate & Prepreg as laminated)	- maximum	<5.4	<5.4	4.8	2.5.5.3 2.5.5.5 2.5.5.6
7. 介质损耗 Loss Tangent at 1 MHz, (Laminate & Prepreg as laminated)	- maximum	<0.035	<0.035	0.010	2.5.5.3 2.5.5.3 2.5.5.9
8. 弯曲强度 Flexural Strength, A. 纵向 Length direction B. 横向 Cross direction	N/mm <sup>2</sup> , minimum	- -	415 345	480 440	2.4.4
9. 高温弯曲强度 Flexural Strength at Elevated Temperature, length direction,	N/mm <sup>2</sup> minimum	-	-	-	2.4.4.1
10. 耐电弧性 Arc Resistance	S minimum	60	60	98	2.5.1
11. 热应力冲击 Thermal Stress A. 未蚀刻 Unetched B. 蚀刻 Etched	10 sec at 288℃	Pass Visual Pass Visual	Pass Visual Pass Visual	Pass Pass	2.4.13.1
12. 电气强度 Electric Strength (Laminate & Prepreg as laminated)	kV/mm minimum	30	-	-	2.5.6.2
13. 燃烧性 Flammability (Laminate & Prepreg as laminated)	Rating	V-0	V-0	V-0	UL94
14. 玻璃态转化温度 Glass Transition Temperature	℃	--	≥150	155	2.4.24 2.4.25
15. 热分解温度 Decomposition Temperature	℃	--	≥325	375	TBD (5% wt loss)
16. 膨胀系数Z-Axis CTE A. Alpha 1 B. Alpha 2 C. 50 to 260℃	PPM/℃ PPM/℃ %	-- -- --	≤60 ≤300 ≤3.5	40 245 3.0	2.4.24
17. 耐热性(除去铜箔) Thermal Resistance (Copper removed) A.T260 B.T288 C.T300	Minutes Minutes Minutes	-- -- --	≥30 ≥5 AABUS	>60 >60 --	2.4.24.1
18. 耐CAF性能 CAF Resistance	Pass/Fail	--	AABUS	Pass	2.6.25

\*AABUS = 供需双方商定 As agreed upon between user and supplier.

● **NY3150 产品使用指引 Process guideline**

**1. 搬运及储存要求 Handling and Storage:**

- 半固化片和基板必须水平平坦放置，轻拿轻放，避免折伤。

Prepreg and Laminate should always be stored flat and horizontally. To avoid damage is recommended.

- 半固化片可以在干冷的环境下保存 3 个月（温度<23℃，相对湿度: <50%）

Shelf life is 3 months when prepreg stored in a cool dry environment (Temp.: <23℃ R.H.: <50%).

- 基板可以在常温干燥的环境下保存 1 年。

Shelf life is 1 year when laminate stored in a dry environment.

**2. PCB 内层制作指引 PCB Inner Layer Process guideline:**

- 基板在用于量产前，必须先做首板测试并得到合适制作参数（尺寸补偿系数等）。

First around must be taken and find a suitable parameter (as dimension compensation, etc) before mass production.

- 内层线路板在棕化后必须烘烤 120 摄氏度 30 分钟以上，以去除水气。

Inner layers should be baked for at least 30 min at 120℃ after black or brown oxides treatment

**3. PCB 压合制作参考 Multi-layer Lamination Suggestion:**

- 升温速率 Heating rate (80℃~ 140℃) / 高压设定 Highest Pressure:

慢升温速率: 1.0~2.0℃/min 高压设定: 350~400 psi, 快升温速率: 2.0~3.0℃/min 高压设定: 300~350 psi.

Slow heating rate: 1.0~2.0℃/min, Pressure: 350~400 psi. Fast heating rate: 2.0~3.0℃/min, Pressure: 300~350 psi.

- 固化条件: 压机每本中间层板温必须在 190 摄氏度以上保持 40 分钟，以保证树脂完全固化。

Curing condition: Temperature of the inner boards, keep at least 40 minutes at 190℃ and above.

- 降温速率: 中间层板温高于 140 摄氏度时，降温速率应在 2.0℃/min 以下，以确保热应力完全释放。

Cooling rate: <2.0℃/min, when the temperature of the inner boards is over 140℃, in order to relax the thermal stress.

(建议压合程式如下图 Recommended Press Cycle as below).

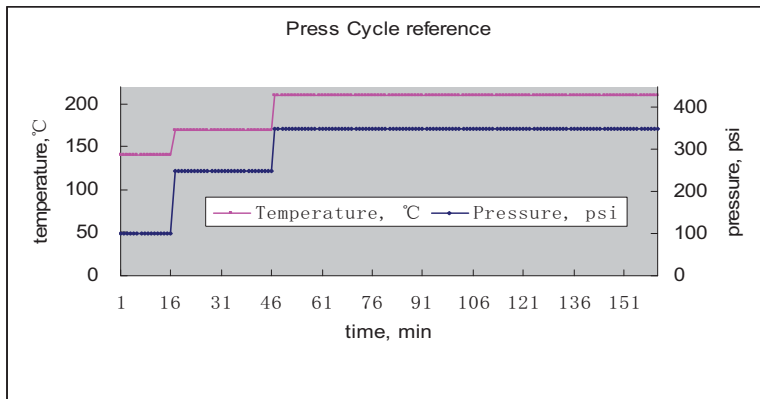

**4. 其它制程 The other processes:**

- 钻孔: 钻孔参数必须依据钻咀质量、孔径、铜厚、板厚、层数、及叠板高度等条件设定，并且在量产前必须进行首板试验。

Drilling parameters are mainly dependent on the drill bit quality, hole size, copper thickness, layer thickness, layer number and stack height, and etc. First around must be taken and find a suitable parameter before mass production.

- 烘烤: 建议钻孔后及除胶渣前烘烤 150 摄氏度 2 小时以上，以去除释放机械应力。

To bake after drilling 150℃/ 2 hours, in order to relax the mechanical stress.

- 除胶渣: 一般情况下普通 FR4 的除胶渣条件可能不适合此款材料，建议咨询药水供应商并作适当调整，如除胶时间、温度等。

The typical parameters used to desmear Normal FR-4 may not produce optimum hole topography for NY3150, so you should consult with your chemical supplier to optimize your desmear condition, as desmear time or temperature, etc.

- 外型加工: 一般情况下普通的冲模条件可能不适合此款材料，建议咨询设备供应商并作适当调整，如冲床重量、模具类型等。

The typical punching parameters may not produce optimum hole topography for NY3150, so you should consult with your equipment supplier to optimize your punching condition, as punching power or die type, etc.

--- 以上指引，仅供参考。The above process guideline is for general reference only. ---



SHANGHAI NANYA COPPER CLAD LAMINATE CO., LTD.  
上海南亞覆銅箔板有限公司

NO. 158 CHANGXIANG ROAD NANXIANG SHANGHAI P. R. CHINA

中國上海南翔昌翔路 158 號

TEL: 0086-21-59175555 FAX: 0086-21-69178833

INTERNET HTTP: www.ccl-china.com

E-MAIL: sales@ccl-china.com

物质安全资料手册

MATERIAL SAFETY DATA MANUAL

1、产品及公司名称、地址 PRODUCT AND COMPANY IDENTIFICATION

产品名称: 无卤覆铜箔层压板(黄料)、半固化片

Product Name: HALOGEM-FREE Copper clad laminate (Yellow)、 prepreg

产品用途: 用于印制线路板、制作多层板

Using of the Product: Making for Printed Circuit Board and Mality-lay Board

公司名称及地址: 上海南亞覆銅箔板有限公司

上海南翔昌翔路158号

Company Name and Address: Shanghai Nanya Copper Clad Laminate CO., LTD.  
NO.158, Changxiang Road, Nanxiang, Shanghai,  
P. R. CHINA

如果您有任何问题或建议的话, 请按如下方式联系我们:

电话: 0086-21-5917-5555

传真: 0086-21-6917-8833

E-MAIL: sales@ccl-china.com

If you have any questions and suggestions, please feel free to contact us and no hesitation

TEL: 0086-21-5917-5555

FAX: 0086-21-6917-8833

E-MAIL: sales@ccl-china.com



SHANGHAI NANYA COPPER CLAD LAMINATE CO., LTD.

上海南亞覆銅箔板有限公司

NO. 158 CHANGXIANG ROAD NANXIANG SHANGHAI P. R. CHINA

中國上海南翔昌翔路 158 號

TEL: 0086-21-59175555 FAX: 0086-21-69178833

INTERNET HTTP: [www.ccl-china.com](http://www.ccl-china.com)

E-MAIL: [sales@ccl-china.com](mailto:sales@ccl-china.com)

若要更多的信息，欢迎您登陆我们的网址：

For more information, welcome to INTERNET HTTP:

[http: www.ccl-china.com](http://www.ccl-china.com)

2、产品的组成 COMPOSITION OF THE PRODUCT

原材料名称	含量%
Raw Material	contend
玻璃纤维布	
Fibre Glass Cloth	30~40
铜箔	
Copper Foil	15~25
环氧树脂	
Epoxy Resin	40~70

3、物化性能 PHYSICAL AND CHEMICAL PROPERTIES

外观:	板材颜色为黄色
Appearance:	Yellow in normal
气味:	常态下为无味固体
Odor:	solid state, none
比重:	(水=1.0) $1.7 \pm 0.25$
Density:	(Water =1.0) $1.7 \pm 0.25$
水溶性:	不溶固体
Solubility:	Negligible in water

4、防火测试 FIRE PROOFING TEST

易燃性:	不适应
Flammable Properties:	N/A
燃烧等级:	UL 94-V0



SHANGHAI NANYA COPPER CLAD LAMINATE CO., LTD.

上海南亞覆銅箔板有限公司

NO. 158 CHANGXIANG ROAD NANXIANG SHANGHAI P. R. CHINA

中國上海南翔昌翔路 158 號

TEL: 0086-21-59175555 FAX: 0086-21-69178833

INTERNET HTTP: [www.ccl-china.com](http://www.ccl-china.com)

E-MAIL: [sales@ccl-china.com](mailto:sales@ccl-china.com)

---

Flame rate:	UL 94-V <sub>0</sub>
灭火介质:	水、CO <sub>2</sub> 、干粉灭火器及细砂
Extinguishing Medium:	Water、CO <sub>2</sub> 、Dry chemical or sand
不正常火灾:	当发生热温度时，可能会释放出NO化合物
Fire in Especial:	Making decompose, releasing the NO Compound
灭火人身安全:	消防员必须穿戴专业的保护装置和正压呼吸系统
Personal Protection:	Firemen should wear proper equipment and posit a pressure self-contained breathing apparatus

#### 5、防静电 ANTI-STATIC

产生环境:	非常干燥、空气完全不流通
Environment:	Exceeding dry and the air no current completely
产生原因:	从堆叠的板料中拿起或放入瞬时
The Reason:	Removing or depositing in a stack of material, causing spark
防护措施:	拿起或放入时，戴上手套
Protective Measure:	Removing or depositing, wearing mittens.

#### 6、稳定性及反应性 STABILITY AND REACTIVITY

常态是否稳定:	稳定
Normally Stable:	Stable
不兼容性:	不确定
Incompatibilities:	Not determine
是否存在危险聚合物:	无
Hazardous Polymerization:	None



SHANGHAI NANYA COPPER CLAD LAMINATE CO., LTD.

上海南亞覆銅箔板有限公司

NO. 158 CHANGXIANG ROAD NANXIANG SHANGHAI P. R. CHINA

中國上海南翔昌翔路 158 號

TEL: 0086-21-59175555 FAX: 0086-21-69178833

INTERNET HTTP: www.ccl-china.com

E-MAIL: sales@ccl-china.com

## 7、危险性 HAZARDS IDENTIFICATION

潜在的危险品

Potential Health Hazards

粉末:	当生产、成品切削时, 粉末会飞散出
Powder:	Fibrous dust may be released from the fiber-glass cloth substrate when machined
皮肤:	粉末会导致中等程度的皮肤过敏
Skin:	Dust may cause moderate skin irritation
眼睛:	粉末会导致中等程度的眼睛过敏
Eyes:	Dust may cause moderate eyes irritation

## 8、加热时的危害 HAZARDS WHEN HEATED

现象:	会产生难闻的气味, 常时间闻此气味严重者, 会出现头痛、头晕
Appearance:	Making afflictive gas when heated. For brief contact to dust, no precarious other than headachy and giddy
措施:	设置排气装置, 不断更换新鲜空气
Protection:	Putting up exhaust. Changing fresh air constantly

## 9、首要防护措施 FIRST AID MEASURES

皮肤:	除去已污染的衣物, 用流动水冲洗不小于10分钟; 如有持续过敏现象, 求助医生
Skin:	Wash in flowing water on less 15 minutes; if irrigation persists consult a physician
眼睛:	马上用流动水冲洗15分钟以上, 并不时眨眼睛, 切勿揉搓, 如有持续过敏现象, 求助医生



SHANGHAI NANYA COPPER CLAD LAMINATE CO., LTD.

上海南亞覆銅箔板有限公司

NO. 158 CHANGXIANG ROAD NANXIANG SHANGHAI P. R. CHINA

中國上海南翔昌翔路 158 號

TEL: 0086-21-59175555 FAX: 0086-21-69178833

INTERNET HTTP: [www.ccl-china.com](http://www.ccl-china.com)

E-MAIL: [sales@ccl-china.com](mailto:sales@ccl-china.com)

Eye: Irrigate with flowing water for 15 minutes immediately, blinking continually, forbidding kneading; if irrigation persists consult a physician

吸入: 如粉尘烟气太重, 及时转移到空气新鲜的地方, 危急情况, 进行人工呼吸, 并求助医生诊断

Inhalation: if overcome by dust or smoke, moving to fresh air, no breathing, giving mouth-to-mouth resuscitation, and calling physician

#### 10、工程控制 ENGINEERING CONTROLS

安装、使用除尘通风设备

Setting and using exhaust ventilation to control dust

#### 11、个人防护措施 PERSONAL PROTECTION

皮肤保护: 短暂接触粉尘, 需要时清洗身体或衣服

常接触或常时间接触粉尘, 穿戴防护装置

Skin Protection: For brief contact to dust, no precarious other than clean body covering clothing should be needed

眼睛保护: 使用有关材料操作时, 佩带眼睛保护装置

Eye Protection: Using appropriate eye protection when machining material

呼吸保护: 大气中的玻璃纤维粉尘颗粒不宜大于 $10\text{mg}/\text{m}^3$ , 铜屑粉尘颗粒必须小于 $1\text{mg}/\text{m}^3$

Respiratory Protection: The fiberglass in atmospheric should be maintained no more than  $10\text{mg}/\text{m}^3$  and copper dust must be under  $1\text{mg}/\text{m}^3$

#### 12、毒物学资料 TOXICOLOGICAL INFORMATION





SHANGHAI NANYA COPPER CLAD LAMINATE CO., LTD.

上海南亞覆銅箔板有限公司

NO. 158 CHANGXIANG ROAD NANXIANG SHANGHAI P. R. CHINA

中國上海南翔昌翔路 158 號

TEL: 0086-21-59175555 FAX: 0086-21-69178833

INTERNET HTTP: [www.ccl-china.com](http://www.ccl-china.com)

E-MAIL: [sales@ccl-china.com](mailto:sales@ccl-china.com)

---

敏感反应:	粉尘将导致眼、皮肤中毒过敏
Immediate (Acute) Effects:	Dust may cause moderate eyes, skin, and respiratory irritation
慢性反应:	未知
Delayed (Subchronic & chronic) Effects:	None known

### 13、生态学资料 ECOLOGICAL INFORMATION

非生物降解

Not biodegradable

### 14、排放程序及废物处置 SPILL PROCEDURES WASTE DISPOSAL

排放程序:	如材料不被污染, 将其存入洁净的容器中再使用; 如被污染, 将其存入指定容器中待处理
Spill Procedures:	If material is not contaminated, scoop into clean containers for reuse. Else, scoop it into containers or disposal
废物处置:	对加工处理出来的废物统一放置, 由认定的清运商进行相关的处理
Waste Disposal:	Land filling of cured material in a admissive facility in accordance with local regulations in acceptable disposal method



**QMTS2.E213990**

**Polymeric Materials - Filament-wound Tubing, Industrial Laminates, Vulcanized Fiber, and Materials for Use in Fabricating Recognized Printed Wiring Boards - Component**

Enhanced searching capability for this category can be found in UL's iQ Family of Databases ([iq.ul.com](http://iq.ul.com)).

[Page Bottom](#)

**Polymeric Materials - Filament-wound Tubing, Industrial Laminates, Vulcanized Fiber, and Materials for Use in Fabricating Recognized Printed Wiring Boards - Component**

See General Information for Polymeric Materials - Filament-wound Tubing, Industrial Laminates, Vulcanized Fiber, and Materials for Use in Fabricating Recognized Printed Wiring Boards - Component

**SHANGHAI NANYA COPPER CLAD LAMINATES CO LTD**

E213990

158 CHANGXIANG RD

NANXIANG, SHANGHAI 210802 CHINA

**Industrial laminates:**

Mtl Dsg	ANSI Type	Color	Build up		R.T.I.		H				Meets 746E DSR
			Min Thk (mm)	Flame Class	Elec (°C)	Mech (°C)	H W I	H A I	V T R	C T I	
<b>Industrial laminates, furnished as sheets or rolls.</b>											
<b>NY1150</b>	FR-4	NC	0.38	V-0	130	130	0	3	-	-	Yes
			0.63	V-0	130	140	0	3	-	-	Yes
			1.40	V-0	130	140	0	2	-	3	Yes
<b>Industrial laminates, furnished as sheets, rods or tubes.</b>											
<b>NY1600</b>	FR-4	NC	0.38	V-0	130	130	0	3	-	-	Yes
			0.63	V-0	130	140	0	3	-	-	Yes
			1.40	V-0	130	140	0	2	-	0	Yes
<b>NY2140, SN-L2(NY1140)</b>											
	FR-4	NC, YL	0.38	V-0	130	130	0	3	2	3	Yes
			0.63	V-0	130	140	0	3	2	3	Yes
			1.40	V-0	130	140	0	2	0	3	Yes
<b>NY2150</b>	FR-4	NC	0.38	V-0	130	130	0	3	-	-	Yes
			0.63	V-0	130	140	0	3	-	-	Yes
			1.40	V-0	130	140	0	2	-	3	Yes
<b>NY2170</b>	FR-4	NC	0.38	V-0	130	130	0	3	-	-	Yes
			0.63	V-0	130	140	0	3	-	-	Yes
			1.40	V-0	130	140	0	2	-	3	Yes
<b>NY3150</b>	FR-4	NC	0.38	V-0	130	130	0	3	-	-	Yes
			0.63	V-0	130	140	0	3	-	-	Yes
			1.4	V-0	130	140	0	2	-	3	Yes
<b>SN-CEM-3</b>	No ANSI	NC	0.63	V-0	50	50	-	-	-	-	-
<b>SN-L5 (LF)</b>											

	No ANSI	YL	0.38	V-0	-	-	-	-	-	-	-
			0.63	V-0	-	-	-	-	-	-	-
			1.40	V-0	-	-	-	-	-	-	-
<b>Industrial laminates.</b>											
<b>NY3140</b>	FR-4	NC	0.38	V-0	130	130	0	3	-	-	Yes
			0.63	V-0	130	140	0	3	-	-	Yes
			1.40	V-0	130	140	0	2	-	3	Yes

**Ultrathin build ups:**

Build Up					Laminate			Prepreg		
Mtl Dsg	ANSI Type	Min Thk (mm)	TI Elec	TI Mech	Mtl Dsg	Thk (mic)	TI Elec	Mtl Dsg	Thk (mic)	TI Elec
<b>Ultrathin industrial laminates and bonding layers, furnished in sheet form, for use in multilayer printed wiring boards where the thickness is built up to the minimum specified.</b>										
<b>NY1150</b>	FR-4	0.38	130	130	NY1150	50	90	NY1150P	50	90
		0.63	130	140	NY1150	50	90	NY1150P	50	90
<b>NY1600</b>	FR-4	0.38	130	130	NY1600	50	90	NY1600P	50	90
		0.63	130	140	NY1600	50	90	NY1600P	50	90
<b>NY2140, SN-L2(NY1140)</b>										
	FR-4	0.38	130	140	NY2140, SN-L2(NY1140)	50	90	NY2140P, SN-P2(NY1140P)	50	90
<b>NY2150</b>	FR-4	0.38	130	130	NY2150	50	90	NY2150P	50	90
		0.63	130	140	NY2150	50	90	NY2150P	50	90
<b>NY2170</b>	FR-4	0.38	130	130	NY2170	50	90	NY2170P	50	90
		0.63	130	140	NY2170	50	90	NY2170P	50	90
<b>NY3150</b>	FR-4	0.38	130	130	NY3150	50	90	NY3150P	50	90
		0.63	130	140	NY3150	50	90	NY3150P	50	90
<b>SN-L5 (LF)</b>	No ANSI	0.38	-	-	SN-L5 (LF)	75	-	SN-P3 (LF)	75	-

**Metal clad industrial laminates:**

Metal Clad Dsg	Lam-inate Dsg	Pre-preg Dsg	ANSI Type	Bld up Min Thk (mm)	Clad Cond Thk			Max Area Dia (mm)	Flame Class	Max Oper Temp (°C)	Solder Lts	
					Min Ext (mic)	Max Ext (mic)	Max Int (mic)				Temp (°C)	Time (sec)
<b>Metal clad industrial laminates for use in multilayer printed wiring boards with copper on one or both sides, furnished as sheets.</b>												
<b>NY2140, SN-L2(NY1140)</b>												
	NY2140, SN-L2(NY1140)	NY2140P, SN-P2(NY1140P)	FR-4	0.38	17	102	68	50.8	V-0	130	288	20
<b>NY3150</b>												
	NY3150	NY3150P	FR-4	0.38	12	102	68	50.8	V-0	130	288	20
<b>Metal clad industrial laminates for use in multilayer printed wiring boards with copper on one or both sides, furnished as sheets or rolls.</b>												
<b>NY1150</b>												

	NY1150	NY1150P	FR-4	0.38	12	102	68	50.8	V-0	130	288	20
<b>Metal clad industrial laminates for use in multilayer printed wiring boards with copper on one or both sides.</b>												
<b>NY1600</b>												
	NY1600	NY1600P	FR-4	0.38	12	102	68	50.8	V-0	130	288	20
<b>NY2150</b>												
	NY2150	NY2150P	FR-4	0.38	12	102	68	50.8	V-0	130	288	20
<b>NY2170</b>												
	NY2170	NY2170P	FR-4	0.38	12	102	68	50.8	V-0	130	288	20
<b>NY3140</b>												
	NY3140	NY3140P	FR-4	0.38	17	102	68	50.8	V-0	130	288	20
<b>Metal clad industrial laminates for use in single layer printed wiring boards with copper on one or both sides, furnished as sheets.</b>												
<b>NY2140, SN-L4 (NY1140)</b>												
	NY2140, SN-L2(NY1140)	-	FR-4	0.38	17	102	-	50.8	V-0	130	288	20
<b>NY3150</b>												
	NY3150	-	FR-4	0.38	12	102	-	50.8	V-0	130	288	20
<b>Metal clad industrial laminates for use in single layer printed wiring boards with copper on one or both sides, furnished as sheets or rolls.</b>												
<b>NY1150</b>												
	NY1150	-	FR-4	0.38	12	102	-	50.8	V-0	130	288	20
<b>Metal clad industrial laminates for use in single layer printed wiring boards with copper on one or both sides.</b>												
<b>NY1600</b>												
	NY1600	-	FR-4	0.38	12	102	-	50.8	V-0	130	288	20
<b>NY2150</b>												
	NY2150	-	FR-4	0.38	12	102	-	50.8	V-0	130	288	20
<b>NY2170</b>												
	NY2170	-	FR-4	0.38	12	102	-	50.8	V-0	130	288	20
<b>NY3140</b>												
	NY3140	-	FR-4	0.38	17	102	-	50.8	V-0	130	288	20

**Metal clad industrial laminates (Flammability Only Recognition):**

				Bld up	Clad Cond Thk			Max		Max	Solder Lts	
Metal Clad Dsg	Lam-inate Dsg	Pre-preg Dsg	ANSI Type	Min Thk (mm)	Min Ext (mic)	Max Ext (mic)	Max Int (mic)	Area Dia (mm)	Flame Class	Oper Temp (°C)	Temp (°C)	Time (sec)
<b>Metal clad industrial laminates for use in multilayer printed wiring boards with copper on one or both sides, furnished as sheets (Flammability Only Recognition).</b>												
<b>SN-L5 (LF)</b>												
	SN-L5 (LF)	SN-P3 (LF)	No ANSI	0.38	-	-	-	-	V-0	-	288	20
<b>Metal clad industrial laminates for use in single layer printed wiring boards with copper on one or both sides, furnished as sheets (Flammability Only Recognition).</b>												

<b>SN-CEM-3</b>												
	SN-CEM-3	-	No ANSI	0.63	-	-	-	-	V-0	-	260	10
<b>SN-L6 (LF)</b>												
	SN-L5 (LF)	-	No ANSI	0.38	-	-	-	-	V-0	-	288	20

Marking: Company name or trademark  and material designation on container or wrapper.  
Last Updated on 2011-05-31

[Questions?](#)

[Print this page](#)

[Notice of Disclaimer](#)

[Page Top](#)

Copyright 2011 Underwriters Laboratories Inc®

The appearance of a company's name or product in this database does not in itself assure that products so identified have been manufactured under UL's Follow-Up Service. Only those products bearing the UL Mark should be considered to be Listed and covered under UL's Follow-Up Service. Always look for the Mark on the product.

UL permits the reproduction of the material contained in the Online Certification Directory subject to the following conditions: 1. The Guide Information, Designs and/or Listings (files) must be presented in their entirety and in a non-misleading manner, without any manipulation of the data (or drawings). 2. The statement "Reprinted from the Online Certifications Directory with permission from Underwriters Laboratories Inc." must appear adjacent to the extracted material. In addition, the reprinted material must include a copyright notice in the following format: "Copyright © 2011 Underwriters Laboratories Inc.®"

An independent organization working for a safer world with integrity, precision and knowledge.



# 佛山市南海区信兴铜铝实业有限公司

## 产品出厂检验报告

FM-ZG-003B

客户名称		玉富同公司		检验日期		2015年03月02日	
产品名称	快削料 3604	规格型号		出货数量		kg	
检 验 情 况							
检验项目		标准要求		检验结果		单项判定	
材料尺寸(mm)		$\Phi 5.2 \begin{matrix} -0.01 \\ -0.03 \end{matrix}$		$\Phi 5.18$		合格	
硬度				HRB	HV	合格	
				77.2	141.3		
化学成份 %	铜(Cu)	61~57		57.8		合格	
	锌(Zn)	余量		余量		合格	
	铅(Pb)	4.0~2.0		2.95		合格	
	铁(Fe)	0.8~0.2		0.455		合格	
	铋(Bi)	$\leq 0.2$		$< 0.020$		合格	
	镉(Cd)	$\leq 0.01$		0.0045		合格	
检验结论		<input checked="" type="checkbox"/> 合格		<input type="checkbox"/> 不合格			

检验: 邝国亨

审核: 刘绍钳

# 信兴铜铝实业有限公司

## MSDS 安全资料表

### 一、物品与厂商资料

文件编号: GT-7-002

物品名称: 铜棒
物品编号: C3604
制造商或供应商名称、地址及电话
紧急联络电话/传真号码: 0757-85595363 0757-85561136

### 二、成分辨识资料

线物质:

中英文名称: CU			
同义名称: 黄铜			
化学文摘社登记号码 (CAS NO): 63338-02-3			
化学成分表			
材料物质名称	化学文摘号	EC. NO 号	物质含量
Cu (铜)	7440-50-8	231-159-6	58.235
Fe (铁)	7439-89-6	231-096-4	0.367
Zn (锌)	1314-13-2	215-222-5	38.4987
Cd (镉)	7440-43-9		0.0033
Pb (铅)	7439-92-1		2.896
危害物质成分 (成分百分比): 铅 $\leq$ 4.0% 镉 $\leq$ 0.005% 六价铬 $\leq$ 0.0007%			

混合物:

化学性质:		
危害物质成分之中英文名称	浓度或浓度范围 (成分百分比)	危害物质分类及图式
Pb (铅)	$\leq$ 4.0%	N/A
Cd (镉)	$\leq$ 0.005%	N/A

### 三、危害辨识资料

最 重 要 危 害 效 应	健康危害效应: 抑制人体细胞功能, 使用免疫减弱
	环境影响: 一般影响
	物理性及化学性危害: N/A
	特殊危害:
主要症状: 呼吸困难、胸闷	

物品危害分类: 慢性、急性危害

### 四、急救措施

不同暴露途径之急救方法: N/A

<ul style="list-style-type: none"><li>吸入: 呼吸道吸入</li><li>皮肤接触: N/A</li><li>眼睛接触: N/A</li><li>食入: 食物食入</li></ul>
最重要症状及危害效应: 肺炎、脑肿及呼吸系统、心血管严重损害

# 信兴铜铝实业有限公司

## MSDS 安全资料表

对急救人员之防设：N/A	
对医师之提示：N/A	
五、灭火措施	
适用灭火剂：不易燃	
灭火时可能遭遇之特殊危害：呼吸道吸入，大量吸入导致呕吐、恶心、腹泻	
特殊灭火程序：N/A	
消防人员之特殊防护设备：N/A	
六、泄漏处理方法	
个人应注意事项：N/A	
环境注意事项：一般环境污染	
不理方法：一般废物、回收、废物处理	
七、安全处置与储存方法	
处置： 铜棒入货架摆放属不易燃物品，人体皮肤接触，均无危害、废弃物由废品回收处理！	
储存： 分类摆放，严禁与氧化剂接触	
八、暴露预防措施	
工程控制：N/A	
控制参数： • 八小时日时量平均容许浓度/短时间时量平均容许浓度/最高容许浓度： • 生物指标：	
个人防护设备：N/A • 呼吸防护：N/A • 手部防护：N/A • 眼睛防护：N/A • 皮肤及身体防护：N/A	
卫生措施：	
九、物理及化学性质	
物质状态：固态	形状：圆棒
颜色：黄色	气味：无味
PH 值：N/A	沸点/沸点范围：
分解温度：N/A	闪火点：°F °C 测试方法：开杯 关杯
自然温度：N/A	爆炸界限：N/A
蒸汽压：N/A	蒸汽密度：N/A
密度：N/A	溶解度：N/A
十、安定性及反应性	
安定性：	



# 信兴铜铝实业有限公司

## MSDS 安全资料表

特殊状况下可能之危害反应： N/A
应避免之状况： N/A
应避免之物质： N/A
危害分解物： N/A

### 十一、毒性资料

急毒性： 一次性大量吸入导致肾衰竭，肝损伤、死亡
局部效应： 胸闷、咳嗽
致敏感性： N/A
慢毒性或长期毒性： 呕心、胸闷、咳嗽
特殊效应： 呼吸系统受损、心血管系统受损及至癌

### 十二、生态资料

可能之环境影响/环境流传： 对环境有一定的影响
----------------------------

### 十三、废弃处置方法

废弃处置方法： 一般废弃由回收公司回收处理
--------------------------

### 十四、运送资料

国际运送规定： N/A
联合国编号： N/A
国内运送规定： N/A
特殊运送方法及注意事项： N/A

### 十五、法规资料

适用法规： 中国
----------

### 十六、其他资料

参考文献 N/A	
制表单位	名称： 信兴铜铝实业有限公司
	地址/电话： 佛山市南海区
制表人	职称： 品管课 姓名（印章）： 任长林
制表日期	2015-03-2



# 深圳市盛世开元塑胶五金有限公司

Shenzhen S-Sky plastic hardware co., LTD

物质安全资料表 (MSDS)

## 一、物品与供应商资料

物品名称：接地锌合金管
制造商或供应商名称、地址： 深圳市盛世开元塑胶五金有限公司 深圳市宝安区松岗街道沙浦围社区创业工业园22栋浦京半导体产业园二期5楼B2
紧急联络电话：0755-36887576 传真：0755-36887577

## 二：成分名细

纯物质：

名称：锌合金				
同义名称：无				
化学物质登记号码 (CAS NO.): 见下表				
危害物质成分 (%)：无				
序号	物质名称	CAS NO.		比例 (%)
1	锌合金	Al	300-92-5	3.9001
2		Mg	53687-75-4	0.031
3		Cu	7440-50-8	0.0522
4		Pb	7439-92-1	0.002
5		Cd	7440-43-9	0.0015
6		Fe	12597-68-1	0.0015
7		Sn	7440-31-5	0.0013
8		Li	7439-93-2	0.0059
9		Mn	7439-96-5	0.0012
10		Zn	7440-66-6	96.0033 (余量)

## 三、危险性资料

危险性：无	环境影响：无
特殊危害：无	危害主要状况：无

## 四、紧急应急措施

不同暴露之急救方法：
吸入：不易吸入
皮肤接触：脱去污染衣物，用肥皂水和清水清洗
眼睛接触：用清水冲洗

## 五、火灾时的处理

选用灭火器：水、二氧化碳、干粉
灭火时可能遭遇之特殊灾害：无
消防人员需配备的防护设备：口罩、手套、防护服

## 六、用于保管的注意

作用：无特殊注意事项
保管：保持现场干净，做好“5S”管理

### 七、物理与化学性质

状态：固体	挥发性：不会挥发
熔点：450~600℃	沸点：无
溶解度：难溶解	爆炸性：安全
着火点：无	可燃性：难燃
氧化性：无	

### 八、有毒性资料

皮肤腐蚀性：无	急性毒性：无
刺激性：无	亚急性毒性：无
感染性：无	慢性毒性：无
致癌性：无	催畸形性：无
致变化性：无	生殖毒性：无

### 九、环境影响

分解性：正常温度下不易分解
积储性：易存放

### 十、废弃注意事项

废弃物处理方法：可回收、可利用
-----------------

### 十一、其它资料

制表单位	名称：深圳市盛世开元塑胶五金有限公司		
	地址：深圳市宝安区松岗街道沙浦围社区创业工业园22栋浦京半导体产业园二期5楼B2		
制表人	李万定	职称	品保部经理
制表时间	2014年7月20日		



# 物质安全资料表 Material Safe Data Sheet

深圳市联丰五金塑胶制品有限公司

SHEN ZHEN CITY LIAN FENG METAL  
PLASTIC CO ; LTD. 1129WORKSHOPS

工厂：深圳市 龙岗区 坪地镇  
六联老围海天工业区

Factory: LiuLian LaoWel Village Industrial Area ,  
Ping Di Town , Long Gang District , ShenZhen

电话：(0755) 84071902

Tel: (0755) 84071902

传真：(0755) 84071901

Fax: (0755) 84071901

电邮：lianfeng@lianfeng1129.com

E-mail: lianfeng@lianfeng1129.com

产品类型：镀金

## 镀液成份：

主要成份	状态	成份含量	CAS 号
金盐	粉末	1g /L	13967-50-5
光泽剂	液体	100ml /L	10124-43-3/11113-75-0
导电盐	固体	50g /L	/
纯水	液体	890ml /L	/

## 危害物质

危害物质成份	要求范围	实测数值
Pb	≤100PPM	N.D
Cd	≤ 5PPM	N.D
Hg	≤ 5PPM	N.D
Cr <sup>+6</sup>	≤ 5PPM	N.D

## 预防措施

可燃性 : N. A  
爆炸可能性: N. A  
环境影响 : 加强空气净化及排风

## 安定性与反应性

安定性 : 根据定时化验, 补充各种原料  
应避免状况: N. A  
危害分解物: 沉降剂定期处理

健康危害入及急求措施

眼睛接触：用清水清洗数分钟后，严重到医院就治  
皮肤接触：用清水清洗数分钟后，严重到医院就治  
食入：速到医院救治

灭火处理

适用灭火剂：N. A  
灭火防护：N. A

暴露预防措施

个人防护设施：N. A  
工程控制：N. A

泄露处理

个人注意事项：N. A  
环境注意事项：加强通风  
清理方式：污水环保程序处理

物理及化学性质

物质状态：液体	形状：N. A
颜色：浅褐色	气味：N. A
PH值：3.8-4.6	沸点：N. A
分解温度：N. A	闪火点（测试方法）：N. A
自燃温度：N. A	爆炸界限：N. A
蒸气度：N. A	蒸气密度：N. A
密度：13-18	溶解度：完全溶解

毒性资料

局部效应：N. A  
致敏感性：调换岗位  
慢毒性或长期毒性：个人操作严格按作业指导书，带各种防毒口罩、产品无毒性

安全处理与储存

安全处理：特定电镀环境  
储存：特定电镀环境双人管理

生态资料

可能之环境影响：N. A

废弃处置方法

废弃处处置方法：依当地环保法规处理

运输注意事项

运送方式及注意事项：定量包装，专车运送。

---

其它资料

制表：李成洁

部门：品保部

电话：0755-84071902

日期：2013.12.20

---

# 物质安全资料表 Material Safe Data Sheet

深圳市联丰五金塑胶制品有限公司

SHEN ZHEN CITY LIAN FENG METAL  
PLASTIC CO ; LTD. 1129WORKSHOPS

工厂：深圳市 龙岗区 坪地镇  
六联老围海天工业区

Factory: LiuLian LaoWel Village Industrial Area ,  
Ping Di Town , Long Gang District , ShenZhen

电话：(0755) 84071902

Tel: (0755) 84071902

传真：(0755) 84071901

Fax: (0755) 84071901

电邮：lianfeng@lianfeng1129.com

E-mail: lianfeng@lianfeng1129.com

产品类型：镀镍

镀液成份：

主要成份	状态	成份含量	CAS NO
镍板	固体	50±10g/L	/
硫酸镍	粉末	250±20g/L	7786-81-4
氯化镍	粉末	50±5g/L	7211-05-5
硼酸	粉末	45±10g/L	10043-35-3
纯水	液体	960ml/L	/

危害物质

危害物质成份	要求范围	实测数值
Pb	≤100PPM	N.D
Cd	N.D	N.D
Hg	N.D	N.D
Cr <sup>+6</sup>	N.D	N.D

预防措施

可燃性 : N. A  
爆炸可能性: N. A  
环境影响 : 加强空气净化及排风

安定性与反应性

安定性 : 根据定时化验, 补充各种原料  
应避免状况: N. A  
危害分解物: 沉降剂定期处理

健康危害及急救措施

眼睛接触：用清水清洗数分钟后，严重到医院就治  
皮肤接触：用清水清洗数分钟后，严重到医院就治  
食入：速到医院救治

灭火处理

适用灭火剂：N. A  
灭火防护：N. A

暴露预防措施

个人防护设施：N. A  
工程控制：N. A

泄露处理

个人注意事项：N. A  
环境注意事项：加强通风  
清理方式：污水环保程序处理

物理及化学性质

物质状态：液体	形状：N. A
颜色：深绿色	气味：N. A
PH值：4.2-4.6	沸点：N. A
分解温度：N. A	闪火点（测试方法）：N. A
自燃温度：N. A	爆炸界限：N. A
蒸气度：N. A	蒸气密度：N. A
密度：15-20	溶解度：完全溶解

毒性资料

局部效应：N. A  
致敏感性：调换岗位  
慢毒性或长期毒性：个人操作严格按作业指导书，带各种防毒口罩、产品无毒性

安全处理与储存

安全处理：特定电镀环境  
储存：正常储存

生态资料

可能之环境影响：N. A

废弃处置方法

废弃处处置方法：依当地环保法规处理



运输注意事项

运送方式及注意事项：定量包装，专车运送。

其它资料

制表：李成洁  
电话：0755-84071902

部门：品保部  
日期：2013.12.20

## PTFE棒材质证明（物性表）

序号	材质项目	物理特性	备注
1	名称	聚四氟乙烯	PTFE
2	密度	2.1~2.3G/cm <sup>3</sup>	
3	吸水率	≤0.00001%	
4	拉伸强度	≥15Mpa	
5	断裂伸长率	≥150%	
6	硬度	50~60	
7	弯曲强度	20.4~21Mpa	
8	压缩强度	11.2~13.8	
9	绝缘强度	18.5~21KV/mm	
10	使用温度	-196℃~+260℃	
11	介电常数	1.85~2.3	
12	介质损耗	∠0.0002	
13	表面电阻	> 10E16欧姆	
14	体积电阻	> 10E16欧姆	
15	收缩率（-70℃）	0.75%	
16	熔点	327±10	
17	导热率	0.02KCAL/M.H.C	

检测日期: 2015.3.11

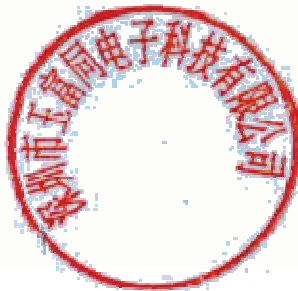

# 物质安全技术说明书(MSDS)

## 1. 产品及企业标识

- 产品名：聚四氟乙烯
- 产品英文名：PTFE
- 生产企业名称：求真电子制品厂
- 地址：东莞大岭山金桔担岭水 76 号
- 电话：0755-29622225 传真：0755-27246896
- 邮编：523528
- 生效日期：2013 年 4 月 21 日

## 2. 成分/组成信息

主要成份	含量%	CAS 编号
聚四氟乙烯 (PTFE)	100	9002-84-0

## 3. 危险性概述

- 危害性类别：不在《常用危险化学品的分类及标志》（GB 13690-92）中
- 侵害途径：吸入，眼睛接触，皮肤接触。
- 健康危害：正常处理时不会产生危害。当加工时，材料在超过分解温度时可能产生有毒气体。吸入，灰尘会引起呼吸道刺激。暴露在 PTFE 分解产物中，可能导致聚合体烟雾发烧症状。有流感症状（高烧、冷颤、肌肉痛）；眼睛接触，灰尘会导致机械性刺激；皮肤接触，灰尘会导致机械性刺激；

## 4. 急救措施

- 皮肤接触：无需就医。
- 眼睛接触：用大量水冲洗，不要揉搓眼睛，如症状持续，需立刻就医。
- 吸入：移到新鲜空气中，保持呼吸通畅，如症状持续，需立刻就医。
- 食入：无需就医。

## 5. 消防措施

- 有害燃烧产物：一氧化碳，二氧化碳，氟化氢。

- 灭火方法及灭火剂：使用水雾，泡沫，干粉和 CO<sub>2</sub>。
- 灭火注意事项：消防员应携带自给式空气呼吸器 (SCBA) 和全身防护服。

## 6. 泄露应急处理

- 隔离泄露污染区,限制出入。
- 个人防护措施,如有毒气体产生,穿戴合适的个人防护用品。不要吸入粉尘。清除火源。防止接触皮肤和眼睛;环境预防措施,防止进入下水道,地表水或者土壤;清除方法,清扫或者铲入合适的容器,等待废弃处理。防止产生气载灰尘。

## 7. 操作处置与储存

- 操作注意事项：密闭操作，提供良好的自然通风条件。  
操作人员必须经过专门培训，严格遵守操作流程。建议操作人员佩戴自吸过滤式防尘口罩。  
远离火种，热源，工作场所严禁吸烟。  
使用防爆型的通风系统和设备。避免产生粉尘。避免与氧化剂接触。  
搬运时要轻装轻卸，防止包装及容器损坏。  
配备相应品种和数量的消防器材及泄露应急处理设备。倒空的容器可能残留有害物。
- 储存注意事项：储存于阴凉，通风的库房。  
远离火种，热源。应与氧化剂分开存放，切忌混储。  
配备相应品种和数量的消防器材。  
储区应备有合适的材料收容泄露物。

## 8. 接触控制/个体防护

- 中国MAC (mg/m<sup>3</sup>) :未制定标准
- 眼睛防护：必要时，佩戴化学安全防护眼镜。
- 其他：如有潜在暴露的地方，提供安全淋浴或者洗眼器。当材料被加工或者产生过多粉尘，不要抽烟或者保留烟雾物质在生产区域。吃饭或者抽烟前彻底清洗手。

## 9. 物理、化学、机械与电力特性

- 外观形态：通常为固态白色，半透明体,有板、棒、管、膜及异性部件等形态。
- 熔点：327 °C

- 标准相对密度：2.1~2.3g/cm<sup>3</sup>
- 吸水率：≤0.00
- 拉伸强度：15-30 Mpa
- 断裂伸长率：200-350 %
- 介电常数：2.5-10Kv/mm

## 10. 稳定性和反应活性

- 禁配物：强氧化剂

## 11. 毒理学资料

- 无资料提供

## 12. 生态学资料

- 无资料提供

## 13. 废弃处置

- 废弃处理方法：请回收废料。在允许接受化学品废物设备中进行处理。如燃烧处理有可能产生氟化氢。

## 14. 运输信息

- 运输注意事项：起运时包装要完整，装载应稳妥。运输过程中要确保容器不泄露，不倒塌，不坠落，不损坏。严禁与氧化剂等混装混运。运输途中应防暴晒，雨淋，防高温。

## 15. 法规信息

- 国内化学品安全法规：《危险化学品安全管理条例》（2002年3月15日国务院发布），针对危险化学品的安全生产、使用、储存、运输、装卸等方面均作出了相应规定。
- 国际法规：欧盟指示 2002/95/EC (RoHS) 符合

## 16. 其他信息

- 参考文献： 无资料
- 提示： 本表所含的信息来源于我们认为准确的数据，但是未提供有关数据准确性或相关使用结果的明确或暗示性的保证。

# FORMOSA PLASTICS CORPORATION

## Material Safety Data Sheet

Japan 13,2009 Page1/2

### 1. COMPANY IDENTIFICATION

Product Name	Polyacetal POM FM090
Company	Formosa Plastics Corporation.
Address	NO.3 Ocean Indust Ocean Village Hsin Kang Township, In Jiayi County, Taiwan.
Telephone	05-377-2111
Fax	05-377-0312

### 2. COMPOSITION/INFORMATION ON INGREDIENTS

Substance or Preparation	Substance
Chemical Name	Polyacetal
Content	>98%(Additives<2%)
CAS No.	9005-73-8
Impurities Contributing to Hazard	None

### 3. HAZARD IDENTIFICATION

Most Important Hazards	None
Adverse Human Health Effects	None
Environmental Effects	None
Physical and Chemical Hazards	None

### 4. FIRST AID MEASURES

Inhalation	In case of gases evolving from melted resin, move subject to fresh air Trea symptomatically.
Skin Contact	In case of pellets or powder, wash with water. In case of melt, wash affected skin area and clothing with plenty of (soap and) water Seek medical advice.
Eye Contact	In case of pellets or powder, flush with plents of water for at least 15 minutes. Seek medical advice if any dust particles still remain. In case of gases evolving from melted resin of high temperature, flush with plenty of water for at least 15 minutes. Seek medical advice if necessary.
Ingestion	Induce vomiting. Rinse mouth with water. Seek medical advice if necessary.

### 5. FIRE-FIGHTING MEASURES

Extinguishing Media	Water, Foam, Dry chemical powder
Special Fire-Fighting Procedure	Self contained breathing apparatus
Fire and Explosion Hazards	None

### 6. ACCIDENTAL RELEASE MEASURES

Methods for Cleaning up	Recovery if not contaminated or Disposal
Personal Precautions	Pellets or powder remained on ground may cause slipping
Environmental Precautions	Gather pellets and powder thoroughly to avoid birds or fishes taking from draining water.

### 7. HANDLING AND STORAGE

HandLing	Prevent from fire around handling area. Maintain good house keeping standards to prevent accumulation of dust. To avoid dust explosion resulting from the existence of powder, electrostatics eliminators and grounding should be fixed to such equipment as air transferring pipes, bag filters and hoppers. Use electrically conductive filters for bag filters.
Storage	Keep the materials at a cool dry place. Protect from direct sunlight, rain and violent temp erature fluctuation. Fire is inhibited around storage area.

# FORMOSA PLASTICS CORPORATION

Page 2/2

## 8. EXPOSURE CONTROLS/PERSONAL PROTECTION

Threshold Limit Value		Not determined
Ventilation		Necessary to exclude dust, fumes and gases.
Personal Protection	Eye	Wear safety glasses for general purpose. Wear chemical goggles for cleaning molding machines.
	Respiratory	Wear masks for cleaning molding machines.
	Gloves	Necessary for handling melted resin.

## 9. PHYSICAL AND CHEMICAL PROPERTIES

Appearance	White pellets
Melting Temperature	Softening above 180 °C
Solubility	Insoluble in water
Specific Gravity	1.41

## 10. STABILITY AND REACTIVITY

Flammability	Yes
Flash Point	440 °C
Auto-ignition Temperature	460 °C
Reactivity with Water	No
Stability	Stable and non-reactive under normal handling and storage condition
Dust Explosion	Lower explosion limit 17.5g/m <sup>3</sup> Minimum ignition energy 350mJ Maximum explosion pressure 5.6x10 <sup>5</sup> Pa Maximum pressure increase rate 3.4x10 <sup>7</sup> Pa/S
Thermal Decomposition Gases	CO, HCN, AN, SM and NO
Combustion Energy	4.5x10 <sup>7</sup> J/kg(9960Kcal/kg)

## 11. TOXICOLOGICAL INFORMATION

Irritation	Fumes or vapors generated from decomposing resin may be irritant to eyes.
Acute oral toxicity(LD50)	Not determined
Mutagenicity	Not determined

## 12. ECOLOGICAL INFORMATION

To avoid being taken by ocean species or birds, disposal of the waste to the ocean and water sources is inhibited.

## 13. DISPOSAL CONSIDERATION

Controlled incineration or landfill according to local, state or national laws and regulations concerning health and pollution.

Inadequate incineration may generate toxic gases such as CO, HCN, AN and SM.

## 14. TRANSPORT INFORMATION

Not classified.

## 15. REGULATORY INFORMATION

Not available.

## 16. OTHER INFORMATION

None.

騰飛提供



# MATERIAL DATA SHEET

Part name: Silicone rubber

Product series: ZY-850 (805.810.820、830、840、860、870、880.890)

Composition/information on Ingredient:

1. Methyl vinyl polysiloxane CAS NO: 68037-87-6

Molecular formula:  $\text{RMe}_2\text{SiO}-(\text{Me}_2\text{SiO})_n-(\text{MeViSiO})_m-\text{SiMe}_2\text{R}$

R:Me. ET. Vi.

WT:65~68%

2. Silicone dioxide CAS NO: 112945-52-5

Molecular formula:  $\text{SiO}_2$

WT:23%~28%

3. Silicone oil CAS NO: 63148-62-9

Molecular formula:  $\text{HO}(\text{R}_2\text{SiO})_n\text{H}$

R : Me. ET. PH.

WT:4%~12%



DONG GUAN NEW ORIENTAL TECHNOLOGY CO.,LTD

QC Department

2014-2-25



## 化学品安全技术说明

样品名称: ZY-850(810/820/830/840/860/870/880/890)

客户名称: 东莞新东方科技有限公司

地 址: 广东省东莞市黄江镇田心村龙和工业区北门巷

审核人

Jackie





# 化学品安全技术说明(GHS版SDS)

根据 欧盟第1907/2008 (EU) 号指令第31章编制

报告编号.: SZC12050981781-3C

日期: 2012年5月17日

1 of 9

## 1 物质及企业信息

产品识别

产品名称 : ZY-850(810/820/830/840/860/870/880/890)

文件编号 : SZC12050981781-3C

制造商/供应商信息

制造商/供应商: 东莞新东方科技有限公司

地址: 广东省东莞市黄江镇田心村龙和工业区北门巷

电话: (0086)-769-83639068

紧急联络电话: N/A

传真: (0086)-769-83639098

电子邮件 : N/A

主要用途 : 适用于生产普通硅橡胶制品和杂件, 普通硅橡胶按键基胶体, 尤其适用于加颜色制品, 适用于模压工艺

可获取更多资料的部门: 东莞新东方科技有限公司

## 2 危险识别

分类: 眼睛过敏类别 2B ; 皮肤腐蚀/过敏类别 2

外观/气味: 半透明

火灾/爆炸危害: 高温易燃

美国国家消防协会(NFPA)分类(范围 0-4): 健康危害=2 火灾危害=1 反应活性=1

0=极小危害, 1=微小危害, 2=中毒危害, 3=严重危害, 4=极度危害

标记要素

危害标识



警示词: 危险

危害警告信息

H313 可能引起轻微的皮肤过敏

H320 可能引起眼睛过敏

危害防范措施

预防:

P264 处置后彻底冲洗

事故响应:

HONGCAI TESTING TECHNOLOGY CO.,LTD

Web: www.hct-test.com Tel: 0755-84616666

Unit D, Penglitai Industrial Estate, Longping Xi Road, Longping District, Shenzhen

E-mail: hongcai@hct-test.com Service Tel: 400-0066-989 Fax: 0755-89598300



No: 0445193



# 化学品安全技术说明(GHS版SDS)

根据 欧盟第1907/2008 (EU) 号指令第31章编制

报告编号.: SZC12050981781-3C

日期: 2012年5月17日

2 of 9

P305+P351+P338 如果进入到眼睛,用水仔细地冲洗好几分钟,翻动眼睑,如有继续冲洗

P332+P313 如果皮肤过敏,请就医

P337+P313 如果持续眼睛过敏,请就医

## 3 组成/成分信息

化学特性: 混合物

描述

混合物: 由以下成分组成

组分名称	CAS RN	EC No	含量 (%)
生胶(甲基乙烯基聚氧硅烷)	68037-87-6	—	65~68
白炭黑(二氧化硅)	112945-52-5	—	23~28
助剂:(羟基硅油)	63148-62-9	—	4~12

## 4 急救措施

应急措施要领

吸入后

- 如果吸入烟尘,请远离受污染区域
- 其他措施通常是不必要的

皮肤接触后

- 立即脱去受污染的衣服和鞋
- 流动清水冲洗皮肤(如果有肥皂的话)
- 持续刺激请就医

眼睛接触后

- 立刻用新鲜的水冲洗
- 确保上下眼皮彼此分开
- 如疼痛持续,不得延迟就医
- 由专业人员对受伤眼睛进行护理

吞咽后

- 立刻喝一杯水
- 急救是必须的,如果有疑问,请联系医生

给医生的建议

根据症状处理

## 5 消防措施

灭火介质

适当的灭火剂

■泡沫

HONGCAI TESTING TECHNOLOGY CO.,LTD

Web:www.hct-test.com

Tel: 0755-84616666

Unit D,Penglitai Industrial Estate, Longping Xi Road,Longping District,Shenzhen

E-mail: hongcai@hct-test.com Service Tel: 400-0066-989 Fax: 0755-89591280



No: 0445194



# 化学品安全技术说明(GHS版SDS)

根据 欧盟第1907/2008 (EU) 号指令第31章编制

报告编号.: SZC12050981781-3C

日期: 2012年5月17日

3 of 9

- 干粉灭火器
- BCF(如果当地政府允许)
- 二氧化碳
- 水雾

不适当的灭火剂

无

产生于此化学物质或混合物的特别有害性

- 燃烧时,可能释放出有毒气体一氧化碳(CO)
- 燃烧产物包括:二氧化碳(CO<sub>2</sub>),二氧化硅(SiO<sub>2</sub>),其他典型的有机燃烧产物
- 可释放出刺鼻烟雾
- 可释放出腐蚀性烟雾

不相容材料

避免和氧化物等混合可能引起着火

对消防员的建议事项

- 穿佩戴呼吸器的全身防护服
- 用水将作为一个良好的喷雾冷却控制火势
- 不要靠近容器

额外信息

无

## 6 意外释放措施

个人的预防措施,保护装置及应急措施步骤

无资料

环境相关预防措施

- 切勿让产品接触到污水系统或任何水源
- 如果渗入了水源和污水系统,请通知有关当局

清洁和收集方法材料

少量泄漏

- 移除所有着火点
- 立即清扫泄漏源
- 避免呼吸蒸汽和接触皮肤和眼睛

大量泄漏

- 清洗受污染区域和通风
- 使用接触防护设备和防尘口罩
- 防止泄漏物进入下水道
- 如有可能覆盖泄漏物
- 用干燥的处理工具进行处理且避免产生灰尘

HONGCAI TESTING TECHNOLOGY CO.,LTD

Web:www.hct-test.com Tel: 0755-84616666

Unit D,Penglitai Industrial Estate, Longping Xi Road,Lonhgang District,Shenzhen

E-mail: hongcai@hct-test.com Service Tel: 400-0066-989 Fax: 0755-89594380



No: 0445195



# 化学品安全技术说明(GHS版SDS)

根据 欧盟第1907/2008 (EU) 号指令第31章编制

报告编号.: SZC12050981781-3C

日期: 2012年5月17日

4 of 9

## 参照其他部分

有关安全处理的资料请参阅第7节

有关个人防护装备的资料请参阅第8节

有关废弃处置的资料请参阅第13节

## 7 处置和储藏

### 处置

#### 安全管理的预防措施

- 避免所有人员接触, 包括吸入
- 穿着防护服避免暴露
- 防止流入下水道
- 避免接触不合适的材料
- 处理后一直用肥皂水冲洗地面
- 不要切割、焊接容器

#### 有关火灾及防止爆炸的资料

避免与氧化物反应

#### 混合危险性等安全储存条件

### 储存

- 储存于最初使用的容器
- 保持容器良好地密封
- 储存于阴凉、干燥有良好通风的区域
- 远离不合适材料和食品容器

#### 有关使用一个普通的储存设施来储存的资料

切勿与强氧化剂存放在一起

#### 和化学物质一起储存的分类



+



X



+



X



X



+

+ : 可以一起储存

x : 禁止一起储存

## 8 接触控制和个人保护

### 有关技术设施的设计的额外资料

没有进一步数据, 见第7项

### 控制变数

暴露控制: N/A

HONGCAI TESTING TECHNOLOGY CO.,LTD

Web: www.hct-test.com Tel: 0755-84616666

Unit D, Penglitai Industrial Estate, Longping Xi Road, Longgang District, Shenzhen

E-mail: hongcai@hct-test.com Service Tel: 400-0066-989 Fax: 0755-89594380



No: 0445196



# 化学品安全技术说明(GHS版SDS)

根据 欧盟第1907/2008 (EU) 号指令第31章编制

报告编号.: SZC12050981781-3C

日期: 2012年5月17日

5 of 9

紧急暴露控制:N/A

在工作场需要监控的限值成分: 见暴露控制

个人防护装备

双手保护



保护手套

手套材料

手套材料取决于材料、质量特征和生产厂家, 手套材料的抵抗力不可预计, 请使用前进行检查。

渗入手套材料的时间

请联系生产厂家获取准确的破裂时间

眼睛保护



安全眼镜

呼吸系统防护



呼吸器

身体保护



全身工作服

## 9物理和化学性质

有关基本物理及化学特征的信息

一般说明

HONGCAI TESTING TECHNOLOGY CO.,LTD

Web: www.hct-test.com

Tel: 0755-84616666

Unit D, Penglitai Industrial Estate, Longping Xi Road, Longgang District, Shenzhen

E-mail: hongcai@hct-test.com Service Tel: 400-0066-988 Fax: 0755-846194380



No: 0445197



# 化学品安全技术说明(GHS版SDS)

根据 欧盟第1907/2008 (EU) 号指令第31章编制

报告编号.: SZC12050981781-3C

日期: 2012年5月17日

6 of 9

外观 : 半透明  
形状 : 无资料  
颜色 : 无资料  
气味 : 无资料  
条件的更改  
熔点/熔化范围 : 不适用  
沸点/沸腾范围 : 不适用  
闪点 : 不适用  
分解温度 : 不适用  
可燃性(固体、气体) : 可燃的  
自动点燃 : 该产品不是自燃的  
爆炸上限(%) : 不适用  
爆炸下限(%) : 不适用  
比重(水=1) : 1.14  
在...里的溶解度/和...的溶混性水: 不能溶解或难以溶解  
粘度(ku) : N/A  
物理性质: 无资料

## 10 稳定性和反应性

反应性: 稳定

化学稳定性

热分解/要避免的情况

如果没有分解按规定使用和贮存

有害反应可能性: 避免与氧化剂接触

禁止混合物质

氧化剂

有害分解物质

在燃烧时可能产生的有毒气体

燃烧时可产生一氧化碳、二氧化碳和其他有害热分解产物

## 11 毒理学信息

对毒性学影响的信息

急性毒性

与分类相关的LD/LC50值

LD50: 不确定的, 请参考其单一成分

LC50: 不确定的, 请参考其单一成分

主要的刺激性影响

HONGCAI TESTING TECHNOLOGY CO.,LTD

Web: www.hct-test.com Tel: 0755-84616666

Unit D, Penglitai Industrial Estate, Longping Xi Road, Longgang District, Shenzhen

E-mail: hongcai@hct-test.com Service Tel: 400-0066-989 Fax: 0755-89594380



No: 0445198





# 化学品安全技术说明(GHS版SDS)

根据 欧盟第1907/2008 (EU) 号指令第31章编制

报告编号.: SZC12050981781-3C

日期: 2012年5月17日

7 of 9

## 皮肤腐蚀/刺激

皮肤接触材料可能是有害的

## 眼睛损伤/刺激

这个材料可能会导致眼睛发炎和可能产生深远的眼部病变

## 吞咽

■偶然的摄入可损害身体脏器

**致敏性:** 没有已知的致敏影响

## 更多毒性的资料

根据有关配制品的一般欧盟分类指南的计算方法 (刊印在最新版本), 该产品没有分类限制

## 12 生态信息

### 12.1 环境数据

不确定的

### 12.2 油和水中的迁移性: 高

### 12.3 持续性/生物降解能力

空气/低

### 12.4 生态毒性

**水生动物毒性:** 不确定的

**生物富集:** 不确定的

**大气环境:** 不确定的

### 额外的生态学资料:

不要排入饮用水系统。不要让产品排入污水排放系统。

**PBT (残留性、生物积累性、毒性物质) 及 vPvB (高残留性、高生物积累性物质) 评价结果**

**PBT:** 不适用的

**vPvB:** 不适用的

## 13 丢弃考虑

### 废弃物处理方法

#### 建议

必须遵照政府的规定来特别处理

### 未清理的包装

必须根据官方的规章来丢弃, 可以再使用不受污染的包装物料

## 14 运输信息

### 陆路运输 (跨境)

**ADR/RID 级别** : 无资料

HONGCAI TESTING TECHNOLOGY CO.,LTD

Web: www.hct-test.com Tel: 0755-84616666

Unit D, Penglilai Industrial Estate, Longping Xi Road, Longgang District, Shenzhen

E-mail: hongcai@hct-test.com Service Tel: 400-0066-989 Fax: 0755-89794380



No: 0445199



# 化学品安全技术说明(GHS版SDS)

根据 欧盟第1907/2008 (EU) 号指令第31章编制

报告编号.: SZC12050981781-3C

日期: 2012年5月17日

8 of 9

UN 号码 : 无资料  
内陆船运  
AND/R 级别 : 无资料  
海运 IMDG  
IMDG Class : 无资料  
IMDG 级别 : 无资料  
空运 ICAO-TI 和 IATA-DGR  
ICAO/IATA 级别 : 无资料  
UN 号码 : 无资料  
包装分类 : 无资料  
包装标志 : 无资料  
包装方法 : 纸箱, 胶框等  
用户特别须知: 摆放整齐无挤压受力

## 15 规章

对相应纯物质或者混合物的安全、健康及环境法规/法律  
国际法律/法规条例

危险和安全信息的要求在标签上

根据EU指引的标签

该产品须遵循欧盟指令/危险物质法规的相关条例

产品的代码和危险标志

N/A

化学安全评估

EEC 分类

Risk 代码

R36/R37/R38

Safety 代码

S24

S25

S26

S37

S39

67/548/EEC指令附件II:有毒物表示

N

Xi

Xn

Risk 警句

对眼睛和皮肤有刺激作用

Safety 警句

避免接触皮肤

避免接触眼睛

不慎与眼睛接触,用大量的水冲洗, 及时联系医生或毒物信息中心

配戴合适的眼镜

穿戴合适的保护衣服和眼镜

环境有害物

刺激

有害





# 化学品安全技术说明(GHS版SDS)

根据 欧盟第1907/2008 (EU) 号指令第31章编制

报告编号.: SZC12050981781-3C

日期: 2012年5月17日

9 of 9

## 16 其他资料

以上资讯来源可靠,但每个提醒和建议不可能面面俱到。使用者应结合实际情况,参考各种资料,做出正确的选择,以保证正确的使用和处理,保证使用者的安全和健康,以及环境的保护。

第3节和第9节信息由东莞新东方科技有限公司提供。

### 缩写:

WHMIS: 加拿大工作场所有害物质信息系统

ACGIH: 美国政府工业卫生协会

OHSA: 美国职业卫生与安全管理局

ADR: 国际公路运输危险货物协议

RID: 国际铁路运输危险货物技术规则

IMDG: 国际海运危险货物规则

IATA: 国际航空交通协会

IATA-DGR: 国际航空交通协会制定的危险货物规则

ICAO: 国际民航组织

ICAO-TL: 国际民航组织制定的危险货物技术指令

LC50: 某动物服用(体重×LC50值(致死浓度值))的毒素会造成50%的死亡

LD50: 某动物服用(体重×LD50值(致死剂量值))的毒素会造成50%的死亡

\*\*\* 文件结束 \*\*\*

本文件 HCT 盖章才生效,本文件不可以随意修改、增加或删除。  
未经本公司书面授权,不得部分复制本报告,不可做宣传品使用,违者必究。  
经与委托方协商达成共识,本文件及其中相应数据不可用于司法途径。



## 说明书摘要

---

本实用新型公开了天线摇杆连接器，它涉及无线遥感器技术领域，壳套为两端透空的筒体，外导体穿设在螺牙体的内部，整个外导体为一体结构的中空设置，其一端内部设置有绝缘体，另一端为同轴线材穿引孔，螺牙体内侧上部设置有凹槽，外导体部插接在凹槽的内部，外导体的中下部设置有凸缘，凸缘的上部设置有一凹槽，凹槽上设有一硅胶圈，硅胶圈的上部设置有黄铜垫圈，螺牙体的上部设置有管口。

- 一, 外导体采用一体结构,
- 二, 绝缘体规避 T 型结构,
- 三, 外导体凸缘上部设有一凹槽.

这三点特征有效的降低了产品的成本, 避免了产品与中国公告第 CN 201256178Y 号专利冲突, 还使产品自带扭力更为稳定.

# 摘要附图

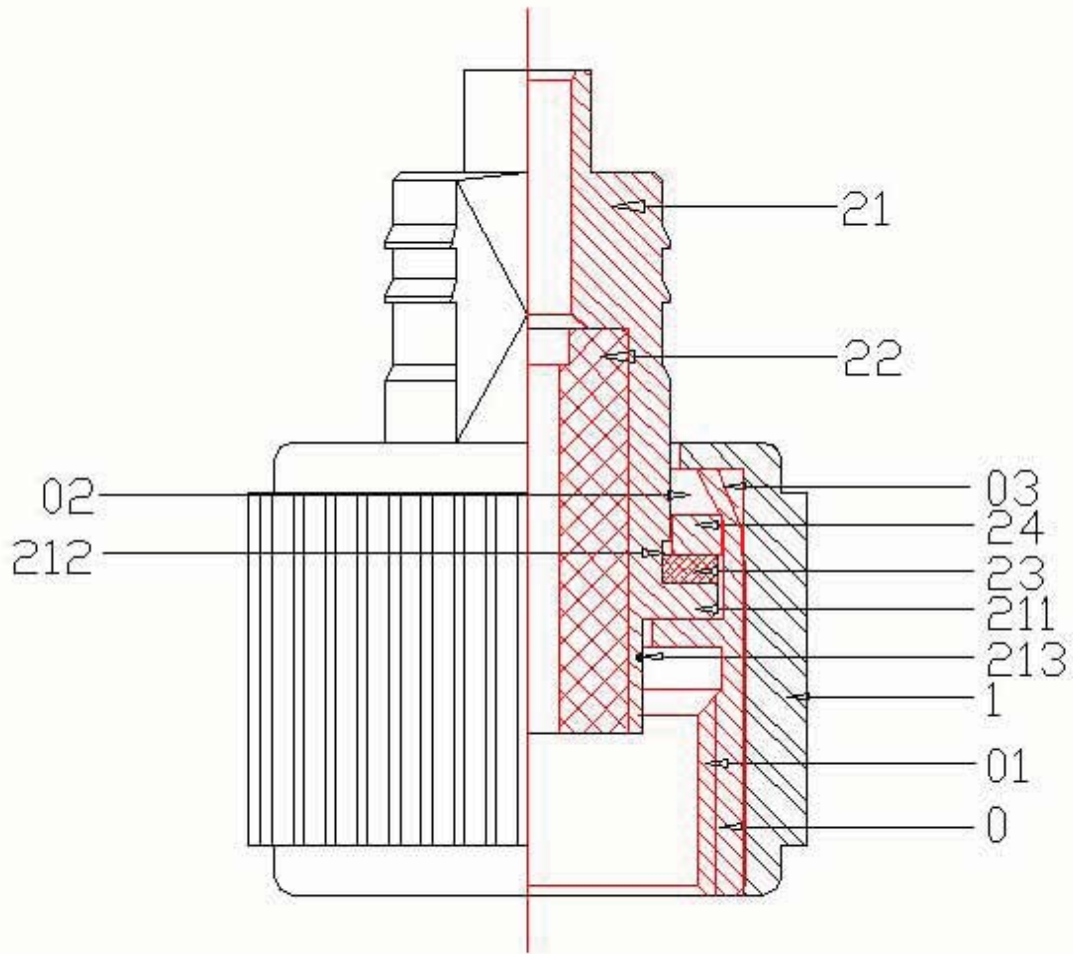

## 权 利 要 求 书

---

1、天线摇杆连接器，其特征在于：它包含螺牙体(0)、壳套(1)和主体(2)；螺牙体(0)为两端透空的筒体，螺牙体(0)内侧的一端设置有螺牙(01)，螺牙体(0)设置在壳套(1)的内部，壳套(1)为两端透空的筒体，主体(2)穿设在螺牙体(0)的内部，所述的主体(2)分为外导体(21)绝缘体(22)黄铜垫圈(23)硅胶圈(24)，外导体(21)内部为中空设置，且内部设置有绝缘体(22)，绝缘体(22)通过打点(213)而固定，螺牙体(0)内侧上部设置有凹槽(02)，外导体(21)插接在凹槽(02)的内部，外导体(21)的中下部设置有凸缘(211)，凸缘(211)的上部设置有一凹槽(212)，凹槽(212)上设置有一硅胶圈(23)，硅胶圈(23)的上部设置有黄铜垫圈(24)，螺牙体(0)的上部设置有管口(03)。

2、根据权利要求1所述的天线摇杆连接器，其特征在于：所述的螺牙体(0)为铜质螺牙体。

3、根据权利要求1所述的天线摇杆连接器，其特征在于：所述的壳套(1)为塑胶壳套。

# 说明书

## 天线摇杆连接器

### 技术领域：

本实用新型涉及天线摇杆连接器，属于无线遥感器技术领域。

### 背景技术：

如中国公告第 CN 201256178Y 号专利，提供了一种连接器，其主体部分被分割为第一段部分和第二段部分，其绝缘体要求为 T 型结构。

由该案可以发现，1. 其主体部分被分割为两段，导致产品增加了车床车制成本的产品组装成本。2. 新产品需要规避 T 型结构的绝缘体。

### 实用新型内容：

针对上述问题，本实用新型要解决的技术问题是提供天线摇杆连接器。

本实用新型的天线摇杆连接器，它包含螺牙体、壳套和主体；螺牙体为两端透空的筒体，螺牙体内侧的一端设置有螺牙，螺牙体设置在壳套的内部，壳套为两端透空的筒体，主体穿设在螺牙体的内部，所述的主体包含外导体，绝缘体，黄铜垫圈，硅胶圈，外导体的内部为中空设置，且外导体的内部设置有绝缘体，通过打点方式固定绝缘体，螺牙体内侧上部设置有凹槽，外导体插接在凹槽的内部，外导体的中下部设置有凸缘，凸缘的上部设置有一凹槽，凹槽上设置有硅胶圈，硅胶圈的上部设置有黄铜垫圈，螺牙体的上部设置有管口。

作为优选，所述的螺牙体为铜质螺牙体。

作为优选，所述的壳套为塑胶壳套。

作为优选，所述的外导体为铜质外导体或压铸锌合金外导体。

本实用新型的有益效果为：

1. 它采用外导体为一体的结构, 省去了不必要的多个产品配件的车制和 unnecessary 的产品组装, 有效降低了产品成品,

2. 绝缘体采用打点固定的结构, 规避了中国公告第 CN 201256178Y 号专利.

3. 在外导体凸缘上面增加凹槽, 有效的提高的连接品产品的扭力稳定性.

#### **附图说明:**

为了易于说明, 本实用新型由下述的具体实施及附图作以详细描述。

图 1 为背景技术中现有的天线摇杆连接器结构示意图,

图 2 为本实用新型的结构示意图,

图 3 为本实用新型的分解结构示意图,

图 4 为本实用新型的剖视图,

图 5 为本实用新型与转接座结合后与天线摇杆结合的立体示意图,

图 6 为本实用新型的效果示意图。

图中: 0-螺牙体; 01-螺牙; 02-凹槽; 03-管口; 1-壳套; 2-主体; 21-第一段部; 211-凸缘; 212-凹槽; 213-打固定点; 22-绝缘体; 23-硅胶; 24-黄铜垫片; 3-转接座; 31-枢接瓣; 4-天线摇杆。

#### **具体实施方式:**

为使本实用新型的目的、技术方案和优点更加清楚明了, 下面通过附图中示出的具体实施例来描述本实用新型。但是应该理解, 这些描述只是示例性的, 而并非要限制本实用新型的范围。此外, 在以下说明中, 省略了对公知结构和技术的描述, 以避免不必要地混淆本实用新型的概念。

如图 1-4 所示, 本具体实施方式采用以下技术方案: 它包含螺牙体 0、壳套 1 和主体 2; 螺牙体 0 为两端透空的筒体, 螺牙体 0 内侧的一端设置



有螺牙 01，螺牙体 0 设置在壳套 1 的内部，壳套 1 为两端透空的筒体，主体 2 穿设在螺牙体 0 的内部，所述的主体(2)分为外导体(21)绝缘体(22)黄铜垫圈(23)硅胶圈(24)，外导体(21)内部为中空设置，且内部设置有绝缘体(22)，绝缘体(22)通过打点(213)而固定，螺牙体(0)内侧上部设置有凹槽(02)，外导体(21)插接在凹槽(02)的内部，外导体(21)的中下部设置有凸缘(211)，凸缘(211)的上部设置有一凹槽(212)，凹槽(212)上设置有一硅胶圈(23)，硅胶圈(23)的上部设置有黄铜垫圈(24)，螺牙体(0)的上部设置有管口(03)

进一步的，所述的螺牙体 0 为铜质螺牙体。

进一步的，所述的壳套 1 为塑胶壳套。

进一步的，所述的外导体为铜质外导体或压铸锌合金外导体

本具体实施方式中螺牙体 0 朝向穿设主体 2 的方向，设有凹槽 02，且该凹槽 02 允许该外导体 21 插入，且该外导体 21 的中下段设有一凸缘 211，在该第一段部上的凸缘 211 上面设有一凹槽 212，凹槽 212 上设有硅胶圈 23，在该硅胶圈 23 上设有一黄铜垫圈 24，通过对螺牙体管口 03 缩口固定住黄铜垫圈 24，从而固定住硅胶圈 23 和外导体 21，利用该硅胶圈 23 材质略有弹性的特点，使螺牙体 0 和壳套 1 与主体 2 间形成一定的扭力，如图 5 为本实用新型与一个转接座 3 相互套合的示意图，该转接座 3 的一端部包括二片枢接瓣 31，配合一个连接件可以令其与天线摇杆 4 结合，如图 6 为使天线使用旋转的过程中主体 2 与转接座 3 不松动。

1. 它采用外导体为一体的结构，省去了不必要的多个产品配件的车制和不必要的产品组装工序，有效降低了产品成品，

2. 绝缘体采用打点固定的结构，规避了中国公告第 CN 201256178Y 号专利。

3. 在外导体凸缘上面增加凹槽，有效的提高的连接器产品的扭力稳

定性.

以上显示和描述了本实用新型的基本原理和主要特征和本实用新型的优点。本行业的技术人员应该了解，本实用新型不受上述实施例的限制，上述实施例和说明书中描述的只是说明本实用新型的原理，在不脱离本实用新型精神和范围的前提下，本实用新型还会有各种变化和改进，这些变化和改进都落入要求保护的本实用新型范围内。本实用新型要求保护范围由所附的权利要求书及其等效物界定。